



KEURIG®

OWNER'S MANUAL

Platinum B70 Keurig® Brewer

IMPORTANT SAFEGUARDS Safe Operation & Use



When using electrical appliances, basic safety precautions should be followed, including the following:

1. Read all instructions before using.
2. Do not touch hot surfaces. Use handles and knobs when available.
3. This appliance must be properly installed and located in accordance with these instructions before it is used.
4. The use of accessory attachments not recommended by the appliance manufacturer may result in fire, electrical shock or injury to persons.
5. Do not place on or near a hot gas or electric burner, or in a heated oven.
6. Do not use outdoors.
7. To protect against fire, electric shock and injury do not immerse cords, plugs, or the appliance in water or any other liquid.
8. Do not overfill the Water Reservoir with water.
9. Use **only water** in this appliance! Do not put any other liquids or foods in the Water Reservoir except as instructed in the Cleaning Instructions in this guide.
10. Turn off and unplug the Brewer before cleaning or maintenance. Allow to cool

before putting on or taking off parts and before cleaning the appliance.

11. For best operation, plug the appliance into its own electrical outlet on a dedicated circuit to prevent flickering of lights, blowing of fuses or tripping a circuit breaker.
12. Do not operate any appliance with a damaged cord or plug or after the appliance malfunctions or is damaged in any manner. Contact Keurig Customer Service to report any malfunction of or damage to the Brewer.
13. Do not let the cord hang over the edge of the table or counter, or touch hot surfaces.
14. To disconnect, press the Power Button on the Brewer to 'OFF' status and then remove the plug from the wall outlet.
15. Close supervision is necessary when any appliance is used by or near children.
16. **Do not lift the Handle to open the Lid of the Brewer while brewing is in progress.**
17. Always keep the Water Reservoir Lid on the Water Reservoir unless you are refilling it.
18. This appliance is equipped with a power cord having a grounding wire with a grounding plug. The appliance must be grounded using a 3-hole properly grounded outlet. In the event of an electrical short

circuit, grounding reduces the risk of electrical shock.

19. If the outlet is a standard 2-prong wall outlet, it is your personal responsibility and obligation to have it replaced with a properly grounded 3-prong wall outlet.
20. Do not, under any circumstances, cut or remove the third (ground) prong from the power cord or use an adapter.
21. Consult a qualified electrician if the grounding instructions are not completely understood, or if doubt exists as to whether the appliance is properly grounded.
22. Do not use the appliance for other than its intended use.

SAVE THESE INSTRUCTIONS.

WARNING TO USERS AND PARENTS

1. **DO NOT** permit children to use Brewer unless there is adult supervision. Brewer dispenses very hot water.
2. **SPECIAL NOTICE FOR HOT COCOA USERS: IMMEDIATELY AFTER USING A HOT COCOA K-CUP® PORTION PACK, RUN a Hot Water Brew Cycle** without a K-Cup® to avoid the possibility of clogging the exit needle. **DO NOT** assume the next user will do this.

CAUTION: There are two sharp needles that puncture the K-Cup® portion pack, one above the K-Cup® Holder and the other in the bottom of the K-Cup® Holder. To avoid risk of injury, do not put your fingers in the K-Cup® Assembly Housing.

CAUTION: There is extremely hot water in the K-Cup® Holder during the brew process. To avoid risk of injury, do not lift the Handle or open the K-Cup® Assembly Housing during the brewing process.

SHORT CORD INSTRUCTIONS: A short power supply cord is provided to reduce the risk of becoming entangled in or tripping over a longer cord.

If an extension cord is used, (1) the marked electrical rating of the cord set or extension cord should be at least as great as the electrical rating of the appliance; (2) the cord should be arranged so that it will not drape over the countertop or tabletop where it can be pulled on by children or tripped over unintentionally; and (3) the extension cord must include a 3-prong grounding plug.

THIS PRODUCT IS FOR **HOUSEHOLD USE ONLY**.

WARNING THIS PRODUCT CONTAINS CHEMICALS, INCLUDING LEAD, WHICH IS KNOWN TO THE STATE OF CALIFORNIA TO CAUSE CANCER, BIRTH DEFECTS OR OTHER REPRODUCTIVE HARM.

 WARNING RISK OF FIRE OR ELECTRIC SHOCK DO NOT OPEN	 WARNING: TO REDUCE THE RISK OF FIRE OR ELECTRIC SHOCK, DO NOT REMOVE THE BOTTOM COVER. NO USER SERVICEABLE PARTS ARE INSIDE. REPAIR SHOULD BE DONE BY AUTHORIZED SERVICE PERSONNEL ONLY.
--	--

TABLE OF CONTENTS

KEURIG® GOURMET SINGLE CUP HOME BREWING SYSTEM Platinum B70 — Using Your Brewer

SET-UP

Helpful Hints	4
Unpacking	4
Features	5

SECTION 1 — SET-UP & FIRST BREW

Set-Up & First Brew	6
---------------------------	---

SECTION 2 — CONTROLS & INDICATORS

Setting the Clock	10
Programming On/Off Features	10
Programming Brew Temperature	12
Programming Brew Size	13

SECTION 3 — CLEANING & MAINTENANCE

Cleaning	13
De-Scaling	14
Storage	15

SECTION 4 — TROUBLESHOOTING

SECTION 5 — WARRANTY

Record your Brewer Serial Number here.

See Unpacking Instructions on page 4 for serial number location.

Removing the serial number label from the Brewer will void warranty.

Set-Up

Helpful Hints

1. Plug Brewer into its own grounded outlet.

If the electric circuit is overloaded with other appliances, your Brewer may not function properly. The Brewer should be operated on its own circuit, separate from other appliances.

2. Keep your Brewer turned “ON”.

To brew a fresh cup of coffee, tea or hot cocoa anytime you want, keep your Brewer turned “ON” all the time. However, the Brewer is fully programmable so you can set it to turn on and off automatically to match your schedule. Or, if you prefer, set the Brewer to automatically turn off after a period of time. Follow the simple instructions on pages 10–13 to find the settings that are most convenient for you.

3. For the best tasting gourmet coffee, tea or hot cocoa, Keurig recommends using bottled or filtered water.

Water quality varies from place to place. If you notice an undesirable taste in your cup of coffee, such as chlorine or other mineral tastes, we recommend you consider using bottled water or water from a filtration system. For best results, carefully follow manufacturer’s instructions when using any water filtration system.

4. Customize the size, flavor & brew that’s perfect for you.

With the choice of over 200 varieties of K-Cup® portion packs and 5 brew sizes (Extra-Small Cup-3.25 oz., Small Cup-5.25 oz., Small Mug-7.25 oz., Large Mug-9.25 oz., and Travel Mug-11.25 oz.) your Keurig® Brewer gives you endless options to customize the size, flavor and brew that’s perfect for you. For a strong, intense cup, select an Extra Bold K-Cup® (with up to 30% more ground coffee than regular varieties) and brew the size that’s right for you. The smaller the brew size, the more intense flavor in your cup. The larger the brew size, the less intense flavor in your cup.

5. Remove K-Cup® portion pack after use.

Please see page 7 for brewing instructions.

6. Brewing into a travel mug.

To brew into a travel mug, simply remove the Drip Tray Assembly and place the travel mug on the Drip Tray Base.

7. De-scale Brewer regularly.

Please see pages 14 and 15 for instructions.

Unpacking Instructions

1. Place Brewer box on a large steady surface (such as a table or countertop) or on the floor. Open the box.

2. Remove enclosed literature.

3. Turn the box on its side with front of box face down.

4. Reach into the box and grasp the plastic bag that contains the Brewer.

5. Carefully pull the plastic bag (and packaging materials) toward you and out of the box. The Brewer will still be encased in the polyfoam and be on its side.

6. Remove the top polyfoam packaging material.

7. Carefully lift Brewer off of the bottom polyfoam and place it upright on a flat, steady surface.

8. Lift plastic bag off of Brewer.

9. Record the serial number for this Brewer on page 3 of this guide. The serial number can be found on the bottom of the Brewer box or on the Brewer behind the Drip Tray (when removed).

10. Place the Brewer upright on a flat, steady surface. Remove tape holding Water Reservoir in place.

We recommend you save all packing materials in case future shipping of the product is necessary.

WARNING:
Keep all plastic bags away
from children.

Features Platinum — Model B70 Brewer

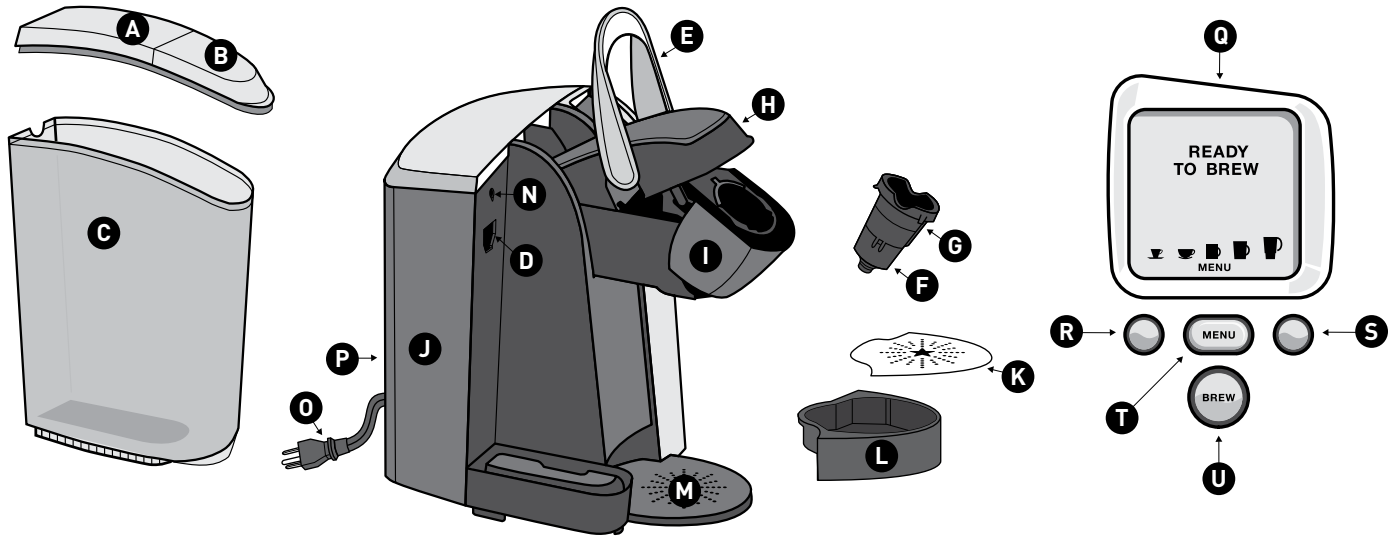

Platinum B70 Brewer

- A. Water Reservoir Lid
- B. Easy-Fill Lid
- C. Water Reservoir
- D. Water Reservoir Lock Tab Slot
- E. Handle
- F. Funnel
- G. K-Cup® Portion Pack Holder (F and G are the K-Cup® Holder Assembly)
- H. Lid
- I. K-Cup® Portion Pack Assembly Housing
- J. Housing
- K. Drip Tray Plate
- L. Drip Tray
- M. Drip Tray Base
- N. Vent
- O. Power Cord
- P. Power Switch (Not shown) Located Rear Right Side of Brewer

Controls and Indicators

- Q. LCD Control Center
- R. Left Button
- S. Right Button
- T. MENU Button
- U. BREW Button

SECTION 1 Set-Up & First Brew

IMPORTANT: You cannot use your Keurig® Brewer until it has been set up for its first use.

NOTE: If Brewer has been exposed to temperatures below freezing, allow Brewer at least two hours to reach room temperature before brewing. A frozen or extremely cold Brewer will not operate.

Setting Up Your Brewer



fig. 1

1. Unwrap cord and plug the Brewer into a grounded outlet. Remove all pieces of packing tape and clear plastic sticker from LCD display.
2. Place a large mug (10 oz. minimum) on the Drip Tray Plate.
3. Remove the Water Reservoir from Brewer by first removing Lid from the Water Reservoir (fig. 1), then lifting the Water Reservoir straight up and toward front of Brewer (may be tight), (fig. 2 A). Rinse with fresh water.
4. Fill Water Reservoir with bottled or filtered water so that the water level is just below the top edge of the Water Reservoir.
5. Place Water Reservoir base into the left side of the Brewer and be sure the Water Reservoir Lock Tab engages with the Brewer. Replace Lid on Water Reservoir. **NOTE: Please ensure the Water Reservoir is seated properly, so that the back of the Water Reservoir is flush with the Brewer (fig. 2 B and C).**

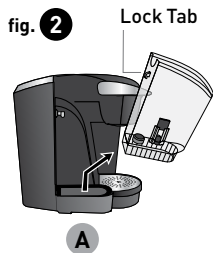
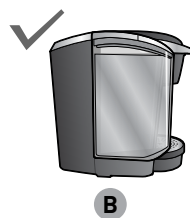
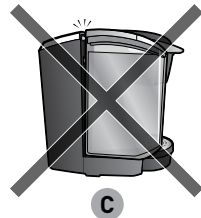

fig. 2



Seated Properly



Not Seated Properly



fig. 3

6. Press and release the Power Switch found directly behind the right side of the Brewer. Switch is spring loaded and will return to original position.
7. The Blue LCD Control Center will come on and indicate "NOT READY". **NOTE: A K-Cup® should not be used for this sequence.**
8. The Brewer will automatically fill the internal tank with water and then the water will be heated. This will take about 4 minutes. During the heating period, "NOT READY" is displayed on the LCD Control Center (fig. 3).
Do not lift Brewer Handle during this 'heating period'. Once the water is heated, "READY TO BREW" will be displayed and the BREW Button will be illuminated (fig. 4).

fig. 4



NOTE: You may see small amounts of water coming from the Vent and dripping into the Water Reservoir during this and subsequent heating — this is normal.

- Lift and lower the Handle. Press the flashing BREW Button to start a cleansing brew without a K-Cup®. Pour the hot water into the sink.

NOTE: A K-Cup® should not be used for this Sequence.

- The one-time set-up process is now complete and you are ready to brew!

NOTE: The Brewer may take 15-30 seconds between brews and then "READY TO BREW" will be displayed.

fig. 5

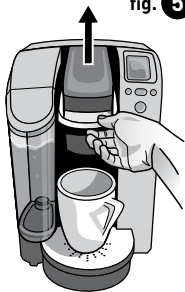

Ready to Brew Your First Cup

- LCD Control Center will indicate "READY TO BREW".
- Place a cup or mug on the Drip Tray Plate.
- Lift the Handle and the K-Cup® Holder will open toward you (fig. 5).

- Select a K-Cup® portion pack.

NOTE: Do not remove the foil lid or puncture the K-Cup®.



fig. 6

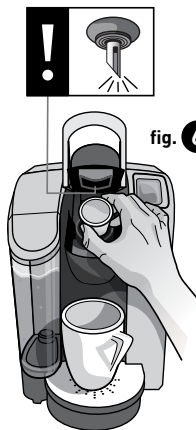

- Place a K-Cup® portion pack in the K-Cup® Holder (fig. 6).

CAUTION: There are two sharp needles that puncture the K-Cup®, one above the K-Cup® Holder and the other in the bottom of the K-Cup® Holder. To avoid risk of injury, do not put your fingers in the K-Cup® Assembly Housing.

- Lower the Handle to close the Lid over the K-Cup® Holder. (When it is closed completely, the LCD Control Center will indicate "READY TO BREW". The Left and Right Buttons will be lit and the BREW Button will flash up to 60 seconds.)

- All brew size icons are lit with the default size flashing (fig. 7). To choose a different size, press Left Button to go down in size or Right Button to go up in size.

NOTE: The Small Mug is the factory set default brew size. To program your favorite brew size see page 13 "Programming Your Brew Size".

- Your choices are a stronger Extra-Small Cup (3.25 oz. serving), a Small Cup (5.25 oz. serving), a Small Mug (7.25 oz. serving), a Large Mug (9.25 oz. serving) or a Travel Mug (11.25 oz. serving).

fig. 7



SECTION 1 Set-Up & First Brew (continued)



fig. 8

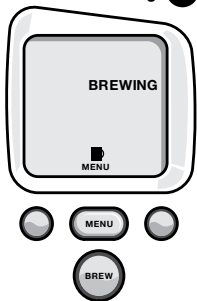

- c. Once size is chosen, press BREW Button. BREW Button will stop flashing, Left and Right Buttons will no longer be lit and icon of brew size will be lit.

7. The LCD Control Center will now display the word 'BREWING' and the serving size you selected will be illuminated on LCD (fig. 8).

CAUTION: There is extremely hot water in the K-Cup® Holder during the brew process. To avoid risk of injury, do not lift the Handle or open the K-Cup® Assembly Housing during the brew process.

8. There may be a short pause prior to coffee being dispensed. The entire brew process lasts for approximately 1 minute and ends with a burst of air to remove all liquid from the K-Cup®.

9. Lift the Handle, remove and dispose of the used K-Cup®.

CAUTION: K-Cup® will be hot.

10. Enjoy your first cup of Keurig Brewed® gourmet coffee, tea or hot cocoa!



11. Your Brewer may display "NOT READY" as it heats water for the next brew cycle. The "READY TO BREW" indication will return to the LCD Control Center in about 15 seconds.

Stopping the Brew Process

If you need to stop the brewing after the process has started, press and release the Power Switch to turn the Brewer 'OFF'. The flow of coffee, tea or hot cocoa will stop, the heating element will shut off and the blue lights illuminating the LCD Control Center and Water Reservoir will disappear.

NOTE: You may get more coffee, tea or hot cocoa in your cup during your next brew. We recommend that you perform a cleansing brew with water-only after a terminated brew. Then your NEXT brew will be the volume you have selected.

fig. 9



Adding Water

The LCD Control Center of your Brewer will indicate when the water level in the tank is low or if the Water Reservoir has been removed by displaying the words "ADD WATER" (fig. 9). The blue light in the Water Reservoir will also blink when water needs to be added. The Brewer will not allow you to brew when "ADD WATER" is displayed (fig. 9).

The Water Reservoir can be filled in two ways.

1. Open the Easy-Fill Lid and pour water directly into the Water Reservoir while it is still attached to the Brewer, then close the Lid. The entire Water Reservoir Lid may be removed completely if preferred.
2. Remove the Water Reservoir from Brewer by first removing Lid from the Water Reservoir, then lifting the Water Reservoir straight up and toward front of Brewer. Fill with water. Place the Water Reservoir back on the Brewer and replace the Lid.

IMPORTANT: Do not remove the Water Reservoir during the brewing process.

Brewing Iced Beverages

Your iced tea and iced coffee taste best when fresh-brewed hot over ice. Try it by placing a tall cup filled with ice on the Drip Tray Plate (the Drip Tray Assembly can be removed to accommodate taller cups), choose your favorite K-Cup® portion pack, select the brew size and press the BREW Button. Also, look for the Brew Over Ice™ icon on K-Cup® portion packs specially crafted to brew over ice!

IMPORTANT: Do not brew into a cup made of glass. Doing so may cause the glass to crack or break.

Brewing Hot Water

Your Brewer is able to produce hot water for making hot cocoa from a packet, for use in cooking, for making soups, etc. Simply follow the instructions on page 7 — “Ready To Brew Your First Cup” without adding a K-Cup®.

NOTE: After brewing a hot cocoa K-Cup®, we recommend running a hot water brew cycle without a K-Cup®.

Purging the Brewer

If your Brewer has not been used for more than one week, you should purge the water from the inner tank.

1. If there is water in the Water Reservoir, remove the Lid, then lift the Water Reservoir straight up and away from Brewer. Discard water, rinse and refill with water. Place the Water Reservoir back on the Brewer and replace the Lid. (If there is no water in the Water Reservoir, simply refill.)
2. Be sure the Brewer is turned on. Raise and lower the Handle on the Brewer without inserting a K-Cup®.
3. The LCD Control Center will display “READY TO BREW”. Brew a Travel Mug (11.25 oz. serving) of water (do not use a K-Cup®).
4. Repeat steps 2 and 3 two more times to completely purge water from inner tank.

If you are experiencing any problems with your Brewer, please contact Customer Service at 1.866.901.BREW (2739).

SECTION 2 Controls & Indicators (LCD Control Center)

Setting the Clock

Setting the clock is optional. When the clock is set, the time will appear in the LCD Control Center. **NOTE: You must set the clock if you will be using the Auto On/Off Time programming feature.**

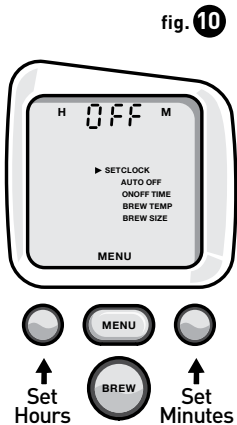

fig. 10

1. Press the MENU Button.
2. The word 'OFF' will appear at the top of the LCD Control Center to indicate that the clock is not set (fig. 10). The programming options will appear on the LCD Control Center with a small arrow pointing to 'SET CLOCK'. "H" (Hour) will appear above the Left Button and "M" (Minute) will appear above the Right Button. The "H" and "M" icons and Left and Right Buttons will flash.
3. Press or hold the Left Button under the flashing "H" until you have reached the appropriate hour. If the hour has passed 12 "PM" will be shown.
4. Press or hold the Right Button under the flashing "M" to set the minutes.

5. When you have reached the correct time, press the MENU Button six times to scroll through the remaining programming steps.

6. The correct time should now be displayed in the LCD Control Center.

NOTE: If power is interrupted to the Brewer by unplugging it, or if power is lost, follow the procedure above to reset the time as the clock will not be visible until the time is set. Brew size and brew temperature menu settings are remembered and restored automatically. All other settings will be restored automatically after clock is set.

Programming On/Off Features

The Brewer provides three modes so that you can enjoy gourmet coffee, tea or hot cocoa on your own schedule. By programming your Brewer to turn on each morning, you will never have to wait for the Brewer to warm up to brew a gourmet cup of coffee. It will take the Brewer approximately 4 minutes to warm up from room temperature.

1. **Leave it ON all the time.** The Brewer can be left on all the time so that it is always ready to brew a fresh cup of gourmet coffee, tea or hot cocoa. To turn the Brewer off at any time, simply press and release the Power Switch. **(NOTE: Although the clock remains on, if set, you can not brew a cup of coffee, tea or hot cocoa.)** Press and release the Power Switch again to restore power to the Brewer. You will have to wait for the water to heat up before the Brewer is ready to brew.
2. **Set the Brewer to "AUTO OFF" following a specified period of time after the last brew.**
 - a. Press the MENU Button twice to program the Auto Off feature. The LCD Control Center will now display the programming options with a small arrow next to "SET AUTO OFF" (fig. 11).

fig. 11

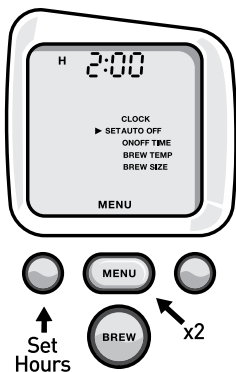

- b. Press or hold the Left Button under the blinking "H" to advance 1 hour at a time, up to 9 hours.
- c. After setting the desired Auto Off time, press the MENU Button five times to scroll through the remaining programming options and exit the programming mode. "AUTO OFF SET" (fig. 12) will now be displayed to indicate that it has been set.
- d. To cancel the Auto Off feature, press the MENU Button twice to reach the "AUTO OFF" programming mode. Press and release the blue Left Button under the blinking "H" to advance one hour at a time until "OFF" is displayed.

fig. 12



3. Program your Brewer for a specific On/Off Time. **NOTE:** To use this programming feature, the clock must be set to the correct time. The clock will not be displayed unless the time is set.

- a. After setting the correct time (required), press the MENU Button three times to program On Time feature. The LCD Control Center will show the programming options with a small arrow next to "SET ON TIME" (fig. 13).
- b. Press or hold the Left Button under the "H" to scroll through the hours to your desired "ON TIME" hour.

fig. 13

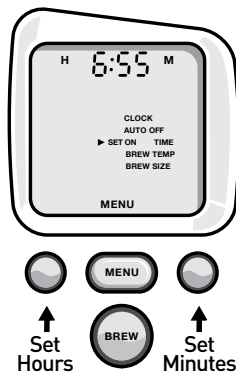

- c. Press or hold the Right Button under the "M" to scroll through the minutes to your desired "ON TIME" minutes.
- d. After setting the desired time, press the MENU Button to save the "ON TIME" and move to the "SET OFF TIME" (fig. 14).
- e. If you want to set an "OFF TIME", repeat the procedure above in steps b & c to set your desired "OFF TIME" (fig. 14).
- f. To complete the process, press the MENU Button three more times to exit the programming mode. The Control Center will now indicate the options you have set.
- g. The Auto On time and Auto Off time functions operate independently from one another. To cancel either set function, follow the steps above and use the "H" and "M" Buttons to advance to 12:00 AM. Make sure the "M" Button is set to :00, then change the "H" Button. When you reach 12:00 AM, the Control Center will display 'OFF' and the function will be disabled.

fig. 14

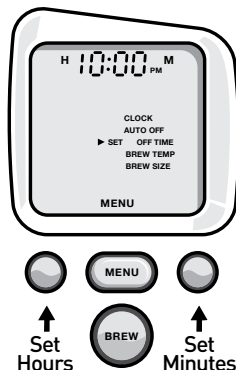

EXAMPLE: If you chose to set the On Time at 6:55 AM and the Off Time for 10:00 PM, then the Brewer will be "READY TO BREW" and maintain hot water in the tank during that time so that it is always ready for you to brew. If you wanted to brew outside this window,

SECTION 2 Controls & Indicators (LCD Control Center)

fig. 15

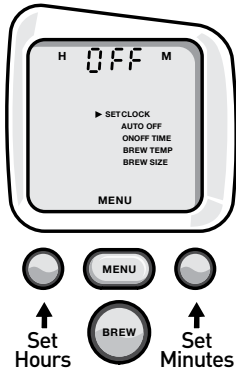

simply press the Power Button and you can brew as soon as the water is heated and the "READY TO BREW" indicator is displayed on the LCD Control Center.

NOTE: The On time and Off time functions operate independently from one another. To cancel either function, follow the steps above and use the "H" and "M" Buttons to advance to 12:00 AM. When you reach 12:00 AM, the Control Center will display 'OFF' and the function will be disabled (fig. 15).

NOTE: The Auto Off timer and the On/Off Time programming options operate independently, but can also be programmed to work together. For example, you can set the On Time function to turn on at 7:00 AM and then set the Auto Off timer function to turn off the Brewer two hours after the last brew.

Programming Brew Temperature (187° – 192° F)

The Brewer brews at a preset temperature of 192°. You can adjust this temperature down by 5 degrees if you prefer a cooler cup of coffee, tea or hot cocoa. Simply follow the instructions below.

fig. 16

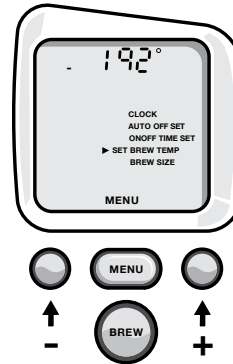

1. Press the MENU Button on the LCD Control Center five times to program the Brew Temperature feature.
2. The LCD Control Center will now display the programming options with a small arrow next to "SET BREW TEMP" (fig. 16). Also, the temperature 192° (initial setting) will be displayed at the top of the LCD Control Center to indicate the current temperature setting.
3. A minus sign will appear over the Left Button and/or a plus sign over the Right Button. Use these Buttons to raise or lower the temperature one degree at a time.
4. Once you have reached your desired brew temperature, press the MENU Button twice to exit the programming mode. "BREW TEMP SET" will be displayed in the LCD Control Center if you have changed it from 192°.

SECTION 3 Cleaning & Maintenance

Cleaning External Parts

Regular cleaning of the Brewer's external components is recommended.

1. Never immerse the Brewer in water or other liquids. The Housing and other external components may be cleaned with a soapy, damp, non-abrasive cloth.
2. The Drip Tray can accumulate up to 12 ounces of overflow. The Drip Tray and Drip Tray Plate should be periodically inspected and rinsed clean. To remove the Drip Tray Assembly, simply slide it toward you, keeping it level at all times to avoid spilling. The Drip Tray and Drip Tray Plate should not be placed in the dishwasher. They should be cleaned with a damp, soapy, non-abrasive cloth and rinsed thoroughly.

5. To change the brew temperature again, repeat steps 1 through 3 to change the temperature up or down, remembering that the temperature can only be between 187° and 192°.

NOTE: At high altitudes (over 5,000 feet) if boiling occurs use the temperature adjustment (+0 and -5 degrees) to lower the temperature.

Programming Your Brew Size

fig. 17

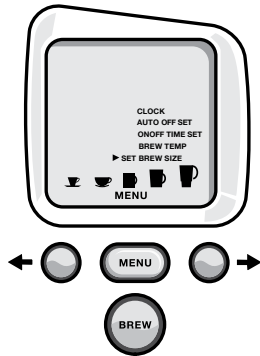

The Brewer is preset with the Small Mug (7.25 oz.) as the default brew size. The default brew size allows the user to avoid scrolling through brew sizes if a particular size is chosen most often.

To change the default brew size to your desired brew size:

1. Press the MENU Button six times.
2. Using Left and Right Buttons, select your desired default brew size (fig. 17).
3. Once the desired default brew size is selected press the MENU Button once to exit. The LCD will display the brew size set.

Cleaning the K-Cup® Holder Assembly

fig. 18

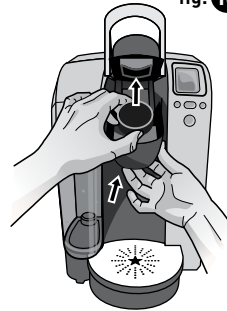

1. **Cleaning the Parts**—The K-Cup® Holder Assembly can be placed onto the top shelf of a dishwasher. **NOTE: Use low temperature cycles in the dishwasher.** To remove from the Brewer, open the cover by lifting the Handle. Grasp the top of the K-Cup® Holder with one hand while pushing up on the bottom of the K-Cup® Holder from underneath with the other until it releases (fig. 18). After cleaning, align the K-Cup® Holder with the opening using the two front ribs as a guide, and snap into place from the top.

SECTION 3 Cleaning & Maintenance (continued)

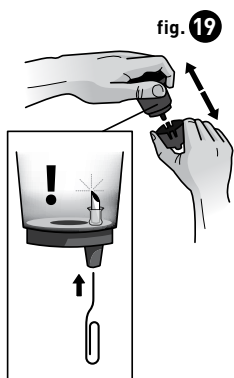

2. **Cleaning the Funnel**—The Funnel can be removed from the K-Cup® Holder by pulling on it until it pops off (fig. 19). The Funnel is dishwasher safe. To replace it, just snap it back onto the K-Cup® Holder Assembly.
3. **Cleaning the Exit Needle**—The Exit Needle is located on the inside bottom of the K-Cup® Holder Assembly. Should a clog arise due to coffee grinds, it can be cleaned using a paper clip or similar tool. Remove K-Cup® Holder assembly and detach Funnel. Insert the paper clip (as shown in fig. 19) into the Needle to loosen the clog and push it out. The K-Cup® Holder is dishwasher safe.

CAUTION: There are sharp needles that puncture the K-Cup® above the K-Cup® Holder and in the bottom of the K-Cup® Holder. To avoid risk of injury, do not put your fingers in the K-Cup® Assembly Housing.

Cleaning the Water Reservoir & Water Reservoir Lid

The Water Reservoir Lid and Water Reservoir should be periodically inspected and cleaned.

The Water Reservoir Lid or Water Reservoir should not be put into the dishwasher. They should be cleaned with a damp, soapy, non-abrasive cloth and rinsed thoroughly. Do not dry the inside of the Water Reservoir with a cloth as lint may remain.

To clean the filter screen at the base of your Water Reservoir, empty the Water Reservoir and follow one or all of the following procedures.

NOTE: If you are using a water filter inside the Water Reservoir, remove it before cleaning.

1. Rinse the filter screen with the strong force of water from your faucet.
2. If you have a sprayer, aim the water spray at the filter screen.
3. Fill the Water Reservoir with approximately two inches of clean water and agitate (shake) the Water Reservoir.

Empty the Water Reservoir then fill it with clean water and return it to the Brewer. If needed, repeat above procedures.

CAUTION: Please rinse the Water Reservoir thoroughly after cleaning to ensure that no cleaners or cleaning solutions remain as they may contaminate the water supply in the Brewer.

De-Scaling Your Brewer

Mineral content in water varies from place to place. Depending on the mineral content of the water in your area, calcium deposits or scale may build up in your Brewer. Scale is non-toxic, but left unattended, it can hinder

fig. 20

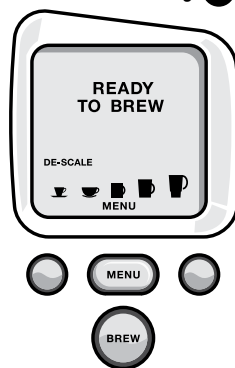

Brewer performance. De-scaling your Brewer helps maintain the heating element and other internal parts of the Brewer that come in contact with water.

The Brewer should be de-scaled every 3-6 months to ensure optimal performance. It is possible for calcium deposits to build up faster, making it necessary to de-scale more often.

You should promptly de-scale if "DE-SCALE" is displayed on the LCD Control Center (fig. 20). However, even if "DE-SCALE" is not displayed, you should continue to de-scale your brewer every 3-6 months. Properly follow the de-scaling procedure described on page 15.

De-Scaling Instructions

A. PREPARE

Step 1: To begin, you will need the following:

- At least 48 ounces of undiluted white vinegar
- Access to an empty sink
- A large ceramic mug (do not use a paper cup)

Step 2: Empty the water in the Water Reservoir.

Step 3: Disable "Auto Off" features.

B. FILL AND CLEAN

Step 1: Pour approximately 48 ounces of the vinegar into the Water Reservoir.

Step 2: Place a large mug on the Drip Tray Plate and run a brew cycle.

- DO NOT USE A K-CUP® PORTION PACK**, just press the BREW Button.
- Pour the contents of the large mug into the sink.

Step 3: Repeat the brew process without a K-Cup® until "ADD WATER" is indicated.

Step 4: Now let the Brewer stand for at least 4 hours while still on.

Step 5: Discard any residual vinegar and rinse the Water Reservoir thoroughly.

C. RINSE

Step 1: Ensure the Water Reservoir is filled with fresh water.

Step 2: Place a large mug on the Drip Tray Plate and run a water brew cycle.
Pour the contents of the large mug into the sink.

Step 3: Repeat brew process until "ADD WATER" is indicated.

Step 4: You may need to perform additional water brew cycles if you notice any residual taste.

NOTE: If "DE-SCALE" is still displayed after completing the procedure, repeat the de-scaling procedure above.

Service

Beyond these recommended cleaning and maintenance procedures this Brewer is not user serviceable. For service, please refer to the Warranty section of this guide.

Storage

Empty the Water Reservoir before storing, and take care to ensure that you store your Brewer in a safe and **frost free** environment. Please be sure to store your Brewer in its **upright position** to avoid water leakage from the inner tank. If you store the Brewer in a cold environment, you run the risk of water freezing inside the Brewer and causing damage. When you prepare to use it after storage, we recommend rinsing the Water Reservoir with fresh water and running three cleansing brews without a K-Cup®.

If you plan to move your Brewer to a different location, turn the Brewer off, unplug it, and empty the Water Reservoir. If your Brewer has been in an environment below freezing, please be sure to let it warm to room temperature for at least 2 hours before using.

Transport Brewer in the upright position to ensure inner tank does not leak through vent.

SECTION 4 Troubleshooting

SITUATION	SOLUTION
Brewer does not have power	<ul style="list-style-type: none">• Plug Brewer into an independent outlet.• Check to be sure that it is plugged in securely.• Plug into a different outlet.• Reset your home's circuit breaker if necessary.• Make sure that the Power Switch has been turned on and LCD lights are illuminated.
Brewer will not brew	<ul style="list-style-type: none">• After placing the K-Cup® in the K-Cup® Holder, make sure the Handle is pushed down securely and the LCD Control Center reads "READY TO BREW" with the Left, Right and BREW Buttons flashing, then press the Left, Right or BREW Button.• If the LCD Control Center indicates "ADD WATER", add water to the Water Reservoir or make sure the Water Reservoir is seated properly in its base.• If the LCD Control Center indicates "ADD WATER" even after refilling, contact Customer Service at 1.866.901.BREW (2739).• The Exit Needle may be clogged (refer to page 14).• If the LCD Control Center indicates "PRIME" and the blue light in the Water Reservoir is flashing, see below.
LCD Control Center indicates "PRIME" and the blue light in the Water Reservoir is flashing	<ul style="list-style-type: none">• Completely remove the Water Reservoir and thoroughly clean (refer to page 14). Ensure the Water Reservoir is fully filled with water. Return it to the Brewer and ensure it is seated properly (refer to page 6).• If you have completed the above procedure two times and this situation persists, contact Customer Service at 1.866.901.BREW (2739).

SITUATION	SOLUTION
Brewing a partial cup	<ul style="list-style-type: none">• The Exit Needle may be clogged (refer to page 14).• Clean the K-Cup® Holder Assembly if necessary and rinse under faucet (refer to page 13).• The Water Reservoir may have been removed during brewing. Replace the Water Reservoir and perform a water brew without a K-Cup®.• "De-Scale" the Brewer (refer to page 14).• If you have repeated the de-scale procedure on your Brewer two times and it is still only brewing a partial cup, contact Customer Service at 1.866.901.BREW (2739).
The time is not displayed on the LCD Control Center	<ul style="list-style-type: none">• The time will not be displayed on the LCD unless you have set it. To set the clock, follow the procedure on page 10.• If power is interrupted to the Brewer, you will need to set the clock again using the procedure on page 10.
Brewer shuts off or turns on automatically	<ul style="list-style-type: none">• Check to make sure that the Auto Off timer and/or On/Off time features have not been set. To do this, press the MENU Button below "MENU" and scroll through the programming options. "OFF" should be displayed for Auto Off timer and On/Off. If "OFF" is not displayed, follow directions on page 10 to reset.
The blue light in Water Reservoir is flashing	<ul style="list-style-type: none">• The water level is low and a full cup cannot be brewed. Add water to Water Reservoir.• If the LCD Control Center indicates "PRIME", please see situation to the left (LCD Control Center indicates "PRIME" and the blue light in the Water Reservoir is flashing).

If any problems persist, contact Customer Service at 1.866.901.BREW (2739)

SECTION 5 Warranty

Limited One Year Warranty

Keurig, Incorporated warrants that your Brewer will be free of defects in materials or workmanship **under normal home** use for one year from the date of purchase. It is recommended that you fill out and return the warranty card enclosed with your Brewer so that your purchase information will be stored in our system. Keurig will, at its option, repair or replace the Brewer without charge upon its receipt of proof of the date of purchase. If a replacement Brewer is necessary to service this warranty, the replacement Brewer may be new or reconditioned. If a replacement Brewer is sent, a new limited one year warranty will be applied to the replacement Brewer.

This warranty only applies to Brewers operated in the United States and Canada. This warranty gives you specific legal rights, and you may also have other rights that vary from state to state and, in the case of Canada, from province to province.

What is not covered by the Limited Warranty?

THIS WARRANTY DOES NOT COVER CONSEQUENTIAL OR INCIDENTAL DAMAGES SUCH AS PROPERTY DAMAGE AND DOES NOT COVER INCIDENTAL COSTS AND EXPENSES RESULTING FROM ANY BREACH OF THIS WARRANTY, EVEN IF FORESEEABLE. Some states or provinces do not allow the exclusion or limitations of incidental or consequential damages, so the above limitation or exclusion may not apply to you depending on the state or province of purchase.

Nor does this warranty cover damages caused by services performed by anyone other than Keurig or its authorized service providers, use of parts other than genuine Keurig parts, or external causes such as abuse, misuse, inappropriate power supply or acts of God.

Other Limitations

THIS WARRANTY IS EXCLUSIVE AND IS IN LIEU OF ANY OTHER EXPRESS WARRANTY, WHETHER WRITTEN OR ORAL. IN ADDITION, KEURIG HEREBY SPECIFICALLY DISCLAIMS ALL OTHER WARRANTIES WITH RESPECT TO YOUR B70 BREWER, INCLUDING ANY IMPLIED WARRANTY OF MERCHANTABILITY OR FITNESS FOR ANY PARTICULAR PURPOSE. Some states or provinces do not allow disclaimers of such implied warranties or limitations on how long an implied warranty lasts, so the above limitation may not apply to you depending on the state or the province of purchase.

How do you obtain warranty service?

Keurig® Brewers are high-quality appliances and, with proper care, are intended to provide years of satisfying performance. However, should the need arise for warranty servicing, simply call Keurig Customer Service at our toll free phone number 1.866.901.BREW (2739). Please do not return your Brewer for servicing without first speaking to Keurig Customer Service to obtain an Authorization to Return number (ATR). Keurig® Brewers returned without an ATR number will be returned to the sender without servicing.

Keurig, Incorporated
55 Walkers Brook Drive
Reading, MA 01867
1.866.901.BREW (2739)

CLICK, CALL OR SHOP | www.keurig.com | 1.866.901.BREW | At over 18,000 stores in the U.S. and Canada

Keurig, Incorporated
55 Walkers Brook Drive
Reading, MA 01867

Keurig, Incorporated is a wholly-owned
subsidiary of Green Mountain Coffee Roasters, Inc.



For Household Use Only

Covered by U.S. Patent Numbers 7,398,726, 7,165,488,
7,347,138, 7,377,162, D544,299, 7,360,418, 7,513,192
and other U.S. and foreign patents pending.

Made and printed in China.