

KEURIG®

K•Mini Plus™

Use & Care Guide

Get the most from your
new Keurig® brewer

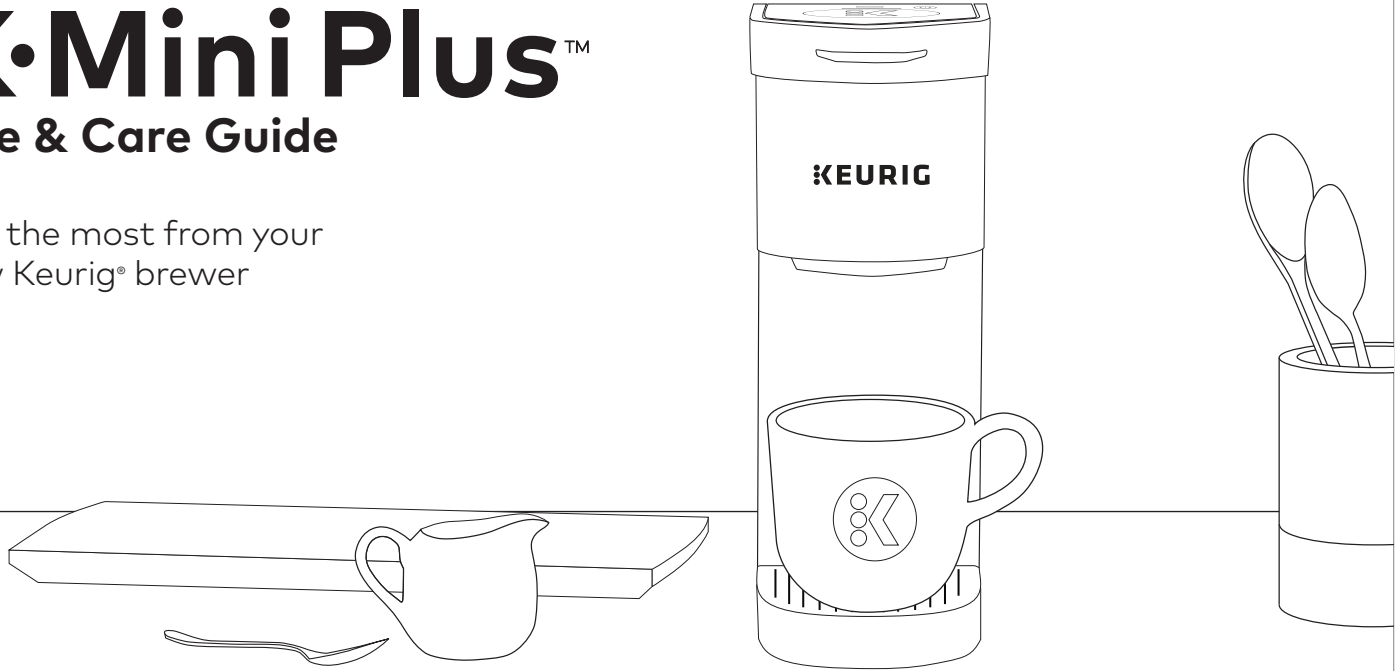

Before You Brew

1 Plug & Power

Remove packing tape from brewer. Pull plug and extend cord from cord storage located at the back of the brewer. Plug into a grounded outlet.

Press the power button. The power button will illuminate.

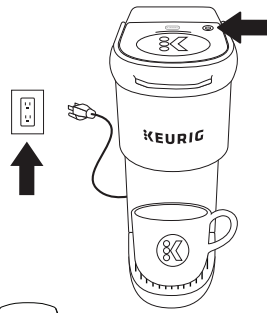

3 Lift & Lower

Lift and lower the handle. **Do not insert a K-Cup® pod.** The brew indicator light will flash to indicate that the brewer is ready.

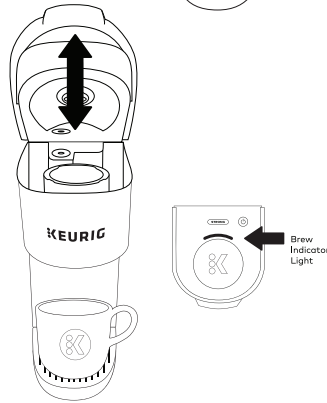

2 Fill & Place

Add 1 cup (8oz) of water into a mug. Lift the water reservoir lid and pour the water into the reservoir. Do not fill past the MAX or below the MIN fill lines. Lower the lid and place your mug on the drip tray.

NOTE: Do not use distilled water.

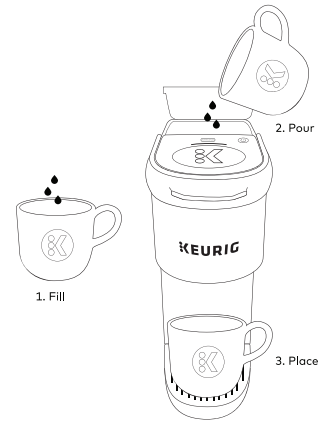

4 Cleansing Brew

Press the brew button. The brew indicator light will illuminate solid, then begin to pulse while the brewer is heating. After about 2 minutes, the brew indicator light will illuminate solid again and the water will begin to dispense. Pour the hot water into the sink.

The one-time setup process is now complete and you are ready to brew!

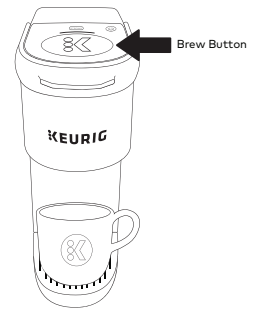

Brew Your First Cup

5 Fill & Place Mug

Add desired amount of water into a mug (6oz minimum, 12oz maximum). Lift the water reservoir lid and pour the water into the reservoir. Do not fill past the MAX or below the MIN fill lines. Lower the lid and place your mug on the drip tray.

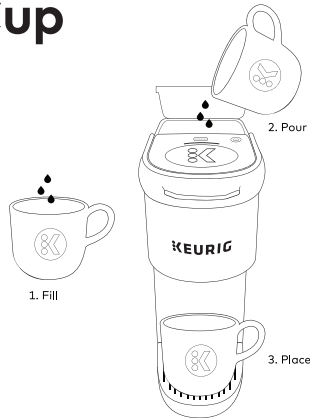

7 Brew & Enjoy!

Press the brew button - for bolder coffee, press the **STRONG** button before pressing the brew button. The brew indicator light will illuminate solid, then begin to pulse while the brewer is heating. After about 2 minutes, the brew indicator light will illuminate solid again and the beverage will begin to dispense.

Brewing is complete when the brew indicator light is no longer illuminated. When complete, lift the handle and dispose of the used K-Cup® pod.

CAUTION: While brewing, there is extremely hot water in the K-Cup® pod holder. To avoid injury, do not lift the handle during the brewing process.

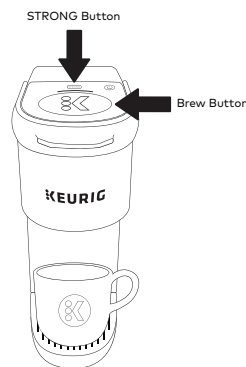

6 Lift & Place Pod

Lift the handle. Place a K-Cup® pod in the K-Cup® pod holder. Lower the handle completely to close the lid. The brew indicator light will flash to indicate that the brewer is ready. **Do not remove the foil lid on the K-Cup® pod.**

High Altitude Brewing: While holding the brewer handle up, push down slowly on the K-Cup® pod in the pod holder until the bottom of the K-Cup® pod is punctured by the exit needle.

Brewer Features

Strong Brew increases your coffee strength and intensity. For bolder coffee press the **STRONG** button.

Pod Storage holds 9 K-Cup® pods and fits in your brewer to save counter space.

Removable Water Reservoir for easy cleaning and filling.

Auto Off: Automatically turns your brewer off 90 seconds after the last brew for energy savings.

Cord Storage: Makes transporting your brewer convenient and keeps countertops tidy.

Travel Mug Friendly: Remove the drip tray to accommodate a travel mug.

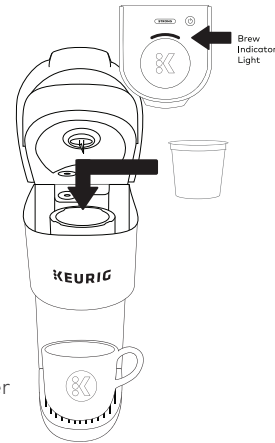

Caring for your Brewer

Regular cleaning keeps your brewer running smoothly. Always be sure to turn off and unplug your brewer before cleaning.



Brewer Exterior

Keep your Keurig® brewer looking its best by cleaning the exterior from time to time. Just clean with a damp, soapy, lint-free, non-abrasive cloth. Never immerse the brewer in water or other liquids.

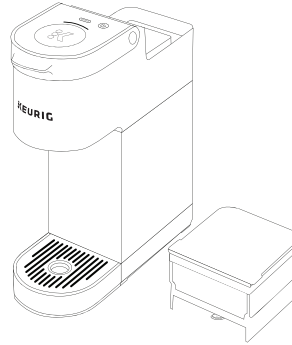

Water Reservoir

The removable water reservoir should be cleaned periodically with a damp, soapy, non-abrasive cloth. Rinse the reservoir thoroughly after cleaning. This will ensure that no cleaning solutions remain in the area as they may contaminate the water supply. Do not dry the inside of the water reservoir with a cloth as lint may remain. Allow the reservoir to dry completely.



Drip Tray

The drip tray can hold up to 8 ounces of overflow and should be emptied and cleaned occasionally. To remove, slide it toward you, keeping it level to avoid spilling. Rinse and clean with a damp, soapy, lint-free, non-abrasive cloth.

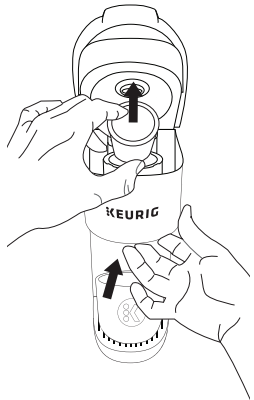

K-Cup® Pod Holder

To remove the K-Cup® pod holder from the brewer, lift the handle and grasp the top of the K-Cup® pod holder with one hand while pushing up on the bottom of the K-Cup® pod holder from underneath with the other until it releases. After cleaning, align the K-Cup® pod holder with the opening using the two front ribs as a guide and snap into place from the top.

CAUTION: There are sharp needles that puncture the K-Cup® pod above the K-Cup® pod holder and in the bottom of the K-Cup® pod holder. To avoid risk of injury, do not put your fingers in the K-Cup® pod holder.

NOTE: Always remove and dispose of the used K-Cup® pod after brewing.

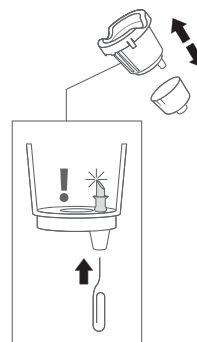

Exit Needle

Remove the pod holder assembly and detach the funnel. Locate the exit needle on the inside bottom of the K-Cup® pod holder. Insert a straightened paper clip into the exit needle to loosen any coffee grounds.

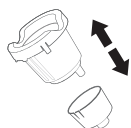

Funnel

Washing the funnel ensures a fresh beverage experience. The funnel should be washed regularly and can be removed from the K-Cup® pod holder by pulling on it until it pops off. To replace it, orient the snaps to the indent and just snap it back onto the K-Cup® pod holder.

Entrance Needle

Lift the brewer handle and locate the entrance needle on the underside of the lid. To clean both holes in the needle, hold the brewer handle in the upward position and with your other hand, carefully insert a straightened paper clip into both holes. Gently move it around to loosen any coffee grounds. Lower the handle completely and run two water-only brew cycles. Do not insert a K-Cup® pod.

TIP: Refer to support.keurig.com for video instructions on cleaning the entrance/exit needles.

Descaling your Brewer

You should descale your brewer every 3-6 months. Properly follow the descaling procedure.

Depending on the mineral content of your water, calcium deposits or scale may build up in your brewer. Scale is non-toxic but if left unattended can hinder brewer performance. Regularly descaling your brewer every 3-6 months helps maintain the heating element, and other internal parts that come in contact with water. Calcium deposits may build up faster, making it necessary to descale more often.

Descaling Procedure

Before you begin, you will need a large ceramic mug, fresh water, Keurig® Descaling Solution, and access to a sink. Do not use a paper cup. Ensure that there is no beverage pod in the K-Cup® pod holder. Please allow approximately 45 minutes for the descaling procedure.

STEP 1: Cleansing Rinse

Turn on your brewer.

Pour one third (4.6oz) of the Keurig® Descaling Solution into the water reservoir then add fresh water to the 10oz fill level.

Place a large ceramic mug on the drip tray plate.

Lift and lower the handle but do not add a K-Cup® pod.

Press the brew button.

Once solution is dispensed, pour the contents into the sink.

STEP 2: Internal Tank Soak

Repeat step 1, but when the brew indicator light turns solid, press the power button as the brewer starts to dispense.

Let the brewer stand for at least 30 minutes.

Press and hold the brew button until the solution begins to dispense. Continue to hold the button until all of the solution has been dispensed.

Pour the contents of the mug into the sink.

STEP 3: Fresh Water Rinse

Repeat step 1 using 12oz of fresh water only. Do not add Keurig® Descaling Solution. Repeat this step two additional times. You may need to perform additional fresh water rinse cycles if you notice any residual taste.

NOTE: The cleaning action of Keurig® Descaling Solution may result in a "foam" dispensed from the brewer. This is natural, as the solution is reacting with the scale inside. For a brewer that is heavily scaled, the brewer may not fill properly after the descaler is added. If this occurs, you may see only a small or no output dispensed, followed by the sound of air blowing out. If this occurs:

- Turn off and unplug the brewer.
- If there is Keurig® Descaling Solution in the water reservoir, discard the contents, rinse the water reservoir thoroughly and refill with water.
- Plug the brewer back in, power on, and repeat the Step 3 Fresh Water Rinse cycle. The brewer should begin to function normally as the solution is rinsed out and the scale is removed. If problem persists, allow brewer to sit unplugged for at least 30 minutes before continuing with the rinse.

Troubleshooting

Grounds in Your Coffee

Grounds may have gathered in the exit or entrance needles and can be cleaned using a straightened paper clip or similar tool.

- Clean the exit needle of the K-Cup® pod holder. Refer to the Exit Needle care instructions.
- Clean the brewer entrance needle. Refer to the Entrance Needle care instructions.

Brewer Will Not Brew

- A minimum of 6oz of water is required to brew. Add an additional 2oz of water to the reservoir to ensure the minimum fill level has been met, then press the brew button. Repeat until the brewer begins to dispense.

Brewing a Partial Cup

- Press the power button. Press and hold the brew button for 5 seconds until all of the water has been dispensed. Discard the contents into the sink. Press the power button to restart.
- The exit needle may be clogged. Refer to the Exit Needle care instructions.
- Clean the K-Cup® Pod Holder, see K-Cup® Pod Holder care instructions.
- The brewer may need to be descaled. If you have repeated the descale procedure on your brewer two times and it is still only brewing a partial cup, contact Customer Service.

Brewer Does Not Have Power or Shuts Off

- Make sure that the power button has been turned on.
- Plug brewer into its own grounded outlet. If the electric circuit is overloaded with other appliances, your brewer may not function properly. The brewer should be operated on its own circuit, separate from other appliances.
- For energy savings, the brewer automatically turns off 90 seconds after the last brew. Press the power button to restart.
- If the brewer still doesn't have power, contact Customer Service.

Click or Call!

Have Questions?

We're here to help. Visit support.keurig.com for step-by-step videos on cleaning, descaling, and more.



Still Need Help?

Give us a call at
1-866-901-BREW (2739)

Helpful Hints

Water quality varies greatly. If you notice an undesirable taste in your beverage (such as chlorine or mineral tastes), we recommend using bottled or filtered water. Do not use distilled water.

Service

Beyond these recommended cleaning and maintenance procedures, this brewer is not user serviceable. For service, please refer to the Warranty section of this guide.

Storage

Empty the water reservoir before storing or transporting and take care to ensure that you store your brewer in a safe and frost free environment. When you prepare to use it after storage, we recommend rinsing the water reservoir with fresh water and descaling the brewer as detailed in the Descaling your Brewer section.

If you plan to move your brewer to a different location, turn the brewer off, unplug it, and empty the water reservoir. If your brewer has been in an environment below freezing, please be sure to let it warm to room temperature for at least 2 hours before using.

Warranty

LIMITED ONE YEAR WARRANTY

Keurig Green Mountain, Inc. (Keurig) warrants that your brewer will be free of defects in materials or workmanship under normal home use for one year from the date of purchase. It is recommended that you register your brewer on keurig.com/new so that your purchase information will be stored in our system. Keurig will, at its option, repair or replace a defective brewer without charge upon its receipt of proof of the date of purchase. If a replacement brewer is necessary to service this warranty, the replacement brewer may be new or reconditioned. If a replacement brewer is sent, a new limited one year warranty will be applied to the replacement brewer.

This warranty only applies to brewers operated in the United States and Canada. This warranty gives you specific legal rights, and you may also have other rights that vary from state to state and, in the case of Canada, from province to province.

Only the use of Keurig® K-Cup® brand pods and accessories will guarantee the proper functioning and lifetime of your Keurig® brewer. Any damage to or malfunction of your brewer resulting from the use of non-Keurig® pods and accessories may not be covered by this warranty or may result in a service fee if the damage or malfunction is determined to be caused by such use.

WHAT IS NOT COVERED BY THE LIMITED WARRANTY?

THIS WARRANTY DOES NOT COVER CONSEQUENTIAL OR INCIDENTAL DAMAGES SUCH AS PROPERTY DAMAGE AND DOES NOT COVER INCIDENTAL COSTS AND EXPENSES RESULTING FROM ANY BREACH OF THIS WARRANTY, EVEN IF FORESEEABLE. Some states or provinces do not allow the exclusion or limitations of incidental or consequential damages, so the above limitation or exclusion may not apply to you depending on the state or province of purchase.

Nor does this warranty cover damages caused by use of non-Keurig® pods or accessories, services performed by anyone other than Keurig or its authorized service providers, use of parts other than genuine Keurig® parts, or external causes such as abuse, misuse, inappropriate power supply, or acts of God.

OTHER LIMITATIONS

THIS WARRANTY IS EXCLUSIVE AND IS IN LIEU OF ANY OTHER EXPRESS WARRANTY, WHETHER WRITTEN OR ORAL. IN ADDITION, KEURIG HEREBY SPECIFICALLY DISCLAIMS ALL OTHER WARRANTIES WITH RESPECT TO YOUR KEURIG® BREWER, INCLUDING ANY IMPLIED WARRANTY OF MERCHANTABILITY OR FITNESS FOR ANY PARTICULAR PURPOSE. Some states or provinces do not allow disclaimers of such implied warranties or limitations on how long an implied warranty lasts, so the above limitation may not apply to you depending on the state or the province of purchase.

HOW DO YOU OBTAIN WARRANTY SERVICE?

Keurig® brewers are high-quality appliances and, with proper care, are intended to provide years of satisfying performance. However, should the need arise for warranty servicing, simply call Keurig Customer Service at our toll free phone number 1.866.901.BREW (2739). Please do not return your brewer for servicing without first speaking to Keurig Customer Service to obtain a Return Materials Authorization (RMA) number. Keurig® brewers returned without a RMA number will be returned to the sender without servicing.

K·Mini Plus™

SINGLE SERVE COFFEE MAKER

- A. Handle
- B. K-Cup® Pod Holder (B and C are the K-Cup® Pod Holder Assembly)
- C. Funnel
- D. K-Cup® Pod Assembly Housing
- E. Drip Tray Plate
- F. Drip Tray
- G. Drip Tray Base
- H. Water Reservoir Lid
- I. Water Reservoir
- J. Power Cord
- K. Cord Storage

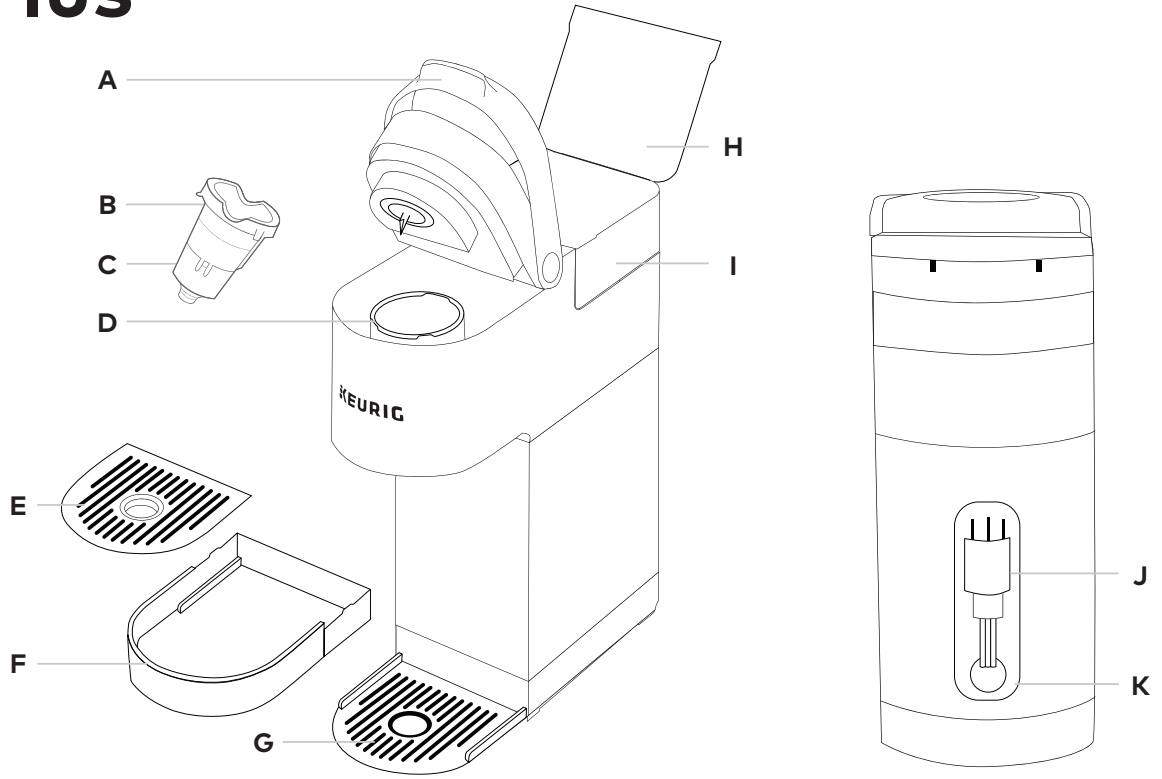

For replacement parts, please visit www.keurig.com

Coffeehouse taste in your own home.

FIND YOUR PERFECT POD

With over 70 brands and hundreds
of varieties, find your match at

keurig.com/new