

# KitchenAid®

## UNDERCOUNTER DISHWASHER

### Use & Care Guide

For questions about features, operation/performance, parts accessories or service, call: **1-800-422-1230**  
In Canada, call for assistance **1-800-461-5681**, for installation and service, call: **1-800-807-6777** or visit our website at...  
[www.kitchenaid.com](http://www.kitchenaid.com) or [www.KitchenAid.ca](http://www.KitchenAid.ca)

## LAVE-VAISSELLE ENCASTRÉ

### Guide d'utilisation et d'entretien

Au Canada, pour assistance composez le **1-800-461-5681**, pour installation ou service composez le **1-800-807-6777** ou visitez notre site web à...  
[www.KitchenAid.ca](http://www.KitchenAid.ca)

Table of Contents/Table des matières..... 2



*Save Water  
no pre-rinsing  
Économie d'eau  
sans prérinçage*

Models/Modèles KUDI01IL, KUDK01IL

8531129

---

# TABLE OF CONTENTS

<b>DISHWASHER SAFETY</b> .....	<b>3</b>
Before Using Your Dishwasher .....	4
<b>PARTS AND FEATURES</b> .....	<b>5</b>
<b>START-UP GUIDE</b> .....	<b>6</b>
Using Your New Dishwasher .....	6
<b>DISHWASHER LOADING</b> .....	<b>6</b>
Loading Suggestions .....	6
Loading Top Rack .....	7
Loading Bottom Rack .....	7
Loading Silverware Basket .....	8
<b>DISHWASHER USE</b> .....	<b>8</b>
Detergent Dispenser .....	8
Rinse Aid Dispenser .....	10
Dishwasher Efficiency Tips .....	10
Cycle Selection Charts .....	11
Canceling a Cycle .....	11
Changing a Cycle or Setting .....	11
Adding Items During a Cycle .....	11
Option Selections .....	12
Status Indicators .....	12
Wash System .....	12
Drying System .....	13
Overfill Protection Float.....	13
<b>WASHING SPECIAL ITEMS</b> .....	<b>13</b>
<b>DISHWASHER CARE</b> .....	<b>14</b>
Cleaning.....	14
Drain Air Gap .....	14
Storing .....	14
<b>TROUBLESHOOTING</b> .....	<b>15</b>
<b>ASSISTANCE OR SERVICE</b> .....	<b>17</b>
In the U.S.A. ....	17
In Canada .....	17
<b>WARRANTY</b> .....	<b>18</b>

# DISHWASHER SAFETY

## Your safety and the safety of others are very important.

We have provided many important safety messages in this manual and on your appliance. Always read and obey all safety messages.



This is the safety alert symbol.

This symbol alerts you to potential hazards that can kill or hurt you and others.

All safety messages will follow the safety alert symbol and either the word "DANGER" or "WARNING." These words mean:

**! DANGER**

**You can be killed or seriously injured if you don't immediately follow instructions.**

**! WARNING**

**You can be killed or seriously injured if you don't follow instructions.**

All safety messages will tell you what the potential hazard is, tell you how to reduce the chance of injury, and tell you what can happen if the instructions are not followed.

## IMPORTANT SAFETY INSTRUCTIONS

**WARNING:** When using the dishwasher, follow basic precautions, including the following:

- Read all instructions before using the dishwasher.
- Use the dishwasher only for its intended function.
- Use only detergents or rinse agents recommended for use in a dishwasher, and keep them out of the reach of children.
- When loading items to be washed:
  - 1) Locate sharp items so that they are not likely to damage the door seal; and
  - 2) Load sharp knives with the handles up to reduce the risk of cut-type injuries.
- Do not wash plastic items unless they are marked "dishwasher safe" or the equivalent. For plastic items not so marked, check the manufacturer's recommendations.
- Do not touch the heating element during or immediately after use.
- Do not operate the dishwasher unless all enclosure panels are properly in place.
- Do not tamper with controls.
- Do not abuse, sit on, or stand on the door or dish racks of the dishwasher.
- To reduce the risk of injury, do not allow children to play in or on the dishwasher.
- Under certain conditions, hydrogen gas may be produced in a hot water system that has not been used for two weeks or more. **HYDROGEN GAS IS EXPLOSIVE.** If the hot water system has not been used for such a period, before using the dishwasher turn on all hot water faucets and let the water flow from each for several minutes. This will release any accumulated hydrogen gas. As the gas is flammable, do not smoke or use an open flame during this time.
- Remove the door to the washing compartment when removing an old dishwasher from service or discarding it.

**SAVE THESE INSTRUCTIONS**

## Before Using Your Dishwasher

### **! WARNING**

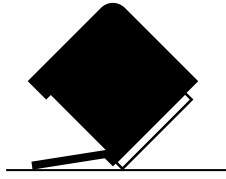

#### **Tip Over Hazard**

**Do not use dishwasher until completely installed.**

**Do not push down on open door.**

**Doing so can result in serious injury or cuts.**

### **! WARNING**



#### **Electrical Shock Hazard**

**Electrically ground dishwasher.**

**Connect ground wire to green ground connector in terminal box.**

**Do not use an extension cord.**

**Failure to follow these instructions can result in death, fire, or electrical shock.**

## **GROUNDING INSTRUCTIONS**

### ■ **For a grounded, cord-connected dishwasher:**

The dishwasher must be grounded. In the event of a malfunction or breakdown, grounding will reduce the risk of electric shock by providing a path of least resistance for electric current. The dishwasher is equipped with a cord having an equipment-grounding conductor and a grounding plug. The plug must be plugged into an appropriate outlet that is installed and grounded in accordance with all local codes and ordinances.

**WARNING:** Improper connection of the equipment-grounding conductor can result in a risk of electric shock. Check with a qualified electrician or service representative if you are in doubt whether the dishwasher is properly grounded. Do not modify the plug provided with the dishwasher; if it will not fit the outlet, have a proper outlet installed by a qualified electrician.

### ■ **For a permanently connected dishwasher:**

The dishwasher must be connected to a grounded metal, permanent wiring system, or an equipment-grounding conductor must be run with the circuit conductors and connected to the equipment-grounding terminal or lead on the dishwasher.

## **SAVE THESE INSTRUCTIONS**

- Install where dishwasher is protected from the elements. Protect against freezing to avoid possible rupture of fill valve. Such ruptures are not covered by the warranty. See "Storing" in the "Dishwasher Care" section for winter storage information.
- Install and level dishwasher on a floor that will hold the weight, and in an area suitable for its size and use.
- Remove all shipping plugs from hoses and connectors (such as the cap on the drain outlet) before installing. See Installation Instructions for complete information.

# PARTS AND FEATURES

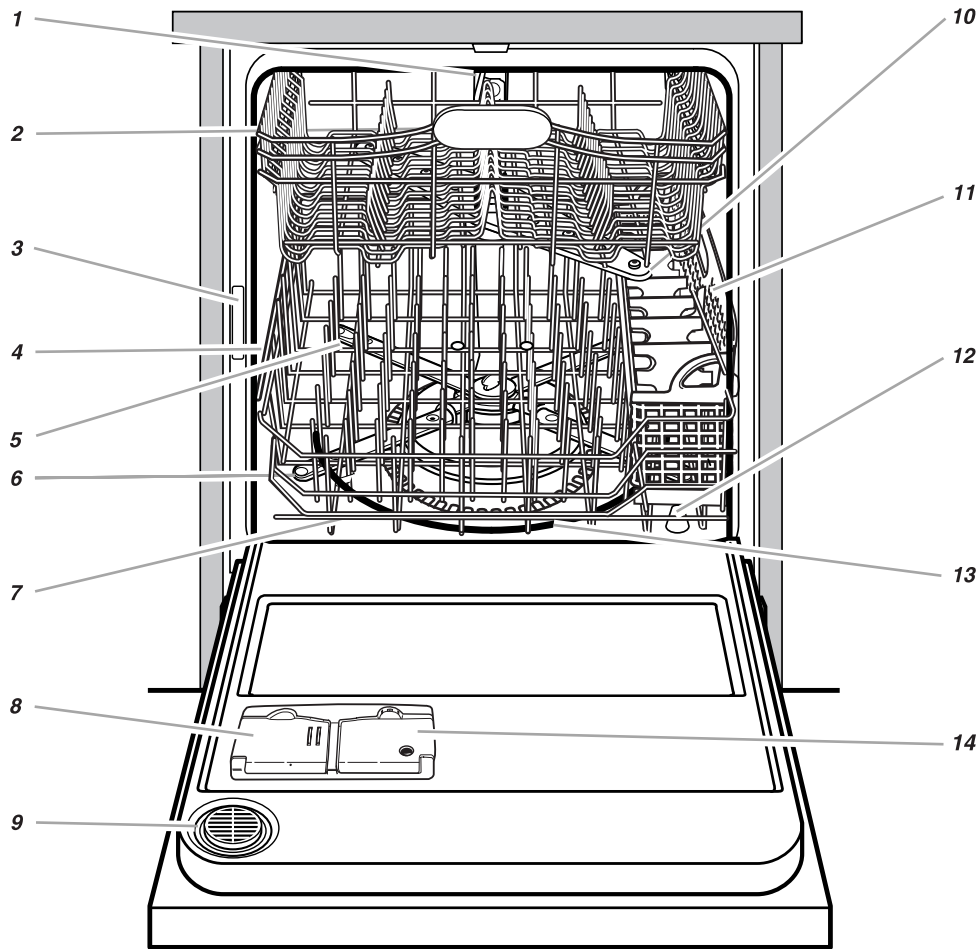

- |                                      |                                    |                               |
|--------------------------------------|------------------------------------|-------------------------------|
| 1. Upper spray                       | 6. 4-way HYDRO SWEEP™<br>spray arm | 11. Silverware basket         |
| 2. Top rack                          | 7. Bottom rack                     | 12. Overfill protection float |
| 3. Model and serial number label     | 8. Detergent dispenser             | 13. Heating element           |
| 4. Water inlet opening [in tub wall] | 9. Vent                            | 14. Rinse aid dispenser       |
| 5. FLEXI-FOLD DOWN™ flexible tines   | 10. Middle spray arm               |                               |

## Control Panel

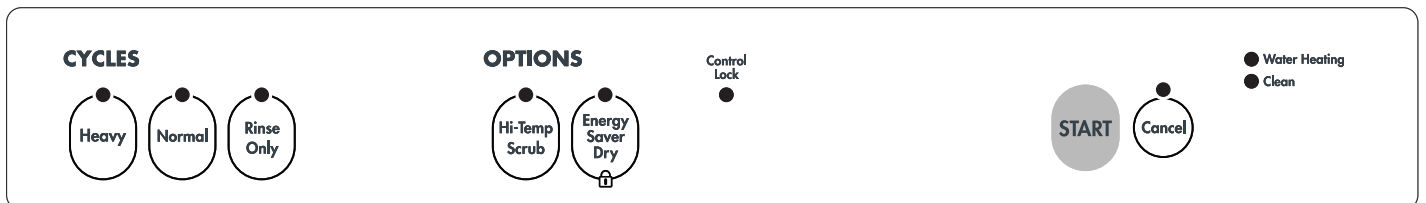

# START-UP GUIDE

Before using your dishwasher, remove all packaging materials. Read this entire Use and Care Guide. You will find important safety information and useful operating tips.

## Using Your New Dishwasher

1. Scrape large food soil and hard items (toothpicks or bones) from dishes.
2. Properly load the dishwasher. (See "Dishwasher Loading.") Make sure nothing prevents the spray arm(s) from spinning freely.

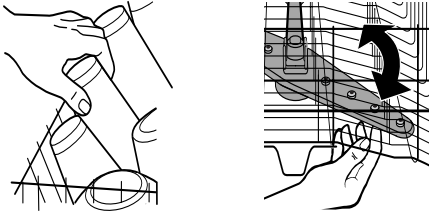

3. Add detergent and check the rinse aid dispenser. Add rinse aid if needed. (See "Dishwasher Use.")

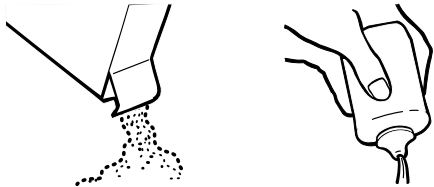

4. Push door firmly closed. The door latches automatically. Run hot water at the sink nearest your dishwasher until the water is hot. (See "Dishwasher Efficiency Tips.") Turn off water.

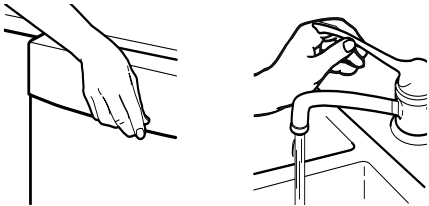

5. Press the desired cycle and option selections. (See "Dishwasher Use.") Press START. Or press START to repeat the same cycle and options as the previous cycle.

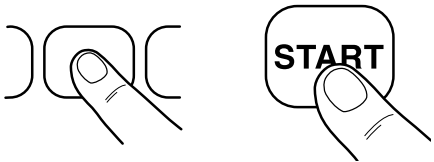

# DISHWASHER LOADING

## Loading Suggestions

- Remove leftover food, bones, toothpicks and other hard items from the dishes. To conserve water, energy and save time it is not necessary to rinse dishes before putting them into the dishwasher. The wash module removes food particles from the water. The module contains a chopping device which will reduce the size of food items.

**NOTE:** If hard items such as fruit seeds, nuts, and egg shells enter the wash module, you might hear chopping, grinding, crunching, or buzzing sounds. These sounds are normal when hard items enter the module. Do not let metallic items (such as pot handle screws) get into the wash module. Damage can occur.

- It is important for the water spray to reach all soiled surfaces.
- Load dishes so they are not stacked or overlapping if possible. For best drying, water must be able to drain from all surfaces.
- Load heavy pots and pans carefully. Heavy items can dent the stainless steel interior of the door if they are dropped or bumped.
- Make sure pot lids and handles, pizza pans, cookie sheets, etc., do not interfere with the spray arm rotation.
- Conserve water, energy and save time over hand rinsing by running a rinse cycle to keep dishes moist if you do not plan to wash them soon. Foods such as eggs, rice, pasta, spinach, and cooked cereals may be hard to remove if they are left to dry over a period of time.

### Quiet operating tips

To avoid thumping/clattering noises during operation:

- Make sure lightweight load items are secured in the racks.
- Make sure pot lids and handles, pizza pans, cookie sheets, etc., do not touch interior walls or interfere with the rotation of the spray arm.
- Load dishes so they do not touch one another.

**NOTE:** For built-in models, keep sink drain plugs closed during dishwasher operation to prevent noise transfer through drains.

## Loading Top Rack

The top rack is designed for cups, glasses, and smaller items. Many items, up to 9 in. (22 cm), fit in the top rack. (See recommended loading patterns shown.)

**NOTE:** The features on your dishwasher rack may vary from the drawings shown.

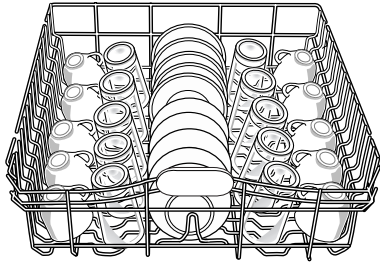

10 place setting

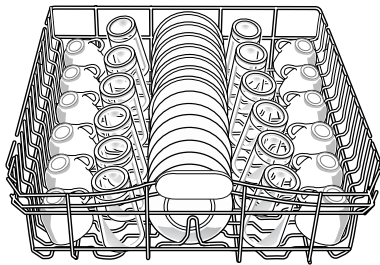

12 place setting

- Place items so open ends face down for cleaning and draining.
- Load glasses and cups in top rack only. The bottom rack is not designed for glasses and cups. Damage can occur.
- Place cups and glasses in the rows between tines. Placing them over the tines can lead to breakage and water spots.

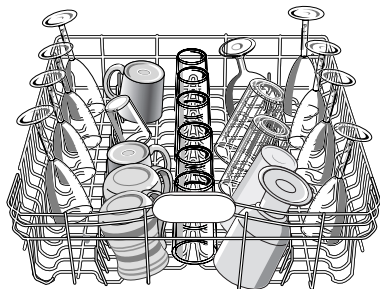

Cup and glass load

- China, crystal, and other delicate items must not touch each other during dishwasher operation. Damage may occur.
- Load plastic items in the top rack only. Only plastic items marked "dishwasher safe" are recommended.
- Load plastic items so the force of the spray does not move them during the cycle.
- To avoid chipping, do not let stemware touch other items.
- Small bowls, pans, and other utensils can be placed in the top rack. Load bowls in the center section for best stability.

## Loading Bottom Rack

The bottom rack is designed for plates, pans, casseroles, and utensils. Many items, up to 13 in. (33 cm) tall, fit in the bottom rack. (See recommended loading patterns shown.)

**NOTE:** The features on your dishwasher rack may vary from the drawings shown.

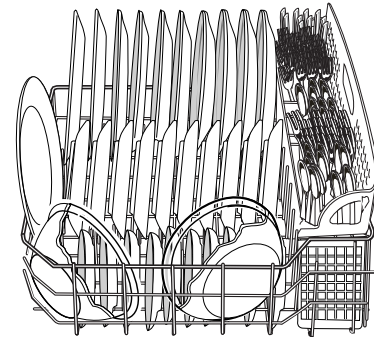

10 place setting

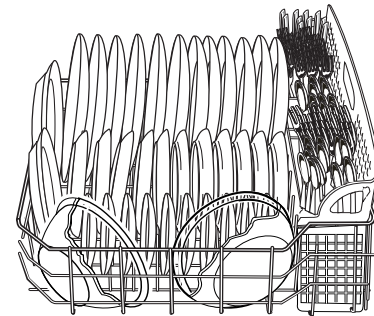

12 place setting

- Do not load glasses, cups, or plastic items in the bottom rack. Load small items in the bottom rack only if they are secured in place.
- Load plates, soup bowls, etc., between tines.
- Overlap the edges of plates for large loads.
- Load soup, cereal, and serving bowls in the rack in a variety of ways depending upon their size and shape. Load bowls securely between the rows of tines. Do not nest bowls because the spray will not reach all surfaces.

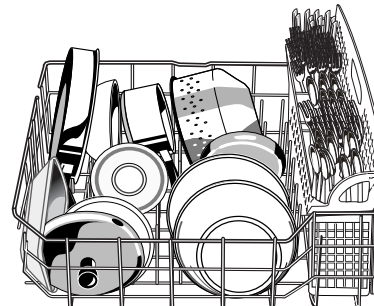

Utensil load

- Load cookie sheets, cake pans, and other large items at the sides and back. Loading such items in front can keep the water spray from reaching the detergent dispenser.

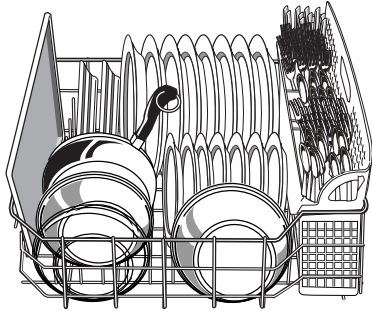

Mixed load

- Secure heavily soiled cookware face down in the rack.
- Make sure pot handles and other items do not stop rotation of the spray arm(s). The spray arm(s) must move freely.
- Do not load items between the bottom rack and the side of the dishwasher tub because they might block the water inlet opening.

### FLEXI-FOLD DOWN™ flexible tines (on some models)

You can fold down one or both rows of tines at the back of the bottom rack.

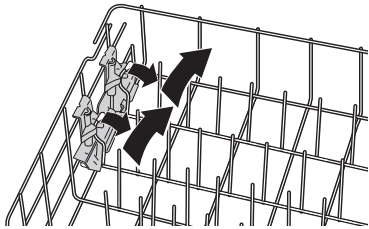

1. Grasp the tip of the tine that is in the tine holder.
2. Gently pull the tine out of the tine holder.
3. Lay the row of tines down in the rack to make room for larger dishes, bowls, pots, pans or roasters.

## Loading Silverware Basket

Load the silverware basket while it is in the bottom rack or take the basket out for loading on a counter or table.

**NOTE:** Unload or remove the basket before unloading the racks to avoid spilling water droplets on the silverware.

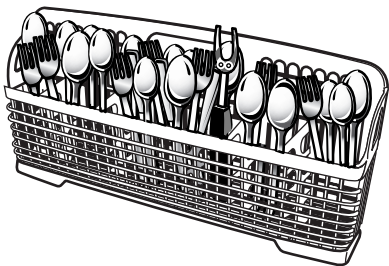

Mix items in each section of the basket with some pointing up and some down to avoid nesting. Spray cannot reach nested items.

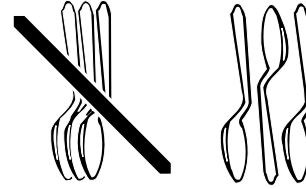

**IMPORTANT:** Always load sharp items (knives, skewers, etc.) pointing down.

### NOTES:

- Do not load silver or silver-plated silverware with stainless steel. These metals can be damaged by contact with each other during washing.
- Some foods (such as salt, vinegar, milk products, fruit juices, etc.) can pit or corrode silverware. Run a rinse cycle if you do not have a full load to wash immediately.

# DISHWASHER USE

## Detergent Dispenser

The detergent dispenser has 2 sections. The smaller Pre-Wash section empties detergent into the dishwasher when you close the door.

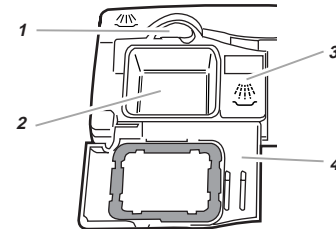

1. Cover latch
2. Main Wash section
3. Pre-Wash section
4. Cover

The larger Main Wash section automatically empties detergent into the dishwasher during the wash. (See the “Cycle Selection Charts.”)

- Use automatic dishwashing detergent only. Other detergents can produce excessive suds that can overflow out of the dishwasher and reduce washing performance.
- Add detergent just before starting a cycle.
- Store tightly closed detergent in a cool, dry place. Fresh automatic dishwasher detergent results in better cleaning.

**NOTE:** Do not use detergent with a rinse cycle.



## Filling the dispenser

1. If the dispenser cover is closed, open the cover by pushing the cover latch.

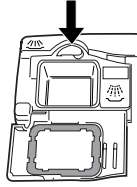

2. Fill the Main Wash section with detergent. See “How Much Detergent to Use.”
3. Fill the Pre-Wash section, if needed.
4. Close the dispenser cover.

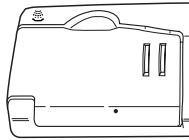

It is normal for the cover to open partially when dispensing detergent.

**NOTE:** Use both sections for cycles with 2 washes. Use only the main wash section for cycles with 1 wash. See the “Cycle Selection Charts” for more details.

## How much detergent to use

- The amount of detergent to use depends on the hardness of your water and the type of detergent. If you use too little, dishes won't be clean. If you use too much in soft water, glassware will etch.
- Water hardness can change over a period of time. Find out your water's hardness by asking your local water department, water softener company, or county extension agent.
- You can order a water hardness test strip. In the U.S.A., call the Customer Interaction Center and ask for Part Number 4171690.
- Different brands of dishwasher detergent have different amounts of phosphorus for softening water. If you have hard water and use a detergent with a phosphorous content of less than 8.7%, you might need to use more detergent, or use a detergent with a phosphorous content higher than 8.7%.

---

## Water Hardness

## Amount of Detergent

---

### Soft to Medium Hard Water

0 to 6 grains per gallon

### For normally soiled loads

- Partially fill the Main Wash section (5 tsp or 25 g)
- Fill the Pre-Wash section (4 tsp or 20 g)

**NOTE:** Add only 2 tsp or 10 g of detergent to the Pre-Wash section if dishes are pre-rinsed or the water is very soft (0 to 2 grains per gallon).

### For heavily soiled loads

- Partially fill the Main Wash section (7 tsp or 35 g)
  - Fill the Pre-Wash section (4 tsp or 20 g)
- 

### Medium to Hard Water

7 to 12 grains per gallon

### For normal and heavily soiled loads

- Partially fill the Main Wash section (7 tsp or 35 g)
  - Fill the Pre-Wash section (4 tsp or 20 g)
- 

### Very Hard Water

13 grains per gallon and above

**NOTE:** It might be necessary to use the Heavy cycle, or a normal cycle with Hi-Temp Scrub, for best wash performance with very hard water.

### For normally and heavily soiled loads

- Fill the Main Wash section (8 tsp or 40 g)
  - Fill the Pre-Wash section (4 tsp or 20 g)
  - Turn the rinse aid dispenser to a higher setting. See “Rinse Aid Dispenser” later in this section.
- 

**NOTE:** Fill amounts shown are for standard powdered detergent. Amounts may vary if you use liquid or concentrated powdered detergent. Follow instructions on the package when using liquid dishwasher detergent or concentrated powdered detergent.

## Rinse Aid Dispenser

Rinse aids prevent water from forming droplets that can dry as spots or streaks. They also improve drying by allowing water to drain off of the dishes during the final rinse by releasing a small amount of the rinse aid into the rinse water. Your dishwasher is designed to use a liquid rinse aid. Do not use a solid or bar-type.

### Filling the dispenser

The rinse aid dispenser holds 4.8 oz (145 mL) of rinse aid. Under normal conditions, this will last for about three months. Rinse aid is released through an opening in the dispenser. When latched properly, the cover remains closed. The cover should be opened only when refilling the dispenser. You do not have to wait until the dispenser is empty to refill it. Try to keep it full, but be careful not to overfill it.

1. Make sure the dishwasher door is fully open.
2. Open the dispenser by pushing the cover latch.

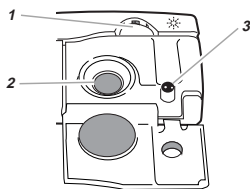

1. Cover latch
2. Rinse aid dispenser
3. Indicator window

3. Add rinse aid until the indicator window looks full.
4. Clean up any spilled rinse aid with a damp cloth.
5. Close the cover.

**NOTE:** The cover latch clicks when the cover is closed and latched.

### Rinse aid setting

The amount of rinse aid released into the final wash can be adjusted. The factory setting is at 2. For most water conditions, set the adjuster to 1 or 2. If there are rings or calcium (hard water) spots on dishes, try a higher setting.

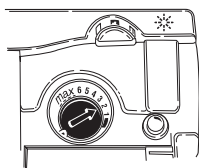

### To adjust the setting

Open the dispenser cover. Turn the adjuster inside the dispenser to the desired setting.

## Dishwasher Efficiency Tips

Hot water dissolves and activates the dishwashing detergent. Hot water also dissolves grease on dishes and helps glasses dry spot-free. Is the water temperature too low? For best dishwashing results, water should be 120°F (49°C) as it enters the dishwasher. Loads may not wash as well if the water temperature is too low. Water that is too hot can make some soils harder to remove and cause certain detergent ingredients not to function. If your water heater is located far from the dishwasher, it may be necessary to run the hot water at the faucet closest to the dishwasher to minimize the amount of cold water in the water line.

### To check water temperature

1. Run hot water at the faucet closest to your dishwasher for at least 1 minute.
2. Place a candy or meat thermometer in a glass measuring cup.



3. Check the temperature on the thermometer as the water is running into the cup.
  - To save water, energy and time, do not rinse dishes before putting them into the dishwasher.
  - Use the Normal cycle whenever possible. This cycle uses less hot water and energy than other cycles.
  - Use a delay feature (on some models) to run your dishwasher during off-peak hours. Local utilities recommend avoiding heavy usage of energy at certain times of day.
  - During the summer, run your dishwasher at night. This reduces daytime heat buildup in the kitchen.
  - Use an air dry, or an energy-saving dry option whenever possible. Allow longer drying times (overnight) when using these options. Use a rinse aid to improve drying.
  - Use cycles or options that add extra heat to the wash or rinse portion of the cycle only when needed.
  - Run your dishwasher with full loads. Run a rinse cycle after meals until the dishwasher is full.
  - If your home is equipped with a water softener, you may want to avoid starting the dishwasher during the regeneration of the softener, as this may contribute to poor wash performance.

## Cycle Selection Charts

Select the wash cycle and options desired. Or press START to repeat the same cycle and options as the previous cycle.

**NOTE:** If the last cycle you completed was a rinse cycle, the dishwasher will run the last full wash cycle and options that you selected when you press Start.

- If the power is off or the door is open for an extended period of time, the Start button memory will default to the Normal cycle with heated drying.
- If you do not run the dishwasher daily, close the door to maintain memory.



A “●” shows what steps are in each cycle.



Temperatures indicate where extra heat is added.



Water usage is shown in U.S. gallons/liters.

This model meets the ENERGY STAR® guidelines for energy efficiency.

Cycle time includes dry time. An asterisk ( \* ) by the cycle time indicates the cycle time might be longer depending on the temperature of the water entering the dishwasher. The cooler the water, the longer the cycle time. If the water is already hot enough, the cycle time will be as shown.

		Use this cycle for heavily-soiled pots, pans, casseroles, regular tableware and harder than normal water conditions.				<b>Use both detergent dispenser sections.</b>	
Pre-Wash	Main Wash	Rinse	Rinse	Final Heated Rinse	Dry	Time (min)	Water Usage (gal/L)
● 130°F (54°C)	● 140°F (60°C)	●		● 140°F (60°C)	●	89*	6.9/26

		Use this cycle for loads with normal amounts of food soil. (The energy-usage label is based on this cycle.)				<b>Use both detergent dispenser sections.</b>	
Pre-Wash	Main Wash	Purge†	Rinse	Final Heated Rinse	Dry	Time (min)	Water Usage (gal/L)
●	● 120°F (49°C)	●		● 140°F (60°C)	●	79*	5.9/22.3

		Use this rinse cycle for rinsing dishes, glasses, and silverware that will not be washed right away.				<b>Do not use detergent with this cycle.</b>	
Pre-Wash	Rinse	Main Wash	Rinse	Final Heated Rinse	Dry	Time (min)	Water Usage (gal/L)
			●			10	1.8/7

† A small amount of water is run through the pump to remove soil particles between the main wash and final rinse.

## Canceling a Cycle

Anytime during a cycle, press



Cancel glows. The dishwasher starts a 2-minute drain (if needed). Let the dishwasher drain completely. The light goes off when the dishwasher finishes the drain.

### To stop the drain

You can press Cancel again to stop the drain immediately. Remember to drain the dishwasher before starting a new cycle.

### To clear the indicators

Press Cancel before starting the dishwasher to clear all options and cycles.

## Changing a Cycle or Setting

### During the first minute of a cycle

Press a new cycle and/or options.

### After the first minute of a cycle

1. Press



Cancel glows. The dishwasher starts a 2-minute drain (if needed). Let the dishwasher drain completely.

2. Check the detergent dispensers. If the main wash cup has opened and the detergent washed away, refill the cups as needed.
3. Close the door.
4. Press a new cycle and/or options.
5. Press START.

## Adding Items During a Cycle

You can add an item anytime before the main wash starts. Open the door and check the detergent dispenser. If the cover is still closed, you can add items.

### To add items

1. Lift up the door latch to stop the cycle. Wait for the spraying action to stop before opening the door.
2. Open the door. If the detergent dispenser cover is still closed, add the item.
3. Close the door firmly until it latches. The dishwasher resumes the cycle after about a 5-second pause.

---

## Option Selections

You can customize your cycles by pressing an option. If you change your mind, press the option again to turn the option off. Select a different option if desired.

You can change an option anytime before the selected option begins. For example, you can press an unheated drying option any time before drying begins.

Press **START** to repeat the same cycle and options as the previous wash cycle.

**NOTE:** If the last cycle you completed was a rinse cycle, when you press Start, the dishwasher runs the last full wash cycle and options.

### Hi-Temp Scrub

Select this option to raise the water temperature in the main wash, and add a rinse. The higher water temperature, and added rinse, help clean tough soils.

This option adds heat, water and wash time to the cycle.



**NOTE:** Hi-Temp Scrub is an option with the Heavy and Normal cycles.

### ENERGY SAVER™ Dry System

Select this option to dry dishes without heat and save energy. ENERGY SAVER™ Dry System is useful when loads contain plastic dinnerware that may be sensitive to high temperatures.



The dishes take longer to dry, and some spotting can occur. For best drying, use a liquid rinse aid. Some items (such as plastics) may need towel drying.

**NOTE:** Rinse Only automatically uses this option. ENERGY SAVER™ Dry System is an option with all other cycles.

### Control Lock

Use Control Lock to prevent unintended use of your dishwasher. You can also use the control lock feature to prevent unintended cycle or option changes during a cycle.



When **CONTROL LOCK** is lit, all buttons are disabled.

#### NOTES:

- The dishwasher door can be opened while the controls are locked.
- You can turn on the Lock while the dishwasher is running.

### To turn on the Lock

Press and hold



for 4 seconds. **CONTROL LOCK** glows.

If you press any pad while your dishwasher is locked, the light flashes 3 times.

### To turn off the Lock

Press and hold **ENERGY SAVER™ Dry System** control for 4 seconds. The light turns off.

---

## Status Indicators

- Water Heating
- Clean

### Water Heating

**WATER HEATING** glows, and the cycle progression pauses, whenever water is heated during a cycle.

Wash or rinse action continues as the water heats.

### Clean

**CLEAN** glows when a cycle is finished. The light turns on when you open the door. The light turns off when you close the door or press **CANCEL**.

---

## Wash System

The five-level wash system provides excellent cleaning results. Four levels of filtration, and a soil collector system, filter the wash water and prevent food particles from redepositing on the clean dishes.

- The wash water continuously flows through the Ultra-Fine filter, trapping food particles.

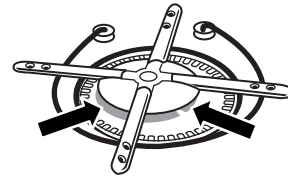

- Two water jets, located under the spray arm remove the food particles from the Ultra-Fine filter.
- A coarse strainer prevents bones, pits, and other large objects from entering the pump system.

**NOTE:** Periodically check the coarse strainer and remove any objects on the strainer.

## Drying System

During drying, you can see steam escaping through the vent at the upper left corner of the door. This is normal as the heat dries your dishes.

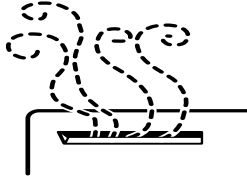

**IMPORTANT:** The vapor is hot. Do not touch the vent during drying.

## Overfill Protection Float

The overfill protection float (in the front right corner of the dishwasher tub) keeps the dishwasher from overflowing. It must be in place for the dishwasher to operate.



Check under the float for objects that may keep the protector from moving up or down.

# WASHING SPECIAL ITEMS

If you have doubts about washing a particular item, check with the manufacturer to see if it is dishwasher safe.

Material	Dishwasher Safe?/Comments
Aluminum	<b>Yes</b> High water temperature and detergents can affect finish of anodized aluminum.
Disposable Aluminum	<b>No</b> Do not wash throwaway aluminum pans in the dishwasher. These might shift during washing and transfer black marks to dishes and other items.
Bottles and Cans	<b>No</b> Wash bottles and cans by hand. Labels attached with glue can loosen and clog the spray arms or pump and reduce washing performance.
Cast Iron	<b>No</b> Seasoning will be removed and iron will rust.

Material	Dishwasher Safe?/Comments
China/ Stoneware	<b>Yes</b> Always check manufacturer's recommendations before washing. Antique, hand-painted, or over-the-glaze patterns may fade. Gold leaf can discolor or fade.
Crystal	<b>Yes</b> Check manufacturer's recommendations before washing. Some types of leaded crystal can etch with repeated washing.
Gold	<b>No</b> Gold-colored flatware will discolor.
Glass	<b>Yes</b> Milk glass yellows with repeated dishwasher washing.
Hollow-Handle Knives	<b>No</b> Handles of some knives are attached to the blade with adhesives which can loosen if washed in the dishwasher.
Pewter, Brass, Bronze	<b>No</b> High water temperatures and detergent can discolor or pit the finish.
Disposable Plastics	<b>No</b> Cannot withstand high water temperatures and detergents.
Plastics	<b>Yes</b> Always check manufacturer's recommendations before washing. Plastics vary in their capacity to withstand high temperatures and detergents. Load plastics in top rack only.
Stainless Steel	<b>Yes</b> Run a rinse cycle if not washing immediately. Prolonged contact with food containing salt, vinegar, milk products, or fruit juice can damage finish.
Sterling Silver or Silver Plate	<b>Yes</b> Run a rinse cycle if not washing immediately. Prolonged contact with food containing salt, acid, or sulfide (eggs, mayonnaise, and seafood) can damage finish.
Tin	<b>No</b> Can rust.
Wooden Ware	<b>No</b> Wash by hand. Always check manufacturer's instructions before washing. Untreated wood can warp, crack, or lose its finish.

---

# DISHWASHER CARE

---

## Cleaning

### Cleaning the exterior

In most cases, regular use of a soft, damp cloth or sponge and a mild detergent is all that is necessary to keep the outside of your dishwasher looking nice and clean.

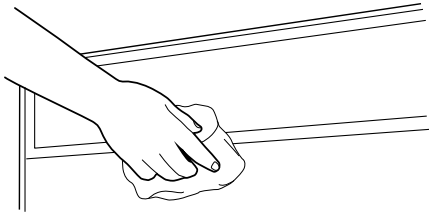

### Cleaning the interior

Hard water minerals can cause a white film to build up on the inside surfaces, especially just beneath the door area.

Do not clean the dishwasher interior until it has cooled. Wear rubber gloves. Do not use any type of cleanser other than dishwasher detergent because it may cause foaming or sudsing.

#### To clean interior

Make a paste with powdered dishwasher detergent on a damp sponge and clean.

#### OR

Use liquid automatic dishwasher detergent and clean with a damp sponge.

#### OR

See the vinegar rinse procedure in "Spotting and filming on dishes" in "Troubleshooting."

**NOTE:** Run a Normal cycle with detergent after cleaning the interior.

---

## Drain Air Gap

Check the drain air gap anytime your dishwasher isn't draining well.

Some state or local plumbing codes require the addition of a drain air gap between a built-in dishwasher and the home drain system. If a drain is clogged, the drain air gap protects your dishwasher from water backing up into it.

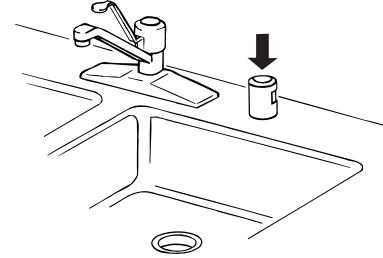

The drain air gap is usually located on top of the sink or countertop near the dishwasher. To order a drain air gap call your local dealer, or in the U.S.A., call the Customer Interaction Center and ask for Part Number 300096.

**NOTE:** The drain air gap is an external plumbing device that is not part of your dishwasher. The warranty provided with your dishwasher does not cover service costs directly associated with the cleaning or repair of the external drain air gap.

#### To clean the drain air gap

Clean the drain air gap periodically to ensure proper drainage of your dishwasher. Follow the cleaning instructions provided by the manufacturer. With most types, you lift off the chrome cover. Unscrew the plastic cap. Then check for any soil buildup. Clean if necessary.

---

## Storing

### Storing for the summer

Protect your dishwasher during the summer months by turning off the water supply and power supply to the dishwasher.

### Winterizing your dishwasher

Protect your dishwasher and home against water damage due to freezing water lines. If your dishwasher is left in a seasonal dwelling or could be exposed to near freezing temperatures, have your dishwasher winterized by authorized service personnel.

---

# TROUBLESHOOTING

First try the solutions suggested here and possibly avoid the cost of a service call...

---

## Dishwasher is not operating properly

---

### ■ Dishwasher does not run or stops during a cycle

Is the door closed tightly and latched?

Is the right cycle selected? Refer to the “Cycle Selection Charts.”

Is there power to the dishwasher? Has a household fuse blown or circuit breaker tripped?

Has the motor stopped due to an overload? The motor automatically resets itself within a few minutes. If it does not restart, call for service.

Is the water shut-off valve (if installed) turned on?

### ■ Dishwasher will not fill

Is the overflow protection float able to move up and down freely? Press down to release.

### ■ Dishwasher seems to run too long

Is the water supplied to the dishwasher hot enough? The dishwasher runs longer while heating water. Refer to the “Dishwasher Efficiency Tips” section.

A delay automatically occurs in some wash and rinse cycles until the water reaches the proper temperature.

### ■ Water remains in the dishwasher

Is the cycle complete?

### ■ Detergent remains in the covered section of the dispenser

Is the cycle complete?

Is the detergent lump-free? Replace detergent if necessary.

### ■ White residue on the front of the access panel

Was too much detergent used? Refer to the “Detergent Dispenser” section.

Is the brand of detergent making excess foam? Try a different brand to reduce foaming and eliminate buildup.

### ■ Odor in the dishwasher

Are dishes washed only every 2 or 3 days? Run a rinse cycle once or twice a day until you have a full load.

Does the dishwasher have a new plastic smell? Run a vinegar rinse as described in “Spotting and filming on dishes” later in this Troubleshooting guide.

### ■ Condensation on the kitchen counter (built-in models)

Is the dishwasher aligned with the countertop? Moisture from the vent in the dishwasher console can form on the counter. Refer to the Installation Instructions for more information.

---

## Dishes are not completely clean

---

### ■ Food soil left on the dishes

Is the dishwasher loaded correctly? Refer to the “Dishwasher Loading” section.

Is the water temperature too low? For best dishwashing results, water should be 120°F (49°C) as it enters the dishwasher. Refer to the “Dishwasher Efficiency Tips” section.

Did you use the correct amount of fresh detergent? Use recommended dishwasher detergents only. Refer to the “Detergent Dispenser” section. Never use less than 1 tb (15 g) per load. Detergent must be fresh to be effective. Store detergent in a cool, dry area. Heavy soil and/or hard water generally require extra detergent.

Is detergent caked in dispenser? Use fresh detergent only. Do not allow detergent to sit for several hours in a wet dispenser. Clean dispenser when caked detergent is present.

Is the pump or spray arm clogged by labels from bottles and cans? If you wash bottles and cans in your dishwasher, check for labels clogging the pump or spray arm.

Is the home water pressure high enough for proper dishwasher filling? Home water pressure should be 20 to 120 psi (138 to 828 kPa) for proper dishwasher fill. A booster pump on the water supply can be added if pressure is too low.

Are high suds slowing the wash arm? Never use soap or laundry detergents. Use recommended dishwasher detergents only.

---

## Spots and stains on dishes

---

### ■ Spotting and filming on dishes

Is your water hard or is there a high mineral content in your water? Conditioning the final rinse water with a liquid rinse aid helps eliminate spotting and filming. Keep the rinse aid dispenser filled.

Is the water temperature too low? For best dishwashing results, water should be 120°F (49°C) as it enters the dishwasher. Refer to the “Dishwasher Efficiency Tips” section.

Did you use the correct amount of effective detergent? Use recommended dishwasher detergents only. Refer to the “Detergent Dispenser” section. Never use less than 1 tb (15 g) per load. Detergent must be fresh to be effective. Store detergent in a cool, dry area. Heavy soil and/or hard water generally require extra detergent.

Is the home water pressure high enough for proper dishwasher filling? Home water pressure should be 20 to 120 psi (138 to 828 kPa) for proper dishwasher fill. A booster pump on the water supply can be added if pressure is too low.

**NOTE:** To remove spots and film from dishes, try a white vinegar rinse. This procedure is intended for occasional use only. Vinegar is an acid and using it too often could damage your dishwasher.

1. Wash and rinse dishes. Use an air-dry or an energy saving dry option. Remove all silverware or metal items.
2. Put 2 cups (500 mL) white vinegar in a glass or dishwasher-safe measuring cup on the bottom rack.
3. Run the dishwasher through a complete washing cycle using an air-dry or an energy saving dry option. Do not use detergent. Vinegar will mix with the wash water.

■ **Silica film or etching (silica film is a milky, rainbow-colored deposit; etching is a cloudy film)**

Sometimes there is a water/chemical reaction with certain types of glassware. This is usually caused by some combination of soft or softened water, alkaline washing solutions, insufficient rinsing, overloading the dishwasher, and the heat of drying. It might not be possible to prevent the problem, except by hand washing.

To slow this process use a minimum amount of detergent but not less than 1 tb (15 g) per load. Use a liquid rinse aid and underload the dishwasher to allow thorough rinsing. Silica film and etching are permanent and cannot be removed. Do not use heated drying.

■ **White spots on cookware with non-stick finish**

Has the dishwasher detergent removed cookware seasoning? Reseason cookware after washing in the dishwasher.

■ **Brown stains on dishes and dishwasher interior**

Does your water have high iron content? Rewash dishes using 1-3 tsp (5-15 mL) of citric acid crystals added to the covered section of the detergent dispenser. Do not use detergent. Follow with a Normal wash cycle with detergent. If treatment is needed more often than every other month, the installation of an iron removal unit is recommended.

■ **Black or gray marks on dishes**

Are aluminum items rubbing dishes during washing? Disposable aluminum items can break down in the dishwasher and cause marking. Hand wash these items. Remove aluminum markings by using a mild abrasive cleaner.

■ **Orange stains on plastic dishes or dishwasher interior**

Are large amounts of tomato-based foods on dishes placed in the dishwasher? Stains gradually fade over time. Regular use of heated drying will slow fading. Stains will not affect dishwasher performance. Regular use of a rinse cycle and an air-dry or energy-saving dry option will reduce the likelihood of staining.

---

**Dishes do not dry completely**

---

■ **Dishes are not dry**

Did you load your dishwasher to allow proper water drainage? Do not overload. Refer to the “Dishwasher Loading” section. Use a liquid rinse aid to speed drying.

Are the plastics wet? Plastics often need towel drying.

Is the rinse aid dispenser empty? Refer to the “Rinse Aid Dispenser” section.

Did you use an air-dry or energy-saving dry option? Use a heated drying option for dryer dishes.

---

**Dishes are damaged during a cycle**

---

■ **Chipping of dishes**

Did you load the dishwasher properly? Load the dishes and glasses so they are stable and do not strike together from washing action. Minimize chipping by moving the rack in and out slowly.

**NOTE:** Antiques, feather-edged crystal, and similar types of china and glassware might be too delicate for automatic dishwashing. Wash by hand.

---

**Noises**

---

■ **Grinding, grating, crunching or buzzing sounds**

A hard object has entered the wash module (on some models). When the object is ground up, the sound should stop.



---

# ASSISTANCE OR SERVICE

Before calling for assistance or service, please check "Troubleshooting." It may save you the cost of a service call. If you still need help, follow the instructions below.

When calling, please know the purchase date and the complete model and serial number of your appliance. This information will help us to better respond to your request.

## If you need replacement parts

If you need to order replacement parts, we recommend that you only use factory specified parts. These parts will fit right and work right, because they are made with the same precision used to build every new KITCHENAID® appliance. To locate factory specified replacement parts in your area, call our Customer Interaction Center telephone number or your nearest designated service center.

---

## In the U.S.A.

Call the KitchenAid Customer Interaction Center toll free: **1-800-422-1230**.

### Our consultants provide assistance with:

- Features and specifications on our full line of appliances.
- Installation information.
- Use and maintenance procedures.
- Accessory and repair parts sales.
- Specialized customer assistance (Spanish speaking, hearing impaired, limited vision, etc.).
- Referrals to local dealers, repair parts distributors, and service companies. KitchenAid designated service technicians are trained to fulfill the product warranty and provide after-warranty service, anywhere in the United States.

To locate the KitchenAid designated service company in your area, you can also look in your telephone directory Yellow Pages.

### For further assistance

If you need further assistance, you can write to KitchenAid with any questions or concerns at:

KitchenAid Brand Home Appliances  
Customer Interaction Center  
553 Benson Road  
Benton Harbor, MI 49022-2692

Please include a daytime phone number in your correspondence.

---

## In Canada

Call the KitchenAid Canada Customer Interaction Center toll free: **1-800-461-5681** Monday to Friday 8:00 a.m. - 6:00 p.m. (EST). Saturday 8:30 a.m. - 4:30 p.m. (EST).

### Our consultants provide assistance with:

- Features and specifications on our full line of appliances.
- Referrals to local dealers.

### For service in Canada

Call **1-800-807-6777**. KitchenAid designated service technicians are trained to fulfill the product warranty and provide after-warranty service, anywhere in Canada.

### For further assistance

If you need further assistance, you can write to KitchenAid Canada with any questions or concerns at:

KitchenAid Canada  
Customer Interaction Center  
1901 Minnesota Court  
Mississauga, Ontario L5N 3A7

Please include a daytime phone number in your correspondence.

---

# KITCHENAID® DISHWASHER WARRANTY

---

## ONE-YEAR FULL WARRANTY

For one year from the date of purchase, when this dishwasher is operated and maintained according to instructions attached to or furnished with the product, KitchenAid will pay for replacement parts and repair labor to correct defects in materials or workmanship. Service must be provided by a KitchenAid designated service company.

---

## SECOND THROUGH FIFTH YEAR LIMITED WARRANTY ON NYLON COATED DISHRACKS, WASH AND DRAIN MOTOR, ELECTRONIC CONTROL SYSTEM AND HEATING ELEMENT

In the second through fifth years from the date of purchase, when this dishwasher is operated and maintained according to instructions attached to or furnished with the product, KitchenAid will pay for replacement parts for the following components if defective in materials or workmanship: the upper and lower nylon racks, the wash and drain motor, the electronic controls, the heating element.

---

## LIFETIME FULL WARRANTY ON STAINLESS STEEL TUB AND INNER DOOR

For the lifetime of the product from the date of purchase, when this dishwasher is operated and maintained according to instructions attached to or furnished with the product, KitchenAid will pay for replacement parts and repair labor for the stainless steel tub and/or inner door if the tub and/or inner door develops a water leak caused by rust-through resulting from defective materials or workmanship. Service must be provided by a KitchenAid designated service company.

---

### KitchenAid will not pay for:

1. Service calls to correct the installation of your dishwasher, to instruct you how to use your dishwasher, to replace house fuses or correct house wiring or plumbing.
  2. Repairs when your dishwasher is used in other than normal, single-family household use.
  3. Damage resulting from accident, alteration, misuse, abuse, fire, floods, acts of God, improper installation, or installation not in accordance with local electrical and plumbing codes, or the use of products not approved by KitchenAid.
  4. Any labor costs during the limited warranty period.
  5. Replacement parts or repair labor costs for units operated outside the United States or Canada.
  6. Pickup and delivery. This product is designed to be repaired in the home.
  7. Repairs to parts or systems resulting from unauthorized modifications made to the appliance.
  8. In Canada, travel or transportation expenses for customers who reside in remote areas.
- 

## KITCHENAID AND KITCHENAID CANADA SHALL NOT BE LIABLE FOR INCIDENTAL OR CONSEQUENTIAL DAMAGES.

Some states or provinces do not allow the exclusion or limitation of incidental or consequential damages, so this exclusion or limitation may not apply to you. This warranty gives you specific legal rights and you may also have other rights which may vary from state to state or province to province.

**Outside the 50 United States and Canada, this warranty does not apply. Contact your authorized KitchenAid dealer to determine if another warranty applies.**

If you need service, first see "Troubleshooting." Additional help can be found by checking "Assistance or Service," or by calling our Customer Interaction Center at **1-800-422-1230**, from anywhere in the U.S.A. or write: KitchenAid Brand Home Appliances, Customer Interaction Center, 553 Benson Road, Benton Harbor, MI 49022-2692. In Canada, call KitchenAid Canada at **1-800-807-6777**. 11/00

---

**Keep this book and your sales slip together for future reference. You must provide proof of purchase or installation date for in-warranty service.**

Write down the following information about your dishwasher to better help you obtain assistance or service if you ever need it. You will need to know your complete model number and serial number. You can find this information on the model and serial number label/plate, located on your appliance as shown in "Parts and Features."

Dealer name \_\_\_\_\_  
Address \_\_\_\_\_  
Phone number \_\_\_\_\_  
Model number \_\_\_\_\_  
Serial number \_\_\_\_\_  
Purchase date \_\_\_\_\_

**8531129**

© 2002. All rights reserved.  
Tous droits réservés.

® Registered Trademark/TM Trademark of KitchenAid, U.S.A., KitchenAid Canada licensee in Canada  
® Marque déposée/TM Marque de commerce de KitchenAid, U.S.A., Emploi licencié par KitchenAid Canada au Canada

6/02  
Printed in U.S.A.  
Imprimé aux É.-U.