

**KitchenAid®**

---

# UNDERCOUNTER DISHWASHER

Use & Care Guide

---

# LAVE-VAISSELLE ENCASTRÉ

Guide d'utilisation et d'entretien

---

Table of Contents/Table des matières.....2



*Save Water  
no pre-rinsing  
Économie d'eau  
sans prérinçage*

Models/Modèles KUDS25SH and KUDC25CH

9744039

[www.kitchenaid.com](http://www.kitchenaid.com)

# TABLE OF CONTENTS

<b>DISHWASHER SAFETY</b> .....	<b>3</b>
Before Using Your Dishwasher.....	4
<b>PARTS AND FEATURES</b> .....	<b>5</b>
<b>START-UP GUIDE</b> .....	<b>7</b>
Using Your New Dishwasher .....	7
<b>LOADING YOUR DISHWASHER</b> .....	<b>7</b>
Loading Suggestions .....	7
Loading the Top Rack.....	8
Loading the Bottom Rack.....	9
Loading the Silverware Basket .....	10
<b>USING YOUR DISHWASHER</b> .....	<b>11</b>
Detergent Dispenser .....	11
How Much Detergent to Use .....	11
Rinse Aid Dispenser.....	12
Dishwasher Efficiency Tips .....	12
Cycle Selection Chart .....	13
Canceling a Cycle .....	14
Changing a Cycle or Setting.....	14
Adding Items During a Cycle .....	14
Option Selections.....	14
Control Panel Lights.....	15
Wash System .....	16
Drying System .....	16
Overfill Protection Float.....	16
<b>WASHING SPECIAL ITEMS</b> .....	<b>17</b>
<b>CARING FOR YOUR DISHWASHER</b> .....	<b>18</b>
Cleaning Your Dishwasher.....	18
Drain Air Gap.....	18
Storing Your Dishwasher .....	19
<b>TROUBLESHOOTING</b> .....	<b>20</b>
<b>ASSISTANCE OR SERVICE</b> .....	<b>22</b>
In the U.S.A. ....	22
In Canada.....	22
<b>WARRANTY</b> .....	<b>23</b>

# TABLE DES MATIÈRES

<b>LA SÉCURITÉ DU LAVE-VAISSELLE</b> .....	<b>24</b>
Avant d'utiliser le lave-vaisselle.....	25
<b>PIÈCES ET CARACTÉRISTIQUES</b> .....	<b>26</b>
<b>GUIDE DE MISE EN MARCHÉ</b> .....	<b>28</b>
Utilisation de votre nouveau lave-vaisselle .....	28
<b>CHARGEMENT DU LAVE-VAISSELLE</b> .....	<b>29</b>
Suggestions de chargement.....	29
Chargement du panier supérieur.....	29
Chargement du panier inférieur.....	31
Chargement du panier à couverts.....	32
<b>UTILISATION DU LAVE-VAISSELLE</b> .....	<b>33</b>
Distributeur de détergent.....	33
Quantité de détergent à utiliser .....	33
Distributeur d'agent de rinçage .....	35
Conseils d'efficacité pour le lave-vaisselle.....	35
Tableau de sélection de programme.....	36
Annulation d'un programme.....	37
Changement d'un programme ou réglage.....	37
Addition de vaisselle durant un programme .....	37
Sélection d'options.....	38
Lampes du tableau de commande.....	39
Système de lavage.....	40
Système de séchage .....	40
Dispositif de protection contre débordement .....	40
<b>LAVAGE D'ARTICLES SPÉCIAUX</b> .....	<b>41</b>
<b>ENTRETIEN DU LAVE-VAISSELLE</b> .....	<b>42</b>
Nettoyage du lave-vaisselle.....	42
Dispositif anti-refoulement.....	42
Remisage du lave-vaisselle .....	43
<b>DÉPANNAGE</b> .....	<b>44</b>
<b>ASSISTANCE OU SERVICE</b> .....	<b>47</b>
Aux États-Unis .....	47
Au Canada .....	47
<b>GARANTIE</b> .....	<b>48</b>

# DISHWASHER SAFETY

## Your safety and the safety of others is very important.

We have provided many important safety messages in this manual and on your appliance. Always read and obey all safety messages.



This is the safety alert symbol.

This symbol alerts you to hazards that can kill or hurt you and others.

All safety messages will be preceded by the safety alert symbol and the word "DANGER" or "WARNING." These words mean:

**⚠ DANGER**

You **will** be killed or seriously injured if you don't follow instructions.

**⚠ WARNING**

You **can** be killed or seriously injured if you don't follow instructions.

All safety messages will identify the hazard, tell you how to reduce the chance of injury, and tell you what can happen if the instructions are not followed.

## IMPORTANT SAFETY INSTRUCTIONS

**WARNING** – When using the dishwasher, follow basic precautions, including the following:

- Read all instructions before using the dishwasher.
- Use the dishwasher only for its intended function.
- Use only detergents or rinse agents recommended for use in a dishwasher, and keep them out of the reach of children.
- When loading items to be washed:
  - 1) Locate sharp items so that they are not likely to damage the door seal; and
  - 2) Load sharp knives with the handles up to reduce the risk of cut-type injuries.
- Do not wash plastic items unless they are marked "dishwasher safe" or the equivalent. For plastic items not so marked, check the manufacturer's recommendations.
- Do not touch the heating element during or immediately after use.
- Do not operate the dishwasher unless all enclosure panels are properly in place.
- Do not tamper with controls.
- Do not abuse, sit on, or stand on the door or dish racks of the dishwasher.
- To reduce the risk of injury, do not allow children to play in or on the dishwasher.
- Under certain conditions, hydrogen gas may be produced in a hot water system that has not been used for two weeks or more. **HYDROGEN GAS IS EXPLOSIVE.** If the hot water system has not been used for such a period, before using the dishwasher turn on all hot water faucets and let the water flow from each for several minutes. This will release any accumulated hydrogen gas. As the gas is flammable, do not smoke or use an open flame during this time.
- Remove the door to the washing compartment when removing an old dishwasher from service or discarding it.

**SAVE THESE INSTRUCTIONS**

# Before Using Your Dishwasher

## **⚠ WARNING**

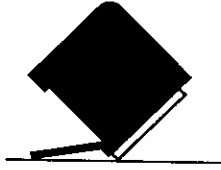

### **Tip Over Hazard**

- Do not use dishwasher until completely installed.**
- Do not push down on open door.**
- Doing so can result in serious injury or cuts.**

## **⚠ WARNING**



### **Electrical Shock Hazard**

- Electrically ground dishwasher.**
- Connect ground wire to green ground connector in terminal box.**
- Do not use an extension cord.**
- Failure to follow these instructions can result in death, fire, or electrical shock.**

- Install where dishwasher is protected from the elements. Protect against freezing to avoid possible rupture of fill valve. Such ruptures are not covered by the warranty. See "Storing Your Dishwasher" in the "Caring for Your Dishwasher" section for winter storage information.
- Install and level dishwasher on a floor that will hold the weight, and in an area suitable for its size and use.
- Remove all shipping plugs from hoses and connectors (such as the cap on the drain outlet) before installing. See Installation Instructions for complete information.

## **GROUNDING INSTRUCTIONS**

- For a grounded, cord-connected dishwasher:  
The dishwasher must be grounded. In the event of a malfunction or breakdown, grounding will reduce the risk of electric shock by providing a path of least resistance for electric current. The dishwasher is equipped with a cord having an equipment-grounding conductor and a grounding plug. The plug must be plugged into an appropriate outlet that is installed and grounded in accordance with all local codes and ordinances.

**WARNING** – Improper connection of the equipment-grounding conductor can result in a risk of electric shock. Check with a qualified electrician or service representative if you are in doubt whether the dishwasher is properly grounded. Do not modify the plug provided with the dishwasher; if it will not fit the outlet, have a proper outlet installed by a qualified electrician.

- For a permanently connected dishwasher:  
The dishwasher must be connected to a grounded metal, permanent wiring system, or an equipment-grounding conductor must be run with the circuit conductors and connected to the equipment-grounding terminal or lead on the dishwasher.

## **SAVE THESE INSTRUCTIONS**

# PARTS AND FEATURES

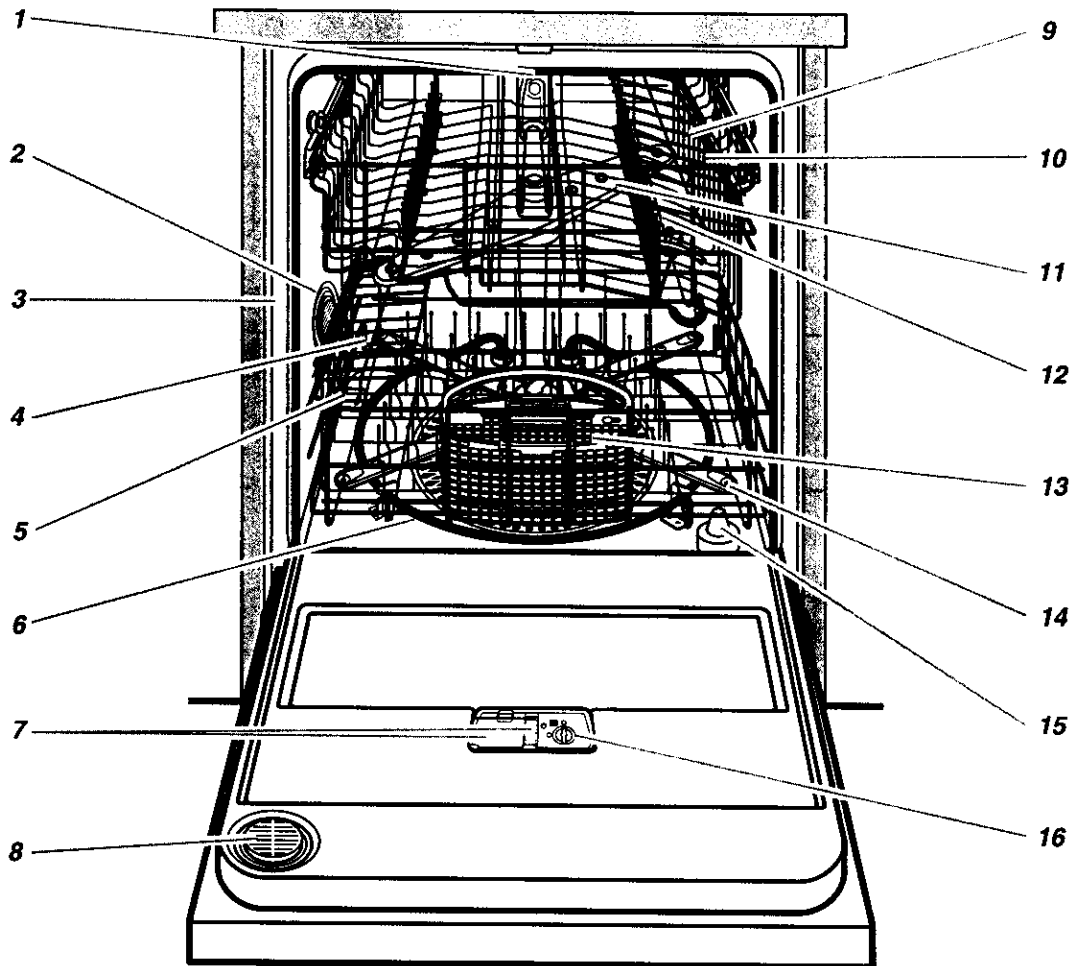

1. Upper spray
2. Water inlet opening
3. Model and serial number label
4. Cup shelf
5. Bottom rack
6. Heating element
7. Detergent dispenser
8. Vent
9. Cup shelf
10. Top rack

11. Top spray arm
12. Stemware holders
13. (FLEXI-BASKET™) split silverware basket
14. (4-WAY HYDRO SWEEP™) spray arm
15. Overfill protection float
16. Rinse aid dispenser

**Other features your dishwasher may have:**

(FLEXI-SPLIT™) fold-down tines, upper rack

No-flip clips

(FLEXI-FOLD DOWN™) fold-down tines, lower rack

# Control Panels

## Model KUDS25SH

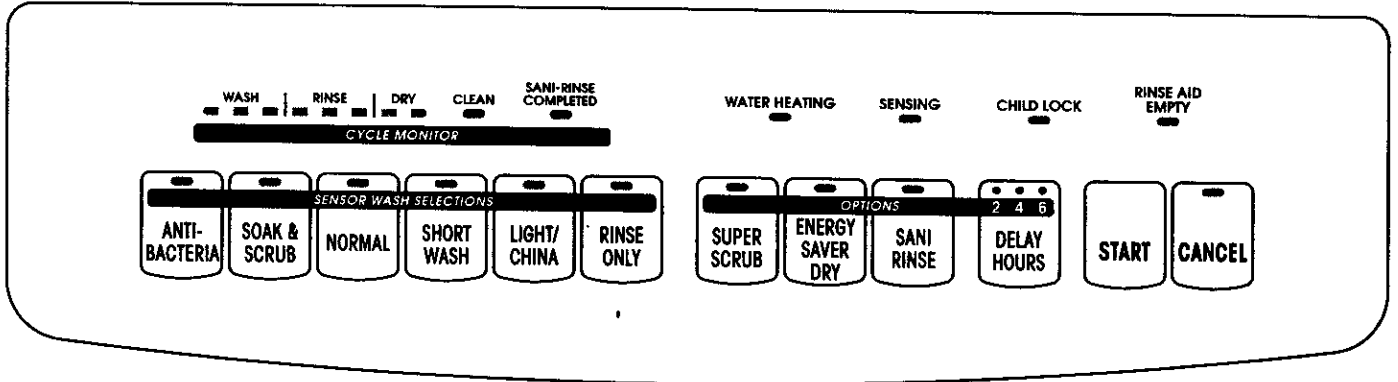

## Models KUDC25CH

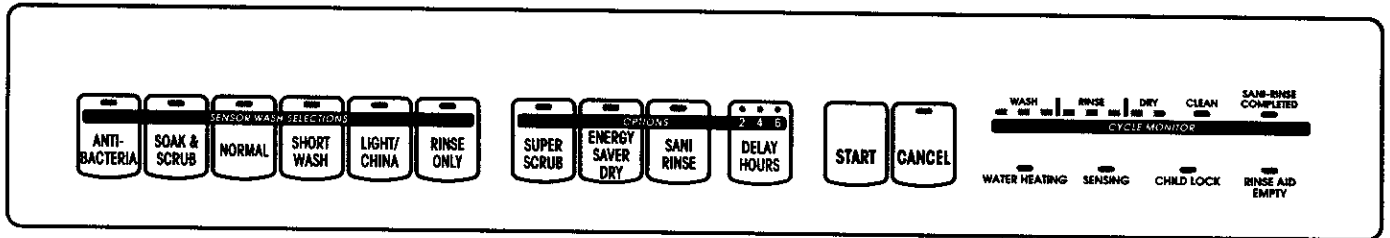

# START-UP GUIDE

Before using your dishwasher, remove all hang tags, temporary labels, and packaging materials. Read this entire Use and Care Guide. You will find important safety information and useful operating tips.

## Using Your New Dishwasher

1. Scrape large food soil and hard items (toothpicks or bones) from dishes.
2. Properly load the dishwasher. (See "Loading Your Dishwasher.") Make sure nothing prevents the spray arm(s) from spinning freely.

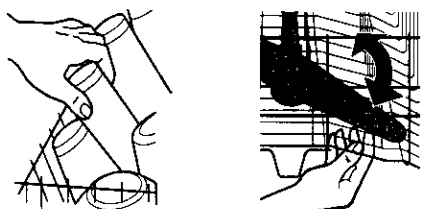

3. Add detergent and check the rinse aid dispenser. Add rinse aid if needed. (See "Using Your Dishwasher.")

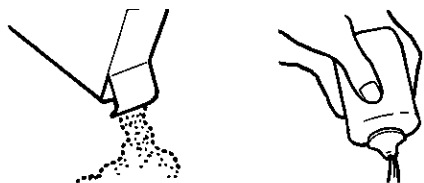

4. Push door firmly closed. The door latches automatically. Run hot water at the sink nearest your dishwasher until the water is hot. (See "Dishwasher Efficiency Tips.") Turn off water.

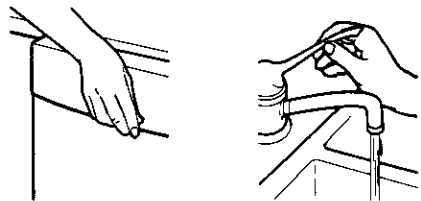

5. Press the desired cycle and option selections. (See "Using Your Dishwasher.") Press START.

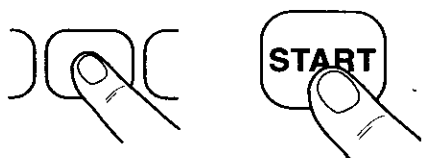

# LOADING YOUR DISHWASHER

## Loading Suggestions

- Remove leftover food, bones, toothpicks and other hard items from the dishes. It is not necessary to rinse the dishes before putting them in the dishwasher. The wash module removes food particles from the water. The module contains a chopping device which will reduce the size of food items.

**NOTE:** If hard items such as fruit seeds, nuts, and egg shells enter the wash module, you might hear chopping, grinding, crunching, or buzzing sounds. These sounds are normal when hard items enter the module. Do not let metallic items (such as pot handle screws) get into the wash module. Damage can occur.

- Load dishes so soiled surfaces face the spray (down or inward). It is important for the water spray to reach all soiled surfaces.
- Load dishes so they are not stacked or overlapping if possible. For best drying, water must be able to drain from all surfaces.
- Load heavy pots and pans carefully. Heavy items can dent the stainless steel interior of the door if they are dropped or bumped.
- Make sure pot lids and handles, pizza pans, cookie sheets, etc., do not interfere with the spray arm rotation.
- Run a rinse cycle to keep dishes moist if you do not plan to wash them soon. Foods like eggs, rice, pasta, spinach, and cooked cereals may be hard to remove if they are left to dry over a period of time.

### Quiet operating tips

To avoid thumping/clattering noises during operation:

- Make sure lightweight load items are secured in the racks.
- Make sure pot lids and handles, pizza pans, cookie sheets, etc., do not touch interior walls or interfere with the rotation of the spray arm.
- Load dishes so they do not touch one another.

**NOTE:** For built-in models, keep sink drain plugs closed during dishwasher operation to prevent noise transfer through drains.

# Loading the Top Rack

The top rack is designed for cups, glasses, and smaller items. (See recommended loading patterns shown.)

**NOTE:** The features on your dishwasher rack may vary from the drawings shown..

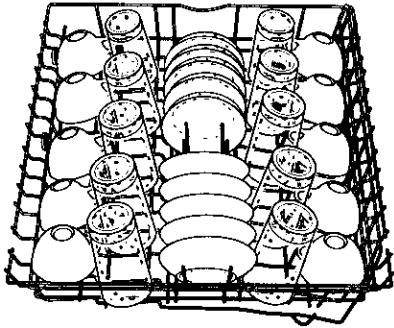

*10 place setting load*

- Place items so open ends face down for cleaning and draining.
- Load glasses and cups in top rack only. The bottom rack is not designed for glasses and cups. Damage can occur.

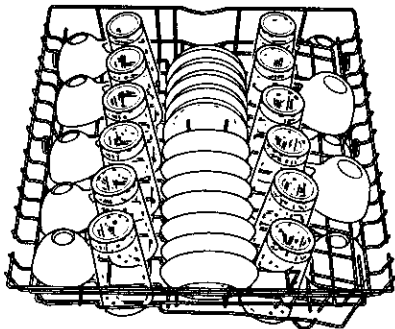

*12 place setting load*

- Place cups and glasses in the rows between prongs. Placing them over the prongs can lead to breakage.

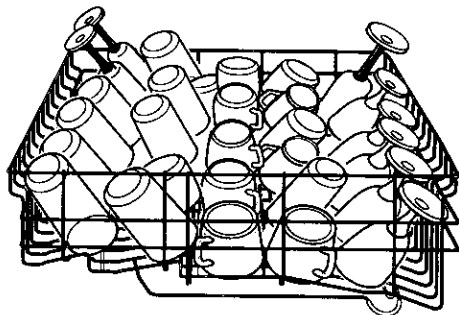

*Cup and glass load*

- To avoid chipping, do not let stemware touch other items.

- China, crystal, and other delicate items must not touch each other during dishwasher operation. Damage can occur.
- Wedge lightweight items against one another or overlap them with heavier dishes.
- Load plastic items securely in the top rack only. Wash only plastic items marked "dishwasher safe."
- Small bowls, pans, and other utensils can be placed in the top rack.
- Load bowls in the center section for best stability.

## Cup shelf

Fold down the extra shelf on the right side of the top rack to hold additional cups, or long items such as utensils and spatulas.

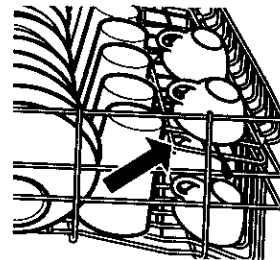

## Split fold-down tines

The row of tines on the right side of the top rack can be adjusted to make room for a variety of dishes. The tine adjusters have teal colored tips.

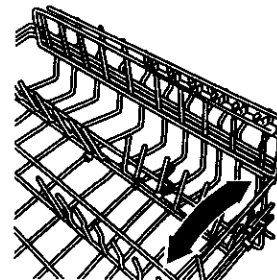

### To adjust the front half

1. Grasp the tip of the tine that is in the tine holder.
2. Gently push the tine out of the tine holder.
3. Move the tines to the left to make room for larger dishes. Move the tines to the right to wedge plastic or other lightweight items against the side of the rack.

### To adjust the back half

Push the tines down gently toward the center of the rack.



## Fold-down tines

The row of tines on the left side of the top rack can be adjusted to make room for a variety of dishes. The tine adjuster has a teal colored tip. Gently push the tine down, toward the center of the rack, to make room for larger dishes.

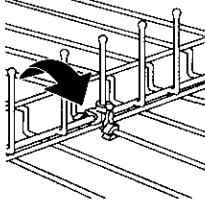

## Stemware holders

Use the stemware holders (attached to the cup shelf) to keep water goblets, wine glasses, etc., in place and prevent damage during washing.

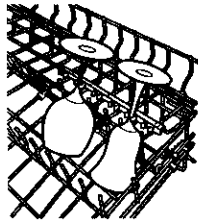

## No-flip clips

The no-flip clips hold lightweight plastic items like cups, lids, or bowls in place during washing. You can move a clip anywhere in the rack.

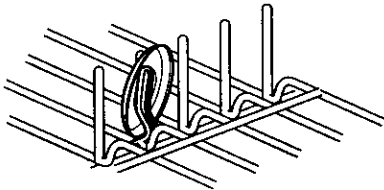

1. Pull the clip up and off the tine.
2. Reposition the clip on another tine.

# Loading the Bottom Rack

The bottom rack is designed for plates, pans, casseroles, and utensils. Items with cooked-on or dried-on food should be loaded with soiled surfaces facing inward to the spray. (See recommended loading patterns shown.)

**NOTE:** The features on your dishwasher rack may vary from the drawings shown.

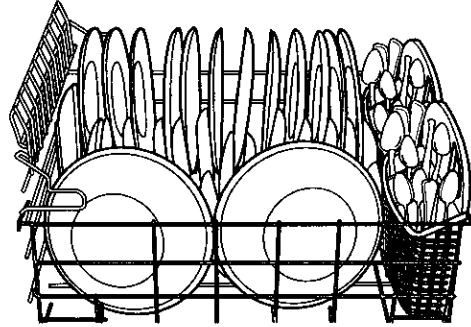

*Mixed load*

- Do not load glasses, cups, or plastic items in the bottom rack. Load small items in the bottom rack only if they are secured in place.
- Load plates, soup bowls, etc., between prongs and facing inward to the spray.
- Overlap the edges of plates for large loads.
- Load soup, cereal, and serving bowls in the rack in a variety of ways depending upon their size and shape. Load bowls securely between the rows of prongs. Do not nest bowls because the spray will not reach all surfaces.

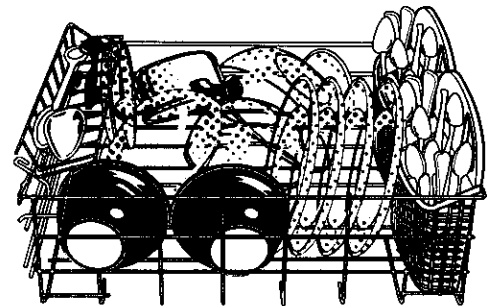

*Utensil load*

- Secure heavily soiled cookware face down in the rack.
- Make sure pot handles and other items do not stop rotation of the spray arm(s). The spray arm(s) must move freely.
- Do not load items between the bottom rack and the side of the dishwasher tub. You can block the water inlet opening.

## Split silverware basket

The split silverware basket can be separated and placed into the bottom rack in several locations.

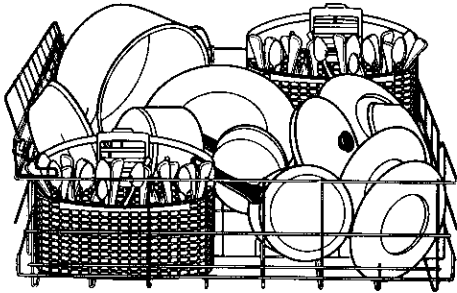

Hold the basket firmly and slide apart. You can use both sections or just one section to load silverware.

## Cup shelf

Fold down the extra shelf on the left side of the lower rack to hold small items such as cups or utensils.

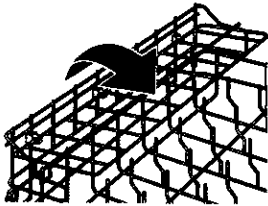

## Fold-down tines

You can fold down one or both rows of tines at the back of the bottom rack.

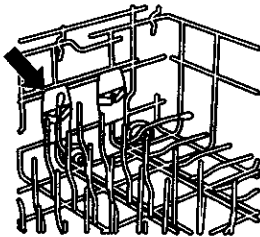

1. Grasp the tip of the tine that is in the tine holder.
2. Gently pull the tine out of the tine holder.
3. Lay the row of tines down in the rack to make room for larger dishes, bowls, pots, pans or roasters.

## Loading the Silverware Basket

Load the silverware basket while it is in the bottom rack or take the basket out for loading on a counter or table.

**NOTE:** You can remove the basket for easy unloading. Always unload or remove the basket before unloading the racks to avoid spilling water droplets on the silverware.

This silverware basket can be separated and placed into the bottom rack in several locations. Hold the basket firmly and slide it apart. Load silverware in both sections or just one, depending upon your load.

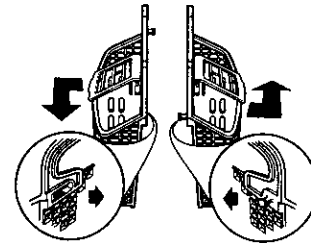

- Place small items like baby bottle caps, jar lids, corn cob holders, etc., in the section(s) with hinged cover(s). Close the cover to hold small items in place.
- Mix items in each section of the basket with some pointing up and some down to avoid nesting. Spray cannot reach nested items.

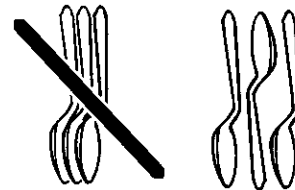

**IMPORTANT:** Always load sharp items (knives, skewers, forks, etc.) pointing down.

### NOTES:

- Do not load silver or silver-plated silverware with stainless steel. These metals can be damaged by contact with each other during washing.
- Some foods (such as salt, vinegar, milk products, fruit juices, etc.) can pit or corrode silverware. Run a rinse cycle if you do not have a full load to wash immediately.

# USING YOUR DISHWASHER

## Detergent Dispenser

The detergent dispenser has 2 sections. The smaller Pre-Wash section empties detergent into the dishwasher when you close the door. The larger Main Wash section automatically empties detergent into the dishwasher during the wash cycle.

- Use automatic dishwashing detergent only. Other detergents can produce excessive suds that can overflow out of the dishwasher and reduce washing performance.
- Add detergent just before starting cycle.
- Store tightly closed detergent in a cool, dry place. Fresh automatic dishwasher detergent results in better cleaning.

**NOTE:** Do not use detergent with a rinse cycle.

### Filling the dispenser

1. If the dispenser cover is closed, open the cover by rotating the button.

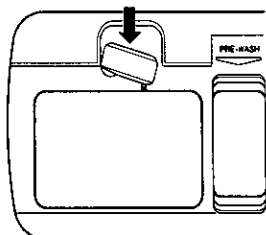

2. Fill the Main Wash section with detergent. See "How Much Detergent to Use."
3. Close the Main Wash dispenser cover. Fill the Pre-Wash section.

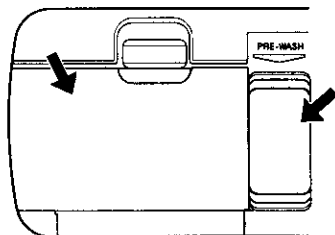

It is normal for the cover to open partially when dispensing detergent.

**NOTE:** Use both sections for cycles with 2 washes. Use only the covered section for cycles with 1 wash. See the "Cycle Selection Chart" for more details.

## How Much Detergent to Use

- The amount of detergent to use depends on the hardness of your water and the type of detergent. If you use too little, dishes won't be clean. If you use too much in soft water, glassware will etch.
- Water hardness can change over a period of time. Find out your water's hardness by asking your local water department, water softener company, or county extension agent.
- You can order a water hardness test strip. Call the Consumer Assistance Center at 1-800-422-1230 and ask for Part Number 4171690.
- Different brands of dishwasher detergent have different amounts of phosphorous for softening water. If you have hard water and use a detergent with a phosphorous content of less than 8.7%, you might need to use more detergent, or use a detergent with a phosphorous content higher than 8.7%.

Water Hardness	Amount of Detergent
<b>Soft to Medium Hard Water</b> 0 to 6 grains per gallon	<b>For normal loads</b> <ul style="list-style-type: none"><li>■ Partially fill the Main Wash section (2 tbs or 30 g)</li><li>■ Fill the Pre-Wash section (2 tbs or 30 g)</li></ul> <p><b>NOTE:</b> Add only 1 tb or 15 g of detergent to the Pre-Wash section if dishes are pre-rinsed or the water is very soft.</p> <p><b>For baked on soil loads:</b></p> <ul style="list-style-type: none"><li>■ Fill the Main Wash section (2 tbs or 30 g)</li><li>■ Fill the Pre-Wash section (2 tbs or 30 g)</li></ul> <p><b>For heavily soiled loads:</b></p> <ul style="list-style-type: none"><li>■ Fill the Main Wash section (3 tbs or 45 g)</li><li>■ Fill the Pre-Wash section (2 tbs or 30 g)</li></ul>
<b>Medium to Hard Water</b> 7 to 12 grains per gallon	<b>For normal and heavily soiled loads:</b> <ul style="list-style-type: none"><li>■ Fill the Main Wash section (3 tbs or 45 g)</li><li>■ Fill the Pre-Wash section (2 tbs or 30 g)</li></ul>

Water Hardness	Amount of Detergent
<b>Very Hard Water</b> 13 grains per gallon and above	<b>For normal loads:</b> <ul style="list-style-type: none"> <li>■ Fill the Main Wash section (3 tbs or 45 g)</li> <li>■ Fill the Pre-Wash section (2 tbs or 30 g)</li> <li>■ Turn the rinse aid dispenser to a higher setting. See "Rinse Aid Dispenser" later in this section.</li> </ul>
<b>NOTE:</b> It might be necessary to use the Soak & Scrub cycle, or the Normal cycle, with a High Temp wash option or Super Scrub (if available) for best wash performance with very hard water.	<b>For heavily soiled loads:</b> <ul style="list-style-type: none"> <li>■ Fill the Main Wash section. (3 tbs or 45 g)</li> <li>■ Fill the Pre-Wash section (2 tbs or 30 g)</li> <li>■ Turn the rinse aid dispenser to a higher setting. See "Rinse Aid Dispenser" later in this section.</li> </ul>

**NOTE:** Fill amounts shown are for standard powdered detergent. Amounts may vary if you use liquid or concentrated powdered detergent. Follow instructions on the package when using liquid dishwasher detergent or concentrated powdered detergent.

## Rinse Aid Dispenser

A rinse aid prevents water from forming droplets that can dry as spots or streaks. It also improves drying by allowing water to drain off of the dishes during the final rinse by releasing a small amount of the rinse aid into the rinse water. Your dishwasher is designed to use a liquid rinse aid. Do not use a solid or bar-type rinse aid.

### Filling the dispenser

The rinse aid dispenser holds 5.2 oz (153.7 mL) of rinse aid. Under normal conditions, this will last for about three months. You do not have to wait until the dispenser is empty to refill it. Try to keep it full, but be careful not to overfill it.

1. Make sure the dishwasher door is fully open.
2. Turn the dispenser knob to OPEN and lift it out.

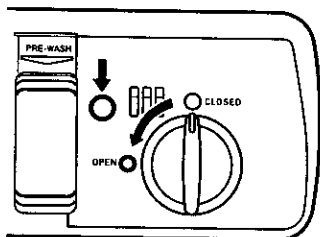

3. Add rinse aid until the indicator window looks full.
4. Clean up any spilled rinse aid with a damp cloth.
5. Replace the dispenser knob and turn it to CLOSED.

### Rinse aid setting

The amount of rinse aid released into the final wash can be adjusted. The factory setting is at 2. For most water conditions set the adjuster to 1 or 2. If there are rings or calcium (hard water) spots on dishes, try a higher setting.

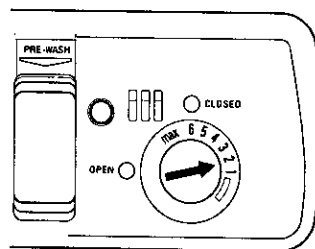

### To adjust the setting

Remove the dispenser knob, then turn the adjuster inside the dispenser to the desired setting.

## Dishwasher Efficiency Tips

Hot water dissolves and activates the dishwashing detergent. Hot water also dissolves grease on dishes and helps glasses dry spot-free. For best dishwashing results, water must be at least 120°F (49°C) as it enters the dishwasher. Loads may not wash as well if the water temperature is too low.

### To check water temperature

1. Run hot water at the faucet closest to your dishwasher for at least 1 minute.
2. Measure the water temperature with a candy or meat thermometer placed in the running stream of water.

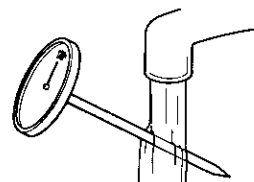

3. If the water temperature at the faucet is below 120°F (49°C), have a qualified person raise the water heater's thermostat setting.
  - Use a low energy, quick, or short cycle whenever possible. These cycles use less hot water and energy than the Normal wash cycle.
  - Use a delay feature (on some models) to run your dishwasher during off-peak hours. Local utilities recommend avoiding heavy usage of energy at certain times of day.
  - During the summer, run your dishwasher at night to reduce daytime heat buildup.

- Use an air dry, or an energy saving dry option whenever possible. Allow longer drying times (overnight) when using these options. Use a rinse aid to improve drying.
- Use cycles or options that add extra heat to the wash or rinse portion of the cycle only when needed.
- Run your dishwasher with full loads. Run a rinse cycle after meals until the dishwasher is full.

## Cycle Selection Chart

Select the wash cycle and options desired. Press START to use the same cycle and option(s) as the previous cycle.

**NOTE:** If the last cycle you completed was a rinse cycle, the dishwasher will run the last full wash cycle and options(s) that you selected when you press Start.

A "●" shows what steps are in each cycle.

### ANTI-BACTERIA

This cycle is the most aggressive cycle to virtually eliminate bacteria from your dish load. Also use this cycle for hard-to-clean, heavily soiled pots, pans, casseroles and regular tableware. The water heats to 135°F (57°C) during pre-wash, 145°F (63°C) in the main wash, and 155°F (68°C) in the final rinse; and when combined with our aggressive wash action and your regular dishwasher detergent, virtually eliminates food-soil bacteria.

**NOTE:** The Sani Rinse option is automatic with this cycle.

Use both detergent dispenser sections.

Pre-Wash	Rinse	Main Wash	Rinse	Purget	Rinse	Dry	Time (min)	Water Usage (gal/L)
●		●	●		●	●	85*	8.6/32.7

### SOAK & SCRUB

Use this cycle for hard-to-clean, heavily soiled pots, pans, casseroles, regular tableware, and harder than normal water conditions. The water heats to 135°F (57°C) during pre-wash, 140°F (60°C) in the main wash, and 140°F (60°C) in the final rinse.

Use both detergent dispenser sections.

Pre-Wash	Rinse	Main Wash	Rinse	Purget	Rinse	Dry	Time (min)	Water Usage (gal/L)
●		●	●		●	●	80*	8.6/32.7

### NORMAL

Use this cycle for loads with normal amounts of food soil. This cycle adds heat to the main wash and heats the water to 140°F (60°C) in the final rinse. (The energy usage label is based on this cycle.) When the wash sensor detects extra food soil, heating time is added in the main wash, if needed, to ensure a 140°F (60°C) wash temperature.

Use both detergent dispenser sections.

Pre-Wash	Rinse	Main Wash	Rinse	Purget	Rinse	Dry	Time (min)	Water Usage (gal/L)
●		●		●	●	●	75*	6.9/26.2

### SHORT WASH

Use this cycle for lightly soiled loads. This cycle adds heat to the main wash and heats the water to 140°F (60°C) in the final rinse. When the wash sensor detects extra food soil, heating time is added in the main wash, if needed, to ensure a 140°F (60°C) wash temperature.

Use both detergent dispenser sections.

Pre-Wash	Rinse	Main Wash	Rinse	Purget	Rinse	Dry	Time (min)	Water Usage (gal/L)
		●	●		●	●	68*	6.5/24.5

### LIGHT/CHINA

Use this cycle for china, crystal, and other delicate items. No extra heat is added to the main wash. Water heats to 130°F (54°C) in the final rinse.

Use covered detergent dispenser.

Pre-Wash	Rinse	Main Wash	Rinse	Purget	Rinse	Dry	Time (min)	Water Usage (gal/L)
		●	●		●	●	60*	6.5/24.5

### RINSE ONLY

Use this rinse cycle for rinsing dishes, glasses, and silverware that will not be washed right away.

Do not use detergent with the rinse cycle.

Pre-Wash	Rinse	Main Wash	Rinse	Purget	Rinse	Dry	Time (min)	Water Usage (gal/L)
	●						10	2.2/8.2

\* Expect longer cycle times if water entering the dishwasher is not hot enough.

† A small amount of water is run through the pump to remove soil particles between the main wash and final rinse.

**NOTE:** The sensor in your dishwasher monitors the soil level. Cycle time and/or water usage can vary from the numbers above as the sensor adjusts the cycle for the best wash performance.

---

## Canceling a Cycle

Anytime during a cycle, press



CANCEL glows. The dishwasher pauses for 5 seconds and starts a 2 minute drain (if needed). Let the dishwasher drain completely. The light goes off when the dishwasher finishes the drain.

---

## Option Selections

You can customize your cycles by pressing an option. If you change your mind, press the option again to turn the option off. Select a different option if desired.

You can change an option anytime before the selected option begins. For example, you can press an unheated drying option any time before drying begins.

Press START to use the same cycle and option(s) as the previous wash cycle.

**NOTE:** If the last cycle you completed was a rinse cycle, when you press Start, the dishwasher runs the last full wash cycle and option(s).

### Super Scrub

Select this high-temperature option for improved cleaning of heavily soiled dishes. Selecting this option adds heat and wash time to the wash cycle. Heating the water helps improve washing results.



**NOTE:** Super Scrub is an option with the Anti-Bacteria, Soak & Scrub and Normal cycles.

### Energy Saver Dry

Select this option to dry dishes without heat and save energy. The dishes take longer to dry and some spotting can occur.



For best drying, use a liquid rinse aid. Some items (such as plastics) may need towel drying.

**NOTE:** Energy Saver Dry is an option with all cycles except Rinse Only.

---

## Changing a Cycle or Setting

### During the first 2 minutes of a cycle

1. Press a new cycle and/or option(s).
2. Check the detergent dispensers. They must be filled properly for the new cycle.

### After the first 2 minutes of a cycle

Press



CANCEL glows. The dishwasher pauses for 5 seconds and starts a 2 minute drain (if needed). Let the dishwasher drain completely.

1. Check the detergent dispensers. They must be filled properly for the new cycle.
2. Close the door.
3. Press a new cycle and/or option(s).
4. Press START.

---

## Adding Items During a Cycle

You can add an item anytime before the main wash starts.

1. Lift up the door latch to stop the cycle. Wait for the spraying action to stop before opening the door.
2. Open the door and add the item.
3. Close the door, but do not latch it. Wait 30 seconds for the air in the dishwasher to warm up. This reduces the amount of moisture escaping from the vent when restarting a cycle.
4. Close the door firmly until it latches. The dishwasher resumes the cycle after about a 5 second pause.

## Sani Rinse option

Select this option to raise the water temperature in the final rinse to approximately 155° F (68° C) for 10 minutes. This high-temperature rinse sanitizes your dishes and glassware in accordance with the NSF International requirements (#95/480/05/2480).



**NOTE:** The Anti-Bacteria cycle automatically uses this option. Sani Rinse is an option with all other cycles, except Rinse Only and Light/China.

## Delay Hours

Select this option to run your dishwasher at a later time or during off-peak hours.

### To delay the start

1. Close the door.
2. Select a wash cycle and option(s).
3. Press DELAY HOURS 1 time for a 2-hour delay, 2 times for a 4-hour delay, or 3 times for a 6-hour delay start.



The number glows above Delay Hours. The dishwasher starts the cycle in the selected number of hours.

4. Press START.

**NOTE:** To cancel the delay, press DELAY HOURS until no number is lit.

### IMPORTANT:

- Operate your dishwasher only when you are at home.
- If your home is equipped with a water softener, do not start the dishwasher during the regeneration of the softener.

# Control Panel Lights

## Cycle Monitor

Follow the progress of your dishwasher cycles on the Cycle Monitor. CLEAN glows when a cycle is finished. The light turns off when you open the door.



## Water Heating light

WATER HEATING glows, and the cycle progression pauses, whenever water is heated during a cycle. Wash or rinse action continues as the water heats.

### WATER HEATING



## Sensing light

Your dishwasher senses the soil level on the dishes. Soil level determines the length of some cycles, the amount of heat added to a wash or rinse, and the cycle needed for the load. SENSING glows during the soil sensing parts of the cycle. Wash action continues while sensing occurs.

### SENSING



## Child Lock light

Use Child Lock to prevent your dishwasher from accidentally being turned on. Use Child Lock, also, to prevent accidental cycle or option changes during a cycle. When CHILD LOCK is lit, all buttons are disabled. You can turn on Child Lock while the dishwasher is running.

### CHILD LOCK



### To turn Child Lock on

Press and hold



for 4 seconds. CHILD LOCK glows. If you press any pad while your dishwasher is locked, the light flashes 3 times.

### To turn Child Lock off

Press and hold ENERGY SAVER DRY for 4 seconds. The light turns off.

**NOTE:** The dishwasher door can be opened while Child Lock is on.

### Rinse Aid Empty light

Fill the Rinse Aid dispenser when RINSE AID EMPTY is lit. A rinse aid prevents water from forming droplets that can dry as spots or streaks.



If the Rinse Aid dispenser is empty, the light glows when you select a cycle or while a cycle is running.

### Sani-Rinse Completed light

If you select the Sani Rinse option, SANI-RINSE COMPLETED glows when the Sani Rinse cycle is finished.



If your dishwasher did not properly sanitize your dishes, the light flashes at the end of the cycle. This can happen if the cycle is interrupted. The light goes off when you open the door.

## Wash System

The five-level wash system provides excellent cleaning results. A triple filtration and soil collector system filters the wash water and prevents food particles from redepositing on the clean dishes.

- The wash water continuously flows through the Ultra-Fine filter, trapping food particles. A small amount of water remains under the filter to keep the pump seal moist.

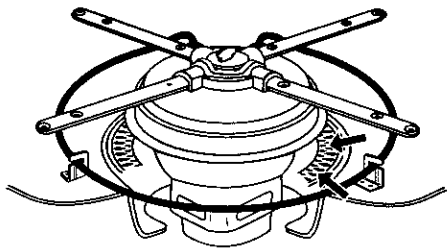

- As the Ultra-Fine filter traps food particles, the pressure in the pump increases. The sensor monitors this pressure and automatically adjusts the wash cycle for the best wash performance.
- Two water jets, located under the spray arm remove the food particles from the Ultra-Fine filter.
- A coarse strainer prevents bones, pits, and other large objects from entering the pump system.

**NOTE:** Periodically check the coarse strainer and remove any objects on the strainer.

### How the sensor adjusts the cycle:

Once soil level is determined, the sensor automatically adds heat, time, or water as needed for proper cleaning.

## Drying System

During drying, you can see steam escaping through the vent at the upper left corner of the door. This is normal as the heat dries your dishes.

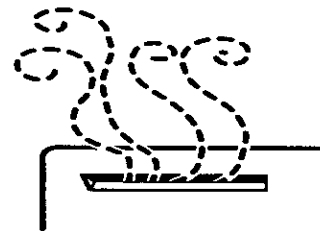

**IMPORTANT:** The vapor is hot. Do not touch the vent during drying.

## Overfill Protection Float

The overfill protector (in the front right corner of the dishwasher tub) keeps the dishwasher from overflowing. It must be in place for the dishwasher to operate.

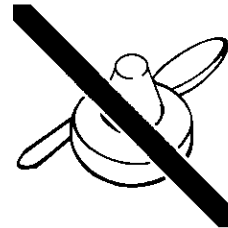

Check under the float for objects that may keep the protector from moving up or down.



# WASHING SPECIAL ITEMS

If you have doubts about washing a particular item, check with the manufacturer to see if it is dishwasher safe.

MATERIAL	DISHWASHER SAFE?/COMMENTS
Aluminum	<b>Yes</b> High water temperature and detergents can affect finish of anodized aluminum.
Disposable Aluminum	<b>No</b> Do not wash throwaway aluminum pans in the dishwasher. These might shift during washing and transfer black marks to dishes and other items.
Bottles and Cans	<b>No</b> Wash bottles and cans by hand. Labels attached with glue can loosen and clog the spray arms or pump and reduce washing performance.
Cast Iron	<b>No</b> Seasoning will be removed and iron will rust.
China/ Stoneware	<b>Yes</b> Always check manufacturer's recommendations before washing. Antique, hand-painted, or over-the-glaze patterns may fade. Gold leaf can discolor or fade.
Crystal	<b>Yes</b> Check manufacturer's recommendations before washing. Some types of leaded crystal can etch with repeated washing.
Gold	<b>No</b> Gold-colored flatware will discolor.
Glass	<b>Yes</b> Milk glass yellows with repeated dishwasher washing.
Hollow-Handle Knives	<b>No</b> Handles of some knives are attached to the blade with adhesives which can loosen if washed in the dishwasher.

MATERIAL	DISHWASHER SAFE?/COMMENTS
Pewter, Brass, Bronze	<b>No</b> High water temperatures and detergent can discolor or pit the finish.
Disposable Plastics	<b>No</b> Cannot withstand high water temperatures and detergents.
Plastics	<b>Yes</b> Always check manufacturer's recommendations before washing. Plastics vary in their capacity to withstand high water temperatures and detergents. Load plastics in top rack only.
Stainless Steel	<b>Yes</b> Run a rinse cycle if not washing immediately. Prolonged contact with food containing salt, vinegar, milk products, or fruit juice can damage finish.
Sterling Silver or Silver Plate	<b>Yes</b> Run a rinse cycle if not washing immediately. Prolonged contact with food containing salt, acid, or sulfide (eggs, mayonnaise, and seafood) can damage finish.
Tin	<b>No</b> Can rust.
Wooden Ware	<b>No</b> Wash by hand. Always check manufacturer's instructions before washing. Untreated wood can warp, crack, or lose its finish.

---

# CARING FOR YOUR DISHWASHER

---

## Cleaning Your Dishwasher

### Cleaning the exterior

In most cases, regular use of a soft, damp cloth or sponge and a mild detergent is all that is necessary to keep the outside of your dishwasher looking nice and clean.

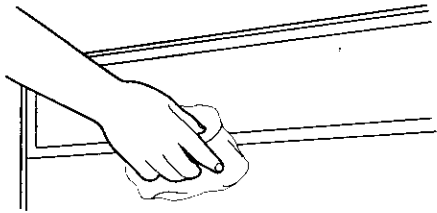

### Cleaning the interior

Hard water minerals can cause a white film to build up on the inside surfaces, especially just beneath the door area.

**Do not** clean the dishwasher interior until it has cooled. Wear rubber gloves. **Do not** use any type of cleanser other than dishwasher detergent because it may cause foaming or sudsing.

#### To clean interior

Make a paste with powdered dishwasher detergent on a damp sponge and clean.

**OR**

Use liquid automatic dishwasher detergent and clean with damp sponge.

**OR**

See the vinegar rinse procedure in "Spotting and filming on dishes" in "Troubleshooting."

**NOTE:** Run a normal wash cycle with detergent after cleaning the interior.

---

## Drain Air Gap

### Check the drain air gap anytime your dishwasher isn't draining well

Some state or local plumbing codes require the addition of a drain air gap between a built-in dishwasher and the home drain system. If a drain is clogged, the drain air gap protects your dishwasher from water backing up into it.

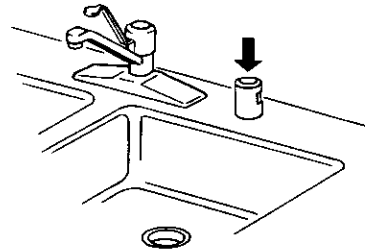

The drain air gap is usually located on top of the sink or countertop near the dishwasher. To order a drain air gap contact your local dealer, or in the U.S.A., call the Consumer Assistance Center at 1-800-422-1230 and ask for Part Number 300096.

**NOTE:** The drain air gap is an external plumbing device that is not part of your dishwasher. The warranty provided with your dishwasher does not cover service costs directly associated with the cleaning or repair of the external drain air gap.

### To clean the drain air gap

Clean the drain air gap periodically to ensure proper drainage of your dishwasher. Follow the cleaning instructions provided by the manufacturer. With most types, you lift off the chrome cover. Unscrew the plastic cap. Then check for any soil buildup. Clean if necessary.

---

# Storing Your Dishwasher

## Storing for the summer

Protect your dishwasher during the summer months by turning off the water supply and power supply to the dishwasher.

## Moving or winterizing your dishwasher

Protect your dishwasher and home against water damage due to freezing water lines. If your dishwasher is left in a seasonal dwelling or could be exposed to near freezing temperatures, have a qualified person do the following:

1. Disconnect power supply to the dishwasher.
2. Turn off water supply to the dishwasher.
3. Remove the 4 screws on the lower access panel. Remove the lower access panel.

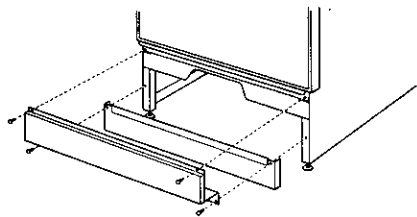

4. Place a shallow pan under the water supply valve. Then, use a wrench to disconnect the water inlet from the water supply valve. Separate the water inlet from the water supply valve and drain water into the pan.

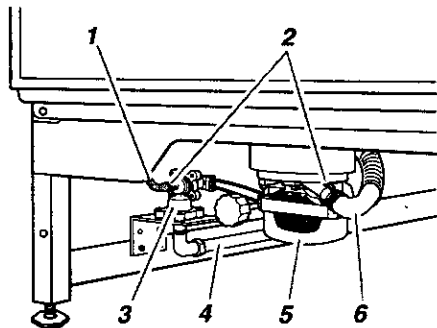

1. Water outlet
2. Spring clamps
3. Water supply valve
4. Water inlet
5. Water pump
6. Drain hose

5. Remove the spring clamp from the water outlet and separate from the water supply valve; drain water into pan.
6. Reconnect both water inlet and water outlet to the water supply valve.
7. Empty the pan and reposition it under the water pump.
8. Remove the clamp and disconnect the drain hose from the water pump; drain water into pan.
9. Reconnect drain hose to the water pump, being sure to position the clamp over the connection.
10. Replace the lower access panel.

**NOTE:** If your dishwasher is connected to a garbage disposal, do not run water into the sink after winterizing. This could cause water to refill the drain hose on your dishwasher.

## Reconnecting your dishwasher

1. Remove the 4 screws on the lower access panel and remove lower access panel.
2. Turn on the water supply to dishwasher.
3. Turn on power supply to dishwasher.
4. Run dishwasher through a complete cycle and check for leaks.
5. Replace lower access panel.

---

# TROUBLE-SHOOTING

First try the solutions suggested here and possibly avoid the cost of a service call...

---

## Dishwasher is not operating properly

---

- **Dishwasher does not run or stops during a cycle**  
Is the door closed tightly and latched?  
  
Is the right cycle selected? Refer to the "Cycle Selection Chart."  
  
Is there power to the dishwasher? Has a household fuse blown or circuit breaker tripped?  
  
Has the motor stopped due to an overload? The motor automatically resets itself within a few minutes. If it does not restart, call for service.  
  
Is the water shut-off valve (if installed) turned on?
- **Dishwasher will not fill**  
Is the overflow protection float able to move up and down freely? Press down to release.
- **Dishwasher seems to run too long**  
Is the water supplied to the dishwasher hot enough? The dishwasher runs longer while heating water. Refer to the "Dishwasher Efficiency Tips" section.  
  
A delay automatically occurs in some wash and rinse cycles until the water reaches the proper temperature.
- **Water remains in the dishwasher**  
Is the cycle complete?
- **Detergent remains in the covered section of the dispenser**  
Is the cycle complete?  
  
Is the detergent lump-free? Replace detergent if necessary.
- **White residue on the front of the access panel**  
Was too much detergent used? Refer to the "Detergent Dispenser" section.  
  
Is the brand of detergent making excess foam? Try a different brand to reduce foaming and eliminate buildup.
- **Odor in the dishwasher**  
Are dishes washed only every 2 or 3 days? Run a rinse cycle once or twice a day until you have a full load.  
  
Does the dishwasher have a new plastic smell? Run a vinegar rinse as described in "Spotting and filming on dishes" later in this Troubleshooting guide.

- **Condensation on the kitchen counter (built-in models)**  
Is the dishwasher aligned with the counter top? Moisture from the vent in the dishwasher console can form on the counter. Refer to the Installation Instructions for more information.

---

## Dishes are not completely clean

---

- **Food soil left on the dishes**  
Is the dishwasher loaded correctly? Refer to the "Loading Your Dishwasher" section.  
  
Is the water temperature too low? If needed, turn home water heater up to ensure water entering dishwasher is at least 120°F (49°C). Refer to the "Dishwasher Efficiency Tips" section.  
  
Did you use the correct amount of fresh detergent? Use recommended dishwasher detergents only. Refer to the "Detergent Dispenser" section. Never use less than one tablespoon per load. Detergent must be fresh to be effective. Store detergent in a cool, dry area. Heavy soil and/or hard water generally require extra detergent.  
  
Is detergent caked in dispenser? Use fresh detergent only. Do not allow detergent to sit for several hours in a wet dispenser. Clean dispenser when caked detergent is present.  
  
Is the pump or spray arm clogged by labels from bottles and cans? Remove labels before washing bottles and cans or wash by hand.  
  
Is the home water pressure high enough for proper dishwasher filling? Home water pressure should be 20 to 120 psi (138 to 828 kPa) for proper dishwasher fill. A booster pump on the water supply can be added if pressure is too low.  
  
Are high suds slowing the wash arm? Never use soap or laundry detergents. Use recommended dishwasher detergents only.

---

## Spots and stains on dishes

---

- **Spotting and filming on dishes**  
Is your water hard or is there a high mineral content in your water? Conditioning the final rinse water with a liquid rinse aid helps eliminate spotting and filming. Keep the rinse aid dispenser filled.  
  
Is the water temperature too low? If needed, turn home water heater up to ensure water entering dishwasher is at least 120°F (49°C). Refer to the "Dishwasher Efficiency Tips" section.  
  
Did you use the correct amount of effective detergent? Use recommended dishwasher detergents only. Refer to the "Detergent Dispenser" section. Never use less than 1 tablespoon per load. Detergent must be fresh to be effective. Store detergent in a cool, dry area. Heavy soil and/or hard water generally require extra detergent.

Is the home water pressure high enough for proper dishwasher filling? Home water pressure should be 20 to 120 psi (138 to 828 kPa) for proper dishwasher fill. A booster pump on the water supply can be added if pressure is too low.

**NOTE:** To remove spots and film from dishes, try a white vinegar rinse. This procedure is intended for occasional use only. Vinegar is an acid and using it too often could damage your dishwasher.

1. Wash and rinse dishes. Use an air-dry or an energy saving dry option. Remove all silverware or metal items.
2. Put 2 cups (473 mL) white vinegar in a glass or dishwasher-safe measuring cup on the bottom rack.
3. Run the dishwasher through a complete washing cycle using an air-dry or an energy saving dry option. Do not use detergent. Vinegar will mix with the wash water.

■ **Silica film or etching (silica film is a milky, rainbow-colored deposit; etching is a cloudy film)**

Sometimes there is a water/chemical reaction with certain types of glassware. This is usually caused by some combination of soft or softened water, alkaline washing solutions, insufficient rinsing, overloading the dishwasher, and the heat of drying. It might not be possible to prevent the problem, except by hand washing.

To slow this process use a minimum amount of detergent but not less than 1 tablespoon per load. Use a liquid rinse aid and underload the dishwasher to allow thorough rinsing. Silica film and etching are permanent and cannot be removed. Do not use heated drying.

■ **White spots on cookware with non-stick finish**

Has the dishwasher detergent removed cookware seasoning? Reseason cookware after washing in the dishwasher.

■ **Brown stains on dishes and dishwasher interior**

Does your water have high iron content? Rewash dishes using 1-3 teaspoons of citric acid crystals added to the covered section of the detergent dispenser. Do not use detergent. Follow with a Normal wash cycle with detergent. If treatment is needed more often than every other month, the installation of an iron removal unit is recommended.

■ **Black or gray marks on dishes**

Are aluminum items rubbing dishes during washing? Disposable aluminum items can break down in the dishwasher and cause marking. Hand wash these items. Remove aluminum markings by using a mild abrasive cleaner.

■ **Orange stains on plastic dishes or dishwasher interior**

Are large amounts of tomato-based foods on dishes placed in the dishwasher? Stains gradually fade over time. Regular use of heated drying will slow fading. Stains will not affect dishwasher performance. Regular use of a rinse cycle and an air-dry or energy-saving dry option will reduce the likelihood of staining.

---

### Dishes do not dry completely

---

■ **Dishes are not dry**

Did you load your dishwasher to allow proper water drainage? Do not overload. Refer to the "Loading Your Dishwasher" section. Use a liquid rinse aid to speed drying.

Are the plastics wet? Plastics often need towel drying.

Is the rinse aid dispenser empty? Refer to the "Rinse Aid Dispenser" section.

Did you use an air-dry or energy-saving dry option? Use a heated drying option for dryer dishes.

---

### Dishes are damaged during a cycle

---

■ **Chipping of dishes**

Did you load the dishwasher properly? Load the dishes and glasses so they are stable and do not strike together from washing action. Minimize chipping by moving the rack in and out slowly.

**NOTE:** Antiques, feather-edged crystal, and similar types of china and glassware might be too delicate for automatic dishwashing. Wash by hand.

---

### Noises

---

■ **Grinding, grating, crunching or buzzing sounds**

A hard object has entered the wash module (on some models). The sound should stop when the object is ground up.

---

# ASSISTANCE OR SERVICE

Before calling for assistance or service, please check "Troubleshooting." It may save you the cost of a service call. If you still need help, follow the instructions below.

When calling, please know the purchase date and the complete model and serial number of your appliance. This information will help us to better respond to your request.

---

## In the U.S.A.

Call the KitchenAid Consumer Assistance Center toll free: **1-800-422-1230**.

### Our consultants provide assistance with:

- Features and specifications on our full line of appliances.
- Installation information.
- Use and maintenance procedures.
- Accessory and repair parts sales.
- Specialized customer assistance (Spanish speaking, hearing impaired, limited vision, etc.).
- Referrals to local dealers, repair parts distributors, and service companies. KitchenAid service technicians are trained to fulfill the product warranty and provide after-warranty service, anywhere in the United States.

To locate the authorized KitchenAid service company in your area, you can also look in your telephone directory Yellow Pages.

### If you need replacement parts

If you need to order replacement parts, we recommend that you only use factory authorized parts. These parts will fit right and work right, because they are made with the same precision used to build every new KITCHENAID® appliance. To locate factory authorized replacement parts in your area, call our Consumer Assistance Center telephone number or your nearest authorized service center.

### For further assistance

If you need further assistance, you can write to KitchenAid with any questions or concerns at:

KitchenAid Brand Home Appliances  
Consumer Assistance Center  
c/o Correspondence Dept.  
2000 North M-63  
Benton Harbor, MI 49022-2692

Please include a daytime phone number in your correspondence.

---

## In Canada

Call the KitchenAid Canada Consumer Assistance Center toll free: **1-800-461-5681** 8:30 a.m. - 6:00 p.m. (EST)

### Our consultants provide assistance with:

- Features and specifications on our full line of appliances.
- Referrals to local dealers.

### For service in Canada

Call **1-800-807-6777**. KitchenAid service technicians are trained to fulfill the product warranty and provide after-warranty service, anywhere in Canada.

### If you need replacement parts

If you need to order replacement parts, we recommend that you only use factory authorized parts. These parts will fit right and work right, because they are made with the same precision used to build every new KITCHENAID® appliance. To locate factory authorized replacement parts in your area, call your nearest authorized service center.

### For further assistance

If you need further assistance, you can write to KitchenAid Canada with any questions or concerns at:

Consumer Relations Center  
KitchenAid Canada  
1901 Minnesota Court  
Mississauga, Ontario L5N 3A7

Please include a daytime phone number in your correspondence.