

Use and Care Guide



KitchenAid®
FOR THE WAY IT'S MADE.®

| | |
|---|----|
| A Note to You | 2 |
| Oven Safety | 3 |
| Parts and Features | 5 |
| Using Your Oven | 6 |
| Using the electronic oven control | 6 |
| Oven settings | 11 |
| Setting the clock | 13 |
| Using the timer | 13 |
| Baking or convection baking | 14 |
| Convection baking tips | 15 |
| Convection roasting | 16 |
| Convection roasting tips | 17 |
| Positioning racks and pans | 17 |
| Bakeware choices | 18 |
| Using aluminum foil | 19 |
| Adjusting oven temperature | 19 |
| Using the temperature probe | 20 |
| Using Convect Full Meal | 22 |
| Using EASY CONVECT™ Conversion | 24 |
| Broiling | 26 |
| Convection broiling | 27 |
| Timed cooking | 29 |
| Dehydrating | 32 |
| Proofing (raising) bread | 33 |
| The oven vent(s) | 34 |
| Using the Self-Cleaning Cycle | 35 |
| Before you start | 35 |
| Before setting controls | 36 |
| Setting the controls | 36 |
| For best cleaning results | 38 |
| How the cycle works | 38 |
| Caring for Your Oven | 39 |
| Cleaning Chart | 39 |
| Removing the oven door | 40 |
| Using and replacing the oven lights | 41 |
| Troubleshooting | 42 |
| Requesting Assistance or Service | 44 |
| Warranty | 48 |

In the U.S.A. for assistance or service,
call the Consumer Assistance Center:

1-800-422-1230

In Canada for assistance or service,
see page 45.

KITCHENAID® Electric Built-In Ovens

**Models: KEBS278D KEBS207D KEBS277D KEBS247D
KEBS208D KEBS107D KEBS177D KEBS147D**

4451952

www.kitchenaid.com

A Note to You

Thank you for buying a KITCHENAID® appliance!

KitchenAid designs the best tools for the most important room in your house. To ensure that you enjoy many years of trouble-free operation, we developed this Use and Care Guide.

It contains valuable information concerning how to operate and maintain your new appliance properly and safely. Please read it carefully. Also, please complete and mail the enclosed Product Registration Card.

Please record your model's information.

Whenever you call our Consumer Assistance Center at **1-800-422-1230** (in Canada, **1-800-461-5681**) or request service for your appliance, you need to know your complete model number and serial number. You can find this information on the model and serial number plate (see diagram in the Parts and Features section for plate location on the lower oven).

Please also record the purchase information.

Model Number _____

Serial Number _____

Purchase/
Installation Date _____

Builder/Dealer
Name _____

Address _____

Phone _____

NOTE: You must provide proof of purchase or installation date for in-warranty service.

Keep this book and the sales slip together in a safe place for future reference.

Oven Safety

Your safety and the safety of others is very important.

We have provided many important safety messages in this manual and on your appliance. Always read and obey all safety messages.



This is the safety alert symbol.

This symbol alerts you to hazards that can kill or hurt you and others.

All safety messages will be preceded by the safety alert symbol and the word "DANGER" or "WARNING." These words mean:

! DANGER

You will be killed or seriously injured if you don't follow instructions.

! WARNING

You can be killed or seriously injured if you don't follow instructions.

All safety messages will identify the hazard, tell you how to reduce the chance of injury, and tell you what can happen if the instructions are not followed.

IMPORTANT SAFETY INSTRUCTIONS

WARNING: To reduce the risk of fire, electrical shock, injury to persons, or damage when using the oven, follow basic precautions, including the following:

- Proper Installation – Be sure the oven is properly installed and grounded by a qualified technician.
- Never Use the Oven for Warming or Heating the Room.
- Do Not Leave Children Alone – Children should not be left alone or unattended in area where oven is in use. They should never be allowed to sit or stand on any part of the oven.
- Wear Proper Apparel – Loose-fitting or hanging garments should never be worn while using the oven.
- User Servicing – Do not repair or replace any part of the oven unless specifically recommended in the manual. All other servicing should be referred to a qualified technician.
- Storage in Oven – Flammable materials should not be stored in an oven.
- Do Not Use Water on Grease Fires – Smother fire or flame or use dry chemical or foam-type extinguisher.
- Use Only Dry Potholders – Moist or damp potholders on hot surfaces may result in burns from steam. Do not let potholder touch hot heating elements. Do not use a towel or other bulky cloth.
- Use Care When Opening Door – Let hot air or steam escape before removing or replacing food.
- Do Not Heat Unopened Food Containers – Build-up of pressure may cause container to burst and result in injury.
- Keep Oven Vent Ducts Unobstructed.

SAVE THESE INSTRUCTIONS

continued on next page



IMPORTANT SAFETY INSTRUCTIONS

- Placement of Oven Racks – Always place oven racks in desired location while oven is cool. If rack must be moved while oven is hot, do not let potholder contact hot heating element in oven.
- DO NOT TOUCH HEATING ELEMENTS OR INTERIOR SURFACES OF OVEN – Heating elements may be hot even though they are dark in color. Interior surfaces of an oven become hot enough to cause burns. During and after use, do not touch, or let clothing or other flammable materials contact heating elements or interior surfaces of oven until they have had sufficient time to cool. Other surfaces of the oven may become hot enough to cause burns – among these surfaces are oven vent openings and surfaces near these openings, oven doors, and windows of oven doors.

For self-cleaning ovens:

- Do Not Clean Door Gasket – The door gasket is essential for a good seal. Care should be taken not to rub, damage, or move the gasket.
- Do Not Use Oven Cleaners – No commercial oven cleaner or oven liner protective coating of any kind should be used in or around any part of the oven.
- Clean Only Parts Listed in Manual.
- Before Self-Cleaning the Oven – Remove broiler pan and other utensils.

SAVE THESE INSTRUCTIONS

Parts and Features

(Models KEBS208D and KEBS278D shown)

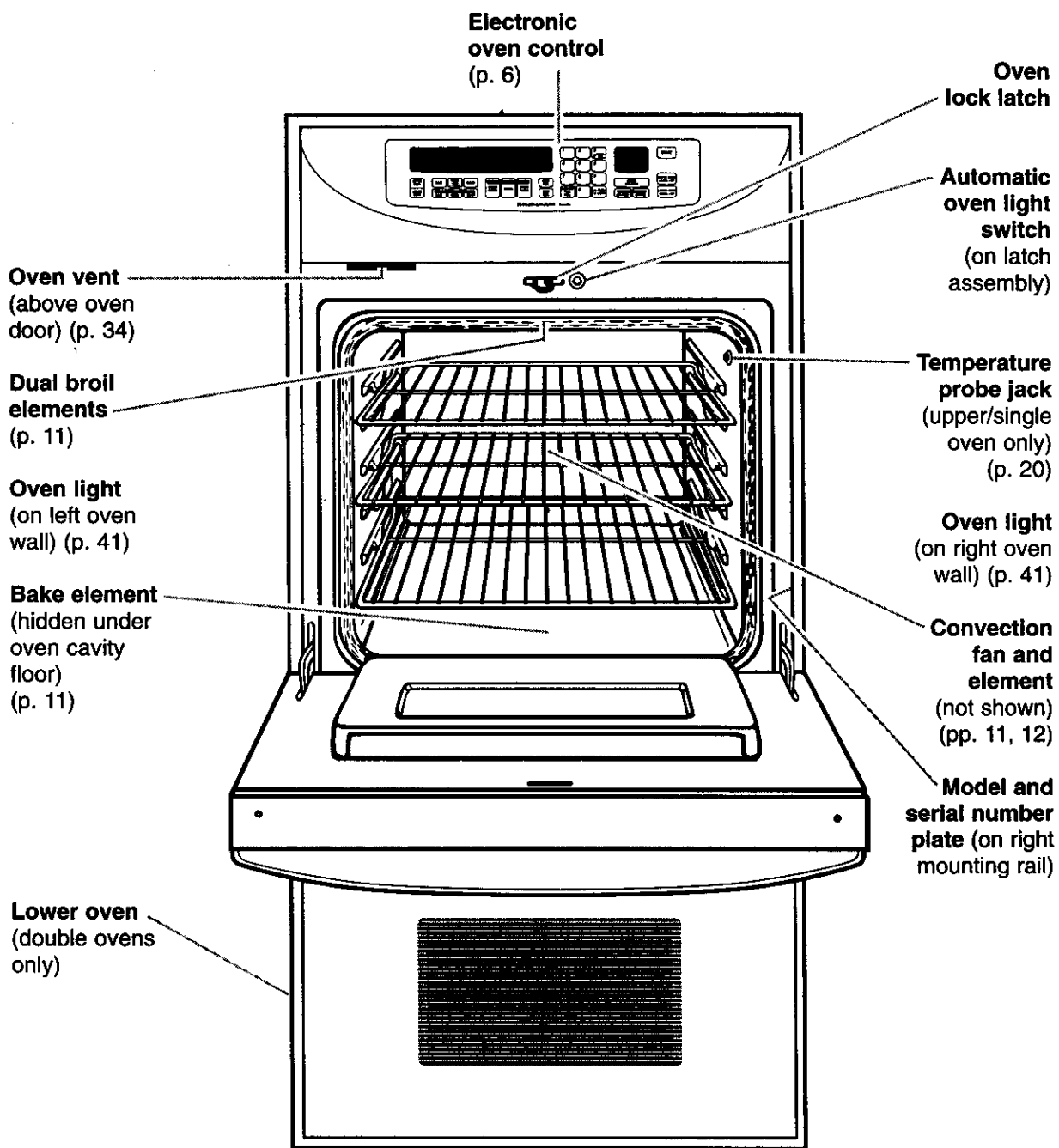

Using Your Oven

Using the electronic oven control (double thermal-convection oven shown)

NOTE: Displays and command pads shown are for double upper ovens. In some cases, lower oven and single oven displays and command pads may look different than those shown.

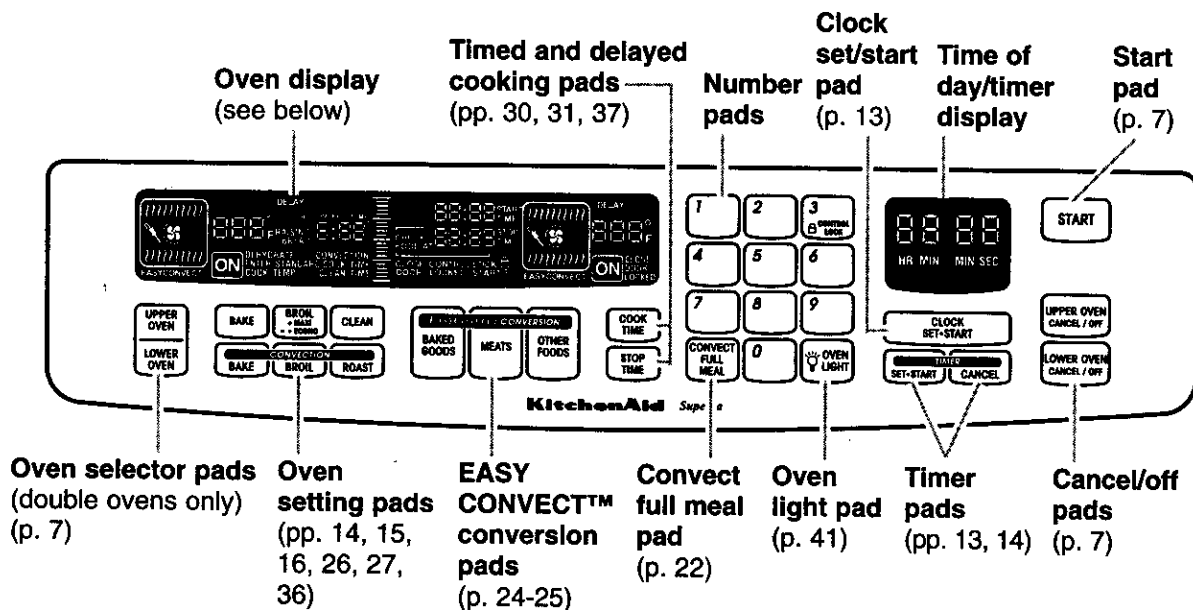

Display/clock

- **When you first plug in the oven**, a tone will sound, the display will be fully lit for a few seconds, and the display will show the last time set and "PF" (power failure). If, after you set the clock, the display again shows "PF", your electricity was off for awhile. Reset the clock. (See "Setting the clock" section.)
- **The display will show "Err"** and three short tones will sound if a time or temperature is incorrectly entered.

To set your oven to cook in Celsius instead of Fahrenheit:

PRESS and hold for 5 seconds



You will know you are in Celsius when "F" disappears. To switch back to Fahrenheit, press and hold BROIL again for 5 seconds. ("F" will reappear.)

If you need to convert temperatures from Celsius to Fahrenheit or vice versa, you can refer to this chart:

Temperature replacement values

| | |
|-------------|-------------|
| 38°C-100°F | 163°C-325°F |
| 60°C-140°F | 177°C-350°F |
| 66°C-150°F | 191°C-375°F |
| 77°C-170°F | 204°C-400°F |
| 93°C-200°F | 218°C-425°F |
| 121°C-250°F | 232°C-450°F |
| 135°C-275°F | 246°C-475°F |
| 149°C-300°F | 260°C-500°F |

Starting an operation

After programming a function, you must press **START** to start the function. If you do not press **START** within 5 seconds of programming, "START?" will show on the display as a reminder.



Canceling an operation

CANCEL/OFF will cancel any function, except for the Clock and Timer functions. When you press **CANCEL/OFF**, the small display will show the time of day, or if Timer is also being used, the time remaining.



(single ovens)
OR

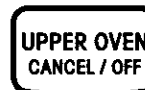

(double ovens)

NOTE: To cancel the timer see "Using the Timer" section.
NOTE: You may hear a fan blowing in the oven even after you press **CANCEL/OFF**. This is the cooling fan. It will turn off when the oven cools.

Changing audible signals

Audible signals tell you if a function is entered correctly or not. They also tell you when a cycle is completed.

To change pitch and loudness of key tone: **PRESS and hold for 5 seconds**



A short tone will sound and "Snd" and "Hi" or "Lo" will appear on the display. Repeat the step above to change to the other setting.

To turn on and off end-of-cycle tones and reminder tones (single or double ovens): **PRESS and hold for 5 seconds**



To turn on and off all reminder tones (single or double ovens): **PRESS and hold for 5 seconds**



To turn on and off all tones (double ovens)/to turn on and off key pad entry tones (single ovens): **PRESS and hold for 5 seconds**



A short tone will sound and "Snd" and "On" or "OFF" will appear on the display to tell you the signals have been changed. Repeat the step above to turn the signals back on.

Selecting an oven (double ovens)

To choose the oven you want to use, press **UPPER OVEN/LOWER OVEN**.

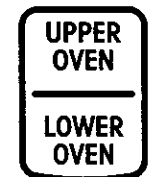

Finding out which oven is in use (double ovens)

Press **UPPER OVEN/LOWER OVEN**. Upper oven or lower oven information will be displayed and the outer oven cavity symbol for the oven being programmed will flash.

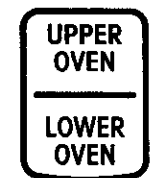



Using Your Oven

Using the control lock

The control lock prevents unwanted use of the oven by disabling the control panel command pads.

NOTES:

- **On double ovens**, control lock is only available when oven is not active or set. On single ovens, control lock is available when oven is active, but it is not available only during the Self-Cleaning cycle or the Sabbath mode.
- **On single ovens**, CANCEL/OFF will still work during control lock, but you will need to press it for 1 second.
- **On both single and double ovens**, the control lock will not disable the Timer. On double ovens, the light, timer, and clock are still available during control lock.
- **Set control lock** when cleaning the control panel to prevent oven from accidentally turning on.

To lock the control panel:

Press and hold CONTROL LOCK (Number Pad 3) for 5 seconds. A single tone will sound and "CONTROL LOCK 



To unlock the control panel:

Press and hold CONTROL LOCK (Number Pad 3) for 5 seconds. A single tone will sound after 5 seconds and "CONTROL LOCK 



Prompt for start

If "START?" is lit, this means that START has not been pressed. If you do not press START, the programmed function will automatically be canceled in 5 minutes.

Setting your oven for the Sabbath

The Sabbath mode is an oven operation designed for the special needs of Orthodox Jews on the Sabbath or holy days. It is only available to provide a continuous untimed bake function or, if desired, a timed bake function. (See below)

NOTE: The Sabbath mode must be set before it can be activated and remains set until canceled.

To SET the Sabbath mode:

1. Open the oven door.
2. Press CANCEL/OFF.



3. Press the Number Pads in the following order: 7, 8, 9, 6. You will hear tones while pressing the Number Pads.



4. Press START. "SAb ON" will appear in the display.



NOTE: Turn the oven light on or off, as desired, by pressing OVEN LIGHT. The oven light will stay turned on or off, whichever you chose, while in the Sabbath mode. Opening the door will not switch the oven light throughout the Sabbath mode.



To START a BAKE function:

1. Press BAKE.



2. Press the Number Pads to set the desired temperature from 170°F to 500°F (77°C to 260°C).

3. Press START.



4. Press and hold Number Pad 6 for 5 seconds. "SAb" will replace the temperature in the display.



To START a TIMED BAKE function:

!WARNING

Food Poisoning Hazard

Do not let food sit in oven more than one hour before or after cooking.

Doing so can result in food poisoning or sickness.

This allows you to start cooking immediately and stop cooking automatically for a predetermined length of time. The oven will shut off at the end of the preset time.

1. Press **BAKE**.



2. Press the Number Pads to set the desired temperature from 170°F to 500°F (77°C to 260°C).

3. Press **COOK TIME**.



4. Press the Number Pads to set the desired cook time up to 9 hours 59 minutes.

5. Press **START**.



6. Press and hold Number Pad 6 for 5 seconds. "SAb" will replace the temperature in the display.



To CHANGE the TEMPERATURE:

1. Press **UPPER OVEN/LOWER OVEN** (double oven only).

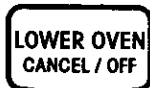
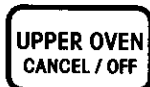

2. Next select a temperature from the following chart and press the corresponding Number Pad for 2 seconds. Each Number Pad is programmed for a specific set temperature:

| NUMBER PAD | SET TEMPERATURE |
|------------|-----------------|
| 1 | 170°F (77°C) |
| 2 | 200°F (93°C) |
| 3 | 250°F (121°C) |
| 4 | 275°F (135°C) |
| 5 | 300°F (149°C) |
| 6 | 325°F (163°C) |
| 7 | 350°F (177°C) |
| 8 | 375°F (191°C) |
| 9 | 400°F (204°C) |
| 0 | 450°F (232°C) |

3. Press **START**.



NOTE: It may take the oven up to one half hour to reach the desired temperature.

To end the Sabbath mode and turn off oven:

- Press and hold Number Pad 6 for 5 seconds. (You only need to do this step once for both ovens.)



Oven functions during the Sabbath mode:

- The oven temperature display will show "SAb".
- No prompts, error messages, or temperature changes will be displayed.
- No tones will sound.
- To prevent accidental keypad presses, only the 1-9, START, UPPER OVEN, and LOWER OVEN pads will work. CANCEL/OFF will also work, but it must be pressed 1 second longer.
- The Element Indicator light will light up when the oven is heating and will go off when the oven stops heating.

continued on next page



Using Your Oven

- **If you open the oven door** when the elements are off, the elements will not turn on. Elements will not turn on immediately after the door is closed. If you open the oven door when the elements are on, the elements will turn off after a delay. Again, elements will not turn on immediately after the door is closed.
- **The preset temperature** will remain the same prior to entering the Sabbath mode unless the preset temperature is changed. The preset temperature takes 15 to 20 seconds to change after the keypad has been pressed.
- **After a new preset temperature** is entered, the oven setting will not change until the previous preset temperature has been reached.
- **The cooling fan** will remain on for the duration of the Sabbath mode.
- **If power failure occurs** in bake or timed bake during the Sabbath mode, the oven will return to a default temperature setting of 350°F (177°C) and reset to the bake mode only.

To use both ovens in the Sabbath mode:

- **Both ovens** must be in BAKE mode before going into the Sabbath mode. If only one oven is on before entering the Sabbath mode, then the other oven cannot be turned on while in the Sabbath mode.
- **The temperature displays** of the active ovens will show "Sab".

To CANCEL the Sabbath mode (OPTIONAL):

Once the Sabbath mode is set, it is not necessary to cancel it.

1. **Open** the oven door.
2. **Press** CANCEL/OFF.



3. **Press** the Number Pads in the following order: 7, 8, 9, 6



4. **Press** CANCEL/OFF. "Sab OFF" will appear in the display.



If a power failure occurs during the Sabbath mode:

The oven will automatically return to the Sabbath mode at the desired temperature when power returns.

Oven settings

This chart tells you when to use each setting. It also explains which elements heat up for each setting.

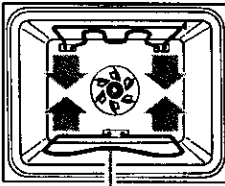
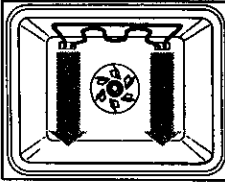
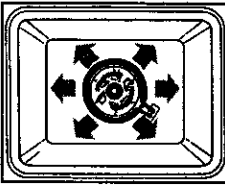
| SETTING | DIAGRAM | SETTING INFORMATION |
|--|--|---|
| <p>BAKE Use this setting for standard baking and roasting.</p> |  <p>Bake element (not visible)</p> | <ul style="list-style-type: none"> • The bottom element and both top elements heat up. • The elements will turn on and off to maintain the oven temperature. • Opening the door during Bake will cause the broil elements to turn off immediately and the bake element to turn off after 2 minutes. |
| <p>BROIL (MAXI/ECONO) Use this setting for broiling regular-sized and smaller cuts of meat, poultry, and fish.</p> |  | <ul style="list-style-type: none"> • Both top elements heat during Maxi Broil. (Maximum browning coverage.) • Only the inner element heats up during Econo Broil. (Browning coverage in center only.) • The elements will turn on and off to maintain the oven temperature. • Opening the door during Broil will cause the broil elements to turn off immediately. |
| <p>CONVECTION BAKE Use this setting for delicate foods and for baking breads and cakes. Use also when baking large quantities of food on more than one oven rack.</p> |  | <ul style="list-style-type: none"> • For faster preheating, the bottom element and both top elements heat up until oven reaches desired temperature. After preheat, only the rear element heats up (in some models the bottom element heats up also). • For even heating, the fan at the back of the oven circulates air in the oven cavity. • The elements will turn on and off to maintain the oven temperature. • Opening the door during Convection Bake will cause the broil elements, convection fan, and rear element to turn off immediately. The bake element will turn off after 2 minutes. |

continued on next page

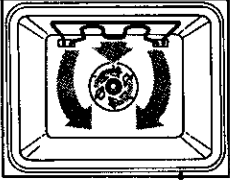
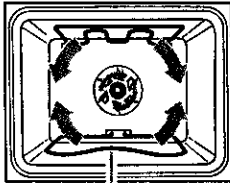
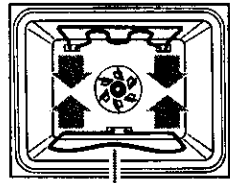

Using Your Oven

| SETTING | DIAGRAM | SETTING INFORMATION |
|--|--|--|
| <p>CONVECTION BROIL Use this setting for broiling thick cuts of meat.</p> |  | <ul style="list-style-type: none">• Both top elements heat up.• For even heating, the fan at the back of the oven circulates air in the oven cavity.• The elements will turn on and off to maintain the oven temperature.• Opening the door during Convection Broil will cause the broil elements and convection fan to turn off immediately. |
| <p>CONVECTION ROAST Use this setting for roasting and baking on one rack.</p> |  <p>Bake element (not visible)</p> | <ul style="list-style-type: none">• The bottom element and both top elements heat up.• For even heating and faster cooking, the fan at the back of the oven circulates air in the oven cavity.• The elements will turn on and off to maintain the oven temperature.• Opening the door during Convection Roast will cause the broil elements and convection fan to turn off immediately. The bake element will turn off after 2 minutes. |
| <p>CLEAN Use this setting for self-cleaning only.</p> |  <p>Bake element (not visible)</p> | <ul style="list-style-type: none">• The bottom element and both top elements heat up. |

Setting the clock

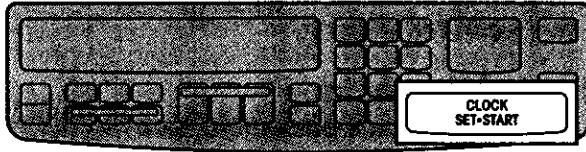

NOTES:

- These examples are for double upper ovens only. Other ovens may look slightly different.
- If a timed oven function is active or programmed, you cannot change the clock. If an untimed oven function is active or programmed, you can change the clock, however the start time will disappear.

1. Press **CLOCK SET/START**.



2. Set time.

PRESS

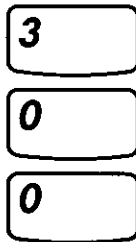

3. Start clock.

PRESS



If time has not been entered correctly, three short tones will sound and "Err" will be displayed. The display will show the last valid time to appear on the display. Repeat Steps 2 and 3 to re-enter the time of day.

To disable the display clock:

You can clear the time of day from the display by pressing and holding **CLOCK SET/START** for 5 seconds. Repeat to see time of day on display again.

Using the timer

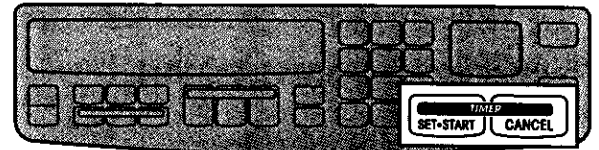

The Timer does not start or stop the oven. It works like a regular kitchen timer. It can be set in hours and minutes up to 99 hours, 59 minutes, or in minutes and seconds up to 99 minutes, 99 seconds.

NOTE: These examples are for double upper ovens only. Other ovens may look slightly different.

1. Press **TIMER SET/START**.

- Once to set hours and minutes
- Twice to set minutes and seconds

PRESS



2. Set time.

PRESS

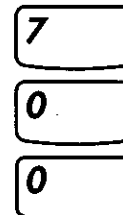

3. Start Timer.

PRESS



The Timer will begin counting down immediately after you press **TIMER SET/START**.

continued on next page



Using Your Oven

4. When time is up, turn off Timer.

When time is up, you will hear four tones unless end-of-cycle tone is disabled. Press **TIMER CANCEL** to clear the display. Also, four tones will sound every minute as an audible reminder unless they are disabled. (See "Changing Audible Signals" in the "Using Your Oven" section.)

To change the timer during its operation:

1. Press **TIMER SET/START**.



2. Enter new desired time.
3. Press **TIMER SET/START**.



To cancel the timer during its operation:

PRESS



You can cancel the Timer any time during its operation.

Baking or convection baking

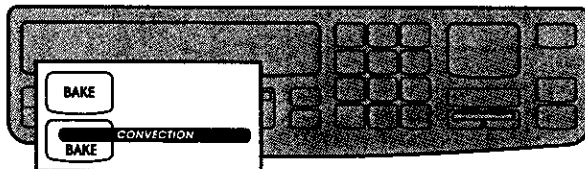

NOTES:

- **These examples** are for double upper ovens only. Other ovens may look slightly different.

- **If you need** to convert temperatures from Celsius to Fahrenheit or vice versa, see the chart in the "Using the electronic oven control" section.

1. Position racks.

For correct rack placement, see the rack placement chart in the "Positioning racks and pans" section.

IMPORTANT: Never place food directly on the oven door or the oven bottom.

Your upper/single oven has 3 racks and 5 rack positions. Your lower oven has either 2 or 3 racks (depending on model) and 5 rack positions. Rack position 5 is the highest position, or farthest from the bottom of the oven. Rack position 1 is the lowest position, or closest to the bottom of the oven.

NOTES:

- **Before turning oven on**, position oven rack(s) in desired location.
- **Be sure** the rack(s) is level.
- **Use pot holders or oven mitts** to protect your hands, if rack(s) must be moved while oven is hot.
- **Do not let** pot holder or oven mitt touch oven bottom.

2. Choose bake setting.

PRESS



to select oven
(for double ovens)

PRESS



OR
PRESS



to select oven
(for double ovens)

PRESS



NOTE: On double ovens, the cavity symbol flashes to tell you which oven you are setting.

3. Set temperature (optional).

Do this step if you want to set a temperature other than 350°F (177°C) for Bake or 300°F (149°C) for Convection Bake.

PRESS

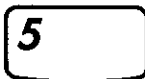
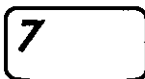

NOTE: See a reliable cookbook or your convection oven cookbook for temperature recommendations.

4. Preheat oven.

PRESS



After the temperature reaches 170°F (77°C), the temperature display will show the actual oven temperature at each 5°F (or 3°C) increase and stop at the set temperature. One long tone will sound when oven is preheated.

5. Put food in oven.

NOTE: If you want to change the baking temperature after baking has begun, repeat Steps 2, 3, and 4.

7. After cooking, turn off oven.

PRESS



(single ovens)

OR

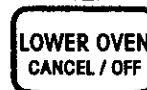

(double ovens)

Roasting meats and poultry

- **For even cooking**, place the meat on a rack in a shallow pan. This keeps the meat out of the drippings and allows the heat to circulate better.
- **Use a meat thermometer** for the most accurate doneness. Insert it so the tip is in the center of the largest muscle or thickest portion of the meat or poultry. Make sure the thermometer is not touching bone, fat, or the bottom of the pan.

Convection baking tips

- **Do not use** aluminum foil when convection baking. Aluminum foil may block airflow.
- **Reduce** recommended recipe oven temperature by approximately 25°F (16°C). Use EASY CONVECT™ Conversion (see the “Using EASY CONVECT Conversion” section).
- **For some recipes**, you can reduce convection baking time compared to standard baking times. Use EASY CONVECT Conversion.

NOTE: Cooking time may be longer when you use more than one rack.

continued on next page



Using Your Oven

- When baking on two or three racks, use the CONVECTION BAKE setting for more even results. (You can also use only one rack when convection baking.)

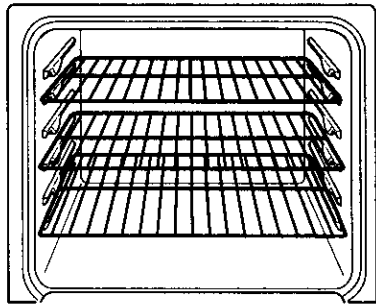

- To use three racks during convection baking, place one rack in position 5 (the highest position), another rack in position 1 (the closest to the oven bottom), and the third rack in position 3. This allows all three racks to be an equal distance apart for better baking.
- Stagger cake pans or other cookware in opposite directions on each rack when three racks are used. This will make sure pans are not directly over each other.

Convection roasting

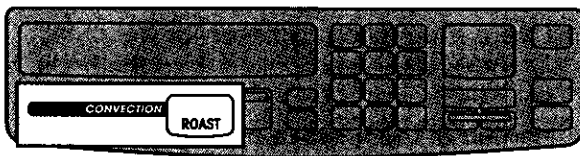

NOTE: These examples are for double upper ovens only. Other ovens may look slightly different.

1. Prepare oven.

Position the rack properly. For correct rack placement, see the rack placement chart in the "Positioning racks and pans" section. Place food in the oven. For large roasts and turkeys, place rack in position 1 or 2. (Preheating is not necessary when roasting.)

2. Choose setting.

PRESS



to select oven
(for double ovens)

PRESS



NOTE: On double ovens, the cavity symbol flashes to tell you which oven you are setting.

3. Set temperature (optional).

Do this step if you want to set a temperature other than 300°F (149°C).

PRESS

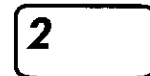
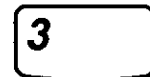

NOTE: See your convection oven cookbook for temperature recommendations.

4. Start oven.

PRESS



NOTES:

- After the temperature reaches 170°F (77°C), the temperature display will show the actual oven temperature at each 5°F (3°C) increase. It will then stop at the set temperature.
- If you want to change the roasting temperature after roasting has begun, repeat Steps 2, 3, and 4.

5. After cooking, turn off oven.

PRESS



(single ovens)

OR



(double ovens)

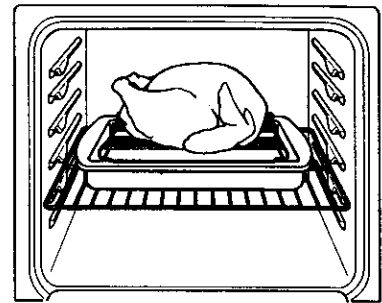

- Use the convection roasting rack on the broiler pan and grid included with your oven. The convection roasting rack rests on the broiler pan and grid. The long side of the rack should be parallel with the oven door for best heat distribution and airflow.

Convection roasting tips

- **Spatter can be reduced** by lining the bottom of the roasting pan with lightly crushed aluminum foil.
- **Use an accurate meat thermometer or temperature probe** (see the "Using the temperature probe" section) to determine when meat has reached desired degree of doneness. Insert the thermometer or probe into the center of the thickest portion of the meat or inner thigh or breast of poultry. For an accurate reading, the tip of the thermometer or probe should not touch fat, bone, or gristle.
- **After reading the thermometer once**, push it further into the meat ½ inch (1.7 cm) or more and read again. If the temperature drops, return the meat to the oven for more cooking.
- **Check pork and poultry** with a thermometer in 2 to 3 places to ensure adequate doneness.
- **Poultry and roasts will be easier to carve** if loosely covered with foil and allowed to stand 10 to 15 minutes after removal from the oven.
- **You can reduce** roasting times and temperatures for most standard recipes when using the Convection Roast setting. See convection roasting chart in your convection oven cookbook for recommended roasting times and temperatures.

Positioning racks and pans

Place the oven racks where you need them before turning on the oven.

- **To move a rack**, pull it out to the stop position, raise the front edge and lift it out.
- **Be sure the rack(s) is level.**
- **Use pot holders or oven mitts** to protect your hands if rack(s) must be moved while the oven is hot.
- **For best performance**, cook on one

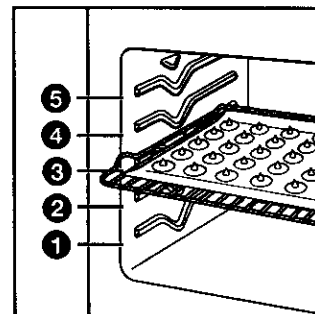

rack. Place the rack so the top of the food will be centered in the oven.

- **When cooking with two racks**, arrange the racks on the 2nd and 4th rack guides. Two sheets of cookies may be baked if sheets are switched at approximately three quarters of the total bake time. Increase baking time, if necessary.
- **For best results** allow 2 inches (5 cm) of space around each pan and between pans and oven walls. Hot air must circulate around the pans in the oven for even heat to reach all parts of the oven. This results in better baking.

continued on next page



Using Your Oven

Where to place pans:

| WHEN YOU HAVE | PLACE |
|---------------|---|
| 1 pan | In center of the oven rack. |
| 2 pans | Side by side or slightly staggered. |
| 3 or 4 pans | In opposite corners on each oven rack. Stagger pans so no pan is directly over another. |

Rack placement for specific foods:

| FOOD | RACK POSITION |
|---|-----------------------------------|
| Frozen pies, large roasts, turkeys, angel food cakes | 1st or 2nd rack guide from bottom |
| Bundt cakes, most quick breads, yeast breads, casseroles, meats | 2nd rack guide from bottom |
| Cookies, biscuits, muffins, cakes, nonfrozen pies | 2nd or 3rd rack guide from bottom |

NOTE: For information on where to place your rack when broiling, see "Broiling guidelines" later in this section.

Bakeware choices

Baking performance is affected by the type of bakeware used. Use the bakeware size recommended in the recipe.

| BAKEWARE TYPE | BEST USED FOR | GUIDELINES |
|---|---|---|
| Light colored aluminum | <ul style="list-style-type: none"> • Light golden crusts • Even browning | <ul style="list-style-type: none"> • Use temperature and time recommended in recipe. |
| Dark aluminum and other bakeware with dark, dull, and/or non-stick finish | <ul style="list-style-type: none"> • Brown, crisp crusts | <ul style="list-style-type: none"> • May reduce baking temperature 25°F (16°C). • Use suggested baking time. • Use temperature and time recommended in recipe for pies, breads, and casseroles. • Place rack in center of oven. |
| Ovenproof glassware, ceramic glass, or ceramic | <ul style="list-style-type: none"> • Brown, crisp crusts | <ul style="list-style-type: none"> • May reduce baking temperature 25°F (16°C). |
| Insulated cookie sheets or baking pans | <ul style="list-style-type: none"> • Little or no bottom browning | <ul style="list-style-type: none"> • Place in the bottom third of oven. • May need to increase baking time. |
| Stainless steel | <ul style="list-style-type: none"> • Light, golden crusts • Uneven browning | <ul style="list-style-type: none"> • May need to increase baking time. |
| Stoneware | <ul style="list-style-type: none"> • Crisp crusts | <ul style="list-style-type: none"> • Follow manufacturer's instructions. |

Using aluminum foil

- Do not line the oven bottom with any type of foil, liners, or cookware. Permanent damage will occur to the oven bottom finish.

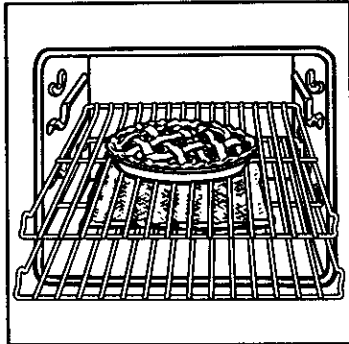

- Do not block the oven bottom vents.

- Do not cover the entire rack with aluminum foil. Doing so will reduce air circulation and overall oven performance.
- To catch spillovers from pies or casseroles place foil on the oven rack below. Foil should be turned up at edges and be at least 1 inch (2.5 cm) larger than dish.
- Place tent-shaped foil loosely over meat or poultry to slow down surface browning for long term roasting. Remove foil for the last 30 minutes.
- Use narrow strips of foil to shield piecrust edges if browning too quickly.

Adjusting oven temperature

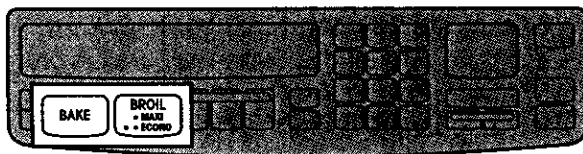

Although your new oven is properly adjusted to provide accurate temperatures, it may cook faster or slower than your old oven.

If, after using the oven for a period of time, you are not satisfied with the baking/roasting results, you can change the offset temperature by following the steps below. The control will “remember” the selected offset even after the power has been interrupted or lost.

NOTES:

- On double ovens, upper and lower oven temperature may be adjusted independently. Press UPPER OVEN/LOWER OVEN.

- DO NOT measure oven temperature with a thermometer. Opening the oven door will affect the oven temperature and give you an inaccurate reading. Also, the thermometer temperature reading will change as your oven cycles.
- These examples are for double upper ovens only. Other ovens may look slightly different.

1. Press and hold BAKE for 5 seconds.

PRESS



to select oven (for double ovens)

PRESS



Hold for 5 seconds

Release the pad when a number and “CAL” appear on the temperature display and you hear a tone.

2. Set new offset temperature.

PRESS



OR



You can set the offset temperature adjustment as low as -35°F (-21°C) or as high as +35°F (+21°C). Each time you press BAKE, the displayed temperature will increase by 5°F (3°C). Each time you press BROIL, the displayed temperature will decrease by 5°F (3°C). (To determine the amount of adjustment needed, see the chart on the next page.)

NOTE: If there is no “F” after the temperature, you are in the Celsius mode.

continued on next page



Using Your Oven

3. Enter the adjustment.

PRESS

START

NOTE: If you press CANCEL/OFF instead of START, the offset temperature will stay the same.

How to determine the amount of adjustment needed

The following chart tells you how much to adjust the offset temperature to get the desired cooking results. You can determine cooking results by amount of browning, moistness, and rising times for baked foods.

| TO COOK FOOD ... | ADJUST BY THIS NUMBER OF DEGREES |
|------------------|------------------------------------|
| A little more | +5°F to +10°F (+3°C to +6°C) |
| Moderately more | +15°F to +20°F (+8°C to +11°C) |
| Much more | +25°F to +35°F (+14°C to +19°C) |
| A little less | -5°F to -10°F (-3°C to -6°C) |
| Moderately less | -15°F to -20°F (-8°C to -11°C) |
| Much less | -25°F to -35°F (-14°C to -19°C) |

Using the temperature probe

(upper/single oven only)

The temperature probe is the most accurate guide to the degree of doneness of meat. Use it when baking, roasting any type of meat or poultry, or cooking casseroles with liquid.



NOTES:

- **These examples** are for double upper ovens only. Other ovens may look slightly different.
- **Do not use** the Temperature Probe when broiling, convection broiling, dehydrating, or raising bread.
- **Unplug** the Temperature Probe before self-cleaning the oven.

1. Insert probe into food.

Insert at least $\frac{3}{4}$ of the probe into the center of the thickest portion of meat or into the inner thigh or breast of poultry, away from fat or bone.

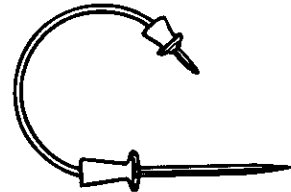

2. Put food in oven.

Place meat on the convection roasting rack, place rack on broiler pan and grid, and place pan in the center of the oven.

3. Connect probe to oven.

Locate the Temperature Probe jack on the right side of the oven wall. Insert plug into jack. (Keep the top of the probe as far as possible from the heat source.)



4. Close oven door.

5. Set temperature (optional).

Do this step if you want to set an internal food temperature (from 130°F [54°C] to 190°F [88°C]) other than 160°F [72°C].

PRESS



to select oven
(for double ovens)

PRESS



NOTE: See a reliable cookbook or your convection oven cookbook for internal food temperature recommendations.

6. Choose cook setting.

- BAKE,
- CONVECTION BAKE, or
- CONVECTION ROAST

PRESS



(example for
Bake)

NOTE: If you press CLEAN, COOK TIME, STOP TIME, or BROIL, the display will show “pull prb out”.

7. Set temperature (optional).

Do this step if you want to set an oven temperature other than the one displayed.

PRESS

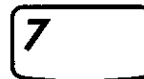
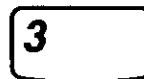

NOTE: See a reliable cookbook or your convection oven cookbook for oven temperature recommendations.

8. Start oven.

PRESS



NOTES:

- **If you do not choose** a cook setting and press START, the oven will default to bake at 350°F (175°C) and start. If you want to cook with another setting or at another temperature, do Steps 6 and 7 and press START.
- **The oven temperature display** will show the set oven temperature throughout temperature probe cooking.
- **After the food temperature** reaches 130°F (54°C), the probe display will show the actual food temperature at each 5°F (3°C) increase and stop at the set temperature. Four tones will sound (if tones are not disabled) and “End” will show when food reaches the set temperature. The oven then shuts off.
- **If you want to change** the probe temperature after cooking has begun:
 - Unplug the probe, then plug it back in. You will be prompted for a new probe temperature. Next, repeat Steps 5 and 8 in that order. You may also change the oven temperature at this point by pressing the desired cook setting pad again.

OR

- Press START and repeat steps 5-8, in that order. You may also change the oven temperature at this point by pressing the desired cook setting pad again.

continued on next page



Using Your Oven

⚠ WARNING



Burn Hazard
 Use an oven mitt to remove temperature probe.
 Do not touch broil element.
 Failure to follow these instructions can result in burns.

9. After cooking, unplug probe.
 The probe symbol will remain lit until you unplug the Temperature Probe.

10. Remove food from oven.
 (This prevents overcooking.)

11. Clean probe.
 Wash with a soapy sponge and dry thoroughly. Use a plastic scouring pad to remove cooked-on foods. You can also clean the probe in a dishwasher.

Using Convection Full Meal

(upper oven/single oven/both ovens on Models KEBS208D and KEBS278D)

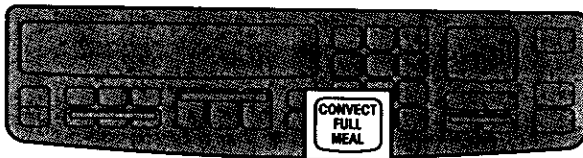

NOTE: These examples are for double upper ovens only. Other ovens may look slightly different.

Convection Full Meal lets you choose from among ten preset oven convection cooking cycles, all using the convection fan. These cycles store commonly used cooking times, cooking temperatures, and probe temperature settings. Convection Full Meal saves you time by limiting the number of pads you have to press when cooking at a favorite cycle. Convection Full Meal also lets you set your own favorite cycle (either convection or nonconvection). On double ovens, you can set two favorite cycles, one for each oven.

1. Place food in cold oven.

If you need the Temperature Probe for your cycle (settings 6 thru 0 in the "Convection Full Meal" chart later in this section), insert probe into food. Place food in oven and plug probe into jack.

2. Press CONVECT FULL MEAL.

PRESS



to select oven
 (for double ovens)

PRESS



3. Press desired Number pad.

PRESS



Use the "Convection Full Meal" chart later in this section as your guide for selecting a cycle.

NOTES:

- On double ovens, the cavity symbol flashes to tell you which oven you are setting.
- You can change the Convection Full Meal cycle any time before pressing START by repeating Step 3.

- You can program your own setting, for each oven in double ovens, which you can then select in the future by pressing UPPER OVEN/LOWER OVEN, CONVECT FULL MEAL and START. (See "To program your own setting" later in this section for more information.)

5. When the Convect Full Meal cycle is done:

Four tones will sound, and the display will show "End". Four reminder tones will sound (unless they have been disabled), every minute until you open the door, remove the probe, or press CANCEL/OFF.

4. Start oven.

PRESS



Convect full meal chart

| CYCLE NUMBER | CONVECTION CYCLE | OVEN TEMP | TIME OR PROBE TEMP | FOOD OR MEAL |
|--------------|------------------|---------------|--------------------|--|
| 1 | Conv. Bake | 325°F (160°C) | 1 hr | Meal#1: Spinach and ricotta stuffed meat loaf, Baked potatoes, Fall apple cake |
| 2 | Conv. Roast | 325°F (160°C) | 1½ hrs | Meal#2: Pesto stuffed turkey breast, Caramel-sweet potato casserole, Rhubarb-pineapple crisp |
| 3 | Conv. Roast | 350°F (175°C) | 40 min | Meal#3: Pork chops with currant-nut stuffing, Cherry cobbler |
| 4 | Conv. Bake | 375°F (190°C) | 45 min | Meal#4: Herb and pecan fried chicken, Crispy potato wedges, Applesauce rhubarb muffins |
| 5 | Conv. Bake | 425°F (220°C) | 20 min | Meal#5: Spicy red snapper, Gruyere pecan biscuits |
| 6 | Conv. Roast | 325°F (160°C) | 140°F (60°C) | Beef, rare |
| 7 | Conv. Roast | 325°F (160°C) | 155°F (68°C) | Beef, medium Pork |
| 8 | Conv. Roast | 325°F (160°C) | 165°F (74°C) | Beef, well done |
| 9 | Conv. Roast | 300°F (150°C) | 135°F (56°C) | Ham, fully cooked |
| 0 | Conv. Bake | 325°F (160°C) | 160°F (71°C) | Casseroles |

NOTE: For the recipes for Meals #1-#5, see the cookbook that comes with your oven.

continued on next page



Using Your Oven

To program your own setting:

1. Press UPPER OVEN/LOWER OVEN.
2. Press CONVECT FULL MEAL.
3. Press the Command Pad to the cook cycle you want (for example, BAKE).
4. Enter the temperature and cook time you want. (The default is Bake at 170°F [75°C] for 2 hours.) Entering a cook time of 0 minutes lets you do untimed cooking.
5. To save only, press CONVECT FULL MEAL.

To cook with this cycle immediately and save it, press START.

NOTE: You can also program a Temperature Probe setting rather than a cook time in upper/single ovens. In double ovens you can program two separate favorite cycles, one for each oven.

When programming your own setting:

1. Start with meat or main dish items (times are more critical with these items).
2. Choose baked goods with bake temperatures similar to those of meat or main dish items. Convection baking time of +/- 10 to 15 minutes and temperatures of +/- 25 to 50 degrees are acceptable.
3. Choose vegetables and fruits last.

Using EASY CONVECT™ Conversion

(upper oven/single oven/both ovens on Models KEBS208D and KEBS278D)

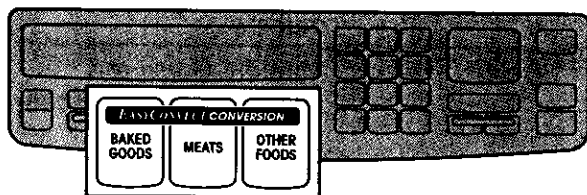

NOTE: These examples are for double upper ovens only. Other ovens may look slightly different.

EASY CONVECT Conversion lets you convection cook without entering convection cook temperatures and times. Simply enter the standard cook temperature and time for the food to be cooked. The oven will reduce

the temperature, or the temperature and time, for convection cooking. (Convection temperatures and times are not as long because the heated air is circulated in the oven cavity for quicker cooking.)

NOTE: The converted temperatures and times are not precise because the food categories you choose from are general. (See "EASY CONVECT Conversion setting chart" later in this section for which foods you can cook in each setting.) To ensure proper cooking, the oven will prompt you to check food at the end of cook time. If food needs more cooking, the oven will continue to cook. If food does not need more cooking, press CANCEL/OFF.

⚠ WARNING

Food Poisoning Hazard

Do not let food sit in oven more than one hour before or after cooking.

Doing so can result in food poisoning or sickness.

1. Place food in oven.

NOTE: For Baked Goods and Other Foods, place food in the oven after the oven has been preheated.

2. Press one of three EASY CONVECT Conversion Pads.

Example for Meats:

PRESS



to select oven
(for double ovens)

PRESS



NOTE: On double ovens, the cavity symbol flashes to tell you which oven you are setting.

3. Enter standard cook temperature.

PRESS

3

2

5

4. Enter standard cook time.

PRESS

1

0

0

NOTES:

- **This step** is not needed when using the temperature probe.
- **To delay convection cooking**, after Step 4, press STOP TIME and enter the desired stop time. Cooking will start at the time equal to the stop time less the cook time. (Example: A cook time of 1 hour and a stop time of 4:00 would give you a start time of 3:00.)

5. Start oven.

PRESS

START

NOTES:

- **The actual temperature** reduction and time savings are different for each food category and oven type.
- **For Baked Goods and Other Foods**, place food in the oven after the oven has been preheated.

6. At end of cook time (nondelayed cooking):

7. Open door and check food (nondelayed cooking).

If you want to continue cooking, close door and the oven will continue cooking. If you do not want to continue cooking, press CANCEL/OFF.

8. When stop time is reached (delayed cooking only):

Four tones will sound, and the display will show "End". Four reminder tones will sound (unless they have been disabled), every minute until you open the door, remove the probe, or press CANCEL/OFF.

EASY CONVECT™ Conversion setting chart

| EASY CONVECT SETTING | FOODS YOU CAN COOK WITH THIS SETTING |
|----------------------|--|
| Baked Goods | Cakes: layer, angel food Breads: quick and yeast Biscuits and cookies Casseroles, including frozen entrees and soufflés Fish |
| Meats | Chicken: whole and pieces Roasts: pork, beef, and ham Meat loaf, Baked potatoes NOTE: Turkey or large poultry are not included because their cooking times vary. |
| Other Foods | Convenience foods: french fries, nuggets, fish sticks, pizza Pies: fruit and custard |



Broiling

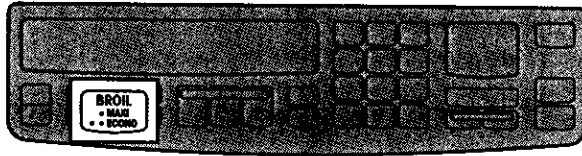

NOTES:

- **These examples** are for double upper ovens only. Other ovens may look slightly different.
- **Preheating** is not necessary when broiling.

1. Position rack.

See the rack placement chart in the "Broiling guidelines" section for recommended rack positions.

NOTES:

- **Before turning oven on**, position oven rack(s) in desired location.
- **Be sure** the rack(s) is level.
- **Use pot holders or oven mitts** to protect your hands, if rack(s) must be moved while oven is hot.
- **Do not let** pot holder or oven mitt touch hot broil element.

2. Put food in oven.

Place food on grid in broiler pan and place in center of the oven rack.

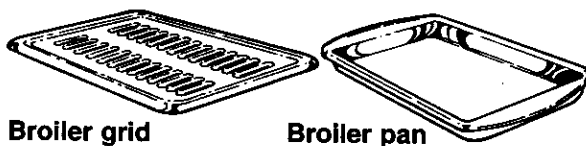

NOTES:

- **Place food** about 3 inches (7.5 cm) or more from the broil element.
- **To ensure adequate grease drainage**, do not use cookie sheets or similar pans for broiling.
- **If foil is used** to cover broiler grid, cut slits in foil to allow grease to drain away.

3. Close door.

NOTE: Do not keep the door open as on other electric ovens. Unlike other electric ovens, the broil element will only stay on with the door closed. This gives you the high heat you need for broiling. However, if you leave the door open, the broil element will go off.

4. Press BROIL.

Once for Maxi Broil
PRESS



to select oven (for double ovens)

PRESS



OR

Twice for Econo Broil
PRESS



to select oven (for double ovens)

PRESS



NOTE: On double ovens, the cavity symbol flashes to tell you which oven you are setting.

5. Set temperature (optional).

Do this step if you want to use variable temperature broiling (see below).

PRESS



6. Start oven.

PRESS



NOTE: If you want to change the broiling temperature after broiling has begun, repeat Steps 4, 5, and 6.

7. When broiling is done, turn off oven.

PRESS



(single ovens)

OR



(double ovens)

Variable temperature broiling

- If food is cooking too fast or you want the food to broil slower from the start, set the broil temperature between 170°F (77°C) and 325°F (163°C). The lower the temperature, the slower the cooking.

- Thicker and unevenly shaped cuts of fish, chicken and other meats may cook better if you use lower broiling temperatures when cooking to well-done.

Convection broiling

(upper oven/single oven/both ovens on Models KEBS208D and KEBS278D)

Use this setting when broiling thick cuts of meat.



NOTE: These examples are for double upper ovens only. Other ovens may look slightly different.

1. Position rack.

See the rack placement chart in the "Broiling guidelines" section for recommended rack positions.

2. Close door.

NOTE: Do not try to convection broil with the door open. The fan and elements will not operate.

3. Choose Convection Broil setting.

PRESS



to select oven (for double ovens)

PRESS



NOTE: On double ovens, the cavity symbol flashes to tell you which oven you are setting.

continued on next page



Using Your Oven

4. Set temperature (optional).

Do this step if you want to set a temperature (up to 500°F [260°C]) other than 450°F (235°C).

PRESS

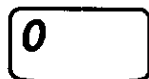
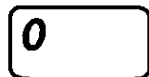

NOTE: See your convection oven cookbook for temperature recommendations.

5. For best results, preheat oven for 5 minutes.

PRESS



NOTE: If you want to change the convection broiling temperature after broiling has begun, repeat Steps 3, 4, and 5.

6. Put food in oven.

Place food on grid in broiler pan and place in center of the oven rack. Turn the pan so the long side is parallel to the oven door for the most even heat and the best airflow.

NOTE: If you want to change the convection broiling temperature after broiling has begun, repeat Steps 3, 4, and 5.

7. When broiling is over, turn off oven.

PRESS



(single ovens)

OR

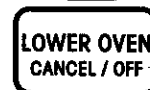

(double ovens)

Broiling guidelines

- Use only the broiler pan and grid provided. They are designed to drain extra juices from the cooking surface. This drainage helps prevent spatter and smoke.
- To make sure the juices drain well, do not cover the grid with foil.
- Trim excess fat to reduce spattering. Slit the fat on the edges to prevent curling.
- Use tongs to turn meat to avoid losing juices.
- Pull out oven rack to stop position before turning or removing food.
- After broiling, remove the pan from the oven when removing the food. Drippings will bake on the pan if left in the heated oven, making cleaning more difficult.
- For easier cleaning, line the bottom of the pan with aluminum foil. Clean the pan and grid as soon as possible after each use.

Recommended rack positions are

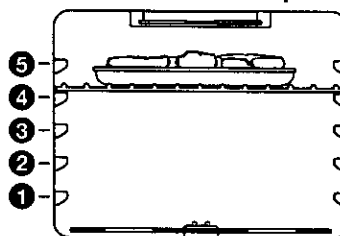

numbered from the bottom (1) to the top (5). For best results, place food 3 inches (7.5 cm) or more from the broil element.

| MEAT | RACK POSITION | TEMPERATURE | APPROXIMATE TOTAL TIME (MINUTES) |
|--|---------------|----------------|----------------------------------|
| Steak, 1" (2.54 cm) thick • rare • medium • well-done | 4 | 500°F (260° C) | 16 21 25 |
| Steak, 1½" (3.815 cm) thick • rare • medium | 4 | 500°F (260° C) | 23 28 |
| Hamburger patties or steaks, ½" (1.27 cm) thick or less • medium | 5 | 500°F (260° C) | 8-12 |
| Lamb chops, 1" (2.54 cm) thick | 4 | 400°F (204° C) | 18-20 |
| Ham slice, ½" (1.27 cm) thick | 4 | 500°F (260° C) | 10-12 |
| 1" (2.54 cm) thick | 4 | 500°F (260° C) | 20-22 |
| Pork chops, 1" (2.54 cm) thick | 4 | 450°F (232° C) | 25-28 |
| Frankfurters | 4 | 500°F (260° C) | 8 |
| Chicken pieces, bone in | 3 | 500°F (260° C) | 32 |
| Fish, ½" (1.27 cm) thick | 3 | 350°F (177° C) | 20 |
| 1" (2.54 cm) thick | 3 | 350°F (177° C) | 20-22 |
| Calves liver, ½" (1.27 cm) thick | 4 | 350°F (177° C) | 10-12 |

NOTE: Times are guidelines only and may need to be adjusted for individual tastes.

Timed cooking

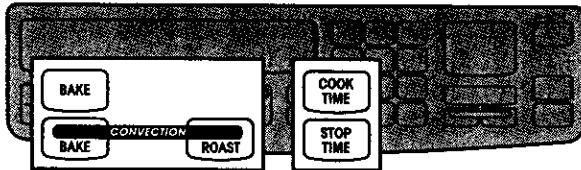

NOTE: These examples are for double upper ovens only. Other ovens may look slightly different.

The electronic clock/oven control will turn the oven on and off at times you set, even when you are not around.

Delayed time cooking is ideal for foods which do not require a preheated oven, such as meats and casseroles. **Do not use delayed time cooking for cakes, cookies, etc. – they will not rise properly. Before using timed cooking, make sure the clock is set to the correct time of day. (See the "Setting the clock" section.)**

! WARNING

Food Poisoning Hazard

Do not let food sit in oven more than one hour before or after cooking. Doing so can result in food poisoning or sickness.

To start baking/roasting now and stop automatically:

1. Prepare oven.

Position the oven rack(s) properly and place the food in the oven. For correct rack placement, see the "Positioning racks and pans" section.

continued on next page



Using Your Oven

2. Choose setting.

- BAKE,
- CONVECTION BAKE, or
- CONVECTION ROAST

PRESS



to select oven (for double ovens)

PRESS



NOTE: On double ovens, the cavity symbol flashes to tell you which oven you are setting.

3. Set temperature (optional).

Do this step if you want to set a temperature other than the one displayed.

PRESS

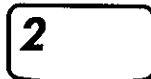
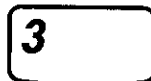

NOTE: See a reliable cookbook or your convection oven cookbook for temperature recommendations.

4. Press COOK TIME.



5. Set cook time.

PRESS

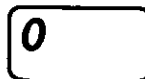
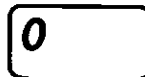
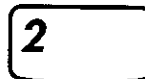

6. Start oven.

PRESS



Vertical bar on display will get shorter as cook time counts down.

7. When baking/roasting is done:

“End” will show on the display. Four tones will sound, followed by four reminder tones (unless they have been disabled), every minute until you open the door, or press CANCEL/OFF.

To delay start and stop automatically:

1. Prepare oven.

Position the oven rack(s) properly and place the food in the oven. For correct rack placement, see the “Positioning racks and pans” section.

2. Choose setting.

- BAKE,
- CONVECTION BAKE, or
- CONVECTION ROAST

PRESS



to select oven (for double ovens)

PRESS



NOTE: On double ovens, the cavity symbol flashes to tell you which oven you are setting.

3. Set temperature (optional).

Do this step if you want to set a temperature other than the one displayed.

PRESS

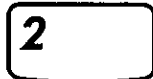
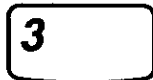

NOTE: See a reliable cookbook or your convection oven cookbook for temperature recommendations.

4. Press COOK TIME.



5. Set cook time.

PRESS

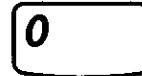
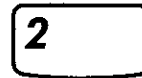

6. Press STOP TIME.



7. Set stop time.

PRESS



8. Press START.



When start time is reached, the vertical bar on display will get shorter as cook time counts down.

9. When baking/roasting is done:

"End" will show on the display. Four tones will sound, followed by four reminder tones (unless they have been disabled), every minute until you open the door, or press CANCEL/OFF.

continued on next page



Using Your Oven

To cancel timed cooking settings:

Press CANCEL/OFF.



(single ovens)

OR



(double ovens)

Dehydrating

(upper oven/single oven/both ovens on Models KEBS208D and KEBS278D)

You can use your THERMAL-CONVECTION™ oven to dehydrate fruits and vegetables.

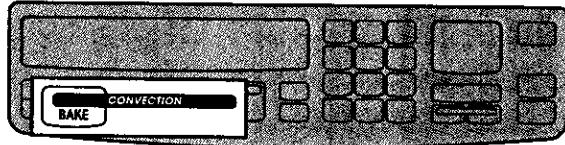

NOTES:

- These examples are for double upper ovens only. Other ovens may look slightly different.
- If you do not turn off oven after dehydrating, the oven will keep running until you press CANCEL/OFF.

1. Prepare food.

Prepare foods as recommended in recipe.

2. Arrange food on drying racks.

Racks are not included with oven. See below to order a dehydration kit* which includes racks and a spacer or contact a local store handling specialty cookware.

3. Place drying racks in the oven to allow maximum air circulation around the racks.

| NUMBER OF RACKS | USE OVEN RACK POSITION |
|-----------------|------------------------|
| 1 rack | 3 |
| 2 racks | 2 and 4 |
| 3 racks | 1, 3, and 5 |

4. Position door.

Attach the dehydration spacer*, which is specially designed to depress the oven light plunger and maintain the operation of the fan during dehydration.

The spacer provides a 1-inch (2.5 cm) gap between the oven frame and the oven door allowing moisture to escape.

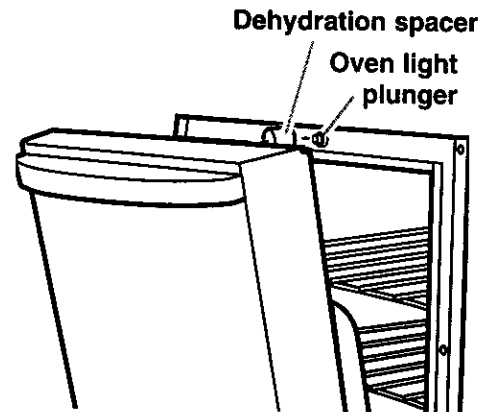

* The dehydration spacer (Part No. 814166) or the dehydration kit which includes racks and a spacer (Part No. 4395974) can be ordered from your dealer, or by calling 1-800-422-1230 and following the instructions and telephone prompts you hear.

5. Press and hold CONVECTION BAKE for 5 seconds.

PRESS



to select oven (for double ovens)

PRESS



Hold for 5 seconds

NOTE: On double ovens, the cavity symbol flashes to tell you which oven you are setting.

6. Set temperature (optional).

Do this step if you want to set a temperature (from 100°F [38°C] to 200°F [95°C]) other than 140°F (60°C).

PRESS

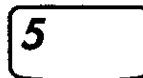

7. Start oven.

PRESS



NOTE: If you want to change the dehydrating temperature after dehydrating has begun, repeat Steps 5, 6, and 7.

8. When dehydrating is done, turn off oven.

PRESS



(single ovens)

OR

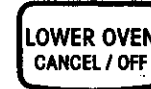

(double ovens)

Proofing (raising) bread

(upper oven/single oven/both ovens on Models KEBS208D and KEBS278D)

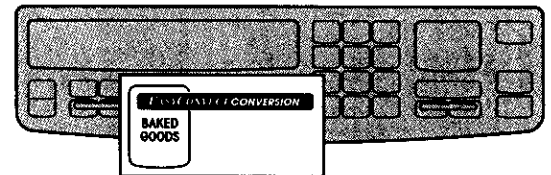

NOTE: These examples are for double upper ovens only. Other ovens may look slightly different.

You can use your THERMAL-CONVECTION™ oven to proof (raise) bread dough. **First proofing:** Place the dough in a lightly greased bowl and loosely cover with waxed paper coated with shortening.

1. Put bowl on Rack 2.

Place the broiler pan on Rack 1 and add two cups of boiling water. Close oven door.

continued on next page



Using Your Oven

2. Press and hold BAKED GOODS for 5 seconds.

PRESS



to select oven (for double ovens)

PRESS



Hold for 5 seconds

NOTE: On double ovens, the cavity symbol flashes to tell you which oven you are setting.

3. Start oven.

PRESS



One long tone will sound when oven is preheated.

4. When proofing is done, turn off oven.

PRESS



(single ovens)

OR

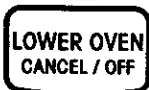
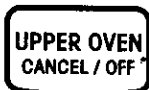

(double ovens)

NOTE: If you do not turn off oven after proofing bread, the oven will keep running until you press CANCEL/OFF.

Second Proofing: Shape the dough and place in baking pan(s). Cover loosely with plastic wrap coated with cooking spray. Put pan(s) on Rack 2. Place the broiler pan on Rack 1 and add 2 cups of boiling water. Close the oven door. Follow Steps 2-4 for first proofing. When proofing is done, remove baking pan(s) and the broiler pan from oven. Reset oven to preheat for baking bread. Before baking, remove plastic wrap from baking pans.

The oven vent(s)

Hot air and moisture escape from the oven(s) through vent(s). The vent is above the oven door. It is needed for air circulation. **Do not block the vent(s).** Poor baking/roasting can result.

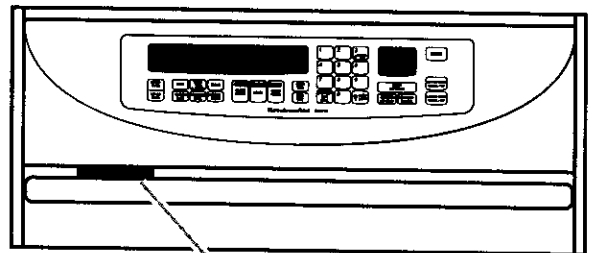

Oven vent

Using the Self-Cleaning Cycle



!WARNING

Burn Hazard

Do not touch the oven during the Self-Cleaning cycle.
Keep children away from oven during Self-Cleaning cycle.
Do not use commercial oven cleaners in your oven.
Failure to follow these instructions can result in burns, or illness from inhaling dangerous fumes.

Before you start

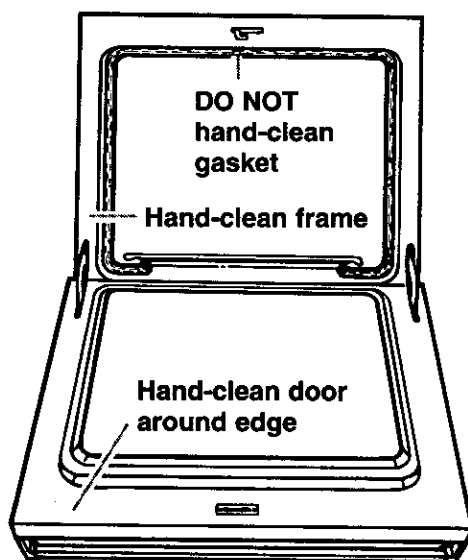

Before you start the Self-Cleaning cycle, make sure you:

NOTE: DO NOT clean, move, or bend the gasket. Poor cleaning, baking, and roasting may result.

- **Hand-clean** the areas shown. They do not get hot enough during the Self-Cleaning cycle for soil to burn away. Use hot water and detergent or a soapy, steel-wool pad for cleaning.
- **Do not** let water, cleaner, etc., enter slots on door and frame.
- **Remove** the broiler pan and grid and any cookware/bakeware being stored in the oven.

- **Wipe out** any loose soil or grease. This will help reduce smoke during the Self-Cleaning cycle.
- **Wipe up** food spills containing sugar as soon as possible after the oven cools down. When sugar is heated to a high temperature in the Self-Cleaning cycle, the high temperature can cause the sugar to burn and react with the porcelain. This can cause staining and etching, pitting, or faint white spots.
- **Remove** the oven racks from the oven if you want them to remain shiny. You can clean the oven racks in the Self-Cleaning cycle, but they will become harder to slide. (See the "Cleaning chart" in the "Caring for Your Oven" section.) If you clean the racks in the Self-Cleaning cycle, place them on the 2nd and 4th rack guides. (The guides are counted from bottom to top.)
- **Heat and odors are normal** during the Self-Cleaning cycle. Keep the kitchen well ventilated by opening a window or by turning on a vent hood or other kitchen vent during the cycle.

IMPORTANT: The health of some birds is extremely sensitive to the fumes given off during the Self-Cleaning cycle. Move birds to another closed and well ventilated room.

continued on next page



Using the Self-Cleaning Cycle

TIPS:

- **Keep the kitchen well ventilated** during the Self-Cleaning cycle to help get rid of heat, odors, and smoke.
- **Clean the oven** before it gets heavily soiled. Cleaning a very soiled oven takes longer and results in more smoke than usual.
- **Do not block the vent** during the Self-Cleaning cycle. Air must move freely for best cleaning results.
- **Do not leave any foil in the oven** during the Self-Cleaning cycle. Foil could burn or melt and damage the oven surface.
- **The oven light will not work** during the Self-Cleaning cycle.

Before setting the controls

- **Make sure clock is set to correct time of day.** The clock cannot be set during the Self-Cleaning cycle.
- **Make sure the oven door is completely closed.**

Setting the controls

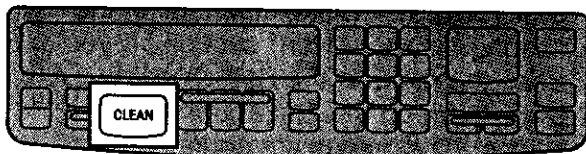

NOTE: These examples are for double upper ovens only. Other ovens may look slightly different.

To start cleaning immediately:

1. Press **CLEAN**.

A 3½-hour Self-Cleaning cycle will be set. (The first 3 hours are for cleaning, the last 30 minutes are for cooling.)

PRESS



to select oven
(for double ovens)

PRESS



NOTE: On double ovens, the cavity symbol flashes to tell you which oven you are setting. The electronic control will not let both ovens be active while one oven is cleaning.

2. Set cleaning time (optional).

If you want a Self-Cleaning cycle other than 3½ hours, press the desired Number pads for the new time from 2½ to 4½ hours.

PRESS

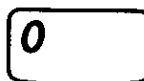
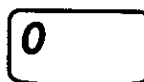
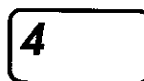

- **Use 2½ hours** for light soil.
- **Use 3½-4½ hours** for moderate to heavy soil.

3. Start oven.

PRESS



NOTE: The door will lock right after you press START.



4. After the Self-Cleaning cycle ends:

YOU SEE

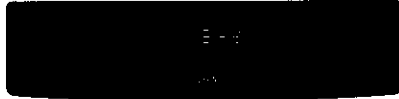

(double oven display)

To delay cleaning start time:

1. Press CLEAN.

A 3½-hour Self-Cleaning cycle will be set. (The first 3 hours are for cleaning, the last 30 minutes are for cooling.)

PRESS



to select oven
(for double ovens)

PRESS



NOTE: On double ovens, the cavity symbol flashes to tell you which oven you are setting. The electronic control will not let both ovens be active while one oven is cleaning.

2. Set cleaning time (optional).

If you want a Self-Cleaning cycle other than 3½ hours, press the desired Number pads for the new time from 2½ to 4½ hours.

PRESS

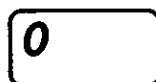
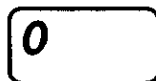

- Use 2½ hours for light soil.
- Use 3½-4½ hours for moderate to heavy soil.

3. Press STOP TIME.



4. Set Stop time.

Example for 7:00:

PRESS

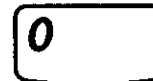
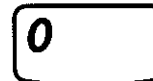
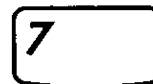

5. Complete entry.

PRESS



NOTES:

- The door will lock right after you press START.
- Lights will stay on until start time is reached.

6. After the Self-Cleaning cycle ends:

YOU SEE

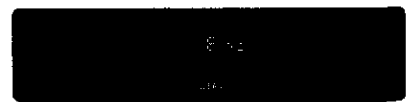

(double oven display)

continued on next page



Using the Self-Cleaning Cycle

To stop the Self-Cleaning cycle at any time:

PRESS



(single ovens)

OR

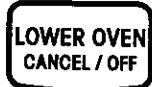

(double ovens)

For best cleaning results

- After the oven cools to room temperature, wipe up any residue or ash with a damp cloth or sponge. If any spots remain, clean with a mild abrasive cleanser or cleaning sponge.
- Clean the oven before it gets heavily soiled. Cleaning a very soiled oven takes longer and results in more smoke than usual.
- If the Self-Cleaning cycle does not get the oven as clean as you expected, the cycle may not have been set long enough or you may not have prepared the oven properly. Set the Self-Cleaning cycle longer the next time and hand-clean areas noted in "Before you start" earlier in this section.

How the cycle works

The Self-Cleaning cycle uses very high heat to burn away soil and grease. During the cycle, the oven gets much hotter than it does for normal baking or broiling. This high heat breaks up the soil or grease and burns it away.

Your oven is preset for a 3½-hour Self-Cleaning cycle. However, you can adjust the cycle time to the amount of soil in your oven. You can set the cycle anywhere between 2½ and 4½ hours. (See "Setting the controls" earlier in this section.)

The graph at the right is representative of a normal, 3½-hour Self-Cleaning cycle. Note that the heating stops after 3 hours, but it takes longer for the oven to cool enough to unlock.

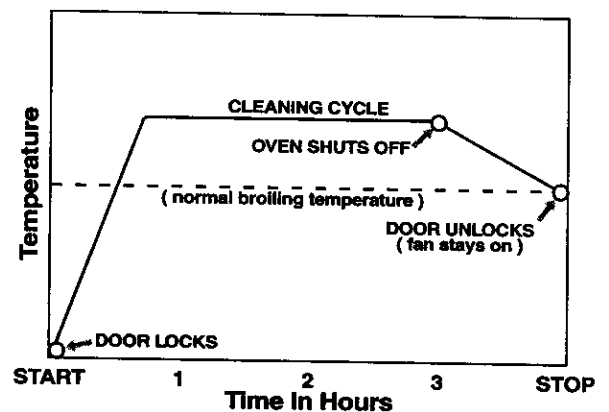

Caring for Your Oven

| | |
|---|---|
|  | !WARNING |
| | <p>Explosion Hazard</p> <p>Do not store flammable materials such as gasoline near this appliance.</p> <p>Doing so can result in death, explosion, or fire.</p> |

Cleaning Chart

Before cleaning, always make sure all controls are off and the range is cool. Refer to instructions on all cleaning products before using them to clean your range.

| PART | CLEANING METHOD | SPECIAL INSTRUCTIONS |
|---|--|--|
| Control Panel | <ul style="list-style-type: none"> • Soap and water • Spray glass cleaner | <ul style="list-style-type: none"> • Wash, rinse and dry with soft cloth. • Do not use steel wool or abrasive cleansers. They may damage the finish. • Apply spray cleaner to paper towel; do not spray directly on panel. <p>NOTE: Set the Control Lock to prevent the oven from accidentally turning on when you are cleaning the panel. (See "Using the control lock" in the "Using Your Oven" section.)</p> |
| Exterior Surfaces (excluding control panel and oven door glass) | <ul style="list-style-type: none"> • Soap and water • Mild liquid cleaner • Spray glass cleaner • Non-abrasive plastic scrubbing pad | <ul style="list-style-type: none"> • DO NOT use abrasive or harsh cleaners like chlorine bleach, ammonia or oven cleaners. • Wash, rinse and dry with soft cloth. • Gently clean around the model and serial plate; too much scrubbing could remove the numbers. |
| Stainless steel surfaces | | <ul style="list-style-type: none"> • Do not use steel wool or soap-filled scouring pads. • Rub in the direction of the grain line to avoid marring the surface. • Always wipe dry to avoid water marks. • If commercial cleaners are used, follow label directions. If product contains chlorine (bleach), wipe thoroughly with clean water and dry with a soft lint-free cloth. Chlorine is a corrosive substance. |
| Routine cleaning and fingerprints | <ul style="list-style-type: none"> • Liquid detergent/soap and water, or all-purpose cleaner | <ul style="list-style-type: none"> • Wipe with damp cloth or sponge, then wipe with clean water and dry. |

continued on next page
39



Caring for Your Oven

| PART | CLEANING METHOD | SPECIAL INSTRUCTIONS |
|---|--|---|
| Stainless steel surfaces (cont.) Stubborn stains and baked-on residue Hard water spots | <ul style="list-style-type: none"> Mildly abrasive cleanser or stainless-steel cleaners Vinegar | <ul style="list-style-type: none"> To avoid marring the surface, rub in the direction of grain lines with a damp cloth or sponge and cleanser. Wipe thoroughly with clean water. Repeat if necessary. Swab or wipe with cloth. Wipe with clean water and dry. |
| Oven door glass | <ul style="list-style-type: none"> Soap and water Non-abrasive plastic scrubbing pad Spray glass cleaner | <ul style="list-style-type: none"> Wash, rinse and dry with soft cloth. Wipe with paper towel. |
| Oven cavity Food spills containing sugar and/or milk All other spills | <ul style="list-style-type: none"> Soap and water Self-cleaning cycle | <ul style="list-style-type: none"> When oven cools, wash, rinse and dry with soft cloth or sponge. See the "Using the self-cleaning cycle" section. |
| Oven racks | <ul style="list-style-type: none"> Soap and water Steel wool pad Self-cleaning cycle | <ul style="list-style-type: none"> Wash, rinse and dry. Place on 2nd and 4th rack guides. Racks will discolor and become harder to slide. After cleaning, apply vegetable oil to rack guides for easier sliding. |
| Broiler pan and grid | <ul style="list-style-type: none"> Soap and water Steel wool pad Dishwasher Solution of 1/2 cup (125 mL) ammonia to 1 gallon (3.78 L) water Mild abrasive cleanser or commercial oven cleaner | <ul style="list-style-type: none"> Wash, rinse and dry. Soak for 20 minutes, then scrub with plastic scrubbing pad. DO NOT clean the pan and grid in the self-cleaning cycle. |

Removing the oven door

For normal use of your oven, you do not need to remove the door. However, you can remove the door by following the instructions in this section.

The oven door is heavy. Use both hands to remove and replace the door. Do not lift and carry the door by the handle. To remove and replace the door you may need help.

To remove:

1. Open door all the way.

NOTE: Two 5/16" (4 mm) Allen wrenches or two nails of similar diameter may be used if factory furnished door removal pins have been misplaced. Be careful not to damage porcelain finish.



2. **Insert** small end of a door removal pin into each door hinge.

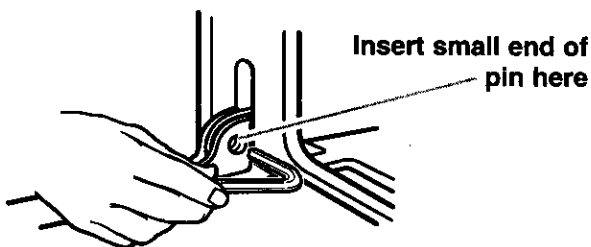

3. **Grasp** under handle and gently close door as far as it will shut. Pull door out at bottom to remove.

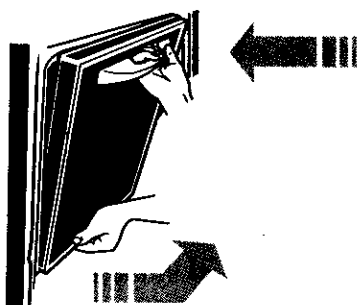

4. **Set** door aside on protected surface.

To replace:

1. **Fit** hinge arms into slots in frame. Push in at lower corners to insure that hinge arms are fully engaged.

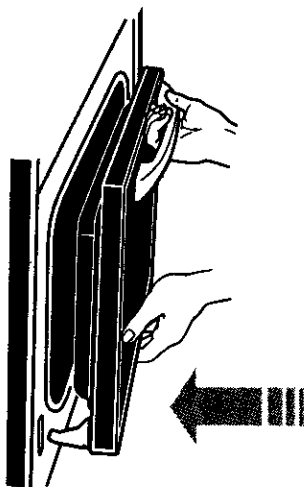



2. **Open** the door all the way.

3. **Remove** the door removal pins from each hole.
4. **Close** the door.

NOTE: If the door does not operate freely, you have not installed it properly. Repeat Steps 1-4.

Using and replacing the oven lights

The oven lights will come on when you open the oven door. To turn the lights on when the oven door is closed, press **OVEN LIGHT**  on the control panel. Press  again to turn off the lights.

NOTES:

- Make sure the oven is cool before replacing the light bulb.
- The oven lights will not work during the Self-Cleaning cycle.

Replacing the oven light:

1. **Unplug** oven or disconnect power.
2. **Remove** glass light cover by grasping the front edge of cover and pulling it away from the side wall of the oven.



3. **Remove** the light bulb from its socket. **Replace** the bulb with another halogen bulb (12 volt, 5 watt maximum, available at most hardware stores).
4. **Replace** the light cover by snapping it back into wall.
5. **Plug in** oven or reconnect power.

Troubleshooting

Most cooking problems often are caused by little things you can find and fix without tools of any kind. Check the lists below and on the next page before calling for assistance or service. If you still need help, see "Requesting Assistance or Service" on pages 44 and 45.

If nothing operates, check the following:

- Is the oven wired into a live circuit with the proper voltage? (See Installation Instructions.)
- Have you blown a household fuse or tripped a circuit breaker?

Other possible problems and their causes:

| PROBLEM | CAUSE/SOLUTION |
|---|---|
| The oven will not operate | <ul style="list-style-type: none"> • You have not set the electronic control correctly. Refer to the section in this manual describing the function you are operating. • You have programmed a delayed start time. Wait for the start time to be reached or cancel and reset the control. |
| The Self-Cleaning cycle will not operate | <ul style="list-style-type: none"> • You have programmed a delayed start time. Wait for the start time to be reached or cancel and reset the control. • You have programmed another function in the other oven on a double oven. Cancel and reprogram oven. |
| Display is blank | <ul style="list-style-type: none"> • You have set the display not to show the clock time. To see the clock time again, press and hold CLOCK SET/START for 5 seconds. |
| The oven temperature seems too low or too high | <ul style="list-style-type: none"> • Adjust the oven temperature control. (See "Adjusting the oven temperature control" section.) |
| Slow baking or roasting | <ul style="list-style-type: none"> • Increase baking or roasting time. • Increase temperature 25°F (14°C) • Preheat oven to selected temperature before placing food in when preheating is recommended. • Choose bakeware that will allow 2 inches (5 cm) of air space around all sides. • Open oven door to check food when timer signals shortest time suggested in recipe. • Oven peeking can make cooking times longer. |
| Baked items too brown on bottom | <ul style="list-style-type: none"> • Preheat oven to selected temperature before placing food in oven. • Choose bakeware that will allow 2 inches (5 cm) of air space around all sides. • Position rack higher in oven. • Decrease oven temperature 15° to 25°F (8° to 14°C). |



| PROBLEM | CAUSE/SOLUTION |
|--|--|
| Unevenly baked items | <ul style="list-style-type: none"> • Check that the oven is level. • Bake in center of oven with 2 inches (5 cm) of space around each pan. • Check to make sure batter is level in pan. |
| Crust edge browns before pie is done | <ul style="list-style-type: none"> • Shield edge with foil. |
| The display is showing "PF" | <ul style="list-style-type: none"> • There has been a power failure. Reset the clock. (See "Setting the clock" in "Using Your Oven" section.) |
| A letter followed by a number shows on the display (for example "E3," "F1") | <ul style="list-style-type: none"> • Press CANCEL/OFF. If the code reappears, note the code and call for service. |
| The key pads do not operate | <ul style="list-style-type: none"> • The Control Lock has been set. Turn off the Control Lock by pressing and holding CONTROL LOCK (Number Pad 3) for 5 seconds. • The Sabbath mode has been set ("Sab" appears on the display). Turn off the Sabbath mode by pressing and holding Number Pad 6 for 5 seconds. |

If none of these items is causing your problem, see "Requesting Assistance or Service".

Requesting Assistance or Service

Before calling for assistance or service, please check the "Troubleshooting Guide" section. It may save you the cost of a service call. If you still need help, follow these instructions.

If you need assistance or service

Call the KitchenAid Consumer Assistance Center toll free: 1-800-422-1230. Our consultants are available to assist you.



When calling:

Please know the purchase date, and the complete model and serial number of your appliance (see the "A Note to You" section). This information will help us to better respond to your request.

Our consultants provide assistance with:

- Features and specifications on our full line of appliances.
- Installation information.

- Use and maintenance procedures.
- Accessory and repair parts sales.
- Specialized customer assistance (Spanish speaking, hearing impaired, limited vision, etc.).
- Referrals to local dealers, service companies, and repair parts distributors.

KitchenAid designated service technicians are trained to fulfill the product warranty and provide after-warranty service, anywhere in the United States.

To locate the KitchenAid designated service company in your area, you can also look in your telephone directory Yellow Pages.

If you need replacement parts

If you need to order replacement parts, we recommend that you only use factory specified parts. These parts will fit right and work right, because they are made with the same precision used to build

every new KITCHENAID® appliance. To locate factory specified replacement parts in your area, call our Consumer Assistance Center telephone number or your nearest designated service center.

For further assistance

If you need further assistance, you can write to KitchenAid with any questions or concerns at:

KitchenAid Brand Home Appliances
Consumer Assistance Center
c/o Correspondence Dept.
2000 North M-63
Benton Harbor, MI 49022-2692

Please include a daytime phone number in your correspondence.



If you need assistance or service in Canada:

Call the KitchenAid Consumer



**Assistance Center toll free:
8:30 a.m. - 6 p.m. (EST) at
1-800-461-5681. Our consult-
ants are available to assist
you.**

When calling:

Please know the purchase date, and the complete model and serial number of your appliance (see the "A Note to You" section). This information will help us to better respond to your request.

Our consultants provide assistance with:

- Features and specifications on our full line of appliances.

If you need service:

Contact Inglis Limited Appliance Service from anywhere in Canada at **1-800-807-6777**.

- Accessory and repair parts sales.
- Specialized customer assistance (French speaking, hearing impaired, limited vision, etc.).
- Referrals to local dealers, service companies, and repair parts distributors.

KitchenAid designated service technicians are trained to fulfill the product warranty and provide after-warranty service, anywhere in Canada.

To locate the KitchenAid designated service company in your area, you can also look in your telephone directory Yellow Pages.

If you need replacement parts

If you need to order replacement parts, we recommend that you only use factory specified parts. These parts will fit right and work right, because they are made with the same precision used to build

every new KITCHENAID® appliance. To locate factory specified replacement parts in your area, call our Consumer Assistance Center telephone number or your nearest designated service center.

For further assistance

If you need further assistance, you can write to KitchenAid with any questions or concerns at:

Consumer Relations Department
KitchenAid Canada
1901 Minnesota Court
Mississauga, Ontario L5N3A7

Please include a daytime phone number in your correspondence.



Notes

KitchenAid[®]

Electric Built-In Oven

Warranty

| LENGTH OF WARRANTY: | KITCHENAID WILL PAY FOR: | KITCHENAID WILL NOT PAY FOR: |
|---|--|---|
| ONE-YEAR FULL WARRANTY FROM DATE OF INSTALLATION. | Replacement parts and repair labor costs to correct defects in materials or workmanship. Service must be provided by a KitchenAid designated servicing company. | A. Service calls to: <ol style="list-style-type: none"> 1. Correct the installation of the oven. 2. Instruct you how to use the oven. 3. Replace house fuses or correct house wiring. B. Repairs when oven is used in other than normal home use. |
| SECOND-THROUGH FIFTH-YEAR LIMITED WARRANTY FROM DATE OF INSTALLATION. | Replacement parts for any oven electric element to correct defects in materials or workmanship. Replacement parts for solid state touch control system to correct defects in materials or workmanship. | C. Damage resulting from accident, alteration, misuse, abuse, acts of God, improper installation, or installation not in accordance with local electrical codes. D. Any labor costs during the limited warranties. E. Replacement parts or repair labor costs for units operated outside the United States and Canada. F. Pickup and delivery. This product is designed to be repaired in the home. |
| SECOND-THROUGH TENTH-YEAR LIMITED WARRANTY FROM DATE OF INSTALLATION. | Replacement parts for the porcelain oven cavity/inner door if the part rusts through due to defects in materials or workmanship. | G. Repairs to parts or systems resulting from unauthorized modifications made to the appliance. H. In Canada, travel or transportation expenses for customers who reside in remote areas. |

3/99

KITCHENAID AND KITCHENAID CANADA DO NOT ASSUME ANY RESPONSIBILITY FOR INCIDENTAL OR CONSEQUENTIAL DAMAGES. Some states or provinces do not allow the exclusion or limitation of incidental or consequential damages, so this exclusion or limitation may not apply to you. This warranty gives you specific legal rights and you may also have other rights which may vary from state to state or province to province.

Outside the United States and Canada, a different warranty may apply. For details, please contact your authorized KitchenAid dealer.

If you need service, first see the "Troubleshooting" section of this book. After checking "Troubleshooting," additional help can be found by checking the "Requesting Assistance or Service" section or by calling our Consumer Assistance Center telephone number, **1-800-422-1230** (toll free), from anywhere in the U.S.A. For service in Canada, call **1-800-807-6777**.