

# Use and Care Guide



TO THE INSTALLER: PLEASE LEAVE THIS INSTRUCTION BOOK WITH THE UNIT.

TO THE CONSUMER: PLEASE READ AND KEEP THIS BOOK FOR FUTURE REFERENCE.

**KitchenAid**  
FOR THE WAY IT'S MADE™

A Note to You .....	2
Range Safety.....	3
Parts and Features .....	5
Using and Caring for Your Cooktop.....	7
Using the surface burners .....	7
Cookware tips .....	10
Characteristics of cookware materials.....	10
Caring for your cooktop .....	11
Cleaning your cooktop.....	13
Using and Caring for Your Oven.....	14
Using the electronic oven control .....	14
Setting the clock .....	15
Oven settings.....	15
Cooking tips.....	17
Bake.....	19
Convection Bake.....	19
Convection Roast .....	19
Broil.....	20
Convection Broil.....	21
Timed cooking.....	22
Proof/Keep Warm .....	23
Bread .....	24
Cleaning your oven and controls.....	24
Using and replacing the oven lights .....	26
Using the Self-Cleaning Cycle .....	27
Before you start .....	27
Before setting the controls.....	28
Setting the controls.....	28
For best cleaning results .....	29
How the cycle works.....	29
Troubleshooting.....	30
Requesting Assistance or Service.....	33
Bread Recipes.....	35
Warranty .....	38

In the U.S.A. for assistance or service,  
call the Consumer Assistance center:

1-800-422-1230

In Canada, for assistance or service,  
see page 34.

## KITCHENAID® Professional Dual Fuel Range

Model: KDRP407H

4452761

[www.kitchenaid.com](http://www.kitchenaid.com)

# A Note to You

*Thank you for buying a KITCHENAID® appliance!*

KITCHENAID® designs the best tools for the most important room in your house. To ensure that you enjoy many years of trouble-free operation, we developed this Use and Care Guide. It contains valuable information concerning how to operate and maintain your new appliance properly. Please read it carefully. Also, please complete and mail the enclosed Product Registration Card.

Please record your model's information.

Whenever you call our Consumer Assistance Center at **1-800-422-1230** (in Canada, **1-800-461-5681**) or request service for your appliance, you need to know your complete model number and serial number. You can find this information on the model and serial number plate (see diagram for location of plate).

Please also record the purchase information.

Model Number \_\_\_\_\_

Serial Number \_\_\_\_\_

Purchase/  
Installation Date \_\_\_\_\_

Builder/Dealer  
Name \_\_\_\_\_

Address \_\_\_\_\_

Phone \_\_\_\_\_

**NOTE:** You must provide proof of purchase or installation date for in-warranty service.

**Keep this book and the sales slip together in a safe place for future reference.**

**WARNING: If the information in this manual is not followed exactly, a fire or explosion may result causing property damage, personal injury or death.**

- Do not store or use gasoline or other flammable vapors and liquids in the vicinity of this or any other appliance.
- **WHAT TO DO IF YOU SMELL GAS**
  - Do not try to light any appliance.
  - Do not touch any electrical switch.
  - Do not use any phone in your building.
  - Immediately call your gas supplier from a neighbor's phone. Follow the gas supplier's instructions.
  - If you cannot reach your gas supplier, call the fire department.
- Installation and service must be performed by a qualified installer, service agency or the gas supplier.

# Range Safety

## Your safety and the safety of others is very important.

We have provided many important safety messages in this manual and on your appliance. Always read and obey all safety messages.



This is the safety alert symbol.

This symbol alerts you to hazards that can kill or hurt you and others.

All safety messages will be preceded by the safety alert symbol and the word "DANGER" or "WARNING." These words mean:

**⚠ DANGER**

You will be killed or seriously injured if you don't follow instructions.

**⚠ WARNING**

You can be killed or seriously injured if you don't follow instructions.

All safety messages will identify the hazard, tell you how to reduce the chance of injury, and tell you what can happen if the instructions are not followed.

## The anti-tip bracket

The range will not tip during normal use. However, tipping can occur if you apply too much force or weight to the open door without the anti-tip bracket properly secured.



**⚠ WARNING**

### Tip Over Hazard

A child or adult can tip the range and be killed.

Connect anti-tip bracket to wall behind range.

Reconnect the anti-tip bracket, if the range is moved.

See the installation instructions for details.

Failure to follow these instructions can result in death or serious burns to children and adults.

Rear Brace

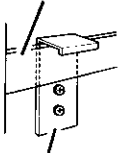

Anti-Tip Bracket

Making sure the anti-tip bracket is installed:

- Slide range forward.
- Look for the anti-tip bracket securely attached to wall behind range.
- Slide range completely back, so anti-tip bracket is over rear brace of range.

## IMPORTANT SAFETY INSTRUCTIONS

**WARNING:** To reduce the risk of fire, electrical shock, injury to persons, or damage when using the range, follow basic precautions, including the following:

- **WARNING – TO REDUCE THE RISK OF TIPPING OF THE RANGE, THE RANGE MUST BE SECURED BY PROPERLY INSTALLED ANTI-TIP DEVICES. TO CHECK IF THE DEVICES ARE INSTALLED PROPERLY, SLIDE RANGE FORWARD. LOOK FOR THE ANTI-TIP BRACKET SECURELY ATTACHED TO WALL BEHIND RANGE. SLIDE RANGE COMPLETELY BACK, SO ANTI-TIP BRACKET IS OVER REAR BRACE OF RANGE.**
- **CAUTION –** Do not store items of interest to children in cabinets above a range or on the backguard of a range – children climbing on the range to reach items could be seriously injured.
- **Proper Installation –** The range, when installed, must be electrically grounded in accordance with local codes or, in the absence of local codes, with the *National Electrical Code, ANSI/NFPA 70*. Be sure the range is properly installed and grounded by a qualified technician.

- Disconnect the electrical supply before servicing the appliance.
- Never Use the Range for Warming or Heating the Room.
- Injuries may result from the misuse of appliance doors or drawers such as stepping, leaning, or sitting on the doors or drawers.
- Maintenance – Keep range area clear and free from combustible materials, gasoline, and other flammable vapors and liquids.
- Storage in or on the Range – Flammable materials should not be stored in an oven or near surface units.
- Top burner flame size should be adjusted so it does not extend beyond the edge of the cooking utensil.

### **For self-cleaning ranges –**

- **Before Self-Cleaning the Oven –** Remove broiler pan and grid and other utensils. Wipe off all excessive spillage before initiating the cleaning cycle.

## SAVE THESE INSTRUCTIONS

The California Safe Drinking Water and Toxic Enforcement Act requires the Governor of California to publish a list of substances known to the State of California to cause cancer, birth defects, or other reproductive harm, and requires businesses to warn of potential exposure to such substances.

**WARNING:** This product contains a chemical known to the State of California to cause cancer, birth defects, or other reproductive harm.

This appliance can cause low-level exposure to some of the substances listed, including benzene, formaldehyde, carbon monoxide, toluene, and soot.

# Parts and Features

## Feature locations

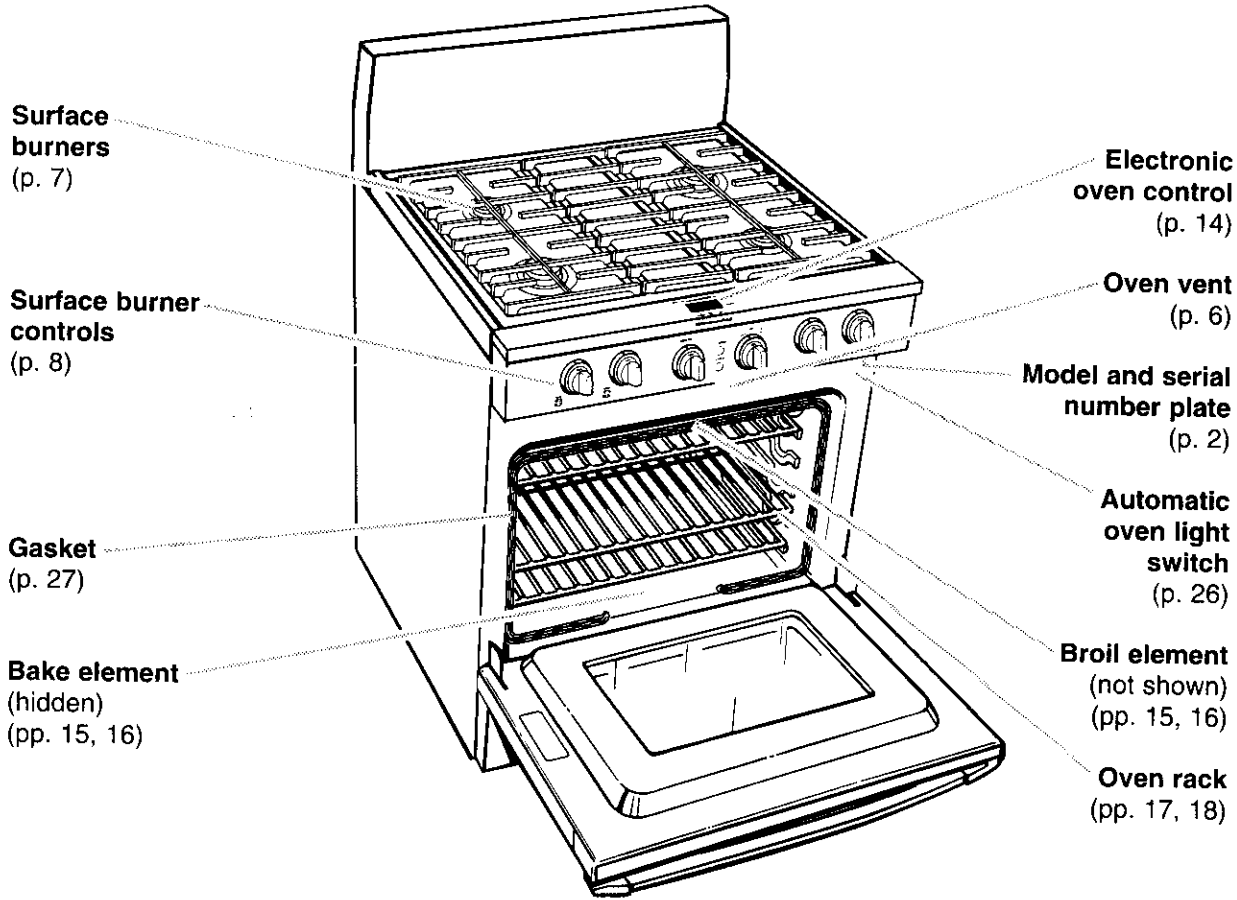

## Surface burner controls

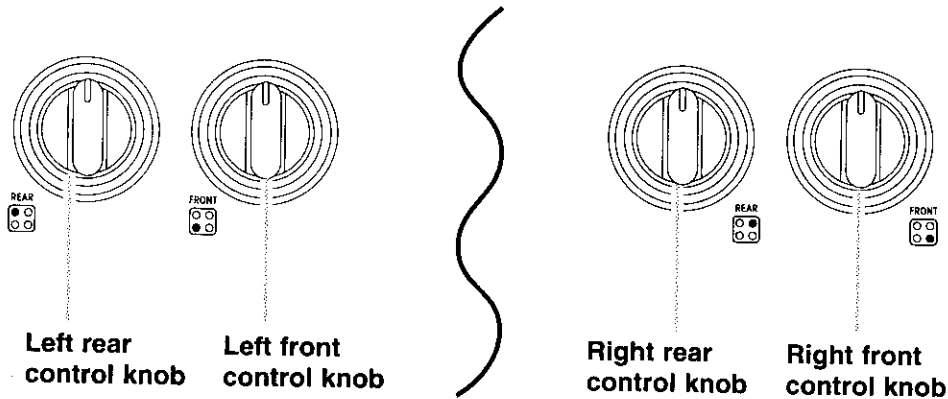

## The oven vent

Hot air and moisture escape from the oven through vent. The vent is above the oven door. It is needed for air circulation. **Do not block the vent.** Poor baking/roasting can result.

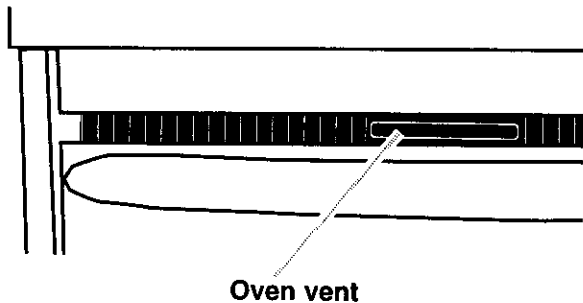

## Removing the oven door

For normal use of your oven, you do not need to remove the door. However, you can remove the door by following the instructions in this section.

The oven door is heavy. Use both hands to remove and replace the door. Do not lift and carry the door by the handle. To remove and replace the door you may need help.

### To remove:

1. **Open** door all the way.

**NOTE:** Two  $\frac{5}{32}$ " (4 mm) Allen wrenches or two nails of similar diameter may be used if factory furnished door removal pins have been misplaced. Be careful not to damage porcelain finish.

2. **Insert** small end of a door removal pin into each door hinge.

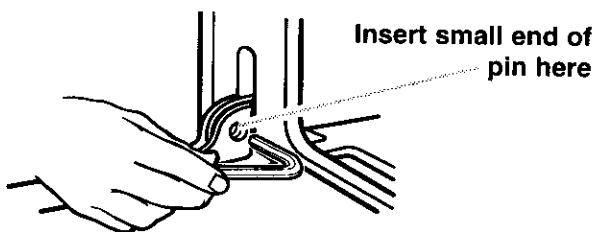

3. **Grasp** under handle and gently close door as far as it will shut. Pull door out at bottom to remove.

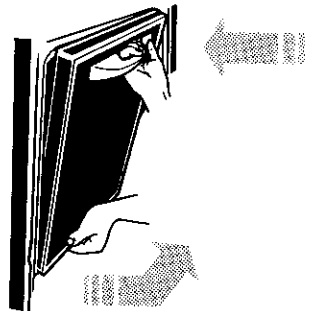

4. **Set** door aside on protected surface.

### To replace:

1. **Fit** hinge arms into slots in frame. Push in at lower corners to insure that hinge arms are fully engaged.

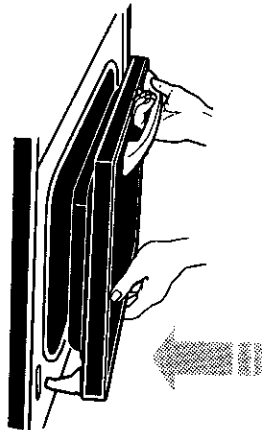

2. **Open** the door all the way.
3. **Remove** the door removal pins from each hole.
4. **Close** the door.

**NOTE:** If the door does not operate freely, you have not installed it properly. Repeat Steps 1-4.

# Using and Caring for Your Cooktop

## Using the surface burners

Your cooktop has sealed gas burners. The sealed burners spread the heat evenly across the bottom of the cookware and provide infinite heat control.

**IMPORTANT:** Your cooktop is factory-set for use with Natural Gas. If you wish to use L.P. gas, an L.P. Gas Conversion Kit is included with your new range. See the instructions included with the L.P. conversion kit for details on making this conversion.

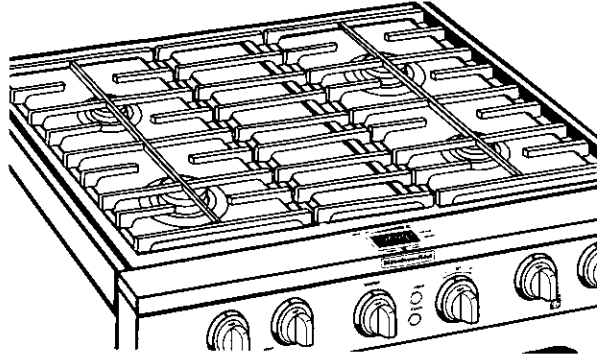

- **Position grate legs** into the leg locators on front and back of cooktop.

# Using and Caring for Your Cooktop

## Using the surface burners:

### Control knobs

1. **Grasp** the control knob.
2. **Push in** and **turn** to LITE. The electric spark ignitor will ignite the gas flowing into the burner. When you hear a clicking sound, you know that the ignitors are working. Gas is flowing as long as knob is not set at OFF.
3. **When the burner is lit, turn** the control knob to the desired flame setting. (See the guide under "Burner heat settings" later in this section.) You can turn the knobs to any of the marked settings. The ignitor will turn off and the clicking will stop when the knob is moved from LITE.

### NOTES:

- **The ignitors** may click a number of times before burner lights. This is normal.
- **All four burner ignitors** will spark regardless of which burner you are using.
- **Visually check** that the burner has lit. If the burner does not ignite, listen for the clicking sound. If you do not hear the ignitor click, **TURN THE BURNER OFF**. Check for a tripped circuit breaker or blown fuse.

Check that the control knob is pressed completely down on valve shaft. **If the spark ignitor still fails to operate, call your nearest designated service outlet.**

Proper grounding and polarity are necessary for correct operation of the electric ignition system. If the wall receptacle does not provide correct polarity, the ignitor will become grounded and click every once in a while, even after the burner has ignited. A qualified electrician should check the wall receptacle to see if it is wired with correct polarity.

**REMEMBER:** When range is in use or during the Self-Cleaning cycle, the entire cooktop area may become hot.

## ⚠ WARNING



### Fire Hazard

**Do not let the burner flame extend beyond the edge of the pan.**

**Turn off all controls when not cooking.**

**Failure to follow these instructions can result in death or fire.**

## Burner heat settings

Use correct burner heat settings (see chart later in this section). If the heat setting is too high, it will affect cooking results.

**Until you get used to the settings, use the following as a guide.**

SETTING	RECOMMENDED USE
LITE	<ul style="list-style-type: none"><li>• To light the burner.</li></ul>
HI	<ul style="list-style-type: none"><li>• To start food cooking.</li><li>• To bring liquid to a boil.</li></ul>
MED to HI	<ul style="list-style-type: none"><li>• To hold a rapid boil.</li><li>• To quickly brown or sear meat.</li></ul>
MED	<ul style="list-style-type: none"><li>• To maintain a slow boil.</li><li>• To fry poultry or meat.</li></ul>
MED to LO	<ul style="list-style-type: none"><li>• To cook pudding, sauce or gravy.</li><li>• To stew or steam food.</li></ul>
LO (with simmer plate)	<ul style="list-style-type: none"><li>• To simmer food.</li><li>• To keep food warm.</li><li>• To melt chocolate or butter.</li></ul>





## Simmer Plate†

One Simmer Plate has been provided with your cooktop. It has been designed to be used with burner settings in the medium to low range on your cooktop when lower temperatures are required for simmering or for maintaining food at a low temperature over an extended period of time. The Simmer Plate is made of aluminum to evenly spread the heat over the bottom of cookware.

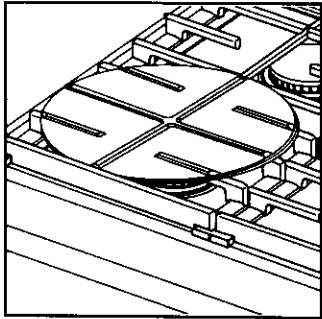

Channels on the bottom of the Simmer Plate (see diagram at left) have been designed so it fits properly and securely over the grate.

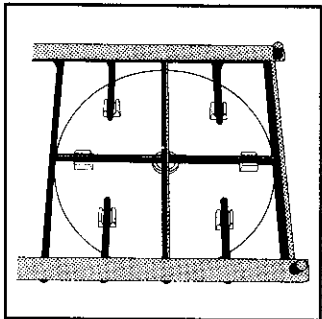

† To order additional Simmer Plates (**Part No. 4455109**), call **1-800-422-1230** (in U.S.A.) or **1-800-461-5681** (in Canada). You will hear a recording. Follow the steps to place order.

## In case of a prolonged power failure

Surface burners can be manually lighted.

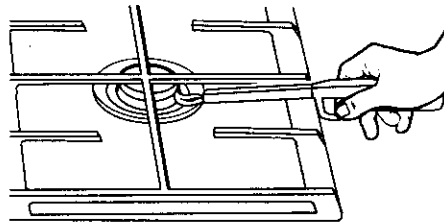

1. **Hold** a lit striker near a burner and **turn** the control knob to the HI position.

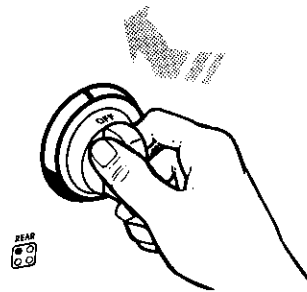

2. **After the burner lights**, turn the control knob to the desired setting.

**NOTE:** Do not leave a burner on without any cookware on the grate. The grate finish can be damaged.

# Using and Caring for Your Cooktop

## Cookware tips

### Home canning information

The large diameter of most water-bath or pressure canners combined with high heat settings for long periods of time can cause damage to the cooktop.

#### To protect your range:

- Center the canner over the surface burner. Do not extend more than 1 inch (2.5 cm) outside the burner area.
- Do not place your canner on two surface burners at the same time.
- Start with hot water, cover with a lid and bring to a boil; then reduce heat to maintain a boil or required pressure levels in a pressure canner.

- Refer to your canner manual for specific instructions.
- For up-to-date information on canning, in the United States, contact your local U.S. Government Agricultural Department Extension Office or companies who manufacture home canning products. In Canada, contact Agriculture Canada.

### Using the right cookware makes a big difference

- The pan should have a flat bottom, straight sides, and a well-fitting lid.
- Choose medium to heavy gauge (thickness) cookware.
- The pan material (metal or glass) affects how quickly and evenly the pan heats.
- When using glass or ceramic cookware, check to make sure it is suitable for use on surface burners.

## Characteristics of cookware materials

The pan material affects how fast heat transfers from the surface cooking area through the pan material and how evenly heat spreads over the pan bottom. Choose pans that provide the best cooking results.

Aluminum	<ul style="list-style-type: none"> <li>• Heats quickly and evenly.</li> <li>• Use for all types of cooking.</li> <li>• Medium or heavy thickness is best for most cooking.</li> <li>• Used as a core or base in cookware to provide even heating.</li> </ul>
Cast iron	<ul style="list-style-type: none"> <li>• Heats slowly and evenly.</li> <li>• Good for browning and frying.</li> <li>• Maintains heat for slow cooking.</li> <li>• Can be coated with porcelain enamel.</li> </ul>
Ceramic or ceramic glass	<ul style="list-style-type: none"> <li>• Heats slowly and unevenly.</li> <li>• Use on low to medium settings.</li> <li>• Follow manufacturer's instructions.</li> </ul>
Copper	<ul style="list-style-type: none"> <li>• Heats very quickly and evenly.</li> <li>• Used as a core or base in cookware to provide even heating.</li> </ul>
Earthenware	<ul style="list-style-type: none"> <li>• Can be used for cooktop cooking if recommended by the manufacturer.</li> <li>• Use on low settings.</li> </ul>
Porcelain enamel-on-steel or enamel-on-cast iron	<ul style="list-style-type: none"> <li>• See cast iron and stainless steel.</li> </ul>
Stainless steel	<ul style="list-style-type: none"> <li>• Heats quickly but unevenly.</li> <li>• A core or base of aluminum or copper on the cookware provides even heating.</li> <li>• Can be coated with porcelain enamel.</li> </ul>

## Caring for your cooktop

Your cooktop is designed for ease of care. You can do most cleaning with items found around the home. Cleaning your cooktop whenever spills or soiling occur will help to keep it looking and operating like new.

### NOTES:

- **Before cleaning** make sure all controls are off and the cooktop is cool.
- **Do not obstruct** the flow of combustion and ventilation air around the burner grates edges.

### Surface burners

- **The burner caps** should be routinely removed and cleaned. Always clean burner caps after a spillover. Keeping the burner caps clean prevents poor ignition and an uneven flame.
- **For proper flow** of gas and ignition of the burner, **do not allow spills, food, cleaning agents, or any other material to enter the gas tube opening.**
- **Occasionally check** the burner flames for proper size and shape as shown later in this section. A good flame is blue in color. If flames are not burning at all ports, you may need to clean the burner ports.

### To clean burners and burner caps:

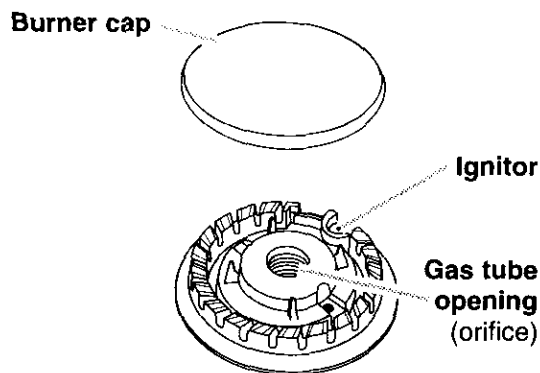

1. **Lift** the burner cap straight up from the burner base.
2. **Clean** burner cap with warm, soapy water and a sponge. For stubborn stains, clean with a non-abrasive scrubbing pad or mild abrasive powdered cleanser. Wipe dry. Do not clean burner cap in dishwasher.
3. **If the gas tube opening** or the orifice, located inside the opening, has become soiled or clogged, **use** a damp cloth to clean the area.
4. **If ports are clogged, clean them with a straight pin. Do not enlarge or distort the port. Do not use a wooden toothpick.** If the burner needs to be adjusted, call a qualified technician for service.
5. **After cleaning** the gas tube opening and ports, **replace** the burner cap. **To replace burner cap, make sure cap is properly aligned and leveled.**
6. **Check** the burner after cleaning for proper lighting. If the burner does not light after you have cleaned it, recheck cap alignment or contact a designated service technician. **Do not** service the sealed burner yourself.

## Adjusting the height of top burner flames

The LO burner flame should be a steady blue flame approximately ¼ inch (6 mm) high. It can be adjusted using the adjustment screw in the center of the valve stem. The valve stem is located directly underneath the control knob.

**To adjust the flame height follow the instructions below:**

1. **Turn** the control knob to "LO."
2. **Remove** the control knob. (If there is not an adjustment screw underneath the knob the flame height is not adjustable.)
3. **Hold** the valve stem with a pair of pliers. The screw is located in the center of the valve stem. Use a small flat head screwdriver to turn the screw until the flame is the proper size.
4. **Replace** the control knob.
5. **Test** the flame by turning the control from "LO" to "HI," checking the flame at each setting.

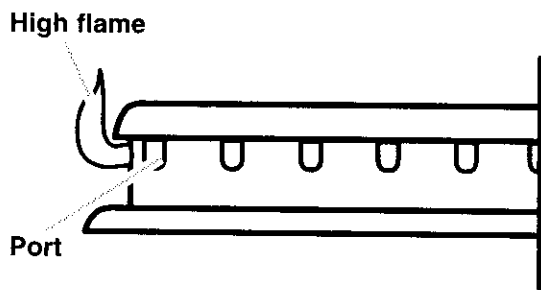
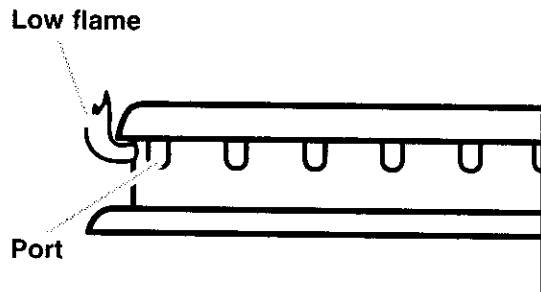
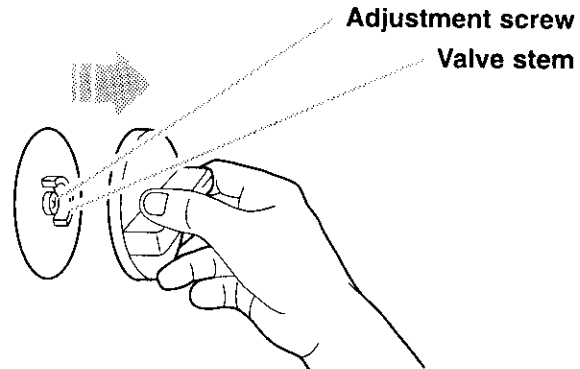

## Cleaning your cooktop

	<b>!WARNING</b>
	<p><b>Explosion Hazard</b></p> <p><b>Do not store flammable materials such as gasoline near this appliance.</b></p> <p><b>Doing so can result in death, explosion, or fire.</b></p>

PART	WHAT TO USE	HOW TO CLEAN
<b>Cooktop Surfaces</b>	<ul style="list-style-type: none"> <li>• Soap and water</li> <li>• Mild liquid cleaner</li> <li>• Spray glass cleaner</li> <li>• Non-abrasive plastic scrubbing pad</li> </ul>	<ul style="list-style-type: none"> <li>• DO NOT use abrasive or harsh cleaners like chlorine bleach, ammonia or oven cleaners.</li> <li>• Wash, rinse and dry with soft cloth.</li> <li>• Gently clean around the model and serial plate; too much scrubbing could remove the numbers.</li> </ul>
<b>Control knobs</b>	<ul style="list-style-type: none"> <li>• Sponge and warm, soapy water</li> </ul>	<ul style="list-style-type: none"> <li>• Turn knobs to RESET and pull straight away from control panel.</li> <li>• Wash, rinse, and dry thoroughly. Do not soak.</li> <li>• <b>Do not use steel wool or abrasive cleansers. They may damage the finish of the knobs.</b></li> <li>• Replace knobs. Make sure all knobs point to RESET.</li> </ul>
<b>Porcelain-coated surface burner grates and caps*</b>	<ul style="list-style-type: none"> <li>• Warm, soapy water and a non-abrasive plastic scrubbing pad and/or mild abrasive powdered cleanser</li> </ul>	<ul style="list-style-type: none"> <li>• Clean as soon as they become dirty and when they are cool enough to handle.</li> <li>• Wash with a mildly abrasive plastic scrubbing pad and warm, soapy water.</li> <li>• For stubborn stains, clean with a scrubbing pad and/or a powdered cleanser and water. Repeat these cleaning steps as needed.</li> <li>• Do not put in oven during self-cleaning cycle.</li> <li>• Do not clean in dishwasher.</li> </ul>
<b>Surface burners</b>		<ul style="list-style-type: none"> <li>• See "Caring for your cooktop" earlier in this section for cleaning instructions.</li> </ul>

\* When the cooktop is cool, remove all spills and clean. Food spills containing acids, such as vinegar and tomato, may affect the finish. To avoid porcelain grate chipping, do not bang grates and caps against each other or other hard surfaces such as cast iron cookware. Because of direct exposure to high temperatures, the grates will gradually lose their shiny appearance. This is normal.

# Using and Caring for Your Oven

This section tells you, step by step, how to operate all oven functions controlled by the electronic control. Carefully follow these instructions, along with the cooking tips and cleaning information, for successful use of your range.

## Using the electronic oven control

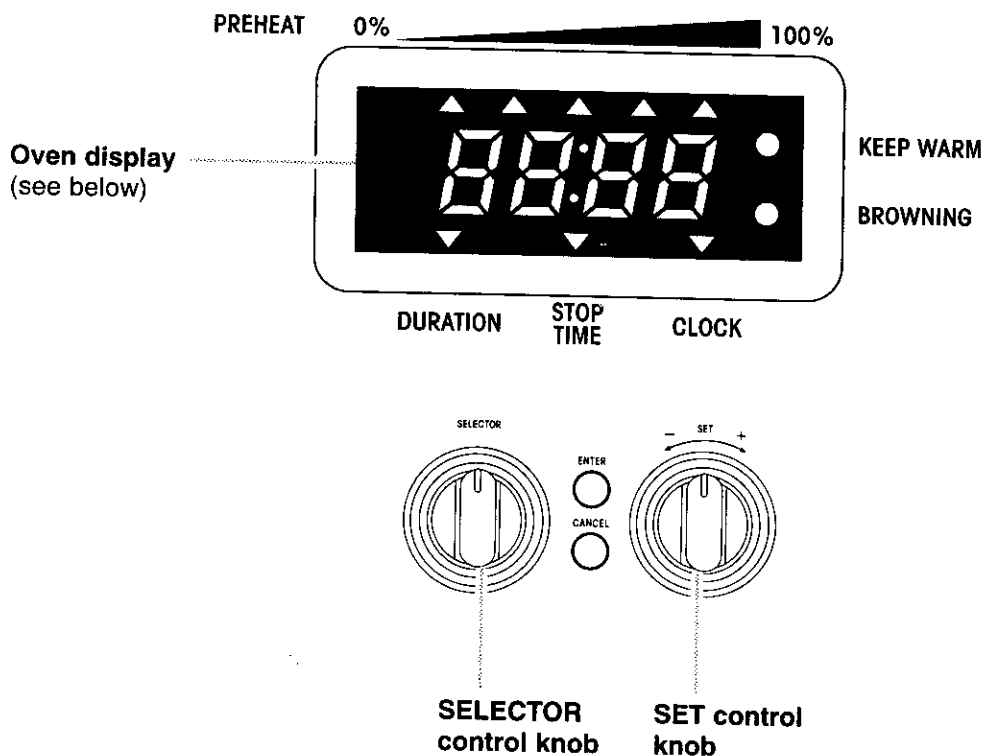

### Display/clock

- When you first power up the oven, the display will show "PF". If, after you set the clock (See "Setting the clock" later in this section), the display again shows "PF," your electricity was off for a while. Reset the clock.

### SELECTOR

- All cooking functions are selected with this knob.
- Once a cycle is complete, you must return to the RESET position to select a new function.

### SET

- All temperature or time adjustments are done with this knob.
- All temperature adjustments are displayed in 5°F (3°C) intervals.
- The speed you turn the knob with is reflected on the display.

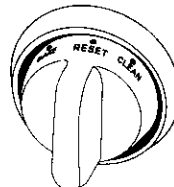

## Starting an operation

After programming a function, you must press ENTER.

## Resetting an operation

- When cooking is done, move SELECTOR knob to RESET position. The oven is then ready for the next cooking function.

## Canceling an operation

- **CANCEL** will cancel any functions, except for the clock/time of day.
- **After canceling an operation**, "End" will be displayed to show the function was cancelled.

To select a new cooking function:

- You must turn SELECTOR back to RESET.

**NOTE:** You may hear the cooling fan after you press CANCEL. It will shut off automatically when the oven cools.

## Setting the clock

1. Place **SELECTOR** in **RESET** position.
2. Press **ENTER** until the display shows "12:00" and the **CLOCK** indicator is blinking.
3. Rotate **SET** until desired time is shown.
4. Press **ENTER** to accept time on display.

## To change current time:

Follow steps 2-4.

## Oven settings

This chart tells you when to use each setting. It also explains which elements heat up for each setting.

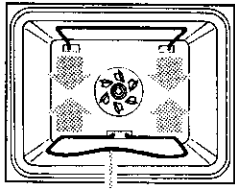
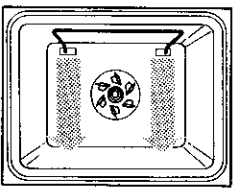
SETTING	DIAGRAM	SETTING INFORMATION
<p><b>BAKE</b> Use this setting for standard baking and roasting.</p>	 <p><b>Bake element</b> (not visible)</p>	<ul style="list-style-type: none"> <li>• The bottom element and top element heat up.</li> <li>• The elements will cycle on and off to maintain the oven temperature.</li> <li>• Opening the door during Bake will cause the bake and broil elements to turn off immediately.</li> </ul>
<p><b>BROIL</b> Use this setting for broiling regular-sized and smaller cuts of meat, poultry, and fish.</p>	 <p><b>Broil element</b> (not visible)</p>	<ul style="list-style-type: none"> <li>• Only the top element heats up during Broil.</li> <li>• The element will cycle on and off to maintain the oven temperature.</li> <li>• Door must be closed during broil.</li> </ul>

# Using and Caring for Your Oven

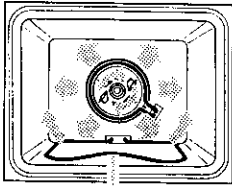
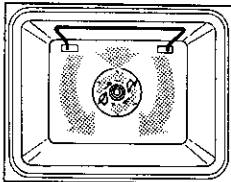
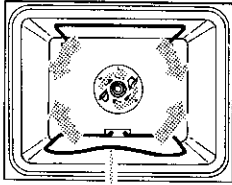
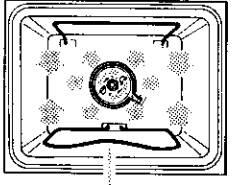
SETTING	DIAGRAM	SETTING INFORMATION
<p><b>CONVECTION BAKE</b> Use this setting for delicate foods and for baking breads and cakes. Use also when baking large quantities of food on more than one oven rack.</p>	 <p><b>Bake element</b> (not visible)</p>	<ul style="list-style-type: none"> <li>• For faster preheating, the bottom element and top element heat up until the oven reaches desired temperature. After preheat, only the rear element and bottom element heat up.</li> <li>• For even heating, the fan at the back of the oven circulates air in the oven cavity.</li> <li>• The elements will cycle on and off to maintain the oven temperature.</li> <li>• Opening the door during Convection Bake will cause the convection fan and the elements to turn off immediately.</li> </ul>
<p><b>CONVECTION BROIL</b> Use this setting for broiling thick cuts of meat.</p>		<ul style="list-style-type: none"> <li>• Only the top element heats up during Convection Broil.</li> <li>• For even heating, the fan at the back of the oven circulates air in the oven cavity.</li> <li>• The element will cycle on and off to maintain the oven temperature.</li> <li>• Opening the door during Convection Broil will cause the broil element and convection fan to turn off immediately.</li> </ul>
<p><b>CONVECTION ROAST</b> Use this setting for roasting and baking on one rack.</p>	 <p><b>Bake element</b> (not visible)</p>	<ul style="list-style-type: none"> <li>• The bottom element and top element heat up.</li> <li>• For even heating and faster cooking, the fan at the back of the oven circulates air in the oven cavity.</li> <li>• The elements will cycle on and off to maintain the oven temperature.</li> <li>• Opening the door during Convection Roast will cause the bake and broil elements and convection fan to turn off immediately.</li> </ul>
<p><b>BREAD</b> Use this setting for baking bread.</p>	 <p><b>Bake element</b> (not visible)</p>	<ul style="list-style-type: none"> <li>• The bottom element and top element heat up until oven reaches preheat temperature.</li> <li>• For even heating, the fan at the back of the oven circulates air in the oven cavity.</li> <li>• After preheat, the elements will cycle on and off to maintain the oven temperature.</li> <li>• Opening the door during Bread will cause the bake and broil elements and convection fan to turn off immediately.</li> </ul>



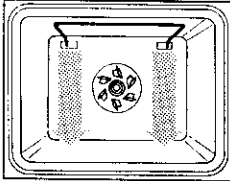
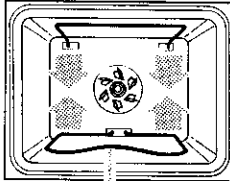
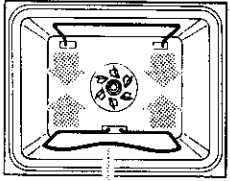

SETTING	DIAGRAM	SETTING INFORMATION
<p><b>PROOF</b> Use this setting to proof bread.</p>		<ul style="list-style-type: none"> <li>• Only the top element heats up during Proof.</li> <li>• The element will cycle on and off to maintain the oven temperature.</li> </ul>
<p><b>KEEP WARM</b> Use this setting to keep hot cooked foods warm.</p>	 <p><b>Bake element</b> (not visible)</p>	<ul style="list-style-type: none"> <li>• The bottom element and top element heat up.</li> <li>• The element will cycle on and off to maintain the oven temperature.</li> </ul>
<p><b>CLEAN</b> Use this setting for self-cleaning only.</p>	 <p><b>Bake element</b> (not visible)</p>	<ul style="list-style-type: none"> <li>• The bottom element and top element heat up.</li> <li>• Oven will remain locked, until the oven has reached a specified temperature (even after canceling).</li> </ul>

## Positioning racks and pans

Place the oven racks where you need them before turning on the oven.

- **To move a rack**, pull it out to the stop position, raise the front edge and lift it out.
- **Be sure the rack(s)** is level.
- **Use pot holders or oven mitts** to protect your hands if rack(s) must be moved while the oven is hot.
- **For best performance**, cook on one rack.

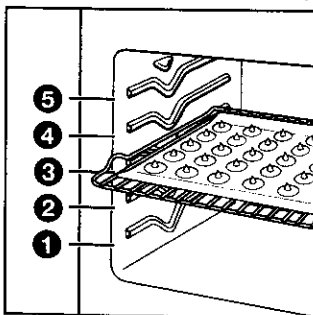

Place the rack so the top of the food will be centered in the oven.

- **When baking on two or three racks**, use the CONVECT BAKE setting for more even results. (You can also use only one rack when convection baking.)
- **To use three racks during convection baking**, place one rack in position 5 (the highest position), another rack in position 1 (the closest to the oven bottom), and the third rack in position 3. This allows all three racks to be an equal distance apart for better baking.
- **For best results** allow 2 inches (5 cm) of space around each pan and between pans and oven walls. Hot air must circulate around the pans in the oven for even heat to reach all parts of the oven. This results in better baking.

- **To use two racks during Convection Bake**, place the racks on the 2nd and 4th rack guides.

# Using and Caring for Your Oven

## Where to place pans:

WHEN YOU HAVE	PLACE
1 pan	In center of the oven rack.
2 pans	Side by side or slightly staggered.
3 or 4 pans	In opposite corners on each oven rack. Stagger pans so no pan is directly over another.

## Rack placement for specific foods:

FOOD	RACK POSITION
Frozen pies, large roasts, turkeys, angel food cakes	1st or 2nd rack guide from bottom
Bundt cakes, most quick breads, yeast breads, casseroles, meats	2nd rack guide from bottom
Cookies, biscuits, muffins, cakes, nonfrozen pies	2nd or 3rd rack guide from bottom

**NOTE:** For information on where to place your rack when broiling, see "Broiling guidelines" later in this section.

## Bakeware choices

Baking performance is affected by the type of bakeware used. Use the bakeware size recommended in the recipe.

BAKEWARE TYPE	BEST USED FOR	GUIDELINES
Light colored aluminum	<ul style="list-style-type: none"> <li>• Light golden crusts</li> <li>• Even browning</li> </ul>	<ul style="list-style-type: none"> <li>• Use temperature and time recommended in recipe.</li> </ul>
Dark aluminum and other bakeware with dark, dull, and/or non-stick finish	<ul style="list-style-type: none"> <li>• Brown, crisp crusts</li> </ul>	<ul style="list-style-type: none"> <li>• May reduce baking temperature 25°F (14°C).</li> <li>• Use suggested baking time.</li> <li>• Use temperature and time recommended in recipe for pies, breads, and casseroles.</li> <li>• Place rack in center of oven.</li> </ul>
Ovenproof glassware, ceramic glass, or ceramic	<ul style="list-style-type: none"> <li>• Brown, crisp crusts</li> </ul>	<ul style="list-style-type: none"> <li>• May reduce baking temperature 25°F (14°C).</li> </ul>
Insulated cookie sheets or baking pans	<ul style="list-style-type: none"> <li>• Little or no bottom browning</li> </ul>	<ul style="list-style-type: none"> <li>• Place in the bottom third of oven.</li> <li>• May need to increase baking time.</li> </ul>
Stainless steel	<ul style="list-style-type: none"> <li>• Light, golden crusts</li> <li>• Uneven browning</li> </ul>	<ul style="list-style-type: none"> <li>• May need to increase baking time.</li> </ul>
Stoneware	<ul style="list-style-type: none"> <li>• Crisp crusts</li> </ul>	<ul style="list-style-type: none"> <li>• Follow manufacturer's instructions.</li> </ul>



## Using aluminum foil

- Do not line the oven bottom with any type of foil, liners, or cookware. Permanent damage will occur to the oven bottom finish.
- Do not cover the entire rack with aluminum foil. Doing so will

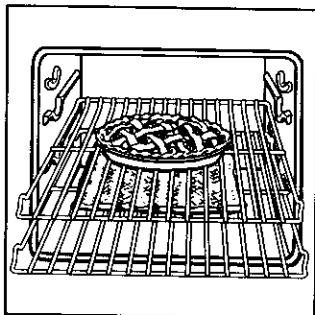

reduce air circulation and overall oven performance.

- To catch spillovers from pies or casseroles place foil on the oven rack below. Foil should be turned up at edges and be at least 1 inch (2.5 cm) larger than dish.
- Place tent-shaped foil loosely over meat or poultry to slow down surface browning for long term roasting. Remove foil for the last 30 minutes.
- Use narrow strips of foil to shield piecrust edges if browning too quickly.

## Bake

1. Turn **SELECTOR** to **BAKE**.

The display will read "350F".

2. Rotate **SET** to desired temperature.

Baking can occur from 170°F to 500°F (77°C to 260°C).

3. Press **ENTER** to start.

4. At end of Bake, turn **SELECTOR** to **RESET**.

## Convection Bake

1. Turn **SELECTOR** to **CONVECT BAKE**.

The display will read "325F".

2. Rotate **SET** to desired temperature.

Baking can occur from 170°F to 500°F (77°C to 260°C).

3. Press **ENTER** to start.

4. At end of Bake, turn **SELECTOR** to **RESET**.

## Convection baking tips

- Do not use aluminum foil when convection baking. Aluminum foil may block airflow.
  - Reduce recommended recipe standard baking temperature by approximately 25°F (14°C).
  - For some recipes, you can reduce convection baking time compared to standard baking times. Check for doneness 5 to 10 minutes before standard baking times end.
- NOTE:** Cooking time may be longer when you use more than one rack.

## Convection Roast

1. Turn **SELECTOR** to **CONVECT ROAST**.

The display will read "300F".

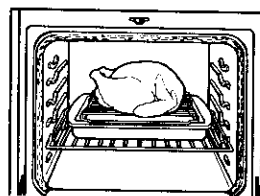

2. Rotate **SET** to desired temperature.

Baking can occur from 170°F to 500°F (77°C to 260°C).

3. Press **ENTER** to start.

4. At the end of Convection Roast, turn **SELECTOR** to **RESET**.

## Convection roasting tips

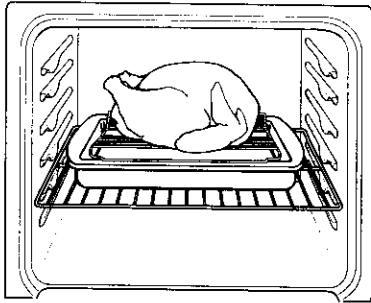

- **Use the convection roasting rack** on the broiler pan and grid included with your oven. The convection roasting rack rests on the broiler pan and grid. The long side of the rack should be parallel with the oven door for best heat distribution and airflow.
- **Spatter can be reduced** by lining the bottom of the roasting pan with lightly crushed aluminum foil.
- **Use an accurate meat thermometer** to determine when meat has reached desired degree of doneness. Insert the thermometer into the center of the thickest portion of the meat. For an accurate reading, the tip of the thermometer should not touch fat, bone, or gristle.
- **After reading the thermometer once,** push it further into the meat  $\frac{1}{2}$  inch (1.7 cm) or more and read again. If the temperature drops, return the meat to the oven for more cooking.
- **Check pork and poultry** with a thermometer in 2 to 3 places to ensure adequate doneness. Insert the thermometer into the center of the thickest portion and ends of pork. Check the inner thighs and breasts of poultry.
- **Poultry and roasts will be easier to carve** if loosely covered with foil and allowed to stand 10 to 15 minutes after removal from the oven.
- **You can reduce** roasting times and temperatures for most standard recipes when using the Convection Roast setting. See convection roasting chart in your convection oven cookbook for recommended roasting times and temperatures.

## Broil

### 1. Position rack.

See the rack placement chart in the "Broiling guidelines" section for recommended rack positions.

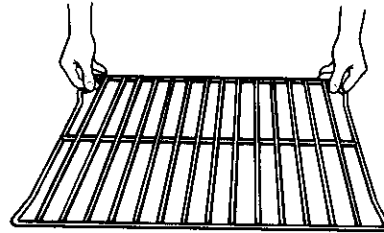

### 2. Put food in oven.

Place food on grid in broiler pan and place in center of the oven rack. Turn the pan so the long side is parallel to the oven door for the most even heat and the best airflow.

### 3. Close door.

### 4. Turn **SELECTOR** to **BROIL**.

The display will read "HI".

### 5. Rotate **SET** to desired broil level.

Your options are: LO, br 2, br 3, br 4, and HI.

**NOTE:** If using the KitchenAid cookbook accompanying this range, your setting equivalents are as follows: LO (235°F [113°C]), br 2 (300°F [149°C]), br 3 (370°F [187°C]), br 4 (435°F [224°C]) and HI (500°F [260°C]).

### 6. Press **ENTER** to start.

### 7. At the end of Broiling, turn **SELECTOR** to **RESET**.



## Convection Broil

Convection broiling is actually high-temperature convection roasting. Use this setting when broiling thick cuts of meat. Results are similar to those you get when using a rotisserie.

### 1. Position rack.

See the rack placement chart in the "Broiling guidelines" section for recommended rack positions.

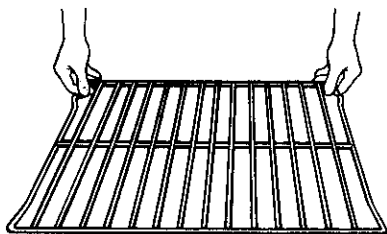

### 2. Put food in oven.

Place food on grid in broiler pan and place in center of the oven rack. Turn the pan so the long side is parallel to the oven door for the most even heat and the best airflow.

**NOTE:** If you want to change the convection broiling temperature after broiling has begun, repeat Steps 3, 4, and 5.

### 3. Close door.

**NOTE:** Do not try to convection broil with the door open. The fan and elements will not operate.

### 4. Turn SELECTOR to CONVECT BROIL.

The display will read "HI".

### 5. Rotate SET to desired convection broil level.

Your options are: LO, br 2, br 3, br 4, and HI.

### 6. Press ENTER to start.

### 7. At the end of Convection Broiling, turn SELECTOR to RESET.

## Broiling guidelines

- **Use only the broiler pan and grid provided.** They are designed to drain extra juices from the cooking surface. This drainage helps prevent spatter and smoke.
- **To make sure the juices drain well,** do not cover the grid with foil.
- **Trim excess fat** to reduce spattering. Slit the fat on the edges to prevent curling.
- **Use tongs** to turn meat to avoid losing juices.
- **Pull out oven rack** to stop position before turning or removing food.
- **After broiling, remove the pan** from the oven when removing the food. Drippings will bake on the pan if left in the heated oven, making cleaning more difficult.
- **For easier cleaning,** line the bottom of the pan with aluminum foil. Clean the pan and grid as soon as possible after each use.

Recommended rack positions are numbered

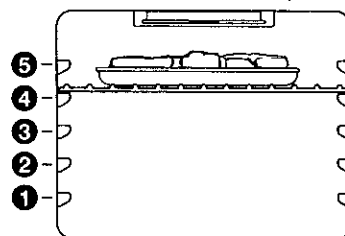

from the bottom (1) to the top (5). **For best results, place food 3 inches (7.5 cm) or more from the broil element.**

## Broiling Chart

- Turn chicken pieces after approximately half of the broiling time.
- Turn food approximately  $\frac{2}{3}$  of the broiling time.

MEAT	RACK POSITION	BROIL LEVEL	APPROXIMATE TIME (MINUTES)
<b>Steak, 1" (2.5 cm) thick</b>	4	HI	
medium rare			21-23
medium			23-25
well done			27-29
<b>Ground Meat Patties, <math>\frac{3}{4}</math>" (1.9 cm) thick, <math>\frac{1}{4}</math> lb (11.3 g) well done</b>	4	HI	20-22
<b>Pork Chops, 1" (2.5 cm) thick</b>	4	HI	30-33
<b>Lamb Chops, 1" (2.5 cm) thick</b>	4	HI	22-26
<b>Chicken</b>			
bone-in pieces	3	HI	34-40
boneless breasts	4	HI	22-32
<b>Fish</b>	4	HI	
fillets $\frac{1}{4}$ - $\frac{1}{2}$ " (0.6-1.2 cm) thick			12-15
steaks $\frac{3}{4}$ -1" (1.9-2.5 cm) thick			24-27

**NOTE:** Times are guidelines only and may need to be adjusted for individual tastes. Very thin cuts, such as fish fillets, may not need to be turned.

## Timed cooking

### **! WARNING**

#### **Food Poisoning Hazard**

Do not let food sit in oven more than one hour before or after cooking.

Doing so can result in food poisoning or sickness.

1. Set desired cooking function.
2. Press ENTER.
3. Set temperature.
4. Press ENTER.
5. Press ENTER again, the DURATION LED will blink and "-0:00" is displayed.
6. Rotate SET to set desired cycle length.
7. Press ENTER again to view the stop time.  
If you want to set a different stop time, turn SET to desired time.

## To use the Browning function:

### 8. Press ENTER again and the browning light will illuminate.

- Select "brn1", "brn2" or "brn3" using SET.

OR

- Select "brn0" to reject the browning option.

## To use the Keep Warm function:

### 9. Press ENTER again and the KEEP WARM light will blink.

- You can choose a 170°F (77°C) keep warm by using SET

OR

- "---F" to reject the Keep Warm option.

### 10. Press ENTER to select the desired keep warm function.

It will default after 8 seconds if ENTER is not pressed.

**NOTE:** If using the KEEP WARM option after cooking your food, you must either open the door to allow the oven to cool, or shorten the cook time of your food as your oven maintains temperature.

## To cancel Duration, Stop time, Browning (if used) and Keep Warm (if used):

Turn SELECTOR to RESET OR Press CANCEL.

## Proof/Keep Warm

### **!WARNING**

#### Food Poisoning Hazard

Do not let food sit in oven more than one hour before or after cooking.

Doing so can result in food poisoning or sickness.

Proof/Keep Warm is actually two separate functions depending on the temperature setting you select. Proof is for proofing bread or yeast doughs. Keep Warm is for keeping hot cooked foods warm.

### 1. Turn SELECTOR to PROOF/KEEP WARM.

The display will read "100F".

### 2. Rotate SET to cycle between PROOF or KEEP WARM.

PROOF, the display will read "100F" or KEEP WARM, the display will read "170F".

### 3. Press ENTER to start.

If KEEP WARM is selected the Keep Warm LED will illuminate.

### 4. Turn SELECTOR to RESET when done.

## To Proof yeast doughs:

### 1. Put the dough in a lightly greased bowl or pan.

Loosely cover with waxed paper coated with shortening. Position bowl or pan on rack position 1 in unheated oven.

### 2. Fill a baking dish with 2 cups (455 mL) of boiling water and place it on the floor of the oven. Close the oven door.



# Using and Caring for Your Oven

**3. Turn SELECTOR to PROOF/KEEP WARM.**

**4. Press ENTER.**

Let the dough rise for the time specified in your recipe or until the dough doubles in size.

**5. Shape dough after it has risen.**

Follow recipe instructions for dough shaping.

**6. At the end of Proofing, press CANCEL.**

## Bread

**1. Turn SELECTOR to BREAD.**

The display will read "430F".

**2. Rotate SET to desired preheat temperature.**

The preheat temperature setting is adjustable between "430F" and "390F".

**3. Press ENTER to start.**

Once the oven reaches preheat, you will hear 1 beep and the oven display will show 40°F (22°C) below preheat temperature setting.

**NOTE:** See Bread recipes in back of Use and Care guide. For best results, do not bake on more than 2 racks at a time when using the BREAD setting.

**4. When bread is done, turn SELECTOR to RESET.**

## Cleaning your oven and controls

PART	WHAT TO USE	HOW TO CLEAN
Control knobs	Sponge and warm, soapy water	<ul style="list-style-type: none"> <li>• Turn knobs to RESET and pull straight away from control panel.</li> <li>• Wash, rinse, and dry thoroughly. Do not soak.</li> <li>• <b>Do not use steel wool or abrasive cleansers. They may damage the finish of the knobs.</b></li> <li>• Replace knobs. Make sure all knobs point to RESET.</li> </ul>
Control panel		<ul style="list-style-type: none"> <li>• See "Cleaning Stainless Steel Surfaces" later in this section.</li> </ul>
Exterior surfaces (other than cooktop)		<ul style="list-style-type: none"> <li>• See "Cleaning Stainless Steel Surfaces" later in this section.</li> </ul>
Broiler grid (clean after each use)	Steel-wool pad and warm, soapy water	<ul style="list-style-type: none"> <li>• Wash, rinse, and dry thoroughly.</li> <li>• <b>Do not clean the grid in the Self-Cleaning cycle.</b></li> </ul>





PART	WHAT TO USE	HOW TO CLEAN
<b>Broiler pan</b>	Steel-wool pad and warm, soapy water <b>OR</b> The Self-Cleaning cycle	<ul style="list-style-type: none"> <li>• Wash, rinse, and dry thoroughly.</li> </ul> <b>OR</b> <ul style="list-style-type: none"> <li>• Leave in oven during Self-Cleaning cycle.</li> </ul> <b>NOTE:</b> Drain excess grease before leaving in oven during Self-Cleaning cycle
<b>Oven racks</b>	Steel-wool pad and warm, soapy water <b>OR</b> The Self-Cleaning cycle	<ul style="list-style-type: none"> <li>• Wash, rinse, and dry thoroughly.</li> </ul> <b>OR</b> <ul style="list-style-type: none"> <li>• Leave in oven during Self-Cleaning cycle.</li> </ul> <b>NOTE:</b> Racks will permanently discolor and become harder to slide if left in oven during the Self-Cleaning cycle. Apply a small amount of vegetable oil to the side rungs to aid sliding.
<b>Oven door glass</b>	Paper towel and spray glass cleaner <b>OR</b> Warm, soapy water and a nonabrasive, plastic scrubbing pad	<ul style="list-style-type: none"> <li>• Make sure oven is cool.</li> <li>• Follow directions provided with the cleaner.</li> <li>• Wash, wipe with clean water, and dry thoroughly.</li> </ul>
<b>Oven cavity</b>	Self-Cleaning cycle	<ul style="list-style-type: none"> <li>• Wipe up food spills containing sugar as soon as possible after the oven cools down. (See the "Using the Self-Cleaning Cycle" section.)</li> </ul>



# Using and Caring for Your Oven

## Cleaning Stainless Steel Surfaces

- Do not use steel wool or soap-filled scouring pads.
- Rub in the direction of the grain line to avoid marring the surface.
- Always wipe dry to avoid water marks.
- GREAT RESULTS™ Stainless Steel Cleaner is the recommended cleaner used. To order call your local dealer or KitchenAid for information.
- If commercial cleaners are used, follow label directions. If product contains chlorine (bleach), rinse thoroughly and dry with a soft, lint-free cloth. Chlorine is a corrosive substance.

	CLEANING AGENT	HOW TO USE
<b>Routine cleaning and fingerprints</b>	Liquid detergent soap and water, all-purpose cleaner	Wipe with damp cloth or sponge, then rinse with clean water and wipe dry.
<b>Stubborn stains and baked-on residue</b>	Mild abrasive cleanser or stainless steel cleaners	Rub in the direction of grain lines with a damp cloth or sponge and cleaner. Rinse thoroughly. Repeat if necessary.
<b>Hard water spots</b>	Vinegar	Swab or wipe with cloth. Rinse with water and dry.

## Using and replacing the oven lights

The oven lights will come on when you open the oven door or when any function (other than CLEAN and PROOF) is selected.

### NOTES:

- Make sure the oven is cool before replacing the light bulb.
- The oven lights will not work during the Self-Cleaning or Proof cycles.

### Replacing the oven light:

1. **Unplug oven** or disconnect power.

2. **Remove** glass light cover by grasping the front edge of cover and pulling it away from the side wall of the oven.

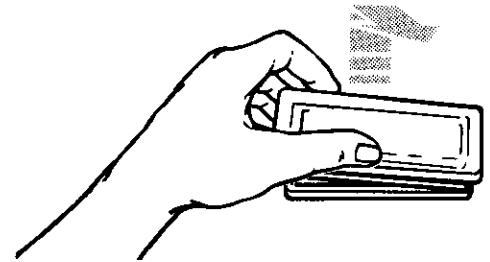

3. **Remove** the light bulb from its socket. **Replace** the bulb with another halogen bulb (12 volt, 5 watt maximum, available at most hardware stores).

4. **Replace** the light cover by snapping it back into wall.

5. **Plug in oven** or reconnect power.

# Using the Self-Cleaning Cycle

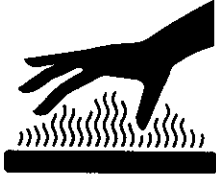
	<b>⚠ WARNING</b>
	<b>Burn Hazard</b> Do not touch the oven during the Self-Cleaning cycle. Keep children away from oven during Self-Cleaning cycle. Do not use commercial oven cleaners in your oven. Failure to follow these instructions can result in burns, or illness from inhaling dangerous fumes.

## Before you start

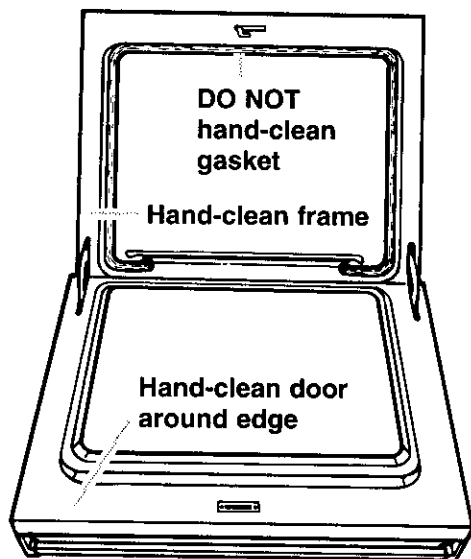

### Before you start the Self-Cleaning cycle, make sure you:

**NOTE:** DO NOT clean, move, or bend the gasket. Poor cleaning, baking, and roasting may result.

- **Hand-clean** the areas shown. They do not get hot enough during the Self-Cleaning cycle for soil to burn away. Use hot water and detergent or a soapy, steel-wool pad for cleaning.
- **Do not** let water, cleaner, etc., enter slots on door and frame.
- **Remove** the broiler grid and any cookware/bakeware being stored in the oven.

- **Wipe out** any loose soil or grease. This will help reduce smoke during the Self-Cleaning cycle.
- **Wipe up** food spills containing sugar as soon as possible after the oven cools down. When sugar is heated to a high temperature in the Self-Cleaning cycle, the high temperature can cause the sugar to burn and react with the porcelain. This can cause staining and etching, pitting, or faint white spots.
- **Remove** the oven racks from the oven if you want them to remain shiny. You can clean the oven racks in the Self-Cleaning cycle, but they will become harder to slide. (See the "Cleaning chart" in the "Caring for Your Oven" section.) If you clean the racks in the Self-Cleaning cycle, place them on the 2nd and 4th rack guides. (The guides are counted from bottom to top.)
- **Heat and odors are normal** during the Self-Cleaning cycle. Keep the kitchen well ventilated by opening a window or by turning on a vent hood or other kitchen vent during the cycle.

**IMPORTANT:** The health of some birds is extremely sensitive to the fumes given off during the Self-Cleaning cycle. Exposure to the fumes may result in death to certain birds. Always move birds to another closed and well ventilated room.

## Using the Self-Cleaning Cycle

### TIPS:

- **Keep the kitchen well ventilated** during the Self-Cleaning cycle to help get rid of heat, odors, and smoke.
- **Clean the oven** before it gets heavily soiled. Cleaning a very soiled oven takes longer and results in more smoke than usual.
- **Do not block the vent** during the Self-Cleaning cycle. Air must move freely for best cleaning results.
- **Do not leave any foil in the oven** during the Self-Cleaning cycle. Foil could burn or melt and damage the oven surface.
- **The oven light will not work** during the Self-Cleaning cycle.
- **Do not use** your cooktop during the Self-Cleaning cycle.

### Before setting the controls

- **Make sure clock is set to correct time of day.** The clock cannot be set during the Self-Cleaning cycle.
- **Make sure the oven door is completely closed.**

### Setting the controls

To start cleaning immediately:

1. Turn **SELECTOR** to **CLEAN**.
2. Rotate **SET** to select "On".
3. Press **ENTER** to start a preset, non-adjustable 3½ hour cycle.

To delay start cleaning cycle:

1. Follow steps 1-3 above, before moving on.

2. Press **ENTER** twice.

The time the cycle will end is displayed and the **STOP TIME LED** will blink.

3. Rotate **SET** to desired **STOP TIME**.

4. Press **ENTER** to accept.

The **DURATION** and **STOP TIME** arrow will illuminate.

**NOTE:** If you set a delayed start for the clean cycle, the oven door will still lock. You have to press **CANCEL** to cancel your selection.

To stop the Self-Cleaning cycle at any time:

Turn **SELECTOR** to **RESET**.

OR

Press **CANCEL**.

To view the time remaining:

Press **ENTER**.

The display will return to "cln" after 5 seconds.

## For best cleaning results

- **After the oven cools to room temperature**, wipe up any residue or ash with a damp cloth or sponge. If any spots remain, clean with a mild abrasive cleanser or cleaning sponge.
- **Clean the oven** before it gets heavily soiled. Cleaning a very soiled oven takes longer and results in more smoke than usual.
- **If the Self-Cleaning cycle does not get the oven as clean as you expected**, you may not have prepared the oven properly. Hand-clean areas noted in "Before you start" earlier in this section.

## How the cycle works

The Self-Cleaning cycle uses very high heat to burn away soil and grease. During the cycle, the oven gets much hotter than it does for normal baking or broiling. This high heat breaks up the soil or grease and burns it away.

The graph below is representative of a normal, 3½-hour Self-Cleaning cycle. Note that the heating stops after 3 hours, but it takes longer for the oven to cool enough to unlock.

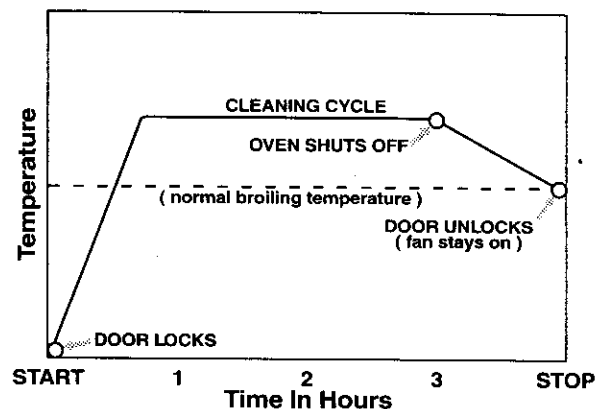

# Troubleshooting

This section is designed to help you save the cost of a service call. It outlines possible problems, their causes, and actions you can take to solve each problem. If you still need assistance or service, call our Consumer Assistance Center (in the U.S.A., see page 33; in Canada, see page 34) for help or calling for service. Please provide a detailed description of the problem, your appliance's complete model and serial numbers, and the purchase or installation date. (See the "A Note to You" section.) This information will help us respond properly to your request.

<b>PROBLEM</b>	<b>POSSIBLE CAUSE</b>	<b>WHAT TO DO</b>
<b>Nothing will operate</b>	The unit is not wired into a live circuit with proper voltage.	Wire the unit into a live circuit with proper voltage. (See Installation Instructions.)
	A household fuse has blown or a circuit breaker has tripped.	Replace household fuse or reset circuit breaker.
	The unit is not properly connected to gas supply.	Contact a designated servicing outlet to reconnect range.
<b>The oven will not operate</b>	You have not set the electronic control correctly.	Refer to the section in this manual describing the function you are operating.
	You have programmed a delayed start time.	Wait for the start time to be reached or cancel and reset the controls.
<b>Burner fails to light</b>	The unit is not plugged in or wired into a live circuit or circuit with proper voltage.	Plug unit into a properly grounded outlet. Wire the unit into a live circuit with proper voltage. (See installation instructions.)
	A household fuse has blown or a circuit breaker has tripped.	Replace household fuse or reset circuit breaker.
	The burner ports are clogged.	Clean with a straight pin. (See page 11.)
<b>Burner flames are uneven</b>	The burner ports are clogged.	Clean with a straight pin. (See page 11.) If this fails, call for service.
	The burner cap is not in position.	Make sure the burner cap is properly seated on the burner head.
<b>Burner flames lift off ports, are yellow, or are noisy when turned off.</b>	The air/gas mixture is incorrect.	Follow instructions on page 12, "Adjusting the height of top burner flame." If this does not work, call service technician to check mixture.
<b>Burner makes popping noises when on</b>	The burner is wet from washing.	Let dry.

<b>PROBLEM</b>	<b>POSSIBLE CAUSE</b>	<b>WHAT TO DO</b>
<b>Burners spark</b>	<p>It is normal for all four burners to spark when a burner is turned on, but has not yet ignited.</p> <p>Continuous sparking may be caused when:</p> <ul style="list-style-type: none"> <li>—There is a faulty spark module.</li> <li>—The wall outlet wiring is incorrect.</li> </ul>	<p>No action is needed. Burner operation is not affected and the sparking should end when the knob is moved from LITE.</p> <p>Contact service technician to replace module.</p> <p>Contact a qualified electrician to correct wiring, if needed.</p>
<b>The surface burner controls will not turn</b>	You are not pushing in before turning.	Push control knob(s) in before turning to a setting.
<b>Cooling fan runs during BAKE, CONVECT BAKE, CONVECT ROAST, BROIL, CONVECT BROIL or CLEAN</b>	It is normal for the fan to automatically run while the oven is in use to cool the electronic control.	
<b>The convection fan does not run all the time</b>	It is normal for the convection fan to shut off when the door is opened.	No action is needed.
<b>The Self-Cleaning cycle will not operate</b>	<p>You have programmed a delayed start time.</p> <p>An "F" code appears on the display.</p>	<p>Wait for the start time to be reached, or cancel and reset the control.</p> <p>Call a service technician to repair.</p>
<b>Odor from oven</b>	Heating of insulation.	Odors are normal when the range is new. The odors will disappear as the oven is used.

continued on next page



# Troubleshooting

PROBLEM	POSSIBLE CAUSE	WHAT TO DO
<b>Cookware is not level on the range (Check to see if liquids are level in cookware.)</b>	Range is not level	Level range. (See Installation Instructions.)
	Cookware does not have flat bottom.	Use cookware with flat bottoms.
<b>Excessive heat on cooktop in areas around cookware</b>	Cookware is not the correct size for the surface cooking area.	Choose cookware the same size or slightly larger than the burner.
<b>Slow baking or roasting</b>	Oven temperature not high enough.	Increase oven temperature 25° F (14°C).
	Oven not preheated before baking.	Preheat oven to selected temperature before placing food in when preheating is recommended.
	Bakeware is not correct size.	Choose bakeware that will allow 2 inches (5 cm) of air space around all sides.
	Opening oven door while food is baking or roasting.	Open door to check food when timer signals shortest time suggested in recipe. "Oven peeking" can make cooking times longer.
<b>Baked items too brown on bottom</b>	Oven not preheated to selected temperature.	Preheat oven to selected temperature before placing food in oven.
	Bakeware is not correct size	Choose bakeware that will allow 2 inches (5 cm) of air space around all sides.
	Oven rack is set too low.	Position rack higher in oven.
	Oven temperature set too high.	Decrease oven temperature 15° to 25°F (8° to 14°C)
<b>Unevenly baked items</b>	Range is not level.	Level the range.
	Food improperly placed in oven.	Bake in center of oven with 2 inches (5 cm) of space around each pan.
	Batter not level in pan.	Make sure batter is leveled in pan before placing in oven.
<b>Crust edge browns before pie is done</b>	Filling requires more baking time than crust	Shield edge with foil.
<b>The display is showing "PF"</b>	There has been a power failure.	Reset the clock. (See page 15.)

If none of these items was causing your problem, see "Requesting Assistance or Service" on page 33 or 34.



# Requesting Assistance or Service

Before calling for assistance or service, please check the "Troubleshooting Guide" section. It may save you the cost of a service call. If you still need help, follow these instructions.

## If you need assistance or service in the U.S.A.:

### Call the KitchenAid Consumer



**Assistance Center toll free: 1-800-422-1230. Our consultants are available to assist you.**

#### When calling:

Please know the purchase date, and the complete model and serial number of your appliance (see the "A Note to You" section). This information will help us to better respond to your request.

#### Our consultants provide assistance with:

- Features and specifications on our full line of appliances.
- Installation information.

- Accessory and repair parts sales.
- Specialized customer assistance (Spanish speaking, hearing impaired, limited vision, etc.).
- Referrals to service companies and repair parts distributors.

**KitchenAid designated service technicians** are trained to fulfill the product warranty and provide after-warranty service, anywhere in the United States.

To locate the KitchenAid designated service company in your area, you can also look in your telephone directory Yellow Pages.

## If you need replacement parts

If you need to order replacement parts, we recommend that you only use factory specified parts. These parts will fit right and work right, because they are made with the same precision used to build

every new KITCHENAID® appliance. To locate factory specified replacement parts in your area, call our Consumer Assistance Center telephone number or your nearest designated service center.

## For further assistance

If you need further assistance, you can write to KitchenAid with any questions or concerns at:

KitchenAid Brand Home Appliances  
Consumer Assistance Center  
c/o Correspondence Dept.  
2000 North M-63  
Benton Harbor, MI 49022-2692

Please include a daytime phone number in your correspondence.

## Requesting Assistance or Service

### If you need assistance or service in Canada:

#### Call the KitchenAid Consumer



**Assistance Center toll free:  
8:30 a.m. - 6 p.m. (EST) at  
1-800-461-5681. Our consult-  
ants are available to assist  
you.**

#### When calling:

Please know the purchase date, and the complete model and serial number of your appliance (see the "A Note to You" section). This information will help us to better respond to your request.

#### Our consultants provide assistance with:

- Features and specifications on our full line of appliances.

#### If you need service:

Contact Inglis Limited Appliance Service from anywhere in Canada at **1-800-807-6777**.

- Accessory and repair parts sales.
- Specialized customer assistance (French speaking, hearing impaired, limited vision, etc.).
- Referrals to local dealers, service companies, and repair parts distributors.

**KitchenAid designated service technicians** are trained to fulfill the product warranty and provide after-warranty service, anywhere in Canada.

To locate the KitchenAid designated service company in your area, you can also look in your telephone directory Yellow Pages.

### If you need replacement parts

If you need to order replacement parts, we recommend that you only use factory specified parts. These parts will fit right and work right, because they are made with the same precision used to build

every new KITCHENAID® appliance. To locate factory specified replacement parts in your area, call our Consumer Assistance Center telephone number or your nearest designated service center.

### For further assistance

If you need further assistance, you can write to KitchenAid with any questions or concerns at:

Consumer Relations Department  
KitchenAid Canada  
1901 Minnesota Court  
Mississauga, Ontario L5N3A7

Please include a daytime phone number in your correspondence.

# Bread Recipes

## Portuguese party bread

### **BIGA:**

- 4 cups (1 L) all-purpose flour
- 1 cup (250 mL) water (100-110°F [38-43°C])
- ¾ tsp. (4 mL) active dry yeast

### **Preparation of the Biga:**

Stir the yeast into warm water. Let stand until the yeast is dissolved. Combine yeast mixture and flour and mix on low speed about 1 minute. Knead on low speed for 5 minutes. Place in a glass or plastic bowl and cover with plastic wrap so that the plastic touches the surface of the biga. Allow to rise for 12 to 14 hours at about 64-68°F (18-20°C).

### **INGREDIENTS:**

- Biga
- 1 pkg. active dry yeast
- 1 cup (250 mL) water (100-110°F [38-43°C])
- 2 cups (500 mL) corn flour
- 4-4½ cups (1-1.12 L) all-purpose flour (divided)
- 1¼ cups (313 mL) milk (95-100°F [35-38°C])
- 3 T (45 mL) butter, softened
- 1 T (15 mL) salt

Pour warm water into mixing bowl and stir in yeast. Let stand until the yeast is dissolved. Add biga to yeast mixture, tearing biga into small pieces. Mix for about 2 minutes. Add corn flour, 3 cups (750 mL) of the all-purpose flour, milk and butter and mix until well combined. Knead the dough for 5 minutes adding the remaining flour as needed until the dough is smooth and elastic. At 2½ minutes into the kneading time, add the salt.

Divide the dough into 4 equal parts and shape into balls. Cover and let stand for 15-20 minutes.

On a lightly floured surface, roll the loaves into 12 in (30.4 cm) circles. Place on baking sheets lined with nonstick parchment paper. Cover and let rise for 70 minutes or proof in oven for 50 minutes.

After rising, sprinkle lightly with flour. Bake using the BREAD setting for about 20-25 minutes.

Makes 4 – 1 lb (455 g) loaves.

## Rye bread

### **BIGA:**

- 4 cups (1 L) all-purpose flour
- 1 cup (250 mL) water (100-110°F [38-43°C])
- ¾ tsp. (4 mL) active dry yeast

### **Preparation of the Biga:**

Stir the yeast into warm water. Let stand until the yeast is dissolved. Combine the yeast mixture and flour and mix on low speed about 1 minute. Knead on low speed for 5 minutes. Place in a glass or plastic bowl and cover with plastic wrap so that the plastic touches the surface of the biga. Allow to rise for 12 to 14 hours at about 64-68°F (18-20°C).

### **INGREDIENTS:**

- Biga
- 1½ tsp. (7 mL) active dry yeast
- 1½ cups (417 mL) water (100-110°F [38-43°C])
- 2¾ cups (687 mL) rye flour
- 1¾-2 cups (438-500 mL) all-purpose flour
- 1 T (15 mL) salt

Pour warm water into mixing bowl and stir in yeast. Let stand until the yeast is dissolved. Add biga to yeast mixture, tearing biga into small pieces. Mix for about 2 minutes. Add the rye flour, 1½ cups (375 mL) of the all-purpose flour and mix until well combined. Knead the dough for 5 minutes adding the remaining flour as needed until the dough is smooth and elastic. At 2½ minutes into the kneading time, add the salt.

Place dough in a greased bowl turning to grease all sides of the dough. Cover with plastic wrap and let stand at room temperature for 15-20 minutes.

Divide the dough into 5 equal parts and shape into round loaves. Let stand, covered, for 15-20 minutes.

Dust surface of loaves with rye flour and place on a baking sheet lined with nonstick parchment paper. Make diagonal slashes about 1 in (2.5 cm) apart with razor blade or sharp knife to form a diamond pattern on the top of each loaf. Cover and let rise for 80-90 minutes or proof in oven for 60 minutes.

Bake using the BREAD setting for about 30-35 minutes.

Makes 5 – 10 oz (285 g) loaves.



## Viennese bread

### INGREDIENTS:

1 cup (250 mL) water, (100-110°F [38-43°C])  
 2 packages active dry yeast  
 7½ - 7¾ cups (1.87-1.94 L) all-purpose flour (divided)  
 1½ cups (375 mL) milk  
 3½ T (52.5 mL) butter  
 2½ T (37.5 mL) granulated sugar  
 1 T (15 mL) salt

### EGG GLAZE:

1 egg  
 1 T (15 mL) milk  
 pinch salt

Pour warm water into mixing bowl and stir in yeast. Let stand until the yeast is dissolved. Mix for about 2 minutes. Add 6 cups (1.5 L) of flour, milk, butter, sugar and mix until well combined. Knead the dough for 5 minutes adding the remaining flour as needed until the dough is smooth and elastic. At 2½ minutes into the kneading time, add the salt.

Cover the dough and allow to stand for 30 minutes.

Divide the dough into 9 equal pieces and form into little loaves. Cover and let stand for 15 minutes.

Stretch into ropes about 16 in (40.6 cm) long and place on a baking sheet lined with nonstick parchment paper. Cover and let rise for 60-70 minutes or proof in oven for 30 minutes.

Mix together ingredients for glaze. Slash loaves in zigzag pattern with razor blade or sharp knife and brush with glaze.

Bake using the BREAD setting for about 20-25 minutes.

Makes 9 – 5 oz (150 mL) loaves.

## Plaited butter loaf

### BIGA:

4 cups (1 L) all-purpose flour  
 1 cup (250 mL) water (100-110°F [38-43°C])  
 ¾ tsp. (4 mL) active dry yeast

### Preparation of the Biga:

Stir the yeast into warm water. Let stand until the yeast is dissolved. Combine yeast mixture and flour and mix on low speed about 1 minute. Knead on low speed for 5 minutes. Place in a glass or plastic bowl and cover with plastic wrap so that the plastic touches the surface of the biga. Allow to rise for 12 to 14 hours at about 64-68°F (18-20°C).

### INGREDIENTS:

Biga  
 4 cups (1 L) all-purpose flour  
 1 cup (250 mL) + 1 T (15 mL) milk (100-110°F [38-43°C])  
 9 T (135 mL) butter  
 2 tsp. (10 mL) granulated sugar  
 1 pkg. active dry yeast  
 1 T (15 mL) salt  
 2 eggs  
 8 oz. (240 mL) grated parmesan cheese

### EGG GLAZE:

1 egg  
 1 T (15 mL) milk  
 pinch salt

Pour warm water into mixing bowl and stir in yeast. Let stand until the yeast is dissolved. Add biga to yeast mixture, tearing biga into small pieces. Mix for about 2 minutes. Add flour, butter, sugar, eggs and salt then mix until well combined. Knead the dough for 5 minutes adding the parmesan cheese a little at a time until the dough is smooth and elastic

Place dough in a greased bowl turning to grease all sides of the dough. Cover with plastic wrap and let stand at room temperature for 15-20 minutes. Grease 3 – 9¼ x 5¼ x 2¾ in (23.5 x 13.5 x 6.9 cm) loaf pans.

Divide the dough into 9 equal pieces and form into ropes about 12 in (30.4 cm) long. Braid 3 ropes together, sealing ends. Tuck ends under slightly and place in pan. Continue with the other loaves. Mix glaze and brush loaves with glaze. Cover and let rise at room temperature for 60-70 minutes or proof in oven for 30 minutes.

Bake using the BREAD setting for about 30-35 minutes. Remove from pans and cool on wire racks.

Makes 3 – 1 lb (455 g) loaves.

## Chocolate chip rolls

### BIGA:

- 4 cups (1 L) all-purpose flour
- 1 cup (250 mL) water (100-110°F [38-43°C])
- ¾ tsp. (4 mL) active dry yeast

### Preparation of the Biga:

Stir the yeast into warm water. Let stand until the yeast is dissolved. Combine yeast mixture and flour and mix on low speed about 1 minute. Knead on low speed for 5 minutes. Place in a glass or plastic bowl and cover with plastic wrap so that the plastic touches the surface of the biga. Allow to rise for 12 to 14 hours at about 64-68°F (18-20°C).

### INGREDIENTS:

- 5½ - 5¾ cups (1.37-1.44 L) all-purpose flour (divided)
- ¾ cup (188 mL) milk (100-110°F [38-43°C])
- ½ cup (125 mL) granulated sugar
- 7 T (105 mL) butter
- 1 pkg. active dry yeast
- 1 T (15 mL) salt
- 4 eggs
- 1½ cups (375 mL) semi-sweet chocolate chips

### EGG GLAZE:

- 1 egg
- 1 T (15 mL) milk
- pinch salt

Pour warm water into mixing bowl and stir in yeast. Let stand until the yeast is dissolved. Add biga to yeast mixture, tearing biga into small pieces. Mix for about 2 minutes. Add 4½ cups (1.12 L) of flour, butter, sugar, eggs and salt then mix until well combined. Knead the dough for 5 minutes adding the remaining flour as needed until the dough is smooth and elastic. Knead in chocolate chips. Place dough in a greased bowl turning to grease all sides of the dough. Cover with plastic wrap and let stand at room temperature for 50 minutes.

Divide the dough into 3 dozen balls about 2½ in (6.3 cm) in diameter each. Place on baking sheets lined with nonstick parchment paper. Mix together ingredients for glaze. Brush rolls with glaze. Cover and let rise for 70-80 minutes or proof in oven for 50 minutes.

Bake using the BREAD setting for about 15-20 minutes. For best results, do not bake on more than 2 racks at a time when using the BREAD setting.

Makes 3 dozen rolls.

## White bread

- ½ cup (125 mL) milk
- 3 T (45 mL) granulated sugar
- 2 tsp. (10 mL) salt
- 3 T (45 mL) butter
- 2 pkg. active dry yeast
- 1½ cup (375 mL) warm water (100-110°F [38-43°C])
- 5-6 cups (1.25-1.5 L) all-purpose flour (divided)

Combine milk, sugar, salt and butter in small saucepan. Heat over low heat until butter melts and sugar dissolves. Cool to lukewarm.

Pour warm water into the mixing bowl. Stir the yeast into the warm water. Let stand until the yeast is dissolved. Add lukewarm milk mixture and 4½ cups (1.12 L) flour. Mix for about 2 minutes, until well combined. Knead the dough for 5 minutes adding the remaining flour as needed until the dough is smooth and elastic.

Place dough in a greased bowl turning to grease all sides of the dough. Cover and let stand at room temperature for 60 minutes or until doubled in size or proof in oven for 40-45 minutes.

Punch dough down and divide in half. Shape into loaves and place in greased 8½ x 4½ x 2½ in (21.5 x 11.4 x 6.3 cm) loaf pans. Cover and let stand at room temperature for 40 minutes or until doubled in size or proof in oven for 25-30 minutes.

Bake using the BREAD setting for 25-30 minutes. Remove from pans and cool on wire racks.

Makes 2 – 1 lb (455 g) loaves.

# KitchenAid®

## Dual Fuel Range

# Warranty

LENGTH OF WARRANTY:	KITCHENAID WILL PAY FOR:	KITCHENAID WILL NOT PAY FOR:
<b>ONE-YEAR FULL WARRANTY</b> FROM DATE OF PURCHASE.	Replacement parts and repair labor costs to correct defects in materials or workmanship. Service must be provided by a KitchenAid designated servicing outlet.	<b>A.</b> Service calls to: 1. Correct the installation of the range. 2. Instruct you how to use the range. 3. Replace house fuses or correct house wiring. <b>B.</b> Repairs when range is used in other than normal home use. <b>C.</b> Damage resulting from accident, alteration, misuse, abuse, fire, flood, acts of God, improper installation, or installation not in accordance with local electrical codes. <b>D.</b> Any labor costs during the limited warranties. <b>E.</b> Replacement parts or repair labor costs for units operated outside the United States and Canada. <b>F.</b> Pickup and delivery. This product is designed to be repaired in the home. <b>G.</b> Repairs to parts or systems resulting from unauthorized modifications made to the appliance. <b>H.</b> In Canada, travel or transportation expenses to customers who reside in remote areas.
<b>SECOND-THROUGH FIFTH-YEAR LIMITED WARRANTY</b> FROM DATE OF PURCHASE.	Replacement parts for any electric element or gas burner to correct defects in materials or workmanship. Replacement parts for solid state electronic control system to correct defects in materials or workmanship.	
<b>SECOND-THROUGH TENTH-YEAR LIMITED WARRANTY</b> FROM DATE OF PURCHASE.	Replacement parts for the porcelain oven cavity/inner door if the part rusts through due to defects in materials or workmanship.	

11/99

**KITCHENAID AND KITCHENAID CANADA DO NOT ASSUME ANY RESPONSIBILITY FOR INCIDENTAL OR CONSEQUENTIAL DAMAGES.** Some states or provinces do not allow the exclusion or limitation of incidental or consequential damages, so this exclusion or limitation may not apply to you. This warranty gives specific legal rights and you may also have other rights which vary from state to state or province to province.

**Outside the 50 United States and Canada, this warranty does not apply. Contact your local KitchenAid dealer to determine if another warranty applies.**

If you need service, first see the "Requesting Assistance or Service" section of this book. After checking "Requesting Assistance or Service," additional help can be found by calling our Consumer Assistance Center telephone number, **1-800-422-1230**, from anywhere in the U.S. For service in Canada, call **1-800-807-6777**.