

# Kodak

# PIXPRO SP360

Action Cam

## User Manual



# ***Before You Start***

---

## **Declaration of Conformity**

Responsible Party: JK Imaging Ltd.



Address: JK Imaging Ltd., 17239 So. Main Street, Gardena, CA 90248 USA

JK Imaging Europe, 71 Clarendon Road, Watford, WD17 1DS, UK

Company Website: <http://kodakpixpro.com>

## **About this Manual**

Thank you for purchasing this product. Please read this manual carefully and keep it in a safe place for future reference.

- JK Imaging Ltd. reserves all rights of this document. No part of this published manual may be reproduced, transmitted, transcribed, stored in a retrieval system or translated into any language or computer language, in any form, by any means, without the prior written permission of JK Imaging Ltd..
- All trademarks mentioned in this manual are used for identification purposes only and are properties of their respective owners.
- This manual provides you with instructions on how to use your new KODAK PIXPRO Action Cam. Every effort has been made to ensure that the contents of this manual are accurate; however JK Imaging Ltd. reserves the right to make changes without notice.
- Throughout this manual,  indicates the useful information, " Page number" indicates an introduction to the contents on this page.

## INDUSTRY CANADA

This device complies with Canadian RSS-210.

This device complies with Industry Canada license-exempt RSS standard (s). Operation is subject to the following two conditions: (1) this device may not cause interference, and (2) this device must accept any interference, including interference that may cause undesired operation of the device.

Radiation Exposure Statement:

This product complies with the Canadian portable RF exposure limit set forth for an uncontrolled environment and is safe for intended operation as described in this manual. Additional RF exposure reduction can be achieved if the product can be kept as far as possible from the user body or set the device to lower output power if such function is available.

## For Customers in Europe

 This symbol [crossed-out wheel bin WEEE Annex IV] indicates separate collection of electrical waste and electronic equipment in the European countries. Please do not throw the equipment into domestic refuse. Please use the return and collection systems available in your country for proper, safe disposal of this product.

 “CE” mark indicates that this product complies with the European requirements for safety, health, environment and customer protection. “CE” marked cameras are intended for sales in Europe.

Europe – EU Declaration of Conformity

This device complies with the essential requirements of the R&TTE Directive 2014/53/EU.

The following test methods have been applied in order to prove presumption of conformity with the essential requirements of the R&TTE Directive 2014/53/EU:

- EN 60950-1: 2006+A11:2009 +A1:2010 +A12:2011

Safety of Information Technology Equipment

- EN 50566: 2013

Product standard to demonstrate compliance of radio frequency fields from handheld and body-mounted wireless communication devices used by the general public (30 MHz — 6 GHz)

- EN 62209-2: 2010

Human exposure to radio frequency fields from handheld and body mounted wireless communication devices — Human models, instrumentation, and procedures

Part 2: Procedure to determine the specific absorption rate (SAR) for wireless communication devices used in close proximity to the human body (frequency range of 30 MHz to 6 GHz)

- EN 300 328 V1.8.1 : 2012

Electromagnetic compatibility and Radio spectrum Matters (ERM); Wideband Transmission systems; Data transmission equipment operating in the 2.4 GHz ISM band and using spread spectrum modulation techniques; Harmonized EN covering essential requirements under article 3.2 of the R&TTE Directive.

- EN 301 489-1 V1.9.2: 2011

Electromagnetic compatibility and Radio Spectrum Matters (ERM); Electro Magnetic Compatibility (EMC) standard for radio equipment and services; Part 1: Common technical requirements.

- EN 301 489-17 V2.2.1:2012

Electromagnetic compatibility and Radio spectrum Matters (ERM); Electro Magnetic Compatibility (EMC) standard for radio equipment and services; Part 17: Specific conditions for 2.4 GHz wideband transmission systems and 5 GHz high performance RLAN equipment.

Manufacturer: Sintai Optical (Shenzhen) Co., Ltd

Address: Qiwei Ind Sec, 1st, 2nd, & 3RD Bldg, Lisonglang Village, Gongming Town, Bao'an District, Shenzhen, Guangdong, China

## For Customers in the U.S.A.

### Federal Communication Commission Interference Statement

This device complies with Part 15 of the FCC Rules. Operation is subject to the following two conditions: (1) This device may not cause harmful interference, and (2) this device must accept any interference received, including interference that may cause undesired operation.

This equipment has been tested and found to comply with the limits for a Class B digital device, pursuant to Part 15 of the FCC Rules. These limits are designed to provide reasonable protection against harmful interference in a residential installation. This equipment generates, uses and can radiate radio frequency energy and, if not installed and used in accordance with the instructions, may cause harmful interference to radio communications. However, there is no guarantee that interference will not occur in a particular installation. If this equipment does cause harmful interference to radio or television reception, which can be determined by turning the equipment off and on, the user is encouraged to try to correct the interference by one of the following measures:

- Reorient or relocate the receiving antenna.
- Increase the separation between the equipment and receiver.
- Connect the equipment into an outlet on a circuit different from that to which the receiver is connected.
- Consult the dealer or an experienced radio/TV technician for help.

FCC Caution: Any changes or modifications not expressly approved by the party responsible for compliance could void the user's authority to operate this equipment.

This transmitter must not be co-located or operating in conjunction with any other antenna or transmitter.

### Radiation Exposure Statement:

This product complies with the FCC portable RF exposure limit set forth for an uncontrolled environment and is safe for intended operation as described in this manual. Additional RF exposure reduction can be achieved if the product can be kept as far as possible from the user body or set the device to lower output power if such function is available.



Packaging: Please follow local regulations for the recycling of packaging.

Batteries: Please dispose of used batteries at designated collection centers.

# Safety Notes

---

## Product Notes:

- Do not disassemble or attempt to repair the product by yourself.
- Do handle the product properly. This product may be damaged if dropped, punctured or crushed.
- Avoid directly touching the lens element, please use professional lens cleaning paper together with lens cleaning agents to wipe the lens and keep the lens clean.
- Do not use corrosive, alcoholic or organic-solvent-containing cleaners to wipe this product.
- Do not use or store this product in high temperature environment.
- Do not expose the lens to strong light sources (e.g. daylight, etc.) for extended periods of time.
- Do not use or store the product in a strong magnetic field environment.
- If the product is quickly transferred from a low temperature environment to a high temperature environment, water condensation may occur in the product due to physical changes. In this case, it is recommended to wait until the product returns to room temperature before you turn it on.
- If a photo or video cannot be played back due to improper operation by user, the Company shall assume no liability or responsibility for compensation.
- Store the product in a dry and clean environment when you are going to store the product for a long period of time.

## Battery Notes:

- Please use a battery that is the same type as the one included.
- If the battery overheats during charging or use, stop charging or use immediately. Turn off the product, remove the battery carefully, and wait until it cools down.
- Please keep the battery contacts clean and dry.
- Please install the battery according to the positive and negative markings on the battery compartment. Never force it into the battery compartment.
- If battery fluid leaks into the product, please contact your retailer. If battery fluid leaks onto your skin, rinse your skin immediately with clean water and seek for medical attention.
- To prevent the battery from being damaged, do not drop the battery, impact it with heavy objects or scratch it with sharp objects.
- Do not let the battery be in contact with metal objects (including coins) in order to avoid short circuiting, discharging, excessive heating, or possible leakage.
- Do not heat the battery or throw it into a fire in order to avoid a possible explosion.
- Remove the battery if it will be stored for a long period of time.
- Do not store the battery in high temperature environment.
- Using the battery in cold environment will result in a much lower performance.
- Do not attempt to disassemble the battery by yourself.
- Please dispose the battery properly according to local laws and regulations (national or regional).

## Memory Card Notes

- The memory card referred to in this manual is a microSD card or microSDHC card.
- Please keep the memory card clean and dry.
- When inserting a memory card, make sure the notch direction of the card matches the notch direction of the memory card mark near the card slot. Do not force the memory card into the card slot.
- Before using a brand new memory card, please format the memory card first.
- A photo or video taken with the product will be stored in the folder that is automatically generated on the memory card. Do not store photos or videos that are not taken using the product in these folders in case that the files cannot be normally recognized in playback.

- Directly editing the data on memory card is not recommended. Copy the data to your computer disk before editing is recommended.
- Please turn the product off before removing the memory card. Otherwise, the memory card could be damaged.
- When the product is stored for a long period of time, please backup the data on the memory card and remove the memory card.



#### **Other Notes:**

- Do not disconnect the power or turn the product off during firmware updating process. Doing so may cause incorrect data to be written and the product may not power on later.
- When using your product on an airplane, observe the relevant rules specified by the airline.
- Due to the limitations of manufacturing technology, the LCD may have a few dead or bright pixels. These pixels do not affect the quality of the photos or videos.
- If the LCD screen is damaged, please pay close attention to the liquid crystal in the screen. If any of the following situations arise, kindly take the recommended actions immediately as indicated below:
  1. If liquid crystal comes in contact with your skin, please wipe your skin with a dry cloth, wash with soap thoroughly, and rinse with plenty of clean water.
  2. If liquid crystal gets into your eye, flush your eye with plenty of clean water immediately for at least 15 minutes. Please also seek for medical assistance.
  3. If liquid crystal is swallowed incautiously, immediately rinse your mouth with clean water and try to induce vomiting. Please also seek for medical assistance.



#### **Waterproof Notes:**

- This product is splashproof for the purposes of daily activities. Before use, please make sure to firmly tighten the lens cover, lock the battery cover, and tightly close the side cover.
- Any scratches, cracks, or small foreign objects (such as sand or hair) attached to the rubber ring inside of the side cover will affect the efficacy of splashproof function. Before use, please check whether the waterproofing rubber is damaged or contaminated with a foreign object before closing the side cover. When there is a foreign object on the waterproofing rubber and its adjacent surfaces, please use a clean, lint-free dry cloth to clean it. If there are any scratches or cracks, immediately go to a service center for maintenance and obtain a replacement waterproofing rubber.
- Before using the product in water, please make sure you place it inside the waterproof housing first. It can be submerged to no more than 60 meters (196 feet) under the water at a temperature not exceeding 40 °C. The product can maintain its waterproof performance for up to 4 hours at the depth of 60 meter(196 feet) under the water.
- Do not open the waterproof housing when submerged in water.
- Do not directly open the side cover or battery cover, nor should you remove the lens cover when the product accidentally comes into contact with water. Please turn off the power and wipe it with a clean, dry, lint-free cloth before opening the battery cover and side cover in order to remove the battery and the memory card.
- When opening the battery cover and the side cover, if there are water droplets on the surfaces located between the interior and the body, please make sure to wipe them off.
- After using the product in the presence of sand, mud or other foreign matter, please rinse it with clean water (please make sure to firmly tighten the lens cover, lock the battery cover, and close the side cover tightly before rinsing). After rinsing, wipe it with a clean, dry, lint-free cloth.













#### **Waterproof / Dustproof / Shockproof/ Freeze-proof:**

- Installing the lens cover, JIS / IEC waterproof grade 5 (IPX5).
- Installing the lens cover, JIS / IEC dustproof grade 6 (IP6X).
- Installing the lens cover, height for shockproof rating is 2.0m.
- Suitable temperature range for freeze proof capability is -10°C and above.

# Contents

---

Before You Start .....	1
Safety Notes .....	4
Contents .....	6
Getting Ready.....	8
Accessories Included.....	8
Kodak PIXPRO SP360 View .....	9
Mounting / Removing Lens Cover .....	10
Installing Battery .....	11
Installing Memory Card.....	12
Charging the Battery.....	13
Configuration and Operation .....	15
Main Screen Display Introduction.....	15
Power On / Off.....	16
Start-up for language, date and time .....	16
Introducing the Menu  .....	17
General Settings  .....	18
Movie Settings  .....	19
Still Image Settings  .....	21

Modes Introduction 	22
■ Wi-Fi mode 	23
■ Movie mode 	26
■ Snap Shot Photo mode 	26
■ Loop recording mode 	26
■ Time Lapse mode 	27
■ Burst mode 	27
Using Interfacing.....	28
Micro USB interface.....	28
Charging .....	28
Using an external power supply.....	28
Data transmission .....	28
Micro HDMI interface.....	29
Appendices.....	30
Specifications .....	30
Prompts and Warning Messages.....	32
Trouble Shooting .....	34
Special Accessories.....	35



# Getting Ready

## Accessories Included

Your product box should contain the product you purchased along with the following accessories. If anything is missing or appears to be damaged, please contact your retailer. (The AC Adapter style will vary according to the power requirement from different countries or regions. Below picture is for reference only)

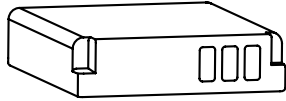

Rechargeable Li-ion battery

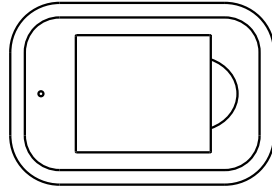

Battery charger

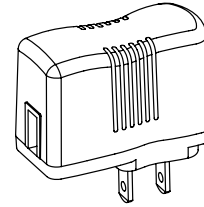

AC adapter

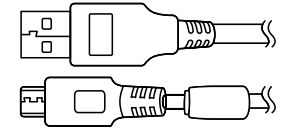

Micro USB cable

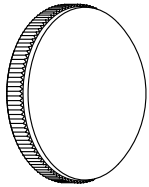

Glass lens cover  
(installed on the product when  
leaving factory)



Protective cover

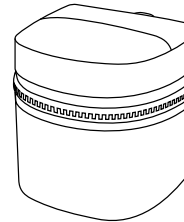

Carrying case

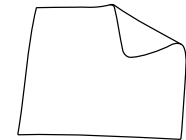

Cleaning cloth

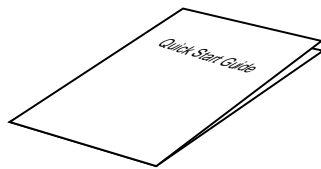

Quick start guide







Warranty card

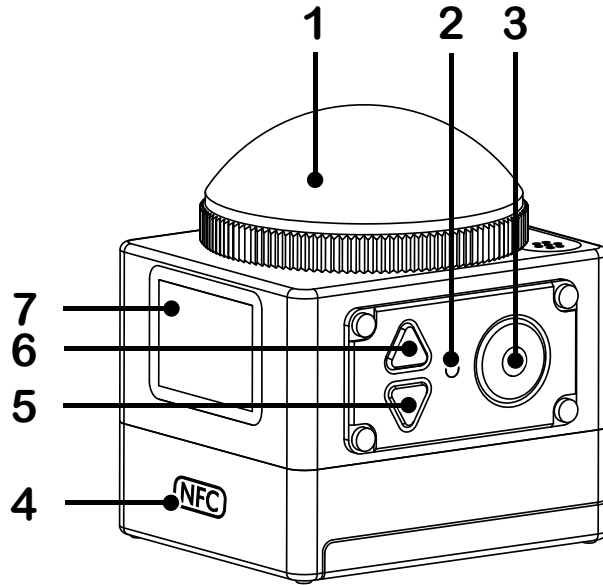

Service card

# Kodak PIXPRO SP360 View



1	Glass lens cover
2	Status indicator
3	 Video recording button / Shooting button / OK button
4	NFC mark
5	 Menu button / Direction button (lower)
6	 Power button / Mode button / Direction button (upper)
7	LCD
8	Microphone
9	Tripod socket
10	Buzzer
11	Side cover
12	Location hole
13	Battery cover
14	Battery cover lock

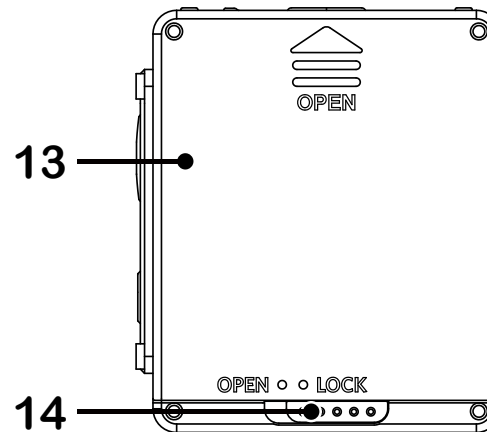
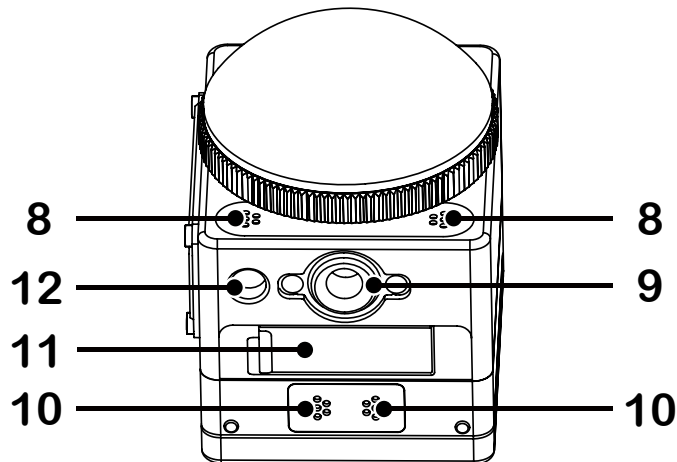

## Mounting / Removing Lens Cover

### Removing lens cover:

Turn the lens cover according to the illustrated direction until it separates from the SP360.

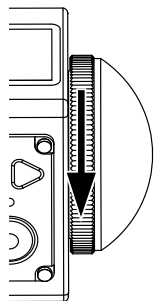

### Mounting lens cover

Turn and firmly tighten the lens cover according to the illustrated direction.

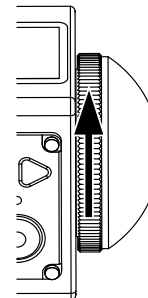

- ④ The lens cover protects the lens from being damaged (dustproof, shockproof and splashproof). Using the lens cover will not influence the image and video quality.
- ④ Before mounting the lens cover, make sure the lens surface is clean and dry. Always use a clean, lint-free dry cloth to clean the lens before shooting or recording so it will not affect the photo or video quality.
- ④ When the SP360 is exposed to extreme temperature differences condensation may form inside of the lens cover. If this happens, remove the lens cover, and clean it with a soft, dry, lint-free cloth, and then reinstall the lens cover.
- ④ If the SP360 will not be used for a period of time, always put the protective cover on it. (as shown in the figure).



# Installing Battery

## 1. Open the battery cover

Push the battery cover lock from "LOCK" to "OPEN" along the direction of arrow ①, push the battery cover along the direction of arrow ②, and open the battery cover along the direction of arrow ③.

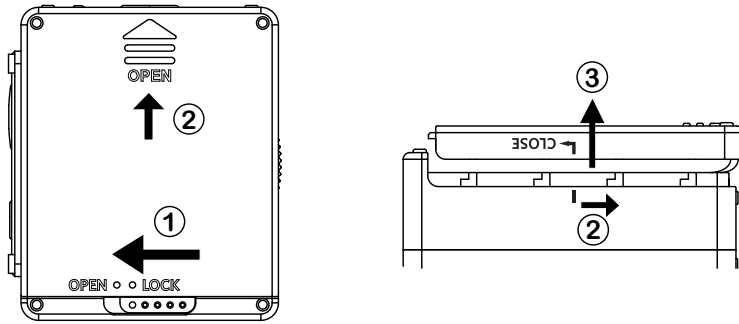

## 2. Insert the battery

Insert the battery into the battery compartment along the direction of arrow ④ (note the location of the + and - symbols)

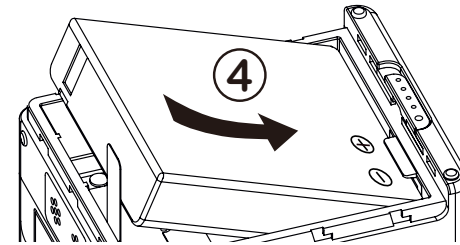

 Gently pull the tape upward to remove the battery. When inserting the battery, please do not fold the tape underneath the battery.

## 3. Close the battery cover

Align the battery cover over the battery compartment as shown and set it in place in the direction of arrow ⑤. Close the battery cover along the direction of arrow ⑥, and push the battery cover lock from "OPEN" to "LOCK" along the direction of arrow ⑦.

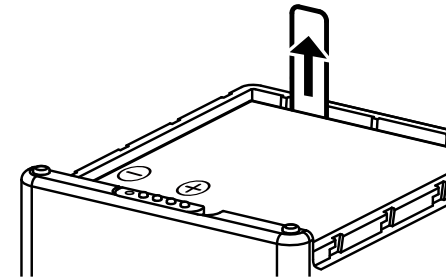
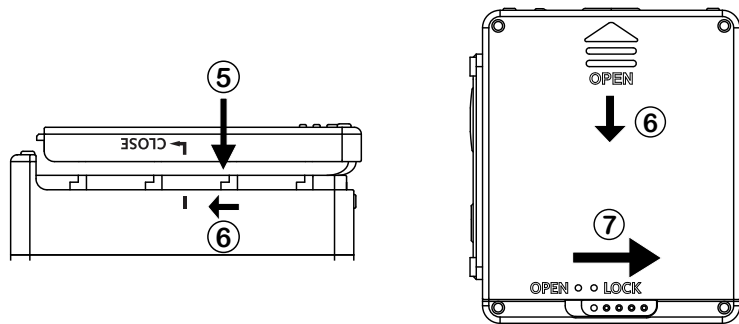

## Installing Memory Card

Open the side cover, then insert the memory card into the card slot (note the direction of the memory card gap), push the bottom end of the memory card with a fingertip into the slot completely, and then close the side cover.

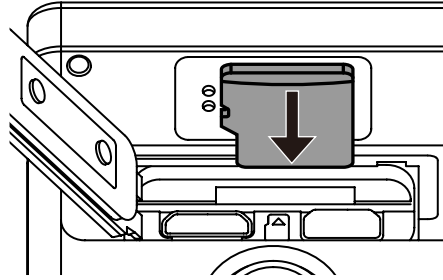

- ④ A memory card (microSD / microSDHC) is optional and is not included in the product package. It needs to be purchased separately. Please use an original memory card which is Class 6 or higher and has a capacity of 4GB to 32GB.
- ④ To remove your memory card, open the side cover, gently press the memory card to eject it and remove it carefully.
- ④ The product will automatically turn off if the memory card is inserted or extracted when the product is on.

## Charging the Battery

 Please use the battery charger or AC adapter to charge the battery in an ambient temperature ranging from 10 °C to 35 °C.

### Charging the battery with a battery charger:

1. Place the battery into the battery charger according to the direction illustrated. Use the Micro USB cable to connect the battery charger and the AC adapter, and then plug the AC adapter into an electrical outlet.

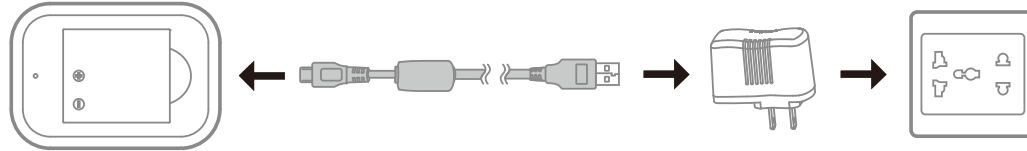

2. The indicator light will turn red while charging. The indicator light becomes green means charging is complete.



 When charging the battery for the first time or after a long period of storage, please make sure that the charging time is no less than four hours.

### Charging the Action Cam with an AC adapter or an external power supply (vehicle power supply, portable power supply, etc):

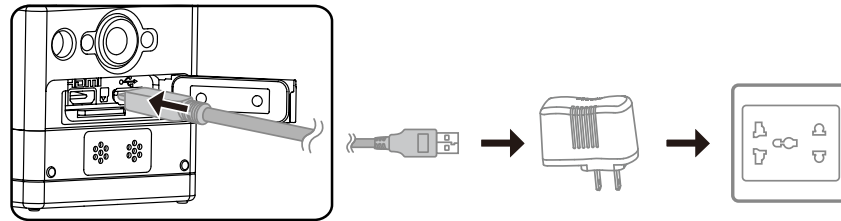
1. Place the battery into the Action Cam.
2. Use the Micro USB cable to connect the Action Cam to the AC adapter first, then plug the AC adapter into the power outlet. Or, use the Micro USB cable to connect the Action Cam to an external power supply (vehicle power supply, portable power supply, etc).



3. "Charging ..." shown on the LCD screen indicates the battery charging has begun.
4. The indicator light will become orange while it's charging. (The Action Cam will automatically shut down after charging is complete.)

 Charging will stop after pressing down the  button while charging.

 If the Action Cam was set to the Loop recording mode before shutdown, it will automatically start up and start recording when a Micro USB cable is connected to the Action Cam and an AC adapter (or to an external power supply). (For example: when the Action Cam is connected to a vehicle power supply, it will start and record automatically when the automobile starts. It will also stop recording, save the files, and power off one minute after the automobile shuts down.)

### Charging the Action Cam with a computer:

1. Place the battery into the Action Cam.
2. Use the Micro USB cable to connect the Action Cam to a computer (while the computer is on).
3. The indicator light will become orange while charging and will turn off automatically after charging is complete.

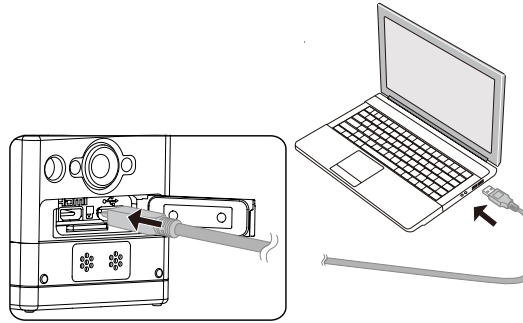

# Configuration and Operation

## Main Screen Display Introduction

### ■ Main screen displays under Wi-Fi mode



### ■ Main screen displays under other modes

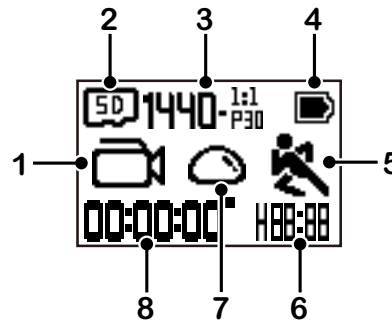

#### 1. Mode

Movie mode

Loop recording mode

Time Lapse mode

Snap Shot Photo mode

Burst mode

#### 2. Memory card / Internal memory

3. Movie size: **FHD-16:9 / 1440-1:1 / 1072-1:1 / 1072-1:1 E15 / HD-4:3 / HD-4:3 / HD-16:9 / HD-16:9 / WVGA-16:9 / WVGA-16:9**

Photo size: **10-M / 5-M / 2-M**

#### 4. Battery status

#### 5. Motion detection (On)

6. Remaining recording time: **H:MM:SS** hh:mm / **M:SS** mm:ss / **---** none

Number of remaining shots: **+88888** ("+9999" will be displayed when it exceeds the maximum available display number) / **-----** none

#### 7. Unfold mode

Dome / Front / Seg (Segment) / Ring

#### 8. Recorded time / photos ("+9999" will be displayed when it exceeds the maximum available display number)



## Power On / Off

### ■ Power on:





When the power is off, press and hold the  button for more than one second to turn on the product.

### ■ Power off:

When the power is on, press and hold the  button for more than one second to turn off the product.



















 If the product cannot be powered on / off normally, you can remove the battery from the action cam to force it to power off.























## Start-up for language, date and time

1. Press and hold the  button to turn on the product. When starting for the first time, the display will show the date and time setting screen, "Y M D hh:mm:ss".
2. The item to be adjusted will be highlighted with a black background color, press the  or  button to adjust the value, press the  button to confirm.
3. After adjusting the "minute" value, press the  button to enter the Wi-Fi main screen.



## Introducing the Menu

- In the main screen (except for Wi-Fi mode), press the  button to enter the first-level menu interface, press the  or  button to select the item, and press the  button to enter the corresponding secondary level menu interface.
  -  In Movie mode/Loop recording mode / Time lapse mode can enter  Movie Settings and  General Settings.
  -  In Snap Shot Photo mode/Burst mode can enter  Still Settings and  General Settings.
- Press the  or  button to select the item, press the  button to confirm and to enter the tertiary menu interface(highlighted with a black background color).
- Press the  or  button to select the item, press the  button to confirm and to back to the secondary level menu interface.
- Select , press the  button to return to the first-level menu interface.
- Select **EXIT**, press the  button to return to the main screen.



First Level Menu	Movie Settings 	Still Settings 	General Settings 	EXIT
Secondary Level Menu	Unfold mode 	Unfold mode 	Volume 	
	Movie size 	Photo size 	Power off 	
	Time Lapse 	White balance 	Date / Time 	
	Loop recording 		Format 	
	Motion detection 	<b>EXIT</b>	Reset settings 	
	Wind cut 		FW version 	
	White balance 			
			<b>EXIT</b>	
	<b>EXIT</b>			

## General Settings

### ■ Volume /

Set the volume of the product.



There are 2 options:

-  Enable
-  Off

### ■ Power off /





When this function is enabled, if there are no actions taken within a set time frame (except while recording or connected to Wi-Fi), the product will automatically shut down.

There are 2 options:

-  60 seconds
-  Off

### ■ Date / Time

Set the date and time of the product.

1. The display shows the date and time setting screen, "Y M D hh:mm:ss";
2. The item to be adjusted will be highlighted with a black background color, press the  or  button to adjust the value, press the  button to confirm;
3. After adjusting the "minute" value, press the  button to enter the secondary level menu interface.



### ■ Format /

Format can clear all data stored in the memory card or the internal memory.

When a memory card is inserted, only the card can be formatted. If you need to format the internal memory, remove the memory card first.

There are 2 options:

- **YES** Confirm
- **NO** Cancel

If select **YES**, press the  button to start formatting, and return to the secondary level menu interface after finishing.

### ■ Reset settings

Reset settings can recover all product settings to the factory defaults (except for date and time).

There are 2 options:

- **YES** Confirm
- **NO** Cancel

If select **YES**, press the  button to start resetting, and return to the secondary level menu interface after finishing.

### ■ FW version

FW version can display the current version. Press the  button to return to the secondary level menu interface.

When a new version is stored in the memory card, the firmware can be updated.

There are 2 options in the update firmware interface:

- **YES** Confirm
- **NO** Cancel

If select **YES**, press the  button to start updating, and the product will automatically shut down after finishing.





 If the low battery warning is shown, charge the battery before updating the firmware.



## Movie Settings



### ■ **Unfold mode (for Movie mode / Loop recording mode / Time Lapse mode)**

Select from several different viewing effects.

There are 5 options:

-  Dome \*<sup>1</sup>
-  Front \*<sup>2</sup>
-  Seg (Segment) \*<sup>1</sup>
-  Ring \*<sup>1</sup>
-  Panorama \*<sup>1</sup>











 \*<sup>1</sup> indicates that the default movie size corresponding to this option is  (1440P30).

 \*<sup>2</sup> indicates that the default movie size corresponding to this option is  (1080P30).

### ■ **Movie size (for Movie mode / Loop recording mode / Time Lapse mode)**

Set video resolution.



There are 10 options:

-  1920×1080(30fps)
-  1440×1440(30fps) \*<sup>3</sup>
-  1072×1072(30fps) \*<sup>3</sup>
-  1072×1072(30fps)(EIS)
-  1280×960(50fps) \*<sup>1</sup>
-  1280×960(30fps)
-  1280×720(60fps) \*<sup>1</sup>
-  1280×720(30fps)
-  848×480(60fps) \*<sup>1</sup> \*<sup>2</sup>
-  848×480(120fps) \*<sup>1</sup> \*<sup>2</sup>

 \*<sup>1</sup> indicates that the selection is unavailable in the Time Lapse modes.















\*<sup>2</sup> indicates that the selection is unavailable in the Loop recording modes.  
If such a movie size is set while in Movie mode, the movie size will be automatically set to  (1080P30) when switching to Loop recording or Time Lapse modes.

 \*<sup>3</sup> means it does not support electronic image stabilization (EIS).

 **WVGA**  (480P120) High speed movie:







- The product shoots ultra high speed movies, and plays back with normal 30fps speed, in order to capture visually indistinguishable moments easily.
- The maximum recordable time is 60 seconds, when the time reaches 60 seconds, the product will automatically stop recording.
- The sound cannot be recorded.
- Motion detection will not work in this mode.

Corresponding table for Movie size and Unfold mode: (O means "available", X means "not available")





					
 1920×1080(30fps)	X	O	X	X	X
 1440×1440(30fps)	O	X	O	O	O
 1072×1072(30fps)	O	X	O	O	O
 1072×1072(30fps)(EIS)	O	X	O	O	O
 1280×960(50fps)	X	O	X	X	X
 1280×960(30fps)	X	O	X	X	X
 1280×720(60fps)	X	O	X	X	X
 1280×720(30fps)	X	O	X	X	X
 848×480(60fps)	X	O	X	X	X
 848×480(120fps)	X	O	X	X	X

## ■ Time Lapse (for Time Lapse mode)

There are 6 options:



-  1 second
-  2 seconds
-  5 seconds
-  10 seconds
-  30 seconds
-  60 seconds

 Time Lapse mode:

-  (960P50) or  (720P60) or  (480P60) or  (480P120) cannot be selected.
- Motion detection will not work in this mode.

## ■ Loop recording (for Loop recording mode)

There are 2 options:

-  5 minutes
-  10 minutes



 Loop recording mode:

-  (480P60) or  (480P120) cannot be selected.
- Motion detection will not work in this mode.



## ■ Motion detection (for Movie mode)

Motion detection means that if the product detects moving objects entering into the view, it will automatically start recording. During the recording process, if there is no moving object detected for 10 continuous seconds, the recording will pause automatically.

There are 2 options:

-  Off
-  Enable

1. Enter the tertiary menu interface of Motion detection, select , and return to the main screen.

2. The display will show the  icon. Press the  button to activate. If the product detects moving objects, it will automatically start recording
3. The product will stop recording when there is no change in the image within 10 seconds. When the image changes again, the product will start recording automatically, and a new video file will be generated after each pause and restart.

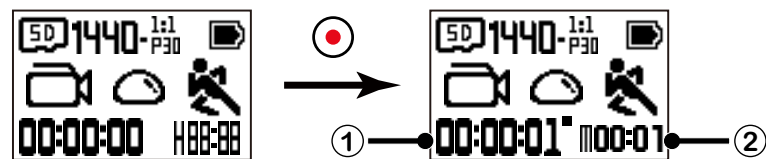

① Indicates the total time of recording

② Indicates the total time from enable the Motion detection



4. Press the  button again to stop recording and detecting.

  (480P120) cannot be selected when the Motion detection is enabled.

## ■ Wind cut (for Movie mode / Loop recording mode / Time Lapse mode)

Wind cut refers to the reduction of noise caused by wind.





There are 2 options:

-  Off
-  Enable

## ■ White balance (for Movie mode / Loop recording mode / Time Lapse mode)

White balance means that the user adjusts the color temperature under different light sources to ensure that the colors are reproduced correctly.

There are 5 options:





-  Auto white balance
-  Daylight
-  Cloudy
-  Fluorescent
-  Underwater



## Still Image Settings



### ■ **Unfold mode(for Snap Shot Photo mode / Burst mode)**

Select from several different viewing effects.

There are 5 options:

-  Dome \*<sup>1</sup>
-  Front \*<sup>2</sup>
-  Seg (Segment) \*<sup>1</sup>
-  Ring \*<sup>1</sup>
-  Panorama \*<sup>1</sup>



 \*<sup>1</sup> indicates that the default photo size corresponding to this option is .

 \*<sup>2</sup> indicates that the default photo size corresponding to this option is .





### ■ **Photo size(for Snap Shot Photo mode / Burst mode)**

Set photo resolution.

There are 3 options:

-  3264x3264(1:1)
-  2592x1944(4:3)
-  1920x1080(16:9)





Corresponding table for Photo size and Unfold mode: (O means "available", X means "not available")

					
	O	X	O	O	O
	X	O	X	X	X
	X	O	X	X	X

### ■ **White balance(for Snap Shot Photo mode / Burst mode)**







White balance means that the user adjusts the color temperature under different light sources to ensure that the colors are reproduced correctly.

There are 5 options:

-  Auto white balance
-  Daylight
-  Cloudy
-  Fluorescent
-  Underwater

## Modes Introduction

In the main screen display, press the  button to switch modes.

6 modes are available: Wi-Fi mode , Movie mode , Snap Shot Photo mode , Loop recording mode , Time Lapse mode , Burst mode .

 Wi-Fi mode  : THE ACTION CAM MUST BE SET TO Wi-Fi MODE IN ORDER TO BE CONNECTED TO AND OPERATED FROM A PC OR A SMART DEVICE.

 If the Action Cam is switched to other modes (Movie mode / Snap Shot Photo mode / Loop recording mode / Time Lapse mode / Burst mode) after Wi-Fi is connected to a PC or a smart device, the Wi-Fi function will automatically turn-off at the Action Cam. IF YOU WANT TO HAVE A CONSISTENT Wi-Fi CONNECTION BETWEEN THE ACTION CAM AND YOUR DEVICE, PLEASE KEEP THE ACTION CAM SET TO Wi-Fi MODE.

## ■ Wi-Fi mode

### Download and Install App

#### ● Smart Device:

Download the App installation package (App name: PIXPRO SP360)  to your smart device from the path below, and install it by following the instructions on the interface.

For Android devices, search and download the App "PIXPRO SP360" in Google play, and install it by following the instructions on the interface.



For iOS devices, search and download the App "PIXPRO SP360" in App store, and install it by following the instructions on the interface.



#### ● PC:

Download Application "PIXPRO SP360" (for PC) installation package  /  from the official website, and install it on your computer by following the prompts on the interface.



<http://kodakpixpro.com/Americas/support/downloads.php>



<http://kodakpixpro.com/Europe/support/downloads.php>



Please review the following items before your first connection:

1. Please do not use in places having high intensity magnetic field, electrostatic and electric wave interference (for example near a microwave oven), which may cause failure in receiving signals.
2. Please do not use Wi-Fi or NFC connection functionality on a plane.
3. To maintain in connection, please keep SP360 within 20 meters (65 feet) without signal shielding interference.
4. SP360 and the smart device can only be connected one to one.
5. SP360 and PC only can be connected one to one.
6. Your smart device operating system version needs to be iOS 7 or higher, or Android 4.0 or higher. iPad mini1 / iPad 2 / iPhone 4s and earlier models (any systemversions) do not support this App.
7. Your computer operating system version needs to be Mac OS X10.10/10.9/10.8 or Window 8/7.







## Connect Action Cam to smart device (or PC) with Wi-Fi.

When in Wi-Fi mode, press the  button to immediately disconnect and exit Wi-Fi mode.

### 1. Action Cam:

Check SSID (Service Set Identifier) (PIXPRO-SP360\_XXXX) and password (initial password: 12345678) indicated on the label in the battery compartment of the Action Cam. In the main interface, press the  button to switch to Wi-Fi mode. The Action Cam will enter the waiting for connection interface after starting Wi-Fi connection one second later:



If you wish to turn off Wi-Fi, press the  button in order to choose whether or not to turn off Wi-Fi. After pressing the  or  button to select **YES**, press the  button to exit Wi-Fi mode.







### 2. Smart Device or PC:

Enable Wi-Fi mode, it will automatically search the nearby Wi-Fi hotspots. Select the one with the same SSID (PIXPRO-SP360\_XXXX) and input the password.

### 3. Action Cam:



When the Wi-Fi connection is successful, enter the Wi-Fi connection interface.



If you wish to disconnect, press the  button. After pressing the  or  button to select **YES**, press the  button to enter the wait for the connection interface. If you would like to exit WiFi completely, press the  button.







### 4. Smart Device or PC:

When connected via Wi-Fi, you can tap the App icon  on the smart device to start it; or double-click the App icon  /  on the desktop of the computer to start it.

### 5. Action Cam:

When the App is connected to the Action Cam the App connected interface will appear.







If you wish to disconnect, press the  button. After pressing the  or  button to select **YES**, press the  button to enter the wait for the connection interface. If you would like to exit WiFi completely, press the  button.







- When recording is started via the App, the Recording interface will appear on the Action Cam.



If you wish to stop recording, you can do so using the APP or by pressing the  button disconnect. After pressing the  or  button to select **YES**, press the  button to enter the wait for the connection interface.



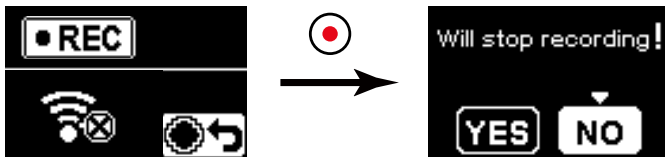

- If the Wi-Fi connection is cut off while recording, the Action Cam will continue to record and enter the connectionless recording interface. If you wish to stop the recording, press the  button to select whether or not to stop recording. After pressing the  or  button to select **YES**, press the  button to enter the wait for the connection interface.



- The Wi-Fi will automatically disconnect if you do not touch the smart device screen within three minutes after starting to record. However, the Action Cam will continue recording.

## Connect Action Cam to smart device with NFC



1. Enable NFC mode on your smart device.
2. Use your smart device to slightly touch the NFC mark on the Action Cam; if the smart device has a prompt tone or vibration, it means the connection is successful.
3. The APP will open automatically on your smart device.

-  The NFC feature will only be available when your smart device's screen is unlocked.
-  After having a successful connection of your smart device with an Action Cam, if you use a different Action Cam to touch the same smart device, the previous connection will be replaced.

## ■ Movie mode

Enables video recording. It is suitable for recording in most conditions.

Operation method:

Press the  button to start recording. Repress the  button to stop recording.

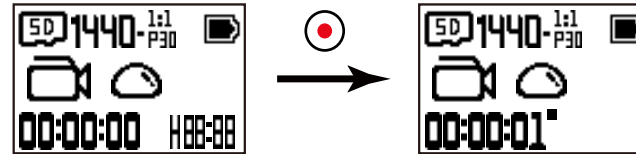

## ■ Snap Shot Photo mode

Enables photo shooting. It is suitable for recording in most conditions.

Operation method:

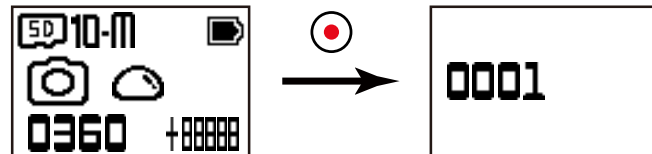

Press the  button for photo.





## ■ Loop recording mode

Loop recording allows for the recording of independent segments of movies according to selected time length from the beginning of recording. The product will continually record movies of the length selected until the record button is pressed to end recording. When the memory card is full, the product will overwrite the recorded files starting from the first movie circularly.

Operation method:

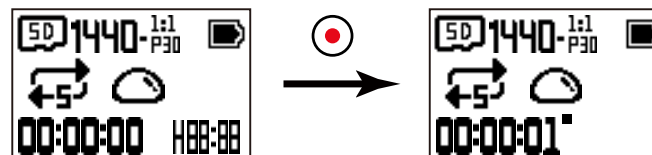
Press the  button to start recording. Repress the  button to stop recording.





 Loop recording functionality can only be activated when a memory card is inserted.

 If the Action Cam was set to the Loop recording mode before shutdown, it will automatically start up and start recording when a Micro USB cable is connected to the Action Cam and an AC adapter (or to an external power supply). (For example: when the Action Cam is connected to a vehicle power supply, it will start and record automatically when the automobile starts. It will also stop recording, save the files, and power off one minute after the automobile shuts down.)

## ■ Time Lapse mode

Time Lapse enables the recording of an interval of time, and splices the frames together to present a condensed video which usually requires a long period of time to complete.

Operation method:

Press the  button to start recording. Repress the  button to stop recording.

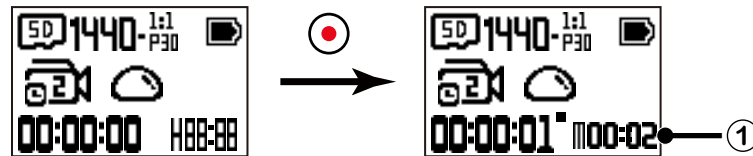

① indicates that the current countdown seconds

 Sound cannot be recorded in this mode.

## ■ Burst mode

Enables ten photos to be captured continuously before auto pause.

Operation method:

Press the  button, it will stop after 10 photos are taken.



# Using Interfacing

## Micro USB interface

### Charging



### Using an external power supply

In case of low battery power, or when a long-term power supply is needed, an external power supply (AC adapter, vehicle power supply, portable power supply or other power unit) can be used instead of a battery. At this time, the setting of functions, photography, and other operations can be performed.

When powered on, use the Micro USB cable to connect the Action Cam to an external power supply. When connected with an external power supply, "⏻" will be displayed on the LCD.

When powered off, use the Micro USB cable to connect the Action Cam to the external power supply. Press and hold the  button to power on. When connected to an external power supply, "⏻" will be displayed on the LCD.



Requirements for the external power supply: output power of 5 V, output current of 1 A.



When powered on with a battery inserted, press and hold the  button to shut down and it starts to charge the battery.



If the Action Cam was set to the Loop recording mode before shutdown, it will automatically start up and start recording when a Micro USB cable is connected to the Action Cam and an AC adapter (or to an external power supply). (For example: when the Action Cam is connected to a vehicle power supply, it will start and record automatically when the automobile starts. It will also stop recording, save the files, and power off one minute after the automobile shuts down.)

### Data transmission

Use the Micro USB cable to connect the Action Cam to a computer and copy files from the Action Cam to the computer.

The steps are as follows:

1. Use the Micro USB cable to connect a computer (the computer should be on) to the Action Cam. During the connection, the Action Cam will display "Connecting ...", and the computer will automatically detect the Action Cam.

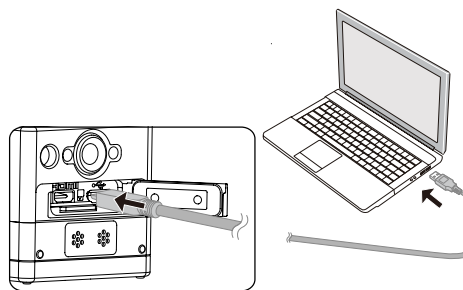

2. Open the Action Cam folder on the computer to copy your files to the computer. After the transmission is completed, please unplug the USB cable in a safe manner according to the computer's settings.

3. The Action Cam will automatically shut down when the Micro USB cable is unplugged.



The Action Cam supports Windows 8/7 and Mac OS X (V10.6.8~V10.10) systems.



If there is a memory card inserted into the Action Cam, only the files in the memory card will be read. If you want to read files in the internal memory, please remove the memory card before connecting to the computer.



A folder called "SCN" is automatically generated in memory card in the process of video storage; please delete this folder after deleting the video files to save more space capacity.

## Micro HDMI interface

The Action Cam can play back videos and photos on a TV through a Micro HDMI cable.



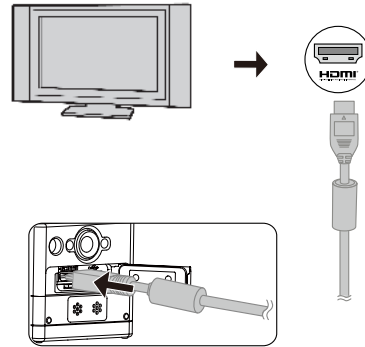

Set up as follows:

1. Use Micro HDMI cable (to be purchased separately) to connect an HDMI-compliant TV and the Action Cam (the Action Cam and the TV need to be powered on);



2. "Connecting ..." will be displayed on the Action Cam. After the connection is successful, files in the internal memory or the memory card will be displayed on the TV.

3. Press the  or  button to browse the files.

4. When a video file appears on the screen, press the  button to start playback, press the  button to rewind, press the  button to fast forward, and press the  button again to pause playback.



When the Action Cam is connected to the TV while powered off, press and hold the  button to power on.

# Appendices

## Specifications











 Design and specifications are subject to change without notice.





Image Sensor	Type	1/2.33" MOS
	Effective Pixels	16.36 Megapixels
	Total Pixels	17.52 Megapixels
Lens	Focal Length	0.805mm
	Equivalent to 35mm film	8.25mm
	F number	F2.8
	Lens Construction	7 groups 9 elements
	Optical Zoom	Fix Focus, 214 Degree
	Focusing Range	50cm~∞
Anti-Handshake	Electronic Image Stabilization	
Number of Recording Pixels	Photo size	10M : 3264×3264(1:1) 5M : 2592×1944(4:3) 2M : 1920×1080(16:9)
	Movie size	1920×1080(30fps) 1440×1440(30fps) 1072×1072(30fps) 1072×1072(30fps)(EIS) 1280×960(50fps) 1280×960(30fps) 1280×720(60fps) 1280×720(30fps) 848×480(60fps) High Speed Movie : 848×480(120fps)
File Format	Photo	Exif 2.3 (JPEG)
	Movie	MP4 [Image: H.264; Audio: AAC(Stereo)]
Modes	Wi-Fi, Movie, Shooting, Loop recording, Time Lapse, Burst	

Splashproof	Equivalent to JIS/IEC IPX5(Body)
Shockproof	Up to 2m
Dustproof	Equivalent to JIS/IEC (IP6X)
Freeze-proofing	-10°C
LCD	1.0 inch TN LCD
Level Gauge	2-axis
ISO Sensitivity	Auto (100~800)
Exposure Metering Method	Artificial Intelligence AE (AiAE)
Exposure Control Method	Program AE
Burst	Supported
White balance	Auto (AWB), Daylight, Cloudy, Fluorescent, Underwater
Recording Media	Internal Memory: Approx. 8MB
	microSD/microSDHC Card (Up to 32GB Support) [MMC Card Not Supported]
Language	English
Interface	USB 2.0 (Micro 5 pin USB) , HDMI (Type D)
Wi-Fi	Supported(802.11b/g/n)
NFC	Supported
Remote Viewfinder	Supported (via smart device)
Power	Rechargeable Li-ion Battery LB-080, 3.6V 1250mAh, In-Action Cam Charging
Shooting Capability (Battery Performance)	Approx. 350Shots (Based on CIPA Standards) Approx. 160min for Video (@1080p/30fps)
Operation Environment	Temperature: -10 ~ 40°C, Humidity: 0 ~ 90%
Dimensions (WxHxD)	Approx.41.1x50.0x52.1mm (excluding glass lens cover) (Based on CIPA Standards)
Weight	Approx. 103g (Body Only)



## Prompts and Warning Messages

Message	Description	Processing mode
	<ul style="list-style-type: none"> <li>■ There are too many files which may cause a delay to power on.</li> <li>■ When pressing the  button for shooting, the memory card cannot be accessed because there are too many folders.</li> </ul>	<ul style="list-style-type: none"> <li>■ After copying the files to the computer, choose to delete or format.</li> </ul>
	<ul style="list-style-type: none"> <li>■ When turning on the product or pressing the  button, the product detects that the memory card is out of capacity.</li> </ul>	<ul style="list-style-type: none"> <li>■ After copying the files to the computer, choose to delete or format.</li> </ul>
	<ul style="list-style-type: none"> <li>■ When turning on the product or pressing the  button, the product detects that the internal memory is out of capacity.</li> </ul>	<ul style="list-style-type: none"> <li>■ After copying the files to the computer, choose to delete or format.</li> <li>■ Use memory card.</li> </ul>
	<ul style="list-style-type: none"> <li>■ The memory card still cannot be recognized after format.</li> <li>■ An error occurs when reading the memory card.</li> <li>■ Interruption is encountered during shooting or recording so it cannot be shooting or recording any further.</li> </ul>	<ul style="list-style-type: none"> <li>■ Format the memory card.</li> </ul>
	<ul style="list-style-type: none"> <li>■ The internal memory still cannot be recognized after format.</li> <li>■ An error occurs when reading the internal memory.</li> <li>■ Interruption is encountered during shooting or recording so it cannot be shooting or recording any further.</li> </ul>	<ul style="list-style-type: none"> <li>■ Format the internal memory.</li> </ul>
	<ul style="list-style-type: none"> <li>■ When a memory card lower than Class 6 is used to record a HD or above movie, the writing speed is too slow and recording will not continue.</li> <li>■ Too many files in the "SCN" folder of the memory card.</li> </ul>	<ul style="list-style-type: none"> <li>■ Please select a Class 6 memory card or above.</li> <li>■ Format the memory card.</li> </ul>
	<ul style="list-style-type: none"> <li>■ When the internal memory fails to record Loop recording, the writing speed will slow down and recording will not continue.</li> </ul>	<ul style="list-style-type: none"> <li>■ Use memory card.</li> </ul>

Message	Description	Processing mode
	<ul style="list-style-type: none"> <li>■ File processing (saving, formatting, etc.) time exceeds 2 seconds.</li> </ul>	<ul style="list-style-type: none"> <li>■ User should do nothing.</li> </ul>
	<ul style="list-style-type: none"> <li>■ Connecting to the computer USB.</li> <li>■ Connecting to the HDMI device.</li> </ul>	<ul style="list-style-type: none"> <li>■ The display will disappear after connection is successful.</li> </ul>
	<ul style="list-style-type: none"> <li>■ A warning for low battery before shutting down automatically.</li> <li>■ The firmware cannot be updated when power is insufficient.</li> </ul>	<ul style="list-style-type: none"> <li>■ Charge or replace with a new battery.</li> </ul>
	<ul style="list-style-type: none"> <li>■ Updating firmware.</li> </ul>	<ul style="list-style-type: none"> <li>■ User should do nothing. The product will turn off automatically after the update is completed.</li> </ul>
	<ul style="list-style-type: none"> <li>■ The product will automatically shut down when the battery temperature becomes too high.</li> </ul>	<ul style="list-style-type: none"> <li>■ Remove the battery carefully when the product is shut down. The battery will be good to use again after cooling down.</li> </ul>

## Trouble Shooting

Problem	Possible causes	Solution
Product does not turn on	<ul style="list-style-type: none"><li>■ The battery has been depleted.</li><li>■ The battery is installed incorrectly.</li></ul>	<ul style="list-style-type: none"><li>■ Charge the battery.</li><li>■ Please follow the charging instructions in the manual to install the battery.</li></ul>
Blurred images	<ul style="list-style-type: none"><li>■ There is dirt on the lens or the glass lens cover.</li></ul>	<ul style="list-style-type: none"><li>■ Clean with a clean, lint-free dry cloth.</li></ul>
Failed to connect Wi-Fi	<ul style="list-style-type: none"><li>■ Wrong password entered.</li></ul>	<ul style="list-style-type: none"><li>■ Please re-enter the password. If you have forgotten the changed password, you can use the reset function to restore the password (initial password: 12345678)</li></ul>
Slow Wi-Fi connection	<ul style="list-style-type: none"><li>■ There are too many programs running simultaneously on the smart device.</li></ul>	<ul style="list-style-type: none"><li>■ Please close other unnecessary programs running on the smart device.</li></ul>

# Special Accessories

There are different options of SP-360 accessories available. Accessory bundles vary per retailer. To purchase additional accessories separately, please contact your local retailer customer service support, or visit <http://kodakpixpro.com> for more customer service details.

- ⚠ Before using (especially in water or strenuous activity), please pay attention to make sure the product is tightly secured to prevent damage or loss of the product.
- ⚠ Please ensure that the adhesive surface is clean before using double-sided adhesive accessories. Dirt, grease, or other foreign matter will reduce the effectiveness of the double-sided adhesive. The double-sided adhesive is not easy to remove after sticking. Please take into account the position and angle of sticking before doing it.
- ⚠ After fully assembling the accessories, please make sure the screw and pre-tightening handle are in the proper position and fully secure.
- ⚠ For ease of assembly, please line up the marks on the base and pre-tightening handle per the diagrams below.

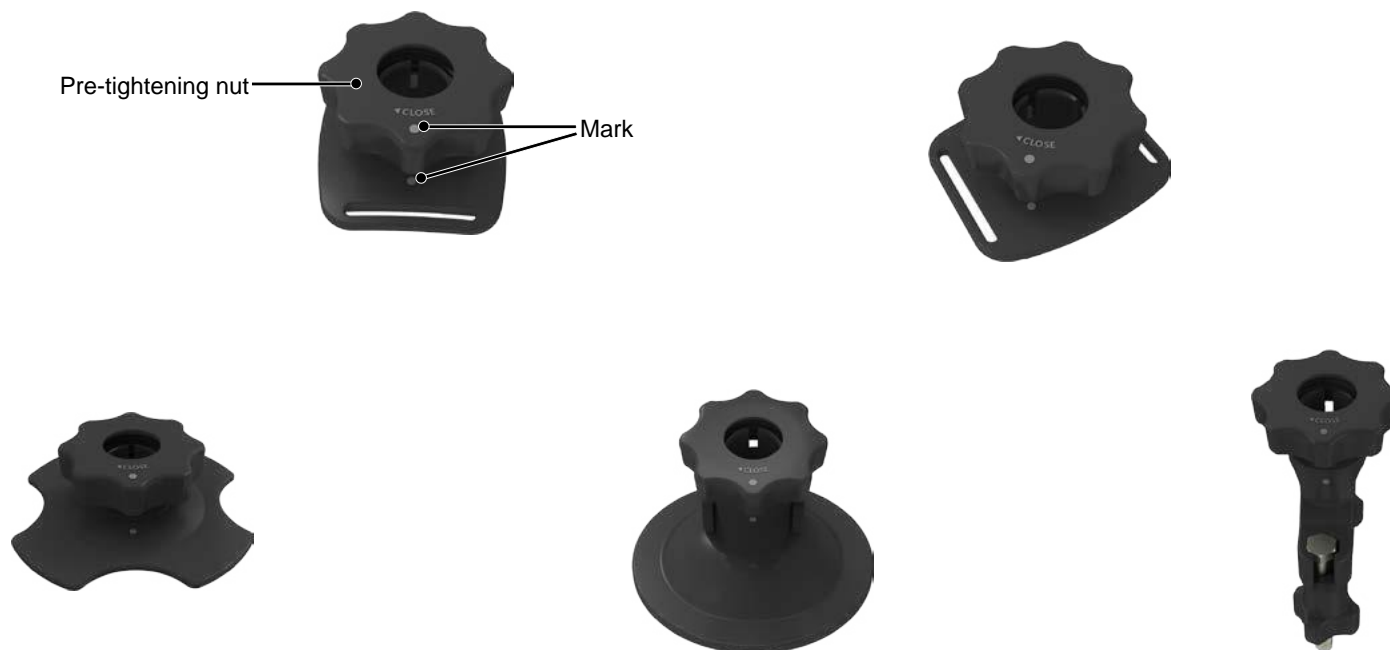

**Standard Housing: For use with other accessories when waterproofing is not required**



**Installation method:**

1. First, insert the adapter into the bottom of the standard housing before using the set screw to tighten.
2. Place the Action Cam inside the standard housing, and press the lock downward until it locks tightly.

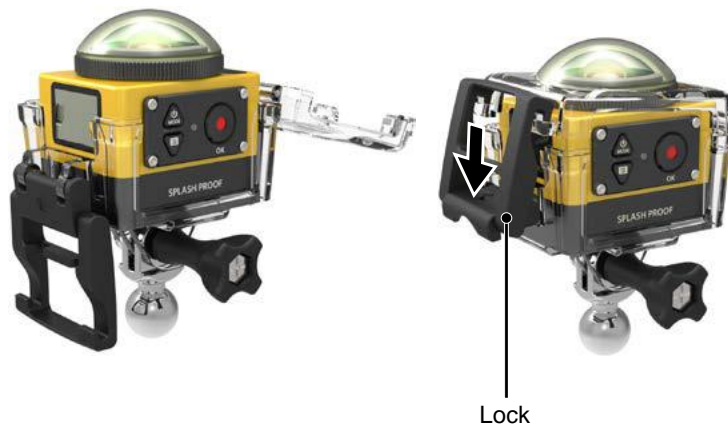
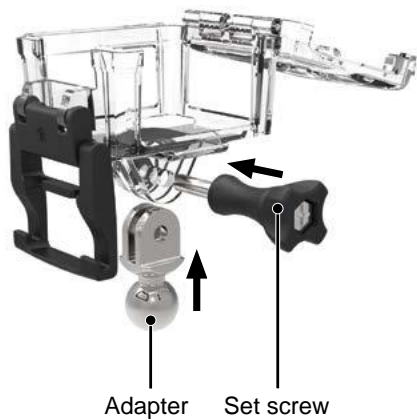

**Waterproof Housing:** For use with other accessories underwater, in rain, on the seashore, or in other circumstances where waterproofing is required



Installation method:

1. First, insert the adapter into the bottom of the waterproof housing before using the set screw for tightening.

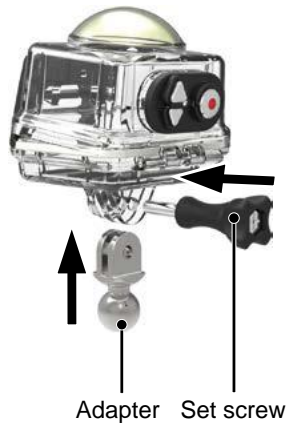

2. Remove the Action Cam's glass lens cover, place the Action Cam into the waterproof housing, put in the anti-fog inserts, and press the lock downward until it locks tightly.

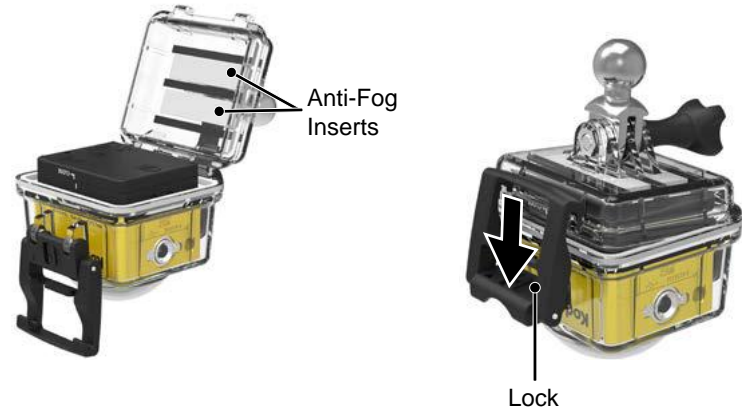

ⓘ Before using the Action Cam in a wet environment, please be sure to put it inside the waterproof housing first. Also, it should not be submerged to a depth greater than 60 m (196 feet) underwater.

ⓘ Anti-fog inserts absorb moisture. Please make sure it is dry before use (heat it in a 80-85°C oven for around 5 minutes). Each anti-fog insert can be reused up to 3-4 times.

**Flat Adhesive Mount:** For tacking onto a skateboard or other flat objects





**Curved Adhesive Mount:** For tacking onto a helmet or other curved objects



Installation method:

There are two types of adhesive mounts: flat and curved. You may select based on the shape of the object to be used.

Both types can be assembled in the same way, take the adhesive mount (flat) as an example:

1. Assemble the adhesive mount or the waterproof housing (  36 /  37).
2. Tie one end of the rope to the adhesive mount and the other end to the standard or waterproof housing.
3. Assemble the adapter, pre-tightening the nut and adhesive mount according to the direction illustrated in the picture. First press the adapter into the adhesive mount and then rotate and tighten the pre-tightening nut.
4. Tack the double-sided adhesive at the bottom of the adhesive mount to the object to be used.

 The double-sided adhesive is disposable. It should be replaced by a new one after being peeled off.

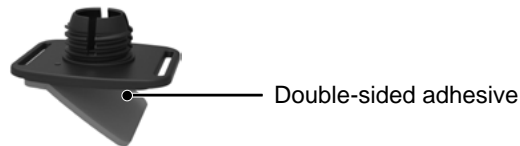

**Bar Mount: For mounting on bicycle handlebars, sailing masts, and other tube-like objects**



**Installation method:**

1. Assemble the standard or waterproof housing. (📖 36 / 📖 37).
2. Set the bar clamp to the handlebar and rotate the screws to tighten.



3. Assemble the adapter, pre-tightening nut and bar clamp in accordance with the direction illustrated in the picture. First press the adapter into the bar clamp and then rotate and tighten the pre-tightening nut.







**Suction Cup Mount: For attachment to automotive windshields (or smooth surfaces)**



**Installation method:**

1. Assemble the standard or waterproof housing (  36 /  37).
2. Assemble the adapter, pre-tightening nut and suction mount in accordance with the direction illustrated in the picture. Press the adapter into the suction mount before rotating and tightening the pre-tightening nut.
3. First, clean the suction mount and the windshield before attaching the suction cup to the windshield. Press down the handle to attach it to the windshield.



## Vented Helmet Strap Mount-A: For mounting on hollow objects like bicycle helmets



### Installation method:

1. Align the locator pole on the mount to the locator hole on the Action Cam, and align the screw on the mount to the Action Cam's tripod socket. Turn the screw with a coin or similar shape object to tighten.



2. Spread out the band before threading both ends into the helmet. Thread both ends of the band into the buckle, and then press down on the buckle clamp.

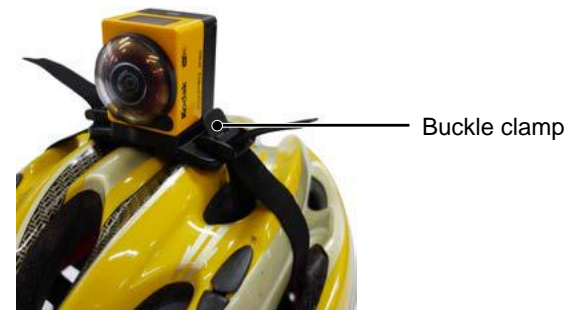

## Vented Helmet Strap Mount-B: For mounting on hollow objects like bicycle helmets



Installation method:



1. Align the mount's locator hole with the Action Cam's locator hole and align the screw on the mount with the Action Cam's tripod socket. Turn the thumb screw to tighten.
2. Spread out the band before threading both ends into the helmet. Thread both ends of the band into the buckle, and then press down on the buckle clamp.



## Head Strap Mount: For wearing on one's head



Installation method:

1. Assemble the standard or waterproof housing (  36 /  37).
2. Insert the base of the standard or waterproof housing to the mount before using the set screw to tighten.



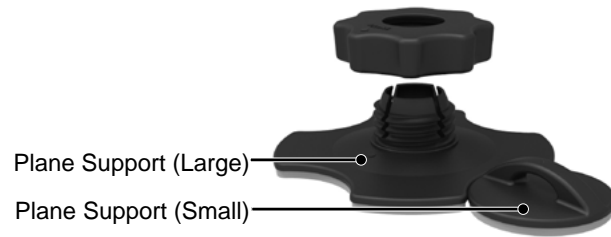

3. Place the band around your head and tighten appropriately.

## Surfboard Adhesive Mount: To be tacked onto watersports equipment like surf boards



### Installation method:

1. Assemble the waterproof housing (  37).
2. Tie one end of the rope to the plane support (small), and the other end to the waterproof housing.
3. Assemble the adapter, pre-tightening nut and plane support (large) in accordance with the direction illustrated in the picture. Press the adapter into the plane support (large) before rotating and tightening the pre-tightening nut.
4. Tack the double-sided adhesive onto the bottom of the plane support (large) and attach the plane support (small) to the object to be used.

 The double-sided adhesive is disposable. It should be replaced with a new one after being peeled off.



**Quick Clip: suitable to be clipped on a belt or harness**



**Installation method:**

1. Align the locator pole on the Quick Clip to the locator hole on the Action Cam, and align the screw of the Quick Clip to the Action Cam tripod mounting hole, and screw it in to tighten.
2. Clip the clip onto a belt.



**Extended Arm:**

You can add one or two extended arms (except head strap mount) to each kit, to provide more flexibility to adjust the mounting angle of the Action Cam.

Supported accessories: Flat Adhesive Mount, Curved Adhesive Mount, Bar Mount, Suction Cup Mount, Surfboard Adhesive Mount.





The Kodak trademark and trade dress are used under license from Kodak.

© 2014 JK Imaging Ltd. All Rights Reserved.

JK Imaging Ltd., 17239 So. Main Street, Gardena, CA 90248 USA

JK Imaging Europe, 71 Clarendon Road, Watford, WD17 1DS, UK

<http://kodakpixpro.com>