



KONICA MINOLTA

bizhub C554e/C454e/ C364e/C284e/C224e QUICK GUIDE





Table of contents

1 Introduction

1.1	Environmental Information	1-3
	Environmental initiatives	1-3
	Energy Star®.....	1-3
	What is an ENERGY STAR® Product?	1-3
	Environmental benefits of power management	1-4
	Recycled Paper.....	1-4
	Duplex printing.....	1-4
1.2	Certification for USA, Canada, México, Brazil and Europe area	1-5
	For U.S.A.....	1-5
	For Canada	1-5
	For México	1-5
	For Brazil	1-5
	For Europe	1-5
1.3	Safety information	1-6
	Warning and precaution symbols	1-6
	Meaning of symbols.....	1-6
1.4	Regulation notices	1-10
	CE Marking (Declaration of Conformity) for users of the European Union (EU).....	1-10
	USER INSTRUCTIONS FCC PART 15 - RADIO FREQUENCY DEVICES (for U.S.A. users).....	1-10
	INTERFERENCE-CAUSING EQUIPMENT STANDARD (ICES-003 ISSUE 4) (for Canada users)	1-10
	For users in countries not subject to class B regulations	1-10
	GS Certification	1-10
	Laser safety.....	1-10
	Internal laser radiation.....	1-11
	CDRH regulations	1-11
	For European users.....	1-11
	For Denmark users.....	1-12
	For Finland, Sweden users	1-12
	For Norway users.....	1-12
	Laser safety label	1-13
	Ozone release	1-13
	Acoustic noise (for European users only).....	1-13
	For EU member states only	1-13
	Telephone Cable (For users in countries subject to class B regulations).....	1-14
1.5	Caution notations and labels	1-15
1.6	Special Notice to User	1-16
	For Europe	1-16
1.7	Space requirements	1-17
	bizhub C554e/C454e	1-17
	bizhub C364e/C284e/C224e	1-18
1.8	Operation precautions	1-19
	Power source	1-19
	Operating environment	1-19
	Storage of copies.....	1-19
	Data stored in this machine	1-19
1.9	Legal restrictions on copying	1-20
1.10	Trademark acknowledgements	1-21
	Copyright	1-22
	Note	1-22
1.11	Software End User License Agreement	1-23
1.12	i-Option LK-105 v3 (searchable PDFs) End User License Agreement	1-25

2 About This Machine

2.1	Intended use of office MFP devices	2-3
	Intended use	2-3
	Impermissible operating conditions.....	2-3
	Exclusion of liability.....	2-3
2.2	Introduction to User's Guide	2-4
2.2.1	Target groups.....	2-4
2.2.2	[Quick Guide] (this manual).....	2-4
2.2.3	[User's Guide Online].....	2-4
	Layout of top page.....	2-4
	Operating environment	2-5
2.2.4	Symbols and notations used in this manual	2-5
	Procedural instruction.....	2-5
	Symbols and notations	2-6
	Notations of application names	2-6
2.3	About this machine	2-7
2.3.1	Optional components (bizhub C554e/C454e).....	2-7
2.3.2	Optional components (bizhub C364e/C284e/C224e).....	2-10
2.3.3	Name of parts (MFP) (bizhub C554e/C454e).....	2-13
	Front side	2-13
	Rear side	2-14
2.3.4	Name of parts (MFP) (bizhub C364e/C284e/C224e)	2-15
	Front side	2-15
	Rear side	2-16
2.3.5	Name of parts (Optional units)	2-17
	Finisher FS-535, Saddle Stitcher SD-512, Punch Kit PK-521 (bizhub C554e).....	2-17
	Job Separator JS-602 (bizhub C554e)	2-19
	Z Folding Unit ZU-606 (bizhub C554e)	2-20
	Post Inserter PI-505 (bizhub C554e).....	2-21
	Finisher FS-533, Punch Kit PK-519	2-22
	Job Separator JS-506.....	2-23
	Finisher FS-534, Saddle Stitcher SD-511, Punch Kit PK-520	2-24
	Large Capacity Unit LU-301/LU-204	2-26
2.4	Power supply	2-27
2.4.1	Turning the power on and off.....	2-27
2.4.2	Operating the Power key	2-28
2.4.3	Power save function	2-29
	Reducing power consumption.....	2-29
2.5	Control Panel	2-30
2.5.1	Name of parts	2-30
2.6	Touch Panel	2-32
2.6.1	Main Menu	2-32
	Layout of main menu	2-32
	Customizing the main menu	2-33
2.6.2	Operating the Touch Panel	2-33
	Tap	2-33
	Double-tap	2-33
	Flick.....	2-34
	Drag	2-34
	Pan.....	2-34
	Long-tap	2-34
	Drag & Drop	2-35
	Pinch in/Pinch out.....	2-35
	Rotation.....	2-35
	Precautions on using the Touch panel	2-36
2.6.3	How to display the keypad	2-36
	How to move the keypad.....	2-37
	How to close the keypad	2-37
	To display the keypad all the time	2-37

2.6.4	Entering characters.....	2-38
	When typing in "Group1":.....	2-38
2.7	Jobs.....	2-39
2.7.1	Job screen	2-39
2.7.2	Multi-job function	2-39
2.8	Loading Paper	2-40
2.8.1	Loading paper in Tray 1 to Tray 4.....	2-40
	Applicable paper types	2-40
	How to load paper	2-40
2.8.2	LCT (built-in).....	2-41
	Applicable paper types	2-41
	How to load paper	2-41
2.8.3	Loading paper into the Large Capacity Unit.....	2-42
	Applicable paper types	2-42
	How to load paper	2-42
2.8.4	Bypass Tray	2-43
	Applicable paper types	2-43
	Applicable paper sizes.....	2-43
	How to load paper	2-43

3 Basic Settings and Operations

3.1	Print Function.....	3-3
3.1.1	Required settings and basic operations (For Windows OS).....	3-3
	Preparation flow.....	3-3
	Operation flow.....	3-3
	Checking the cable connection	3-4
	Checking network settings of this machine.....	3-4
	Installing the printer driver	3-5
	Printing data.....	3-5
	Types of printer drivers	3-6
3.1.2	Required settings and basic operations (For Mac OS).....	3-6
	Preparation flow.....	3-6
	Operation flow.....	3-7
	Checking the cable connection	3-7
	Checking network settings of this machine.....	3-7
	Installing the printer driver	3-9
	Adding and configuring a printer driver	3-10
	Printing data.....	3-10
3.2	Scan-to-Send function	3-11
3.2.1	Various transmission methods.....	3-11
	Sending data to your computer (SMB Send).....	3-11
	Transmitting data as E-mail attachment (E-mail TX).....	3-11
	Saving data to the USB memory device (External memory).....	3-11
	Various methods for transmitting and saving data	3-12
3.2.2	Sending data to your Windows computer (SMB Send).....	3-12
	Preparation flow.....	3-13
	Operation flow.....	3-13
	Checking the cable connection	3-13
	Checking network settings of this machine.....	3-14
	Checklist	3-14
	Checking computer information	3-15
	Configuring your computer.....	3-15
	Registering destinations	3-16
	Sending the original	3-18
3.2.3	Sending data to your Mac computer (SMB Send).....	3-20
	Preparation flow.....	3-20
	Operation flow.....	3-20
	Checking the cable connection	3-21
	Checking network settings of this machine.....	3-21
	Configuring this machine (Mac OS X 10.7 or later).....	3-22
	Checklist	3-23

	Checking computer information	3-23
	Configuring your computer	3-23
	Registering destinations	3-24
	Sending the original	3-26
3.2.4	Transmit the scanned data via E-mail (E-mail TX)	3-28
	Preparation flow	3-28
	Operation flow	3-28
	Checking the cable connection	3-29
	Checking network settings of this machine	3-29
	Configuring the E-mail transmission environment	3-30
	Configuring administrator information	3-31
	Sending the original	3-32
3.3	Fax Function	3-34
3.3.1	Required settings and basic operations	3-34
	Preparation flow	3-34
	Operation flow	3-34
	Checking the cable connection	3-35
	Registering transmission information	3-35
	Selecting the dialing method	3-36
	Sending the original	3-37
3.3.2	Sending a fax directly from a PC (PC-FAX TX)	3-39
	Preparation flow	3-39
	Operation flow	3-40
	Checking the cable connection	3-40
	Checking network settings of this machine	3-41
	Installing the fax driver	3-42
	Sending data	3-43
3.4	Copy Function	3-44
	Basic operations	3-44
	User authentication	3-46
3.5	Registering a destination	3-47
3.5.1	Registering an address book	3-47
	Using the Control Panel to register an address book - Registration from Utility	3-47
	Using the Control Panel to register an address book - Registration in scan/fax mode	3-49
	Using a computer to register a one-touch destination	3-51
3.5.2	Information required to register a destination	3-52
3.5.3	Registering a group	3-53
	Registering a new group	3-53
3.5.4	Retrieving a registered destination	3-55
	Retrieving a destination	3-55
	Specifying a destination	3-56
3.6	Using a USB memory device	3-57
3.6.1	Printing data in a USB memory device	3-57
	Printing data	3-57
3.6.2	Saving the scanned data in the USB memory device (External memory)	3-59
	Specifying functions to be permitted for external memory	3-59
	Saving data in the USB memory device	3-61
3.7	Using the guidance function	3-63
3.7.1	Guidance screen	3-63
	Getting help on the currently displayed screen:	3-63
	Getting help on the desired function or procedure:	3-65
	Help Menu list	3-67



4 Advanced Functions

4.1	Using advanced functions	4-3
4.1.1	What are advanced functions?	4-3
4.1.2	Association with application	4-4
4.1.3	Registering the i-Option license.....	4-4
	Preparation flow	4-4
	Registering the i-Option license.....	4-5
	Enabling the i-Option function	4-7
	Configuring each function.....	4-8

5 Troubleshooting

5.1	Main messages and remedies	5-3
5.1.1	When a message appears to replace consumables or carry out cleaning	5-3
5.1.2	When a paper jam message persists.....	5-4
5.1.3	When an error message appears.....	5-4
5.1.4	When [Stabilizing image.] appears.....	5-5
5.2	When printing quality has deteriorated	5-6
5.2.1	Cleaning the Electrostatic Charger	5-6
5.2.2	Cleaning the Print Head Glass	5-7
5.3	When the machine cannot be powered on	5-9
5.4	When the Touch Panel is not visible	5-10
5.5	When a message appears to replace consumables or carry out cleaning	5-12
	When staples in the finisher have run out	5-12
	When the punch scrap box is full	5-12
	When toner is running out in the Toner Cartridge.....	5-13
	When the Drum Unit needs to be replaced	5-13
	When a Developing Unit needs to be replaced	5-14
	When a Waste Toner Box is full	5-14
5.5.1	Replacing a Toner Cartridge	5-15
	bizhub C554e/C454e	5-15
	bizhub C364e/C284e/C224e	5-16
5.5.2	Replacing a Waste Toner Box	5-17
	bizhub C554e/C454e	5-17
	bizhub C364e/C284e/C224e	5-18
5.5.3	Replacing a Drum Unit.....	5-19
	bizhub C554e/C454e	5-19
	bizhub C364e/C284e/C224e	5-20

6 Index

6.1	Index by item	6-3
------------	----------------------------	------------





Introduction

1 Introduction

This [Quick Guide] uses illustrations to describe operating procedures for the most commonly used functions in an easy-to-understand way.

Start by using this manual to become proficient with the useful functions that this machine offers.

For details on the various functions, refer to the User's Guides on the DVD included with this machine.

In order to operate the machine safely and properly, be sure to read the safety information on page 1-6 of this manual before use.

In addition, this manual contains the following information. Be sure to read the manual before using the machine.

- Items that must be observed to use the machine safely
- Information regarding product safety
- Precautions when using the machine
- Descriptions on trademarks and copyrights

The illustrations and screens used in this manual may appear slightly different from views of the actual equipment and screens.

Tips

- Please keep this manual as well as the attached CD/DVD in a safe place where you can access them easily.

1.1 Environmental Information

Environmental initiatives

The company continuously strives to reduce the negative environmental impacts of all stages of its business operations.

As part of such activities, the company is implementing resource-saving steps by reducing the number of pages in the User's Guide.

For the information necessary to operate the machine, please refer to the bundled User's Guide DVD (HTML format). This guide has an excellent search function.

Functions such as keyword search and filtering by purpose are very useful to help users find what they need to know.

Energy Star®



As an ENERGY STAR® Partner, this machine meets the ENERGY STAR® Guidelines for energy efficiency.

What is an ENERGY STAR® Product?

An ENERGY STAR® product has a special feature that allows it to automatically switch to a "low-power mode" after a period of inactivity. An ENERGY STAR® product uses energy more efficiently, saves you money on utility bills and helps protect the environment.

Environmental benefits of power management

Electricity consumption of a device depends on both its properties and the way of using the device.

Suitable power management setting offers you resource saving usage way. By setting the time to go into power saving modes (e.g. sleep mode) shorter (or optimal), electricity consumption can be reduced.

Recycled Paper

This product can print on recycled paper and environmental stewardship initiatives certified paper which complies with European standard EN 12281 as well as virgin paper. In addition it can print on lighter paper, 64g/m² for example. Using such light paper contributes to resources-saving.

Duplex printing

With a product which has a duplex unit, you can print on both sides of paper automatically.

Using this function leads to reducing consumption of natural resources and your cost.

Attached printer driver provides this duplex printing function as initial setting in your computer (The setting can be changed after installation manually).

1.2 Certification for USA, Canada, México, Brazil and Europe area

For U.S.A

This product is certified by the following model name in U.S.A.

Konica Minolta branded model bizhub C554e, bizhub C454e, C302300 (bizhub C364e, bizhub C284e and bizhub C224e), and bizhub C224e.

For Canada

This product is certified by the following model name in Canada.

Konica Minolta branded model bizhub C554e, bizhub C454e, C302300 (bizhub C364e, bizhub C284e and bizhub C224e), and bizhub C224e.

For México

This product is certified by the following model name in México.

Konica Minolta branded model bizhub C554e, bizhub C454e, C302300 (bizhub C364e, bizhub C284e and bizhub C224e), and bizhub C224e.

For Brazil

This product is certified by the following model name in Brazil.

Konica Minolta branded model bizhub C554e, bizhub C454e, C302300 (bizhub C364e, bizhub C284e and bizhub C224e), and bizhub C224e.

For Europe

This product is certified by the following model name Europe.

Konica Minolta branded model bizhub C554e, bizhub C454e, C302300 (bizhub C364e, bizhub C284e and bizhub C224e), and bizhub C224e.

1.3 Safety information

This section contains detailed instructions on the operation and maintenance of this machine. To achieve optimum utility of this device, all operators should carefully read and follow the instructions in this manual.

Please read the following section before connecting the machine to the supply. It contains important information related to user safety and preventing equipment problems.

Make sure you observe all of the precautions appear in each section of this manual.



KM_Ver.07D_OE

Reference







- Some parts of the contents of this section may not correspond with the purchased product.

Warning and precaution symbols

The following indicators are used on the warning labels or in the manuals to categorize the level of safety warnings.



 WARNING	Ignoring this warning could cause serious injury or even death.
 CAUTION	Ignoring this caution could cause injury or damage to property.

Meaning of symbols

-  A triangle indicates a danger against which you should take precaution.
-  This symbol warns against cause burns.
-  A diagonal line indicates a prohibited course of action.
-  This symbol warns against dismantling the device.
-  A solid circle indicates an imperative course of action.
-  This symbol indicates you must unplug the device.



Disassemble and modification

 WARNING

- Do not modify this product, as a fire, electrical shock, or breakdown could result. If the product employs a laser, the laser beam source could cause blindness. 
- Do not attempt to remove the covers and panels which have been fixed to the product. Some products have a high-voltage part or a laser beam source inside that could cause an electrical shock or blindness. 

Power cord

 WARNING

- Use only the power cord supplied in the package. If a power cord is not supplied, only use the power cord and plug that is specified in POWER CORD INSTRUCTION. Failure to use this cord could result in a fire or electrical shock. 
- Do not use the power cord other than being supplied in the package. If a power cord is not supplied, only use the power cord and plug that is specified in POWER CORD INSTRUCTION. Failure to use this cord could result in a fire or electrical shock. 

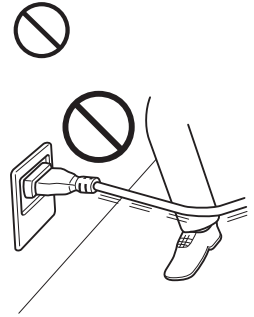

Power cord

- Do not scratch, abrade, place a heavy object on, heat, twist, bend, pull on, or damage the power cord. Use of a damaged power cord (exposed core wire, broken wire, etc.) could result in a fire or breakdown. Should any of these conditions be found, immediately turn OFF the power switch, unplug the power cord from the power outlet, and then call your authorized service representative.



Power source

 **WARNING**



- Do not use the power source voltage other than being specified on the machine. Failure to do that could result in a fire or electrical shock. 
- Do not use a multiple outlet adapter to connect any other appliances or machines. Use of a power outlet for more than the marked current value could result in a fire or electrical shock. 
- Do not use an extension cord in principle. Use of an extension cord could cause a fire or electrical shock. Contact your authorized service representative if an extension cord is required. 

 **CAUTION**



- The outlet must be near the equipment and easily accessible. Otherwise you can not pull out the power plug when an emergency occurs. 

Power plug

 **WARNING**

- Do not unplug and plug in the power cord with a wet hand, as an electrical shock could result. 
- Plug the power cord all the way into the power outlet. Failure to do this could result in a fire or electrical shock. 

 **CAUTION**

- Do not place any objects around the power plug, as the power plug may be difficult to pull out when an emergency occurs. 
- Do not tug the power cord when unplugging. Pulling on the power cord could damage the cord, resulting in a fire or electrical shock. 
- Remove the power plug from the outlet more than one time a year and clean the area between the plug terminals. Dust that accumulates between the plug terminals may cause a fire. 

Grounding

 **WARNING**

- Make sure to ground this product. (Connect the power cord to an electrical outlet that is equipped with a grounding terminal.) Failure to do so and an unlikely event of leakage could result in a fire or electrical shock. 

Installation

WARNING

- Do not place a flower vase or other container that contains water, or metal clips or other small metallic objects on this product. Spilled water or metallic objects dropped inside the product could result in a fire, electrical shock, or breakdown.

Should a piece of metal, water, or any other similar foreign matter get inside the product, immediately turn OFF the power switch, unplug the power cord from the power outlet, and then call your authorized service representative.

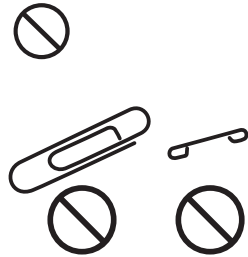

- Do not use flammable sprays, liquids, or gases inside or near this machine. Do not clean the inside of this machine using a flammable gas duster. A fire or explosion could result.

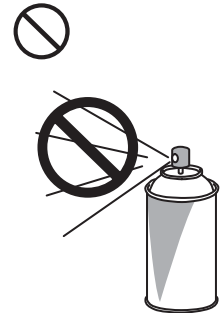

CAUTION

- After installing this product, mount it on a secure base. If the unit moves or falls, it may cause personal injury.



- Do not place the product in a dusty place, or a site exposed to soot or steam, near a kitchen table, bath, or a humidifier. A fire, electrical shock, or breakdown could result.



- Do not place this product on an unstable or tilted bench, or in a location subject to a lot of vibration and shock. It could drop or fall, causing personal injury or mechanical breakdown.



- Do not let any object plug the ventilation holes of this product. Heat could accumulate inside the product, resulting in a fire or malfunction.



Ventilation

CAUTION

- Using this product in a poorly ventilated room for a long time or producing a large volume of copies or prints may cause the odor of exhaust air from the machine. Ventilate the room well.



Actions in response to troubles

WARNING

- Do not keep using this product, if this product becomes inordinately hot or emits smoke, or unusual odor or noise. Immediately turn OFF the power switch, unplug the power cord from the power outlet, and then call your authorized service representative. If you keep on using it as is, a fire or electrical shock could result.



- Do not keep using this product, if this product has been dropped or its cover damaged. Immediately turn OFF the power switch, unplug the power cord from the power outlet, and then call your authorized service representative. If you keep on using it as is, a fire or electrical shock could result.



Actions in response to troubles CAUTION

- The inside of this product has areas subject to high temperature, which may cause burns. When checking the inside of the unit for malfunctions such as a paper mis-feed, do not touch the locations (around the fusing unit, etc.) which are indicated by a "Caution HOT" caution label.

**Consumables** WARNING

- Do not throw the toner cartridge or toner into an open flame. The hot toner may scatter and cause burns or other damage.

 CAUTION

- Do not leave toner-related parts (toner units, PC drum units, imaging units or developing units) within easy reach of children. Licking any of these parts or ingesting toner could damage your health.
- Do not store toner-related parts (toner units, PC drum units, imaging units or developing units) near devices susceptible to magnetism, such as precision equipment and data storage devices, otherwise they may malfunction. They could cause these products to malfunction.

**When moving the machine** CAUTION

- Whenever moving this product, be sure to disconnect the power cord and other cables. Failure to do this could damage the cord or cable, resulting in a fire, electrical shock, or breakdown.
- When moving this product, always hold it at the locations specified in the User's Guide or other documents. If the unit is moved while held at locations other than those specified, it may fall, causing severe personal injury.

**When using the machine** CAUTION

- When using the machine, do not look at the light of the lamp for a prolonged time. Eyestrain could result.

**Papers** CAUTION

- Do not use stapled paper, conductive paper (such as silver paper or carbon paper) or treated heat-sensitive/inkjet paper, otherwise a fire may result.



When the Fax is not installed:

Before successive holidays CAUTION

- Unplug the product when you will not use the product for long periods of time.



1.4 Regulation notices

CE Marking (Declaration of Conformity) for users of the European Union (EU)

This product complies with the following EU directives:
2009/125/EC, 2006/95/EC, 2004/108/EC and 1999/5/EC directives.

This declaration is valid for the area of the European Union.

This device must be used with a shielded interface cable. The use of non-shielded cables is likely to result in interference with radio communications and is prohibited under CISPR rules and local rules.

D.o.C. is available at "<http://www.konicaminolta.eu/>".

USER INSTRUCTIONS FCC PART 15 - RADIO FREQUENCY DEVICES (for U.S.A. users)

NOTE: This equipment has been tested and found to comply with the limits for a Class A digital device, pursuant to Part 15 of the FCC Rules.

These limits are designed to provide reasonable protection against harmful interference when the equipment is operated in a commercial environment. This equipment generates, uses and can radiate radio frequency energy and, if not installed and used in accordance with the instruction manual, may cause harmful interference to radio communications. Operation of this equipment in a residential area is likely to cause harmful interference in which case the user will be required to correct the interference at his own expense.

⚠ WARNING

- The design and production of this unit conform to FCC regulations, and any changes or modifications must be registered with the FCC and are subject to FCC control. Any changes made by the purchaser or user without first contacting the manufacturer will be subject to penalty under FCC regulations.
 - This device must be used with a shielded interface cable. The use of non-shielded cables is likely to result in interference with radio communications and is prohibited under FCC rules.
-

INTERFERENCE-CAUSING EQUIPMENT STANDARD (ICES-003 ISSUE 4) (for Canada users)

This Class A digital apparatus complies with Canadian ICES-003.

Cet appareil numérique de la classe A est conforme à la norme NMB-003 du Canada.

For users in countries not subject to class B regulations

⚠ WARNING

- This is a Class A product. In a domestic environment this product may cause radio interference in which case the user may be required to take adequate measures.
 - This device must be used with a shielded interface cable. The use of non-shielded cables is likely to result in interference with radio communications and is prohibited under CISPR rules and local rules.
-

GS Certification

Konica Minolta branded model bizhub C554e, bizhub C454e, C302300 (bizhub C364e, bizhub C284e and bizhub C224e), and bizhub C224e.

Laser safety

This is a digital machine which operates using a laser. There is no possibility of danger from the laser provided the machine is operated according to the instructions in the manuals.

Since radiation emitted by the laser is completely confined within protective housing, the laser beam cannot escape from the machine during any phase of user operation.

This machine is certified as a Class 1 laser product per IEC 60825-1: 2007: This means the machine does not produce hazardous laser radiation.

Internal laser radiation

Maximum Average Radiation Power: 11.2 μ W (bizhub C554e) / 9.4 μ W (bizhub C454e) / 7.4 μ W (C302300 (bizhub C364e, bizhub C284e and bizhub C224e)) at the laser aperture of the print head unit.

Wavelength: 770-800 nm

This product employs a Class 3B laser diode that emits an invisible laser beam.

The laser diode and the scanning polygon mirror are incorporated in the print head unit.

The print head unit is NOT A FIELD SERVICE ITEM:

Therefore, the print head unit should not be opened under any circumstances.

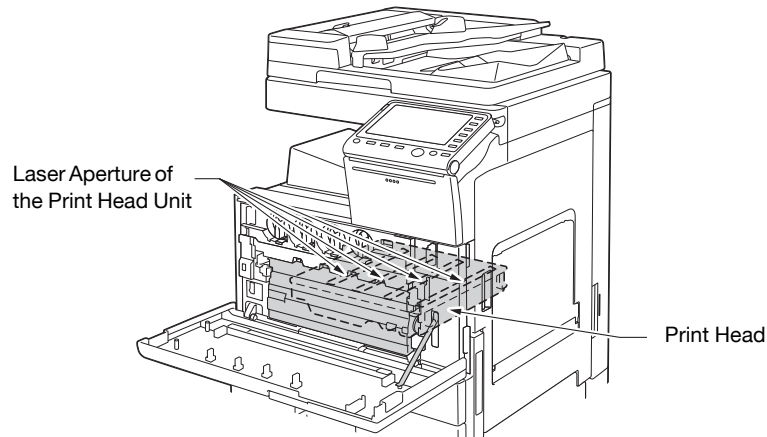

CDRH regulations

This machine is certified as a Class 1 Laser product under Radiation Performance Standard according to the Food, Drug and Cosmetic Act of 1990. Compliance is mandatory for Laser products marketed in the United States and is reported to the Center for Devices and Radiological Health (CDRH) of the U.S. Food and Drug Administration of the U.S. Department of Health and Human Services (DHHS). This means that the device does not produce hazardous laser radiation.

The label shown on page 1-13 indicates compliance with the CDRH regulations and must be attached to laser products marketed in the United States.

⚠ CAUTION

Use of controls, adjustments or performance of procedures other than those specified in this manual may result in hazardous radiation exposure.

- This is a semiconductor laser. The maximum power of the laser diode is 20 mW and the wavelength is 770-800 nm.
-

For European users

⚠ CAUTION

Use of controls, adjustments or performance of procedures other than those specified in this manual may result in hazardous radiation exposure.

- This is a semiconductor laser. The maximum power of the laser diode is 20 mW and the wavelength is 770-800 nm.
-

For Denmark users

ADVARSEL

Usynlig laserstråling ved åbning, når sikkerhedsafbrydere er ude af funktion. Undgå udsættelse for stråling. Klasse 1 laser produkt der opfylder IEC60825 sikkerheds kravene.

- Dette er en halvlederlaser. Laserdiodens højeste styrke er 20 mW og bølgelængden er 770-800 nm.
-

For Finland, Sweden users

LOUKAN 1 LASERLAITE

KLASS 1 LASER APPARAT

VAROITUS

Laitteen Käyttäminen muulla kuin tässä käyttöohjeessa mainitulla tavalla saattaa altistaa käyttäjän turvallisuusluokan 1 ylittävälle näkymättömälle lasersäteilylle.

- Tämä on puolijohdelaser. Laserdiodin suurin teho on 20 mW ja aallonpituus on 770-800 nm.
-

VARNING

Om apparaten används på annat sätt än i denna bruksanvisning specificerats, kan användaren utsättas för osynlig laserstrålning, som överskrider gränsen för laserklass 1.

- Det här är en halvledarlaser. Den maximala effekten för laserdioden är 20 mW och våglängden är 770-800 nm.
-

VAROITUS

- Avattaessa ja suojalukitus ohitettaessa olet alttiina näkymättömälle lasersäteilylle. Älä katso säteeseen.
-

VARNING

- Osynlig laserstrålning när denna del är öppnad och spärren är urkopplad. Betrakta ej strålen.
-

For Norway users

ADVARSEL!

Dersom apparatet brukes på annen måte enn spesifisert i denne bruksanvisning, kan brukeren utsettes for usynlig laserstråling som overskrider grensen for laser klass 1.

- Dette en halvleder laser. Maksimal effekt till laserdiode er 20 mW og bølgelengde er 770-800 nm.
-

Laser safety label

A laser safety label is attached to the outside of the machine, as shown below.

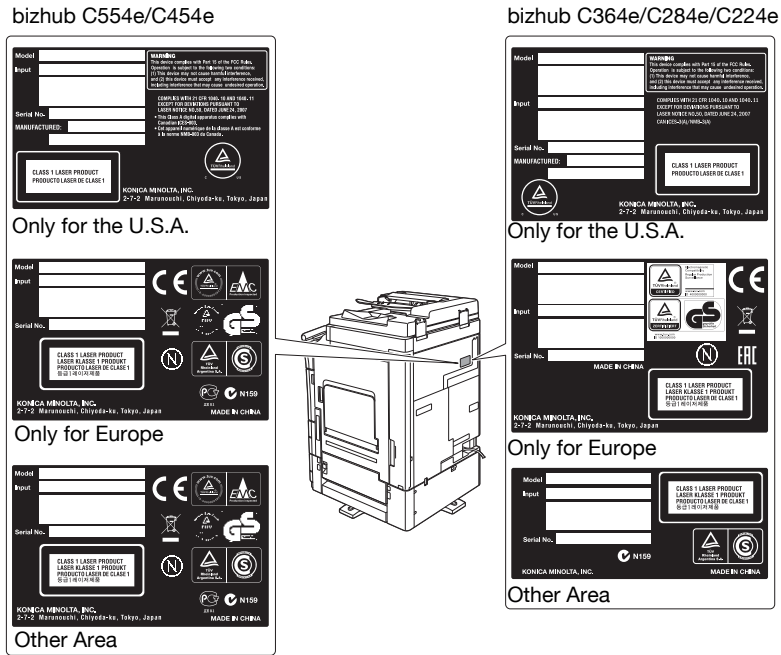

Ozone release

Locate the Machine in a Well-Ventilated Room

A negligible amount of ozone is generated during normal operation of this machine. An unpleasant odor may, however, be created in poorly ventilated rooms during extensive machine operations. For a comfortable, healthy and safe operating environment, it is recommended that the room be well ventilated.

Placer l'appareil dans une pièce largement ventilée

Une quantité d'ozone négligable est dégagée pendant le fonctionnement de l'appareil quand celui-ci est utilisé normalement. Cependant, une odeur désagréable peut être ressentie dans les pièces dont l'aération est insuffisante et lorsque une utilisation prolongée de l'appareil est effectuée. Pour avoir la certitude de travailler dans un environnement réunissant des conditions de confort, santé et de sécurité, il est préférable de bien aérer la pièce où se trouve l'appareil.

Acoustic noise (for European users only)

Der höchste Schalldruckpegel beträgt 70 dB(A) oder weniger gemäß EN ISO 7779.

For EU member states only

This symbol means: Do not dispose of this product together with your household waste!

Please refer to the information of your local community or contact our dealers regarding the proper handling of end-of-life electric and electronic equipments. Recycling of this product will help to conserve natural resources and prevent potential negative consequences for the environment and human health caused by inappropriate waste handling.



This product complies with RoHS (2011/65/EU) Directive.

Telephone Cable (For users in countries subject to class B regulations)

Connect a telephone cable with a ferrite core to the telecommunication port of this machine. (Connect the modular jack on the ferrite-core-equipped end of the telephone cable to the telecommunication port.)

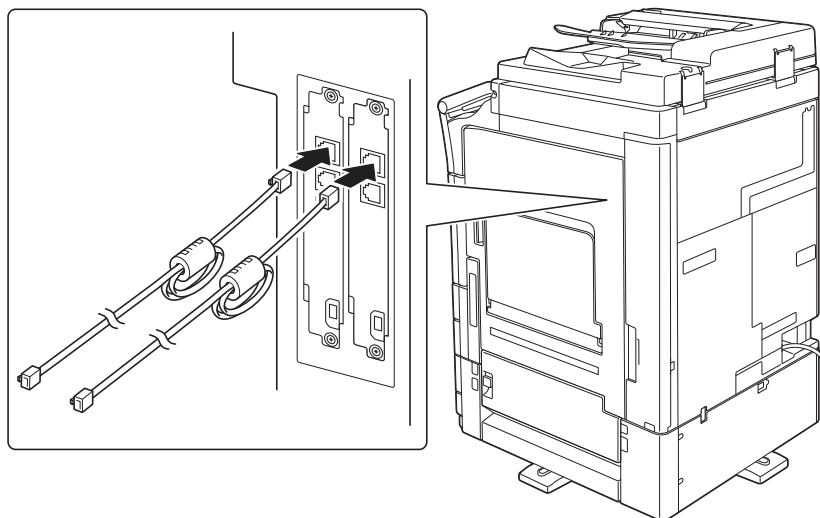

1.5 Caution notations and labels

Safety precaution notations and labels appear on this machine at the following positions. Be very careful that an accident does not occur when operations such as removing paper jams and staple jams are performed.

Legal Restrictions on Copying Certain types of documents must never be copied by the copier for the purpose or with the intent to pass copies of such documents off as the original. The following is not a complete list but is meant to be used as a guide to responsible copying.
Financial Instruments: #Personal Checks #Travelers Checks #Money Orders #Certificates of Deposit #Stocks or other Certificates of Investment #Stock Certificates #Legal Documents: #Post Stamps (cancelled or uncanceled) #Checks or Drafts issued by Government Agencies #Warrant Revenue Stamps (cancelled or uncanceled) #Passports #Immigration Papers #Motor Vehicle Licenses and Titles #Wills and Property Title and Deeds #General: #Identification Cards, Badges, or Insignias #Copyrighted Works without permission of the copyright owner #Labels: #Labels placed on an enclosure to give contents or to give someone or those of an without permission of the copyright owner. When in doubt about the nature of a document, consult with legal counsel.



CAUTION
 Do not alter or remove any covers or panels attached to this machine, otherwise you may be exposed to laser radiation.

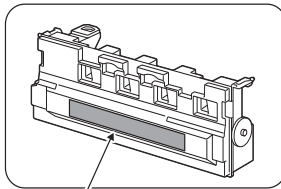

CAUTION
 It is illegal to copy certain types of documents. Never copy such documents.

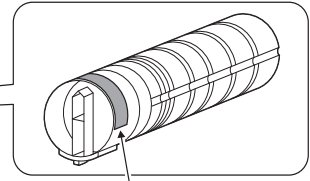

WARNING
 Do not burn used toner cartridges. Toner expelled from the fire is dangerous.



WARNING
 Do not burn the used waste-toner box. Toner expelled from the fire is dangerous.

CAUTION
 Do not position the used waste-toner box so that it is standing on end or tilted, otherwise toner may spill.



CAUTION
 The area around the fusing unit is extremely hot. Touching any part other than those indicated may result in burns.

NOTICE

Do not remove caution labels or notations. If any caution label or caution notation is soiled, please clean to make legible. If you cannot make them legible, or if the caution label or notation is damaged, please contact your service representative.

1.6 Special Notice to User

For Europe

The Facsimile has been approved in accordance with Council Decision 1999/5/ EC for pan-European single terminal connection to the public switched telephone network (PSTN). However, due to differences between the individual PSTNs provided in different countries, the approval does not, of itself, give an unconditional assurance of successful operation on every PSTN network terminal point.

In the event of problems, you should contact your equipment supplier in the first instance.



1.7 Space requirements

To ensure that machine operation, consumables replenishing, part replacement, and regular maintenance can easily be performed, adhere to the recommended space requirements detailed below.

bizhub C554e/C454e

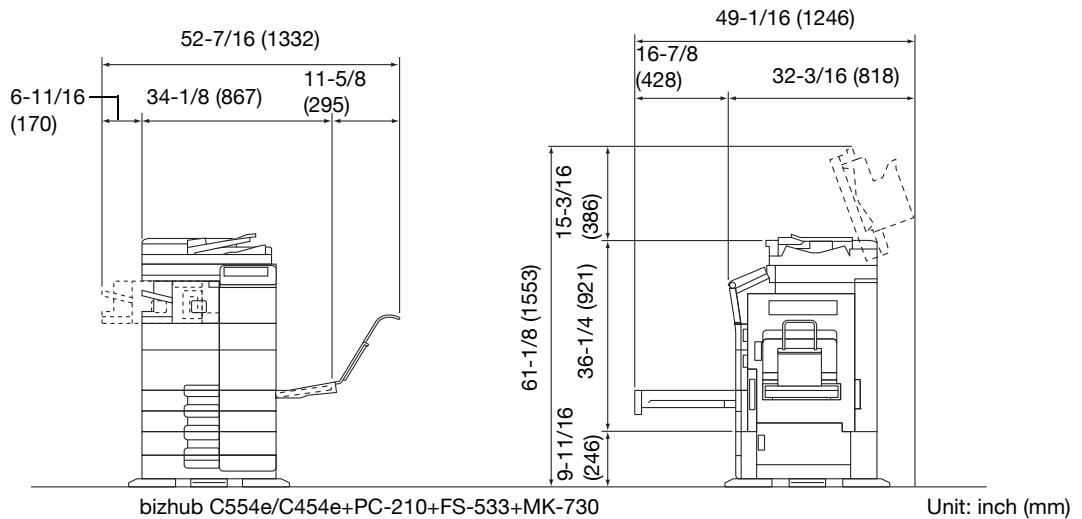
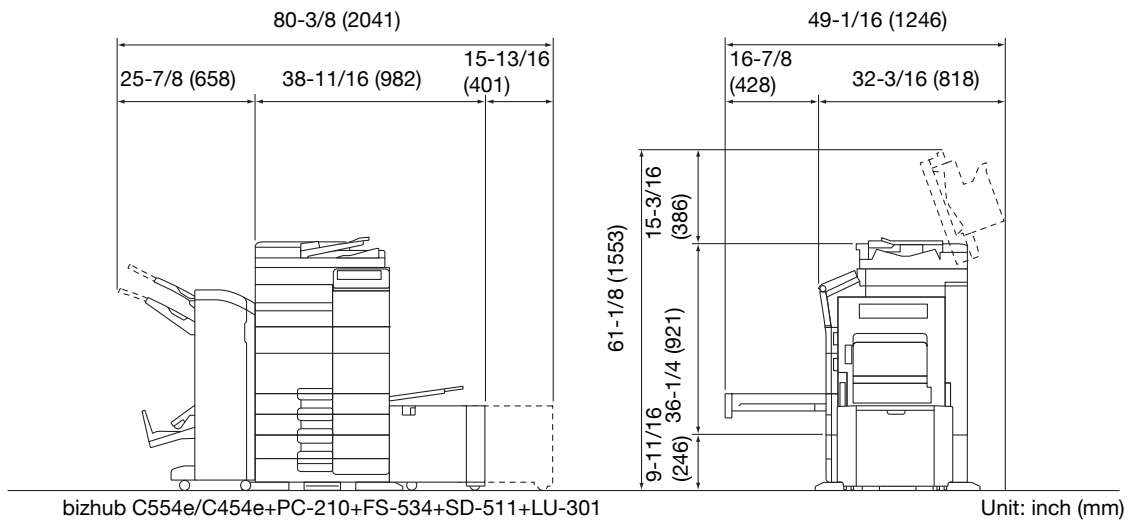
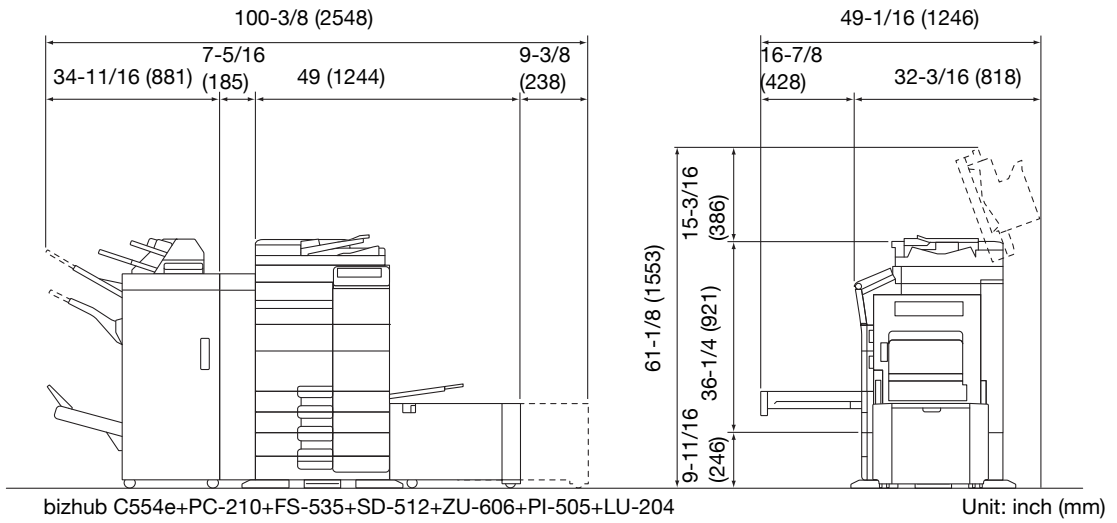

bizhub C364e/C284e/C224e

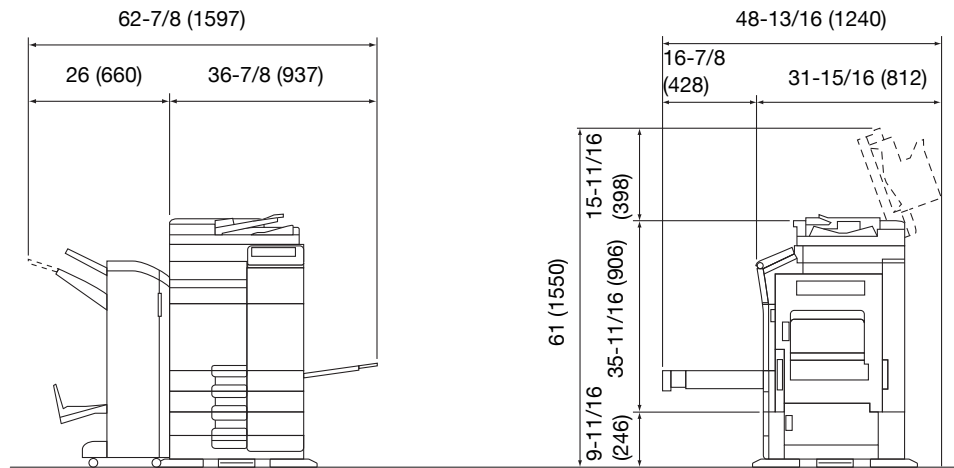

bizhub C364e/C284e/C224e + DF-624 + PC-210 + FS-534 + SD-511

Unit: inch (mm)

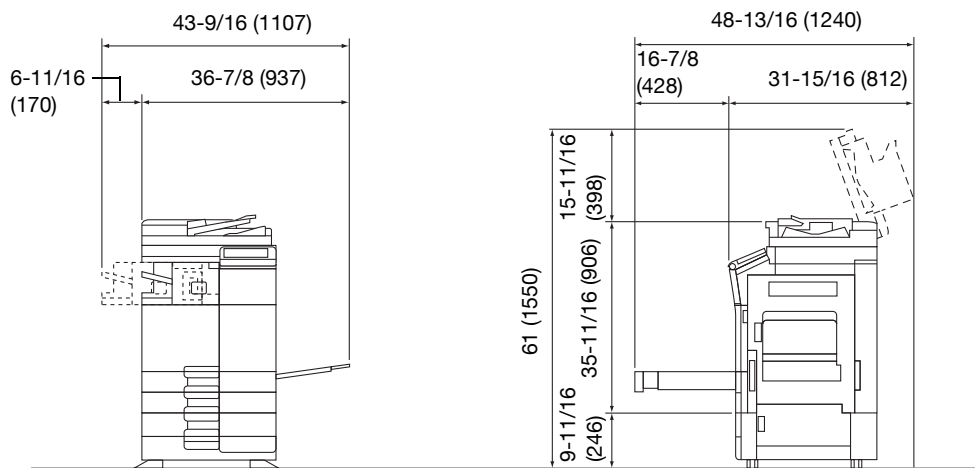

bizhub C364e/C284e/C224e + DF-624 + PC-210 + FS-533

Unit: inch (mm)

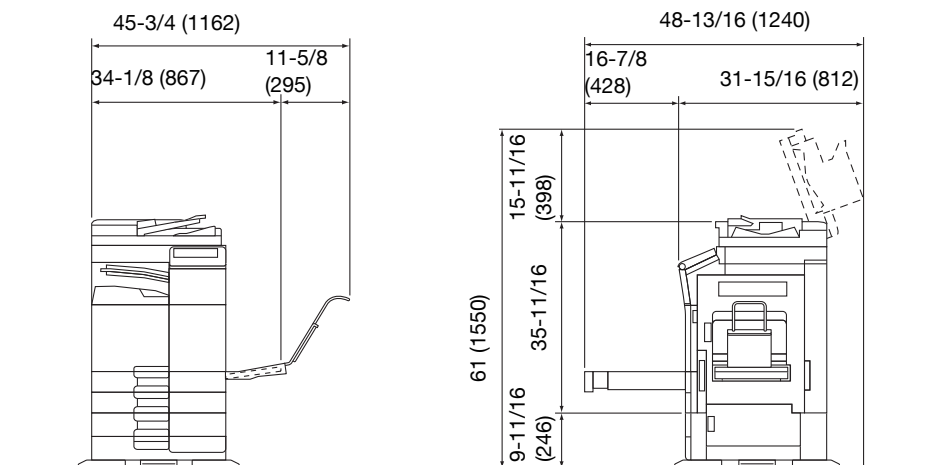

bizhub C364e/C284e/C224e + DF-624 + PC-210 + JS-506 + MK-730

Unit: inch (mm)

NOTICE

Be sure to allow a clearance of 8 inches (200 mm) or more at the back of this machine for the ventilation duct.

1.8 Operation precautions

To ensure the optimum performance of this machine, observe the precautions described below.

Power source

The power source requirements are as follows.

- Voltage fluctuation: Maximum $\pm 10\%$ (at 110 V/120 V/220 to 240 V AC)
- Frequency fluctuation: Maximum ± 3 Hz (at 50 Hz/60 Hz)
- Use a power source with as little voltage or frequency fluctuations as possible.

Operating environment

The environmental requirements for correct operation of the machine are as follows.

- Temperature: 50°F (10°C) to 86°F (30°C) with fluctuations of no more than 18°F (10°C) within an hour
- Humidity: 15% to 85% with fluctuations of no more than 10% within an hour

Storage of copies

To store copies, follow the recommendation listed below.

- Copies that are to be kept for a long time should be kept where they are not exposed to light in order to prevent them from fading.
- Adhesive that contains solvent (e.g., spray glue) may dissolve the toner on copies.
- Color copies have a thicker layer of toner than normal black-and-white copies. Therefore, when a color copy is folded, the toner at the fold may peel off.

Data stored in this machine

For the machine with hard disk, it is suggested to delete all data stored in all hard disk areas using the overwrite all data function to prevent leakage of data prior to transfer or disposal of the machine, or returning of the leased machine.

For details of the overwrite all data function, refer to the DVD. Contact your service representative before deleting data.

It is recommended to backup HDD periodically as the measures for HDD defect. For the detail information of HDD backup, contact your service representative.

1.9 Legal restrictions on copying

Certain types of originals must never be copied with the purpose or intent to pass copies of such originals off as the originals.

The following is not a complete list, but is meant to be used as a guide to responsible copying.

<Financial Instruments>

- Personal checks
- Traveler's checks
- Money orders
- Certificates of deposit
- Bonds or other certificates of indebtedness
- Stock certificates

<Legal Originals>

- Food stamps
- Postage stamps (canceled or uncanceled)
- Checks or drafts drawn by government agencies
- Internal revenue stamps (canceled or uncanceled)
- Passports
- Immigration papers
- Motor vehicle licenses and titles
- House and property titles and deeds

<General>

- Identification cards, badges, or insignias
- Copyrighted works without permission of the copyright owner

In addition, it is prohibited under any circumstances to copy domestic or foreign currencies, or works of art without permission of the copyright owner.

When in doubt about the nature of an original, consult with legal counsel.

NOTICE

This machine provides the forgery prevention function in order to prevent financial instruments from being copied illegally.

We appreciate your understanding that printed images may infrequently have some noise or image data may not be stored under certain circumstances due to this forgery prevention function.

1.10 Trademark acknowledgements

KONICA MINOLTA, the KONICA MINOLTA logo, Giving Shape to Ideas, PageScope, and bizhub are registered trademarks or trademarks of KONICA MINOLTA, INC.

Netscape is a registered trademark of Netscape Communications Corporation in the United States and other countries.

Mozilla and Firefox are trademarks of the Mozilla Foundation.

Novell and Novell NetWare are registered trademarks of Novell, Inc. in the United States and other countries.

Microsoft, Windows, Windows Vista, Windows 7, and Windows 8 are either registered trademarks or trademarks of Microsoft Corporation in the United States and/or other countries.

PowerPC is a trademark of IBM Corporation in the United States, or other countries, or both.

In regard to the Citrix Technology Member

KONICA MINOLTA, INC. is a Citrix Technology Member

The Citrix Technology Member is a program that, in combination with a solution of Citrix, promotes and develops solutions in order to be an industry leader in providing customers with better solutions.

XenApp™, Citrix XenServer™ and Citrix Presentation Server™ are trademarks of Citrix®

Apple, Macintosh and Mac OS are registered trademarks of Apple Computer, Inc. Safari is a trademark of Apple Computer, Inc.

Adobe, the Adobe logo, Acrobat and PostScript are either registered trademarks or trademarks of Adobe Systems Incorporated in the United States and/or other countries.

Ethernet is a registered trademark of Xerox Corporation.

PCL is a registered trademark of Hewlett-Packard Company Limited.

CUPS and CUPS logo are registered trademark of Easy Software Products.

This machine and PageScope Box Operator are based in part on the work of the Independent JPEG Group.

Compact-VJE

Copyright 1986-2009 Yahoo Japan Corp.

RC4® is a registered trademark or trademark of EMC Corporation in the United States and/or other countries.

RSA and BSAFE are registered trademarks or trademarks of EMC Corporation in the United States and other countries.



License information

[This product/Product name] includes RSA BSAFE Cryptographic software from EMC Corporation.

Advanced Wnn

"Advanced Wnn"© OMRON SOFTWARE CO., Ltd. 2006 All Rights Reserved.



ABBYY and FineReader are registered trade marks of ABBYY Software House.

Copyright © Extended Systems, Inc., 2000-2005.

Portions copyright ©iAnywhere Solutions, Inc.,
and Sybase, an SAP Company 2005-2012.

All rights reserved.

ThinPrint is a registered trademark or trademark of Cortado AG in Germany and other countries.

All other product and brand names are trademarks or registered trademarks of their respective companies or organizations.

Copyright

KONICA MINOLTA, INC. maintains the copyright of the printer drivers.

© 2013 KONICA MINOLTA, INC. All Rights Reserved.

Note

User's Guide may not be reproduced in part or in full without permission.

KONICA MINOLTA, INC. will not be held liable for any incidents caused by using this printing system or User's Guide.

Information included in User's Guide is subject to change without notice.

1.11 Software End User License Agreement

PLEASE READ CAREFULLY THE LICENSE AGREEMENT BELOW BEFORE DOWNLOADING, INSTALLING OR USING THE SOFTWARE. DOWNLOADING, INSTALLING OR USING THE SOFTWARE SHALL BE DEEMED YOUR LAWFUL ACCEPTANCE OF THE TERMS AND CONDITIONS BELOW. IF YOU DO NOT AGREE TO THEM, DO NOT DOWNLOAD, INSTALL, NOR USE THE SOFTWARE.

1. SOFTWARE

"Software" means this computer program (software), independent from its distribution channel, i.e. whether downloaded on royalty-free basis (which may include digitally encoded, machine readable, scalable outline font data as encoded in a special format) or obtained on DVD or any other physical data carrier, together with all codes, techniques, software tools, format, design, concepts, methods and ideas associated with the computer program and all documentation related thereto.

2. COPYRIGHT AND INTELLECTUAL PROPERTY RIGHTS

This is a license agreement and not an agreement for sale. Konica Minolta Business Solutions Europe GmbH ("Konica Minolta") owns, or has been licensed from other owners ("Konica Minolta Licensor"), copyrights and other intellectual property rights of the Software, and any and all rights and title to the Software and any copy made from it are retained by Konica Minolta or Konica Minolta Licensor. In no event, this Agreement shall be deemed to assign any copyright and/or any intellectual property rights of the Software from Konica Minolta or Konica Minolta Licensor to you. Except as stated in this Agreement, you are not granted any rights to patents, copyrights, trade names, trademarks (whether registered or unregistered), or any other rights, franchises or licenses in respect of the Software. The Software is protected by copyright laws and international treaty provisions.

3. LICENSE

Konica Minolta hereby grants to you, and you agree to accept a non-exclusive, non-transferable and limited license, and you may:

- (i) install and use the Software only on your computer(s) connected via inhouse network with a product for which this Software is designed;
- (ii) allow users of the computers described above to use the Software, provided that you assure that all such users comply with the terms of this Agreement;
- (iii) use the Software only for your own customary business or personal purpose;
- (iv) make one copy of the Software only for backup or installation purpose in the support of the normal and intended use of the Software;
- (v) transfer the Software to other party by transferring a copy of this Agreement and all documentation along with the Software, provided that (a) you must, at the same time, either transfer to such other party or destroy all your other copies of the Software, (b) such transfer of possession terminates your license from Konica Minolta, and (c) you must assure that such other party has agreed to accept and be bound by the terms and conditions of this Agreement. If such other party does not accept such terms and conditions then you shall not transfer any copy of the Software.

4. RESTRICTIONS

(1) You must not without the prior written consent of Konica Minolta:

- (i) use, copy, modify, merge or transfer copies of the Software except as provided herein;
- (ii) reverse engineer, reverse assemble, reverse compile or any other way analyze the Software except permitted by law;
- (iii) sublicense, rent, lease or distribute the Software or any copy thereof; or
- (iv) remove, use, or alter any trademark, logo, copyright or other proprietary notices, legends, symbols or labels in the Software.

(2) You agree that you will not export the Software in any form in violation of any applicable laws and regulations regarding export control of any country.

5. LIMITED WARRANTIES

The Software is provided to you "as is" without any warranties whatsoever. The express terms of this Agreement are in lieu of all other warranties, express or implied and Konica Minolta, its affiliate companies and Konica Minolta Licensor disclaim all warranties with regard to the Software, express or implied, including, without limitation, implied warranties of merchantability, fitness for a particular purpose and non-infringement of third party rights. The disclaimer of warranty hereunder does not affect your statutory rights. In case of the disclaimer is not allowed by applicable law, the disclaimer shall only apply to you to the maximum extent permitted by the law.

6. LIMITATION OF REMEDIES

In no event will Konica Minolta, its affiliate companies nor Konica Minolta Licensor be liable for any lost profits, lost data, or any other indirect, special, punitive, incidental or consequential damages that result from use or inability to use the Software, even if Konica Minolta, its affiliate companies, its authorized remarketers or Konica Minolta Licensor have been advised of the possibility of such damages or for any claim by you based on a third party claim.

7. TERMINATION

You may terminate this license at any time by destroying the Software and all your copies of it. This Agreement shall also terminate if you fail to comply with any terms hereof. Upon such termination, you must immediately destroy all copies of the Software in your possession.

8. GOVERNING LAW

This Agreement shall be governed by the laws of the country where the delivery is made to the original customer.

9. SEVERABILITY

In the event that any part or parts of this Agreement shall be held illegal or null and void by any court or administrative body of competent jurisdiction, such determination shall not affect the remaining parts of this Agreement and they shall remain in full force and effect as if such part or parts determined illegal or void had not been included.

10. NOTICE TO US GOVERNMENT END USERS

The Software is a "commercial item," as that term is defined at 48 C.F.R. 2.101 (October 1995), consisting of "commercial computer software" and "commercial computer software documentation," as such terms are used in 48 C.F.R. 12.212 (September 1995). Consistent with 48 C.F.R. 12.212 and 48 C.F.R. 227.7202-1 through 227.7202-4 (June 1995), all U.S. Government End Users shall acquire the Software with only those rights set forth herein.

YOU ACKNOWLEDGE THAT YOU HAVE READ THIS AGREEMENT, UNDERSTAND IT, AND AGREE TO BE BOUND BY ITS TERMS AND CONDITIONS. NEITHER PARTY SHALL BE BOUND BY ANY OTHER STATEMENTS OR REPRESENTATIONS THAT ARE INCONSISTENT WITH THE TERMS AND CONDITIONS OF THIS AGREEMENT. NO AMENDMENT TO THIS AGREEMENT IS EFFECTIVE UNLESS IN WRITING AND SIGNED BY DULY AUTHORIZED REPRESENTATIVES OF EACH PARTY.

1.12 i-Option LK-105 v3 (searchable PDFs) End User License Agreement

Subject to your purchase of a license key of i-Option LK-105 v3 (searchable PDFs, or "Program"), KONICA MINOLTA, INC. (KM) grants you a non-exclusive and non-transferable sublicense to use the Program provided that you comply with all terms and conditions stated in this Agreement.

1. You agree not to reproduce, modify, or adapt the Program. You may not allow a third party to use the Program or transfer it to a third party.
2. You agree that you will not attempt to alter, disassemble, decrypt, reverse engineer, or decompile the Program.
3. KM or its licensor own the copyright and other intellectual property rights. No copyright or other intellectual property rights shall be transferred to you through the granting to you of a license to use the Program.
4. IN NO EVENT WILL KM OR ITS LICENSOR BE LIABLE TO YOU FOR ANY CONSEQUENTIAL, INCIDENTAL INDIRECT, PUNITIVE OR SPECIAL DAMAGES, INCLUDING ANY LOST PROFITS OR LOST SAVING, EVEN IF KM HAS BEEN ADVISED OF THE POSSIBILITY OF SUCH DAMAGES, OR FOR ANY CLAIM BY ANY THIRD PARTY. KM OR ITS LICENSOR DISCLAIMS ALL WARRANTIES WITH REGARD TO THE PROGRAM, EXPRESS OR IMPLIED, INCLUDING, WITHOUT LIMITATION IMPLIED WARRANTIES OF MERCHANTABILITY, FITNESS FOR A PARTICULAR PURPOSE, TITLE AND NON-INFRINGEMENT OF THIRD PARTY RIGHTS. SOME STATES OR JURISDICTIONS DO NOT ALLOW THE EXCLUSION OR LIMITATION OF INCIDENTAL, CONSEQUENTIAL OR SPECIAL DAMAGES, SO THE ABOVE LIMITATIONS MAY NOT APPLY TO YOU.
5. You agree that you will not export the Program in any form in violation of any applicable laws and regulations regarding export control of any countries.
6. Notice to Government End Users (this provision shall apply to U.S. government end users only) The Program is a "commercial item," as that term is defined at 48 C.F.R.2.101, consisting of "commercial computer software" and "commercial computer software documentation," as such terms are used in 48 C.F.R. 12.212. Consistent with 48 C.F.R. 12.212 and 48 C.F.R. 227.7202-1 through 227.7202-4, all U.S. Government End Users acquire the Program with only those rights set forth herein.
7. This license shall automatically terminate upon a failure on your part to comply with any term or condition of this Agreement, in which case you agree to immediately stop use of the Program.
8. This Agreement shall be governed by the laws of Japan.



About This Machine

2 About This Machine

2.1 Intended use of office MFP devices

Intended use

This Multi Function Product incorporates the functionality of multiple office devices in one. It is designed to be used as an office system for the following purposes:

- Print, copy, scan and fax documents.
- Use available finishing functions such as duplexing, stapling, hole-punching and booklet creation if appropriate options are installed.
- Store scanned documents on external USB memory devices; send scanned documents to network scan destinations such as FTP, WebDAV and Email.

The intended use also requires that:

- The system is used within the limits of device specifications and specifications of optional components,
- All safety instructions in the related user's guides are observed,
- Legal restrictions on copying (see page 1-20) are observed,
- Inspection and maintenance instructions are adhered to,
- General, national and company safety provisions are observed.

Impermissible operating conditions

The system may not be operated if:

- Errors or damage have been discovered,
- Maintenance intervals have been exceeded,
- Mechanical or electrical functions do not work as they should.

Exclusion of liability

The manufacturer of the system assumes no liability for damages if the system was operated under impermissible conditions.

2.2 Introduction to User's Guide

The user's guide of this product is provided on a DVD which includes the [Quick Guide] (PDF) and the [User's Guide Online] (HTML).

If you want to learn about more detailed functions or operation methods, refer to the [User's Guide Online].

2.2.1 Target groups

The user's guides (see page 2-4) are intended for the following users of the system:

User	Persons using the system for its intended use (see page 2-3) as well as managing system functions and consumables according to the assigned user rights.
Administrator	Persons managing consumables, system functions, users and access rights; adjusting system settings, and establishing network connections.

Everyone who uses this system must have read and understood the related user's guides.

2.2.2 [Quick Guide] (this manual)

This guide describes basic machine procedures and setting methods used to configure each function. It introduces important functions that make it easier to use this machine.

This guide also contains notes and precautions that should be followed in order to use this machine.

Please be sure to read this manual before using this machine.

2.2.3 [User's Guide Online]

The DVD which includes the User's Guide is provided with this machine.

Select a desired function on the top page (Home), and check the details of the function.

Selecting [Introduction] on the top page (Home) allows you to view detailed methods for using the User's Guide.

Layout of top page



No.	Name	Description
1	[Search by Function]	Searches for desired information using functions such as printing or scanning and buttons displayed on the touch panel.
2	[Search]	Enter one or multiple keywords to search within the User's Guide. (Some pages are not targeted for searching.)
3	[Search by Usage]	Searches for the required operations of this machine based on the request format of "wanting to do something". This function provides security measures against various situations and methods to bring about cost reductions.
4	[Search by Illustration]	Searches for the required operations of this machine based on the output result, functions, and operation images.

Operating environment

Item	Specifications
Supported Operating Systems	Windows XP (SP3), Windows Vista (SP2), Windows 7 (SP1), Windows 8 Mac OS X10.4/10.5/10.6/10.7/10.8
Supported Web browsers	Windows: Internet Explorer 6.x/7.x/8.x/9.x/10.x (Desktop version), Firefox 3.x/4.x/ESR 10.0 or later, Google Chrome Mac OS: Safari 3.1 or later /4.x/5.x/6.x <ul style="list-style-type: none"> We recommend that you use the latest Web browser that is compatible with your operating system to help you use this machine more conveniently and comfortably. Check that JavaScript in your Web browser is enabled. The User's Guide uses JavaScript for the page display and search functions. In Internet Explorer 6.x/7.x, it may take some time for a page to display after you click a button or a menu in the table of contents.
Display resolution	1024 x 768 pixels or more

2.2.4 Symbols and notations used in this manual

Procedural instruction

- ✓ This check mark symbol shows a precondition of a procedure.
- 1 This format number "1" represents the first step.
- 2 This format number represents the order of serial steps.
 - This symbol indicates a supplementary explanation of a procedural instruction.

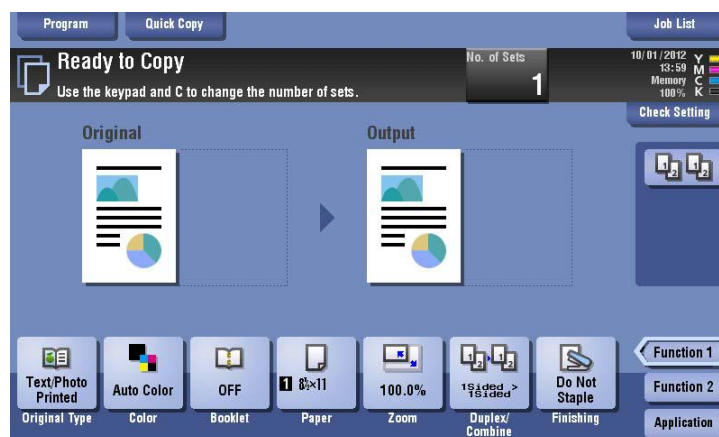

Symbols and notations

WARNING

- This symbol indicates that a failure to heed the instructions may lead to death or serious injury.

CAUTION

- This symbol indicates that negligence of the instructions may lead to mishandling that may cause injury or property damage.

NOTICE

This symbol indicates a risk that may result in damage to this machine or documents. Follow the instructions to avoid property damage.

Tips

- This symbol indicates supplemental information of a topic as well as options required to use a function.



Reference

This symbol indicates reference functions related to a topic.

Notations	Description
Related setting	This shows the settings related to a particular topic for any user.
Related setting (for the administrator)	This shows the settings related to a topic only for administrators.
✓	This check mark symbol shows a precondition of a procedure.
→	This symbol indicates a supplementary explanation of a procedural instruction.
[]	An item enclosed by brackets [] indicates a key name on the Touch Panel or computer screen, or the name of a user's guide.
Bold text	This presents a key name, part name, product name, or option name on the Control Panel .

Notations of application names

This manual describes application names as shown below.

Application name	Notations used in this manual
PageScope Web Connection	Web Connection
PageScope My Panel Manager	My Panel Manager

2.3 About this machine

2.3.1 Optional components (bizhub C554e/C454e)

Various optional components can be added to meet your office requirements.

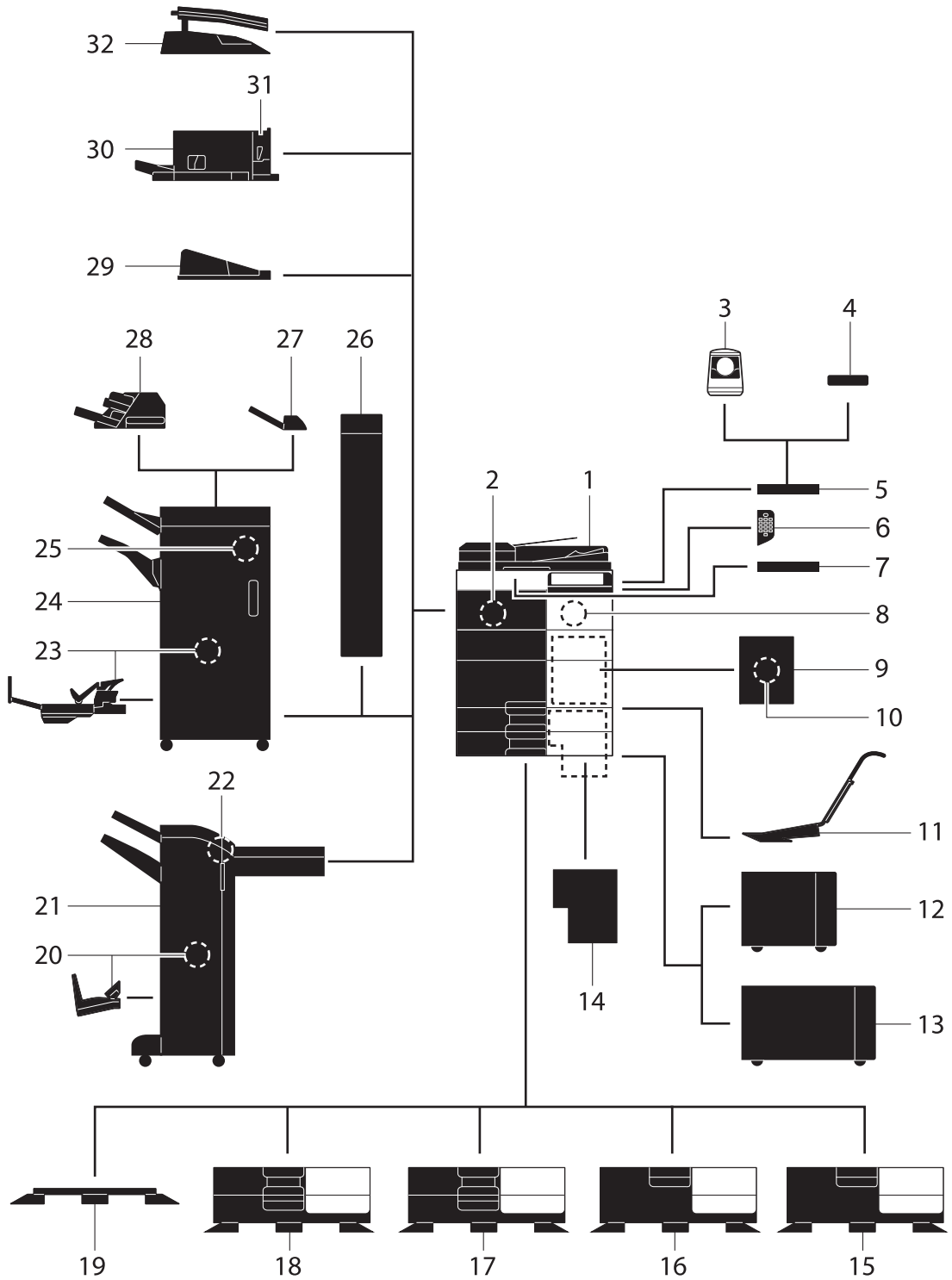

No.	Name	Description
1	Main unit	Scans the original in the scanner section, and prints a scanned image in the printer section.
2	Fax Kit FK-511	Required to use the fax function.
3	Authentication Unit AU-102 (Biometric Type)	Working Table WT-506 is required as a stand.
4	Authentication Unit AU-201 (IC Card Type)	Working Table WT-506 is required as a stand.
5	Working Table WT-506	Provides an area to temporarily place an original or other materials. This is also used when the Authentication Unit is installed.
6	Keypad KP-101	It is equipped on the side of the Control Panel . Allows you to enter numbers by using the hardware keypad.
7	Keyboard Holder KH-102	Install this holder to use an external keyboard.
8	Security Kit SC-508	Supports functions such as Copy Guard to prevent unauthorized copying.
9	Fax Mount Kit MK-728	This unit is required to install FAX Kit FK-508 . This option can be used in North America.
10	FAX Kit FK-508	Used to add telephone lines. Fax Mount Kit MK-728 is required to install FAX Kit FK-508 . This option can be used in North America.
11	Mount Kit MK-730	Used to print on banner paper.
12	Large Capacity Unit LU-301	Allows you to load up to 3000 sheets of 8-1/2 × 11 (A4) size paper.
13	Large Capacity Unit LU-204	Allows you to load up to 2500 sheets of SRA3 or 11 × 17 (A3) size paper.
14	Image Controller IC-414	Built-in Image Controller . Installing this unit provides higher quality printing results.
15	Desk DK-510	Used to place this machine on the floor.
16	Paper Feed Cabinet PC-410	Can load up to 2500 sheets of 8-1/2 × 11 (A4) size paper.
17	Paper Feed Cabinet PC-210	Can load up to 500 sheets respectively into the top and bottom trays.
18	Paper Feed Cabinet PC-110	Can load up to 500 sheets into the top tray. (The bottom tray is a storage box.)
19	Desk DK-705	Used to place this machine on the floor.
20	Saddle Stitcher SD-511	Used to add the bind/fold function to the Finisher FS-534 .
21	Finisher FS-534	Sorts, groups, or staples output sheets as required.
22	Punch Kit PK-520	Used to add the punch function to the Finisher FS-534 .
23	Saddle Stitcher SD-512	Used to add the bind/fold function to the Finisher FS-535 (only for bizhub C554e).
24	Finisher FS-535	Sorts, groups, or staples output sheets as required (only for bizhub C554e).
25	Punch Kit PK-521	Used to add the punch function to the Finisher FS-535 (only for bizhub C554e).
26	Z Folding Unit ZU-606	Adds the Z-fold or punch function to the Finisher FS-535 (only for bizhub C554e).
27	Job Separator JS-602	Feeds out printed sheets (only for bizhub C554e).
28	Post Inserter PI-505	Inserts a cover sheet into copied or printed sheets (only for bizhub C554e).
29	Output Tray OT-506	Collects printed pages.
30	Finisher FS-533	Sorts, groups, or staples output sheets as required. This unit can be installed in this machine.
31	Punch Kit PK-519	Used to add the punch function to the Finisher FS-533 .

No.	Name	Description
32	Job Separator JS-506	Used to separate output sheets into two trays in the body of the machine.
<i>The following options are built into this machine and are not shown in the figure above.</i>		
33	Stamp Unit SP-501	Stamps a scanned original when sending a fax.
34	Spare TX Marker Stamp 2	A replacement stamp for the Stamp Unit SP-501 .
35	Local Interface Kit EK-607	Install this unit when using the linkage function with a Bluetooth-compatible device.
36	Video Interface Kit VI-506	This unit is required to install Image Controller IC-414 .
37	i-Option LK-101 v3	Supports the web browser function that is one of the advanced functions.
38	i-Option LK-102 v3	Supports the PDF processing function that is one of the advanced functions.
39	i-Option LK-105 v3	Supports the searchable PDF function that is one of the advanced functions.
40	i-Option LK-106	Used to add a bar code font that is one of special fonts.
41	i-Option LK-107	Used to add a unicode font that is one of special fonts.
42	i-Option LK-108	Used to add an OCR font that is one of special fonts.
43	i-Option LK-110	Supports advanced functions such as a function that converts a file into a DOCX or XLSX type, a function that generates highly-functional and high quality data, and the E-mail RX Print function. For details on the available functions, refer to the [User's Guide Online] on the DVD.
44	i-Option LK-111	Supports the ThinPrint function that is one of the advanced functions.
45	i-Option LK-115	Allows you to manage confidential information on this machine using TPM (Trusted Platform Module) that is one of the advanced functions.
46	Upgrade Kit UK-204	Required when: <ul style="list-style-type: none"> • Installing i-Option; • Using the My Address function in conjunction with My Panel Manager; and • Using the Overlay or Registered Overlay function.
47	Upgrade Kit UK-208	Allows you to use this machine in a wireless network environment.
<i>The following options are not shown in the figure.</i>		
48	Heater HT-509	Prevents paper in a paper tray from being affected by humidity. Desk DK-510 or Paper Feed Cabinet is required to install this unit.
49	Power Supply BOX MK-734	Used to turn Heater operations on or off.
50	Mount Kit MK-735	Required to install Authentication Unit AU-201 (IC Card Type).

2.3.2 Optional components (bizhub C364e/C284e/C224e)

Various optional components can be added to meet your office requirements.

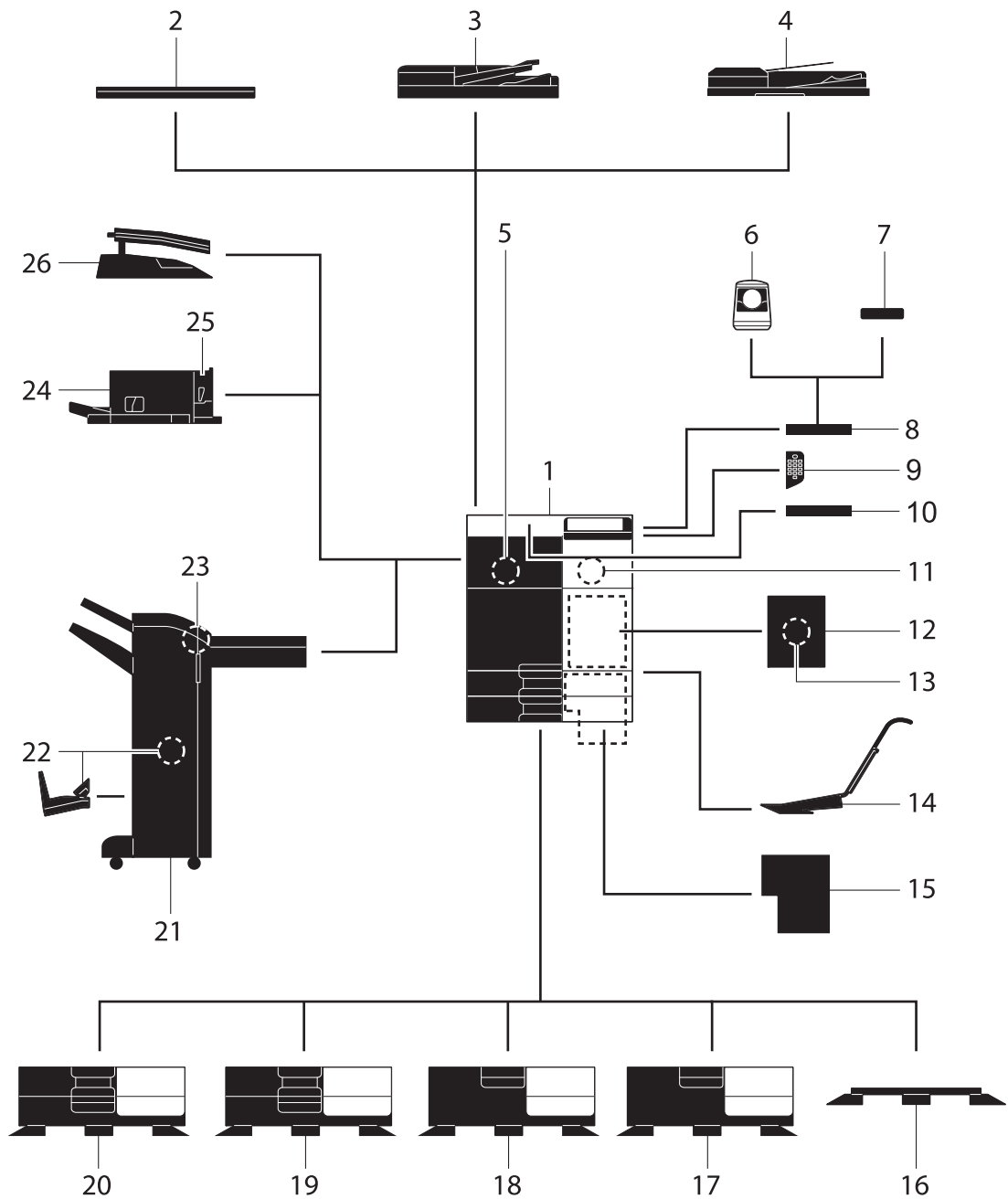

No.	Name	Description
1	Main unit	Scans the original in the scanner section, and prints a scanned image in the printer section.
2	Original Cover OC-511	Used to fix the loaded originals.
3	Reverse Automatic Document Feeder DF-624	Automatically feeds and scans originals by page.
4	Dual Scan Document Feeder DF-701	Scans the front and back sides of the sheet at the same time. This enables higher-speed scanning.
5	Fax Kit FK-511	Required to use the fax function.
6	Authentication Unit AU-102 (Biometric Type)	The Working Table WT-506 is required as a stand.
7	Authentication Unit AU-201 (IC Card Type)	The Working Table WT-506 is required as a stand.
8	Working Table WT-506	Provides an area to temporarily place an original or other materials. This is also used when the Authentication Unit is installed.
9	Keypad KP-101	It is equipped on the side of the Control Panel . Allows you to enter numbers by using the hardware keypad.
10	Keyboard Holder KH-102	Install this holder to use an external keyboard.
11	Security Kit SC-508	Supports functions such as Copy Guard to prevent unauthorized copying.
12	Fax Mount Kit MK-728	This unit is required to install FAX Kit FK-508 . This option can be used in North America.
13	FAX Kit FK-508	Used to add telephone lines. Fax Mount Kit MK-728 is required to install FAX Kit FK-508 . This option can be used in North America.
14	Mount Kit MK-730	Used to print on banner paper.
15	Image Controller IC-414	External image controller. Installing this unit provides the higher-quality printing result (only for bizhub C364e/C284e).
16	Desk DK-705	Used to place this machine on the floor.
17	Desk DK-510	Used to place this machine on the floor.
18	Paper Feed Cabinet PC-410	Can load up to 2500 sheets of 8-1/2 × 11 (A4) size paper.
19	Paper Feed Cabinet PC-210	Can load up to 500 sheets respectively into the top and bottom trays.
20	Paper Feed Cabinet PC-110	Can load up to 500 sheets into the top tray. (The bottom tray is a storage box.)
21	Finisher FS-534	Sorts, groups, or staples output sheets as required. The Desk DK-510 or Paper Feed Cabinet is required to install this unit.
22	Saddle Stitcher SD-511	Used to add the bind/fold function to the Finisher FS-534 .
23	Punch Kit PK-520	Used to add the punch function to the Finisher FS-534 .
24	Finisher FS-533	Sorts, groups, or staples output sheets as required. This unit can be installed in this machine.
25	Punch Kit PK-519	Used to add the punch function to the Finisher FS-533 .
26	Job Separator JS-506	Used to separate output sheets into two trays in the body of the machine.
<i>The following options are built into this machine and are not shown in the figure above.</i>		
27	Stamp Unit SP-501	Stamps a scanned original when sending a fax.
28	Spare TX Marker Stamp 2	A replacement stamp for the Stamp Unit SP-501 .
29	Local Interface Kit EK-607	Install this unit when using the linkage function with a Bluetooth-compatible device.
30	Video Interface Kit VI-506	This unit is required to install Image Controller IC-414 onto bizhub C364e or bizhub C284e .

No.	Name	Description
31	i-Option LK-101 v3	Supports the web browser function that is one of the advanced functions.
32	i-Option LK-102 v3	Supports the PDF processing function that is one of the advanced functions.
33	i-Option LK-105 v3	Supports the searchable PDF function that is one of the advanced functions.
34	i-Option LK-106	Used to add a bar code font that is one of special fonts.
35	i-Option LK-107	Used to add a unicode font that is one of special fonts.
36	i-Option LK-108	Used to add an OCR font that is one of special fonts.
37	i-Option LK-110	Supports advanced functions such as a function that converts a file into a DOCX or XLSX type, a function that generates highly-functional and high quality data, and the E-mail RX Print function. For details on the available functions, refer to the [User's Guide Online] on the DVD.
38	i-Option LK-111	Supports the ThinPrint function that is one of the advanced functions.
39	i-Option LK-115	Allows you to manage confidential information on this machine using TPM (Trusted Platform Module) that is one of the advanced functions.
40	Upgrade Kit UK-204	Required when: <ul style="list-style-type: none"> • Installing i-Option; • Using the My Address function in conjunction with My Panel Manager; and • Using the Overlay or Registered Overlay function.
41	Upgrade Kit UK-208	Allows you to use this machine in a wireless network environment.
42	Upgrade Kit UK-209	Used to connect an Android tablet terminal to this machine and display the Control Panel on the Android tablet terminal, enabling remote-control operations. <ul style="list-style-type: none"> • This unit is required when using Original Cover or Reverse Automatic Document Feeder. • If you are using Dual Scan Document Feeder, Upgrade Kit UK-209 (dual scan board) is already installed on this machine.
The following options are not shown in the figure.		
43	Heater HT-509	Prevents paper in a paper tray from being affected by humidity. Desk DK-510 or Paper Feed Cabinet is required to install this unit.
44	Power Supply BOX MK-734	Used to turn Heater operations on or off.
45	Mount Kit MK-735	Required to install Authentication Unit AU-201 (IC Card Type).

2.3.3 Name of parts (MFP) (bizhub C554e/C454e)

Front side

The illustration shows the main unit that contains the **Output Tray** and **Paper Feed Cabinet**.

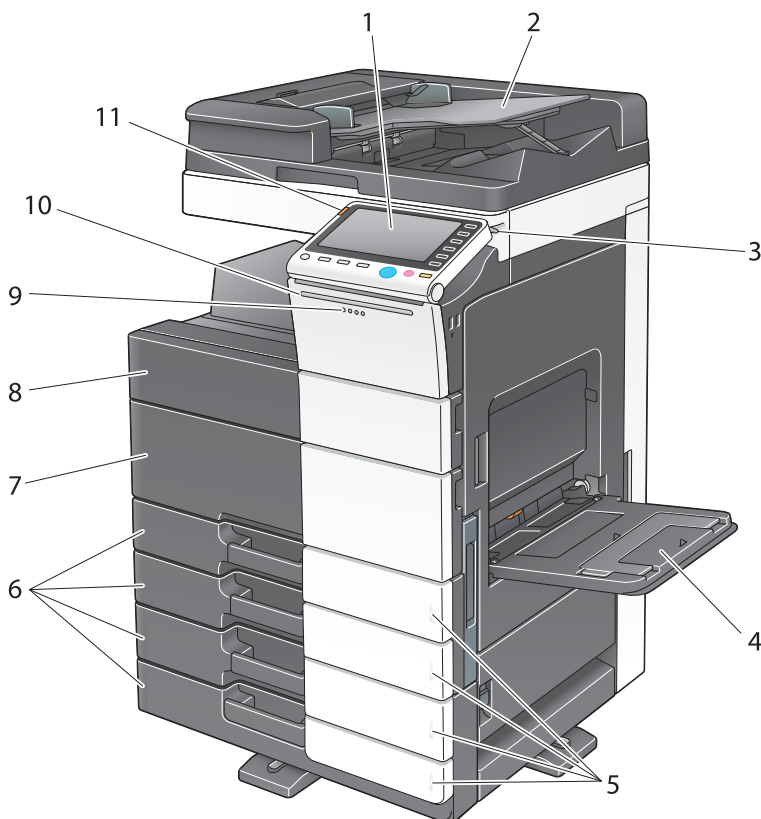

No.	Name	Description
1	Control Panel	Use the Touch Panel or buttons on this panel to operate this machine.
2	Original Tray	Load the original.
3	Stylus Pen	Used to operate the Touch Panel .
4	Bypass Tray	Used to load custom-size paper or special paper.
5	Paper-Empty Indicator	Flashes orange when a tray runs low on paper and lights up orange when the tray runs out of paper.
6	Paper Tray	Used to load standard-size paper.
7	Lower Front Door	Open this door to replace consumables or to maintenance this machine.
8	Upper Front Door	Open this door to replace a Toner Cartridge .
9	Data Indicator	Flashes blue while this machine is receiving a job. If a job is currently spooled, this indicator lamp lights up blue.
10	Status Indicator	Flashes white during printing.
11	Warning Indicator	Flashes orange if a warning occurs. Lights up orange if this machine has stopped due to an error.

Rear side

The illustration shows the main unit that contains the **Paper Feed Cabinet**, **Fax Kit FK-511**, **FAX Kit FK-508**, **Fax Mount Kit**, and **Power Supply BOX**.
(**FAX Kit FK-508** and **Fax Mount Kit** can be used in North America.)

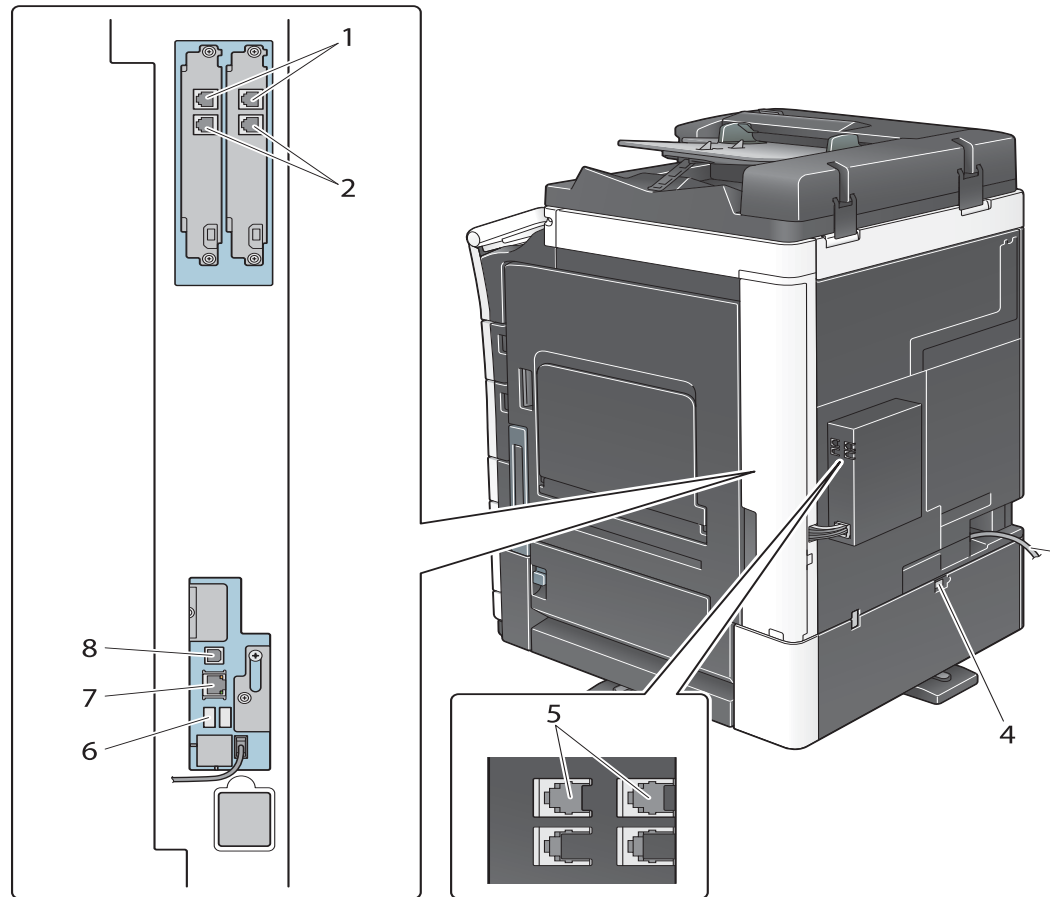

No.	Name
1	Telephone Jack 1/2 (LINE PORT 1/2)
2	Jack for connecting a telephone (TEL PORT1/2)
3	Power Cord
4	Heater Power Switch
5	Telephone Jack 3/4 (FAX3/4)
6	USB Port (Type A) USB2.0/1.1
7	Network Connector (10Base-T/100Base-TX/1000Base-T)
8	USB Port (Type B) USB2.0/1.1



Reference

For details, refer to the [User's Guide Online] on the DVD.

2.3.4 Name of parts (MFP) (bizhub C364e/C284e/C224e)

Front side

The illustration shows the main unit that contains the **Reverse Automatic Document Feeder** and **Paper Feed Cabinet**.

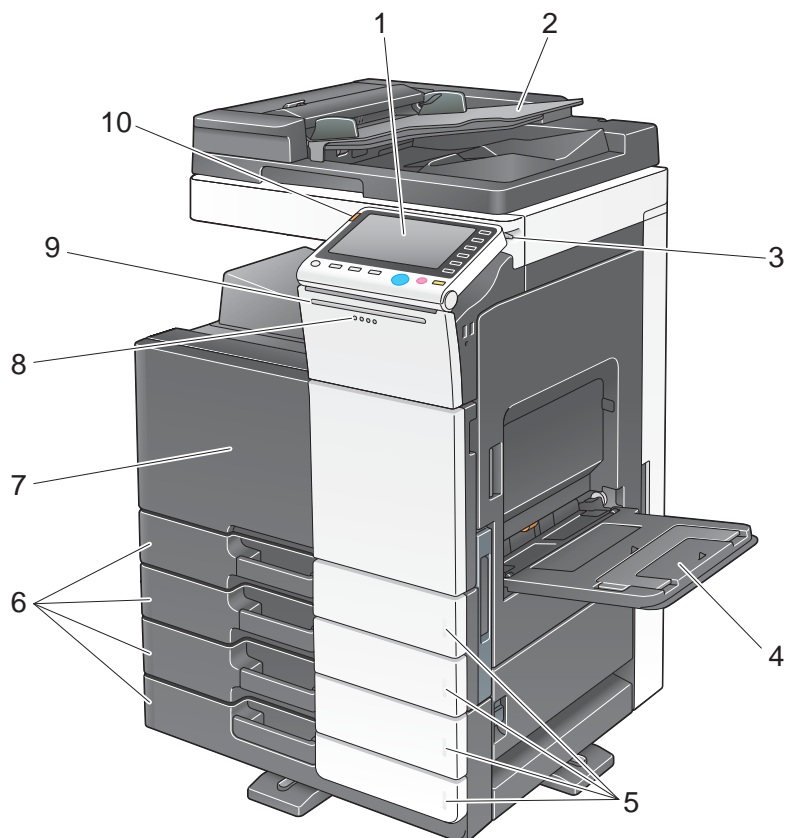

No.	Name	Description
1	Control Panel	Use the Touch Panel or buttons on this panel to operate this machine.
2	Original Tray	Load the original.
3	Stylus Pen	Used to operate the Touch Panel .
4	Bypass Tray	Used to load custom-size paper or special paper.
5	Paper-Empty Indicator	Flashes orange when a tray runs low on paper and lights up orange when the tray runs out of paper.
6	Paper Tray	Used to load standard-size paper.
7	Front Door	Open this door to replace consumables or to maintain this machine.
8	Data Indicator	Flashes blue while this machine is receiving a job. If a job is currently spooled, this indicator lamp lights up blue.
9	Status Indicator	Flashes white during printing.
10	Warning Indicator	Flashes orange if a warning occurs. Lights up orange if this machine has stopped due to an error.

Rear side

The illustration shows the main unit that contains the **Reverse Automatic Document Feeder**, **Paper Feed Cabinet**, **Fax Kit FK-511**, **FAX Kit FK-508**, **Fax Mount Kit**, and **Power Supply BOX**.
(**FAX Kit FK-508** and **Fax Mount Kit** can be used in North America.)

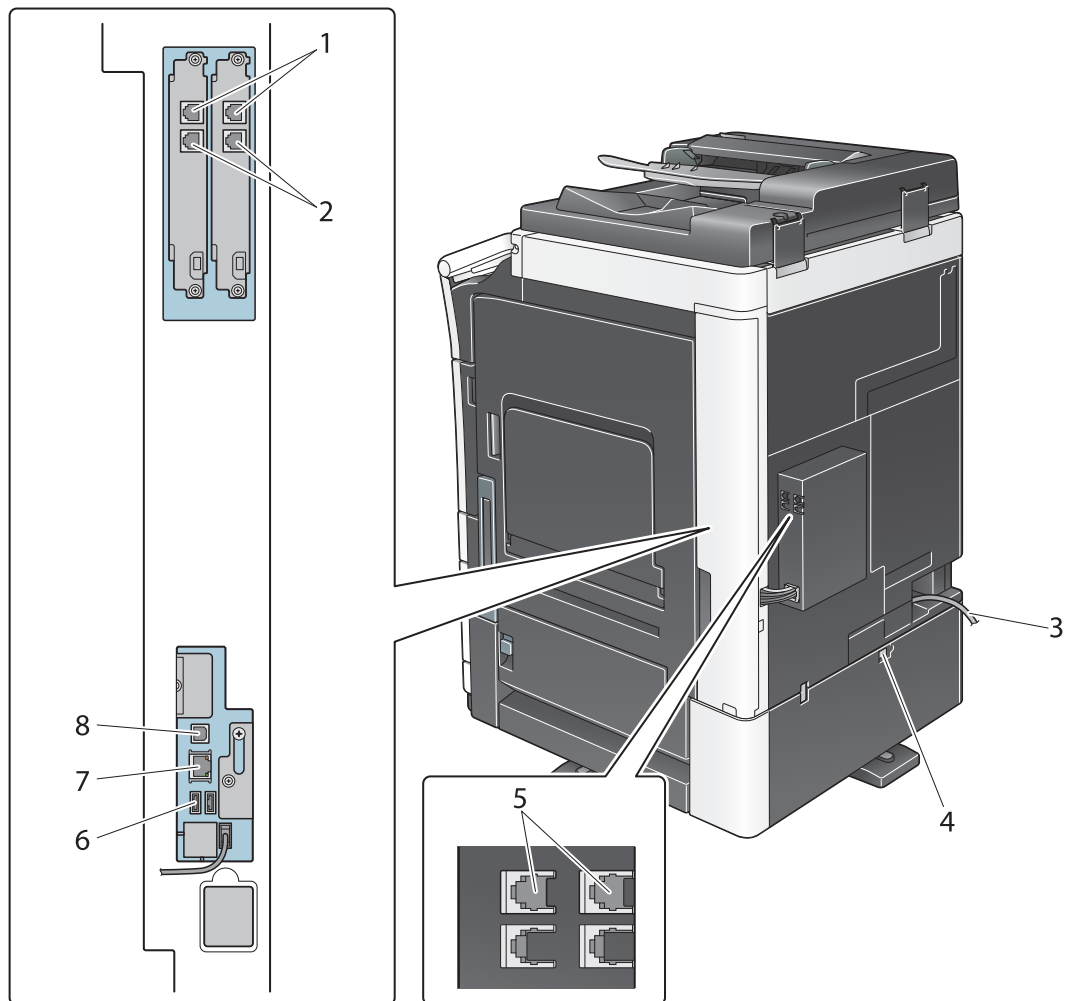

No.	Name
1	Telephone Jack 1/2 (LINE PORT 1/2)
2	Jack for connecting a telephone (TEL PORT1/2)
3	Power Cord
4	Heater Power Switch
5	Telephone Jack 3/4 (FAX3/4)
6	USB Port (Type A) USB2.0/1.1
7	Network Connector (10Base-T/100Base-TX/1000Base-T)
8	USB Port (Type B) USB2.0/1.1



Reference

For details, refer to the [User's Guide Online] on the DVD.

2.3.5 Name of parts (Optional units)

This section shows the names of distinctive parts for each optional unit that can be installed in this machine.

Finisher FS-535, Saddle Sticher SD-512, Punch Kit PK-521 (bizhub C554e)

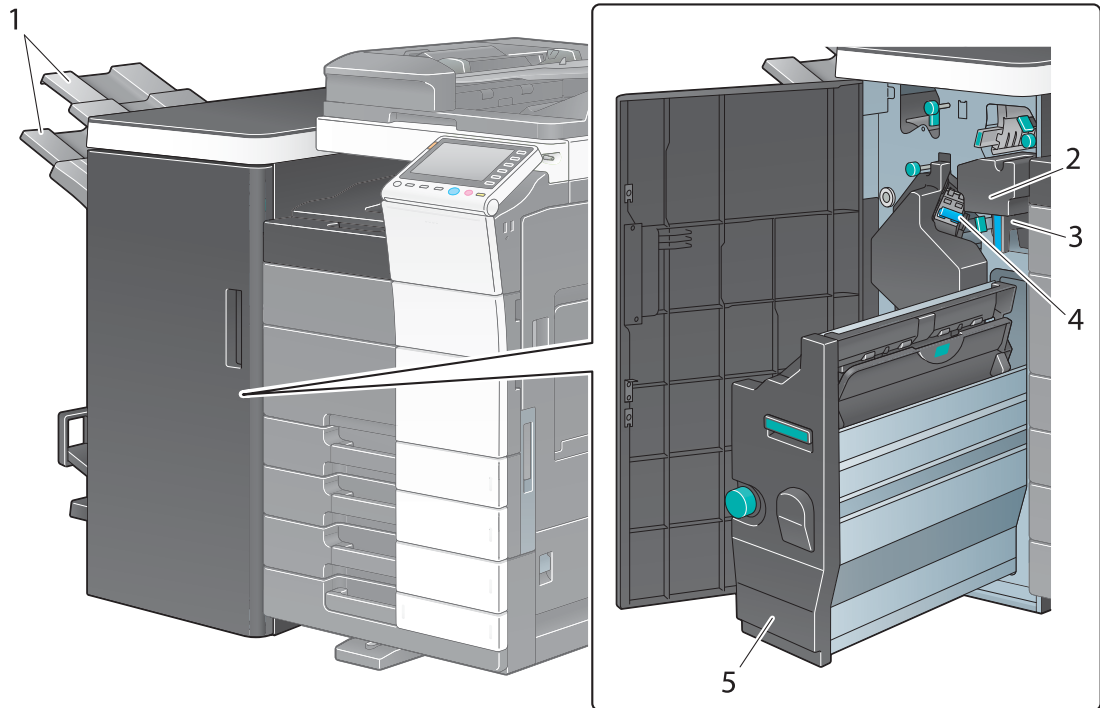

No.	Name
1	Output Tray
2	Punch Kit
3	Punch Scrap Box
4	Staple Cartridge
5	Saddle Sticher

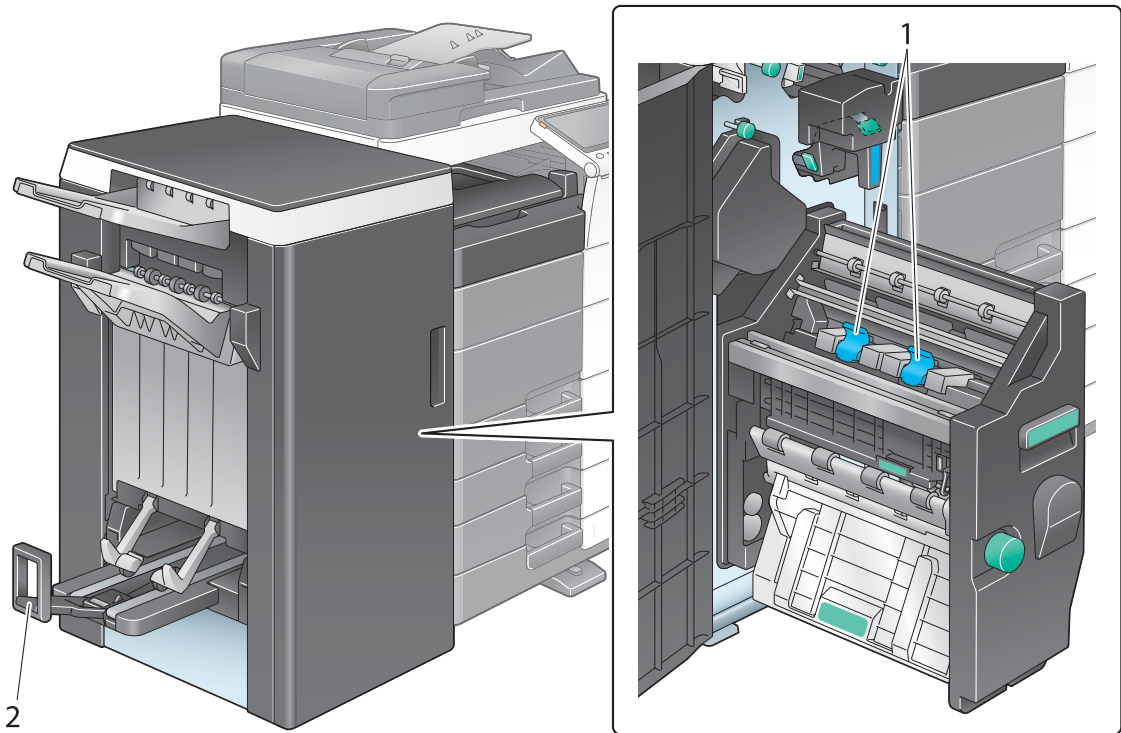

No.	Name
1	Staple Cartridge
2	Folding Output Tray

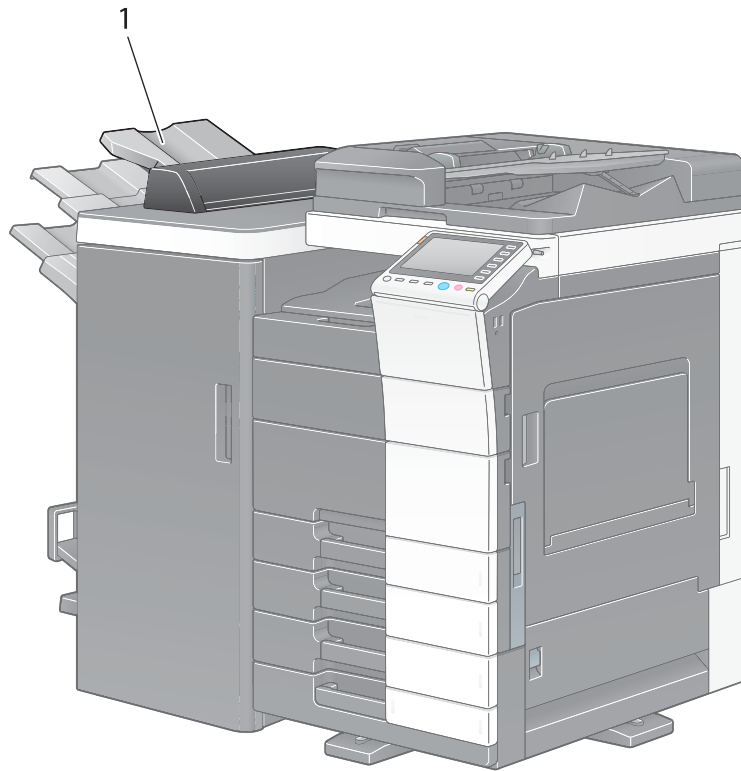
Job Separator JS-602 (bizhub C554e)

No.	Name
1	Output Tray

Z Folding Unit ZU-606 (bizhub C554e)

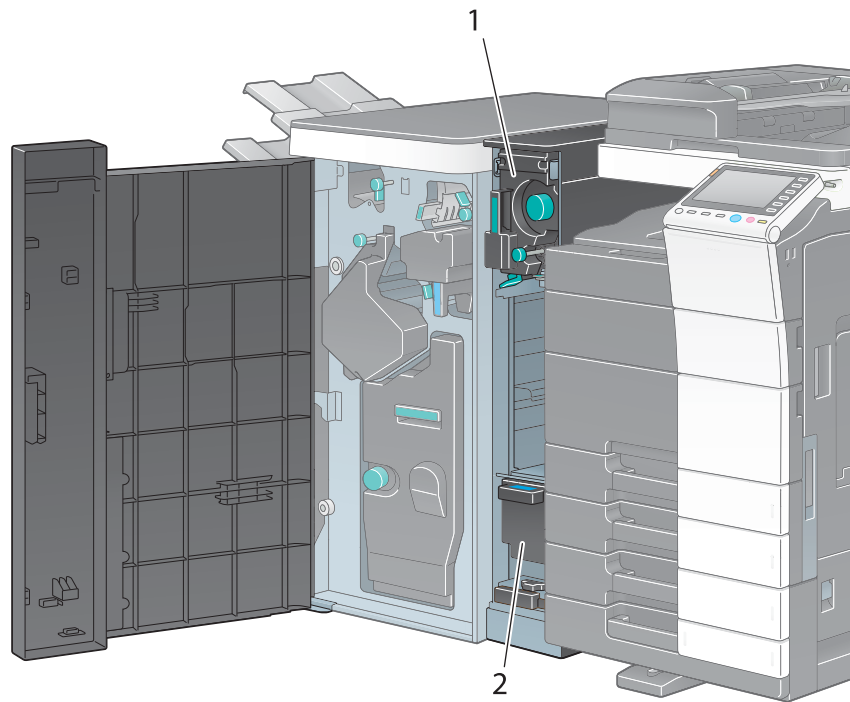

No.	Name
1	Z Folding/Conveyance Unit
2	Punch Scrap Box

Post Inserter PI-505 (bizhub C554e)

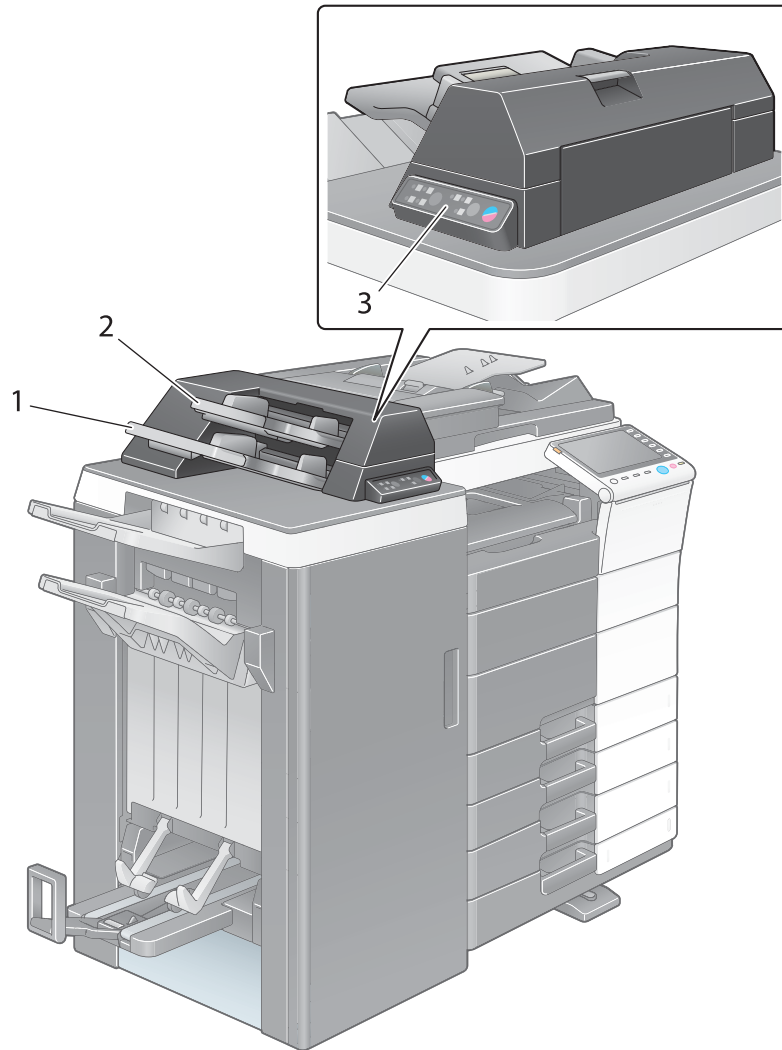

No.	Name
1	Lower Tray
2	Upper Tray
3	Post Inserter Control Panel



Reference

For details on how to use the **Post Inserter Control Panel**, refer to the *User's Guide DVD*.

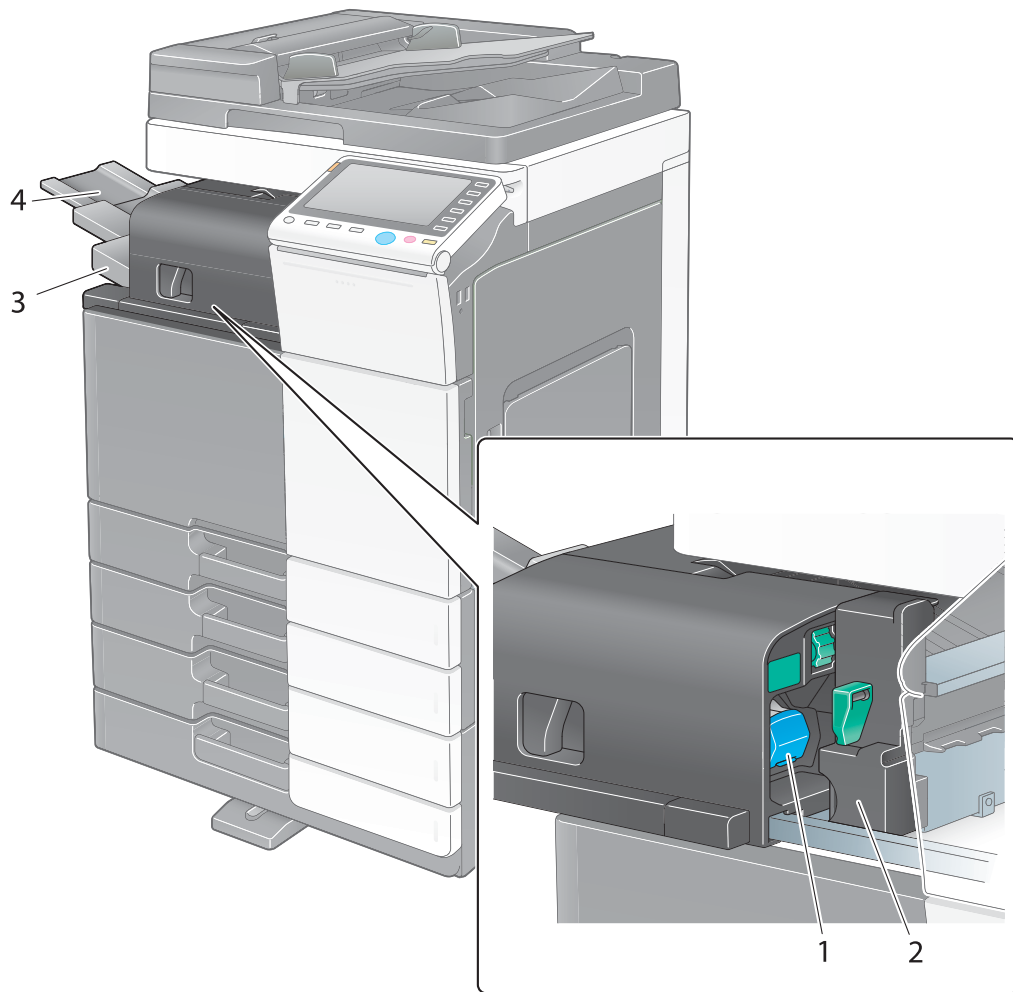
Finisher FS-533, Punch Kit PK-519

No.	Name
1	Staple Cartridge
2	Punch Kit
3	Output Tray
4	Tray Extension

Job Separator JS-506

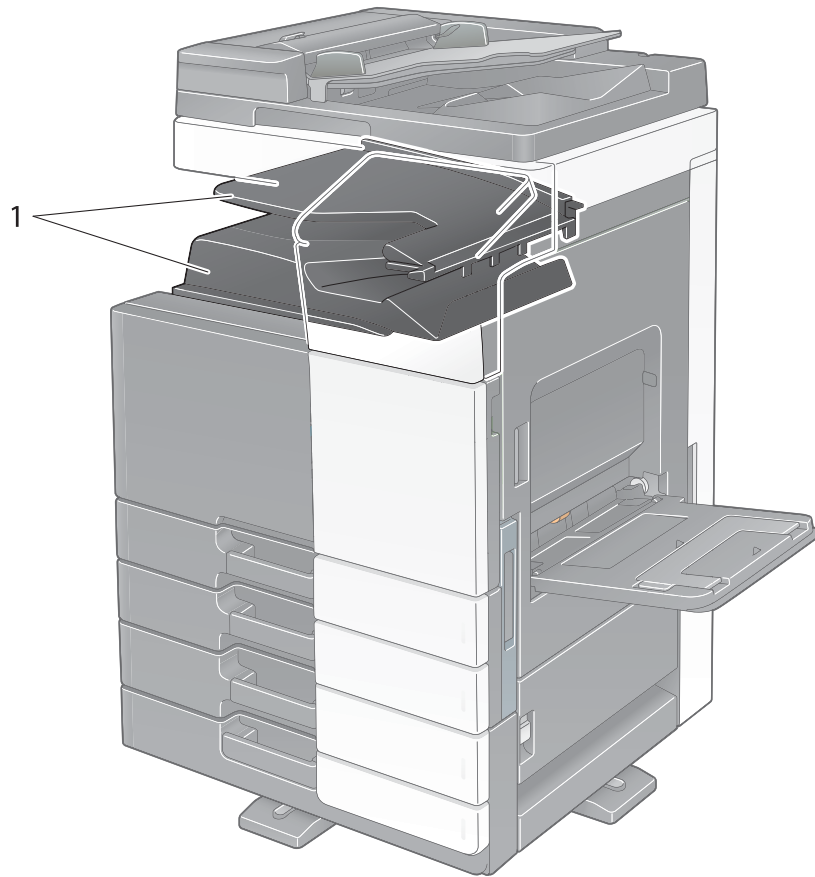

No.	Name
1	Output Tray

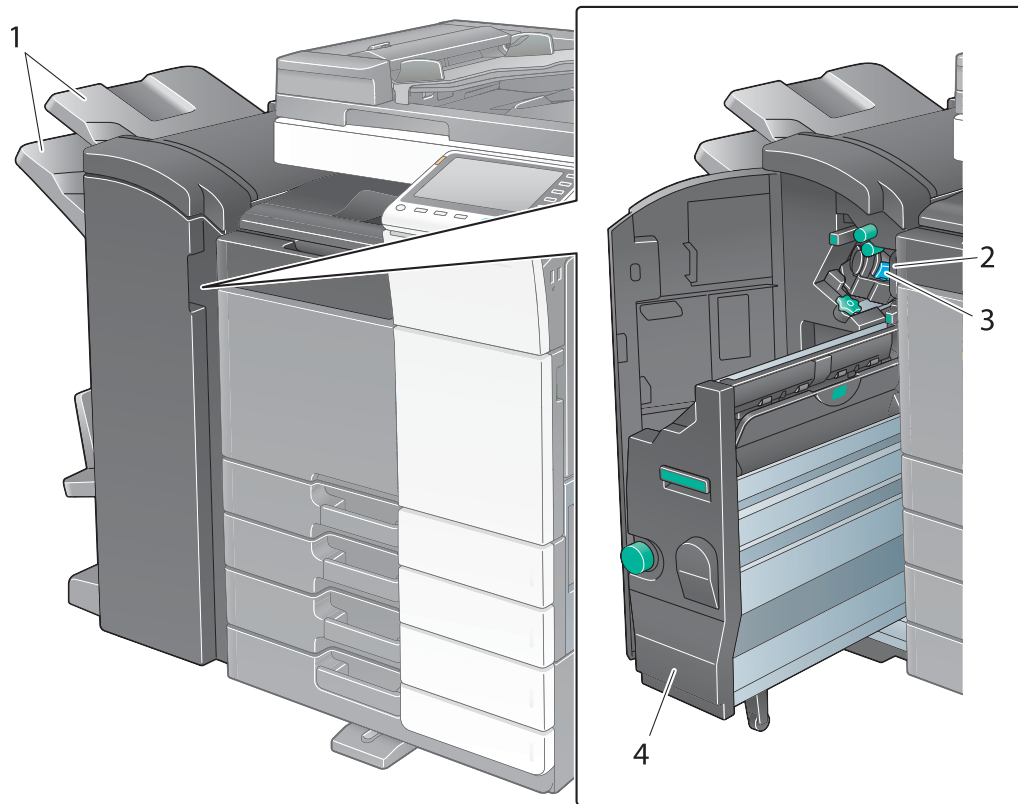
Finisher FS-534, Saddle Sticher SD-511, Punch Kit PK-520

No.	Name
1	Output Tray
2	Punch Scrap Box
3	Staple Cartridge
4	Saddle Sticher

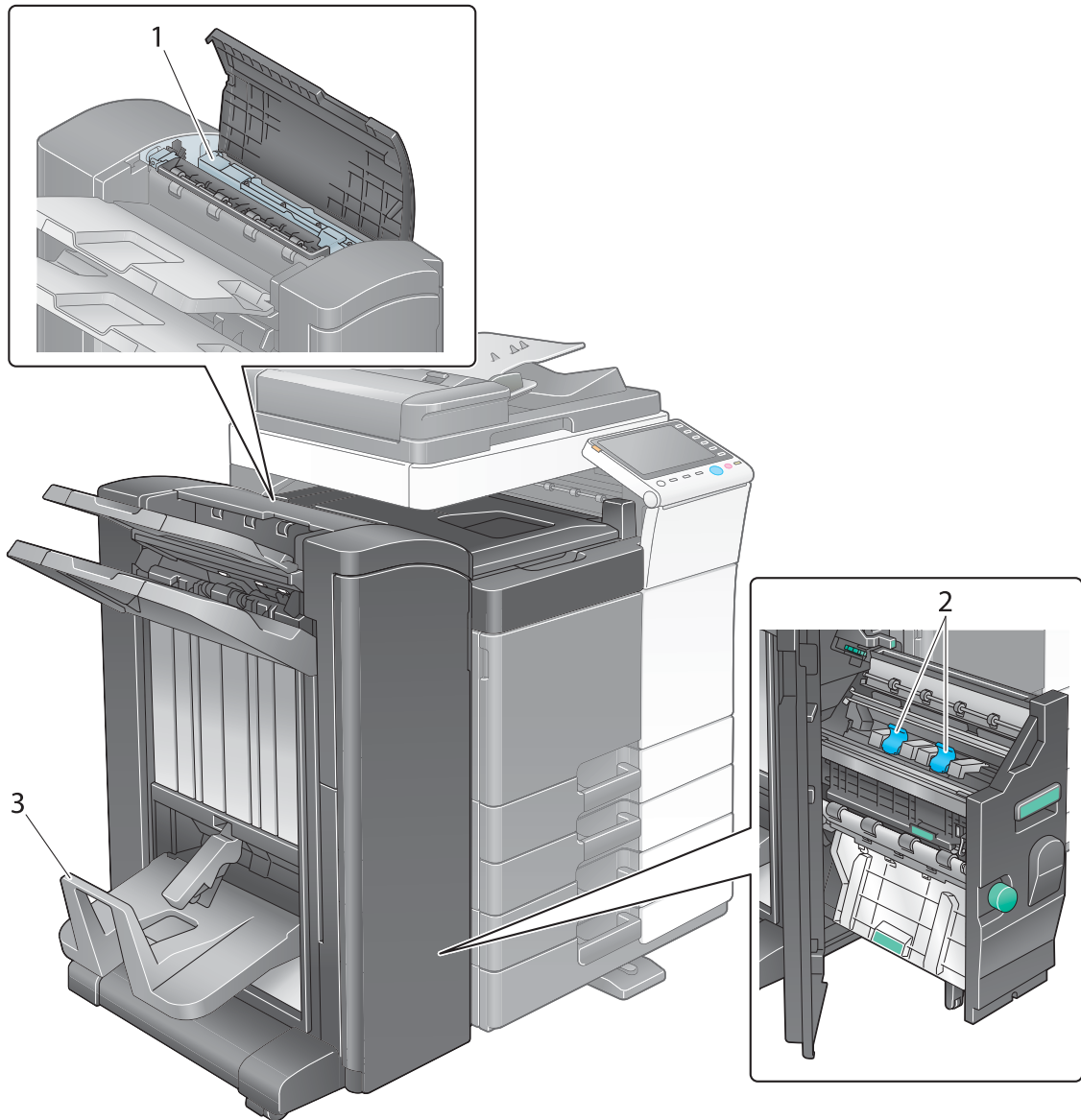

No.	Name
1	Punch Kit
2	Staple Cartridge
3	Folding Output Tray

Large Capacity Unit LU-301/LU-204

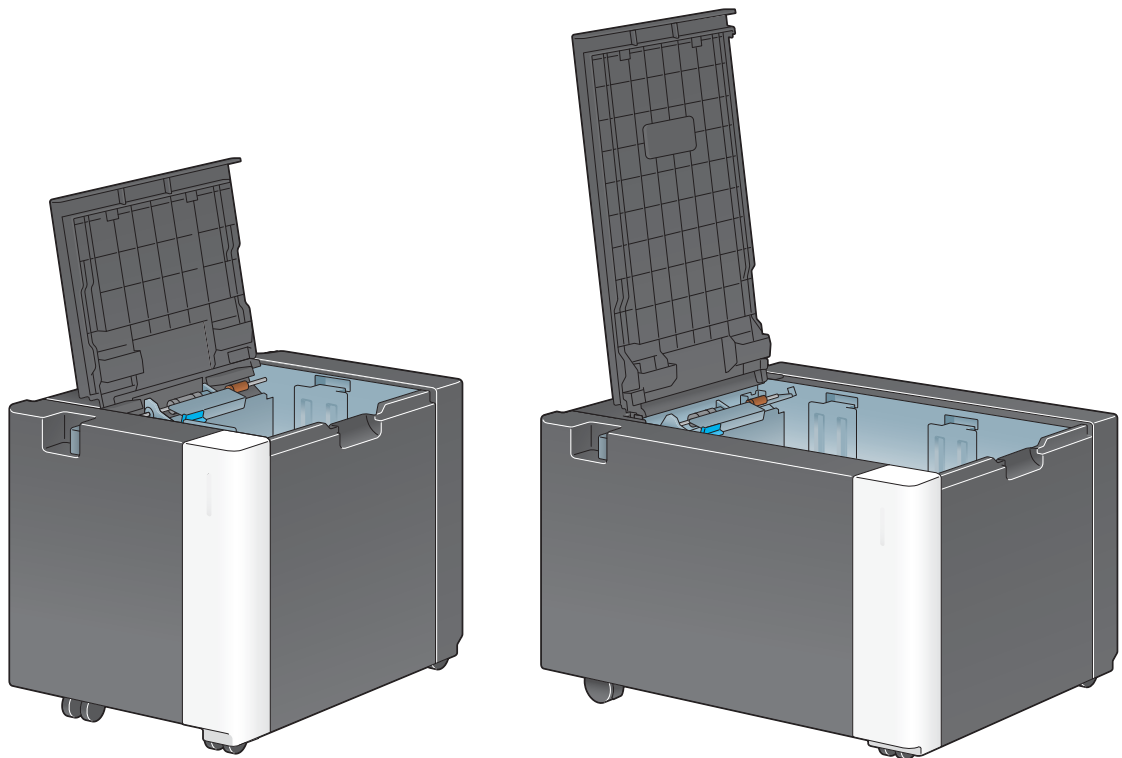

Reference

For details, refer to the [User's Guide Online] on the DVD.

2.4 Power supply

This machine provides two power switches: **Power** key on the **Control Panel** and **Main Power Switch** on the machine. Under normal conditions, operate the **Power** key of the **control panel**. Use **Main Power Switch** to restart this machine.

2.4.1 Turning the power on and off

Turn the power on and off only when necessary, for example, when the administrative settings are changed or a power failure occurs.

- 1 Open the **Lower Front Door** or **Front Door**, and turn the **Main Power Switch** on.

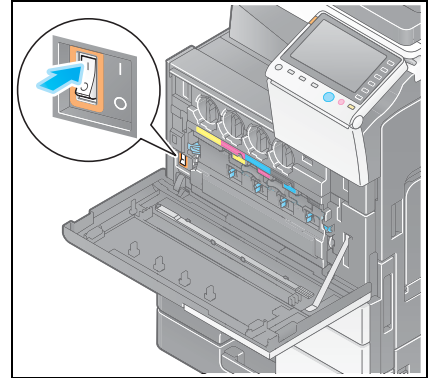

- 2 Turn the **Main Power Switch** off.

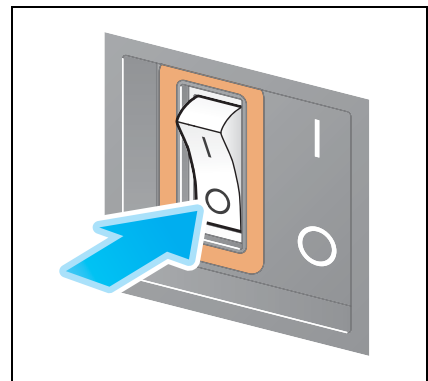

NOTICE

To restart this machine, turn the **Main Power Switch** off and on again after 10 or more seconds have passed.

2.4.2 Operating the Power key

To immediately shift to the power save mode, for example, when work is finished or when not operating this machine for a long period of time, press the **Power** key.

The machine shifts to different power save modes depending on how long the **Power** key is pressed.

Pressing the **Power** key briefly during operation shifts to the low power or sleep mode. Holding down the Power key shifts to the Sub Power OFF mode.

To return this machine from the power save mode to the normal mode, press the **Power** key again.

In the low power or sleep mode, you can return this machine from the power save mode to the normal mode simply by placing your hand close to the **Control Panel**.

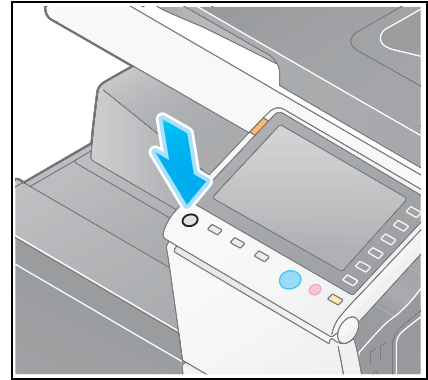

Status of this machine		Description
Power Save mode	Low Power or Sleep mode	Flashes blue. This machine returns to the normal mode when data or faxes are received.
	Sub Power OFF mode	Lights up orange. This machine can receive data or faxes, but cannot scan or print an original. If data or faxes are received when the machine is in the Sub Power OFF mode, they are printed when the machine returns to the normal mode.
Normal mode	During operation	Lights up blue.

2.4.3 Power save function

If the specified time (default: 15 minutes) elapses after the machine becomes inactive, the machine automatically shifts to the power save mode; for example, the touch panel display is turned off. The **Power** key flashes blue in the power save mode. The power save mode returns to the normal mode by pressing any key on the **Control Panel** for instance.

There are two power save modes: the low power mode and the sleep mode. Sleep mode provides a greater power saving effect than Low Power mode. However, the time required to return to Normal mode is longer than the time required to revert to Low Power mode.



Reference

The time required to shift to each mode can be changed in the Administrator Settings. For details, refer to the [User's Guide Online] on the DVD.

Reducing power consumption

To reduce power consumption in the standby state, change [Power Key Setting] to [Sub Power OFF].

Tap [Utility], and select [Administrator Settings] - [System Settings] - [Power Supply/Power Save Settings] - [Power Key Setting].

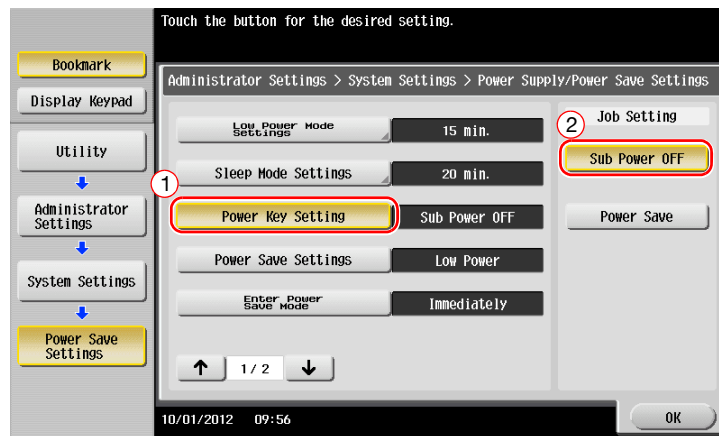

After the setting is changed, the power save mode shifts as shown below depending on how the **Power** key is pressed.

- Pressing the **Power** key
 - This machine shifts to the Sub Power OFF mode.
 - In the Sub Power OFF mode, the machine can receive data or faxes, but cannot scan or print an original.
 - If data or faxes are received when the machine is in the Sub Power OFF mode, they are printed when the machine returns to the normal mode.
- Holding down the **Power** key
 - This machine shifts to the ErP Auto Power OFF mode.
 - In the ErP Auto Power OFF mode, this machine cannot receive data or faxes and also cannot scan or print an original.
 - This function provides a greater power saving effect than the Sub Power OFF mode, which is close to the state where the main power is turned off.

To enable the machine to return to the normal mode from the Sub Power OFF or ErP Auto Power OFF mode, press the **Power** key again.



Reference

For details, refer to the [User's Guide Online] on the DVD.

2.5 Control Panel

The **Keypad KP-101** is equipped on the right side of the **Control Panel**.

2.5.1 Name of parts



No.	Name	Description
1	Touch Panel	Various screens and messages are displayed. Directly touch the Touch panel to configure each setting.
2	[Menu]	Tap this button to display the main menu.
3	[Enlarge Display]	Enters Enlarge Display mode.
4	[Guidance]	Tap this button to display the Help Menu. You can display descriptions of the functions and operating procedures on the screen.
5	[Access]	If user authentication or account track is enabled, enter the user name and password for user authentication or the account name and password for account track, then tap this button to start the use of this machine. After a target operation is completed, tap this button once again to end the use of this machine.
6	[Interrupt]	Tap this button to enter the Interrupt mode. The indicator lamp lights up blue in the Interrupt mode. To cancel the Interrupt mode, tap [Interrupt] again.
7	[Preview]	Tap this button to print a single proof copy to be checked before printing a large number of copies. This function can also display a finishing image with the current settings on the Touch Panel .
8	Reset	Press this key to reset all settings, excluding the registered ones, that you entered using the Control Panel .
9	Stop	Press this key to temporarily stop an active copy, scan, or print job.
10	Start	Press to start the copy, scan or fax operation.
11	Register key	Press each key to switch the display of the Touch Panel to a function assigned to a Register key. <ul style="list-style-type: none"> • 1 (Scan/Fax): Switches to the scan/fax function. • 2 (Copy): Switches to the copy function. • 10Keypad (Keypad): Displays the Keypad on the Touch panel. The Register key can be assigned to any function in the Administrator Settings to be easy to use.

No.	Name	Description
12	Power	Press this key to switch to the power save mode. In the normal mode, the key lights up blue. In the power save mode, the key blinks blue or lights up orange. To create a higher power saving effect, you can change the setting in [Power Key Setting] of Administrator Settings. For [Power Key Setting], refer to page 2-29.
13	Warning Indicator	Flashes orange if a warning occurs. Lights up orange if this machine has stopped due to an error.

Equipped with the **Keypad KP-101**

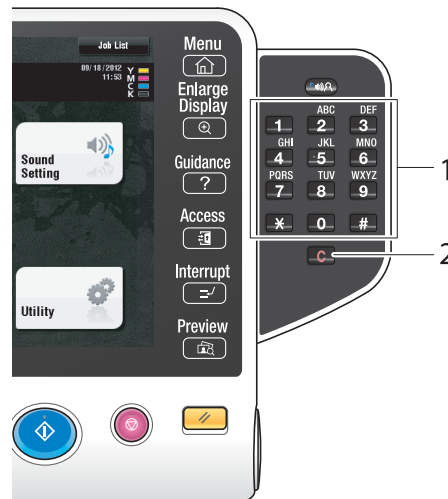

No.	Name	Description
1	Keypad	Use this Keypad to enter numeric values such as the number of copies, zoom ratio, and fax number.
2	C	Press this key to cancel numeric values such as the number of copies, zoom ratio, and size you entered using the Keypad .

2.6 Touch Panel

2.6.1 Main Menu

Tap [Menu] on the **Control Panel** to display the main menu. In the main menu, you can configure settings such as frequently used functions or a shortcut key for jumping to each mode.

Layout of main menu

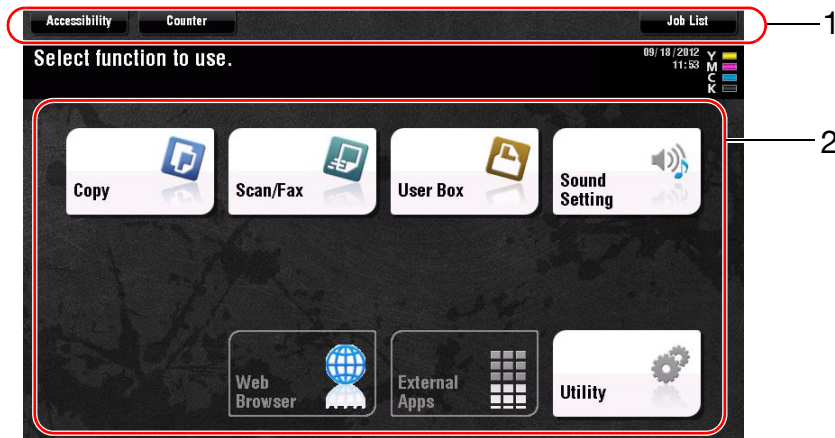

No.	Name	Description
1	[Accessibility]	Tap this button to adjust a Touch Panel pressing position, change keying sounds, and configure the operating environment of the Control Panel .
	[Counter]	Tap this button to display the total number of pages printed on this machine on a function or color basis.
	[Job List]	Tap this button to display active or standby jobs. If necessary, you can view job logs or print a communication report. For details, refer to page 2-39.
2	Main menu keys	Display shortcut keys assigned to any function. By default, the main menu shows [Copy], [Scan/Fax], [User Box], [Sound Setting], and [Utility].
	[Utility]	Tap this button to configure settings of this machine or view the use status of this machine. <ul style="list-style-type: none"> [Utility] is always displayed.

Customizing the main menu

The main menu can be extended to three screens as necessary. Up to 25 keys can be assigned to three main menu screens which can be switched.

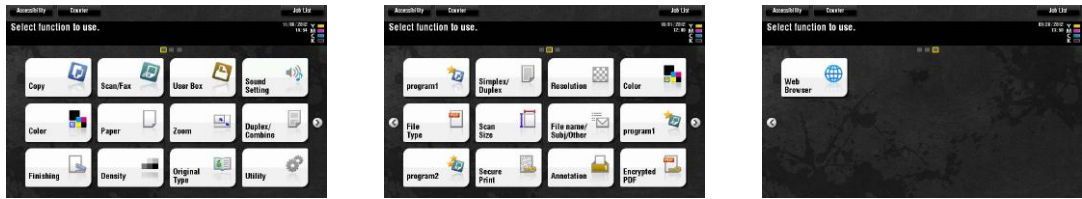

In addition, you can specify your favorite background pattern.



Reference

For details, refer to the [User's Guide Online] on the DVD.

2.6.2 Operating the Touch Panel

The **Touch Panel** of this machine supports user-friendly operations, such as, sliding a finger on the Touch Panel.

Tap

Lightly touch the screen with your finger, then remove your finger from the screen immediately. This action can select or determine a menu.

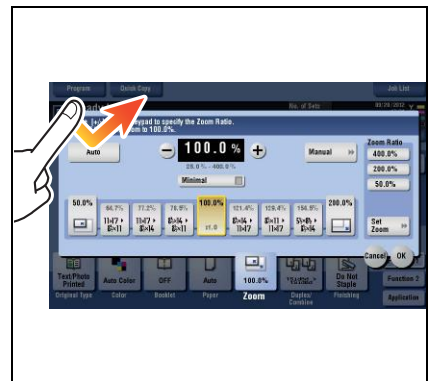

Double-tap

Lightly touch the screen with your finger twice in succession. Used to retrieve detailed information, to enlarge a thumbnail or preview image, and to open a User Box.



Flick

Make a slight fillip while sliding your finger on the screen. Used to scroll the destination/job list or to feed a page in the Main menu screen/Preview screen.



Drag

To move the scroll bar or document, place your finger on it and move your finger. Used to move the scroll bar or document.

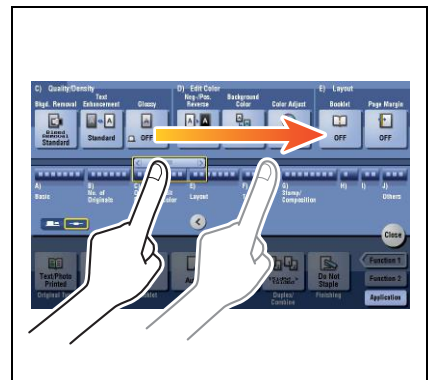

Pan

Slide your finger parallel in a front-to-back and side-to-side direction on the screen. Used to move to the intended display location if data spans multiple screens.

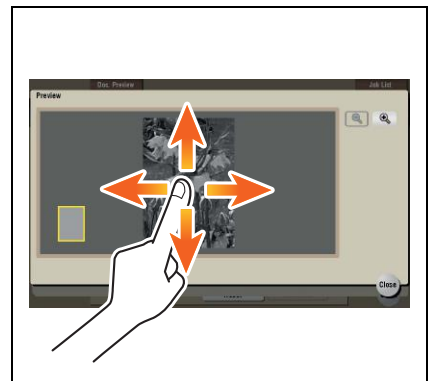

Long-tap

Hold down the document by the finger. Used to display the icon related to the document.

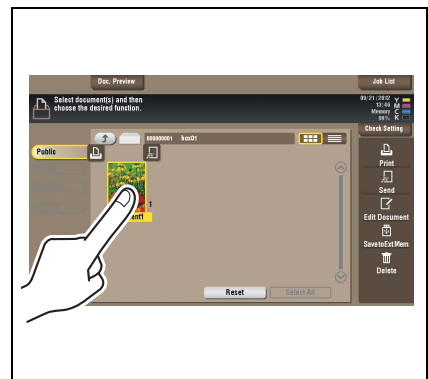

Drag & Drop

Slide your finger to the intended place and release it while a document is selected. Used to move the document to the intended place.

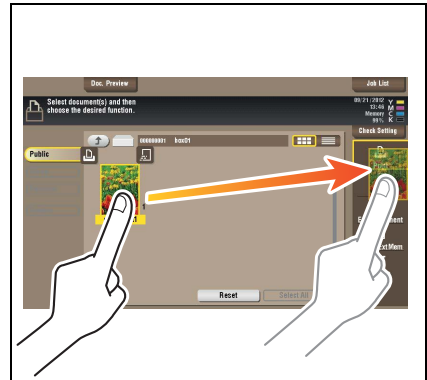

Pinch in/Pinch out

Place two fingers on the screen and then open or close them. Used to enlarge or reduce a preview image.

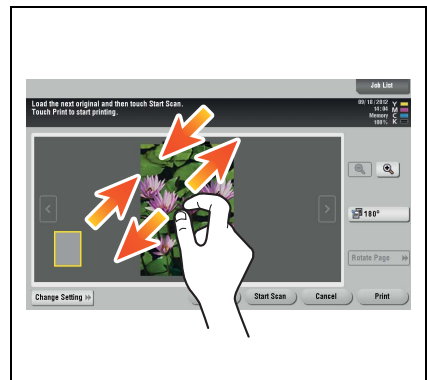

Rotation

Place two fingers on the screen and then rotate them. Used to rotate a preview image.

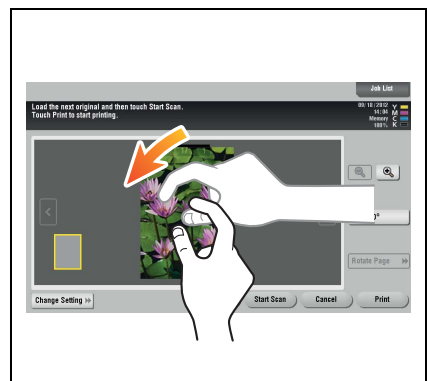

Precautions on using the Touch panel

This machine features a capacitance-base touch panel. Note the following points when operating the **Touch Panel**.

- Use your finger or the **Stylus Pen** supplied with this machine. Note that the **Touch Panel** will not respond appropriately if you operate it using your nail or a pen tip instead of your finger or the **Stylus Pen**.
- Applying a strong force to the **Touch Panel** will damage the **Touch Panel**, and potentially cause a breakage.
- When operating in the **Touch Panel**, do not press on it using excessive force or with a pointed object such as a mechanical pencil.
- The **Touch Panel** may not respond appropriately, if operated with a wet finger.
- The **Touch Panel** will not respond appropriately, if operated with hands with gloves on. It is recommended that you use the **Stylus Pen** supplied with this machine or your finger.
- The **Touch Panel** may not respond appropriately, if the distance between you and a fluorescent lamp is 20 inches (50 cm) or less while you are operating the **Touch Panel**.
- Avoid using the **Touch Panel** at a site near a device that generates electric noise (such as a generator and an air conditioner). The electric noise may cause the **Touch Panel** to operate erratically.

2.6.3 How to display the keypad

When tapping the input area on the copy screen and etc. for entering the number of copies or entering adjustment values, the **Keypad** will be displayed.

It can also be displayed by pressing the 10keypad provided for the **Register** key.

Input area for entering the number of copies

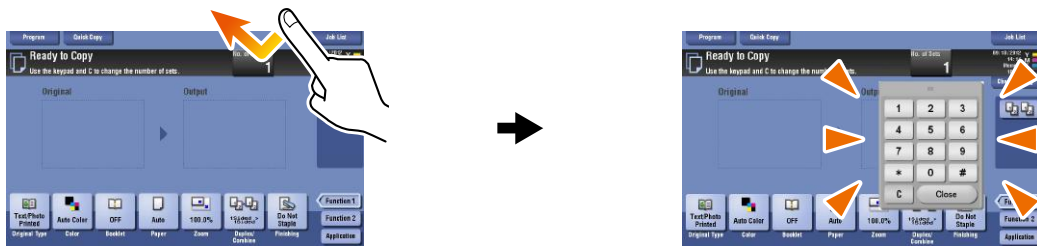

Input area for entering values

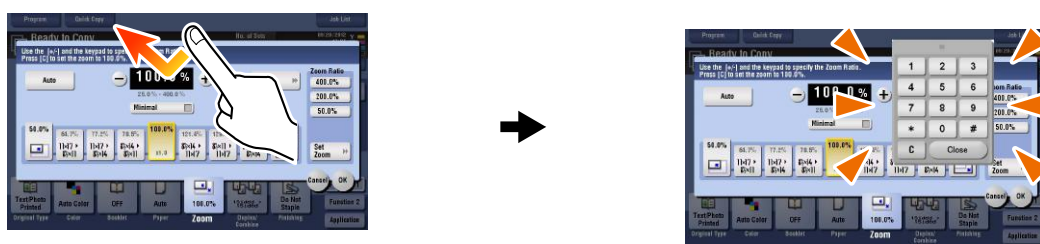

How to move the keypad

Move your finger while the upper side of **Keypad** is being pressed.



How to close the keypad

After entering, tap [Close] to close the **Keypad**.

It can also be closed by pressing the 10keypad provided for the **Register** key.



To display the keypad all the time

The **Keypad** can be displayed all the time on the copy screen, print setting screen for boxes or browser.



Reference

For details, refer to the [User's Guide Online] on the DVD.

2.6.4 Entering characters

When entering characters to register an address or program, use the keyboard screen displayed on the Touch Panel.

When typing in "Group1":

- 1 To type in uppercase letters or symbols, tap the [Shift] key.
 - If you mistyped, tap [←] or [→] to move the cursor to the character you want to clear, then tap the [Delete] key.
 - Tap the [Shift] key again to return to the original keyboard screen.

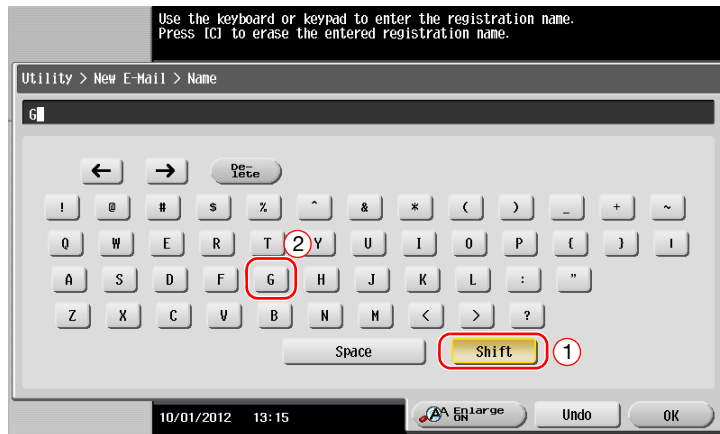

- 2 After typing completes, tap [OK].

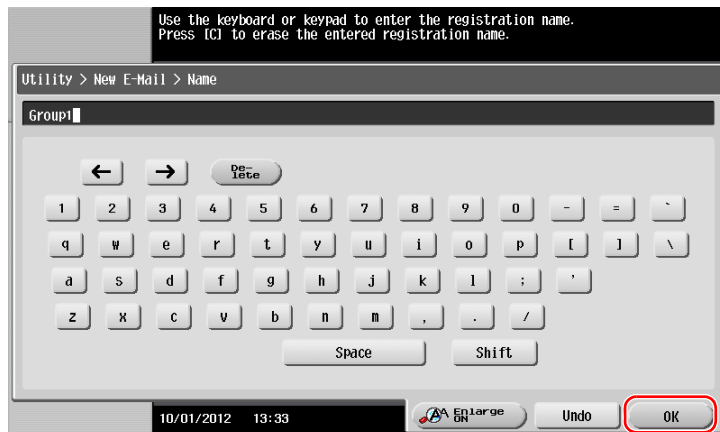

2.7 Jobs

2.7.1 Job screen

A job refers to an operation such as printing, sending, receiving, or saving.

When you tap [Job List] in the main menu or the main screen of each mode, the Job screen appears.

In the Job screen, you can view a list or history of a job currently being executed or print a sending-receiving result report.

In general, jobs are executed starting from the job at the top of the list of currently active jobs. If you are in a hurry to execute any particular jobs, you can rearrange the job execution order.

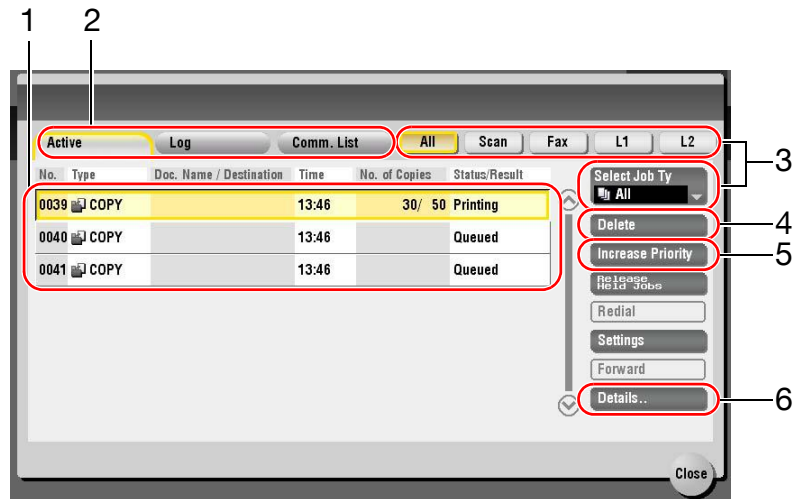

No.	Description
1	Displays jobs.
2	Select a job type. In [Comm. List], you can also print a sending-receiving result report.
3	Tap this button to narrow down the jobs to be displayed.
4	Tap this button to delete a job.
5	Tap this button to select a job to be executed preferentially.
6	Tap this button to view details of a selected job.

2.7.2 Multi-job function

While a job is active, you can register another job. Up to 251 jobs can be registered in total.

The table below shows the maximum number of jobs that can be registered for each function.

Function	Minimum number of jobs	Maximum number of jobs
Copy	5	61
Print	10	66
Scan	5	61
Fax memory TX	50	106
Fax RX	100	156
Sharing	56	-

Reference

- These values may vary depending on conditions.
- For details, refer to the [User's Guide Online] on the DVD.

2.8 Loading Paper

2.8.1 Loading paper in Tray 1 to Tray 4

Up to 500 sheets of plain paper can be loaded into each tray. **Tray3** and **Tray4** are optional.

Applicable paper types

Plain paper, single-side-only paper, thin paper, special paper, thick paper, letterhead, colored paper, and recycled paper

How to load paper

- 1 Pull out the tray.

NOTICE

*Be careful not to touch the **Film**.*

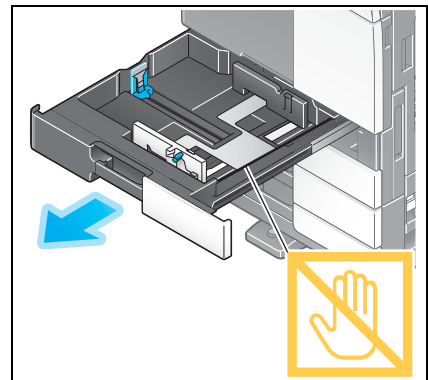

- 2 Slide the **Lateral Guide** to fit the size of the paper to be loaded.

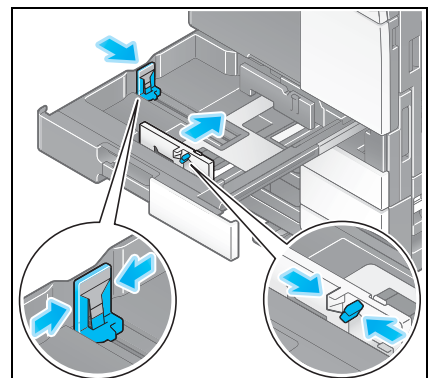

- 3 Load paper into the tray.
→ Load paper into the tray with the print side facing up.

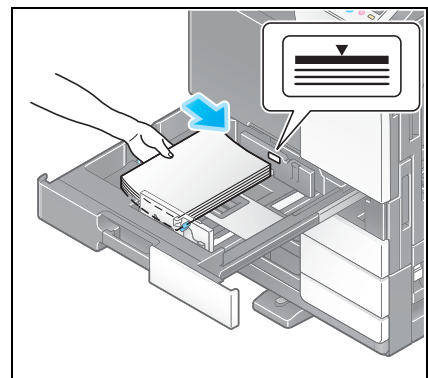

- 4 When loading paper other than plain paper, specify the paper type. For details, refer to page 2-43.

2.8.2 LCT (built-in)

Up to 2500 sheets of plain paper can be loaded into the **LCT (built-in)**. The **LCT (built-in)** is an option.

Applicable paper types

Plain paper, single-side-only paper, thin paper, special paper, thick paper, letterhead, colored paper, and recycled paper

How to load paper

- 1 Pull out the tray.

NOTICE

*Be careful not to touch the **Film**.*

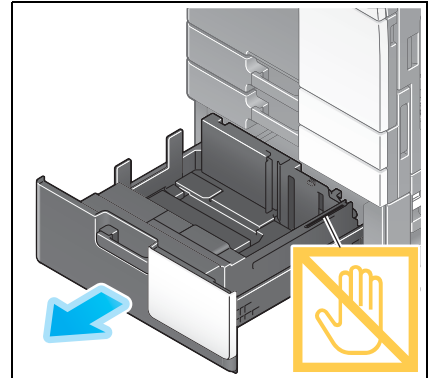

- 2 Load paper into the right tray.

→ Load paper into the tray with the print side facing up.

NOTICE

Do not load the tray with paper of a size other than that previously specified. To change the paper size, contact your service representative.

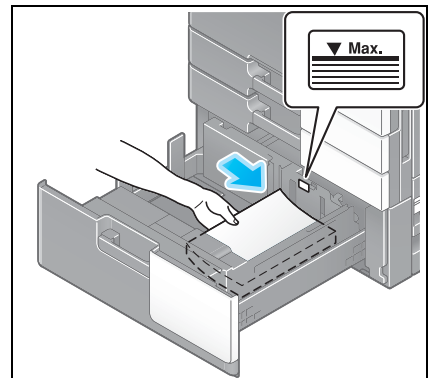

- 3 Load paper into the left tray.

→ Load paper into the tray with the print side facing up.

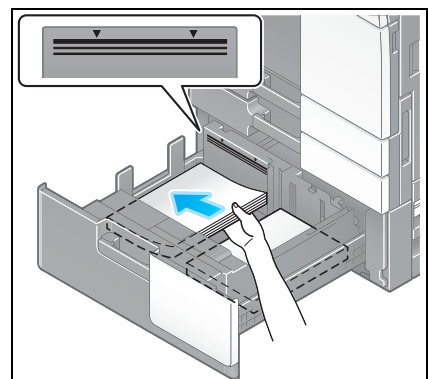

- 4 When loading paper other than plain paper, specify the paper type. For details, refer to page 2-43.

2.8.3 Loading paper into the Large Capacity Unit

Up to 3000 sheets of plain paper can be loaded into **Large Capacity Unit LU-301**, and up to 2500 sheets of plain paper into **Large Capacity Unit LU-204**.

The **Large Capacity Unit** is an option.

Applicable paper types

Plain paper, single-side-only paper, thin paper, special paper, thick paper, letterhead, colored paper, recycled paper

How to load paper

- 1 Open the door.

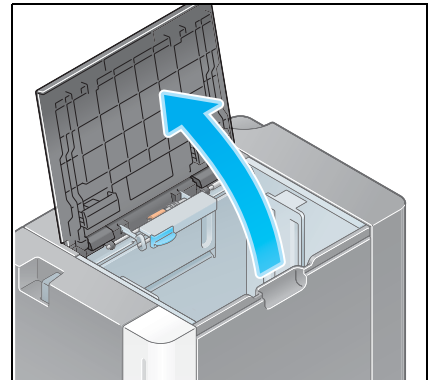

- 2 Lift the **Paper Feed Roller**, and load paper into the unit.
→ Load paper into the tray with the print side facing down.

NOTICE

*Exercise care not to touch the surface of the **Paper Feed Roller** with your hand.*

*Do not load the **Large Capacity Unit** with paper of a size other than that previously specified. To change the paper size, contact your service representative.*

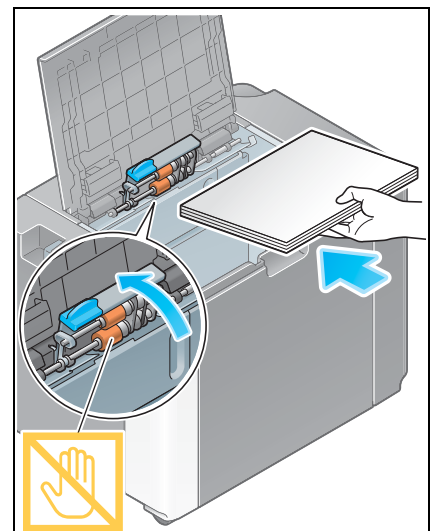

- 3 When loading paper other than plain paper, specify the paper type. For details, refer to page 2-43.

2.8.4 Bypass Tray















Use the **Bypass Tray** when printing on a paper size other than for paper trays, or printing on envelopes or transparencies.

To use the **Bypass Tray**, load paper and specify the paper type.

Applicable paper types

Plain paper, single-side-only paper, special paper, thick paper, postcard (4 × 6 (A6 Card)), transparency, let-head, colored paper, envelope, label sheets, index paper, recycled paper, and banner paper

Applicable paper sizes

Type	Size
Standard-size paper	12 × 18  to 5-1/2 × 8-1/2  /  , 4 × 6  , SRA3  , A3  to A6  , B4  to B6  , A6 card  , 8 × 13  , 16K  /  , 8K  , banner paper
Custom-size paper	Paper width: 3-9/16 to 12-5/8 inches (90 mm to 320 mm) Paper length: 5-1/2 to 47-1/4 inches (139.7 mm to 1,200 mm)

How to load paper

- 1 Open the tray.
 - To load large-sized paper, pull out the **Tray Extension**.
 - To load banner paper, install the **Mount Kit MK-730** for banner paper.

NOTICE

*Exercise care not to touch the surface of the **Paper Feed Roller** with your hands.*

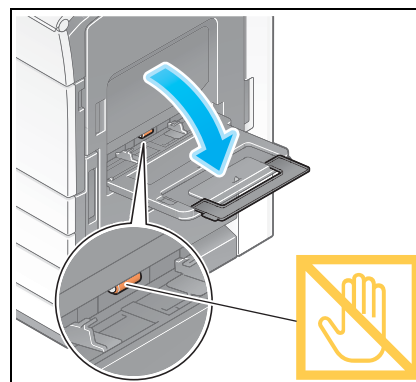

- 2 After loading paper, adjust the **Lateral Guide**.
 - Load paper into the tray with the print side facing down.

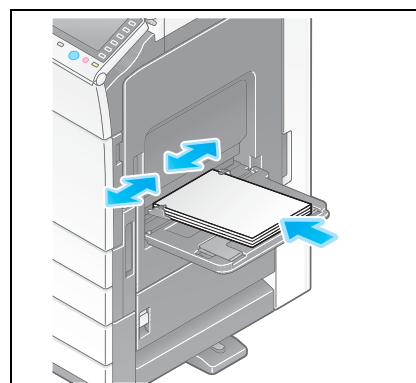

- 3 Specify the paper type. Tap [Paper].

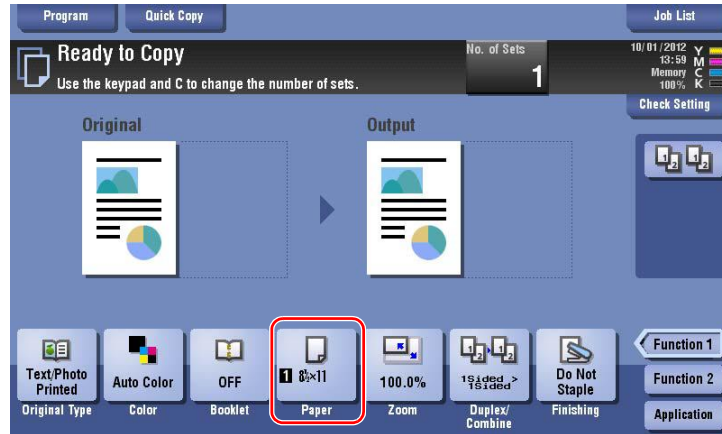

- 4 Select [↓], then tap [Change Tray Setting].



- 5 Select the paper type.

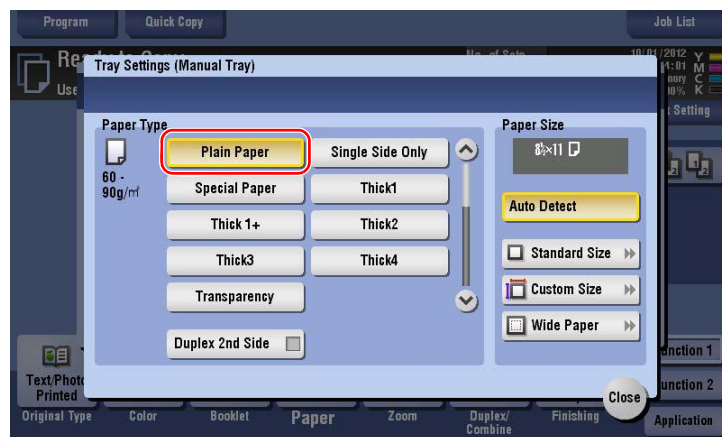

6 Specify the paper size.

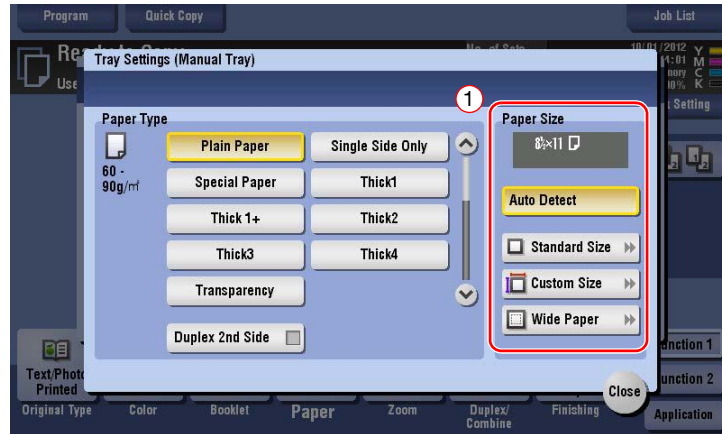

→ For Auto Detect

[Auto Detect] detects the paper size automatically when standard-size paper is loaded into a tray.

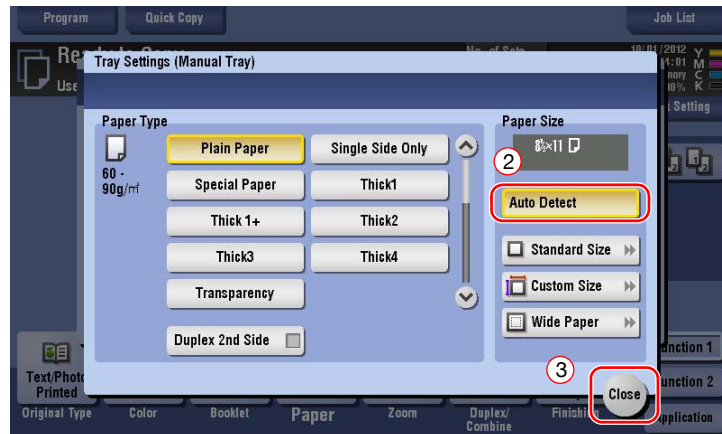

→ For Standard Size

[Standard Size] is available when loading a postcard or standard-size paper for overseas.



→ For Custom Size

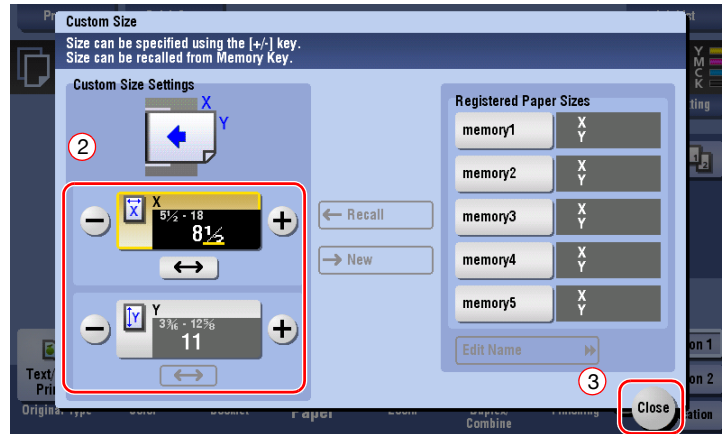

→ For Wide Paper

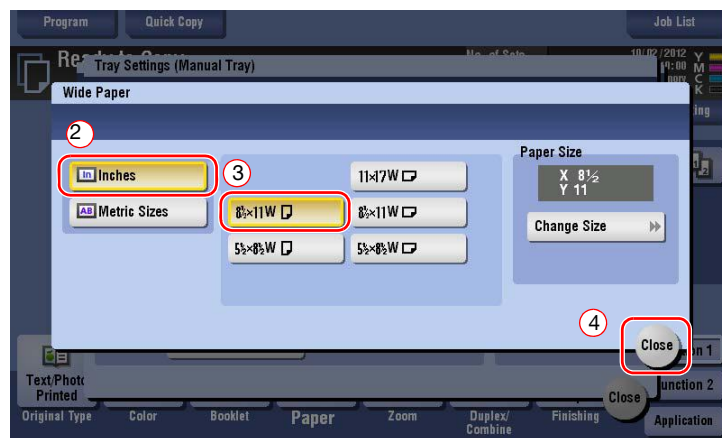

A large, bold, black number '3' is centered within a gray square. The square is positioned to the left of the main title text.

Basic Settings and Operations

3 Basic Settings and Operations

3.1 Print Function

3.1.1 Required settings and basic operations (For Windows OS)

Print data created on your computer via the network.

This section describes how to configure standard print settings using the installer.



Preparation flow

The following describes a preparation flow to print data. For details, refer to the relevant page.

This preparation is not required the second time or subsequent times.

- 1 Checking the cable connection (Administrator)
 - Check that this machine is correctly connected to the network cable. For details, refer to page 3-4.
- 2 Checking network settings of this machine (Administrator)
 - Check the network settings of this machine. For details, refer to page 3-4.
 - The network can be used with the default settings unless otherwise requested.
- 3 Installing the printer driver
 - Install the printer driver on the computer. For details, refer to page 3-5.

Operation flow

The following describes a flow to print data from your computer. For details, refer to page 3-5.

- 1 Opening original data
 - Open the data you want to print using the application software.
- 2 Configuring the printer driver for printing
 - Select a printer driver, and change the setting if necessary before printing.

Checking the cable connection

Check that a LAN cable is connected to the LAN port of this machine and the green LED is on.

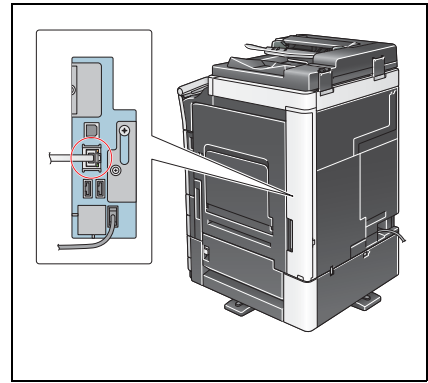

Checking network settings of this machine

Tap [Utility], and select [Device Information]. Check that the IP address is displayed.

- For IPv4 environment

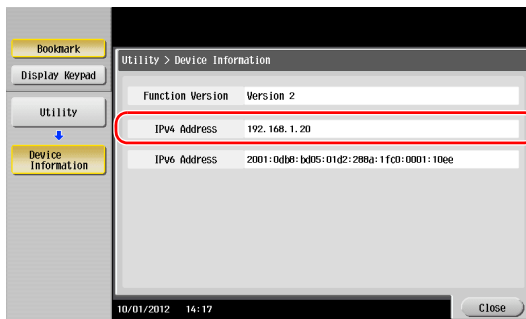

- For IPv6 environment



Tips

- In general, the default settings are available for network connection; however, some network environments require a change on network settings.
- If no IP address is displayed, you need to configure the network. Tap [Utility], and select [Administrator Settings] - [Network Settings] - [TCP/IP Settings]. Configure the required settings to suit your environment. For details, refer to the [User's Guide Online] on the DVD.

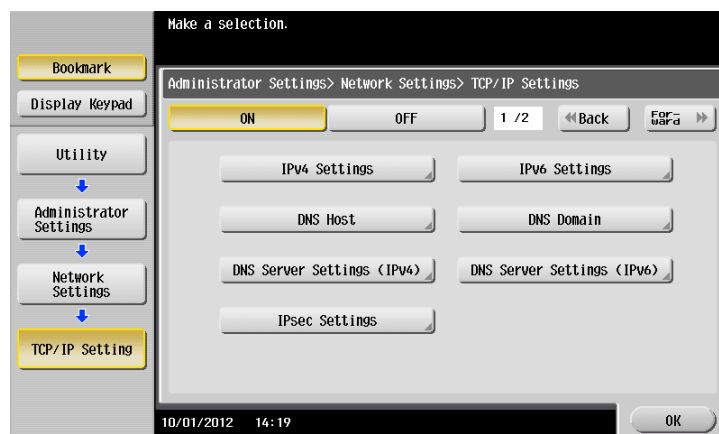

Installing the printer driver

Use the installer to install the printer driver.

- ✓ This operation requires administrator privileges for your computer.

- 1 Insert the DVD-ROM which includes the printer driver into the DVD-ROM drive of the computer.

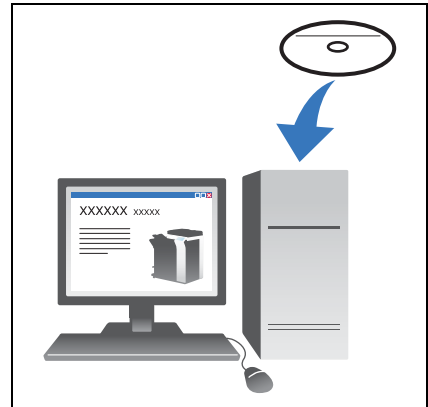

- 2 Click [Printer Install].

- 3 Proceed with the procedure according to the on-screen instructions.

This automatically searches for the appropriate network and displays printers and MFPs that are compatible with the printer driver.

- 4 Select this machine from the list.

→ If multiple identical models are displayed, check the IP address to select an appropriate one. For details on how to check the IP address of this machine, refer to page 3-4.

- 5 Select the check boxes of the printer drivers to be installed.

- 6 Click [Install].

- 7 Click [Finish].

Printing data

- 1 Open the data you want to print using the application software.

- 2 In the [File] menu, click [Print].

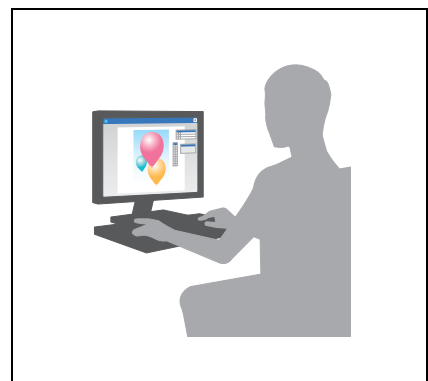

- 3 Select the installed printer driver, and click [Print].

Tips

- Clicking [Preferences] can change the setting of the printer driver as required.
- If user authentication is enabled in this machine, specify the required data such as the user name and password.

Types of printer drivers

Select a printer driver that will meet your printing requirements.

Driver type	Description
PCL	This is a standard driver for printing general office documents. Among the three drivers, this driver provides the fastest printing speed.
PS	This driver is effective to exactly print data that is created using PostScript-compatible application software from Adobe or other vendors. This driver is often used in graphics and light printing applications where good color reproducibility is important.
XPS	Developed after Windows Vista, this driver supports XML Paper Specification (XPS). This driver has several advantages, including high-quality reproduction of translucence.

3.1.2 Required settings and basic operations (For Mac OS)

Print data created on your computer via the network.

This section describes how to configure a printer driver, for the OS X 10.6 environment, Bonjour connection, and use of metric-size paper as major conditions.



Preparation flow

The following describes a preparation flow to print data. For details, refer to the relevant page.

This preparation is not required the second time or subsequent times.

- 1 Checking the cable connection (Administrator)
 - Check that this machine is correctly connected to the network cable. For details, refer to page 3-7.
- 2 Checking network settings of this machine (Administrator)
 - Check the network settings of this machine. For details, refer to page 3-7.
 - The network can be used with the default settings unless otherwise requested.
- 3 Installing the printer driver
 - Install the printer driver on the computer. For details, refer to page 3-9.
- 4 Adding and configuring a printer driver
 - Set up your computer so that data can be printed using the installed printer driver. For details, refer to page 3-10.

Operation flow

The following describes a flow to print data from your computer. For details, refer to page 3-10.

- 1 Opening original data
 - Open the data you want to print using the application software.
- 2 Configuring the printer driver for printing
 - Select a printer driver, and change the setting if necessary before printing.

Checking the cable connection

Check that a LAN cable is connected to the LAN port of this machine and the green LED is on.

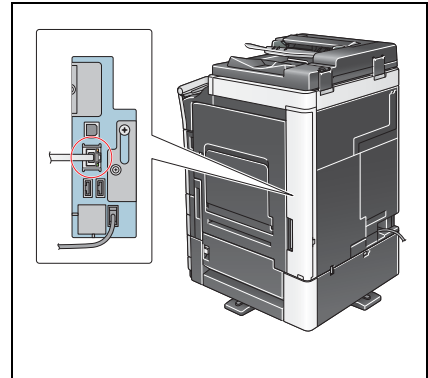

Checking network settings of this machine

- 1 Tap [Utility], and select [Device Information]. Check that the IP address is displayed.

- For IPv4 environment



- For IPv6 environment



- 2 Specify the Bonjour name. Tap [Utility], and select [Administrator Settings] - [Network Settings] - [Bonjour Setting] - [ON].

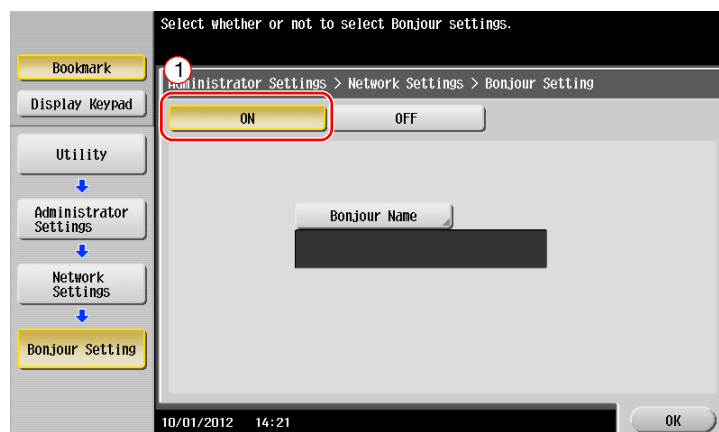

- The Bonjour name is displayed on the printer driver as a connected device name. For "bizhub C364e (5A:0C:4B)", "bizhub C364e" indicates the product name, and "(5A:0C:4B)" indicates the last three bytes of the MAC address.

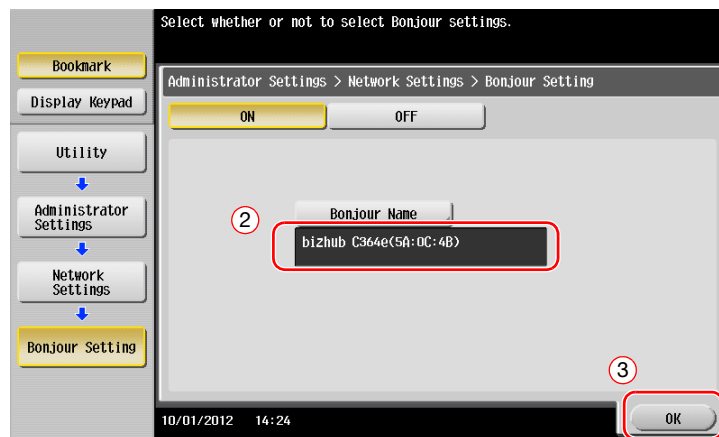

- To change the Bonjour name, tap [Bonjour Name], and enter the name using the displayed keyboard.



If no IP address is displayed in Step 1, you need to set up the network.

- Tap [Utility], and select [Administrator Settings] - [Network Settings] - [TCP/IP Settings]. Configure the required settings to suit your environment. For details, refer to the [User's Guide Online] on the DVD.

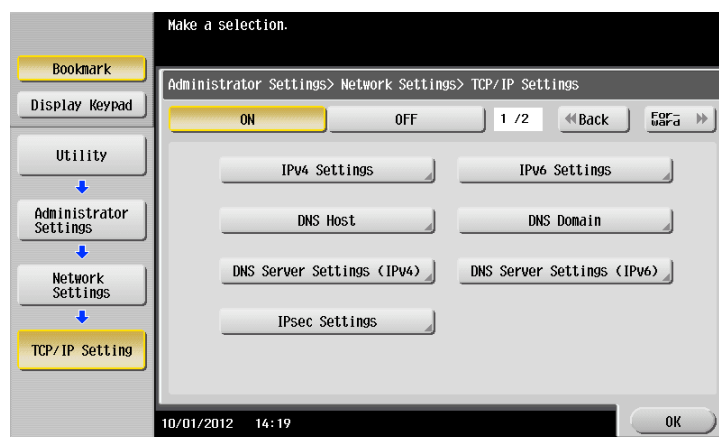

Installing the printer driver

Use the installer to install the printer driver.

- ✓ This operation requires administrator privileges for your computer.

- 1 Insert the DVD-ROM which includes the printer driver into the DVD-ROM drive of the computer.

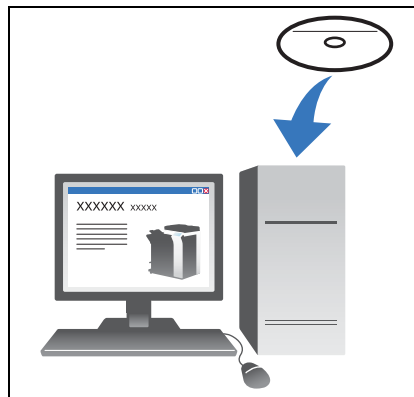

- 2 Select the target printer driver, and copy it to the desktop.
Example: /Driver/OS_10_6_x/Letter/
bizhub_C554_C364_106.pkg (Printer driver for OS X 10.6)
→ When ordinarily using metric-sized paper, select a printer driver in the "A4" directory.
→ The last three digits of the printer driver name indicate the version of the operating system.

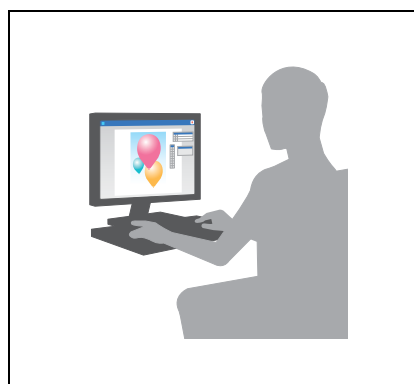

- 3 Double-click the file copied onto the desktop.
- 4 Proceed with the procedure according to the on-screen instructions until the installation screen appears.
- 5 Click [Install].
- 6 When a prompt message appears to ask you to enter the name and password, type in the name and password of the user with administrator privileges.
- 7 Click [Close].

Adding and configuring a printer driver

Set up your computer so that data can be printed using the installed printer driver.

- ✓ This operation requires administrator privileges for your computer.

1 In the Apple Menu, click [System Preferences] - [Print & Fax].

2 Click [+].

This automatically searches for the appropriate network and displays printers and MFPs that are compatible with the printer driver.

3 Select a printer for the Bonjour connection. Search for this machine from the list of printers for which [Kind] is set to [Bonjour], and click it.

→ If you cannot identify the connected machine because multiple same product names are listed, check with the administrator.

This automatically searches for a printer driver compatible with the selected printer.

4 Check that the printer driver is displayed.

5 Select the installed optional units.

Printing data

1 Open the data you want to print using the application software.

2 From the [File] menu, select [Print].

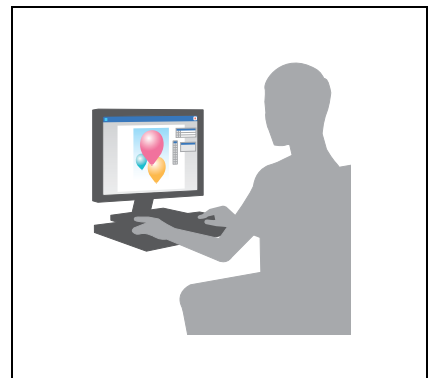

3 Select the Bonjour name of this machine.

Tips

- If necessary, you can change the settings of the printer driver.

3.2 Scan-to-Send function

3.2.1 Various transmission methods

The original data scanned by this machine can be sent and saved using a variety of methods.

Sending data to your computer (SMB Send)

Send scanned data to a computer on the network. Once settings are configured, you can send data easily. For details, refer to page 3-12 and page 3-20.



Transmitting data as E-mail attachment (E-mail TX)

Send scanned data as an E-mail attachment. This function is useful when you want to forward data to an outside location. For details, refer to page 3-28.

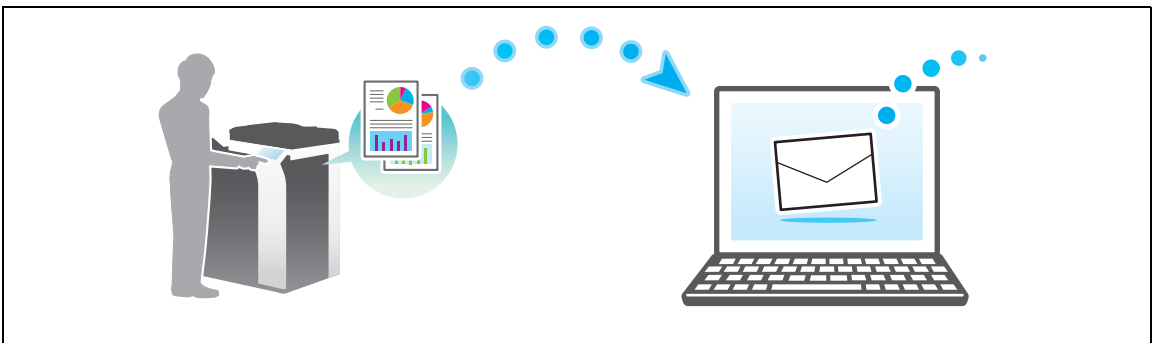

Saving data to the USB memory device (External memory)

Directly save scanned data on the USB memory device connected to this machine. For details, refer to page 3-59.

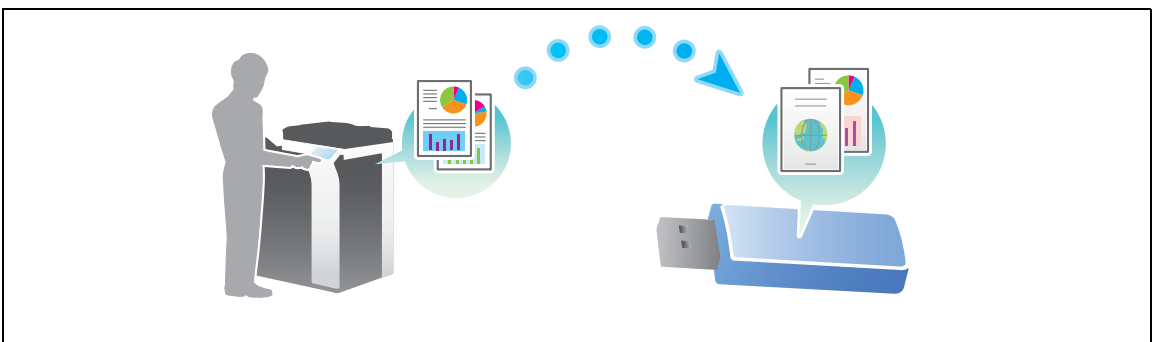

Various methods for transmitting and saving data

In addition to the above, data can be sent and saved in various methods. Select the appropriate one to meet your needs.

- Issuing a scan instruction from a computer (Web service function)
- Saving data to a User Box on the HDD (Save in User Box)
- Sending to an FTP server (FTP TX)
- Sending to a WebDAV server (WebDAV Send)



Reference

For details, refer to the [User's Guide Online] on the DVD.

3.2.2 Sending data to your Windows computer (SMB Send)

Send scanned data to a computer on the network.

Once settings are configured, you can send data easily.



Preparation flow

The following describes a preparation flow for sending scanned data. For details, refer to the relevant page. This preparation is not required the second time or subsequent times.

- 1 Checking the cable connection (Administrator)
 - Check that this machine is correctly connected to the network cable. For details, refer to page 3-13.
- 2 Checking network settings of this machine (Administrator)
 - Check the network settings of this machine. For details, refer to page 3-14. The network can be used with the default settings unless otherwise requested.
- 3 Checking computer information
 - Check the information required for Store Address, and fill out the checklist. For details, refer to page 3-15.
- 4 Configuring your computer
 - Configure settings to share a computer, or create a dedicated folder to receive files. For details, refer to page 3-15.
- 5 Registering destinations
 - Register destinations to which files are sent while checking the checklist. For details, refer to page 3-16.

Operation flow

The following describes a transmission flow. For details, refer to page 3-18.

- 1 Loading the original
- 2 Selecting a destination
 - Select a registered destination, and check the settings such as the file type and image quality.
- 3 Press the **Start** key.
 - Press the **Start** key to scan the original.

Checking the cable connection

Check that a LAN cable is connected to the LAN port of this machine and the green LED is on.

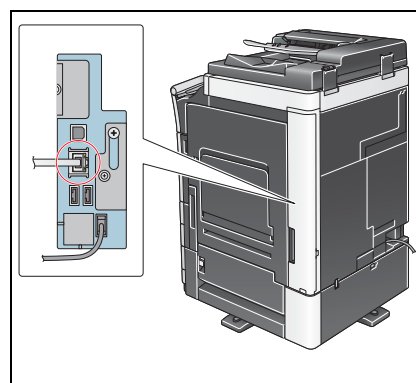

Checking network settings of this machine

Tap [Utility], and select [Device Information]. Then, check that the IP address is displayed.

- For IPv4 environment
- For IPv6 environment

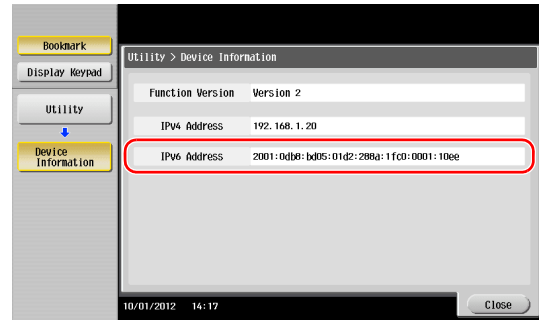
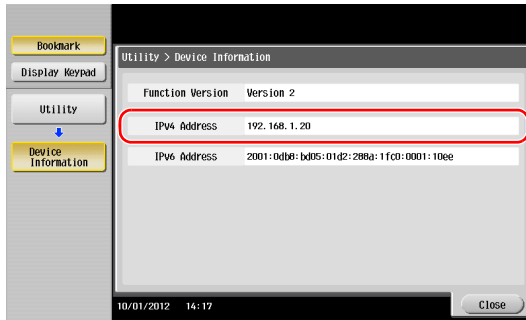

Tips

- In general, the default settings are available for network connection; however, some network environments require a change on network settings.
- If no IP address is displayed, you need to configure the network. Tap [Utility], and select [Administrator Settings] - [Network Settings] - [TCP/IP Settings]. Configure the required settings to suit your environment. For details, refer to the [User's Guide Online] on the DVD.

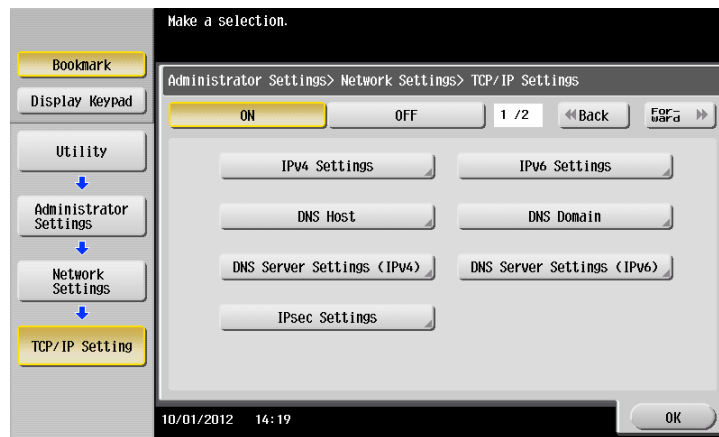

Checklist

While making notes in the checklist shown below, check computer information and configure settings for preparation. The completed checklist is used for Store Address.

Name	Entry column	Detail
Host Address	Host name or IP address to which the scanned data is sent	page 3-15
File Path	Name of the dedicated folder to receive the scanned data	page 3-15
User ID	User name required to log in to the computer	page 3-15
Password	Password required to log in to the computer <ul style="list-style-type: none"> • You should not enter this column for security reasons. 	Contact your system administrator.

Checking computer information

Check the host address and user ID, and write them down.

- 1 Display the Properties window of the computer.
 - In Windows 8, right-click on the Start window, then select [All apps] - [Computer]. On the toolbar, select [Computer] - [System properties].
 - In Windows Vista/7, from the Start menu, select [Computer] - [System properties].
 - In Windows XP, open the Start menu, and right-click on [My Computer], and select [Properties].
- 2 Check the computer name, and write it down in the Host address column of the checklist.
- 3 Open the command prompt.
 - In Windows 8, right-click on the Start window, then select [All apps] - [Command Prompt].
 - In Windows Vista/7, from the Start menu, select [All Programs] - [Accessories] - [Command Prompt].
 - In Windows XP, open the Start menu, and select [Programs] - [Accessories] - [Command Prompt].
- 4 Check the user name, and write it down in the User ID column of the checklist.

Configuring your computer

Create a new folder, and enable the sharing settings.

- ✓ This operation requires administrator privileges for your computer.

- 1 Display the Network and Sharing Center window to configure a sharing setting.
 - In Windows 8, right-click on the Start window, select [All apps] - [Control Panel] - [Network and Internet] - [Network and Sharing Center] - [Change advanced sharing settings], then select the [Turn on file and printer sharing] check box.
 - In Windows 7, from the Start menu, select [Control Panel] - [Network and Internet] - [Network and Sharing Center] - [Change advanced sharing settings] then select the [Turn on file and printer sharing] check box.
 - In Windows Vista, open the Start menu, select [Control Panel] - [Network and Sharing Center], then turn on [File sharing].
 - For Windows XP, the control panel setting is not required.
- 2 Create a new folder, and write down the folder name in the File path column of the checklist.
- 3 Only for Windows XP, check the folder options.
 - Double-click the folder, select [Tools] - [Folder Options...] then click the [View] tab.
 - Clear the [Use simple file sharing (Recommended)] check box.
- 4 Configure the setting to share the folder created in Step 2. Right-click on the folder, then click [Properties].
 - For Windows XP, right-click on the folder, then click [Sharing and Security].
- 5 Click the [Sharing] tab, then click [Advanced Sharing].
 - For Windows XP, [Advanced Sharing] does not appear.
- 6 Select the [Share this folder] check box, then click [Permissions].
- 7 Select [Everyone] from the [Group or user names:] list, then select all of the [Allow] check boxes.

Registering destinations

While checking the created checklist, register the folder for receiving the scanned data as an address book of this machine.

- 1 Tap [Utility], and select [One-Touch/ User Box Reg.] - [Create One-Touch Destination] - [Address Book (Public)] - [PC (SMB)].

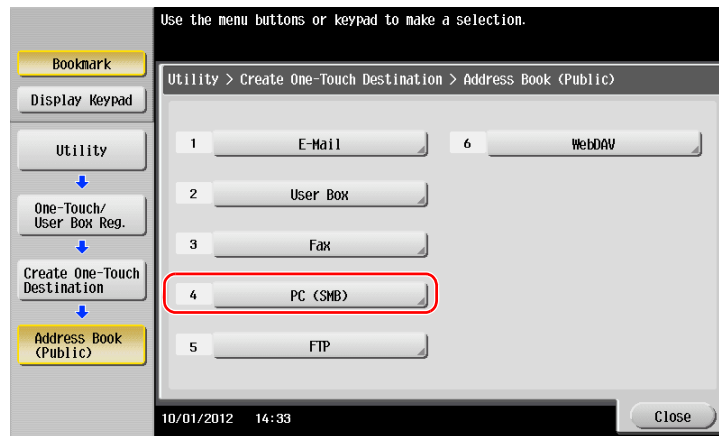

- 2 Tap [New].

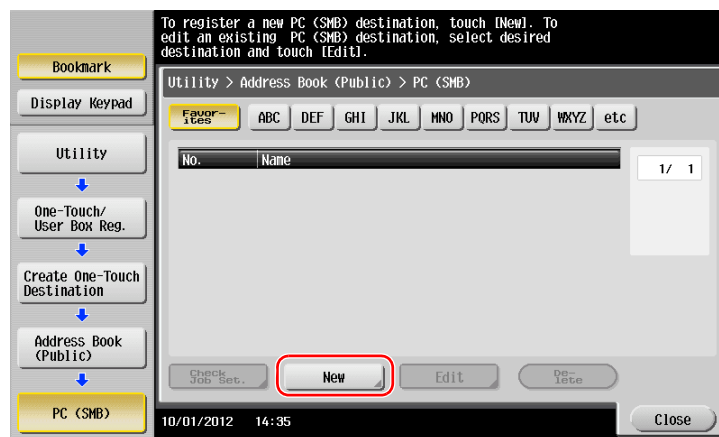

- 3 For [Name], specify the name to be displayed on the assigned key.
For [Sort Character], enter the same name as [Name].

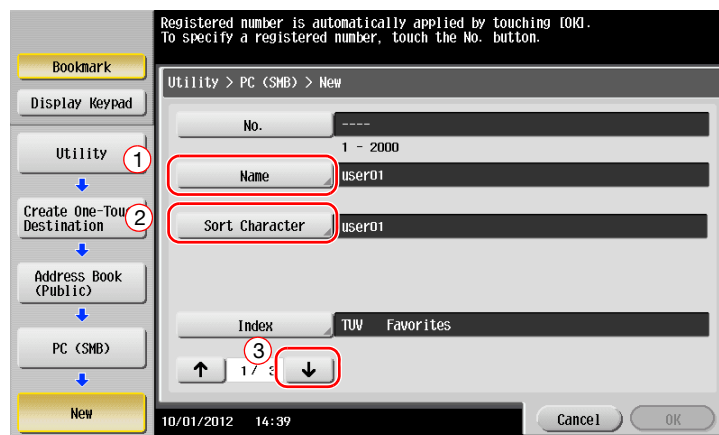

→ This sets the appropriate index for the name, which you entered into [Name], to [Index]. To change the setting, tap [Index].

- 4 While checking the checklist, enter the user ID and password you wrote down.

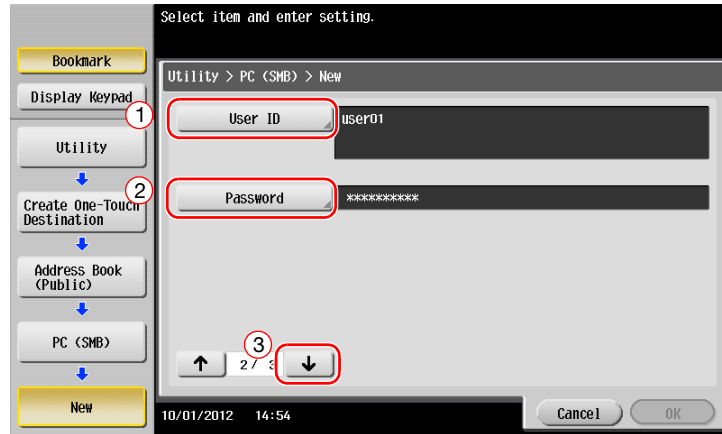

- 5 While checking the checklist, enter the host address and file path you wrote down.

→ When not specifying a folder, enter a slash "/" for the file path. When specifying a folder, enter only the folder name without slash "/".

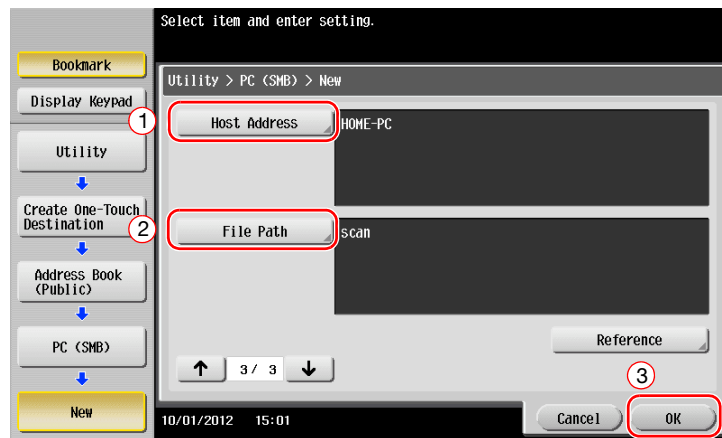

- 6 Tap [Close].

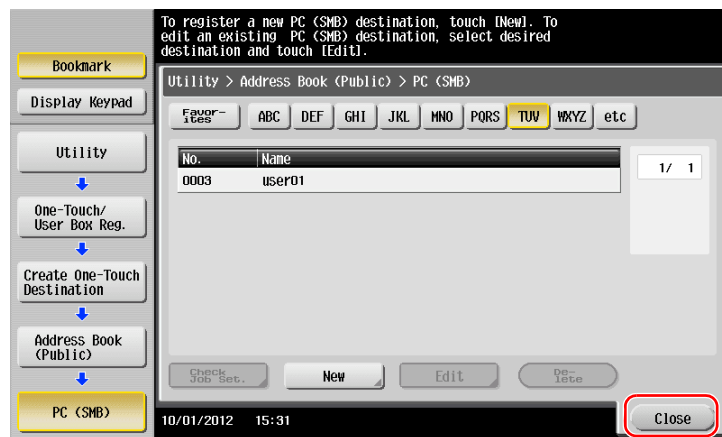

Sending the original

- 1 Load the original.

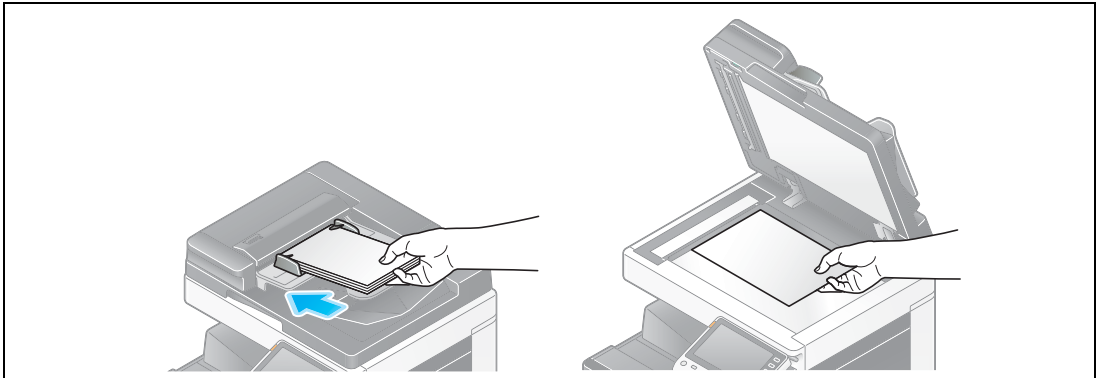

- 2 Tap [Scan/Fax].

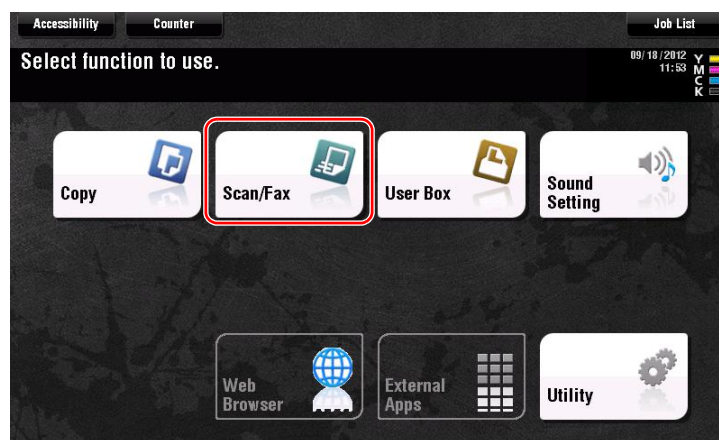

- 3 Select a destination.

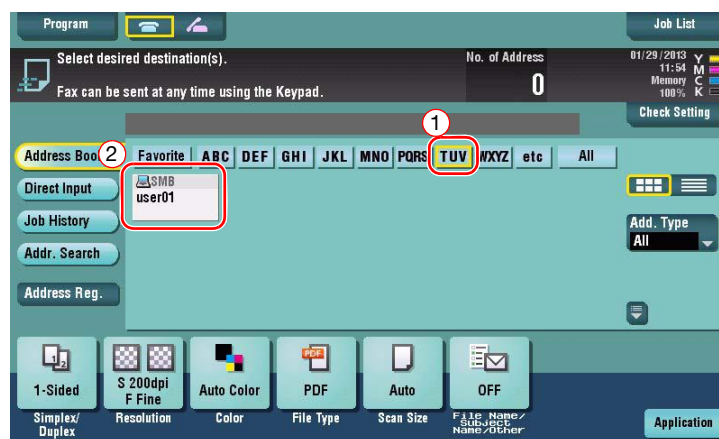

- 4 Check the setting if necessary.
 → Tap [Check Setting] to check the setting.



- You can also check the setting using the keys displayed on the **Touch Panel**.
 → To change the setting, tap the desired key on the **Touch Panel**.

Settings	Description
[Simplex/Duplex]	Select whether to scan one or both sides of the original.
[Resolution]	Specify the scanning resolution.
[Color]	Select whether to scan the original in color or black and white mode.
[File Type]	Select the type of the file to save scanned data.
[Scan Size]	Specify the size of the original to be scanned.
[File Name/Subject Name/Other]	Change the file name or the subject of an E-mail to be sent.

- 5 Press the **Start** key.

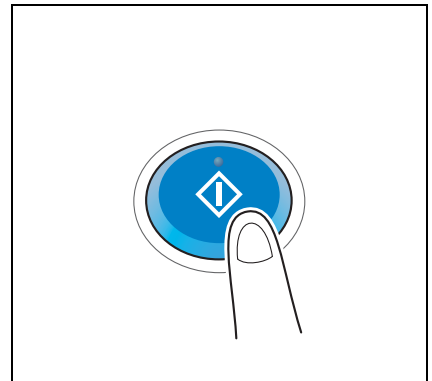

3.2.3 Sending data to your Mac computer (SMB Send)

Send scanned data to a computer on the network.

Once settings are configured, you can send data easily.

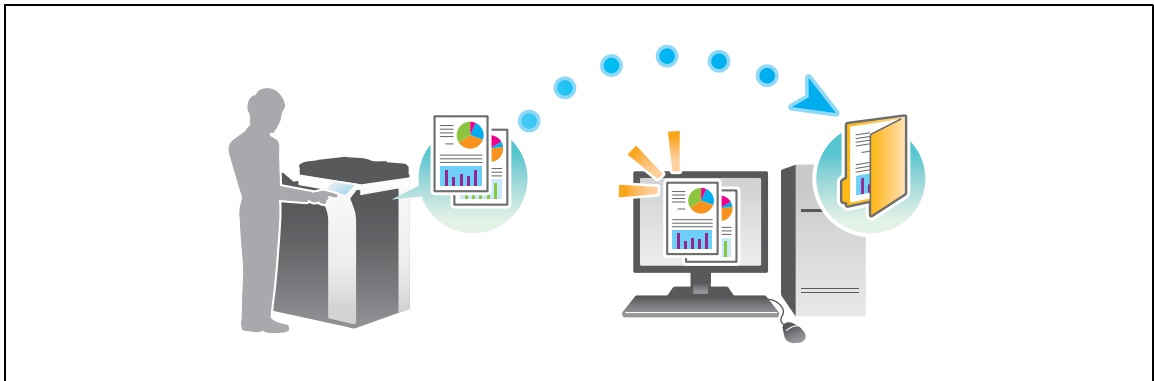

Preparation flow

The following describes a preparation flow for sending scanned data. For details, refer to the relevant page.

This preparation is not required the second time or subsequent times.

- 1 Checking the cable connection (Administrator)
 - Check that this machine is correctly connected to the network cable. For details, refer to page 3-21.
- 2 Checking network settings of this machine (Administrator)
 - Check the network settings of this machine. For details, refer to page 3-21.
- 3 Checking computer information
 - Check the information required for Store Address, and fill out the checklist. For details, refer to page 3-23.
- 4 Configuring your computer
 - Configure settings to share a computer, or create a dedicated folder to receive files. For details, refer to page 3-23.
- 5 Registering destinations
 - Register destinations to which files are sent while checking the checklist. For details, refer to page 3-24.

Operation flow

The following describes a transmission flow. For details, refer to page 3-26.

- 1 Loading the original
- 2 Selecting a destination
 - Select a registered destination, and check the settings such as the file type and image quality.
- 3 Press the **Start** key.
 - Press the **Start** key to scan the original.

Checking the cable connection

Check that a LAN cable is connected to the LAN port of this machine and the green LED is on.

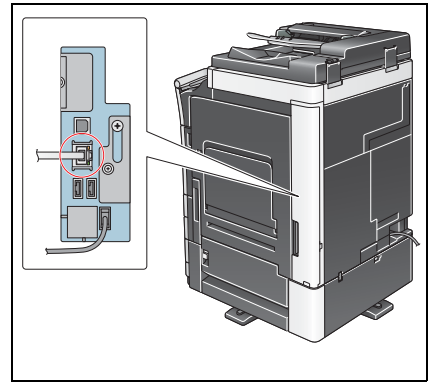

Checking network settings of this machine

Tap [Utility], and select [Device Information].

Check that the IP address is displayed.

- For IPv4 environment

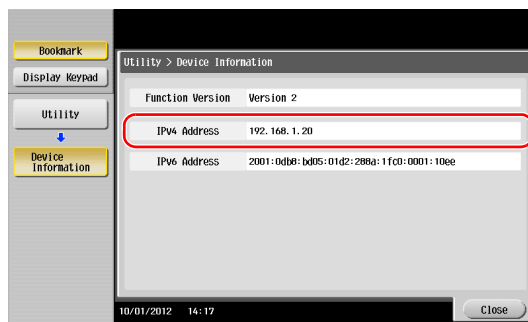

- For IPv6 environment

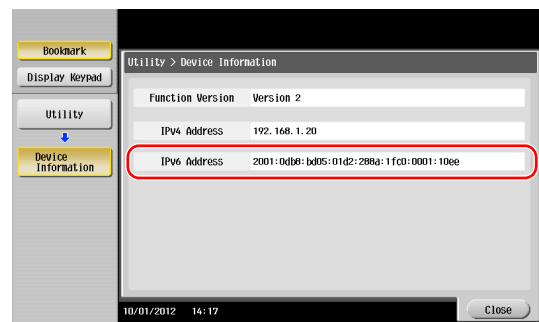

Tips

- In Mac OS X10.6 or earlier, the default settings are available during general use, but you need to change settings depending on your network environment.
- If no IP address is displayed, you need to configure the network. Tap [Utility], and select [Administrator Settings] - [Network Settings] - [TCP/IP Settings]. Configure the required settings to suit your environment. For details, refer to the [User's Guide Online] on the DVD.

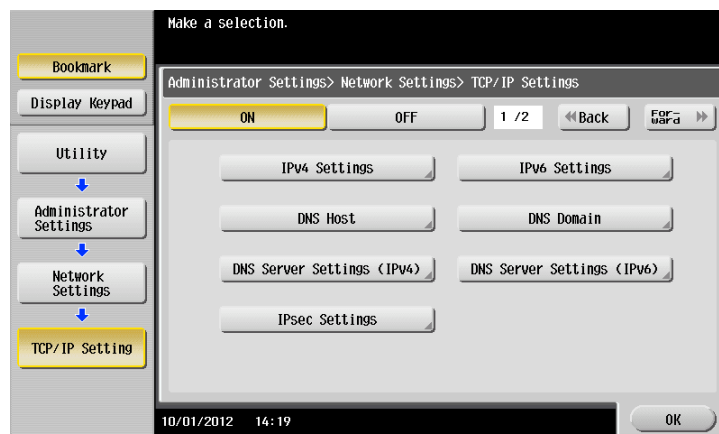

Configuring this machine (Mac OS X 10.7 or later)

The following settings are only required in Mac OS X 10.7 or later.

- Select [NTLM v1/v2] in [Utility] - [Administrator Settings] - [Network Settings] - [SMB Settings] - [Client Settings], then tap [OK].

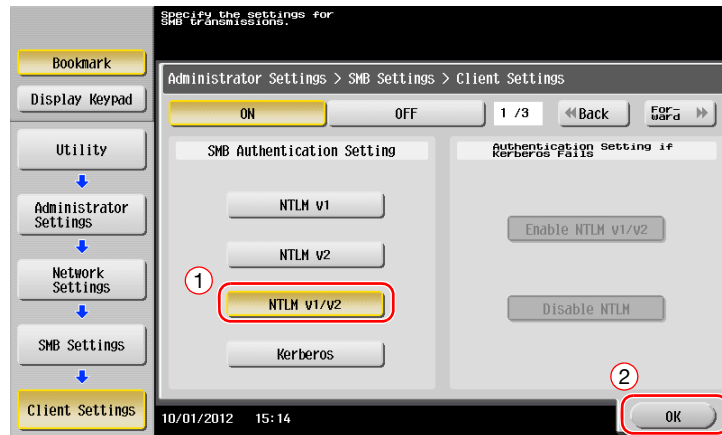

- Select [ON] in [Utility] - [Administrator Settings] - [Network Settings] - [SMB Settings] - [Direct Hosting Setting], then tap [OK].

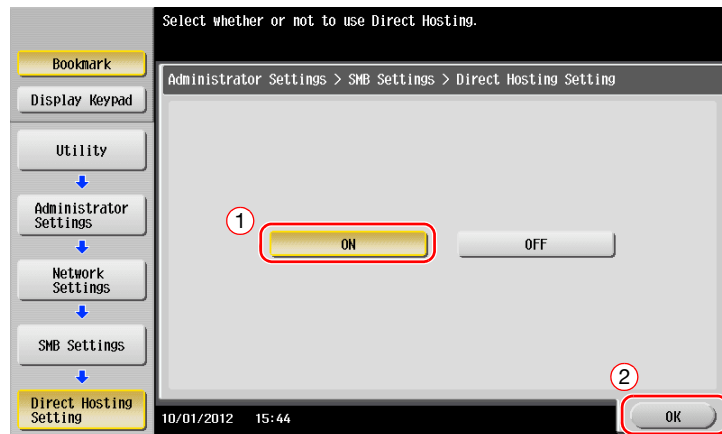

- Select [Utility] - [Administrator Settings] - [System Settings] - [Date/Time Settings] to specify the same date/time and time zone between this machine and your computer, then tap [OK].

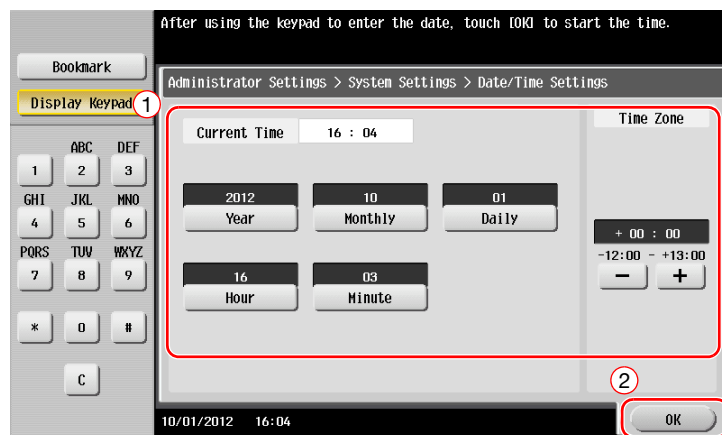

Checklist

While making notes in the checklist shown below, check computer information and configure settings for preparation. The completed checklist is used for Store Address.

Name	Entry column	Detail
Host Address	IP address to which the scanned data is sent	page 3-23
File Path	Name of the dedicated folder to receive the scanned data	page 3-23
User ID	User name required to log in to the computer	page 3-23
Password	Password required to log in to the computer <ul style="list-style-type: none"> Entering the password here is not recommended for security reasons. 	Contact your system administrator.

Checking computer information

Check the host address and user ID.

- ✓ This operation requires administrator privileges for your computer.
- ➔ Check the IP address and user name, and write it down in the Host Address and User ID columns of the checklist.

Configuring your computer

Create a new folder, and enable the sharing settings.

- ✓ This operation requires administrator privileges for your computer.
- 1 Create a new folder, and write down the folder name in the File path column of the checklist.
- 2 Enable the folder sharing settings. In the Apple menu, select [System Preferences] - [Sharing].
- 3 Select the [File Sharing] check box, then click [Options...].
- 4 Select the [Share files and folders using SMB (Windows)] and user name check boxes, then click [Done].
- 5 Under [Shared Folders:], click [+].
- 6 Select a new folder.
- 7 Click the new folder to check the access right.
If the access right is changed to [Read & Write], the setting is completed.

Registering destinations

While checking the created checklist, register the folder for receiving the scanned data as an address book of this machine.

- 1 Tap [Utility], and select [One-Touch/ User Box Reg.] - [Create One-Touch Destination] - [Address Book (Public)] - [PC (SMB)].

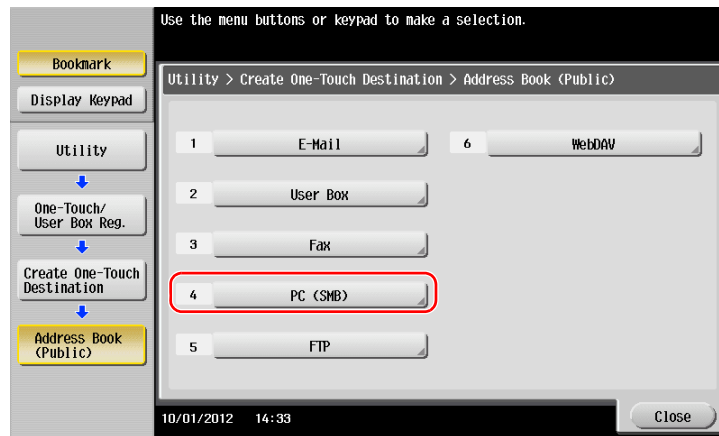

- 2 Tap [New].

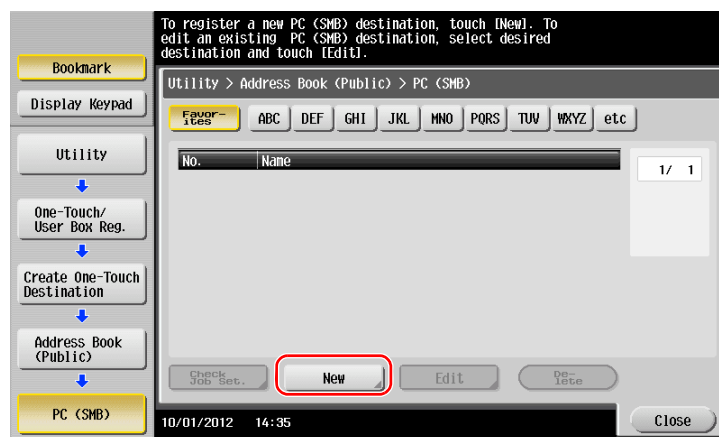

- 3 For [Name], specify the name to be displayed on the assigned key.
→ For [Sort Character], enter the same name as [Name].

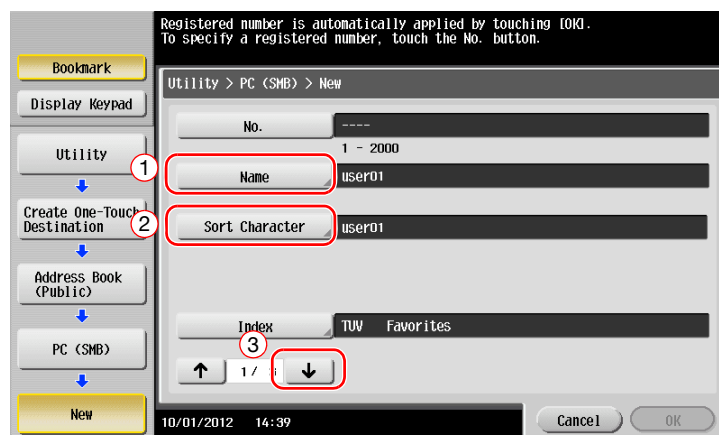

- This sets the appropriate index for the name, which you entered into [Name], to [Index]. To change the setting, tap [Index].

- 4 While checking the checklist, enter the user ID and password you wrote down.

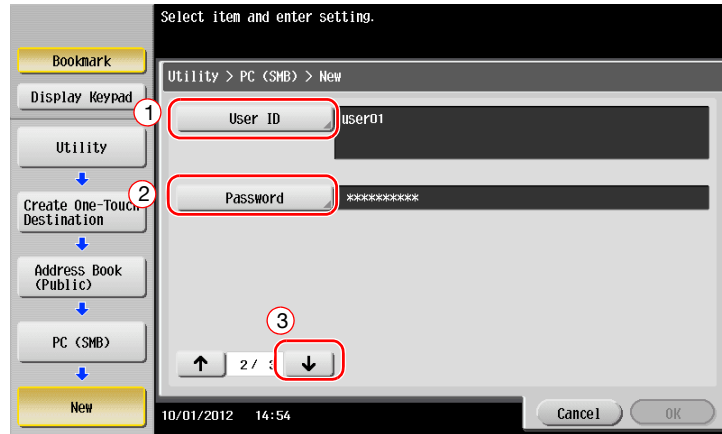

- 5 While checking the checklist, enter the host address and file path you wrote down.
 → When not specifying a folder, enter a slash "/" for the file path. When specifying a folder, enter only the folder name without slash "/".

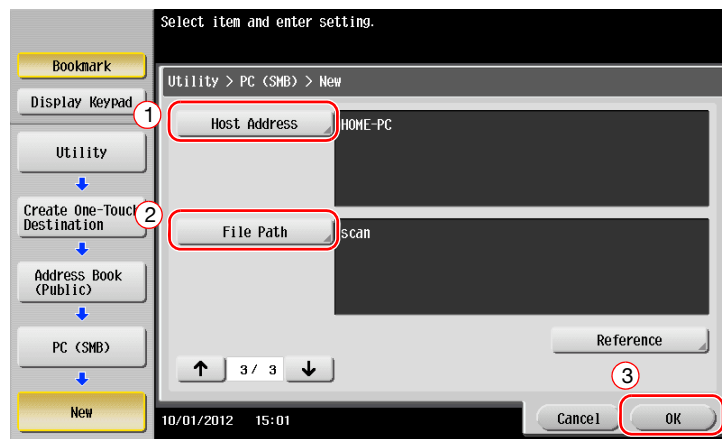

- 6 Tap [Close].

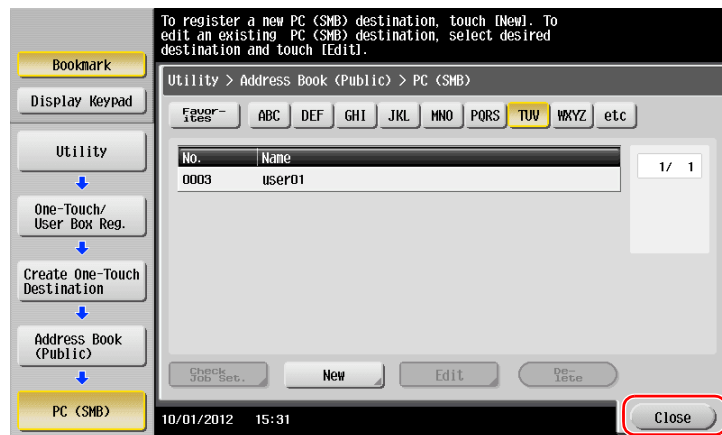

Sending the original

- 1 Load the original.

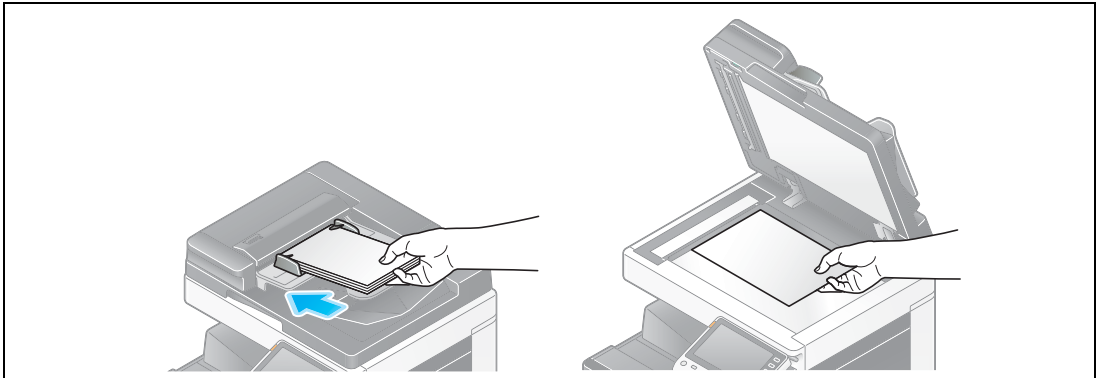

- 2 Tap [Scan/Fax].

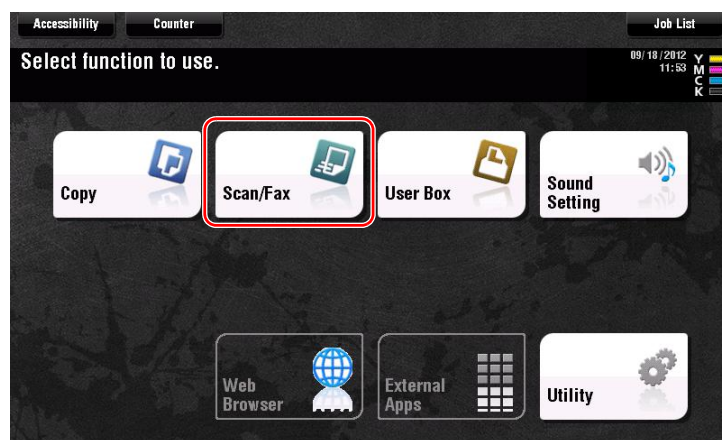

- 3 Select a destination.

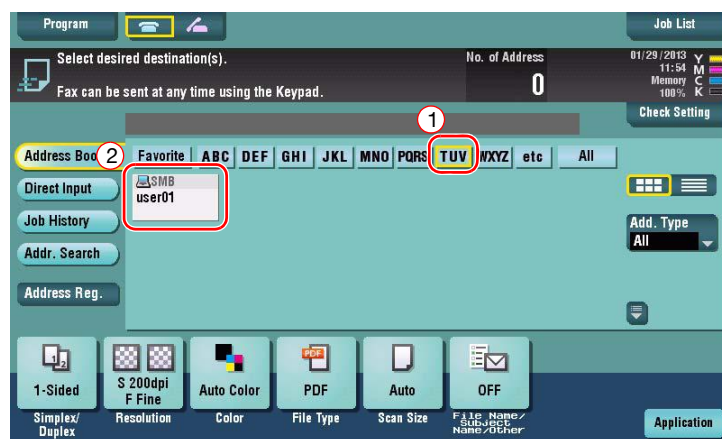

- 4 Check the setting if necessary.
 → Tap [Check Setting] to check the setting.

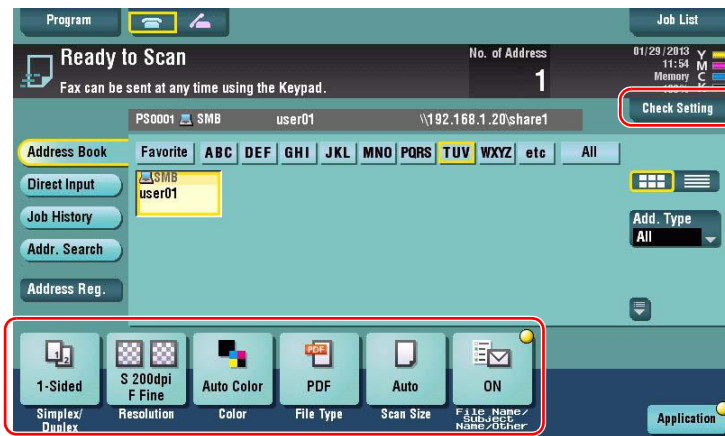

- You can also check the setting using the keys displayed on the **Touch Panel**.
 → To change the setting, tap the desired key on the **Touch Panel**.

Settings	Description
[Simplex/Duplex]	Select whether to scan one or both sides of the original.
[Resolution]	Specify the scanning resolution.
[Color]	Select whether to scan the original in color or black and white mode.
[File Type]	Select the type of the file to save scanned data.
[Scan Size]	Specify the size of the original to be scanned.
[File Name/Subject Name/Other]	Change the file name or the subject of an E-mail to be sent.

- 5 Press the **Start** key.

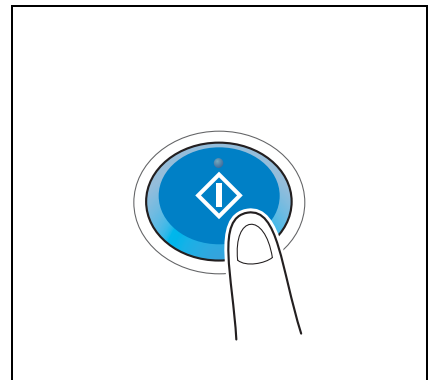

3.2.4 Transmit the scanned data via E-mail (E-mail TX)

Send scanned data as an E-mail attachment.

This function allows you to receive data at an outside location, which is useful when a quick measure is required.

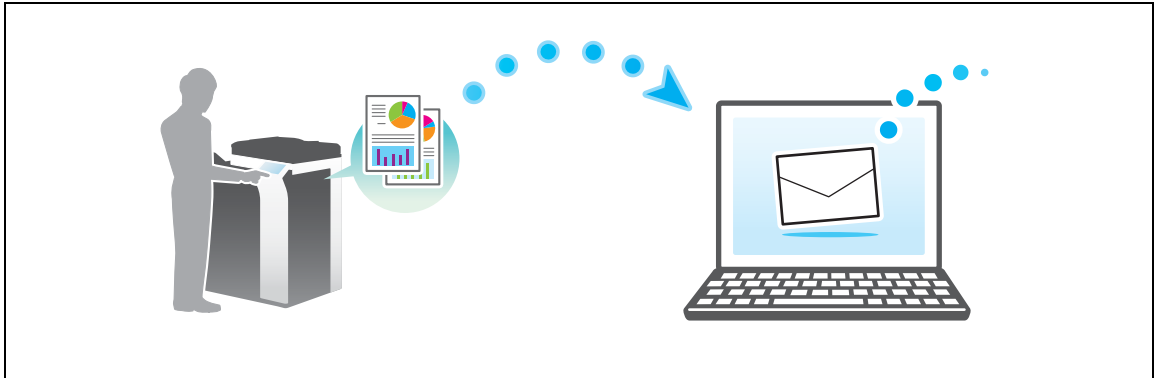

Preparation flow

The following describes a preparation flow for sending scanned data. For details, refer to the relevant page. This preparation is not required the second time or subsequent times.

- 1 Checking the cable connection (Administrator)
 - Check that this machine is correctly connected to the network cable. For details, refer to page 3-29.
- 2 Checking network settings of this machine (Administrator)
 - Check the network settings of this machine. For details, refer to page 3-29.
- 3 Configuring the E-mail transmission environment (Administrator)
 - Configure a server for E-mail TX. For details, refer to page 3-30.
- 4 Configuring administrator information (Administrator)
 - Register the administrator name and E-mail address used as the sender's address of an E-mail to be sent. For details, refer to page 3-31.

Operation flow

The following describes a transmission flow. For details, refer to page 3-32.

- 1 Loading the original
- 2 Entering a destination
 - Enter the destination E-mail address, and check the settings such as the file type and image quality.
- 3 Press the **Start** key.
 - Press the **Start** key to scan the original.

Checking the cable connection

Check that a LAN cable is connected to the LAN port of this machine and the green LED is on.

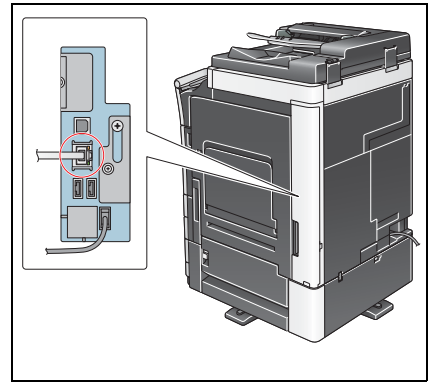

Checking network settings of this machine

Tap [Utility], and select [Device Information].

Check that the IP address is displayed.

- For IPv4 environment

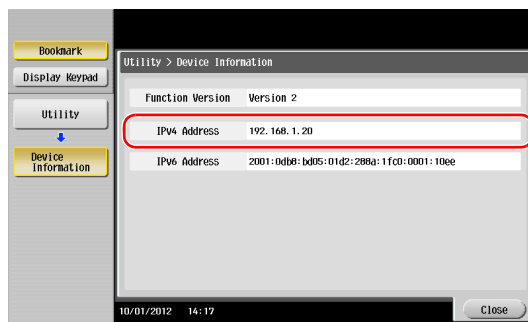

- For IPv6 environment

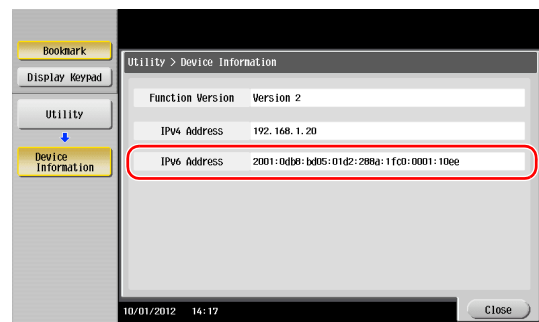

Tips

- In general, the default settings are available for network connection; however, some network environments require a change on network settings.
- If no IP address is displayed, you need to configure the network. Tap [Utility], and select [Administrator Settings] - [Network Settings] - [TCP/IP Settings]. Configure the required settings to suit your environment. For details, refer to the [User's Guide Online] on the DVD.

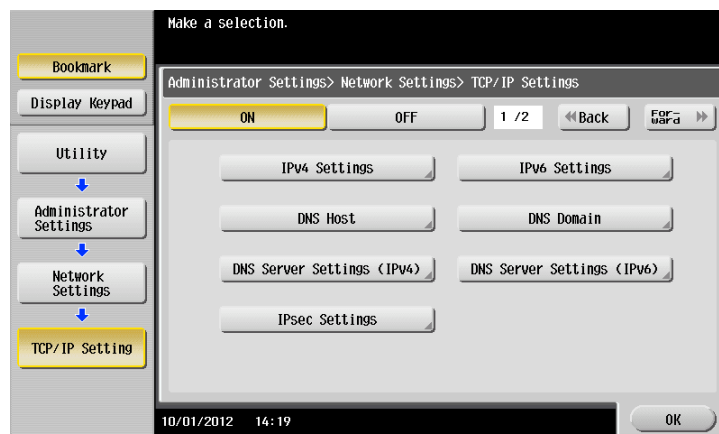

Configuring the E-mail transmission environment

- 1 Tap [Utility], and select [Administrator Settings] - [Network Settings] - [E-Mail Settings].

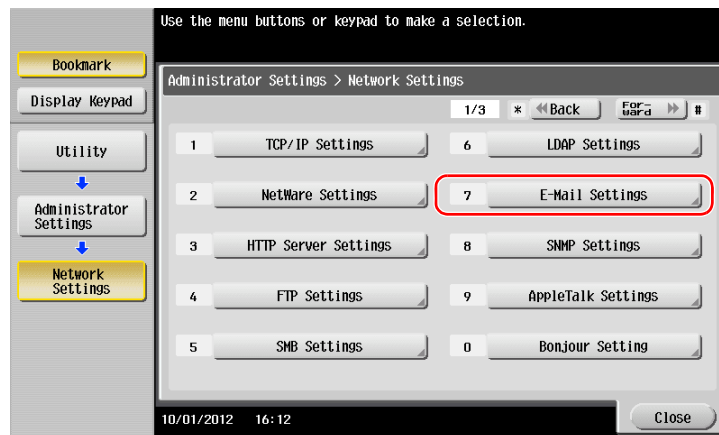

- 2 Tap [E-Mail TX (SMTP)].

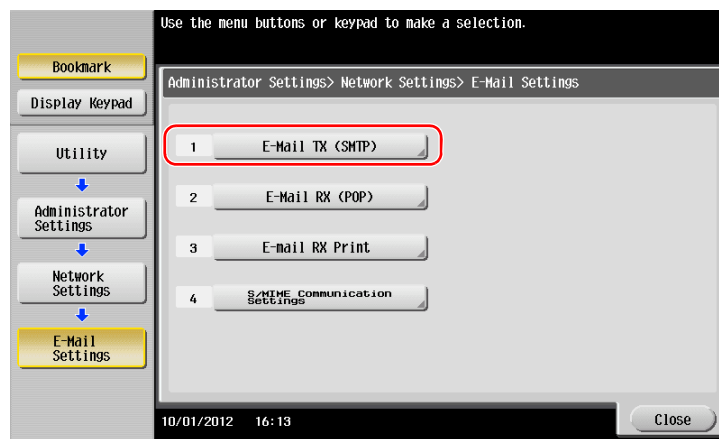

- 3 Select [ON] to enable E-mail TX (SMTP) settings and E-mail TX function.

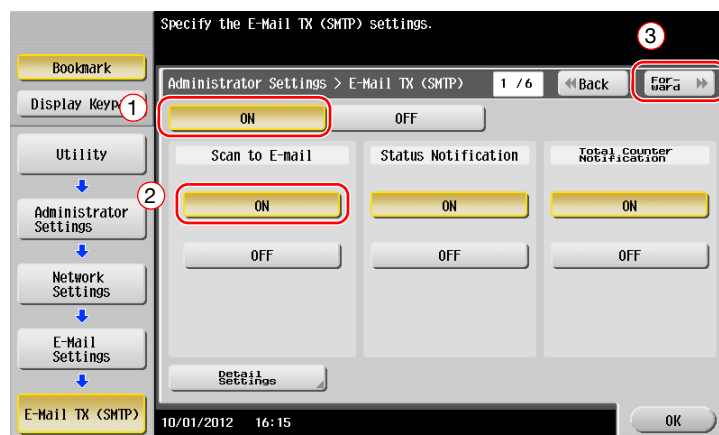

- 4 Enter the SMTP server address.

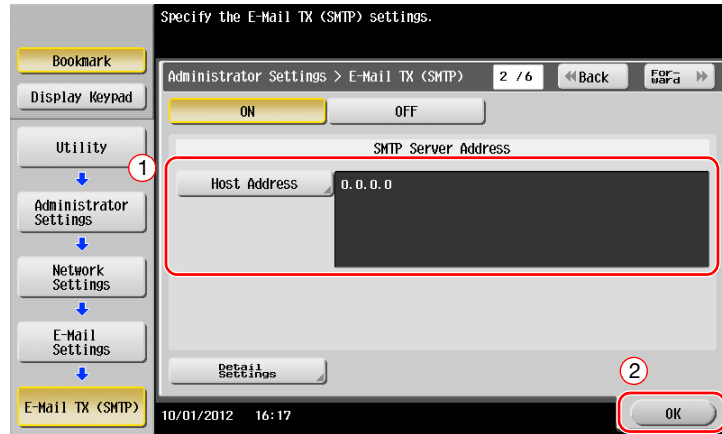

Configuring administrator information

- 1 Tap [Utility], and select [Administrator Settings] - [Administrator/Machine Settings] - [Administrator Registration].

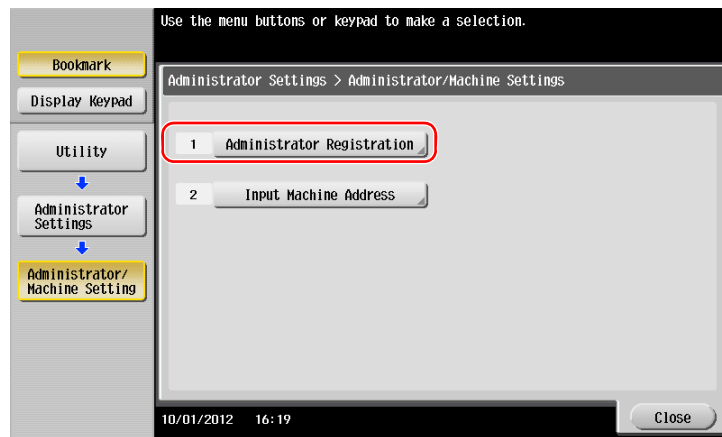

- 2 Enter the required information, then tap [OK].

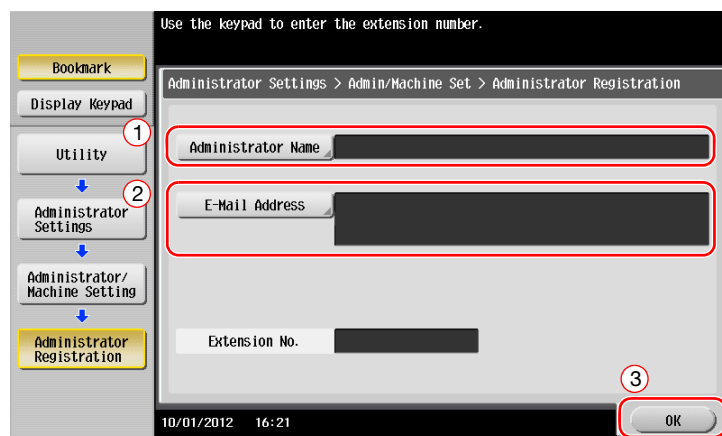

Sending the original

- 1 Load the original.

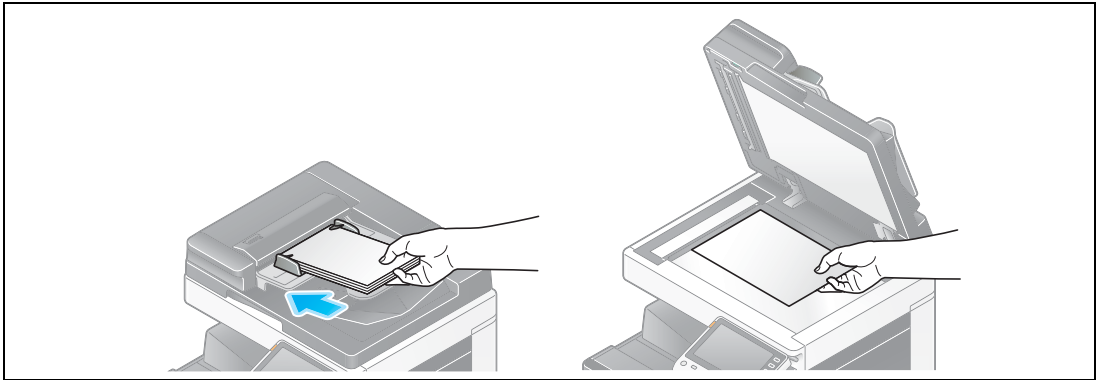

- 2 Tap [Scan/Fax].

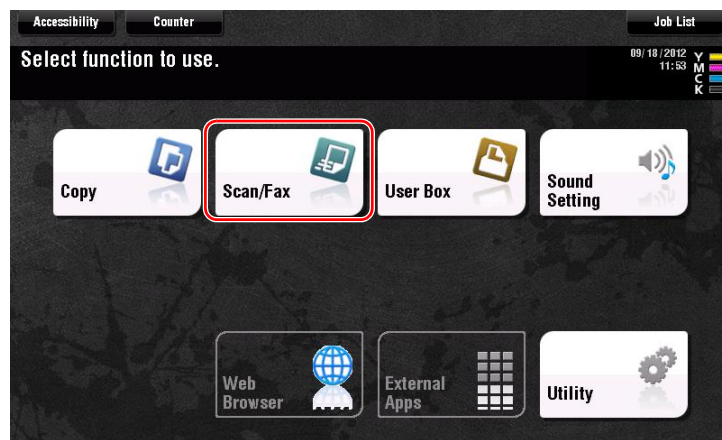

- 3 Enter a destination.

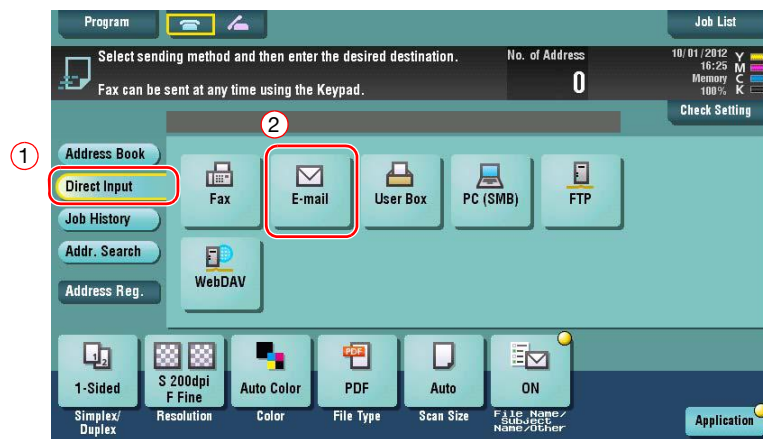

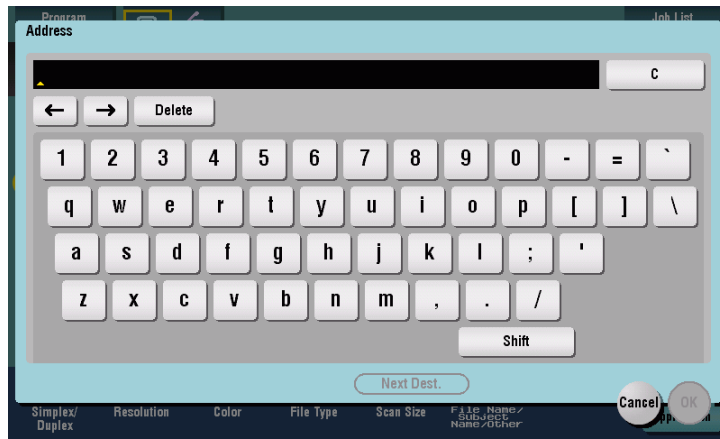

- 4 Check the setting if necessary.
 → Tap [Check Setting] to check the setting.

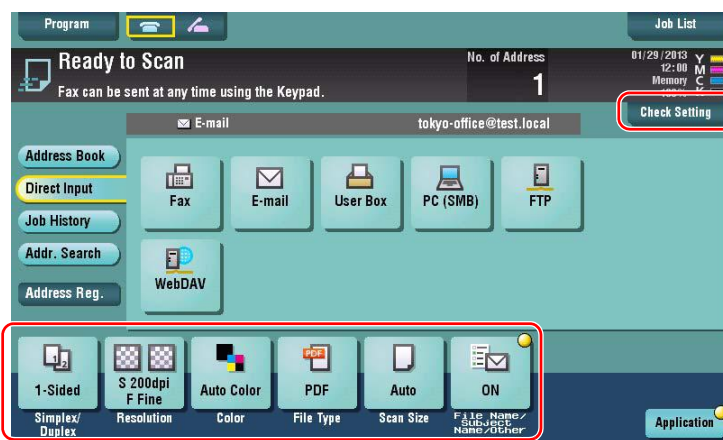

- You can also check the setting using the keys displayed on the **Touch Panel**.
 → To change the setting, tap the desired key on the **Touch Panel**.

Settings	Description
[Simplex/Duplex]	Select whether to scan one or both sides of the original.
[Resolution]	Specify the scanning resolution.
[Color]	Select whether to scan the original in color or black and white mode.
[File Type]	Select the type of the file to save scanned data.
[Scan Size]	Specify the size of the original to be scanned.
[File Name/Subject Name/Other]	Change the file name or the subject of an E-mail to be sent.

- 5 Press the **Start** key.

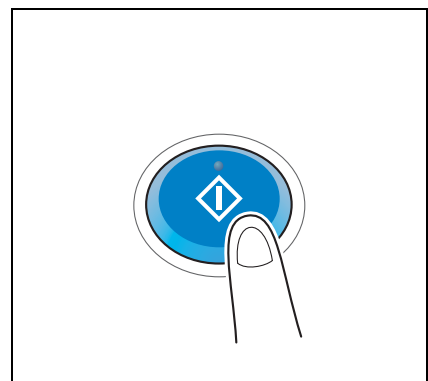

3.3 Fax Function

3.3.1 Required settings and basic operations

This section describes the settings required to send and receive a fax via a telephone line as well as the basic operations.

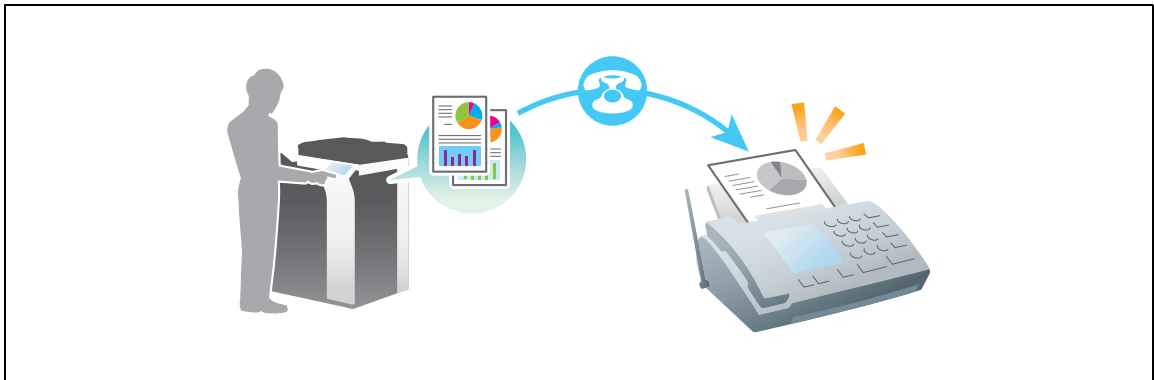

Preparation flow

The following describes a preparation flow to send a fax. For details, refer to the relevant page.

This preparation is not required the second time or subsequent times.

- 1 Checking the cable connection (Administrator)
 - Check that this machine is correctly connected to the telephone line. For details, refer to page 3-35.
- 2 Registering transmission information (Administrator)
 - Specify the name and fax number to be displayed as a sender when sending a fax from this machine. For details, refer to page 3-35.
- 3 Selecting the dialing method (Administrator)
 - Select the dialing method to suit your environment. For details, refer to page 3-36.

Operation flow

The following describes a flow to send a fax. For details, refer to page 3-37.

- 1 Loading the original
- 2 Entering a destination
 - Enter the destination fax number, and check the settings such as the image quality.
- 3 Press the **Start** key.
 - Press the **Start** key to send the original.

Checking the cable connection

Check that a modular cable is connected to the LINE port of this machine.

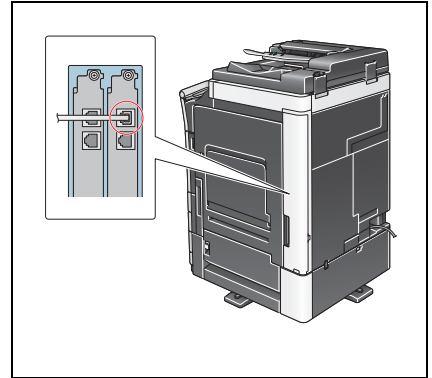

Registering transmission information

- 1 Tap [Utility], and select [Administrator Settings] - [Fax Settings] - [Header Information].

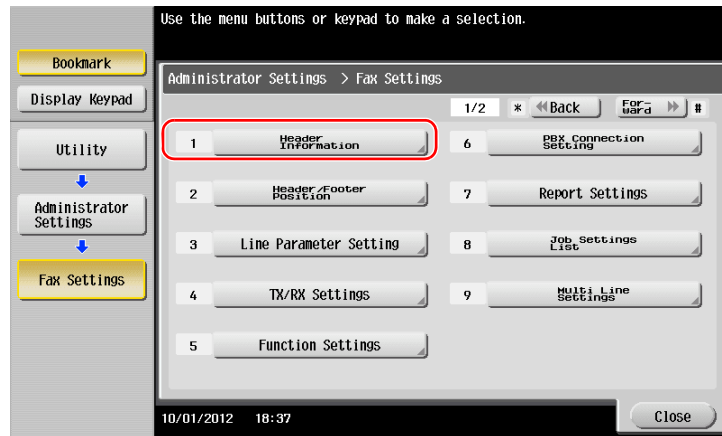

- 2 Enter the sender information, then tap [OK].

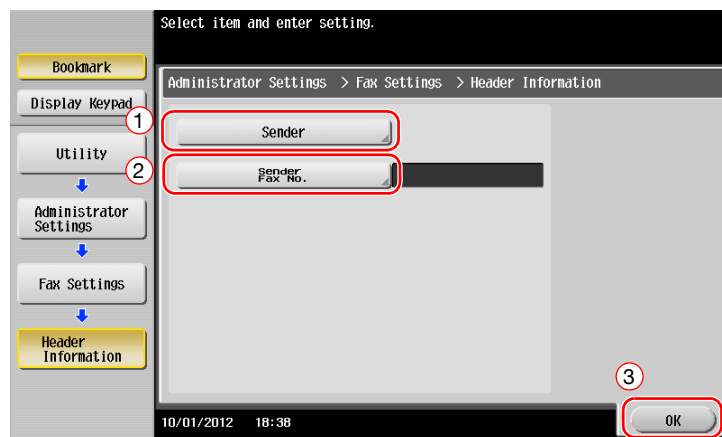

- Sender settings

Enter the name to be displayed as a sender.

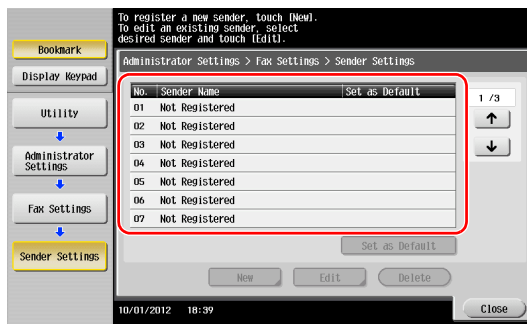

- Sender Fax No. Settings

Enter the fax number to be displayed as a sender.

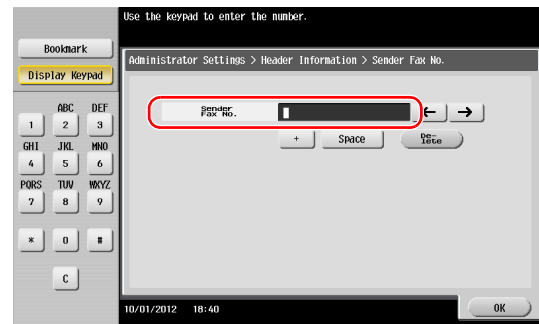

Selecting the dialing method

- 1 Tap [Utility], and select [Administrator Settings] - [Fax Settings] - [Line Parameter Setting].

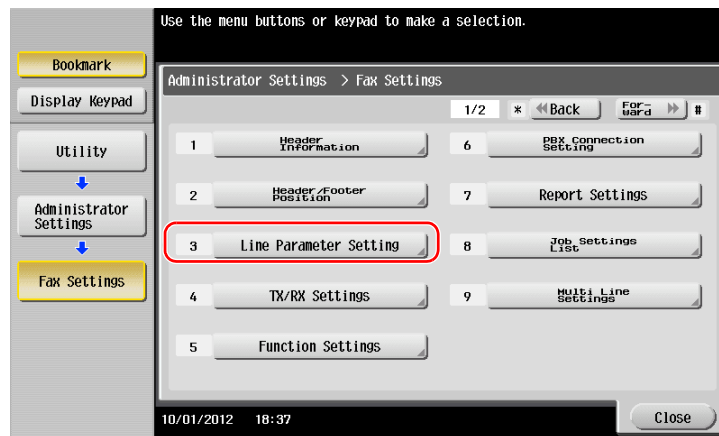

- 2 Tap [Dialing Method].

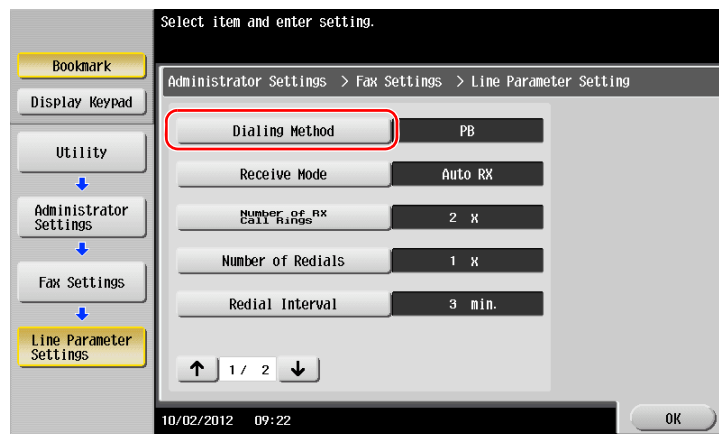

- 3 For the push-button type, select [PB], and for the dial-pulse type, select [10pps].

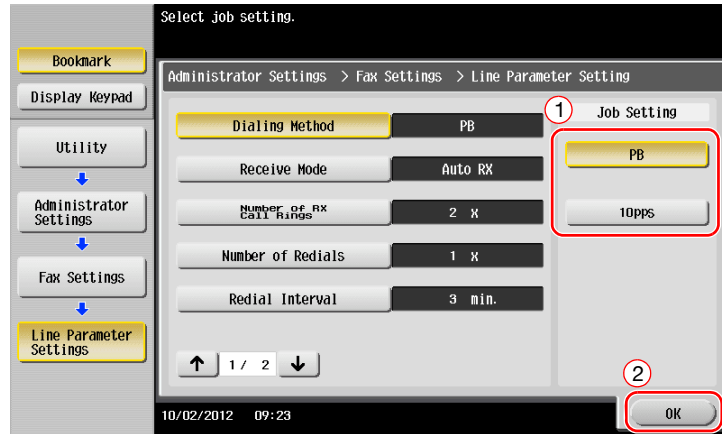

If you do not know the type of the dialing method:

- If you do not know the type of the dialing method, operate push buttons of your phone. When you hear "beep boop beep", set [Dialing Method] to [PB].
- If you do not hear "beep boop beep" after operating push buttons, select [10pps].

Sending the original

- 1 Load the original.

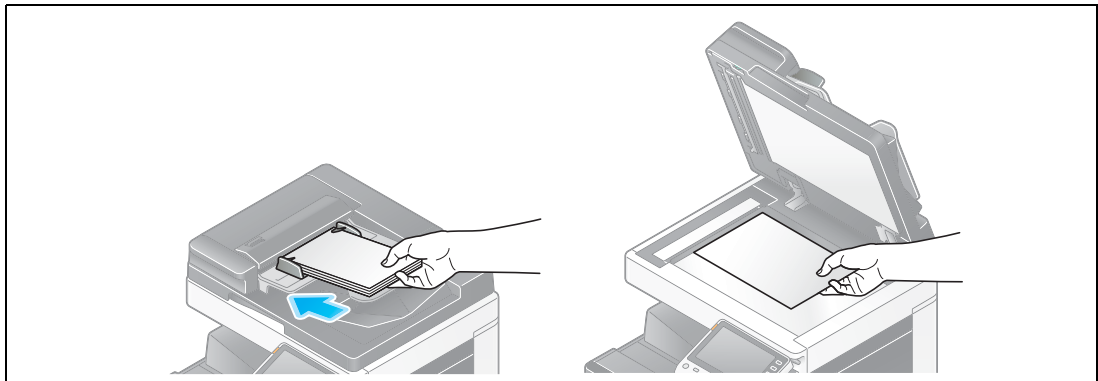

- 2 Tap [Scan/Fax].

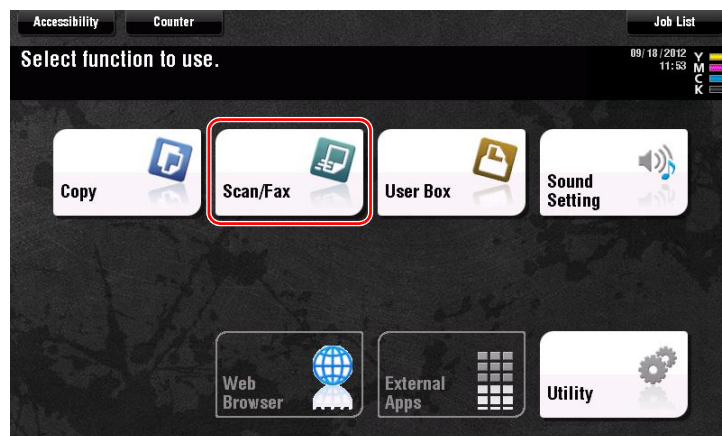

3 Enter a destination.



4 Check the setting if necessary. → Tap [Check Setting] to check the setting.

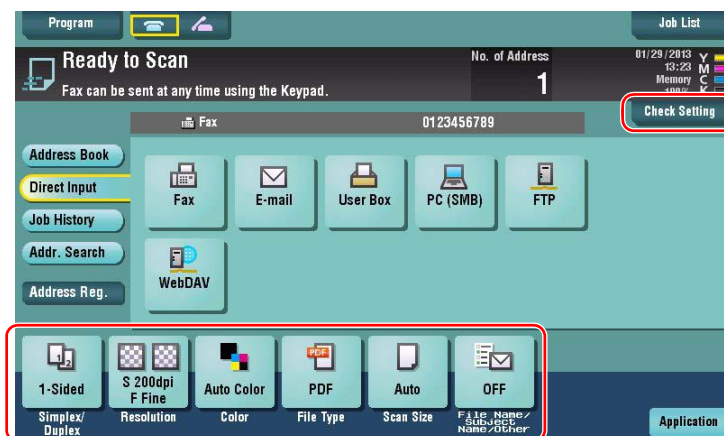

→ You can also check the setting using the keys displayed on the **Touch Panel**.

→ To change the setting, tap the desired key on the **Touch Panel**.

[Color], [File Type], and [File Name/Subject Name/Other] are not available when sending to a fax number.

Settings	Description
[Simplex/Duplex]	Select whether to scan one or both sides of the original.
[Resolution]	Specify the scanning resolution.
[Scan Size]	Specify the size of the original to be scanned.

- 5 Press the **Start** key.

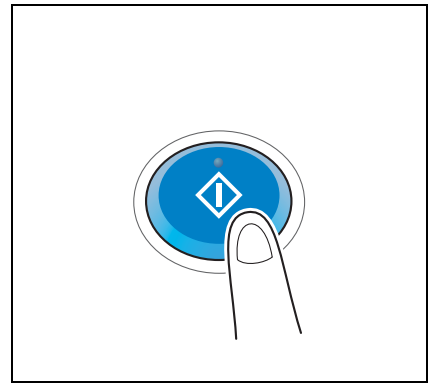

3.3.2 Sending a fax directly from a PC (PC-FAX TX)

You can send a fax to the destination fax machine in the same manner as you print out data created on your computer.

Advantages to send a fax directly from a computer

- Realizing paper saving
- Completing fax operations without leaving your desk
- Offering clear images by sending data directly from a computer

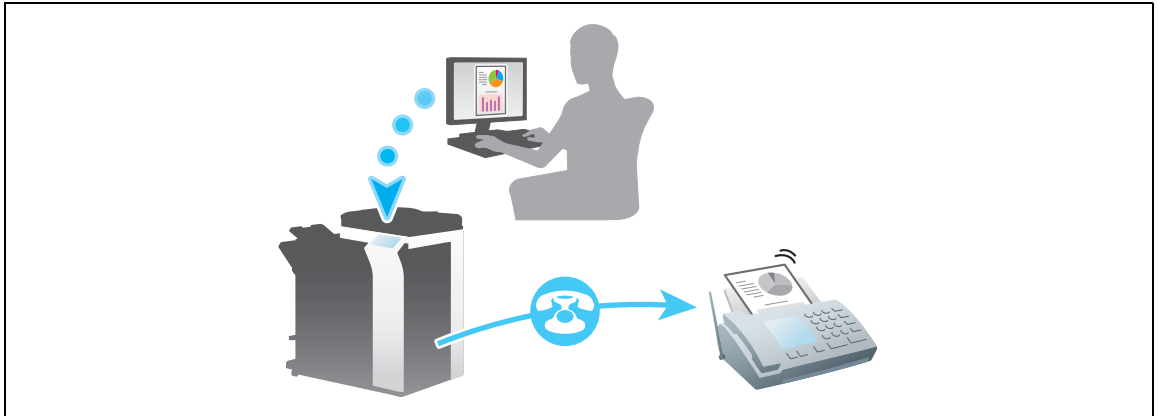

NOTICE

This function is not supported in the Mac operating system.

Preparation flow

The following describes a preparation flow to send a fax from a computer. For details, refer to the relevant page.

This preparation is not required the second time or subsequent times.

- 1 Checking the cable connection (Administrator)
 - Check that this machine is correctly connected to the telephone line and network cable. For details, refer to page 3-40.
- 2 Checking network settings of this machine (Administrator)
 - Check the network settings of this machine. For details, refer to page 3-41. The network can be used with the default settings unless otherwise requested.
- 3 Installing the fax driver on your computer
 - Install the printer driver on your computer. For details, refer to page 3-42.

Operation flow

The following describes a flow to send a fax. For details, refer to page 3-43.

- 1 Creating data
 - Create data to be sent using application software.
- 2 Configuring the fax driver
 - Select a fax driver, and change the setting if necessary.
- 3 Entering a destination to send data
 - Enter a destination to send data.

Checking the cable connection

- 1 Check that a modular cable is connected to the LINE port of this machine.

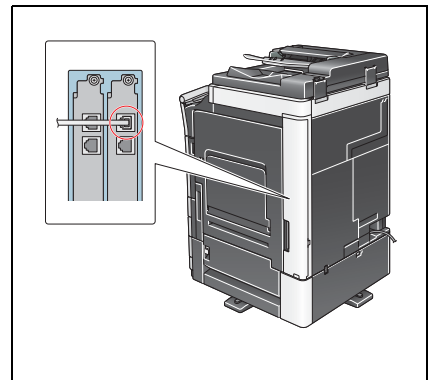

- 2 Check that a LAN cable is connected to the LAN port of this machine and the green LED is on.

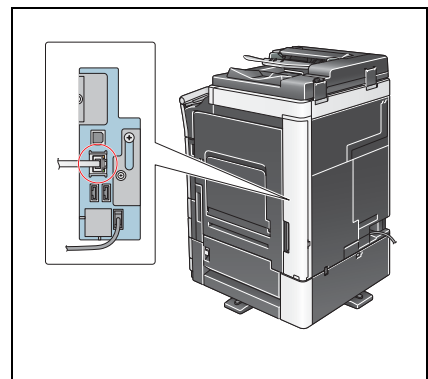

Checking network settings of this machine

Tap [Utility], and select [Device Information]. Check that the IP address is displayed.

- For IPv4 environment
- For IPv6 environment

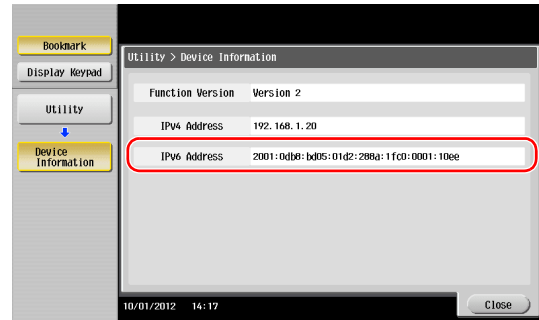
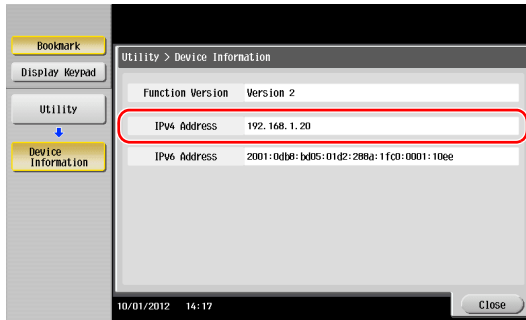

Tips

- In general, the default settings are available for network connection; however, some network environments require a change on network settings.
- If no IP address is displayed, you need to configure the network. Tap [Utility], and select [Administrator Settings] - [Network Settings] - [TCP/IP Settings]. Configure the required settings to suit your environment. For details, refer to the [User's Guide Online] on the DVD.

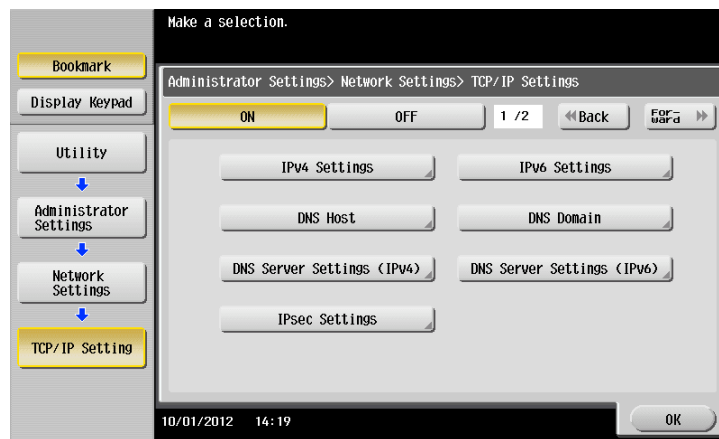

Installing the fax driver

Use the installer to install the fax driver.

This section describes how to configure the standard print settings.

✓ This operation requires administrator privileges for your computer.

- 1 Insert the DVD-ROM which includes the printer driver into the DVD-ROM drive of the computer.



- 2 Click [Printer Install].
- 3 Proceed with the procedure according to the on-screen instructions.
Printers and MFPs connected to the network are automatically searched for.
- 4 Select this machine from the list.
- 5 Select a fax driver.
- 6 Click [Install].
- 7 Click [Finish].

Sending data

- 1 Create data to be sent using application software.
- 2 From the [File] menu, select [Print].

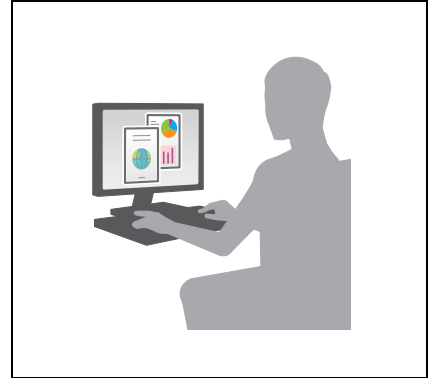

- 3 Select the fax driver of this machine, and click [Print].
 - Clicking [Preferences] can change the setting of the printer driver as required.
 - If user authentication is enabled in this machine, specify the required data such as the user name and password.
- 4 Enter the destination [Name] and [FAX Number].
 - To send data to more than one destination, repeat this step.
 - Clicking [Add from Address Book] can retrieve the registered destinations of this machine.
- 5 Click [OK].

3.4 Copy Function

Basic operations

The following describes the basic operations to make a copy.

- 1 If user authentication is enabled, the login screen appears. Tap the entry field or keyboard icon to enter the required item, then tap [Login] or [Access].
 - If IC card or biometric authentication is enabled, refer to page 3-46.

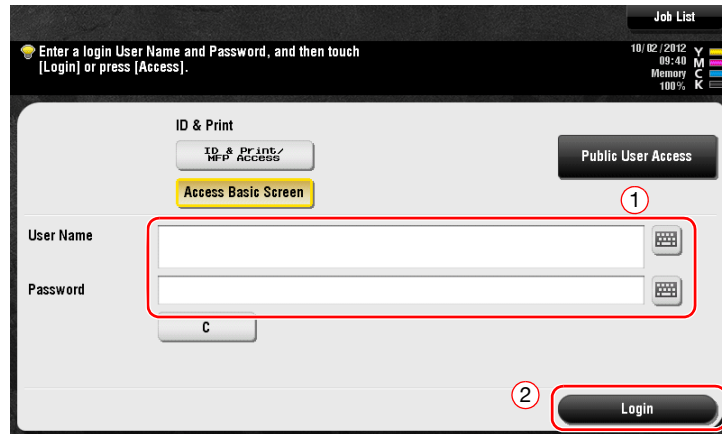

- 2 Load the original.

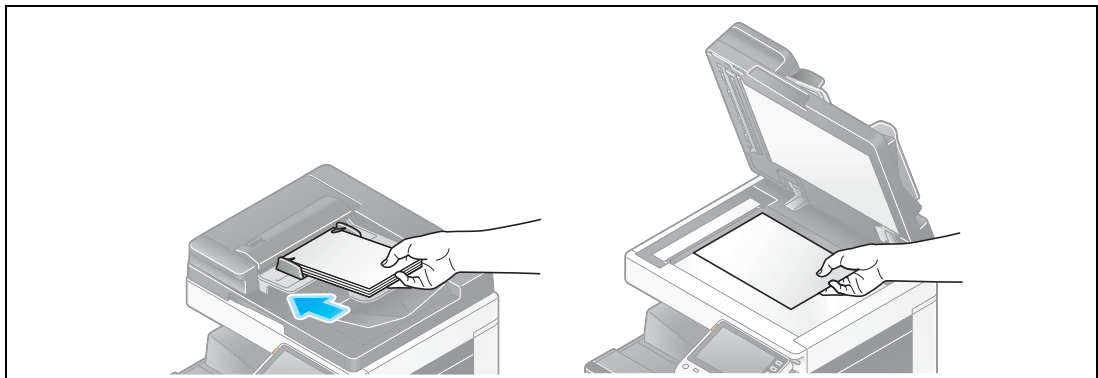

- 3 Tap [Copy].

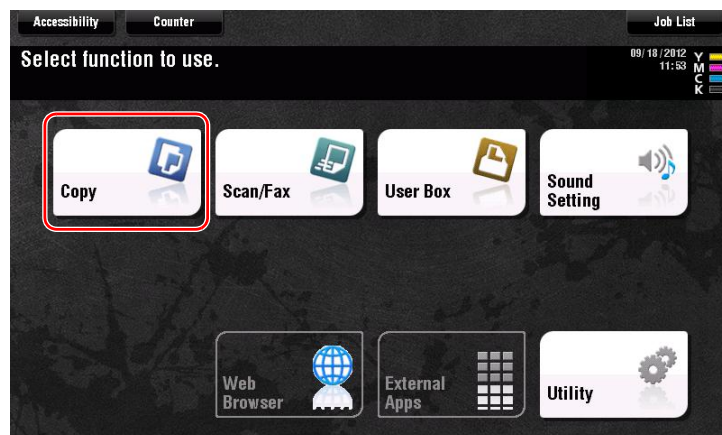

- 4 Check the basic settings.
- Check the output image configured as specified while viewing the output illustrations displayed on the **Touch Panel**.
 - Tapping [Check Setting] can check detailed settings.

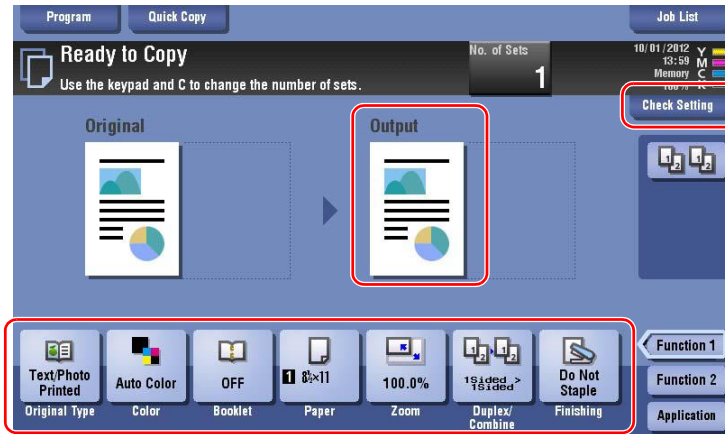

- To change the setting, tap the desired key on the **Touch Panel**.

Settings	Description
[Original Type]	Specify the original type of the original.
[Color]	Specify the color to output an image.
[Booklet]	The pages in the original data are arranged and spread in a booklet format and printed on both sides of sheets.
[Paper]	Specify the output paper.
[Zoom]	Specify the zoom ratio.
[Duplex/Combine]	Specify double-sided copying or combine copying.
[Finishing]	Configure the offset, punch, or staple setting for output paper.
[Density]	Adjust the copy density.

- 5 Tap the input area for entering the number of copies.

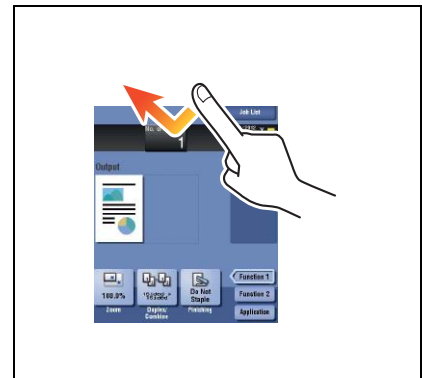

- 6 Enter the number of copies using the keypad, and press the **Start** key.

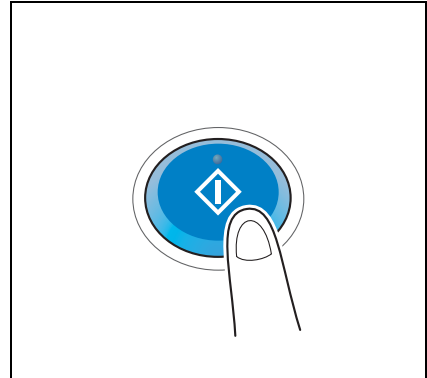
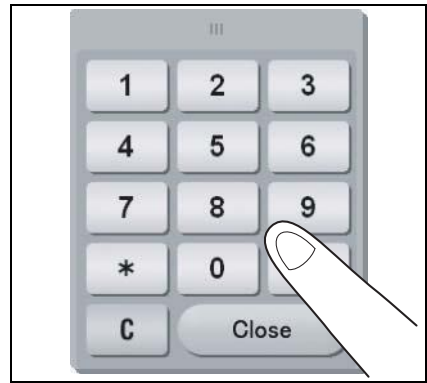

User authentication

You can perform authentication by user or group in this machine.

Installing optional units enables IC card or biometric authentication.

If IC card authentication is enabled, pass or place the IC card over or on the card reader of the authentication unit.

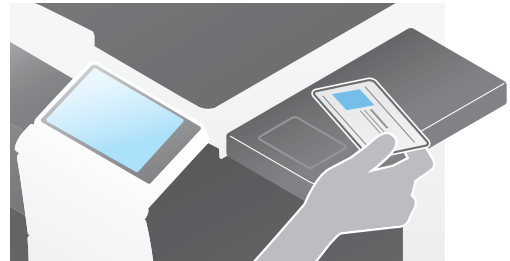

If biometric authentication is enabled, put your finger on the finger vein reader of the authentication unit.



3.5 Registering a destination

3.5.1 Registering an address book

The fax and scan-to-send functions can register the frequently used destinations as address books. This section explains an example to register an address book to which a fax is sent.

Using the Control Panel to register an address book - Registration from Utility

Select a destination type, and register destination information.

- 1 Tap [Utility], and select [One-Touch/ User Box Reg.] - [Create One-Touch Destination] - [Address Book (Public)].
- 2 Select the type of the destination you want to register.

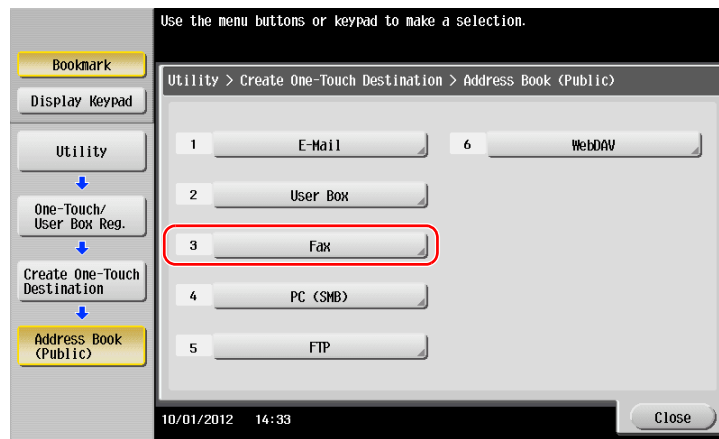

- 3 Tap [New].

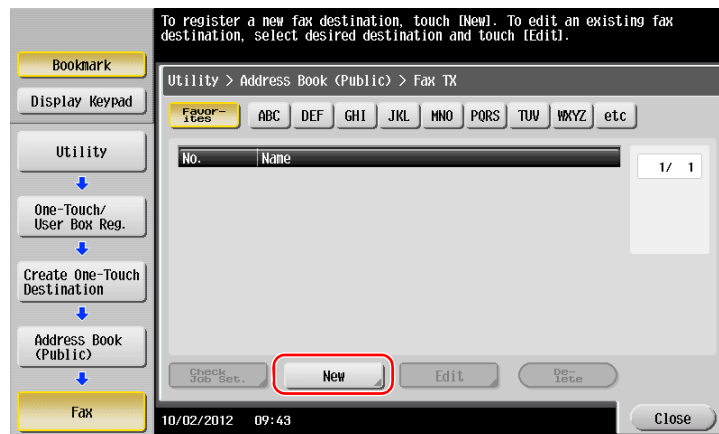

- 4 Enter the destination name you want to register.
- Tap [Name], and enter the destination name using the displayed keyboard.
 - For [Sort Character], enter the same name as [Name].

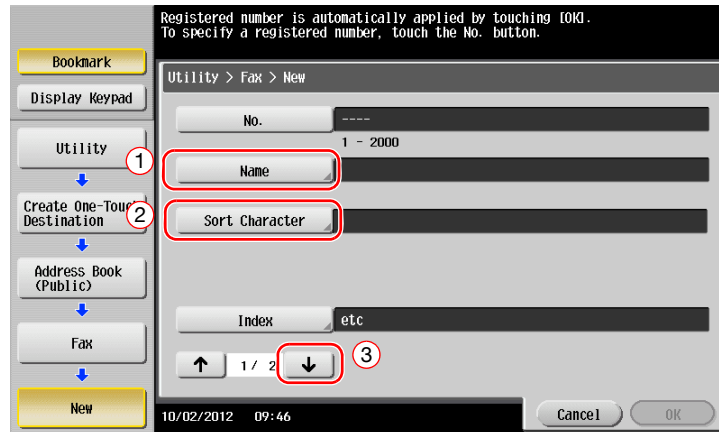

- This sets the appropriate index for the name, which you entered into [Name], to [Index]. To change the setting, tap [Index].
- Entry items and the number of setting screens vary depending on the destination type. Use [↑] or [↓] to switch setting screens while entering the required items. For information on entry items, refer to page 3-52.

- 5 Enter the fax number.

- Tap [Display Keypad] to display the keypad, and enter the fax number.

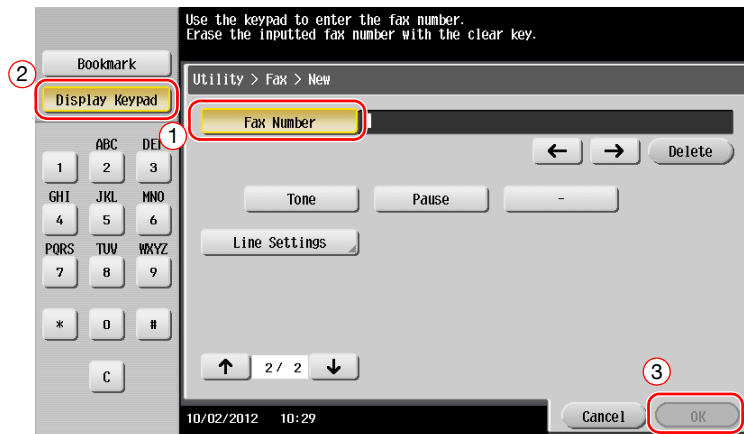

- 6 Tap [Close].

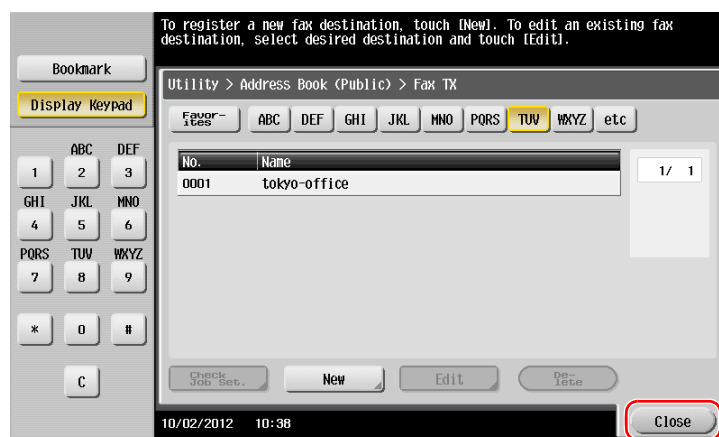

Using the Control Panel to register an address book - Registration in scan/fax mode

Select a destination type, and register destination information.

- 1 Display the scan/fax screen.
- 2 Tap [Address Reg.].

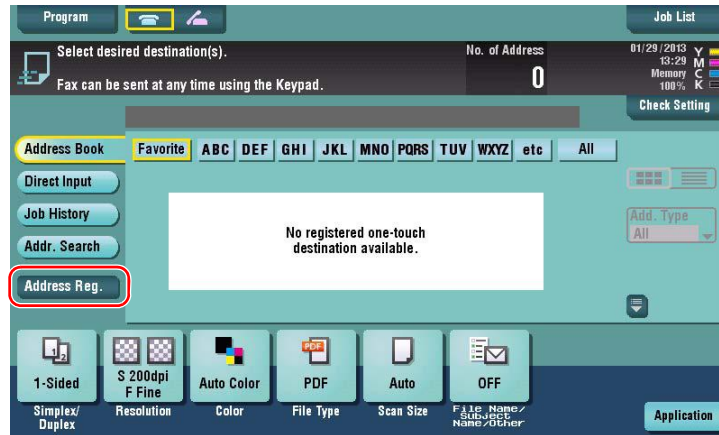

- 3 Tap [Input New Address].

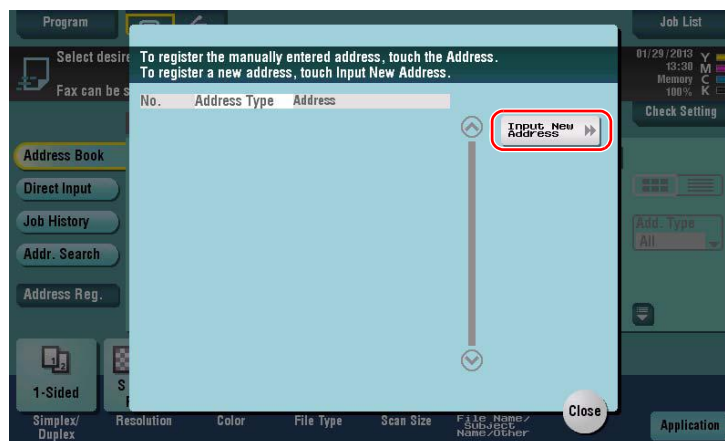

- 4 Select a destination type.

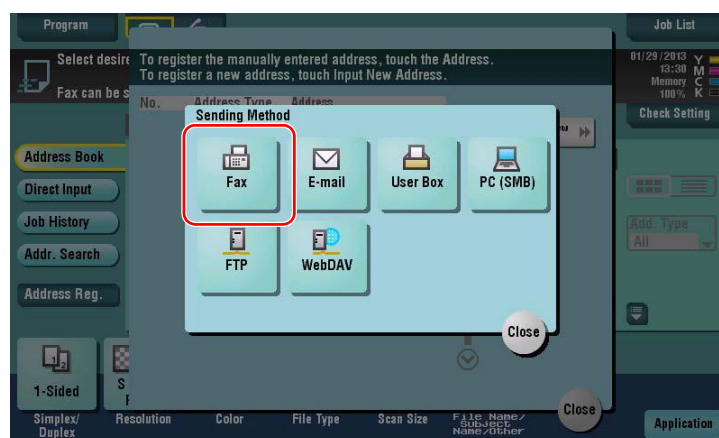

- 5 Enter the fax number.
- For [Index], set searching words corresponding to [Name].
 - For [Name], enter the destination name to be registered by using the displayed keyboard.
 - For [Sort Character], enter the same name as [Name].

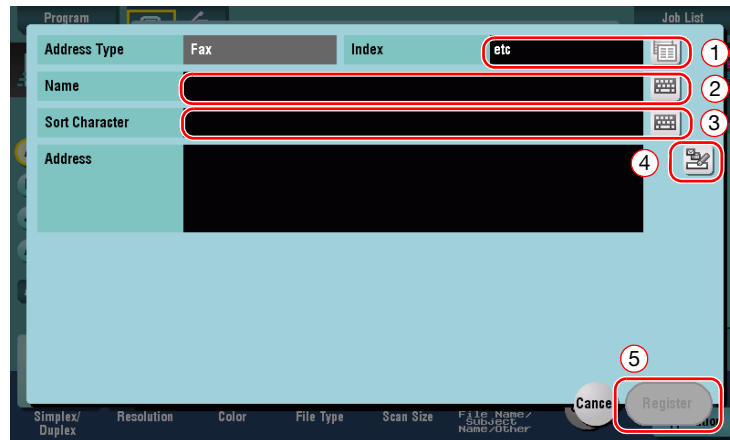

- Entry items and the number of setting screens vary depending on the destination type. For information on entry items, refer to page 3-52.

Registration by Direct Input

- The destination entered by using the [Direct Input] button can be registered before sending data as well.

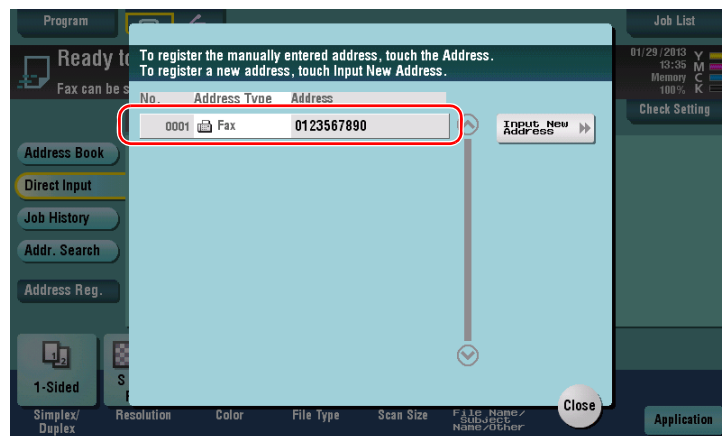

What is an index?

- This is used as an index of a registered destination. Tap the Index key to narrow down a target destination.
- If [Favorite] is selected as an index, the destination appears in the basic screen of the transmission screen after it has been registered in the address book; enabling the user to easily select a destination.

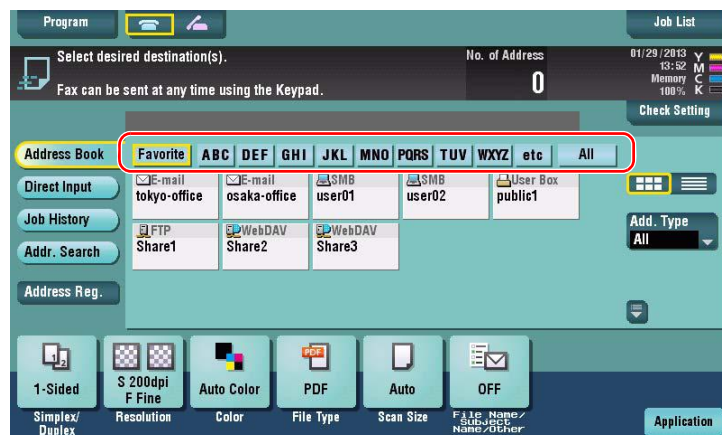

Using a computer to register a one-touch destination

In addition to using the **Control Panel**, address books can be registered from a computer using the utility software, **Web Connection**.

NOTICE

When using Internet Explorer 6 in the IPv6 environment, you need to correct the hosts file in advance. For details, refer to the [User's Guide Online] on the DVD.

- 1 Check the IP address of this machine
 - Tap [Utility], and select [Device Information]. Check that the IP address is displayed.
- For IPv4 environment
 - For IPv6 environment

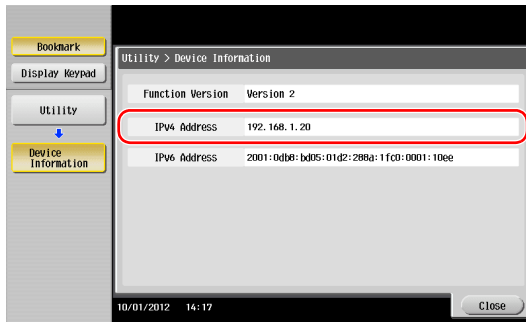

- If no IP address is displayed, you need to configure the network. For details, refer to the [User's Guide Online] on the DVD.

- 2 Start a Web browser, enter the IP address of this machine into the URL field, then press the [Enter] key.
 - For "http://192.168.1.20/", "192.168.1.20" is an IP address.
 - If you use a Web browser other than Internet Explorer 6 in the IPv6 environment, enclose the IPv6 address in []. For example, if the IPv6 address of this machine is "fe80::220:6bff:fe10:2f16", type in "http://[fe80::220:6bff:fe10:2f16]/".
 - If the login screen appears, enter the required items, then click [Login].
- 3 Select [Store Address] and click [New Registration].
- 4 Select the type of the destination you want to register.
- 5 Enter the required information such as the name, fax number, and index.

3.5.2 Information required to register a destination

The items to be entered or the number of screens required to register a destination vary depending on the transmission type. This section describes specific information required to register a destination.

Tips

- Setting items that can generally be used with defaults are omitted in this table.

Item		Description
[E-Mail]	[Name]	Enter the name of the destination to be registered as an address book.
	[E-Mail Address]	Enter the E-mail address used as the destination.
[User Box]	[Name]	Enter the name of the destination to be registered as an address book.
	[User Box]	Select a User Box to be used as a destination.
[Fax]	[Name]	Enter the name of the destination to be registered as an address book.
	[Fax Number]	Enter the fax number of the destination.
[PC (SMB)]	[Name]	Enter the name of the destination to be registered as an address book.
	[User ID]	Enter the login name of the destination computer.
	[Password]	Enter the password required to log in to the computer.
	[Host Address]	Enter the computer name or IP address. <ul style="list-style-type: none"> • Only uppercase letters are available for the computer name.
	[File Path]	Enter the folder name to be used as the destination.
[FTP]	[Name]	Enter the name of the destination to be registered as an address book.
	[Host Address]	Enter the address of the FTP server.
	[File Path]	Enter the directory to be used as the destination.
	[User ID]	Enter the user ID required to log in with FTP.
	[Password]	Enter the password required to log in with FTP.
[WebDAV]	[Name]	Enter the name of the destination to be registered as an address book.
	[User ID]	Enter the user ID required to log in with WebDAV.
	[Password]	Enter the password required to log in with WebDAV.
	[Host Address]	Enter the address of the WebDAV server.
	[File Path]	Enter the directory to be used as the destination.

3.5.3 Registering a group

Several address books can be registered as a group.

This function is useful when you have jobs involving sending data to specified members at periodic intervals.

Registering a new group

- 1 Tap [Utility], and select [One-Touch/ User Box Reg.] - [Create One-Touch Destination] - [Group].
- 2 Tap [New].

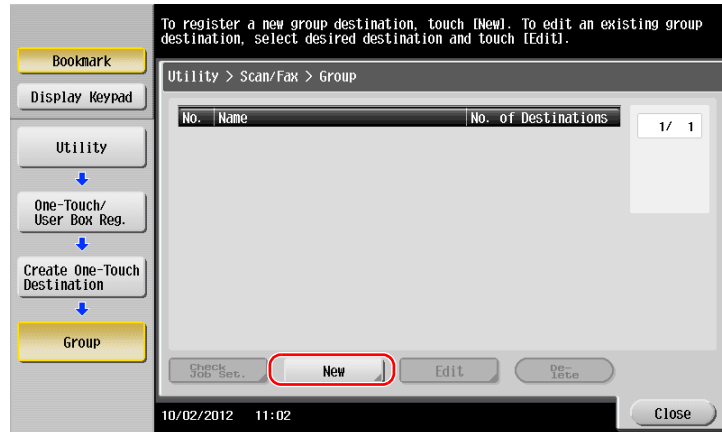

- 3 Enter the destination name you want to register.
 - Tap [Name], and enter the destination name using the displayed keyboard.
 - For [Sort Character], enter the same name as [Name].

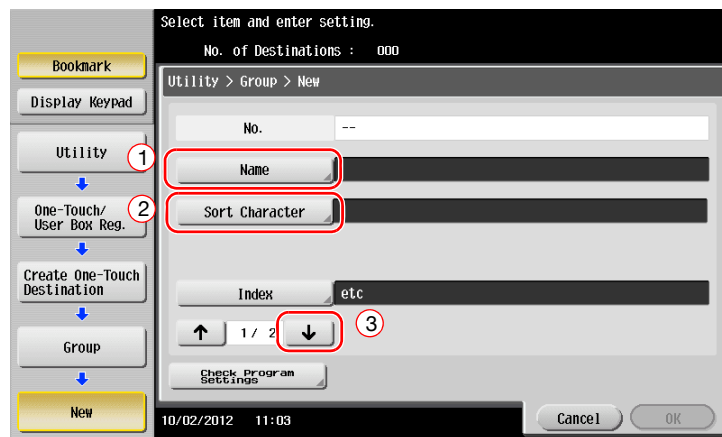

- This sets the appropriate index for the name, which you entered into [Name], to [Index]. To change the setting, tap [Index].

4 Select destinations to be grouped.

Display and select the target address book on the destination selection screen. The following two methods can be used to search for a destination.

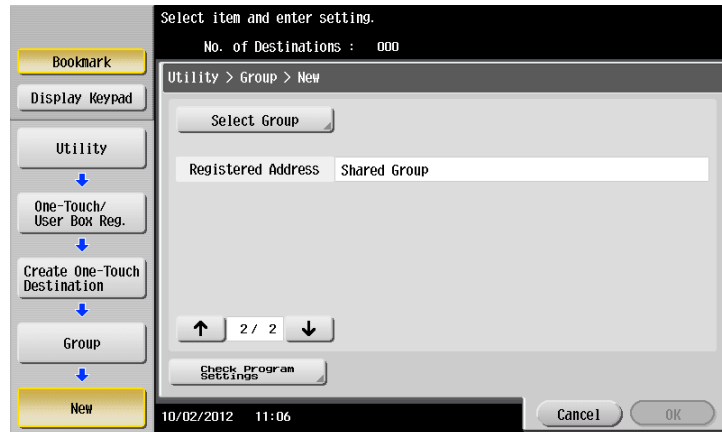

→ Search by index: Searches for the target destination name using an index.

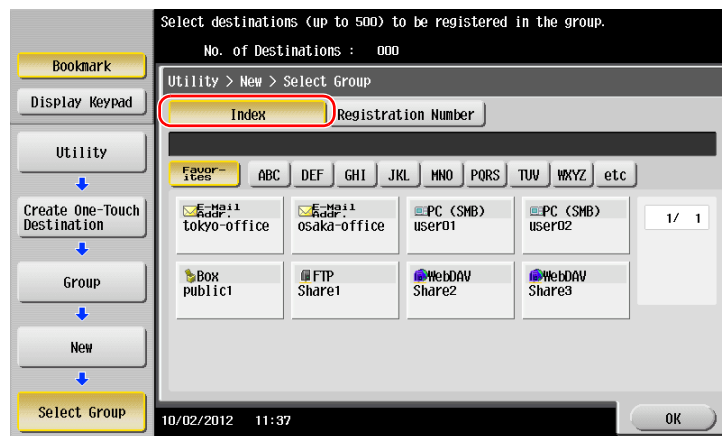

→ Search by registration number: Searches for the target destination using a registration number.

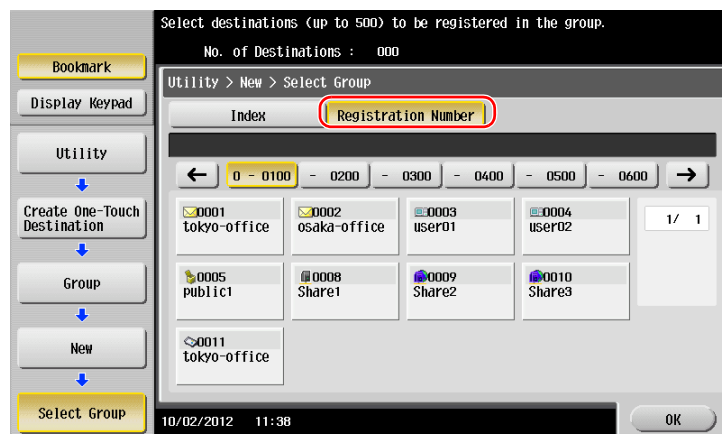

5 Repeat Step 4 until you select all address books to be grouped.

3.5.4 Retrieving a registered destination

Retrieve an address book or group to specify it as a destination to which data is sent.

Retrieving a destination

- 1 Tap [Scan/Fax].

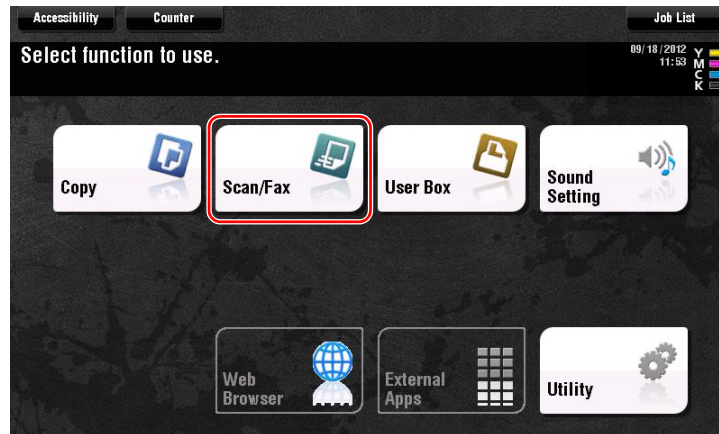

The destinations, which are categorized into [Favorite] when registering indexes, are displayed on the basic screen.

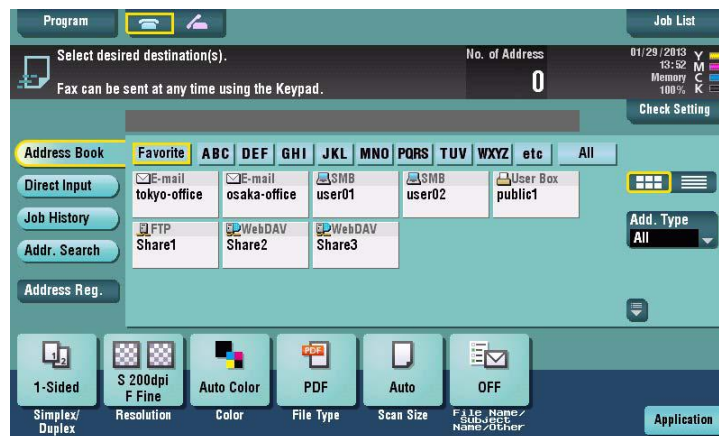

- 2 Narrow down destinations using index and address type.

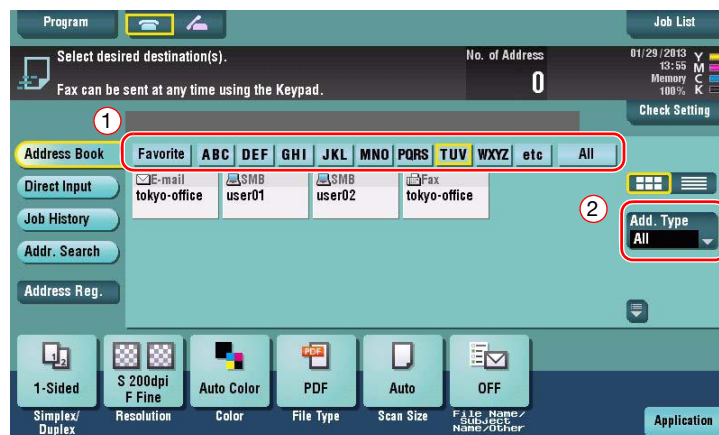

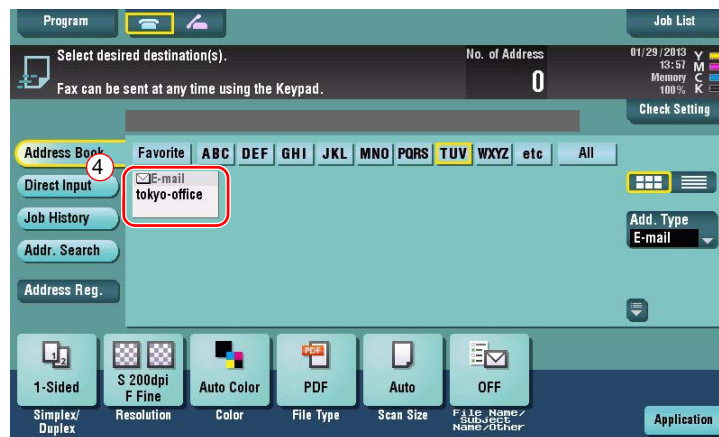

Specifying a destination

In addition to retrieving a registered destination, a destination can be specified in various methods.

Item	Description
Direct Input	Directly enter a destination using the keyboard screen or keypad.
Job History	Specify a target destination in the job history (latest five destinations) on the scan/fax screen.
Search	Retrieves destination candidates by the prefix search function using the name (registered destination name) or address (fax number, E-mail address, or computer name). This function is convenient when there are too many registered destinations.



Reference

For details, refer to the [User's Guide Online] on the DVD.

3.6 Using a USB memory device

3.6.1 Printing data in a USB memory device

Data saved in the USB memory device can be printed. This function is useful when printing data created on a computer that is not connected to the network.

Available USB memory device

- Compatible with USB version 2.0/1.1 interface
- Formatted in FAT32
- Without security function added, or with security function that can be turned off as required
- There is no upper limit for the memory size.

Available printing file types

- PDF, Compact PDF, JPEG, TIFF, XPS, Compact XPS, OOXML (.docx/.xlsx/.pptx), and PPML (.ppml/.vdx/.zip)
- Other file types are not supported on this machine.

Printing data

- 1 Connect a USB memory device to this machine.

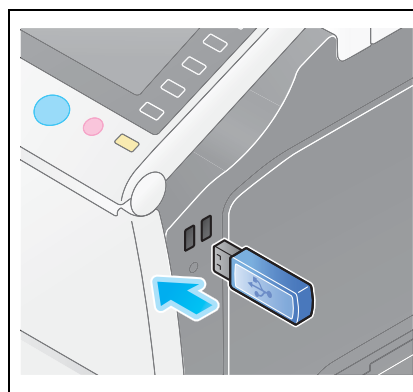

NOTICE

Do not insert the USB memory device into the USB port close to the rear panel of this machine.

Do not use a USB device other than a flash-memory device.

- 2 Tap [Print a document from External Memory.].

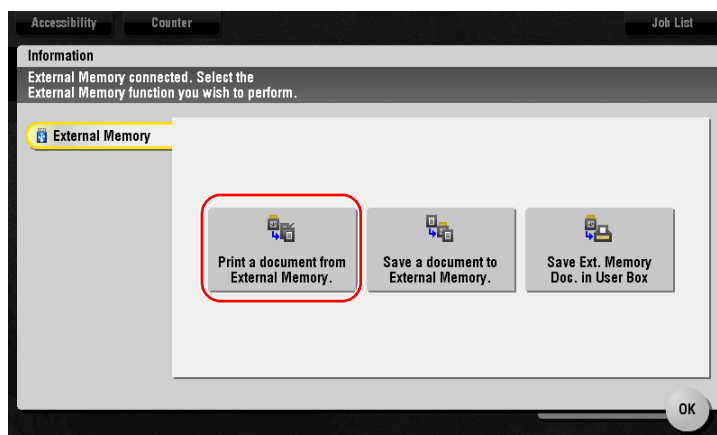

- 3 Select data to be printed, and tap [Print].

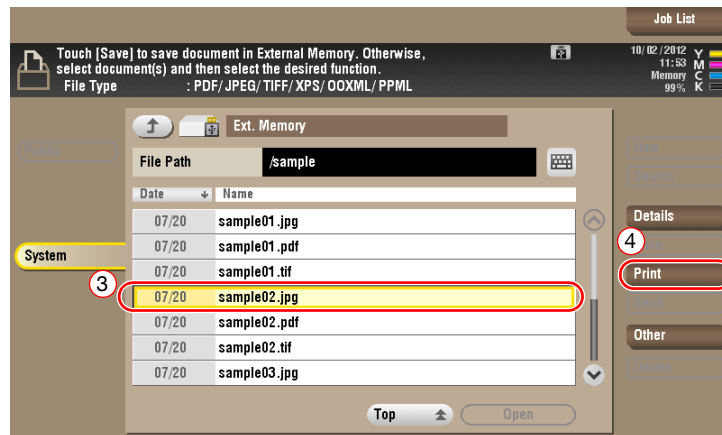
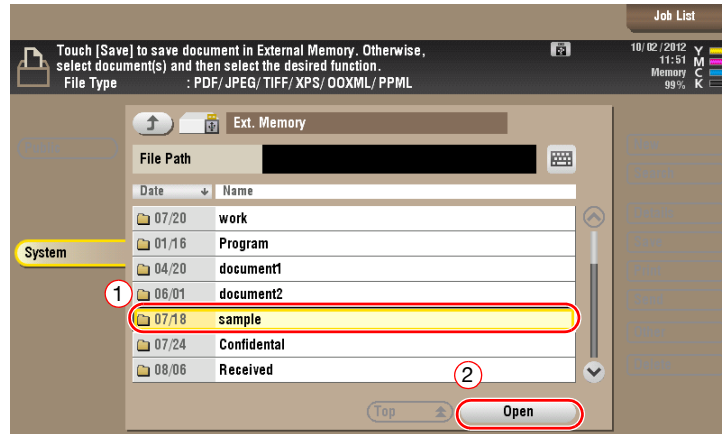

- 4 Check print settings.

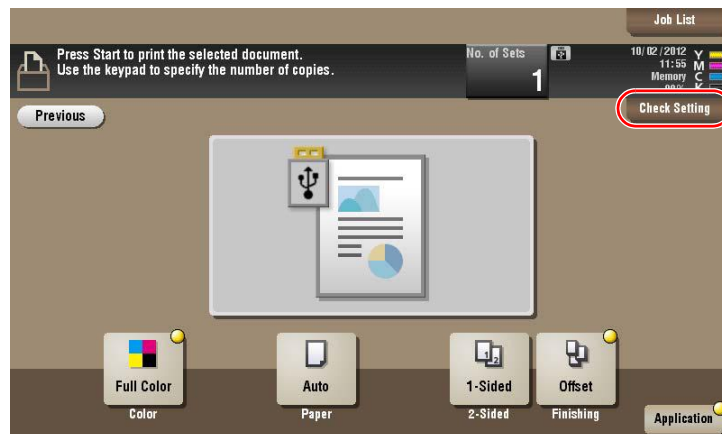

- 5 Press the **Start** key.

NOTICE

Do not disconnect the USB memory device during data printing.

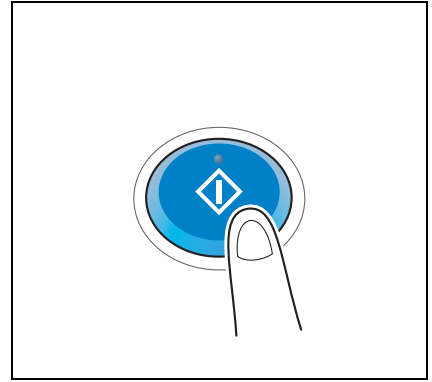

3.6.2 Saving the scanned data in the USB memory device (External memory)

The data scanned on this machine can be saved to the USB memory device, so it is convenient when printing data created on a computer that is not connected to the network.

Available USB memory device

- Compatible with USB version 2.0/1.1 interface
- Formatted in FAT32
- Without security function added, or with security function that can be turned off as required
- There is no upper limit for the memory size.

Specifying functions to be permitted for external memory

Change the settings to save documents in the USB memory device.

- 1 Tap [Utility], and select [Administrator Settings] - [System Settings] - [User Box Settings].

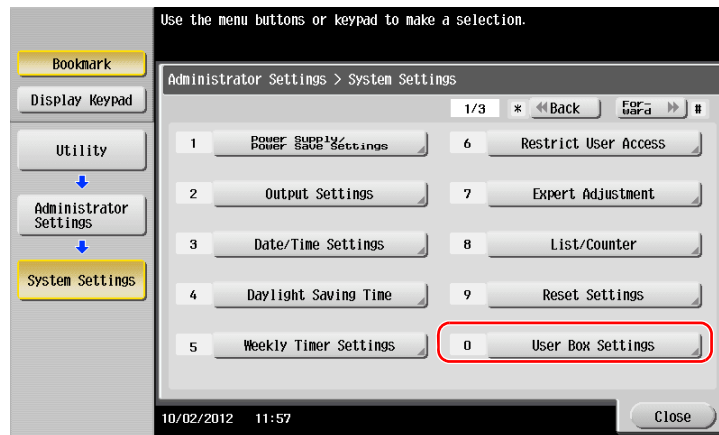

- 2 Tap [External Memory Functional Settings].

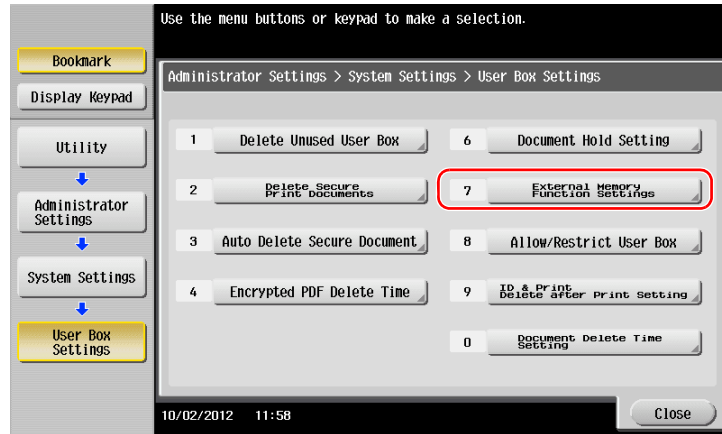

- 3 Select [Save Document] and [ON]. Tap [OK].

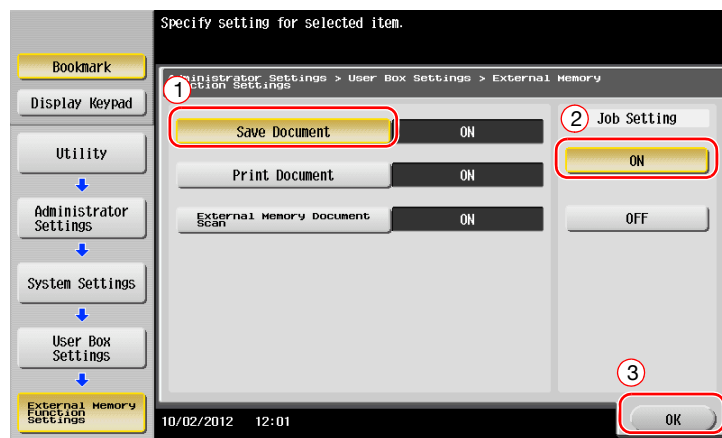

Saving data in the USB memory device

- 1 Load the original.

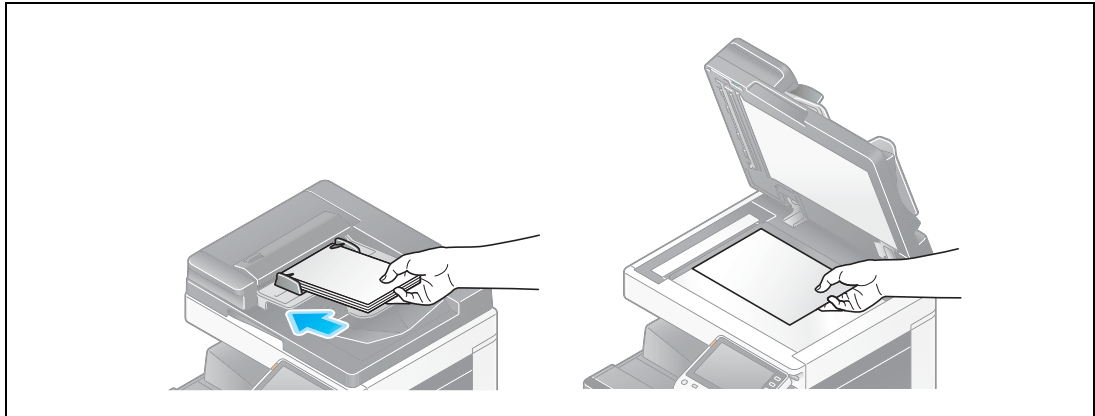

- 2 Connect a USB memory device to this machine.

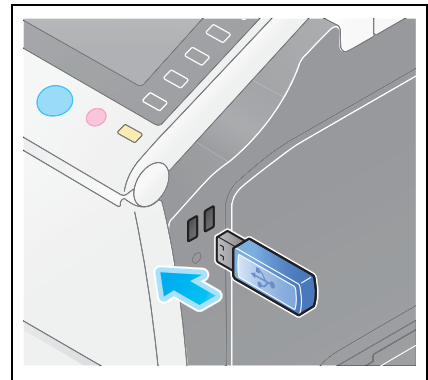

NOTICE

Do not insert the USB memory device into the USB port close to the rear panel of this machine.

Do not use a USB device other than a flash-memory device.

- 3 Tap [Save a document to External Memory.].

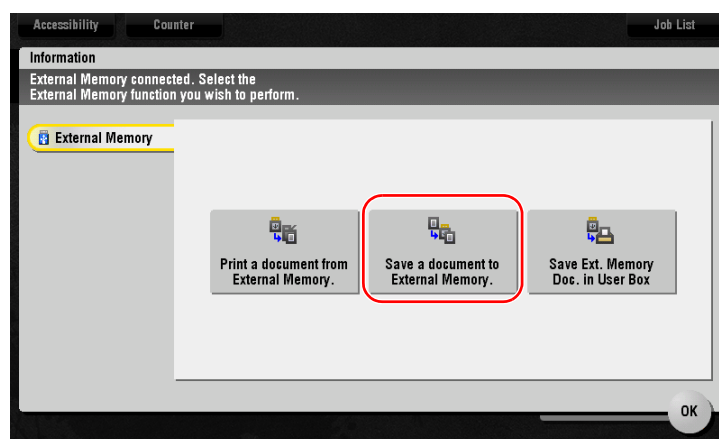

4 Check the file name.

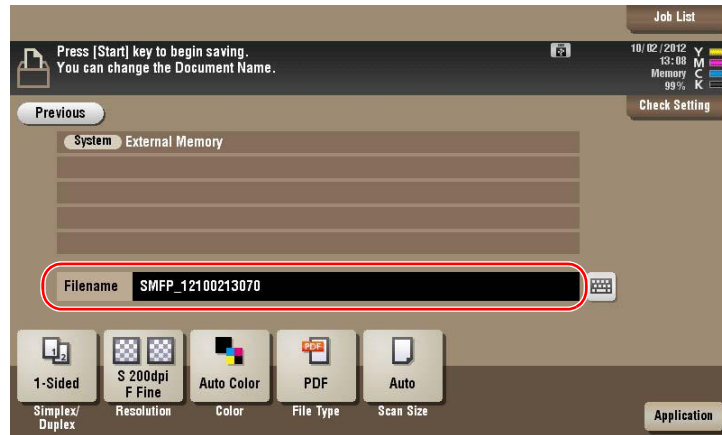

5 If necessary, check the setting to save data.

- Tap [Check Setting] to check the setting.
- To change a file name, tap the file name or keyboard icon.

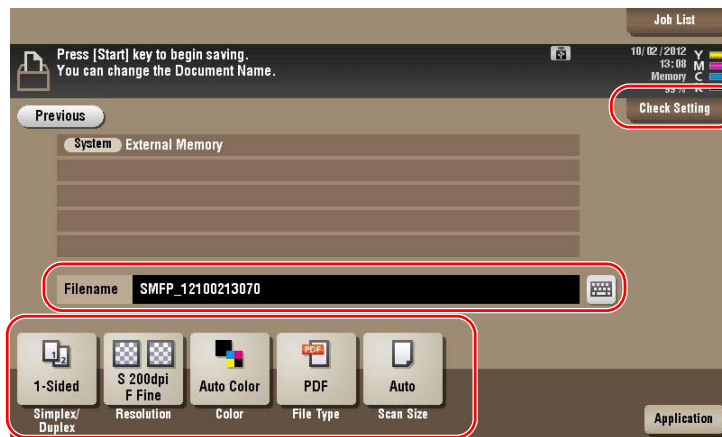

- You can also check the setting using the keys displayed on the **Touch Panel**.
- To change the setting, tap the desired key on the **Touch Panel**.

Settings	Description
[Simplex/Duplex]	Select whether to scan one or both sides of the original.
[Resolution]	Specify the scanning resolution.
[Color]	Select whether to scan the original in color or black and white mode.
[File Type]	Select the type of the file to save scanned data.
[Scan Size]	Specify the size of the original to be scanned.

6 Press the **Start** key.

NOTICE

Do not disconnect the USB memory device during data saving.

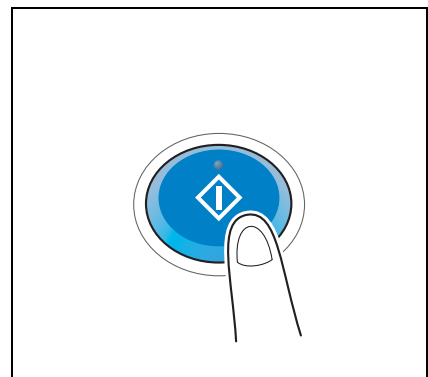

3.7 Using the guidance function

3.7.1 Guidance screen

This machine provides the guidance function to display the description of a function on the screen and view an operation procedure with moving images.

If you have any questions during operation, try to use this guidance function.

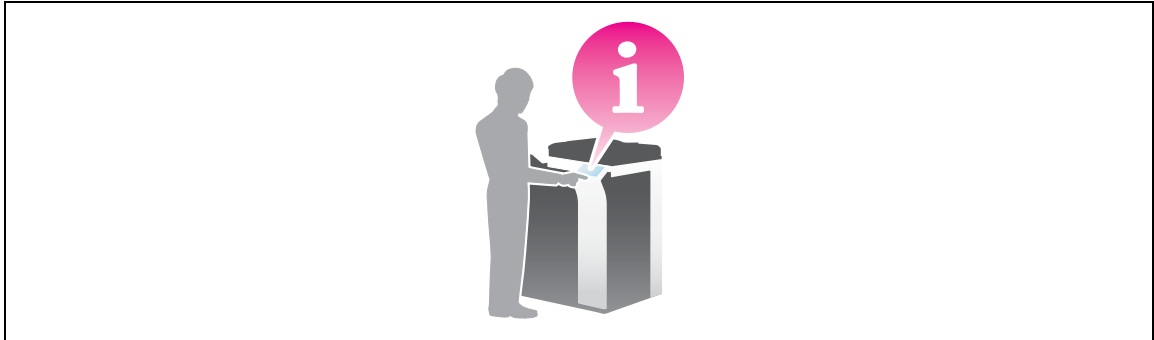

Getting help on the currently displayed screen:

Select [Function] on the Help Menu to display the guidance screen.

- 1 Press the **Guidance** key.

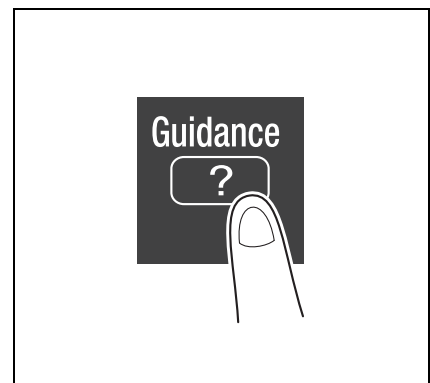

- 2 Select a menu.

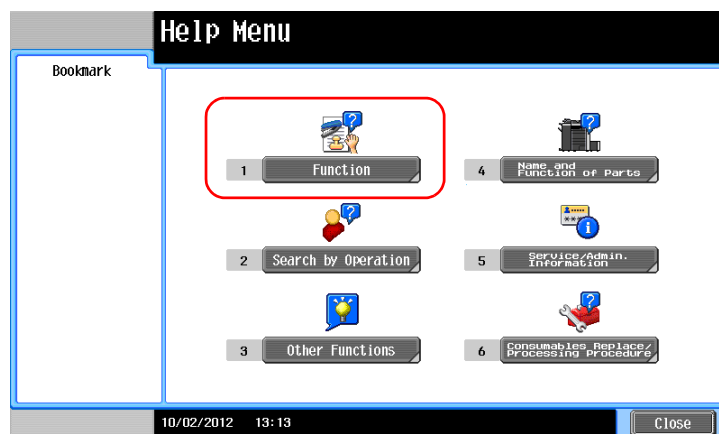

3 Narrow down the information you want to know.

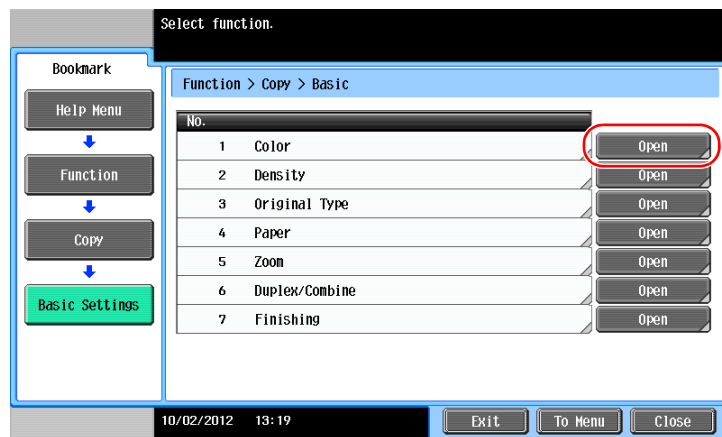
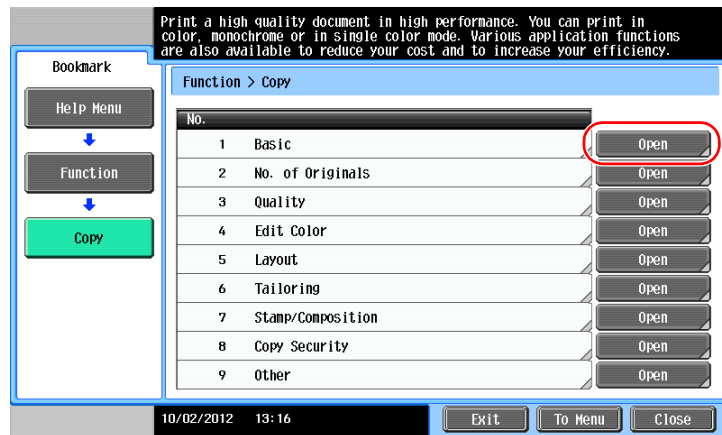
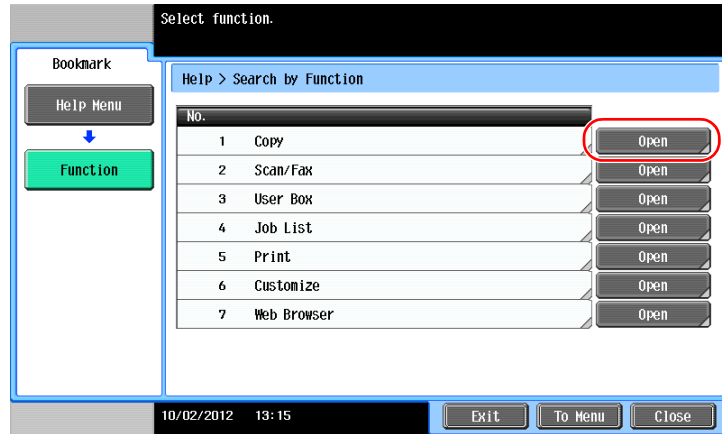

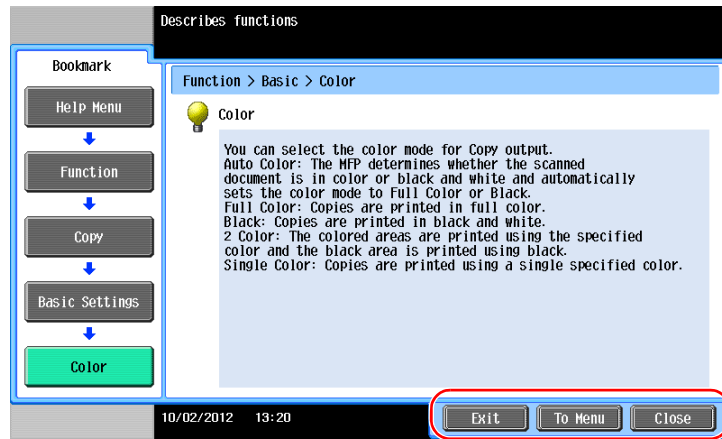

Name	Description
[Exit]	Returns to the main menu.
[To Menu]	Returns to the Help Menu.
[Close]	Returns to the preceding screen.

Getting help on the desired function or procedure:

Open the Help Menu, and select a menu depending on an objective to display the guidance screen.

- 1 Press the **Guidance** key.

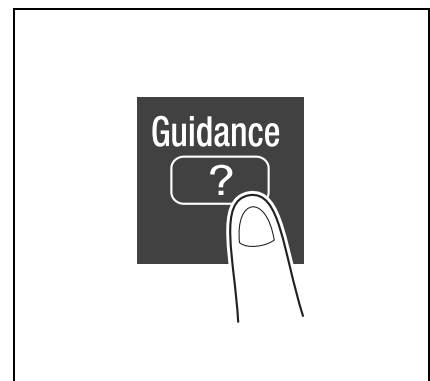

- 2 Select a menu.

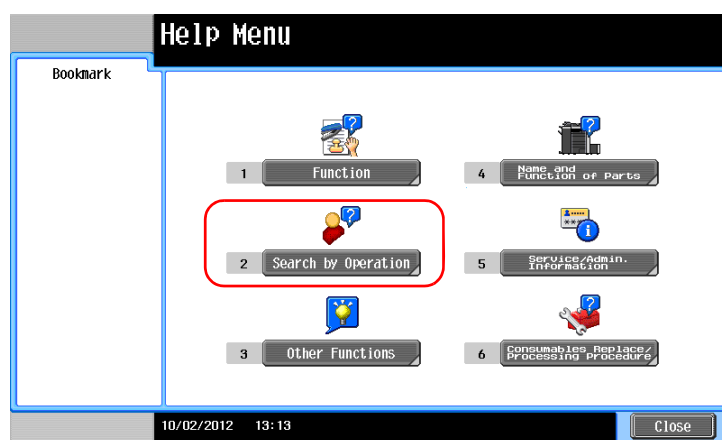

3 Narrow down the information you want to know.

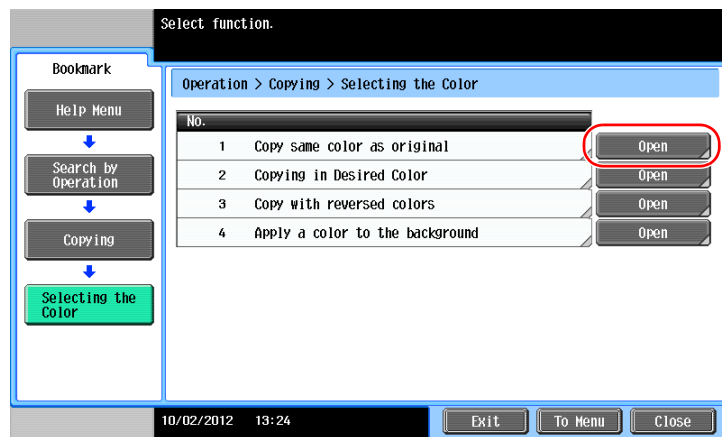
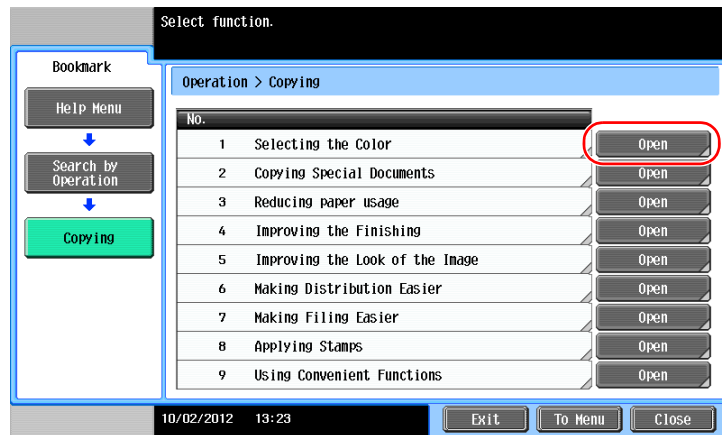
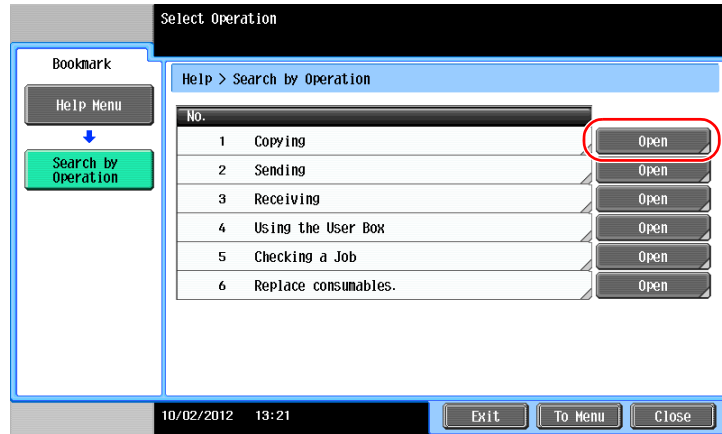

- 4 Tapping [Go to function] opens the setting screen of a target function, enabling you to configure the settings immediately.

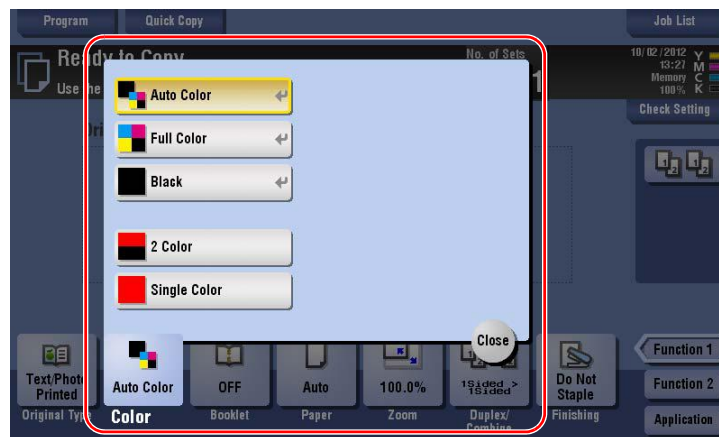
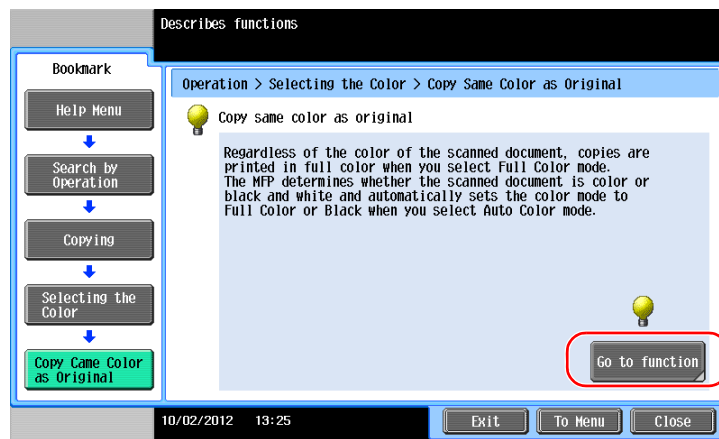

Help Menu list

The Help Menu provides the following information:

Name	Description
[Function]	Tap this button to display the guidance menu that has been sorted according to the function names to be displayed on the screen.
[Search by Operation]	Tap this button to display operation examples and explanations of this machine sorted by function.
[Other Functions]	Tap this button to display the guidance menu of the functions and settings that make it easier to use this machine.
[Name and Function of Parts]	Tap this button to check the name or function of each part of this machine.
[Service/Admin. Information]	Tap this button to display the service or administrator information, administrator name, extension number, and E-mail address.
[Consumables Replace/Processing Procedure]	Tap this button to check the consumables replacement or punch scraping procedure with moving images.



Advanced Functions

4 Advanced Functions

4.1 Using advanced functions

4.1.1 What are advanced functions?

Various functions for further enhancement of the MFP operability are expressed as advanced functions in this manual.

This machine provides the following advanced functions.

Tips

- To use an advanced function, you need to register **i-Option** or associate with the **My Panel Manager** application.

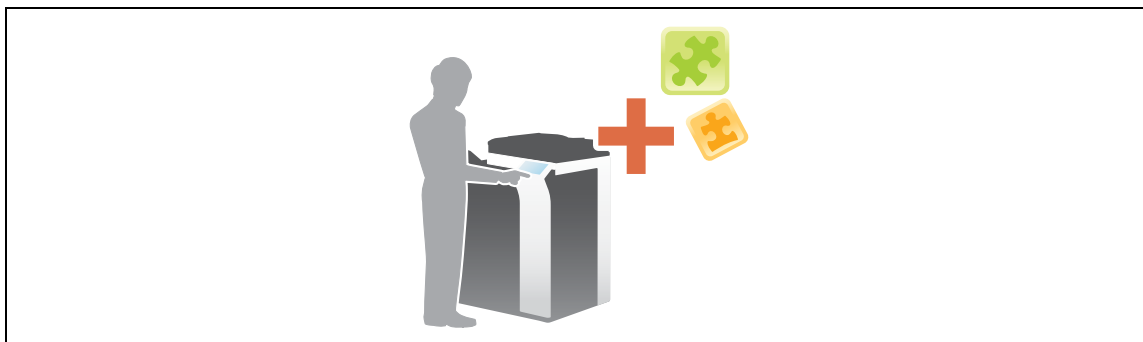

Name	Description
PDF processing	You can configure the required settings when converting scanned data to a PDF file. <ul style="list-style-type: none"> • This requires the registration of i-Option LK-102 v3.
Searchable PDF	You can convert the scanned data to a searchable PDF file. <ul style="list-style-type: none"> • This requires the registration of i-Option LK-105 v3.
Web Browser	You can use the Web browser on the Touch Panel of this machine. You can access contents on the Internet or intranet. <ul style="list-style-type: none"> • This requires the registration of i-Option LK-101 v3.
File Type Extension	Supports functions such as a function that converts a file into a DOCX or XLSX type, a function that generates highly-functional and high quality data, and the E-mail RX Print function. <ul style="list-style-type: none"> • This requires the registration of i-Option LK-110.
ThinPrint	Allows you to use this machine as ThinPrint Client (.print Client) when ThinPrint is enabled. <ul style="list-style-type: none"> • This requires the registration of i-Option LK-111.
TPM	Allows you to manage confidential information on this machine using Trusted Platform Module. <ul style="list-style-type: none"> • This requires the registration of i-Option LK-115.
My Panel	You can customize the control panel display of this machine for each user. <ul style="list-style-type: none"> • This requires the association with My Panel Manager.
My Address	You can use the address book for personal use (My Address Book). <ul style="list-style-type: none"> • This requires the association with My Panel Manager.

In addition, this machine supports advanced functions such as the barcode font, unicode font, and OCR font. For details, refer to the [User's Guide Online] on the DVD.

4.1.2 Association with application

To use the My Panel or My Address function, you need to purchase **My Panel Manager** and enable the target function in the application side.

For details on how to enable such a function, refer to the **My Panel Manager** User's Guide.

Tips

- The **Upgrade Kit UK-204** is required to use the My Address function.

4.1.3 Registering the i-Option license

To add an optional function to this machine, you need to purchase **i-Option** and register its license.

Tips

- The **Upgrade Kit UK-204** is required to use **i-Option LK-101 v3/LK-102 v3/LK-105 v3/LK-106/LK107/LK-108/LK-110**.
- **i-Option LK-110** includes the function licenses for **i-Option LK-102 v3** and **i-Option LK-105 v3**. If you purchase **i-Option LK-110**, you do not need to purchase **i-Option LK-102 v3** or **i-Option LK-105 v3**.

For details on how to purchase or install an optional unit, contact your service representative.

Preparation flow

The following describes a preparation flow to use advanced functions. For details, refer to the relevant page.

This preparation is not required the second time or subsequent times.

- 1 Registering the **i-Option** license (Administrator)
 - Register the option license on a dedicated Web site. For details, refer to page 4-5.
- 2 Enabling the **i-Option** function (Administrator)
 - Enter the license code to enable the function. For details, refer to page 4-7.
- 3 Configuring each function (Administrator)
 - Configure the required settings for each advanced function. For details, refer to page 4-8.



Reference

For details on the procedure, refer to the [User's Guide Online] on the DVD.

Registering the i-Option license

Register the request code and the contents of the token certificate on the Web site of the License Management Server (LMS).

- 1 Tap [Utility], and select [Administrator Settings] - [Forward] - [License Settings] - [Get Request Code].

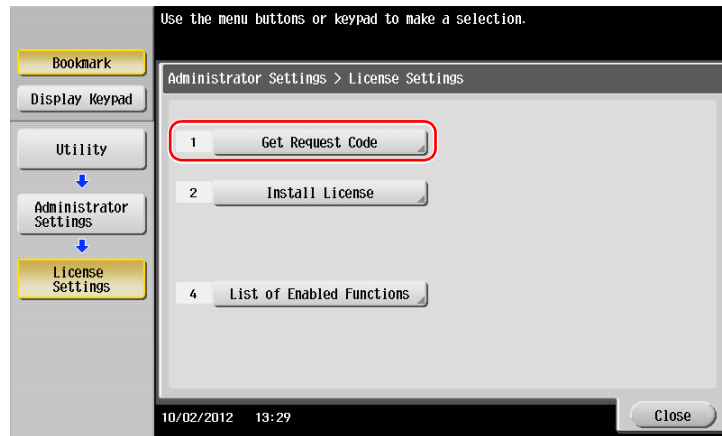

- 2 Tap [Yes] and [OK].



- 3 Tapping [Print] prints the serial number and request code.
 - Prepare at hand the printed serial number, request code, and token certificate supplied with **i-Option**.
- 4 Access the Web site of the License Management Server (LMS). Enter the [MFP Serial Number] and [Request Code], then click [Next].
 - The URL is described in the token certificate.

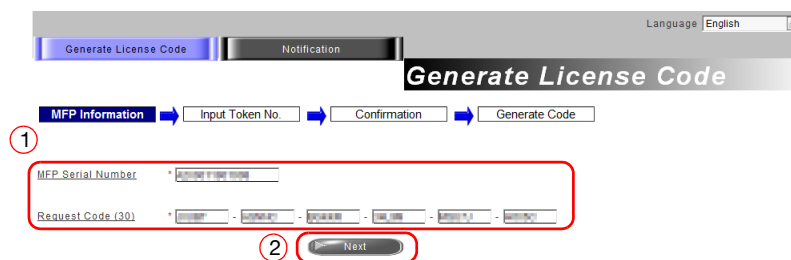

- 5 Enter the [Token Number], select the option you want to register from the [Product Description] list, then click [Next].

The screenshot shows the 'Input Token Number' step of the 'Generate License Code' process. The interface includes a progress bar with steps: MFP Information, Input Token No., Confirmation, and Generate Code. Below the progress bar, the MFP Serial Number and Request Code are displayed. A red circle labeled '1' highlights the 'Token Number (20)' input field and the 'Product Description' dropdown menu, which is currently set to 'i-Option LK-105 v3'. A red circle labeled '2' highlights the 'Next' button.

- 6 Confirm the registration contents, then click [Generate License Code].

The screenshot shows the 'Confirm Information' step. The progress bar now highlights the 'Confirmation' step. The MFP Serial Number and Request Code are visible. A red circle highlights the 'Generate License Code' button. Below the main form, a table displays the confirmed information:

Token Number	Product Description
XXXXXXXXXXXXXXXXXXXX	i-Option LK-105 v3

- 7 The license code and function code are issued.

The screenshot shows the 'License Code and Serial Number' step. The progress bar highlights the 'Generate Code' step. A message states: 'You have successfully generated a License Code. Please save all information for future use.' Below this, the MFP Serial Number, License Code (with instructions for Web Connection and MFP), and Function Code are displayed. A table shows the Product Description as 'i-Option LK-105 v3'. At the bottom, there are buttons for 'Download', 'Print', and 'Generate Additional License Codes'.

Tips

- The issued license code and function code are required to enable **i-Option**. You should write them down on a memo pad or print them out on paper by clicking [Print].
- You could also store them in your USB memory device. The license code input could be omitted by using a USB memory device to achieve a convenient operation.
- When using a USB memory device, insert the USB memory device and click [Download] to store the license code.

Enabling the i-Option function

Register the license and function codes in this machine.

By inputting the codes

- 1 Tap [Utility], and select [Administrator Settings] - [Forward] - [License Settings] - [Install License] - [Function/License Code].

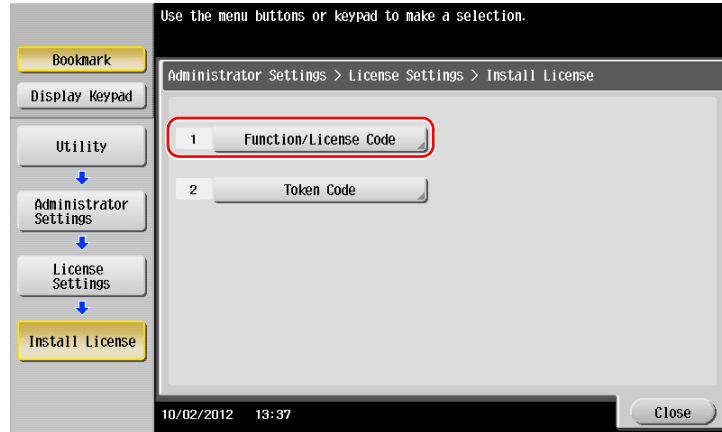

- 2 Enter the license and function codes you wrote down.

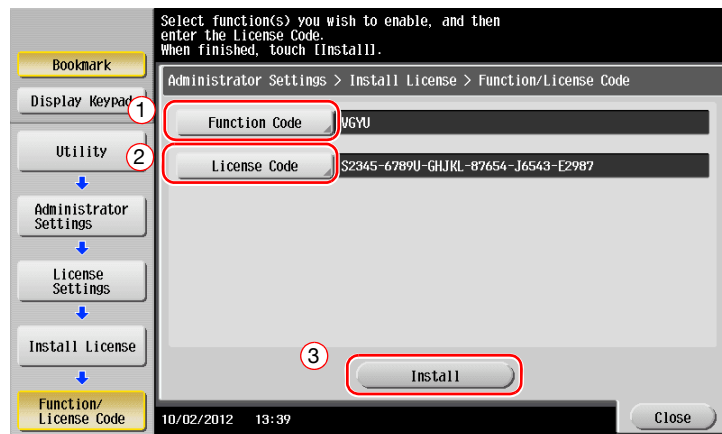

- 3 Select [Yes], then tap [OK].

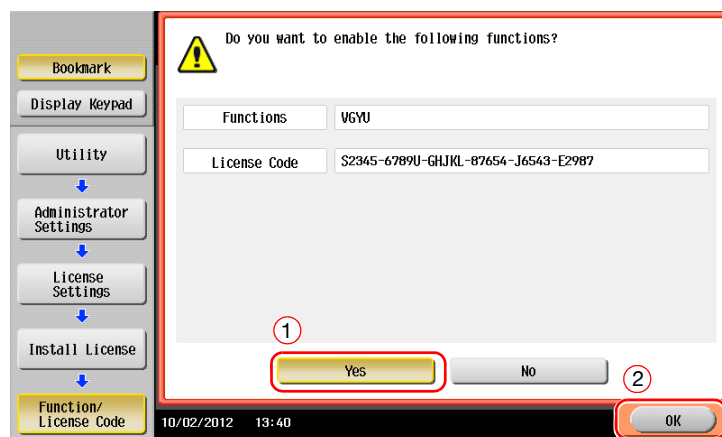

This machine restarts automatically.

By using a USB memory device

- 1 Connect the USB memory device stored with the license code.

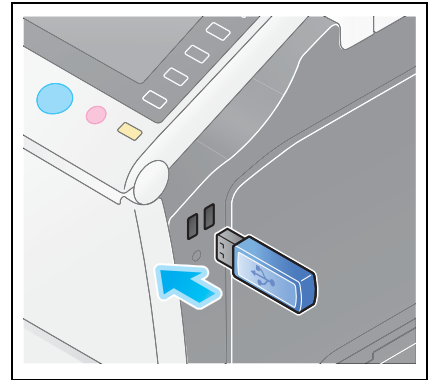

- 2 Tap [Utility], and select [Administrator Settings] - [Forward] - [License Settings] - [Install License from Ext. Memory].

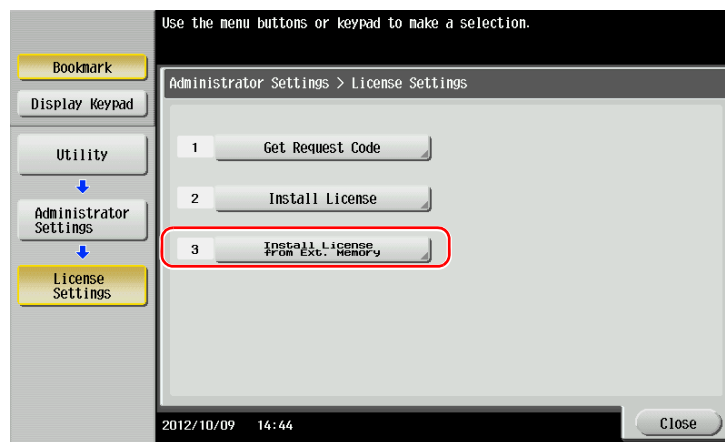

- 3 Select [Yes], then tap [OK].

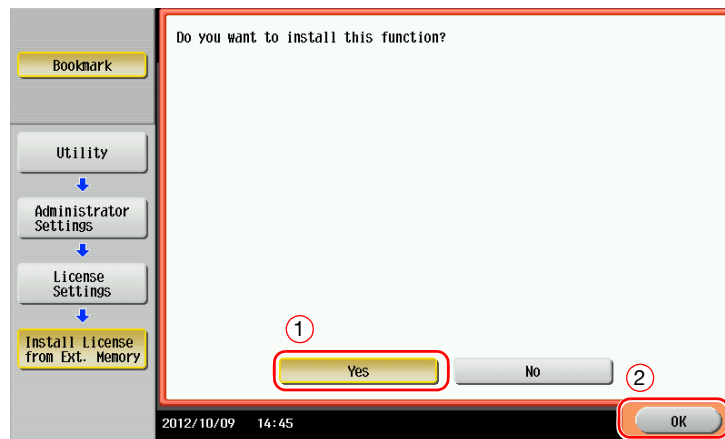

This machine restarts automatically.

Configuring each function

Configure the required settings for each advanced function.

**Reference**

For details on the required setting items for each advanced function, refer to the [User's Guide Online] on the DVD.



5 Troubleshooting

5 Troubleshooting

5.1 Main messages and remedies

5.1.1 When a message appears to replace consumables or carry out cleaning

A message appears indicating the time(s) that expiring consumables used in this machine should be replaced. Also, a message appears when the **Slit Scan Glass** is dirty.

Replace consumables mentioned in the displayed message or clean the **Slit Scan Glass**.

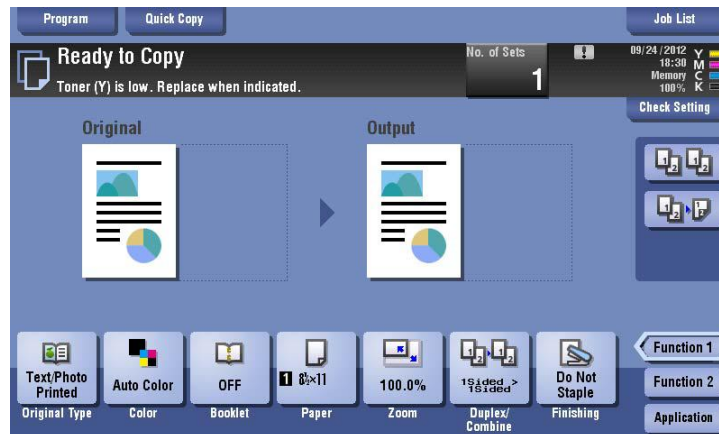

A message recommending that parts be replaced indicates that certain consumables are running out. Although you can still continue to print for a while after the message is displayed, it is advisable to promptly prepare replacement consumables.

- For a **Toner Cartridge**: [Toner is low. Replace when indicated.] appears, followed by [Replace Toner Cartridge.]. Replace the Toner Cartridge based on the maintenance contract.
- For **Drum Unit**: When the message [The Drum Unit needs to be replaced.] appears, replace it based on the maintenance contract.
- For **Developing Unit**: When the message [The Developing Unit needs to be replaced.] appears, contact your service representative.
- For **Waste Toner Box**: When the message [Waste Toner Box needs to be replaced.] appears, replace it based on the maintenance contract.

Contact your service representative if the messages continue to appear even after replacement or cleaning has been carried out.

5.1.2 When a paper jam message persists

There may be a paper jam occurring in sections other than those indicated on the **Touch Panel**. Check the sections again not shown on the **Touch Panel**.

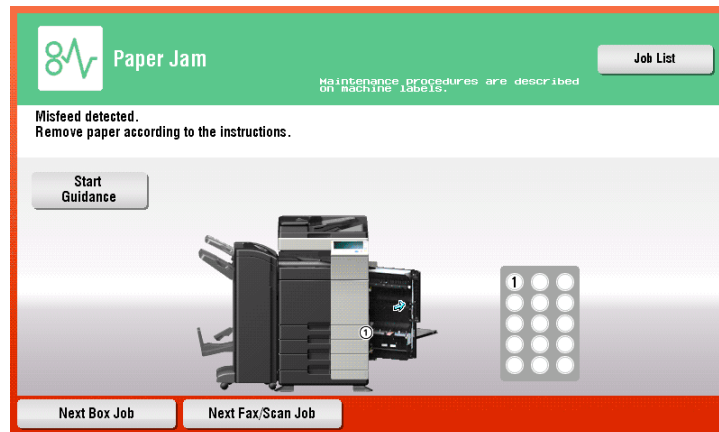

Check the following items:

- Check for any pieces of paper left in the back of the section indicated on the **Touch Panel**. If the paper cannot be easily removed, do not continue; instead contact your service representative.
- Once again, open and close the door at the section with the location number indicated on the **Touch Panel**. This action may clear the message.

Contact your service representative if the paper jam indication persists even after you have checked.

5.1.3 When an error message appears

When an error is detected, the following message appears. Take the appropriate action according to the message displayed on the screen. If you cannot resolve the error, write down the [Trouble Code], and contact your service representative with the power plug disconnected from the power outlet.

In normal circumstances, the phone number and fax number for your service representative appear in the center of the screen.

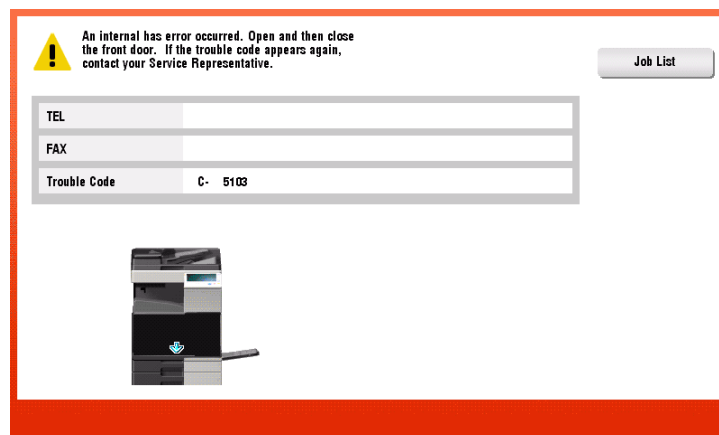

NOTICE

If a defective part can be separated in order to be able to continue operations after a problem has been detected, [Continue] or [Recover Data] is displayed. To continue operations, select any key. However, the problem has not been resolved, so contact your service representative immediately.

5.1.4 When [Stabilizing image.] appears

This automatically performs a function to adjust printing quality in order to maintain a certain level of color reproduction quality. This "printing quality adjustment" is referred to as "image stabilization".

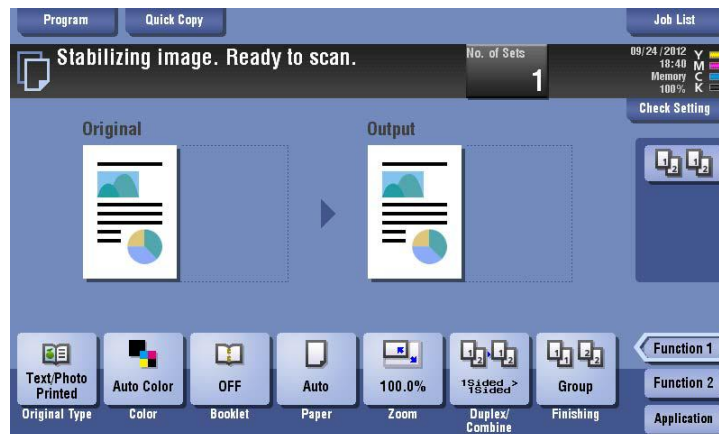

Image stabilization is performed while a large number of copies are being output or the temperature or humidity inside the machine has changed.

Upon completion of image stabilization, printing is automatically resumed. Wait for a moment.

In case image stabilization does not finish after a short while, contact your service representative.

NOTICE

You cannot interrupt or prohibit image stabilization.



Reference

To perform image stabilization on a voluntary basis, refer to the User's Guide DVD.

5.2 When printing quality has deteriorated

5.2.1 Cleaning the Electrostatic Charger

If the **Electrostatic Charger** is dirty, linear smudges may appear on a print image. If this occurs, clean the **Electrostatic Charger** according to the following procedure.

- 1 Open the **Lower Front Door** or **Front Door** of the machine.

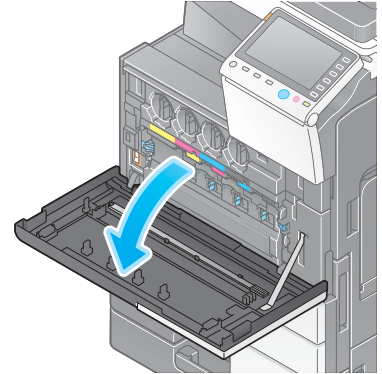

- 2 Carefully pull out the **Charger Cleaner** towards yourself up to the position at which it stops. Then, carefully press it against the back side.
→ Repeat the steps above three times.

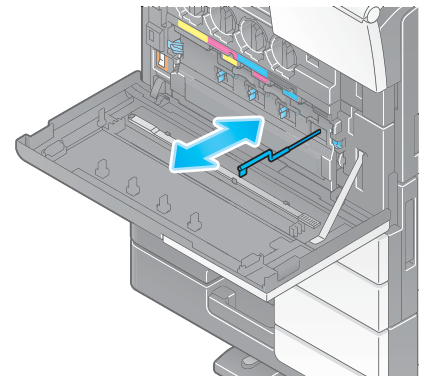

- 3 Securely press the **Charger Cleaner**, and close the **Lower Front Door** or **Front Door** of the machine.

5.2.2 Cleaning the Print Head Glass

Printing quality deteriorates if the **Print Head Glass** is dirty. If this occurs, clean the **Print Head Glass** according to the following procedure.

- 1 Open the **Lower Front Door** or **Front Door** of the machine.

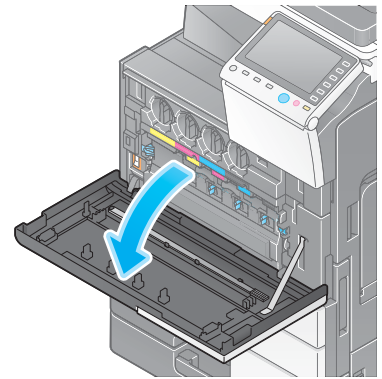

- 2 Release the **Waste Toner Box Lock Lever**, then remove the **Waste Toner Box**.

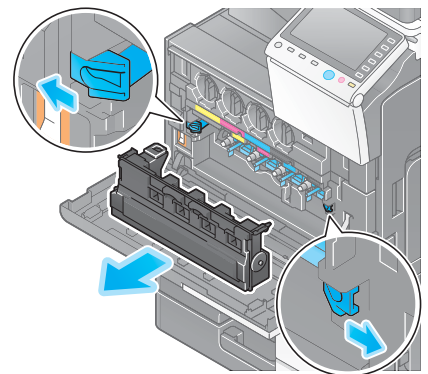

- 3 Remove the **Printhead Cleaner** from the **Lower Front Door** or **Front Door** of this machine.

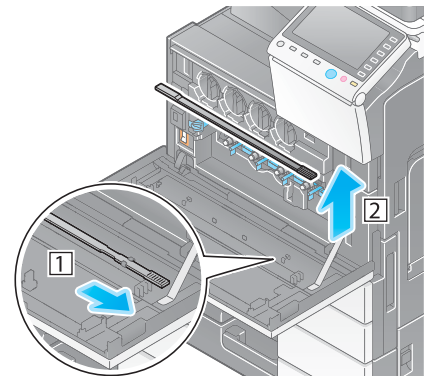

- 4 Slowly insert the **Printhead Cleaner** all the way to the back end of the **Print Head Glass** section, and then slowly pull it out.
 - Repeat this operation approximately three times for all of the **Print Head Glass** sections.

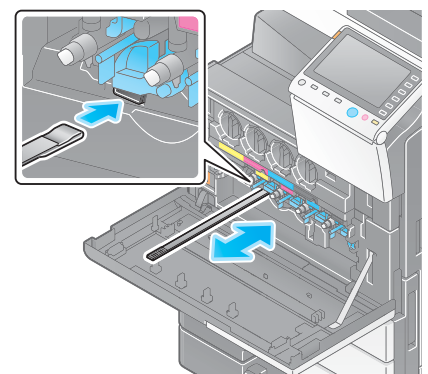

- 5 Mount the **Printhead Cleaner** onto the **Lower Front Door** or **Front Door** of this machine.
- 6 Install the **Waste Toner Box**.
- 7 Close the **Lower Front Door** or **Front Door** of the machine.

5.3 When the machine cannot be powered on

This machine has two power sources. Check the **Main Power Switch** and the **Power** key for the status.

- Check whether the power plug of this machine is firmly plugged into the power outlet. Also check that the breaker has not tripped.
- Check to see that the **Main Power Switch** and the **Power** key are turned ON.

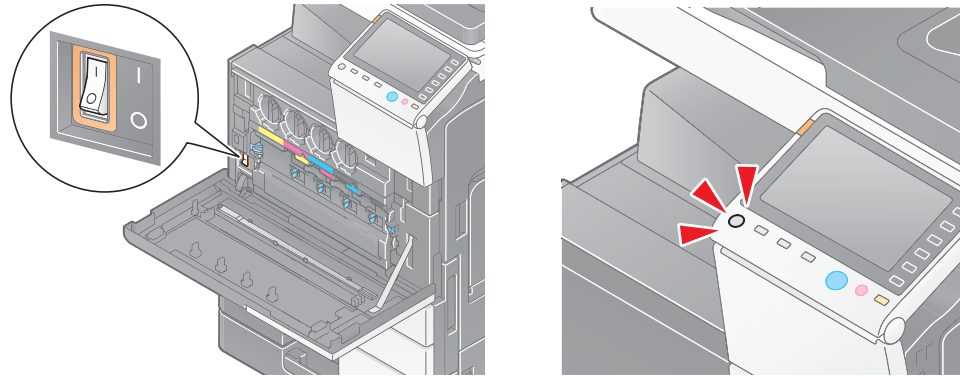

In case the machine cannot be powered on even after checking, contact your service representative.

5.4 When the Touch Panel is not visible

If a certain length of time has elapsed without any operations being carried out on this machine, the **Touch Panel** may turn off.

Check the following items:

- Tap [Accessibility] and select [Brightness Adjustment], and select [Low] or [High] to adjust the contrast for the **Touch Panel**.

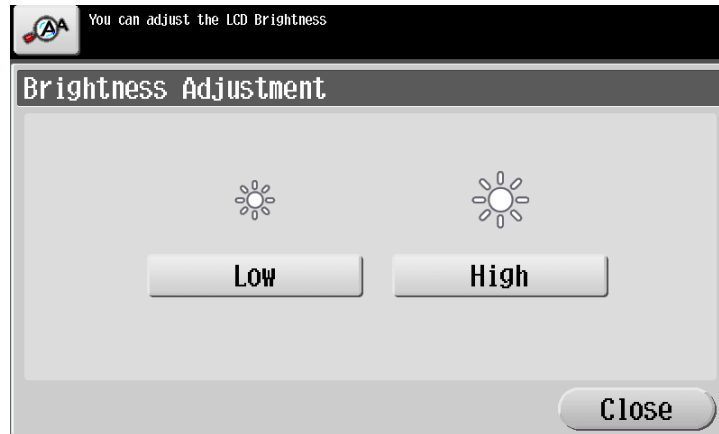

- Touch the **Touch Panel**. In Power Save (Low Power/Sleep) mode, this machine returns from Power Save mode when the **Touch Panel** is touched or a key on the **Control Panel** is pressed, and the **Touch Panel** appears normally.
- On the **Control Panel**, press the **Power** key. If the Weekly Timer setting has put the machine in Erp Auto Power OFF mode, press the **Power** key to display the **Touch Panel**. To use it outside the preset operating hours, follow the on-screen instructions.

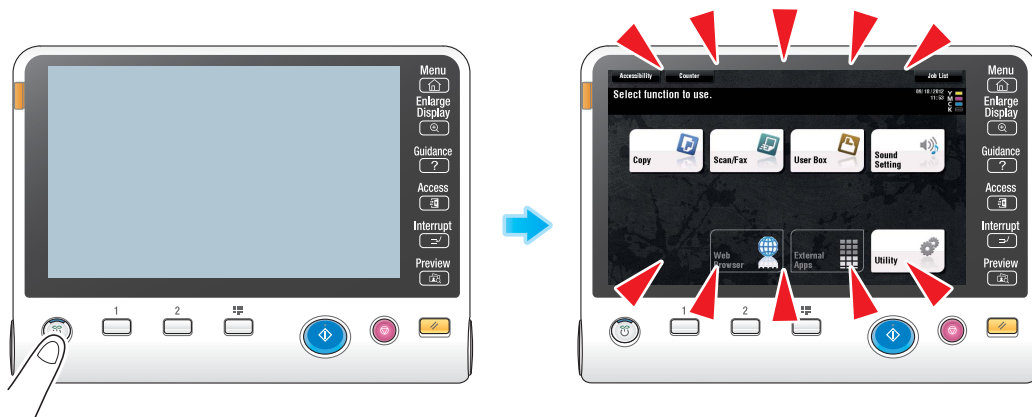

- Check to see that the **Main Power Switch** and the **Power** key are turned ON.

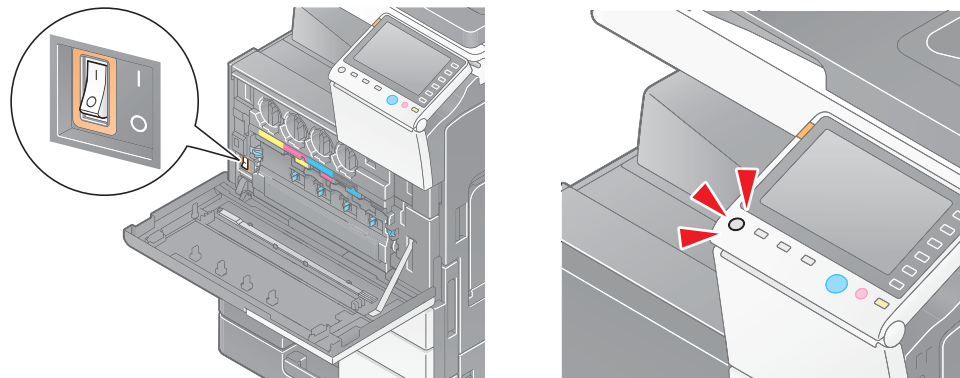

In case the **Touch Panel** does not appear even after checking it, contact your service representative.

5.5 When a message appears to replace consumables or carry out cleaning

When staples in the finisher have run out

When staples in the **Finisher** have run out, the following message appear.

Take action while referring to the label inside the machine.

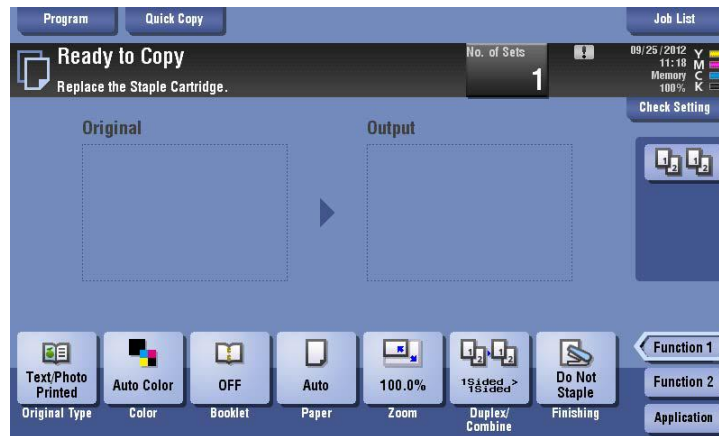

When the punch scrap box is full

When the punch scrap box is full, the following message appears (at replacement by user).

Take action while referring to the label inside the machine.

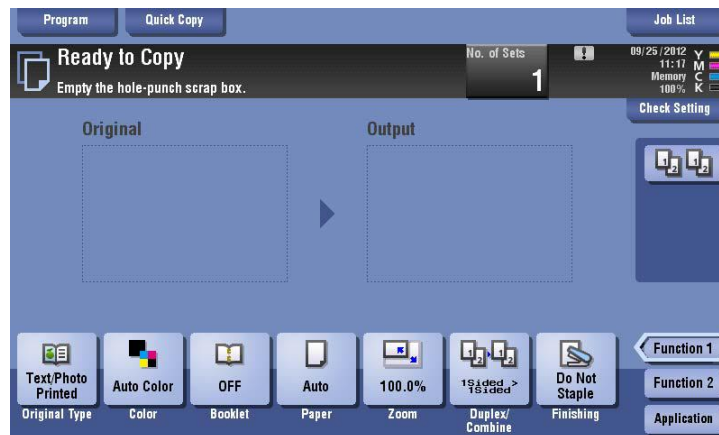

When toner is running out in the Toner Cartridge

When toner is running out in **Toner Cartridge**, a message appears as shown below (at replacement by user).

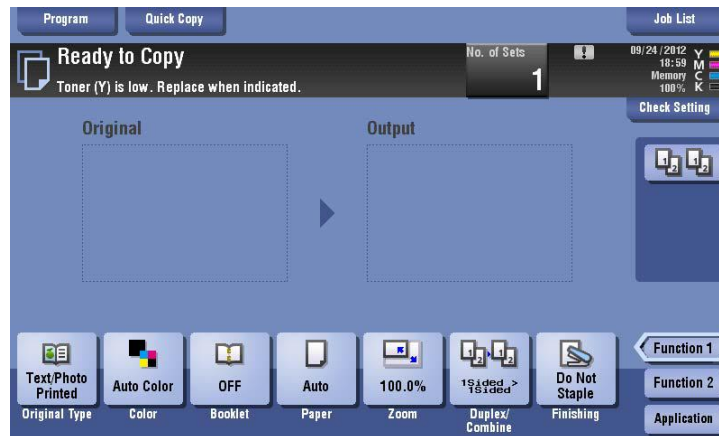

When the Drum Unit needs to be replaced

When the replacement time has come for the **Drum Unit**, the following message appears (at replacement by user). Tap [Start Guidance], then follow the displayed guidance to take an action.

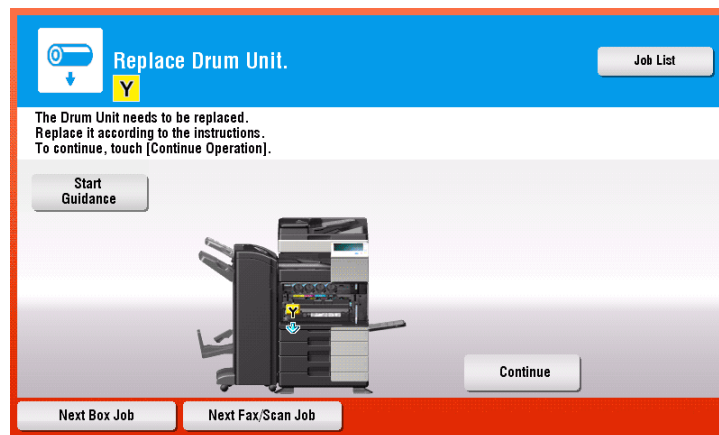

Tips

- By the factory default status, this message is displayed only in some area.
- The settings by the service representative are required to display a message about **Drum Unit**. For details, contact your service representative.

When a Developing Unit needs to be replaced

When the replacement time has come for a **Developing Unit**, the following message appears. If the message appears, contact your service representative.

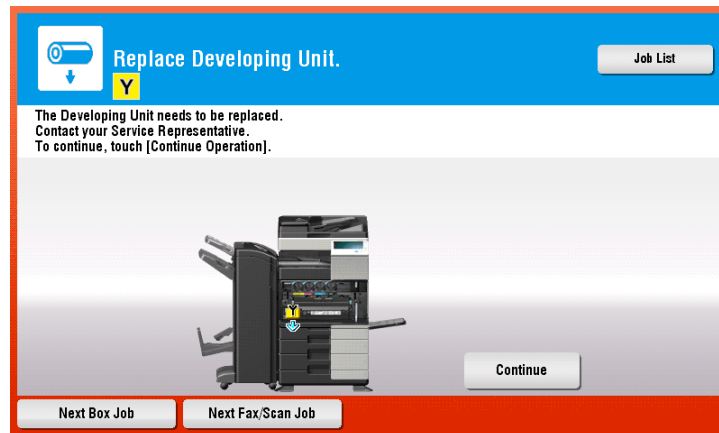

Tips

- By the factory default status, this message is displayed only in some area.
- The settings by the service representative are required to display a message about **Developing Unit**. For details, contact your service representative.

When a Waste Toner Box is full

When the **Waste Toner Box** is full, the following message appears (at replacement by user). Tap [Start Guidance], then follow the displayed guidance to take an action.

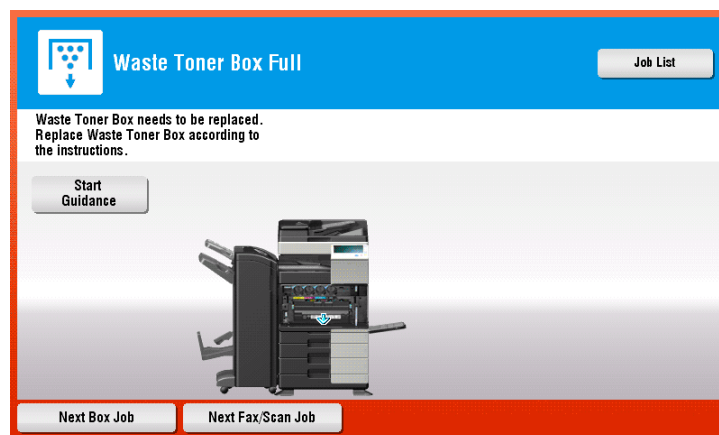

5.5.1 Replacing a Toner Cartridge

bizhub C554e/C454e

The following example shows how to replace a **Yellow Toner Cartridge**.

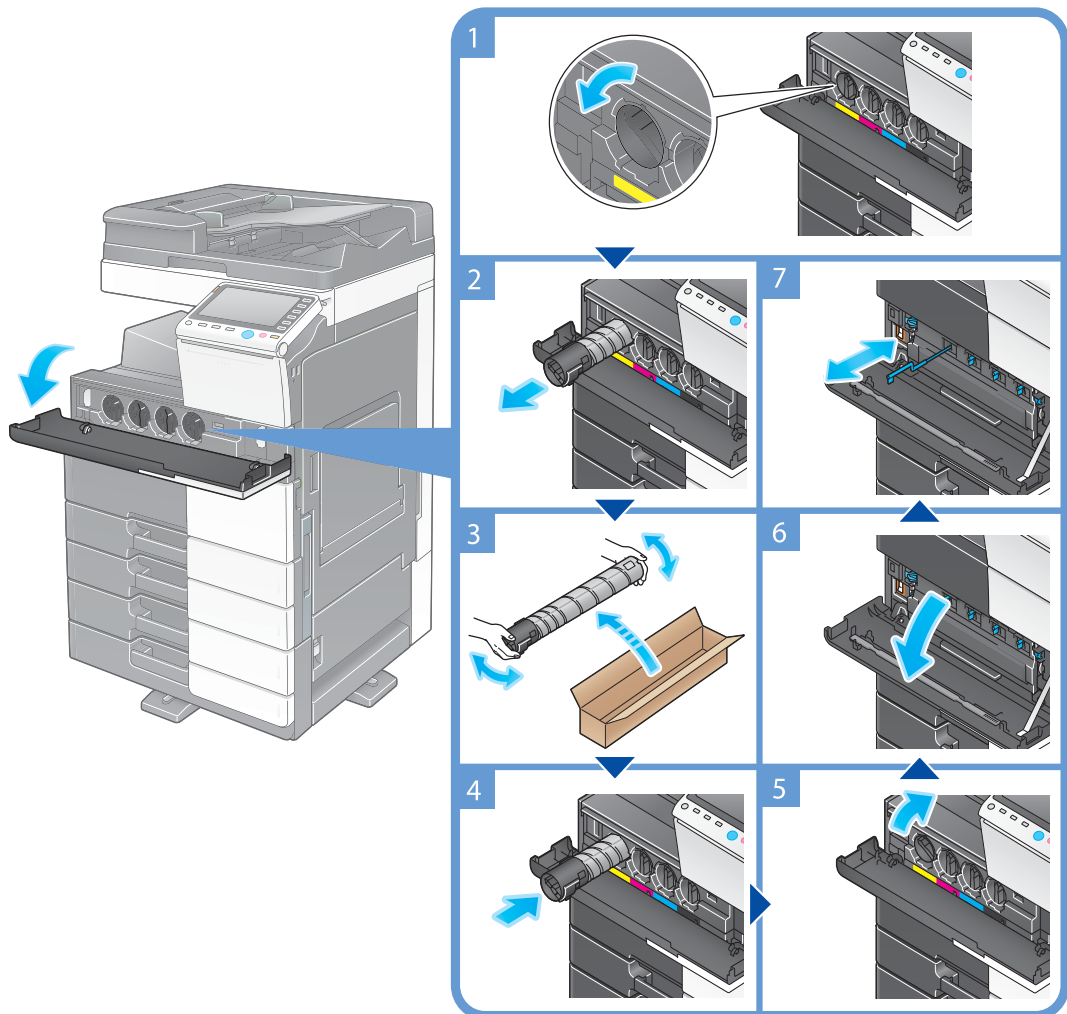

Tips

- Shake a new **Toner Cartridge** well, approximately 5 to 10 times, before installing it.
- If a Toner Cartridge other than for black is empty, printing can be continued forcibly using black. Tap [Continue], and then select a desired print job.
- Do not forcibly open or disassemble a **Toner Cartridge** (toner container).
- Do not forcibly remove or dispose of toner that remains in a **Toner Cartridge** (toner container).
- After replacing a **Toner Cartridge**, be sure to clean the **Electrostatic Charger** for each color. For details on how to clean the **Electrostatic Charger**, refer to page 5-6.

NOTICE

Install a **Toner Cartridge** for each label color. If you try to forcibly install a Toner Cartridge in the incorrect position, it may result in a failure.

⚠ CAUTION

Handling toner and Toner Cartridge

- Do not throw a toner or **Toner Cartridge** into a fire. Doing so may cause hot toner to spray in all directions, which may cause burn injuries.
- Be careful not to get the inside of the machine, your clothes, or hands dirty with toner.
- If any toner gets on your hands, wash it off using water or neutral detergent.
- If any toner gets into your eyes, immediately wash it out with water and consult your doctor.

bizhub C364e/C284e/C224e

The following example shows how to replace a **Yellow Toner Cartridge**.

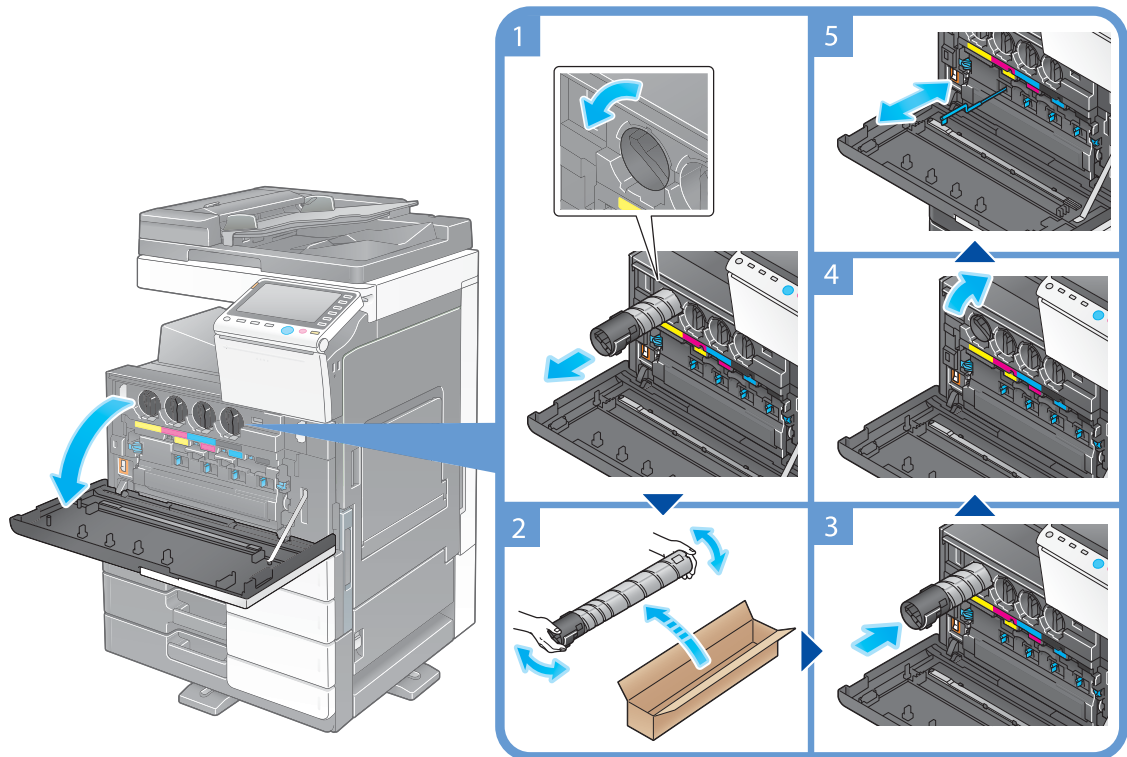

Tips

- Shake a new **Toner Cartridge** well, approximately 5 to 10 times, before installing it.
- If a Toner Cartridge other than for black is empty, printing can be continued forcibly using black. Tap [Continue], and then select a desired print job.
- Do not forcibly open or disassemble a **Toner Cartridge** (toner container).
- Do not forcibly remove or dispose of toner that remains in a **Toner Cartridge** (toner container).
- After replacing a **Toner Cartridge**, be sure to clean the **Electrostatic Charger** for each color. For details on how to clean the **Electrostatic Charger**, refer to page 5-6.

NOTICE

Install a **Toner Cartridge** for each label color. If you try to forcibly install a Toner Cartridge in the incorrect position, it may result in a failure.

⚠ CAUTION

Handling toner and Toner Cartridge

- Do not throw a toner or **Toner Cartridge** into a fire. Doing so may cause hot toner to spray in all directions, which may cause burn injuries.
- Be careful not to get the inside of the machine, your clothes, or hands dirty with toner.
- If any toner does get on your hand, wash it off using water or neutral detergent.
- If any toner gets into your eyes, immediately wash it out with water and consult your doctor.

5.5.2 Replacing a Waste Toner Box

bizhub C554e/C454e

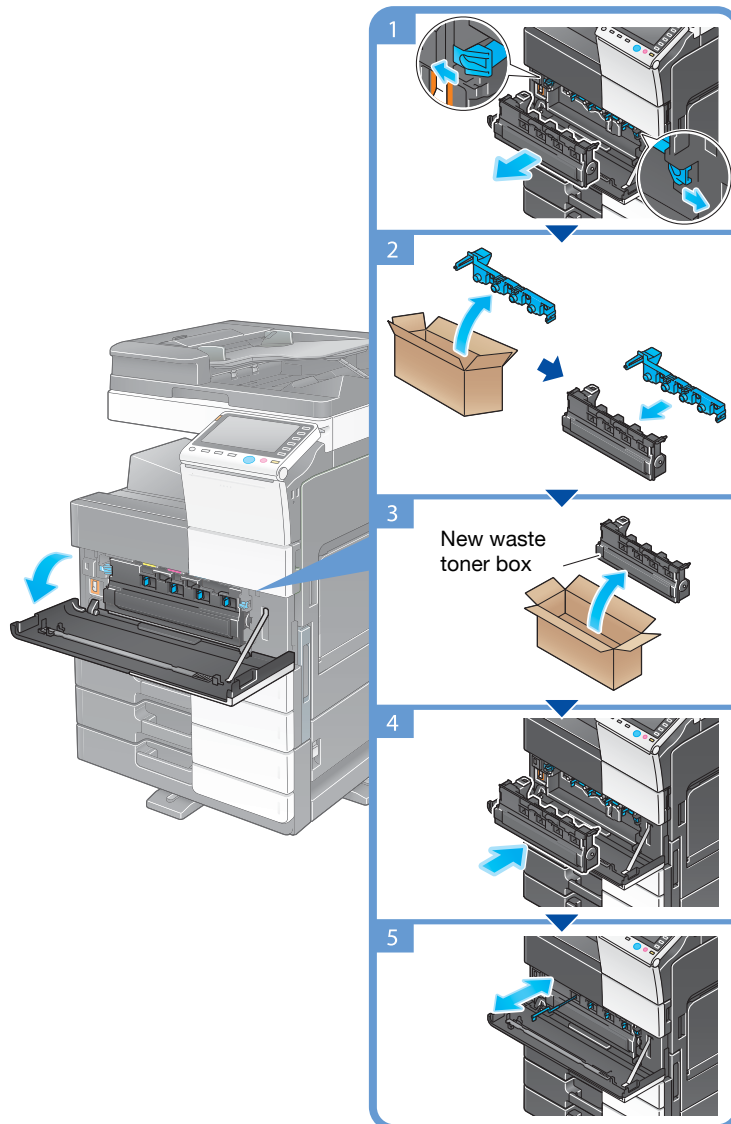

Tips

- Your service representative will recover your used **Waste Toner Box**. Place a cap on it and store it in a box.
- After replacing a **Waste Toner Box**, be sure to clean the **Electrostatic Charger** for each color. For details on how to clean the **Electrostatic Charger**, refer to page 5-6.

⚠ CAUTION

Handling toner and Waste Toner Box

- Do not throw a toner or **Waste Toner Box** into a fire. Doing so may cause hot toner to spray in all directions, which may cause burn injuries.
- Be careful not to get the inside of the machine, your clothes, or hands dirty with toner.
- If any toner gets on your hands, wash it off using water or neutral detergent.
- If any toner gets into your eyes, immediately wash it out with water and consult your doctor.

bizhub C364e/C284e/C224e

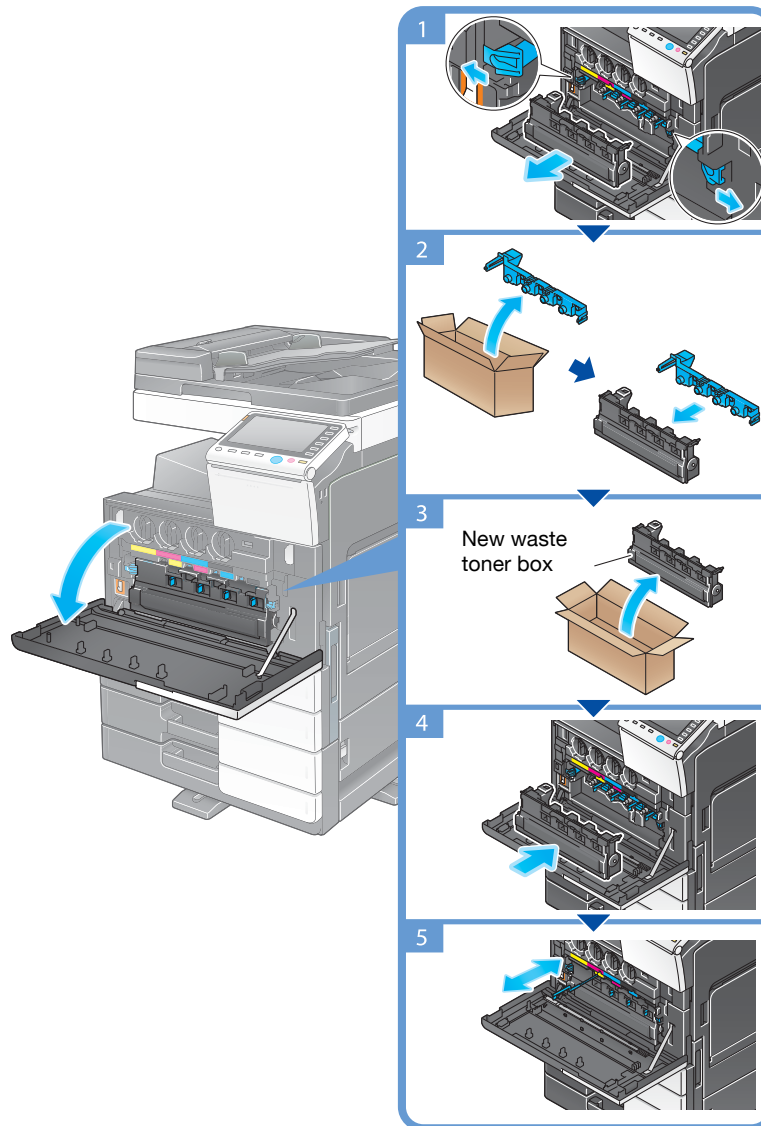

Tips

- Your service representative will recover your used **Waste Toner Box**. Place a cap on it and store it in a box.
- After replacing a **Waste Toner Box**, be sure to clean the **Electrostatic Charger** for each color. For details on how to clean the **Electrostatic Charger**, refer to page 5-6.

⚠ CAUTION

Handling toner and Waste Toner Box

- Do not throw a toner or **Waste Toner Box** into a fire. Doing so may cause hot toner to spray in all directions, which may cause burn injuries.
- Be careful not to get the inside of the machine, your clothes, or hands dirty with toner.
- If any toner does get on your hand, wash it off using water or neutral detergent.
- If any toner gets into your eyes, immediately wash it out with water and consult your doctor.

5.5.3 Replacing a Drum Unit

bizhub C554e/C454e

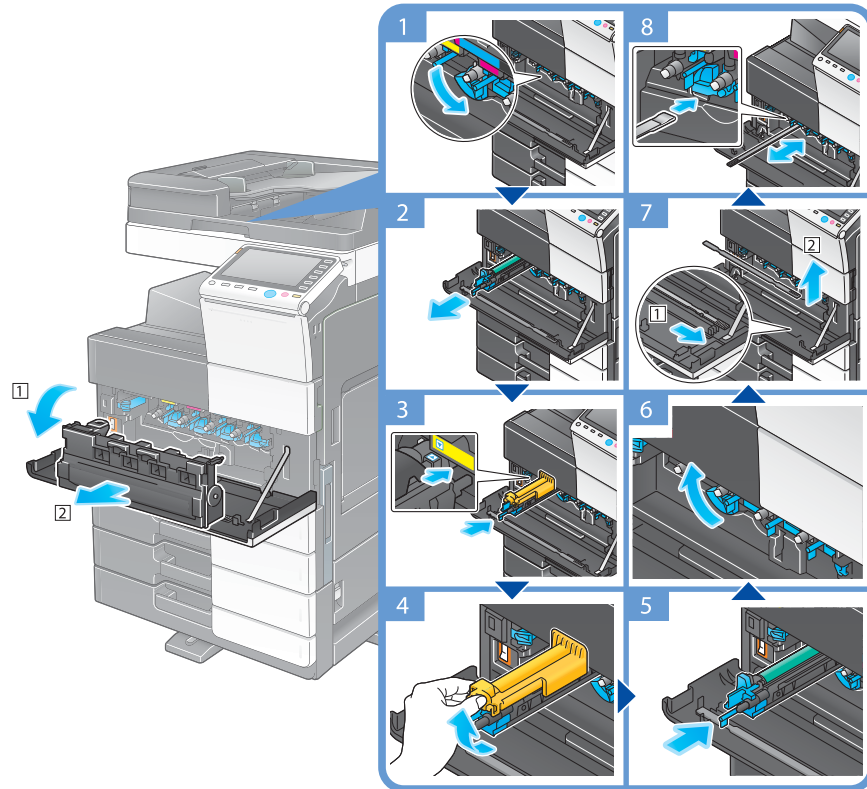

Unpacking the drum unit

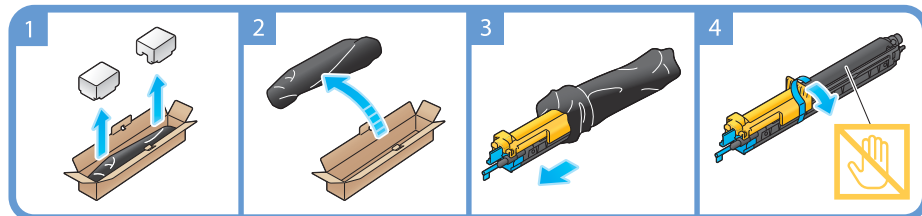

Tips

- Your service representative can recover your used **Drum Unit**. Put it in a black plastic bag and store it in a box by itself.
- A **Drum Unit** may be damaged due to exposure to light. Do not take a Drum Unit out of a black plastic bag until just before it is to be installed.
- If the replacement time of a **Drum Unit** other than for black is reached, printing can be continued forcibly using black. Tap [Continue], and then select a desired print job.
- After replacing a **Drum Unit**, be sure to clean the **Print Head Glass** for each color. For details on how to clean the Print Head Glass, refer to page 5-7.

⚠ CAUTION Handling toner and Drum Unit

- Do not throw a **Drum Unit** into a fire. Doing so may cause hot toner to spray in all directions, which may cause burn injuries.
- Be careful not to get the inside of the machine, your clothes, or hands dirty with toner.
- If any toner gets on your hands, wash it off using water or neutral detergent
- If any toner gets into your eyes, immediately wash it out with water and consult your doctor.

bizhub C364e/C284e/C224e

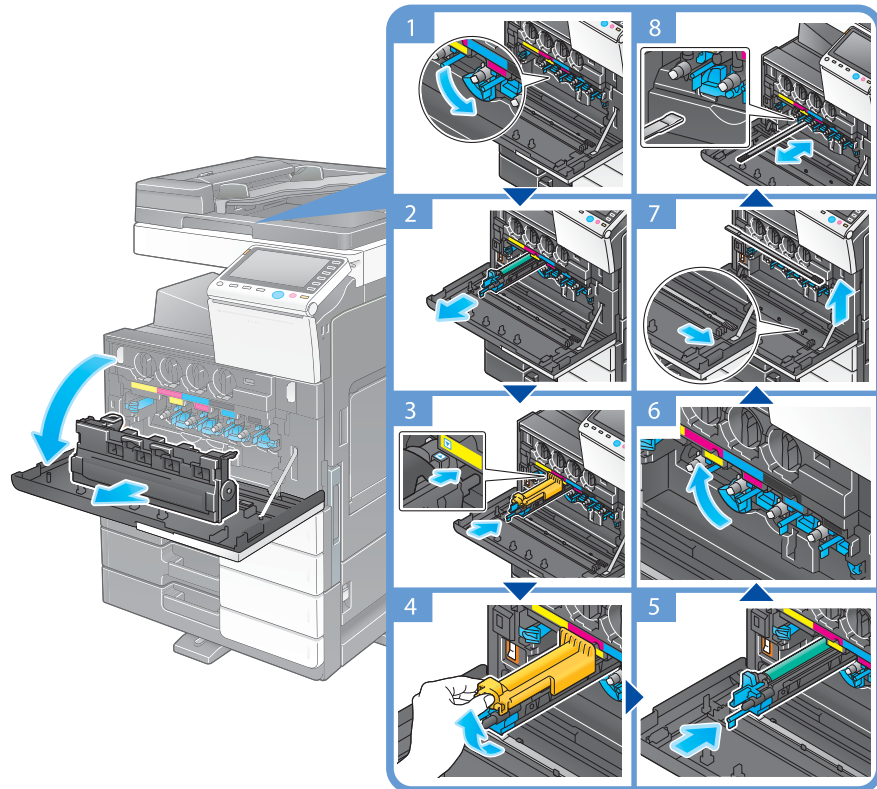

Unpacking the drum unit

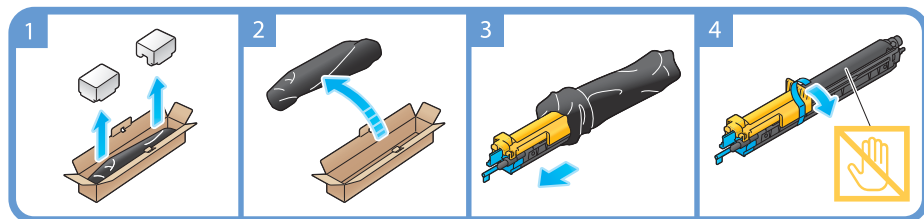

Tips

- Your service representative will collect your used **Drum Unit**. Put it in a black plastic bag and store it in a box by itself.
- A **Drum Unit** may be damaged due to exposure to light. Do not take a Drum Unit out of a black plastic bag until just before it is to be installed.
- If the replacement time of a **Drum Unit** other than for black is reached, printing can be continued forcibly using black. Tap [Continue], and then select a desired print job.
- After replacing a **Drum Unit**, be sure to clean the **Print Head Glass** for each color. For details on how to clean the **Print Head Glass**, refer to page 5-7.

⚠ CAUTION

Handling toner and Drum Unit

- Do not throw an **Drum Unit** into a fire. Doing so may cause hot toner to spray in all directions, which may cause burn injuries.
- Be careful not to get the inside of the machine, your clothes, or hands dirty with toner.
- If any toner does get on your hand, wash it off using water or neutral detergent.
- If any toner gets into your eyes, immediately wash it out with water and consult your doctor.



6

Index

6 Index

6.1 Index by item

A

Address Book *3-47*

Advanced Functions *4-3*

C

Control Panel *2-30*

Copy function *3-44*

D

Dialing Method *3-36*

E

E-mail TX *3-28*

Entering Characters *2-38*

ErP Auto Power OFF *2-29*

F

Fax TX *3-34*

G

Group *3-53*

Guidance function *3-63*

I

Installing the fax driver *3-42*

Installing the printer driver *3-5, 3-9*

i-Option *4-4*

J

Job *2-39*

K

Keypad *2-36*

L

License Management Server (LMS) *4-5*

Loading Paper *2-40, 2-41, 2-42, 2-43*

Low Power mode *2-29*

M

Main Menu *2-32*

MFP *2-13, 2-15*

Multi-job *2-39*

O

Options *2-7, 2-10, 2-17*

P

PC-Fax TX *3-39*

PCL *3-6*

Power Save mode *2-29*

Print Function *3-3, 3-6*

Printing from a USB memory device *3-57*

PS *3-6*

R

Request Code *4-5*

S

Safety information *1-6*

Saving the scanned data *3-59*

Search *3-55*

Sender Fax No. Settings *3-36*

Sender settings *3-36*

Sleep mode *2-29*

SMB Send *3-12, 3-20*

Sub Power OFF *2-28*

T

Token Certificate *4-5*

Touch Panel *2-32, 2-33*

U

User authentication *3-46*

X

XPS *3-6*

