

bizhub C360/C280/C220

User's Guide [Print Operations]





Table of contents

1 Introduction

1.1	Welcome	1-2
1.1.1	User's guides	1-2
1.1.2	User's Guide	1-3
1.2	Conventions used in this manual	1-4
1.2.1	Symbols used in this manual	1-4
	To use this machine safely.....	1-4
	Procedural instruction.....	1-4
	Key symbols.....	1-5
1.2.2	Original and paper indications	1-5
	Original and paper sizes	1-5
	Original and paper indications	1-5

2 Overview

2.1	Printer controller	2-2
2.1.1	Roles of the printer controller	2-2
2.1.2	Flow of printing	2-3
2.1.3	Control panel.....	2-4
2.2	Operating environment.....	2-6
2.2.1	Connectable computers and operating system.....	2-6
	Windows	2-6
	Macintosh	2-6
2.2.2	Interfaces used for connection	2-7
	Ethernet.....	2-7
	USB interface.....	2-7
	Connection diagram.....	2-7
2.3	Setup procedure	2-8
2.3.1	For network connection	2-8
2.3.2	For local connection	2-9
2.4	Contents of CD-ROM.....	2-10

3 Precautions for Installation

3.1	Introduction	3-2
3.2	Printer drivers compatible with respective operating systems.....	3-3
3.3	Connection methods selectable in each operating system.....	3-5
3.3.1	Windows Vista/Server 2008	3-5
3.3.2	Windows 2000/XP/Server 2003	3-6
3.3.3	Windows NT 4.0.....	3-7
3.3.4	Mac OS X 10.2/10.3/10.4/10.5	3-7
3.3.5	Mac OS 9.2	3-8
3.3.6	NetWare	3-8

4 Easy Installation Using the Installer (Windows)

4.1	Installer	4-2
4.1.1	Operating environment of the installer.....	4-2
4.2	Easy installation procedure using the installer	4-3
4.2.1	Settings of this machine	4-3
	TCP/IP settings for the machine	4-3
	RAW port number/IPP setting for the machine	4-3
4.2.2	Installing the printer driver	4-3



5 Manual Installation Using the Add Printer Wizard

5.1	Windows Vista/Server 2008	5-2
5.1.1	For network connection (LPR/Port 9100/SMB)	5-2
	Settings for the machine.....	5-2
	Installing the printer driver by searching for the printer using the Add Printer Wizard.....	5-2
	Installing the printer driver by creating a printer port.....	5-5
5.1.2	For network connection (IPP/IPPS)	5-7
	Settings for the machine.....	5-7
	Installing the printer driver manually using the Add Printer Wizard	5-8
5.1.3	For network connection (Web service print)	5-9
	Settings for the machine.....	5-9
	Installing the printer from the Network window	5-9
	Installing the printer driver by specifying the IP address using the Add Printer Wizard	5-10
5.1.4	For local connection	5-12
5.2	Windows XP/Server 2003	5-13
5.2.1	For network connection (LPR/Port9100)	5-13
	Settings for the machine.....	5-13
	Installing the printer driver manually using the Add Printer Wizard	5-13
5.2.2	For network connection (SMB)	5-17
	Settings for the machine.....	5-17
	Installing the printer driver by specifying the printer using the Add Printer Wizard.....	5-17
5.2.3	For network connection (IPP/IPPS)	5-19
	Settings for the machine.....	5-19
	Installing the printer driver manually using the Add Printer Wizard	5-20
5.2.4	For local connection	5-21
5.3	Windows 2000	5-22
5.3.1	For network connection (LPR/Port9100)	5-22
	Settings for the machine.....	5-22
	Installing the printer driver manually using the Add Printer Wizard	5-22
5.3.2	For network connection (SMB)	5-24
	Settings for the machine.....	5-24
	Installing the printer driver manually using the Add Printer Wizard	5-24
5.3.3	For network connection (IPP/IPPS)	5-25
	Settings for the machine.....	5-25
	Installing the printer driver manually using the Add Printer Wizard	5-25
5.3.4	For local connection	5-26
5.4	Windows NT 4.0	5-28
5.4.1	For network connection (LPR)	5-28
	Settings for the machine.....	5-28
	Installing the printer driver manually using the Add Printer Wizard	5-28

6 Installation on Macintosh Computers

6.1	Mac OS X 10.2/10.3/10.4/10.5	6-2
6.1.1	Installing the printer driver	6-2
6.1.2	Selecting and connecting a printer (OS X 10.4/10.5).....	6-3
	Configuring the Bonjour settings	6-3
	Configuring the AppleTalk settings.....	6-4
	Configuring the LPR settings	6-6
	Configuring the IPP settings	6-8
6.1.3	Selecting and connecting a printer (OS X 10.2/10.3).....	6-10
	Configuring the Rendezvous settings.....	6-10
	Configuring the AppleTalk settings.....	6-11
	Configuring the LPR settings	6-12
	Configuring the IPP settings	6-14
6.2	Mac OS 9.2	6-16
6.2.1	Installing the printer driver	6-16
6.2.2	Selecting and connecting a printer	6-16
	Configuring the AppleTalk settings.....	6-16
	Configuring the LPR settings	6-17



7 Installation when Using NetWare

7.1	NetWare	7-2
7.1.1	Network Settings	7-2
7.1.2	Configuring the Windows client	7-2

8 Uninstalling the Printer Driver

8.1	Windows	8-2
8.1.1	Uninstalling the printer driver using the uninstallation program	8-2
8.1.2	Uninstallation by the installer	8-2
8.1.3	Manual uninstallation	8-3
8.2	Macintosh	8-4
8.2.1	For Mac OS X.....	8-4
8.2.2	For Mac OS 9.2.....	8-4

9 Print function of PCL/PS/XPS drivers for Windows

9.1	Print operations	9-2
9.2	Default settings of the printer driver	9-4
9.2.1	Displaying the Properties window	9-4
9.2.2	Configure tab	9-4
9.2.3	Settings tab.....	9-5
9.2.4	Registering the default settings	9-7
9.3	Common Setting	9-8
9.4	Parameter details	9-10
9.4.1	My Tab	9-10
	Edit [My Tab]	9-11
9.4.2	[Basic] tab	9-12
9.4.3	[Layout] tab	9-14
9.4.4	[Finish] tab.....	9-15
9.4.5	[Cover Mode] tab	9-16
9.4.6	[Stamp/Composition] tab.....	9-17
	Editing watermark	9-19
	Editing overlay.....	9-20
	Editing the copy security	9-21
	Editing date/time and page number	9-23
9.4.7	[Quality] tab.....	9-23
9.4.8	[Other] tab	9-26

10 Print Functions of Mac OS X

10.1	Print operations	10-2
10.2	Default settings of the printer driver	10-4
10.2.1	Option settings.....	10-4
10.2.2	Registering the default settings	10-5
10.3	Common Setting	10-6
10.4	adding a custom size	10-8
10.5	Parameter details	10-9
10.5.1	[Page Attributes]	10-9
10.5.2	[Copies & Pages].....	10-10
10.5.3	[Output Method].....	10-10
	Checking the [Output Method] detail settings	10-12
10.5.4	[Layout / Finish].....	10-13
10.5.5	[Paper Tray / Output Tray]	10-15
10.5.6	[Cover Mode / Transparency Interleave].....	10-16
10.5.7	[Per Page Setting]	10-17
	Editing Per Page Setting.....	10-18



10.5.8	[Stamp / Composition]	10-18
	Editing the copy security	10-19
	Editing Date/Time	10-21
	Editing Page Number	10-21
	Editing Header/Footer	10-22
10.5.9	[Quality]	10-22

11 Print Functions of Mac OS 9.2

11.1	Print operations	11-2
11.2	Default settings of the printer driver	11-3
11.2.1	Option settings.....	11-3
11.2.2	Registering the default settings	11-4
11.3	Parameter details	11-5
11.3.1	Page Attributes	11-5
11.3.2	Specifying the custom page sizes	11-5
11.3.3	General.....	11-6
11.3.4	[Layout] (Combination).....	11-6
11.3.5	Printer specific options (Finishing Option 1 to 5).....	11-7

12 Function Details

12.1	Proof Print	12-2
12.1.1	Setting the printer driver	12-2
	For Windows	12-2
	For Mac OS X.....	12-3
12.1.2	Recalling a job from the control panel	12-3
12.2	Secure Print	12-5
12.2.1	Setting the printer driver	12-5
	For Windows	12-5
	For Mac OS X.....	12-6
12.2.2	Recalling a job from the control panel	12-7
	When the [Confidential Document Access Method] is set to [Mode 1]	12-8
	When the [Confidential Document Access Method] is set to [Mode 2]	12-10
12.3	Save in User Box	12-12
12.3.1	Setting the printer driver	12-12
	For Windows	12-12
	For Mac OS X.....	12-13
12.3.2	Recalling a job from the control panel	12-14
12.4	Printing a document on the machine for which user authentication is specified	12-16
	For Windows	12-16
	For Mac OS X.....	12-18
12.5	Printing a document on the machine for which Account Track function is enabled	12-19
12.5.1	Setting the printer driver	12-19
	For Windows	12-19
	For Mac OS X.....	12-20
12.6	ID & Print	12-22
12.6.1	Setting the printer driver	12-22
	For Windows	12-22
	For Mac OS X.....	12-24
12.6.2	Recalling a job from the control panel	12-25
	Entering the user information and printing.....	12-25
	Printing a document by specifying it from the [ID & Print User Box]	12-26
	Logging in using the authentication unit.....	12-28
12.7	Printing from a cellular phone or PDA	12-29
12.7.1	Operating environment	12-29
12.7.2	Printing a document.....	12-29
12.8	Specifying the encryption passphrase by the user	12-32
12.8.1	Settings for the machine.....	12-32

12.8.2	Setting the printer driver	12-34
	For Windows.....	12-34
	For Mac OS X.....	12-35
12.9	Specifying the ICC profile	12-36
12.9.1	Setting the printer driver	12-36
	For Windows.....	12-36
	For Mac OS X.....	12-37
12.10	Registering the ICC profiles in the printer driver.....	12-38
12.10.1	Setting the printer driver	12-38
	For Windows.....	12-38
	For Mac OS X.....	12-39
12.11	Banner printing function.....	12-41
12.11.1	Paper.....	12-41
	Applicable paper.....	12-41
12.11.2	Printer drivers and supported operating systems.....	12-41
12.11.3	Configuring the printer driver	12-41
	For Windows.....	12-41
	For Mac OS X.....	12-41
12.11.4	Printing.....	12-43

13 Settings on the Control Panel

13.1	Basic operations of User Settings.....	13-2
13.1.1	Displaying the User Settings screen.....	13-2
13.2	User settings	13-4
13.2.1	PDL Setting.....	13-4
13.2.2	Number of Copies.....	13-5
13.2.3	Original Direction	13-6
13.2.4	Spool Print Jobs in HDD before RIP.....	13-7
13.2.5	A4/A3<->LTR/LGR Auto Switch	13-8
13.2.6	Banner Sheet Setting.....	13-9
13.2.7	Binding Direction Adjustment	13-10
13.2.8	Line Width Adjustment.....	13-11
13.2.9	Gray Background Text Correction	13-12
13.2.10	Paper Tray.....	13-13
13.2.11	Paper Size.....	13-14
13.2.12	2-Sided Print	13-15
13.2.13	Binding Position.....	13-16
13.2.14	Staple.....	13-17
13.2.15	Punch.....	13-18
13.2.16	Banner Sheet Paper Tray.....	13-19
13.2.17	Font Settings.....	13-20
13.2.18	Symbol Set.....	13-21
13.2.19	Font Size	13-22
13.2.20	Line/Page	13-23
13.2.21	CR/LF Mapping.....	13-24
13.2.22	Print PS Errors	13-25
13.2.23	ICC Profile Settings.....	13-26
13.2.24	Auto Trapping	13-28
13.2.25	Black Overprint	13-29
13.2.26	Verify XPS Digital Signature.....	13-30
13.2.27	Print Reports	13-31
13.2.28	TIFF Image Paper Setting	13-32
13.2.29	Link File Error Notification.....	13-34
13.2.30	Use Proxy Server	13-35
13.2.31	Print.....	13-37
13.3	Basic operations in Administrator Settings.....	13-39

13.3.1	Displaying the Administrator Settings screen	13-39
13.4	Administrator Settings.....	13-41
13.4.1	Print/Fax Output Setting	13-41
13.4.2	Output Tray Settings.....	13-42
13.4.3	Delete Secure Print Documents.....	13-43
13.4.4	Auto Delete Secure Document	13-44
13.4.5	ID & Print Delete Time	13-45
13.4.6	ID & Print Delete after Print Setting.....	13-46
13.4.7	Skip Job Operation Settings.....	13-47
13.4.8	ID & Print Settings.....	13-48
13.4.9	ID & Print Operation Settings.....	13-49
13.4.10	Default Operation Selection	13-50
13.4.11	Print without Authentication.....	13-51
13.4.12	Single Color > 2 Color Output Management	13-52
13.4.13	I/F timeout setting	13-53
13.4.14	Print XPS Errors	13-54
13.4.15	PSWC Direct Print.....	13-55
13.4.16	Assign Account to Acquire Device Info	13-55
13.4.17	Configuring Authentication under OpenAPI Settings	13-57
13.4.18	Configuring the cellular phone or PDA settings.....	13-58
13.4.19	Print Data Capture	13-59
13.4.20	Secure Print Only	13-59
13.4.21	Driver Password Encryption Setting	13-61

14 PageScope Web Connection

14.1	Using PageScope Web Connection	14-2
14.1.1	Operating environment	14-2
14.1.2	Accessing PageScope Web Connection	14-2
14.1.3	Web browser cache	14-3
	For Internet Explorer	14-3
	For Netscape Navigator.....	14-3
	For Mozilla Firefox.....	14-3
14.1.4	Online help function	14-3
14.2	Login and Logout	14-4
14.2.1	Login and logout flows.....	14-4
	When user authentication or account track is not enabled	14-4
	When User Authentication or Account Track is enabled	14-5
14.2.2	Logout.....	14-6
14.2.3	Login	14-7
	Login options	14-7
	Logging in as a public user.....	14-8
	Logging in as a registered user.....	14-9
	Logging in to the administrator mode.....	14-10
	Display mode in administrator mode.....	14-11
	Logging in as the User Box Administrator	14-12
14.3	Structure of pages	14-13
14.4	Overview of the user mode	14-15
14.4.1	Information	14-15
14.4.2	Job	14-16
14.4.3	User Box	14-16
14.4.4	Direct print	14-17
14.4.5	Address Registration.....	14-18
14.4.6	Customize	14-19
14.5	Administrator mode overview.....	14-20
14.5.1	Maintenance	14-20
14.5.2	System Settings.....	14-21



14.5.3	Security	14-23
14.5.4	User authentication/Account track	14-24
14.5.5	Network.....	14-25
14.5.6	User Box	14-26
14.5.7	Printer Setting	14-27
14.5.8	Address Registration.....	14-28
14.5.9	Fax Settings	14-29
14.5.10	Setting for each purpose	14-30

15 Troubleshooting

15.1	Cannot print.....	15-2
15.2	Cannot configure the settings/Cannot print according to the settings.....	15-4
15.2.1	The printer driver settings have no effect	15-4
15.2.2	Others	15-5
15.2.3	Error message.....	15-5

16 Appendix

16.1	Product specifications.....	16-2
16.2	Printing reports	16-6
16.2.1	Configuration page	16-6
16.2.2	PCL font list	16-7
16.2.3	PS font list.....	16-8
16.2.4	GDI demo page.....	16-9
16.3	PPD driver (For Linux and applications)	16-10
16.3.1	PPD driver types	16-10
16.3.2	PPD driver for Linux.....	16-10
	Registering the PPD driver for Linux.....	16-10
	Configuring the PPD driver for Linux	16-10
	Registering the PPD driver for OpenOffice	16-10
	Printing with OpenOffice.....	16-11
16.3.3	PPD driver for applications	16-11
	How to print	16-11
16.4	If the bit number differs between the server operating system and client operating system.....	16-12
16.4.1	Installing the additional driver	16-12
16.5	Glossary	16-13

17 Index

17.1	Index by item	17-2
17.2	Index by button.....	17-5



Introduction

1 Introduction

1.1 Welcome

Thank you for purchasing this machine.

This User's Guide describes the functions, operating instructions, precautions for correct operation, and simple troubleshooting guidelines of this machine. In order to obtain maximum performance from this product and use it effectively, please read this User's Guide as necessary.

1.1.1 User's guides

Printed manual	Overview
[Quick Guide Copy/Print/Fax/Scan/Box Operations]	This manual describes operating procedures and the functions that are most frequently used in order to enable you to begin using this machine immediately. This manual contains notes and precautions that should be followed to ensure safe usage of this machine. Please be sure to read this manual before using this machine.
User's guide CD manuals	Overview
[User's Guide Copy Operations]	This manual describes details on copy mode operations and the settings of this machine. <ul style="list-style-type: none"> • Specifications of originals and copy paper • Copy function • Maintaining this machine • Troubleshooting
[User's Guide Enlarge Display Operations]	This manual describes details on operating procedures of the enlarge display mode. <ul style="list-style-type: none"> • Copy function • Scanning function • G3 fax function • Network fax function
[User's Guide Print Operations]	This manual describes details on printer functions. <ul style="list-style-type: none"> • Printer function • Setting the printer driver
[User's Guide Box Operations]	This manual describes details on the boxed functions using the hard disk. <ul style="list-style-type: none"> • Saving data in user boxes • Retrieving data from user boxes • Transferring and printing data from user boxes
[User's Guide Network Scan/Fax/Network Fax Operations]	This manual describes details on transmitting scanned data. <ul style="list-style-type: none"> • E-mail TX, FTP TX, SMB TX, Save in User Box, WebDAV TX, Web Services • G3 fax • IP Address Fax, Internet Fax
[User's Guide Fax Driver Operations]	This manual describes details on the fax driver function that transmits faxes directly from a computer. <ul style="list-style-type: none"> • PC-FAX
[User's Guide Network Administrator]	This manual describes details on setting methods for each function using the network connection. <ul style="list-style-type: none"> • Network settings • Settings using PageScope Web Connection

User's guide CD manuals	Overview
[User's Guide Advanced Function Operations]	This manual describes details on functions that become available by registering the optional license kit and by connecting to an application. <ul style="list-style-type: none">• Web browser function• Image panel• PDF Processing Function• Searchable PDF• My panel and My address functions
[Trademarks/Copyrights]	This manual describes details on trademarks and copyrights. <ul style="list-style-type: none">• Trademarks and copyrights

1.1.2 User's Guide

This User's Guide is intended for users ranging from those using this machine for the first time to administrators.

It describes basic operations, functions that enable more convenient operations, maintenance procedures, simple troubleshooting operations, and various setting methods of this machine.

Note that basic technical knowledge about the product is required to enable users to perform maintenance work or troubleshooting operations. Limit your maintenance and troubleshooting operations to the areas explained in this manual.

Should you experience any problems, please contact our service representative.

1.2 Conventions used in this manual

1.2.1 Symbols used in this manual

Symbols are used in this manual to express various types of information.

The following describes each symbol related to correct and safe usage of this machine.

To use this machine safely

⚠ WARNING

- This symbol indicates that a failure to heed the instructions may lead to death or serious injury.

⚠ CAUTION

- This symbol indicates that negligence of the instructions may lead to mishandling that may cause injury or property damage.

NOTICE

This symbol indicates a risk that may result in damage to this machine or documents. Follow the instructions to avoid property damage.

Procedural instruction

- ✓ This check mark indicates an option that is required in order to use conditions or functions that are prerequisite for a procedure.

1 This format number "1" represents the first step.

2 This format number represents the order of serial steps.

- This symbol indicates a supplementary explanation of a procedural instruction.

The operation procedures are described using illustrations.

- This symbol indicates transition of the control panel to access a desired menu item.

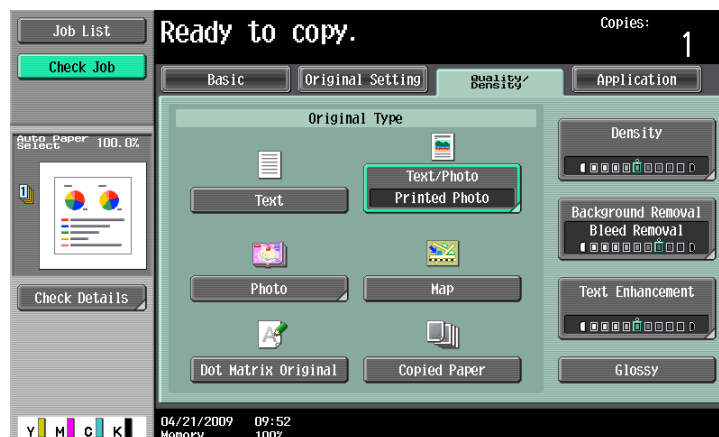

This symbol indicates a desired page.



Reference

This symbol indicates a reference.

View the reference as required.

Key symbols

[]

Key names on the touch panel and computer screen, or manual names are indicated by these brackets.

Bold text

Key names, part names, product names and option names on the control panel are indicated in bold text.

1.2.2 Original and paper indications

Original and paper sizes

The following explains the indication for originals and paper described in this manual.

When indicating the original or paper size, the Y side represents the width and the X side the length.

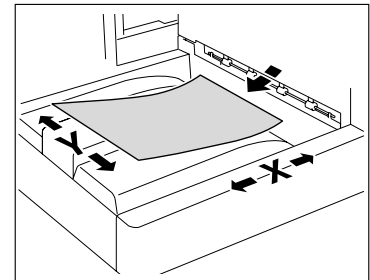

Original and paper indications

▣ indicates the paper size with the length (X) being longer than the width (Y).

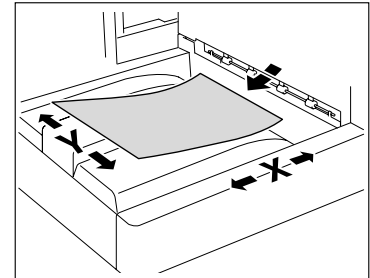

▣ indicates the paper size with the length (X) being shorter than the width (Y).

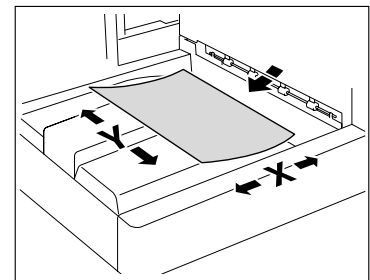



2

Overview

2 Overview

This chapter describes the overview and connection environment of the printer controller that provides the printer function.

2.1 Printer controller

The printer controller is a device that enables the printing and network printing functions on this machine.

2.1.1 Roles of the printer controller

Incorporating the printer controller enables this machine to function as a printing system, allowing printing using applications on the computer connected to this machine. When using this machine as a network printer, you can print using applications on the computer.

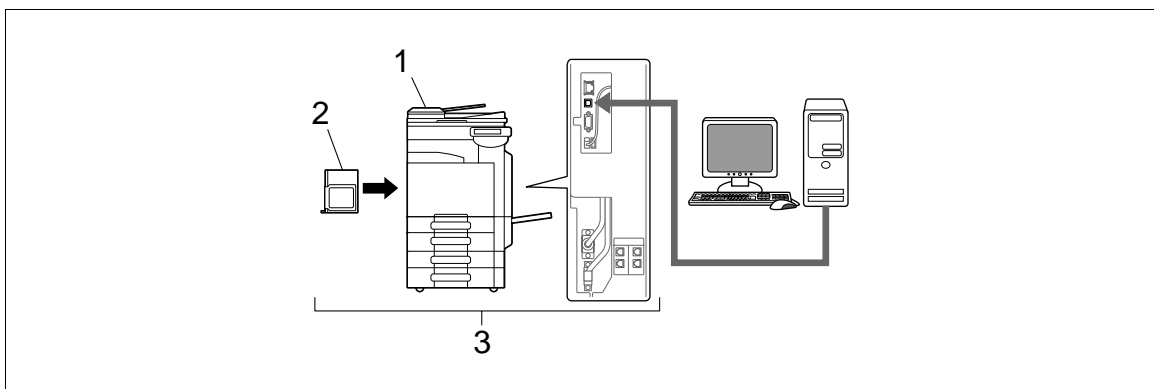

1. This machine
2. Printer controller
3. Printing system

The printer controller provides the following functions.

- Printing data sent from a printer driver on a computer
- Support of network protocols including TCP/IP (IPv4/IPv6), IPX/SPX, and AppleTalk
- Printing via a network using Web service (Windows Vista/Server 2008), SMB (Windows), LPR or IPP printing
- Configuring settings for this machine and the printer controller from a client computer via the network (using a Web browser)
- Control of the number of pages to be printed (the User Authentication and Account Track functions)
- Fax operations using a computer (PC-FAX transmission)

Reference

To use the fax function, the optional **Fax Kit** is required. For details on the PC-FAX transmission, refer to the [User's Guide Fax Driver Operations].

2.1.2 Flow of printing

The following outlines the flow of operations for using this printing system as a printer.

Print data sent from an application is received by the printer driver.

The data is sent to the machine via the USB interface for USB connection or via Ethernet (TCP/IP, IPX/SPX, AppleTalk) for network connection. Then the data is passed from the machine to the printer controller. The printer controller rasterizes images (expands output target characters and images to bitmap data). This data is printed from this machine.

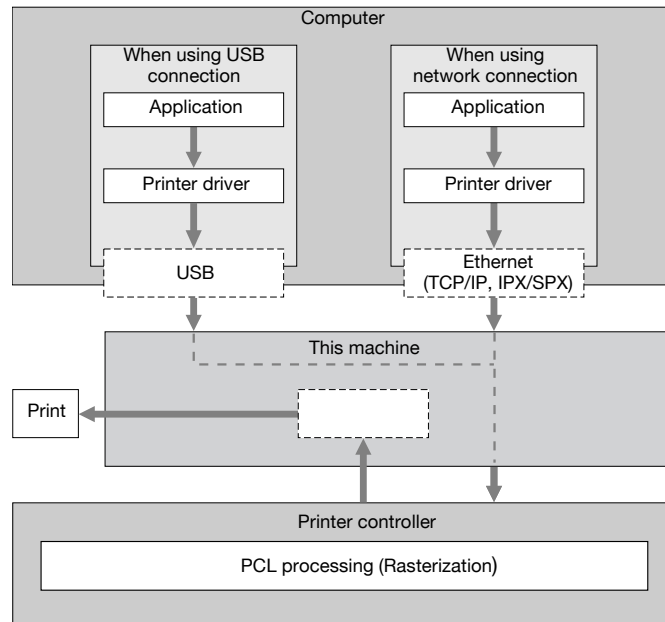

While this machine is operating as a printer, originals can be scanned using the copy function or network scan function. To use the copy function of this machine, press the **Copy** key on the control panel.

When a print job is received during copying, the data is stored in the memory of this machine. When the copying is completed, the print job is automatically printed.

2.1.3 Control panel

The printer driver settings are mainly configured on the computer. However, printing the font list and configuring the printer controller settings and default print settings are available using the control panel of this machine.

The following describes the important keys used for the printer function.

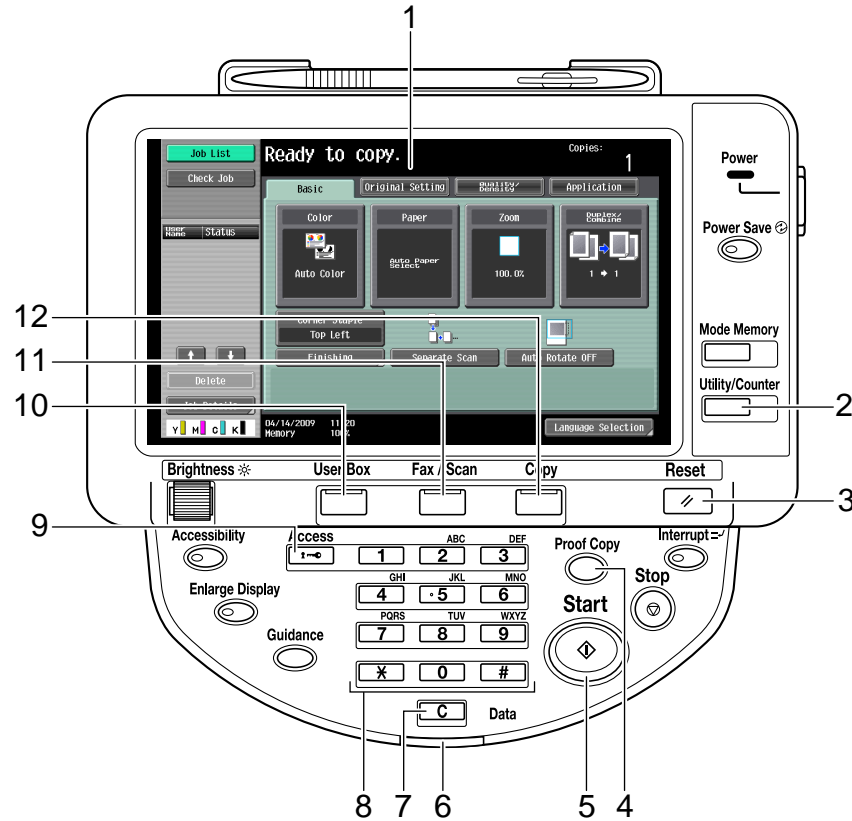

No.	Name	Description
1	Touch Panel	Various screens and messages are displayed. Configure various settings by directly pressing the touch panel.
2	Utility/Counter	Press this key to display the [Utility] screen and the Meter Count screen.
3	Reset	Press this key to reset all settings (except programmed settings) entered using the control panel or touch panel.
4	Proof Copy	Press this key to perform proof printing when a proof print job is stored.
5	Start	Press this key to start the operation of the selected function. When this machine is ready to begin the operation, the indicator on the Start key lights up in blue. If the indicator on the Start key lights up in orange, the operation cannot begin.
6	Data Indicator	Flashes in blue while a print job or fax is being received. Lights up in blue when a print job or fax is queued to be printed or while it is being printed.
7	C (clear)	Press this key to erase a value entered using the keypad or characters entered from the keyboard on the screen.
8	Keypad	Press to enter numbers. Use the keypad to enter the administrator password or other setting values.

No.	Name	Description
9	Access	If user authentication and account track is enabled, press this key after entering the user name and password (for user authentication) or the account name and password (for account track) in order to use this machine.
10	User Box	Press this key to enter User Box mode. While the machine is in User Box mode, the indicator on the User Box key lights up in green. For details, refer to the [User's Guide Box Operations].
11	Fax/Scan	Press this key to enter Fax/Scan mode. While the machine is in Fax/Scan mode, the indicator on the Fax/Scan key lights up in green. For details, refer to the [User's Guide Network Scan/Fax/Network Fax Operations].
12	Copy	Press this key to enter Copy mode (The machine is in Copy mode in default). While the machine is in Copy mode, the indicator on the Copy key lights up in green. For details, refer to the [User's Guide Copy Operations].

Reference

- The default print settings can be changed in the [Utility] mode.
- You can use this machine as a printer in either of User Box, Fax/Scan, and Copy modes.

**Reference**

For details on proof printing, refer to page 12-2.

2.2 Operating environment

This section describes the system requirements for using this printing system and the interfaces used for connection.

2.2.1 Connectable computers and operating system

Make sure that the computer to be connected meets the following conditions.

Windows

Operating system	The supported OS varies depending on the type of printer driver. For details, refer to page 3-3.
CPU	Any processor of the same or higher specifications as recommended for your operating system
Memory	Memory capacity as recommended for your operating system Sufficient memory resource is required for your operating system and the applications to be used.
Drive	CD-ROM drive

Macintosh

Operating system	Mac OS 9.2/OS X (10.2.8, 10.3, 10.4, 10.5)
CPU	PowerPC, Intel Processor (Intel Processor must be Mac OS X 10.4/10.5 only)
Memory	Memory capacity as recommended for your operating system
Drive	CD-ROM drive

2.2.2 Interfaces used for connection

To connect this printing system to a computer, the following interfaces can be used.

Ethernet

Use this interface to use this printing system via a network connection.

It supports 1000Base-T, 100Base-TX, and 10Base-T standards. In addition, TCP/IP (LPD/LPR, IPP, SMB), Web services, IPX/SPX (NetWare), AppleTalk (EtherTalk) protocols are supported.

USB interface

Use this interface to use this printing system via a USB connection. The USB interface can be connected to a computer running Windows. A USB cable is required for connection. Use a type A (4 pin, male) or type B (4 pin, male) USB cable. A USB cable measuring three meters or less is recommended.

Connection diagram

The printer cables are connected to each port on this machine.

Back side of the machine

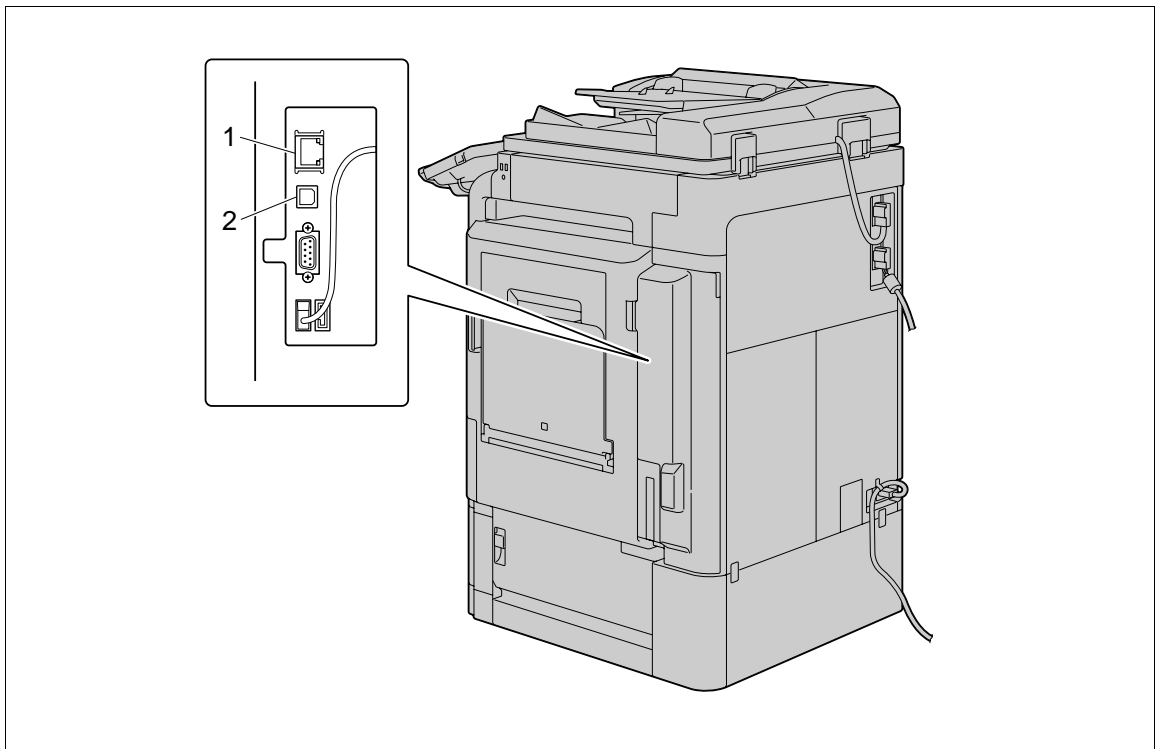

1. Ethernet port (1000Base-T/100Base-TX/10Base-T)
2. USB port

2.3 Setup procedure

To use this printing system, you must complete the setup in advance.

The setup refers to a series of procedures for connecting the machine to the computer and installing the printer driver to the computer.

Perform the setup using the following procedures.

2.3.1 For network connection

- 1 Connect this machine to the computer.
- 2 Check that the computer to be used is connected to the network.
- 3 Specify the IP address of this machine, and then connect it to the network.
- 4 Change the network settings for this machine according to the connection method or protocol.
 - LPR: In [LPD Setting], enable LPD printing.
 - Port9100: In [TCP/IP Settings], enable the RAW port number (initial setting: [9100]).
 - SMB: Configure settings of [Print Settings] in [SMB Settings].
 - IPP/IPPS: In [IPP Settings], enable IPP printing. To use IPPS printing, install the certificate in advance.
 - Web Service Print: In [Web Service Settings], enable the print function.
 - Bonjour: In [Bonjour Setting], enable Bonjour.
 - AppleTalk: In [AppleTalk Settings], enable AppleTalk.
- 5 Install the printer driver.
 - Specify the network port for the printer driver according to the connection method or protocol.
- 6 Install the screen fonts.
 - The CD-ROM contains the European TrueType fonts as "screen fonts". The "Screen Font" or "Screen Fonts" folder in the CD-ROM contains the screen fonts.
 - Install the screen fonts using the standard function for the OS of adding fonts. For details, refer to Help of the Operating System.
 - Macintosh fonts are compressed. Decompress them before installing.

Reference

- After installing the printer driver, perform test print to make sure that the connections are made properly.



Reference

For details on the connectable interfaces, refer to page 2-7.

For details on the network settings, refer to the [User's Guide Network Administrator].

The procedure for installing the printer driver varies depending on the connection method, operating system of the computer, and printer driver. For details, refer to page 3-2.

To update an existing printer driver, uninstall it first. For details, refer to page 8-2.

Configure the interface timeout settings in the Utility menu on the control panel if necessary. For details, refer to page 13-53.

2.3.2 For local connection

- 1 Connect this machine to the computer.
- 2 Install the printer driver.
- 3 Install the screen fonts.
 - The CD-ROM contains the European TrueType fonts as "screen fonts". The "ScreenFont" or "Screen Fonts" folder in the CD-ROM contains the screen fonts.
 - Install the screen fonts using the standard function for the OS of adding fonts. For details, refer to Help of the Operating System.

2.4 Contents of CD-ROM

The following CD-ROMs are included with this machine:

- Driver CD-ROM Vol.1 Windows Driver
Contains the printer driver for Windows and screen fonts.
- Driver CD-ROM Vol.2 TWAIN, Macintosh Driver
Contains the printer driver for Macintosh, screen fonts, and TWAIN driver.
- Application CD-ROM (**PageScope Utilities CD-ROM**)
Contains the application software and manuals integrated with this machine. This CD-ROM also contains the **PageScope Web Connection** manual.
- User's guide CD-ROM
Contains the user's guide.

Reference

- In User's Guide manuals, location paths of folders or files may not contain the root directory.
- Be sure to use the files contained in the EN (English) folder.



Precautions for Installation

3 Precautions for Installation

The following describes the information necessary for selecting a printer driver.

3.1 Introduction

This chapter describes the information you should keep in mind before installing the printer driver.

The procedure for installing the printer driver varies depending on how this machine is connected to the computer, operating system installed on the computer, and type of the printer driver to be installed.

To determine the printer driver to be installed and connection method, check the operating system of the computer and connection environment.

Select the installation method according to the printer driver and connection method.

3.2 Printer drivers compatible with respective operating systems

Before using this printing system, you must install the printer driver.

The following lists the printer drivers included on the CD and the supported operating systems. Select the required printer driver.

Printer driver	Page description language	Supported Operating Systems
KONICA MINOLTA PCL Driver (PCL driver)	PCL6	Windows NT Workstation Version 4.0 (Service Pack 6 or later) Windows NT Server Version 4.0 (Service Pack 6 or later) Windows 2000 Professional (Service Pack 4 or later) Windows 2000 Server (Service Pack 3 or later) Windows XP Home Edition (Service Pack 1 or later) Windows XP Professional (Service Pack 1 or later) Windows Server 2003, Standard Edition (Service Pack 1 or later) Windows Server 2003, Enterprise Edition (Service Pack 1 or later) Windows Server 2003 R2, Standard Edition Windows Server 2003 R2, Enterprise Edition Windows XP Professional x64 Edition Windows Server 2003, Standard x64 Edition Windows Server 2003, Enterprise x64 Edition Windows Server 2003 R2, Standard x64 Edition Windows Server 2003 R2, Enterprise x64 Edition Windows Vista Business * Windows Vista Enterprise * Windows Vista Home Basic * Windows Vista Home Premium * Windows Vista Ultimate * Windows Server 2008 Standard * Windows Server 2008 Enterprise * * Supports 32-bit (x86)/64-bit (x64) environment.
PostScript KONICA MINOLTA driver (PS driver)	PostScript 3 Emulation	Windows 2000 Professional (Service Pack 4 or later) Windows 2000 Server (Service Pack 3 or later) Windows XP Home Edition (Service Pack 1 or later) Windows XP Professional (Service Pack 1 or later) Windows Server 2003, Standard Edition (Service Pack 1 or later) Windows Server 2003, Enterprise Edition (Service Pack 1 or later) Windows Server 2003 R2, Standard Edition Windows Server 2003 R2, Enterprise Edition Windows XP Professional x64 Edition Windows Server 2003, Standard x64 Edition Windows Server 2003, Enterprise x64 Edition Windows Server 2003 R2, Standard x64 Edition Windows Server 2003 R2, Enterprise x64 Edition Windows Vista Business * Windows Vista Enterprise * Windows Vista Home Basic * Windows Vista Home Premium * Windows Vista Ultimate * Windows Server 2008 Standard * Windows Server 2008 Enterprise * * Supports 32-bit (x86)/64-bit (x64) environment.
PostScript PPD driver (PS-PPD)		Mac OS 9.2 or later, Mac OS X 10.2.8/10.3/10.4/10.5
KONICA MINOLTA XPS Driver (XPS driver)	XPS	Windows Vista Business * Windows Vista Enterprise * Windows Vista Home Basic * Windows Vista Home Premium * Windows Vista Ultimate * Windows Server 2008 Standard * Windows Server 2008 Enterprise * * Supports 32-bit (x86)/64-bit (x64) environment.

Printer driver	Page description language	Supported Operating Systems
Fax driver		Windows NT Workstation Version 4.0 (Service Pack 6 or later) Windows NT Server Version 4.0 (Service Pack 6 or later) Windows 2000 Professional (Service Pack 4 or later) Windows 2000 Server (Service Pack 3 or later) Windows XP Home Edition (Service Pack 1 or later) Windows XP Professional (Service Pack 1 or later) Windows Server 2003, Standard Edition (Service Pack 1 or later) Windows Server 2003, Enterprise Edition (Service Pack 1 or later) Windows Server 2003 R2, Standard Edition Windows Server 2003 R2, Enterprise Edition Windows XP Professional x64 Edition Windows Server 2003, Standard x64 Edition Windows Server 2003, Enterprise x64 Edition Windows Server 2003 R2, Standard x64 Edition Windows Server 2003 R2, Enterprise x64 Edition Windows Vista Business * Windows Vista Enterprise * Windows Vista Home Basic * Windows Vista Home Premium * Windows Vista Ultimate * Windows Server 2008 Standard * Windows Server 2008 Enterprise * * Supports 32-bit (x86)/64-bit (x64) environment.

Reference

- Select the page description language according to the application used for printing.
- Either of the installer or Add Printer Wizard can be used for installing the PCL driver, PS driver, and XPS driver for Windows.



Reference

For details on the fax drivers, refer to the [User's Guide Fax Driver Operations].

3.3 Connection methods selectable in each operating system

The connection method for this machine varies depending on the operating system of the computer. The printer driver installation method also varies depending on the connection method. This machine can be connected via a network or a USB interface. In network connection, the printer driver installation method varies depending on the protocol to be used.

Network connection (Ethernet):

This machine is connected as a network printer.

This printing system supports 1000Base-T, 100Base-TX, and 10Base-T standards. In addition, TCP/IP (LPD/LPR, IPP, SMB), IPX/SPX (NetWare), AppleTalk (EtherTalk) protocols are supported.

The applicable protocols vary depending on the operating system of the computer.

USB interface:

This machine is connected as a local printer. The USB interface can be connected to a computer running Windows.

For USB connection, this manual covers only the plug and play based setup procedures.

3.3.1 Windows Vista/Server 2008

Setup procedures	Connection method		Reference page
Connection method in which installer-based setup is possible	Port 9100	A network connection using the PORT9100 print service. It uses a TCP/IP protocol and the RAW printing port.	p. 4-2 <ul style="list-style-type: none"> Select a connection method during installation procedures. Select [Normal Printing] for the Port 9100 or USB connection method, or [Internet Printing] for the IPP connection method.
	IPP	A network connection using the IPP (Internet Printing Protocol) print service. Printing via the Internet is possible with the HTTP (HyperText Transfer Protocol) of the TCP/IP protocol.	
	USB	A connection using a USB port.	
Connection method in which setup is possible using Add Printer Wizard	LPR	A network connection using the LPR (Line Printer Remote) print service. It uses a TCP/IP protocol and the LPR printing port.	p. 5-2
	Port9100	A network connection using the PORT9100 print service. It uses a TCP/IP protocol and the RAW printing port.	
	SMB	A network connection using SMB (Server Message Block) for sharing files or printers in Windows. It supports the TCP/IP protocol.	
	IPP/IPPS	A network connection using the IPP (Internet Printing Protocol) print service. Printing via the Internet is possible with the HTTP (HyperText Transfer Protocol) of the TCP/IP protocol. IPPS is an IPP for SSL encrypted communication.	
	Web service print	It is a connection corresponding to Web Service function of Windows Vista/Server 2008 and capable of automatically detecting the printer on the network.	
	USB	A connection using a USB port.	
Connection method in which plug and play-based setup is possible	USB	A connection using a USB port.	p. 5-12

Reference

- To use Windows Vista/Server 2008, log on to the computer using a user name with Administrator privileges, and then install the printer driver.

**Reference**

Before you can use this machine in the network environment, you must configure network settings for this machine. For details, refer to [User's Guide Network Administrator].

In Windows Vista/Server 2008, you cannot set up IPPS connection (Secure Print) using the installer. To use IPPS connection, use the Add Printer Wizard. For details, refer to page 5-7.

3.3.2 Windows 2000/XP/Server 2003

Setup procedures	Connection method		Reference page
Connection method in which installer-based setup is possible	Port9100	A network connection using the PORT9100 print service. It uses a TCP/IP protocol and the RAW printing port.	p. 4-2 <ul style="list-style-type: none"> Select a connection method during installation procedures. Select [Normal Printing] for the Port9100 or USB connection method, [Internet Printing] for the IPP connection method, or [Secure Printing] for the IPPS connection method.
	IPP/IPPS	A network connection using the IPP (Internet Printing Protocol) print service. Printing via the Internet is possible with the HTTP (HyperText Transfer Protocol) of the TCP/IP protocol. IPPS is an IPP for SSL encrypted communication.	
	USB	A connection using a USB port.	
Connection method in which setup is possible using Add Printer Wizard	LPR	A network connection using the LPR (Line Printer Remote) print service. It uses a TCP/IP protocol and the LPR printing port.	Windows XP/ Server 2003: p. 5-13 Windows 2000:p. 5-22
	Port9100	A network connection using the PORT9100 print service. It uses a TCP/IP protocol and the RAW printing port.	
	SMB	A network connection using SMB (Server Message Block) for sharing files or printers in Windows. It supports the TCP/IP protocol.	
	IPP/IPPS	A network connection using the IPP (Internet Printing Protocol) print service. Printing via the Internet is possible with the HTTP (HyperText Transfer Protocol) of the TCP/IP protocol. IPPS is an IPP for SSL encrypted communication.	
	USB	A connection using a USB port.	
Connection method in which plug and play-based setup is possible	USB	A connection using a USB port.	Windows XP/ Server 2003: p. 5-21 Windows 2000:p. 5-26

Reference

- To use Windows 2000/XP/Server 2003, log on to the computer using a user name with the Administrator privileges, and then install the printer driver.
- The installer does not support installation in the IPv6 environment of Windows XP/Server 2003.

**Reference**

Before you can use this machine in the network environment, you must configure network settings for this machine. For details, refer to [User's Guide Network Administrator].

3.3.3 Windows NT 4.0

Setup procedures	Connection method		Reference page
Connection method in which installer-based setup is possible	Network connection	LPR	p. 4-2 *Select a connection method during installation procedures. Select [Normal Printing] for the LPR connection method.
Connection method in which setup is possible using Add Printer Wizard	LPR	A network connection using the LPR print service.	p. 5-28

Reference

- When using Windows NT4.0, log on to the computer using a user name with the Administrator privilege, and then install the printer driver.
- In Windows NT4.0, to install the printer driver for this machine connected directly to the network using TCP/IP protocol, you must have the [Microsoft TCP/IP Printing] service installed in your computer.
- To use the installer in Windows NT4.0, you must have Internet Explorer 5.0 or later installed in your computer.



Reference

Before you can use this machine in the network environment, you must configure network settings for this machine. For details, refer to [User's Guide Network Administrator].

3.3.4 Mac OS X 10.2/10.3/10.4/10.5

Setup procedures	Connection method		Reference page
Connection method in which setup is possible	Bonjour	A network connection using Bonjour and Rendezvous.	p. 6-2 • Install your desired driver using the installer and specify the connection method when selecting the printer.
	AppleTalk	A network connection using AppleTalk.	
	LPR	A network connection using the LPR print service.	
	IPP	A network connection using the IPP print service.	



Reference

Before you can use this machine in the network environment, you must configure network settings for this machine. For details, refer to [User's Guide Network Administrator].

3.3.5 Mac OS 9.2

Setup procedures	Connection method		Reference page
Connection method in which setup is possible	AppleTalk	A network connection using AppleTalk.	p. 6-16 <ul style="list-style-type: none"> Specify the connection method when selecting a printer.
	LPR	A network connection using the LPR print service.	



Reference

Before you can use this machine in the network environment, you must configure network settings for this machine. For details, refer to [User's Guide Network Administrator].

3.3.6 NetWare

NetWare version	Protocol used	Connection method
NetWare 4.x	IPX	Bindery Pserver Nprinter/Rprinter
NetWare 5.x	IPX	NDS Pserver Nprinter/Rprinter
	TCP/IP	NDPS
NetWare 6.x	IPX	NDS Pserver
	TCP/IP	NDPS



Reference

For details on the NetWare functions, refer to the NetWare operation manual.

To use the machine in the NetWare environment, you must configure the network settings for the machine in advance. For details, refer to [User's Guide Network Administrator].



Easy Installation Using the Installer (Windows)

4 Easy Installation Using the Installer (Windows)

This chapter describes the procedure for installing the Windows printer driver using the installer.

4.1 Installer

The installer automatically detects the printer on the same TCP/IP network as your computer or the machine connected via USB to your computer, and allows you to install the required printer driver. You can also install the printer driver by manually specifying the connection destination.

The printer drivers that can be installed using the installer are PCL driver, PS driver, XPS driver and fax driver.

4.1.1 Operating environment of the installer

Operating system	Windows NT Workstation Version 4.0 (Service Pack 6 or later) Windows NT Server Version 4.0 (Service Pack 6 or later) Windows 2000 Professional (Service Pack 4 or later) Windows 2000 Server (Service Pack 3 or later) Windows XP Home Edition (Service Pack 2 or later) ^{*1} Windows XP Professional (Service Pack 2 or later) ^{*1} Windows Server 2003, Standard Edition (Service Pack 1 or later) Windows Server 2003, Enterprise Edition (Service Pack 1 or later) Windows Server 2003 R2, Standard Edition Windows Server 2003 R2, Enterprise Edition Windows XP Professional x64 Edition Windows Server 2003, Standard x64 Edition Windows Server 2003, Enterprise x64 Edition Windows Server 2003 R2, Standard x64 Edition Windows Server 2003 R2, Enterprise x64 Edition Windows Vista Business ^{*2} Windows Vista Enterprise ^{*2} Windows Vista Home Basic ^{*2} Windows Vista Home Premium ^{*2} Windows Vista Ultimate ^{*2} Windows Server 2008 Standard ^{*2} Windows Server 2008 Enterprise ^{*2} ^{*1} The operating environment required for the printer driver is service pack 1 or later. ^{*2} Supports 32-bit (x86)/64-bit (x64) environment.
CPU	Any processor of the same or higher specifications as recommended for your operating system
Memory	Memory capacity as recommended for your operating system Sufficient memory resource is required for your operating system and the applications to be used.

Reference

- Installing the driver to Windows NT4.0/2000/XP/Vista/Server 2003/Server 2008-based computers requires the administrator authority.
- If a wizard window for adding new hardware opens when using USB connection, click [Cancel].
- The installer supports installation in both IPv4/IPv6 environments of Windows Vista/Server 2008 only. Note that it does not support [Secure Printing] (IPPS) in Windows Vista/Server 2008 and [Internet Printing] (IPP) in the IPv6 environment.
- In Windows NT4.0, to install the printer driver for this machine connected directly to the network using TCP/IP protocol, you must have the [Microsoft TCP/IP Printing] service installed in your computer.
- To use the installer in Windows NT4.0, you must have Internet Explorer 5.0 or later installed in your computer.

4.2 Easy installation procedure using the installer

4.2.1 Settings of this machine

Before you can use this machine through the network connection, you must configure the network settings for this machine.

TCP/IP settings for the machine

In [TCP/IP Settings] of this machine, specify the IP address.



Reference

When this machine is connected through the network, you must previously specify the IP address on this machine so that it can be detected automatically. For details, refer to [User's Guide Network Administrator].

RAW port number/IPP setting for the machine

Change the network settings for this machine according to the connection method or protocol.

- Port9100: In [TCP/IP Settings], enable the RAW port number (initial setting: [9100]).
- IPP/IPPS: In [IPP Settings], enable IPP printing.



Reference

For details on TCP/IP setting and IPP setting for this machine, refer to [User's Guide Network Administrator].

Before you can use IPPS printing, you must register a certificate with this machine. You can use the self-signed certificate that is preinstalled in this machine. For details, refer to [User's Guide Network Administrator].

4.2.2 Installing the printer driver

- 1 Insert the printer driver CD-ROM for Windows into the CD-ROM drive of the computer.
 - Make sure that the installer starts, and then go to Step 2.
 - If the installer does not start, open the printer driver folder on the CD-ROM, double-click [Setup.exe], and then go to Step 3.
 - When installing the driver on a Windows Vista-/Server 2008-based computer, click [Allow] or [Continue] if the [User Account Control] window appears.
- 2 Click [Printer Install].

The printer driver installer starts.

- 3 To agree with all terms in the license agreement, click [AGREE].
- If you disagree, you will not be able to install the driver.
 - In the language display box, you can change the language used with the installer as required.

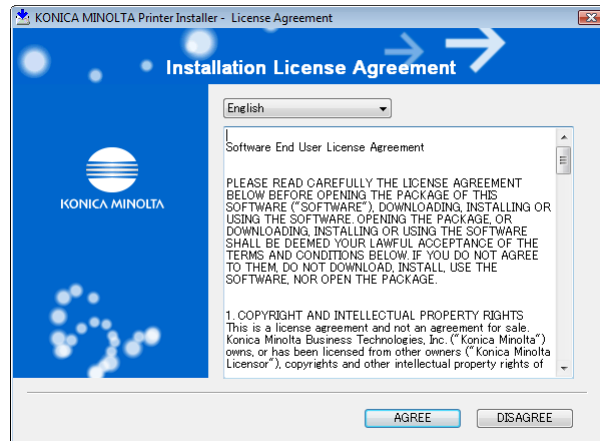

- 4 When a page for selecting menu to setup appears, select [Install printers/MFPs], and then click [Next].
- Connected printers and MFPs are detected.
- For Windows Vista/Server 2008, you can select [Preference for IPv4] or [Preference for IPv6]. If the printer/MFP is detected using both IPv4 and IPv6, the selected address is prioritized.
 - If no printer is detected, turn this machine off, then on again.
In this case, turn off this machine, and then wait approximately 10 seconds before turning it on again. If you turn this machine on immediately after turning it off, it may not function correctly.

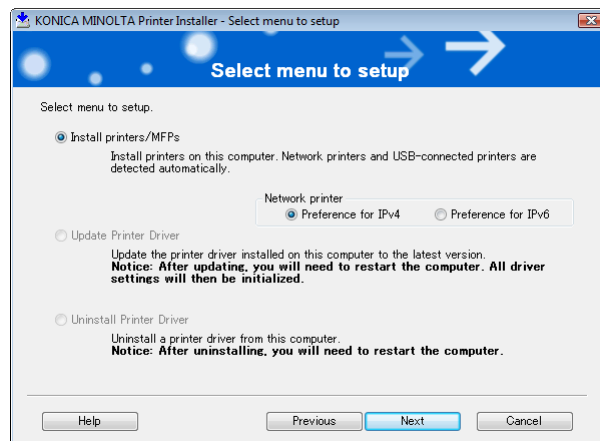

- 5 Select this machine, and then click [Next].
- If the connection to this machine cannot be recognized, it is not displayed in the list. If this is the case, select [Specify the Printer/MFP Except for the Above. (IP Address, Host Name...)] on the lower part of the page, and then specify your printer manually.
 - As a printing method, you can select [Normal Printing] (Port9100, USB), [Internet Printing] (IPP), or [Secure Printing] (IPPS). Note that [Secure Printing] (IPPS) is available only when SSL is enabled for **PageScope Web Connection** and IPP is enabled.
 - In Windows Vista/Server 2008, you cannot set up [Secure Printing] (IPPS connection) using the installer. To use IPPS connection, use Add Printer Wizard. For details, refer to page 5-7.
 - Windows Vista/Server 2008 supports both IPv4 and IPv6 environments, however, it does not support [Internet Printing] (IPP) in the IPv6 environment.

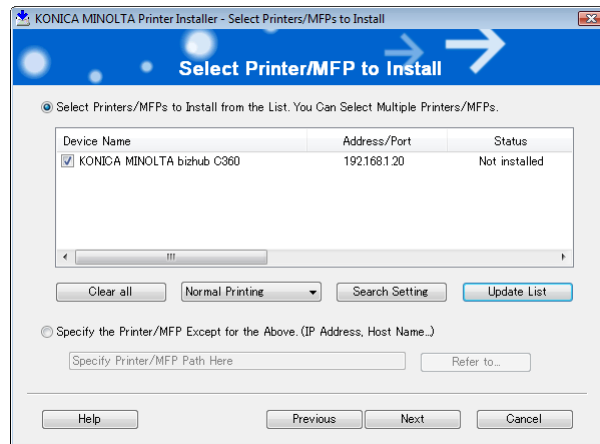

- 6 Check the installation contents.
- To change the contents, click [Installation Settings], and then continue with Step 7.
 - If not changing the contents, skip to Step 8.

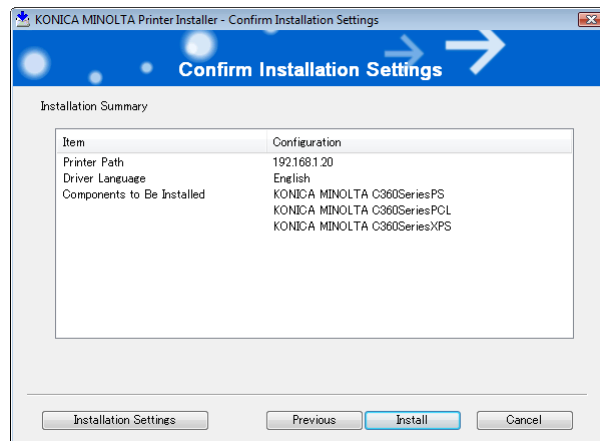

- 7 Select the components to be installed, and then click [OK].
- For details on the fax drivers, refer to the [User's Guide Fax Driver Operations].

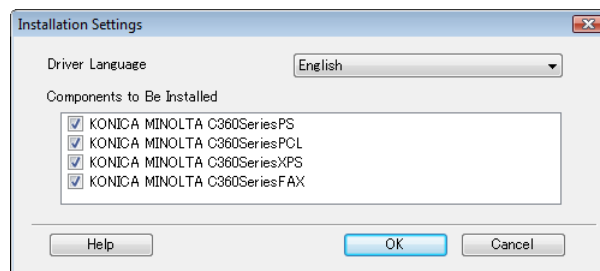

- 8 In the [Confirm Installation Settings] page, click [Install].
 - In Windows Vista/Server 2008, when the [Windows Security] window for verifying the publisher, click [Install this driver software anyway].
 - In Windows XP/Server 2003/2000, when the "Windows logo testing" or [Digital Signature] window appears, click [Continue Anyway] or [Yes].
- 9 On the [Finish Installing Drivers] page, click [Finish].

The installation is complete.

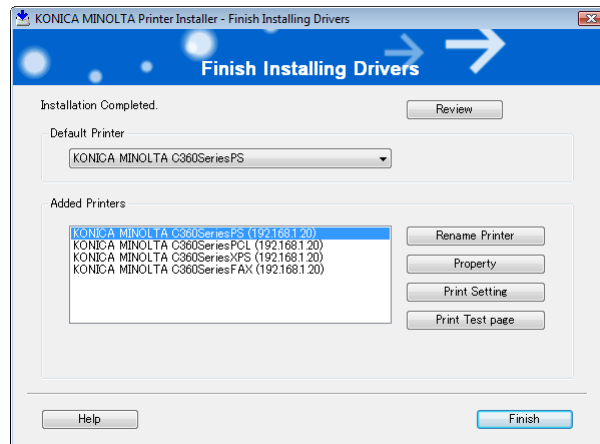

On the [Installation Completed.] page, you can confirm the installed items or change settings.

[Review]: Click this button to check the installed items.

[Rename Printer]: Click this button to rename the printer.

[Property]: Click this button to configure property settings for the printer. For details, refer to page 9-4.

[Print Setting]: Click this button to display the [Printing Preferences] page of the printer driver and to configure various function settings. For details, refer to page 9-10.

[Print Test page]: Click this button to perform test print.



Manual Installation Using the Add Printer Wizard

5 Manual Installation Using the Add Printer Wizard

This chapter describes the procedure for installing the Windows printer driver using the standard Windows Add Printer function, without using the installer.

5.1 Windows Vista/Server 2008

5.1.1 For network connection (LPR/Port 9100/SMB)

In Windows Vista/Server 2008, you can install the printer driver either by searching for the printer on the network, or by creating a new printer port.

Settings for the machine

Before using Port9100, LPR, or SMB printing, you must configure the network settings for the machine.

Items to be configured	Description
IP address	In [TCP/IP Settings] of the machine, specify the IP address.
RAW port number	To use Port9100 printing: In [TCP/IP Settings] for the machine, enable the RAW port number (initial setting: [9100]).
LPD Setting	To use LPR printing: In [LPD Setting] for the machine, enable LPD printing.
SMB Setting	To use SMB printing: At [Print Settings] in [SMB Settings] for the machine, specify Net-BIOS Name, Print Service Name, and Workgroup.



Reference

For details on the network settings for the machine, refer to the [User's Guide Network Administrator].

To use SMB printing in the IPv6 environment, [Direct Hosting Setting] for the machine must be enabled. For details, refer to [User's Guide Network Administrator].

Installing the printer driver by searching for the printer using the Add Printer Wizard.

- ✓ Installing the driver to Windows Vista/Server 2008-based computers requires the administrator authority.
 - ✓ Since the printer is searched for during the installation, be sure to connect this machine to the network before turning it on.
- 1 Insert the printer driver CD-ROM for Windows into the CD-ROM drive of the computer.
 - 2 Click [Start], and then select [Control Panel].
 - 3 Click [Printers] under [Hardware and Sound].
The [Printers] window appears.
→ When [Control Panel] is displayed in Classic View, double-click [Printers].

- 4 Click [Add a printer] on the toolbar.

In Windows Vista:

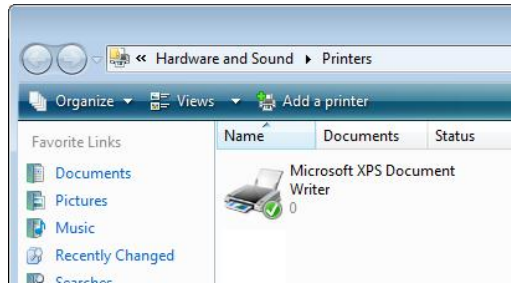

In Windows Server 2008:

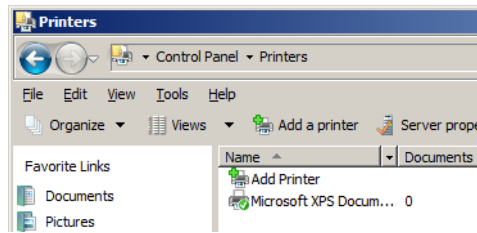

The [Add Printer] wizard appears.

- 5 Click [Add a network, wireless or Bluetooth printer].

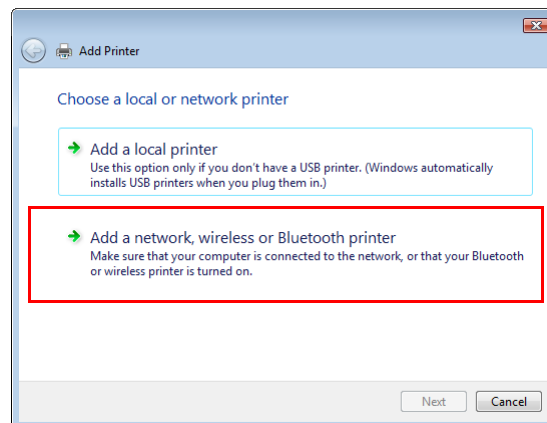

Connected printers are detected.

- If no printer is detected, turn this machine off, then on again.
 In this case, turn off the printer, and then wait approximately 10 seconds before turning it on again.
 If you turn this machine on immediately after turning it off, it may not function correctly.

- 6 Select your machine from the list, and then click [Next].
 - To use the LPR/Port9100 protocol, select the printer with its IP address.
 - To use the SMB connection, select the printer with its "\\NetBIOS name\print service name".
 - For the SMB connection, click [Next], and then click [OK] in the [Connect to Printer] page that appears.
 - It may take some time to finish searching the entire list of printers.

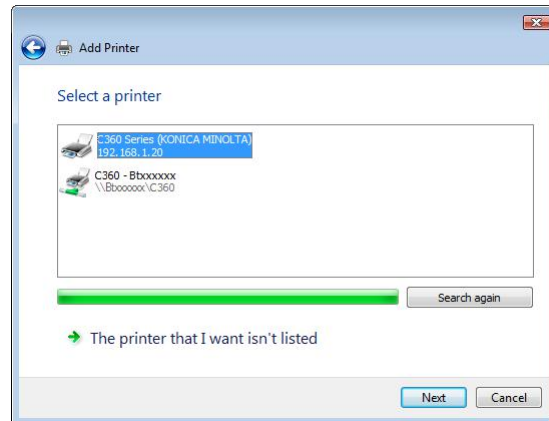

- 7 Click [Have Disk...].
- 8 Click [Browse...].
- 9 Select a desired printer driver folder in the CD-ROM, and then click [Open].
 - Select a folder according to the printer driver, operating system, and language to be used. Selectable printer drivers:
PCL driver, PS driver, XPS driver and fax driver
- 10 Click [OK].
The [Printers] list appears.
- 11 Click [Next].

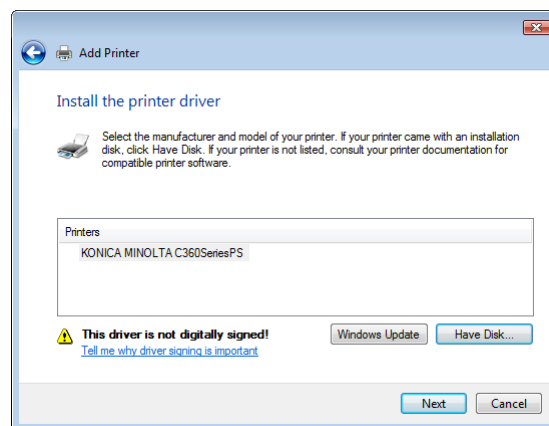

→ To use the SMB connection, click [OK].

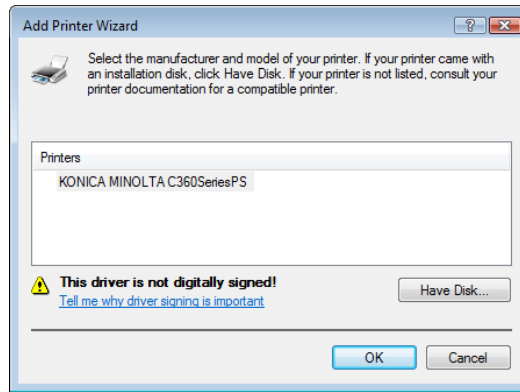

12 Follow the instructions on the pages that follow.

→ If the [User Account Control] window appears, click [Continue].

→ If the [Windows Security] window for verifying the publisher appears, click [Install this driver software anyway].

13 Click [Finish].

14 After finishing the installation, make sure that the icon for the installed printer is displayed in the [Printers] window.

15 Remove the CD-ROM from the CD-ROM drive.

This completes the printer driver installation.

Installing the printer driver by creating a printer port

- ✓ Installing the driver to Windows Vista/Server 2008-based computers requires the administrator authority.
- ✓ Since the printer is searched for during the installation, be sure to connect this machine to the network before turning it on.

1 Insert the printer driver CD-ROM for Windows into the CD-ROM drive of the computer.

2 Click [Start], and then select [Control Panel].

3 Click [Printers] under [Hardware and Sound].

The [Printers] window appears.

→ When [Control Panel] is displayed in Classic View, double-click [Printers].

4 Click [Add a printer] on the toolbar.

In Windows Vista:

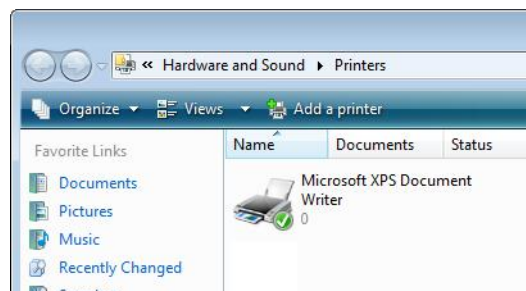

In Windows Server 2008:

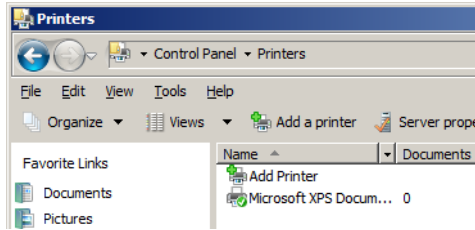

The [Add Printer] wizard appears.

- 5 Click [Add a local printer].

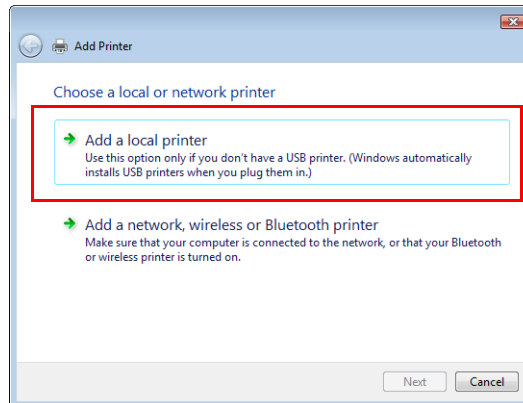

The page for [Choose a printer port] appears.

- 6 Click [Create a new port:], and then select the port type.
 - To use the LPR/Port9100 protocol, select [Standard TCP/IP Port].
 - To use the SMB connection, select [Local Port].
- 7 Click [Next].
- 8 Specify the IP address and port.
 - To use the LPR/Port9100 protocol, select [TCP/IP Device], and then enter the IP address.
 - To use the SMB connection, enter "\\NetBIOS name\print service name" in the [Port Name] box.
 - Enter the same NetBIOS name and print service name specified in [Print Settings] in [SMB Settings].
- 9 Click [Next].
 - If the [Additional Port Information Required] dialog box appears, go to Step 10.
 - If the [Install the printer driver] dialog box appears, go to Step 13.
- 10 Select [Custom], and then click [Settings...].
- 11 Change the settings according to the port, and then click [OK].
 - For LPR connection, select [LPR], and then enter "Print" in the [Queue Name:] box.
 - You must discriminate between upper and lower case letters when entering it.
 - For Port9100, select [Raw], and then enter a RAW port number (initial setting: [9100]) in the [Port Number:] box.
 - If both LPR and Port9100 are enabled on this machine, the printer driver is connected to this machine using LPR.
- 12 Click [Next].

The [Install the printer driver] page appears.

- 13 Click [Have Disk...].
- 14 Click [Browse...].
- 15 Select a desired printer driver folder in the CD-ROM, and then click [Open].
 - Select a folder according to the printer driver, operating system, and language to be used. Selectable printer drivers:
PCL driver, PS driver, XPS driver and fax driver
- 16 Click [OK].
The [Printers] list appears.
- 17 Click [Next].

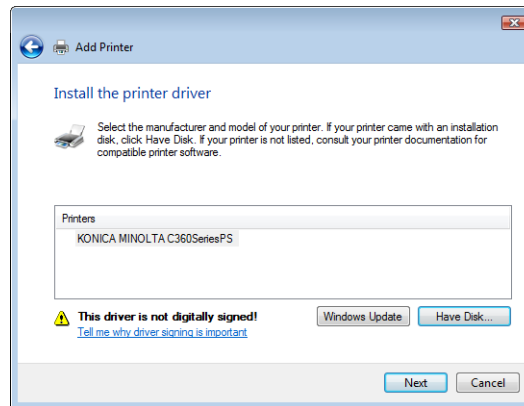

- 18 Follow the instructions on the pages that follow.
 - If the [User Account Control] window appears, click [Continue].
 - If the [Windows Security] window for verifying the publisher appears, click [Install this driver software anyway].
- 19 Click [Finish].
- 20 After finishing the installation, make sure that the icon for the installed printer is displayed in the [Printers] window.
- 21 Remove the CD-ROM from the CD-ROM drive.
This completes the printer driver installation.

5.1.2 For network connection (IPP/IPPS)

Settings for the machine

To use IPP printing, you must configure the network settings for the machine in advance.

Items to be configured	Description
IP address	In [TCP/IP Settings] of the machine, specify the IP address.
IPP Setting	In [IPP Settings] for the machine, enable IPP printing.



Reference

For details on the network settings for the machine, refer to the [User's Guide Network Administrator].

Before you can use IPPS printing, you must register a certificate with this machine. You can use the self-signed certificate that is preinstalled in this machine. For details, refer to [User's Guide Network Administrator].

Installing the printer driver manually using the Add Printer Wizard

- ✓ Installing the driver to Windows Vista/Server 2008-based computers requires the administrator authority.
- 1** Insert the printer driver CD-ROM for Windows into the CD-ROM drive of the computer.
- 2** Click [Start], and then select [Control Panel].
- 3** Click [Printers] under [Hardware and Sound].
The [Printers] window appears.
→ When [Control Panel] is displayed in Classic View, double-click [Printers].
- 4** Click [Add a printer] on the toolbar.
The [Add Printer] wizard appears.
- 5** Click [Add a network, wireless or Bluetooth printer].
Connected printers are detected.
- 6** In the window showing the search result, click [The printer that I want isn't listed].
- 7** In the [Select a shared printer by name] box, enter the URL for the machine in the following format, and then click [Next].
 - `http://<IP address for the machine>/ipp`
Example: When the IP address for the machine is 192.168.1.20, `http://192.168.1.20/ipp`
 - When specifying to use IPPS printing, enter "`https://<host name>.<domain name>/ipp`". <Host name>. For <domain name>, specify the host name and domain name registered for the DNS server being used.
 - If the certificate for the machine is not the one issued by the certifying authority, you must register the certificate for the machine on the Windows Vista/Server 2008 system as the certificate by "Trusted Root Certification Authorities" for the computer account.
 - When registering a certificate to the machine, confirm that <host name>.<domain name> is displayed as the common name of the certificate.
- 8** Click [Have Disk...].
- 9** Click [Browse...].
- 10** Select a desired printer driver folder in the CD-ROM, and then click [Open].
 - Select a folder according to the printer driver, operating system, and language to be used. Selectable printer drivers:
PCL driver, PS driver, XPS driver and fax driver
- 11** Click [OK].
The [Printers] list appears.
- 12** Click [OK].
- 13** Follow the instructions on the pages that follow.
 - If the [User Account Control] window appears, click [Continue].
 - If the [Windows Security] window for verifying the publisher appears, click [Install this driver software anyway].
- 14** Click [Finish].
- 15** After finishing the installation, make sure that the icon for the installed printer is displayed in the [Printers] window.
- 16** Remove the CD-ROM from the CD-ROM drive.
This completes the printer driver installation.

Once the settings for the printer have been configured, you can use the printer in the same way as a general local printer.

5.1.3 For network connection (Web service print)

In Windows Vista/Server 2008, printers supporting the Web service print function on the network can be located and installed.



Reference

To install a different printer driver in the computer where one has already been installed, you must uninstall the currently installed one along with its package. For details, refer to page 8-3.

Settings for the machine

To use the Web service print, you must configure the network settings for the machine in advance.

Items to be configured	Description
IP address	In [TCP/IP Settings] of the machine, specify the IP address.
Web Service Settings	In [Web Service Settings] for the machine, enable the print function.



Reference

For details on the network settings for the machine, refer to the [User's Guide Network Administrator].

Installing the printer from the Network window

- ✓ Installing the driver to Windows Vista/Server 2008-based computers requires the administrator authority.
- 1 Turn on the power of the machine while it is connected to the network.
Since the printer is searched for during the installation, be sure to connect the machine to the network.
- 2 To use the Web service print, check that [Network discovery] is enabled in [Network and Sharing Center] on the computer.
- 3 Insert the printer driver CD-ROM for Windows into the CD-ROM drive of the computer.
- 4 Press the [Start] key, and then select [Network].
The [Network] window appears, starting to search for the computers and devices on the network.
- 5 Select the device name of the machine, and then click [Install] on the toolbar.
 - If the [User Account Control] window appears, click [Continue].
A printer compatible with the selected Web service print function is located, and then the [Found New Hardware] dialog box appears.
- 6 Follow the instructions on the pages that follow.
 - If the [User Account Control] window appears, click [Continue].
 - If the [Windows Security] window for verifying the publisher appears, click [Install this driver software anyway].



Reference

The operating steps in the [Found New Hardware] dialog box are the same as those described in "Installing the printer driver by specifying the IP address using the Add Printer Wizard". For details, refer to Steps 11 through 20 in the succeeding section.

Installing the printer driver by specifying the IP address using the Add Printer Wizard

- ✓ Installing the driver to Windows Vista/Server 2008-based computers requires the administrator authority.
 - ✓ Since the printer is searched for during the installation, be sure to connect this machine to the network before turning it on.
- 1 Turn on the power of the machine while it is connected to the network.
Since the printer is searched for during the installation, be sure to connect the machine to the network.
 - 2 To use the Web service print, check that [Network discovery] is enabled in [Network and Sharing Center] on the computer.
 - 3 Insert the printer driver CD-ROM for Windows into the CD-ROM drive of the computer.
 - 4 Click [Start], and then select [Control Panel].
 - 5 Click [Printers] under [Hardware and Sound].
The [Printers] window appears.
→ When [Control Panel] is displayed in Classic View, double-click [Printers].
 - 6 Click [Add a printer] on the toolbar.
In Windows Vista:

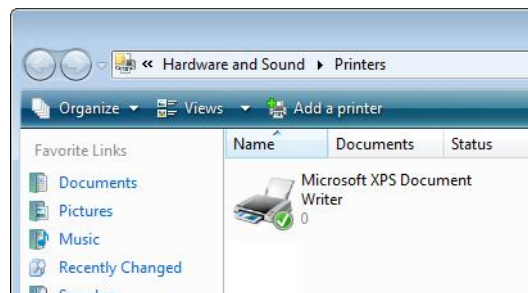

In Windows Server 2008:

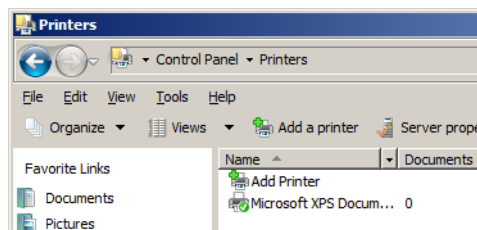

The [Add Printer] wizard appears.

- 7 Click [Add a local printer].

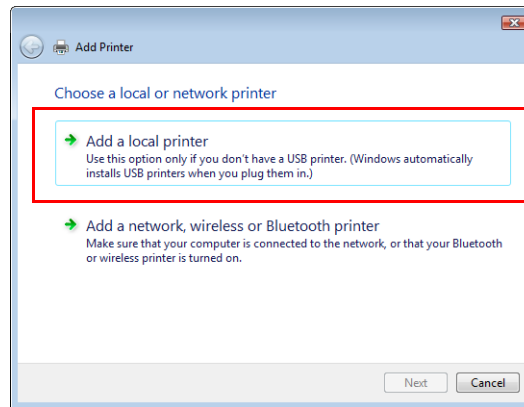

The page for [Choose a printer port] appears.

- 8 Click [Create a new port:], and then select the port type.
 → Select [Standard TCP/IP Port].
- 9 Click [Next].
- 10 Select [Web Services Device], enter the IP address, and click [Next].

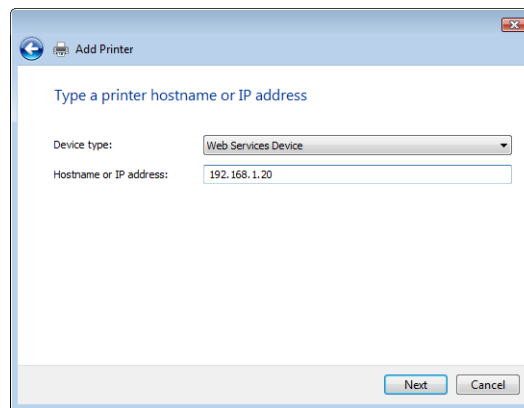

A printer of the entered IP address that is compatible with the Web service print function is located, and then the [Found New Hardware] dialog box appears.

- 11 Click [Locate and install driver software (recommended)].
- 12 If a dialog box to confirm whether to search online appears, click [Don't search online].
- 13 Click [Browse my computer for driver software (advanced)].
- 14 Click [Browse...].
- 15 Select a desired printer driver folder in the CD-ROM, and then click [Open].
 → Select a folder according to the printer driver, operating system, and language to be used. Selectable printer drivers:
 PCL driver, PS driver, XPS driver and fax driver
- 16 Click [Next].
- 17 Follow the instructions on the pages that follow.
 → If the [User Account Control] window appears, click [Continue].
 → If the [Windows Security] window for verifying the publisher appears, click [Install this driver software anyway].

- 18 Click [Close].
- 19 After finishing the installation, make sure that the icon for the installed printer is displayed in the [Printers] window.
- 20 Remove the CD-ROM from the CD-ROM drive.
This completes the printer driver installation.

5.1.4 For local connection

When this machine is connected via a USB port, the printer driver can be installed with plug and play.

Reference

- When a USB connection is used, the printer driver is installed easily with the plug and play feature. However, it can also be installed using the Add Printer Wizard. To use the Add Printer Wizard, select the USB port to be connected in the [Choose a printer port] page.

- 1 Connect this machine to the computer using a USB cable, and then start the computer.

NOTICE

When starting up the computer, do not plug in or unplug the cable.

- 2 Turn on the main power of this machine.

The [Found New Hardware] dialog box appears.

- If the [Found New Hardware] dialog box does not appear, turn this machine off, then on again. In this case, turn off this machine, and then wait approximately 10 seconds before turning it on again. If you turn this machine on immediately after turning it off, it may not function correctly.

- 3 Click [Locate and install driver software (recommended)].

The dialog box requesting the disk (CD-ROM) appears.

- If you do not have the disk (CD-ROM), click [I don't have the disc, show me other options]. On the next page, select [Browse my computer for driver software (advanced)], and then specify a desired printer driver folder.
- Select a folder according to the printer driver, operating system, and language to be used.

- 4 Insert the printer driver CD-ROM for Windows into the CD-ROM drive of the computer.

The information on the disk is searched for, and then the list of the software supported by this machine appears.

- 5 Select a desired printer driver name, and then click [Next].

- Selectable printer drivers:
PCL driver, PS driver, XPS driver and fax driver

- 6 Follow the instructions on the pages that follow.

- If the [User Account Control] window appears, click [Continue].

- 7 When the installation completes, click [Close].

- 8 After finishing the installation, make sure that the icon for the installed printer is displayed in the [Printers] window.

- If the [Windows Security] window for verifying the publisher appears, click [Install this driver software anyway].

- 9 Remove the CD-ROM from the CD-ROM drive.

This completes the printer driver installation.

5.2 Windows XP/Server 2003

5.2.1 For network connection (LPR/Port9100)

To use LPR/Port9100 printing, specify the port while installing the printer driver.

Settings for the machine

To use Port9100 or LPR printing, you must configure the network settings for the machine in advance.

Items to be configured	Description
IP address	In [TCP/IP Settings] of the machine, specify the IP address.
RAW port number	To use Port9100 printing: In [TCP/IP Settings] for the machine, enable the RAW port number (initial setting: [9100]).
LPD Setting	To use LPR printing: In [LPD Setting] for the machine, enable LPD printing.



Reference

For details on the network settings for the machine, refer to the [User's Guide Network Administrator].

Installing the printer driver manually using the Add Printer Wizard

✓ Installing the driver to Windows XP/Server 2003-based computers requires the administrator authority.

1 Insert the printer driver CD-ROM for Windows into the CD-ROM drive of the computer.

2 Click [Start], and then select [Printers and Faxes].

→ If [Printers and Faxes] is not displayed in the [Start] menu, open [Control Panel] from the [Start] menu, click [Printers and Other Hardware], then click [Printers and Faxes].

3 In Windows XP, select [Add a printer] from the [Printer Tasks] menu.
In Windows Server 2003, double-click [Add Printer].

In Windows XP:

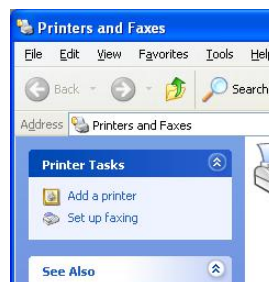

In Windows Server 2003:

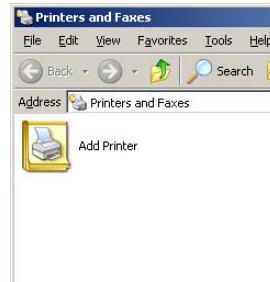

The [Add Printer Wizard] appears.

- 4 Click [Next >].
- 5 Select [Local printer attached to this computer], and then click [Next >].
→ Clear the [Automatically detect and install my Plug and Play printer] check box.

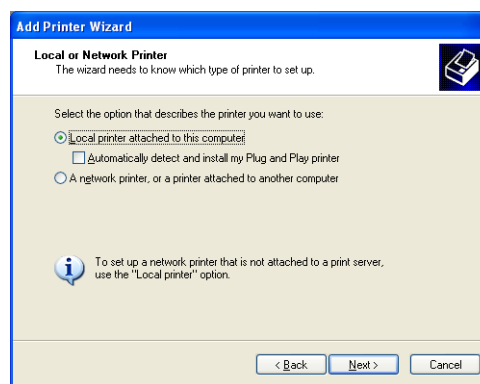

The [Select a Printer Port] page appears.

- 6 Select [Create a new port:], and then select [Standard TCP/IP Port] as the [Type of port:].

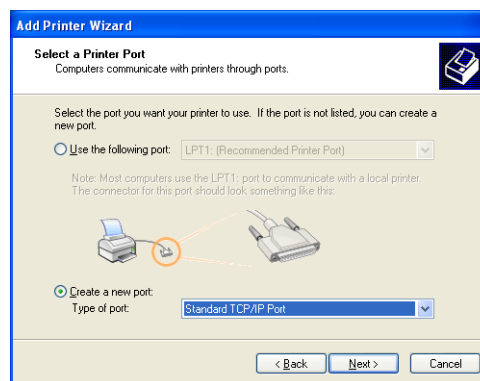

- 7 Click [Next >].
[Add Standard TCP/IP Printer Port Wizard] starts.
- 8 Click [Next >].

- 9 In the [Printer Name or IP Address:] box, enter the IP address for the machine, and then click [Next >].
- If the [Additional Port Information Required] dialog box appears, go to Step 10.
 - If the [Finish] screen appears, go to Step 13.

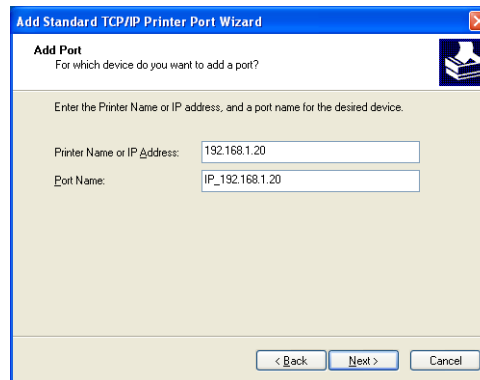

- 10 Select [Custom], and then click [Settings:].
- 11 Change the settings according to the port, and then click [OK].
- For LPR connection, select [LPR], and then enter "Print" in the [Queue Name:] box.
 - You must discriminate between upper and lower case letters when entering it.
 - For Port9100, select [Raw], and then enter a RAW port number (initial setting: [9100]) in the [Port Number:] box.
- 12 Click [Next >].
- 13 Click [Finish].
[Add Printer Wizard] appears.
- 14 Click [Have Disk...].
- 15 Click [Browse...].
- 16 Select a desired printer driver folder in the CD-ROM, and then click [Open].
- Select a folder according to the printer driver, operating system, and language to be used. Selectable printer drivers:
PCL driver, PS driver and fax driver
- 17 Click [OK].
The [Printers] list appears.
- 18 Click [Next >].

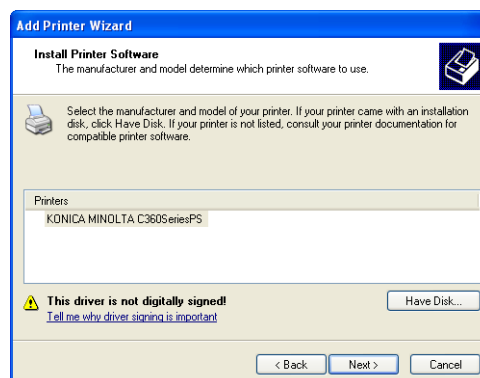

- 19 Follow the instructions on the pages that follow.
- To use a network connection, perform a test print after the network settings have been configured.

- 20 Click [Finish].
 - If the "Windows logo testing" or [Digital Signature] window appears, click [Continue Anyway] or [Yes].
- 21 After finishing the installation, make sure that the icon for the installed printer is displayed in the [Printers and Faxes] window.
- 22 Remove the CD-ROM from the CD-ROM drive.
This completes the printer driver installation.

5.2.2 For network connection (SMB)

To use SMB printing, specify the port by specifying the printer while installing the printer driver. The printer can be specified either by searching for the printer on the network, or by entering the printer name directly.

Settings for the machine

To use SMB printing, you must configure the network settings for the machine in advance.

Items to be configured	Description
IP address	In [TCP/IP Settings] of the machine, specify the IP address.
SMB Setting	To use SMB printing: At [Print Settings] in [SMB Settings] for the machine, specify Net-BIOS Name, Print Service Name, and Workgroup.



Reference

For details on the network settings for the machine, refer to the [User's Guide Network Administrator].

To use SMB printing in the IPv6 environment, [Direct Hosting Setting] for the machine must be enabled. For details, refer to [User's Guide Network Administrator].

Installing the printer driver by specifying the printer using the Add Printer Wizard

✓ Installing the driver to Windows XP/Server 2003-based computers requires the administrator authority.

- 1 Insert the printer driver CD-ROM for Windows into the CD-ROM drive of the computer.
- 2 Click [Start], and then select [Printers and Faxes].
 - If [Printers and Faxes] is not displayed in the [Start] menu, open [Control Panel] from the [Start] menu, click [Printers and Other Hardware], then click [Printers and Faxes].
- 3 In Windows XP, select [Add a printer] from the [Printer Tasks] menu.
In Windows Server 2003, double-click [Add Printer].

In Windows XP:

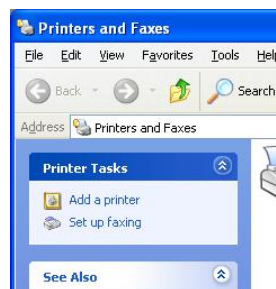

In Windows Server 2003:

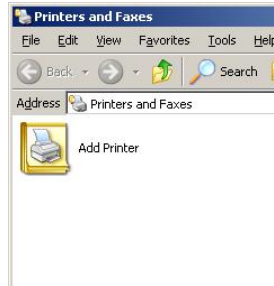

The [Add Printer Wizard] appears.

- 4 Click [Next >].
- 5 Select [Local printer attached to this computer], and then click [Next >].
→ Clear the [Automatically detect and install my Plug and Play printer] check box.



The page for [Select a Printer Port] appears.

- 6 Click [Create a new port:], select [Local Port] as the [Type of port:], and then click [Next >].

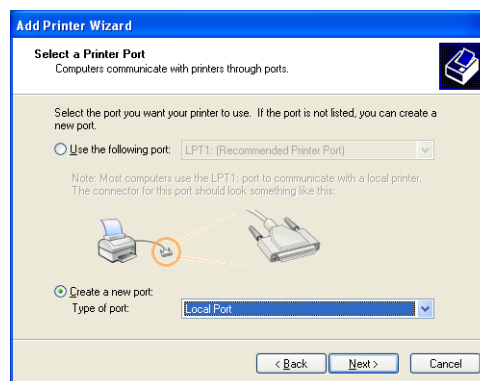

- 7 Enter "\\NetBIOS name\print service name" in the [Port Name] box.
→ Enter the same NetBIOS name and print service name specified in [Print Settings] in [SMB Settings].
- 8 Click [OK].
[Add Printer Wizard] appears.
- 9 Click [Have Disk...].

- 10 Click [Browse...].
- 11 Select a desired printer driver folder in the CD-ROM, and then click [Open].
 - Select a folder according to the printer driver, operating system, and language to be used. Selectable printer drivers:
PCL driver, PS driver and fax driver
- 12 Click [OK].
The [Printers] list appears.
- 13 Click [Next >].

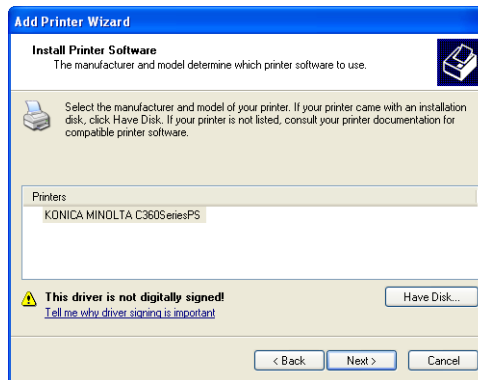

- 14 Follow the instructions on the pages that follow.
 - To use a network connection, perform a test print after the network settings have been configured.
- 15 Click [Finish].
 - If the "Windows logo testing" or [Digital Signature] window appears, click [Continue Anyway] or [Yes].
- 16 After finishing the installation, make sure that the icon for the installed printer is displayed in the [Printers and Faxes] window.
- 17 Remove the CD-ROM from the CD-ROM drive.
This completes the printer driver installation.

5.2.3 For network connection (IPP/IPPS)

To use IPP printing, specify the port while installing the printer driver.

Settings for the machine

To use IPP printing, you must configure the network settings for the machine in advance.

Items to be configured	Description
IP address	In [TCP/IP Settings] of the machine, specify the IP address.
IPP Setting	In [IPP Settings] for the machine, enable IPP printing.



Reference

For details on the network settings for the machine, refer to the [User's Guide Network Administrator].

Before you can use IPPS printing, you must register a certificate with this machine. You can use the self-signed certificate that is preinstalled in this machine. For details, refer to [User's Guide Network Administrator].

Installing the printer driver manually using the Add Printer Wizard

- ✓ Installing the driver to Windows XP/Server 2003-based computers requires the administrator authority.
- 1** Insert the printer driver CD-ROM for Windows into the CD-ROM drive of the computer.
- 2** Click [Start], and then select [Printers and Faxes].
 - If [Printers and Faxes] is not displayed in the [Start] menu, open [Control Panel] from the [Start] menu, click [Printers and Other Hardware], then click [Printers and Faxes].
- 3** In Windows XP, select [Add a printer] from the [Printer Tasks] menu.
In Windows Server 2003, double-click [Add Printer].
The [Add Printer Wizard] appears.
- 4** Click [Next >].
- 5** In the [Local or Network Printer] page, select [A network printer, or a printer attached to another computer], and then click [Next >].
- 6** In the [Specify a Printer] page, select [Connect to a printer on the Internet or on a home or office network:].
- 7** In the [URL:] field, enter the URL for the machine in the following format, and then click [Next >].
 - http://<IP address for the machine>/ipp
Example: When the IP address for the machine is 192.168.1.20, http://192.168.1.20/ipp
 - When specifying to use IPPS printing, enter "https://<IP address for the machine>/ipp".
 - If a confirmation dialog box appears after clicking [Next >], click [OK].
- 8** Click [Have Disk...].
- 9** Click [Browse...].
- 10** Select a desired printer driver folder in the CD-ROM, and then click [Open].
 - Select a folder according to the printer driver, operating system, and language to be used. Selectable printer drivers:
PCL driver, PS driver and fax driver
- 11** Click [OK].
The [Printers] list appears.
- 12** Click [OK].
- 13** Follow the instructions on the pages that follow.
- 14** Click [Finish].
 - If the "Windows logo testing" or [Digital Signature] window appears, click [Continue Anyway] or [Yes].
- 15** After finishing the installation, make sure that the icon for the installed printer is displayed in the [Printers and Faxes] window.
- 16** Remove the CD-ROM from the CD-ROM drive.
This completes the printer driver installation.

Once the settings for the printer have been configured, you can use the printer in the same way as a general local printer.

5.2.4 For local connection

When this machine is connected via a USB port, the printer driver can be installed with plug and play.

Reference

- When a USB connection is used, the printer driver is installed easily with the plug and play feature. However, it can also be installed using the Add Printer Wizard. To use the Add Printer Wizard, select the USB port to be connected in the [Choose a printer port] page.

1 Connect this machine to the computer using a USB cable, and then start the computer.

NOTICE

When starting up the computer, do not plug in or unplug the cable.

2 Insert the printer driver CD-ROM for Windows into the CD-ROM drive of the computer.

3 Turn on the main power of this machine.

The [Found New Hardware Wizard] window appears.

→ If the [Found New Hardware Wizard] window does not appear, turn the machine off, then on again. In this case, turn off this machine, and then wait approximately 10 seconds before turning it on again. If you turn the printer on immediately after turning it off, it may not function correctly.

→ If a page with a message saying "Windows connect to Windows Update" appears, select ["No, not this time"].

4 Select [Install from a list or specific location (Advanced)], and then click [Next >].

5 Under [Search for the best driver in these locations.], select [Include this location in the search:], and then click [Browse].

6 Select a desired printer driver folder in the CD-ROM, and then click [OK].

→ Select a folder according to the printer driver, operating system, and language to be used. Selectable printer drivers:
PCL driver, PS driver and fax driver

7 Click [Next >], and then follow the instructions on the pages that follow.

8 Click [Finish].

→ If the "Windows logo testing" or [Digital Signature] window appears, click [Continue Anyway] or [Yes].

9 After finishing the installation, make sure that the icon for the installed printer is displayed in the [Printers and Faxes] window.

10 Remove the CD-ROM from the CD-ROM drive.

This completes the printer driver installation.

5.3 Windows 2000

5.3.1 For network connection (LPR/Port9100)

To use LPR/Port9100 printing, specify the port while installing the printer driver.

Settings for the machine

To use Port9100 or LPR printing, you must configure the network settings for the machine in advance.

Items to be configured	Description
IP address	In [TCP/IP Settings] of the machine, specify the IP address.
RAW port number	To use Port9100 printing: In [TCP/IP Settings] for the machine, enable the RAW port number (initial setting: [9100]).
LPD Setting	To use LPR printing: In [LPD Setting] for the machine, enable LPD printing.



Reference

For details on the network settings for the machine, refer to the [User's Guide Network Administrator].

Installing the printer driver manually using the Add Printer Wizard

- ✓ Installing the driver to Windows 2000-based computers requires the administrator authority.
- 1 Insert the printer driver CD-ROM for Windows into the CD-ROM drive of the computer.
- 2 Click [Start], and then select [Settings] - [Printers].
- 3 Double-click [Add Printer].
The [Add Printer Wizard] appears.
- 4 Follow the instructions on the pages that follow.
- 5 On the window for specifying how the printer is attached, select [Local printer], and then click [Next >].
→ Clear the [Automatically detect and install my Plug and Play printer] check box.

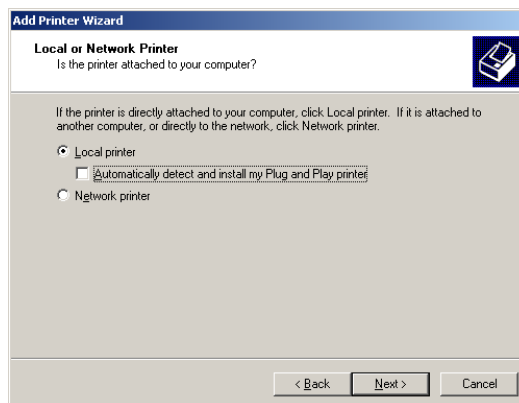

The page for [Select the Printer Port] appears.

- 6 Click [Create a new port:], and then select [Standard TCP/IP Port] as the type of port.
- 7 Click [Next >].
[Add Standard TCP/IP Printer Port Wizard] starts.
- 8 Click [Next >].

- 9 In the [Printer Name or IP Address:] box, enter the IP address for the machine, and then click [Next >].
 - If the [Additional Port Information Required] dialog box appears, go to Step 10.
 - If the [Finish] page appears, go to Step 13.
- 10 Select [Custom], and then click [Settings...].
- 11 Change the settings according to the port, and then click [OK].
 - For LPR connection, select [LPR], and then enter "Print" in the [Queue Name:] box.
 - You must discriminate between upper and lower case letters when entering it.
 - For Port9100, select [Raw], and then enter a RAW port number (initial setting: [9100]) in the [Port Number:] box.
- 12 Click [Next >].
- 13 Click [Finish].
[Add Printer Wizard] appears.
- 14 Click [Have Disk...].
- 15 Click [Browse...].
- 16 Select a desired printer driver folder in the CD-ROM, and then click [Open].
 - Select a folder according to the printer driver, operating system, and language to be used. Selectable printer drivers:
PCL driver, PS driver and fax driver
- 17 Click [OK].
The [Printer:] list appears.
- 18 Click [Next >].

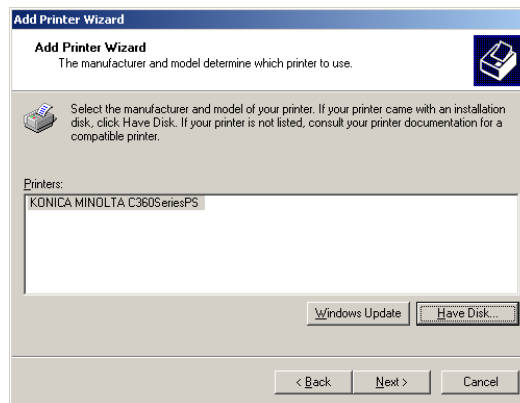

- 19 Follow the instructions on the pages that follow.
- 20 Click [Finish].
 - If the [Digital Signature] window appears, click [Yes].
- 21 After finishing the installation, make sure that the icon for the installed printer is displayed in the [Printers] window.
- 22 Remove the CD-ROM from the CD-ROM drive.
This completes the printer driver installation.

5.3.2 For network connection (SMB)

To use SMB printing, specify the port by specifying the printer while installing the printer driver.

Settings for the machine

To use SMB printing, you must configure the network settings for the machine in advance.

Items to be configured	Description
IP address	In [TCP/IP Settings] of the machine, specify the IP address.
SMB Setting	To use SMB printing: At [Print Settings] in [SMB Settings] for the machine, specify NetBIOS Name, Print Service Name, and Workgroup.



Reference

For details on the network settings for the machine, refer to the [User's Guide Network Administrator].

Installing the printer driver manually using the Add Printer Wizard

- ✓ Installing the driver to Windows 2000-based computers requires the administrator authority.
- 1** Insert the printer driver CD-ROM for Windows into the CD-ROM drive of the computer.
- 2** Click [Start], and then select [Settings] - [Printers].
- 3** Double-click [Add Printer].
The [Add Printer Wizard] appears.
- 4** Follow the instructions on the pages that follow.
- 5** On the window for specifying how the printer is attached, select [Local printer], and then click [Next >].
→ Clear the [Automatically detect and install my Plug and Play printer] check box.
The page for [Select the Printer Port] appears.
- 6** Click [Create a new port:], and then select [Local Port] as the port type.
- 7** Click [Next >].
- 8** Enter "\\NetBIOS name\print service name" in the [Port Name] box.
→ Enter the same NetBIOS name and print service name specified in [Print Settings] in [SMB Settings].
- 9** Click [OK].
[Add Printer Wizard] appears.
- 10** Click [Have Disk...].
- 11** Click [Browse...].
- 12** Select a desired printer driver folder in the CD-ROM, and then click [Open].
→ Select a folder according to the printer driver, operating system, and language to be used. Selectable printer drivers:
PCL driver, PS driver and fax driver

- 13 Click [OK].
The [Printer:] list appears.
- 14 Click [Next >].
- 15 Follow the instructions on the pages that follow.
- 16 Click [Finish].
→ If the [Digital Signature] window appears, click [Yes].
- 17 After finishing the installation, make sure that the icon for the installed printer is displayed in the [Printers] window.
- 18 Remove the CD-ROM from the CD-ROM drive.
This completes the printer driver installation.

5.3.3 For network connection (IPP/IPPS)

For IPP printing, configure the network settings before installing the printer driver.

Settings for the machine

To use IPP printing, you must configure the network settings for the machine in advance.

Items to be configured	Description
IP address	In [TCP/IP Settings] of the machine, specify the IP address.
IPP Setting	In [IPP Settings] for the machine, enable IPP printing.



Reference

For details on the network settings for the machine, refer to the [User's Guide Network Administrator].

Before you can use IPPS printing, you must register a certificate with this machine. You can use the self-signed certificate that is preinstalled in this machine. For details, refer to [User's Guide Network Administrator].

Installing the printer driver manually using the Add Printer Wizard

- ✓ Installing the driver to Windows 2000-based computers requires the administrator authority.
- 1 Insert the printer driver CD-ROM for Windows into the CD-ROM drive of the computer.
 - 2 Click [Start], and then select [Settings] - [Printers].
 - 3 Double-click the [Add Printer] icon.
The [Add Printer Wizard] appears.
 - 4 Click [Next].
 - 5 In the [Local or Network Printer] page, select [Network printer], and then click [Next >].
 - 6 In the [Locate Your Printer] page, select [Connect to a printer on the Internet or your intranet].
 - 7 In the [URL:] field, enter the URL for the machine in the following format, and then click [Next].
→ `http://<IP address for the machine>/ipp`
Example: When the IP address for the machine is 192.168.1.20, `http://192.168.1.20/ipp`
→ When specifying to use IPPS printing, enter "`https://<IP address for the machine>/ipp`".
 - 8 When the confirmation dialog box appears, click [OK].

- 9 Click [Have Disk...].
- 10 Click [Browse...].
- 11 Select a desired printer driver folder in the CD-ROM, and then click [Open].
 - Select a folder according to the printer driver, operating system, and language to be used. Selectable printer drivers:
PCL driver, PS driver and fax driver
- 12 Click [OK].

The [Printer:] list appears.
- 13 Click [OK].
- 14 Follow the instructions on the pages that follow.
- 15 Click [Finish].
 - If the [Digital Signature] window appears, click [Yes].
- 16 After finishing the installation, make sure that the icon for the installed printer is displayed in the [Printers] window.
- 17 Remove the CD-ROM from the CD-ROM drive.

This completes the printer driver installation.

Once the settings for the printer have been configured, you can use the printer in the same way as a general local printer.

5.3.4 For local connection

When this machine is connected via a USB port, the printer driver can be installed with plug and play.

Reference

- When a USB connection is used, the printer driver is installed easily with the plug and play feature. However, it can also be installed using the Add Printer Wizard. To use the Add Printer Wizard, select the USB port to be connected in the [Select the Printer Port] page.

- 1 Connect this machine to the computer using a USB cable, and then start the computer.

NOTICE
When starting up the computer, do not plug in or unplug the cable.
- 2 Insert the printer driver CD-ROM for Windows into the CD-ROM drive of the computer.
- 3 Turn on the main power of this machine.

The [Found New Hardware Wizard] window appears.

 - If the [Found New Hardware Wizard] window does not appear, turn the machine off, then on again. In this case, turn off this machine, and then wait approximately 10 seconds before turning it on again. If you turn the printer on immediately after turning it off, it may not function correctly.
- 4 Click [Next >].
- 5 Select [Search for a suitable driver for my device (recommended)], and then click [Next >].
- 6 Select [Specify a Location], and then click [Next >].
- 7 Click [Browse...].
- 8 Select a desired printer driver folder in the CD-ROM, and then click [Open].
 - Select a folder according to the printer driver, operating system, and language to be used. Selectable printer drivers:
PCL driver, PS driver and fax driver

- 9 Click [OK], and then follow the instructions on the pages that follow.
- 10 Click [Finish].
 - If the [Digital Signature] window appears, click [Yes].
- 11 After finishing the installation, make sure that the icon for the installed printer is displayed in the [Printers] window.
- 12 Remove the CD-ROM from the CD-ROM drive.

This completes the printer driver installation.

5.4 Windows NT 4.0

5.4.1 For network connection (LPR)

To use LPR printing, specify the port while installing the printer driver.

Settings for the machine

To use LPR printing, you must configure the network settings for the machine in advance.

Items to be configured	Description
IP address	In [TCP/IP Settings] of the machine, specify the IP address.
LPD Setting	To use LPR printing: In [LPD Setting] for the machine, enable LPD printing.



Reference

For details on the network settings for the machine, refer to the [User's Guide Network Administrator].

Installing the printer driver manually using the Add Printer Wizard

- ✓ Installing the driver to Windows NT 4.0-based computers requires the administrator authority.
 - ✓ In Windows NT4.0, to use the LPR port, you must have the [Microsoft TCP/IP Printing] service installed in your computer.
- 1 Insert the printer driver CD-ROM for Windows into the CD-ROM drive of the computer.
 - 2 Click [Start], and then select [Settings] - [Printers].
 - 3 Double-click the [Add Printer] icon.
The [Add Printer Wizard] appears.
 - 4 On the page for specifying how the printer is attached, select [This computer].
 - 5 Click [Next >].
A page for selecting a port appears.
 - 6 Click [Add Port...].
 - 7 From the [Available Printer Ports] list, select [LPR Port], and then click [New Port...].
 - 8 Enter the IP address of the machine in the "Address" box, enter "Print" in the "Queue Name" box, and then click [OK].
→ You must discriminate between upper and lower case letters when entering it.
 - 9 Select the created port, and then click [Next >].
 - 10 Click [Have Disk...].
 - 11 Click [Browse...].
 - 12 Select a desired printer driver folder in the CD-ROM, and then click [Open].
→ Select a folder according to the printer driver, operating system, and language to be used. Selectable printer drivers:PCL driver and fax driver
 - 13 Click [OK].
The [Printer:] list appears.
 - 14 Click [Next >].

- 15 Follow the instructions on the pages that follow.
- 16 Click [Finish].
- 17 After finishing the installation, make sure that the icon for the installed printer is displayed in the [Printers] window.
- 18 Remove the CD-ROM from the CD-ROM drive.
This completes the printer driver installation.



Installation on Macintosh Computers

6 Installation on Macintosh Computers

This chapter describes the settings necessary when using Macintosh and the procedure for installing printer drivers for Macintosh.

6.1 Mac OS X 10.2/10.3/10.4/10.5

6.1.1 Installing the printer driver

- 1 Start the Macintosh computer.
- 2 Insert the printer driver CD-ROM for Macintosh into the CD-ROM drive of the computer.
 - Exit all running applications, if any.
- 3 Open the folder in the CD-ROM that contains the desired printer driver.
 - Select a folder according to the printer driver, operating system, and language to be used.
- 4 Copy the driver file onto the desktop according to the Mac OS version.
 - OS X 10.2: bizhub_C360_102.pkg
 - OS X 10.3: bizhub_C360_103104.pkg
 - OS X 10.4: bizhub_C360_103104.pkg
 - OS X 10.5: bizhub_C360_105.pkg
 - For OS X 10.5, the driver folder varies depending on the paper size. Select the appropriate driver folder for your environment.
 - To use metric-based paper size (A4 and the like): Select a file in "WW_A4" folder.
 - To use inch-based paper size (8 1/2 × 11 in letter size): Select "WW_Letter" folder.
- 5 Double-click the file copied onto the desktop.

The installer starts.

 - To cancel installation, press [Cancel].
- 6 Click [Continue] following the instructions on the pages that follow until the [Installation] page appears.
 - When the name and password prompt appears during the procedure, enter the administrator name and password.
- 7 In the [Installation] page, click [Install].

The printer driver is installed in the computer. When the installation is completed, a message appears.

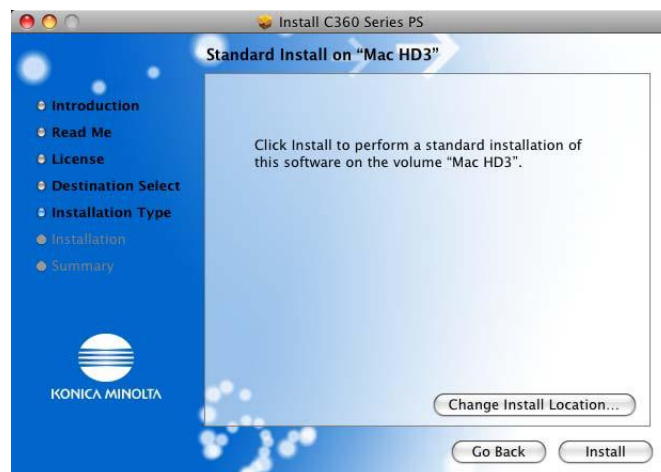

→ For OS X 10.2/10.3/10.4, when the printer driver is installed for the second and subsequent times, [Install] may change to [Upgrade].

8 Click [Close].

This completes the printer driver installation.

Next, select a printer.

6.1.2 Selecting and connecting a printer (OS X 10.4/10.5)

In OS X 10.4/10.5, the printer can be connected with Bonjour, AppleTalk, LPR (LPD), or IPP.

After configuring the network setting for the machine, selecting this machine as the printer to be used in the [Print & Fax] window enables printing.

Configuring the Bonjour settings

Configuring the [Bonjour Setting] for the machine

Enable Bonjour in [Bonjour Setting] for the machine, and then enter the Bonjour name.



Reference

For details on the [Bonjour Setting] for the machine, refer to the [User's Guide Network Administrator].

Adding a printer

1 In the [Apple Menu], select [System Preferences...].

2 Click the [Print & Fax] icon.

3 Click [+] on the [Print & Fax] window.

4 Click [Default].

Connected printers are detected.

→ If no printer is detected, turn this machine off, then on again.

In this case, turn off this machine, and then wait approximately 10 seconds before turning it on again. If you turn the printer on immediately after turning it off, it may not function correctly.

5 From the [Printer Name] list, select the desired Bonjour-connected model name.

The printer driver corresponding to the selected printer name is automatically selected.

→ After the printer driver is selected, go to Step 7.

→ If an incorrect printer driver is selected, go to Step 6.

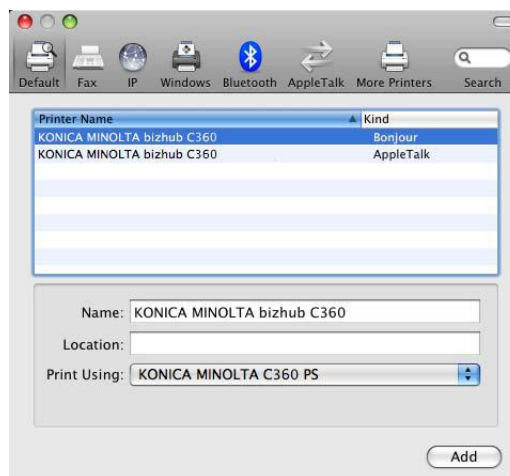

- 6 Select the desired printer driver manually.
- When OS X 10.5 is used, select the [Select a driver to use...] from the [Print Using:], and then select the printer driver of the desired model name from the list.
 - When OS X 10.4 is used, select [KONICA MINOLTA] from the [Print Using:], and then select the printer driver of the desired model name from the list.

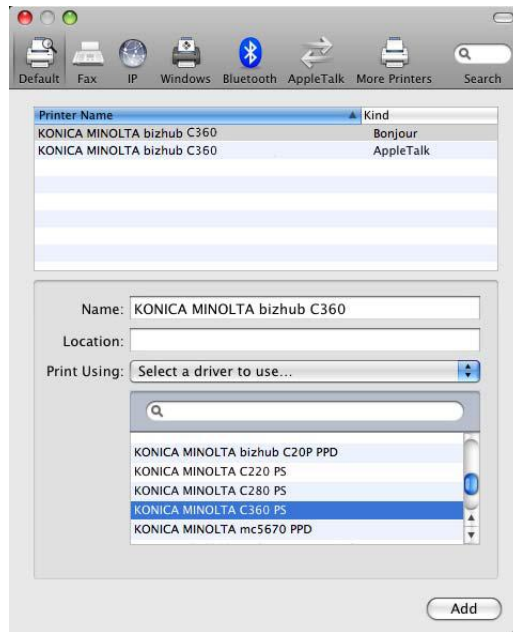

- 7 Click [Add].
- When the selected printer is registered in the [Print & Fax], the setting procedure is completed.
- If the [Installable Options] window appears, proceed to change the option settings as necessary. For details, refer to page 10-4.

Reference

- For OS X 10.4, you can also add a printer by clicking [Add] in the [Printer Setup Utility] window.

Configuring the AppleTalk settings

Configuring the [AppleTalk Settings] for the machine

Enable AppleTalk in [AppleTalk Settings], and then enter the printer name.



Reference

For details on the [AppleTalk Settings] for the machine, refer to the [User's Guide Network Administrator].

Configuring the [AppleTalk Settings] for the computer

Configure the AppleTalk settings for the Macintosh computer connected to the printer.

- 1 In the [Apple Menu], select [System Preferences...].
- 2 Click the [Network] icon.
- 3 The Ethernet setting window appears.
 - For OS X 10.5, select [Ethernet], and then click [Advanced...].
 - For OS X 10.4, select [Built-in Ethernet], and then click [Configure...].
- 4 Double-click the [AppleTalk] tab to enable AppleTalk.
- 5 Click the close button at the top left corner of the window.
 - When the [This service has unsaved changes] message appears, click [Apply].

Adding a printer

- 1 In the [Apple Menu], select [System Preferences...].
- 2 Click the [Print & Fax] icon.
- 3 Click [+] on the [Print & Fax] window.
- 4 Click [Default].

Connected printers are detected.

→ If no printer is detected, turn this machine off, then on again.

In this case, turn off this machine, and then wait approximately 10 seconds before turning it on again. If you turn the printer on immediately after turning it off, it may not function correctly.

- 5 From the [Printer Name] list, select the desired AppleTalk-connected model name.

The printer driver corresponding to the selected printer name is automatically selected.

→ After the printer driver is selected, go to Step 7.

→ If an incorrect printer driver is selected, go to Step 6.

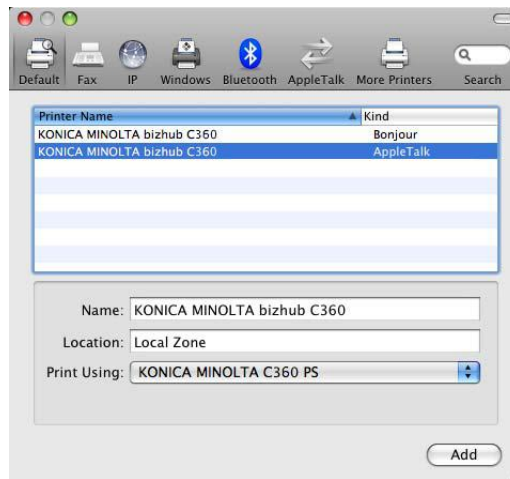

- 6 Select the desired printer driver manually.

→ When OS X 10.5 is used, select the [Select a driver to use...] from the [Print Using:], and then select the printer driver of the desired model name from the list.

→ When OS X 10.4 is used, select [KONICA MINOLTA] from the [Print Using:], and then select the printer driver of the desired model name from the list.

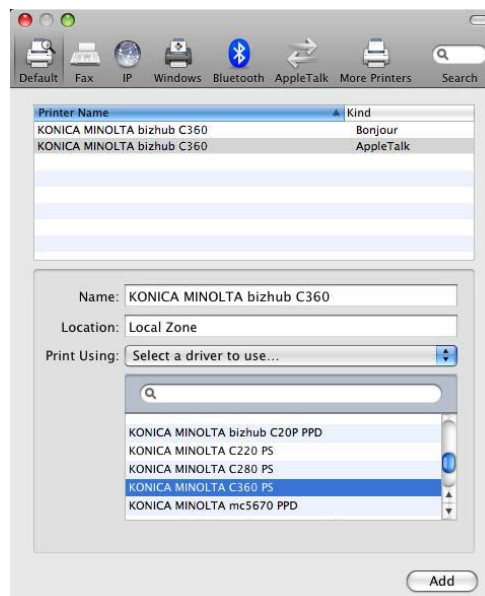

7 Click [Add].

When the selected printer is registered in the [Print & Fax], the setting procedure is completed.

- If the [Installable Options] window appears, proceed to change the option settings as necessary.
For details, refer to page 10-4.

Reference

- For OS X 10.4, you can also add a printer by clicking [Add] in the [Printer Setup Utility] window.

Configuring the LPR settings

[TCP/IP Settings] for the machine

Specify the IP address for the machine.

[LPD Setting] for the printer

Before using LPR printing, enable LPD printing in [LPD Setting] for the machine.

**Reference**

For details on specifying the IP address for the machine, refer to the [User's Guide Network Administrator].

For details on the [LPD Setting] for the machine, refer to the [User's Guide Network Administrator].

Configuring the TCP/IP settings for the computer

Configure the TCP/IP settings for the Macintosh computer connected to the printer.

- 1** In the [Apple Menu], select [System Preferences...].
- 2** Click the [Network] icon.
- 3** The Ethernet setting window appears.
 - For OS X 10.5, select [Ethernet], and then click [Advanced...].
 - For OS X 10.4, select [Built-in Ethernet], and then click [Configure...].
- 4** Click the [TCP/IP] tab.
- 5** Configure the settings including the IP address and subnet mask according to the settings of the network to which the Macintosh computer is connected.
- 6** Click the close button at the top left corner of the window.
 - When the [This service has unsaved changes] message appears, click [Apply].

Adding a printer

- 1** In the [Apple Menu], select [System Preferences...].
- 2** Click the [Print & Fax] icon.
- 3** Click [+] on the [Print & Fax] window.
- 4** Click [IP] or [IP Printer].
- 5** In [Protocol:], select [Line Printer Daemon - LPD].

6 In [Address:], enter the IP address for the machine.

The printer driver corresponding to this machine being identified with its IP address is automatically selected.

→ After the printer driver is selected, go to Step 8.

→ If an incorrect printer driver is selected, go to Step 7.

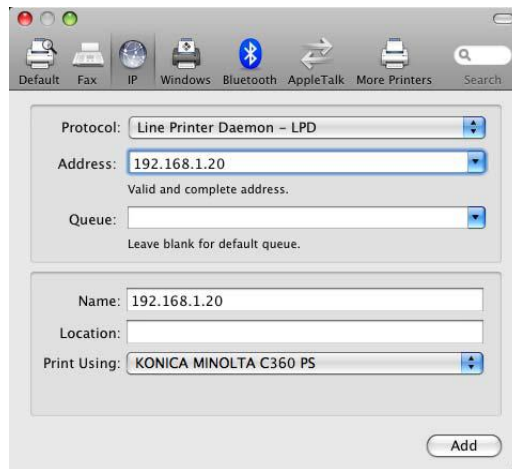

7 Select the desired printer driver manually.

→ When OS X 10.5 is used, select the [Select a driver to use...] from the [Print Using:], and then select the printer driver of the desired model name from the list.

→ When OS X 10.4 is used, select [KONICA MINOLTA] from the [Print Using:], and then select the printer driver of the desired model name from the list.

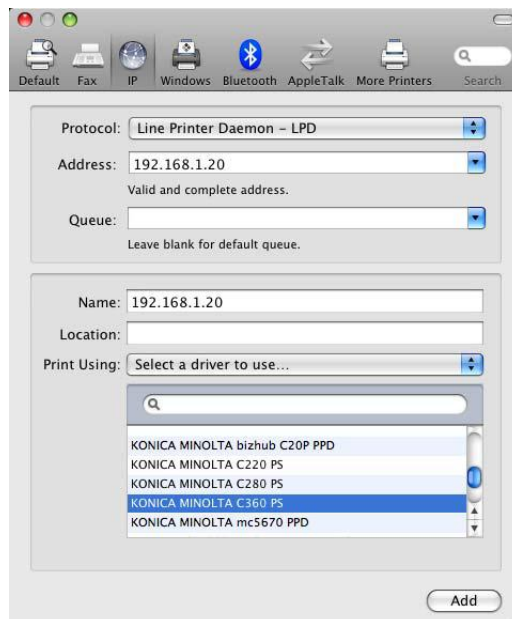

8 Click [Add].

When the selected printer is registered in the [Print & Fax], the setting procedure is completed.

→ If the [Installable Options] window appears, proceed to change the option settings as necessary. For details, refer to page 10-4.

Reference

- For OS X 10.4, you can also add a printer by clicking [Add] in the [Printer Setup Utility] window.

Configuring the IPP settings

[TCP/IP Settings] for the machine

Specify the IP address for the machine.

[IPP Settings] for the machine

In [IPP Settings] for the machine, enable IPP printing.



Reference

For details on specifying the IP address for the machine, refer to the [User's Guide Network Administrator].

For details on the [IPP Settings] for the machine, refer to the [User's Guide Network Administrator].

Configuring the TCP/IP settings for the computer

Configure the TCP/IP settings for the Macintosh computer connected to the printer.

- 1 In the [Apple Menu], select [System Preferences...].
- 2 Click the [Network] icon.
- 3 The Ethernet setting window appears.
 - For OS X 10.5, select [Ethernet], and then click [Advanced...].
 - For OS X 10.4, select [Built-in Ethernet], and then click [Configure...].
- 4 Click the [TCP/IP] tab.
- 5 Configure the settings including the IP address and subnet mask according to the settings of the network to which the Macintosh computer is connected.
- 6 Click the close button at the top left corner of the window.
 - When the [This service has unsaved changes] message appears, click [Apply].

Adding a printer

- 1 In the [Apple Menu], select [System Preferences...].
- 2 Click the [Print & Fax] icon.
- 3 Click [+] on the [Print & Fax] window.

[Printer Browser] appears.
- 4 Click [IP] or [IP Printer].
- 5 In [Protocol:], select [Internet Printing Protocol - IPP].

- 6 In [Address:], enter the IP address for the machine. In [Queue:], enter "ipp".

The printer driver corresponding to this machine being identified with its IP address is automatically selected.

→ After the printer driver is selected, go to Step 8.

→ If an incorrect printer driver is selected, go to Step 7.

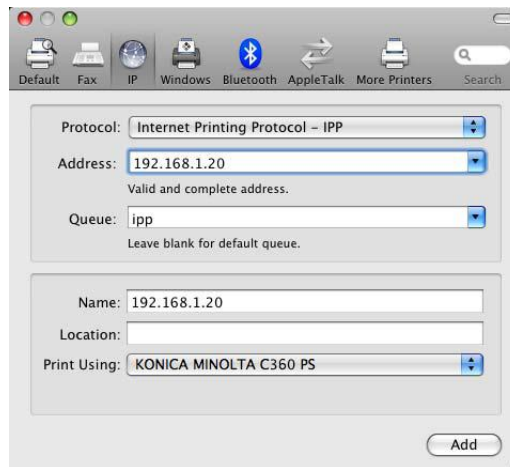

- 7 Select the desired printer driver manually.

→ When OS X 10.5 is used, select the [Select a driver to use...] from the [Print Using:], and then select the printer driver of the desired model name from the list.

→ When OS X 10.4 is used, select [KONICA MINOLTA] from the [Print Using:], and then select the printer driver of the desired model name from the list.

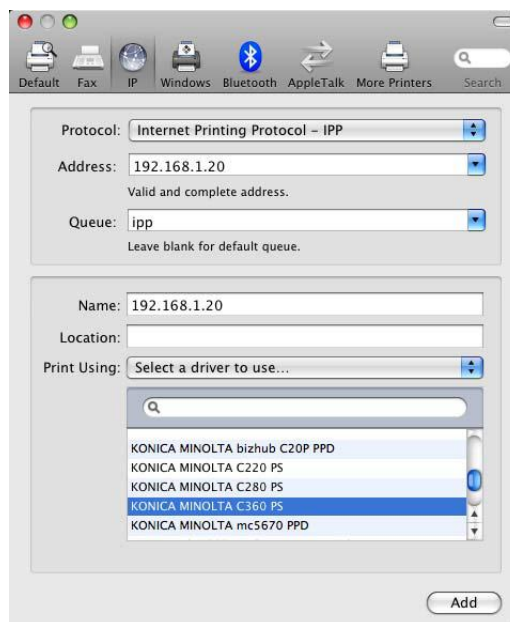

- 8 Click [Add].

When the selected printer is registered in the [Print & Fax], the setting procedure is completed.

→ If the [Installable Options] window appears, proceed to change the option settings as necessary. For details, refer to page 10-4.

Reference

- For OS X 10.4, you can also add a printer by clicking [Add] in the [Printer Setup Utility] window.

6.1.3 Selecting and connecting a printer (OS X 10.2/10.3)

In OS X 10.2/10.3, the printer can be connected with Rendezvous, AppleTalk, LPR (LPD), or IPP.

After configuring the network setting for the machine, selecting this machine as the printer to be used in [Printer Setup Utility] or [Print Center] enables printing.

Configuring the Rendezvous settings

Configuring the [Bonjour Setting] for the machine

Enable Bonjour in [Bonjour Setting] for the machine, and then enter the Bonjour name.



Reference

For details on the [Bonjour Setting] for the machine, refer to the [User's Guide Network Administrator].

Adding a printer

- 1 Select [Macintosh HD] - [Applications] - [Utilities] where the driver has been installed, and then double-click [Printer Setup Utility] or [Print Center] to open it.
- 2 When the [You have no printers available.] window appears, click [Add]. When the [Printer List] appears, click [Add].
 - If available printers have already been specified, the [You have no printers available.] window does not appear.
- 3 Select [Rendezvous] for the connection method.

Connected printers are detected.

 - If no printer is detected, turn this machine off, then on again.
In this case, turn off this machine, and then wait approximately 10 seconds before turning it on again. If you turn the printer on immediately after turning it off, it may not function correctly.
- 4 From the [Name] list, select the desired model name.

The printer driver corresponding to the selected printer name is automatically selected.

 - After the printer driver is selected, go to Step 6.
 - If an incorrect printer driver is selected, go to Step 5.

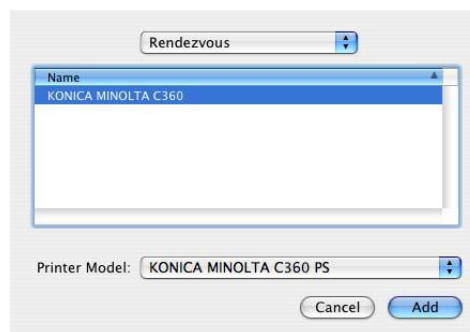

- 5 Select the desired printer driver manually.
 - From [Printer Model], select [KONICA MINOLTA], and then select the desired model from the list of model names.

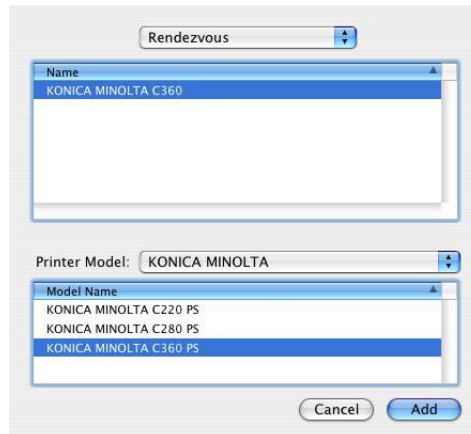

- 6 Click [Add].
 - When the selected printer is registered in the [Printer List], the setting procedure is completed.

Configuring the AppleTalk settings

Configuring the [AppleTalk Settings] for the machine

Enable AppleTalk in [AppleTalk Settings], and then enter the printer name.



Reference

For details on the [AppleTalk Settings] for the machine, refer to the [User's Guide Network Administrator].

Configuring the AppleTalk settings for the computer

Configure the AppleTalk settings for the Macintosh computer connected to the printer.

- 1 In the [Apple Menu], select [System Preferences...].
- 2 Click the [Network] icon.
- 3 From [Show:], select [Built-in Ethernet].
- 4 Click the [AppleTalk] tab, and then select the [Make AppleTalk Active] check box.
- 5 Click the close button at the top left corner of the window.
 - When the [This service has unsaved changes or Apply configuration changes] message appears, click [Apply].

Adding a printer

- 1 Select [Macintosh HD] - [Applications] - [Utilities] where the driver has been installed, and then double-click [Printer Setup Utility] or [Print Center] to open it.
- 2 When the [You have no printers available.] window appears, click [Add]. When the printer list appears, click [Add].
 - If available printers have already been specified, the [You have no printers available.] window does not appear.

- 3 Select [AppleTalk] for the connection method, and then select the zone to which the machine is connected.
Connected printers are detected.
→ If no printer is detected, turn this machine off, then on again.
In this case, turn off this machine, and then wait approximately 10 seconds before turning it on again. If you turn the printer on immediately after turning it off, it may not function correctly.
- 4 From the [Name] list, select the desired model name.
The printer driver corresponding to the selected printer name is automatically selected.
→ After the printer driver is selected, go to Step 6.
→ If an incorrect printer driver is selected, go to Step 5.



- 5 Select the desired printer driver manually.
→ From [Printer Model], select [KONICA MINOLTA], and then select the desired model from the list of model names.

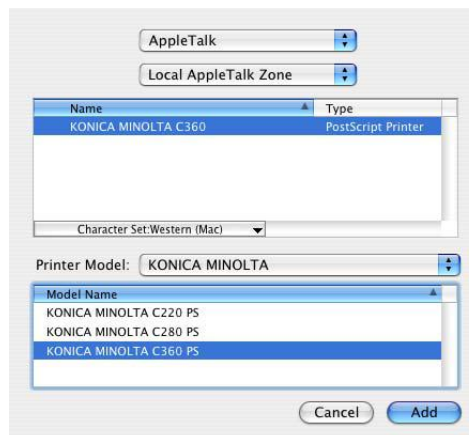

- 6 Click [Add].
When the selected printer is registered in the [Printer List], the setting procedure is completed.

Configuring the LPR settings

[TCP/IP Settings] for the machine

Specify the IP address for the machine.

[LPD Setting] for the printer

Before using LPR printing, enable LPD printing in [LPD Setting] for the machine.



Reference

For details on specifying the IP address for the machine, refer to the [User's Guide Network Administrator].

For details on the [LPD Setting] for the machine, refer to the [User's Guide Network Administrator].

Configuring the TCP/IP settings for the computer

Configure the TCP/IP settings for the Macintosh computer connected to the printer.

- 1 In the [Apple Menu], select [System Preferences...].
- 2 Click the [Network] icon.
- 3 From [Show], select [Built-in Ethernet].
- 4 Click the [TCP/IP] tab.
- 5 Select the [Configure:] item and configure the settings including the IP address and subnet mask according to the settings for the network to which the Macintosh computer is connected.
- 6 Click the close button at the top left corner of the window.
 - When the [This service has unsaved changes or Apply configuration changes] message appears, click [Apply].

Adding a printer

- 1 Select [Macintosh HD] - [Applications] - [Utilities] where the driver has been installed, and then double-click [Printer Setup Utility] or [Print Center] to open it.
- 2 When the [You have no printers available.] window appears, click [Add]. When the printer list appears, click [Add].
 - If available printers have already been specified, the [You have no printers available.] window does not appear.
- 3 Select [IP Printing] for the connection method.
- 4 For OS X 10.3, select [LPD/LPR] for [Printer Type:].
- 5 In [Printer Address:], enter the IP address for the machine.
- 6 From [Printer Model:], select [KONICA MINOLTA], select the desired model from the list of model names, and then click [Add].

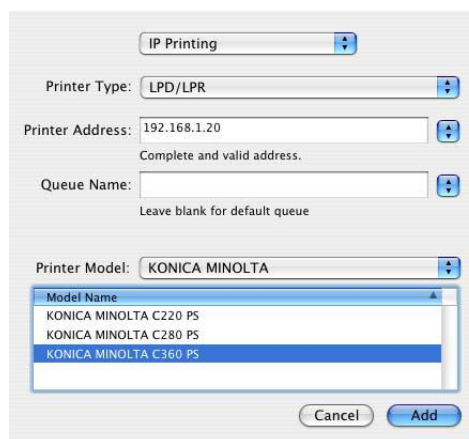

When the selected printer is registered in the [Printer List], the setting procedure is completed.

Configuring the IPP settings

[TCP/IP Settings] for the machine

Specify the IP address for the machine.

[IPP Settings] for the machine

In [IPP Settings] for the machine, enable IPP printing.



Reference

For details on specifying the IP address for the machine, refer to the [User's Guide Network Administrator].

For details on the [IPP Settings] for the machine, refer to the [User's Guide Network Administrator].

Configuring the TCP/IP settings for the computer

Configure the TCP/IP settings for the Macintosh computer connected to the printer.

- 1 In the [Apple Menu], select [System Preferences...].
- 2 Click the [Network] icon.
- 3 From [Show], select [Built-in Ethernet].
- 4 Click the [TCP/IP] tab.
- 5 Select the [Configure:] item and configure the settings including the IP address and subnet mask according to the settings for the network to which the Macintosh computer is connected.
- 6 Click the close button at the top left corner of the window.
 - When the [This service has unsaved changes or Apply configuration changes] message appears, click [Apply].

Adding a printer

- 1 Select [Macintosh HD] - [Applications] - [Utilities] where the driver has been installed, and then double-click [Printer Setup Utility] or [Print Center] to open it.
- 2 When the [You have no printers available.] window appears, click [Add]. When the printer list appears, click [Add].
 - If available printers have already been specified, the [You have no printers available.] window does not appear.
- 3 Select [IP Printing] for the connection method.
- 4 For OS X 10.3, select [Internet Printing Protocol - IPP] for [Printer Type:].
- 5 In [Printer Address:], enter the IP address for the machine.
 - Leave [Queue Name:] blank.

- 6 From [Printer Model], select [KONICA MINOLTA], select the desired model from the list of model names, and then click [Add].

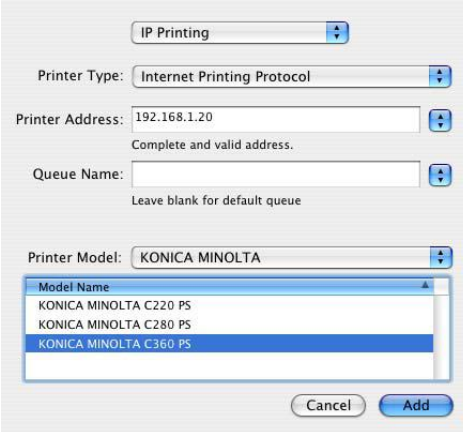

The screenshot shows the 'Add Printer' dialog box in Mac OS X. The 'IP Printing' section is active. The 'Printer Type' is set to 'Internet Printing Protocol'. The 'Printer Address' is '192.168.1.20'. The 'Queue Name' is empty. The 'Printer Model' dropdown is open, showing a list of model names: 'KONICA MINOLTA C220 PS', 'KONICA MINOLTA C280 PS', and 'KONICA MINOLTA C360 PS'. The 'Add' button is highlighted.

When the selected printer is registered in the [Printer List], the setting procedure is completed.

6.2 Mac OS 9.2

6.2.1 Installing the printer driver

After being connected, this machine can be used as a printer by selecting a PostScript printer and specifying the "printer description (PPD) file".

First, copy the "printer description (PPD) file" to the computer.

- 1 Insert the printer driver CD-ROM for Macintosh into the CD-ROM drive of the computer.
- 2 Open the folder in the CD-ROM that contains the desired printer driver.
 - Select a folder according to the printer driver, operating system, and language to be used.
- 3 Select the PPD file "KONICAMINOLTAC360UVxxx.ppd", and copy it to [Macintosh HD] - [System Folder] - [Extension] - [Printer Descriptions] on the computer.

This completes the printer driver installation.

6.2.2 Selecting and connecting a printer

In OS 9, the printer can be connected using AppleTalk or LPR (LPD).

Configure the network settings for the machine, and then select the printer.

Configuring the AppleTalk settings

Configuring the [AppleTalk Settings] for the machine

Enable AppleTalk in [AppleTalk Settings], and then enter the printer name.



Reference

For details on the [AppleTalk Settings] for the machine, refer to the [User's Guide Network Administrator].

Configuring the AppleTalk settings for the computer

Configure the AppleTalk settings for the Macintosh computer connected to the printer.

- 1 In the [Apple Menu], select [Control Panels] - [AppleTalk].
- 2 From [Connect via:], select [Ethernet].
- 3 Click the close button at the top left corner of the window.
 - When the [Save changes to the current configuration?] message appears, click [Save].

Selecting a printer

- 1 In the [Apple Menu] menu, select [Chooser].
- 2 Make sure that [AppleTalk] is set to [Active], and then click the "LaserWriter" icon.
- 3 From the [Select a PostScript Printer:] list, click the desired model name, and then click [Create].

The window for selecting a PostScript printer description (PPD) file appears.

- If a different PPD file has already been selected, click [Setup...] in Step 3, and then click [Select PPD...] from the window that is already displayed.

- 4 Click the applicable PPD file, and then click [Select] (or [Open]).

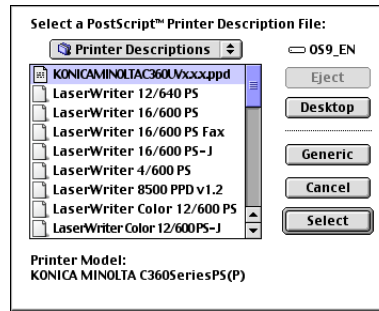

When the selected printer is registered in the [Chooser], the setting procedure is completed.

- If the window showing the installable options appears, proceed to change the option settings as necessary. Go to Step 5.
- If the [Chooser] window appears, go to Step 7.

- 5 Specify the options installed in the machine.

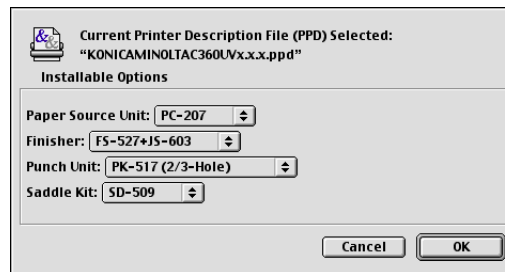

- 6 Click [OK].
The [Chooser] window appears again.
- 7 Close the [Chooser] window.

Configuring the LPR settings

[TCP/IP Settings] for the machine

Specify the IP address for the machine.

[LPD Setting] for the printer

Before using LPR printing, enable LPD printing in [LPD Setting] for the machine.



Reference

For details on specifying the IP address for the machine, refer to the [User's Guide Network Administrator].

For details on the [LPD Setting] for the machine, refer to the [User's Guide Network Administrator].

Configuring the TCP/IP settings for the computer

Configure the TCP/IP settings for the Macintosh computer connected to the printer.

- 1 In the [Apple Menu], select [Control Panels] - [TCP/IP].
- 2 From [Connect via:], select [Ethernet].
- 3 Select the [Configure:] item and configure the settings including the IP address and subnet mask according to the settings for the network to which the Macintosh computer is connected.
- 4 Click the close button at the top left corner of the window.
→ When the [Save changes to the current configuration?] message appears, click [Save].

Adding a printer

- 1 Select [Macintosh HD] - [Applications (Mac OS 9)] - [Utilities], and then double-click [Desktop Printer Utility] to open it.

The [New Desktop Printer] window appears.

- 2 In [Printing:], select [LaserWriter].
- 3 In [Create Desktop...], select [Printer (LPR)].

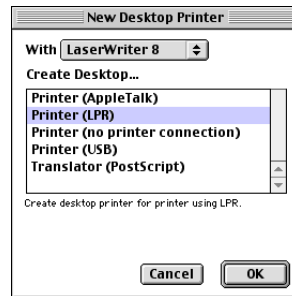

The [Untitled] window appears.

- 4 In [PostScript™ Printer Description (PPD) File], click [Change...].
The window for selecting a PostScript printer description (PPD) file appears.

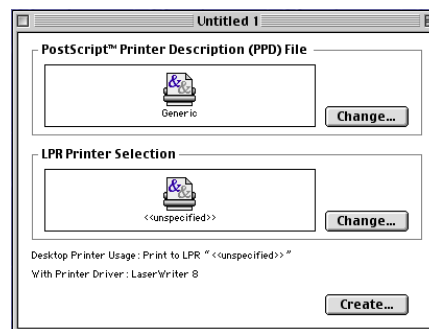

- 5 Click the applicable PPD file, and then click [Select].
The [Untitled] window appears again.
- 6 Click [Change...] for [LPR Printer Selection].
The window for entering the IP address appears.
- 7 In [Printer Address:], enter the IP address of the machine, and then click [OK].
The [Untitled] window appears again.
- 8 Click [Create...].
The window for saving the settings appears.
- 9 Enter the [Save desktop printer as], and then click [Save].
An icon for the LPR printer is created on the desktop.



Installation when Using NetWare

7 Installation when Using NetWare

This chapter describes the settings necessary when using NetWare and the procedure for installing printer drivers for the Windows client.

7.1 NetWare

7.1.1 Network Settings

In the [NetWare Settings] screen for the machine, specify [IPX Setting] and [NetWare Print Mode].



Reference

For details on the NetWare settings for the machine, refer to the [User's Guide Network Administrator].

7.1.2 Configuring the Windows client

For the Windows client that uses a printer, install the printer driver using the [Add Printer Wizard].

- ✓ Administrator authority is required for installation.
- 1 Insert the printer driver CD for Windows into the CD-ROM drive of the computer.
- 2 Open the [Printers] window or [Printers and Faxes] window.
- 3 Perform [Add a printer] or [Add Printer].
The [Add Printer Wizard] appears.
- 4 In the port settings, browse the network and specify the name of the created queue (or NDPS printer name).
- 5 From the printer model list, specify the desired folder in the CD-ROM that contains the printer driver.
 - Select a folder according to the printer driver, operating system, and language to be used.
Selectable printer drivers:
Windows 2000/XP/Server 2003: PCL driver, PS driver
Windows Vista/Server 2008: PCL driver, PS driver, XPS driver
Windows NT4.0: PCL driver
- 6 Follow the instructions on the pages that follow to complete the installation.

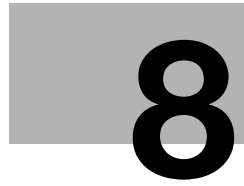

Uninstalling the Printer Driver

8 Uninstalling the Printer Driver

This chapter describes the procedure for uninstalling the printer driver.

8.1 Windows

When you have to remove the printer driver, for example, when reinstallation of the printer driver is necessary, remove the driver using the following procedure.

8.1.1 Uninstalling the printer driver using the uninstallation program

If you used the installer to install the printer driver, the printer driver uninstaller is installed.

- 1 Click [Start], and then select [All Programs] (or [Programs]) - [KONICA MINOLTA] - [C360Series] - [Uninstall Printer Driver].
- 2 Select the components to be removed, and then click [Uninstall].
 - From then on, follow the instructions on the pages that follow.

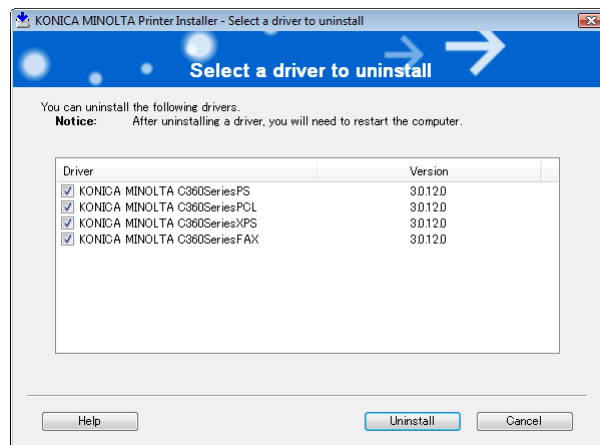

- 3 If the dialog box prompting to restart the computer, click [OK].

8.1.2 Uninstallation by the installer

If the printer driver was installed with the installer, it can be uninstalled by the installer.

- 1 Insert the printer driver CD-ROM for Windows into the CD-ROM drive of the computer.
 - Make sure that the installer starts, and then go to Step 2.
 - If the installer does not start, open the printer driver folder on the CD-ROM, double-click [Setup.exe], and then go to Step 3.
- 2 Click [Printer Install].
 - The printer driver installer starts.
- 3 Click [AGREE] in the license agreement window.
- 4 When a page for selecting menu to setup appears, select [Uninstall Printer Driver], and then click [Next].
- 5 Select the components to be removed, and then click [Uninstall].
 - From then on, follow the instructions on the pages that follow.
- 6 If the dialog box prompting to restart the computer, click [OK].

8.1.3 Manual uninstallation

If the printer driver was installed without using the installer, manually delete the printer driver.

- 1 Open the [Printers] window or [Printers and Faxes] window.
- 2 Select the icon for the printer to be uninstalled.
- 3 Press the [Delete] key on the computer to uninstall the printer driver.
- 4 From then on, follow the instructions on the pages that follow.
 When the printer driver has been deleted, the icon disappears from the [Printers] or [Printers and Faxes] window.
 In Windows NT 4.0, this completes the uninstallation process. Go to Step 10.
 In Windows 2000/XP/Vista/Server 2003/Server 2008, go on to uninstall the printer driver from the server properties.
- 5 Open [Server Properties].
 - In Windows Vista/Server 2008, right-click on the area that has nothing displayed in the [Printers] window, click [Run as administrator] - [Server Properties].
 - In Windows 2000/XP/Server 2003, click the [File] menu, then [Server Properties].
 - If the [User Account Control] window appears, click [Continue].
- 6 Click the [Driver] tab.
- 7 From the [Installed printer drivers:] list, select the printer driver to be removed, and then click [Remove...].
 - In Windows Vista/Server 2008, go to Step 8.
 - In Windows 2000/XP/Server 2003, go to Step 9.
- 8 In the dialog box for confirming the items to be removed, select [Remove driver and driver package.], and then click [OK].
- 9 In the dialog box for confirming if you are sure to remove the printer, click [Yes].
 - In Windows Vista/Server 2008, the dialog box appears to reconfirm if you are sure. Click [Uninstall].
- 10 Close the open windows, and then restart the computer.
 - Be sure to restart the computer.
 This completes removing the printer driver.

Reference

- In Windows 2000/XP/Server 2003, even if the printer driver is deleted using the preceding method, the model information file will remain in the computer. For this reason, when reinstalling the same version of the printer driver, the driver may not be rewritten. In this case, remove the following files as well.
- Check the "C:\WINDOWS\system32\spool\drivers\w32x86" folder ("C:\WINDOWS\system32\spool\drivers\x64" folder in the x64 system, and "C:\WINNT\system32\spool\drivers\w32x86" folder in Windows 2000), and if there is a folder (file described in "oem*.inf" shown below in Windows 2000) of the corresponding model, remove it. However, if multiple drivers are installed including the PCL KONICA MINOLTA driver, PostScript KONICA MINOLTA driver and fax driver, the model information of all drivers is deleted. To leave drivers other than the fax driver, do not remove the folder.
- From the "C:\WINDOWS\inf" folder ("C:\WINNT\inf" folder in Windows 2000), remove "oem*.inf" and "oem*.PNF" ("*" included in the file name indicates a number, which differs depending on the computer environment).
 Before removing these files, open the inf file, and then check the model name described on the last few lines to confirm it is the file for the corresponding model. The number of the PNF file is the same as that of the inf file.
- In Windows Vista/Server 2008, this operation is not necessary if you have selected [Remove driver and driver package.].

8.2 Macintosh

When you have to remove the printer driver, for example, when reinstallation of the printer driver is necessary, remove the driver using the following procedure.

8.2.1 For Mac OS X

- 1 Open the [Print & Fax] (or [Printer Setup Utility]/[Print Center]) window.
 - The [Print & Fax] window can be opened from the [System Preferences...] in the [Apple Menu] (OS X 10.3/10.4/10.5).
 - The [Printer Setup Utility]/[Print Center] window can be opened from [Macintosh HD] - [Applications] - [Utilities] (OS X 10.2/10.3/10.4).
- 2 Select the printer name to be deleted, and then click [-] (or [Delete]).

The selected printer is deleted.
- 3 Close the [Print & Fax] (or [Printer Setup Utility]/[Print Center]) window.
- 4 Drag the following installed files, which are located in [Macintosh HD] - [Library] - [Printers] - [PPDs] - [Contents] - [Resources] ([Resources] - [en.lproj]) for OS X 10.2/10.3/10.4) to the [Trash] icon.
 - [KONICAMINOLTAC360.gz]
 - [KONICAMINOLTAC280.gz]
 - [KONICAMINOLTAC220.gz]
- 5 Delete unnecessary files from [Library] - [Printers].
 - Drag the [C360] folder, which is located in [Library] - [Printers] - [KONICAMINOLTA], to the [Trash] icon.
 - In addition, for Mac OS X 10.2, drag all the [KONICA MINOLTA C360] folders, which are located in [Library] - [Printers] - [PPDPlugins], to the [Trash] icon.
- 6 Restart the computer.

This completes removing the printer driver.

8.2.2 For Mac OS 9.2

- 1 Drag the printer icon on the desktop to the [Trash] icon.
- 2 Drag the PPD file "KONICAMINOLTAC360UVxxx.ppd", which is located in [Macintosh HD] - [System Folder] - [Extension] - [Printer Descriptions], to the [Trash] icon.

The related printer driver files are deleted.
- 3 Restart the computer.

This completes removing the printer driver.

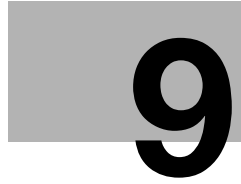

**Print function of PCL/PS/XPS
drivers for Windows**

9 Print function of PCL/PS/XPS drivers for Windows

This chapter describes functions of the PCL/PS/XPS printer drivers for Windows.

9.1 Print operations

Print jobs are specified from the application software.

- 1 Open the data in the application, and click [File]. Then click [Print] from the menu.
 - If the menu is not available, click [Print].
- 2 Check that the printer name has been selected in [Printer Name] (or [Select Printer]).
 - If the printer is not selected, click to select the printer.
 - The [Print] dialog box differs depending on the application.

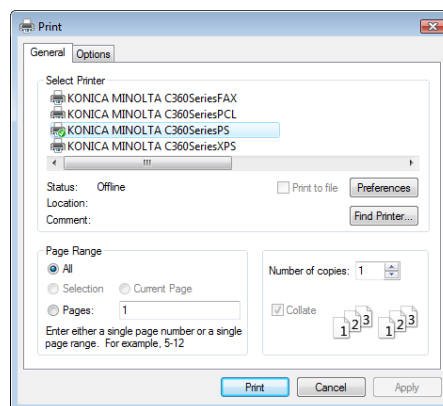

- 3 Specify the print range and the number of copies to print.
- 4 Click [Properties] (or [Preferences]) to change the printer driver settings as necessary.
 - Clicking [Properties] or [Preferences] in the [Print] window displays the [Printing Preferences] page of the printer driver where you can configure various functions. For details, refer to page 9-10.
 - [Printing Preferences] of the printer driver changed in the [Print] window are not saved, and the original settings are restored when you exit the application.
- 5 Click [Print].

Printing is executed and the data indicator of the machine flashes.

 - When [Secure Print Only] is set to [On] on [Device Option] of the [Configure] tab, [Secure Print] window appears. Go to Step 6.

- 6 Enter the ID and password of the document, and then click [OK].
Data is sent and saved in the [Secure Document User Box] of this machine.

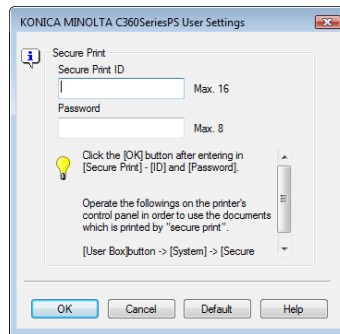

Reference

For details on the [Configure] tab, refer to page 9-4.

For details on secure printing, refer to page 12-5.

9.2 Default settings of the printer driver

When you have installed the printer driver, you need to change the initialization conditions such as options, user authentication and account track functions and enable functions of the machine from the [Printing Preferences] window of the printer driver.

NOTICE

If the model name, installed options, user authentication and account track functions for the machine are not specified on the [Configure] tab, the option functions cannot be used from the [Printing Preferences] window of the printer driver. Be sure to configure the settings for the installed options.

9.2.1 Displaying the Properties window

- 1 Open the [Printers] window or [Printers and Faxes] window.
 - In Windows Vista/Server 2008, click [Start], open [Control Panel], and then click [Printers] in [Hardware and Sound]. When [Control Panel] is displayed in Classic View, double-click [Printers].
 - In Windows XP/Server 2003, click [Start], then [Printers and Faxes].
 - In Windows XP/Server 2003, if [Printers and Faxes] is not displayed in the [Start] menu, open [Control Panel] from the [Start] menu, select [Printers and Other Hardware], then [Printers and Faxes]. When [Control Panel] is displayed in Classic View, double-click [Printers].
 - In Windows 2000/NT 4.0, click [Start], and then select [Settings], then [Printers].
- 2 Right-click the icon of the installed printer, and click [Properties].

9.2.2 Configure tab

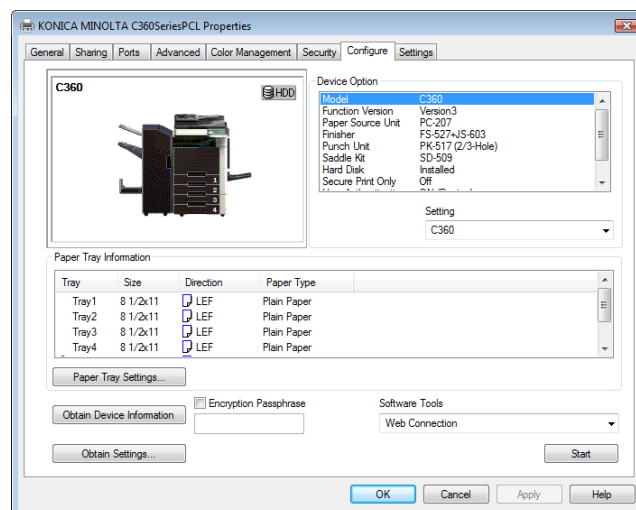

Specify the model name used and presence or absence of the installed options, user authentication and account track functions, and then allow the printer driver to use the functions of the machine.

Item Name	Functions
[Device Option]	Configure the model name of the machine and the status of the installed printer options and user authentication/account track. Specify the status of each item in the [Setting] box.
[Paper Tray Information]	Displays the paper type assigned for each paper tray. Click [Paper Tray Settings...] to configure the settings for each paper tray.
[Obtain Device Information]	Click this button to communicate with this machine and load the status of the installed options.
[Obtain Settings...]	Click this button to configure conditions such as the destination when you perform [Acquire Device Information]. When automatically acquiring device information, enable [Auto]. If necessary, you can select [Enter Password to acquire Device Information] and specify a password for authentication to acquire device information. This then performs password authentication when acquiring device information.

Item Name	Functions
[Encryption Passphrase]	Any string used to encrypt communication with this machine. If the encryption passphrase for the machine was changed from [Use Factory Default] to [User-Defined], enter the same encryption passphrase as for the machine. An encryption key is automatically created for the entered text, and used for communication with the machine.
[Software Tools]	Allows you to start up the software tools such as PageScope Web Connection .

Reference

- The machine type and option in [Device Option] are specified automatically if [Obtain Settings...] is set to [Auto]. If [Auto] is not enabled, be sure to specify the machine and option manually or using [Obtain Device Information].
- [Function Version] supports the version of this machine. To check the version of this machine, click **Utility/Counter** in the control panel, and click [Device Information]. If [Device Information] is not displayed, the version is assumed to be "Version 2". The contents of this manual support the functions of Version 3.
- When [Secure Print Only] is set to [On] in [Device Option], only the secure print jobs are allowed. For details on secure printing, refer to page 12-5.
- In [Encryption Passphrase], enter the encryption passphrase that matches the one that configured in [Driver Password Encryption Setting] of the machine.
- The function of [Acquire Device Information] is available only when your computer is connected to and can communicate with the machine. To use [Acquire Device Information], in [Administrator Settings] of this machine, set [System Connection] - [OpenAPI Settings] - [Authentication] to [OFF]. For details, refer to page 13-57.
- If [Enter Password to acquire Device Information] is selected in [Obtain Settings...], check that the password matches that specified in [Assign Account to Acquire Device Info] of this machine. Enter the password using up to eight characters, excluding spaces and "".

**Reference**

For details on allowing the user to specify [Encrypt. Passphrase], refer to page 12-32.

For details on [Assign Account to Acquire Device Info] of this machine, refer to page 13-55.

9.2.3 Settings tab

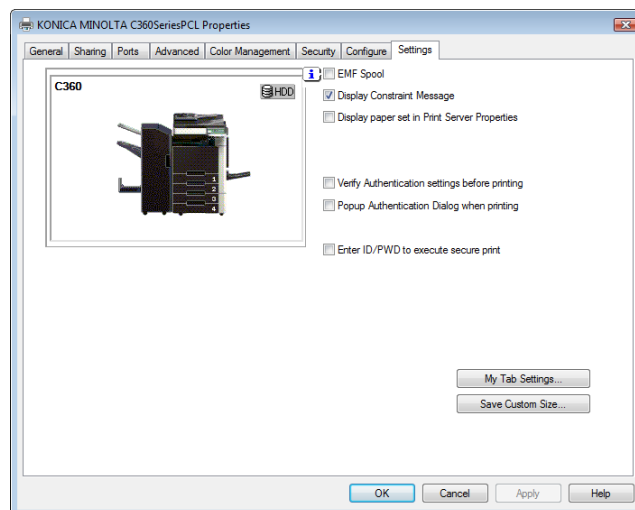

The Settings tab allows you to change the default settings for displaying the confirmation messages or the window for entering the authentication settings.

Item Name	Functions
[EMF Spool]	Select this check box when meta file (EMF) spool is required for use in its own system environment.

Item Name	Functions
[Display Constraint Message]	Select this check box to display the message when functions that cannot be configured simultaneously are enabled for the printer driver.
[Display paper set in Print Server Properties]	Select this check box to use forms added in the [Server Properties] dialog box of the Printers window.
[Verify Authentication settings before printing]	Select this check box to verify authentication settings for this machine before printing, and display the message if they are not satisfied.
[Popup Authentication Dialog when printing]	Select this check box to display the [User Authentication/Account Track] dialog box when specifying printing, prompting entering the user name and account name.
[Enter ID/PWD to execute secure print]	Select this check box to display the [Secure Print] dialog box prompting entry of ID and password when performing secure print.
[My Tab Settings]	Configure the settings to display My Tab for the printer driver. [Display My Tab]: Displays or hides My Tab. Select this check box to display My Tab. [Share My Tab]: Specifies whether to share the function layout on My Tab. If this check box is selected, the My Tab layout specified in the server side is inherited to that in the client side when specifying a shared printer of the server from a client and installing the printer driver. Also, this function hides the [Edit My Tab] key in the client side to prohibit a client user from editing My Tab. [Prohibit Editing]: Prohibits or allows each user to edit My Tab. If this check box is selected, the [Edit My Tab] key is hidden to prohibit each user from editing My Tab. [Display Note]: Displays or hides a note on My Tab. If this check box is selected, a note on My Tab is displayed.
[Save Custom Size...]	Click this button to register custom paper sizes.

Reference

- [EMF Spool] and [Save Custom Size...] are functions available only for the PCL driver.
- To use the EMF spool function with a PS/XPS driver, select [Enable advanced printing features] in the [Advanced] tab to enable the EMF spool.
- To display [Server Properties], in Windows Vista/Server 2008, right-click on the area that has nothing displayed in the [Printers] window, and click [Run as administrator] - [Server Properties]. In Windows 2000/XP/Server 2003, click the [File] menu, then [Server Properties].
- The paper set in Print Server Properties for the printer driver is allowable in the following ranges.
 Custom sizes available in printer driver:
 Width: 3-1/2 to 12-1/4 inches (9.00 to 31.11 cm)
 Length: 5-1/2 to 18 inches (13.97 to 45.72 cm)
 Banner sizes available in printer driver:
 Width: 8-1/4 to 11-11/16 inches (21.00 to 29.70 cm)
 Length: 18 to 47-1/4 inches (45.73 to 120.0 cm)
 Allowable range of large size 1:
 Width: 3-9/16 to 8-1/4 inches (9.00 to 20.90 cm)
 Length: 18 to 46-13/16 inches (45.73 to 118.90 cm)
 Allowable range of large size 2:
 Width: 11-11/16 to 12-1/4 inches (29.71 to 31.12 cm)
 Length: 18 to 46-13/16 inches (45.73 to 118.90 cm)
 Allowable range of large size 3:
 Width: 12-1/4 to 33-1/8 inches (31.12 to 84.10 cm)
 Length: 5-1/2 to 46-13/16 inches (13.97 to 118.90 cm)
 The paper size registered in the range of the above custom sizes or banner sizes are available in both of [Original Size] and [Paper Size] of the printer driver. However, the paper size registered in the allowable range of each large size is available only in [Original Size] of the printer driver.
- To enable each user to use functions on My Tab at the same layout, the settings can be configured using **Driver Packaging Utility** included in the application CD-ROM. When creating a driver package using **Driver Packaging Utility**, change the printer driver used as the package source to the desired My Tab position to copy the printer setting in the **Driver Packaging Utility** settings. For details on the **Driver Packaging Utility** settings, refer to the **Driver Packaging Utility** Help.



Reference

For details on the My Tab function, refer to page 9-10.

9.2.4 Registering the default settings

The settings for the machine functions configured when printing can only be applied while using the application. When you exit the application, the settings return to their default settings.

To register the settings, change the printer driver basic settings (default settings).

- 1 Open the [Printers] window or [Printers and Faxes] window.
 - In Windows Vista/Server 2008, click [Start], open [Control Panel], and then click [Printers] in [Hardware and Sound]. When [Control Panel] is displayed in Classic View, double-click [Printers].
 - In Windows XP/Server 2003, click [Start], then [Printers and Faxes].
 - In Windows XP/Server 2003, if [Printers and Faxes] is not displayed in the [Start] menu, open [Control Panel] from the [Start] menu, select [Printers and Other Hardware], then [Printers and Faxes]. When [Control Panel] is displayed in Classic View, double-click [Printers].
 - In Windows 2000/NT 4.0, click [Start], and then select [Settings], then [Printers].
- 2 Right-click the icon of the installed printer, and click [Printing Preferences...].
 - In Windows NT 4.0, right-click the icon of the installed printer, and then click [Document Defaults...]. The [Printing Preferences] dialog box of the printer appears.
- 3 Change the settings of the function, and then click [OK] to exit the function.

The changed settings are applied when the printer is used by all of the application software.



Reference

For details on the function and settings of the printer driver, refer to page 9-10.



The printer driver has the function to save the setting as a [Favorite Setting]. For details, refer to page 9-8.

9.3 Common Setting

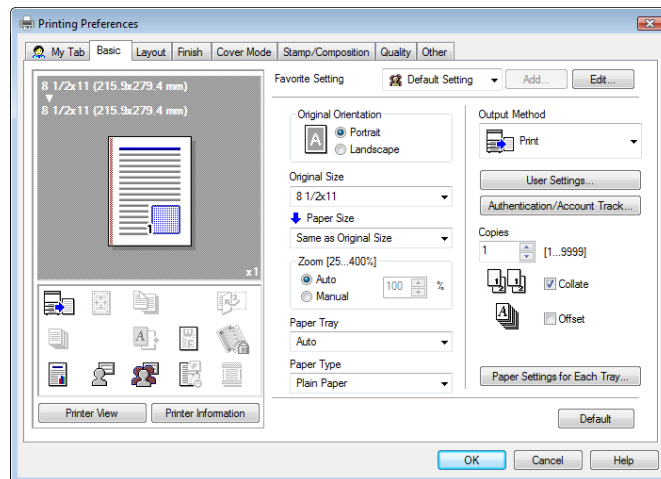
This section describes the settings and buttons common to tabs.

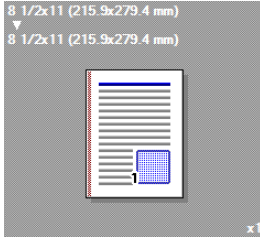

Item Name	Functions
[OK]	Click this button to enable changed settings and close the properties window.
[Cancel]	Click this button to disable (cancel) changed settings and close the properties window.
[Help]	Click this button to display Help of the items in the displayed window.
[Add...] (Favorite Setting)	Click this button to save current settings so that they can be recalled later. In [Restore Items], check the setting item to be called when [Favorite Setting] is selected. The following functions are available in [Restore Items]. <ul style="list-style-type: none"> • Original size, original orientation • Copies • List information of paper type settings • List information of overlay • Watermark list information and share setting If any of these functions is not selected, its setting is not changed even if [Favorite Setting] is selected.
[Edit...](Favorite Setting)	Click this button to change saved settings. In [Option...], you can change whether to select the [Restore Items] check box.
[Default]	Click this button to return to the default settings.

Item Name	Functions
View	<p>Selecting [Paper View] displays the sample page layout based on current settings for checking the output result image.</p> <p>Selecting [Printer View] displays a printer figure showing the options installed in the machine such as the paper tray.</p> <p>Paper:</p>  <p>Printer:</p> 
[Printer Information]	<p>Click this button to start PageScope Web Connection and check the printer information. This button is enabled only when your computer can communicate with this machine.</p>

9.4 Parameter details

The Printing Preferences window is the window to configure the printer driver functions. Click [Properties] (or [Preferences]) in the Print dialog box, or right-click the printer icon in the [Printers] or [Printers and Faxes] window, and then specify [Printing Preferences...] ([Document Defaults...] for Windows NT 4.0) to open it.

9.4.1 My Tab

My Tab allows you to customize the display contents. By registering frequently used setting functions to My Tab, the printer driver can be easier to use, and you can modify various settings from a single window.

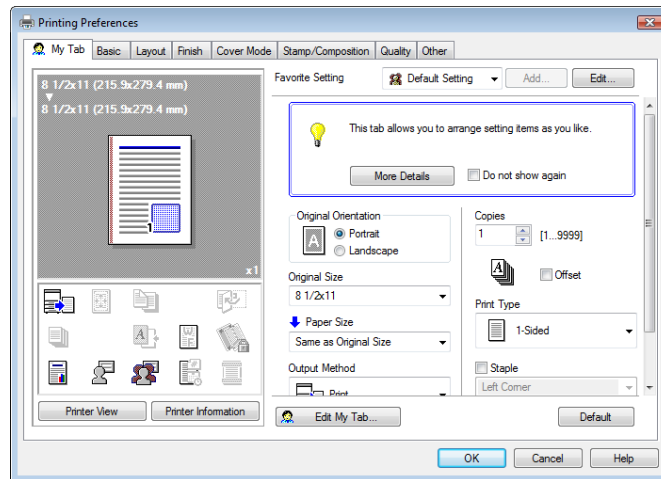

Function Name	Option	Description
[More Details]	–	Click this button to display the Help of My Tab.
[Do not show again]	ON/OFF	Select this check box to hide the comment field containing [More Details] from the next time.
[Edit My Tab...]	–	Click this button to register or delete the functions displayed on My Tab. For details, refer to page 9-11.

Reference

- The comment field containing [More Details] or [Do not show again] is not displayed if [Display Note] is disabled in [My Tab Settings] of the [Settings] tab.
- [Edit My Tab...] is not displayed when [Prohibit Editing] is enabled in [My Tab Settings] of the [Settings] tab.
- Items other than the above are customized on [Edit My Tab...], and the specific display contents vary depending on the registered contents.



Reference

For details on the [Settings] tab, refer to page 9-5.

Edit [My Tab]

Reference

- [Edit My Tab...] is not displayed when [Prohibit Editing] is enabled in [My Tab Settings] of the [Settings] tab.

- 1 On [My Tab], click [Edit My Tab...].
- 2 Select the function you want to register on [My Tab], and then click [to the LEFT] or [to the RIGHT].
 - Select the desired function from those indicated in the respective tabs in [Setting Item List].
 - Clicking [to the LEFT] places the selected function on the left side of [My Tab] and likewise clicking [to the RIGHT] places it on the right side of [My Tab].
 - At the left of the functions currently registered to [My Tab], the icons indicating the [LEFT side]/[RIGHT side] appear.

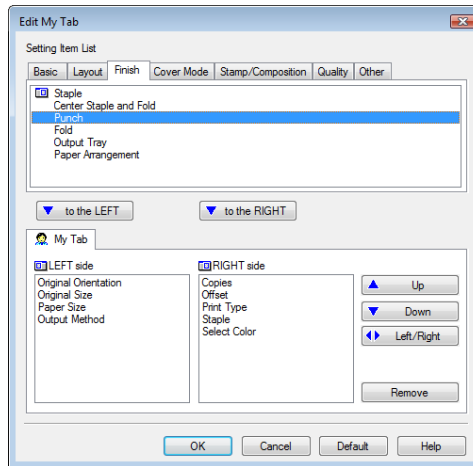

- 3 The following describes how to change the layout of the registered functions.
 - Select the function whose position you want to move and click [Up], [Down], [Left/Right] as needed.
 - To delete a function from [My Tab], select the function you want to delete, and then click [Remove].

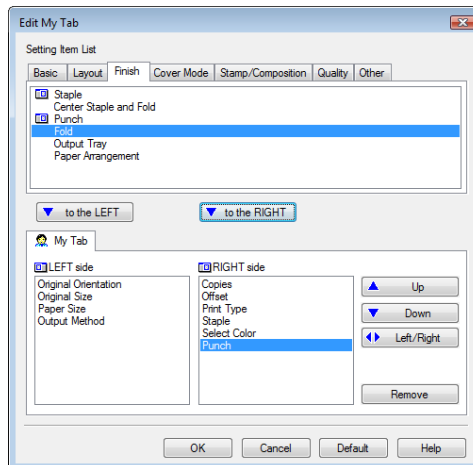

- 4 Click [OK].

9.4.2 [Basic] tab

The Basic tab allows you to configure the basic printing functions such as paper size and type as well as output method.

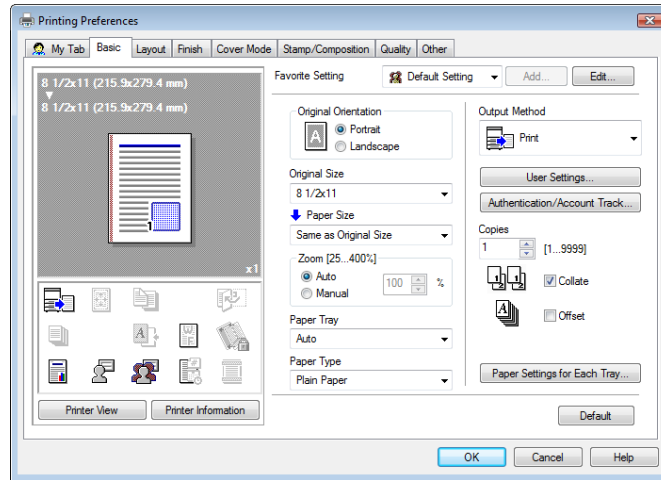

Function Name	Option	Description
[Original Orientation]	Portrait, Landscape	Select the orientation for the original.
[Original Size]	The paper sizes registered as the standard paper sizes and custom sizes	Select the paper size of the original.
	Custom Size	Register custom sizes.
[Paper Size]	The paper sizes registered as the standard paper sizes and custom sizes that can be used with the machine	Specify the output paper size. If it is different from the original size and the zoom is set to [Auto], the output image will be enlarged or reduced to fit the size.
	Custom Size	Register custom sizes.
[Zoom]	25 to 400%	Select an enlarge or reduce ratio.
[Paper Tray]	Auto, Tray 1 to Tray 4, LCT, Bypass Tray	Select a paper tray to be used. Selectable items vary depending on the option installation status.
[Paper Type]	Paper types available for the machine	Select a paper type to be used for printing. It can be changed only when Paper Tray is set to [Auto]. When Paper Tray is not set to [Auto], the paper types registered in [Paper Settings for Each Tray] are available.

Function Name	Option	Description
[Output Method]	[Print]	Select this option to print immediately.
	[Secure Print]	Select this option to save the document to be printed in [Secure Document User Box] of the machine. When printing, entering the [ID] and [Password] is required from the control panel of the machine. Select this option when printing highly confidential documents.
	[Save in User Box]	Select this option to save the document to be printed in a User Box of the machine.
	[Save in User Box/Print]	Select this option to save the document in a User Box and print at the same time.
	[Proof Print]	After one copy of the document is printed, the machine stops printing temporarily. Select this option to avoid misprinting a large volume of print jobs.
	[ID&Print]	Select this option to save the document to be printed in [ID & Print User Box] of the machine. When printing, user authentication must be performed via the control panel of the machine.
[User Settings...]	–	Specify the ID and password, or the file name and User Box number when performing [Secure Print] or [Save in User Box].
[Authentication/Account Track...]	–	Click this button to specify the user name and password when [User Authentication] is enabled on this machine, or the account name and password when [Account Track] is enabled on this machine.
[Copies]	1 to 9999	Specify the number of copies to be printed.
[Collate]	ON/OFF	Select this check box to collate pages sequentially when printing multiple sets of copies.
[Offset]	ON/OFF	Select this check box to stagger each set when printing multiple sets of copies.
[Paper Settings for Each Tray...]	[Paper Type Settings]	Select a paper tray to be specified. Selectable items vary depending on the option installation status.
	[Paper Type]	Select the type of paper to be loaded onto the paper tray.

Reference

- Paper size "12 × 18" is equivalent to 304.8 × 457.2 mm that is slightly larger than A3.
- In [Original Size], you can select A0, A1, A2, B1, B2, or B3; however, the printing paper size is reduced to the size specified in [Paper Size]. [Same as Original Size] cannot be selected in [Paper Size]. The large size registered for the paper set in Print Server Properties is also reduced to the size specified in [Paper Size]. The paper set in Print Server Properties is available when [Display paper set in Print Server Properties] is selected in the [Settings] tab.
- To use paper of which the size is other than the standard sizes, specify the custom paper size. You can register a custom size by selecting [Custom Size] from the paper size or original size option.
- To print data of the size corresponding to the full standard size, selecting "W" of the standard size paper for original size enables the data to be printed at the center of paper larger than the original size. For example, if you want to center and print 8-1/2 × 11 size data on 11 × 17 sized paper, create data with the "8-1/2 × 11W" size, and then, using the printer driver, set [Original Size] to [8-1/2 × 11W] and specify the paper tray to be used as [Paper Tray].
On the machine side, set 11 × 17 size paper in the tray to be used, select the tray in [Paper] of the [Basic] screen of the control panel, and select [Change Tray Settings] - [Wide Paper] to specify [8-1/2 × 11W]. Then, confirm that [Auto Detect] is selected for [Custom Size] and 11 × 17 is displayed. When 12-1/4 × 18 paper is loaded, you must select [12-1/4 × 18] for [Custom Size].
To print on custom sized paper, use the bypass tray, select [Change Tray Settings] - [Wide Paper] to specify [8-1/2 × 11W], and enter the desired paper size to be used for [Change Size].
- Specify [Side2] when printing on the back side of paper.
- [User] of Paper Type is the frequently used paper type registered on the machine side. For details on registering the user paper, refer to the [User's Guide Copy Operations].

Reference

For details on the paper sizes loadable in the paper trays, refer to the [User's Guide Copy Operations].

For details on the output method, refer to page 12-2.

9.4.3 [Layout] tab

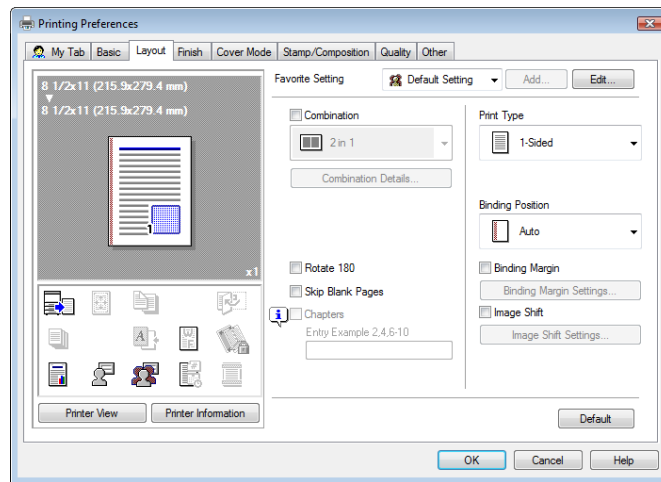

Function Name	Option	Description
[Combination]	2 in 1, 4 in 1, 6 in 1, 9 in 1, 16 in 1, 2 × 2, 3 × 3, 4 × 4	Select any of the options to print multiple pages of the original on to one sheet or print information on one page of the original on to several sheets. In [Combination Details...], specify the page order and use of the border frame.
[Combination Details...]	[Combination]	Select the combination condition.
	[Layout Order]	Specify the layout order. It can be specified when N in 1 is specified for Combination.
	[Border]	Specify the presence and type of border lines. It can be specified when N in 1 is specified for Combination.
	[Overlap width line]	Specify the presence of overlap width line. It can be specified when N × N is specified for Combination.
[Rotate 180]	ON/OFF	Select this check box to rotate the document 180° to print.
[Skip Blank Pages]	ON/OFF	Select this check box to not print any blank pages.
[Chapters]	ON/OFF	Select this check box to specify the page to be printed on the front side. It can be specified when Print Type is [2-Sided] or [Booklet].
[Entry]	–	Specify the pages to be printed on the front side when [Chapters] is selected.
[Print Type]	[1-Sided], [2-Sided], [Booklet]	Specify 2-Sided Print or Booklet printing.
[Binding Position]	[Auto], [Left Bind], [Right Bind], [Top Bind]	Specify the binding position.
[Binding Margin]	ON/OFF	Select this check box to specify the binding margin. Click [Binding Margin Settings...] to specify the margin values.

Function Name	Option	Description
[Binding Margin Settings...]	[Shift Mode]	Select how to process the image to prepare the page margin.
	[Front Side]/[Back Side]	Specify the binding margin values. For 2-sided printing, clearing the [Same value for front and back sides] check box allows you to specify different values for the front and back sides.
	[Unit]	Select a unit to be used for specifying the size.
[Image Shift]	ON/OFF	Select this check box to print by shifting the entire print image. Click [Image Shift Settings...] to specify the image shift values.
[Image Shift Settings...]	[Unit]	Select a unit to be used for specifying the size.
	[Front Side]/[Back Side]	Specify the shift direction and values. For 2-sided printing, clearing the [Same value for Front and Back sides] check box allows you to specify different values for the front and back sides.

Reference

- The options "2 × 2, 3 × 3 and 4 × 4" for [Combination], which are for printing a sheet of original onto multiple sheets of paper, are available only for the PCL driver.
- The [Skip Blank Pages] function is available for the PCL/XPS drivers.
- The positions of binding margins vary according to the [Binding Position] setting.

9.4.4 [Finish] tab

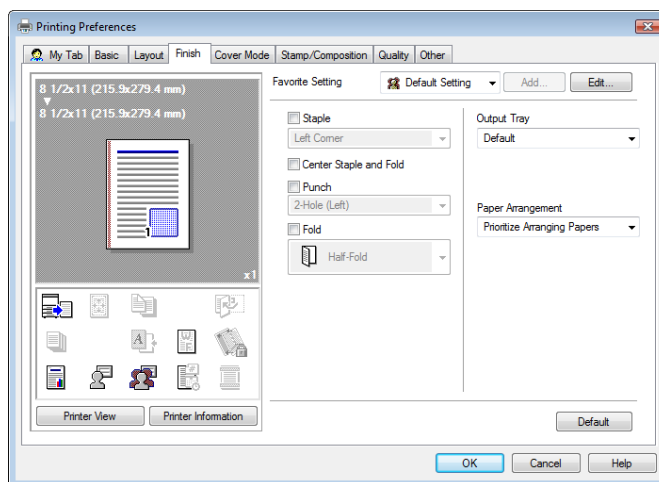

Function Name	Option	Description
[Staple]	ON/OFF, Left Corner/Right Corner/2 Position (Left)/2 Position (Right)/2 Position (Top)	Select this check box to specify stapling. From the drop-down list, specify the number of staples and the stapling position.
[Center Staple and Fold]	ON/OFF	Select this check box to specify center staple and fold.
[Punch]	ON/OFF, 2-Hole (Left)/2-Hole (Right)/2-Hole (Top)/3-Hole (Left)/3-Hole (Right)/3-Hole (Top)/4-Hole (Left)/4-Hole (Right)/4-Hole (Top)	Select this check box to specify hole punching. From the drop-down list, specify the number of punches and the punching position.
[Fold]	ON/OFF, [Half-Fold]	Select this check box to specify folding. From the drop-down list, specify the folding condition.

Function Name	Option	Description
[Output Tray]	Default, Tray 1 and Tray 3	Specify the tray to output the printed pages. Selectable items vary depending on the option installation status.
[Paper Arrangement]	[Prioritize Arranging Papers]/[Prioritize Productivity]	Specify the method for paper arrangement (adjusting the binding position) for 2-sided printing. When [Prioritize Arranging Papers] is selected, the paper arrangement process is performed after receiving all data. When [Prioritize Productivity] is selected, the paper arrangement process is performed while receiving and printing data.

Reference

- The [Staple] function is available only if the optional **Finisher FS-527** or **Finisher FS-529** is installed.
- The [Punch] function is available only when the **Punch Kit** is installed on the optional **Finisher FS-527**.
- The [Center Staple and Fold] and [Fold] functions are available only when the **Saddle Stitcher** is installed on the optional **Finisher FS-527**.

9.4.5 [Cover Mode] tab

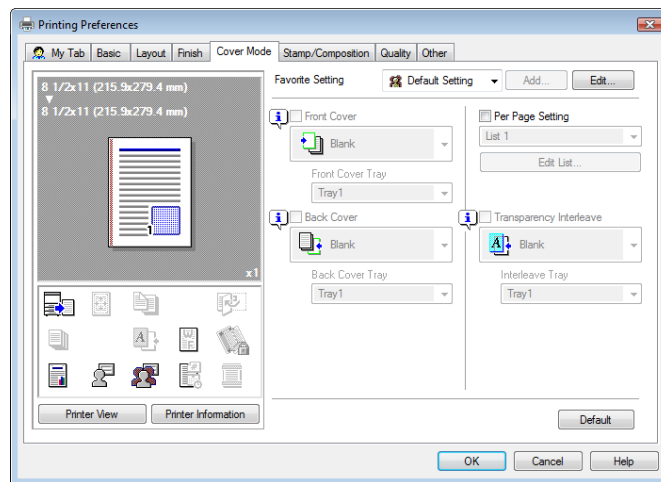

Function Name	Option	Description
[Front Cover]	ON/OFF, [Blank]/[Print]	Select this check box to attach a front cover page. It can be specified when any other option than [Auto] is selected for Paper Tray.
[Front Cover Tray]	Tray 1 to Tray 4, LCT, Bypass Tray	Select the paper tray for the front cover sheet. Selectable items vary depending on the option installation status.
[Back Cover]	ON/OFF, [Blank]/[Print]	Select this check box to attach a back cover page. It can be specified when any other option than [Auto] is selected for Paper Tray.
[Back Cover Tray]	Tray 1 to Tray 4, LCT, Bypass Tray	Select the paper tray for the back cover sheet. Selectable items vary depending on the option installation status.
[Per Page Setting]	ON/OFF	Select this check box to insert paper between pages and switch the paper and tray for each page. [Edit List...] allows you to create a list specifying conditions on a page basis.

Function Name	Option	Description
[Edit List...]	[List Name]	Select the name of the list to be edited. The settings are listed.
	[Edit List Name...]	Rename a list.
	[Up]/[Down]	Click the button to move the selected condition row up or down. Move the rows so that the page numbers are arranged in ascending order.
	[Add]	Click this button to add a condition. Specify conditions in [Add/Edit].
	[Delete]	Click this button to delete the selected condition row.
	[Page Number]	Specify the page numbers using a numerical value. To specify multiple pages, separate each page number with a comma or specify the range using a hyphen.
	[Print Type]	Specify the print type from the [Change Settings] drop-down list.
	[Paper Tray]	Specify the paper tray to be used from the [Change Settings] drop-down list.
	[Staple]	From the [Change Settings] drop-down list, specify the number of staples and the stapling position.
[Transparency Interleave]	ON/OFF, [Blank]	Select this check box to insert interleaves when printing transparencies. It can be specified when [Transparency] is selected for Paper Type.
[Interleave Tray]	Tray 1 to Tray 4, LCT	Select the paper tray for the transparency interleaves. Selectable items vary depending on the option installation status.

9.4.6 [Stamp/Composition] tab

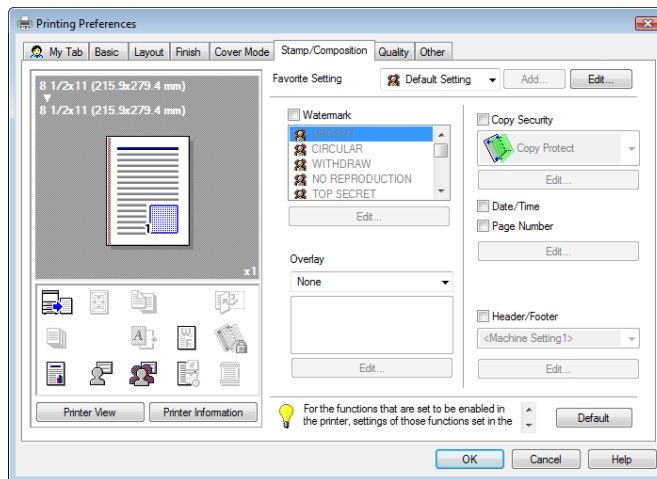

Function Name	Option	Description
[Watermark]	ON/OFF	Select this check box to print the document with a watermark (character stamp) overlapped. Clicking [Edit...] allows you to create, change, or delete watermarks.
[Edit...]	–	For details, refer to page 9-19.

Function Name	Option	Description
[Overlay]	[None]	The overlay function is not used.
	[Create Host Image]	Printing the original with this setting creates the overlay data. Created data is saved in the computer.
	[Print Host Image]	Select this option to print the original on top of the overlay data created with [Create Host Image]. Selecting this setting displays the overlay data stored in the computer in the list below, allowing you to select it. Clicking [Edit...] allows you to specify the overlay printing conditions.
	[Print Device Image]	Select this option to print the original on top of an overlay data of the machine. Clicking [Edit...] allows you to specify the overlay data and conditions registered in this machine.
[Edit...]	–	For details, refer to page 9-20.
[Copy Security]	ON/OFF, [Copy Protect]/[Repeatable Stamp]/[Copy Guard]/[Password Copy]	Specify the special pattern or password to prevent copying. Click [Edit...] to specify items to be printed, positions, composition method and password. If you select [Password Copy], the [Edit...] screen appears where you can specify a password.
[Edit...]	–	For details, refer to page 9-21.
[Date/Time]	ON/OFF	Select this check box to print the date and time. Click [Edit...] to specify items and pages to be printed and positions.
[Page Number]	ON/OFF	Select this check box to print page number. Click [Edit...] to specify items and pages to be printed and positions.
[Edit...]	–	For details, refer to page 9-23.
[Header/Footer]	Machine Setting 1 to Machine Setting 20	Select this check box to print the header and footer. Select the header/footer from the list specified in the main unit. Clicking [Edit...] allows you to specify items and pages to be printed.
[Edit...]	[Acquire Device Information]	Select this option to communicate with the machine to read the header settings configured on the machine.
	[Distribution Control Number]	When printing multiple copies, this function prints the number of copies in the header/footer.
	[Edit...]	Specify the distribution control number conditions.
	[Pages]	Specify the pages to be printed.
	[Text Color]	Specify the text color used for printing.

Reference

- [Print Device Image] of the [Overlay] function is available only for the PCL driver.
- The function of [Acquire Device Information] is available only when your computer is connected to and can communicate with the machine.
To use [Acquire Device Information], in [Administrator Settings] of the machine, set [System Connection] - [OpenAPI Settings] - [Authentication] to [OFF]. For details, refer to page 13-57.
- [Copy Guard] and [Password Copy] are available when [Password Copy] and [Copy Guard] are set to [Yes] in [Administrator Settings] - [Security Settings] - [Security Details] under this machine while the optional **Security Kit SC-507** is installed. For details, refer to the [User's Guide Copy Operations].

Editing watermark

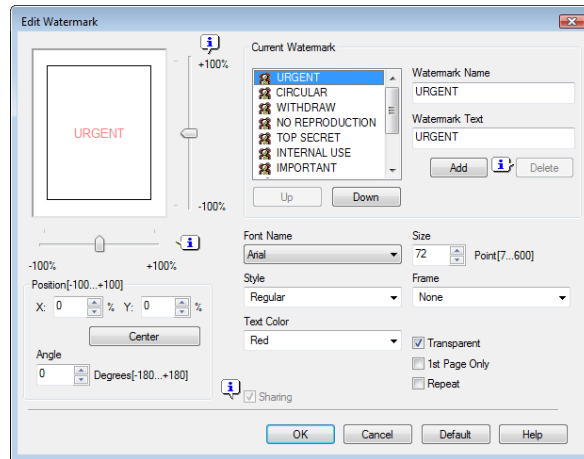

Function Name	Description
[Watermark Name]	Enter the name of the watermark. You can enter up to 30 characters.
[Watermark Text]	Enter the text to be printed as the watermark. You can enter up to 30 characters.
[Add]	Click this button to create a new watermark.
[Delete]	Click this button to delete the selected watermark.
[↑]/[↓]	Click the button to change the order of items displays in the list. This allows you to move the frequently used items upward.
[Position]	Select the vertical and lateral positions. You can specify the positions using the scroll bars provided on the right of and under the image.
[Center]	Click this button to return the watermark back to the center position.
[Angle]	Specify the watermark print angle.
[Font Name]	Select the font.
[Size]	Select the size.
[Style]	Select the style.
[Frame]	Select the frame style.
[Text Color]	Specify the watermark text color.
[Transparent]	Select this check box to print the watermark in a transparent image.
[1st Page Only]	Select this check box to print the watermark only on the first page.
[Repeat]	Select this check box to print the watermark on one page repeatedly.
[Sharing]	Select this check box to register the watermark for sharing it with other users or clear this check box to register it for private use.

Editing overlay

The window to be displayed by clicking [Edit...] varies depending on the overlay selection ([Print Host Image] or [Print Device Image]).

When [Print Host Image] is selected:

You can specify the overlay printing conditions. When the overlay data does not appear in the list, read it by specifying the file.

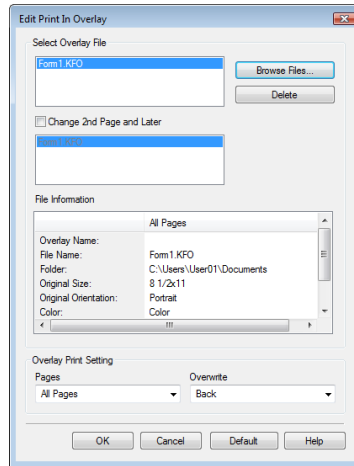

Function Name	Description
[Browse Files...]	Click this button to load the overlay file.
[Delete]	Click this button to delete the selected overlay.
[Change 2nd Page and Later]	Select this check box to change the overlay files of the 2nd and subsequent pages.
[File Information]	Displays the information of the selected overlay.
[Pages]	Specify the pages to be printed.
[Overwrite]	Specify the sequence for printing the overlay on top of the original.

When [Print Device Image] is selected:

You can specify the overlay printing conditions by specifying the overlay registered in the machine.

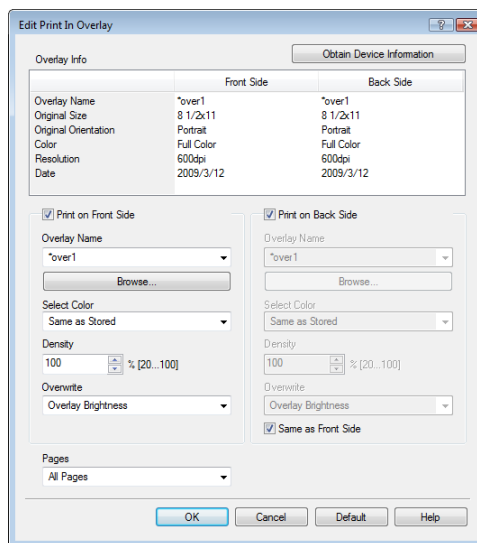

Function Name	Description
[Obtain Device Information]	Select this option to communicate with the machine to read the overlay settings configured on the machine.

Function Name	Description
[Overlay Info]	Displays the information of the selected overlay.
[Print on Front Side]/[Print on Back Side]	Select the check box to specify whether printing is done or not for each of the front side/back side.
[Overlay Name]	Select the overlay name registered in the machine.
[Browse...]	Click this button to display the detailed information of the selected overlay.
[Select Color]	Select the overlay printing color.
[Density]	Select the overlay printing density.
[Overwrite]	Specify the sequence for printing the overlay on top of the original.
[Same as Front Side]	Clear this check box to specify the same value for both the front and back sides.
[Pages]	Specify the pages to be printed.

Reference

- [Print Device Image] of the [Overlay] function is available only for the PCL driver.
- The function of [Acquire Device Information] is available only when your computer is connected to and can communicate with the machine. To use [Acquire Device Information], in [Administrator Settings] of this machine, set [System Connection] - [OpenAPI Settings] - [Authentication] to [OFF]. For details, refer to page 13-57.

Editing the copy security

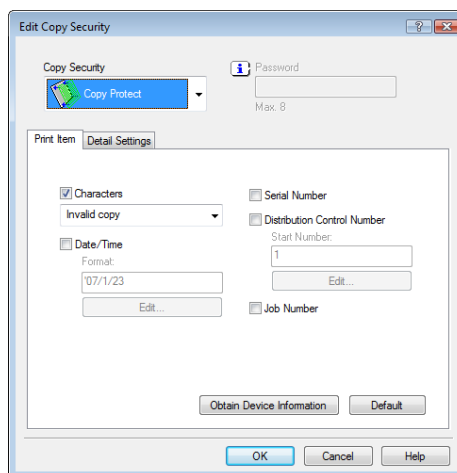

Function Name	Description
[Copy Security]	Select a function to prevent unauthorized copying. [Copy Protect]: Composes the specified text in the background before printing data. Copy Protect text is not highly visible when printing, but the text is highlighted when a document is copied illegally. [Repeatable Stamp]: Composes the specified text before printing data. This stamp is distinguishable even during printing. [Copy Guard]: Composes Copy Guard patterns before printing data. If a document is copied illegally on the machine that supports this function, the composed pattern is scanned, and the copying process is cancelled. [Password Copy]: Composes Password Copy patterns before printing data. If a document is copied illegally on the machine that supports this function, the composed pattern is scanned, and you are prompted to enter the password. To copy a document, enter the specified password when printing.
[Password]	Enter the password for [Password Copy].

Function Name	Description
[Characters]	Select this check box to embed the selected character string in a pattern. A preregistered character string (common stamp) or a character string registered in the machine (registered stamp) can be specified.
[Date/Time]	Select this check box to embed the selected date and time in a pattern. Click [Edit...] under [Format] to specify the display type and presence or absence of the time display.
[Serial Number]	Select this check box to embed the serial number of the machine in a pattern.
[Distribution Control Number]	Select this check box to embed the copy number in a pattern when printing multiple copies. Click [Edit...] under [Start Number] to specify the start number and number of digit to be displayed.
[Job Number]	Select this check box to embed the print job number in a pattern for documents that are automatically paginated.
[Obtain Device Information]	Select this option to communicate with the machine to read the copy security settings configured on the machine.

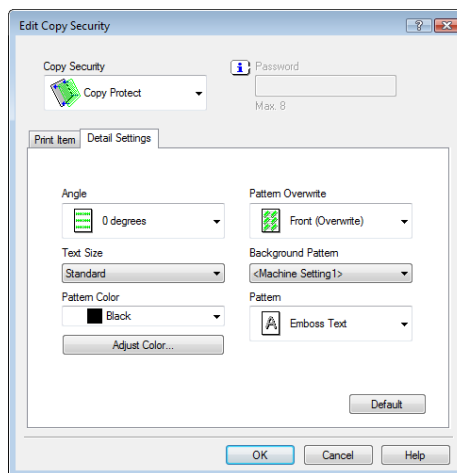

Function Name	Description
[Angle]	Specify the pattern angle.
[Text Size]	Specify the text size of a pattern.
[Pattern Color]	Specify the color of the pattern. Click [Adjust Color] to specify the density and color contrast.
[Pattern Overwrite]	Specify the sequence for printing a pattern on top of the original.
[Background Pattern]	Specify the background pattern.
[Pattern]	Specify the embedding method of a pattern.

Reference

- The function of [Acquire Device Information] is available only when your computer is connected to and can communicate with the machine. To use [Acquire Device Information], in [Administrator Settings] of the machine, set [System Connection] - [OpenAPI Settings] - [Authentication] to [OFF]. For details, refer to page 13-57.
- Items that can be specified vary depending on the selected [Copy Security] function.

Editing date/time and page number

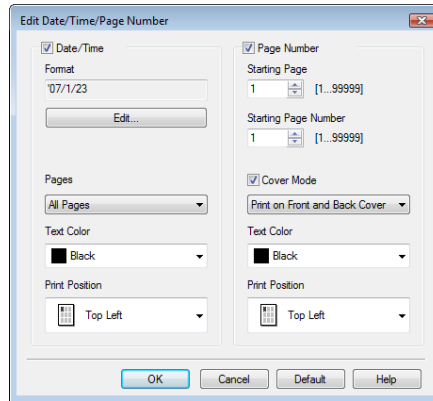

Function Name	Description
[Format]	Displays the format of the date and time to be printed. Click [Edit...] to specify the display type and presence or absence of the time display.
[Pages]	Specify the pages to print the date and time.
[Text Color]	Specify the text color used for printing.
[Print Position]	Specify the print position.
[Starting Page]	Specify the page to start printing the page number.
[Starting Page Number]	Specify the start number for printing the page number.
[Cover Mode]	Specify whether the page number is printed on the front cover page and the back cover page, when attaching the cover pages.
[Text Color]	Specify the text color used for printing.
[Print Position]	Specify the print position.

9.4.7 [Quality] tab

The functions displayed vary depending on which of the PCL/PS/XPS drivers is used.
PCL driver

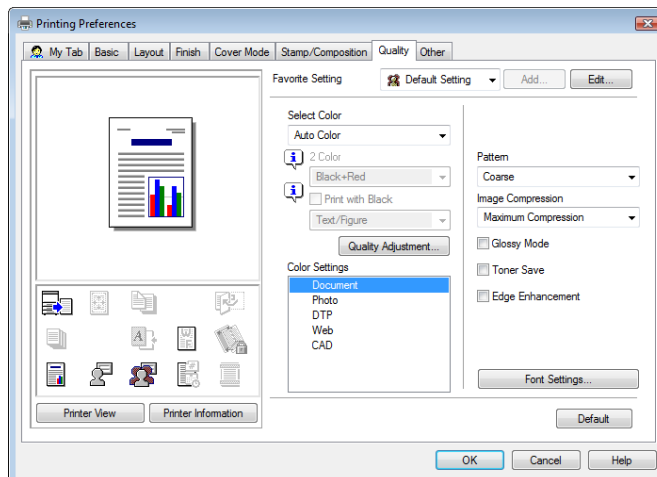

PS driver

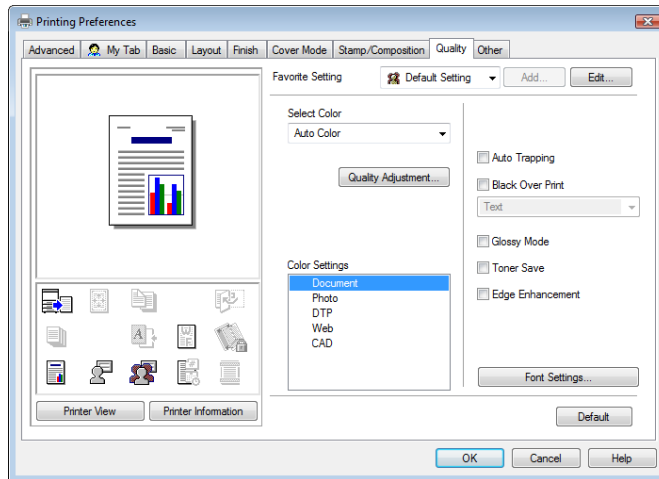

XPS driver

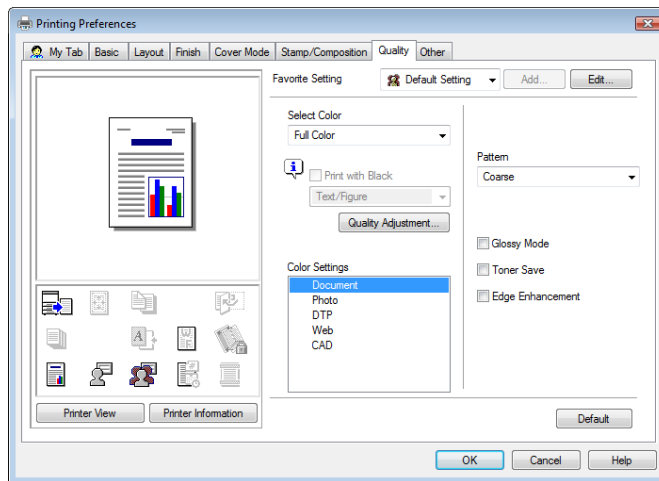

Function Name	Option	Description
[Select Color]	[Auto Color]	Select this option to identify the colors used in the print data to use them in printing.
	[Full Color]	Select this option to print in full-color processes (YMCK) regardless of the print data (color/gray scale).
	[Gray Scale]	Select this option to print in gray scale.
	[2 Color]	Select this option to print in 2 colors.
[2 Color]	[Black+Red] [Black+Green] [Black+Blue] [Black+Cyan] [Black+Magenta] [Black+Yellow]	It can be specified when you have selected [2 Color] in [Select Color]. The color area and gray scale area are printed in the specified 2 colors.
[Print with Black]	ON/OFF [Text], [Text/Figure], [All]	It can be specified when you have selected [Gray Scale] in [Select Color]. It protects the tinted characters, lines and figures from being printed lighter according to the selected conditions.
[Quality Adjust-ment...]	—	Click this button to adjust the image quality. Select [Simple] to adjust entire documents or [Detail] to adjust the text, photos, figures, tables, and graphs in each original. For PS drivers, profiles can also be managed here.

Function Name	Option	Description
[Color Settings]	[Document], [Photo], [DTP], [Web], [CAD]	Select any of the options to print with a quality suitable for the selected original. [Document]: Select this option to print with a quality suitable for documents with many characters. [Photo]: Select this option to print with a quality suitable for photos. [DTP]: Select this option to print with a quality suitable for documents produced by DTP. [Web]: Select this option to print with a quality suitable for Web page printing. [CAD]: Select this option to print with a quality suitable for CAD data printing.
[Pattern]	[Fine], [Coarse]	Specify fineness of the graphic patterns.
[Image Compression]	[Best Quality], [Maximum Compression]	Specify the compression ratio for a graphic image.
[Auto Trapping]	ON/OFF	Select this option to superimpose neighboring colors to print so as to prevent white space being generated around a picture.
[Black Over Print]	ON/OFF [Text], [Text/Figure]	Select this check box to superimpose black color on a neighboring color to print so as to prevent white space being generated around black characters or figures. You can specify to cause the overlapping on the characters alone or on characters and figures.
[Glossy Mode]	ON/OFF	Select this check box to print using a gloss finish.
[Toner Save]	ON/OFF	Select this check box to adjust the printing density in order to save the amount of toner consumed.
[Edge Enhancement]	ON/OFF	Select this check box to enhance the edges of characters, graphics and images so that thin lines and small letters become clearly visible.
[Font Settings...]	–	Select whether the fonts to be downloaded from the computer to this machine are bitmap fonts or outline fonts. Also specify whether to replace the TrueType fonts by printer fonts when printing. If garbled characters are detected while printing data using the PCL driver, set download fonts to bitmap fonts, and set printer fonts to OFF.

Reference

- The [2 Color] option of [Select Color] is available only for the PCL driver. [2 Color] allows you to specify a combination of two colors.
- The [Full Color] option of [Select Color] is available for the PS/XPS driver.
- The [Auto Color] option of [Select Color] is available for the PCL/PS driver.
- The [Print with Black] function that becomes available when you select [Gray Scale] in [Select Color] is available for the PCL/XPS drivers.
- The [Pattern] function is available for the PCL/XPS drivers.
- The [Image Compression] function is available only for the PCL driver.
- The [Auto Trapping] and [Black Over Print] functions are available only for the PS drivers.
- For the PS drivers, profile management with [Quality Adjustment] is also available. For details, refer to page 12-36 and page 12-38.
- The [Font Settings] function is available for the PCL/PS drivers.

9.4.8 [Other] tab

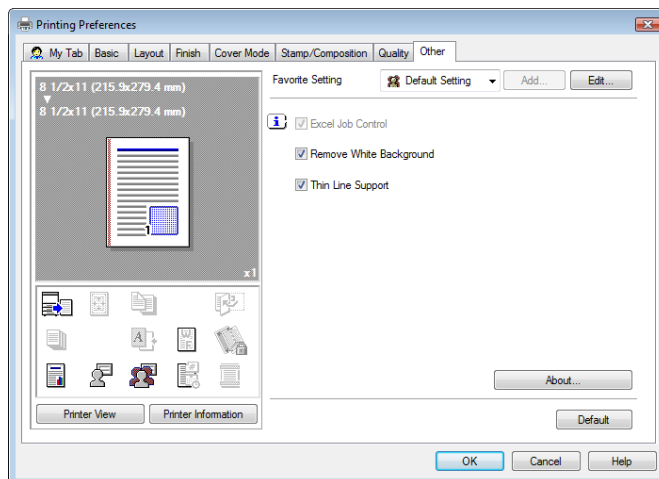

Function Name	Option	Description
[Excel Job Control]	ON/OFF	When multiple Microsoft Excel sheets with different page settings are printed at one time, the sheets may be separated into single-sheet jobs depending on the data contained. Select this check box to minimize such job separation.
[Remove White Background]	ON/OFF	When an overlay file is printed on top of Microsoft PowerPoint data, white areas are removed so that the white background of the PowerPoint data does not hide the overlay file. Clear this check box to print the original data as is without removing the background.
[Thin Line Support]	ON/OFF	When printing with reduced size, thin lines may become blurred. Select this check box to prevent the thin lines from becoming blurred.
[About...]	–	Click this button to display the printer driver version information.

Reference

- The [Remove White Background] function is available for the PCL/XPS drivers.
- The [Thin Line Support] function is available only for the PCL driver.
- The [Excel Job Control] and [Remove White Background] settings are not available in Windows XP Professional x64, Windows Vista x64, Windows Server 2003 x64, or Windows Server 2008 x64.
- You can change the [Excel Job Control] setting only when the printer driver setting dialog is displayed from the [Printers] ([Printers and Faxes] in Windows XP/Server 2003) window.

10

Print Functions of Mac OS X

10 Print Functions of Mac OS X

This chapter describes the functions of the PS printer driver for OS X.

10.1 Print operations

Print jobs are specified from the application software.

- 1 Open the data in the application, and click [File]. Then click [Print] from the menu.
 - If the menu is not available, click [Print].
 - The [Print] window appears.
- 2 Check that the desired printer name is selected in [Printer:].
 - If the target printer is not selected, select it.

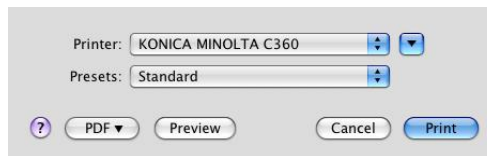

- If the printer does not appear, select the printer from [Print & Fax], [Printer Setup Utility] or [Print Center]. For details, refer to page 6-3 and page 6-10.
 - The [Print] window varies depending on the application software.
- 3 Specify the print range and the number of copies to print.
 - When the setting items are not displayed in OS X 10.5, click  on the right side of [Printer:].

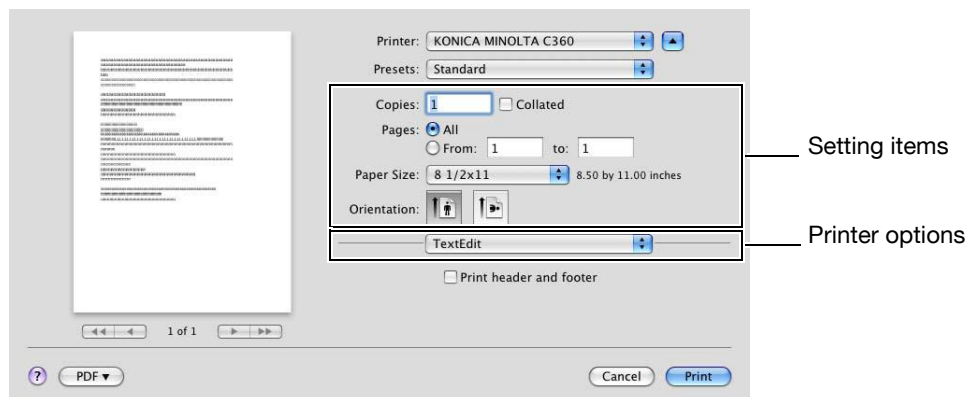

- 4 Switch the setting window as necessary to change the printer driver settings.
 - When you change the pop-up menu of the print options, another setting window of the printer driver appears, allowing you to configure various functions. For details, refer to page 10-9.
 - The printer driver settings changed in the [Print] window are not saved, and the original settings are restored when you exit the application.
- 5 Click [Print].

Printing is executed and the data indicator of the machine flashes.

 - When [Secure Print Only] is selected in [Installable Options], the [Secure Print] window appears. Go to Step 6.

- 6 Enter the [Secure Print ID:] and [Password:] of the document, and then click [OK].
Data is sent and saved in the [Secure Document User Box] of this machine.

**Reference**

For details on [Installable Options], refer to page 10-4.

For details on [Secure Print], refer to page 12-5.

10.2 Default settings of the printer driver

When you have installed the printer driver, you need to change the initialization conditions such as options and enable functions of the machine from the printer driver.

NOTICE

Any options that are installed in the machine but not configured ion the [Printer Info] tab cannot be used by the printer driver. Be sure to configure the settings for the installed options.

10.2.1 Option settings

- 1 Open the [Print & Fax] (or [Printer Setup Utility]/[Print Center]) window.
 - The [Print & Fax] window can be opened from the [System Preferences...] in the [Apple Menu] (OS X 10.4/10.5).
 - The [Printer Setup Utility]/[Print Center] window can be opened from [Macintosh HD] - [Applications] - [Utilities].
- 2 Display the [Printer Info] window.
 - For the [Print & Fax] window, click [Options & Supplies...] (OS X 10.5) or [Printer Setup...] (OS X 10.4).
 - For the [Printer Setup Utility]/[Print Center] window, select [Show Info] of the [Printers] menu.
- 3 Display the [Installable Options] window.
 - For Mac OS X 10.5, click [Driver].
 - In OS X 10.2/10.3/10.4, select [Installable Options].
- 4 Specify the installed options.

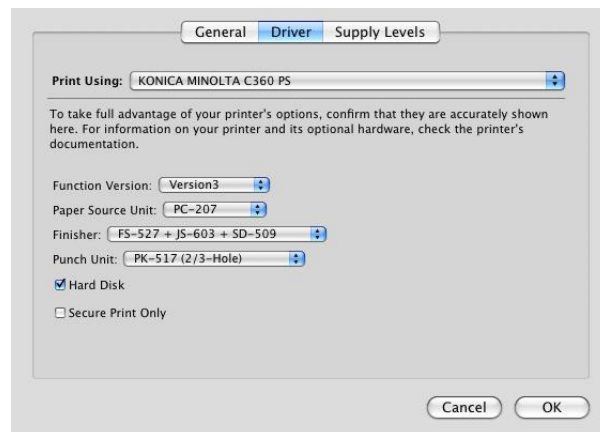

- 5 Click [OK] or [Apply Changes], and then close the [Printer Info] window.

Reference

- Be sure to select the appropriate option.
- [Function Version] supports the version of this machine. To check the version of this machine, click **Utility/Counter** in the control panel, and click [Device Information]. If [Device Information] is not displayed, the version is assumed to be "Version 2". The contents of this manual support the functions of Version 3.
- When [Secure Print Only] is selected, only the secure print jobs are allowed. For details on secure printing, refer to page 12-5.

10.2.2 Registering the default settings

The settings for the machine functions configured when printing can only be applied while using the application. When you exit the application, the settings return to their default settings.

To register the settings, save the printer driver settings. For Mac OS X, you can register the paper setting as the default setting. Settings for other print functions can be saved using the [Presets] function and used by recalling them as necessary.

Settings configured in the [Page Setup] dialog box are saved by selecting [Save As Default] in [Settings:].

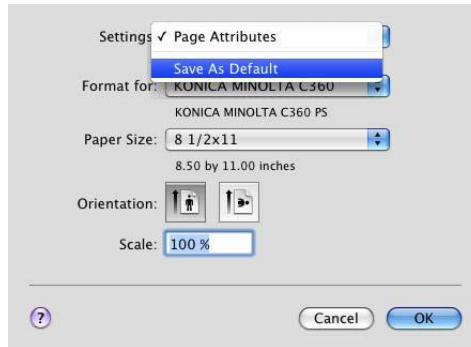

The functions of the printer driver configured in the [Print] window are saved by selecting [Save As] in [Presets:].

These settings can be used by selecting them in [Presets:].

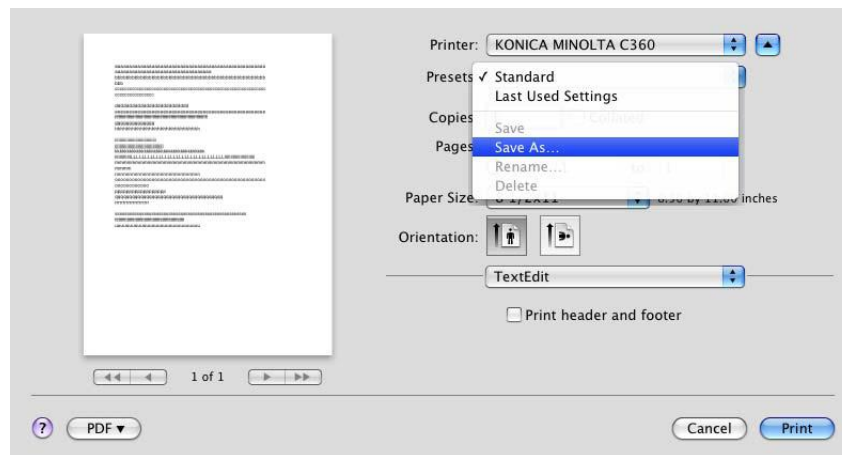

Reference

- The [Per Page Setting] list is not saved with the preset.



Reference

For details on the function and settings of the printer driver, refer to page 10-9.

10.3 Common Setting

The following describes the common settings that are displayed when you specify, in the [Print] window, the functions unique to the machine ([Output Method], [Layout / Finish], [Paper Tray / Output Tray], [Cover Mode / Transparency Interleave], [Per Page Setting], [Stamp / Composition] and [Quality]).

OS X 10.5:

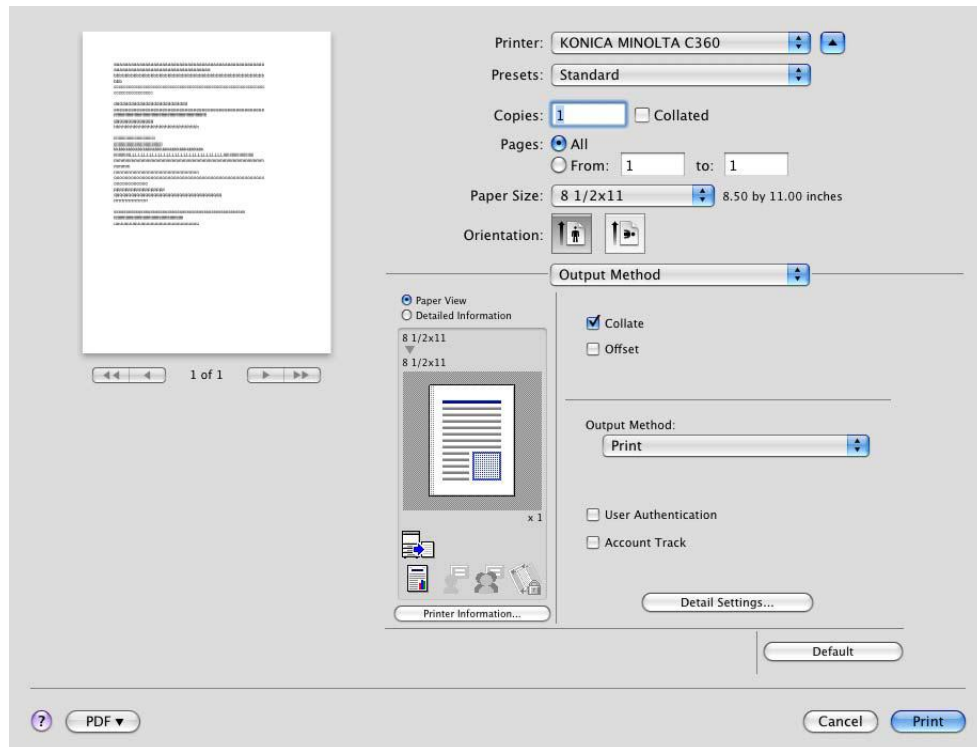

OS X 10.4:

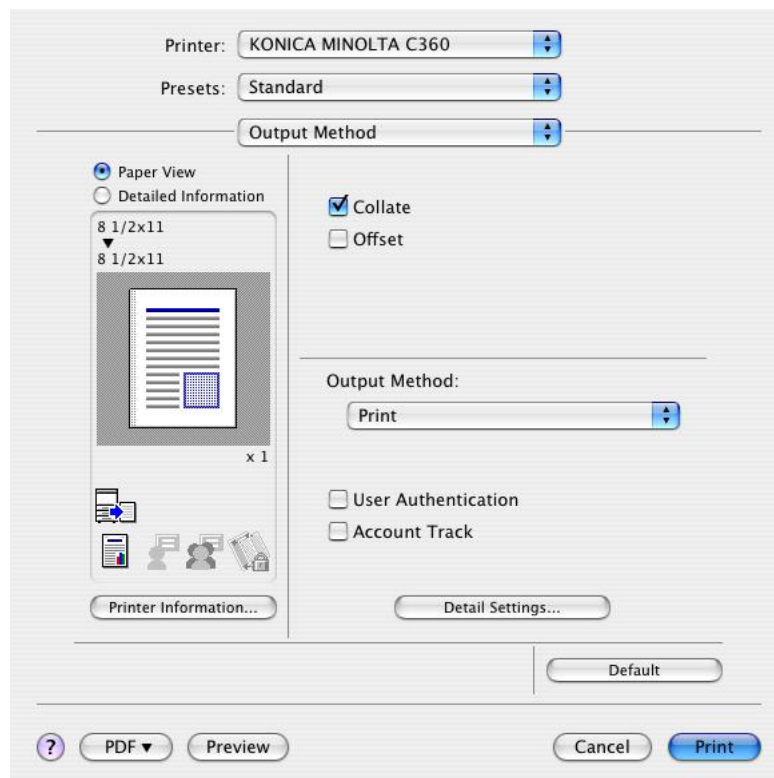

Item Name	Functions
[Paper View]	Displays the sample page layout based on current settings for checking the print result image.
[Detailed Information]	Displays the current settings in texts.
[Printer Information]	Displays the installation option status.
[Default]	Click this button to return to the default settings.
[Cancel]	Click this button to disable (cancel) changed settings and close the properties window.
[Print]	Click this button to enable changed settings for printing.

Reference

- Clicking [Acquire Device Information] in the Printer Information window communicates with the machine and load the status of the installed options. This function is available only when your computer is connected to and can communicate with the machine.

10.4 adding a custom size

To use paper of other than a standard size, register a custom paper size.

- 1 From the [File] menu, select [Page Setup].
- 2 Open the window for registering a custom size.
 - For Mac OS X 10.4/10.5, select [Manage Custom Sizes...] from the Paper Size list.
 - For Mac OS X 10.2/10.3, select [Custom Paper Size] from [Settings:].
- 3 Click [+] (OS X 10.4/10.5) or [New] (OS X 10.2/10.3).
- 4 Enter the paper size name.

Be sure to use paper size names other than existing names, such as A4 and Custom.
- 5 Configure the following items.
 - Page Size (Paper Size): Specify the paper size.
 - Printer Margins: Specify the paper margins.

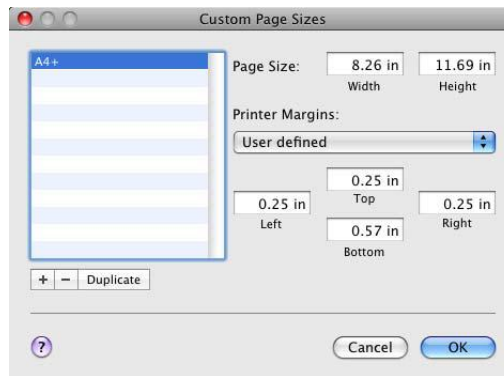

- 6 Click [OK] for OS X 10.4/10.5, or click [Save] for OS X 10.2/10.3.

This saves the custom paper size, which can be selected from the Paper Size drop-down list in [Page Attributes].

Reference

- For Mac OS X 10.5, you can also select [Manage Custom Sizes...] with [Paper Size:] in the [Print] window.

10.5 Parameter details

The printer driver functions are specified in the following windows: [Page Attributes] specified in the [Page Setup] window and [Output Method], [Layout / Finish], [Paper Tray / Output Tray], [Cover Mode / Transparency Interleave], [Per Page Setting], [Stamp / Composition] and [Quality] specified in the [Print] window.

10.5.1 [Page Attributes]

From the [File] menu, select in [Page Setup] .

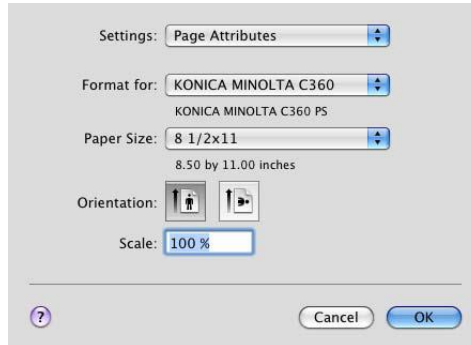

Function Name	Option	Description
[Paper Size:]	The paper sizes registered as the standard paper sizes and custom sizes that can be used with the machine	Specify the output paper size.
	Manage Custom Sizes (OS X 10.4/10.5)	
[Orientation:]	Portrait, Landscape	Select the orientation for the original.
[Scale:]	— (Varies depending on the version of OS X.)	Select an enlarge or reduce ratio.

Reference

- Paper size "12 × 18" is equivalent to 304.8 × 457.2 mm that is slightly larger than A3.
- To use paper of which the size is other than the standard sizes, specify the custom paper size. For details on registering the custom size, refer to page 10-8.
- To print data of the size corresponding to the full standard size, selecting "W" of the standard size paper for original size enables the data to be printed at the center of paper larger than the original size. For example, if you want to center and print 8-1/2 × 11 size data on 11 × 17 sized paper, create data with the "8-1/2 × 11W" size, and then, using the printer driver, set [Paper Size] to [8-1/2 × 11W] and specify the paper tray to be used as [Paper Tray].
On the machine side, set 11 × 17 size paper in the tray to be used, select the tray in [Paper] of the [Basic] screen of the control panel, and select [Change Tray Settings] - [Wide Paper] to specify [8-1/2 × 11W]. Then, confirm that [Auto Detect] is selected for [Custom Size] and 11 × 17 is displayed.
When 12-1/4 × 18 paper is loaded, you must select [12-1/4 × 18] for [Custom Size].
To print on custom sized paper, use the bypass tray, select [Change Tray Settings] - [Wide Paper] to specify [8-1/2 × 11W], and enter the desired paper size to be used for [Change Size].
- For Mac OS X 10.5, you can specify [Paper Size] and [Orientation] also from the Print window.



Reference

For details on the paper sizes loadable in the paper trays, refer to the [User's Guide Copy Operations].

10.5.2 [Copies & Pages]

From the [File] menu, select in [Print].

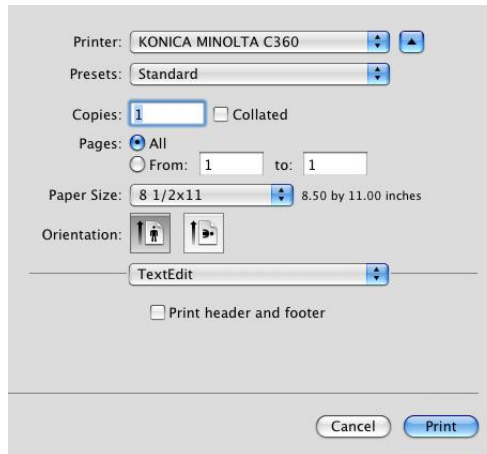

Function Name	Option	Description
[Copies:]	1 to 9999	Specify the number of copies to be printed.
[Collated]	ON/OFF	Do not specify this function. Specify this function at [Collate] in [Output Method].
[Pages:]	–	Specify the page range to print.

Reference

- For OS X 10.5, [Paper Size:] and [Orientation:] are also displayed, but the function is the same as that available from [Page Attributes].
- When the setting items are not displayed in OS X 10.5, click  on the right side of [Printer:].

10.5.3 [Output Method]

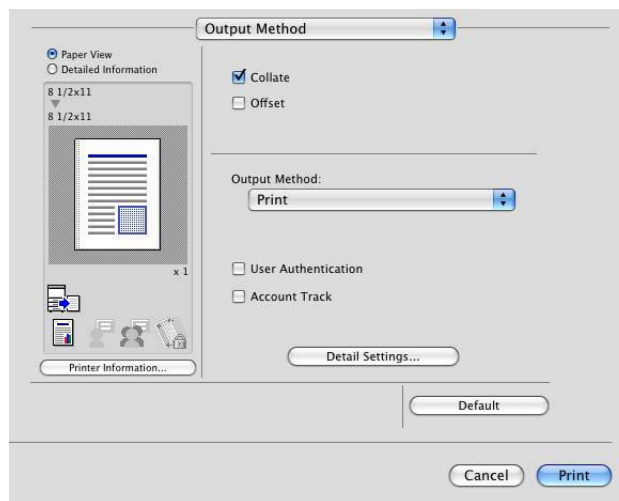

Function Name	Option	Description
[Collate]	ON/OFF	Select this check box to collate pages sequentially when printing multiple sets of copies.
[Offset]	ON/OFF	Select this check box to stagger each set when printing multiple sets of copies.

Function Name	Option	Description
[Output Method:]	[Print]	Select this option to print immediately.
	[Secure Print]	Select this option to save the document to be printed in [Secure Document User Box] of the machine. When printing, entering the ID and password is required from the control panel of the machine. Select this option when printing highly confidential documents.
	[Save in User Box]	Select this option to save the document to be printed in a User Box of the machine.
	[Save in User Box and Print]	Select this option to save the document in a User Box and print at the same time.
	[Proof Print]	After one copy of the document is printed, the machine stops printing temporarily. Select this option to avoid misprinting a large volume of print jobs.
	[ID&Print]	Select this option to save the document to be printed in [ID & Print User Box] of the machine. When printing, user authentication must be performed via the control panel of the machine.
[User Authentication]	–	Select this check box to specify the user name and password if [User Authentication] has been specified for the machine. Selecting this check box displays the setting window.
[Account Track]	–	Select this check box to specify the account name and password if [Account Track] has been specified for the machine. Selecting this check box displays the setting window.
[Detail Settings...]	–	Click this button to display the window for configuring the detail settings.



Reference

For details on each print function in [Output Method:], refer to page 12-2.

Checking the [Output Method] detail settings

Clicking [Detail Settings...] displays the [Output Method:] functions for which detail settings can be specified.

Clicking [Expand All] displays the settings.

Selecting a function and clicking [Settings...] displays the window for specifying the detail settings for the selected function.

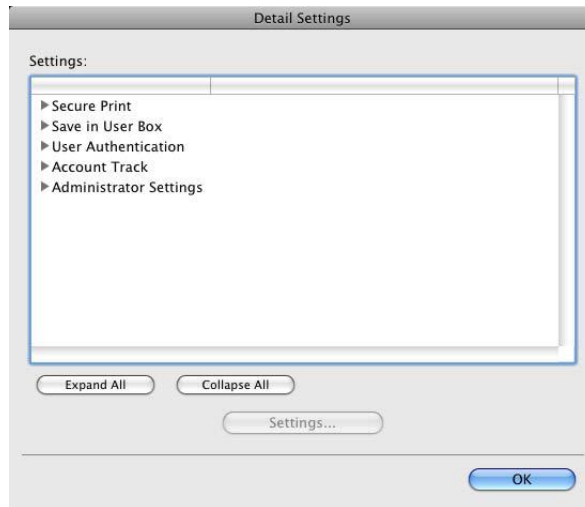

Function Name	Description
[Secure Print]	This is the same window as that appears when you specify [Secure Print] in [Output Method:].
[Save in User Box]	This is the same window as that appears when you specify [Save in User Box] or [Save in User Box and Print] in [Output Method:].
[User Authentication]	This is the same window as that appears when you select the [User Authentication] check box in [Output Method:].
[Account Track]	This is the same window as that appears when you select the [Account Track] check box in [Output Method:].
[Administrator Settings]	Select this option to display the window for changing the display settings of the User Authentication Settings window and changing the [Encryption Passphrase:].

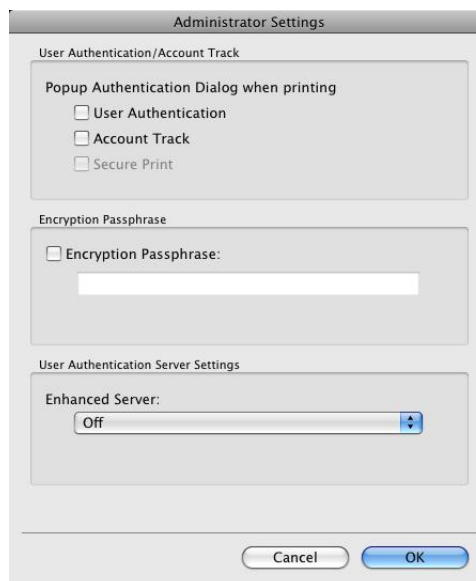

Function Name	Description
[Popup Authentication Dialog when printing]	Select this check box to display the User Authentication, Account Track or Secure Print window when specifying printing, prompting entering the user name, account name, document ID and password.
[Encryption Passphrase:]	Any string used to encrypt communication with this machine. If the encryption passphrase for the machine was changed from [Use Factory Default] to [User-Defined], enter the same encryption passphrase as for the machine. An encryption key is automatically created for the entered text, and used for communication with the machine.
[Enhanced Server:]	Set this item to [On] when the external server authentication is used.

Reference

- In [Encryption Passphrase:], enter the encryption passphrase that matches the one that configured in [Driver Password Encryption Setting] of the machine.



Reference

For details on allowing the user to specify [Encryption Passphrase:], refer to page 12-32.

10.5.4 [Layout / Finish]

The [Layout] window and the [Finish] window can be switched.

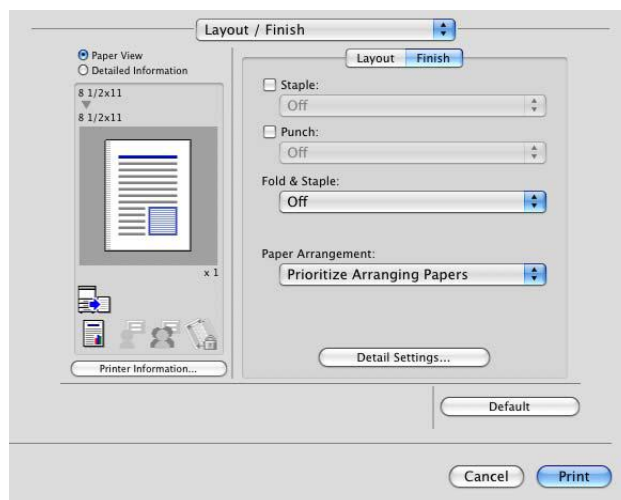
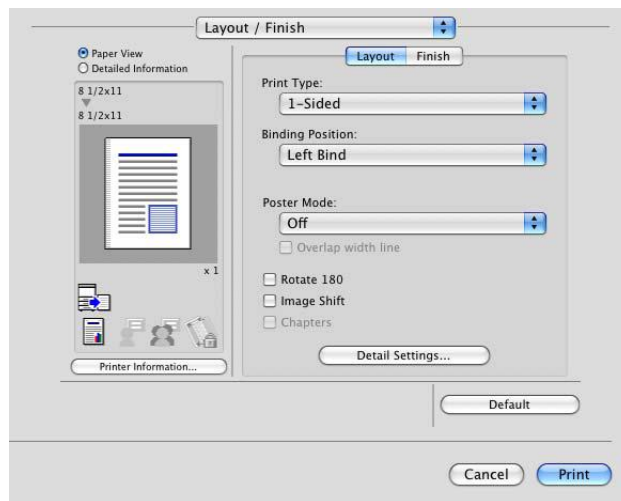

Function Name	Option	Description
[Print Type:]	[1-Sided], [2-Sided], [Booklet]	Specify 2-Sided Print or Booklet printing.
[Binding Position:]	[Left Bind], [Right Bind], [Top Bind]	Specify the binding position.
[Poster Mode:]	Off, 2 × 2, 3 × 3, 4 × 4	Select this option to print one sheet of an original divided into multiple pages. In [Overlap width line], specify the presence of the border frame. Printing documents containing pages of different sizes or orientations in one job may cause images to be partially lost or overlapped.
[Overlap width line]	ON/OFF	Specify the presence of overlap width line. It can be specified when Poster Mode is set to an option other than [Off].
[Rotate 180]	ON/OFF	Select this check box to rotate the document 180° to print.
[Image Shift]	ON/OFF	Select this check box to print by shifting the entire print image. In the window that appears when this option is selected, detailed amount of shift can be specified.
	[Front Side]/[Back Side]	Specify the shift direction and values. For 2-sided printing, clearing the [Same value for Front and Back sides] check box allows you to specify different values for the front and back sides.
[Chapters]	ON/OFF	Select this check box to specify the page to be printed on the front side. In the window that appears when this option is selected, the page can be specified. It can be specified when Print Type is [2-Sided] or [Booklet].
	[Page Number:]	Specify the pages to be printed on the front side when [Chapters] is selected.
[Staple:]	ON/OFF	Select this check box to specify stapling. From the drop-down list, specify the number of staples and the stapling position.
[Punch:]	ON/OFF	Select this check box to specify hole punching. From the drop-down list, specify the number of punches.
[Fold & Staple:]	OFF, [Center Staple and Fold], [Half-Fold]	Specify the fold and staple.
[Paper Arrangement:]	[Prioritize Arranging Papers]/[Prioritize Productivity]	Specify the method for paper arrangement (adjusting the binding position) for 2-sided printing. When [Prioritize Arranging Papers] is selected, the paper arrangement process is performed after receiving all data. When [Prioritize Productivity] is selected, the paper arrangement process is performed while receiving and printing data.

Reference

- The [Staple:] function is available only if the optional **Finisher FS-527** or **Finisher FS-529** is installed.
- The [Punch:] function is available only when the **Punch Kit** is installed on the optional **Finisher FS-527**.
- The [Fold & Staple:] function is available only when the **Saddle Stitcher** is installed on the optional **Finisher FS-527**.

10.5.5 [Paper Tray / Output Tray]

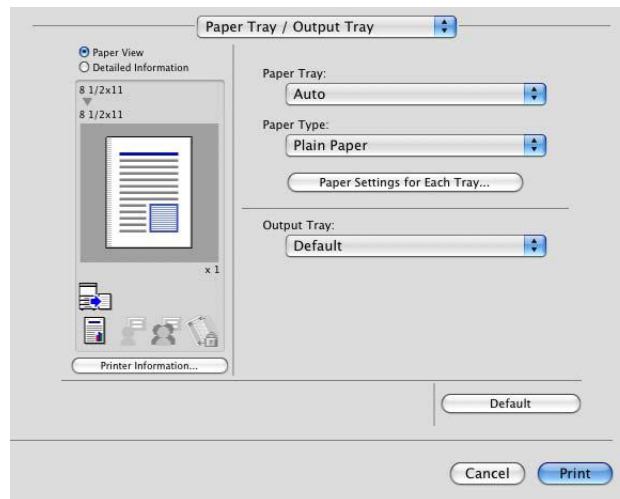

Function Name	Option	Description
[Paper Tray:]	Auto, Tray 1 to Tray 4, LCT, Bypass Tray	Select a paper tray to be used. Selectable items vary depending on the option installation status.
[Paper Type:]	Paper types available for the machine	Select a paper type to be used for printing. It can be changed only when Paper Tray is set to [Auto]. When Paper Tray is not set to [Auto], the paper types registered in [Paper Settings for Each Tray...] are available.
[Paper Settings for Each Tray...]	[Paper Tray:]	Select a paper tray to be specified. Selectable items vary depending on the option installation status.
	[Paper Type:]	Select the type of paper to be loaded onto the paper tray.
[Output Tray:]	Default, Tray 1 and Tray 3	Specify the tray to output the printed pages. Selectable items vary depending on the option installation status.

Reference

- Specify [Duplex Side 2] when printing on the back side of paper.
- [User] of Paper Type is the frequently used paper type registered on the machine side. For details on registering the user paper, refer to the [User's Guide Copy Operations].

10.5.6 [Cover Mode / Transparency Interleave]

The [Cover Mode] setting window and the [Transparency Interleave] window can be switched.

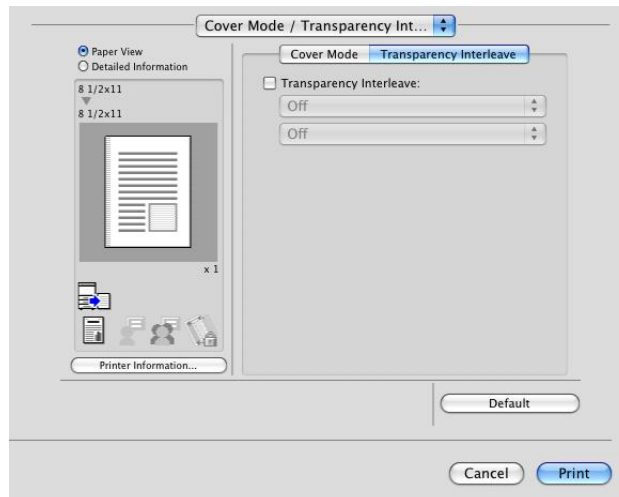
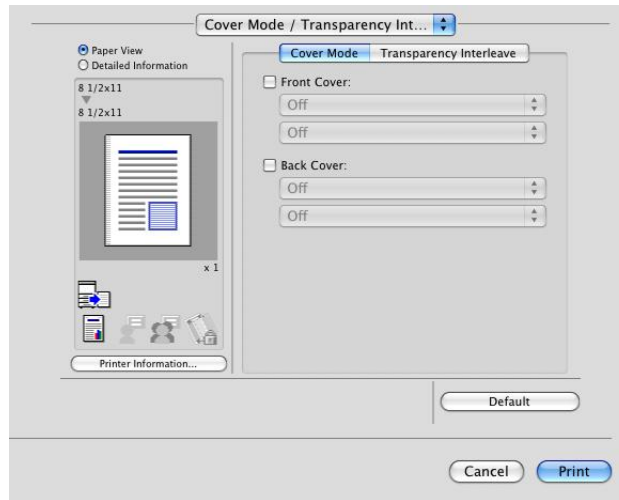

Function Name	Option	Description
[Front Cover:]	ON/OFF	Select this check box to attach a front cover page. It can be specified when any other option than [Auto] is selected for Paper Tray.
	Off, [Print], [Blank]	Select whether to print on the front cover sheet.
	Off, Tray 1 to Tray 4, LCT, Bypass Tray	Select the paper tray for the front cover sheet. Selectable items vary depending on the option installation status.
[Back Cover:]	ON/OFF	Select this check box to attach a back cover page. It can be specified when any other option than [Auto] is selected for Paper Tray.
	Off, [Print], [Blank]	Select whether to print on the back cover sheet.
	Off, Tray 1 to Tray 4, LCT, Bypass Tray	Select the paper tray for the back cover sheet. Selectable items vary depending on the option installation status.

Function Name	Option	Description
[Transparency Interleave:]	ON/OFF	Select this check box to insert interleaves when printing transparencies. It can be specified when [Transparency] is selected for Paper Type.
	Off, [Blank]	It is specified so that the transparency interleave is output in blank (this setting cannot be changed).
	Off, Tray 1 to Tray 4, LCT	Select the paper tray for the transparency interleaves. Selectable items vary depending on the option installation status.

10.5.7 [Per Page Setting]

The print type and paper tray can be specified for each page. This function is convenient if you want to change the paper tray while printing multiple pages. The settings can be registered in the list and used as necessary.

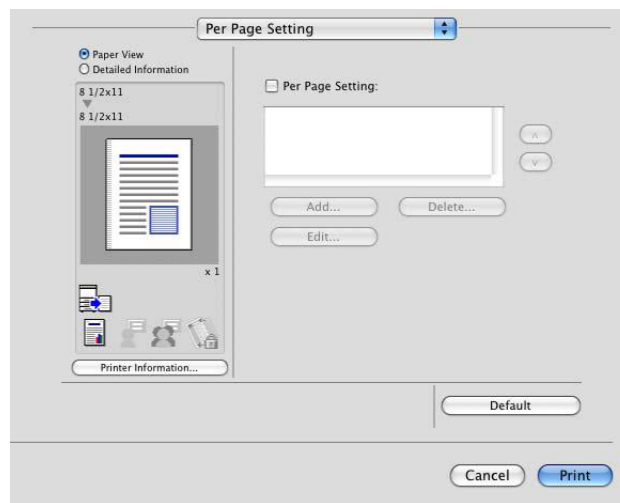

Function Name	Option	Description
[Per Page Setting:]	ON/OFF	Select this check box to insert paper between pages and switch the paper and tray for each page.
[Add...]	–	Click this button to display the [Per Page Setting] dialog box to create a list specifying conditions.
[Delete...]	–	Click this button to delete the list.
[Edit...]	–	Click this button to display the [Per Page Setting] dialog box to edit a list specifying conditions.

Editing Per Page Setting

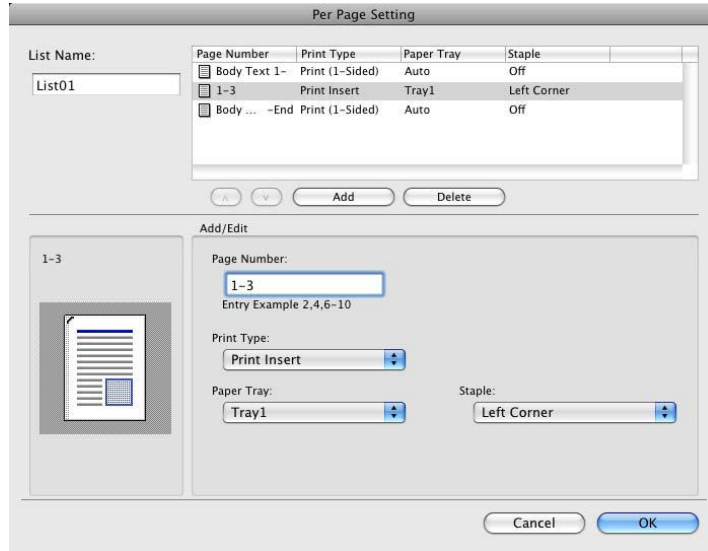

Function Name	Description
[List Name:]	Enter the name of the list.
[Add]	Add a condition to the list.
[Delete]	Delete a condition from the list.
[▲][▼]	Sort the selected condition rows according to page number.
[Page Number:]	Enter the page number of the selected condition row. Specify the page numbers using a numerical value. To specify multiple pages, separate each page number with a comma (for example, "2,4,6") or specify the range using a hyphen (for example, "6-10").
[Print Type:]	Select Print or Blank and 2-Sided or 1-Sided printing for the selected condition row.
[Paper Tray:]	Specify the paper tray used to print the selected condition row.
[Staple:]	Specify the number of staples and the stapling position for the selected condition row.

10.5.8 [Stamp / Composition]

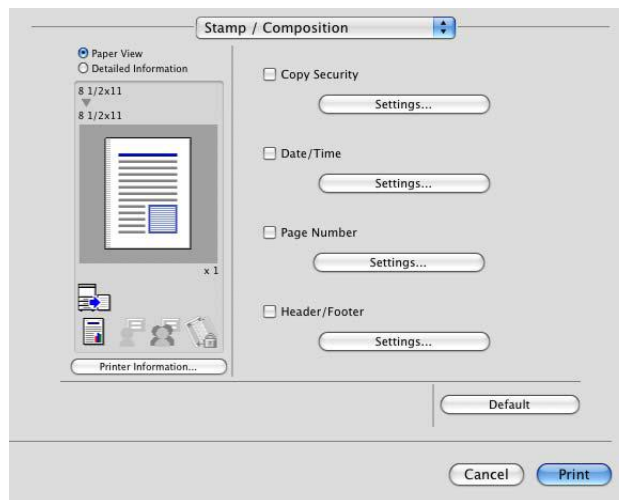

Function Name	Option	Description
[Copy Security]	ON/OFF	Specify the special pattern or password to prevent copying. Click [Settings...] to specify items to be printed, positions, composition method and password.
[Settings...]	–	For details, refer to page 10-19.
[Date/Time]	ON/OFF	Select this check box to print the date and time. Click [Settings...] to specify items and pages to be printed and positions.
[Settings...]	–	For details, refer to page 10-21.
[Page Number]	ON/OFF	Select this check box to print page number. Click [Settings...] to specify items and pages to be printed and positions.
[Settings...]	–	For details, refer to page 10-21.
[Header/Footer]	ON/OFF	Select this check box to print the header and footer. Select the header/footer from the list specified in the main unit. Click [Settings...] to specify items and pages to be printed.
[Settings...]	–	For details, refer to page 10-22.

Editing the copy security



Function Name	Description
[Copy Security:]	Select a function to prevent unauthorized copying. [Copy Protect]: Composes the specified text in the background before printing data. Copy Protect text is not highly visible when printing, but the text is highlighted when a document is copied illegally. [Repeatable Stamp]: Composes the specified text before printing data. This stamp is distinguishable even during printing. [Copy Guard]: Composes Copy Guard patterns before printing data. If a document is copied illegally on the machine that supports this function, the composed pattern is scanned, and the copying process is cancelled. [Password Copy]: Composes Password Copy patterns before printing data. If a document is copied illegally on the machine that supports this function, the composed pattern is scanned, and you are prompted to enter the password. To copy a document, enter the specified password when printing.
[Password:]	Enter the password for [Password Copy].

Function Name	Description
[Characters:]	Select this check box to embed the selected character string in a pattern. A preregistered character string (common stamp) or a character string registered in the machine (registered stamp) can be specified.
[Date/Time:]	Select this check box to embed the selected date and time in a pattern. Selecting from the drop-down list allows you to specify the display type and presence or absence of the time display.
[Serial Number]	Select this check box to embed the serial number of the machine in a pattern.
[Distribution Control Number:]	Select this check box to embed the copy number in a pattern when printing multiple copies. The start number or number of digits can be specified.
[Job Number]	Select this check box to embed the print job number in a pattern for documents that are automatically paginated.

Reference

- [Copy Guard] and [Password Copy] are available when [Password Copy] and [Copy Guard] are set to [Yes] in [Administrator Settings]-[Security Settings]-[Security Details] under this machine while the optional **Security Kit SC-507** is installed. For details, refer to the User's Guide [Copy Operations].



Function Name	Description
[Text Size:]	Specify the text size of a pattern.
[Angle:]	Specify the pattern angle.
[Pattern:]	Specify the embedding method of a pattern.
[Pattern Overwrite:]	Specify the sequence for printing a pattern on top of the original.
[Background Pattern:]	Specify the background pattern.
[Adjust Color...]	Specify the color of the pattern.

Reference

- Items that can be specified vary depending on the selected [Copy Security] function.

Editing Date/Time

Function Name	Description
[Format:]	Displays the format of the date and time to be printed.
[Pages:]	Specify the pages to print the date and time.
[Text Color:]	Specify the text color used for printing.
[Print Position:]	Specify the print position.

Editing Page Number

Function Name	Description
[Starting Page:]	Specify the page to start printing the page number.
[Starting Page Number:]	Specify the start number for printing the page number.
[Cover Mode:]	Specify whether the page number is printed on the front cover page and the back cover page, when attaching the cover pages.
[Text Color:]	Specify the text color used for printing.
[Print Position:]	Specify the print position.

Editing Header/Footer

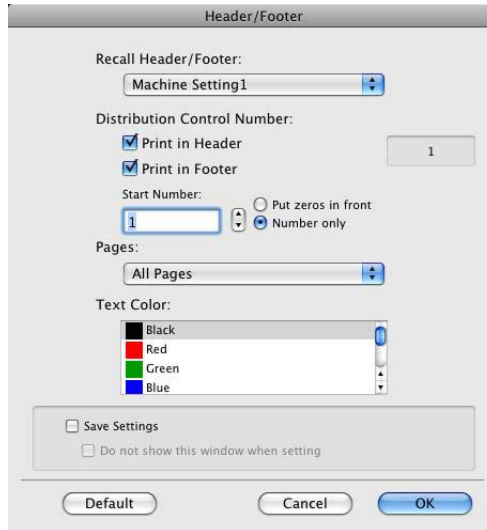

Function Name	Description
[Recall Header/Footer:]	Select the header/footer setting registered in the machine.
[Distribution Control Number:]	When printing multiple copies, this function prints the number of copies in the header/footer. The start number or number of digits can be specified.
[Pages:]	Specify the pages to print the header/footer.
[Text Color:]	Specify the text color used for printing.

10.5.9 [Quality]

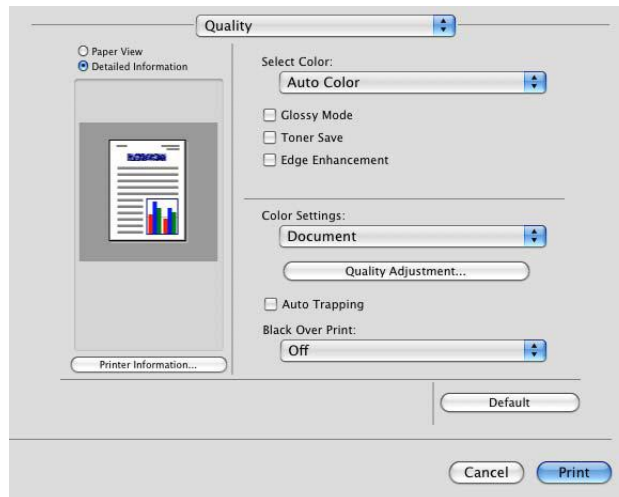

Function Name	Option	Description
[Select Color:]	[Auto Color], [Full Color], [Gray Scale]	Specify the color to be printed. [Auto Color]: Select this option to identify the colors used in the print data to use them in printing. [Full Color]: Select this option to print in full-color processes (CMYK) regardless of the print data (color/gray scale). [Gray Scale]: Select this option to print in gray scale.
[Glossy Mode]	ON/OFF	Select this check box to print using a gloss finish.
[Toner Save]	ON/OFF	Select this check box to adjust the printing density in order to save the amount of toner consumed.

Function Name	Option	Description
[Edge Enhancement]	ON/OFF	Select this check box to enhance the edges of characters, graphics and images so that thin lines and small letters become clearly visible.
[Color Settings:]	[Document], [Photo], [DTP], [Web], [CAD]	Select any of the options to print with a quality suitable for the selected original. [Document]: Select this option to print with a quality suitable for documents with many characters. [Photo]: Select this option to print with a quality suitable for photos. [DTP]: Select this option to print with a quality suitable for documents produced by DTP. [Web]: Select this option to print with a quality suitable for Web page printing. [CAD]: Select this option to print with a quality suitable for CAD data printing.
[Quality Adjustment...]	–	Click this button to adjust the image quality. Adjust the text, photos, figures, tables, and graphs in each original. Profiles can also be managed here.
[Auto Trapping]	ON/OFF	Select this option to superimpose neighboring colors to print so as to prevent white space being generated around a picture.
[Black Over Print:]	Off, [Text], [Text/Figure]	Select this check box to superimpose black color on a neighboring color to print so as to prevent white space being generated around black characters or figures. You can specify to cause the overlapping on the characters alone or on characters and figures.



Reference

For details on managing the profile, refer to page 12-36 and page 12-38.



Print Functions of Mac OS 9.2

11 Print Functions of Mac OS 9.2

This chapter describes the functions of the printer driver for OS 9.2.

11.1 Print operations

Print jobs are specified from the application software.

- 1 Open the data in the application, and click [File]. Then click [Print] from the menu.
 - If the menu is not available, click [Print].
 - The [Print] window appears.
- 2 Check that the desired printer name is selected in [Printer:].
 - If the target printer is not selected, select it.
 - If the printer does not appear, select the printer from [Chooser]. For details, refer to page 6-16.
 - The [Print] window varies depending on the application software.

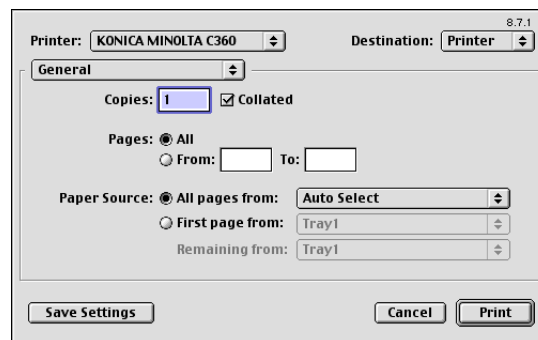

- 3 Specify the print range and the number of copies to print.
- 4 Switch the setting window as necessary to change the printer driver settings.
 - When you change the menu of [General], another setting window of the printer driver appears, allowing you to configure various functions. For details, refer to page 11-5.
 - The printer driver settings changed in the [Print] window are not saved, and the original settings are restored when you exit the application.
- 5 Click [Print].

Printing is executed and the data indicator of the machine flashes.

11.2 Default settings of the printer driver

When you have installed the printer driver, you need to change the initialization conditions such as options and enable functions of the machine from the printer driver.

NOTICE

Any options that are installed in the machine but not configured cannot be used by the printer driver. Be sure to configure the settings for the installed options.

11.2.1 Option settings

- 1 In the [Apple Menu] menu, select [Chooser].
- 2 Select the printer name.
- 3 Click [Setup...].
- 4 Click [Configure].

The option setting window appears.

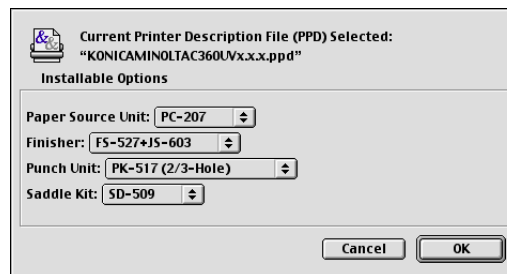

→ When the printer is specified as the LPR printer, double-click the LPR printer icon on the desktop, click [Change Setup...] in the [Printer] menu to display the option setting window.

- 5 Specify the options installed in the machine.
- 6 Click [OK].
The [Chooser] window appears again.
- 7 Close the [Chooser] window.



Reference

The option settings are displayed automatically when the printer driver is selected for the first time. For details, refer to page 6-16.

11.2.2 Registering the default settings

The settings for the machine functions configured when printing can only be applied while using the application. When you exit the application, the settings return to their default settings.

To register the settings, save the printer driver settings. For OS 9.2, click [Save Settings] in the [Print] window to save the settings.

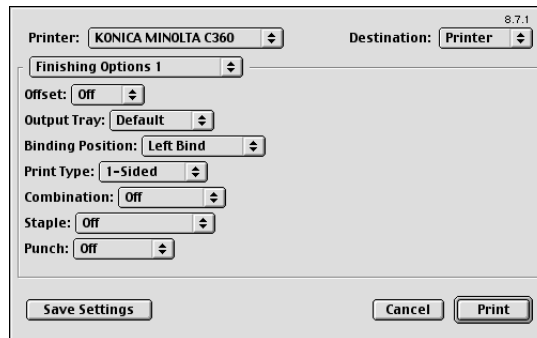

Reference

For details on the function and settings of the printer driver, refer to page 11-5.

Reference

- The settings in the [Page Setup] dialog box cannot be saved.

11.3 Parameter details

The printer driver function settings can be configured in [Page Attributes] in the [Page Setup] dialog box or [Layout] or [Finishing Options] in the [Print] window.

11.3.1 Page Attributes

From the [File] menu, select in [Page Setup].

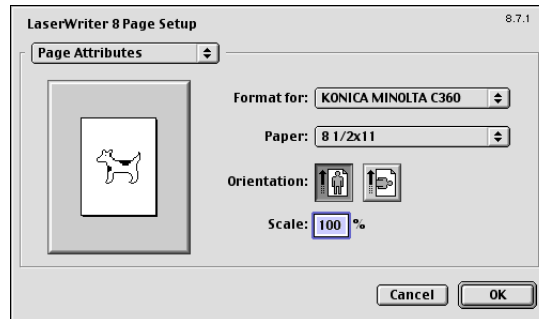

Function Name	Description
[Paper:]	Specify the output paper size.
[Orientation:]	Select the orientation for the original.
[Scale:]	Select an enlarge or reduce ratio.

Reference

- To use paper of which the size is other than the standard sizes, specify the custom paper size. For details on registering the custom size, refer to page 11-5.

11.3.2 Specifying the custom page sizes

Select [Custom Page Sizes] in the [Page Setup] dialog box.

- From the [File] menu, select [Page Setup].
- Select [Custom Page Sizes].
- Click [New].
- Configure the following items.

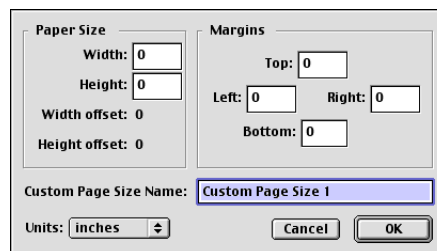

Function Name	Description
[Paper Size]	Specify the desired paper size.
[Margins]	Specify the paper margins.
[Custom Page Size Name]	Enter the registered name for the specified paper size or margins, and then click [OK].
[Units:]	Select the unit to specify the margins.

5 Click [OK].

This saves the custom page settings, which can be selected from the Paper drop-down list in [Page Attributes].

11.3.3 General

From the [File] menu, select in [Print].

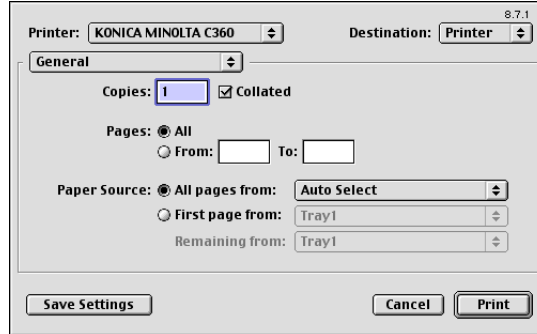

Function Name	Description
[Copies:]	Specify the number of copies to be printed.
[Collated]	Select this check box to collate pages sequentially when printing multiple sets of copies.
[Pages:]	Specify the page range to print.
[Paper Source]	Select the paper tray and paper type to be used.

11.3.4 [Layout] (Combination)

Specify this item to print multiple pages on one page.

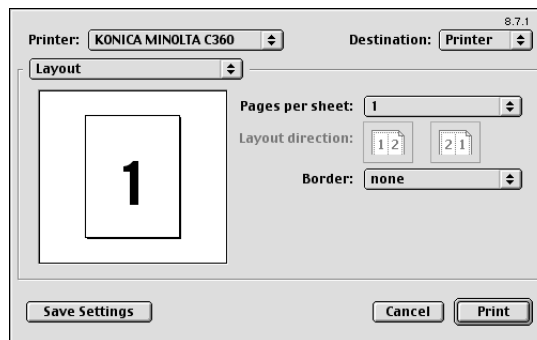

Function Name	Description
[Pages per sheet:]	Multiple pages can be combined on a single page.
[Layout direction]	Specify the page combination order.
[Border:]	Specify the borders between pages.

11.3.5 Printer specific options (Finishing Option 1 to 5)

Specify the printer specific options. These options can be specified when functions of the machine such as stapling and punching are to be used.

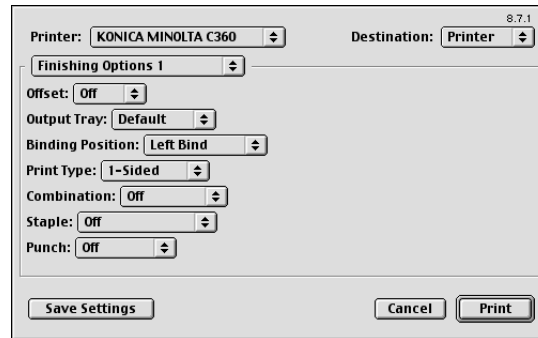

Function Name	Description
[Offset:]	Specify offset.
[Output Tray:]	Select the output tray.
[Binding Position:]	Specify the binding position.
[Print Type:]	Perform 2-sided printing.
[Combination:]	Perform booklet printing.
[Staple:]	Perform stapling.
[Punch:]	Perform hole punching.
[Fold]	Perform folding.
[Front Cover:]	Select this option to attach a front cover page.
[Front Cover Tray:]	Select the paper tray for the front cover sheet.
[Back Cover:]	Select this option to attach a back cover page.
[Back Cover Tray:]	Select the paper tray for the back cover sheet.
[Transparency Interleave:]	Select the option to insert interleaves between transparencies.
[Interleave Tray:]	Select the paper tray for the transparency interleaves.
[Output Method:]	Specify the [Proof Print] function that pauses the printing after one copy of the document is output so that you can check how it is printed.
[Select Color:]	Select whether to print in color or gray scale.
[Glossy Mode:]	Select this check box to print using a gloss finish.
[Color Settings:]	Select any of the options to print with a quality suitable for the original.
[Auto Trapping:]	Select this option to superimpose neighboring colors to print so as to prevent white space being generated around a picture.
[Black Over Print:]	Select this check box to superimpose black color on a neighboring color to print so as to prevent white space being generated around black characters or figures. You can specify to cause the overlapping on the characters alone or on characters and figures.
[Color Matching (Text):]	Select this option to adjust the color quality of the text in the original.
[Pure Black (Text):]	Select whether to use (ON/OFF) the Pure Black function for the texts in the original.
[Screen (Text):]	Select whether to use screening for the texts in the original.
[Color Matching (Photo):]	Select this option to adjust the color quality of the photos in the original.
[Pure Black (Photo):]	Select whether to use (ON/OFF) the Pure Black function for the photos in the original.
[Screen (Photo):]	Select whether to use screening for the photos in the original.
[Smoothing (Photo):]	Select whether to use smoothing for the photos in the original.

Function Name	Description
[Color Matching (Graphic):]	Select this option to adjust the color quality of the figures, tables, or graphs in the original.
[Pure Black (Graphic):]	Select whether to use (ON/OFF) the Pure Black function for the figures, tables, or graphs in the original.
[Screen (Graphic):]	Select whether to use screening for the figures, tables, or graphs in the original.
[Smoothing (Graphic):]	Select whether to use smoothing for the figures, table, or graphs in the original.
[Toner Save:]	Select this check box to adjust the printing density in order to save the amount of toner consumed.
[Edge Enhancement:]	Select this check box to enhance the edges of characters, graphics and images so that thin lines and small letters become clearly visible.

Reference

- The [Staple:] function is available only if the optional **Finisher FS-527** or **Finisher FS-529** is installed.
- The [Punch:] function is available only when the **Punch Kit** is installed on the optional **Finisher FS-527**.
- The [Fold:] function is available only when the **Saddle Stitcher** is installed on the optional **Finisher FS-527**.

12

Function Details

12 Function Details

This chapter describes the functions that require special attention, for example, when combining the printer driver and panel operation of the machine.

12.1 Proof Print

The Proof Print function is a feature used when printing out multiple copies. It allows the printer to output one copy and pause the printing operation before printing the remaining number of copies. Because this function allows confirming the printed result before outputting the remaining copies, it is helpful in preventing misprinting when producing a large number of copies.

The Proof Print function can be specified using the printer driver when printing, and printing of the remaining number of copies can be performed from the control panel.

12.1.1 Setting the printer driver

The following five printer drivers support this feature.

- KONICA MINOLTA PCL Printer Driver for Windows (PCL driver)
- KONICA MINOLTA PostScript Printer Driver for Windows (PS driver)
- KONICA MINOLTA XPS Printer Driver for Windows (XPS driver)
- KONICA MINOLTA PostScript PPD Printer Driver for Mac OS X
- KONICA MINOLTA PostScript PPD Printer Driver for Mac OS 9.2

Perform printing with the following settings specified.

- Output Method: [Proof Copy]
- Number of Copies: Multiple sets

For Windows

- 1 Click to display the [Basic] tab.
- 2 Select [Proof Copy] in [Output Method].

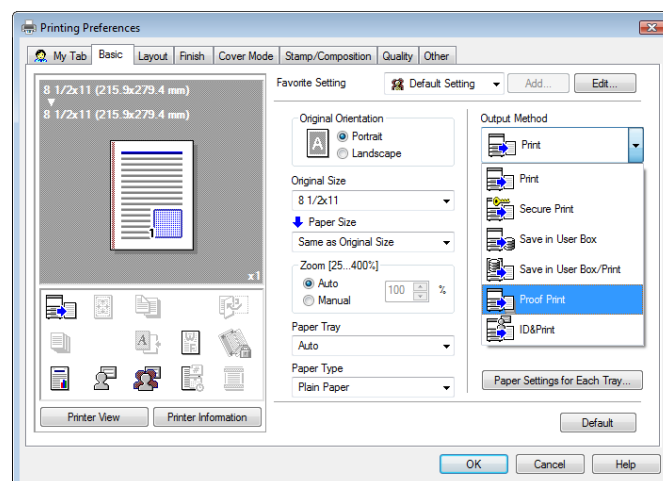

- 3 Specify the desired number of copies and print.
One copy is printed for checking.

For Mac OS X

- 1 Display the [Output Method] window.
- 2 Select [Proof Print] in [Output Method:].

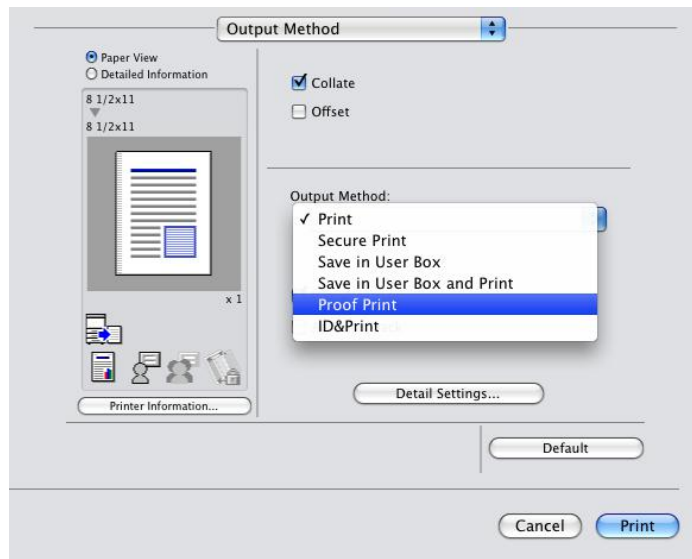

- 3 Specify the desired number of copies and print.
One copy is printed for checking.
→ In OS 9.2, the proof printing can be selected at [Output Method:] in [Finishing Options 3] screen.

12.1.2 Recalling a job from the control panel

Reference

- For details on the functions of the keys on the control panel, refer to the [User's Guide Copy Operations].

- 1 Press [Job List] on the control panel, and then press [Job Details].

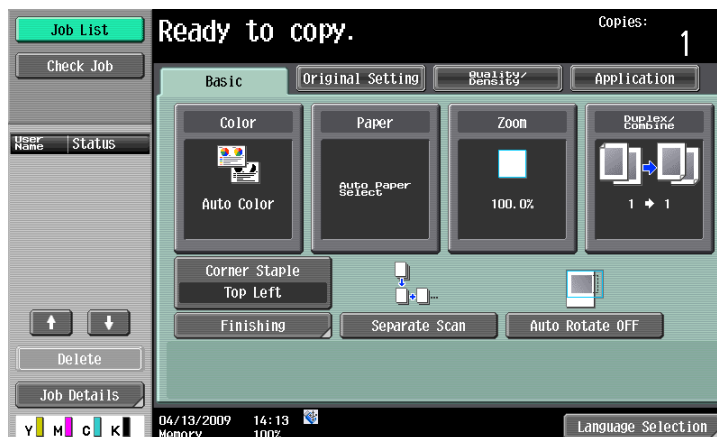

The Print window appears.

- 2 While [Current Jobs] is displayed, press [Release Held Job].

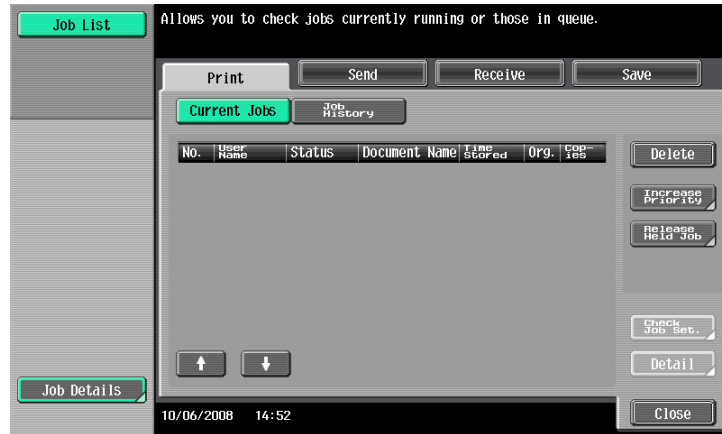

The [Release Held Job] screen appears.

- 3 From the job list, select the job you want to print.
- To print the remaining number of copies, continue with Step 6.
 - To change the printing conditions, continue with Step 4.

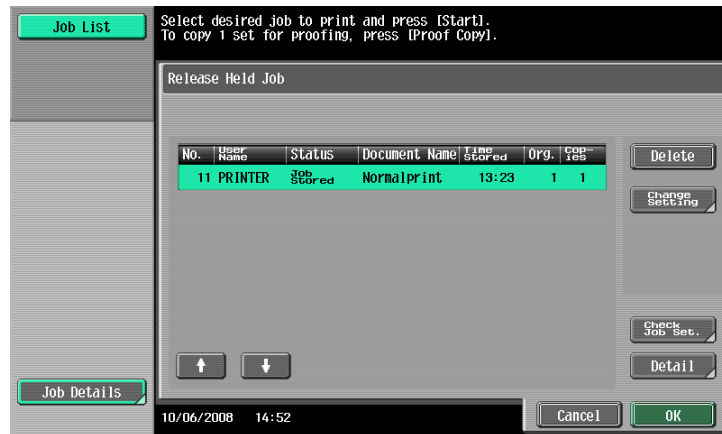

→ If the job you want to release is not displayed, press [↑] or [↓] until the desired job is displayed. If an incorrect job was selected, touch the button for the selected job again to deselect it.

- 4 Press [Change Setting].

The [Change Setting] screen appears.

→ To check the results of setting changes, select the job whose sample copy is to be printed from the job list, and then press the **Proof Copy** key on the control panel. One copy is printed for checking. After performing the **Proof Copy** key, the original settings are restored. Configure the settings again as necessary.

- 5 Change the printing conditions in the [Change Setting] screen, and then press [OK].

The [Release Held Job] screen appears again.

→ To cancel releasing the held job, press [Cancel].

- 6 Press [OK] or the **Start** key in the control panel.

The stored job is changed to an active job, and then printed.

12.2 Secure Print

The Secure Print function saves print jobs in the Secure Print User Box of the machine. Because the job is output only by entering the ID and password from the control panel, it is helpful for outputting highly confidential documents.

The Secure Print function can be specified using the printer driver when printing, and printing can be performed from the control panel.

In order to prevent information leakage, you can restrict the printings done on this machine only to the secure printing.

Reference

For details on the function to limit to the secure printing only on the machine, refer to page 13-59.

For details on the printer driver settings for Windows, refer to page 9-4, and for Mac OS X, refer to page 10-4.

Reference

- When the secure printing is frequently used, it will be helpful to configure [Custom Display Settings] - [User Box Settings] of the machine so that [Secure Document User Box] always appears on the screen. For details, refer to the [User's Guide Box Operations].

12.2.1 Setting the printer driver

The following four printer drivers support this feature.

- KONICA MINOLTA PCL Printer Driver for Windows (PCL driver)
- KONICA MINOLTA PostScript Printer Driver for Windows (PS driver)
- KONICA MINOLTA XPS Printer Driver for Windows (XPS driver)
- KONICA MINOLTA PostScript PPD Printer Driver for Mac OS X

Perform printing with the following settings specified.

- Output Method: [Secure Print]

For Windows

- 1 Click to display the [Basic] tab.
- 2 Select [Secure Print] in [Output Method].

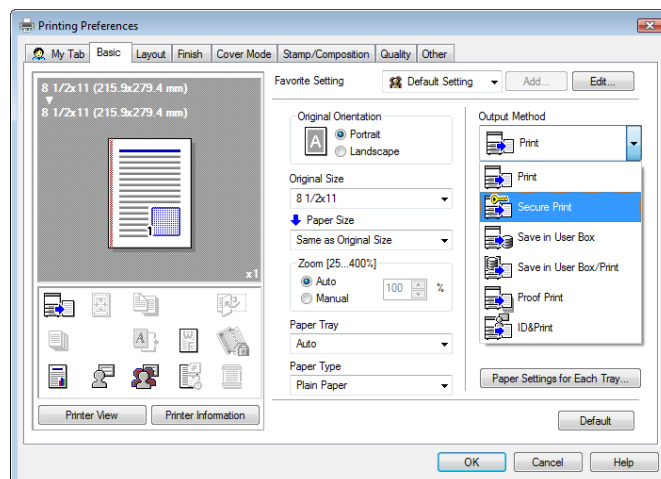

- 3 Enter the [Secure Print ID] and [Password].

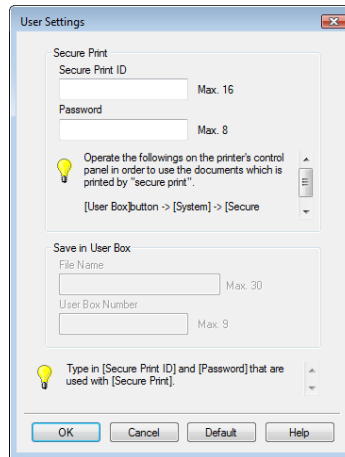

- When [Password Rules] is enabled on the machine, the passwords that can be used for secure printing are limited. If a password that does not comply with the password rules is entered, the job is deleted. For details on the [Password Rules], refer to the [User's Guide Copy Operations].

- 4 Print the document.

- The ID and password required for secure printing can be registered in advance on [User Settings...] of the [Basic] tab. To use the same ID and password whenever you print, register them in advance so that the screen to prompt entering the ID and password does not appear when you select [Secure Print].

For Mac OS X

- 1 Display the [Output Method] window.
- 2 Select [Secure Print] in [Output Method].

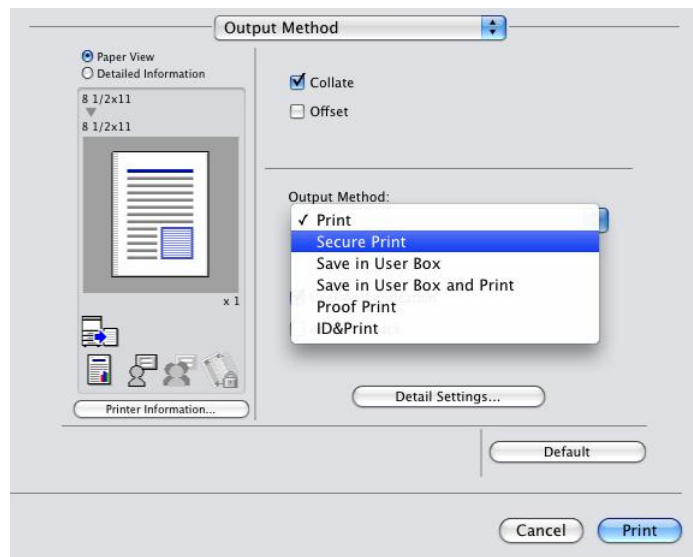

- 3 Enter the [Secure Print ID:] and [Password:].



- Selecting the [Save Settings] check box saves the settings. In addition, if the [Do not show this window when setting] check box is selected, the dialog box does not appear when the function is specified.
- When [Password Rules] is enabled on the machine, the passwords that can be used for secure printing are limited. If a password that does not comply with the password rules is entered, the job is deleted. For details on the [Password Rules], refer to the [User's Guide Copy Operations].

- 4 Print the document.

12.2.2 Recalling a job from the control panel

The [Secure Print] jobs are saved in the [Secure Document User Box]. To print a secured document, the ID and password that have been specified in the printer driver are required.

Reference

- Secured documents are automatically deleted after a certain length of time has elapsed since their registration. The default setting for this time is 1 day, and the value can be specified in the administrator mode. For details, refer to page 13-44.
- To manually delete a secured document that has been printed, operate in administrator mode. For details, refer to page 13-43.



Reference

For details on the functions of the keys on the control panel, refer to the [User's Guide Copy Operations].

For details on the User Box functions of the machine, refer to the [User's Guide Box Operations].

For details on specifying the [Confidential Document Access Method], refer to the [User's Guide Copy Operations].

When the [Confidential Document Access Method] is set to [Mode 1]

- 1 Press the **User Box** key on the control panel.
→ Press [User Box] when the application menu is displayed.
- 2 Select [Secure Document User Box] in [System User Box], and then press [Use/File].



- 3 Enter the [ID] for the secure print document, and then press [OK].



- 4 Enter the password for the secure print document, and then press [OK].
If the specified ID and password match, the list of secure print documents appears.



- 5 Select the document to be printed on the [Print] tab, and then press [Print].
The contents and a preview of the document can be checked in [Document Details].



- 6 Change the print conditions as necessary.

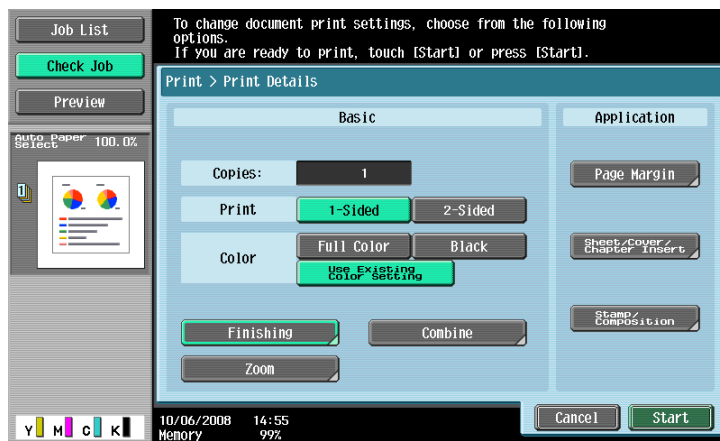

- 7 Press [Start] or the **Start** key in the control panel.
The document is printed.
→ To stop operations, press [Cancel].

When the [Confidential Document Access Method] is set to [Mode 2]

- 1 Press the **User Box** key on the control panel.
→ Press [User Box] when the application menu is displayed.
- 2 Select [Secure Document User Box] in [System User Box], and then press [Use/File].



- 3 Enter the [ID] for the secure print document, and then press [OK].
The list of secure print documents matching the specified ID appears.



- 4 Select the document you want to print and then press [Enter Password].

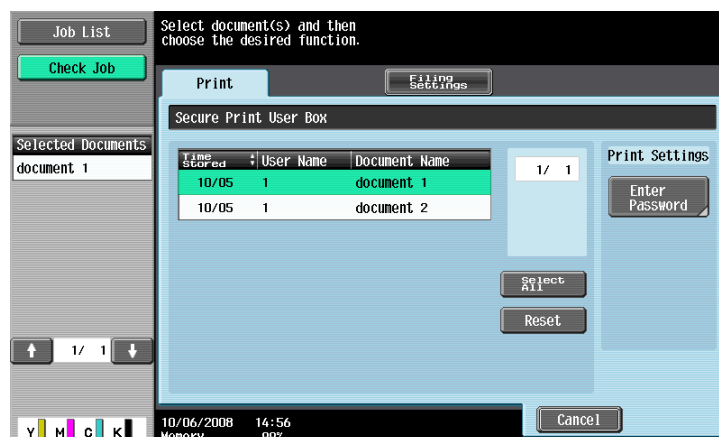

- 5 Enter the password for the secure print document, and then press [OK].
The list of secure print documents matching the specified password appears.
→ If [Prohibited Functions When Authentication Error] in Administrator Settings is set to [Mode 2] and a user enters an incorrect password the specified number of times, the document is locked. To release from the operation prohibition status, contact your administrator.
- 6 Select the document to be printed on the [Print] tab, and then press [Print].
The contents and a preview of the document can be checked in [Document Details].

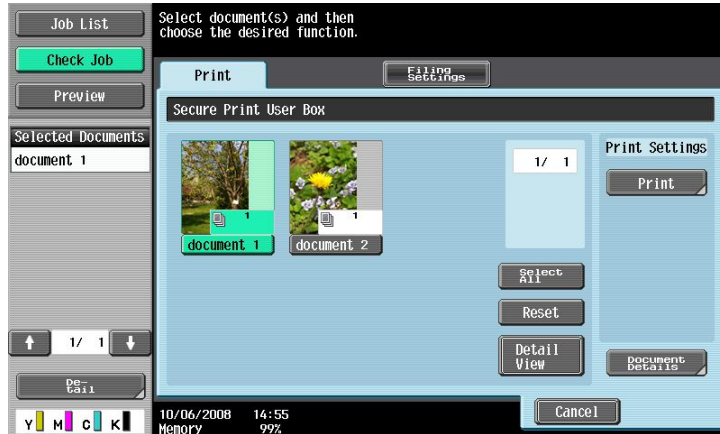

- 7 Change the print conditions as necessary.

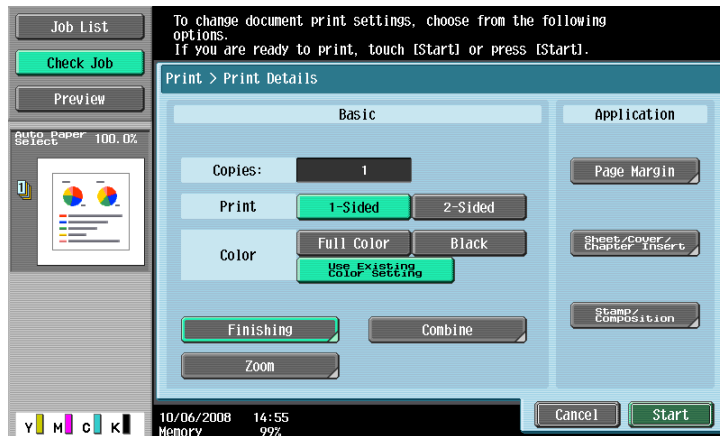

- 8 Press [Start] or the **Start** key in the control panel.
→ The document is printed.
→ To stop operations, press [Cancel].

12.3 Save in User Box

The Save in User Box function saves print jobs in a User Box of the machine. Because the print jobs are printed by specifying the User Box from the control panel, this function can also be used for document distribution.

The Save in User Box function can be specified using the printer driver when printing, and printing or distribution can be performed from the control panel.

Reference

For details on the User Box functions of the machine, refer to the [User's Guide Box Operations].

12.3.1 Setting the printer driver

The following four printer drivers support this feature.

- KONICA MINOLTA PCL Printer Driver for Windows (PCL driver)
- KONICA MINOLTA PostScript Printer Driver for Windows (PS driver)
- KONICA MINOLTA XPS Printer Driver for Windows (XPS driver)
- KONICA MINOLTA PostScript PPD Printer Driver for Mac OS X

Perform printing with the following settings specified.

- Output Method: [Save in User Box] or [Save in User Box/Print]

Reference

- Create the User Box for saving the data in advance with the User Box function of the machine. For details on the User Box functions of the machine, refer to the [User's Guide Box Operations].

For Windows

- 1 Click to display the [Basic] tab.
- 2 Select [Save in User Box] or [Save in User Box/Print] in [Output Method].
 - To save data in a User Box and print at the same time, select [Save in User Box/Print].

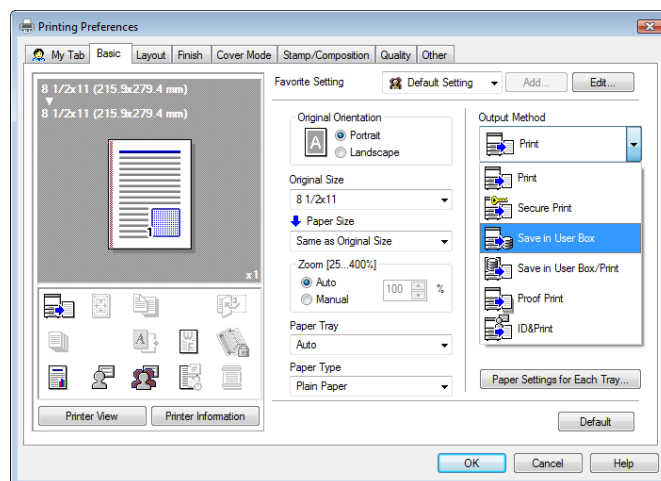

- 3 Enter the [File Name] of the document and the [User Box Number] for the save location.

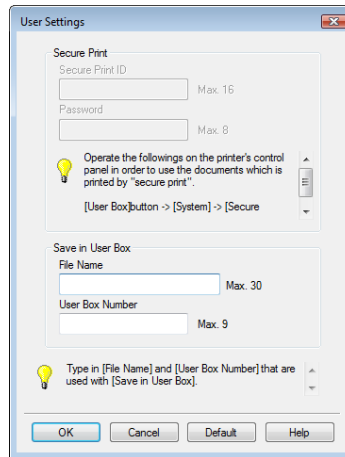

- 4 Print the document.

→ The file name and the User Box number required for saving data in the User Box can be registered in advance on [User Setting] of the [Basic] tab. To use the same file name and User Box number whenever you save documents, register them in advance so that the screen to prompt entering the file name and User Box number does not appear when you select [Save in User Box].

For Mac OS X

- 1 Display the [Output Method] window.
- 2 Select [Save in User Box] or [Save in User Box and Print] in [Output Method:].

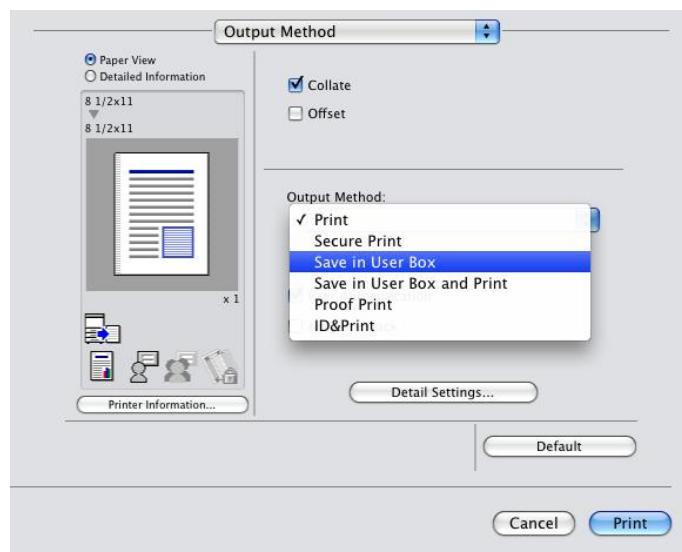

- 3 Enter the [File Name:] of the document and the [User Box Number:] for the save location.



- Selecting the [Save Settings] check box saves the settings. In addition, if the [Do not show this window when setting] check box is selected, the dialog box does not appear when the function is specified.

- 4 Print the document.

12.3.2 Recalling a job from the control panel

The [Save in User Box] and [Save in User Box/Print] jobs are saved in a User Box of the specified number.

To print a document saved in a User Box, open the specified box to retrieve the document. If a password is specified for the User Box, the User Box password is required.

Reference

- User Box documents are automatically deleted after a certain length of time has elapsed since their registration. The default setting for this time is 1 day, and the value can be specified when creating a User Box.



Reference

For details on the functions of the keys on the control panel, refer to the [User's Guide Copy Operations].

For details on the User Box functions of the machine, refer to the [User's Guide Box Operations].

- 1 Press the **User Box** key on the control panel.
 - Press [User Box] when the application menu is displayed.
- 2 Select the desired User Box number, and then press [Use/File].
 - Boxes are classified as [Public] User Boxes, [Personal] User Boxes, or [Group] User Boxes. Specify the desired User Box from the classification of the saved User Boxes. The User Box number can be directly specified.
 - If a password is specified for the User Box, go to Step 3.
 - If a password is not specified for the User Box, go to Step 4.



- 3 Enter the User Box password, and then press [OK].
A list of documents in the specified User Box appears.



- 4 Select the document to be printed on the [Print] tab, and then press [Print].

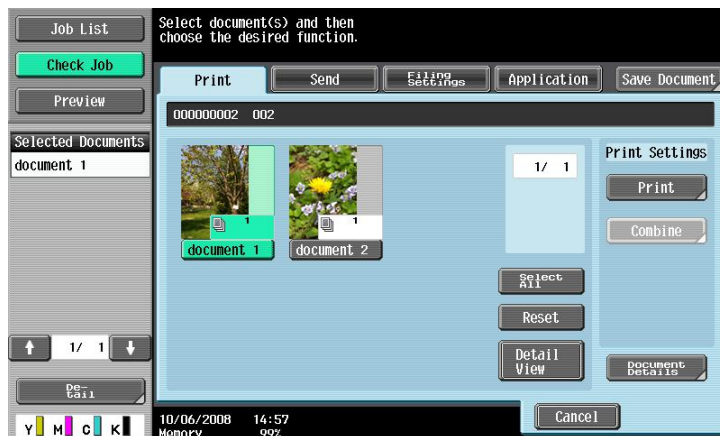

→ Documents saved in User Boxes can be transmitted via E-mail or fax. For details on the User Box functions of the machine, refer to the [User's Guide Box Operations].

- 5 Change the print conditions as necessary.

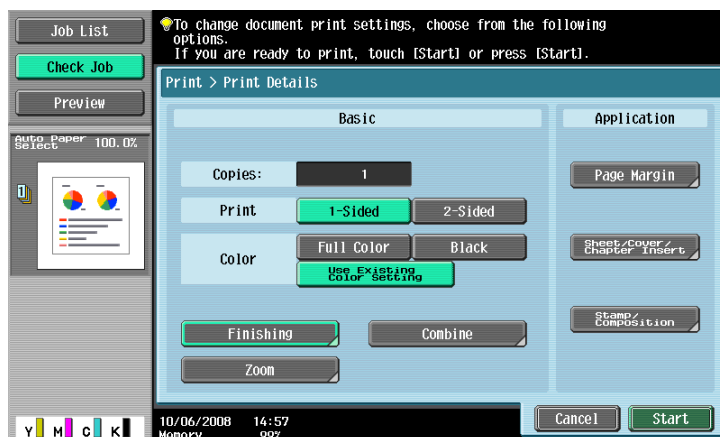

- 6 Press [Start] or the **Start** key in the control panel.
The document is printed.
→ To stop operations, press [Cancel].

12.4 Printing a document on the machine for which user authentication is specified

When [User Authentication] is specified on the machine, a user name and password must be entered when printing.

The following four printer drivers support this feature.

- KONICA MINOLTA PCL Printer Driver for Windows (PCL driver)
- KONICA MINOLTA PostScript Printer Driver for Windows (PS driver)
- KONICA MINOLTA XPS Printer Driver for Windows (XPS driver)
- KONICA MINOLTA PostScript PPD Printer Driver for Mac OS X

Reference

- If you enter an incorrect user name or password for the [User Authentication] settings of this machine or have not enabled [User Authentication], you will not be authenticated by this machine and the job will be discarded when printing.
- If an incorrect password is entered the specified number of times while [User Authentication] settings are configured on the machine and [Prohibited Functions When Authentication Error] is set to [Mode 2], the user may be locked and access to the machine may be blocked.
- Even a registered user cannot print a document if the user is not allowed to print. In addition, color printing is not available for a user who is not authorized for color printing. For user authentication, contact the administrator of the machine.
- Even when using an optional **Authentication Unit** for [User Authentication], enter the user name and password. For details, refer to the [User's Guide Copy Operations].

For Windows

- 1 Click to display the [Basic] tab.
- 2 Click [Authentication/Account Track...].

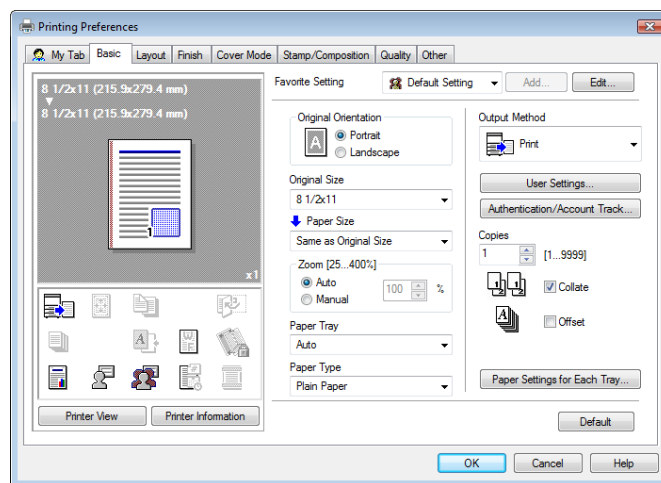

- 3 Select [Recipient User], and then enter a [User Name] and [Password] that are registered with the machine.
- The user name and password can each contain up to 64 characters.
 - If [Public User] access is allowed on the printer, the printer can be used by [Public User].
 - The password can also be specified in the printer driver in advance as the default value, and individual jobs do not require password entry.

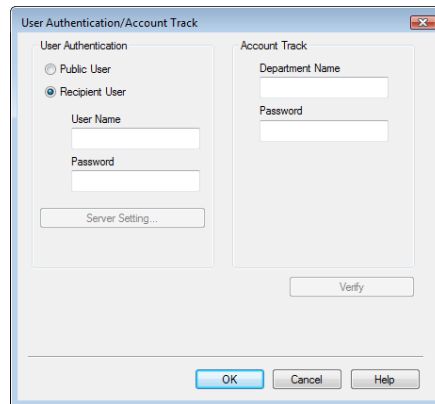

- When user authentication is performed with the **PageScope Authentication Manager**, you must enter the user information specified by the server administrator. The windows and input items that appear vary according to the settings. For details, contact your server administrator.

- 4 Click [OK] to determine the settings and start printing.

If the entered user name is a name enabled on the machine, the job is printed and counted as a job for the specified user.

Reference

- If user authentication is not enabled in the [Configure] tab, user authentication will not be performed. If you are using the user authentication, be sure to enable it in the [Device Option] list. For details, refer to page 9-4.
- It is necessary to configure server settings when user authentication is performed with the server. Click [Server Setting...], and then select a server.
- Clicking [Verify] allows communication with this machine to confirm whether the entered user can be authenticated. This function is available only when your computer is connected to and can communicate with this machine.
- When authentication is performed with the **PageScope Authentication Manager**, in the [Administrator Settings] of this machine, set [System Connection] – [OpenAPI Settings] – [Authentication] to [OFF]. For details, refer to page 13-57.

For Mac OS X

- 1 Display the [Output Method] window.
- 2 Select the [User Authentication] check box.

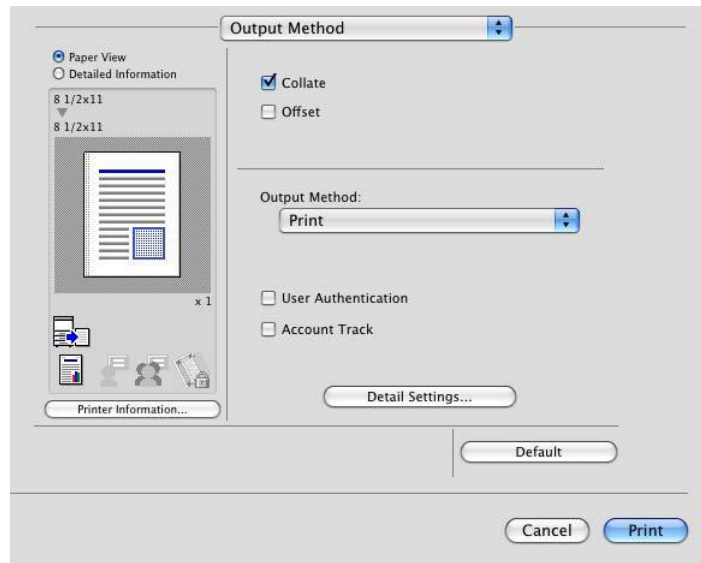

- 3 Select [Recipient User], and then enter a [User Name:] and [Password:] that are registered with the machine.
 - The user name and password can each contain up to 64 characters.
 - If [Public User Access] access is allowed on the printer, the printer can be used by [Public User].



- Selecting the [Save Settings] check box saves the settings. In addition, if the [Do not show this window when setting] check box is selected, the dialog box does not appear when the function is specified.
 - When user authentication is performed with the **PageScope Authentication Manager**, you must enter the user information specified by the server administrator. The windows and input items that appear vary according to the settings. For details, contact your server administrator.
- 4 Click [OK] to determine the settings and start printing.

If the entered user name is a name enabled on the machine, the job is printed and counted as a job for the specified user.

Reference

- It is necessary to configure server settings when user authentication is performed with the server. Click [User Authentication Server Setting...], and then select a server.
- When authentication is performed with the **PageScope Authentication Manager**, in [Administrator Settings] of this machine, set [System Connection] – [OpenAPI Settings] – [Authentication] to [OFF]. For details, refer to page 13-57.

12.5 Printing a document on the machine for which Account Track function is enabled

When the [Account Track] settings are configured on the machine, you must enter the account track code (access code) when printing.

The following four printer drivers support this feature.

- KONICA MINOLTA PCL Printer Driver for Windows (PCL driver)
- KONICA MINOLTA PostScript Printer Driver for Windows (PS driver)
- KONICA MINOLTA XPS Printer Driver for Windows (XPS driver)
- KONICA MINOLTA PostScript PPD Printer Driver for Mac OS X

Reference

- If you enter an incorrect access code for the [Account Track] settings on the machine or have not enabled [Account Track], you will not be authenticated by the printer and the job will be discarded when printing.
If an incorrect password is entered the specified number of times while the [Account Track] setting is configured on the machine and [Prohibited Functions When Authentication Error] is set to [Mode 2], the account will be locked and access to the machine will be blocked.
- Even a registered account cannot print a document if the account is not allowed to print. In addition, color printing is not available for a user who is not authorized for color printing.
- For account track, contact the administrator of the machine.

12.5.1 Setting the printer driver

For Windows

- 1 Click to display the [Basic] tab.
- 2 Click [Authentication/Account Track...].

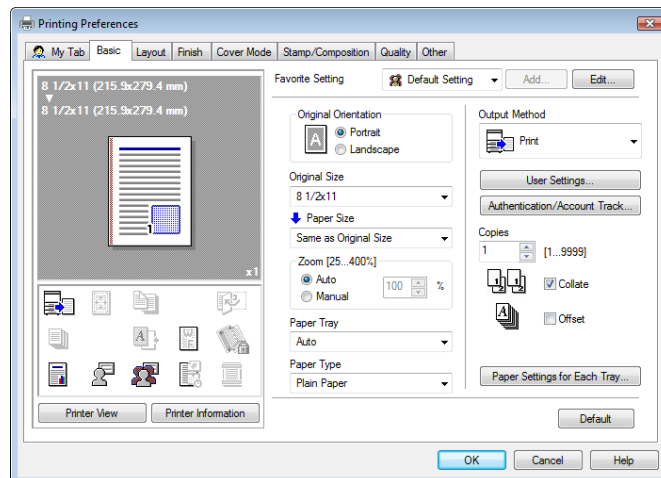

- 3 Enter an [Department Name] and [Password] that are registered with the machine.
 - The account name and password can each contain up to 8 characters.
 - The password can also be specified in the printer driver in advance as the default value, and individual jobs do not require password entry.

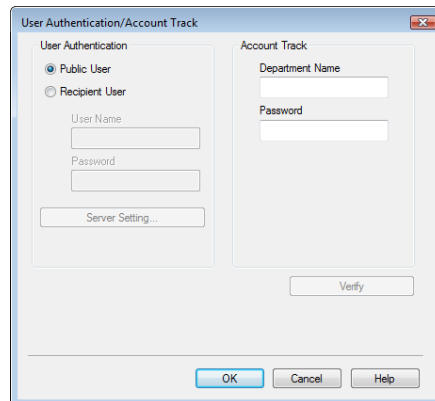

- 4 Click [OK] to determine the settings and start printing.

If the entered access code is an access code enabled on the machine, the job is printed and counted as a job for the specified account.

Reference

- If account track is not enabled on the [Configure] tab, account track cannot be performed. If you are using account track, be sure to enable it in the [Device Option] list. For details, refer to page 9-4.
- Clicking [Verify] allows communication with the machine to confirm whether the entered account can be authenticated. This function is available only when your computer is connected to and can communicate with this machine.

For Mac OS X

- 1 Display the [Output Method] window.
- 2 Select the [Account Track] check box.

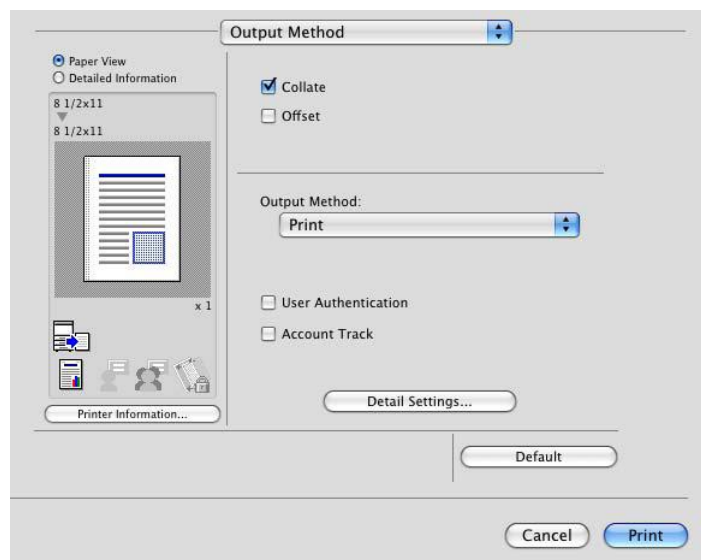

- 3 Add an [Department Name:] and [Password:] that are registered with the machine.
 - The account name and password can each contain up to 8 characters.



The screenshot shows a dialog box titled "Account Track". It features a small icon of a person with a speech bubble on the left. The main area contains two text input fields: "Department Name:" and "Password:". Below these fields is a section with two checkboxes: "Save Settings" and "Do not show this window when setting". At the bottom, there are three buttons: "Default", "Cancel", and "OK".

- Selecting the [Save Settings] check box saves the settings. In addition, if the [Do not show this window when setting] check box is selected, the dialog box does not appear when the function is specified.
- 4 Click [OK] to determine the settings and start printing.

If the entered access code is an access code enabled on the machine, the job is printed and counted as a job for the specified account.

12.6 ID & Print

When the ID & Print function is used, printing is started only after the user name and password entered from the control panel of the machine are accepted and the authentication process has been completed successfully. This is helpful in maintaining security of the document.

To use the ID & Print function, the user authentication must be completed on the machine.

When processing a print job from a computer, specify ID & Print after entering the user name and password from the printer driver.

Data to be printed in the ID & Print mode is saved in the [ID & Print User Box], and after printing, they are automatically deleted from the [ID & Print User Box]. You can also print the data saved in the [ID & Print User Box] by entering the user name and password from the control panel of the machine to log in to the printer.

When the optional **Authentication Unit (biometric type) AU-101**, **Authentication Unit (biometric type) AU-102**, or **Authentication Unit (IC card type) AU-201** is used for [User Authentication], you can start printing or log in to this machine simply by touching the authentication unit with your finger or IC card.



Reference

To enable the ID & Print function when printing a document from the computer, specify the function from the printer driver. For details, refer to page 12-22.

For details on the operation of the job saved in the [ID & Print User Box], refer to page 12-25.

For details on using the authentication unit for printing or logging in, refer to page 12-28.

12.6.1 Setting the printer driver

For Windows

- 1 Click to display the [Basic] tab.
- 2 Click [Authentication/Account Track...].

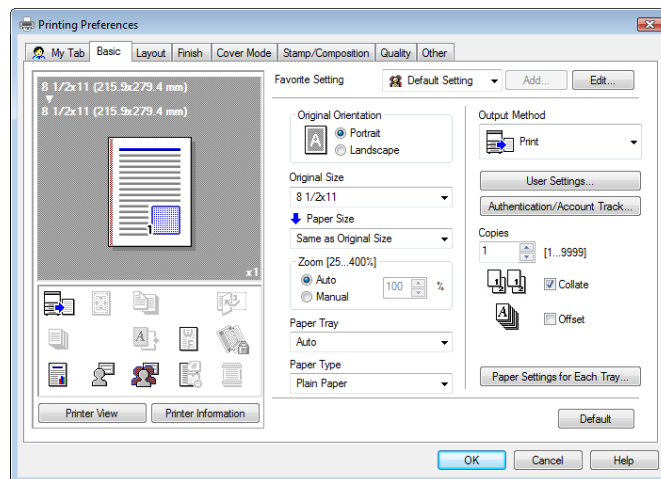

- 3 Select [Recipient User], enter the [User Name] and [Password] that are registered with the machine and click [OK].

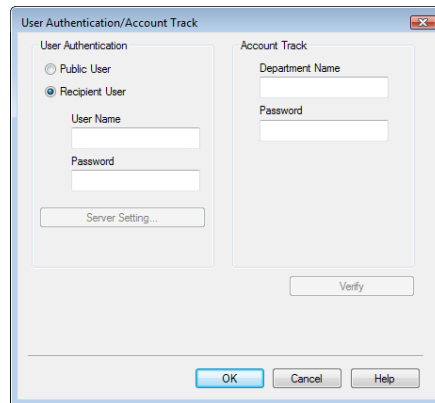

- For details on the user authentication, refer to page 12-16.
- If [User Authentication/Account Track] - [User Authentication Settings] - [Administrative Setting] - [ID & Print Settings] - [Public User] is set to [Save] in the [Administrator Settings] of the machine and the public user job is permitted, public user jobs are also saved in the [ID & Print User Box]. For details, refer to page 13-48.

- 4 Select [ID&Print] in [Output Method].

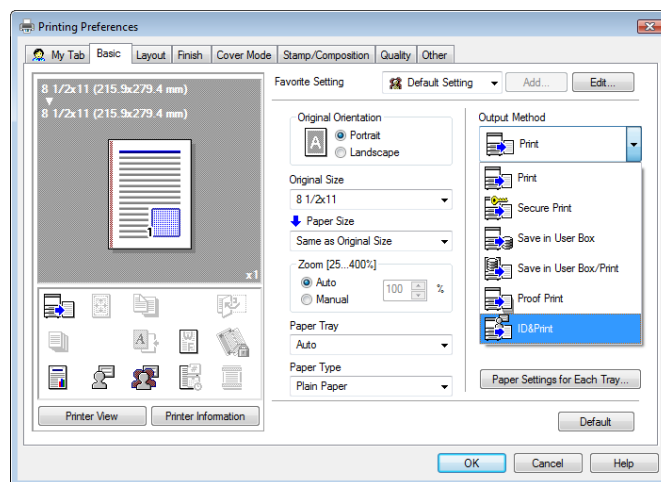

- If [User Authentication/Account Track] - [User Authentication Settings] - [Administrative Setting] - [ID & Print Settings] - [ID & Print] is set to [ON] in the [Administrator Settings] of the machine, general print jobs are also saved in the [ID & Print User Box]. For details, refer to page 13-48.

- 5 Print the document.

For Mac OS X

- 1 Display the [Output Method] window.
- 2 Select the [User Authentication] check box.

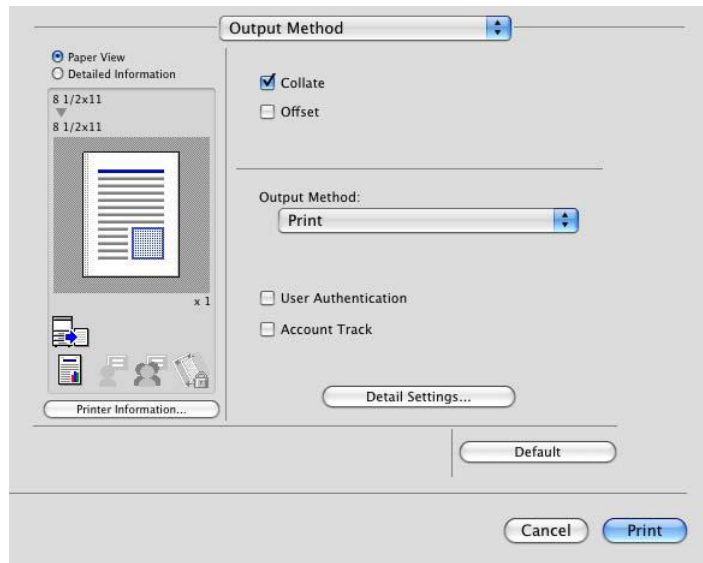

- 3 Select [Recipient User], enter the [User Name:] and [Password:] that are registered with the machine and click [OK].



- For details on the user authentication, refer to page 12-16.
- If [User Authentication/Account Track] - [User Authentication Settings] - [Administrative Setting] - [ID & Print Settings] - [Public User] is set to [Save] in the [Administrator Settings] of the machine and the public user job is permitted, public user jobs are also saved in the [ID & Print User Box]. For details, refer to page 13-48.

- 4 Select [ID&Print] in [Output Method:].

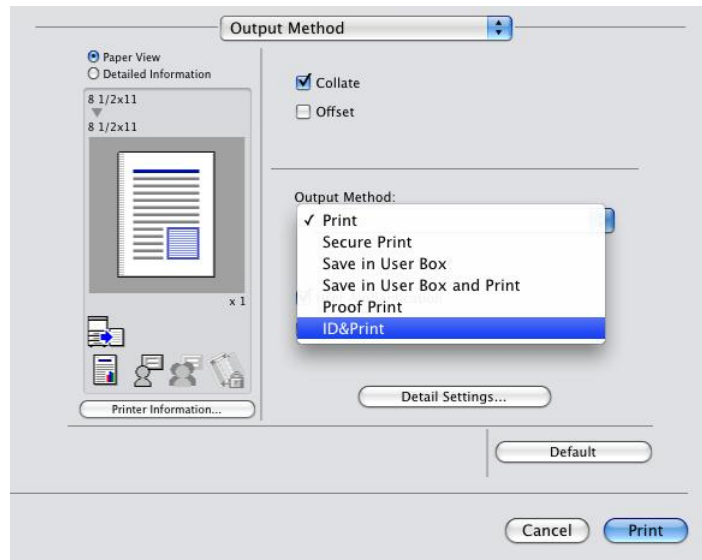

- If [User Authentication/Account Track] - [User Authentication Settings] - [Administrative Setting] - [ID & Print Settings] - [ID & Print] is set to [ON] in the [Administrator Settings] of the machine, general print jobs are also saved in the [ID & Print User Box]. For details, refer to page 13-48.

- 5 Print the document.

12.6.2 Recalling a job from the control panel

Reference

- For a public user, a document can be printed by opening the ID & Print User Box after logging in as a public user.

Entering the user information and printing

- 1 Enter the [User Name] and [Password] from the control panel of the printer.
 - If the control panel shows a screen that appears after logging in, for example, when public user access is allowed without requiring to log in, logging out by pressing the **Access** key brings up a login screen.

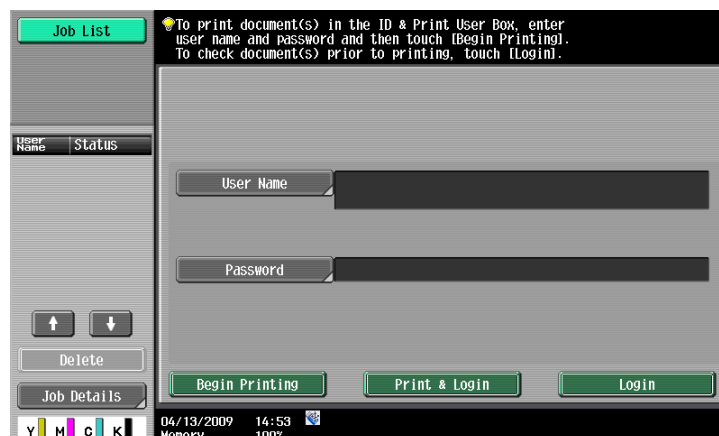

2 Press [Begin Printing].

Once the user is authenticated, the print job is printed.

- Press [Print & Login] to enable printing of the job and normal login.
- Press [Login] for the normal login without printing the job. After logging in, open the [ID & Print User Box] to print the document.
- If there are multiple print jobs, all the jobs are printed. To select the documents to print, press [Login] and then print the desired documents from the [ID & Print User Box].
- When the optional **Authentication Unit** is installed, [ID & PW] and [Auth. Unit] appear. By selecting a button, the ID & PW or authentication unit can be selected and used as the authentication method.

Printing a document by specifying it from the [ID & Print User Box]

Reference

- When the [ID & Print User Box] is frequently used, it will be helpful to configure [Custom Display Settings] - [User Box Settings] of the machine so that [ID & Print User Box] always appears on the screen. For details, refer to the [User's Guide Box Operations].

1 Enter the [User Name] and [Password] from the control panel of the printer.

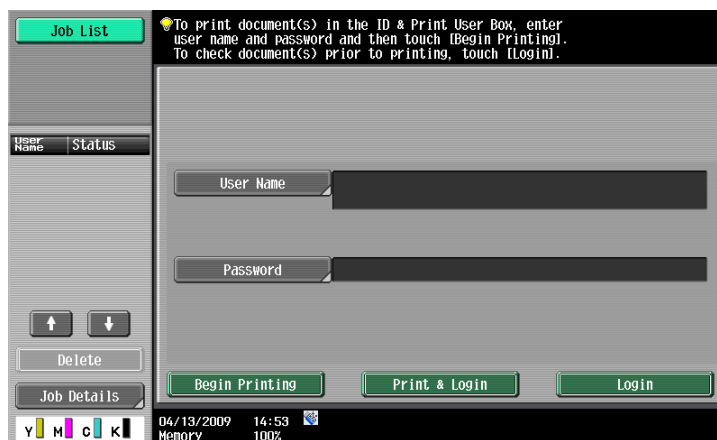

2 Press [Login].

Log in to the machine.

3 Press the **User Box** key on the control panel.

- Press [User Box] when the application menu is displayed.

4 Select [ID & Print User Box] in [System User Box], and then press [Use/File].

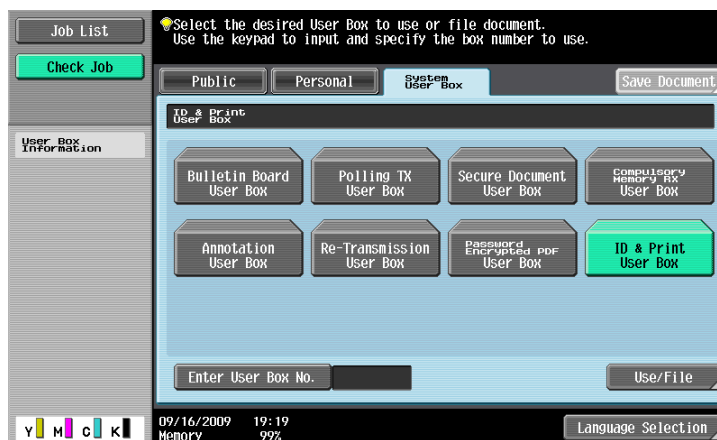

- 5 Select the document you want to print and then press [Print].
 → The contents and a preview of the document can be checked in [Document Details].



→ To stop operations, press [Cancel].

- 6 When a screen confirming the deletion of the job appears, select the processing method.
 → Selecting [Print & Delete] prints and deletes the document in the [ID & Print User Box].

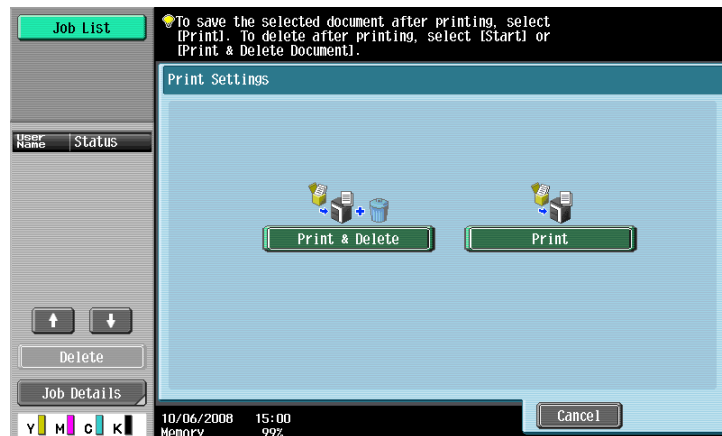

The document is printed.

Reference

- When [System Settings] - [User Box Settings] - [ID & Print Delete after Print Setting] is set to [Confirm with User] in [Administrator Settings] of the machine, printing a document by specifying from [ID & Print User Box] displays the screen to confirm the deletion of the job. For details, refer to page 13-46.

Logging in using the authentication unit

- 1 Press [Auth. Unit], and then press [Begin Printing].

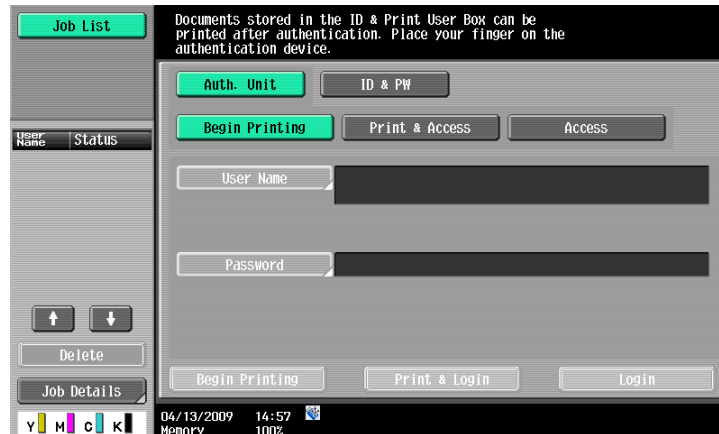

- 2 Touch the authentication unit with the finger or IC card.

Once the user is authenticated, the print job is printed.

- Press [Print & Access] to enable printing of the job and a normal login.
- Logging in by pressing [Access] allows you to log in as usual without printing a job. After logging in, open the [ID & Print User Box] to print the document.
- If [ID & Print Operation Settings] is set to [Print All Jobs] when there are multiple jobs, all jobs are output in a single authentication. If it is set to [Print Each Job], the jobs are printed one by one in the order they have been stored.

Reference

- You can specify [ID & Print Operation Settings] in [User Authentication/Account Track] - [User Authentication Settings] - [Administrative Setting] - [ID & Print Operation Setting] of the [Administrator Settings] of the machine. For details, refer to page 13-49.
- To select the documents to print when there are multiple print jobs, press [Access] and then print the desired documents from the [ID & Print User Box].
- Even when the authentication unit is installed, you can enter the user information and print using [ID & PW]. For details, refer to page 12-25.
- To change the operation ([Begin Printing], [Print & Access], or [Access]) selected in the initial page, select [Administrator Settings] - [User Authentication/Account Track] - [User Authentication Settings] - [Administrative Settings] - [Default Operation Selection]. For details, refer to page 13-50.

Reference

- For details on the optional **Authentication Unit**, refer to the [User's Guide Copy Operations].

12.7 Printing from a cellular phone or PDA

Configure settings to wirelessly connect this machine to a cellular phone or PDA with the Bluetooth function installed and to print data stored in such a terminal or save it in a User Box of this machine.

12.7.1 Operating environment

The cellular phones and PDAs that can be connected to this machine and the printable file type must satisfy the following conditions.

Communication protocol	Bluetooth Ver. 2.0 + EDR
Supporting profile	OPP/BPP/SPP
Supporting file type	PDF/Compact PDF/XPS/Compact XPS/TIFF/JPEG/XHTML/Repli-Go <ul style="list-style-type: none"> For XHTML file types, the machine supports the character code of UTF-8/Shift-JIS/ISO-8859 and the link file extensions of JPEG/JPG/PNG. This machine supports RepliGo version 2.1.0.9.
PIN code	4-digit number

Reference

- To print documents from a cellular phone or PDA, the optional **Local Interface Kit EK-605** is required. The settings for enabling a Bluetooth communication are also required. Contact your service representative in advance.
- If you cannot access the link file when attempting to print an XHTML file, the document will either not be printed or will be printed in a black frame depending on the setting in [User Settings] - [Cellular Phone/PDA Setting] - [Link File Error Notification]. For details, refer to page 13-34.
- To access the link file for printing an XHTML file, [WebDAV Settings] of this machine is required. To use a proxy for connection, register a proxy server in [Administrator Settings] - [Network Settings] - [WebDAV Settings] - [WebDAV Client Settings] - [Proxy Server Address], and set [User Settings] - [Cellular Phone/PDA Setting] - [Proxy Server Use] to [ON]. For details, refer to page 13-35.
- The communication speed may drop or communication may be interrupted due to obstacles, signal quality, magnetic field or static electricity.
- Protected documents and image data may not be sent depending on the security setting of the cellular phone or PDA.

12.7.2 Printing a document

Reference

- To print from a cellular phone or PDA, set [Administrator Settings] – [System Connection] – [Cellular Phone/PDA Setting] to [Allow] in advance. For details, refer to page 13-58. To use a Bluetooth communication, [Bluetooth Setting] must be enabled in this machine. For details, refer to the [User's Guide Network Administrator].
- When [User Authentication] is specified on this machine, even a registered user cannot print a document unless printing from a cellular phone or PDA is allowed in the machine setting. For user authentication, contact the administrator of the machine.
- For details on the User Box functions of the machine, refer to the [User's Guide Box Operations].
- For the operation of a cellular phone or PDA, refer to the operation manual of the cellular phone or PDA.

1 Set the cellular phone or PDA to enable Bluetooth communication.

2 Press the **User Box** key on the control panel.

→ Press [User Box] when the application menu is displayed.

- 3 Select [Mobile/PDA] in [System User Box], and press [Use/File].



- 4 Press [Print List].
 → To save data in a User Box, press [Save in User Box], and select the desired User Box.

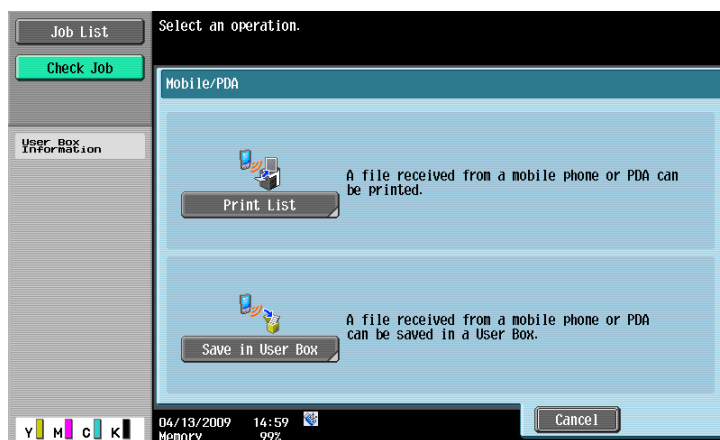

- 5 Check the displayed PIN code.

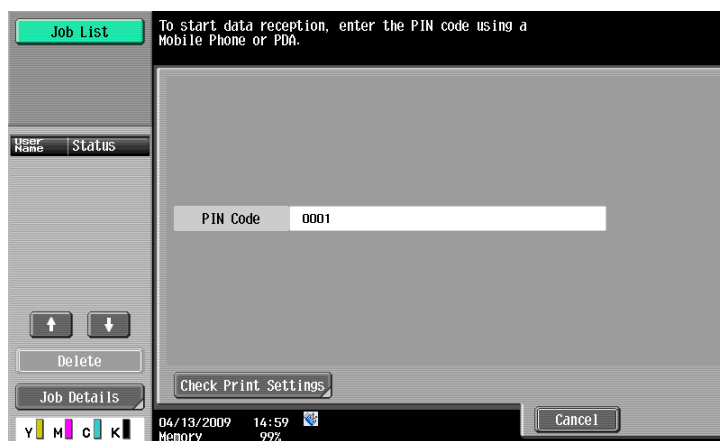

- 6 Select this machine in the cellular phone or PDA.
 → Select the data you want to send if it is selectable.
- 7 Enter the 4-digit PIN code into the cellular phone or PDA.
 → You can check the print setting in [Check Print Settings].
 Once the PIN code is verified, connection is established and data transmission and printing start.

**Reference**

You can configure print settings from the cellular phone or PDA in [User Setting] – [Cellular Phone/PDA Setting] – [Print]. For details, refer to page 13-37.

12.8 Specifying the encryption passphrase by the user

The machine and the printer driver communicate with each other by encrypting a user password, account password or secure document password using a common encryption key.

Although an encryption passphrase for generating the common encryption key is preset as a default setting, it can also be generated with a user-defined encryption passphrase.

To specify a user-defined encryption passphrase, specify the same encryption passphrase both for the machine and the printer driver.

Reference

- If different values are used for the encryption passphrase for the machine and the printer driver, the machine cannot decrypt the encrypted user password, account password or secure document password, and printing cannot be performed.
- The common encryption key is automatically generated by the [Encryption Passphrase]. The common encryption key cannot be specified directly.

12.8.1 Settings for the machine

Go to Administrator Settings to configure the settings for the machine.

- 1 In the [Administrator Settings] screen, press [Security Settings].
- 2 In the [Security Settings] screen, press [Driver Password Encryption Setting].
- 3 Press [User-Defined].
 - If you do not specify a user-defined [Encryption Passphrase], press [Use Factory Default].

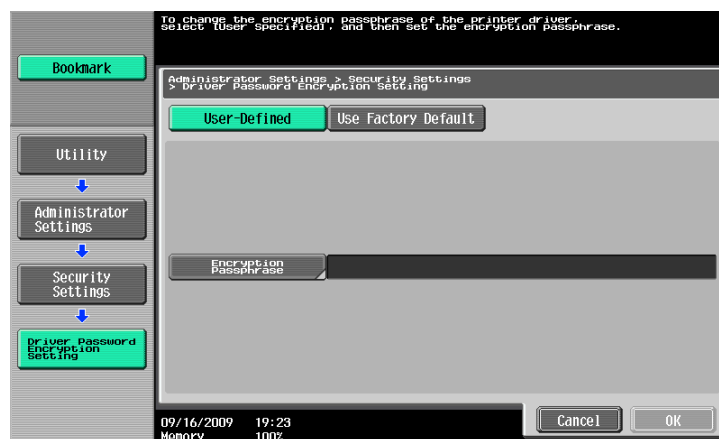

- 4 Press [Encryption Passphrase].

- 5 Press [Encryption Passphrase], and then enter the encryption passphrase.

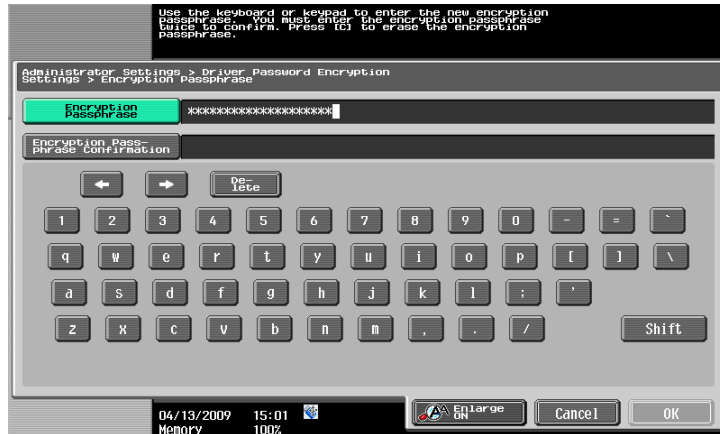

- Enter the [Encryption Passphrase] with 20 alphanumeric letters. Specify the same [Encryption Passphrase] for the machine and the printer driver.
- An encryption passphrase using a series of the same letters (for example, "1111") is invalid.

- 6 Press [Encryption Passphrase Confirmation], and then enter the encryption passphrase again.



- 7 Press [OK].

This sets the encryption passphrase.

12.8.2 Setting the printer driver

The following four printer drivers support this feature.

- KONICA MINOLTA PCL Printer Driver for Windows (PCL driver)
- KONICA MINOLTA PostScript Printer Driver for Windows (PS driver)
- KONICA MINOLTA XPS Printer Driver for Windows (XPS driver)
- KONICA MINOLTA PostScript PPD Printer Driver for Mac OS X

For Windows

- 1 Display the Properties window.
 - The Properties window can be displayed by opening the [Printers] or [Printers and Faxes] window and right-clicking the icon of the installed printer, and then clicking [Properties].
- 2 Click the [Configure] tab.
- 3 Select the [Encrypt. Passphrase] check box, and then enter the encryption passphrase.
 - If you do not specify a user-defined [Encrypt. Passphrase], clear the [Encrypt. Passphrase] check box.

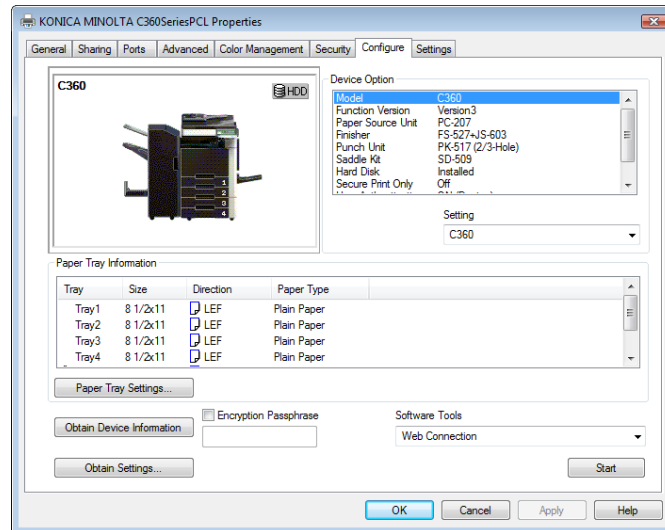

- Enter the [Encrypt. Passphrase] with 20 alphanumeric letters. Specify the same [Encrypt. Passphrase] for the machine and the printer driver.
 - An encryption passphrase using a series of the same letters is invalid.
 - When OpenAPI is used and SSL is enabled, it is possible for the machine to obtain the common encryption key provided that the device information of the printer driver can be obtained automatically.
- 4 Click [OK].

For Mac OS X

- 1 Display the [Output Method] window.
- 2 Click [Detail Settings...].
The [Detail Settings] window appears.
- 3 Select [Administrator Settings], and then click [Settings...].

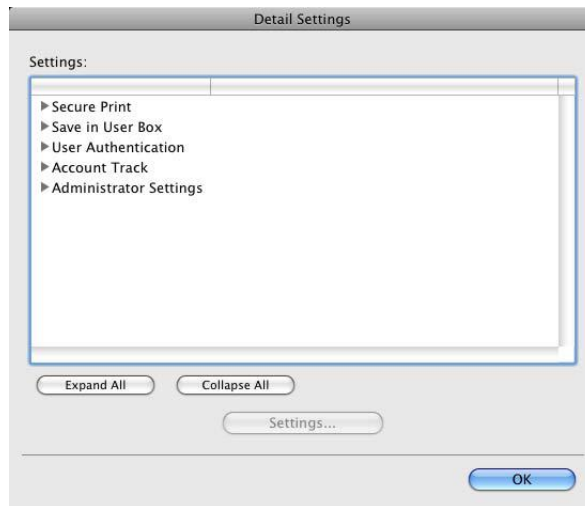

The [Administrator Settings] dialog box appears.

- 4 Select the [Encryption Passphrase:] check box, and then enter the encryption passphrase.
 - If you do not specify a user-defined [Encryption Passphrase:], clear the [Encryption Passphrase:] check box.

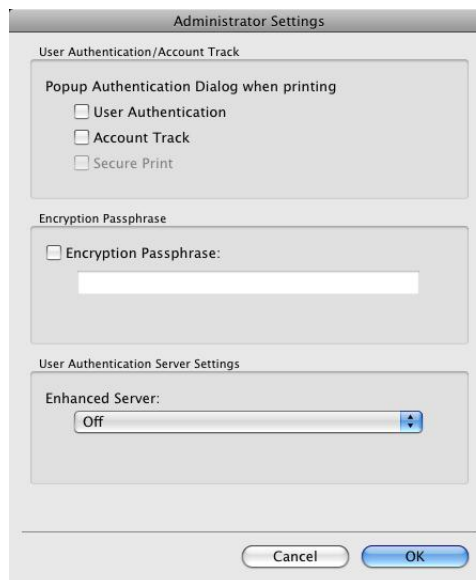

- Enter the [Encryption Passphrase:] with 20 alphanumeric letters. Specify the same [Encryption Passphrase:] for the machine and the printer driver.
- An encryption passphrase using a series of the same letters is invalid.

- 5 Click [OK].

12.9 Specifying the ICC profile

The printer driver has a function to specify the ICC profile registered on the machine when printing.

Reference

- The default setting for the ICC profile registered on the machine can be specified in [ICC Profile Settings]. For details, refer to page 13-26.
- To utilize the ICC profiles added to the machine, the ICC profiles on the machine must be registered in the printer driver in advance. For details, refer to page 12-38.

12.9.1 Setting the printer driver

The following two printer drivers support this feature.

- KONICA MINOLTA PostScript Printer Driver for Windows (PS driver)
- KONICA MINOLTA PostScript PPD Printer Driver for Mac OS X

For Windows

- 1 Click to display the [Quality] tab.
- 2 Click [Quality Adjustment...].
The [Quality] dialog box appears.
- 3 Click [Detail] and select a document type.
- 4 Click to display the [ICC Profile] tab.

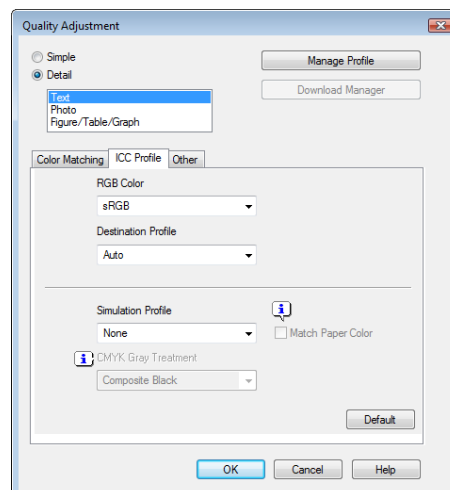

- 5 Configure the settings for [RGB Color], [Destination Profile], and [Simulation Profile].
→ The ICC profiles registered in the printer driver can be selected.
When printing, color processing is performed according to the selected ICC profiles.
- 6 Click [OK].

For Mac OS X

- 1 Display the [Quality] window.
- 2 Click [Quality Adjustment...].
The [Quality Adjustment] dialog box appears.
- 3 Configure the settings for [RGB Color:], [Destination Profile:], and [Simulation Profile:] according to the type of the document to be printed.
→ The ICC profiles registered in the printer driver can be selected.



When printing, color processing is performed according to the selected ICC profiles.

- 4 Click [OK].

12.10 Registering the ICC profiles in the printer driver

Additional ICC profiles downloaded and added to the machine can be registered in the printer driver.

A registered ICC profile can be specified when printing.

Reference

- The ICC profiles are registered to the machine using the "Download Manager(bizhub)" application. For details, refer to the Help for the application software.

12.10.1 Setting the printer driver

The following two printer drivers support this feature.

- KONICA MINOLTA PostScript Printer Driver for Windows (PS driver)
- KONICA MINOLTA PostScript PPD Printer Driver for Mac OS X

For Windows

- ✓ The [Color Profile Management] function communicates with the machine to read the ICC profiles available to the machine. This function is available only when your computer is connected to and can communicate with this machine.
- ✓ If connected via a USB connector, the ICC profiles available to the machine cannot be read.

- 1 Click to display the [Quality] tab.
- 2 Click [Quality Adjustment...].
The [Quality Adjustment] dialog box appears.
- 3 Click [Manage Profile].

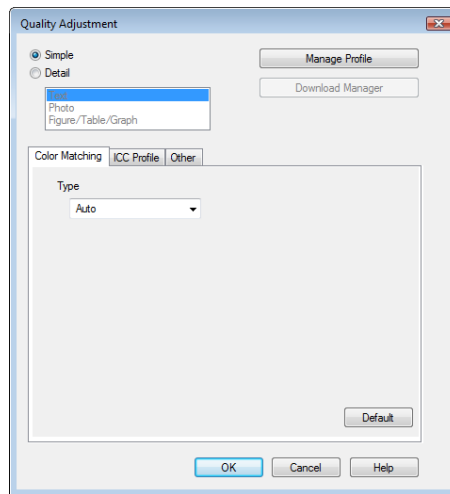

The [Color Profile Management] dialog box appears.

- Clicking [Download Manager] launches the "Download Manager (bizhub)" application. This function is available only when "Download Manager (bizhub)" is installed.

- 4 Check that a list of available profiles that are additionally registered on the machine is displayed.

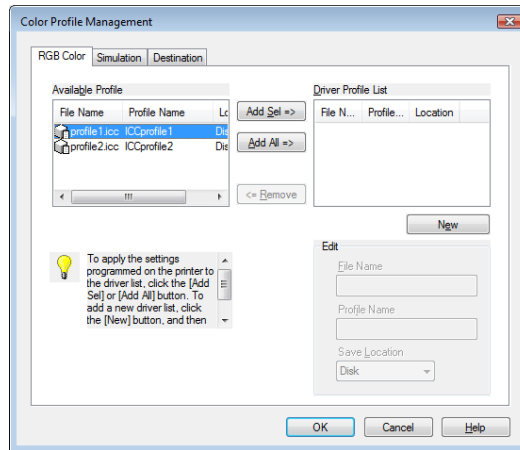

- 5 Click the tab and select a color profile type.
- 6 Select a desired profile from the [Available Profile] list, and then click [Add Sel].
Click [Remove] to delete an unnecessary ICC profile.
- To register the current driver settings as the profile, click [New], and then enter the [File Name] and [Profile Name].
 - The profile name can be changed in [Edit].
- The selected profile is added to [Driver Profile List] and it can be selected in the ICC Profile entries in the [Quality Adjustment] dialog box.
- 7 Click [OK].

For Mac OS X

- ✓ The [Color Profile Management] function communicates with the machine to read the profiles available to the machine. This function is available only when your computer is connected to and can communicate with this machine.
- 1 Display the [Quality] window.
 - 2 Click [Quality Adjustment...].
The [Quality Adjustment] dialog box appears.
 - 3 Click [Manage Profile].



The [Color Profile Management] dialog box appears.

→ Clicking [Download Manager] launches the "Download Manager (bizhub)" application. This function is available only when "Download Manager (bizhub)" is installed.

- 4 Check that a list of available profiles that are additionally registered on the machine is displayed.

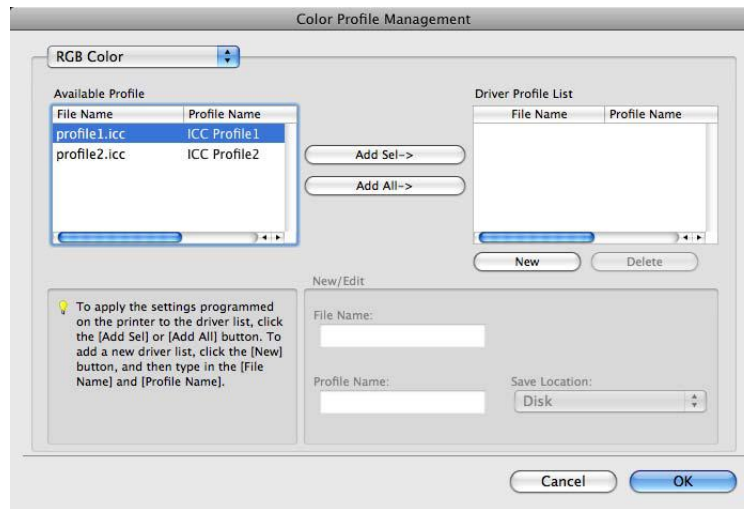

- 5 Select a color profile type from the drop-down list.

- 6 Select a desired profile from the [Available Profile] list, and then click [Add Sel].
Click [Delete] to delete an unnecessary ICC profile.

→ To register the current driver settings as the profile, click [New], and then enter the [File Name] and [Profile Name].

→ The profile name can be changed in [New/Edit].

The selected profile is added to [Driver Profile List] and it can be selected in the ICC Profile entries in the [Quality Adjustment] dialog box.

- 7 Click [OK].

12.11 Banner printing function

On this machine, paper size up to 47-1/4 inches (1200 mm) in length can be loaded into the bypass tray for printing, by configuring on the control panel.

In the following sections, loading long paper and printing on it are referred to as banner printing.

12.11.1 Paper

Applicable paper

Paper width	Paper length	Paper weight
8-1/4 to 11-11/16 inches (210 to 297 mm)	18 to 47-1/4 inches (457.3 to 1200 mm)	33-13/16 to 55-7/8 lb (127 g/m ² to 210 g/m ²) (Using the printer driver, select the paper type appropriate for the weight of the banner paper to be used. 33-13/16 lb to 41-3/4 lb (127 g/m ² to 157 g/m ²): Thick 1, Thick 1 (Side 2) 42 lb to 55-5/8 lb (158 g/m ² to 209 g/m ²): Thick 2, Thick 2 (Side 2) 55-7/8 lb (210 g/m ²): Thick 3, Thick 3 (Side 2))

12.11.2 Printer drivers and supported operating systems

The following drivers support banner printing.

- KONICA MINOLTA PCL Driver for Windows (PCL driver)
- KONICA MINOLTA PostScript Driver for Windows (PS driver)
- KONICA MINOLTA XPS Printer Driver for Windows (XPS driver)
- KONICA MINOLTA PostScript PPD Printer Driver for Mac OS X

12.11.3 Configuring the printer driver

Specify the output paper size as a custom paper size.

For Windows

- 1 Click the [Basic] tab.
→ With the KONICA MINOLTA PCL Driver, custom size setting can also be registered in advance on the [Settings] tab of the printer driver accessed from the Windows' [Printers] ([Printers and Faxes] for Windows XP/Server 2003) window.
- 2 Select [Custom Size] from [Original Size] or [Paper Size].
The [Custom Size Settings] dialog box appears.
- 3 Select the width and the length of the custom size according to the unit you use and then click [OK].
The [Confirm setting changes] dialog box appears.
- 4 Click [Yes].
- 5 If necessary, configure [Paper Settings for Each Tray...], [Bypass Tray], [Paper Type], and other settings.
- 6 Click [OK].

For Mac OS X

- 1 From the [File] menu, select [Page Setup].

- 2 Open the window for registering a custom size.
 - For Mac OS X 10.4/10.5, select [Manage Custom Sizes...] from the Paper Size list.
 - For Mac OS X 10.2/10.3, select [Custom Paper Size] from [Settings:].
- 3 Click [+] (OS X 10.4/10.5) or [New] (OS X 10.2/10.3).
- 4 Enter the paper size name.
 - Be sure to use paper size names other than existing names, such as A4 and Custom.
- 5 Configure the following items.
 - Page Size (Paper Size): Specify the desired banner size.
This value must be in the allowable range of banner size (paper width: 8-1/4 to 11-11/16 inches (210 to 297 mm), paper length: 18 to 47-1/4 inches (457.3 to 1200 mm)).
 - Printer Margins: Specify the paper margins.
- 6 Click [OK] for OS X 10.4/10.5, or click [Save] for OS X 10.2/10.3.
The custom paper size is then registered.
- 7 Select the created custom paper size from the paper size in [Page Attributes]. For Mac OS X10.5, you can also select the paper size from [Paper Size:] on the Print window.
- 8 Select [Print] in the [File] menu to display the Print window.
- 9 Check that [Paper Tray:] in [Paper Tray / Output Tray] is set to "Bypass Tray" and [Paper Type:] is set to the desired paper type ("Thick 1 to Thick 3" etc.), and also they are grayed out to prevent them from being changed.
 - If [Paper Type:] is invalid, specify the paper type in [Paper Settings for Each Tray...].
 - If the specified paper size is not in the allowable range of the banner size, [Paper Tray:] or [Paper Type:] is not grayed out to enable you to change them. In this case, check the setting of the custom paper size.

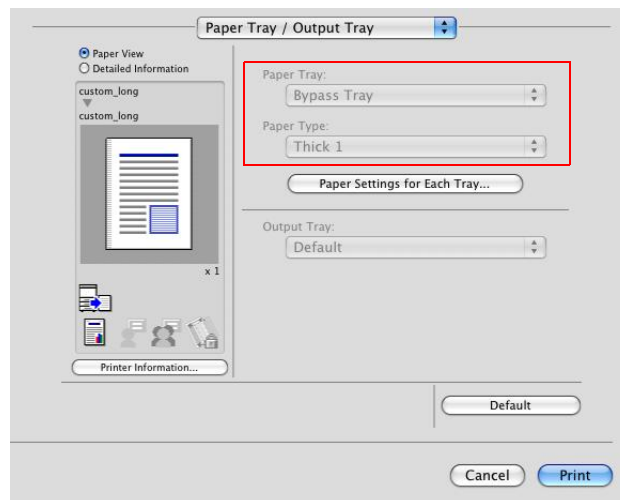

- 10 If necessary, specify other items, and click [Print].

Reference

- If the specified paper size or paper type is not in the allowable range of the banner size, an error message is displayed when printing, or the job is discarded, resulting in a printing failure.

12.11.4 Printing

- 1 Press the **Utility/Counter** key on the control panel.
- 2 Press [Banner Printing].
- 3 Press [Allow], and then the [OK].

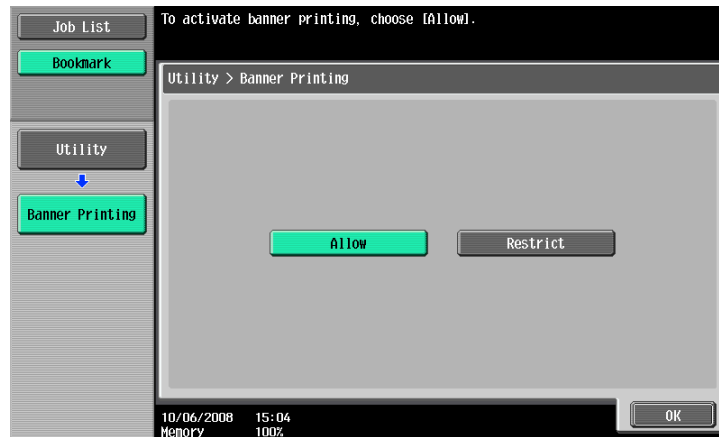

- 4 Check that the screen shows the machine is waiting for the banner printing job before sending the document data of the banner size to be printed from the computer.

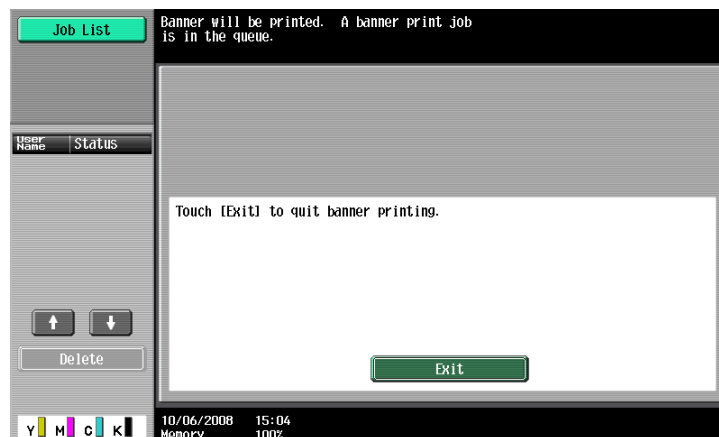

→ If data of non-banner size is sent, the job will be discarded.

- 5 Open the **Bypass Tray**.
- 6 Install the **Mount Kit** to the **Bypass Tray**.

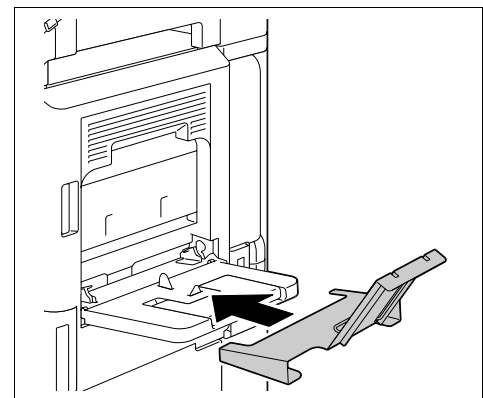

- 7 Set the **Guidance** of the **Mount Kit**.

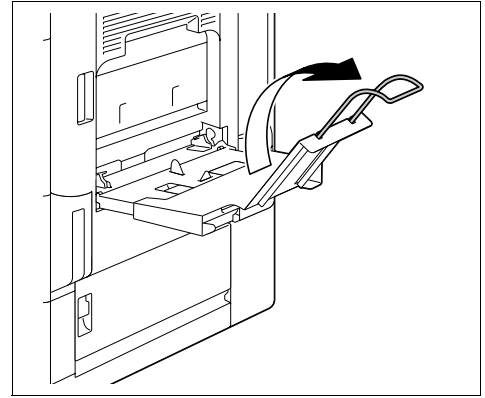

- 8 With the side to be printed on facing down, insert the paper as far as possible into the feed slot. Place as many sheets as the specified number of copies to be printed into the tray.
- 9 Slide the **Lateral Guide** of the **Bypass Tray** to make it fit to the size of paper being loaded.

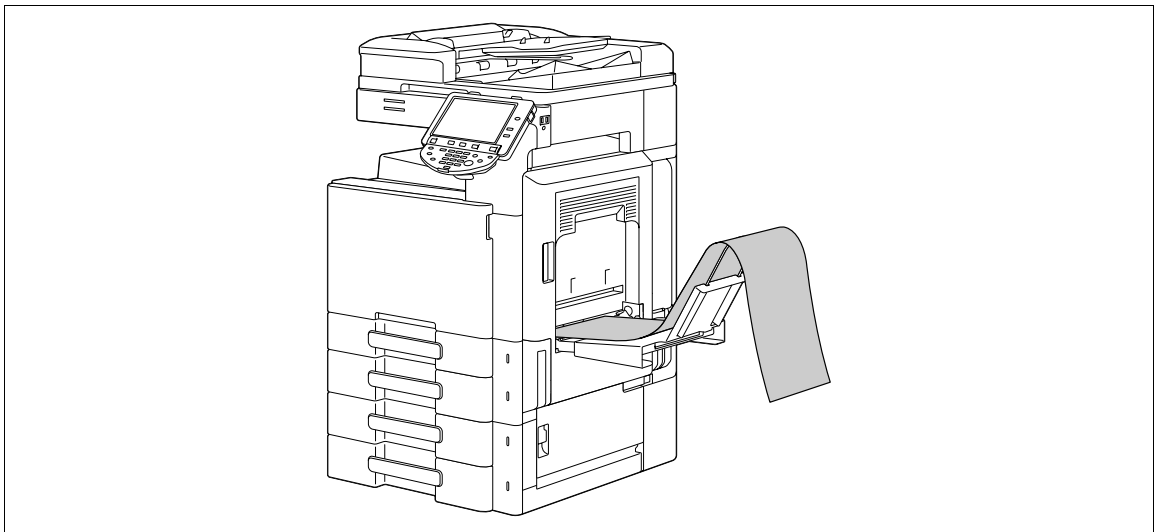

- 10 When the following screen appears, press [Complete].

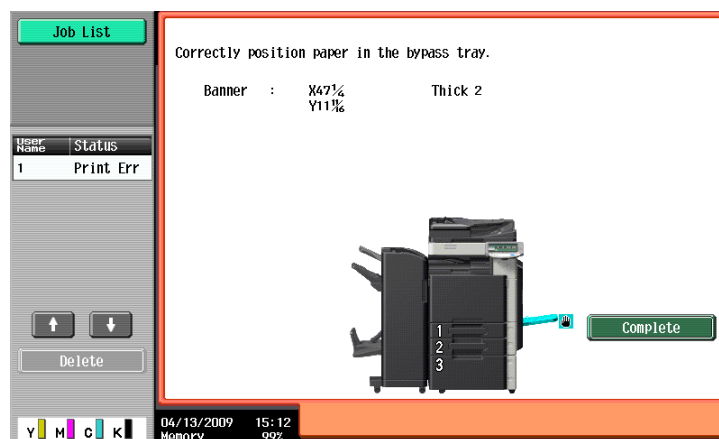

Printing of the data starts.

Print while holding by hand the paper to be printed and output.

To print another document successively, send its data from the computer.

11 To finish printing, press [Exit].

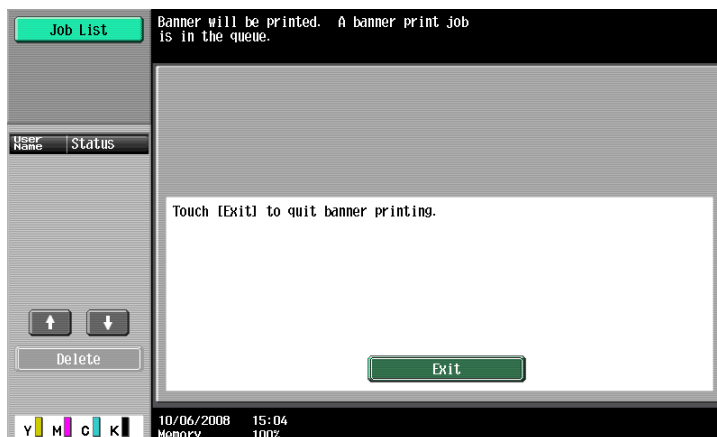

12 Press [Yes].

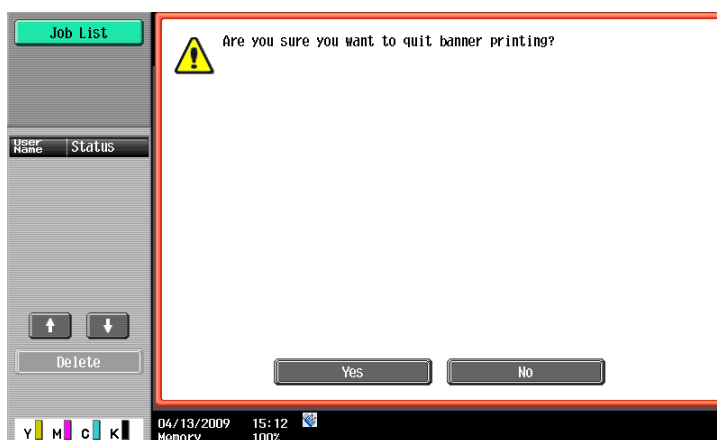

13

Settings on the Control Panel

13 Settings on the Control Panel

This chapter describes the printer-related functions that can be specified from the control panel.

13.1 Basic operations of User Settings

13.1.1 Displaying the User Settings screen

- 1 Press the **Utility/Counter** key.

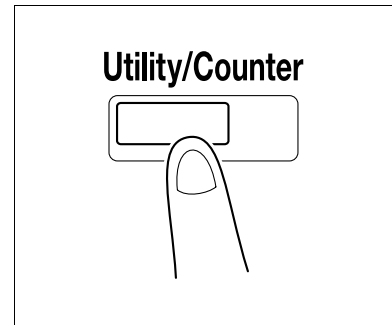

- 2 Press [User Settings].

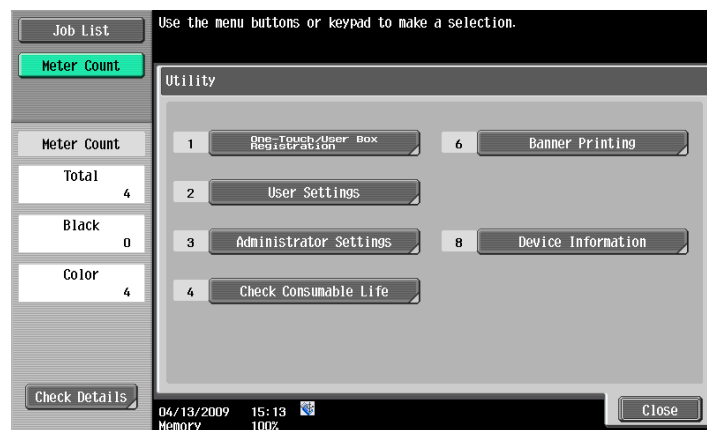

The User Settings screen appears.

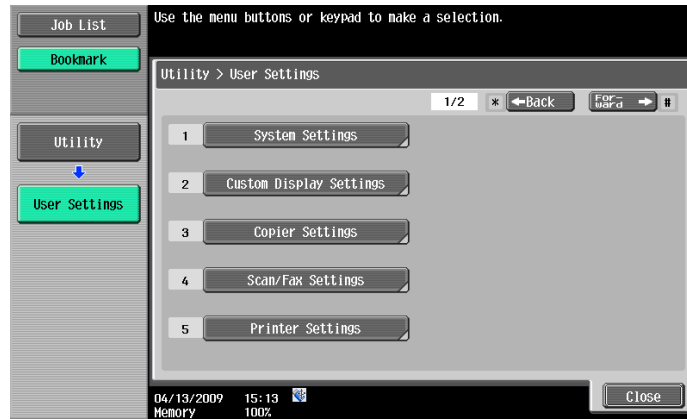

- It can also be selected by pressing the key in the keypad of the number indicated on the desired button.
For [User Settings], press the **2** key in the keypad.
- To finish configuring the Utility mode settings, press the **Utility/Counter** key. You can also exit the Utility screen by pressing [Close] until either the Copy, Fax/Scan or User Box screen appears.
- To return through the hierarchy of the Utility menu, press [Close] until the desired screen appears. Alternatively, press an item in the upper hierarchy in the sub-menu area to return to the item.

13.2 User settings

13.2.1 PDL Setting

Configure settings for the Page Description Language. (Default: [Auto])

- [Auto]: Select this option to automatically switch between PCL and PS.
- [PCL]: Select this option to use PCL only.
- [PS]: Select this option to use PS only.

1 In the User Settings screen, press [Printer Settings].

→ For details on displaying the User Settings screen, refer to page 13-2.

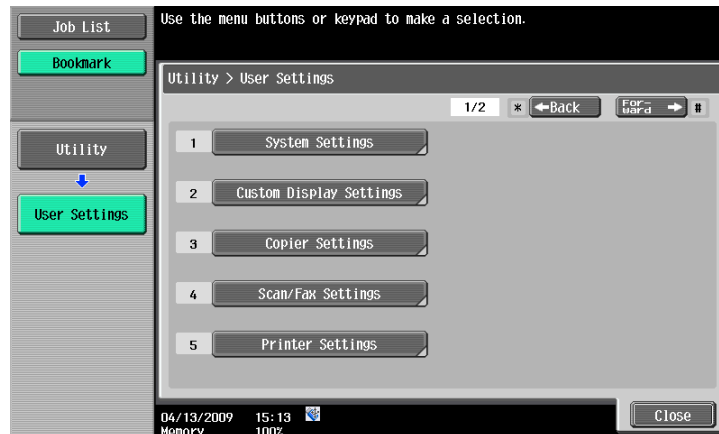

2 Press [Basic Settings].



3 Press [PDL Setting].



- 4 Press the desired button.



13.2.2 Number of Copies

Specify the default number of sets. (Default: 1)

- 1 In the User Settings screen, press [Printer Settings].
→ For details on displaying the User Settings screen, refer to page 13-2.
- 2 Press [Basic Settings].
- 3 Press [Number of Copies].



- 4 Press the **C** key to clear the value, and then use the keypad to enter the number of sets. (1 to 9999)
→ If a value outside of the allowable range is specified, the message "Input error" appears. Enter a number within the allowable range.



- 5 Press [OK].
The number of sets is specified.

13.2.3 Original Direction

Specify the default image direction. (Default: [Portrait])

- [Portrait]: Select this option to print the image vertically.
- [Landscape]: Select this option to print the image horizontally.

- 1 In the User Settings screen, press [Printer Settings].
→ For details on displaying the User Settings screen, refer to page 13-2.
- 2 Press [Basic Settings].
- 3 Press [Original Direction].



- 4 Press the desired button.



13.2.4 Spool Print Jobs in HDD before RIP

Specify the spool function. (Default: [ON])

- [ON]: When the next job is received while processing a job, the print data is stored in HDD.
- [OFF]: The print data is not stored in HDD.

Reference

- Normally, do not change this setting to [OFF]. Otherwise, normal printing may be interfered.

- 1 In the User Settings screen, press [Printer Settings].
→ For details on displaying the User Settings screen, refer to page 13-2.
- 2 Press [Basic Settings].
- 3 Press [Spool Print Jobs in HDD before RIP].



- 4 Press the desired button.



13.2.5 A4/A3<->LTR/LGR Auto Switch

When the paper of the size specified with the printer driver is not loaded on the tray, size conversion between A4 and Letter, or A3 and Ledger is executed to use paper of the next most similar size. (Default: [OFF])

Reference

- The image may be affected since printing is forced.
- 1 In the User Settings screen, press [Printer Settings].
→ For details on displaying the User Settings screen, refer to page 13-2.
 - 2 Press [Basic Settings].
 - 3 Select [A4/A3<->LTR/LGR Auto Switch].



- 4 Press the desired button.



13.2.6 Banner Sheet Setting

Specify whether to print the banner page (cover page) showing the sender or title of the print job. (Default: [OFF])

- [ON]: Select this option to print the banner page.
- [OFF]: Select this option to not print the banner page.

- 1 In the User Settings screen, press [Printer Settings].
→ For details on displaying the User Settings screen, refer to page 13-2.
- 2 Press [Basic Settings].
- 3 Switch the page by pressing [↑] or [↓], and then press [Banner Sheet Setting].



- 4 Press the desired button.

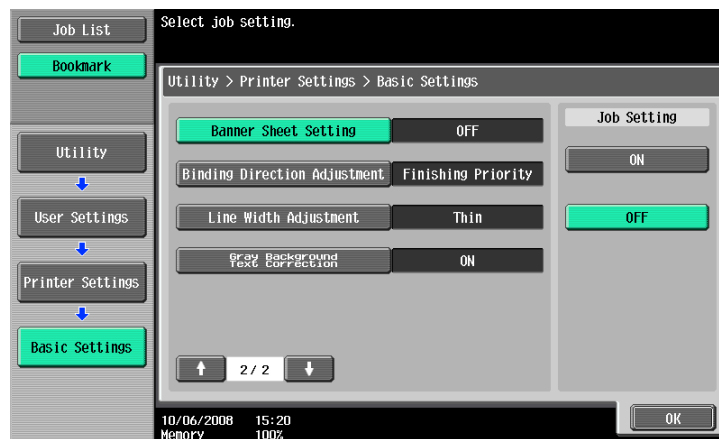

13.2.7 Binding Direction Adjustment

Specify the method for paper arrangement (adjusting the binding position) for 2-sided printing. (Default: [Finishing Priority])

To increase the print efficiency, specify [Productivity Priority]. If the desired binding position and width cannot be achieved, specify [Finishing Priority].

- [Finishing Priority]: All pages can be processed to an optimum condition because the machine adjusts the binding positions after receiving the print data.
- [Productivity Priority]: Printing is performed efficiently because the printer processes data while receiving or printing concurrently.
- [Control Adjustments]: The printer follows the settings configured in the printer driver without adjusting the binding position.

- 1 In the User Settings screen, press [Printer Settings].
→ For details on displaying the User Settings screen, refer to page 13-2.
- 2 Press [Basic Settings].
- 3 Switch the page by pressing [↑] or [↓], and then press [Binding Direction Adjustment].

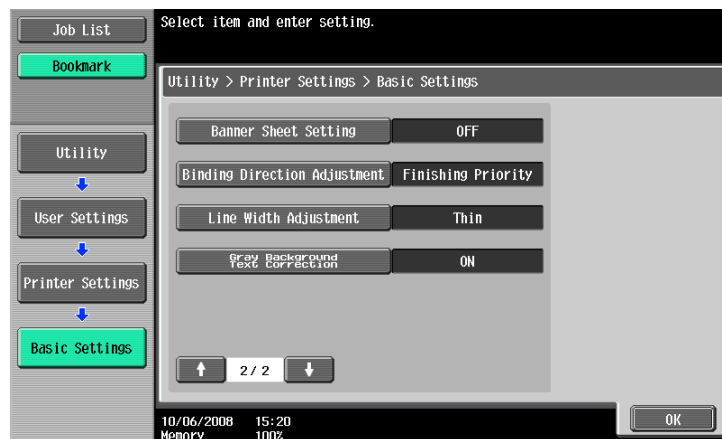

- 4 Press the desired button.



13.2.8 Line Width Adjustment

Line width can be adjusted so that thin lines and small letters become easy to see. (Default: [Thin])

- [Thin]: Select this option to draw letters and lines sharply. Details of letters and figures are printed elaborately.
- [Normal]: Select this option to draw letters and lines with a normal thickness.
- [Thick]: Select this option to draw letters and lines thickly. Letters and figures are printed clearly.

- 1 In the User Settings screen, press [Printer Settings].
→ For details on displaying the User Settings screen, refer to page 13-2.
- 2 Press [Basic Settings].
- 3 Switch the page by pressing [↑] or [↓], and then press [Line Width Adjustment].



- 4 Press the desired button.

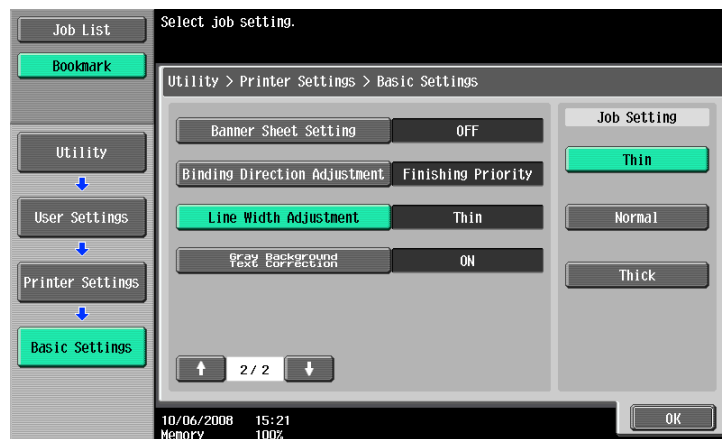

13.2.9 Gray Background Text Correction

Letters or lines on a gray background may look thicker than those on a non-gray background. This feature allows you to correct the line width setting.

- [ON]: Select this option to make the width of letters and lines on a gray background identical to that of those letters and lines on a non-gray background.
- [OFF]: Select this option to not make a correction.

- 1 In the User Settings screen, press [Printer Settings].
→ For details on displaying the User Settings screen, refer to page 13-2.
- 2 Press [Basic Settings].
- 3 Switch the page by pressing [↑] or [↓], and then press [Gray Background Text Correction].



- 4 Press the desired button.

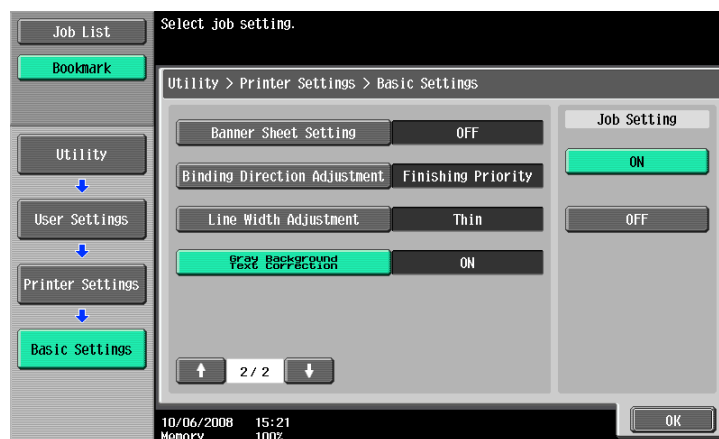

13.2.10 Paper Tray

Specify the default paper tray setting. (Default: [Auto])

- 1 In the User Settings screen, press [Printer Settings].
→ For details on displaying the User Settings screen, refer to page 13-2.
- 2 Press [Paper Setting].



- 3 Press [Paper Tray].



- 4 Press the button for the desired paper tray.
→ To select the paper tray automatically, press [Auto].



- 5 Press [OK].

13.2.11 Paper Size

Specify the default paper size setting. (Default: Varies depending on the area.)

- 1 In the User Settings screen, press [Printer Settings].
→ For details on displaying the User Settings screen, refer to page 13-2.
- 2 Press [Paper Setting].
- 3 Select [Paper Size].



- 4 Press the desired button.
→ When selecting other paper size, press [↑] or [↓] to switch the page.



- 5 Press [OK].

13.2.12 2-Sided Print

Configure the default 2-sided printing setting. (Default: [OFF])

- 1 In the User Settings screen, press [Printer Settings].
→ For details on displaying the User Settings screen, refer to page 13-2.
- 2 Press [Paper Setting].
- 3 Press [2-Sided Print].



- 4 Press the desired button.

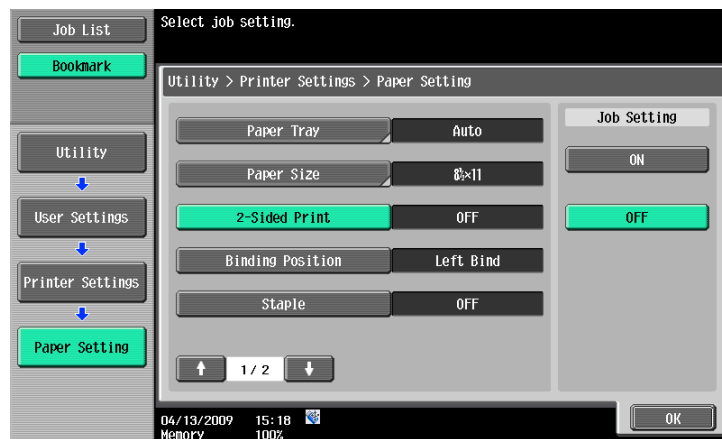

13.2.13 Binding Position

Specify the default binding position for 2-sided printing. (Default: [Left Bind])

- 1 In the User Settings screen, press [Printer Settings].
→ For details on displaying the User Settings screen, refer to page 13-2.
- 2 Press [Paper Setting].
- 3 Press [Binding Position].



- 4 Press the desired button.



13.2.14 Staple

Configure the staple setting when the data to be printed has no staple setting information. (Default: [OFF])

- 1 In the User Settings screen, press [Printer Settings].
→ For details on displaying the User Settings screen, refer to page 13-2.
- 2 Press [Paper Setting].
- 3 Press [Staple].



- 4 Press the desired button.

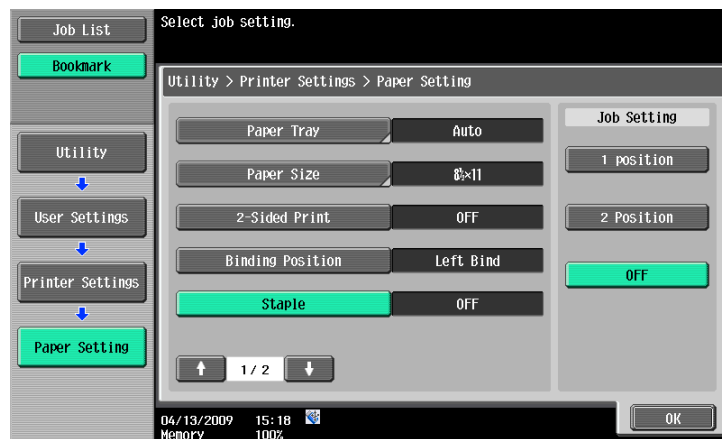

Reference

- The staple function is available only when the optional **Finisher FS-527** or **Finisher FS-529** is installed.

13.2.15 Punch

Configure the punch setting when the data to be printed has no punch setting information. (Default: [OFF])

- 1 In the User Settings screen, press [Printer Settings].
→ For details on displaying the User Settings screen, refer to page 13-2.
- 2 Press [Paper Setting].
- 3 Switch the page by pressing [↑] or [↓], and then press [Punch].

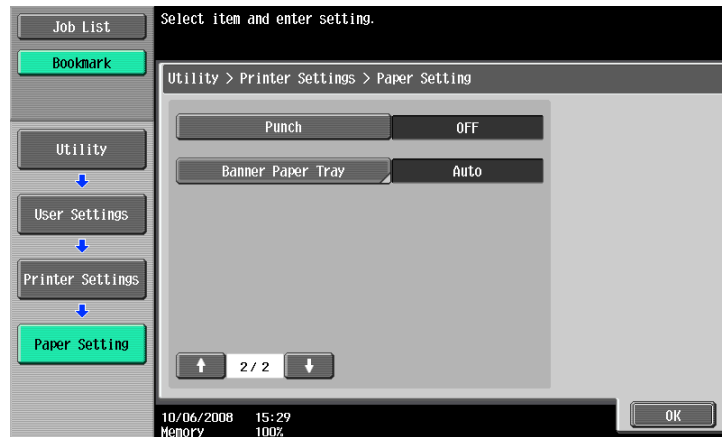

- 4 Press the desired button.

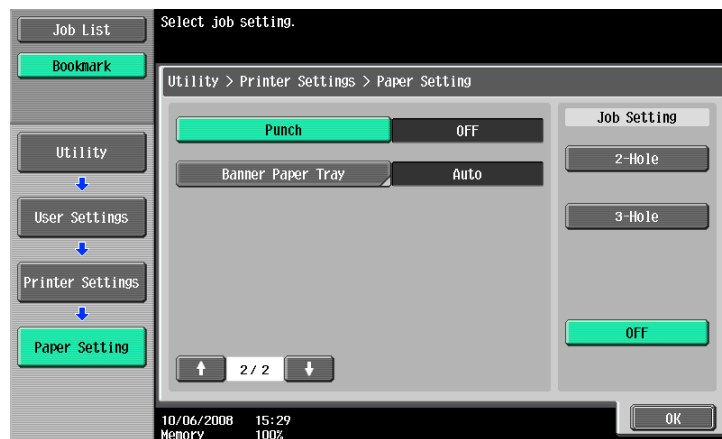

Reference

- The punch function is available only when the punch kit is installed on the optional **Finisher FS-527**.

13.2.16 Banner Sheet Paper Tray

Specify the paper tray used to print banner pages. (Default: [Auto])

- 1 In the User Settings screen, press [Printer Settings].
→ For details on displaying the User Settings screen, refer to page 13-2.
- 2 Press [Paper Setting].
- 3 Switch the page by pressing [↑] or [↓], and then press [Banner Paper Tray].



- 4 Press the desired button.

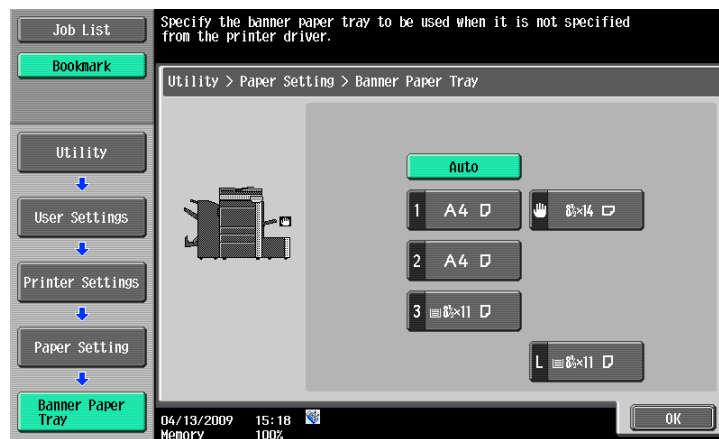

- 5 Press [OK].

13.2.17 Font Settings

Configure the default font setting. (Default: Courier)

- 1 In the User Settings screen, press [Printer Settings].
→ For details on displaying the User Settings screen, refer to page 13-2.
- 2 Press [PCL Settings].

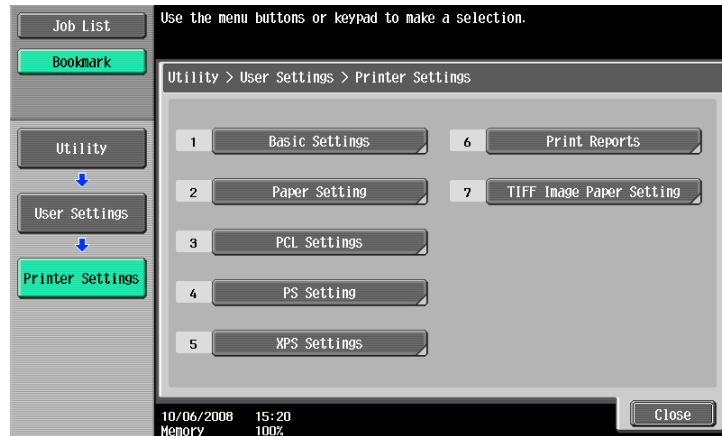

- 3 Press [Font Settings].



- 4 Press [Resident Font].
→ If downloaded fonts are available, [Download Font] can also be selected.

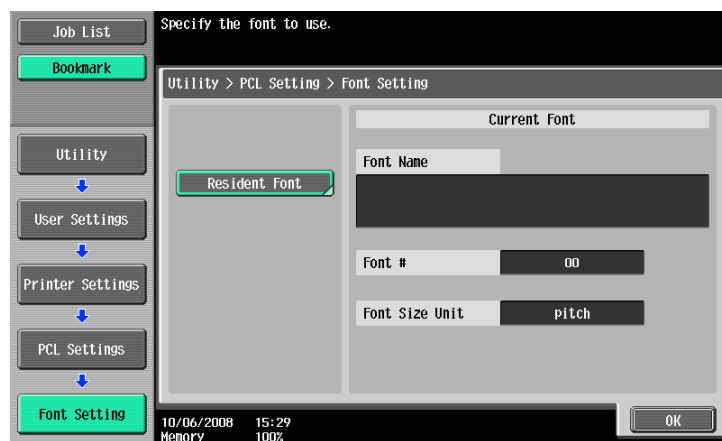

- 5 Press the desired font name.
 - Switch the page by pressing [↑] or [↓], and then press the desired font name.
 - You can check the font number and the font size unit of the selected font.

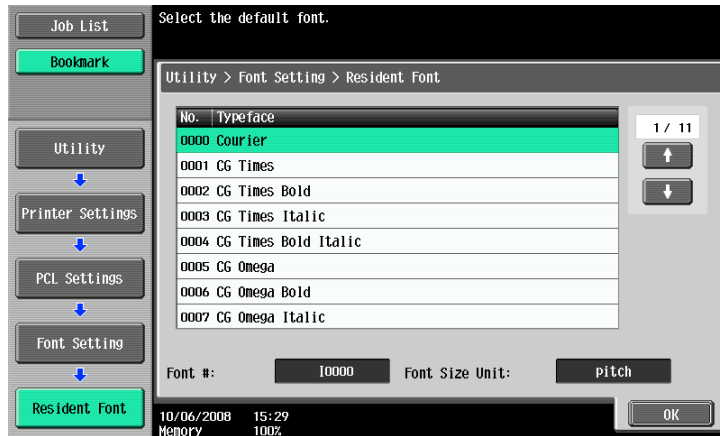

- 6 Press [OK].

13.2.18 Symbol Set

Configure the default font symbol set setting. (Default: Varies depending on the area.)

- 1 In the User Settings screen, press [Printer Settings].
 - For details on displaying the User Settings screen, refer to page 13-2.
- 2 Press [PCL Settings].
- 3 Press [Symbol Set].



- 4 Press the desired symbol set name.
 - Switch the page by pressing [↑] or [↓], and then press the desired symbol set name.

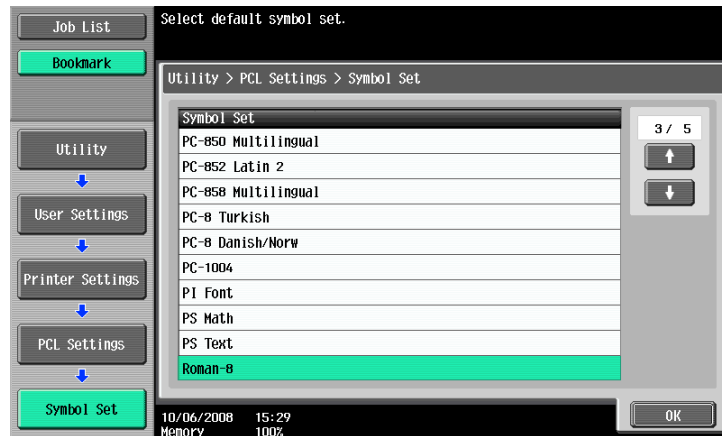

- 5 Press [OK].

13.2.19 Font Size

Specify the default font size value. (Default: [Scalable Font] - 12.00 Point/[Bitmap Font] - 10.00 Pitch)

- [Scalable Font]: Specify the font size in points.
- [Bitmap Font]: Specify the width of the bitmap font in pitches.

- 1 In the User Settings screen, press [Printer Settings].
 - For details on displaying the User Settings screen, refer to page 13-2.
- 2 Press [PCL Settings].
- 3 Press [Font Size].



- 4 Press the **C** key to clear the value, and then use the keypad to enter the size. (Scalable font: 4.00 Point - 999.75 Point, Bitmap Font: 0.44 Pitch - 99.00 Pitch)
- If a value outside of the allowable range is specified, the message "Input error" appears. Enter a number within the allowable range.

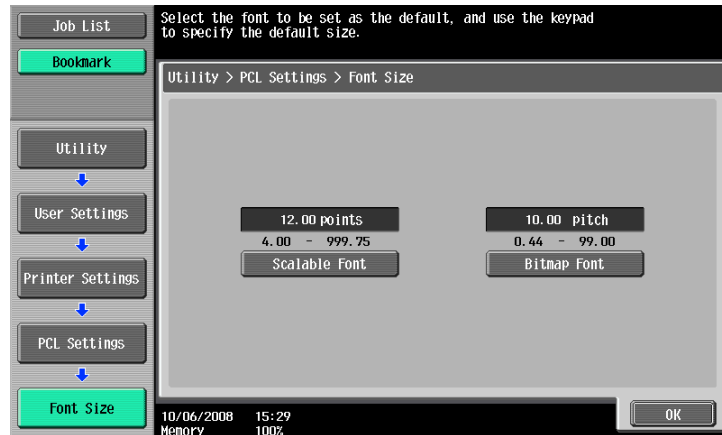

- 5 Press [OK].
The font size is set.

13.2.20 Line/Page

Specify the number of lines per page when printing text. (Default: Varies depending on the area.)

- 1 In the User Settings screen, press [Printer Settings].
→ For details on displaying the User Settings screen, refer to page 13-2.
- 2 Press [PCL Settings].
- 3 Press [Line/Page].



- 4 Press the **C** key to clear the value, and then use the keypad to enter the number of lines. (5 lines to 128 lines)
- If a value outside of the allowable range is specified, the message "Input error" appears. Enter a number within the allowable range.

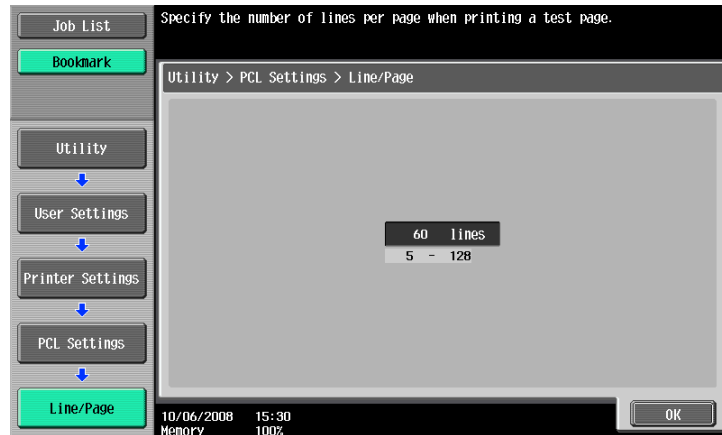

- 5 Press [OK].
The number of lines is set.

13.2.21 CR/LF Mapping

Specify the CR/LF substitution method when printing text data. (Default: [No])

- [Mode 1]: Select this option to substitute CR with CR-LF.
- [Mode 2]: Select this option to substitute LF with CR-LF.
- [Mode 3]: Select this option to substitute with CR-LF.
- [No]: Select this option not to perform substitution.

- 1 In the User Settings screen, press [Printer Settings].
→ For details on displaying the User Settings screen, refer to page 13-2.
- 2 Press [PCL Settings].
- 3 Press [CR/LF Mapping].

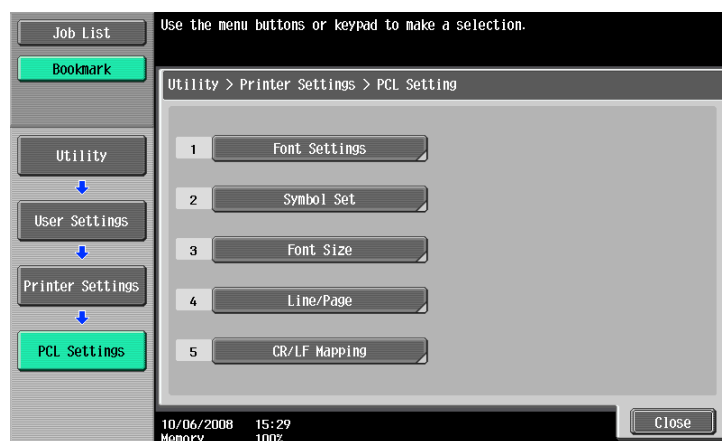

- 4 Select [Yes] or [No]. If [Yes] is selected, be sure to also press the button for the desired setting.



- 5 Press [OK].

13.2.22 Print PS Errors

Specify whether to print the error message when an error occurs during PS rasterization. (Default: [OFF])

- 1 In the User Settings screen, press [Printer Settings].
→ For details on displaying the User Settings screen, refer to page 13-2.
- 2 Press [PS Setting].



- 3 Press [Print PS Errors].

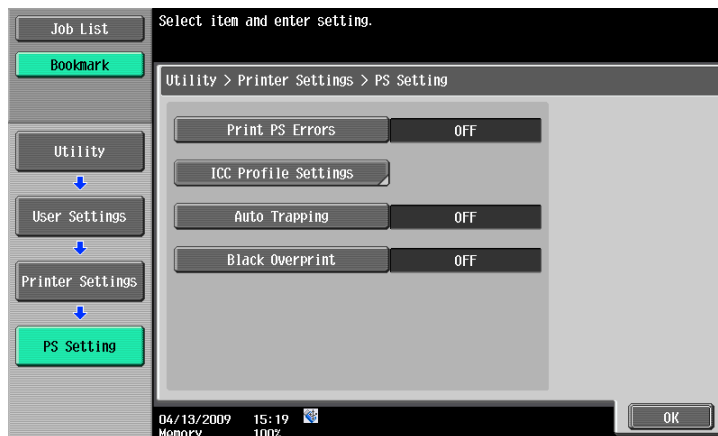

- 4 Press the desired button.

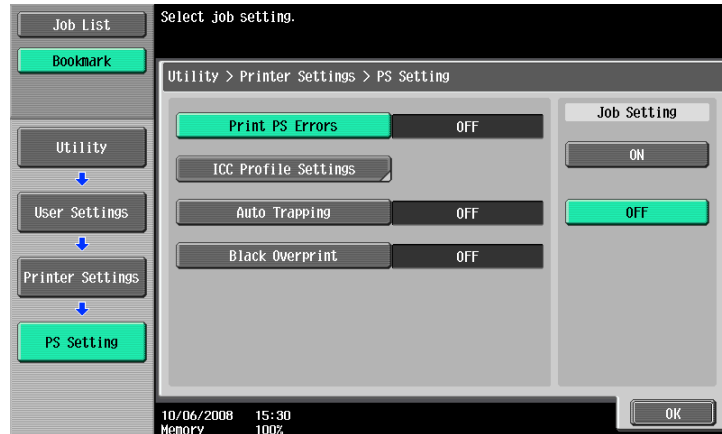

13.2.23 ICC Profile Settings

Configure the default profile setting to be displayed in the printer driver.



Reference

For details on selecting the ICC profiles on the printer driver, refer to page 12-36.

- 1 In the User Settings screen, press [Printer Settings].
→ For details on displaying the User Settings screen, refer to page 13-2.
- 2 Press [PS Setting].
- 3 Press [ICC Profile Settings].

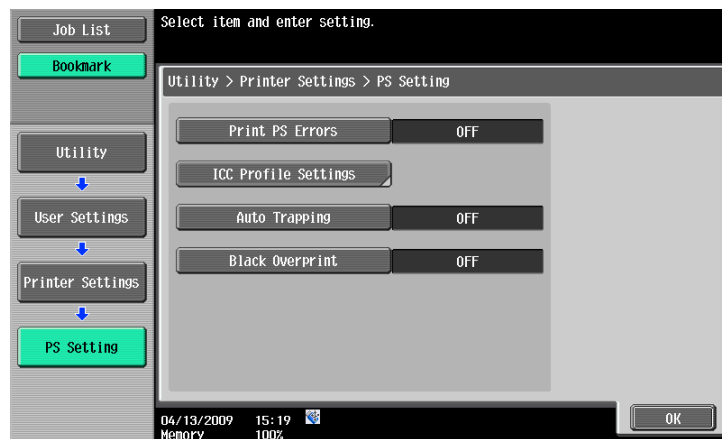

- 4 Press the desired setting item.

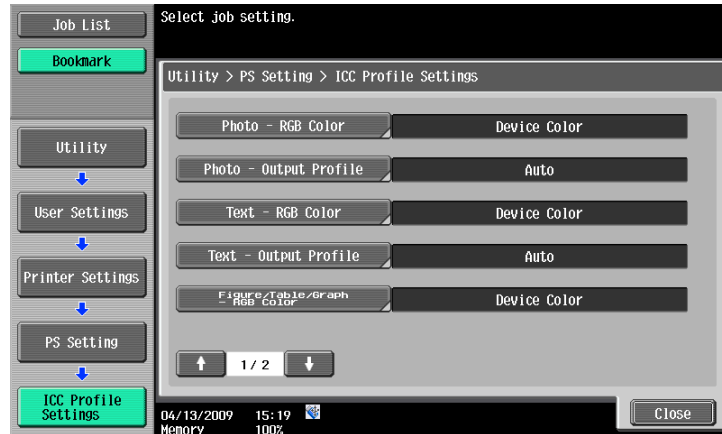

- 5 Press the desired profile name.

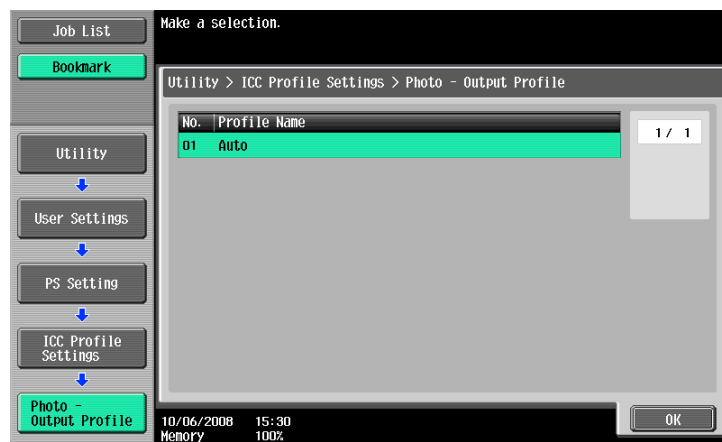

- 6 Press [OK].

13.2.24 Auto Trapping

Select this option to superimpose neighboring colors to print so as to prevent white space being generated around a picture. (Default: [OFF])

- [ON]: Adjacent colors are overprinted. If white lines appear at borders of colors on a graph or figure, select [ON].
- [OFF]: The data is printed as is without being trap-processed.

Reference

- If color-dulling results at the border of colors when [ON] is selected, change it to [OFF].
- Trapping process is sometimes specifiable with the application. When the trapping process is specified in the application, specify [OFF] on the machine side.

- 1 In the User Settings screen, press [Printer Settings].
→ For details on displaying the User Settings screen, refer to page 13-2.
- 2 Press [PS Setting].
- 3 Press [Auto Trapping].

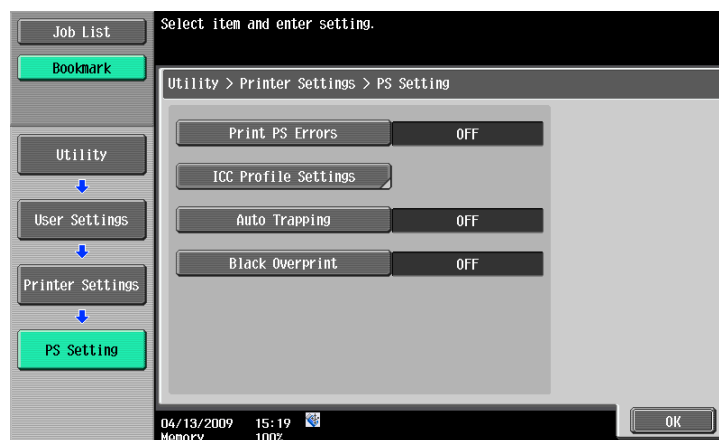

- 4 Press the desired button.

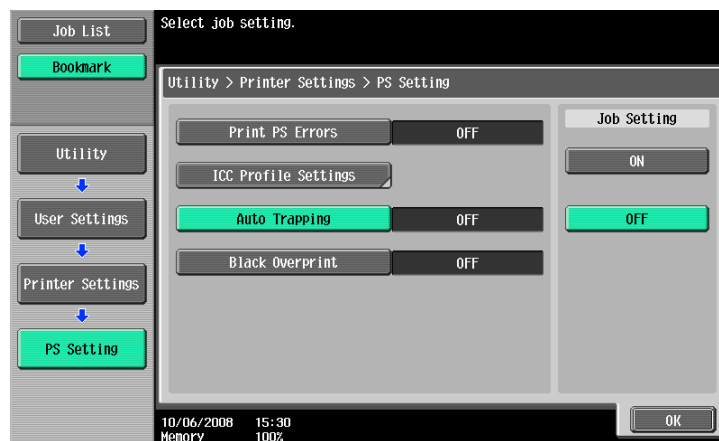

13.2.25 Black Overprint

Select this option to print with no white space around black characters or figures. (Default: [OFF])

- [Text/Figure]: Adjacent portion between a text and figure is overprinted with black. Use this setting when a white line appears around the black portion in a graph or figure.
- [Text]: Black is overprinted on the adjacent colors in the text portion. Use this setting when a white line appears around the text.
- [OFF]: The data is printed as is without overprinting with black.

Reference

- If color-dulling results around the black portion when [ON] is selected, change it to [OFF].
- The black overprinting process is sometimes specifiable with the application. When the trapping process is specified in the application, specify [OFF] on the machine side.

- 1 In the User Settings screen, press [Printer Settings].
→ For details on displaying the User Settings screen, refer to page 13-2.
- 2 Press [PS Setting].
- 3 Press [Black Overprint].

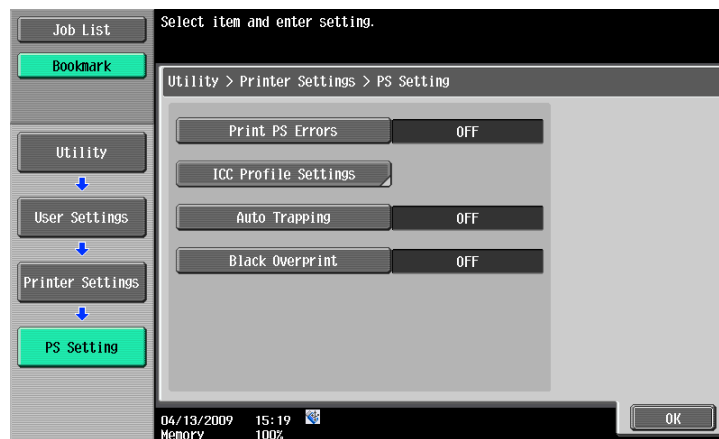

- 4 Press the desired button.

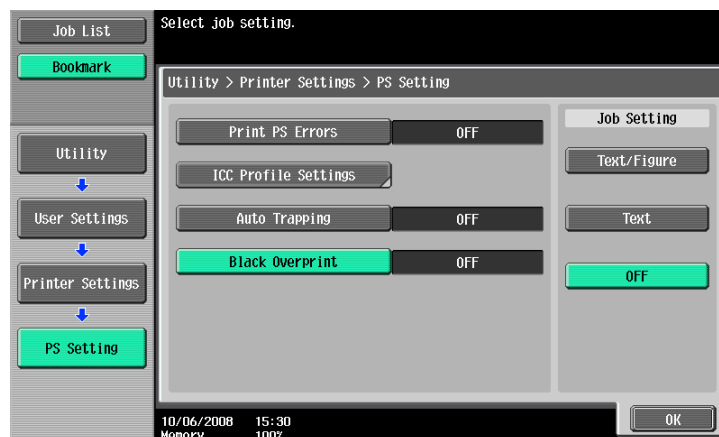

13.2.26 Verify XPS Digital Signature

Specify whether to perform digital signature verification in XPS printing. When [ON] is specified for the signature verification, the document without a valid digital signature is not printed. (Default: [OFF])

- 1 In the User Settings screen, press [Printer Settings].
 - For details on displaying the User Settings screen, refer to page 13-2.
- 2 Press [XPS Settings].
 - If an error is detected in the signature verification while [Print XPS Errors] is specified to print the information, the error information is printed. For details, refer to page 13-54.



- 3 Press [Verify XPS Digital Signature].

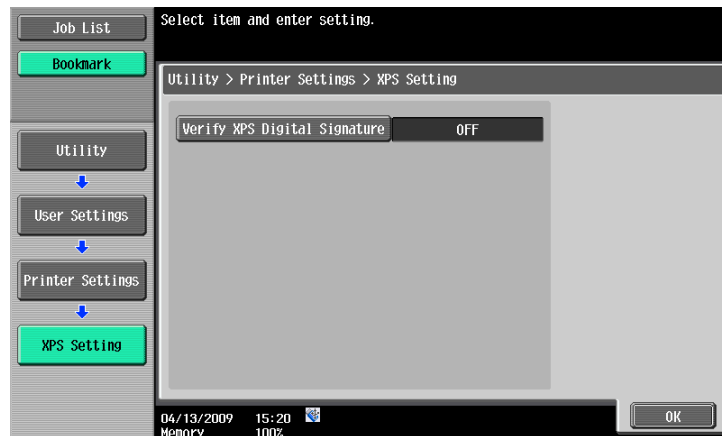

- 4 Press the desired button.



13.2.27 Print Reports

Print reports. The following four types of reports can be output. The following describes the report output method taking the PCL font list output process as an example.

- [Configuration Page]: Select this option to output the list of settings of the machine.
- [Demo Page]: Select this option to output a test page.
- [PCL Font List]: Select this option to output the PCL font list.
- [PS Font List]: Select this option to output the PS font list.

1 In the User Settings screen, press [Printer Settings].
→ For details on displaying the User Settings screen, refer to page 13-2.

2 Press [Print Reports].



- 3 Press the desired button.



- 4 Press the button of the desired paper tray, and then either 1-Sided or 2-Sided button.

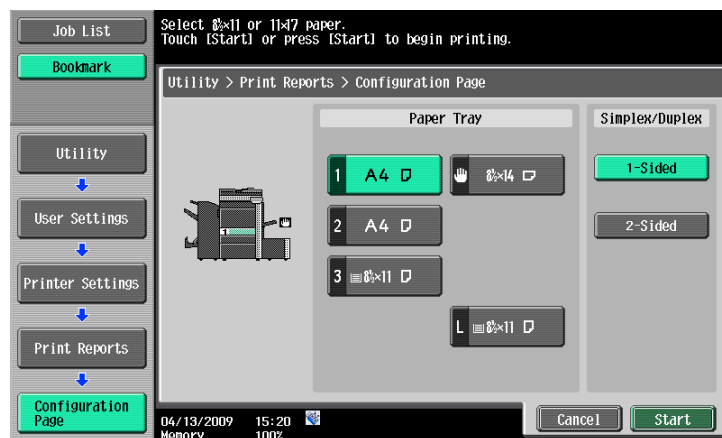

- 5 Press [Start] or the **Start** key to print the report.
 → To stop operations, press [Cancel].

13.2.28 TIFF Image Paper Setting

Select this option to configure how to determine the paper size when directly printing TIFF or JPEG image data. (Default: [Auto Paper Select])

Direct print is used to print documents using the direct print function of **PageScope Web Connection** or from external memory, or cellular phone/PDA.

- [Auto Paper Select]:
 For TIFF/JPEG (JFIF), select this option to calculate the size of the image based on its resolution and the number of pixels to print the image on paper that fits the image size. Select this option to print images on paper of the same size as the image.
 For JPEG (EXIF), an image is printed based on the paper size that is specified in [User Settings] - [Printer Settings] - [Paper Setting] - [Paper Size]. An image is enlarged or reduced to fit the paper size.
- [Priority Paper Size]:
 When printing from a cellular phone or PDA, an image is printed based on the paper size that is specified in [User Settings] - [Cellular Phone/PDA Settings] - [Print] - [Paper].
 When using direct printing from PageScope Web Connection or external memory, an image is printed based on the paper size that is specified in [User Settings] - [Printer Settings] - [Paper Setting] - [Paper Size].
 An image is enlarged or reduced to fit the paper size.

- 1 In the User Settings screen, press [Printer Settings].
 → For details on displaying the User Settings screen, refer to page 13-2.

- 2 Press [TIFF Image Paper Setting].



- 3 Press [Paper Selection].



- 4 Press the desired button.

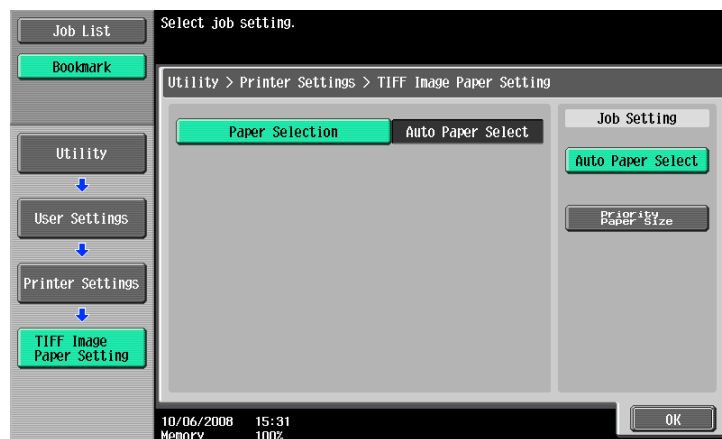

13.2.29 Link File Error Notification

This function enables you to specify processing to be performed if the machine cannot access a link file when attempting to print an XHTML file from a cellular phone or PDA. (Default: [ON])

- [ON]: Prints a link file part in a black frame.
- [OFF]: Does not print a link file part.

Reference

- Cellular Phone/PDA Setting is displayed when the optional **Local Interface Kit EK-605** is installed while [Bluetooth Setting] is enabled in this machine and [Cellular Phone/PDA Setting] is enabled in Administrator Settings. For details, refer to page 13-58.

- 1 In the User Settings screen, press [Cellular Phone/PDA Setting].
 - For details on displaying the User Settings screen, refer to page 13-2.
 - [Cellular Phone/PDA Setting] is displayed in the 2/2 screen. Press [Forward →] to switch the screen.

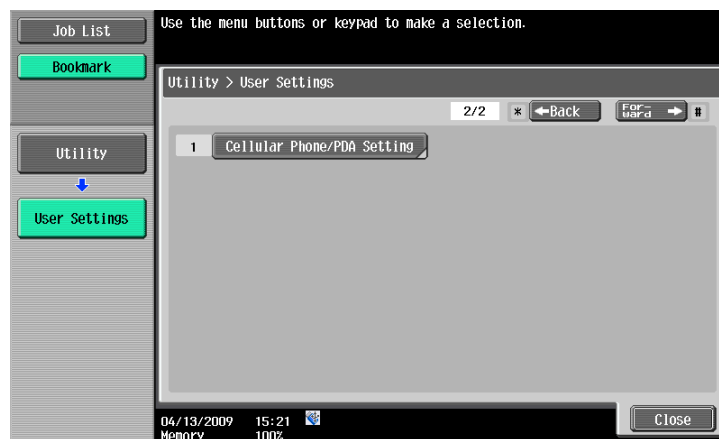

- 2 Press [Link File Error Notification].

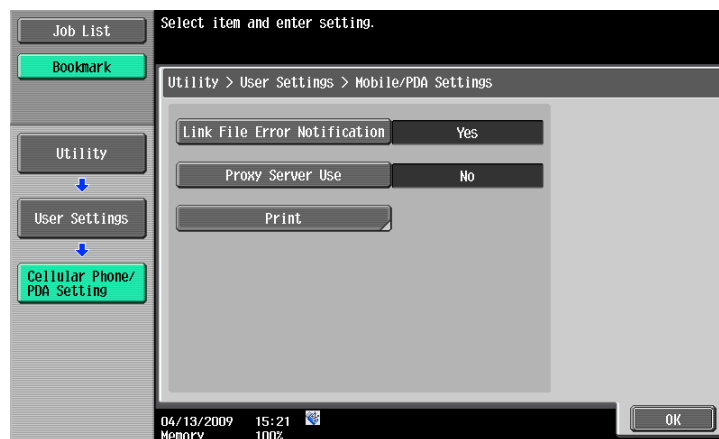

- 3 Press the desired button.

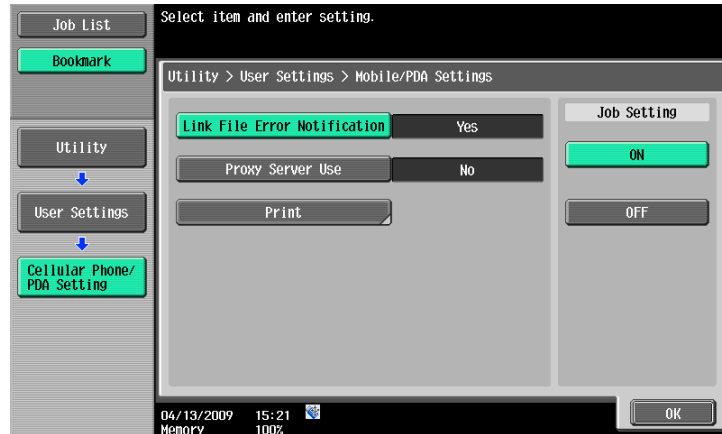

13.2.30 Use Proxy Server

This function enables you to specify whether the machine uses a proxy server to access a link file when printing an XHTML file from a cellular phone or PDA. (Default: [OFF])

- [ON]: Uses a proxy server.
- [OFF]: Does not use a proxy server.

Reference

- Cellular Phone/PDA Setting is displayed when the optional **Local Interface Kit EK-605** is installed while [Bluetooth Setting] is enabled in this machine and [Cellular Phone/PDA Setting] is enabled in Administrator Settings. For details, refer to page 13-58.
- When using a proxy server for connection, select [Administrator Settings] - [Network Settings] - [WebDAV Settings] - [WebDAV Client Settings] - [Proxy Server Address] to register the desired proxy server. For details, refer to the [User's Guide Network Administrator].

- 1 In the User Settings screen, press [Cellular Phone/PDA Setting].
- For details on displaying the User Settings screen, refer to page 13-2.
 - [Cellular Phone/PDA Setting] is displayed in the 2/2 screen. Press [Forward →] to switch the screen.

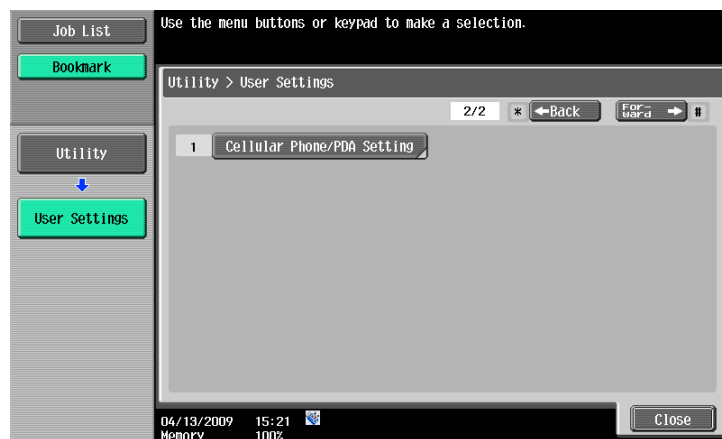

- 2 Press [Proxy Server Use].

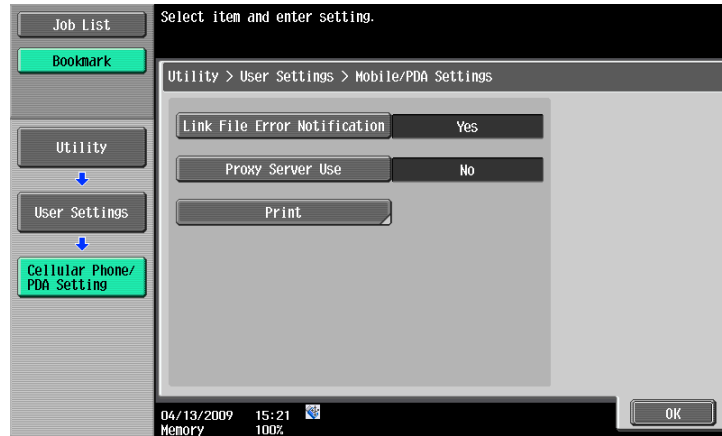

- 3 Press the desired button.

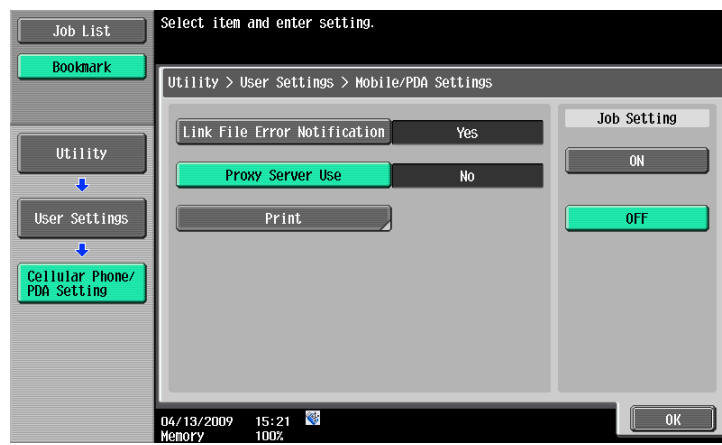

13.2.31 Print

Specify print conditions to print a document from a cellular phone or PDA. (Default: [1-Sided], [Full Color], [Finishing]-None)

- Basic - Print: Select 1-Sided or 2-Sided.
- Basic - Full Color: Select Full Color or Black.
- Basic - Paper: Select the printing paper size if the sent data does not contain paper size information.
- Basic - Finishing: Specify Fold/Bind, Staple, or Punch.
- Application - Margin: Select the margin position.
- Application - Stamp/Composition: Composes the following contents when printing.

[Date/Time]	The date and time of printing are printed on the pages.
[Page Number]	A page number is printed on all pages of a document.
[Stamp]	A preset character string such as "URGENT" is printed on pages.
[Copy Security]	A pattern to prevent unauthorized copying is printed on pages. [Copy Protect]: Prints hidden text. [Copy Guard]: Prints a Copy Guard pattern. [Password Copy]: Prints a password for Password Copy.
[Stamp Repeat]	Text or an image is repeatedly printed on all pages.

Reference

- Cellular Phone/PDA Setting is displayed when the optional **Local Interface Kit EK-605** is installed while [Bluetooth Setting] is enabled in this machine and [Cellular Phone/PDA Setting] is enabled in Administrator Settings For details, refer to page 13-58.
- The contents of [TIFF Image Paper Setting] also affect the paper size output when printing from a cellular phone or PDA. For details, refer to page 13-32.
- [Copy Guard] or [Password Copy] is displayed when the optional **Security Kit SC-507** is installed. For details, refer to the [User's Guide Copy Operations].

1 In the User Settings screen, press [Cellular Phone/PDA Setting].

→ For details on displaying the User Settings screen, refer to page 13-2.

→ [Cellular Phone/PDA Setting] is displayed in the 2/2 screen. Press [Forward→] to switch the screen.

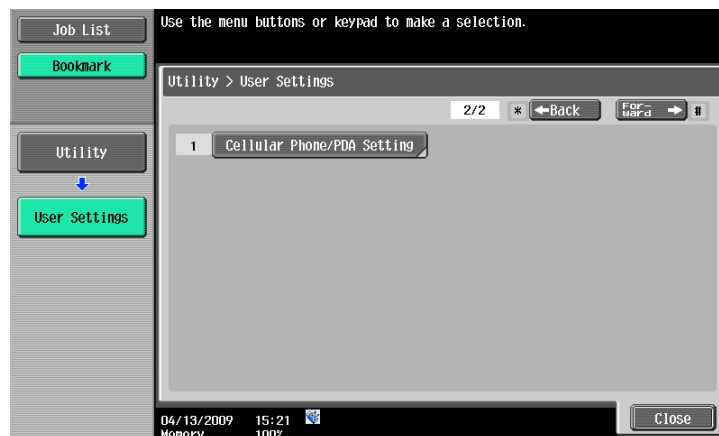

- 2 Press [Print].

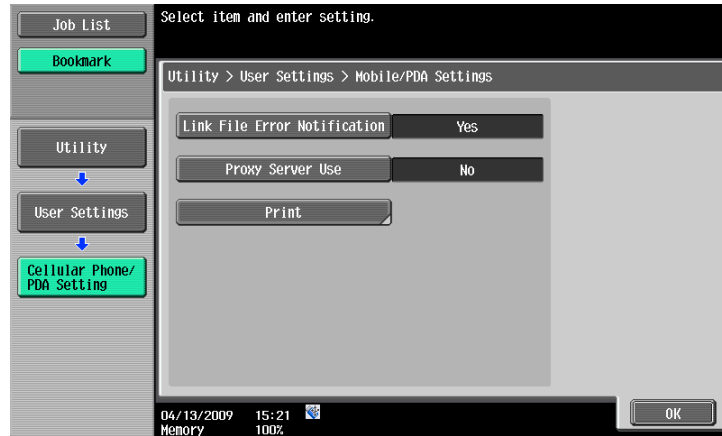

- 3 Press the desired button.



13.3 Basic operations in Administrator Settings

13.3.1 Displaying the Administrator Settings screen

- 1 Press the **Utility/Counter** key.

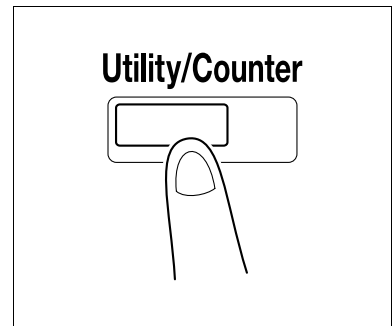

- 2 Press [Administrator Settings].

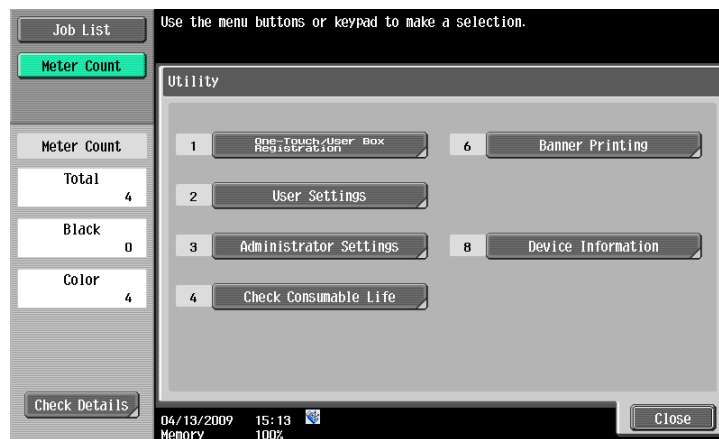

- 3 Enter the password, and then press [OK].
 → For details on setting or changing the password, refer to the [User's Guide Copy Operations].



The Administrator Settings screen appears.



- It can also be selected by pressing the key in the keypad of the number indicated on the desired button. For [Administrator Settings], press the **3** key on the keypad.
- To finish configuring the Utility mode settings, press the **Utility/Counter** key. You can also exit the Utility screen by pressing [Close] until either the Copy, Fax/Scan or User Box screen appears.
- To return through the hierarchy of the Utility menu, press [Close] until the desired screen appears. Alternatively, press an item in the upper hierarchy in the sub-menu area to return to the item.

13.4 Administrator Settings

13.4.1 Print/Fax Output Setting

Specify the timing for printing; to print data when it is received, after the reception is completed, or simultaneously as it is being received.

This setting can be configured separately between for printer and for fax. (Default: [Print] - [Page Print], [Fax] - [Batch Print])

- 1 In the Administrator Settings screen, press [System Settings].
→ For details on displaying the Administrator Settings screen, refer to page 13-39.
- 2 In the System Settings screen, press [Output Settings].
- 3 In the Output Settings screen, press [Print/Fax Output Setting].

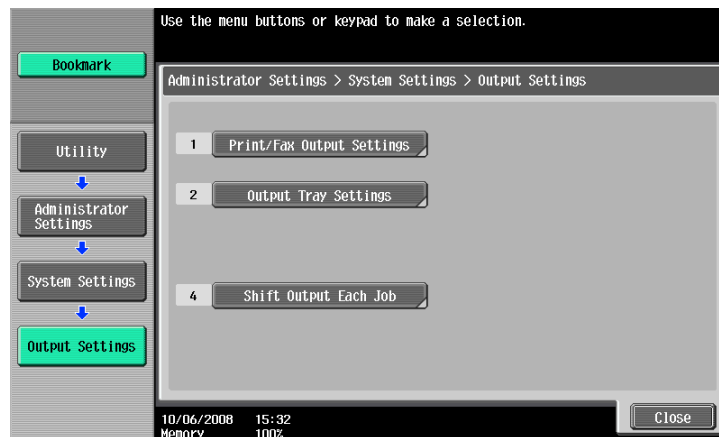

The Print/Fax Output Setting screen appears.

- 4 Press [Print] or [Fax].
- 5 Press the desired button.

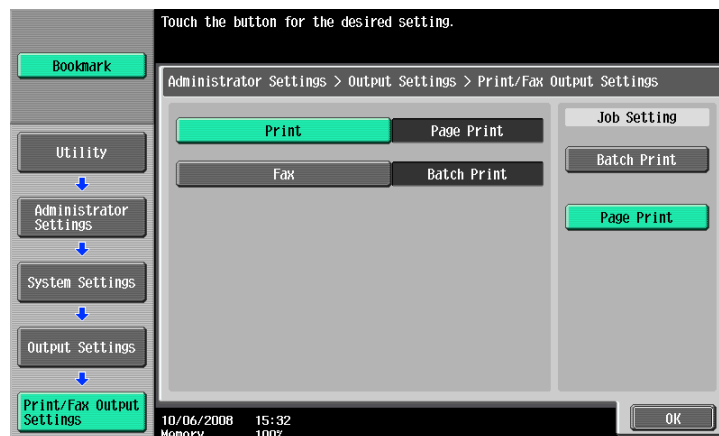

The timing for printing data is set.

→ If Batch Print is selected, printing starts after all the data is received. If Page Print is selected, printing starts when the data for the first page is received.

Reference

- If the [Administrator Security Levels] is set to [Level 2], this setting item can be specified in the User Settings as well. Press [User Settings] - [System Settings] - [Output Settings] - [Print/Fax Output Settings] to display the Print/Fax Output Setting screen.
- For details on the administrator security levels, refer to the [User's Guide Copy Operations].

13.4.2 Output Tray Settings

Configure the default output tray settings. (Default: [Print] - [Tray 2])

- 1 In the Administrator Settings screen, press [System Settings].
→ For details on displaying the Administrator Settings screen, refer to page 13-39.
- 2 In the System Settings screen, press [Output Settings].
- 3 In the Output Settings screen, press [Output Tray Settings].

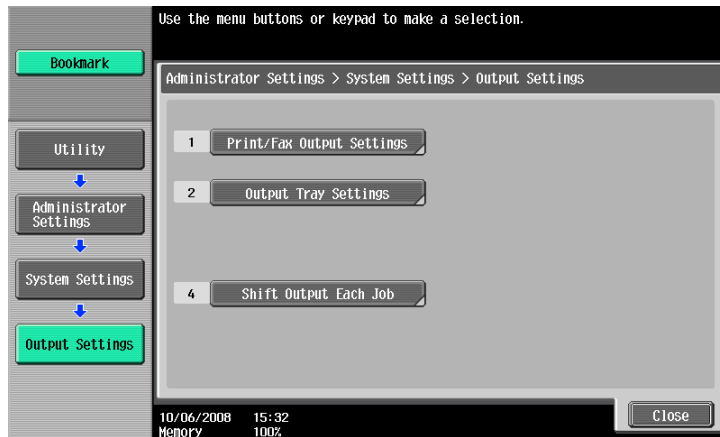

The Output Tray Settings screen appears.

- 4 Press the desired button.

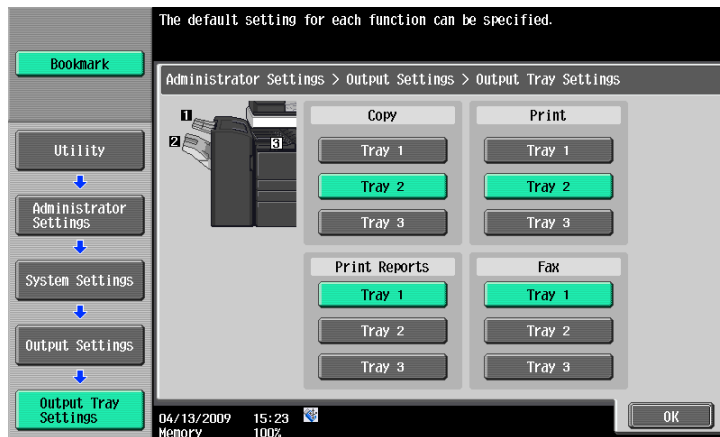

- 5 Press [OK].
The output tray is set.

13.4.3 Delete Secure Print Documents

This function deletes all the secure print documents saved.

- 1 In the Administrator Settings screen, press [System Settings].
→ For details on displaying the Administrator Settings screen, refer to page 13-39.
- 2 In the System Settings screen, press [User Box Settings].
- 3 In the User Box Settings screen, press [Delete Secure Print Documents].



- 4 To delete the secure print documents, press [Yes].



- 5 Press [OK].

13.4.4 Auto Delete Secure Document

Specify the length of time for deleting a secure document after it is saved. (Default: [1 day])

- 1 In the Administrator Settings screen, press [System Settings].
→ For details on displaying the Administrator Settings screen, refer to page 13-39.
- 2 In the System Settings screen, press [User Box Settings].
- 3 In the User Box Settings screen, press [Auto Delete Secure Document].



- 4 Press the desired button.
→ To specify the time manually, press [Time] and then enter the time from the keypad.



- 5 Press [OK].

13.4.5 ID & Print Delete Time

Specify the length of time for deleting an ID & print document after it is saved. (Default: [1 day])

Reference

- [ID & Print Delete Time] is displayed when the user authentication is enabled on the machine.

- 1 In the Administrator Settings screen, press [System Settings].
→ For details on displaying the Administrator Settings screen, refer to page 13-39.
- 2 In the System Settings screen, press [User Box Settings].
- 3 In the User Box Settings screen, press [ID & Print Delete Time].



- 4 Press the desired button.
→ To specify the time manually, press [Time] and then enter the time from the keypad.

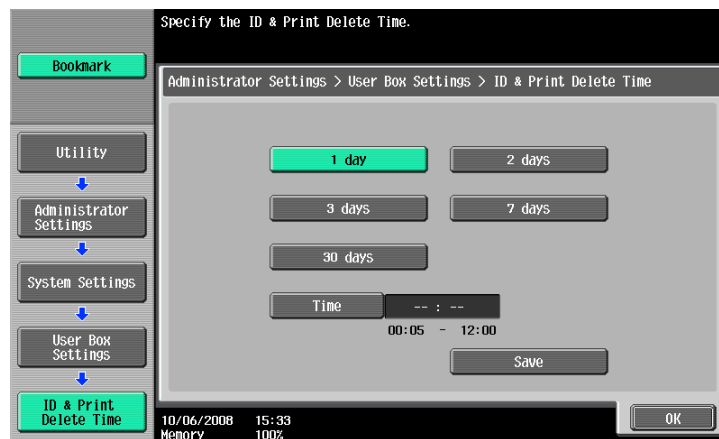

- 5 Press [OK].

13.4.6 ID & Print Delete after Print Setting

Specify whether to delete the ID & Print document after it is printed. (Default: [Confirm with User])

- [Confirm with User]: Select this option to display the screen where the user can select whether the document printed from the ID & Print User Box is deleted after it is printed. Select this option if you want to leave the document.
- [Always Delete]: Select this option to delete the document after printing. Deletion is not confirmed with user.

- 1 In the Administrator Settings screen, press [System Settings].
→ For details on displaying the Administrator Settings screen, refer to page 13-39.
- 2 In the System Settings screen, press [User Box Settings].
- 3 In the User Box Settings screen, press [ID & Print Delete after Print Setting].



- 4 Press the desired button.

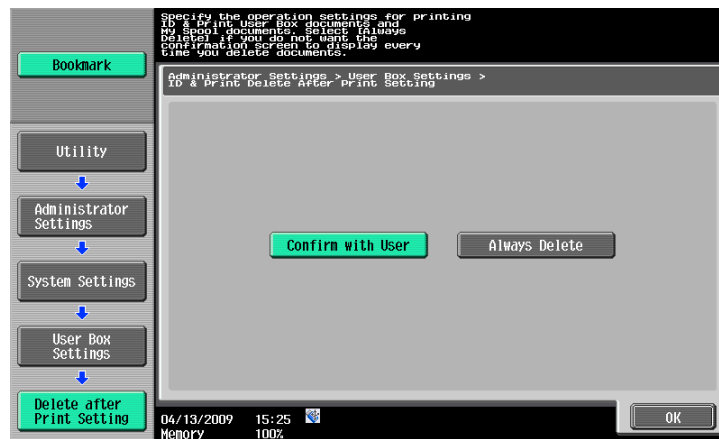

- 5 Press [OK].

13.4.7 Skip Job Operation Settings

Specify whether to start processing for the next job when the current job stops due to running out of paper in the paper tray. (Default: [Yes])

- [Yes]: Select this option to give precedence to processing of other job while maintaining the stopped job in the queued state. The queued job is processed after the problem is solved. This function is helpful because it prevents other jobs from queuing for simple reasons such as paper in a specific paper tray running out.
- [No]: If a single job is stopped, all other jobs are queued for processing as well. All jobs are processed after the problem is solved.

- 1 In the Administrator Settings screen, press [System Settings].
→ For details on displaying the Administrator Settings screen, refer to page 13-39.
- 2 In the System Settings screen, switch the page by pressing [←] or [→], and then press [Skip Job Operation Settings].

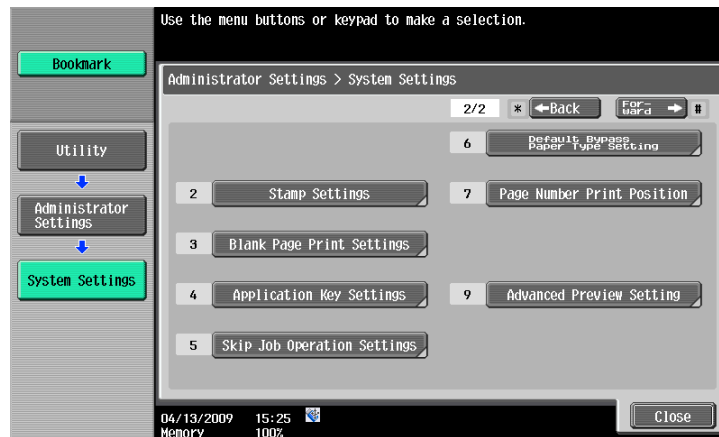

- 3 Press [Fax] or [Other than Fax].
- 4 Press the desired button.



13.4.8 ID & Print Settings

Specify whether to use the ID & Print function on the machine that performs user authentication or account track. (Default: [OFF])

- ID & Print [ON]: Select this option to process all print jobs requested from a registered user as ID & Print jobs and save them in [ID & Print User Box] even if [ID & Print] is not enabled on the printer driver.
- ID & Print [OFF]: Select this option to process jobs as ID & Print jobs only when [ID & Print] is enabled on the printer driver. Among print jobs requested from a registered user, [Print] jobs, for which [ID & Print] is not enabled on the printer driver, are output without being processed as ID & Print jobs.
- Public User [Print Immediately]: Select this option to output the public user jobs or jobs without user authentication information without saving.
- Public User [Save]: Select this option to process the public user jobs or jobs without user authentication information as ID & Print jobs and save them in the [ID & Print User Box].

Reference

- A public user job is printed or saved when public user printing is enabled.
- A user-unauthorized job is printed or saved when [Print without Authentication] is enabled.

- 1 In the Administrator Settings screen, press [User Authentication/Account Track].
→ For details on displaying the Administrator Settings screen, refer to page 13-39.
- 2 In the User Authentication/Account Track screen, press [User Authentication Settings].
- 3 In the User Authentication Settings screen, press [Administrative Setting].



- 4 In the Administrative Settings screen, press [ID & Print Settings].

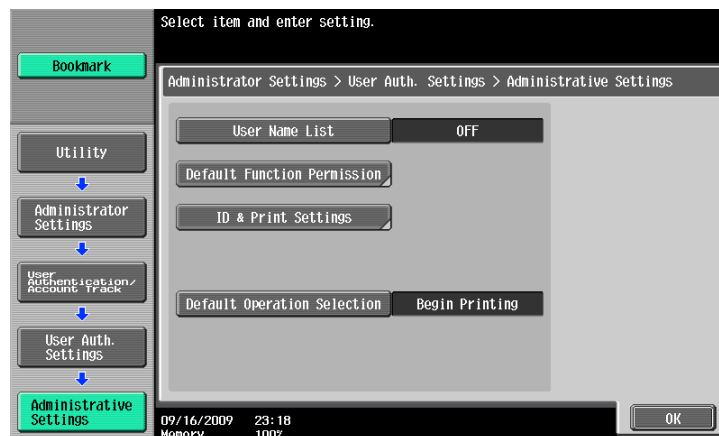

5 Specify [ID&Print] and [Public User].



6 Press [OK].

13.4.9 ID & Print Operation Settings

Specify the printing method when using the ID & Print function on an optional **Authentication Unit**. (Default: [Print All Jobs])

- [Print All Jobs]: Select this option to print all the documents authenticated at one setting when multiple documents are saved in the ID & Print User Box.
- [Print Each Job]: Select this option to print a document for each authentication when multiple documents are saved in the ID & Print User Box.

Reference

- The ID & Print Operation Settings appears on the screen only when an optional **Authentication Unit** is installed.

- 1 In the Administrator Settings screen, press [User Authentication/Account Track].
→ For details on displaying the Administrator Settings screen, refer to page 13-39.
- 2 In the User Authentication/Account Track screen, press [User Authentication Settings].
- 3 In the User Authentication Settings screen, press [Administrative Setting].



4 In the Administrative Settings screen, press [ID & Print Operation Settings].

- 5 Press the desired button.

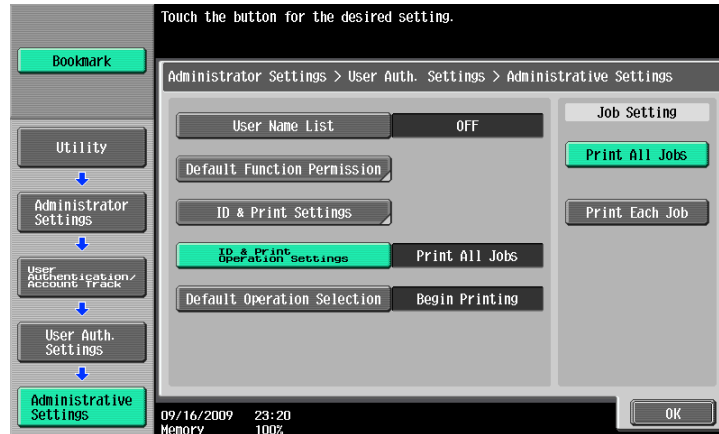

13.4.10 Default Operation Selection

Configure the default setting of the operation to be performed after authentication has been completed on the authentication unit (success in login) while this machine is holding ID & print jobs. (Default: [Begin Printing])

- [Begin Printing]: Select this option to print an ID & print job simultaneously with authentication. This option is convenient when there are many ID & print users. However, when using the copy or scan function on the control panel, select [Print & Access] or [Access] before authentication.
- [Print & Access]: Select this option to print an ID & print job simultaneously with authentication, and log in to the basic page. When using only the ID & print function, select [Begin Printing] before authentication.
- [Access]: Click this option to log in to the basic page. ID & print jobs are not executed. This option is convenient when there are few ID & print users. When using only the ID & Print function, select [Begin Printing] before authentication.

- 1 In the Administrator Settings screen, press [User Authentication/Account Track].
→ For details on displaying the Administrator Settings screen, refer to page 13-39.
- 2 In the User Authentication/Account Track screen, press [User Authentication Settings].
- 3 In the User Authentication Settings screen, press [Administrative Settings].



- 4 In the Administrative Setting screen, press [Default Operation Selection].

- 5 Press the desired button.

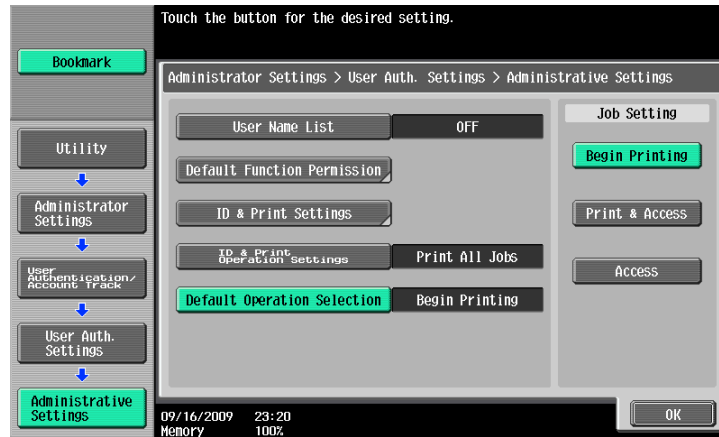

13.4.11 Print without Authentication

Specify whether to allow the print jobs without authentication specified when the machine is performing user authentication or account track. (Default: [Restrict])

- [Allow]: Select this option to allow the print jobs to be printed when an ID and password for user authentication or an account name and password for account track are not specified. Printing is counted as a public job.
- [Restrict]: Select this option not to allow the print jobs to be printed when an ID and password for user authentication or an account name and password for account track are not specified.

Reference

- If the print jobs without authentication specified are permitted to be printed, printing can be performed on this machine performing user authentication or account track, even if user authentication or account track is not specified in the printer driver. Select Restrict if you want to control usage for the counter management or security reasons.
- A print job without authentication specified means a job that performed printing without enabling User Authentication or Account Track in the printer driver. In Windows, it means a job for which User Authentication or Account Track is set to [Disable] in [Configure] tab - [Device Option] in the Properties window. In Macintosh OS X, it means a job for which the User Authentication or Account Track check box is not selected in the [Output Method] window.

- 1 In the Administrator Settings screen, press [User Authentication/Account Track].
→ For details on displaying the Administrator Settings screen, refer to page 13-39.
- 2 In the User Authentication/Account Track screen, press [Print without Authentication].
- 3 Press the desired button.

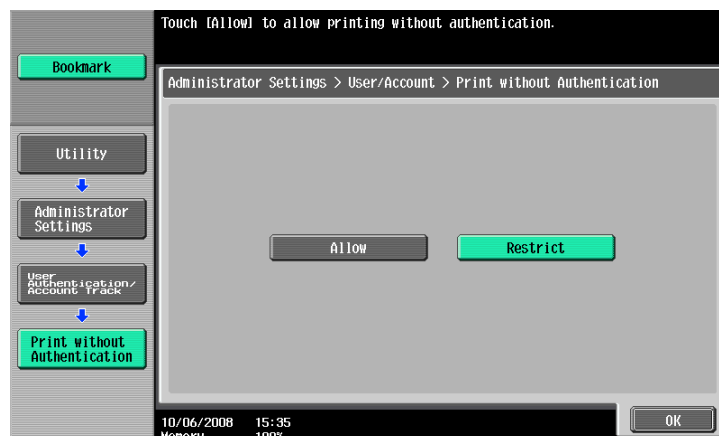

- 4 Press [OK].
The print without authentication is specified.

13.4.12 Single Color > 2 Color Output Management

Configure whether to manage the output of a single color or 2 colors as color print or black print. When managing it as black print, even a user who is restricted from performing color printing can create a single color or 2 color output. (Default: [Color])

- [Color]: Select this option to count the printing done in a single color or 2 colors as color printing.
- [Black]: Select this option to count the printing done in a single color or 2 color as black printing.

- 1 In the Administrator Settings screen, press [User Authentication/Account Track].
→ For details on displaying the Administrator Settings screen, refer to page 13-39.
- 2 In the User Authentication/Account Track screen, press [User/Account Common Setting].
- 3 In the User/Account Common Setting screen, press [Single Color > 2 Color Output Management].
- 4 Press the desired button.



13.4.13 I/F timeout setting

Specify the time until a communication timeout occurs for each of the USB or network interface. (Default: 60 sec.)

- 1 In the Administrator Settings screen, press [Printer Settings].
→ For details on displaying the Administrator Settings screen, refer to page 13-39.
- 2 In the Printer Settings screen, press the interface to specify.

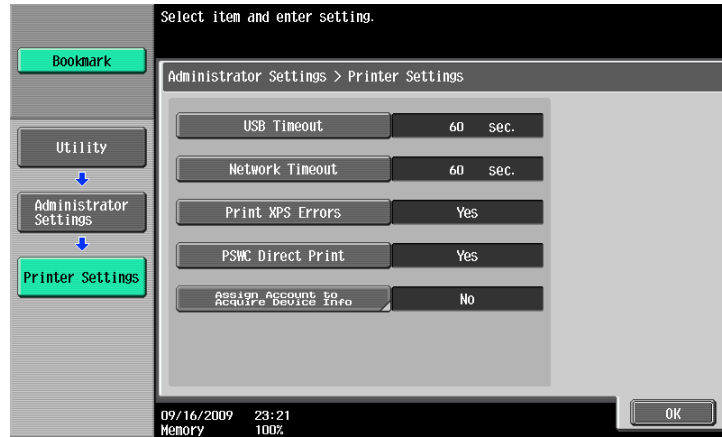

- 3 Press the **C** key to clear the value, and then use the keypad to enter the time. (10 to 1,000 sec.)
→ If a value outside of the allowable range is specified, the message "Input error" appears. Enter a number within the allowable range.



The time until a communication timeout occurs is set.

13.4.14 Print XPS Errors

Specify whether to print the error message when an error occurs during XPS printing. (Default: [No])

- 1 In the Administrator Settings screen, press [Printer Settings].
→ For details on displaying the Administrator Settings screen, refer to page 13-39.
- 2 Press [Print XPS Errors].

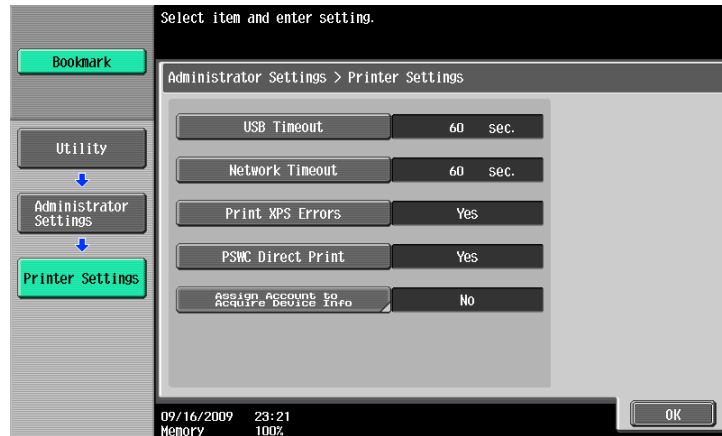

- 3 Press the desired button.



13.4.15 PSWC Direct Print

Specify whether to allow the direct print from **PageScope Web Connection**. (Default: [Yes])

- [Yes]: Select this option to allow direct print from **PageScope Web Connection**.
- [No]: Select this option not to allow direct print from **PageScope Web Connection**.

- 1 In the Administrator Settings screen, press [Printer Settings].
→ For details on displaying the Administrator Settings screen, refer to page 13-39.
- 2 Press [PSWC Direct Print].

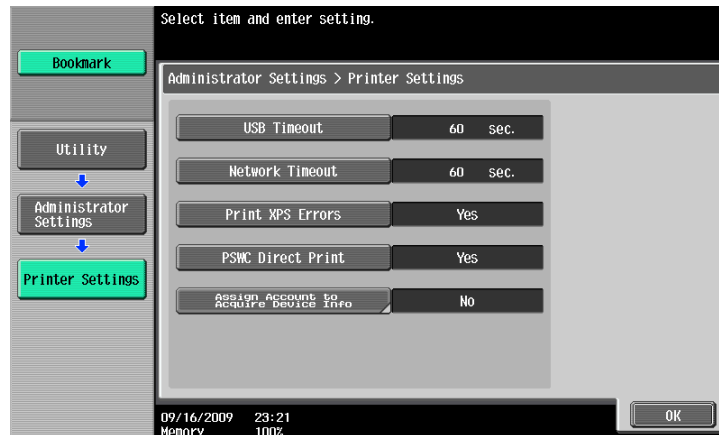

- 3 Press the desired button.

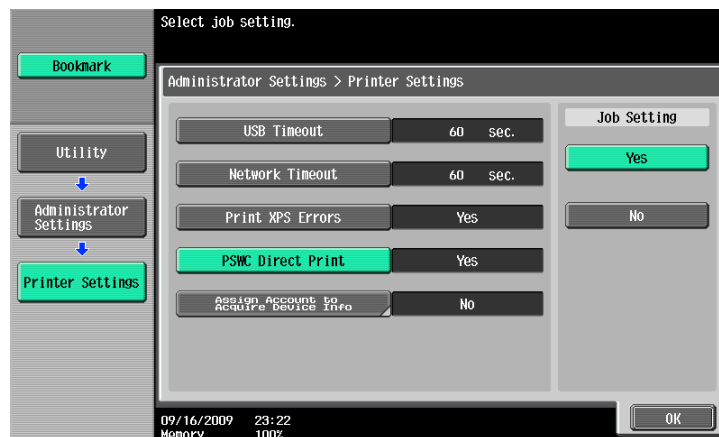

13.4.16 Assign Account to Acquire Device Info

Specify whether this machine requests the password from the Windows printer driver when the Windows printer driver acquires device information, for example, which options are installed in this machine. (Default: [No])

- [No]: Does not request the password.
- [Yes]: Requests the password. Press [Password], and enter the password.
For the printer driver, also enter the password specified in this machine. If the password is invalid, you cannot acquire device information.

Reference

- Enter the password using up to eight characters.
- If a password is specified in [Assign Account to Acquire Device Info], enter the same value in [Enter Password to acquire Device Information] of the printer driver. For details, refer to page 9-4.

- 1 In the Administrator Settings screen, press [Printer Settings].
→ For details on displaying the Administrator Settings screen, refer to page 13-39.

- 2 Press [Assign Account to Acquire Device Info].

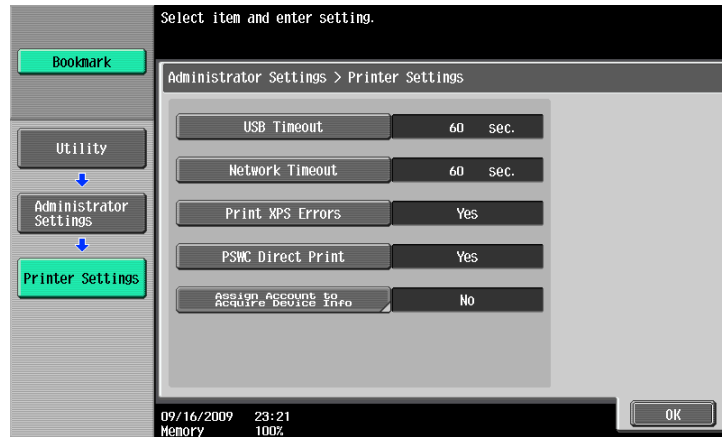

- 3 Press the desired button.

→ To specify a password, select [Yes].

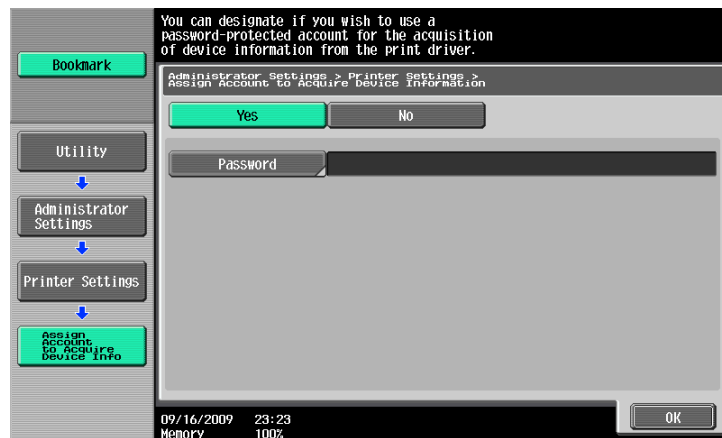

- 4 When specifying a password, continuously press [Password].

- 5 Enter the password, and then press [OK].

→ The password is specified.



13.4.17 Configuring Authentication under OpenAPI Settings

When user authentication is performed or when acquiring the device information with the **PageScope Authentication Manager**, set the Authentication setting of the OpenAPI Setting screen of the machine to [OFF]. (Default: [OFF])

- 1 In the Administrator Settings screen, press [System Connection].
→ For details on displaying the Administrator Settings screen, refer to page 13-39.
- 2 In the System Connection screen, press [OpenAPI Settings].
- 3 In the OpenAPI Settings screen, press [Authentication].



- 4 Set [Authentication] to [OFF].

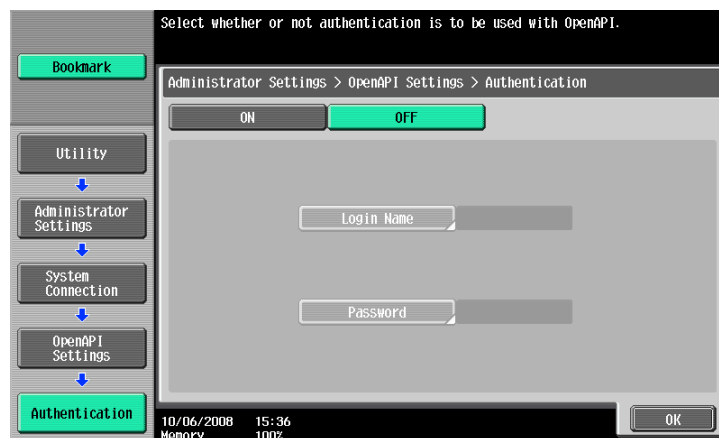

- 5 Press [OK].
The authentication settings are configured.

13.4.18 Configuring the cellular phone or PDA settings

You can specify whether to allow printing from a cellular phone or PDA and saving in a User Box. (Default: [Restrict])

- [Allow]: Allow printing from a cellular phone or PDA, and saving in a User Box.
- [Restrict]: Not allow printing from a cellular phone or PDA, or saving in a User Box.

Reference

- [Cellular Phone/PDA Setting] is displayed when the optional **Local Interface Kit EK-605** is installed while [Bluetooth Setting] is enabled in this machine. For details, refer to the [User's Guide Network Administrator]. To enable a Bluetooth communication, contact your service representative in advance.

- 1 In the Administrator Settings screen, press [System Connection].
→ For details on displaying the Administrator Settings screen, refer to page 13-39.
- 2 In the System Connection screen, press [Cellular Phone/PDA Setting].
- 3 Press the desired button.

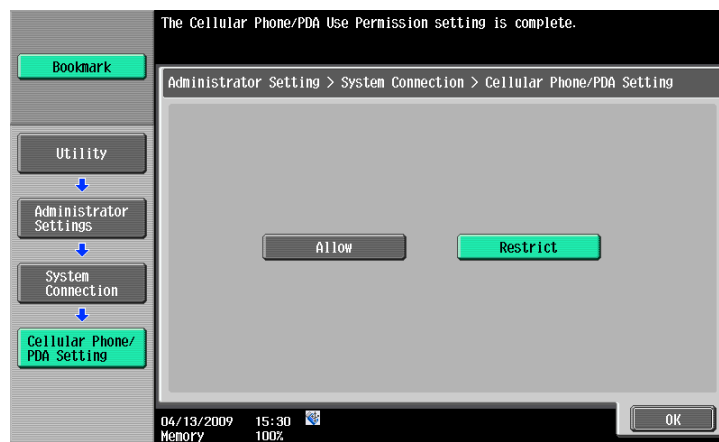

- 4 Press [OK].
The Mobile/PDA Settings is specified.

13.4.19 Print Data Capture

Specify whether to allow or prohibit data capturing of a print job. (Default: [Allow])

Reference

- For details on capturing data of a print job, contact the technical representative.
- 1 In the Administrator Settings screen, press [Security Settings].
→ For details on displaying the Administrator Settings screen, refer to page 13-39.
 - 2 In the Security Settings screen, press [Security Details].
 - 3 In the Security Details screen, press [Print Data Capture].
 - 4 Press the desired button.



Whether to allow or prohibit data capturing of a print job is specified.

→ For details, contact your technical representative.

13.4.20 Secure Print Only

Specify whether the printing from the computer should be limited only to the security document. (Default: [No])

Whenever printing is done from the printer driver, the data must be transmitted using the secure printing. Because this setting requires ID/password for every print job, your job is protected from intercepting by a third party.

- [Yes]: Select this option to limit the printing only to the secure documents.
- [No]: Select this option not to limit the printing to the secure documents.

Reference

- When you print a document on the machine with [Secure Print Only] set to [Yes], specify [Secure Print Only] on the printer driver so that only the [Secure Print] jobs are transmitted.
- If a normal print job is sent to the machine where [Secure Print Only] is set to [Yes], the print job is deleted.



Reference

For details on secure printing, refer to page 12-5.

- 1 In the Administrator Settings screen, press [Security Settings].
→ For details on displaying the Administrator Settings screen, refer to page 13-39.
- 2 In the Security Settings screen, press [Security Details].
- 3 Switch the page by pressing [↑] or [↓], and then press [Secure Print Only].

4 Press the desired button.



Whether the printing should be limited to security documents is specified.

13.4.21 Driver Password Encryption Setting

For the common encryption key to be added to print jobs, specify whether to use the factory default setting or to change to a user-defined encryption passphrase. (Default: [Use Factory Default])

- [User-Defined]: Specify an encryption passphrase. Enter an encryption passphrase of 20 characters.
- [Use Factory Default]: Select this option to use the encryption passphrase <a preset encryption key (common key) that is not exposed> preset at shipping.

Reference

- An encryption passphrase must be specified using 20 characters.
- User, account, and secure document passwords are encrypted by the common encryption key.
- When [User-Defined] is selected for the encryption passphrase, select the check box for the encryption passphrase in the printer driver to enable it, and then enter the same value. If different values are used for the encryption passphrase for the machine and the printer driver, the machine cannot decrypt the encrypted user password, account password or secure document password, and printing cannot be performed. For details, refer to page 12-32.
- When OpenAPI is used and SSL is enabled, it is possible for the machine to obtain the common encryption key provided that the device information of the printer driver can be obtained automatically.

- 1 In the Administrator Settings screen, press [Security Settings].
→ For details on displaying the Administrator Settings screen, refer to page 13-39.
- 2 In the Security Settings screen, press [Driver Password Encryption Setting].
- 3 Press the desired button.

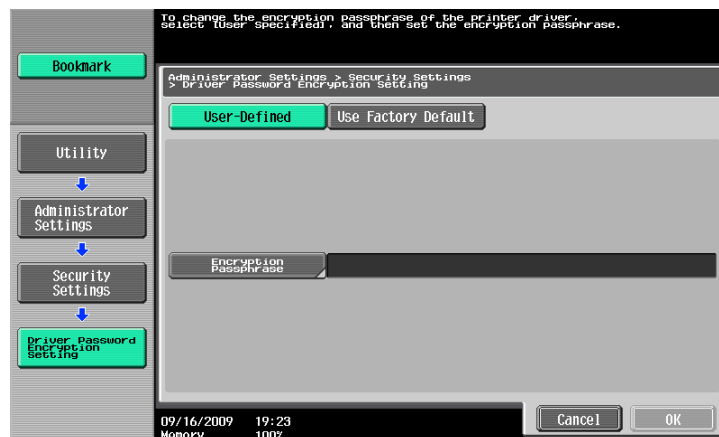

Reference

For details on selecting [User-Defined] for the encryption passphrase, refer to page 12-32.

14

PageScope Web Connection

14 PageScope Web Connection

14.1 Using PageScope Web Connection

PageScope Web Connection is a device control utility provided by the HTTP server built in the printer controller. Using a Web browser on a computer connected to the network, you can change machine settings and check the status of the machine. Using this utility, you can configure some settings, which are to be handled in the control panel of this machine, through your computer, and also smoothly enter characters.

14.1.1 Operating environment

Network	Ethernet (TCP/IP)
Applications on computer	<p>Web browser:</p> <p><For Windows NT4.0/2000/XP/Server 2003/Vista></p> <ul style="list-style-type: none"> • Microsoft Internet Explorer Ver. 6/7/8 (JavaScript and Cookies enabled) • Netscape Navigator 7.02 or later (JavaScript and Cookies enabled) • Mozilla Firefox 1.0 or later (JavaScript and Cookies enabled) <p><For Macintosh MacOS 9.x/MacOS X></p> <ul style="list-style-type: none"> • Netscape Navigator 7.02 or later (JavaScript and Cookies enabled) • Mozilla Firefox 1.0 or later (JavaScript and Cookies enabled) <p><For Linux></p> <ul style="list-style-type: none"> • Netscape Navigator 7.02 or later (JavaScript and Cookies enabled) • Mozilla Firefox 1.0 or later (JavaScript and Cookies enabled) <p>Adobe® Flash® Player:</p> <ul style="list-style-type: none"> • Plug-in Ver.7.0 or later required to select Flash as the display format. • Plug-in Ver.9.0 or later required to use the Data Management Utility (font/macro data management).

14.1.2 Accessing PageScope Web Connection

- ✓ Start the Web browser to access **PageScope Web Connection**.
- ✓ If User Authentication is enabled, enter the user name and password. For details, refer to page 14-9.
- ✓ For details on setting the IP address of this machine, refer to [User's Guide Network Administrator].
- ✓ **PageScope Web Connection** has two view modes: Flash and HTML. For details, refer to page 14-7.

1 Start the Web browser.

2 Enter the IP address of the machine in the URL field, and then press [Enter].

`http://<IP address of the machine>/`

Example: When the IP address of this machine is 192.168.1.20:

- `http://192.168.1.20/`

When IPv6 is set to [ON] while a browser other than Internet Explorer 6 is used:

- Enter the IPv6 address enclosed in brackets [] to access PageScope Web Connection.
- `http://[IPv6 address of this machine]/`

Example: When the IPv6 address of this machine is fe80::220:6bff:fe10:2f16:

- `http://[fe80::220:6bff:fe10:2f16]/`
- If IPv6 is set to [ON] while Internet Explorer is used, add "fe80::220:6bff:fe10:2f IPv6_MFP_1" to the hosts file in advance, and specify the address with the domain name.

The main menu or login page appears.

14.1.3 Web browser cache

The Web browser has the cache function; therefore, the latest information may not be shown in the page displayed using **PageScope Web Connection**. Using the cache function may result in an operation failure. When using **PageScope Web Connection**, disable the cache function on the Web browser.

Reference

- Some Web browser versions may provide different menus and item names. For details, refer to the Help for the Web browser.
- With the cache function enabled, timeout occurs in the administrator mode, and after that, how many time you try to access, just timeout recurs. It results in the control panel of this machine being locked, and you cannot handle the control panel. In this case, turn the main power off, and then turn it on again. To avoid this problem, disable the cache function.

For Internet Explorer

- 1 Select [Internet Options] in the [Tools] menu.
- 2 In the [General] tab, select [Temporary Internet files] - [Settings].
- 3 Select [Every visit to the page], and click [OK].

For Netscape Navigator

- 1 Select [Preferences] in the [Edit] menu.
- 2 In [Category] on the left, select [Advanced] - [Cache].
- 3 In [Document in cache is compared to document on network], select [Every time].

For Mozilla Firefox

- 1 Select [Options] in the [Tools] menu.
- 2 Select [Privacy], and then click [Settings] in the Private Data section.
- 3 Select the [Cache] check box under [Private Data] select the [Clear private data when closing Firefox] check box under [Settings], and then click [OK].

14.1.4 Online help function

After logging in to **PageScope Web Connection**, click  ; you can display the online help for the currently configured function.

Reference

- To display the online help, connect your computer to the Internet.

14.2 Login and Logout

14.2.1 Login and logout flows

Accessing with **PageScope Web Connection** displays the login page when User Authentication or Account Track is enabled, and displays the login page in the public user mode when User Authentication or Account Track is not enabled. When re-logging in to this machine as a different user or as an administrator, log out once, and log in again.

When user authentication or account track is not enabled

You are automatically logged in as a public user.

The screenshot shows the PageScope Web Connection interface for a public user. At the top, it says "Public" and "To Login Screen". Below that, there are "Ready to Scan" and "Ready to Print" indicators. A navigation menu on the left includes "Device Information", "Configuration Summary", "Option", "Consumables", "Meter Count", "Online Assistance", "Function Permission Information", "Network Setting Information", "Print Setting Information", and "Print Information". The main content area displays "Device Information" for an MFP, including device name, location, serial number, and type. It also shows a toner status table and a paper tray table.

Toner	Status	Percentage
Yellow	[Progress Bar]	100%
Magenta	[Progress Bar]	100%
Cyan	[Progress Bar]	100%
Black	[Progress Bar]	100%

Select	Tray	Paper Size	Paper Type	Paper Status
<input checked="" type="radio"/>	Bypass	8 1/2" x 11" LEF	Plain Paper	Empty
<input type="radio"/>	Tray 1	8 1/2" x 11" LEF	Plain Paper	Ready
<input type="radio"/>	Tray 2	8 1/2" x 11" LEF	Plain Paper	Ready
<input type="radio"/>	Tray 3	8 1/2" x 11" LEF	Plain Paper	Ready
<input type="radio"/>	Tray 4	8 1/2" x 11" LEF	Plain Paper	Ready

Output Tray
Tray 1 / Tray 2

Administrator Information
 Administrator Name: admin
 Extension No.:
 Admin. E-mail Address: admin@test.local



To log in as an administrator, log out once.



Login as an administrator again.

Language OS Language (OS Language)

Login Public User
 Administrator

View Mode Flash HTML
Flash Player is necessary to see in Flash form. [Get ADOBE FLASHPLAYER](#)

User Assist Display dialog box in case of warning.

Starting-up Data Management Utility
Flash Player is required to use the Data Management Utility.
[Manage Copy Protect Data](#)
[Manage Stamp Data](#)
[Manage Font/Macro \(*1\)](#)
(*1) Can only run on Windows Internet Explorer and Flash Player Version 9 and above environments.

When User Authentication or Account Track is enabled

If **PageScope Authentication Manager** is used for authentication, ask your server administrator about the login procedure.

The User Authentication or Account Track page appears. Enter the required items to log in.

Language OS Language (OS Language)

Login Public User
 Registered User
User Name
Password
 Administrator

View Mode Flash HTML
Flash Player is necessary to see in Flash form. [Get ADOBE FLASHPLAYER](#)

User Assist Display dialog box in case of warning.

Starting-up Data Management Utility
Flash Player is required to use the Data Management Utility.
[Manage Copy Protect Data](#)
[Manage Stamp Data](#)
[Manage Font/Macro \(*1\)](#)
(*1) Can only run on Windows Internet Explorer and Flash Player Version 9 and above environments.



To log in as a different user or as an administrator, log out once.



Log in again.

14.2.2 Logout

Click [Logout] or [To Login Screen] at the upper right of the window. A logout confirmation page appears. Click [OK] to return to the login page.

Reference

- The login page that appears differs depending on whether Authentication is enabled in this machine.
- When logged in as a public user, [To Login Screen] appears. When logged in as a registered user or an administrator, [Logout] appears.
- If timeout occurred because no operation was performed for the specified period during login or if authentication setting was changed using the control panel while logging in to the user mode, you will automatically log out of the mode.
- For details on how to specify the timeout period of the user or administrator modes, refer to page 14-23.

14.2.3 Login

PageScope Web Connection provides the user or administrator mode depending on how to log in. If necessary, you can log in to the user mode as an administrator or User Box administrator depending on user authentication or User Box administrator setting.

Reference

- You can log in as a User Box administrator when the User Box administrator is enabled using the control panel. For details on the User Box administrator settings, permissions and password settings, refer to the [User's Guide Box Operations].
- When logged in to the user mode as an administrator, jobs that could not be deleted in the administrator mode can be deleted.
- In the login page, select the desired Data Management Utility. For details on Data Management Utility, refer to the [User's Guide Network Administrator].

Login options

You can select items as required when logging in.

Item	Description
[Language]	Select the display language.
[View Mode]	Select Flash or HTML. <ul style="list-style-type: none"> • If the screen reader software is used, we recommend selecting [HTML] as the view mode. • In an IPv6 environment, select [HTML]. • Flash Player is required when selecting [Flash].
[User Assist]	Select the [Display dialog box in case of warning.] check box to display the dialog box when a warning has occurred or during operation after login.

Reference

- If [Flash] is selected in [View Mode], the following items are displayed using Flash.
 - Status icons and messages
 - Status of [Paper Tray] in the page displayed when [Device Information] is selected on the Information tab
 - Page display of [Job]

Logging in as a public user

If user authentication is not enabled on the machine, you will be logging in as a public user. In the login page, select [Public User Access], and click [Login].

Language OS Language (OS Language) ▾

Login Public User
 Administrator

View Mode Flash HTML
Flash Player is necessary to see in Flash form. [Get ADOBE FLASHPLAYER](#)

User Assist Display dialog box in case of warning. **Login**

Starting-up Data Management Utility
Flash Player is required to use the Data Management Utility.
[Manage Copy Protect Data](#)
[Manage Stamp Data](#)
[Manage Font/Macro \(*1\)](#)
(*1) Can only run on Windows Internet Explorer and Flash Player Version 9 and above environments.

Logging in as a registered user

Specify the registered user name and password to log in when User Authentication is enabled in this machine.

→ In the login page, enter the user name and the password, and click [Login].

KONICA MINOLTA **PAGE SCOPE** **Web Connection**

Language OS Language (OS Language) ▾

Login

Public User

Registered User

User Name

Password

Administrator

View Mode Flash HTML

Flash Player is necessary to see in Flash form. [Get ADOBE FLASHPLAYER](#)

User Assist Display dialog box in case of warning.

Starting-up Data Management Utility

Flash Player is required to use the Data Management Utility.

[Manage Copy Protect Data](#)

[Manage Stamp Data](#)

[Manage Font/Macro \(*1\)](#)

(*1) Can only run on Windows Internet Explorer and Flash Player Version 9 and above environments.

Reference

- If Account Track is enabled, also enter the account name and password.
- To select a user name from a list, click [User List].
- If External Server Authentication is enabled, select a server.
- To log in to the user mode as an administrator, select [Administrator] - [Administrator (User Mode)], and enter the administrator password.
- If [Prohibited Functions When Authentication Error] in Administrator Settings is set to [Mode 2] and a user enters an incorrect password the specified number of times, that user is locked out and can no longer use the printer. Contact your administrator to cancel operation restrictions.
- [User List] is available only when [User Name List] is set to [ON]. For details, refer to the [User's Guide Copy Operations].

Logging in to the administrator mode

To configure the system or network setting, log in to the administrator mode.

- 1 Select [Administrator], and click [Login].

- 2 Enter the administrator password, and click [OK].

- To log in to the user mode as an administrator, select [Administrator (User Mode)] , and enter the administrator password.
- Logging in to the administrator mode locks the control panel of this machine, and you will not be able to use it.
- Depending on the status of this machine, you may not be able to log in to the administrator mode.
- If [Prohibited Functions When Authentication Error] in the Administrator Settings is set to Mode 2 and an incorrect password is entered the specified number of times, it is no longer possible to log in to the administrator mode. For details on the Prohibited Functions When Authentication Error parameter, refer to the [User's Guide Copy Operations].
- The password entry page varies depending on the machine settings.
- You can display the explanation of functions (Help) when necessary. To display Help, select [ON] in Display Setting.
[On Mouse] : Point the cursor to display Help.
[On Focus] : Select an item to display Help.

Display mode in administrator mode

In [System Settings] - [Display Setting], the display mode in the administrator mode can be selected from [Tab Function Display] or [List Function Display]. This manual shows an example where [List Function Display] is set as the display mode.

In either display mode, the available items are the same.

In the default setting, the screen is displayed in [Tab Function Display].

In [Tab Function Display], click the desired icon to change the menu.

Administrator Logout ?

Ready to Scan
Ready to Print

Meter Count
ROM Version
Import/Export
Status Notification Setting
Total Counter Notification Setting
Date/Time Setting
Timer Setting
Network Error Code Display Setting
Reset
License Settings
Edit Font/Macro
Job Log

Total Counter

Total	1
Total Duplex	0
# of Originals	1
# of Used Paper	1

Copy Counter

	Full Color	Black	Single Color	2 Color	Total
Total	0	1	0	0	1
Large Size	0	0	0	0	0

Print Counter

	Full Color	Black	2 Color	Total
Total	0	0	0	0
Large Size	0	0	0	0

Scan / Fax Counter

	Print (Full Color)	Print (Black)	Scans
Total	0	0	14
Large Size	0	0	0

Fax TX: 1
Fax RX: 0

Total (Copy + Print)

	Full Color	Black	2 Color
Total	0	1	0

Paper Size / Type Counter

Paper Size	Paper Type	Count
11" x 17"	Not Specified	0
8 1/2" x 14"	Not Specified	0
8 1/2" x 11"	Not Specified	0
5 1/2" x 8 1/2"	Not Specified	0
A3	Not Specified	0
B4	Not Specified	0
B5	Not Specified	0
A4	Not Specified	0
A5	Not Specified	0
Others	Not Specified	0

In [List Function Display], change the menu from the list box.

Select the desired menu in the drop-down list, click [Display].

Administrator Logout ?

Ready to Scan
v Menu (Admin Mode)

Maintenance Display To Main Menu

Meter Count
ROM Version
Import/Export
Status Notification Setting
Total Counter Notification Setting
Date/Time Setting
Timer Setting
Network Error Code Display Setting
Reset
License Settings
Edit Font/Macro
Job Log

Total Counter

Total	137
Total Duplex	12
# of Originals	143
# of Used Paper	106

Copy Counter

	Full Color	Black	Single Color	2 Color	Total
Total	39	55	0	0	94
Large Size	4	0	0	0	4

Print Counter

	Full Color	Black	2 Color	Total
Total	22	5	3	30
Large Size	0	0	0	0

Scan / Fax Counter

	Print (Full Color)	Print (Black)	Scans
Total	0	13	54
Large Size	0	0	0

Fax TX: 0
Fax RX: 0

Total (Copy + Print)

	Full Color	Black	2 Color
Total	61	60	3

Paper Size / Type Counter

Paper Size	Paper Type	Count
11" x 17"	Not Specified	0
8 1/2" x 14"	Not Specified	0
8 1/2" x 11"	Not Specified	0
5 1/2" x 8 1/2"	Not Specified	0
A3	Not Specified	0
B4	Not Specified	0
B5	Not Specified	0
A4	Not Specified	1
A5	Not Specified	0
Others	Not Specified	0

Logging in as the User Box Administrator

You can log in to the user mode as an administrator to delete a job when User Authentication is enabled in this machine. If necessary, you can log in to the user mode as a User Box administrator when the User Box administrator is enabled using the control panel.

- In the login page, select [Administrator] and click [Login].
 - To log in to the user mode as a User Box administrator, select [User Box Administrator], and enter the User Box administrator's password.

Reference

- To log in to the user mode as an administrator, select [Administrator] - [Administrator (User Mode)], and enter the administrator password.
- If [Prohibited Functions When Authentication Error] in the Administrator Settings is set to [Mode 2] and an incorrect password is entered the specified number of times, it is no longer possible to log in to the administrator mode. For details on the Prohibited Functions When Authentication Error parameter, refer to the [User's Guide Copy Operations].
- The password entry page varies depending on the machine settings.
- You can display the explanation of functions (Help) when necessary. To display Help, select [ON] in Display Setting.
 - [On Mouse]: Point the cursor to display Help.
 - [On Focus]: Select an item to display Help.

14.3 Structure of pages

Logging in to **PageScope Web Connection** displays the page that is configured as shown below. The following shows an example of the page displayed when Device Information is selected in the Information tab.

Reference

- The contents of the **PageScope Web Connection** pages vary depending on the options installed in this machine or the settings of this machine.

The screenshot shows the PageScope Web Connection interface for a Konica Minolta bizhub C360. The interface is divided into several sections:

- Header (1-8):** Includes the Konica Minolta logo (1), the PageScope Web Connection logo (2), the user name 'user01' (3), and buttons for 'Logout' (6) and 'Change Password' (7).
- Navigation (10):** A sidebar menu with options: Device Information (selected), Configuration Summary, Option, Consumables, Meter Count, Online Assistance, Change User Password, Function Permission Information, Network Setting Information, Print Setting Information, and Print Information.
- Device Information (11):** Displays details for device KMBT_C360, including a toner status table.

Toner	Status	Percentage
Yellow	[Progress bar]	98%
Magenta	[Progress bar]	99%
Cyan	[Progress bar]	99%
Black	[Progress bar]	98%
- Paper Tray (12):** Displays a table of paper tray settings.

Select	Tray	Paper Size	Paper Type	Paper Status
<input checked="" type="radio"/>	Bypass	8 1/2" x 11" LEF	Plain Paper	Empty
<input type="radio"/>	Tray 1	8 1/2" x 11" SEF	Plain Paper	Ready
<input type="radio"/>	Tray 2	8 1/2" x 11" LEF	Plain Paper	Ready
<input type="radio"/>	Tray 3	8 1/2" x 11" SEF	Plain Paper	Ready
<input type="radio"/>	Tray 4	8 1/2" x 11" LEF	Plain Paper	Ready
- Administrator Information:** Shows fields for Administrator Name (admin), Extension No., and Admin. E-mail Address (admin@123.com).

No.	Item	Description
1	KONICA MINOLTA logo	Click this logo to jump to the Konica Minolta Web site at the following URL. http://www.konicaminolta.com/
2	PageScope Web Connection logo	Click this logo to display the version information of PageScope Web Connection .
3	Login user name	Displays the current login mode icon and user name (public, administrator, User Box administrator, registered user, or account). Click the user name to display the login user name.
4	Status display	Displays the status of the printer and scanner sections of this machine with icons and messages. Clicking the desired icon when an error occurs displays the information (Consumable Info, Paper Tray, or user registration page) associated with the icon to enable you to check the status.
5	Message display	Displays the operating status of this machine.
6	[To Login Screen]/ [Logout]	Click this button to log out the current mode and log in again. When logged in as a public user, [To Login Screen] appears. When logged in as a registered user or an administrator, [Logout] appears.

No.	Item	Description
7	[Change Password]	Click this button to jump to the user password change page. This button appears only in the user mode page in which you logged in as a registered user.
8	Help	You can display the online help for the currently configured function. For the specified pages, refer to [Online Assistance] in page 14-21.
9	Refresh	Click this icon to refresh the information displayed in the page.
10	Icon	Select the category of the item to be displayed. The following icons are displayed in the user mode. <ul style="list-style-type: none">• Information• Job• User Box• Direct Print• Store Address• Customize
11	Menu	Displays information and setting for the selected icon. The menu that appears in this area varies depending on which icon was selected.
12	Information and settings	Displays the details of the item selected in the menu.

14.4 Overview of the user mode

After logging in to PageScope Web Connection in the user mode, the following functions can be specified.

14.4.1 Information



Reference

You can also check the explanation of the user mode in the **PageScope Web Connection** online help or **PageScope Web Connection** manual included in the application CD-ROM. For details on the online help, refer to page 14-3.

The screenshot displays the user interface for a user named 'user01'. At the top, there are 'Logout' and 'Change Password' buttons. Below the user name, there are status indicators for 'Ready to Scan' and 'Ready to Print'. A navigation menu on the left lists various options under 'Device Information', including 'Configuration Summary', 'Option', 'Consumables', 'Meter Count', 'Online Assistance', 'Change User Password', 'Function Permission Information', 'Network Setting Information', 'Print Setting Information', and 'Print Information'. The main content area shows 'Device Information' for a device named 'KMBT_C360', including its location, engine serial number, and type. A 'Toner' status table shows levels for Yellow, Magenta, Cyan, and Black. Below that is a 'Paper Tray' table with columns for Select, Tray, Paper Size, Paper Type, and Paper Status. At the bottom, 'Administrator Information' is displayed, including the administrator's name, extension number, and email address.

Toner	Status	Level
Yellow		98%
Magenta		99%
Cyan		99%
Black		98%

Select	Tray	Paper Size	Paper Type	Paper Status
<input checked="" type="radio"/>	Bypass	8 1/2" x 11" LEF	Plain Paper	Empty
<input type="radio"/>	Tray 1	8 1/2" x 11" SEF	Plain Paper	Ready
<input type="radio"/>	Tray 2	8 1/2" x 11" LEF	Plain Paper	Ready
<input type="radio"/>	Tray 3	8 1/2" x 11" SEF	Plain Paper	Ready
<input type="radio"/>	Tray 4	8 1/2" x 11" LEF	Plain Paper	Ready

Administrator Information	Value
Administrator Name	admin
Extension No.	
Admin. E-mail Address	admin@123.com

Item	Description
[Device Information]	Enables you to check the components, options, consumables, and meter counts of this machine.
[Online Assistance]	Enables you to check the online assistance about this product.
[Change User Password]	Changes the password of the login user.
[Function Permission Information]	Enables you to check the function permission information about the user or account.
[Network Setting Information]	Enables you to check the network settings of this machine.
[Print Setting Information]	Enables you to check the printer controller settings of this machine.
[Print Information]	Prints font or configuration information.

14.4.2 Job

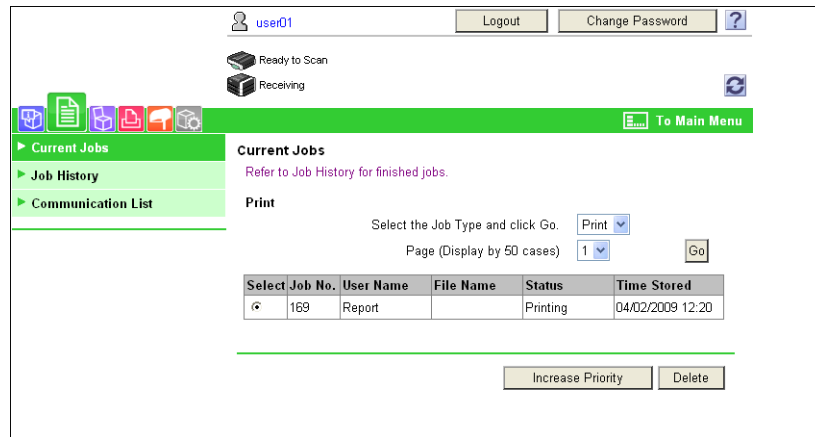

Item	Description
[Current Jobs]	Enables you to check the currently executed job or queued jobs.
[Job History]	Enables you to check the executed jobs.
[Communication List]	Enables you to check the completed transmission and reception jobs.

14.4.3 User Box

Reference

For details on the operating procedures for User Boxes, refer to the [User's Guide Box Operations].

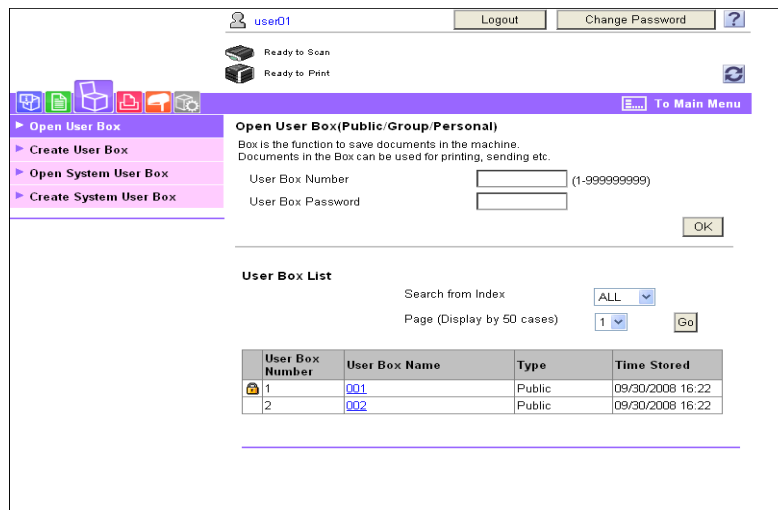

Item	Description
[Open User Box]	Opens the currently created User Box (Public, Personal, or Group User Box) to enable you to print, send, or download a document saved in the User Box or to change the User Box setting.
[Create User Box]	Enables to create a new User Box.

Item	Description
[Open System User Box]	Displayed when the optional Fax Kit is installed. This function opens the System User Box (Bulletin Board, Polling TX, Memory RX, or Relay User Box) to enable you to handle a document saved in the User Box or change the User Box setting.
[Create System User Box]	Displayed when the optional Fax Kit is installed. This function enables you to create a new Bulletin Board or Relay User Box.

14.4.4 Direct print

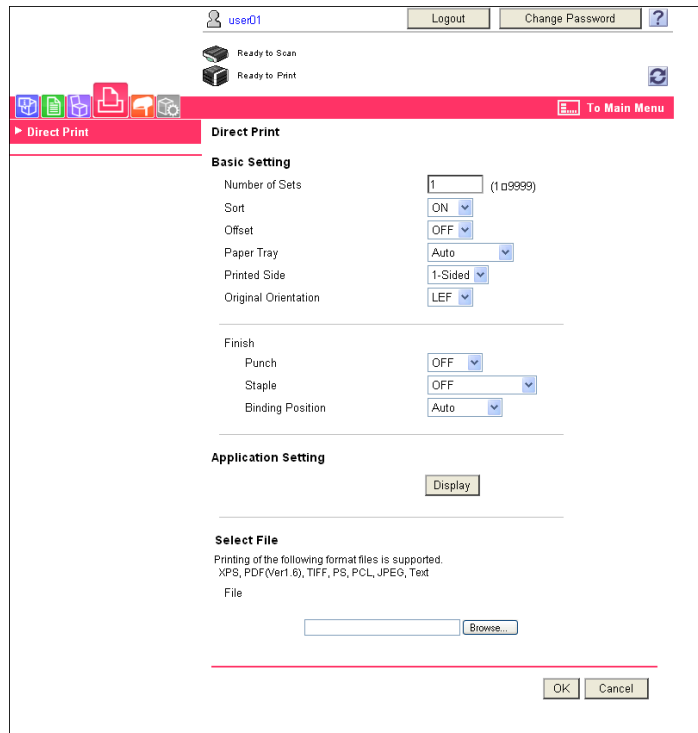

Item	Description
[Direct Print]	Specify a file saved in the computer to print it using this machine. If necessary, you can select Application to save a document in the specified User Box.

Reference

- [Direct Print] may not be displayed depending on settings in the administrator mode.

14.4.5 Address Registration

[Store Address] may not be displayed depending on settings in the administrator mode.

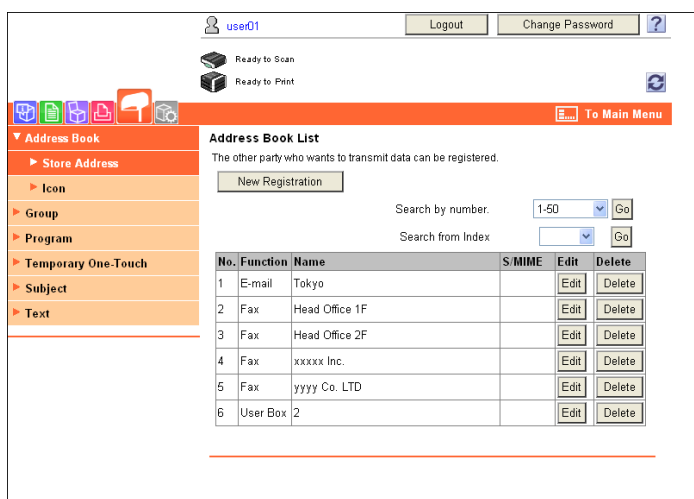

Item	Description
[Address Book]	Enables you to check the address book registered in this machine or to register and change an address.
[Group]	Enables you to check the group address book registered in this machine or to register and change an address.
[Program]	Enables you to check the program address book registered in this machine or to register and change an address.
[Temporary One-Touch]	Enables you to check the temporary program address book registered in this machine or to register and change an address.
[Subject]	Allows you to register or change up to 10 subjects when sending E-mails.
[Text]	Allows you to register or change up to 10 body messages when sending E-mails.

14.4.6 Customize

This function enables you to specify the initial screen after logging in.

Item	Description
[Option]	Enables you to configure the settings displayed in the initial page after logging in to this machine.

14.5 Administrator mode overview

Logging in to the administrator mode enables you to use the following functions.

Reference

- For details on the administrator mode, refer to the [User's Guide Network Administrator].
- The administrator modes are classified into two display modes: [Tab Function Display] and [List Function Display]. This manual shows an example where [List Function Display] is set as the display mode. For details, refer to page 14-11.

14.5.1 Maintenance

The screenshot displays the Administrator mode interface. At the top, it shows the user 'Administrator' and a 'Logout' button. Below this, there are status indicators: 'Ready to Scan' and 'In Menu (Admin Mode)'. The main content area is titled 'Maintenance' and has a 'Display' dropdown menu. A 'To Main Menu' button is also present. The left sidebar contains a list of menu items: Meter Count, ROM Version, Import/Export, Status Notification Setting, Total Counter Notification Setting, Date/Time Setting, Timer Setting, Network Error Code Display Setting, Reset, License Settings, Edit Font/Macro, and Job Log. The main area displays several data tables:

Total Counter	
Total	137
Total Duplex	12
# of Originals	143
# of Used Paper	106

Copy Counter					
	Full Color	Black	Single Color	2 Color	Total
Total	39	55	0	0	94
Large Size	4	0	0	0	4

Print Counter				
	Full Color	Black	2 Color	Total
Total	22	5	3	30
Large Size	0	0	0	0

Scan / Fax Counter			
	Print (Full Color)	Print (Black)	Scans
Total	0	13	54
Large Size	0	0	0

Fax TX	0
Fax RX	0

Total (Copy + Print)			
	Full Color	Black	2 Color
Total	61	60	3

Paper Size / Type Counter		
Paper Size	Paper Type	Count
11" x 17"	Not Specified	0
8 1/2" x 14"	Not Specified	0
8 1/2" x 11"	Not Specified	0
5 1/2" x 8 1/2"	Not Specified	0
A3	Not Specified	0
B4	Not Specified	0
B5	Not Specified	0
A4	Not Specified	1
A5	Not Specified	0
Others	Not Specified	0

Item	Description
[Meter Count]	Enables you to check the meter count of this machine.
[ROM Version]	Enables you to check the ROM version.
[Import/Export]	Saves (exports) setting information of this machine as a file, or writes (imports) it from a file to this machine.
[Status Notification Setting]	Configure the function to be reported to a registered user when an error has occurred in this machine. Specify the destination and items to notify a registered user of an error.
[Total Counter Notification Setting]	Configure the setting to notify the target user of the total counter by E-mail, and register the E-mail address of the destination.
[Date/Time Setting]	Specify the date and time displayed in this machine.
[Timer Setting]	Configure Power Save or Weekly Timer Setting in this machine.

Item	Description
[Network Error Code Display Setting]	Specify whether to display the network error code.
[Reset]	Clears all settings for the network, controller and destinations.
[License Settings]	Allows you to issue a license and enable functions. Also, a request code can be issued.
[Edit Font/Macro]	Adds font or macro.
[Job Log]	Allows you to create and download log data of the jobs that were executed in this machine.

14.5.2 System Settings

Reference

- To use this machine as a scanner with the application software under TWAIN, install the dedicated driver software "KONICA MINOLTA TWAIN". For details, refer to the TWAIN driver manual in the CD supplied together with this machine.

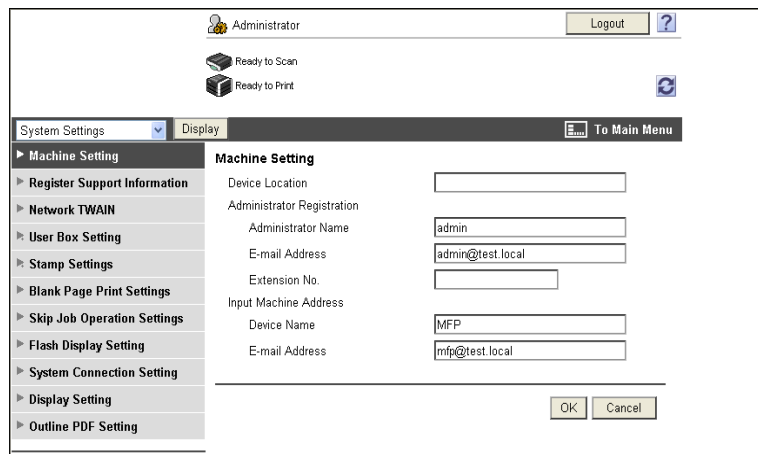

Item	Description
[Machine Setting]	Changes the registration information of this machine.
[Register Support Information]	Specify support information (such as contact name, corporate URL, or online manual URL) of this machine. To display this information, select [Information] - [Online Assistance].
[Network TWAIN]	Specify the time to release the operation lock when scanning (excluding push-scanning). If necessary, configure settings to enable saving or reading a document in or from the external memory.
[User Box Setting]	Define the User Box functions such as deleting an unnecessary User Box or specifying the document deletion time. If necessary, configure settings to enable saving or reading a document in or from the external memory.
[Stamp Settings]	Register a header or footer.
[Blank Page Print Settings]	Specify whether to print contents configured in "Stamp/Composition" on blank pages.
[Skip Job Operation Settings]	Specify whether to skip a job.
[Flash Display Setting]	Specify whether to allow or restrict the flash display.
[System Connection Setting]	Configure the automatic setting of Prefix/Suffix or the setting for printing data in a cellular phone.

Item	Description
[Display Setting]	Select the display mode in the administrator mode from [Tab Function Display] or [List Function Display].
[Outline PDF Setting]	Specify whether to outline text.

14.5.3 Security

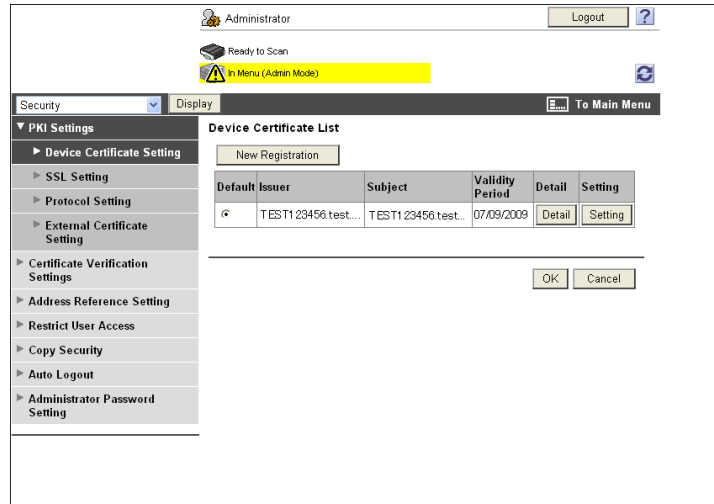

Item	Description
[PKI Settings]	Register device certificates and configure the SSL, protocol, or external certificate settings.
[Certificate Verification Settings]	Specify the items to validate a certificate.
[Address Reference Setting]	When giving destination access permission, specify a reference allowed group name or access allowed level.
[Restrict User Access]	Specify the function to restrict user operations.
[Copy Security]	Specify whether to use the copy guard or password copy function.
[Auto Logout]	Specify the time to automatically log out the administrator or user mode.
[Administrator Password Setting]	Specify the password to log in to the administrator mode.

[Administrator Password Setting] is not displayed when:

- The SSL certificate is not installed
- [Enhanced Security Mode] is enabled.
- [Mode using SSL/TLS] is set to [None] in [Security] - [PKI Settings] - [SSL Setting] even though a device certificate is already registered

14.5.4 User authentication/Account track

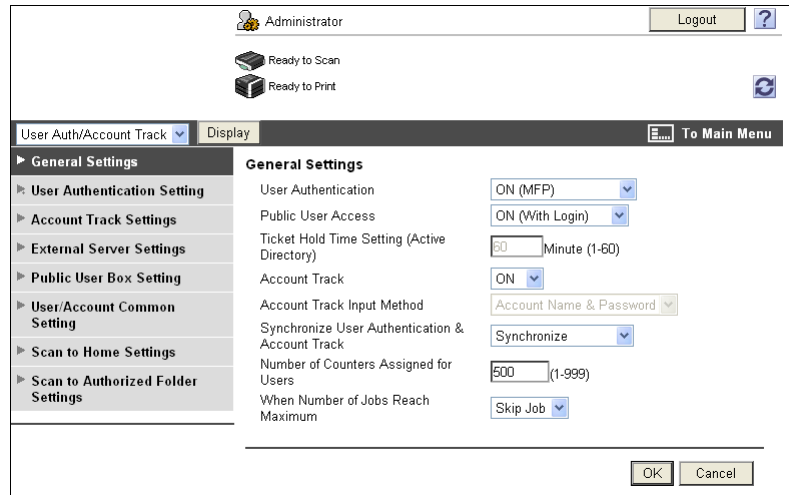

Item	Description
[General Settings]	Configure the User Authentication or Account Track setting in this machine. To enable authentication, configure the number of assigned counters or the When Number of Jobs Reach Maximum setting.
[User Authentication Setting]	When enabling User Authentication, register the target user or configure user setting.
[Account Track Settings]	When enabling Account Track, register and edit the target account.
[External Server Settings]	When enabling external server authentication, register the external server.
[Public User Box Setting]	Specify the upper limit of the number of User Boxes.
[User/Account Common Setting]	Specify whether to print data in single color or two-color mode.
[Scan to Home Settings]	Configure the setting to send a file to the Home folder.
[Scan to Authorized Folder Settings]	Configure settings to restrict manual transmission destination.

14.5.5 Network

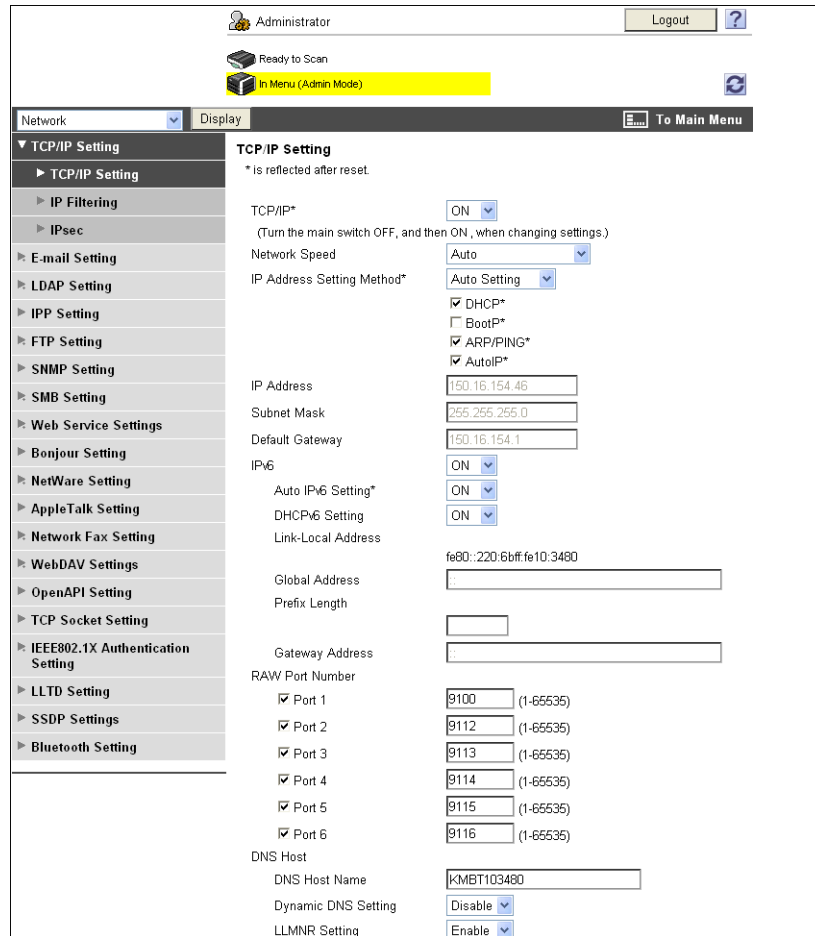

Item	Description
[TCP/IP Setting]	Configure the TCP/IP setting when connecting this machine via network.
[E-mail Setting]	Configure the settings to send or receive E-mails (including Internet fax), and specify the extension function such as E-mail authentication.
[LDAP Setting]	Configure the settings to register the LDAP server.
[IPP Setting]	Configure the IPP print setting.
[FTP Setting]	Configure the settings to use this machine as an FTP client or server.
[SNMP Setting]	Configure SNMP settings.
[SMB Setting]	Configure the SMB client, WINS, or SMB print setting.
[Web Service Settings]	Configure the settings to perform scanning or printing using Web services.
[Bonjour Setting]	Configure Bonjour settings.
[NetWare Setting]	Configure NetWare settings.
[AppleTalk Setting]	Configure AppleTalk settings.
[Network Fax Setting]	Configure the direct SMTP TX or direct SMTP RX settings.
[WebDAV Settings]	Configure the WebDAV settings.
[OpenAPI Settings]	Configure the OpenAPI settings.
[TCP Socket Setting]	Configure the TCP Socket settings to have a data communication between this machine and the application software in your computer.

Item	Description
[IEEE802.1x Authentication Setting]	Configure IEEE802.1X authentication settings.
[LLTD Setting]	Select whether to enable or disable LLTD.
[SSDP Settings]	Configure the SSDP settings.
[Bluetooth Setting]	Select whether to enable or disable Bluetooth. <ul style="list-style-type: none"> To enable a Bluetooth communication, contact your service representative in advance.

14.5.6 User Box

Logging in to the administrator mode enables you to handle a User Box without entering the password when opening it.

The screenshot displays the Administrator mode interface. At the top, there is a 'Logout' button and a help icon. Below that, there are status indicators for 'Ready to Scan' and 'Ready to Print'. A navigation menu on the left includes 'Box' (selected), 'Display', and 'To Main Menu'. The main content area is titled 'Open User Box(Public/Group/Personal)' and contains a description: 'Box is the function to save documents in the machine. Documents in the Box can be used for printing, sending etc.' Below this is a 'User Box Number' input field with a '(1-99999999)' hint and an 'OK' button. Underneath is a 'User Box List' section with a search filter set to 'ALL' and a page indicator 'Page (Display by 50 cases) 1 Go'. The table below shows the following data:

User Box Number	User Box Name	Type	Time Stored
1	001	Public	09/30/2008 16:22
2	box02	Public	09/30/2008 16:22
6	box03	Public	10/01/2008 12:56

Item	Description
[Open User Box]	Opens the currently created User Box (Public, Group, or Personal User Box) to enable you to change the User Box setting. <ul style="list-style-type: none"> Document operations are not available in the administrator mode. User Box operations are available even if a password is specified for the target User Box.
[Create User Box]	Enables to create a new User Box.
[Open System User Box]	Enables you to open the System User Box (Bulletin Board, Relay, or Annotation User Box) to enable you to handle a document saved in the User Box or change the User Box setting. <ul style="list-style-type: none"> The Bulletin Board and Relay User Boxes are available when the optional Fax Kit FK-502 is installed.
[Create System User Box]	Enables you to create a new Bulletin Board, Relay, or Annotation User Box.

14.5.7 Printer Setting

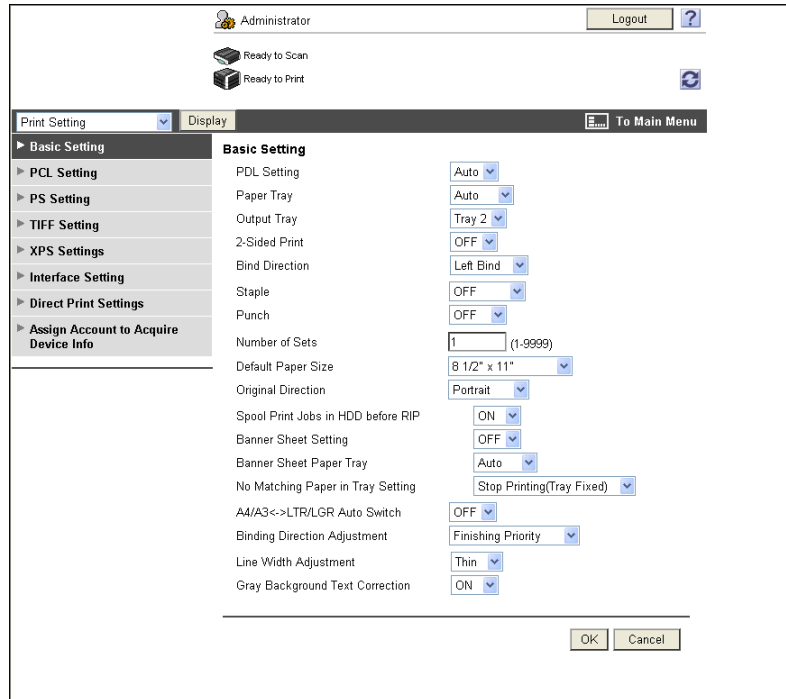

Item	Description
[Basic Setting]	Specify the default values of the printer.
[PCL Setting]	Specify the default values in the PCL mode.
[PS Setting]	Specify the default values in the PS mode.
[TIFF Setting]	Specify the paper to print TIFF images.
[XPS Settings]	Configure the XPS print settings.
[Interface Setting]	Specify the timeout period of the interface.
[Direct Print Settings]	Configure the settings to enable direct printing using PageScope Web Connection .
[Assign Account to Acquire Device Info]	Select whether to specify a password to acquire device information through the printer driver. If [ON] is selected, specify the password.

14.5.8 Address Registration

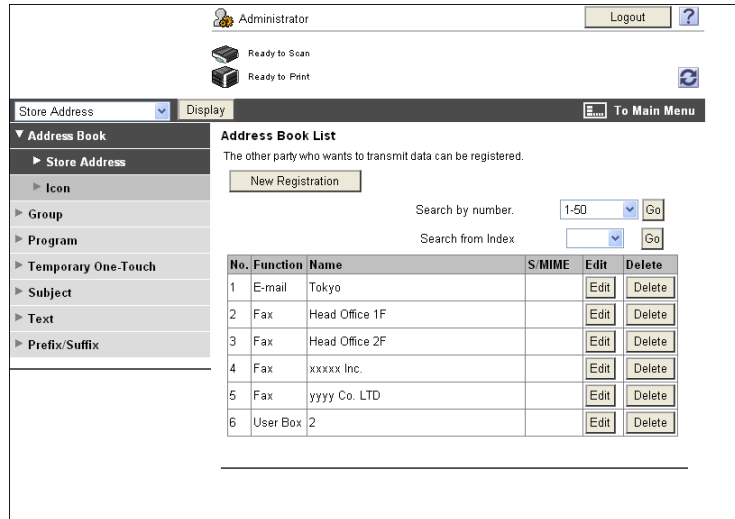

Item	Description
[Address Book]	Enables you to check the address book registered in this machine or to register and change an address.
[Group]	Enables you to check the group address book registered in this machine or to register and change an address.
[Program]	Enables you to check the program address book registered in this machine or to register and change an address.
[Temporary One-Touch]	Enables you to check the temporary program address book registered in this machine or to register and change an address.
[Subject]	Registers up to 10 subjects when sending E-mails.
[Text]	Registers up to 10 body messages to be used when sending E-mails.
[Application Registration]	Registers application settings and server addresses when using the applications such as RightFax Server registered in the external server. Registering applications and servers enables you to automatically connect to the server of the selected application. <ul style="list-style-type: none"> [Application Registration] is not displayed when the optional Fax Kit is installed.
[Prefix/Suffix]	Registers Prefix or Suffix to be added as destination information when E-mailing.

14.5.9 Fax Settings

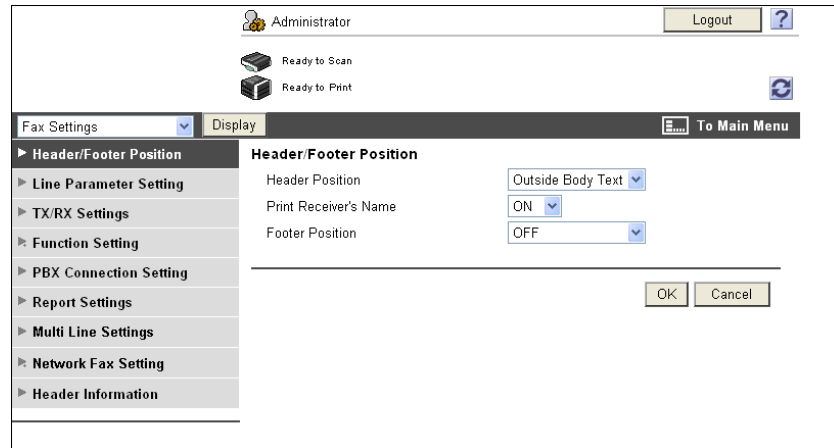

Item	Description
[Header/Footer Position]	Configure the setting to print the sender or receiving information.
[Line Parameter Setting]	Specify the fax line such as Dialing Method.
[TX/RX Settings]	Configure the paper, User Box, and other settings for sending or receiving data.
[Function Setting]	Configure the fax settings for Memory RX or Network Fax.
[PBX Connection Setting]	Specify the outside line at PBX connection.
[Report Settings]	Configure the setting for a report, for example, Activity Report, to be output when sending or receiving data.
[Multi Line Settings]	Specify the parameters and functions of the extended line. <ul style="list-style-type: none"> This item is displayed when a line is extended.
[Network Fax Setting]	Configure the setting to use network fax.
[Header Information]	Registers sender information and fax number when sending data.

14.5.10 Setting for each purpose

Configure the settings according to the instructions shown in the window for items requiring multiple settings.

The available setting items are as follows.

- Configure the settings for sending a scanned document
- Configure the network print settings
- Restrict users using this machine

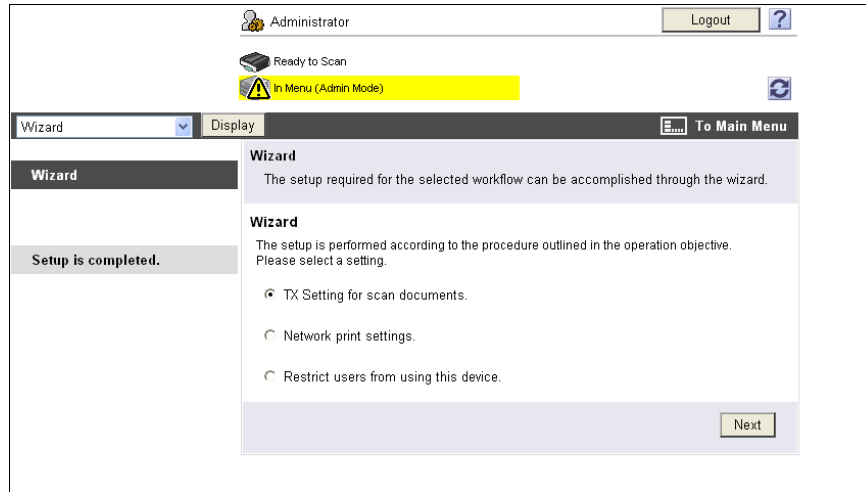

Reference

- As the setting procedure proceeds, its progress flow is displayed on the left.
- If setting is cancelled, you will return to the Setting for each purpose screen after the items that were configured before cancellation have been applied.

15

Troubleshooting

15 Troubleshooting

15.1 Cannot print

This section describes how to solve issues and problems that you may encounter while using the printer.

If you cannot print even when you have completed the printing procedure, check the following items in order from beginning to end.

Problem	Possible Cause	Remedy
A message saying "Printer is not connected" or "Print Error" appears on the computer screen.	The printer driver specified when printing may not be supported by the printer controller.	Check the specified printer name.
	The network or USB cable may be disconnected.	Check that the cable is correctly connected.
	An error may have occurred on this machine.	Check the control panel of this machine.
	Memory may be insufficient.	Perform a test printing to check whether printing is possible.
A postscript error appears on the computer screen.	Memory of the computer may be insufficient.	Perform a test printing to check whether printing is possible.
	There may be an error in the application software settings.	Refer to the user's manual of the application software to check the settings.
	The file printing settings may be incorrect.	Change the settings and try to print again.
Print processing on the computer finished, but printing does not start.	The printer driver specified when printing may not be supported by the printer controller.	Check the specified printer name.
	The network or USB cable may be disconnected.	Check that the cable is correctly connected.
	An error may have occurred on this machine.	Check the control panel of this machine.
	Unprocessed jobs may remain on this machine and be waiting to be processed.	Check the processing order for the job using Job List on the control panel of this machine. When [Skip Job Operation Settings] is enabled in the [Administrator Settings] of this machine, only the jobs without a problem are processed.
	When executing the print job, [Save in User Box] may have been specified.	Check from the control panel of the machine whether the intended print job is held in a User Box.
	When executing the print job, [Secure Print Only] may have been specified.	Check from the control panel of the machine whether the intended print job is held in the [Secure Print User Box].
	[Secure Print Only] may be specified on the machine.	Use [Secure Print] when executing the print job.
	When the account track is enabled, you may have entered an unregistered account track code or password.	Enter the correct account track code and password.

Problem	Possible Cause	Remedy
	When the user authentication is enabled, you may have entered an unregistered user name or password.	Enter the correct user name or password.
	Different encryption passphrases may be specified for the printer driver and the machine.	Specify the same encryption passphrase for the machine and the printer driver.
	Memory of the computer may be insufficient.	Perform a test printing to check whether printing is possible.
	Network connection with the printer controller is not established (when connecting via the network).	Contact your network administrator.
	This machine may be in the enhanced security mode.	Configure authentication settings in the enhanced security mode. For details, contact the printer administrator.
Printing order is disturbed - a job sent later is printed before the preceding jobs.	An error may have occurred on the printer for a reason such as running out of paper.	When [Skip Job Operation Settings] is enabled in the [Administrator Settings] of the printer, only the jobs without a problem are processed and those with any problem are held in queue.
Secure print is not available.	The password rules may be enabled on the machine.	Specify a password according to the password rules.
	Different encryption passphrases may be specified for the printer driver and the machine.	Specify the same encryption passphrase for the machine and the printer driver.
Jobs saved in a User Box have disappeared.	Jobs saved in a User Box may be deleted due to the settings on the machine.	Check the User Box settings for the machine. For details, refer to the [User's Guide Box Operations].
Printing in the user authentication or account track mode is not available.	The user name, account name or password is incorrect.	Enter the correct user name, account name and password.
	User authentication or account track may be disabled on the printer driver.	Enable user authentication or account track on the printer driver.
	Different encryption passphrases may be specified for the printer driver and the machine.	Specify the same encryption passphrase for the machine and the printer driver.
	The entered user name or account name may not be authorized.	Check with the administrator whether the user name or account name concerned is authorized for printing.
Printing is not available when you have selected [Public User] in user authentication.	Printing by public users may be prohibited on the machine.	Check with the administrator whether printing by public users is permitted.

When the above troubleshooting does not eliminate the problem, refer to the [User's Guide Copy Operations].

15.2 Cannot configure the settings/Cannot print according to the settings

Check the following items when you cannot configure settings of the printer driver or cannot print according to the settings you have configured.

Reference

- Some items for the printer driver may not be configured simultaneously.

15.2.1 The printer driver settings have no effect

Problem	Possible Cause	Remedy
Cannot select items in the printer driver.	Some functions cannot be combined.	Grayed out items cannot be configured.
A "conflict" message saying "unable to configure" or "function will be canceled" appears.	You are trying to configure the functions that cannot be combined.	Check carefully the functions you have specified, and then specify the functions that can be combined.
Cannot print according to the settings you have configured.	The settings may not be configured correctly.	Check the setting of each item of the printer driver.
	The selected functions can be combined in the printer driver, but may not be combined in this machine.	
	The paper size or paper orientation specified in the application may take precedence over the settings in the printer driver when printing.	Configure settings in the application correctly.
The watermark cannot be printed.	The watermark settings may not be configured correctly.	Check the watermark settings.
	The density of the watermark may be too light.	Check the density setting.
	Some graphic applications do not print watermarks.	When using such a program, the watermark cannot be printed.
The staple function cannot be specified.	The staple function cannot be used if the Paper Type is set to Thick or Transparency.	Check the setting of each item of the printer driver.
	The staple function requires the optional Finisher FS-527 or Finisher FS-529 .	Install the required options and enable them on the printer driver.
Cannot staple.	When printing a large number of pages, stapling cannot be performed.	Change the number of pages to be printed.
	If the document contains pages of different sizes, stapling cannot be performed.	Check the document.
The stapling position is not as expected.	The orientation setting is not correct.	Check the stapling position in the printer driver settings.
Cannot specify the punch function.	The hole punching cannot be specified when Booklet, Transparency, Thick 2, Thick 3, or Envelope is selected as the paper type.	Check the setting of each item of the printer driver.
	The optional Finisher FS-527 and Punch Kit are required.	Install the required options and enable them on the printer driver.

Problem	Possible Cause	Remedy
Cannot punch.	Printed pages may be fed out without being punched if the paper is loaded into the paper source with an incorrect orientation.	Check the orientation setting.
The punch position is not as expected.	The orientation setting is not correct.	Check the punching position in the printer driver settings.
Combination fails; pages are not combined, but are printed separately.	Originals having different orientations are combined.	Align the orientations of the original.
The overlay is not printed properly.	Memory of the computer may be insufficient.	Simplify the overlay to reduce the data size.
	Overlay data was created in color.	For color overlay data, the overlay is printed in color even if Gray Scale is selected with the PCL driver.
Garbled characters are detected when printing.	It may be impossible to obtain any outline image from the OS.	If garbled characters are detected while printing data using the PCL driver, set download fonts to bit-map fonts, and set printer fonts to OFF.
Images are not printed properly.	Memory of the computer may be insufficient.	Simplify the images to reduce the data size.
Paper is not fed from the specified paper source.	Paper will not be fed from the specified paper source if that paper source is loaded with paper of a different size or orientation.	Load the paper of the appropriate size and orientation into the desired paper source.
The user authentication or account track setting field is grayed out and cannot be specified.	User authentication or account track may be disabled on the Windows printer driver.	In the [Configure] tab, enable user authentication or account track.

15.2.2 Others

Problem	Possible Cause	Remedy
Cannot install the printer driver.	It has already been installed in Windows Vista/Server 2008 as a printer compatible with the Web service print function.	If you try to install a printer driver in Windows Vista/Server 2008 by use of the Web service print function, it is recognized as installed before the actual installation is completed. Uninstall the printer in the [Network] Window, and then install it again.

15.2.3 Error message

Message	Cause and remedy
Cannot connect to the network	A connection to the network was not able to be established. Make sure that the network cable is correctly connected. In addition, make sure that [Network Settings] in [Administrator Settings] have been correctly configured.

16

Appendix

16 Appendix

16.1 Product specifications

Item		Specifications
Type		Built-in printer controller
Power supply		Common with the machine
RAM		2,048 MB
HDD		bizhub C360/bizhub C280 : 250GB bizhub C220 : Option
I/F		Ethernet (1000Base-T/100Base-TX/10Base-T) USB 2.0
Frame type		Ethernet 802.2 Ethernet 802.3 Ethernet II Ethernet SNAP
Supported protocols		TCP/IP (IPv4/IPv6), BOOTP, ARP, ICMP, DHCP, DHCPv6, AutoIP, SLP, SNMP, FTP, LPR/LPD, RAW Socket, SMB over, TCP/IP, IPP, HTTP, POP, SMTP, LDAP, NTP, SSL, IPX/SPX, AppleTalk, Bonjour, NetBEUI, WebDAV, DPWS, S/MIME, IPsec, DNS, DynamicDNS, LLMNR, LLTD
Printer language		PCL5/c6 Emulation PCL XL ver. 2.1 Emulation PostScript 3 Emulation (3016) XPS ver.1.0
Operating environment conditions		Temperature: 10 to 30 degrees Centigrade Humidity: 15 to 85%RH
Resolution	Data processing	600 × 600 dpi (Print and Fax functions) 400 × 400 dpi (Fax function) 200 × 200 dpi (Fax function)
	Print	600 dpi × 600 dpi
Supported paper sizes		Maximum standard size (For banner printing: Paper width 8-1/4 to 11-11/16 inches (210 to 297 mm) × paper length 18 to 47-1/4 inches (457.3 to 1200 mm))
Fonts (Built-in fonts)		<PCL> European 80 fonts <PostScript 3 Emulation> European 137 fonts
Compatible computer		IBM PC or compatible, and Macintosh (PowerPC, Intel Processor: Intel Processor is for Mac OS X 10.4/10.5 only)

Item	Specifications	
Printer driver	KONICA MINOLTA PCL Driver (PCL driver)	Windows NT Workstation Version 4.0 (Service Pack 6 or later) Windows NT Server Version 4.0 (Service Pack 6 or later) Windows 2000 Professional (Service Pack 4 or later) Windows 2000 Server (Service Pack 3 or later) Windows XP Home Edition (Service Pack 1 or later) Windows XP Professional (Service Pack 1 or later) Windows Server 2003, Standard Edition (Service Pack 1 or later) Windows Server 2003, Enterprise Edition (Service Pack 1 or later) Windows Server 2003 R2, Standard Edition Windows Server 2003 R2, Enterprise Edition Windows XP Professional x64 Edition Windows Server 2003, Standard x64 Edition Windows Server 2003, Enterprise x64 Edition Windows Server 2003 R2, Standard x64 Edition Windows Server 2003 R2, Enterprise x64 Edition Windows Vista Business * Windows Vista Enterprise * Windows Vista Home Basic * Windows Vista Home Premium * Windows Vista Ultimate * Windows Server 2008 Standard * Windows Server 2008 Enterprise * * Supports 32-bit (x86)/64-bit (x64) environment.
	KONICA MINOLTA PostScript Driver (PS driver)	Windows 2000 Professional (Service Pack 4 or later) Windows 2000 Server (Service Pack 3 or later) Windows XP Home Edition (Service Pack 1 or later) Windows XP Professional (Service Pack 1 or later) Windows Server 2003, Standard Edition (Service Pack 1 or later) Windows Server 2003, Enterprise Edition (Service Pack 1 or later) Windows Server 2003 R2, Standard Edition Windows Server 2003 R2, Enterprise Edition Windows XP Professional x64 Edition Windows Server 2003, Standard x64 Edition Windows Server 2003, Enterprise x64 Edition Windows Server 2003 R2, Standard x64 Edition Windows Server 2003 R2, Enterprise x64 Edition Windows Vista Business * Windows Vista Enterprise * Windows Vista Home Basic * Windows Vista Home Premium * Windows Vista Ultimate * Windows Server 2008 Standard * Windows Server 2008 Enterprise * * Supports 32-bit (x86)/64-bit (x64) environment.

Item	Specifications
KONICA MINOLTA XPS Driver (XPS driver)	Windows Vista Business * Windows Vista Enterprise * Windows Vista Home Basic * Windows Vista Home Premium * Windows Vista Ultimate * Windows Server 2008 Standard * Windows Server 2008 Enterprise * * Supports 32-bit (x86)/64-bit (x64) environment.
PostScript PPD driver (PS-PPD)	Mac OS 9.2 or later Mac OS X 10.2.8/10.3/10.4/10.5
Fax driver	Windows NT Workstation Version 4.0 (Service Pack 6 or later) Windows NT Server Version 4.0 (Service Pack 6 or later) Windows 2000 Professional (Service Pack 4 or later) Windows 2000 Server (Service Pack 3 or later) Windows XP Home Edition (Service Pack 1 or later) Windows XP Professional (Service Pack 1 or later) Windows Server 2003, Standard Edition (Service Pack 1 or later) Windows Server 2003, Enterprise Edition (Service Pack 1 or later) Windows Server 2003 R2, Standard Edition Windows Server 2003 R2, Enterprise Edition Windows XP Professional x64 Edition Windows Server 2003, Standard x64 Edition Windows Server 2003, Enterprise x64 Edition Windows Server 2003 R2, Standard x64 Edition Windows Server 2003 R2, Enterprise x64 Edition Windows Vista Business * Windows Vista Enterprise * Windows Vista Home Basic * Windows Vista Home Premium * Windows Vista Ultimate * Windows Server 2008 Standard * Windows Server 2008 Enterprise * * Supports 32-bit (x86)/64-bit (x64) environment.
Utility	PageScope Web Connection Compatible Web browsers: <For Windows NT4.0/2000/XP/Server 2003/Vista> <ul style="list-style-type: none"> • Microsoft Internet Explorer Ver. 6/7 (JavaScript and Cookies enabled) • Netscape Navigator 7.02 or later (JavaScript and Cookies enabled) • Mozilla Firefox 1.0 or later (JavaScript and Cookies enabled) <For Macintosh MacOS 9.x/MacOS X> <ul style="list-style-type: none"> • Netscape Navigator 7.02 or later (JavaScript and Cookies enabled) • Mozilla Firefox 1.0 or later (JavaScript and Cookies enabled) <For Linux> <ul style="list-style-type: none"> • Netscape Navigator 7.02 or later (JavaScript and Cookies enabled) • Mozilla Firefox 1.0 or later (JavaScript and Cookies enabled) Adobe® Flash® Player : <ul style="list-style-type: none"> • Plug-in Ver.7.0 or later required to select Flash as the display format. • Plug-in Ver.9.0 or later required to use the Data Management Utility (font/macro data management).

Item	Specifications
MetaFrame operating environment	<p>The operation of this driver has been confirmed only in the following environments.</p> <p>Server OS: Windows 2000 Advanced server/Windows 2003 Enterprise Server</p> <p>MetaFrame: Citrix® MetaFrame® Presentation Server 3.0</p> <p>Citrix® MetaFrame® Presentation Server 4.0</p> <p>Client OS: Windows 2000/Windows XP</p> <p>ICAClient: ICA32bit</p> <p>* For operating in an environment other than those described above, consult the dealer.</p>

16.2 Printing reports

16.2.1 Configuration page

KONICA MINOLTA C360

Configuration Page

Print Operation Menu Map

Basic Setting

Default Paper Size	= A4
Paper Tray	= Auto
Output Tray	= Elevate Tray
Binding Position	= Left Binding
Double-Sided	= Off
Staple	= Off
Hole-Punch	= Off
Orientation	= Portrait
# of Sets	= 1
No Matching Paper in Tray Setting	= Stop Printing (Tray Fixed)
Spool Setting	= On
Convert	= Off
PDL Setting	= Auto
Banner Setting	= Disable
Banner Paper Tray	= Auto

PCL Setting

Font Source	= 1
Font Number	= 0
Font Point	= 12.00
Font Pitch	= 10.00
Symbol Set	= PC-8, Code Page 437
Line/Page	= 64 [Line / Page]
CR/LF Mapping	= Off

PS Setting

Print Reports	= Disable
Text RGB Source	= 4
Text Destination Profile	= Auto
Image RGB Source	= 4
Image Destination Profile	= Auto
Graphics RGB Source	= 4
Graphics Destination Profile	= Auto
Simulation Profile	= None

XPS Settings

Verify XPS Digital Signature	= Disable
------------------------------	-----------

Test Print

Configuration	
PCL Font List	
PS Font List	
Demo Page	

I/F Setting

Network Rx Timeout	= 60 [sec.]
USB Timeout	= 60 [sec.]
Print XPS Errors	= Enable

Installed

Printer HDD	= Installed
Printer Memory	= 3328 [MByte]

Printer Information

Installed Tray

Tray 1	= A4
Tray 2	= A4
Tray 3	= A4
Tray 4	= A4
LCT	= A4

Option

Duplex Unit	= Installed
Finisher	= Available
Punch Unit	= Available
Fold Unit	= Available
Fax Unit	= Available
Mailbin Unit	= Not Available

Firmware Version

Management Version	= 2
Printer Controller	= A0ED0Y0-3000-0000-0000

Network

MAC Address

MAC Address	= 00:20:6B: [REDACTED]
-------------	------------------------

TCP/IP

TCP/IP	= Enable
IP Address	= 150.16.154.37
Subnet Mask	= 255.255.255.0
Default Gateway	= 150.16.154.1
RAW Port 0	= 9100
RAW Port 1	= 9112
RAW Port 2	= 9113
RAW Port 3	= 9114
RAW Port 4	= 9115
RAW Port 5	= 9116

Netware

Netware	= Disable
---------	-----------

Appletalk

Appletalk	= Disable
-----------	-----------

SMB

SMB	= Enable
-----	----------

16.2.2 PCL font list

KONICA MINOLTA C360

PCL Font List

P.1

Resident Fonts

Font	Pitch/Point	Escape Sequence	Font #
Courier	Scalable	<esc>(01X<esc>(s0p10h0s0b4099T	00000
CG Times	Scalable	<esc>(01X<esc>(s1p12v0s0b4101T	00001
CG Times Bold	Scalable	<esc>(01X<esc>(s1p12v0s3b4101T	00002
<i>CG Times Italic</i>	Scalable	<esc>(01X<esc>(s1p12v1s0b4101T	00003
<i>CG Times Bold Italic</i>	Scalable	<esc>(01X<esc>(s1p12v1s3b4101T	00004
CG Omega	Scalable	<esc>(01X<esc>(s1p12v0s0b4113T	00005
CG Omega Bold	Scalable	<esc>(01X<esc>(s1p12v0s3b4113T	00006
<i>CG Omega Italic</i>	Scalable	<esc>(01X<esc>(s1p12v1s0b4113T	00007
<i>CG Omega Bold Italic</i>	Scalable	<esc>(01X<esc>(s1p12v1s3b4113T	00008
<i>Coronet</i>	Scalable	<esc>(01X<esc>(s1p12v1s0b4116T	00009
Clarendon Condensed	Scalable	<esc>(01X<esc>(s1p12v4s3b4140T	00010
Univers Medium	Scalable	<esc>(01X<esc>(s1p12v0s0b4148T	00011
Univers Bold	Scalable	<esc>(01X<esc>(s1p12v0s3b4148T	00012
<i>Univers Medium Italic</i>	Scalable	<esc>(01X<esc>(s1p12v1s0b4148T	00013
<i>Univers Bold Italic</i>	Scalable	<esc>(01X<esc>(s1p12v1s3b4148T	00014
Univers Condensed Medium	Scalable	<esc>(01X<esc>(s1p12v4s0b4148T	00015
Univers Condensed Bold	Scalable	<esc>(01X<esc>(s1p12v4s3b4148T	00016
<i>Univers Condensed Medium Italic</i>	Scalable	<esc>(01X<esc>(s1p12v5s0b4148T	00017
<i>Univers Condensed Bold Italic</i>	Scalable	<esc>(01X<esc>(s1p12v5s3b4148T	00018
Antique Olive	Scalable	<esc>(01X<esc>(s1p12v0s0b4168T	00019
Antique Olive Bold	Scalable	<esc>(01X<esc>(s1p12v0s3b4168T	00020
<i>Antique Olive Italic</i>	Scalable	<esc>(01X<esc>(s1p12v1s0b4168T	00021
Garamond Antiqua	Scalable	<esc>(01X<esc>(s1p12v0s0b4197T	00022
Garamond Halbfett	Scalable	<esc>(01X<esc>(s1p12v0s3b4197T	00023
<i>Garamond Kursiv</i>	Scalable	<esc>(01X<esc>(s1p12v1s0b4197T	00024

16.2.3 PS font list

KONICA MINOLTA C360

PS Font List

P.1

Resident Fonts

Font		Font #
Albertus MT	AlbertusMT	00000
<i>Albertus MT Italic</i>	AlbertusMT-Italic	00001
Albertus MT Light	AlbertusMT-Light	00002
Antique Olive Roman	AntiqueOlive-Roman	00003
<i>Antique Olive Italic</i>	AntiqueOlive-Italic	00004
Antique Olive Bold	AntiqueOlive-Bold	00005
Antique Olive Compact	AntiqueOlive-Compact	00006
<i>Apple Chancery</i>	Apple-Chancery	00007
Arial	ArialMT	00008
<i>Arial Italic</i>	Arial-ItalicMT	00009
Arial Bold	Arial-BoldMT	00010
Arial Bold Italic	Arial-BoldItalicMT	00011
ITC Avant Garde Gothic Book	AvantGarde-Book	00012
<i>ITC Avant Garde Gothic Book Oblique</i>	AvantGarde-BookOblique	00013
ITC Avant Garde Gothic Demi	AvantGarde-Demi	00014
ITC Avant Garde Gothic Demi Oblique	AvantGarde-DemiOblique	00015
Bodoni Roman	Bodoni	00016
<i>Bodoni Italic</i>	Bodoni-Italic	00017
Bodoni Bold	Bodoni-Bold	00018
Bodoni Bold Italic	Bodoni-BoldItalic	00019
Bodoni Poster	Bodoni-Poster	00020
Bodoni Poster Compressed	Bodoni-PosterCompressed	00021
ITC Bookman Light	Bookman-Light	00022
<i>ITC Bookman Light Italic</i>	Bookman-LightItalic	00023
ITC Bookman Demi	Bookman-Demi	00024
ITC Bookman Demi Italic	Bookman-DemiItalic	00025
Carta	Carta	00026
Chicago	Chicago	00027
Clarendon Roman	Clarendon	00028
Clarendon Bold	Clarendon-Bold	00029

16.2.4 GDI demo page

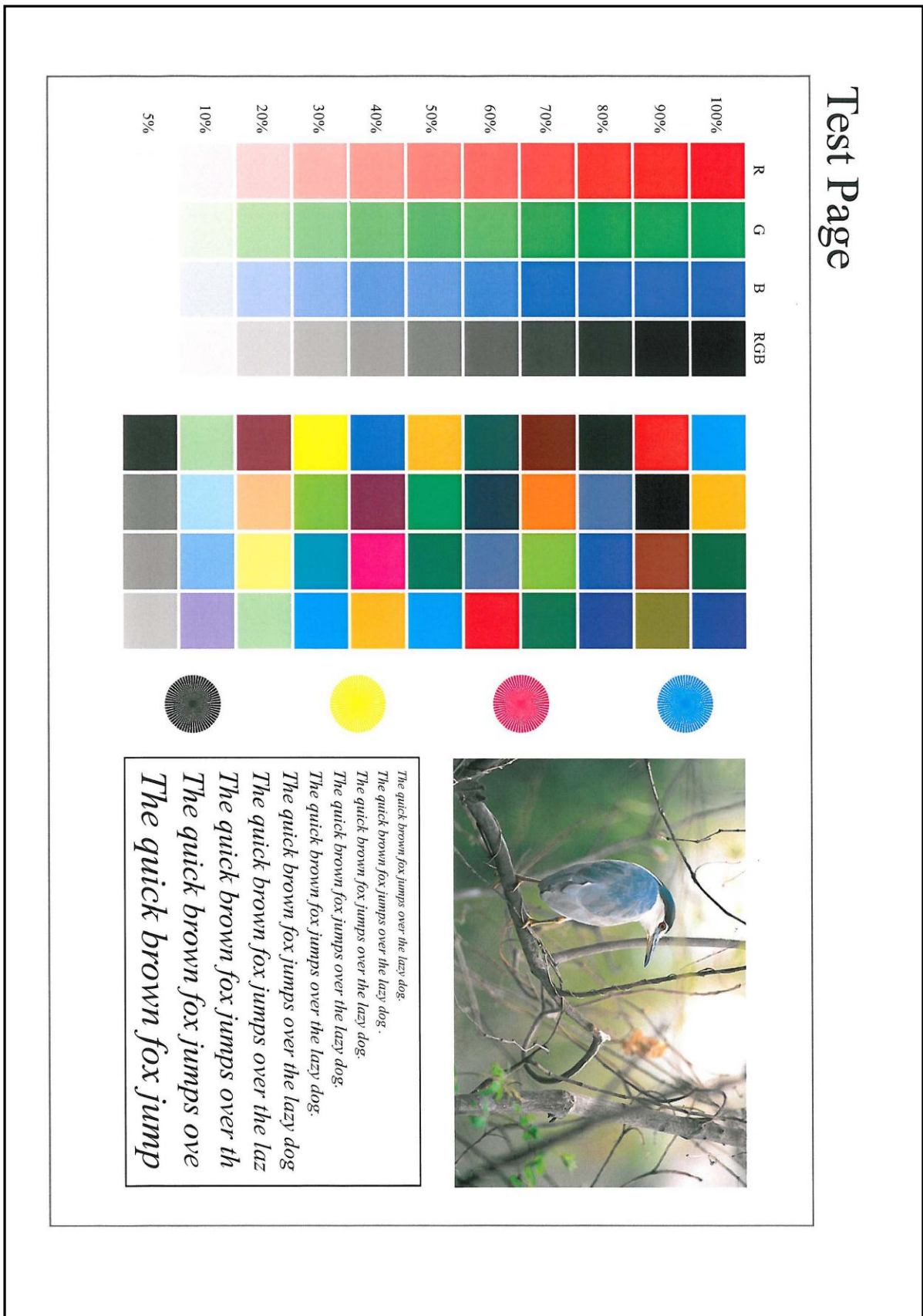

16.3 PPD driver (For Linux and applications)

16.3.1 PPD driver types

The PPD driver contains the PPD information for Mac OS 9, Linux, and applications.

- Driver for Linux: Install for use with Linux (Contains PPD for Linux and PPD for OpenOffice)
- Driver for applications: Install when using applications such as Adobe PageMaker that require the PPD driver.

16.3.2 PPD driver for Linux

Operating environment

The PPD driver operates in the environment where systems are combined as follows.

- OS:Red Hat Enterprise Linux 4 -CupsVersion:1.1
- OS:SuSE Linux 10.1 -CupsVersion:1.2
- OpenOffice v1.1.5

Registering the PPD driver for Linux

- 1 Copy the PPD file to the CUPS model directory. (/usr/share/cups/model for major Linux)
- 2 In [Add Printer] of the CUPS printing system, specify PPD to add this machine.
→ For details on CUPS, refer to [Help] in the CUPS Web management page.

Configuring the PPD driver for Linux

In [Configure Printer] of the CUPS printing system, configure the functions.

Registering the PPD driver for OpenOffice

- 1 In [Add Printer] of the CUPS printing system, specify PPD to add this machine.
- 2 Open the OpenOfficePrinterAdministrator tool.
- 3 Click [New Printer].
- 4 In the [Choose a device type] window, select [add a printer], and then click [Next].
- 5 In the [Choose a driver] window, click [import].
- 6 Select [KONICA MINOLTA C360 OpenOffice PPD], and then click [OK].
- 7 From the [Please Select a Suitable driver.] list, select [KONICA MINOLTA C360 OpenOffice PPD], and then click [Next].
- 8 In the [Choose a command line] window, select the printer registered to CUPS, and then click [Next].
- 9 Click [Finish].

Printing with OpenOffice

- 1 In OpenOffice, select File-Print.
- 2 Select [KONICA MINOLTA C360 OpenOffice PPD] in [Printer name].
- 3 Click [Properties].
- 4 Select the desired setting in [Page size], and then click [OK].
To configure settings other than Page Size, click [Configure Printer] in CUPS.
- 5 Click [OK] in the OpenOffice print window to print.

16.3.3 PPD driver for applications

PPD registration destination (Example: Adobe PageMaker)

- For PageMaker 6.0:
Copy the PPD file to RSRC\PPD4 under the folder to which PageMaker is installed.
- For PageMaker 6.5 and 7.0:
Copy the PPD file to RSRC\<<Language>\PPD4 under the folder to which PageMaker is installed.

How to print

- 1 Select [File] - [Print].
- 2 From the [PPD] box in the print window, select this machine.
- 3 Configure the [Paper] and [Features] settings for the printer.
- 4 Click the [Print] button to print.

16.4 If the bit number differs between the server operating system and client operating system

If the bit number differs between the print server's running operating system and client computer's running operating system while Windows Server 2008 is running on the print server, the additional driver may not be installed correctly on the print server.

To solve this problem, specify the setup information file (ntprint.inf) of the operating system with a different bit number when installing the additional driver on the print server.

The following describes how to install the additional driver by specifying a setup information file in a different computer from that the print server.

Reference

- Before starting this procedure, prepare to configure a different client computer from that of the print server and install the operating system that has a bit number different from that of the print server.
- On the print server side, the system drive of the client computer is assigned as the network drive. Configure the setting to share the drive to be assigned in advance.

16.4.1 Installing the additional driver

This example shows the operation when installing Windows Server 2008 (32-bit version) on the print server and Windows Vista (64-bit version) in the client computer.

1. Configure the setting to share the drive (ordinarily, drive C) where the client computer's operating system is installed.
2. On the print server, the drive (example: "C") of the client computer, which is shared in Step 1, is assigned as the network drive (example: "z").
3. Install the 32-bit operating system driver on the print server.
4. Open the [Print Properties] window of the created printer.
5. Select the [Sharing] tab, and select the [Share this printer] check box.
6. Click [Additional Drivers].
The Additional Drivers page appears.
7. Select the [x64] check box in the [Processor] column, and click [OK].
8. Specify the folder that contains the 64-bit operating system driver.
This displays a page to request a setup information file.
9. Click [Browse], and specify the setup information file (ntprint.inf) in the client computer to which the network drive is assigned.
 - Specify the following file.
"z:\Windows\System32\DriverStore\FileRepository\ntprint.inf_xxx"
 - In this path, "z" indicates the network drive that was assigned the above. "_xxx" at the end of this path varies depending on the driver version.
 - The setup information file may be stored at a different location depending on your client computer. If folder "amd64" resides in the same hierarchy as that of "ntprint.inf", specify a setup information file for 64-bit operating system under that folder. To additionally install a 32-bit operating system driver, specify a setup information file under folder "i386" that is in the same hierarchy as that of "ntprint.inf".
10. Click [Open].
Installation starts.
11. When the installation completes, click [Close].
The additional installation of the 64-bit operating system driver is then completed.

16.5 Glossary

Term	Description
10Base-T/ 100Base-TX/ 1000Base-T	A set of specifications under the Ethernet standards. Those cables that consist of twisted copper wire pairs are used. The transmission rates of 10Base-T, 100Base-TX and 1000Base-T are respectively 10Mbps, 100Mbps and 1000Mbps.
Adobe® Flash®	Software or its file format developed by Adobe Systems Inc. (formerly by Macromedia, Inc.), used to create a content by compiling vector-graphic animations and sounds. The software allows handling interactive contents using keyboard or mouse. The files can be kept relatively compact and accessed from a Web browser with dedicated plug-in software.
AppleTalk	The generic name for the protocol suite developed by Apple Computer for computer networking.
bit	The abbreviation for binary digit. The smallest unit of information (data quantity) handled by a computer or printer. A bit uses only a 0 or a 1 to indicate data.
BMP	The abbreviation for bitmap. This is a file format for saving image data. (The file extension is ".bmp".) Commonly used on Windows platforms. BMP covers the color depth from monochrome (2 values) to full color (16,777,216 colors). BMP images are not suitable for compressed storage.
Bonjour	A Macintosh network technology, automatically detecting a device connected to the network for automatic configuration. Previously called "Rendezvous", and has been changed to "Bonjour" since Mac OS X v10.4.
BOOTP	The abbreviation for Bootstrap Protocol. The protocol is used for a client computer on the TCP/IP network to load network configuration automatically from a server. Instead of BOOTP, DHCP, an advanced protocol based on BOOTP, is typically used today.
Byte	A byte indicates a unit of information (data quantity) handled by a computer or printer. A byte consists of eight bits.
CMYK	The acronym for Cyan, Magenta, Yellow, and Black. The colors in the toner or ink used for color printing. Changing the mixing ratio of the four CMYK colors allows creating any type of full colors.
Default Gateway	A device, such as a computer or router, used as a "gateway" to access computers on different LANs.
DHCP	The acronym for Dynamic Host Configuration Protocol. The protocol is used for a client computer on the TCP/IP network to load network configuration automatically from a server. Just using a DHCP server to centrally manage IP addresses of the DHCP clients enables you to construct a network without IP address conflicts or other troubles.
DNS	The acronym for Domain Name System. DNS allows for obtaining the IP address corresponding to a host name in network environments. This system enables a user to access other computers on the network by specifying host names instead of elusive and non-intuitive IP addresses.
DPI (dpi)	The acronym for Dots Per Inch. A unit of resolution used for printers and scanners. This indicates the number of dots used to represent an inch. The higher this value, the higher the resolution.
FTP	The acronym for File Transfer Protocol. This is a protocol used for transferring files via the Internet, an intranet or other TCP/IP network.
HTTP	The acronym for HyperText Transfer Protocol. This is a protocol used to send or receive data between a Web server and a client (such as a Web browser). HTTP can exchange files such as images, sounds, and movies that are associated with documents, including their presentation formats and other information.
IPP	The acronym for Internet Printing Protocol. This is a protocol used to send or receive print data or control printers via the Internet or other TCP/IP network. IPP can also send and print data to printers in remote areas via the Internet.
IPX	One of the protocols used for NetWare. IPX runs in the network layer of the OSI reference model.

Term	Description
IPX/SPX	The abbreviation for Internetwork Packet Exchange/Sequenced Packet Exchange. This is a protocol developed by Novell, Inc., typically used in NetWare environments.
IP Address	An address or a code used to identify an individual network device on the Internet. IPv4 (Internet Protocol version 4), a protocol widely used today, adopts a 32-bit number for an IP address separated into four sections. An example of an IPv4 IP address is: 192.168.1.10. On the other hand, IPv6 (Internet Protocol version 6), the next generation protocol, adopts 128-bit IP addresses. An IP address is assigned to every computer or other device connected to the Internet.
LAN	The acronym for Local Area Network. This is a network constructed by connecting computers on the same floor, in the same building, or in neighboring buildings.
LPD	The acronym for Line Printer Daemon. This is a platform-independent printer protocol running on the TCP/IP network. The protocol was originally developed for BSD UNIX, and has become one of the printing protocols typically used among general computers.
LPR/LPD	The acronym for Line Printer Request/Line Printer Daemon. This is a printing method implemented via networks, used for Windows NT or UNIX based systems. It uses TCP/IP to output printing data from Windows or UNIX to a printer on the network.
MAC address	MAC is the acronym for Media Access Control. A MAC address is an ID number unique to each Ethernet card, enabling sending or receiving data to or from other Ethernet cards. A Mac address is a 48-bit number. The first 24 bits are controlled by IEEE and used to allocate a unique number to each manufacture, whereas the latter 24 bits are used by each manufacturer to assign a unique number to each card.
NDPS	The acronym for Novell Distributed Print Services. This provides a high performance printing solution in NDS environments. Using NDPS for the print server simplifies and automates complicated management activities related to printer use. For example, you can print to a desired printer or automatically download the printer driver for a newly installed printer. NDPS print servers also integrate management related to the network printers.
NDS	The acronym for Novell Directory Services. This allows the centralized management in a hierarchical structure of shared resources such as servers, printers and users information on the network, as well as the access privilege and other information related to the users.
NetBIOS	The abbreviation for Network Basic Input Output System. This is a communication interface developed by IBM.
NetBEUI	The abbreviation for NetBIOS Extended User Interface. This is a network protocol developed by IBM. NetBEUI enables you to construct a small-scale network simply by configuring computer names.
NetWare	A network operating system developed by Novell. This uses NetWare IPX/SPX for the communication protocol.
Nprinter/ Rprinter	A remote printer support module used when using a printer server in NetWare environments. Rprinter is used for NetWare 3.x, and Nprinter for NetWare 4.x.
OHP/OHT	A transparent sheet used for OHP (Overhead projector). This is used for presentations.
OS	The acronym for Operating System. This is base software used to control the system of a computer. Windows, MacOS, or UNIX is an OS.
PDF	The acronym for Portable Document Format. This is an electronically formatted document with file extension of ".pdf". PDF is a PostScript based format, and can be viewed using Adobe Acrobat Reader, a free viewer software.
PDL	The acronym for Page Description Language. This is a language used to instruct a page printer about images being printed on each page.
PostScript	A typical page-descriptive language developed by Adobe and commonly used for high quality printing.
PPD	The acronym for PostScript Printer Description. This is a file with the description of resolution, available paper sizes, and other information specific to a PostScript printer model.

Term	Description
Proxy server	A server that is installed to act as an intermediary connection between each client and different servers to effectively ensure security over the entire system for Internet connections.
PServer	A print server module available in NetWare environments. This module monitors, changes, pauses, restarts, or cancels print jobs.
RIP	The acronym for Raster Image Processor. RIP extracts picture images from text data created using PostScript or other page description language. This processor is usually integrated into a printer.
RGB	The acronym for Red, Green, and Blue. The RGB are the primary three colors used for monitor and other devices, producing any of the full colors by changing their brightness ratio.
Samba	UNIX server software which uses SMB (Server Message Block) to make UNIX system resources available to Windows environments.
SLP	The acronym for Service Location Protocol. This is a protocol that provides capabilities such as finding services or automatic client configuration on the TCP/IP network.
SMB	The acronym for Server Message Block. This is a protocol for sharing files and printers mainly over the Windows network.
SMTP	The acronym for Simple Mail Transfer Protocol. It is a protocol used to transmit or transfer E-mail messages.
SNMP	The acronym for Simple Network Management Protocol. This is a management protocol in the TCP/IP network environments.
TCP/IP	The acronym for Transmission Control Protocol/Internet Protocol. It is a de facto standard protocol widely used for the Internet. An IP address is used to identify each network device.
TrueType	A type of outline font developed by Apple and Microsoft, and currently used as a standard font type for Macintosh and Windows. This type of font can be used both for display and printing.
USB	The acronym for Universal Serial Bus. This is a general-purpose interface defined for connecting a mouse, printer, and other devices with a computer.
WINS	The acronym for Windows Internet Naming Service. This is a service, available in Windows environments, to call the name server responsible for conversion between a computer name and an IP address.
XPS	The abbreviation for XML Paper Specification. This is one of the electronic document formats developed by Microsoft Corporation. It is first supported in Windows Vista.
Outline font	A type of fonts represented using lines and curves to display an outline of a character. Larger-size characters can be displayed on a screen or printed with no jagged edges.
Uninstallation	To delete software installed on a computer
Ethernet	A standard for LAN transmission lines.
Print job	A print request transmitted from a computer to a printing device.
Install	To install hardware, operating systems, applications, printer drivers, or other software on to a computer.
Web browser	Software used to view Web pages. Typical Web browsers include Internet Explorer and Netscape Navigator.
Resolution	The resolution value indicates how much detail of an object can be reproduced precisely on an image or a print matter.
Color matching	A technology for minimizing the difference in colors among different devices such as scanners, displays and printers.
Brightness	Brightness of a display or other screen.
Queue name	<ul style="list-style-type: none"> • A name assigned to each device for allowing printing to the device via network. • A logical printer name required for LPD/LPR printing.

Term	Description
Shared printer	A printer connected to a server on the network and configured to be used by multiple computers.
Client	A computer using services provided by servers via the network.
Gray scale	A form of presenting monochrome image by using the gradation information shifting from black to white.
Gateway	Hardware and software used as the point where a network is connected to a network. A gateway not only connects networks but also changes data formats, addresses, and protocols according to the connected networks.
Subnet mask	A value used to divide a TCP/IP network into small networks (subnetworks). This is used to identify how many higher-order bits of an IP address are used for the network address.
Screen font	A type of fonts used for displaying characters and symbols on a CRT or other monitor.
Spool	The acronym for Simultaneous Peripheral Operation On-Line. Data to be output to a printer is not sent directly to the printer, but is temporarily stored in another location. The stored data is then sent collectively to the printer.
Touch & Print	A feature that allows documents sent from the printer driver to be printed simply by placing your finger or IC card on the authentication unit connected to the printer when the user authentication is enabled. In order to use the Touch & Print feature, an authentication unit must be connected to this machine, and the vein patterns or the ID of the IC card for each user must be registered.
Driver	Software that works as a bridge between a computer and a peripheral device.
Hard disk	A large capacity storage device for storing data. The data is retained even after the power is turned off.
Peer-to-peer	A type of network where the connected devices can be communicate with each other without using a dedicated server.
Plug and play	A mechanism used to immediately detect a peripheral device when it is plugged into a computer, and search for an appropriate driver automatically, so that the device becomes operable.
Printer driver	Software that works as a bridge between a computer and a printer.
Printer buffer	A memory area temporarily used for processing data of print jobs.
Print queue	A software system used by a spooler to save generated print jobs.
Frame type	A type of communication format used in NetWare environments. For mutual communication, the same frame type is required.
Preview	A function allowing you to view a result image before being actually processed for printing or scanning.
Protocol	A rule enabling a computer to communicate with other computers or peripherals.
Property	Attribute information. When using a printer driver, different functions can be configured by utilizing its properties. By using properties of a file, you can check the attribute information about the file.
Profile	A color attribute file. This contains overall input and output correlation data of primary colors, specifically used by the color input and output devices to reproduce colors.
Host name	The name used to identify a device on a network.
Memory	A storage device used for storing data temporarily. Some types of memory retain data even after the power is turned off, while others not.
Local printer	A printer connected to a parallel or USB port of a computer.

17

Index

17 Index

17.1 Index by item

Numerics

2-sided printing 13-15

A

Accessing 14-2
 Account track 12-19, 14-5
 Adding a printer 5-2, 5-13, 5-22, 5-28
 Address registration 14-18, 14-28
 Administrator mode 14-10, 14-20
 Administrator settings 10-12, 13-39
 AppleTalk 3-7, 3-8, 6-4, 6-11, 6-16
 Assign account to acquire device info 13-55
 Authentication 13-57
 Authentication and printing 12-22
 Authentication unit 12-28
 Auto size switching between A4/A3 and LTR/LGR
 13-8
 Auto trapping 9-25, 10-23, 11-7, 13-28

B

Back cover 9-16, 10-16, 11-7
 Banner printing 12-41
 Banner sheet paper tray 13-19
 Banner sheet setting 13-9
 Basic tab 9-12
 Binding direction adjustment 13-10
 Binding margin 9-14
 Binding position 9-14, 10-14, 11-7, 13-16
 Black over print 9-25, 10-23, 11-7, 13-29
 Bonjour 3-7, 6-3

C

Cannot configure the settings 15-4
 Cannot print 15-2
 Capturing print data 13-59
 CD-ROM 2-10
 Cellular phone or PDA 12-29
 Cellular phone or PDA settings 13-58
 Center stapling and folding 9-15, 10-14
 Checking jobs 14-16
 Collated 10-10, 11-6
 Collating 9-13, 10-10
 Color settings 9-25, 10-23, 11-7
 Combination 9-14, 11-7
 Configure tab 9-4
 Connection diagram 2-7
 Connection methods 3-5
 Control panel 2-4
 Copy security 9-18, 9-21, 10-19
 Cover mode tab 9-16

Cover mode/transparency interleave 10-16
 CR/LF mapping 13-24
 Custom page sizes 11-5
 Custom size 9-12, 10-8
 Customizing 14-19

D

Date 9-18, 10-19
 Date/time 9-23, 10-21
 Default operation selection 13-50
 Default settings 9-4, 10-4, 11-3
 Deleting secure print documents 13-43
 Device option 9-4
 Direct printing 14-17
 Driver password encryption setting 13-61

E

Edge enhancement 9-25, 10-23
 Encryption passphrase 9-5, 10-13, 12-32
 Error message 15-5
 Ethernet 2-7

F

Fax driver 3-4
 Fax settings 14-29
 Finish tab 9-15
 Finishing options 11-7
 Flow of printing 2-3
 Folding 9-15, 10-14, 11-7
 Font settings 13-20
 Font size 13-22
 Front cover 9-16, 10-16, 11-7

G

GDI demo page 16-9
 General settings 11-6
 Glossary 16-13
 Glossy mode 9-25, 10-22, 11-7
 Gray background text correction 13-12

H

Header/footer 9-18, 10-19, 10-22

I

ICC profile 12-36
 ICC profile settings 13-26
 ID & print deletion time 13-45
 ID & print operation settings 13-49
 ID & print settings 13-48
 ID & print settings for deletion after printing 13-46
 Image compression 9-25

Image shift9-15, 10-14
 Installer4-2
 Installing4-3, 6-2
 Interfaces2-7
 Interleaving OHP transparencies9-17, 10-17, 11-7
 IPP 3-5, 5-7, 5-19, 5-25, 6-8, 6-14
 IPP setting4-3
 IPPS 3-5, 5-7, 5-19, 5-25

L

Layout11-6
 Layout tab9-14
 Layout/finishing10-13
 Line width adjustment13-11
 Line/page13-23
 Linux16-10
 Local connection 2-9, 5-12, 5-21, 5-26
 Logging in14-4, 14-7
 Logging out14-4, 14-6
 LPD6-6, 6-12, 6-17
 LPR 3-5, 5-2, 5-13, 5-22, 5-28, 6-6, 6-12, 6-17

M

Mac3-7
 Mac OS 9.23-8
 Macintosh2-6, 6-2, 8-4
 Maintenance14-20
 Mode 112-8
 Mode 212-10
 My tab9-10

N

NetWare3-8, 7-2
 Network14-25
 Network connection2-8
 Network window5-9
 Number of copies 9-13, 10-10, 11-6, 13-5
 Number of copies and pages10-10

O

Offsetting9-13, 10-10, 11-7
 Online help14-3
 OpenAPI settings13-57
 Operating environment2-6, 4-2, 14-2
 Operating system2-6
 Option10-4, 11-3
 Orientation10-9, 11-5
 Original direction13-6
 Original orientation9-12
 Original size9-12
 OS2-6
 OS 10.23-7, 6-2
 OS 10.33-7, 6-2
 OS 10.43-7, 6-2
 OS 10.53-7, 6-2
 OS 92-6
 OS 9.26-16, 8-4, 11-2

OS X2-6, 6-2, 8-4, 10-2
 Other tab9-26
 Output method 9-13, 10-10, 10-11, 11-7
 Output tray 9-16, 10-15, 11-7
 Output tray settings13-42
 Overlap width line10-14
 Overlay 9-18, 9-20

P

Page attributes 10-9, 11-5
 Page number 9-18, 9-23, 10-19, 10-21
 Pages10-10, 11-6
 PageScope Web Connection14-2
 Paper11-5
 Paper arrangement 9-16, 10-14
 Paper size 9-12, 10-9, 13-14
 Paper source11-6
 Paper tray 9-12, 10-15, 13-13
 Paper tray/output tray10-15
 Paper type 9-12, 10-15
 Paper view10-7
 Parameter details 9-10, 10-9, 11-5
 Pattern9-25
 PCL driver 3-3, 9-2
 PCL font list16-7
 PDL setting13-4
 Per page setting 9-16, 10-17
 Plug and play 5-12, 5-21, 5-26
 Port 9100 3-5, 5-2, 5-13, 5-22
 Poster mode10-14
 PostScript3-3
 PPD driver 3-3, 16-10
 Print9-2
 Print type 9-14, 10-14, 11-7
 Print/fax output setting13-41
 Printer controller2-2
 Printer driver 4-3, 15-4
 Printer drivers3-3
 Printer setting14-27
 Printer specific options11-7
 Printing 2-6, 10-2, 11-2, 12-43
 Printing PS errors13-25
 Printing reports13-31, 16-6
 Printing without authentication13-51
 Printing XPS errors13-54
 Product specifications16-2
 Proof print12-2
 Properties9-4
 PS driver 3-3, 9-2
 PS font list16-8
 PSWC direct printing13-55
 Public user14-8
 Punching 9-15, 10-14, 11-7, 13-18

Q

Quality10-22

- Quality tab9-23
- R**
- RAW port4-3
- Recalling jobs 12-3, 12-7, 12-14, 12-25
- Registered user 14-9
- Rendezvous6-10
- Rotating 180 degrees9-14, 10-14
- S**
- Saving in user boxes 12-12
- Scale 10-9, 11-5
- Secure documents auto deletion time setting 13-44
- Secure print only 13-59
- Secure printing 12-5
- Security 14-23
- Selecting a printer6-3, 6-16
- Selecting colors9-24, 10-22, 11-7
- Separating chapters9-14, 10-14
- Setting for each purpose 14-30
- Settings 13-2
- Setup2-8
- Single color and 2 color output management 13-52
- Skip job operation settings 13-47
- Skipping blank pages9-14
- SMB 3-5, 5-2, 5-17, 5-24
- Spool settings 13-7
- Stamp/composition 10-18
- Stamp/composition tab9-17
- Stapling 9-15, 10-14, 11-7, 13-17
- Structure of pages 14-13
- Symbol set 13-21
- System settings 14-21
- T**
- TCP/IP settings4-3
- TIFF image paper setting 13-32
- Time9-18, 10-19
- Timeout 13-53
- Toner Save9-25, 10-22
- Troubleshooting 15-2
- U**
- Uninstalling8-2
- USB2-7, 3-5
- User authentication 12-16, 14-5
- User authentication/account track 14-24
- User box 14-16, 14-26
- User box administrator 14-12
- User mode 14-15
- User settings 13-2
- V**
- Verifying XPS digital signatures 13-30
- Viewing information 14-15
- W**
- Watermark9-17, 9-19
- Web browser 14-3
- Web service 3-5, 5-9
- Windows 2-6, 8-2
- Windows 2000 3-6, 5-22
- Windows NT 4.0 3-7, 5-28
- Windows Server 2003 3-6, 5-13
- Windows Server 2008 3-5, 5-2
- Windows Vista 3-5, 5-2
- Windows XP 3-6, 5-13
- X**
- XPS driver 3-3, 9-2
- Z**
- Zoom9-12

17.2 Index by button

Numerics

2-Sided Print 13-15

A

A4/A3<->LTR/LGR Auto Switch 13-8
 Account Track 10-11
 Acquire Device Information 9-18
 Add a printer 5-2
 Administrator Settings 13-39
 Assign Account to Acquire Device Info 13-55
 Auth. Unit 12-25
 Authentication 13-57
 Authentication/Account Track 9-13, 12-19
 Auto Delete Secure Document 13-44
 Auto Trapping 13-28

B

Banner Paper Tray 13-19
 Banner Printing 12-43
 Banner Sheet Setting 13-9
 Basic Settings 13-4
 Binding Direction Adjustment 13-10
 Binding Margin Settings 9-15
 Binding Position 13-16
 Black Overprint 13-29

C

Cellular Phone/PDA Settings 13-58
 Combination Details 9-14
 Configuration Page 13-31
 CR/LF Mapping 13-24

D

Default Operation Selection 13-50
 Delete Secure Print Documents 13-43
 Demo Page 13-31
 Detail Settings 10-11
 Driver Password Encryption Setting 12-32, 13-61

E

Edit My Tab 9-11
 Editing watermark 9-19

F

Font Settings 13-20
 Font Size 13-22

G

Gray Background Text Correction 13-12

I

ICC Profile Settings 13-26
 ID & Print Delete after Print Setting 13-46
 ID & Print Delete Time 13-45
 ID & Print Operation Settings 13-49
 ID & Print Settings 13-48
 ID & Print User Box 12-26

Image Shift Settings 9-15
 Install 4-3

L

Line Width Adjustment 13-11
 Line/Page 13-23
 Login 12-25, 14-8
 Logout 14-6

M

Mobile/PDA 12-30

N

Network Timeout 13-53
 Number of Copies 13-5

O

Obtain Device Information 9-4, 9-20, 9-22
 OpenAPI Settings 13-57
 Original Direction 13-6
 Output Tray Settings 13-42

P

Paper Setting 13-13
 Paper Size 13-14
 Paper Tray 13-13
 Paper Tray Information 9-4
 Paper View 9-9
 PCL Font List 13-31
 PCL Settings 13-20
 PDL Setting 13-4
 Preferences 9-2
 Print 9-2, 10-2, 11-2
 Print & Login 12-25
 Print Data Capture 13-59
 Print PS Errors 13-25
 Print Reports 13-31
 Print without Authentication 13-51
 Print XPS Errors 13-54
 Print/Fax Output Setting 13-41
 Printer Settings 13-4, 13-53
 Printer View 9-9
 Properties 9-2
 PS Font List 13-31
 PS Setting 13-25
 PSWC Direct Print 13-55
 Punch 13-18

Q

Quality Adjustment 9-24, 10-23

S

Save Custom Size 9-6
 Secure Print Document Box 12-7
 Secure Print Only 13-59
 Single Color > 2 Color Output Management 13-52
 Skip Job Operation Settings 13-47

Spool Print Jobs in HDD before RIP	13-7
Staple	13-17
Symbol Set	13-21

T

TIFF Image Paper Setting	13-32
To Login Screen	14-6

U

Uninstall	8-2, 8-4
USB Timeout	13-53
User Authentication	10-11
User Box	12-7, 12-25
User Settings	9-13, 13-2
Utility/Counter	13-2

V

Verify XPS Digital Signature	13-30
------------------------------------	-------

X

XPS Setting	13-30
-------------------	-------



KONICA MINOLTA

<http://konicaminolta.com>