

bizhub C353/C253/C203

User's Guide [Enlarge Display Operations]

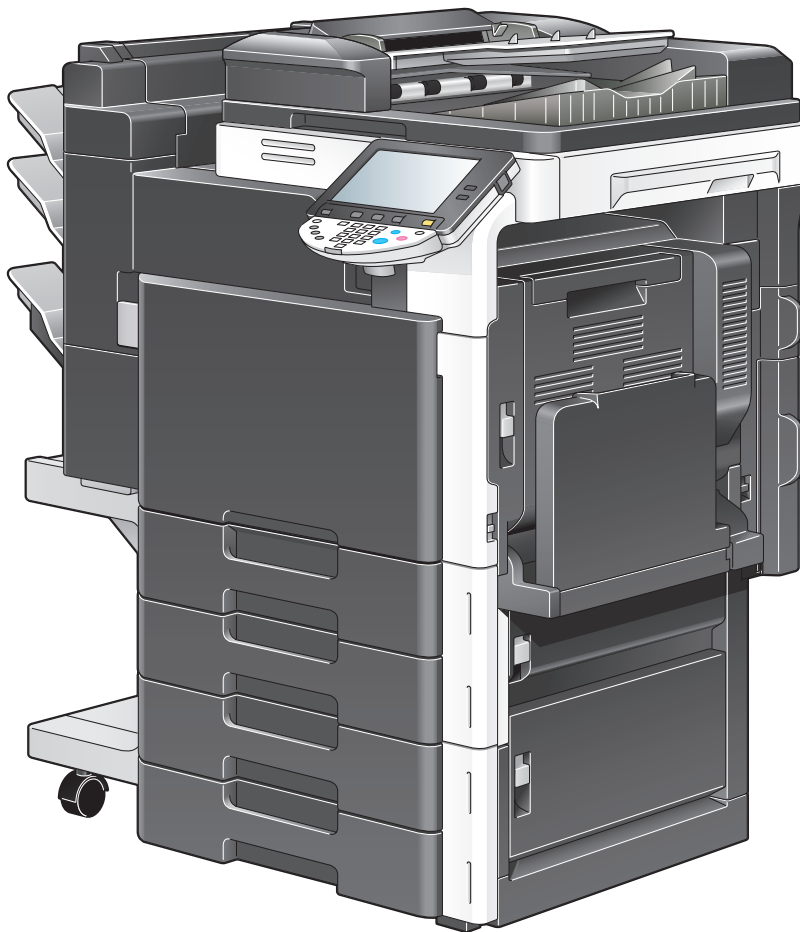

Introduction

Thank you for choosing this machine.

The bizhub C353/C253/C203 User's Guide [Enlarge Display Operations] contains details on the operation of the various functions available in the Enlarge Display mode of the bizhub C353/C253/C203 and on the various operating precautions. In order to ensure that this machine is used correctly and efficiently, carefully read the Enlarge Display Mode Operations volume of the User's Guide before using the machine.

In order to operate the machine safely and properly, be sure to read the Quick Guide [Copy/Print/Fax/Scan/Box Operations].

For descriptions on trademarks and copyrights, refer to [Trademarks/Copyrights].

Views of the actual equipment may be slightly different from the illustrations used in this User's Guide [Enlarge Display Operations].

Explanation of manual conventions

CAUTION

CAUTION

- Failure to observe instructions highlighted in this manner may result in serious injuries or property damage.
Observe all cautions in order to ensure safe use of this machine.
-



Reminder

Text highlighted in this manner indicates operation precautions. Carefully read and observe this type of information.



Detail

Text highlighted in this manner provides more detailed information concerning operating procedures and other descriptions.



Note

Text highlighted in this manner indicates sections containing additional information. If necessary, refer to the indicated sections.



[]

Names highlighted as shown above indicate keys on the control panel and buttons in the touch panel.



Contents

1 Before use

1.1 Names of control panel parts and their functions	1-2
1.2 Adjusting the angle of the control panel	1-4
1.2.1 To adjust the angle of the control panel	1-4
1.3 Screens in Enlarge Display mode	1-6
1.3.1 Displaying screens in Enlarge Display mode	1-6
1.4 Touch panel	1-8
1.4.1 Touch panel operation	1-8
1.4.2 Icons that appear in the screen	1-8
1.4.3 Paper type icons	1-9
1.4.4 Paper supply icons	1-11
1.5 Feeding the original	1-12
1.5.1 Loading the original into the ADF	1-12
1.5.2 Placing the original on the original glass	1-13
1.6 Specifying original settings	1-15
1.6.1 Copying originals of mixed sizes ("Mixed Original" setting)	1-15
1.6.2 Loading folded originals ("Z-Folded Original" setting)	1-17
1.6.3 Selecting the original orientation (Original Direction settings) ...	1-19
1.6.4 Selecting the position of the binding margin (Original Binding Position/Binding Position settings)	1-21

2 Using copy functions

2.1 General copy operation	2-2
2.2 Selecting a Color setting	2-4
2.3 Selecting the Paper settings	2-6
2.3.1 Automatically selecting the paper size ("Auto" Paper setting)	2-6
2.3.2 Manually selecting the desired paper size	2-8
2.4 Specifying a Zoom setting	2-10
2.4.1 Selecting a zoom ratio	2-11

2.5	Selecting original and copy settings	2-12
2.5.1	Selecting single-sided or double-sided copies	2-13
2.6	Selecting a combined copy setting	2-15
2.7	Selecting Finishing settings	2-17
2.7.1	Selecting the finishing method	2-18
2.7.2	Selecting Staple/Punch settings	2-19
2.7.3	Selecting a folding or binding setting	2-21
2.8	Selecting not to rotate the image	2-24
2.9	Selecting the quality of the original	2-25
2.10	Selecting the density settings	2-28
2.10.1	Adjusting the print density (Density settings)	2-28
2.10.2	Adjusting the background density (Background Removal settings)	2-29
2.11	Selecting the Paper settings	2-31
2.11.1	Selecting a Paper Type setting	2-31
2.11.2	Printing double-sided copies manually	2-33
2.11.3	Selecting a Paper Size setting	2-36
2.12	Scanning the next original to be copied while a copy job is being printed (next job reservation)	2-40
2.13	Pausing scanning/printing	2-41
2.14	Printing a proof to check the settings (Proof Copy)	2-42

3 Using fax/scan functions

3.1	General fax/scan operation	3-2
3.2	Specifying a destination	3-4
3.2.1	Selecting a destination from the address book	3-5
3.2.2	Selecting a destination from the job log	3-7
3.2.3	Selecting a destination with an LDAP search	3-8
3.2.4	Directly typing in the number	3-10
3.3	Specifying scanning settings (Scan Settings)	3-13
3.3.1	Simplex/Duplex	3-13
3.3.2	Original Type	3-15



3.3.3 Resolution	3-17
3.3.4 Density	3-19
3.3.5 File Type	3-20
3.3.6 Color (Image Adjust)	3-22
3.3.7 Background Removal (Image Adjust)	3-24
3.3.8 Scan Size	3-26
3.3.9 Original Settings	3-27
3.4 Using a program	3-30
3.5 Checking the destinations	3-32

4 Logging on and logging off

4.1 When a logon screen appears	4-2
4.1.1 When the screen to enter the user name appears	4-2
4.1.2 When the screen to enter the account name and password appears	4-5



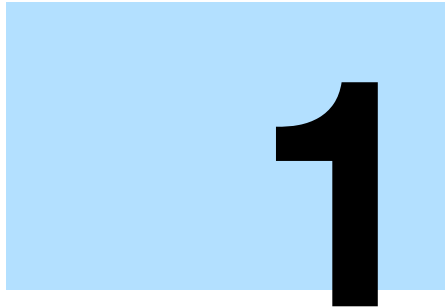

Before use

1 Before use

1.1 Names of control panel parts and their functions



Note

For details, refer to the User's Guide [Copy Operations], the User's Guide [Network Scan/Fax/Network Fax Operations].

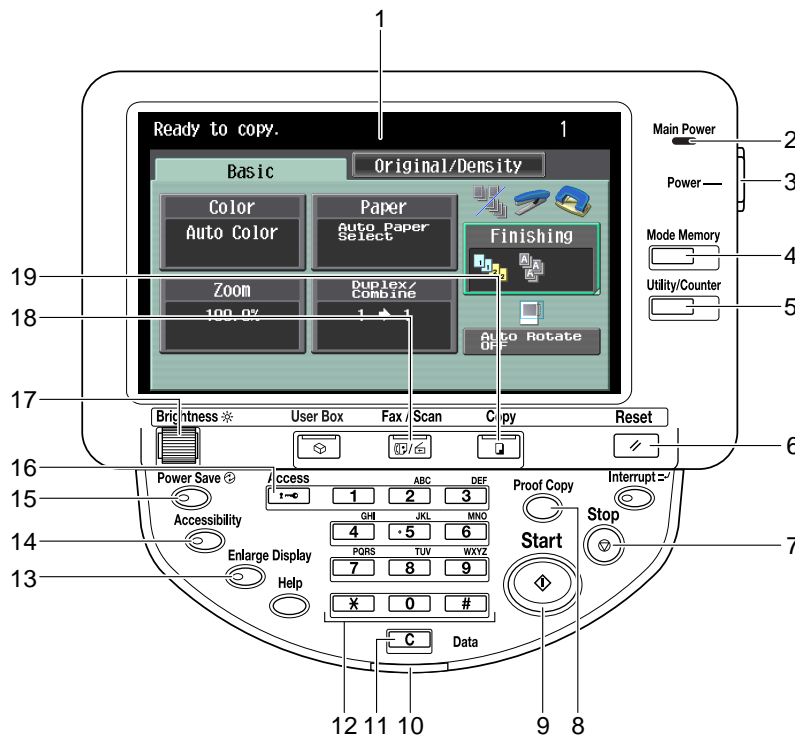

No.	Part name	Description
1	Touch panel	Displays various screens and messages. Specify the various settings by directly touching the panel.
2	Main Power indicator	Lights up in green when the machine is turned on with the main power switch.
3	[Power] (auxiliary power) key	Press to turn on/off machine operations. When turned off, the machine enters a state where it conserves energy.
4	[Mode Memory] key	Programmed fax/scan settings can be recalled to be used again. (See p. 3-30)
5	[Utility/Counter] key	Press to display the Meter Count screen and the Utility screen.

No.	Part name	Description
6	[Reset] key	Press to clear all settings (except programmed settings) entered in the control panel and touch panel.
7	[Stop] key	Pressing the [Stop] key during an operation temporarily stops the operation.
8	[Proof Copy] key	Press to print a single proof copy to be checked before printing a large number of copies. (See p. 2-42)
9	[Start] key	Press to start the operation. When this machine is ready to begin the operation, the indicator on the [Start] key lights up in blue. If the indicator on the [Start] key lights up in orange, the operation cannot begin. Press to restart a stopped job.
10	Data indicator	Flashes in blue while a print job or fax is being received. Lights up in blue while a print job or fax is queued to be printed or is being printed.
11	[C] (clear) key	Press to clear a value (such as the number of copies, a zoom ratio, or a size) entered using the keypad.
12	Keypad	Use to type in the number of copies to be produced. Use to type in the zoom ratio. Use to type in the various settings.
13	[Enlarge Display] key	Press to enter or exit Enlarge Display mode.
14	[Accessibility] key	Press to display the screen for specifying settings for user accessibility functions.
15	[Power Save] key	Press to enter Low Power mode. While the machine is in Low Power mode, the indicator on the [Power Save] key lights up in green and the touch panel goes off. To cancel Low Power mode, press the [Power Save] key again.
16	[Access] key	If user authentication or account track settings have been applied, press this key after entering the user name and password (for user authentication) or the account name and password (for account track) in order to use this machine.
17	Brightness dial	Use to adjust the brightness of the touch panel.
18	[Fax/Scan] key	Press to enter Fax/Scan mode. While the machine is in Fax/Scan mode, the indicator on the [Fax/Scan] key lights up in green.
19	[Copy] key	Press to enter Copy mode. (As a default, the standard-sized Copy mode screen is displayed.) While the machine is in Copy mode, the indicator on the [Copy] key lights up in green.

1.2 Adjusting the angle of the control panel

The control panel can be adjusted to either of three angles.

In addition, the control panel can be tilted to the left.

Adjust the control panel to the angle that allows for easy operation.

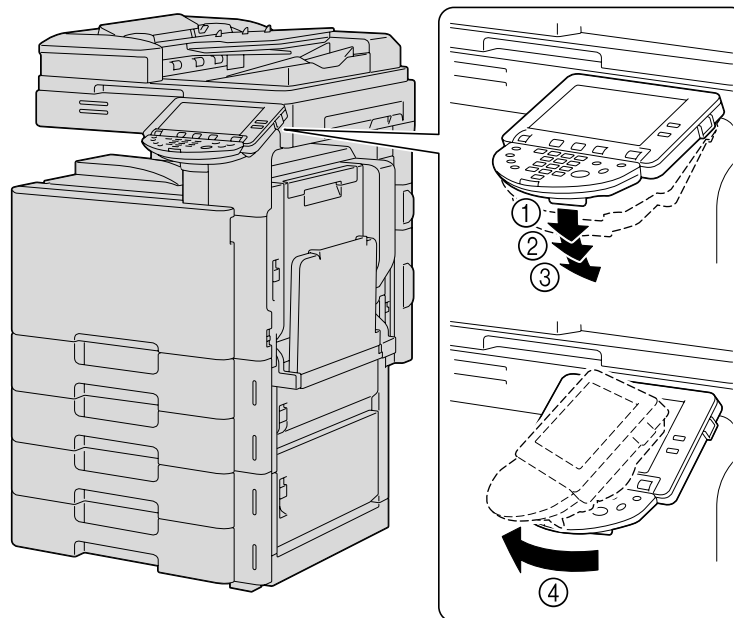

- ① Upper position (base position)
- ② Middle position
- ③ Lower position
- ④ Left tilt position

1.2.1 To adjust the angle of the control panel

1

Pull the control panel release lever toward you to raise or lower the control panel.

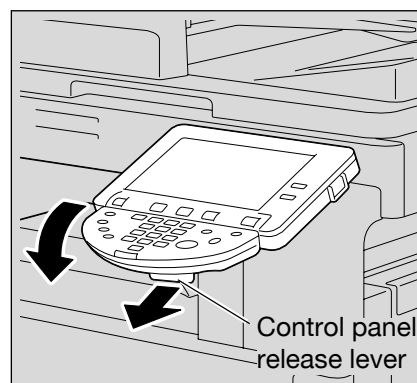

- 2** To tilt the control panel to the left, hold the bottom of the control panel, and then tilt the panel to the left.

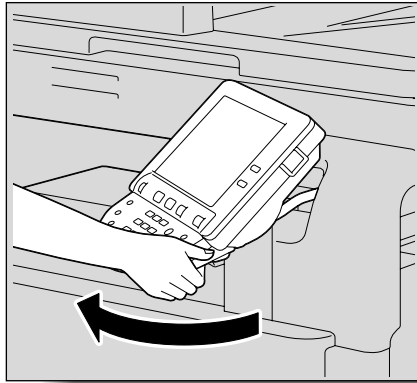

- Do not grab the touch panel when turning the control panel to the left or right.



1.3 Screens in Enlarge Display mode

1.3.1 Displaying screens in Enlarge Display mode

1 Press the [Copy] or [Fax/Scan] key in the control panel to display the desired screen.

2 Press the [Enlarge Display] key in the control panel.

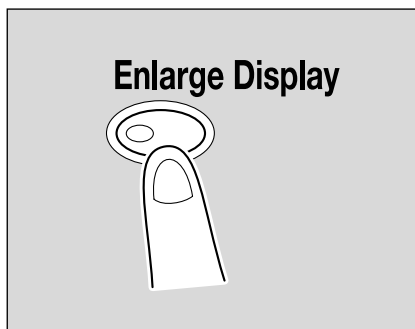

- Depending on the settings specified in Accessibility mode, a message appears, requesting confirmation to cancel the settings that cannot be specified in Enlarge Display mode. For details on specifying settings in the Accessibility screen, refer to the User's Guide [Copy Operations].

The screen is displayed in Enlarge Display mode. While screens are displayed in Enlarge Display mode, pressing the [Copy] or [Fax/Scan] key displays the normal screen.



3 To return to the standard-sized screens from the screens in Enlarge Display mode, press the [Enlarge Display] key in the control panel.

**Detail**

The default settings for Enlarge Display mode can be changed.

To change the default settings, specify desired settings in Enlarge Display mode, and then press the [Accessibility] key. On the Accessibility Setting screen 2/2, touch [Default Enlarge Display Settings], press the [Copy] key or the [Fax/Scan] key, and then specify "Current Setting".

The default settings can be also changed in Utility mode. For details, refer to the User's Guide [Copy Operations].

1.4 Touch panel

1.4.1 Touch panel operation





To activate a function or to select a setting, lightly touch the button in the touch panel for the desired function or setting.



Reminder

Do not apply extreme pressure to the touch panel, otherwise it may be scratched or damaged. Never push down on the touch panel with force, and never use a hard or pointed object to make a selection in the touch panel.

1.4.2 Icons that appear in the screen

Icon	Description
	This button appears when there is a message indicating that a print error occurred. Touch this button to display the message, and then perform the necessary steps.
	Touch this button to display the message at an enlarged size.
	Indicates that an error occurred during an image stabilization operation, a print operation or a scan operation. Touch this icon to view a screen containing a warning code.
	This button appears when there is a message indicating that consumables must be replaced or the machine requires maintenance. Touch this button to display the message, and then perform the replacement or maintenance procedure.

1.4.3 Paper type icons







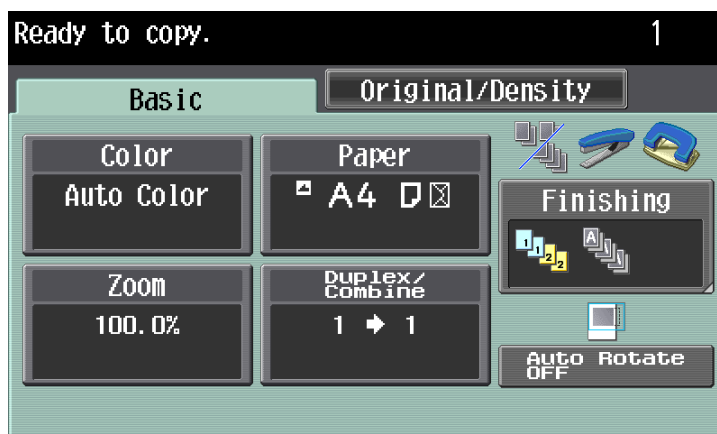
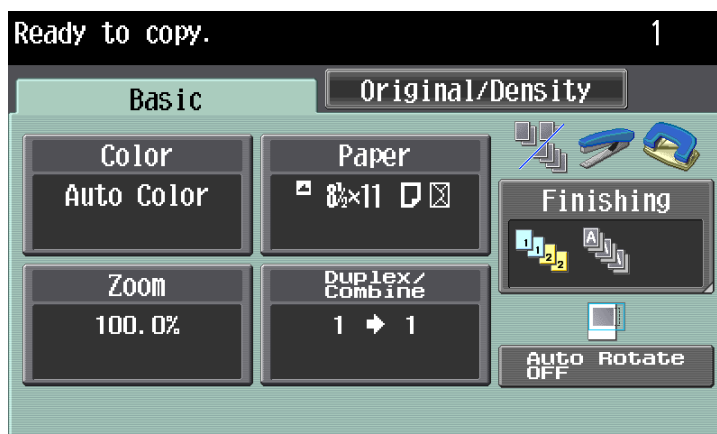







**Note**

For details, refer to the User's Guide [Copy Operations].

If paper other than plain paper is specified for the selected paper tray when using a copy function, the icon indicating the paper type appears under "Paper" in the Basic screen.



Paper type icons that appear



Thick 1 	Thick 2 	Thick 3 
Thick 4 	Single Side Only 	Transparency 
Envelope 	Letterhead 	Special Paper 
Colored Paper 	Duplex 2nd Side/Plain Paper 	Duplex 2nd Side/Thick 1 
Duplex 2nd Side/Thick 2 	Duplex 2nd Side/Thick 3 	Duplex 2nd Side/Thick 4 

1.4.4 Paper supply icons

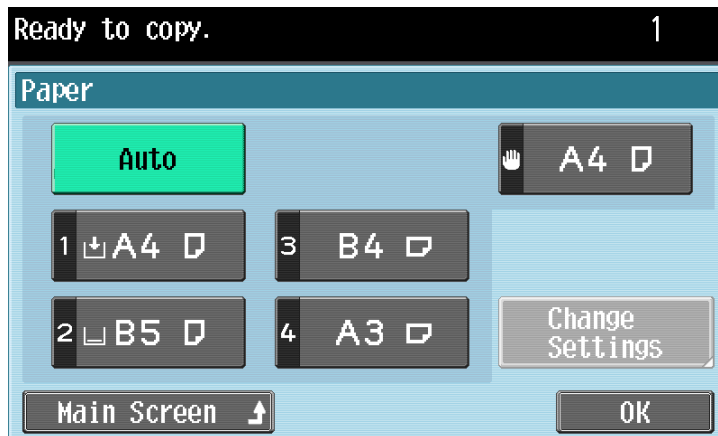
The amount of paper remaining is indicated in the Copy mode screen where the paper size is selected. For details about the screen for selecting the paper size, refer to "Selecting the Paper settings" on page 2-6.



Paper supply icons that appear

Icon	Description
	This icon indicates that very little paper remains in the paper tray.
	This icon indicates that paper is not loaded in the paper tray.

1.5 Feeding the original



Note

For details, refer to the *User's Guide [Copy Operations]* and the *User's Guide [Network Scan/Fax/Network Fax Operations]*.

The original can be fed in either of the following ways. Be sure to position the original correctly according to the type of original being scanned.

- Using the ADF
- Using the original glass



Detail

The ADF is an option.

1.5.1 Loading the original into the ADF

1

Place the original in the original feed tray in the order to be scanned with the side to be scanned faces up.

- Load the original pages so that the top of the original is toward the back or the right side of the machine.

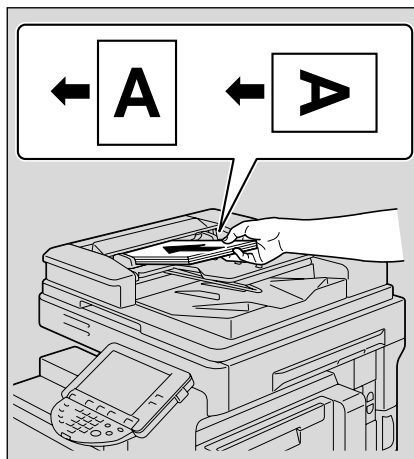

- Slide the lateral guides against the edges of the original.

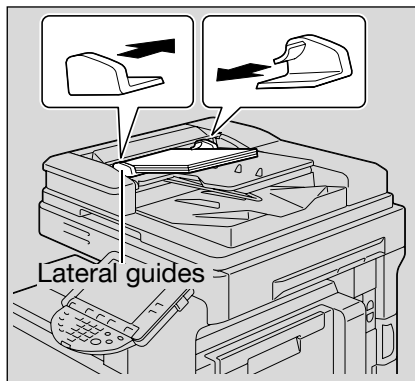

1.5.2 Placing the original on the original glass

- Lift open the ADF or the original cover.
 - When placing the original on the original glass, be sure to lift open the ADF or the original cover at least 20°. If the original is placed on the original glass without the ADF being lifted at least 20°, the correct original size will not be detected.

- Place the original on the original glass with the side to be scanned faces down.
 - Load the original pages so that the top of the original is toward the back or the left side of the machine.

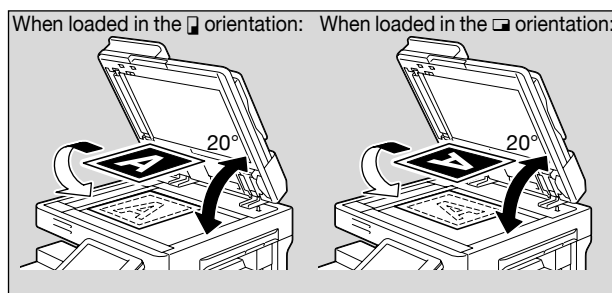

-
- 3** Align the original with the  mark in the back-left corner of the original scales.

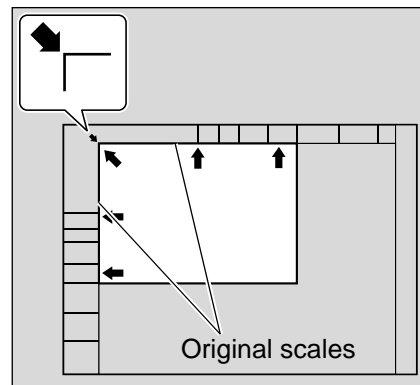

-
- 4** Close the ADF or the original cover.

1.6 Specifying original settings



Note

For details, refer to the *User's Guide [Copy Operations]*.

To make desired copies, specify status, direction and other setting items for originals.

For details on selecting the original type when using fax/scanning functions, refer to "[Original Settings](#)" on page 3-27.

1.6.1 Copying originals of mixed sizes ("Mixed Original" setting)

Originals of different sizes can be loaded together into the ADF to be fed and scanned one by one automatically.

1

Slide the lateral guides of the ADF to fit the size of the largest page.

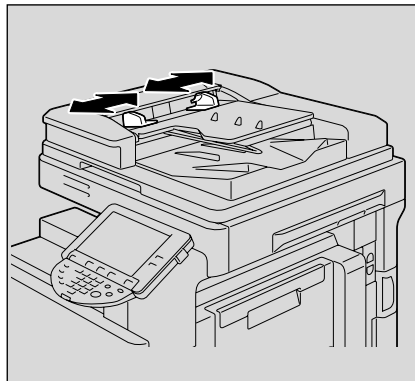

2

Align the originals as the references so that the side to be scanned faces up.

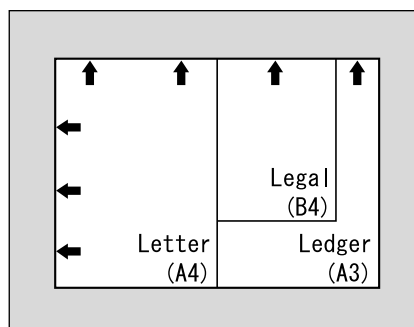

3 Place the original in the original feed tray in the order to be scanned with the side to be scanned faces up.

- Slide the lateral guides against the edges of the original.
- Load the original pages into the ADF so that the top of the pages is toward the left side of the machine.

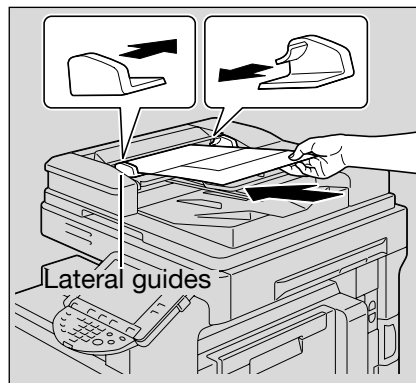

4 In the main screen, touch the Original/Density tab.

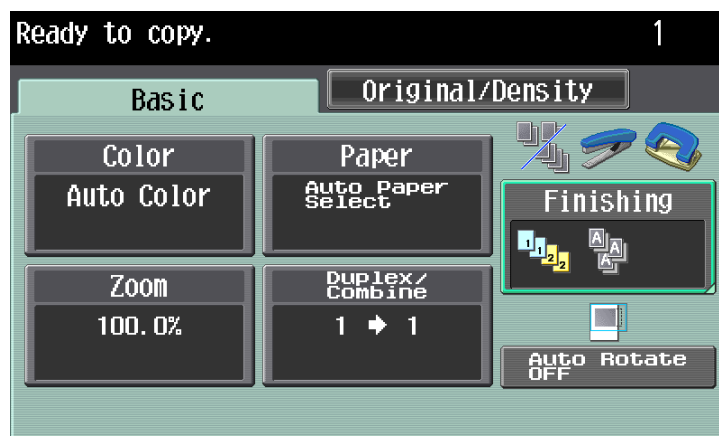

The Original/Density screen appears.

5 Touch [Mixed Original].



- To cancel the "Mixed Original" setting, touch [Mixed Original] again to deselect it.

1.6.2 Loading folded originals ("Z-Folded Original" setting)

If folded originals are loaded into the ADF to be copied, the original size is correctly detected.



Note

Load the original into the ADF.

The length of the first page of the original is detected, and all pages of the original are scanned at that size.



Reminder

Unfold folded originals before loading them into the ADF. If the original is copied without being unfolded, a paper misfeed may occur.

1 Position the original to be copied.

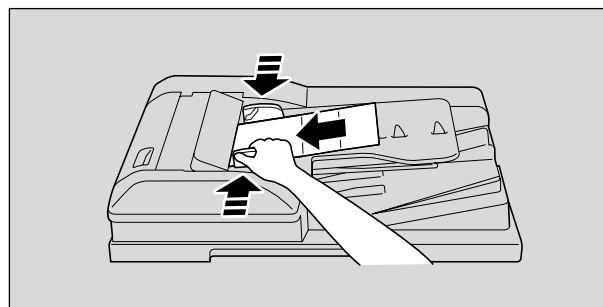

- 2** In the main screen, touch the Original/Density tab.



The Original/Density screen appears.



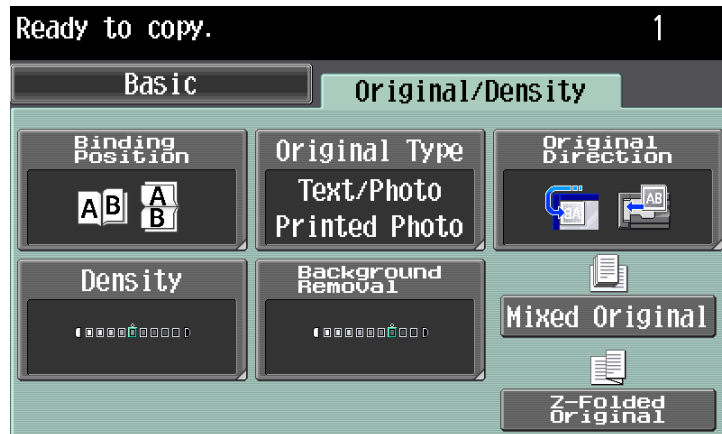

- 3** Touch [Z-Folded Original].



- To cancel the "Z-Folded Original" setting, touch [Z-Folded Original] again to deselect it.

1.6.3 Selecting the original orientation (Original Direction settings)

When copying double-sided originals or making double-sided copies or combined copies, specify the original orientation, otherwise the copies may not be printed in the correct page order or correct front and back page arrangement.

Setting	Description
	Select this setting for an original loaded with the top toward the back of this machine.
	Select this setting for an original loaded with the top toward the front of this machine.
	Select this setting for an original loaded into the ADF with the top of the original toward the left side of this machine.
	Select this setting for an original loaded into the ADF with the top of the original toward the right side of this machine. Select this setting for an original placed on the original glass with the top of the original toward the left side of this machine.

1 Position the original to be copied.

- For details on positioning the original, refer to "[Feeding the original](#)" on page 1-12.

2 In the Basic screen, touch [Duplex/Combine]. Otherwise, touch the Original/Density tab.

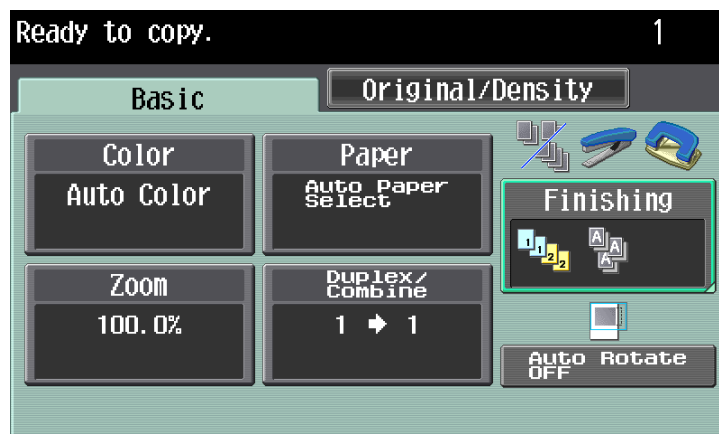

- 3** Touch [Original Direction].
From the Duplex/Combine screen

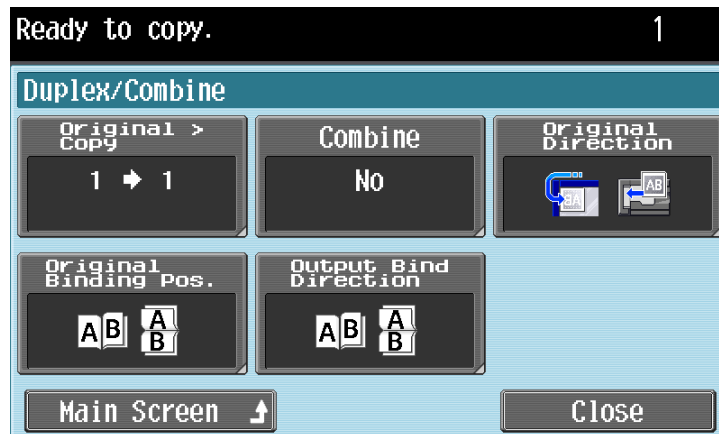

From the Original/Density screen



The Original Direction screen appears.

- 4** Touch the button for the orientation of the loaded original, and then touch [OK].

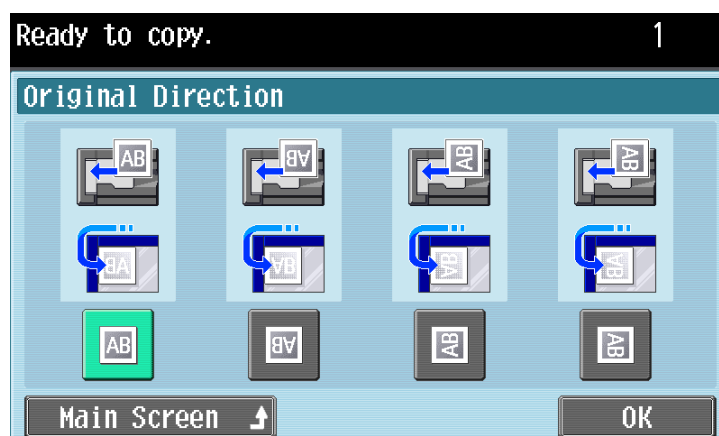

- To return to the main screen, touch [Main Screen].

1.6.4 Selecting the position of the binding margin (Original Binding Position/Binding Position settings)

If a double-sided original is loaded into the ADF, specify the position of the top of the back side of the original by specifying the binding margin position for the original.

Setting	Description
Left	Select this setting if the original is loaded with the binding margin at the left.
Top	Select this setting if the original that is loaded has a binding margin at the top.
Right	Select this setting if the original is loaded with the binding margin at the right.
Auto	With this setting, the binding margin is set at the top or at the left. Select this setting to automatically select the position of the binding margin. If the original length is 11-11/16 inch (297 mm) or less, a binding position along the long side of the original is selected. If the original length is more than 11-11/16 inch (297 mm), a binding position along the short side of the original is selected.

1 Position the original to be copied.

- For details on positioning the original, refer to ["Feeding the original" on page 1-12.](#)

2 In the Basic screen, touch [Duplex/Combine]. Otherwise touch the Original/Density tab.

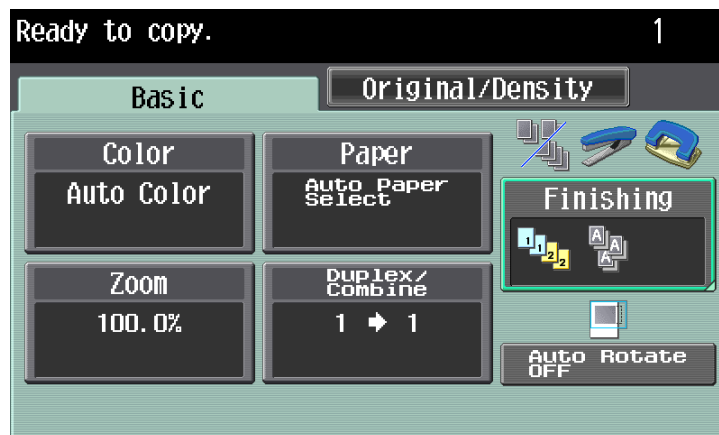

- 3** In the Duplex/Combine screen, touch [Original Binding Pos.]. Otherwise, touch [Binding Position] in the Original/Density screen.

From the Duplex/Combine screen

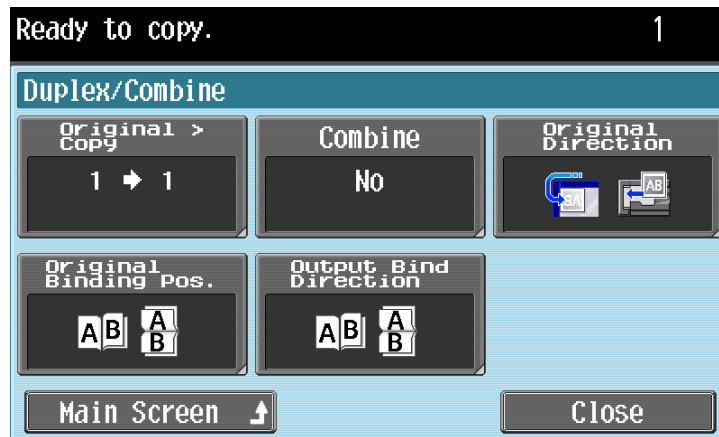

From the Original/Density screen



- 4** Touch the button for the desired binding margin position, and then touch [OK].

From the Original Binding Position screen



From the Binding Position screen

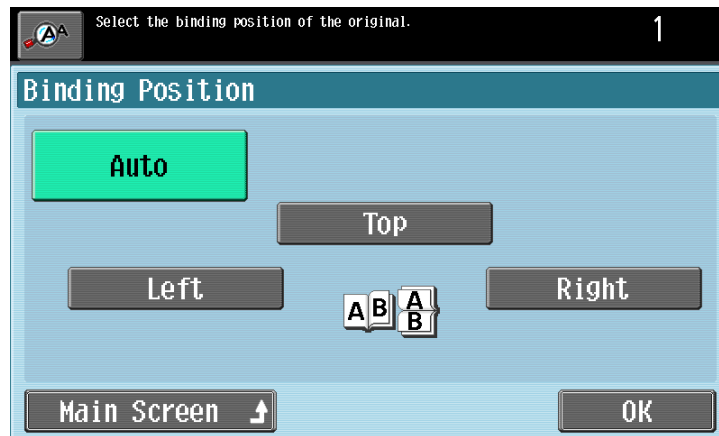

- To return to the main screen, touch [Main Screen].



Using copy functions

2 Using copy functions

2.1 General copy operation



Note

For details on the copy operation, refer to the User's Guide [Copy Operations].

This section contains information on the general operation for making copies.

- 1 Press the [Copy] key in the control panel, and then press the [Enlarge Display] key.

The Copy mode screen appears in Enlarge Display mode.

- 2 Position the original to be copied.
 - For details on positioning the original, refer to "Feeding the original" on page 1-12.

- 3 Specify the desired copy settings.

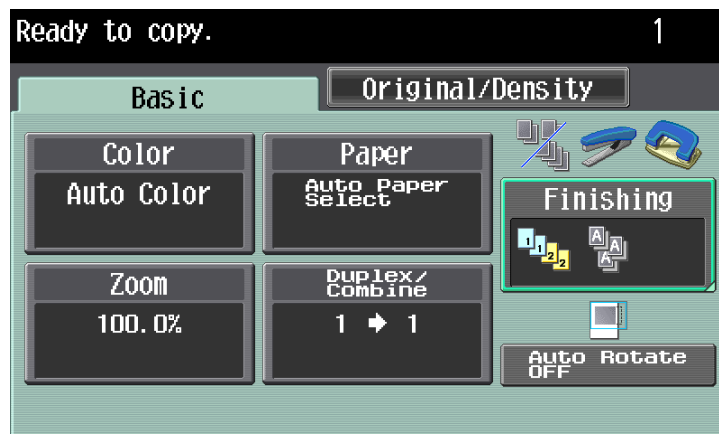

- For details on specifying original settings, refer to page 1-15.
- For details on selecting the Color setting, refer to page 2-4.
- For details on selecting the Paper settings, refer to page 2-6.
- For details on selecting the Zoom setting, refer to page 2-10.
- For details on selecting the original and copy settings, refer to page 2-12.
- For details on selecting a Combine setting, refer to page 2-15.
- For details on selecting Finishing settings, refer to page 2-17.
- For details on specifying settings to not rotate the image, refer to page 2-24.

- For details on selecting the original image quality, refer to [page 2-25](#).
- For details on selecting a copy density setting, refer to [page 2-28](#).
- To cancel the setting and select the default, press the [Reset] key.

4 Using the keypad, type in the desired number of copies.

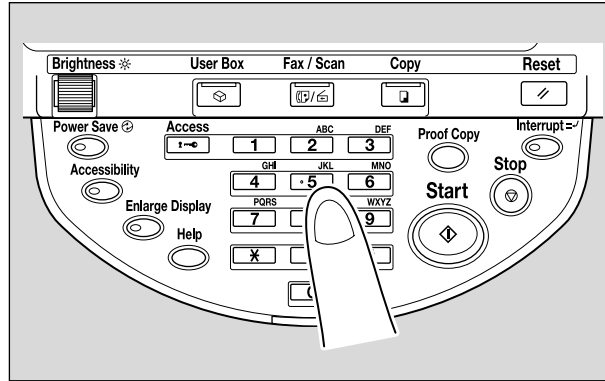

- If the number of copies was incorrectly entered, press the [C] (clear) key in the keypad, and then specify the correct number of copies.

5 Press the [Start] key.

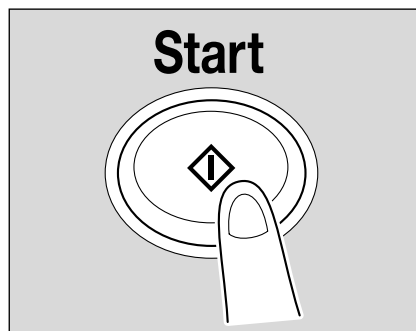

2.2 Selecting a Color setting

When making copies, a printing color can be selected.

The following Color settings are available.

Setting	Description
Auto Color	Select this setting to automatically detect whether the scanned original is in color or in black and white, then select the appropriate Color setting ("Full Color" or "Black").
Full Color	Select this setting to print the copy in full color, regardless of whether the scanned original is in color or in black and white.
2 Color	Select this setting to print all areas of the scanned original determined to be in color with the specified color, and print all areas determined to be black in black. (The colors used for the areas printed in color are: red, green, cyan, blue, yellow or magenta.)
Black	Select this setting to print the copy in black and white, regardless of whether the scanned original is in color or in black and white.

Follow the procedure described below to select the Color setting.

- 1 In the Basic screen, touch [Color].

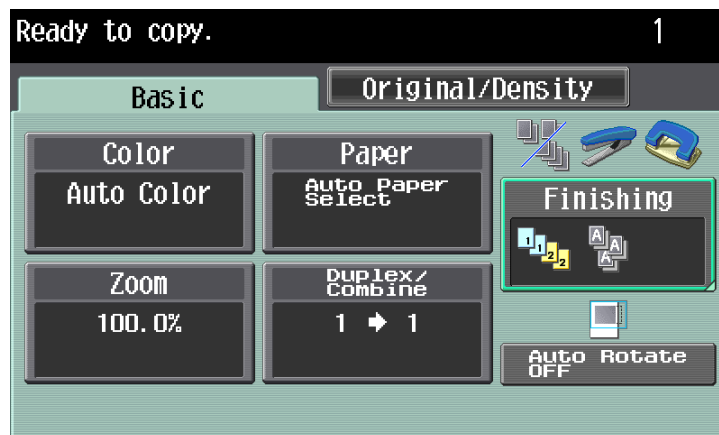

The Color screen appears.

2 Select the desired Color setting.

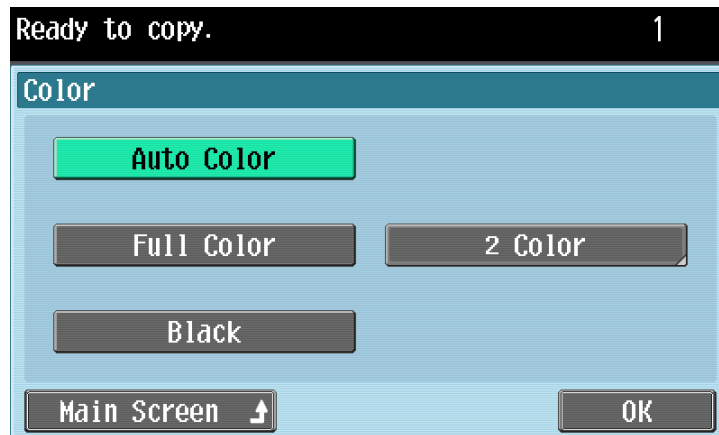

- To return to the main screen, touch [Main Screen].
- If the "2 Color" setting was selected, touch the button for the desired color, and then touch [OK].

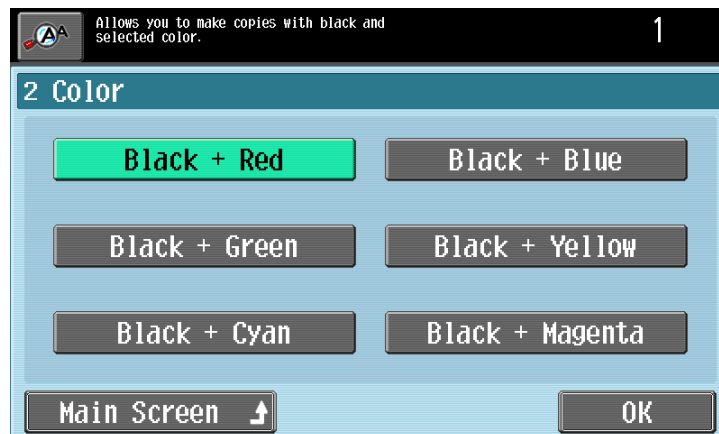

3 Touch [OK].

The Basic screen appears again.

2.3 Selecting the Paper settings

The paper size can be selected automatically according to the original size or it can be specified manually. Specify the paper size according to the corresponding procedure, depending on the desired copy settings.

2.3.1 Automatically selecting the paper size ("Auto" Paper setting)

The size of the loaded original is detected, and copies are produced using paper of the same size.

If the "Full Size" Zoom setting was specified, paper of the same size as the original is selected.

If the zoom ratio was increased or decreased, a paper size that corresponds to the specified zoom ratio is automatically selected.



Note

The "Auto Zoom" setting and the "Auto" Paper setting cannot both be selected at the same time. If the "Auto Paper Select" was selected at the "Auto Zoom" setting, the Zoom screen appears. Touch the button for the desired zoom ratio.

1 In the Basic screen, touch [Paper].

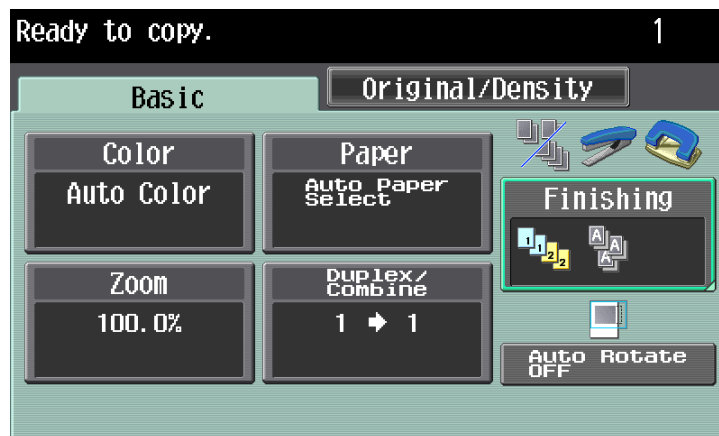

The Paper screen appears.

2 Touch [Auto].

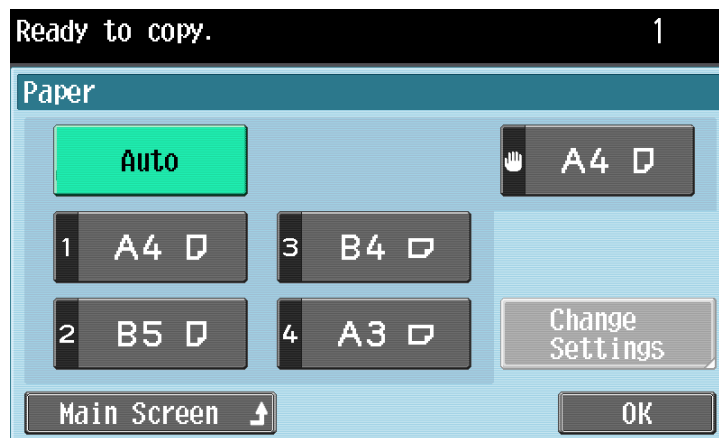
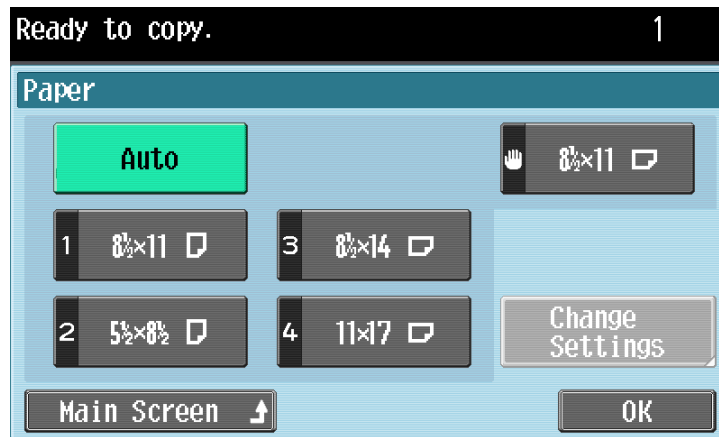

- To return to the main screen, touch [Main Screen].

3 Touch [OK].

The Basic screen appears again.

2.3.2 Manually selecting the desired paper size

The paper tray loaded with paper of the desired size can be selected manually. By also selecting the Auto Zoom setting, the most appropriate zoom ratio is selected based on the size of the loaded original and the specified paper size.



Note

Load the papers of the appropriate size into the paper tray in advance. For details on loading paper, refer to the User's Guide [Copy Operations].

- 1 In the Basic screen, touch [Paper].



The Paper screen appears.

- 2** Select the paper tray loaded with paper of the desired size.

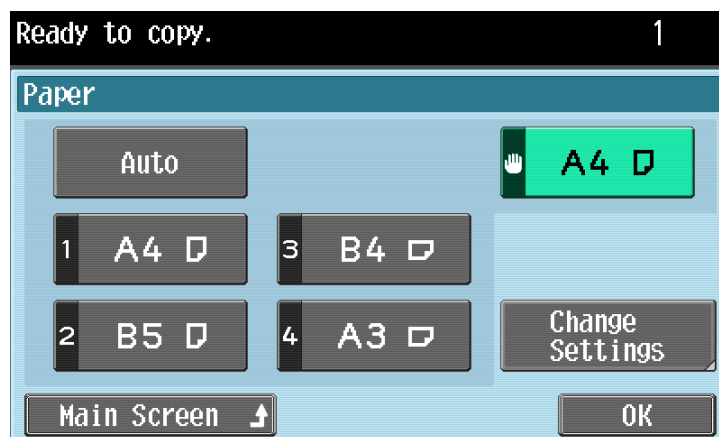
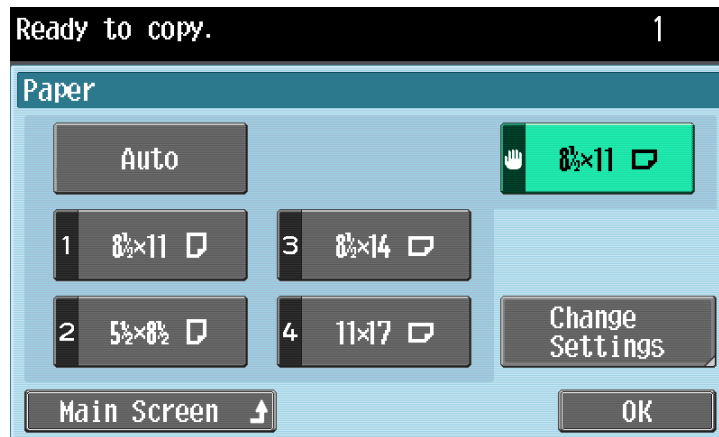

- To return to the main screen, touch [Main Screen].

- 3** Touch [OK].
The Basic screen appears again.

2.4 Specifying a Zoom setting

The zoom ratio can be set in order to make a copy on paper with a size different than the original or to enlarge or reduce the size of the copy image.

The zoom ratio can be specified in any of the following ways.

Setting	Description
Auto Zoom ^{*1}	The most appropriate zoom ratio is automatically selected based on the size of the loaded original and the specified paper size.
Full Size	A copy that is the same size as the original (100.0%) is produced.
Enlarge	The most suitable enlargement zoom ratios for copying from common standard original sizes to standard paper sizes are preset.
Reduce ^{*2}	The most suitable reduction zoom ratios for copying from common standard original sizes to standard paper sizes are preset.
Zoom	By using the keypad, a zoom ratio between 25.0% and 400.0% can be typed in directly without changing the height-to-width ratio.
Set Zoom Ratio ^{*2*3}	Programmed zoom ratios can be recalled to be used again for copying.

^{*1} The "Auto Zoom" setting and the "Auto" Paper setting cannot both be selected at the same time.

If the "Auto Zoom" was selected at the "Auto Paper Select" setting, the Paper screen appears. Touch the button for the desired paper.

^{*2} When selecting a Reduce setting or a programmed zoom ratio, "Minimal" can be selected. Touch [Minimal] to produce a copy with the original image slightly reduced (93.0%) and centered in the paper.

The zoom ratio of the "Minimal" setting can be changed (between 90.0% and 99.9%). For details, refer to the User's Guide [Copy Operations].

^{*3} The programmed zoom ratios can be changed. For details, refer to the User's Guide [Copy Operations].

Follow the procedure described below to specify the Zoom setting.

2.4.1 Selecting a zoom ratio

- 1 In the Basic screen, touch [Zoom].

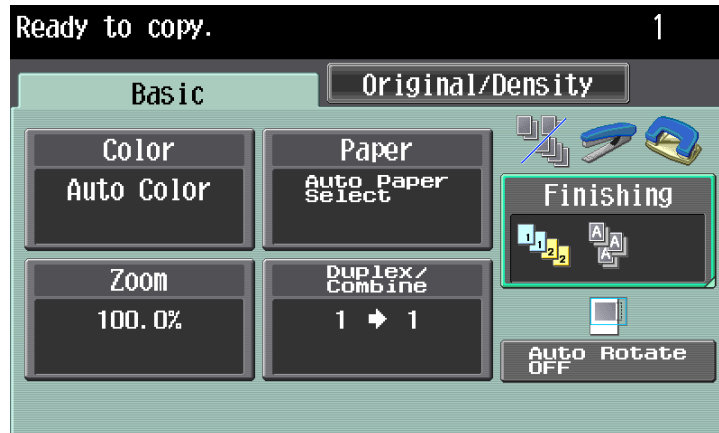

The Zoom screen appears.

- 2 Touch the button for the desired zoom ratio.

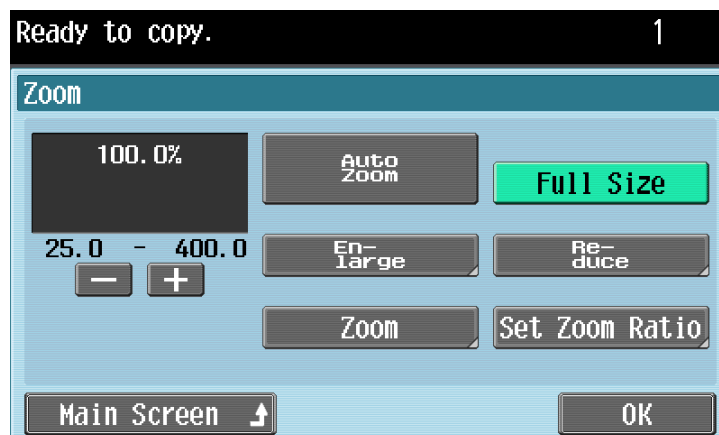

- To return to the main screen, touch [Main Screen].
- If "Enlarge", "Reduce" or "Set Zoom Ratio" was selected, select the desired zoom ratio, and then touch [OK].
- If "Zoom" was selected, use the keypad to type in the desired zoom ratio, and then touch [OK].
- Touch [+] to enlarge the zoom ratio, and touch [-] to reduce the zoom ratio in 0.1% increments.

- 3 Touch [OK].

The Basic screen appears again.

2.5 Selecting original and copy settings

The type of original and copy can be specified.

The following original and copy settings are available.

Setting	Description
1 > 1	Select this setting to produce single-sided copies from single-sided originals.
1 > 2 ^{*1}	Select this setting to produce one double-sided copy from two single-sided originals.
2 > 1 ^{*2}	Select this setting to produce two single-sided copies from one double-sided original.
2 > 2 ^{*1*2}	Select this setting to produce double-sided copies from double-sided originals.

^{*1} If "1 > 2" or "2 > 2" is selected, specify the binding margin position for the copy and the orientation of the loaded original, otherwise the copies will not be printed as desired.

For details on specifying the original orientation, refer to ["Selecting the original orientation \(Original Direction settings\)" on page 1-19](#).

^{*2} If "2 > 1" or "2 > 2" is selected, select the position of the binding margin and the orientation of the loaded original, otherwise the copies will not be printed as desired.

For details on specifying the original orientation, refer to ["Selecting the original orientation \(Original Direction settings\)" on page 1-19](#).

For details on specifying the binding margin position of the original, refer to ["Selecting the position of the binding margin \(Original Binding Position/Binding Position settings\)" on page 1-21](#).



Detail

When the original is scanned from the original glass using the "1 > 2", "2 > 1" or "2 > 2" settings, the scanned pages are stored and printed together.

Follow the procedures described below to select original and copy settings.

2.5.1 Selecting single-sided or double-sided copies

- 1 In the Basic screen, touch [Duplex/Combine].

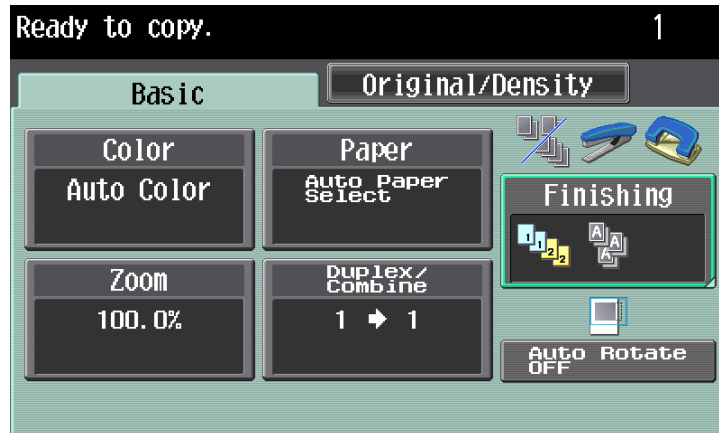

The Duplex/Combine screen appears.

- 2 Touch [Original > Copy].

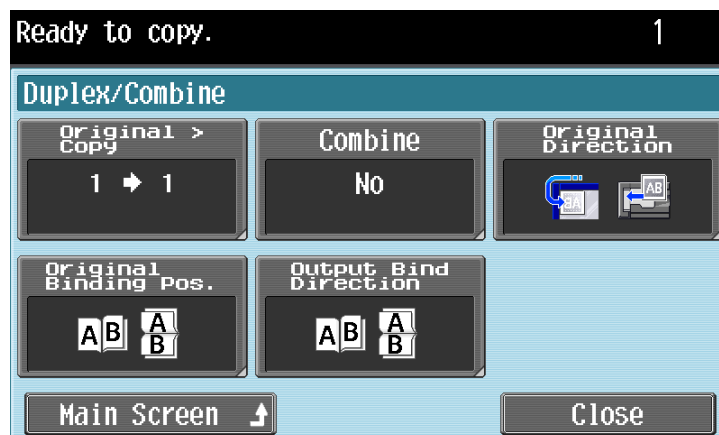

- To return to the main screen, touch [Main Screen].
The Duplex Settings screen appears.

- 3** Touch the button for the desired settings, and then touch [OK].

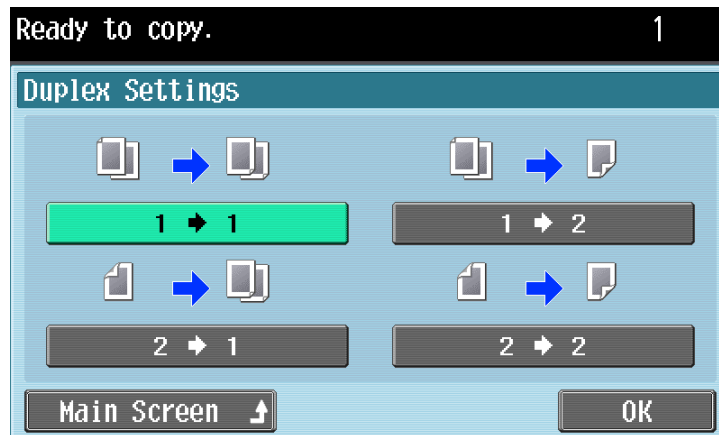

- If "1 > 2" or "2 > 2" is selected, touch [Output Bind Direction], select the binding position for the copy, and then touch [OK].

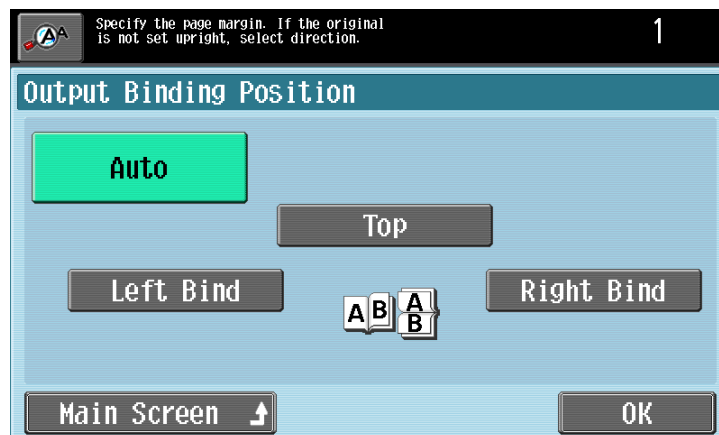

- If "Auto" is selected, the binding margin is set at the top or at the left. The binding position is automatically determined according to the orientation of the loaded original. If the original length is 11-11/16 inch (297 mm) or less, a binding position along the long side of the paper is selected. If the original length is more than 11-11/16 inch (297 mm), a binding position along the short side of the paper is selected.

- 4** Touch [Close].

The Basic screen appears again.

2.6 Selecting a combined copy setting

Two original images can be combined and printed on a single page, reducing paper use.

- 1 In the Basic screen, touch [Duplex/Combine].

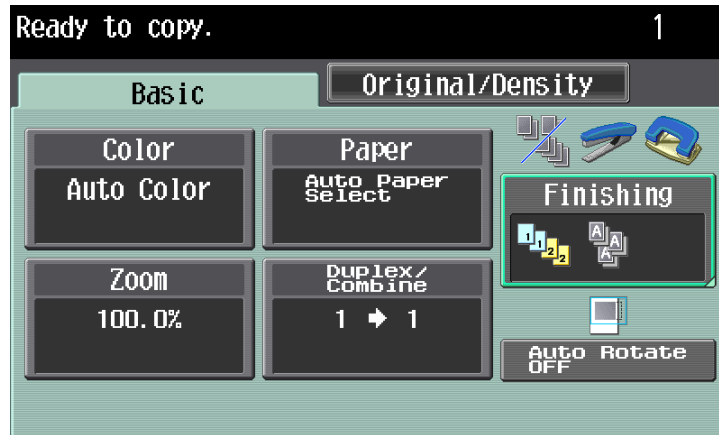

The Duplex/Combine screen appears.

- 2 Touch [Combine].

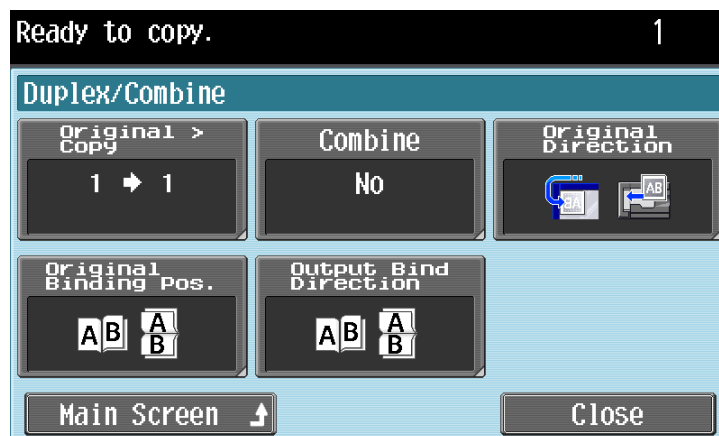

- To return to the main screen, touch [Main Screen].
- The Combine screen appears.

- 3** Touch [2in1], and then touch [OK].

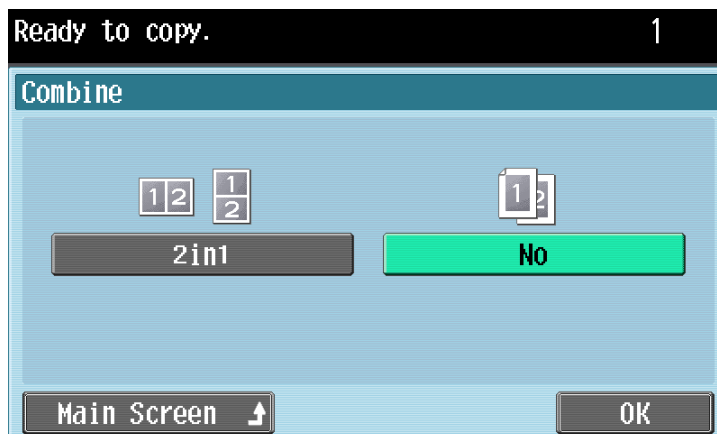

- 4** Touch [Close].
The Basic screen appears again.



2.7 Selecting Finishing settings

Various settings can be selected for sorting and finishing copies fed into the output tray.

The following Finishing settings are available.

Setting	Description
Collate (By Set)	Select this setting to separate each set of a multi-page original.
Group	Select this setting to separate the copies of each page in a multi-page original.
Offset ^{*1}	Select this setting to feed out and sort printed copies in an alternating crisscross pattern if the sorting conditions are met when no finisher is installed. Select this setting to feed out and stack the printed copies on top of each other with each set shifted to separate it when a finisher or a separator is installed.
Staple ^{*2*3}	Select one of these settings to bind the printed copies with staples. "Corner" or "2 Position" can be selected.
Punch ^{*4*5}	Select one of these settings to punch holes in the copies for filing them.
Center Staple ^{*6}	Select this setting to staple copies at two places along the center before feeding them out.
Half-Fold ^{*6}	Select this setting to fold copies in half before feeding them out.
Center Staple & Fold ^{*7}	Select this setting to staple copies at two places along the center, then fold the copies in half before feeding them out.

^{*1} If no finisher or separator is installed and all of the following conditions are met, printed copies can be fed out and sorted in an alternating crisscross pattern.

- 8-1/2 × 11 or 5-1/2 × 8-1/2-size (A4- or B5-size) paper is used.
- Paper of the same size and type is loaded with the  orientation in one paper tray and with the  orientation in another tray.
- The "Auto" Paper setting is selected.
- The "Auto" Paper setting is not selected when the "Mixed Original" setting is selected.

^{*2} If a Staple setting is selected, the "Collate (By Set)" setting is automatically selected. The "Offset" setting cannot be selected at the same time that a Staple setting is selected.

^{*3} The Staple settings are available only if the optional finisher is installed.

^{*4} The Punch settings are available only if punch kit is installed on optional finisher.

- *5 The number of punched holes differ depending on the country (region) where the unit is installed. For details, consult your service representative.
- *6 The Half-Fold and Center Staple settings are available only if the saddle stitcher is installed on optional finisher FS-519.
- *7 The Center Staple & Fold settings are available if the saddle stitcher is installed on optional finisher FS-519 or optional finisher FS-609 is installed.

Follow the procedures described below to select Finishing settings.

2.7.1 Selecting the finishing method

- 1 In the Basic screen, touch [Finishing].

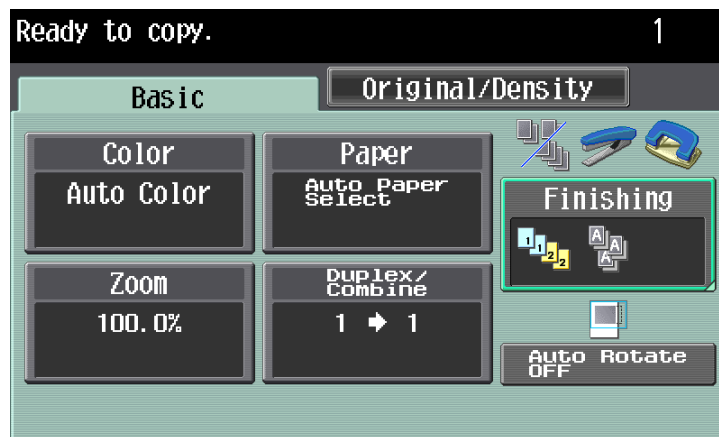

The Finishing screen appears.

- 2 Select the desired Finishing settings.

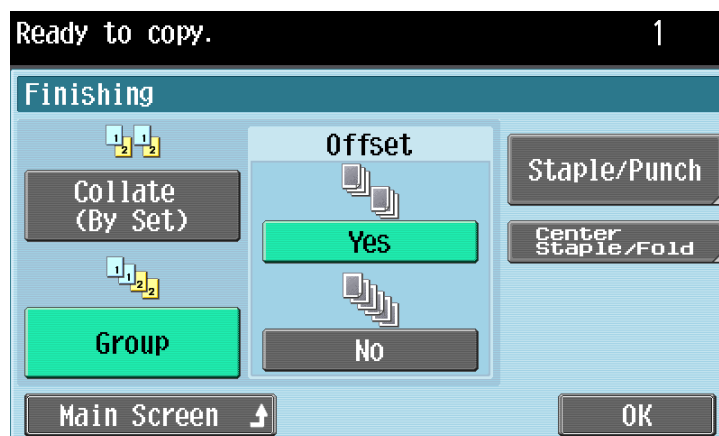

- To return to the main screen, touch [Main Screen].

- 3 Touch [OK].
The Basic screen appears again.

2.7.2 Selecting Staple/Punch settings

- 1 In the Basic screen, touch [Finishing].

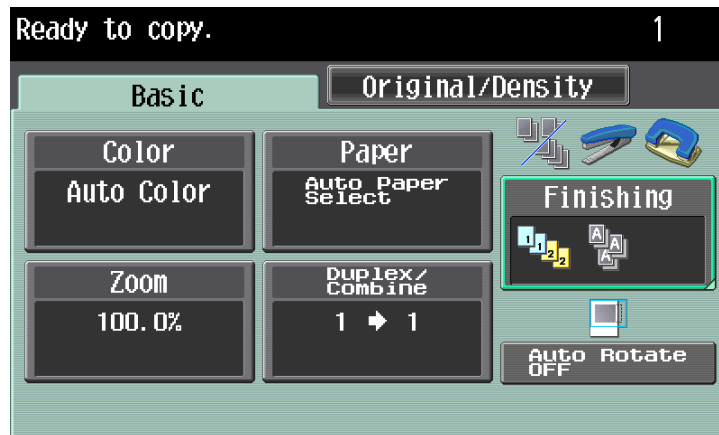

- 2 Touch [Staple/Punch].

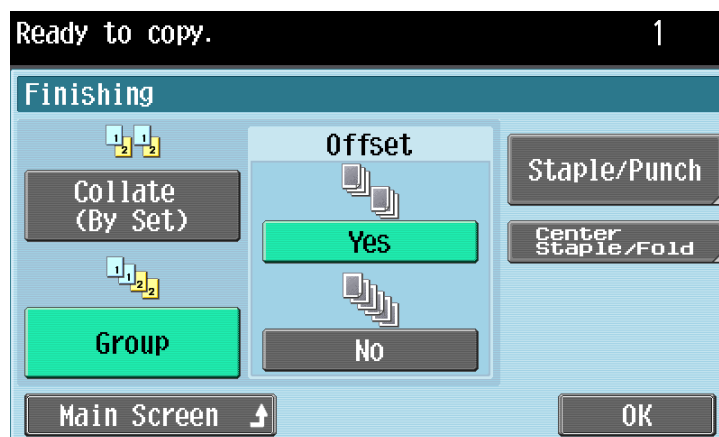

- To return to the main screen, touch [Main Screen].
The Staple/Punch screen appears.

- 3** Touch the button for the desired settings, and then touch [Position Setting].

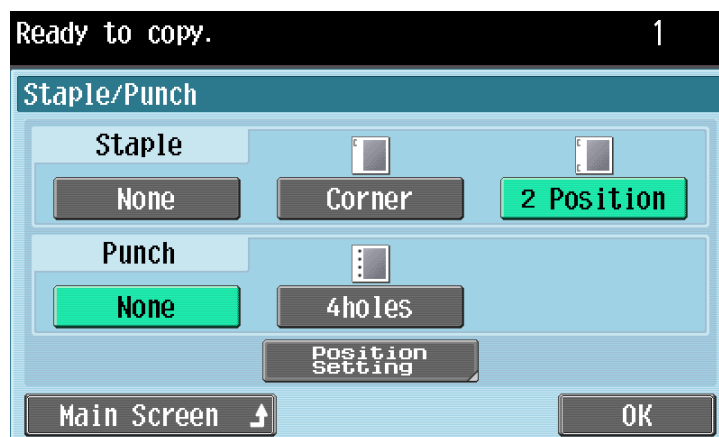
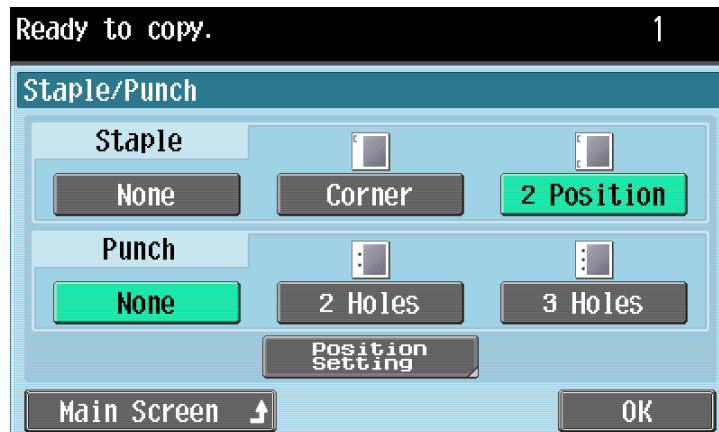

- 4** Select the desired position.
- Touch [Auto] to automatically determine the stapling or hole-punching position according to the orientation of the loaded original. The paper is stapled or holes are punched along the long side of the paper if the original length is 11-11/16 inch (297 mm) or less or along the short side of the paper if the original length is more than 11-11/16 inch (297 mm).
- When the "2 Position" Staple setting is selected

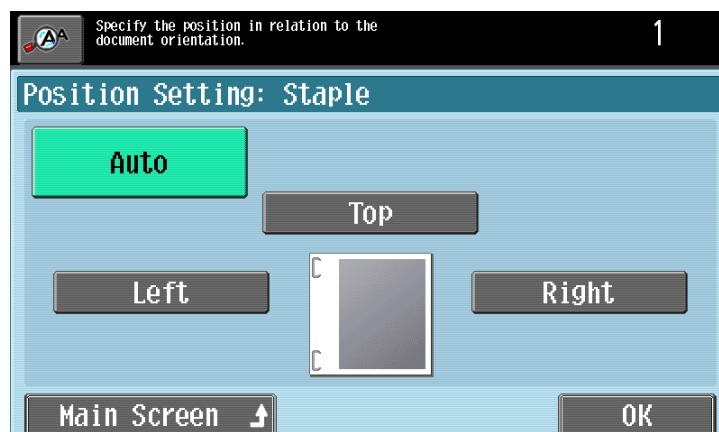

- 5** Touch [OK], and then touch [OK] in the next two screens that appear. Otherwise, touch [Main Screen].

The Basic screen appears again.



Note

The number of punched holes differs depending on the country (region) where the unit is installed. For details, consult your service representative.

2.7.3 Selecting a folding or binding setting

- 1** In the Basic screen, touch [Finishing].

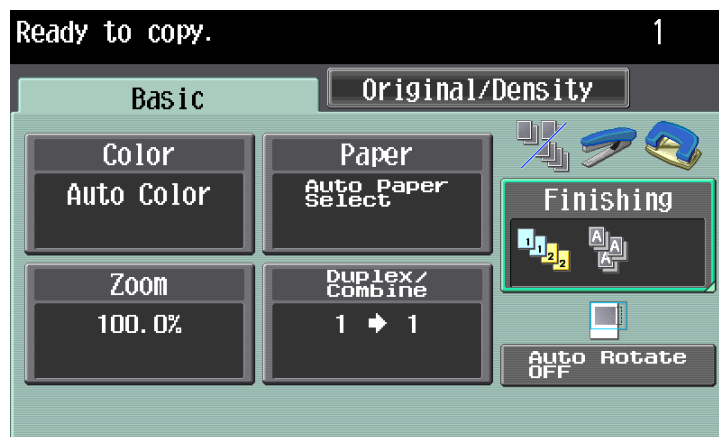

2 Touch [Center Staple/Fold] or [Center Staple & Fold].

When the saddle stitcher is installed on finisher FS-519

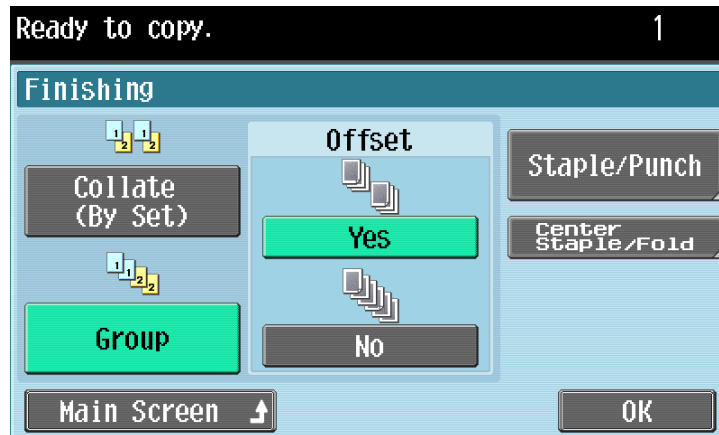

When finisher FS-609 is installed

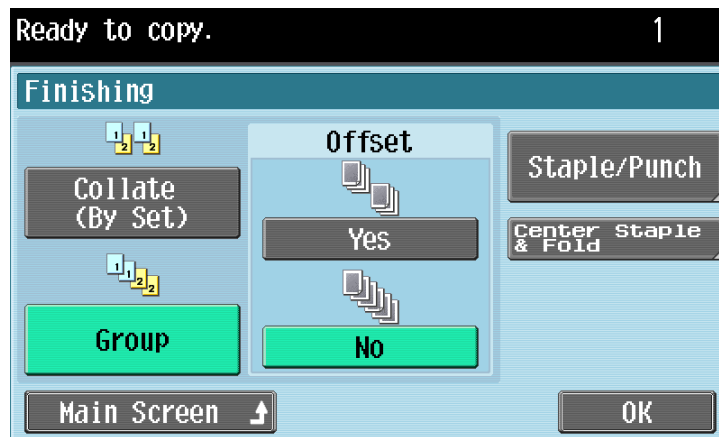

- To return to the main screen, touch [Main Screen].
A screen appears, allowing folding or binding settings to be specified.

3 Select the desired settings.

When the saddle sticher is installed on finisher FS-519

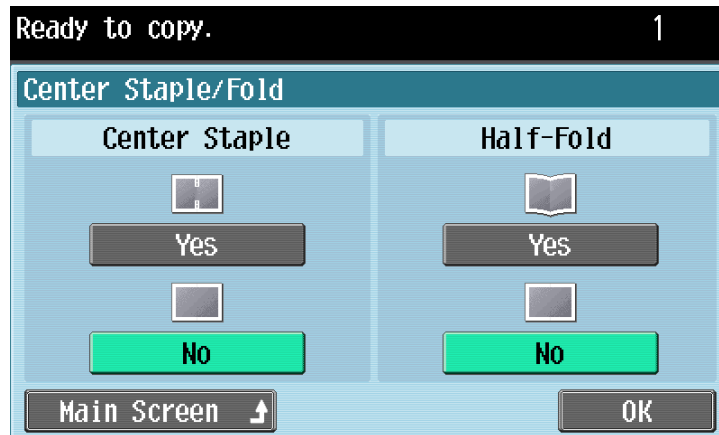

When finisher FS-609 is installed

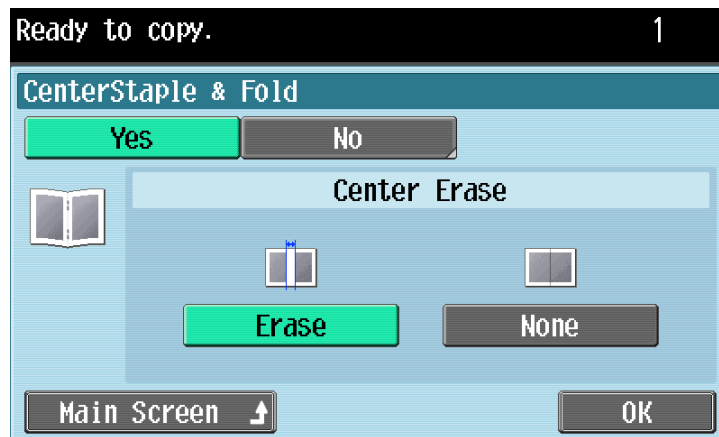

- When finisher FS-609 is installed, touch the button for the desired Center Erase setting. To erase the area along the center, touch [Erase]. To not erase the area along the center, touch [None].
- To cancel the setting, touch [No].

4 Touch [OK], and then touch [OK] in the next screen that appears. Otherwise, touch [Main Screen].

The Basic screen appears again.

2.8 Selecting not to rotate the image

Copies can be printed with the image not rotated to fit the orientation of the loaded paper.

**Note**

Depending on the paper size and zoom ratio, some parts of the image may be lost.

Follow the procedure described below to select the setting to not rotate the image.

- Touch [Auto Rotate OFF].

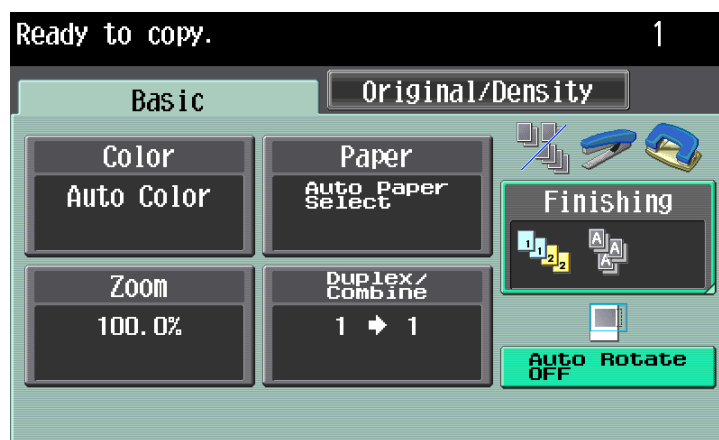

- To cancel the setting for not rotating the image, touch [Auto Rotate OFF] again.

2.9 Selecting the quality of the original

Select an original quality setting. Select the setting for the original type to better adjust the copy quality.

The following Original Type settings are available.

Setting	Description
Text	Select this setting when copying originals containing only text.
Map	Select this setting when copying originals containing pencil markings or fine colored lines or originals with a background color, such as maps.
Dot Matrix Original	Select this setting when copying originals containing only text that appears faint (such as that written with a pencil).
Copied Paper	Select this setting when copying images (originals) printed with this machine.
Text/Photo	Select this setting when copying originals containing both text and photos.
Photo	Select this setting when copying originals containing only photos (halftones).

If "Text/Photo" or "Photo" is selected, the photo type can also be selected.

Setting	Description
Photo Paper	Select this setting for photos printed on photo paper.
Printed Photo	Select this setting for printed photos, such as in books or magazines.

Follow the procedure described below to select an Original Type setting.

1

Position the original to be copied.

- For details on positioning the original, refer to ["Feeding the original" on page 1-12.](#)

2 Touch the Original/Density tab.

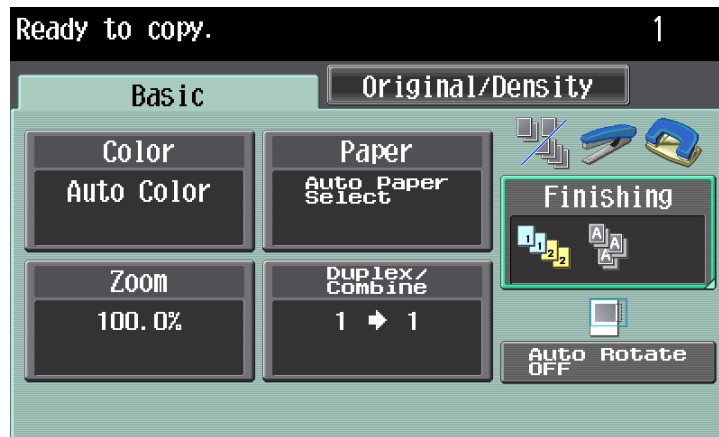

The Original/Density screen appears.

3 Touch [Original Type].



The Original Type screen appears.

4 Touch the button for the quality setting most appropriate for the loaded original.

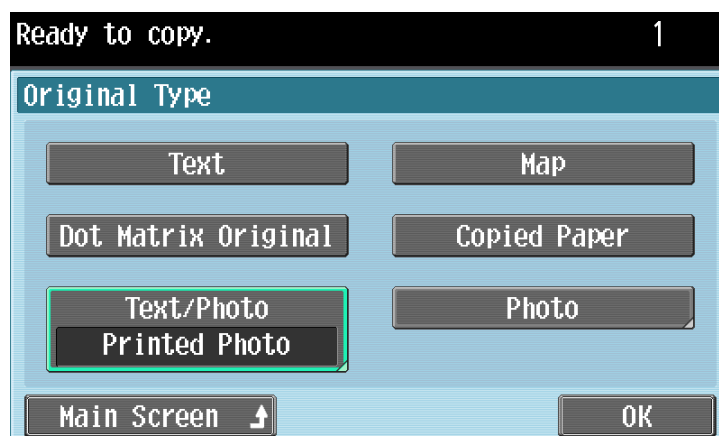

- If "Text/Photo" or "Photo" is selected, select the photo type, and then touch [OK].

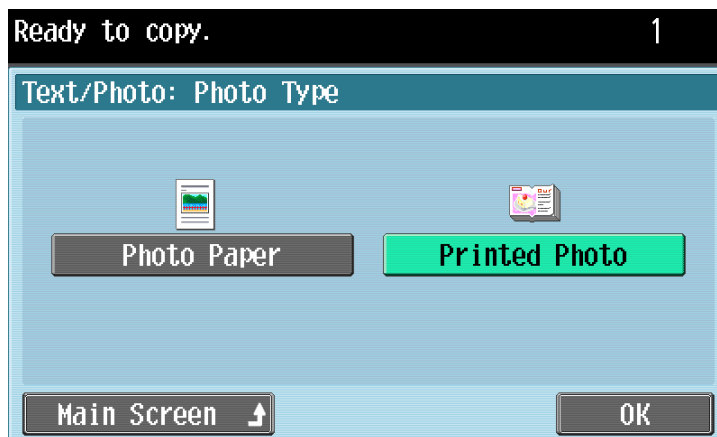

- To return to the main screen, touch [Main Screen].

5

Touch [OK].

The Original/Density screen appears again.

2.10 Selecting the density settings

The copy density and the background density can be adjusted according to the original.

The following density adjustments are available.

Parameter	Description
Density	The print image density can be adjusted to one of nine levels.
Background Removal	The density of the background color of the original can be adjusted to one of nine levels.

Follow the procedures described below to select the density settings.

2.10.1 Adjusting the print density (Density settings)

- 1 Touch the Original/Density tab.

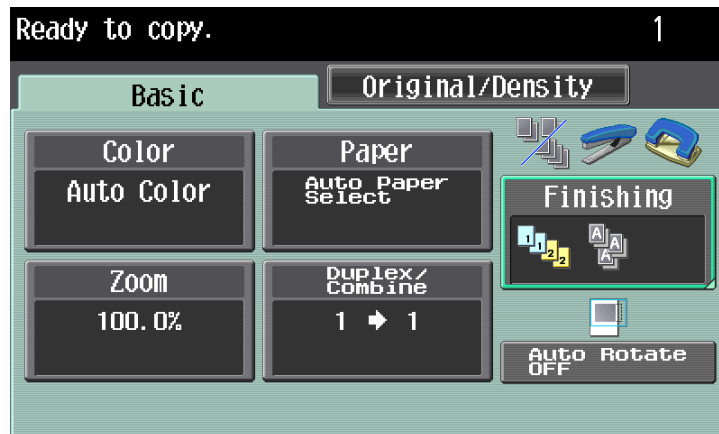

The Original/Density screen appears.

- 2 Touch [Density].



The Density screen appears.

3 Select the desired Density setting.

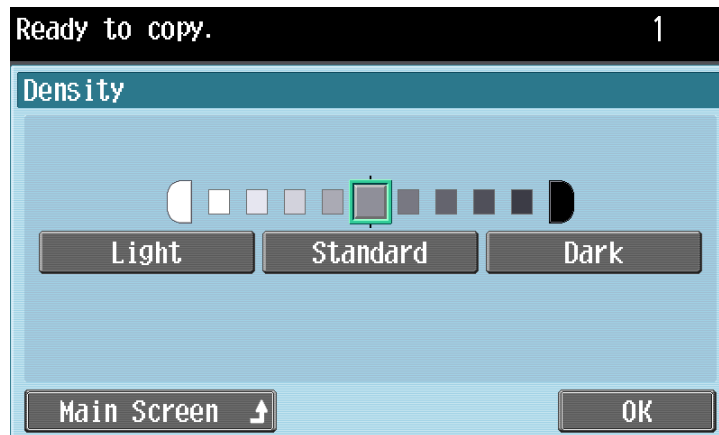

- Each time [Light] or [Dark] is touched, the density is lightened or darkened by one level.
- To select the center setting (default setting), touch [Standard].
- To return to the main screen, touch [Main Screen].

4 Touch [OK].

The Original/Density screen appears again.

2.10.2 Adjusting the background density (Background Removal settings)

1 Touch the Original/Density tab.

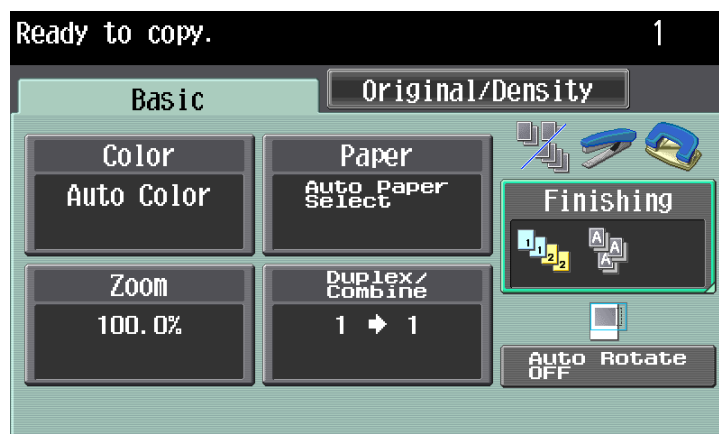

The Original/Density screen appears.

2 Touch [Background Removal].



The Background Removal screen appears.

3 Select the desired Background Removal setting.

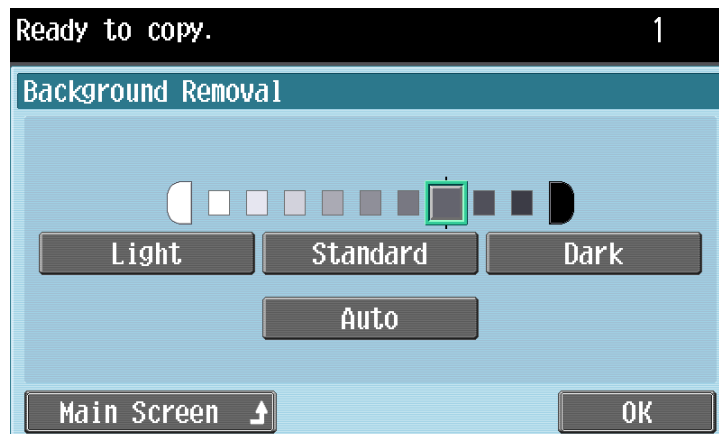

- Each time [Light] or [Dark] is touched, the density is lightened or darkened by one level.
- To select the third setting from the right (default setting), touch [Standard].
- Touch [Auto] to automatically adjust the level of the background density according to the original being printed.
- To return to the main screen, touch [Main Screen].

4 Touch [OK].

The Original/Density screen appears again.

2.11 Selecting the Paper settings

2.11.1 Selecting a Paper Type setting

If paper other than plain paper, such as OHP transparencies or special paper, is loaded in a paper tray, be sure to change the paper type setting for that tray.

The following procedure describes how to specify the setting for special paper loaded into the bypass tray.



Note

There are limits on the types of paper that can be loaded in a paper tray. For details on the types of paper that can be loaded, refer to the User's Guide [Copy Operations].



Reminder

If special paper is loaded into a paper tray, be sure to select the corresponding paper type for that tray, otherwise a paper misfeed may occur.

- 1 In the Basic screen, touch [Paper].

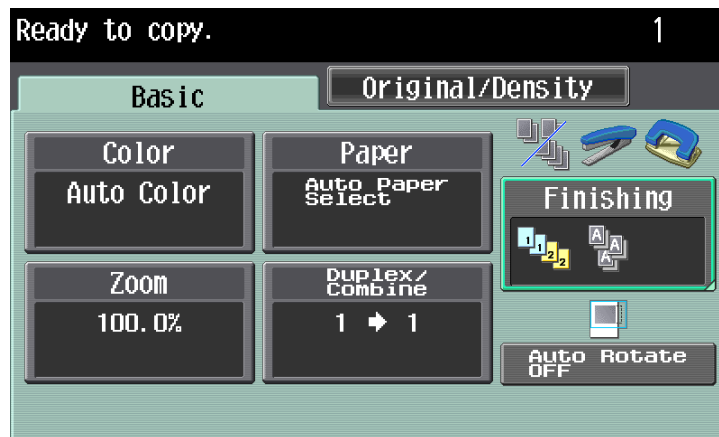

The Paper screen appears.

- 2** Touch the button for the bypass tray, and then touch [Change Settings].

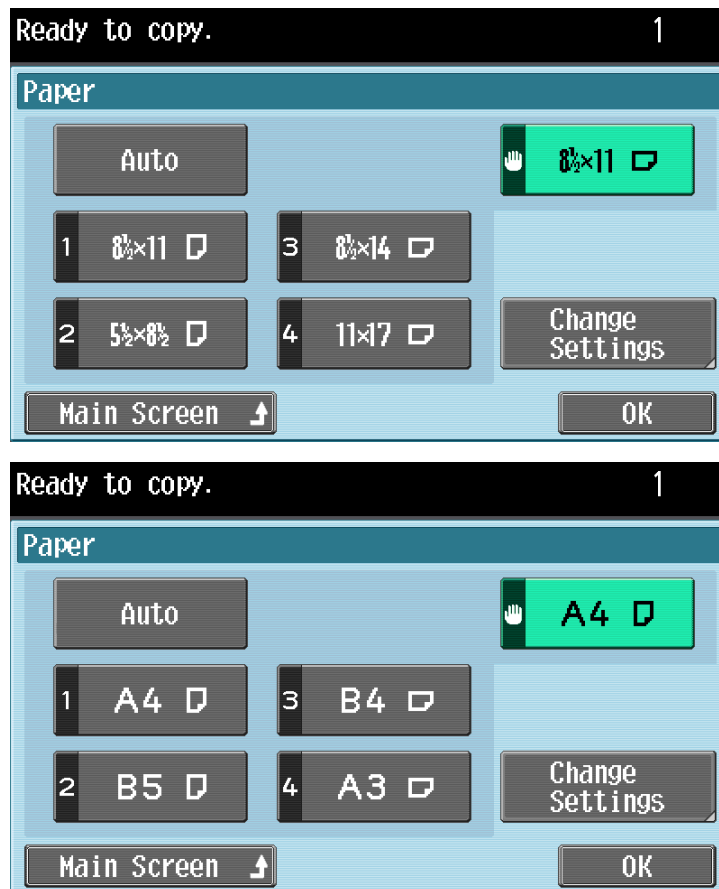

- To return to the main screen, touch [Main Screen].
- To specify a special paper for any paper tray other than the bypass tray, touch the button for the corresponding paper tray.
- If a setting for special paper is selected for a paper tray, that tray is not selected automatically with the "Auto" Paper setting. However, if the "Single Side Only" setting is selected for the paper tray, that tray is given priority with single-sided printing.

- 3** Touch [Paper Type].

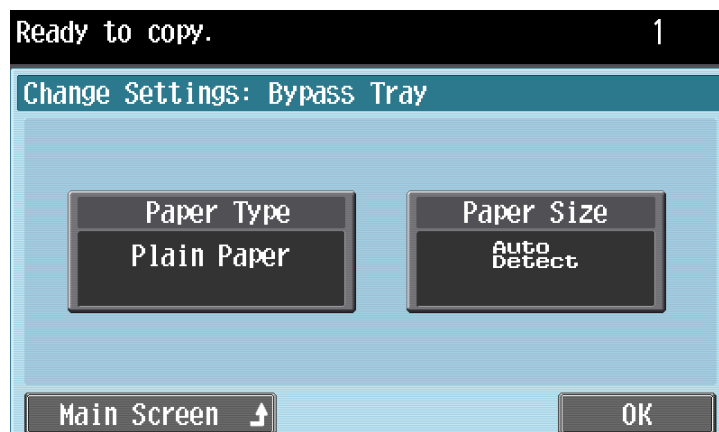

- 4** Select the appropriate setting for the type of special paper that is loaded.

Touch the button for the desired paper type.

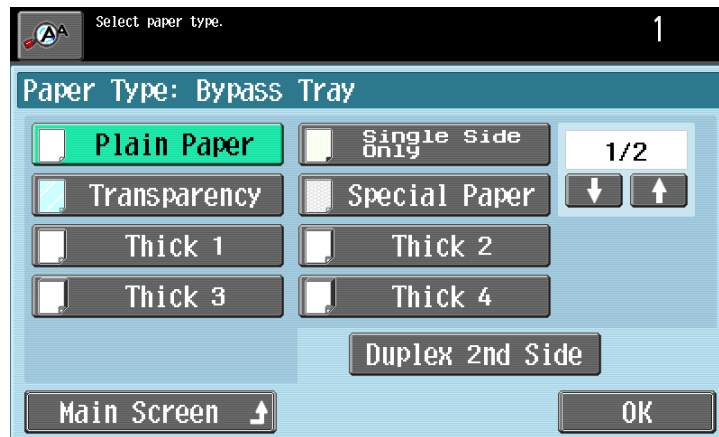

- To print on letterheads, colored paper or envelopes, touch [↓] or [↑].

- 5** Touch [OK], and then touch [OK] in the next two screens that appear. Otherwise, touch [Main Screen].

The Basic screen appears again.

2.11.2 Printing double-sided copies manually

The "Duplex 2nd Side" setting is used to print double-sided copies on paper that cannot be fed through the automatic duplex unit.

The paper to be used for printing the duplex second side can be loaded into the bypass tray.



Note

A paper tray set to "Duplex 2nd Side" is not selected when the "Auto" Paper setting is selected.

- 1 In the Basic screen, touch [Paper].

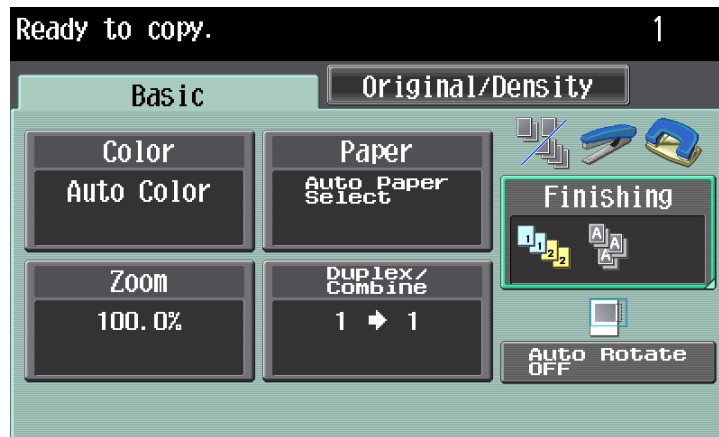

The Paper screen appears.

- 2 Touch the button for the bypass tray, and then touch [Change Settings].

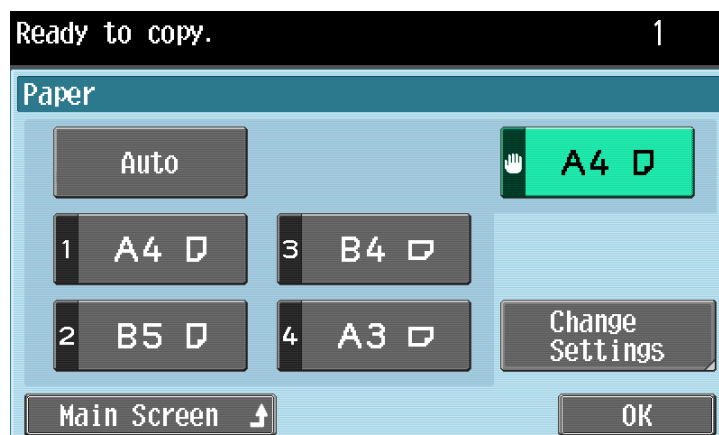
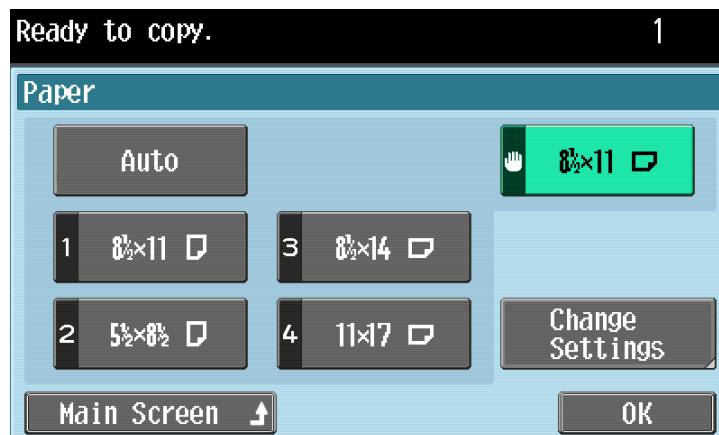

- To return to the main screen, touch [Main Screen].

3 Touch [Paper Type].

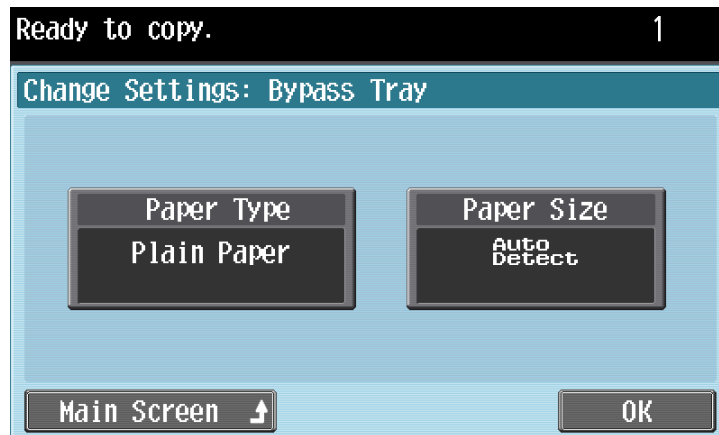

4 Select the type of paper to be loaded and touch [Duplex 2nd Side].

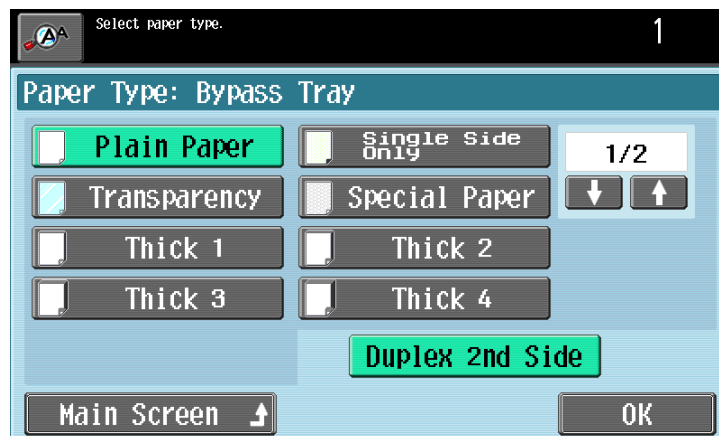

5 Touch [OK], and then touch [OK] in the next two screens that appear. Otherwise, touch [Main Screen].

The Basic screen appears again.

2.11.3 Selecting a Paper Size setting

The paper size can be set for the paper tray so that it can be used with the specified paper size.



Note

For details on loading paper, refer to the User's Guide [Copy Operations].

The paper size can be selected for the bypass tray in any of the following ways.

Setting	Description
Auto Detect ^{*1}	Select this setting to automatically detect the size of the paper loaded into the bypass tray.
Metric Sizes ^{*2}	A metric paper size can be set so that the paper tray is used specifically with the selected paper size.
Inch Sizes ^{*2}	A paper size in inches can be set so that the paper tray is used specifically with the selected paper size.
Other ^{*2}	A paper size other than the preset metric and inch sizes can be set so that the paper tray is used specifically with the selected paper size.
Custom Size ^{*3}	A custom paper size can be set so that the paper tray is used specifically with the selected paper size.
Wide Paper ^{*1*4}	A wide paper size can be set so that the paper tray is used specifically with the selected paper size.

^{*1} Settings can be specified for trays 1 and 2. When the optional single paper feed cabinet or double paper feed cabinet is installed, settings can be also specified for trays 3 and 4. In addition, [12-1/4×18 

^{*2} If paper other than the specified paper size is loaded, a paper misfeed may occur since the paper size is not automatically detected.

^{*3} In order to specify a custom paper size in Enlarge Display mode, the custom paper size must first be stored before entering Enlarge Display mode. For details, refer to the User's Guide [Copy Operations].

^{*4} Wide paper is a size larger than the standard size and allows copies of standard-sized originals to be printed so that there is no loss at the edges. For example, if 11 × 17 wide (A3 wide) paper is used, an area up to 12-1/4 inch × 18 inch (311.1 mm × 457.2 mm) can be printed, allowing the entire area of an 11 × 17-size (A3-size) original to be printed.

The following procedure describes how to specify the size of the paper loaded into the bypass tray.

- 1 In the Basic screen, touch [Paper].

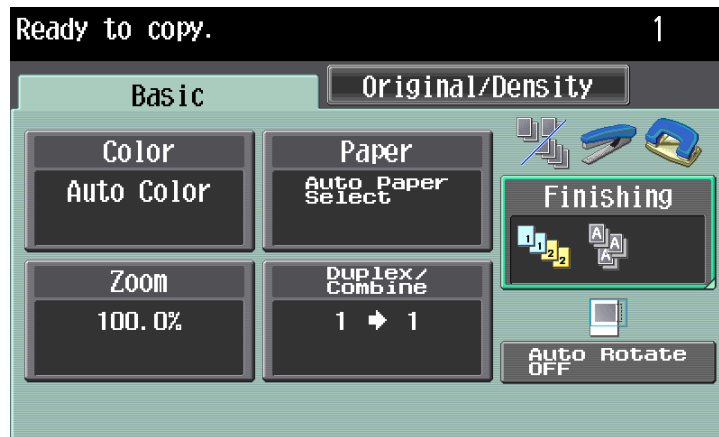

The Paper screen appears.

- 2 Touch the button for the bypass tray, and then touch [Change Settings].

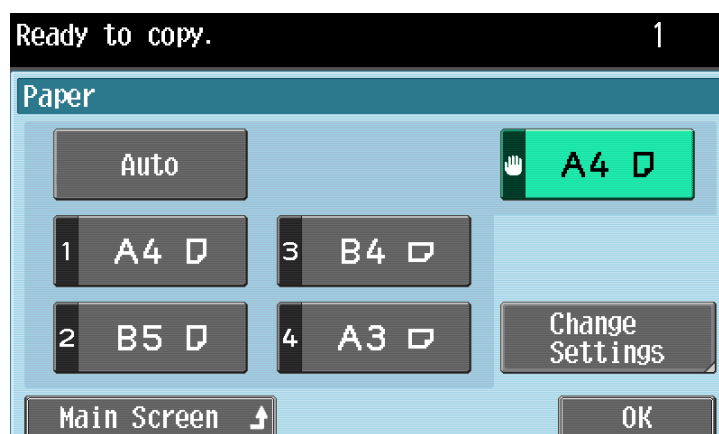
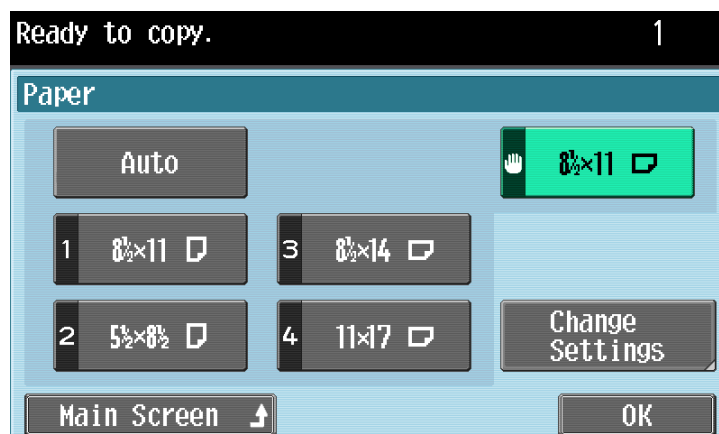

- To return to the main screen, touch [Main Screen].
- To change the setting of special paper for any paper tray other than the bypass tray, touch the button for the corresponding paper tray.

3 Touch [Paper Size].

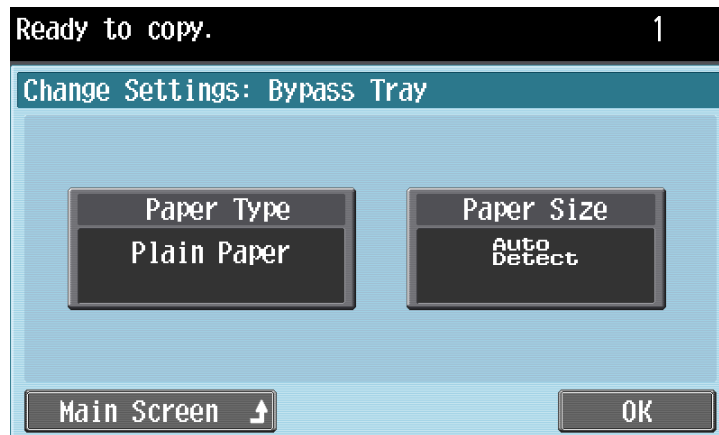

4 Touch either [Auto Detect] or select the desired paper size.

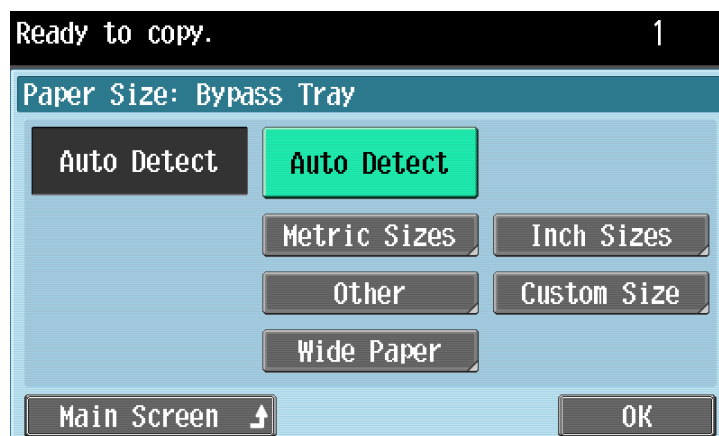
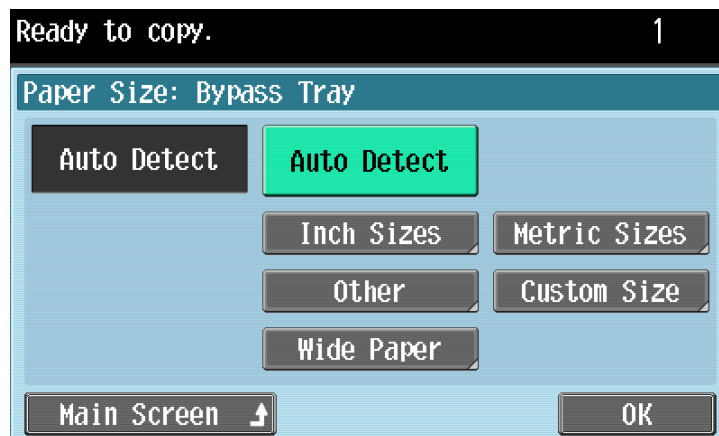

- If a button other than [Auto Detect] was touched, select the desired paper size, and then touch [OK].

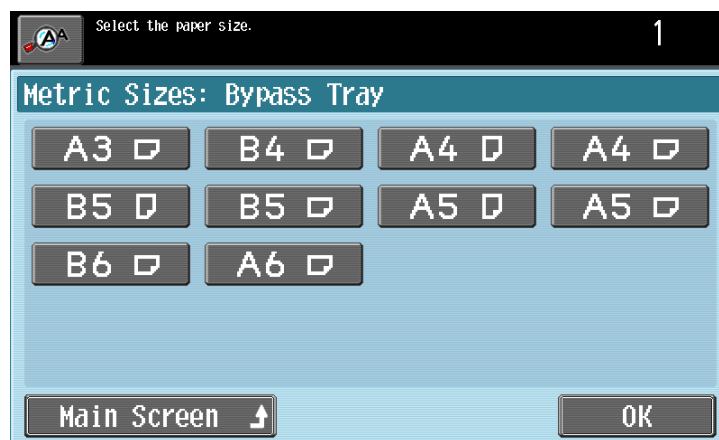

- 5 Touch [OK], and then touch [OK] in the next two screens that appear. Otherwise, touch [Main Screen].

The Basic screen appears again.

2.12 Scanning the next original to be copied while a copy job is being printed (next job reservation)

The settings for the next copy job can be specified and the original can be scanned while a job is being printed so that it can be printed once the current copy job is finished.



Detail

Up to 61 copy jobs, including the current copy job, can be queued.

A copy job can be reserved after scanning of the loaded original is finished. The next job cannot be reserved while an original is being scanned.

1

If the message "Ready to accept another job." appears while printing the current job, an original can be loaded, and copy settings can be specified for the next copy job.

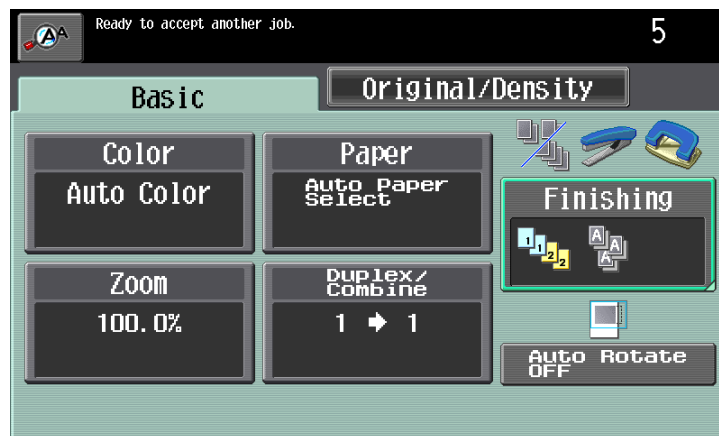

- If the "Copy Operating Screen" parameter was set to "Yes", touch [Next Copy Job] in the screen that appears during printing to display the Basic screen.
- For details on positioning the original, refer to ["Feeding the original" on page 1-12.](#)

2

Press the [Start] key.

3

After the current job is finished, the next copy job begins.

2.13 Pausing scanning/printing

Follow the procedure described below to temporarily stop scanning the original and stop the printing operation.

- 1 Press the [Stop] key while an original is being scanned or a job is being printed.



- Scanning/printing temporarily stops.
- If an original is being scanned for a job, pressing the [Stop] key temporarily stops scanning.



The message "Job has stopped." appears.

- 2 To continue all temporarily stopped jobs, press the [Start] key.
 - To delete a temporarily stopped job, select the job that you wish to delete, and then touch [Delete].
 - Select only one job at a time to be deleted.

2.14 Printing a proof to check the settings (Proof Copy)

Before printing a large number of copies, a single proof copy can first be printed so that it can be checked. This prevents copy errors from occurring.



Note

When printing a proof copy, specify multiple copies.

This feature cannot be used if the "Group" setting is selected.

1

Position the original to be copied.

- For details on positioning the original, refer to "[Feeding the original](#)" on [page 1-12](#).

2

Select the desired copy settings.

3

Press the [Proof Copy] key.

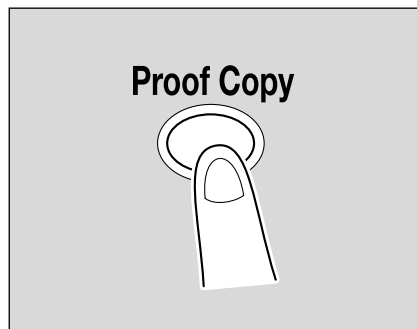

- If the original was loaded on the original glass, touch [Finish], and then press the [Start] key.

A single proof copy is printed.

4

Check the proof copy.

- To change the copy settings, press the [C] (clear) key or the [Reset] key, and then change the settings.

5 Touch [Print].

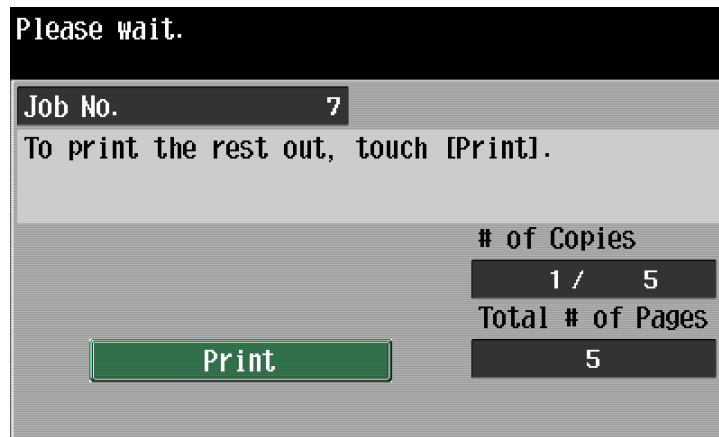

The remaining copies are queued as a copy job.



3

Using fax/scan functions

3 Using fax/scan functions

3.1 General fax/scan operation



Note

For details on performing fax and scan operations, refer to the User's Guide [Network Scan/Fax/Network Fax Operations].



Detail

Specify the fax settings and network settings and register destinations before entering Enlarge Display mode. For details, refer to the User's Guide [Network Scan/Fax/Network Fax Operations] and the User's Guide [Network Administrator].

This section contains information on the general operation for sending faxes and scans.

- 1 Press the [Fax/Scan] key in the control panel, and then press the [Enlarge Display] key.

The Fax/Scan mode screen appears in Enlarge Display mode.

- 2 Position the original to be copied.

– For details on positioning the original, refer to [page 1-12](#).

- 3 Specify the destination.



– For details on specifying destinations, refer to [page 3-4](#).

- To erase the entered destination, press the [C] (clear) key.

4 Specify the necessary scanning settings.

- For details on specifying scanning settings, refer to [page 3-13](#).
- To cancel the setting and select the default, press the [Reset] key.

5 Press the [Start] key.

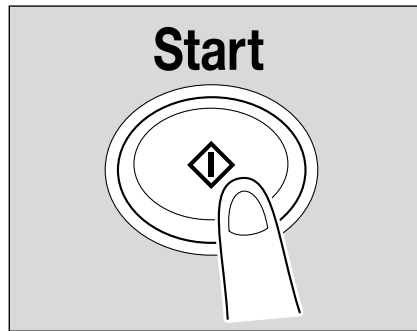

- If the machine is set to display the transmission result report screen, a screen appears, requesting confirmation to print the transmission result report. To print the transmission result report, touch [Yes], and then touch [OK].
- To stop the transmission, press the [Stop] key.
- Pressing the [Stop] key during scanning temporarily stops the scan operation.

Scanning of the original begins, and then the fax is sent.



Detail

If the "Destination Check Display Function" parameter was set to "ON", the Destination Settings screen appears. Check the destinations, and then touch [Send].

If the machine is set to print the transmission result report, the transmission result report is printed if the transmission could not be completed.

3.2 Specifying a destination



Detail

Destinations must first be registered in Utility mode. Fax transmission destinations can also be registered. For details on registering destinations, refer to the User's Guide [Network Scan/Fax/Network Fax Operations].

The scan data can be sent in any of the following ways.

Network Scan operations

Method	Description
Scan to E-mail	The Scan to E-Mail operation is used to send scan data to a specified E-mail address as a file attachment.
Scan to FTP	In a network environment with a FTP server, scan data can be sent to a specified folder in the FTP server on the network. This function is suitable for transmitting large-sized data, such as high-resolution data.
Scan to SMB	Scan data can be sent directly to a specific computer on the network. In order to perform a Scan to SMB operation, first specify shared file settings in Windows on the computer receiving the data.
Scan to File (WebDAV)	In a network environment with a WebDAV server, scan data can be sent to a specified folder in the WebDAV server on the network. WebDAV is based on extended specifications of HTTP, and therefore the security technology of HTTP can be used. These settings ensure safer file transmission by encrypting communication with the WebDAV server using SSL.

Fax operations

Method	Description
Fax transmission	The scan data can be sent to the fax number specified for the destination. Color faxes cannot be sent or received.

Network Fax operations

Method	Description
Internet fax transmission	The scan data can be sent as an E-mail attachment (TIFF format) through an intranet (company network) or the Internet. Color faxes cannot be sent or received.
IP address fax transmission	Faxes can be sent on an IP network. Scan data can be sent to the IP address or host name specified for the destination. This operation can only be used through an intranet. Color faxes cannot be sent or received.



Detail

Multiple destinations can be specified at the same time.

To send or receive faxes manually, touch [Off-Hook]. When this button is touched, the dial tone can be heard from the speaker. For more details, refer to the User's Guide [Network Scan/Fax/Network Fax Operations]. This feature is not available with Internet faxing or IP faxing.

The procedure for specifying the destination where scan data is to be sent is described below.

3.2.1 Selecting a destination from the address book

Follow the procedure described below to select an already registered destination.

Touch the button for the desired destination in the Address Book screen to select a destination.

A destination can be searched for by the destination type or the destination name.

1

In the Address Book screen, touch [Other Dest.].



The Other Destinations screen appears.

2 Touch the button for the desired destination type.

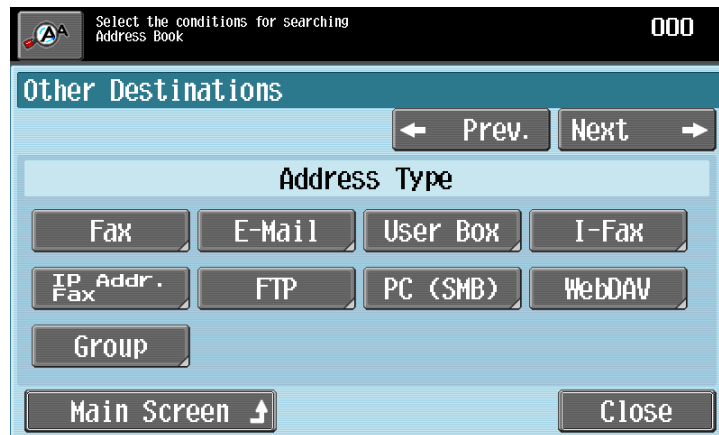

- To select the index characters, touch [Next→].

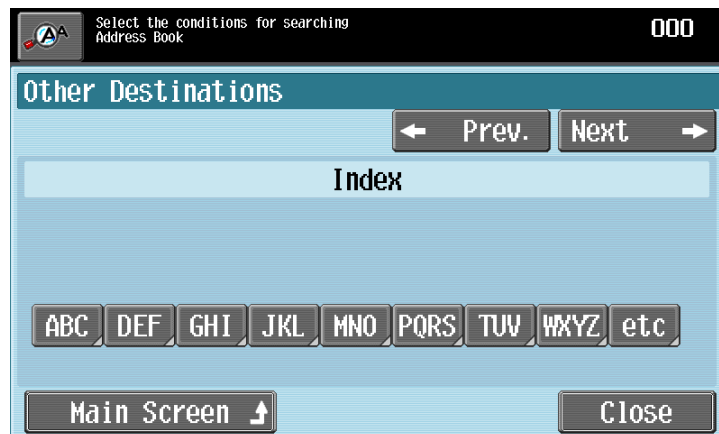

- To select a destination from registered group, touch [Group]. To select all destinations registered with the selected group, touch [Select All] in the Group Details screen. To cancel all of the selected destinations, touch [Reset].

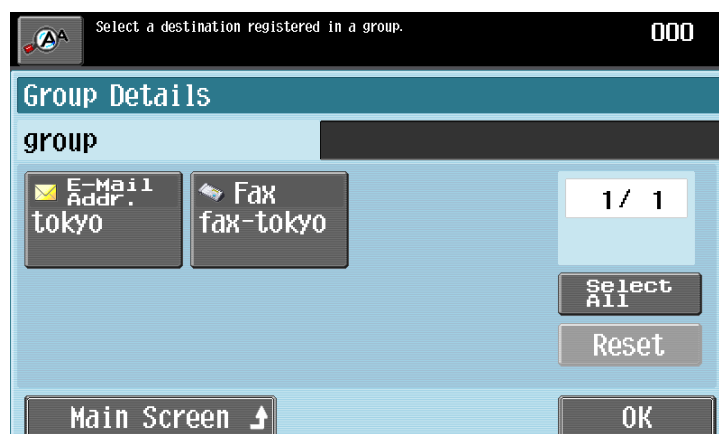

- To return to the Address Book screen, touch [Main Screen].

- 3 Touch the button for the desired destination, and then touch [OK].
 - To cancel a selection, touch the button for a selected destination again.

- 4 Touch [Close].

3.2.2 Selecting a destination from the job log

Follow the procedure described below to select a destination from the job log.



Note

This feature is not available with Internet faxing or IP address faxing.

- 1 Touch the Job History tab.



The Job History list appears.

- 2 Select the desired destination.



- The last five destinations where a transmission was sent are displayed.
- To cancel a selection, touch the button for a selected destination again.

3.2.3 Selecting a destination with an LDAP search

Follow the procedure described below to search for an E-mail address registered with the LDAP server and select the destination.



Detail

In order to perform an LDAP search, LDAP must be enabled and an LDAP server must be registered. For details on specifying LDAP settings, refer to the User's Guide [Network Administrator].

If "Manual Destination Input" in Administrator mode is set to "Restrict", the LDAP search feature is not available. For details on specifying the setting for the "Manual Destination Input" parameter, refer to the User's Guide [Network Administrator].

- 1 Touch the Address Search tab.



- If multiple LDAP servers are specified, select the server to be searched, and then touch [OK].

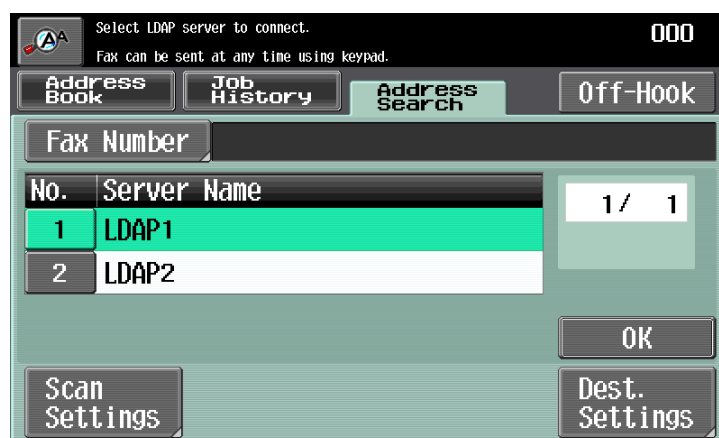

2 Select the search method.

- To specify a search word, touch [Search]. To specify multiple search conditions, touch [Advanced Search].
- When there is only one LDAP server

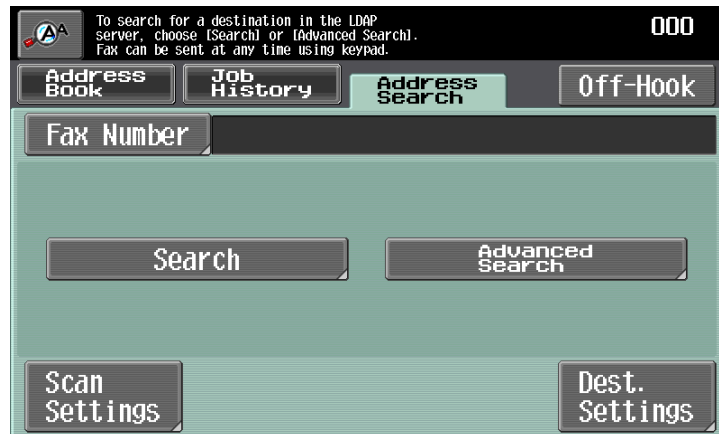

- When there are multiple LDAP servers

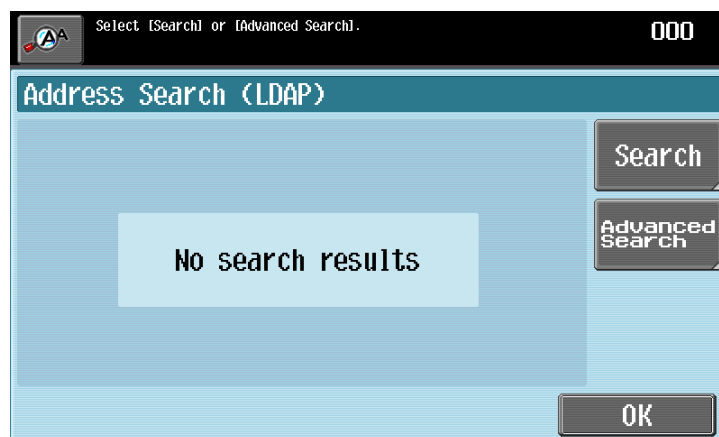

- Authentication may be necessary, depending on the LDAP server that is specified.

3 Specify the search conditions, and then touch [Start Search].

For a simple search



For an advanced search



The search results are displayed.

- 4 Touch the button for the desired destination, and then touch [OK].
 - To cancel a selection, touch the button for a selected destination again.

3.2.4 Directly typing in the number

Follow the procedure described below to directly type in the fax number or the registration number for an address book destination during a fax transmission.

✎ ...

Note

If "Manual Destination Input" in Administrator mode is set to "Restrict", a fax number cannot be entered. For details on specifying the setting for the "Manual Destination Input" parameter, refer to the User's Guide [Network Administrator].

- 1 Touch [Fax Number].



The Fax Number screen appears.

2

Using the control panel keypad or the keypad that appears in the touch panel, type in the fax number.

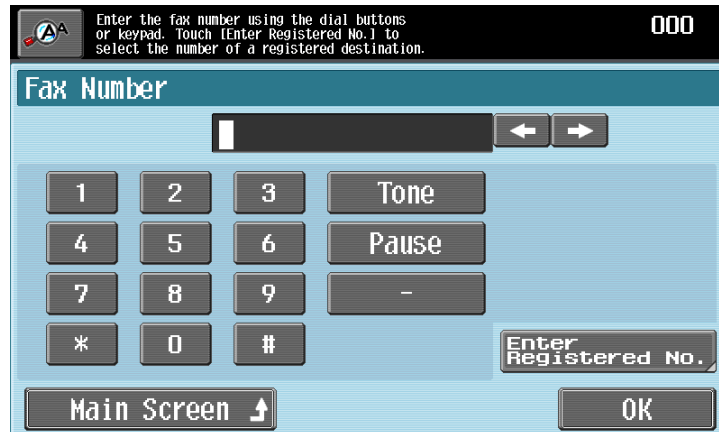

- Otherwise, touch [Enter Registered No.], use the keypad to type in destination registration number, and then touch [Apply].

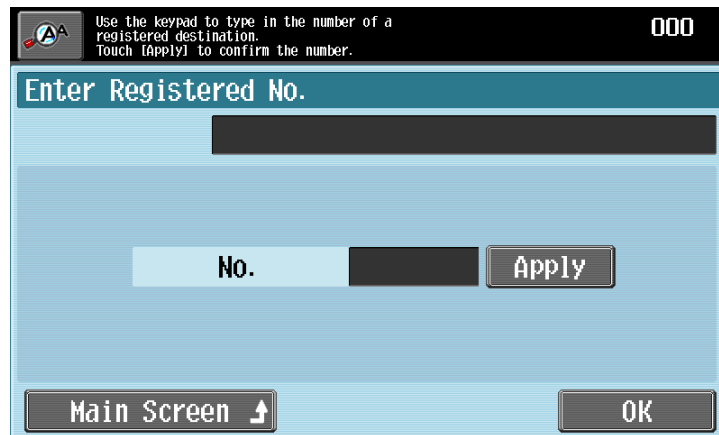

- To specify an additional recipient, touch [Next Destination], and then enter the number.
- To return to the Address Book screen, touch [Main Screen].
- When typing in a fax number:
 - [Tone]: If pulse dialing is being used, touch this button to send a push-button tone. This is used when a fax information service is being used. "T" appears in the screen. If pulse dialing is being used, use [*] to switch to a push-button tone.
 - [Pause]: Touch this button to insert a pause when dialing. Touch [Pause] once to insert a 1-second pause. In addition, multiple pauses can be entered. "P" appears in the screen. If the PBX (private branch exchange) connection is enabled, touch [Pause] after the outside line access code (for example, "0") for reliable dialing when transmitting from an inside line to an outside line. "P" appears in the screen.
 - [–]: Touch this button to insert the dash as separator symbol while dialing. This has no effect on the dialing. "-" appears in the screen.
- To change a character in the entered text, touch [←] and [→] to move the cursor to the character to be changed, and then touch [Delete].

3

Touch [OK].

- If a destination registration number is entered, touch [OK], and then touch [OK] in the next screen that appears.

3.3 Specifying scanning settings (Scan Settings)

Touch [Scan Settings] in the Fax/Scan mode screen, and then specify the original scanning settings.

3.3.1 Simplex/Duplex

Select the appropriate ADF scanning method according to your original. The following scanning methods are available.

Setting	Description
1-Sided	Select this setting to scan a single-sided original.
2-Sided	Select this setting to scan a double-sided original.
Cover + 2-Sided	Select this setting to scan an original where the first page is single-sided and the remaining pages are double-sided.

1

Touch [Scan Settings] in the Fax/Scan mode screen.



The Scan Settings screen appears.

2 Touch [Simplex/Duplex].

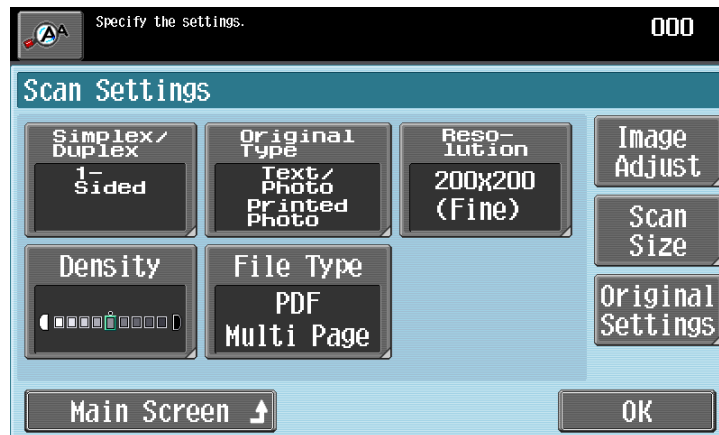

- To return to the Address Book screen, touch [Main Screen]. The Simplex/Duplex screen appears.

3 Select the scanning method.



4 Touch [OK], and then touch [OK] in the next screen that appears. Otherwise, touch [Main Screen].

3.3.2 Original Type

Select the appropriate Original Type setting according to your original.

The following Original Type settings are available.

Setting	Description
Text	Select this setting when scanning originals consisting only of text. If an original containing photos is scanned using this setting, the halftones of the photo will not be reproduced and the entire photo will appear black.
Dot Matrix Original	Select this setting when scanning originals with faint text (such as that written in pencil).
Copied Paper	Select this setting when scanning copied originals.
Text/Photo	Select this setting when scanning originals consisting of both text and photos (halftones). This setting should be selected for originals containing text and photos combined in a single page or over multiple pages.
Photo	Select this setting when scanning originals consisting of only photos (halftones).

If "Text/Photo" or "Photo" is selected, the photo type can also be selected.

Setting	Description
Photo Paper	Select this setting for photos printed on photo paper.
Printed Photo	Select this setting for printed photos, such as in books or magazines.

1

Touch [Scan Settings] in the Fax/Scan mode screen.



The Scan Settings screen appears.

2 Touch [Original Type].

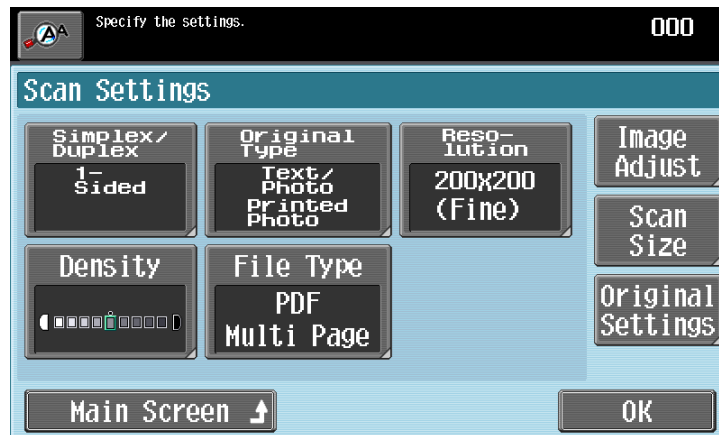

- To return to the Address Book screen, touch [Main Screen]. The Original Type screen appears.

3 Touch the button for the quality setting most appropriate for the loaded original.

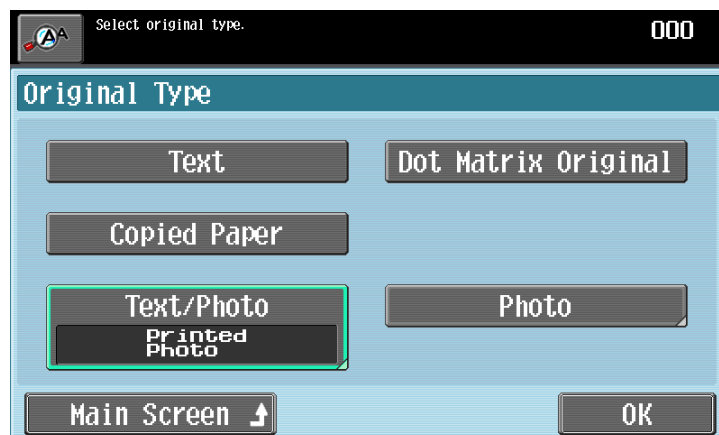

- If "Text/Photo" or "Photo" is selected, select the photo type, and then touch [OK].

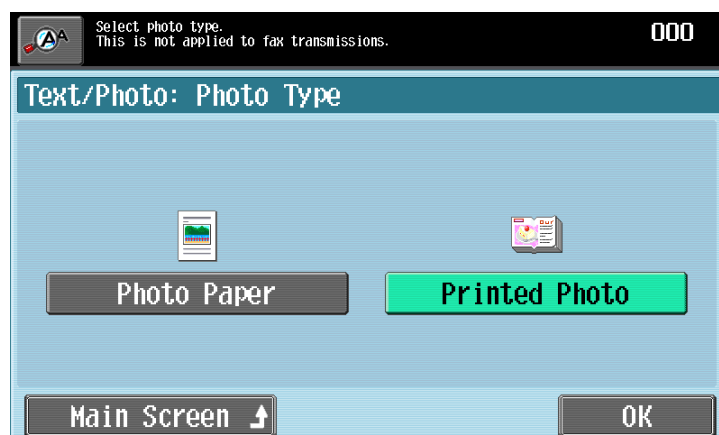

- 4 Touch [OK], and then touch [OK] in the next screen that appears. Otherwise, touch [Main Screen].

3.3.3 Resolution

Select the detailedness for scanning originals.

The following Resolution settings are available.

Setting	Description
200 × 100 (Standard)	Select this setting to reduce the transmission time.
200 × 200 (Fine)	Select this setting when scanning regular originals.
300 × 300 dpi	Select this setting to scan originals at a higher resolution than that of regular originals.
400 × 400 (Super Fine)	Select this setting when scanning originals with small print or with illustrations.
600 × 600 (Ultra Fine)	Select this setting when scanning originals with particularly fine print or with detailed illustrations.

- 1 Touch [Scan Settings] in the Fax/Scan mode screen.



The Scan Settings screen appears.

2 Touch [Resolution].

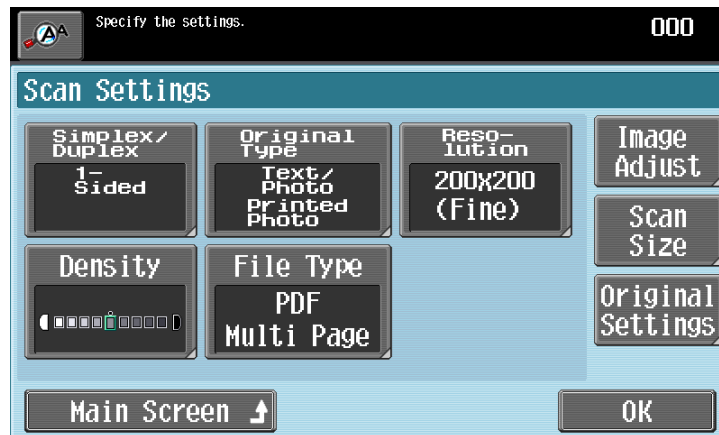

- To return to the Address Book screen, touch [Main Screen]. The Resolution screen appears.

3 Select the resolution.



- A more finely scanned original has more information to be sent, therefore, the transmission time increases.
- If "600 × 600 (Ultra Fine)" or "400 × 400 (Super Fine)" is selected, the fax is sent with a resolution appropriate for the recipient's machine if it cannot receive a fax with the specified resolution.

4 Touch [OK], and then touch [OK] in the next screen that appears. Otherwise, touch [Main Screen].

3.3.4 Density

Select the appropriate Density setting according to your original.
The density can be adjusted to one of nine levels.

- 1 Touch [Scan Settings] in the Fax/Scan mode screen.



The Scan Settings screen appears.

- 2 Touch [Density].

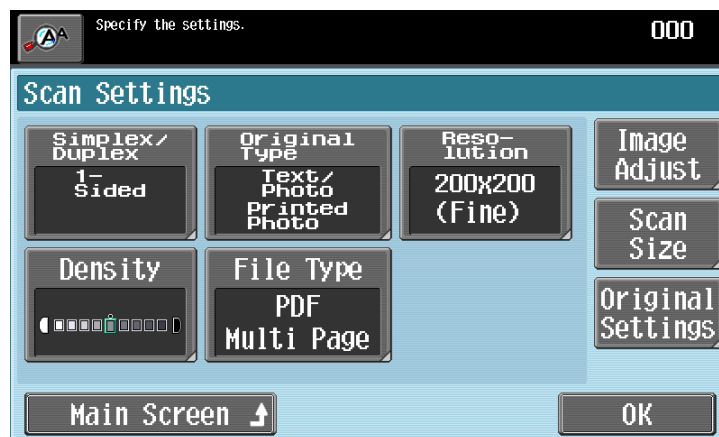

- To return to the Address Book screen, touch [Main Screen].
The Density screen appears.

3 Select the desired Density setting.

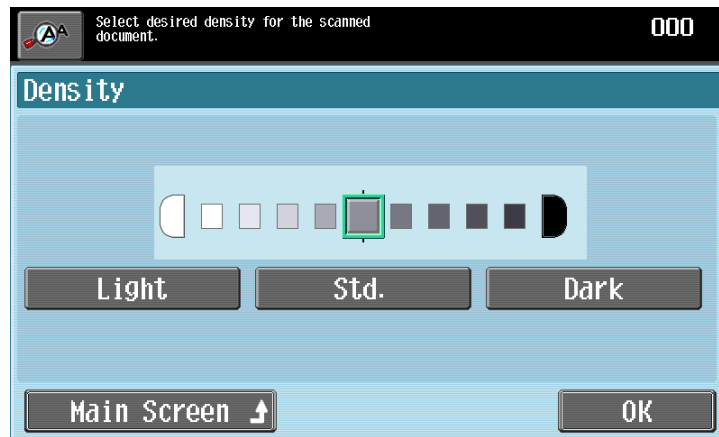

- Each time [Light] or [Dark] is touched, the density is lightened or darkened by one level.
- To select the center setting (default setting), touch [Std.].

4 Touch [OK], and then touch [OK] in the next screen that appears. Otherwise, touch [Main Screen].

3.3.5 File Type

Select the file format for saving the scan data. The following file formats are available.

Setting	Description
PDF	Select this setting to save the data in the PDF format.
Compact PDF	Select this setting to save the data in a highly compressed PDF format.
TIFF	Select this setting to save data in the TIFF format.
JPEG	Select this setting to save the data in the JPEG format.
XPS	Select this setting to save the data in the XPS format.

Some format settings for the file to be saved may not be available, depending on the selected Color setting and fax destination.



Note

For fax transmissions and Internet fax transmissions, the file type is fixed to the TIFF format.

- 1 Touch [Scan Settings] in the Fax/Scan mode screen.



The Scan Settings screen appears.

- 2 Touch [File Type].

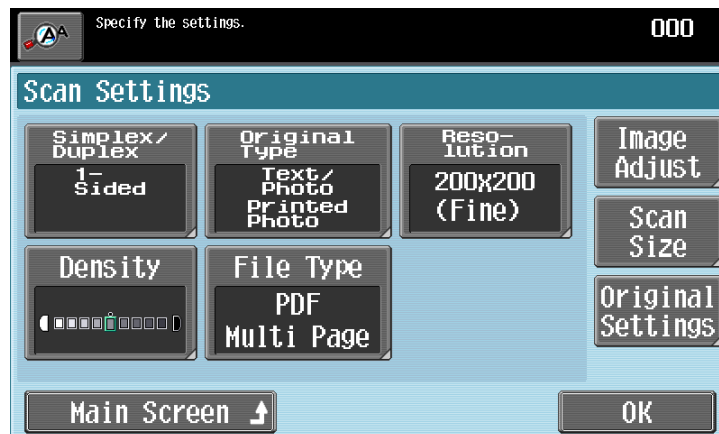

– To return to the Address Book screen, touch [Main Screen].
The File Type screen appears.

- 3 Select the file format and the page setting.

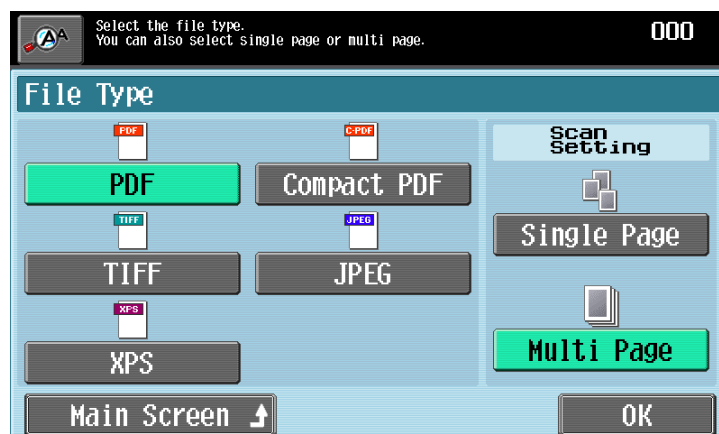

- If "Single Page" is selected under "Scan Setting", a file is created in a format where the data for each page can be saved when downloading.
- If "Multi Page" is selected under "Scan Setting", a single file is created from the entire scanned original. This setting cannot be selected when "File Type" is set to "JPEG".

4 Touch [OK], and then touch [OK] in the next screen that appears. Otherwise, touch [Main Screen].

3.3.6 Color (Image Adjust)

Select whether the original will be scanned in color or black and white.

The following Color settings are available.

Setting	Description
Auto Color	Select this setting to automatically detect the color of the original and scan it with the corresponding setting.
Full Color	Select this setting to scan in full color.
Gray Scale	Select this setting for originals with many halftones, such as in black-and-white photos.
Black	Select this setting for originals with distinct black and white areas, such as in line drawings.

Some Color settings may not be available, depending on the selected File Type setting.



Note

For fax transmissions and Internet fax transmissions, the color is fixed to 2 color of black and white.

1 Touch [Scan Settings] in the Fax/Scan mode screen.



The Scan Settings screen appears.

2 Touch [Image Adjust].

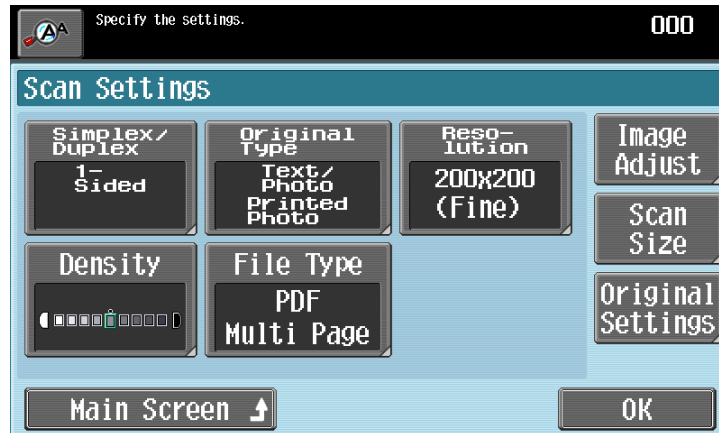

– To return to the Address Book screen, touch [Main Screen].
The Image Adjust screen appears.

3 Select the color type.



4 Touch [OK], and then touch [OK] in the next screen that appears. Otherwise, touch [Main Screen].

3.3.7 Background Removal (Image Adjust)

The scanning density of the original background can be adjusted. When originals printed on colored paper are scanned in color, the background may become black. In that case, the density of the background can be adjusted.

- 1 Touch [Scan Settings] in the Fax/Scan mode screen.



The Scan Settings screen appears.

- 2 Touch [Image Adjust].

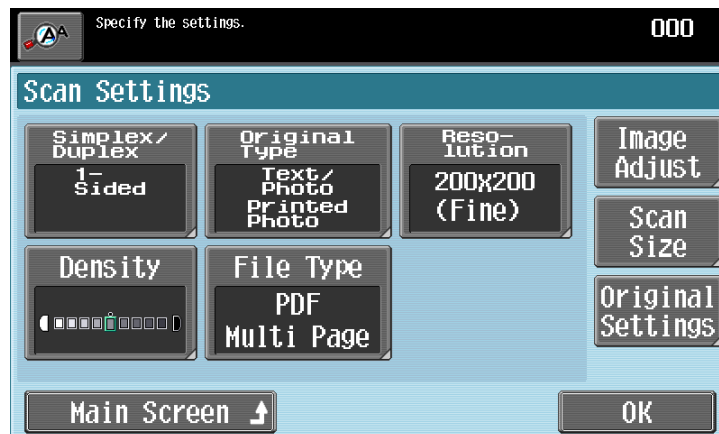

- To return to the Address Book screen, touch [Main Screen].
- The Image Adjust screen appears.

3 Touch [Background Removal].

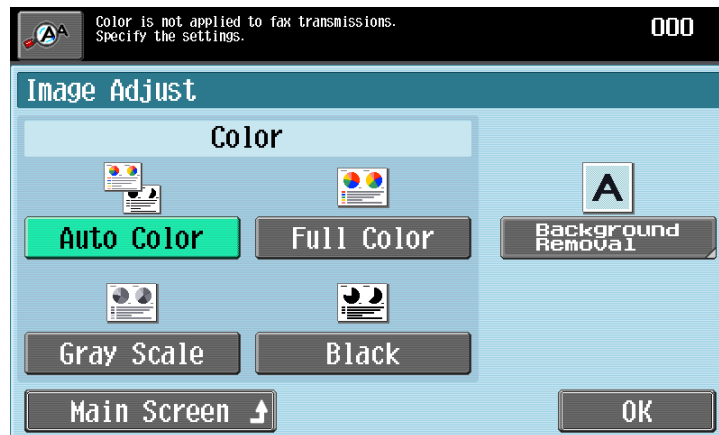

The Background Removal screen appears.

4 Adjust the density as desired.

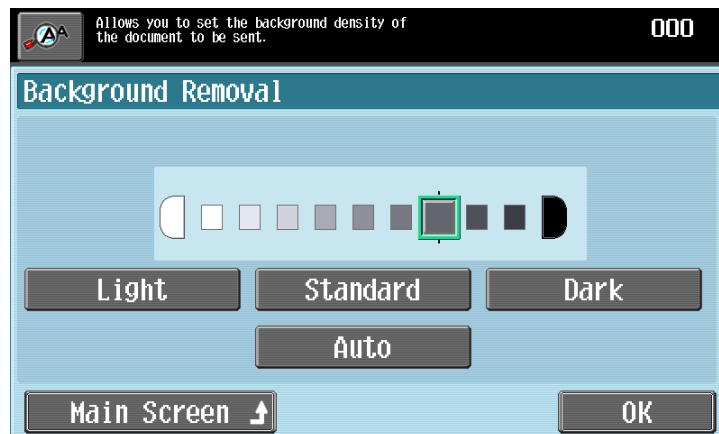

- Each time [Light] or [Dark] is touched, the density is lightened or darkened by one level.
- To select the third setting from the right (default setting), touch [Standard].
- Touch [Auto] to automatically adjust the level of the background density according to the original being copied.

5 Touch [OK], and then touch [OK] in the next two screens that appear. Otherwise, touch [Main Screen].

3.3.8 Scan Size

Specify the size of paper to be scanned. The scan size can be specified with any of the following methods.

Settings	Description
Auto	Select this setting to detect the size of the first page in the loaded original.
Metric Sizes	Select a preset paper size (such as A4 or B5) and orientation.
Inch Sizes	Select a preset paper size and orientation in inch sizes.
Other	Select a preset paper size and orientation in a size other than metric or inch sizes.

1 Touch [Scan Settings] in the Fax/Scan mode screen.



The Scan Settings screen appears.

2 Touch [Scan Size].



– To return to the Address Book screen, touch [Main Screen].
The Scan Size screen appears.

3 Select the desired size and orientation.

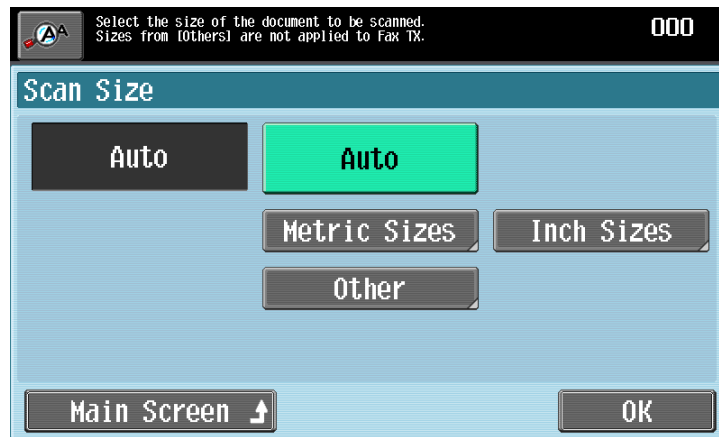

- If a button other than [Auto] was touched, select the desired paper size, and then touch [OK].

4 Touch [OK], and then touch [OK] in the next screen that appears. Otherwise, touch [Main Screen].

3.3.9 Original Settings

Select the binding position and orientation of the original.

Parameter	Description
Original Direction	Select the orientation of the original. After the original is scanned, the data is processed so that it is correctly oriented. For details on selecting the original orientation, refer to "Selecting the original orientation (Original Direction settings)" on page 1-19.
Binding Position	Select the binding position, for example, when holes are punched in the original or the original is stapled. In addition, specify the binding position when a double-sided original is loaded. This adjusts the scan of double-sided originals so that the binding position is not reversed. Left: Select this setting for an original with a binding margin on the left side. Top: Select this setting for an original with a binding margin at the top. Auto: The binding margin is on the long side if the page is 11-11/16 inch (297 mm) or less, or it is on the short side if the page is more than 11-11/16 inch (297 mm).

These functions can be used together.

**Note**

[Original Direction] is not available with fax function.

- 1 Touch [Scan Settings] in the Fax/Scan mode screen.



The Scan Settings screen appears.

- 2 Touch [Original Settings].



- To return to the Address Book screen, touch [Main Screen]. The Original Settings screen appears.

3 Select the original settings.



- Touching [Original Direction] displays the Original Direction screen. Touch the button for the desired orientation, and then touch [OK].

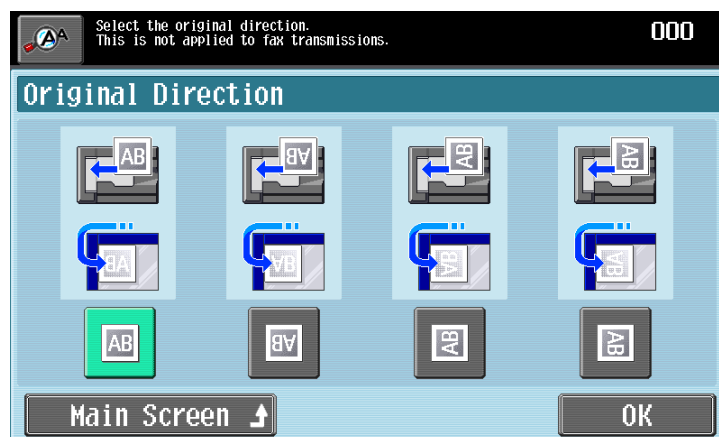

- Touching [Binding Position] displays the Binding Position screen. Touch the button for the desired original binding position, and then touch [OK].

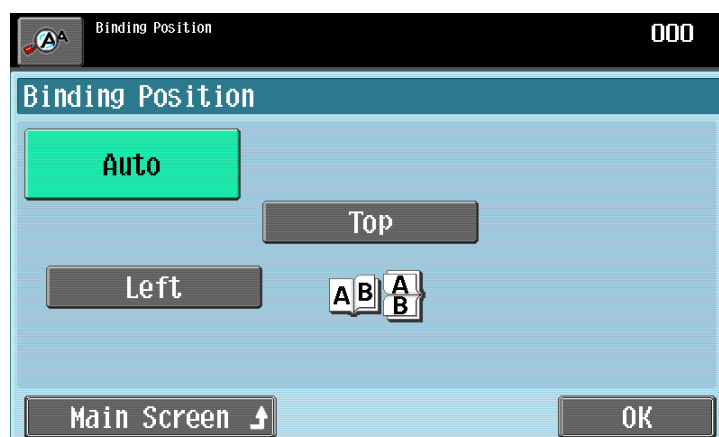

4 Touch [Close], and then touch [OK] in the next screen that appears. Otherwise, touch [Main Screen].

3.4 Using a program

"Program" refers to the set of destinations and scan settings that are registered together. These are convenient for frequently sending transmissions with the same settings. The following procedure describes how to send data by selecting a program that has been registered in advance.



Note

If no destinations are registered with programs, destinations cannot be selected. For details on registering programs, refer to the User's Guide [Network Scan/Fax/Network Fax Operations].

- 1 With the Fax/Scan mode screen displayed, press the [Mode Memory] key.

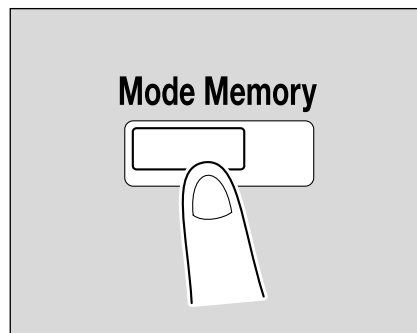

The Recall Scan/Fax Program screen appears.

- 2 Touch the button for the desired program.



- Touch [Page List] to select the page of programs to be displayed.
- Touch [←Previous Page] or [Next Page→] to display the previous or next page of programs.
- To scroll through the page, touch [↑] or [↓].

- To cancel the setting, touch the button again to deselect it.
- Only one program can be selected.

3

Touch [OK] or [Main Screen].

- To specify multiple destinations, add a destination. For details, refer to ["Specifying a destination" on page 3-4](#).

3.5 Checking the destinations

The specified destinations can be checked. In addition, destinations can be removed or their information can be checked.

- 1 In the Fax/Scan mode screen, touch [Dest. Settings].



The Destination Settings screen appears, and the specified destinations can be checked.

- 2 Select the desired destination from the list of destinations.



- To return to the Address Book screen, touch [Main Screen].

- 3** Touch [Details], and then check the destination details.

Address Details		No. 001	
Type	E-Mail Addr.	No.	E0001
Name	tokyo		
Destination	tokyo@test.local		
Main Screen		Close	

- To delete a destination, select a destination, and then touch [Delete] to display a message requesting confirmation to delete the destination.

⚠ Do you want to delete this destination?

No.	E0001
Type	E-Mail Addr.
Name	tokyo
Destination	tokyo@test.local

Yes No OK

- 4** Touch [Close].



4

Logging on and logging off

4 Logging on and logging off

4.1 When a logon screen appears



Note

For details, refer to the User's Guide [Copy Operations].

4.1.1 When the screen to enter the user name appears

If the message "Enter User Name and password, and then touch [Login] or press the [Access] key." appears, user authentication settings have been specified on this machine.

If user authentication settings have been applied, this machine can only be used by users who enter their user name and password. When the following screen appears, type in the user name and password.

For a user name and password, contact the machine's administrator.

1

Touch [User Name].

- The screen that appears differs depending on the Authentication method settings in the Administrator Settings.
- If an authentication unit (biometric type) has been installed, place your finger on the authentication unit (biometric type) to display the Basic screen. For details on performing authentication using the authentication unit (biometric type) and registering information, refer to the User's Guide [Copy Operations] or the manual included with the authentication unit (biometric type).

- If the authentication unit (IC card type) has been installed, place the IC card on the authentication unit (IC card type) to complete authentication and display the Basic screen. For details on performing authentication using the authentication unit (IC card type) and registering information, refer to the User's Guide [Copy Operations] or the manual included with the authentication unit (IC card type).
- If [User Name List] appears, the desired user name can be selected from the list. Touch [User Name List], touch the button for the desired user name to select it, and then touch [OK]. Continue with step 3.
- If "Public User Access" on the General Settings screen is set to "Allow", users with no access to a user name and password can touch [Public User Access] to use this machine.
- If external server authentication was selected as the user authentication method, [Server Name] appears. Touch [Server Name], and then select the desired server.

2

Using the control panel keypad or the keyboard that appears in the touch panel, type in the user name, and then touch [OK].



- Touch [Shift] to change the characters that are displayed.
- To change a character in the entered text, touch [←] and [→] to move the cursor to the character to be changed, touch [Delete], and then type in the desired letter or number.
- To clear all entered text, press the [C] (clear) key.
- To revert to the previously entered text, touch [Undo].

3 Touch [Password].



- 4 Using the control panel keypad or the keyboard that appears in the touch panel, type in the password, and then touch [OK].
- To return to the main screen without changing the settings, touch [Cancel].

5 Touch [Login] or press the [Access] key.

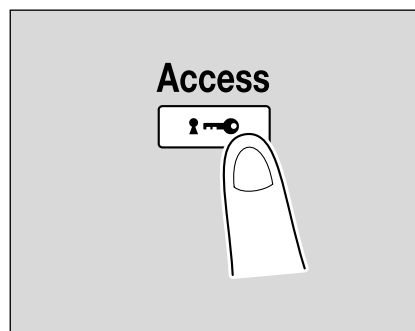

- If account track settings have been applied in Administrator mode, the account track screen appears. However, if "Synchronize User Authentication & Account Track" in Administrator mode has been set to "Synchronize", the account track screen does not appear if the users and accounts are synchronized.

The Basic screen appears.

- 6** When you are finished performing the desired operations, press the [Access] key.

A message appears, requesting confirmation to log off.

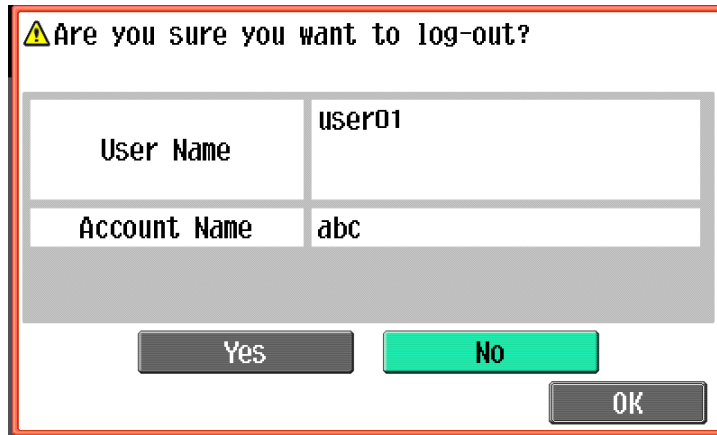

- 7** Touch [Yes], and then touch [OK].

The main screen appears again.

4.1.2 When the screen to enter the account name and password appears

If the message "Enter Account Name and password, and then touch [Login] or press the [Access] key." appears, account track settings have been specified on this machine.

If account track settings have been applied, this machine can only be used by users who enter their account name and password. When the following screen appears, type in the account name and password.

For an account name and password, contact the machine's administrator.



Detail

If "Account Track Input Method" in Administrator mode was set to "Password Only", log on is possible by only entering the password. For details, refer to the User's Guide [Copy Operations].

1 Touch [Account Name].

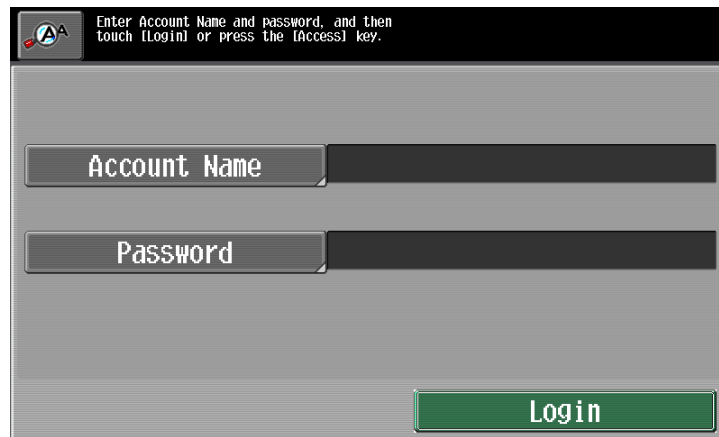

- The screen that appears differs depending on the Authentication method settings in the Administrator Settings.

2 Using the control panel keypad or the keyboard that appears in the touch panel, type in the account name, and then touch [OK].



- Touch [Shift] to change the characters that are displayed.
- To change a character in the entered text, touch [←] and [→] to move the cursor to the character to be changed, touch [Delete], and then type in the desired letter or number.
- To clear all entered text, press the [C] (clear) key.
- To revert to the previously entered text, touch [Undo].

3 Touch [Password].

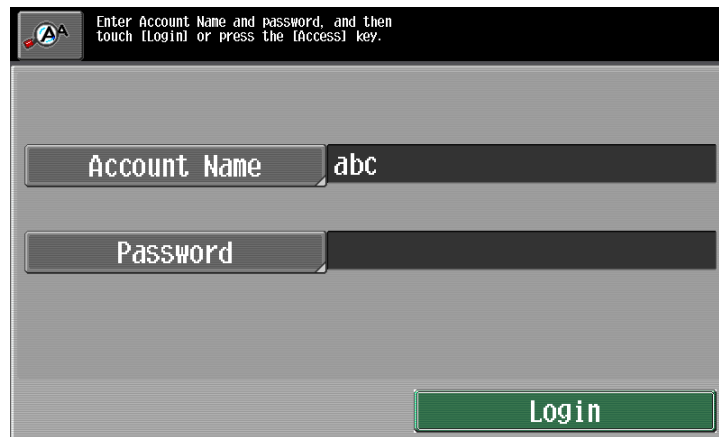

- 4 Using the control panel keypad or the keyboard that appears in the touch panel, type in the password, and then touch [OK].
- To return to the main screen without changing the settings, touch [Cancel].

5 Touch [Login] or press the [Access] key.

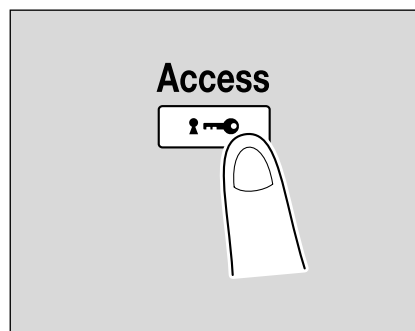

The Basic screen appears.

- 6** When you are finished performing the desired operations, press the [Access] key.

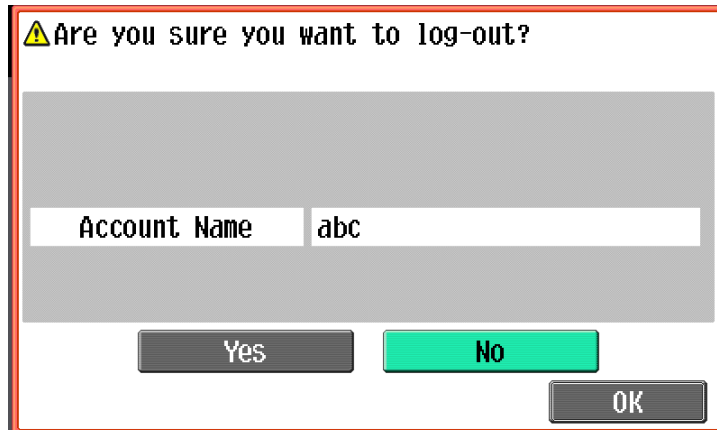

A message appears, requesting confirmation to log off.

- 7** Touch [Yes], and then touch [OK].
- The original screen appears again. The screen that appears differs depending on the Administrator mode settings that have been specified.



KONICA MINOLTA

<http://konicaminolta.com>