



www.lg.com

43UK6300PUE	55UK6300BUB	65UK6200PUA
43UK6300BUB	65UK6300PUE	43UK6090PUA
49UK6300PUE	65UK6300BUB	49UK6090PUA
49UK6300BUB	43UK6200PUA	50UK6090PUA
50UK6300PUE	49UK6200PUA	55UK6090PUA
50UK6300BUB	55UK6200PUA	60UK6090PUA
55UK6300PUE	60UK6200PUA	65UK6090PUA

ENGLISH

Easy Setup Guide

Please read this manual carefully before operating your set and retain it for future reference.

ESPAÑOL

Guía Rápida de Configuración

Lea atentamente este manual antes de poner en marcha el equipo y consérvelo para futuras consultas.

FRANÇAIS

Guide de configuration rapide

Avant d'utiliser l'appareil, veuillez lire attentivement ce manuel et le conserver pour pouvoir vous y reporter ultérieurement.



(1901-REV04)
Printed in Korea

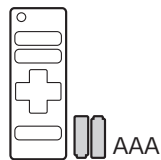
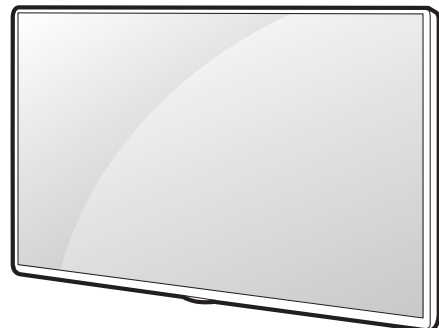

a
X 2
(M4 X L16)

X 4
(M4 X L16)

b
X 6
(M4 X L20)

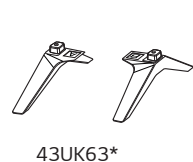

43UK63*

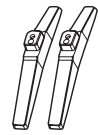

43UK62*
43UK60*

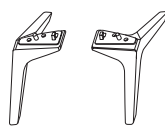

49/50/55/65UK63*
49/55/60/65UK62*
49/50/55/60/65UK60*

ENGLISH Read **Safety and Reference.**

ESPAÑOL Leer **Seguridad y Consultas.**

FRANÇAIS Lisez **Sécurité et références.**



43UK62*, 43UK60*

1

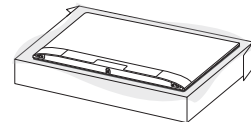

2

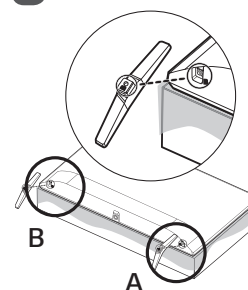

3

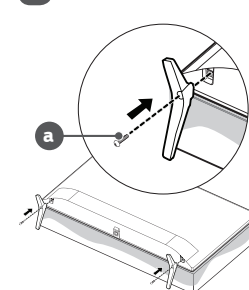

4

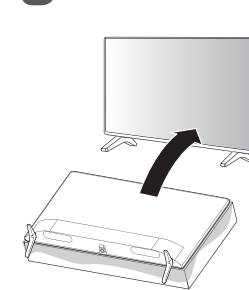

5

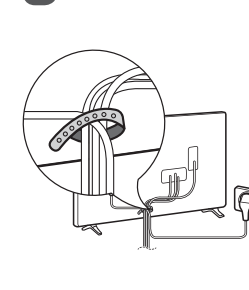

43UK63*

1

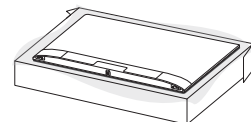

2

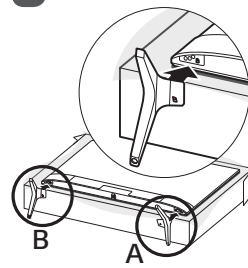

3

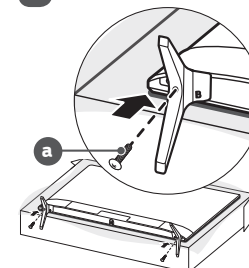

4

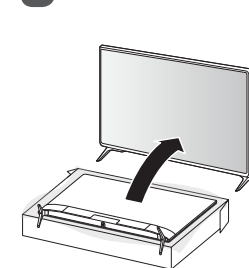

5

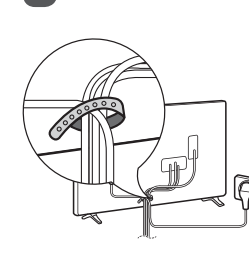

49/50/55/65UK63*, 49/55/60/65UK62*, 49/50/55/60/65UK60*

1

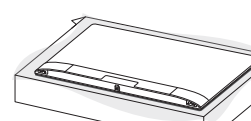

2

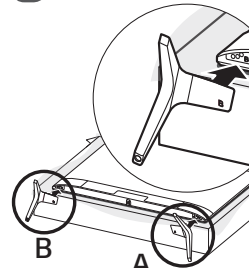

3

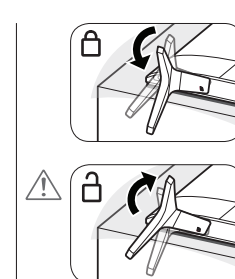
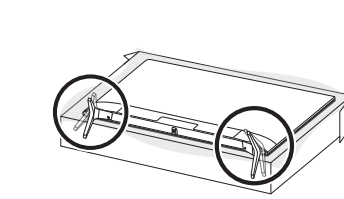

4-A 49/50/55UK63*, 49/55UK62*
49/50/55UK60*

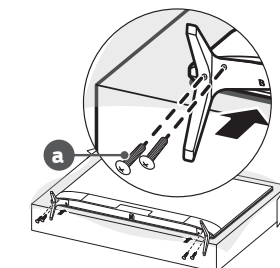

4-B 65UK63*, 60/65UK62*
60/65UK60*

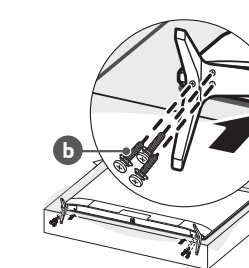

5

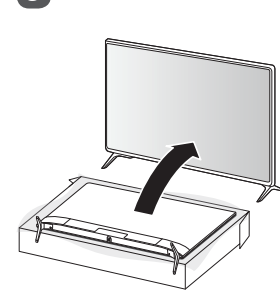

6

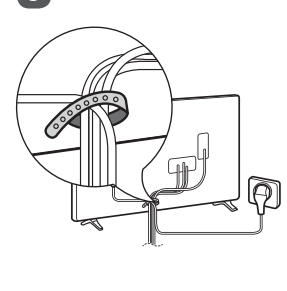

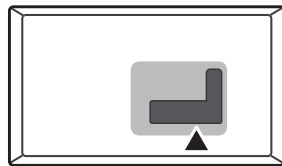

www.lg.com/us/support

ENGLISH
Easy TV Connect Guide (Animation)
ESPAÑOL
Guía Rápida de Conexión del
televisor
(Sólo en Inglés)
FRANÇAIS
Guide simplifié pour la connexion
du téléviseur
(Offert en anglais seulement)

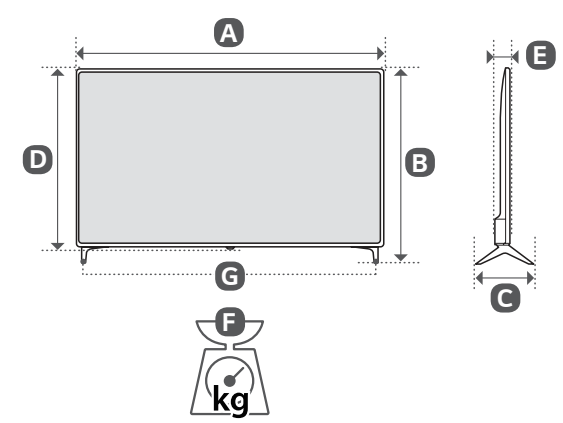
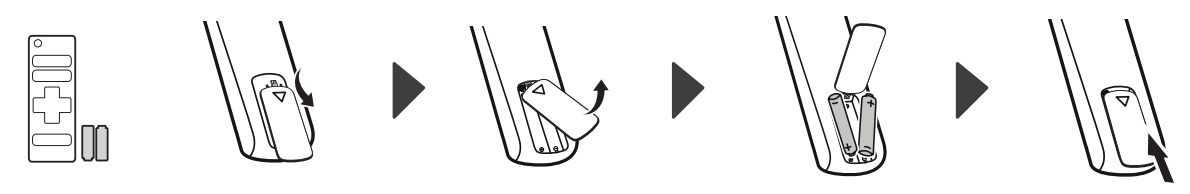
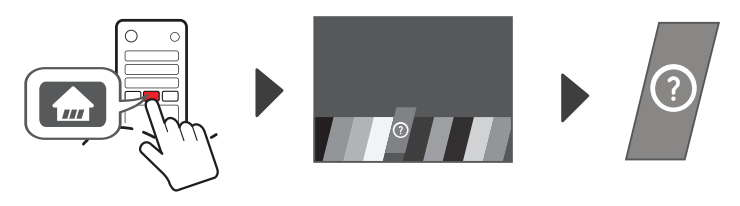
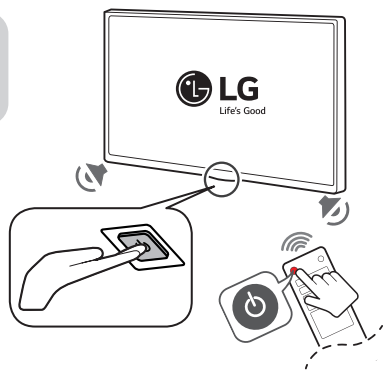
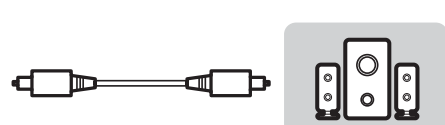
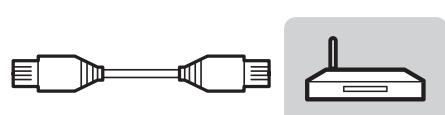
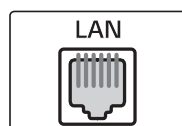
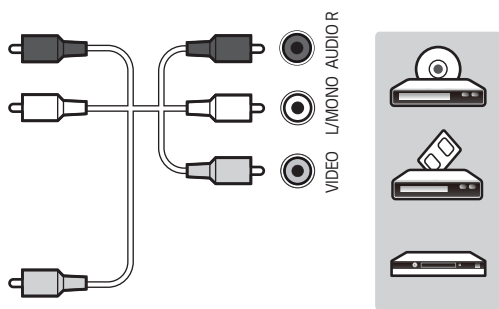
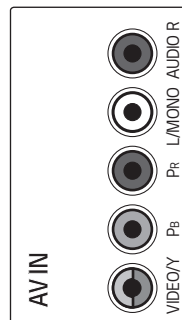
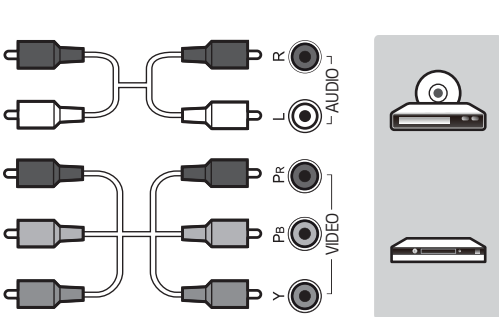
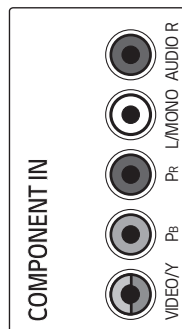
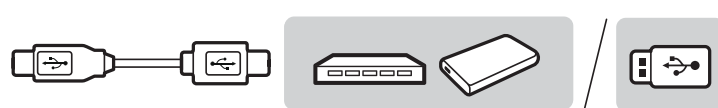
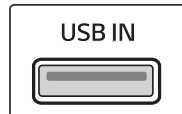
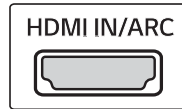
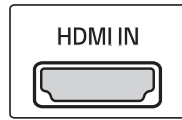
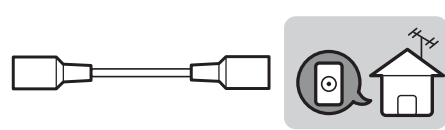
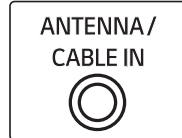

A B C D E : mm (inches / pulgadas / po)
F G : kg (lbs / libras / lb)

MODELS MODELOS MODÈLES	A		B		C		D		E		F		F - G		Power consumption
	Consumo de potencia														
	Consommation électrique														
43UK6300PUE 43UK6300BUB	977 (38.4)	977 (38.4)	629 (24.7)	629 (24.7)	216 (8.5)	216 (8.5)	575 (22.6)	575 (22.6)	80.8 (3.1)	80.8 (3.1)	8.4 (18.5)	8.4 (18.5)	8.3 (18.2)	8.3 (18.2)	95 W
49UK6300PUE 49UK6300BUB	1,110 (43.7)	1 110 (43.7)	709 (27.9)	709 (27.9)	231 (9)	231 (9)	650 (25.5)	650 (25.5)	81.1 (3.1)	81.1 (3.1)	11.3 (24.9)	11.3 (24.9)	11.1 (24.4)	11.1 (24.4)	120 W
50UK6300PUE 50UK6300BUB	1,133 (44.6)	1 133 (44.6)	723 (28.4)	723 (28.4)	231 (9)	231 (9)	663 (26.1)	663 (26.1)	87.9 (3.4)	87.9 (3.4)	10.8 (23.8)	10.8 (23.8)	10.6 (23.3)	10.6 (23.3)	130 W
55UK6300PUE 55UK6300BUB	1,247 (49)	1 247 (49)	785 (30.9)	785 (30.9)	231 (9)	231 (9)	729 (28.7)	729 (28.7)	88.6 (3.4)	88.6 (3.4)	13.9 (30.6)	13.9 (30.6)	13.7 (30.2)	13.7 (30.2)	135 W
65UK6300PUE 65UK6300BUB	1,468 (57.7)	1 468 (57.7)	917 (36.1)	917 (36.1)	269 (10.5)	269 (10.5)	854 (33.6)	854 (33.6)	89.9 (3.5)	89.9 (3.5)	21.4 (47.1)	21.4 (47.1)	21.0 (46.2)	21.0 (46.2)	190 W
43UK6200PUA	975 (38.3)	975 (38.3)	615 (24.2)	615 (24.2)	188 (7.4)	188 (7.4)	574 (22.5)	574 (22.5)	80.3 (3.1)	80.3 (3.1)	8.4 (18.5)	8.4 (18.5)	8.3 (18.2)	8.3 (18.2)	95 W
49UK6200PUA	1,108 (43.6)	1 108 (43.6)	705 (27.7)	705 (27.7)	235 (9.2)	235 (9.2)	649 (25.5)	649 (25.5)	79.5 (3.1)	79.5 (3.1)	11.0 (24.2)	11.0 (24.2)	10.9 (24)	10.9 (24)	120 W
55UK6200PUA	1,247 (49)	1 247 (49)	783 (30.8)	783 (30.8)	235 (9.2)	235 (9.2)	728 (28.6)	728 (28.6)	88.3 (3.4)	88.3 (3.4)	13.3 (29.3)	13.3 (29.3)	13.2 (29.1)	13.2 (29.1)	135 W
60UK6200PUA 60UK6090PUA	1,368 (53.8)	1 368 (53.8)	857 (33.7)	857 (33.7)	255 (10)	255 (10)	796 (31.3)	796 (31.3)	89.1 (3.5)	89.1 (3.5)	19.6 (43.2)	19.6 (43.2)	19.4 (42.7)	19.4 (42.7)	205 W
65UK6200PUA	1,468 (57.7)	1 468 (57.7)	913 (35.9)	913 (35.9)	255 (10)	255 (10)	854 (33.6)	854 (33.6)	89.9 (3.5)	89.9 (3.5)	21.2 (46.7)	21.2 (46.7)	21.0 (46.2)	21.0 (46.2)	165 W
43UK6090PUA	977 (38.4)	977 (38.4)	615 (24.2)	615 (24.2)	187 (7.3)	187 (7.3)	575 (22.6)	575 (22.6)	80.8 (3.1)	80.8 (3.1)	8.4 (18.5)	8.4 (18.5)	8.3 (18.2)	8.3 (18.2)	95 W
49UK6090PUA	1,110 (43.7)	1 110 (43.7)	705 (27.7)	705 (27.7)	235 (9.2)	235 (9.2)	650 (25.5)	650 (25.5)	81.1 (3.1)	81.1 (3.1)	11.3 (24.9)	11.3 (24.9)	11.1 (24.4)	11.1 (24.4)	120 W
50UK6090PUA	1,133 (44.6)	1 133 (44.6)	716 (28.1)	716 (28.1)	235 (9.2)	235 (9.2)	663 (26.1)	663 (26.1)	87.9 (3.4)	87.9 (3.4)	10.8 (23.8)	10.8 (23.8)	10.7 (23.5)	10.7 (23.5)	130 W
55UK6090PUA	1,247 (49)	1 247 (49)	780 (30.7)	780 (30.7)	235 (9.2)	235 (9.2)	729 (28.7)	729 (28.7)	88.6 (3.4)	88.6 (3.4)	13.8 (30.4)	13.8 (30.4)	13.7 (30.2)	13.7 (30.2)	135 W
65UK6090PUA	1,468 (57.7)	1 468 (57.7)	913 (35.9)	913 (35.9)	255 (10)	255 (10)	854 (33.6)	854 (33.6)	89.9 (3.5)	89.9 (3.5)	21.2 (46.7)	21.2 (46.7)	21.0 (46.2)	21.0 (46.2)	190 W

Power requirement / Alimentación requerida / Alimentation

AC 100-240 V ~ 50 / 60 Hz