

ThinkPad

User Guide

ThinkPad Edge E431 and E531

Notes: Before using this information and the product it supports, be sure to read and understand the following:

- *Safety, Warranty, and Setup Guide*
- *Regulatory Notice*
- “Important safety information” on page vi
- Appendix D “Notices” on page 161

The *Safety, Warranty, and Setup Guide* and the *Regulatory Notice* have been uploaded to the Web site. To refer to them, go to <http://www.lenovo.com/ThinkPadUserGuides> and click **User Guides & Manuals**, then follow the instructions on the screen.

First Edition (April 2013)

© Copyright Lenovo 2013.

LIMITED AND RESTRICTED RIGHTS NOTICE: If data or software is delivered pursuant a General Services Administration “GSA” contract, use, reproduction, or disclosure is subject to restrictions set forth in Contract No. GS-35F-05925.

Contents

Read this first	v	Presentations and multimedia.	39
Important safety information	vi	Changing display settings	39
Conditions that require immediate action	vii	Using an external monitor	39
Safety guidelines	vii	Using a projector	41
		Using the Extend desktop function	41
Chapter 1. Product overview	1	Using audio features	42
Locating computer controls, connectors, and indicators.	1	Using the integrated camera	42
Front view	1	Using the optical drive	43
Right-side view.	5	Using a flash media card.	43
Left-side view	6	Inserting a flash media card.	43
Bottom view	9	Removing a flash media card	44
Rear view	10		
Status indicators	10	Chapter 3. You and your computer	45
Locating important product information	12	Accessibility and comfort	45
Machine type and model label.	12	Ergonomic information.	45
FCC ID and IC Certification number label	12	Comfort	46
Certificate of Authenticity label	13	Accessibility information	46
Features	13	Traveling with your computer	47
Specifications	15	Travel tips.	47
Operating environment	15	Travel accessories	47
Lenovo programs	16		
Accessing Lenovo programs on the Windows 7 operating system	16	Chapter 4. Security	49
Accessing Lenovo programs on the Windows 8 operating system	18	Attaching a mechanical lock	49
An introduction to Lenovo programs	18	Using passwords.	49
		Passwords and sleep mode.	49
		Typing passwords	49
		Power-on password	50
		Hard disk passwords	50
		Supervisor password	52
		Hard disk security	54
		Using the fingerprint reader.	54
		Notice on deleting data from your hard disk drive or solid-state drive	56
		Using firewalls	57
		Protecting data against viruses	57
Chapter 2. Using your computer	21	Chapter 5. Recovery overview	59
Registering your computer	21	Recovery overview for Windows 7 models.	59
Frequently asked questions	21	Creating and using a recovery media	59
Using the multi-touch screen	23	Performing backup and recovery operations	60
Special keys	25	Using the OneKey Recovery Pro workspace	61
ThinkPad Edge E431 special keys	25	Creating and using a rescue medium	62
ThinkPad Edge E531 special keys	27	Reinstalling preinstalled programs and device drivers	63
Using the ThinkPad pointing device	29	Solving recovery problems	63
Power management	30	Recovery overview for Windows 8 models.	64
Checking the battery status.	30		
Using the ac power adapter.	31		
Charging the battery	31		
Maximizing the battery life	32		
Managing the power plans	32		
Power-saving modes	32		
Handling the battery.	34		
Connecting to the network	35		
Ethernet connections	35		
Wireless connections	36		

Chapter 6. Replacing devices 67

Static electricity prevention 67
Replacing the battery 67
Replacing the SIM card 69
Replacing the keyboard 70
 ThinkPad Edge E431 70
 ThinkPad Edge E531 76
Replacing the hard disk drive or solid-state drive 82
Replacing the optical drive 85
 ThinkPad Edge E431 85
 ThinkPad Edge E531 87
Replacing a wireless LAN card 89
Replacing a wireless WAN card 92
Replacing a memory module 94
Replacing the backup battery 96

Chapter 7. Advanced configuration 101

Installing a new operating system 101
 Before you begin 101
 Installing the Windows 7 operating system 102
 Installing the Windows 8 operating system 103
Installing device drivers 103
 Installing the driver for the 4-in-1 media card reader 103
 Installing the driver for USB 3.0 on the Windows 7 operating system 104
 Installing the ThinkPad monitor file for Windows 2000/XP/Vista/7 on the Windows 7 operating system 104
 Installing other drivers and software on the Windows 7 operating system 104
ThinkPad Setup 105
 Main menu 105
 Config menu. 106
 Date/Time menu 109
 Security menu 110
 Startup menu 114
 Restart menu 117
 Updating your system UEFI BIOS 117

Chapter 8. Preventing problems 119

General tips for preventing problems 119
Making sure device drivers are current 120
Taking care of your computer 121
 Cleaning the cover of your computer 122

Chapter 9. Troubleshooting computer problems 125

Diagnosing problems 125
Troubleshooting 125
 Computer stops responding 125

Spills on the keyboard 126
Error messages 126
Errors without messages 128
Beep errors 129
Memory module problems 130
Networking problems 130
Problems with the keyboard and other pointing devices. 132
Problems with the display and multimedia devices. 133
Fingerprint reader problems. 138
Battery and power problems 138
Problems with drives and other storage devices. 141
A software problem 142
A USB problem 143

Chapter 10. Getting support 145

Before you contact Lenovo 145
Getting help and service 146
 Using diagnostic programs 146
 Lenovo Support Web site. 146
 Calling Lenovo 146
 Finding ThinkPad options 147
Purchasing additional services 148

Appendix A. Regulatory information 149

Wireless related information 149
 Location of the UltraConnect wireless antennas 150
 Locating wireless regulatory notices 151
Export classification notice 151
Electronic emission notices. 151
 Federal Communications Commission Declaration of Conformity 151
 Industry Canada Class B emission compliance statement 152
 European Union - Compliance to the Electromagnetic Compatibility Directive 152
 German Class B compliance statement 152
 Korea Class B compliance statement 153
 Japan VCCI Class B compliance statement 153
 Japan compliance statement for products which connect to the power mains with rated current less than or equal to 20 A per phase 153
 Lenovo product service information for Taiwan 153

Appendix B. WEEE and recycling statements 155

Important WEEE information 155

Japan recycling statements	155
Recycling information for Brazil	156
Battery recycling information for the European Union	156
Battery recycling information for Taiwan.	157
Battery recycling information for the United States and Canada.	157
Recycling information for China	157

Appendix C. ENERGY STAR model information 159

Appendix D. Notices.	161
Trademarks	162

Appendix E. Restriction of Hazardous Substances Directive (RoHS) 163

European Union RoHS	163
China RoHS.	163
Turkish RoHS	163
Ukraine RoHS	164
India RoHS	164

Read this first

Be sure to follow the important tips given here to get the most use and enjoyment out of your computer. Failure to do so might lead to discomfort or injury, or cause your computer to fail.

Protect yourself from the heat that your computer generates.



When your computer is turned on or the battery is charging, the base, the palm rest, and some other parts may become hot. The temperature they reach depends on the amount of system activity and the level of charge in the battery.

Extended contact with your body, even through clothing, could cause discomfort or even a skin burn.

- Avoid keeping your hands, your lap, or any other part of your body in contact with a hot section of the computer for any extended time.
- Periodically take hands from using the keyboard by lifting your hands from the palm rest.

Protect yourself from the heat generated by the ac power adapter.



When the ac power adapter is connected to an electrical outlet and your computer, it generates heat.

Extended contact with your body, even through clothing, may cause a skin burn.

- Do not place the ac power adapter in contact with any part of your body while it is in use.
- Never use it to warm your body.

Prevent your computer from getting wet.



To avoid spills and the danger of electrical shock, keep liquids away from your computer.

Protect the cables from being damaged.

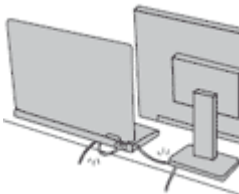

Applying strong force to cables may damage or break them.

Route communication lines, or the cables of an ac power adapter, a mouse, a keyboard, a printer, or any other electronic device, so that they cannot be walked on, tripped over, pinched by your computer or other objects, or in any way subjected to treatment that could interfere with the operation of your computer.

Protect your computer and data when moving it.



Before moving a computer equipped with a hard disk drive, do one of the following, and make sure that the power switch is off or is blinking:

- Turn it off.
- Put it in sleep mode.
- Put it in hibernation mode.

This will help to prevent damage to the computer, and possible loss of data.

Handle your computer gently.



Do not drop, bump, scratch, twist, hit, vibrate, push, or place heavy objects on your computer, display, or external devices.

Carry your computer carefully.



- Use a quality carrying case that provides adequate cushioning and protection.
- Do not pack your computer in a tightly packed suitcase or bag.
- Before putting your computer in a carrying case, make sure that it is off, in sleep mode, or in hibernation mode. Do not put a computer in a carrying case while it is turned on.

Important safety information

Note: Read the important safety information first.

This information can help you safely use your notebook computer. Follow and retain all information included with your computer. The information in this document does not alter the terms of your purchase agreement or the Lenovo® Limited Warranty. For more information, see “Warranty Information” in the *Safety, Warranty, and Setup Guide* that comes with your computer.

Customer safety is important. Our products are developed to be safe and effective. However, personal computers are electronic devices. Power cords, power adapters, and other features can create potential safety risks that can result in physical injury or property damage, especially if misused. To reduce these risks, follow the instructions included with your product, observe all warnings on the product and in the operating instructions, and review the information included in this document carefully. By carefully following the information contained in this document and provided with your product, you can help protect yourself from hazards and create a safer computer work environment.

Note: This information includes references to power adapters and batteries. In addition to notebook computers, some products (such as speakers and monitors) ship with external power adapters. If you have such a product, this information applies to your product. In addition, computer products contain a coin-sized internal battery that provides power to the system clock even when the computer is unplugged, so the battery safety information applies to all computer products.

Conditions that require immediate action

Products can become damaged due to misuse or neglect. Some product damage is serious enough that the product should not be used again until it has been inspected and, if necessary, repaired by an authorized servicer.

As with any electronic device, pay close attention to the product when it is turned on. On very rare occasions, you might notice an odor or see a puff of smoke or sparks vent from your product. Or you might hear sounds like popping, cracking or hissing. These conditions might merely mean that an internal electronic component has failed in a safe and controlled manner. Or, they might indicate a potential safety issue. However, do not take risks or attempt to diagnose the situation yourself. Contact the Customer Support Center for further guidance. For a list of Service and Support phone numbers, see the following Web site:
<http://www.lenovo.com/support/phone>

Frequently inspect your computer and its components for damage or wear or signs of danger. If you have any question about the condition of a component, do not use the product. Contact the Customer Support Center or the product manufacturer for instructions on how to inspect the product and have it repaired, if necessary.

In the unlikely event that you notice any of the following conditions, or if you have any safety concerns with your product, stop using the product and unplug it from the power source and telecommunication lines until you can speak to the Customer Support Center for further guidance.

- Power cords, plugs, power adapters, extension cords, surge protectors, or power supplies that are cracked, broken, or damaged.
- Signs of overheating, smoke, sparks, or fire.
- Damage to a battery (such as cracks, dents, or creases), discharge from a battery, or a buildup of foreign substances on the battery.
- A cracking, hissing or popping sound, or strong odor that comes from the product.
- Signs that liquid has been spilled or an object has fallen onto the computer product, the power cord or power adapter.
- The computer product, power cord, or power adapter has been exposed to water.
- The product has been dropped or damaged in any way.
- The product does not operate normally when you follow the operating instructions.

Note: If you notice these conditions with a product (such as an extension cord) that is not manufactured for or by Lenovo, stop using that product until you can contact the product manufacturer for further instructions, or until you get a suitable replacement.

Safety guidelines

Always observe the following precautions to reduce the risk of injury and property damage.

Service and upgrades

Do not attempt to service a product yourself unless instructed to do so by the Customer Support Center or your documentation. Only use a Service Provider who is approved to repair your particular product.

Note: Some computer parts can be upgraded or replaced by the customer. Upgrades typically are referred to as options. Replacement parts approved for customer installation are referred to as Customer Replaceable Units, or CRUs. Lenovo provides documentation with instructions when it is appropriate for customers to install options or replace CRUs. You must closely follow all instructions when installing or replacing parts. The Off state of a power indicator does not necessarily mean that voltage levels inside a product are zero. Before you remove the covers from a product equipped with a power cord, always make

sure that the power is turned off and that the product is unplugged from any power source. If you have any questions or concerns, contact the Customer Support Center.

Although there are no moving parts in your computer after the power cord has been disconnected, the following warnings are required for your safety.

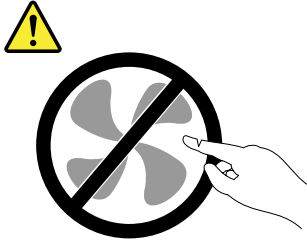

CAUTION:
Hazardous moving parts. Keep fingers and other body parts away.

CAUTION:



Before replacing any CRUs, turn off the computer and wait three to five minutes to let the computer cool before opening the cover.

Power cords and power adapters



Use only the power cords and power adapters supplied by the product manufacturer.

The power cords shall be safety approved. For Germany, it shall be H05VV-F, 3G, 0.75 mm², or better. For other countries, the suitable types shall be used accordingly.

Never wrap a power cord around a power adapter or other object. Doing so can stress the cord in ways that can cause the cord to fray, crack, or crimp. This can present a safety hazard.

Always route power cords so that they will not be walked on, tripped over, or pinched by objects.

Protect power cords and power adapters from liquids. For instance, do not leave your power cord or power adapter near sinks, tubs, toilets, or on floors that are cleaned with liquid cleansers. Liquids can cause a short circuit, particularly if the power cord or power adapter has been stressed by misuse. Liquids also can cause gradual corrosion of power cord terminals and/or the connector terminals on a power adapter, which can eventually result in overheating.

Always connect power cords and signal cables in the correct order and ensure that all power cord connectors are securely and completely plugged into receptacles.

Do not use any power adapter that shows corrosion at the ac input pins or shows signs of overheating (such as deformed plastic) at the ac input pins or anywhere on the power adapter.

Do not use any power cords where the electrical contacts on either end show signs of corrosion or overheating or where the power cord appears to have been damaged in any way.

Extension cords and related devices

Ensure that extension cords, surge protectors, uninterruptible power supplies, and power strips that you use are rated to handle the electrical requirements of the product. Never overload these devices. If power strips are used, the load should not exceed the power strip input rating. Consult an electrician for more information if you have questions about power loads, power requirements, and input ratings.

Plugs and outlets



If a receptacle (power outlet) that you intend to use with your computer equipment appears to be damaged or corroded, do not use the outlet until it is replaced by a qualified electrician.

Do not bend or modify the plug. If the plug is damaged, contact the manufacturer to obtain a replacement.

Do not share an electrical outlet with other home or commercial appliances that draw large amounts of electricity; otherwise, unstable voltage might damage your computer, data, or attached devices.

Some products are equipped with a three-pronged plug. This plug fits only into a grounded electrical outlet. This is a safety feature. Do not defeat this safety feature by trying to insert it into a non-grounded outlet. If you cannot insert the plug into the outlet, contact an electrician for an approved outlet adapter or to replace the outlet with one that enables this safety feature. Never overload an electrical outlet. The overall system load should not exceed 80 percent of the branch circuit rating. Consult an electrician for more information if you have questions about power loads and branch circuit ratings.

Be sure that the power outlet you are using is properly wired, easily accessible, and located close to the equipment. Do not fully extend power cords in a way that will stress the cords.

Be sure that the power outlet provides the correct voltage and current for the product you are installing.

Carefully connect and disconnect the equipment from the electrical outlet.

Power supply statement



Never remove the cover on a power supply or any part that has the following label attached.



Hazardous voltage, current, and energy levels are present inside any component that has this label attached. There are no serviceable parts inside these components. If you suspect a problem with one of these parts, contact a service technician.

External devices

CAUTION:

Do not connect or disconnect any external device cables other than USB and 1394 cables while the computer power is on; otherwise, you might damage your computer. To avoid possible damage to attached devices, wait at least five seconds after the computer is shut down to disconnect external devices.

General battery notice



DANGER

Personal computers manufactured by Lenovo contain a coin cell battery to provide power to the system clock. In addition, many mobile products, such as notebook computers, utilize a rechargeable battery pack to provide system power when in portable mode. Batteries supplied by Lenovo for use with your product have been tested for compatibility and should only be replaced with approved parts.

Never attempt to open or service any battery. Do not crush, puncture, or incinerate batteries or short circuit the metal contacts. Do not expose the battery to water or other liquids. Only recharge the battery pack strictly according to instructions included in the product documentation.

Battery abuse or mishandling can cause the battery to overheat, which can cause gasses or flame to “vent” from the battery pack or coin cell. If your battery is damaged, or if you notice any discharge from your battery or the buildup of foreign materials on the battery leads, stop using the battery and obtain a replacement from the battery manufacturer.

Batteries can degrade when they are left unused for long periods of time. For some rechargeable batteries (particularly Lithium Ion batteries), leaving a battery unused in a discharged state could increase the risk of a battery short circuit, which could shorten the life of the battery and also can pose a safety hazard. Do not let rechargeable Lithium-Ion batteries completely discharge or store these batteries in a discharged state.

Rechargeable battery notice



DANGER

Do not attempt to disassemble or modify the battery pack. Attempting to do so can cause an explosion, or liquid leakage from the battery pack. A battery pack other than the one specified by Lenovo, or a disassembled or modified battery pack is not covered by the warranty.

If the rechargeable battery pack is incorrectly replaced, there is danger of an explosion. The battery pack contains a small amount of harmful substances. To avoid possible injury:

- Replace only with a battery of the type recommended by Lenovo.
- Keep the battery pack away from fire.
- Do not expose it to water or rain.
- Do not attempt to disassemble it.
- Do not short-circuit it.
- Keep it away from children.
- Do not drop the battery pack.

Do not put the battery pack in trash that is disposed of in landfills. When disposing of the battery, comply with local ordinances or regulations.

The battery pack should be stored at room temperature, charged to approximately 30 to 50% of capacity. We recommend that battery pack be charged about once per year to prevent overdischarge.

Lithium coin cell battery notice



DANGER

Danger of explosion if battery is incorrectly replaced.

When replacing the lithium coin cell battery, use only the same or an equivalent type that is recommended by the manufacturer. The battery contains lithium and can explode if not properly used, handled, or disposed of.

Do not:

- Throw or immerse into water
- Heat to more than 100°C (212°F)
- Repair or disassemble

Dispose of the battery as required by local ordinances or regulations.

The following statement applies to users in the state of California, U.S.A.

California Perchlorate Information:

Products containing manganese dioxide lithium coin cell batteries may contain perchlorate.

Perchlorate Material - special handling may apply, See www.dtsc.ca.gov/hazardouswaste/perchlorate

Heat and product ventilation



DANGER

Computers, ac power adapters, and many accessories can generate heat when turned on and when batteries are charging. Notebook computers can generate a significant amount of heat due to their compact size. Always follow these basic precautions:

- When your computer is turned on or the battery is charging, the base, the palm rest, and some other parts may become hot. Avoid keeping your hands, your lap, or any other part of your body in contact with a hot section of the computer for any extended length of time. When you use the keyboard, avoid keeping your palms on the palm rest for a prolonged period of time. Your computer generates some heat during normal operation. The amount of heat depends on the amount of system activity and the battery charge level. Extended contact with your body, even through clothing, could cause discomfort or even a skin burn. Periodically take breaks from using the keyboard by lifting your hands from the palm rest; and be careful not to use the keyboard for any extended length of time.
- Do not operate your computer or charge the battery near flammable materials or in explosive environments.

- Ventilation slots, fans and/or heat sinks are provided with the product for safety, comfort, and reliable operation. These features might inadvertently become blocked by placing the product on a bed, sofa, carpet, or other flexible surface. Never block, cover, or disable these features.
- When the ac power adapter is connected to an electrical outlet and your computer, it generates heat. Do not place the adapter in contact with any part of your body while using it. Never use the ac power adapter to warm your body. Extended contact with your body, even through clothing, may cause a skin burn.

For your safety, always follow these basic precautions with your computer:

- Keep the cover closed whenever the computer is plugged in.
- Regularly inspect the outside of the computer for dust accumulation.
- Remove dust from vents and any perforations in the bezel. More frequent cleanings might be required for computers in dusty or high-traffic areas.
- Do not restrict or block any ventilation openings.
- Do not operate your computer inside furniture, as this might increase the risk of overheating.
- Airflow temperatures into the computer should not exceed 35°C (95°F).

Electrical current safety information



DANGER

Electric current from power, telephone, and communication cables is hazardous.

To avoid a shock hazard:

- Do not use your computer during a lightning storm.
- Do not connect or disconnect any cables or perform installation, maintenance, or reconfiguration of this product during an electrical storm.
- Connect all power cords to a properly wired and grounded electrical outlet.
- Connect to properly wired outlets any equipment that will be attached to this product.
- Whenever possible, use one hand only to connect or disconnect signal cables.
- Never turn on any equipment when there is evidence of fire, water, or structural damage.
- Disconnect the attached power cords, battery pack, and all the cables before you open the device covers, unless instructed otherwise in the installation and configuration procedures.
- Do not use your computer until all internal parts enclosures are fastened into place. Never use the computer when internal parts and circuits are exposed.



DANGER

Connect and disconnect cables as described in the following procedures when installing, moving, or opening covers on this product or attached devices.

To connect:

1. Turn everything OFF.
2. First, attach all cables to devices.
3. Attach signal cables to connectors.
4. Attach power cords to outlets.
5. Turn devices ON.

To disconnect:

1. Turn everything OFF.
2. First, remove power cords from outlets.
3. Remove signal cables from connectors.
4. Remove all cables from devices.

The power cord must be disconnected from the wall outlet or receptacle before installing all other electrical cables connected to the computer.

The power cord may be reconnected to the wall outlet or receptacle only after all other electrical cables have been connected to the computer.

Laser compliance statement



CAUTION:

When laser products (such as CD-ROMs, DVD drives, fiber optic devices, or transmitters) are installed, note the following:

- Do not remove the covers. Removing the covers of the laser product could result in exposure to hazardous laser radiation. There are no serviceable parts inside the device.
- Use of controls or adjustments or performance of procedures other than those specified herein might result in hazardous radiation exposure.



DANGER

Some laser products contain an embedded Class 3A or Class 3B laser diode. Note the following.

Laser radiation when open. Do not stare into the beam, do not view directly with optical instruments, and avoid direct exposure to the beam.

Liquid crystal display (LCD) notice

CAUTION:

The LCD is made of glass, and rough handling or dropping the computer can cause the LCD to break. If the LCD breaks and the internal fluid gets into your eyes or on your hands, immediately wash the affected areas with water for at least 15 minutes; if any symptoms are present after washing, get medical care.

Note: For products with mercury-containing fluorescent lamps (for example, non-LED), the fluorescent lamp in the liquid crystal display (LCD) contains mercury; dispose of according to local, state, or federal laws.

Using headphones or earphones

If your computer has both a headphone connector and an audio-out connector, always use the headphone connector for headphones (also called a headset) or earphones.

CAUTION:

Excessive sound pressure from earphones and headphones can cause hearing loss. Adjustment of the equalizer to maximum increases the earphone and headphone output voltage and the sound pressure level. Therefore, to protect your hearing, adjust the equalizer to an appropriate level.

Excessive use of headphones or earphones for a long period of time at high volume can be dangerous if the output of the headphone or earphone connectors do not comply with specifications of EN 50332-2. The headphone output connector of your computer complies with EN 50332-2 Sub clause 7. This specification limits the computer's maximum wide band true RMS output voltage to 150 mV. To help protect against hearing loss, ensure that the headphones or earphones you use also comply with EN 50332-2 (Clause 7 limits) for a wide band characteristic voltage of 75 mV. Using headphones that do not comply with EN 50332-2 can be dangerous due to excessive sound pressure levels.

If your Lenovo computer came with headphones or earphones in the package, as a set, the combination of the headphones or earphones and the computer already complies with the specifications of EN 50332-1. If different headphones or earphones are used, ensure that they comply with EN 50332-1 (Clause 6.5 Limitation Values). Using headphones that do not comply with EN 50332-1 can be dangerous due to excessive sound pressure levels.

Additional safety information**DANGER**

Plastic bags can be dangerous. Keep plastic bags away from babies and children to avoid danger of suffocation.

Notice for tablet personal computer users**Safety notice for users in Australia****DANGER**

Do not connect phone line while using tablet mode.

Notice for users in the U.S.A.

Many personal computer products and accessories contain cords, cables or wires, such as power cords or cords to connect the accessory to a personal computer. If this product has such a cord, cable or wire, then the following warning applies:

WARNING: Handling the cord on this product or cords associated with accessories sold with this product will expose you to lead, a chemical known to the State of California to cause cancer, and birth defects or other reproductive harm. ***Wash hands after handling.***

Save these instructions.

Chapter 1. Product overview

This chapter provides information about the locations of connectors, locations of important product labels, computer features, specifications, operating environment, and preinstalled programs.

This chapter contains the following topics:

- “Locating computer controls, connectors, and indicators” on page 1
- “Locating important product information” on page 12
- “Features” on page 13
- “Specifications” on page 15
- “Operating environment” on page 15
- “Lenovo programs” on page 16

Locating computer controls, connectors, and indicators

This section introduces the computer hardware features to give you the basic information you will need to start using the computer.

Front view

ThinkPad Edge E431 front view



Figure 1. ThinkPad Edge E431 front view

1 Built-in microphones	5 Media card reader slot
2 Integrated camera	6 Fingerprint reader

3 TrackPoint® pointing stick	7 Touch pad
4 System status indicator (illuminated ThinkPad® logo)	8 Power button

1 Built-in microphones

The built-in microphones capture sound and voice when used with a program capable of handling audio.

Depending on your model, your computer might come with one microphone.

2 Integrated camera

Your computer has an integrated camera. Use the camera to take pictures or hold a video conference. For details, see “Using the integrated camera” on page 42.

ThinkPad pointing device

3 TrackPoint pointing stick

7 Touch pad

The keyboard contains the ThinkPad pointing device. Pointing, selecting, and dragging are all part of a single process that you can perform without moving your fingers from a typing position. For more information, see “Using the ThinkPad pointing device” on page 29.

4 System status indicator (illuminated ThinkPad logo)

The illuminated ThinkPad logo on the palm rest functions as a system status indicator. For the detailed information about the location and meaning of the indicator, see “Status indicators” on page 10.

5 Media card reader slot

Your computer has a media card reader slot. For more information about the supported cards, see “Using a flash media card” on page 43.

6 Fingerprint reader

Some models have a fingerprint reader. Fingerprint authentication technology provides a simple and secure user access by associating your fingerprint with a password. For details, see “Using the fingerprint reader” on page 54.

8 Power button

Use the power button to turn on the computer.

To turn off the computer, use the **Start** menu shutdown option on the Microsoft® Windows® 7 operating system. For the Windows 8 operating system, move the cursor to the bottom right corner of the screen to bring up the charms. Then click **Settings → Power → Shut down**.

If your computer stops responding and you cannot turn it off, press and hold the power button for four seconds or more. If the computer still is not responding, remove the ac power adapter or the supported ThinkPad OneLink Dock and the battery to reset the computer.

You also can program the power button so that by pressing the power button you can shut down the computer or put it into sleep or hibernation mode. To achieve this, you need to change your power plan settings. To access power plan settings, do the following:

- For Windows 7: Open the Power Manager program and then click **Power Plan** or click **Advanced → Power Plan**. For instructions on how to start the Power Manager program, see “Accessing Lenovo programs on the Windows 7 operating system” on page 16.

- For Windows 8: Click the battery status icon in the Windows notification area, and then click **More power options** → **Choose what the power buttons do**.

ThinkPad Edge E531 front view



Figure 2. ThinkPad Edge E531 front view

1 Built-in microphones	6 Media card reader slot
2 Integrated camera	7 Fingerprint reader
3 TrackPoint pointing stick	8 Touch pad
4 Numeric keypad	9 Power button
5 System status indicator (illuminated ThinkPad logo)	

1 Built-in microphones

The built-in microphones capture sound and voice when used with a program capable of handling audio.

Depending on your model, your computer might come with one microphone.

2 Integrated camera

Your computer has an integrated camera. Use the camera to take pictures or hold a video conference. For more information about how to use the camera, refer to “Using the integrated camera” on page 42.

ThinkPad pointing device

3 TrackPoint pointing stick

8 Touch pad

The keyboard contains the ThinkPad pointing device. Pointing, selecting, and dragging are all part of a single process that you can perform without moving your fingers from a typing position. For more information, see “Using the ThinkPad pointing device” on page 29.

4 Numeric keypad

Your computer has a numeric keypad that can be used to quickly input numbers.

5 System status indicator (illuminated ThinkPad logo)

The illuminated ThinkPad logo on the palm rest functions as a system status indicator. For the detailed information about the location and meaning of the indicator, see “Status indicators” on page 10.

6 Media card reader slot

Your computer might have a media card reader slot. For details, see “Using a flash media card” on page 43.

6 Fingerprint reader

Some models have a fingerprint reader. Fingerprint authentication technology provides a simple and secure user access by associating your fingerprint with a password. For details, see “Using the fingerprint reader” on page 54.

9 Power button

Use the power button to turn on the computer.

To turn off the computer, use the **Start** menu shutdown option on the Windows 7 operating system. For the Windows 8 operating system, move the cursor to the bottom right corner of the screen to bring up the charms. Then click **Settings → Power → Shut down**.

If your computer stops responding and you cannot turn it off, press and hold the power button for four seconds or more. If the computer still is not responding, remove the ac power adapter or the supported ThinkPad OneLink Dock and the battery to reset the computer.

You also can program the power button so that by pressing the power button you can shut down the computer or put it into sleep or hibernation mode. To achieve this, you need to change your power plan settings. To access power plan settings, do the following:

- For Windows 7: Open the Power Manager program and then click **Power Plan** or click **Advanced → Power Plan**. For instructions on how to start the Power Manager program, see “Accessing Lenovo programs on the Windows 7 operating system” on page 16.
- For Windows 8: Click the battery status icon in the Windows notification area, and then click **More power options → Choose what the power buttons do**.

Right-side view

Note: Your computer keyboard might look different from the following illustration.



Figure 3. ThinkPad Edge E431 and E531 right-side view

1 Always On USB connector	4 ac power connector
2 Optical drive	5 Lenovo OneLink connector
3 Ethernet connector	

1 Always On USB connector

By default, the Always On Universal Serial Bus (USB) connector enables you to charge some mobile digital devices and smartphones when your computer is in sleep or hibernation mode.

If you want to charge these devices when your computer is turned off, do the following:

1. Connect the computer to an ac power supply.
2. Go to ThinkPad Setup and enable **Always On USB Charge in off mode**. For more information, see “Config menu” on page 106.
3. Do one of the following:
 - For Windows 7: Open the Power Manager program and click **Global Power Settings** or click **Advanced** → **Global Power Settings**. Then select **Enable Always On USB** and click **OK**.
 - For Windows 8: Press the Windows key to go to the Start screen. Click **Lenovo Settings** → **Power**. Then select **Enable when the computer is off** under **Always On USB**.

2 Optical drive

The optical drive reads optical discs.

3 Ethernet connector

Connect your computer to a local area network (LAN) with the Ethernet connector.



To avoid the risk of electrical shock, do not connect the telephone cable to the Ethernet connector. You can only connect an Ethernet cable to this connector.

Two indicators, to the upper right and left of the connector, show the status of the network connection. When your computer connects to a LAN and a session with the network is available, the upper left indicator is steady green. While data is being transmitted, the upper right indicator blinks yellow.

4 ac power connector

5 Lenovo OneLink connector

When the ac power adapter is connected to the ac power connector, it provides power to the computer and charges the battery. When a supported ThinkPad OneLink Dock is connected to the Lenovo OneLink connector, it can not only extend the computer capabilities but also provide ac power to the computer and charge the battery.

To use the Lenovo OneLink connector, you need to remove the connector cover from the Lenovo OneLink connector first.

Note: Ensure that you keep the connector cover. Reattach it to the Lenovo OneLink connector when you are not using the Lenovo OneLink connector.

Left-side view

ThinkPad Edge E431 left-side view



Figure 4. ThinkPad Edge E431 left-side view

1 Security keyhole	4 USB 3.0 connectors
2 Fan louvers (left)	5 HDMI port
3 VGA connector	6 Combo audio jack

1 Security keyhole

Purchase a security cable lock that fits this keyhole to lock your computer to a stationary object to protect your computer from theft.

2 Fan louvers (left)

The internal fan and louvers enable air to circulate in the computer and cool the central processor.

Note: To avoid impeding airflow, do not place any obstacle in front of the fan.

3 VGA connector

Attach a video graphics array (VGA) compatible monitor or projector to your computer to display the computer output.

4 USB 3.0 connectors

The USB 3.0 connectors are used for connecting devices compatible with a USB interface, such as a USB printer or a digital camera.

Note: When you attach a USB cable to the connector, ensure that the USB mark is facing upward. Otherwise the connector might be damaged.

5 HDMI port

Your computer supports the high-definition multimedia interface (HDMI) port, a digital audio, and video interface that can connect a compatible digital audio device or video monitor, such as an high-definition television (HDTV).

6 Combo audio jack

To listen to the sound from your computer, connect a headphone or a headset that has a 3.5 mm 4-pole plug to the combo audio jack.

Notes:

- If you are using a headset with a function switch, do not press this switch while using the headset. If you press it, the headset microphone will be disabled, and the integrated microphones on the computer will be enabled instead.
- The combo audio jack does not support a conventional microphone. For more information, see “Using audio features” on page 42.

ThinkPad Edge E531 left-side view



Figure 5. ThinkPad Edge E531 left-side view

1 Security keyhole	4 HDMI port
2 Fan louvers (left)	5 USB 3.0 connectors
3 VGA connector	6 Combo audio jack

1 Security keyhole

Purchase a security cable lock that fits this keyhole to lock your computer to a stationary object to protect your computer from theft.

2 Fan louvers (left)

The internal fan and louvers enable air to circulate in the computer and cool the central processor.

Note: To avoid impeding airflow, do not place any obstacle in front of the fan.

3 VGA connector

Attach a VGA compatible monitor or projector to your computer to display the computer output.

4 HDMI port

Your computer supports the HDMI port, a digital audio, and video interface that can connect a compatible digital audio device or video monitor, such as an HDTV.

5 USB 3.0 connectors

The USB 3.0 connectors are used for connecting devices compatible with a USB interface, such as a USB printer or a digital camera.

Note: When you attach a USB cable to the connector, ensure that the USB mark is facing upward. Otherwise the connector might be damaged.

6 Combo audio jack

To listen to the sound from your computer, connect a headphone or a headset that has a 3.5 mm 4-pole plug to the combo audio jack.

Notes:

- If you are using a headset with a function switch, do not press this switch while using the headset. If you press it, the headset microphone will be disabled, and the integrated microphones on the computer will be enabled instead.
- The combo audio jack does not support a conventional microphone. For more information, see “Using audio features” on page 42.

Bottom view

Note: Your computer bottom view might look slightly different from the following illustration.

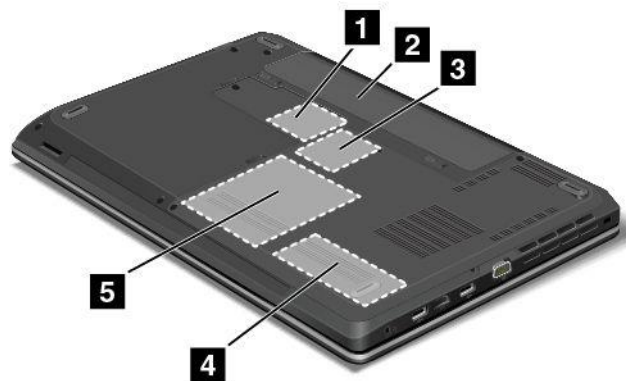

Figure 6. ThinkPad Edge E431 and E531 bottom view

1 PCI Express Mini Card slot for wireless LAN card	4 Memory upgrade slot
2 Battery	5 Hard disk drive or solid-state drive
3 Slot for wireless WAN card or M.2 solid-state drive	

1 PCI Express Mini Card slot for wireless LAN card

Your computer might have a wireless LAN card installed in the PCI Express Mini Card slot for you to establish wireless LAN connections.

2 Battery

Use your computer with battery power whenever ac power is unavailable.

3 Slot for wireless WAN card or M.2 solid-state drive

Your computer might have a wireless wide area network (WAN) card installed in this slot for you to establish wireless WAN connections.

For some models, an M.2 solid-state drive might be installed for data storage instead of a wireless WAN card.

4 Memory-upgrade slot

You can increase the amount of memory in your computer by installing a memory module in the memory-upgrade slot. Memory modules are available as options from Lenovo.

5 Hard disk drive or solid-state drive

Your computer might have a large-capacity, customer-upgradable hard disk drive or solid-state drive that can meet a variety of storage demands.

Note: The hidden service partition is the reason why there is less free space than expected on your hard disk drive or solid-state drive.

Rear view



Figure 7. ThinkPad Edge E431 and E531 rear view

1 Fan louvers (rear)	
-----------------------------	--

1 Fan louvers (rear)

The internal fan and louvers enable air to circulate in the computer and cool the central processor.

Note: To avoid impeding airflow, do not place any obstacle in front of the fan.

Status indicators

Your computer has several status indicators showing the status of your computer.

Note: Your computer keyboard might look different from the following illustration.



1 Fn Lock indicator

The Fn Lock indicator shows the status of Fn Lock function. For more information, see “Special keys ” on page 25.

2 Speaker mute indicator

When the speaker mute indicator is on, the speakers are muted.

3 Microphone mute indicator

When the microphone mute indicator is on, the microphones are muted.

4 Camera status indicator

When the Camera status indicator is on, the camera is in use.

5 6 System status indicators

The illuminated dots in the ThinkPad logo on the outer lid of your computer and on the palm rest show the system status of your computer:

- **Blinks three times:** The computer is initially connected to the power.
- **On:** The computer is in use.
- **Off:** The computer is off or in hibernation mode.
- **Slow blinking:** The computer is entering sleep or hibernation mode.

- **Fast blinking:** The computer is entering hibernation mode.

Locating important product information

This section provides information to help you locate your machine type and model label, FCC ID and IC Certification label, and the Microsoft Certificate of Authenticity (COA) label.

Machine type and model label

The machine type and model label identifies your computer. When you contact Lenovo for help, the machine type and model information helps support technicians to identify your computer and provide faster service.

You can find the machine type and model of your computer on the label as shown below:

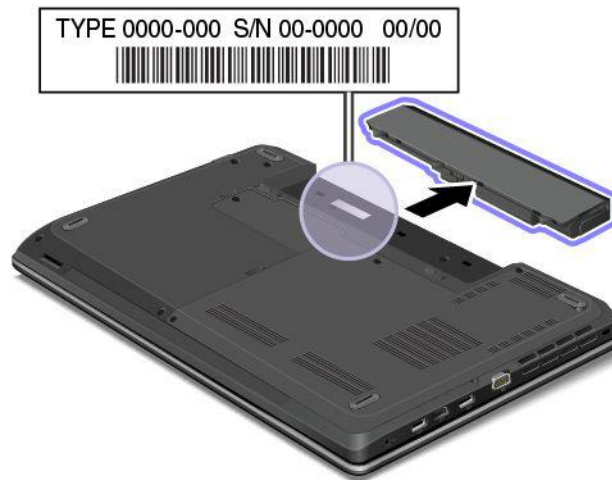

FCC ID and IC Certification number label

There is no FCC ID or IC Certification number for the wireless LAN card **1** and wireless WAN card **2** shown on the enclosure of your computer. The FCC ID and IC Certification number label is affixed on the wireless LAN card and wireless WAN card installed in the computer.

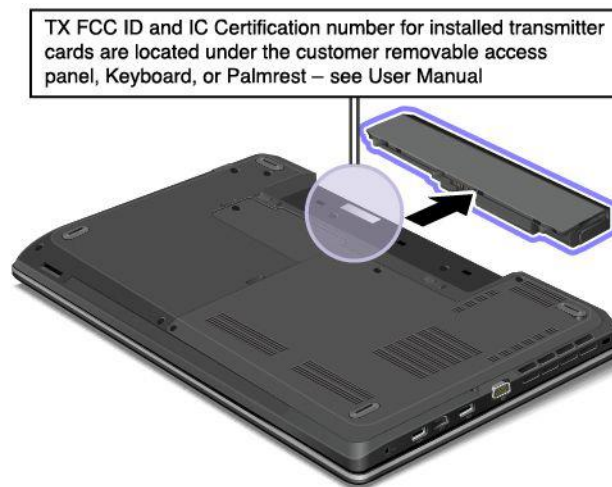

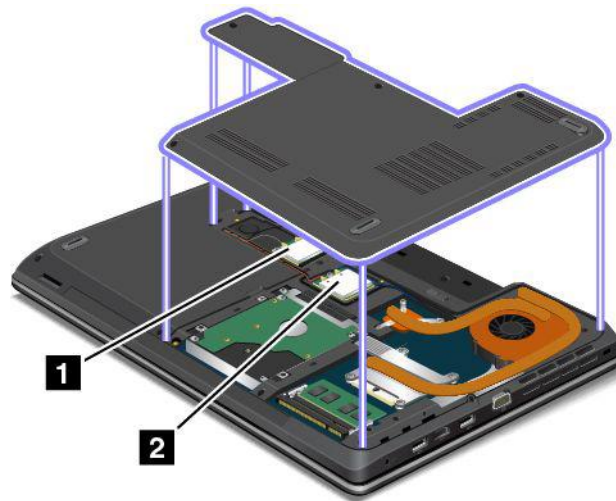

If you need to remove the wireless LAN card for repair or replacement, follow the procedure in “Replacing a wireless LAN card” on page 89.

If you have purchased a wireless WAN enabled computer, the wireless WAN card is preinstalled at the factory. If you need to remove this card for repair or replacement, follow the procedure in “Replacing a wireless WAN card” on page 92.

Note: Only Lenovo authorized wireless LAN or wireless WAN cards are allowed to be used in your computer. If you install an unauthorized card that is not approved for use in your computer, the computer will not start, but will only display an error message and emit audible beeps.

Certificate of Authenticity label

The Certificate of Authenticity label for the preinstalled operating system is attached. Printed on this label are the product ID and the product key information for your computer. Record this information and keep it in a safe place. You might need these numbers to start your computer or reinstall the operating system.

The Certificate of Authenticity label applies only to computers preinstalled with the Windows 7 operating system.

The Certificate of Authenticity label of your computer is shown as below:



Features

This topic lists the features of your computer.

Processor

- To view the processor information of your computer, do the following:
 - For Windows 7: Click **Start** and right-click **Computer**. Then click **Properties**.
 - For Windows 8: Move the cursor to the bottom right corner of the screen to bring up the charms. Then click **Settings** → **PC info**.

Memory

- Double data rate 3 synchronous dynamic random access memory modules (DDR3 SDRAM)

Storage device

- 2.5-inch hard disk drive with a height of 7 mm (0.28 inch) or 9.5 mm (0.37 inch)
- 2.5-inch solid-state drive with a height of 7 mm (0.28 inch)
- Small-capacity M.2 solid-state drive for caching only (on some models)

Display

The color display uses the Thin Film Transistor (TFT) technology.

- Size:
 - For E431 models: 14.0 inches (355.6 mm)
 - For E531 models: 15.6 inches (396.2 mm)
- Resolution:
 - LCD:
 - For E431 models: Up to 1366 x 768 or 1600 x 900, depending on the model
 - For E531 models: Up to 1366 x 768 or 1920 x 1080, depending on the model
 - External monitor: Up to 2048 x 1536
- Brightness control
- Integrated camera
- Built-in microphones

Keyboard

- 6-row keyboard
- ThinkPad pointing device (TrackPoint pointing device and multi-touch touch pad)
- Fn key
- Numeric keypad (on some models)

Interface

- External monitor connectors (VGA connector and HDMI connector)
- Combo audio jack
- Two USB 3.0 connectors
- One Always On USB connector (USB 2.0)
- RJ45 Ethernet connector
- 4-in-1 digital media card reader
- Lenovo OneLink connector

- ac power connector

Optical drive

- Multi-Burner drive

Wireless features

- Integrated wireless LAN
- Integrated wireless WAN (on some models)
- Integrated Bluetooth (on some models)

Security features

- Fingerprint reader (on some models)

Specifications

This section lists the physical specifications for your computer.

Size

- For E431 models:
 - Width: 344 mm (13.54 inches)
 - Depth: 239 mm (9.41 inches)
 - Height: 26.3 mm (1.04 inches)
- For E531 models:
 - Width: 377 mm (14.84 inches)
 - Depth: 250 mm (9.84 inches)
 - Height: 26.6 mm (1.05 inches)

Heat output

- 65 W (222 Btu/hr) maximum or 90 W (307 Btu/hr) maximum (depending on the model)

Power source (ac power adapter)

- Sine-wave input at 50 to 60 Hz
- Input rating of the ac power adapter: 100 to 240 V ac, 50 to 60 Hz

Battery pack

- Lithium-ion (Li-Ion) battery pack

Battery life

- For the percentage of the remaining battery power, check the battery status icon in the Windows notification area.

Operating environment

This section provides information about your computer operating environment.

Environment:

- Maximum altitude without pressurization: 3048 m (10 000 ft)
 - Temperature
 - At altitudes up to 2438 m (8000 ft)
 - Operating: 5.0°C to 35.0°C (41°F to 95°F)
 - Storage: 5.0°C to 43.0°C (41°F to 109°F)
 - At altitudes above 2438 m (8000 ft)
 - Maximum temperature when operating under the unpressurized condition: 31.3°C (88°F)
- Note:** When you charge the battery pack, its temperature must be at least 10°C (50°F).
- Relative humidity:
 - Operating: 8% to 80%
 - Storage: 5% to 95%

If possible, place your computer in a well-ventilated and dry area without direct exposure to sunshine.

Keep electrical appliances such as an electric fan, radio, air conditioner, and microwave oven away from your computer because the strong magnetic fields generated by these appliances can damage the monitor and data on the hard disk drive or solid-state drive.

Do not place any beverages on top of or beside the computer or other attached devices. If liquid is spilled on or in the computer or an attached device, a short circuit or other damage might occur.

Do not eat or smoke over your keyboard. Particles that fall into your keyboard can cause damage.

Lenovo programs

Your computer comes with Lenovo programs to help you work more easily and securely. Depending on the Windows operating system preinstalled, the programs might vary.

To learn more about the programs and other computing solutions offered by Lenovo, go to <http://www.lenovo.com/support>.

Accessing Lenovo programs on the Windows 7 operating system

On the Windows 7 operating system, you can access Lenovo programs from either the Lenovo ThinkVantage® Tools program or from Control Panel.

Accessing Lenovo programs from the Lenovo ThinkVantage Tools program

To access Lenovo programs from the Lenovo ThinkVantage Tools program, click **Start → All Programs → Lenovo ThinkVantage Tools**. Then double-click a program icon to access the program.

Note: If a program icon in the Lenovo ThinkVantage Tools program navigation window is dimmed, it indicates that you need to install the program manually. To install the program manually, double-click the program icon. Then, follow the instructions on the screen. When the installation process completes, the program icon will be activated.

Table 1. Programs in the Lenovo ThinkVantage Tools program

Program	Icon name
Access Connections™	Internet Connection
Active Protection System™	Airbag Protection

Table 1. Programs in the Lenovo ThinkVantage Tools program (continued)

Program	Icon name
Client Security Solution	Enhanced Security
Communications Utility	Web Conferencing
Lenovo Solution Center	System Health and Diagnostics
Mobile Broadband Connect	3G Mobile Broadband
OneKey® Recovery Pro	Enhanced Backup and Restore
Password Manager	Password Vault
Power Manager	Power Controls
Recovery Media	Factory Recovery Disks
SimpleTap	SimpleTap
System Update	Update and Drivers

Note: Depending on your computer model, some of the programs might not be available.

Accessing Lenovo programs from Control Panel

To access Lenovo programs from Control Panel, click **Start → Control Panel**. Then depending on the program you want to access, click the corresponding section and then click the corresponding green text.

Note: If you do not find the program you need in Control Panel, open the Lenovo ThinkVantage Tools program navigation window and double-click the dimmed icon to install the program you need. Then, follow the instructions on the screen. When the installation process completes, the program icon will be activated, and you can find the program in Control Panel.

The programs and the corresponding sections and green texts in Control Panel are listed in the following table.

Table 2. Programs in Control Panel

Program	Control Panel section	Green text in Control Panel
Access Connections	Network and Internet	Lenovo - Internet Connection
Active Protection System	System and Security Hardware and Sound	Lenovo - Airbag Protection
Client Security Solution	System and Security	Lenovo - Enhanced Security
Communications Utility	Hardware and Sound	Lenovo - Web Conferencing
Lenovo Solution Center	System and Security	Lenovo - System Health and Diagnostics
Message Center Plus	Programs	Messages from Lenovo
Mobile Broadband Connect	Network and Internet	Lenovo - 3G Mobile Broadband
OneKey Recovery Pro	System and Security	Lenovo - Enhanced Backup and Restore
Password Manager	System and Security User Accounts and Family Safety	Lenovo - Password Vault
Power Manager	Hardware and Sound System and Security	Lenovo - Power Controls
Recovery Media	System and Security	Lenovo - Factory Recovery Disks

Table 2. Programs in Control Panel (continued)

Program	Control Panel section	Green text in Control Panel
SimpleTap	Programs	Lenovo - SimpleTap
System Update	System and Security	Lenovo - Update and Drivers

Note: Depending on your computer model, some of the programs might not be available.

Accessing Lenovo programs on the Windows 8 operating system

If your computer is preinstalled with the Windows 8 operating system, you can access Lenovo programs by doing either of the following:

- Click the **Lenovo QuickLaunch** icon from the taskbar. A list of programs is displayed. Double-click a Lenovo program to launch it. If a desired program is not in the list, click the plus icon +.
- Press the Windows key to go to the Start screen. Click a Lenovo program to launch it. If you cannot find the program you need, move the cursor to the bottom right corner of the screen to bring up the charms. Then click the **Search** charm to search for the desired program.

Your computer supports the following Lenovo programs:

- Active Protection System
- Fingerprint Software
- Lenovo Companion
- Lenovo Cloud Storage
- Lenovo Settings
- Lenovo Mobile Access
- Lenovo Solution Center
- Lenovo QuickLaunch
- Lenovo Support
- Lenovo ThinkVantage Tools
- Password Manager
- System Update

Note: The Password Manager program is not preinstalled on your computer. You can download it from the Lenovo Support Web site at <http://www.lenovo.com/support>.

For an introduction to these programs, see “An introduction to Lenovo programs” on page 18.

An introduction to Lenovo programs

This topic provides a brief introduction to some Lenovo programs.

Note: Depending on your computer model, some of the programs might not be available.

• Access Connections

The Access Connections program is a connectivity assistant program for creating and managing location profiles. Each location profile stores all the network and Internet configuration settings needed for connecting to a network infrastructure from a specific location such as a home or an office.

By switching between location profiles as you move your computer from place to place, you can quickly and easily connect to a network with no need to reconfigure your settings manually and restart the computer each time.

- **Active Protection System**

The Active Protection System program protects your hard disk drive when the shock sensor inside your computer detects a condition that could damage the drive, such as system tilt, excessive vibration, or shock. The hard disk drive is less vulnerable to damage when it is not operating. This is because when the hard disk drive is not operating, the system stops it from spinning, and might also move the read and write heads of the drive to areas that do not contain data. As soon as the shock sensor senses that the environment is stable again (minimal change in system tilt, vibration, or shock), it turns on the hard disk drive.

- **Client Security Solution**

The Client Security Solution program protects your computer by securing client data and deflecting security breach attempts. It also can help manage your passwords, recover a forgotten password, monitor security settings on your computer, and suggest how to enhance your computer security.

- **Communications Utility**

Use the Communications Utility program to configure settings for the integrated camera and audio devices.

- **Fingerprint Software**

If your system comes with a fingerprint reader, the Fingerprint Software program enables you to enroll your fingerprint and associate it with your Windows password. As a result, the fingerprint authentication can replace your password and enable simple and secure user access.

- **Lenovo Cloud Storage**

The Lenovo Cloud Storage program enables you to upload and store your local files to a remote Lenovo server. You can view and download the stored files at any time.

- **Lenovo Companion**

Through the Lenovo Companion program, you can get the information about the accessories for your computer, view blogs and articles about your computer, and check for other recommended programs.

- **Lenovo Settings**

Use the Lenovo Settings program to enhance your computing experience by turning your computer into a portable hotspot, configuring camera and audio settings, optimizing your power settings, and creating and managing multiple network profiles.

- **Lenovo Mobile Access**

The Lenovo Mobile Access program enables you to manage your mobile broadband connection. You can create an account, add money to the account, and purchase mobile broadband sessions using your account.

- **Lenovo Solution Center**

The Lenovo Solution Center program enables you to troubleshoot and resolve computer problems. It combines diagnostic tests, system information collection, security status, and support information, along with hints and tips for maximum system performance.

- **Lenovo QuickLaunch**

The Lenovo QuickLaunch program provides you with quick access to programs installed on your computer, including Lenovo programs, Microsoft programs, and other third party programs.

- **Lenovo Support**

The Lenovo Support program enables you to register your computer with Lenovo, check the computer health condition and battery status, download and view user manuals for your computer, get the warranty information of your computer, and explore help and support information.

- **Lenovo ThinkVantage Tools**

The Lenovo ThinkVantage Tools program helps you work more easily and securely by providing easy access to various program, such as: Lenovo Solution Center, OneKey Recovery Pro, and so on.

- **Message Center Plus**

The Message Center Plus program automatically displays messages to inform you about important notices from Lenovo, such as alerts on system updates and alerts on conditions that require your attention.

- **Mobile Broadband Connect**

The Mobile Broadband Connect program enables your computer to connect to the mobile broadband (3G) network through a supported wireless WAN card.

- **Password Manager**

The Password Manager program automatically captures and fills in authentication information for Windows programs and Web sites.

- **Power Manager**

The Power Manager program provides convenient, flexible, and complete power management for your computer. It enables you to adjust your computer power settings to achieve the best balance between performance and power saving.

- **Recovery Media**

The Recovery Media program enables you to restore the contents of the hard disk drive to the factory default settings.

- **OneKey Recovery Pro**

The OneKey Recovery Pro program is a one-button recovery and restore solution that includes a set of self-recovery tools to help you diagnose computer problems, get help, and recover from system crashes, even if you cannot start the Windows operating system.

- **SimpleTap**

The SimpleTap program provides you with a quick way to customize some basic computer settings such as muting the speakers, adjusting the volume, locking the computer operating system, launching a program, opening a Web page, opening a file. You also can use the SimpleTap program to access the Lenovo App Shop, from which you can download various programs and computer software.

To start the SimpleTap program in a quick way, do any of the following:

- Click the red SimpleTap launch point on the desktop. The red launch point is available on the desktop after you have launched the SimpleTap program for the first time.
- Press the black button on the keyboard (next to the volume control buttons).

Note: The SimpleTap program is only available on certain models preinstalled with the Windows 7 operating system. If your Windows 7 model is not preinstalled with the SimpleTap program, you can download it from <http://www.lenovo.com/support>.

- **System Update**

The System Update program helps you keep the software on your computer up-to-date by downloading and installing software update packages (Lenovo programs, device drivers, UEFI BIOS updates, and other third-party programs).

Chapter 2. Using your computer

This chapter provides information on using some of the computer components.

This chapter contains the following topics:

- “Registering your computer” on page 21
- “Frequently asked questions” on page 21
- “Special keys ” on page 25
- “Using the ThinkPad pointing device” on page 29
- “Power management” on page 30
- “Connecting to the network” on page 35
- “Presentations and multimedia” on page 39
- “Using audio features” on page 42
- “Using the integrated camera” on page 42
- “Using the optical drive” on page 43
- “Using a flash media card” on page 43

Registering your computer

When you register your computer, information is entered into a database, which enables Lenovo to contact you in case of a recall or other severe problem. After you registered your computer with Lenovo, you will also receive quicker service when you call Lenovo for help. In addition, some locations offer extended privileges and services to registered users.

To register your computer with Lenovo, do one of the following:

- Go to <http://www.lenovo.com/register> and follow the instructions on the screen to register your computer.
- Connect your computer to the Internet and register your computer through a preinstalled registration program:
 - For Windows 7: The preinstalled Lenovo Product Registration program launches automatically after you have used your computer for a time. Follow the instructions on the screen to register your computer.
 - For Windows 8: Open the Lenovo Support program. Then click **Registration** and follow the instructions on the screen to register your computer.

Frequently asked questions

The following are a few tips that will help you optimize the use of your computer.

To ensure that you receive the best performance from your computer, go to the following Web page to find information such as aids for troubleshooting and answers to frequently asked questions:
<http://www.lenovo.com/support/faq>

Can I get my user guide in another language?

- To download the user guide in another language, go to: <http://www.lenovo.com/support>. Then follow the instructions on the screen.

How can I use the battery power more effectively?

- To conserve power, or to suspend operation without exiting programs or saving files, see “Power-saving modes” on page 32.
- To achieve the best balance between performance and power saving, create and apply power plans. See “Managing the power plans” on page 32
- If your computer will be turned off for an extended period of time, you can prevent battery power from draining by removing the battery. Look for more information about using the battery in “Power management” on page 30.

Concerned about security or need to securely dispose of data stored on your hard disk drive or solid-state drive?

- Study Chapter 4 “Security” on page 49 section to find out how you can protect your computer from theft and unauthorized use.
- Use the Password Manager program to protect the data stored on your computer. For details, see the help information system of the program.
- Before you dispose of the data on the hard disk drive or solid-state drive, be sure to read “Notice on deleting data from your hard disk drive or solid-state drive” on page 56.

Is getting connected in different locations a challenge?

- To troubleshoot a wireless networking issue, go to:
<http://www.lenovo.com/support/faq>
- Take advantage of the networking features provided by the Access Connections program (on the Windows 7 operating system) or Location Awareness program in Lenovo Settings (on the Windows 8 operating system).
- To learn more about using the wireless features of your computer, refer to “Wireless connections” on page 36.
- To travel more confidently, be sure to check the tips in “Traveling with your computer” on page 47.
- Press F8 to enable or disable the wireless features.

How do I give presentations or attach an external monitor often?

- Make sure that you follow the procedure for “Using an external monitor” on page 39.
- With the Extend desktop function, you can display output on both the computer display and an external monitor.

How do I attach or replace a device?

- See Chapter 6 “Replacing devices” on page 67 for more information about replacing the devices of your computer.

You have been using your computer for some time already, and it is getting slower?

- Follow the “General tips for preventing problems” on page 119.
- You can diagnose problems yourself by using the preinstalled diagnostic software.
- Check for recovery solutions in Chapter 5 “Recovery overview” on page 59.

Print the following sections and keep them with your computer in case you are unable to access this online user guide when necessary.

- “Installing a new operating system” on page 101
- “Computer stops responding” on page 125
- “Power problems” on page 139

Using the multi-touch screen

This topic provides instructions on how to use the multi-touch screen that is available on some models.

Tap

Tap on the screen with your fingertip to launch an application, select an item, or open a menu.

Press and hold

Press and hold an item or a blank area on the screen for a few seconds until an action occurs.

Drag

Tap and hold your finger on an item, such as an image or an icon on the screen, then pull it along with your finger to the desired location.

Swipe or slide

Move your finger horizontally on the screen to scroll through Web pages, lists, picture thumbnails, and so on.

Zoom in or zoom out

Move two fingers closer together on the screen to zoom out, or move two fingers apart on the screen to zoom in.

Rotate

Put two or more fingers on an item, and then rotate your fingers. This operation enables you to rotate the selected items in a direction you move your fingers.

Double tap

For some applications, quickly tap twice on the screen to zoom in. Double-tap again to zoom out.

Windows 8 touch gestures and mouse actions

The following table lists the touch gestures and mouse actions supported by the Window 8 operating system.

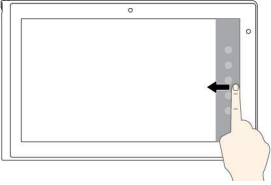
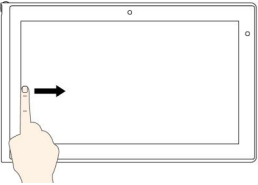
Tasks	Touch gestures (touch models only)	Mouse actions
To display the charms that contain system commands, such as Start , Settings , Search , Share , and Devices	Swipe in from the right edge. 	Move the pointer to the lower-right or upper-right corner of your screen.
To display the open applications and switch applications	Swipe in from the left edge. 	Move the pointer to the upper-left corner of your screen, and then click.

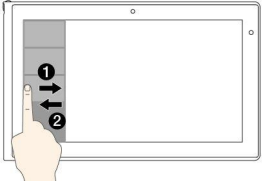
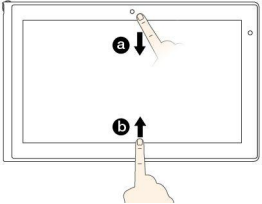
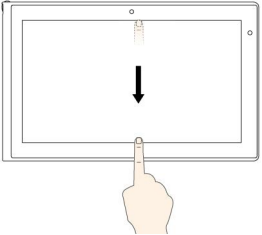
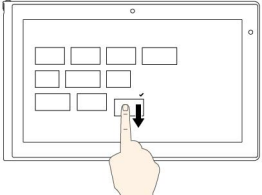
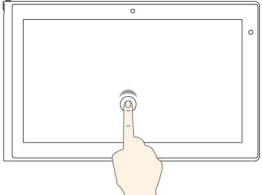
Tasks	Touch gestures (touch models only)	Mouse actions
To view the recently used applications or select an application from the list	Swipe in and out on the left edge. 	Move the pointer to the upper-left corner of your screen, and then move it downward.
To view all applications on the Start screen or view the application commands on an open application, such as Copy , Save , and Delete , depending on the applications	Swipe in from the top or bottom edge. 	Right-click a blank area on the Start screen or right-click an open application.
To close the current application	Swipe in from the top edge to the bottom. 	Click the top of the application, and then drag it to the bottom of your screen.
To enlarge or reduce the size of an icon, remove an icon from the Start screen, or remove an application	Move the desired icon downward until a tick icon (✓) is displayed, then release your finger. 	Right-click the desired icon.
To open an application on the Start screen or perform an action on an open application, such as Copy , Save , and Delete , depending on the application	Tap. 	Click.

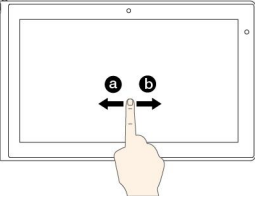
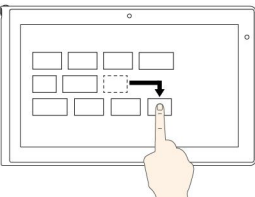
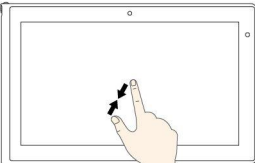
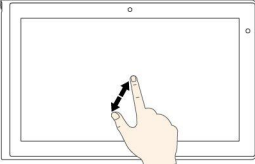
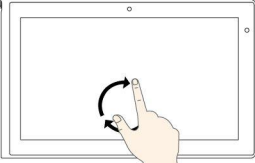
Tasks	Touch gestures (touch models only)	Mouse actions
To scroll through items, such as lists, pages, and photos	Slide. 	Scroll the mouse wheel, move the scroll bar, or click the scroll arrow.
To move an object	Drag an item to the desired location. 	Click, hold, and drag an item.
To zoom out	Move two fingers closer together. 	Press the Ctrl key while scrolling the mouse wheel backward.
To zoom in	Move two fingers farther apart. 	Press the Ctrl key while scrolling the mouse wheel forward.
To rotate an item	Put two or more fingers on an item, and then rotate your fingers (supported only on some models). 	If the application supports rotation, click the rotation icon.

Special keys



Your computer has several special keys to help you work more easily and effectively.

ThinkPad Edge E431 special keys

The following figure shows the locations of main special keys for ThinkPad Edge E431.





1 Function keys

- 
: Press Fn+Esc to enable or disable the Fn Lock function.

When the Fn Lock function is disabled: The Fn Lock indicator is off (default mode). To initiate the special function of each key, press the function keys directly. To input F1–F12, you need to press the Fn key and the corresponding function key.

When the Fn Lock function is enabled: The Fn Lock indicator turns on. To input F1–F12, press the function keys directly. To initiate the special function of each key, you need to press the Fn key and the corresponding function key.

- : Mutes or unmutes the speakers. When the speakers are muted, the speaker mute indicator turns on. If you mute the sound and turn off your computer, the sound will remain muted when you turn on your computer again. To turn on the sound, press F1, F2, or F3.

- : Decreases the speaker volume.

- : Increases the speaker volume.

- : Mutes or unmutes the microphones. When the microphones are muted, the microphone mute indicator turns on.

- : Darkens the display.





- : Brightens the display.

You can temporarily change the computer display brightness by pressing the two keys. To change the default brightness level, right-click the battery status icon in the Windows notification area. Then click **Adjust screen brightness** and make changes as desired.

- : Switches the display output location between the computer display and an external monitor. For more information, refer to “Presentations and multimedia” on page 39.

Note: To switch between the computer display and an external monitor, the Windows+P key combination also is available.

- : Enables or disables the built-in wireless networking features. For more information on the wireless features, refer to “Wireless connections” on page 36.

- : For Windows 8: Opens the **Settings** charm.
For Windows 7: Opens **Control Panel**.
- : For Windows 8: Opens the **Search** charm.
For Windows 7: Opens **Windows Search**.
- : Views the programs that you have opened.
- : For Windows 8: Views all the programs.
For Windows 7: Opens **Computer**.
- **Fn+B**: Has the same function as the Break key.
- **Fn+P**: Has the same function as the Pause key.
- **Fn+S**: Has the same function as the SysRq key.
- **Fn+K**: Has the same function as the ScrLK key.

2 Windows key

On the Windows 7 operating system, press the Windows key to open the **Start** menu. On the Windows 8 operating system, press the Windows key to switch between the current workspace and the Start screen.

For information about using the Windows key with other keys, refer to the help information system of the Windows operating system.



ThinkPad Edge E531 special keys



The following figure shows the locations of main special keys for ThinkPad Edge E531.



1 Additional shortcut keys

Your computer might have four additional shortcut keys:

- : Launches calculator
- : Locks operating system

- : Opens the default browser
- : Opens **Computer**

Note: Depending on your computer model, the shortcut keys might not be available.

2 Numeric keypad

You can use this numeric keypad to input numbers quickly.

Note: Depending on your computer model, the numeric keypad might not be available.

3 Windows key

On the Windows 7 operating system, press the Windows key to open the **Start** menu. On the Windows 8 operating system, press the Windows key to switch between the current workspace and the Start screen

For information about using the Windows key with other keys, refer to the help information system of the Windows operating system.

4 Function keys





- : Press Fn+Esc to enable or disable the Fn Lock function.

When the Fn Lock function is disabled: The Fn Lock indicator is off (default mode). To initiate the special function of each key, press the function keys directly. To input F1–F12, you need to press the Fn key and the corresponding function key.

When the Fn Lock function is enabled: The Fn Lock indicator turns on. To input F1–F12, press the function keys directly. To initiate the special function of each key, you need to press the Fn key and the corresponding function key.

- : Mutes or unmutes the speakers. When the speakers are muted, the speaker mute indicator turns on.

If you mute the sound and turn off your computer, the sound will remain muted when you turn on your computer again. To turn on the sound, press F1, F2, or F3.





- : Decreases the speaker volume.
- : Increases the speaker volume.
- : Mutes or unmutes the microphones. When the microphones are muted, the microphone mute indicator turns on.
- : Darkens the display.
- : Brightens the display.

You can temporarily change the computer display brightness by pressing the two keys. To change the default brightness level, right-click the battery status icon in the Windows notification area. Then click **Adjust screen brightness** and make changes as desired.

- : Switches the display output location between the computer display and an external monitor. For more information, refer to “Presentations and multimedia” on page 39.

Note: To switch between the computer display and an external monitor, the Windows+P key combination also is available.

- : Enables or disables the built-in wireless networking features. For more information on the wireless features, refer to “Wireless connections” on page 36.

- : For Windows 8: Opens the **Settings** charm.
For Windows 7: Opens **Control Panel**.
- : For Windows 8: Opens the **Search** charm.
For Windows 7: Opens **Windows Search**.
- : Views the programs that you have opened.
- : For Windows 8: Views all the programs.
For Windows 7: Opens **Computer**.
- **Fn+B**: Has the same function as the Break key.
- **Fn+P**: Has the same function as the Pause key.
- **Fn+S**: Has the same function as the SysRq key.
- **Fn+K**: Has the same function as the ScrLK key.

Using the ThinkPad pointing device

The ThinkPad pointing device consists of the TrackPoint pointing stick **1** and the touch pad **2**. The whole touch pad is an active area sensitive to finger movement. The left click zones **3** and right click zones **5** work as the left and right mouse buttons on a conventional mouse. The scroll zone **4** enables you to scroll Web pages or documents in any direction.

Note: Your computer keyboard might look slightly different from the following illustration.

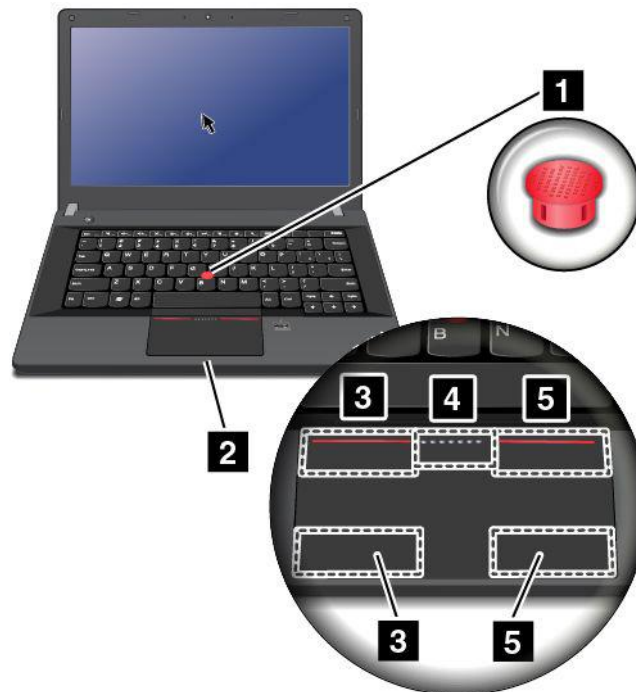

Using the TrackPoint pointing stick

To use the TrackPoint pointing stick, apply pressure to the nonslip cap on the pointing stick in any direction parallel to the keyboard. Then you can move the cursor. But the pointing stick itself does not move. The speed at which the cursor moves depends on the pressure you apply to the pointing stick.

Using the multi-touch touch pad

The touch pad of your computer supports multi-touch with which you can zoom in, zoom out, scroll, or rotate on the screen while browsing the Internet or reading or editing a document.

Customizing the ThinkPad pointing device

You can customize the ThinkPad pointing device to achieve the extended functions of the ThinkPad pointing device.

To customize the ThinkPad pointing device, do the following:

1. Go to Control Panel.
2. Click **Hardware and Sound** → **Mouse** → **ThinkPad**.
3. Follow the instructions on the screen.

Replacing the cap

The cap **1** on the end of the TrackPoint pointing stick is removable. After you use the cap for a period of time, you can replace the cap with a new one.

Note: The TrackPoint cap used in your computer has grooves **2** as shown in the following illustration. Ensure that you replace the TrackPoint cap with a correct one that has such grooves.

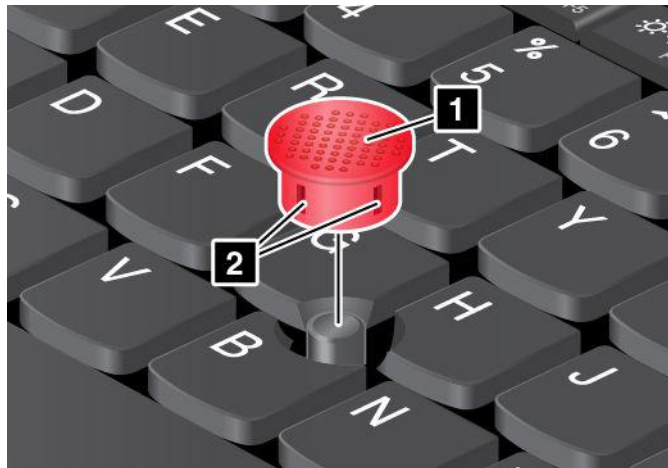

Power management

When you use your computer away from electrical outlets, you depend on battery power to keep your computer running. Different computer components consume power at different rates. The more you use the power-intensive components, the faster you consume battery power. Mobility has revolutionized business by allowing you to take your work wherever you go. With ThinkPad batteries, you will be able to work longer without being tied to an electrical outlet.

Checking the battery status

The battery status icon in the Windows notification area displays the percentage of battery power remaining.

The rate at which you use battery power will determine how long you can use the battery of your computer between charges. Because each computer user has different habits and needs, it is difficult to predict how long a battery charge will last. There are two main factors:

- How much energy is stored in the battery when you begin to work.
- The way you use your computer: how often you access the hard disk drive or solid-state drive; how bright you make the computer display.

To check for detailed battery status information, do the following:

- For Windows 7: Open the Power Manager program and click the **Battery** tab.
- For Windows 8: Open the Lenovo Support program and click **Battery Health**. Or open the Lenovo Settings program and click **Power**.

Using the ac power adapter

The power to run your computer can come either from the lithium-ion (Li-ion) battery pack provided with it, or from ac power through the ac power adapter.

The ac power adapter that comes with your computer has two basic components:

- The transformer pack that converts ac power for use with the computer.
- The power cord that plugs into the ac outlet and into the transformer pack.

Attention: Using an improper power cord could cause severe damage to your computer.

Connecting the ac power adapter

To use the ac power adapter, do the following.

Note: Ensure that you take these steps in the given order.

1. Plug the power cord into an electrical outlet.
2. Connect the power cord to the transformer pack.
3. Connect the ac power adapter to the ac power connector of the computer.

Tips on using the ac power adapter

- When the ac power adapter is not in use, disconnect it from the electrical outlet.
- Do not bind the power cord tightly around the ac power adapter transformer pack when it is connected to the transformer.
- Before you charge the battery, make sure that its temperature is at least 10°C (50°F).
- You can charge the battery when the ac power adapter is connected to the computer and the battery is installed. You need to charge it in any of the following conditions:
 - A new battery is installed.
 - The percentage of power remaining is low.
 - The battery has not been used for a long time.

Charging the battery

When you find that the percentage of power remaining is low or when the power alarm goes off, you need to charge your battery or replace it with a charged battery.

If an ac outlet is convenient, plug the ac power adapter into it, and then insert the jack into the computer. The battery will be fully charged in about 3 to 6 hours. This is affected by the battery size and the physical environment.

To increase the life of the battery, the computer does not start recharging the battery if the remaining power is greater than 95%.

Maximizing the battery life

To maximize the life of the battery, do the following:

- Use the battery until the charge is completely depleted; that is, use the battery until the battery status indicator starts blinking orange.
- Recharge the battery completely before using it. The battery is fully charged if the battery indicator shows green.
- Always use power-saving mode. For more information about power-saving mode, refer to “Power-saving modes” on page 32.

Managing the power plans

You can manage the power plans to achieve the best balance between performance and power saving. To change the power plan, do the following:

1. Click the battery status icon in the Windows notification area. Click **More power options**.
2. Select the power plan as desired.

You also can change power plan settings, or create a new power plan. For more information, refer to the help information system of the program.

Power-saving modes

You can use the following power-saving modes to conserve the power of your computer.

- **Screen blank (for the Windows 7 operating system only)**
The computer display requires considerable battery power. To turn off power to the display, right-click the battery gauge icon from the Windows notification area and select **Power off display**.
- **Sleep**
In sleep mode, your work is saved to memory, and then the solid-state drive or the hard disk drive and the computer display are turned off. When your computer wakes up, your work is restored within seconds.
 - For Windows 7:
 1. Click **Start**.
 2. Click the triangle mark on the right side of the **Shut down** icon; then select **Sleep**.
 - For Windows 8:
 1. Move the cursor to the bottom right corner of the screen to bring up the charm.
 2. Click **Settings → Power → Sleep**.
- **Hibernation**
By using this mode, you can turn off your computer completely without saving files or exiting from any programs that are running. When the computer enters hibernation, all open programs, folders, and files are saved to the hard disk, and then the computer turns off.

To put the computer into hibernation mode, change your power plan settings. To access power plan settings, do the following:

- For Windows 7:

1. Open the Power Manager program.
 2. Click **Power Plan** or click **Advanced → Power Plan**.
- For Windows 8:
 1. Click the battery status icon in the Windows notification area.
 2. Click **More power options**. Then click **Change plan settings** that is next to your power plan.
 - **30 Day Standby function**

Depending on the computer model, your computer might support the 30 Day Standby function. When this function is enabled, the computer consumes even less power in sleep mode and takes only seconds to resume normal operation when you press the power button. To enable the 30 Day Standby function, do the following:

 - For Windows 7:
 1. Open the Power Manager program.
 2. Click **Global Power Settings** or click **Advanced → Global Power Settings**.
 3. Select **Enable 30 Day Standby**; then click **OK**.
 - For Windows 8:
 1. Open the Lenovo Settings program.
 2. Click **Power**.
 3. Under **30 Day Standby**, move the slider to the right.
 - **Always On USB function off**

The Always On USB drains your battery power. You can disable it when you do not need it. To disable the Always On USB function, do the following:

 - For Windows 7:
 1. Open the Power Manager program.
 2. Click **Global Power Settings** or click **Advanced → Global Power Settings**.
 3. Unselect **Enable Always On USB**; then click **OK**.
 - For Windows 8:
 1. Open the Lenovo Settings program.
 2. Click **Power**.
 3. Under **Always On USB**, move the slider to the left.
 - **Wireless off**

When you are not using the wireless features, such as Bluetooth or wireless LAN, turn them off. This will help conserve power. To turn off the wireless features, press F8.

Enabling the wakeup function

If you put your computer into hibernation mode, and the wakeup function is disabled (this is the default setting), the computer does not consume any power. If the wakeup function is enabled, it consumes a small amount of power.

To enable the wakeup function, do the following:

1. Go to Control Panel and click **System and Security**.
2. Click **Administrative Tools**.
3. Double-click **Task Scheduler**. If you are prompted for an administrator password or confirmation, type the password or provide confirmation.
4. From the left pane, select the task folder for which you want to enable the wakeup function. The scheduled tasks are displayed.

5. Click a scheduled task, and then click the **Conditions** tab.
6. Under **Power**, select the check box for **Wake the computer to run this task**.

Setting the actions for critical and low power

When your battery power falls below a certain level, some actions will be triggered. For example, the alarm will go off or your computer will go into sleep or hibernation mode or power off.

To set the actions triggered and the corresponding critical and low power level, do the following:

1. Click the battery status icon in the Windows notification area, and then click **More power options**.
2. Click **Change plan settings → Change advanced power settings → Battery**.
3. Change the settings as you desire in the **Battery** list.

Handling the battery

This system supports only batteries specially designed for this specific system and manufactured by Lenovo or an authorized builder. The system does not support unauthorized batteries or batteries designed for other systems. If an unauthorized battery or a battery designed for another system is installed, the system will not charge.

Attention: Lenovo has no responsibility for the performance or safety of unauthorized batteries, and provides no warranties for failures or damage arising out of their use.

Note: If an unauthorized battery is installed, the following message will be displayed: “The battery installed is not supported by this system and will not charge. Please replace the battery with the correct Lenovo battery for this system.”



DANGER

Do not attempt to disassemble or modify the battery pack.

Attempting to do so can cause an explosion, or liquid leakage from the battery pack.

A battery pack other than the one specified by Lenovo, or a disassembled or modified battery pack is not covered by the warranty.



DANGER

If the rechargeable battery pack is incorrectly replaced, there is danger of an explosion. The battery pack contains a small amount of harmful substances. To avoid possible injury:

- **Replace only with a battery of the type recommended by Lenovo.**
- **Keep the battery pack away from fire.**
- **Do not expose it to excessive heat.**
- **Do not expose it to water or rain.**
- **Do not short-circuit it.**
- **Store it in a cool dry place.**
- **Keep it away from children.**

The battery pack is a consumable supply. If your battery begins to discharge too quickly, replace the battery pack with a new one of the type recommended by Lenovo. For more information on replacing the battery pack, contact your Customer Support Center.

 **DANGER**

Do not drop, crush, puncture, or subject to strong forces. Battery abuse or mishandling can cause the battery to overheat, which can cause gasses or flame to “vent” from the battery pack or coin cell. If your battery is damaged, or if you notice any discharge from your battery or the buildup of foreign materials on the battery leads, stop using the battery and obtain a replacement from the battery manufacturer.

 **DANGER**

Only recharge the battery pack strictly according to instructions included in the product documentation.

 **DANGER**

Do not put the battery pack in trash that is disposed of in landfills. When disposing of the battery, comply with local ordinances or regulations and your company's safety standards.

 **DANGER**

There is a danger of an explosion if the backup battery is incorrectly placed. The lithium battery contains lithium and can explode if it is not properly handled, or disposed of. Replace only with a battery of the same type. To avoid possible injury or death, do not: (1) throw or immerse into water, (2) allow it to heat to more than 100°C (212°F), or (3) attempt to repair or disassemble it. Dispose of it as required by local ordinances or regulations and your company's safety standards.

Connecting to the network

Your computer has one or more network cards that enable you to connect your computer to the Internet and other network connections.

Ethernet connections

You can connect to your network or a broadband connection, such as DSL or CATV, by use of the Ethernet feature built into your computer. This feature enables you to do 1Gbps half or full duplex data transmission.

If you are using the Windows 7 operating system, the Access Connections program also enables you to manage your location profiles. For instructions on how to start the Access Connections program, see “Accessing Lenovo programs on the Windows 7 operating system” on page 16.

For more information, see the help information system of the program.

 **DANGER**

Your computer has an Ethernet connector. To avoid the risk of electrical shock, do not connect the telephone cable to the Ethernet connector.

Wireless connections

Wireless communication is the transfer of data without the use of cables but by means of radio waves only.

Depending on the wireless device used in your computer, you might be able to connect to the following categories of wireless networks.

Wireless LAN

A wireless local area network (LAN) covers a relatively small geographic area, such as an office building or a house. Devices based on the 802.11 standards can connect to this network.

Your computer comes with a built-in wireless network card and a configuration utility to help you make wireless connections and monitor the status of your connection, so that you can stay connected to your network while you are in the office, in a meeting room, or at home, with no need for a wired connection.

Wireless WAN

Wireless Wide Area Network (wireless WAN), using cellular networks for data transmission, enables you to establish wireless connections over remote public or private networks. These connections can be maintained over a large geographical area, such as a city or an entire country, by use of multiple antenna sites or satellite systems maintained by wireless service providers.

Note: Wireless WAN service is provided by authorized service providers in some countries.

Some ThinkPad notebook computers come with a built-in wireless WAN card integrating some wireless WAN technologies, such as 1xEV-DO, CDMA, HSPA, HSPA+, 3G or GPRS. By using the built-in wireless WAN card and the configuration utility that comes with your computer, you can establish wireless WAN connections and monitor the status of your connection.

Bluetooth

Bluetooth is one of a number of technologies used to create a wireless personal area network. Bluetooth can connect devices a short distance from one another, and is commonly used for connecting peripheral devices to a computer, transferring data between hand-held devices and a personal computer, or remotely controlling and communicating with devices such as mobile phones.

Tips for using the wireless connection features

To achieve the best connection, use the following guidelines:

- Keep your computer away from your body.
- Place your computer so that there are as few obstacles as possible between the wireless LAN access point and the computer.
- Open your computer display to an angle slightly greater than 90 degrees.
- If you use the wireless feature (the 802.11 standard) of your computer simultaneously with a Bluetooth option, the data transmission speed can be delayed and the performance of the wireless feature can be degraded.

Note: You can purchase a wireless network card as an option from Lenovo at: <http://www.lenovo.com/accessories/services/index.html>.

Using the wireless LAN and wireless WAN features

To enable or disable the wireless features, do one of the following:

- For Windows 7: Press F8 to open the wireless radio switchboard. Turn on or turn off the wireless feature as desired.

- For Windows 8: Press F8 to enable or disable the Airplane mode. When the Airplane mode is enabled, all of your wireless devices are turned off.

To establish a wireless connection, turn on the wireless feature. And then Double-click a network to connect to it. Provide required information if needed.

If you need to connect to different wireless networks in different locations, use the following software to manage multiple network profiles so that the computer connects to an available network automatically when the location changes:

- For Windows 7: Use the Access Connections program. For instructions on how to start the Access Connections program, see “Accessing Lenovo programs on the Windows 7 operating system” on page 16.
- For Windows 8: Open the Lenovo Settings program and click **Location Awareness**. See “Accessing Lenovo programs on the Windows 8 operating system” on page 18.

Attention:

- If you want to use the wireless features on an airplane, check the services with the airline before boarding the airplane.
- If there are restrictions on the use of computer wireless features on an airplane, you need to disable your computer wireless features before boarding. .

To locate the wireless antennas on your computer, see “Location of the UltraConnect wireless antennas” on page 150.

Using Bluetooth

Some models are equipped with a Bluetooth card that is compliant with Bluetooth Specification 4.0.

To enable the Bluetooth feature on the Windows 7 operating system, press F8 to open the wireless radio switchboard. Then turn on the Bluetooth radio. For the Windows 8 operating system, the Bluetooth feature is on by default.

Sending data to a Bluetooth-enabled device

To send data to a Bluetooth-enabled device, do the following:

1. Enable the Bluetooth feature.
2. Right-click the data that you want to send.
3. Select **Send To → Bluetooth Devices**.

To receive the data, click the Bluetooth icon in the Windows notification area, and click **Receive a File**.

For details, refer to the Windows help information system.

Checking the wireless network connection status

You can check your computer wireless network connection status and wireless signal strength through the wireless network connection status icon in the Windows notification area. The more bars encompassed, the better the signal.





For the Windows 7 operating system, you also can check the Access Connections gauge, the Access Connections status icon, or the Access Connections wireless network connection status icon in the Windows notification area.

Access Connections gauge





On the Windows 7 operating system, the Access Connections gauge in the Windows notification area displays the status and signal strength of your wireless connection.

You can find more detailed information about the status and signal strength of your wireless connection by opening the Access Connections program or by right-clicking the Access Connections gauge in the Windows notification area and selecting **View Status of Wireless Connection**.

- Access Connections gauge states: wireless LAN

-  Power to the wireless radio is off or no signal.
-  Power to the wireless radio is on. The signal strength of the wireless connection is poor. To improve the signal strength, move your computer closer to the wireless access point.
-  Power to the wireless radio is on. The signal strength of the wireless connection is marginal.
-  Power to the wireless radio is on. The signal strength of the wireless connection is excellent.

- Access Connections gauge states: wireless WAN

-  No signal
-  Signal level 1
-  Signal level 2
-  Signal level 3



Note: For more information about the Access Connections Gauge, see the Access Connections help information system.

Access Connections status icon

The Access Connections status icon displays general connection status.

Note: To display the Access Connections status icon, click **Show hidden icons** on the taskbar. To add the icons to the taskbar permanently, click **Customize** and proceed to customize the settings. For more information about the icons, see the Access Connections help information system.

- Access Connections status icon states

-  No location profile is active or none exists.
-  Current location profile is disconnected.
-  Current location profile is connected.











Access Connections wireless status icon

The Access Connections wireless status icon displays the status and signal strength of your wireless connection.

You can find more detailed information about the status and signal strength of your wireless connection either by opening the Access Connections program or by double-clicking the Access Connections wireless status icon in the Windows notification area.

- Wireless status icon states: wireless LAN

-  Power to the wireless radio is off.

-  Power to the wireless radio is on. No association.
-  Power to the wireless radio is on. No signal.
-  Power to the wireless radio is on. The signal strength of the wireless connection is excellent.
-  Power to the wireless radio is on. The signal strength of the wireless connection is marginal.
-  Power to the wireless radio is on. The signal strength of the wireless connection is poor. To improve the signal strength, move your computer closer to the wireless access point.
- Wireless status icon states: wireless WAN
 -  Power to the wireless radio is off.
 -  No association
 -  No signal
 -  Signal level 1
 -  Signal level 2
 -  Signal level 3

Note: If you have trouble in making a connection, try moving your computer closer to your wireless access point.

Presentations and multimedia

You can connect your computer to a projector to give presentations or you can connect your computer to an external monitor to expand your workspace.

Changing display settings

You can change the display settings, such as font size.

Changing the font size

To change the font size, do the following:

1. Right-click on the desktop, and click **Personalize**.
2. Click **Display** at the left.
3. Select the desired font size.
4. Click **Apply**. The change will take effect after you log off.

Using an external monitor

Your computer can support a maximum video resolution of up to 2048x1536, provided that the external monitor also supports that resolution. For more information, refer to the manuals provided with your monitor.

You can set any resolution for either the computer display or the external monitor. When you use both at the same time, the resolution of both is the same. If you set a higher resolution for the computer display, you can see only part of the screen at a time. You can see other parts by moving the image with the TrackPoint pointing device or another pointing device.

You can move the display output to the computer display, the external monitor, or both by changing settings in the Display Settings window.

Connecting an external monitor

To connect an external monitor, do the following:

1. Connect the external monitor to the monitor connector; then connect the monitor to an electrical outlet.
2. Turn on the external monitor.
3. Change the display output location by pressing F7. This enables you to switch among viewing output on the external monitor, the computer monitor, and both monitors.

Note: If your computer cannot detect the external monitor, right-click on the desktop, then select **Screen resolution**. Click the **Detect** button.

Setting the monitor type

To set your monitor type, do the following:

1. Connect the external monitor to the monitor connector, and then connect the monitor to an electrical outlet.
2. Turn on the external monitor.
3. Right-click on the desktop, and then click **Screen resolution**.

Note: If your computer cannot detect the external monitor, click the **Detect** button.

4. Click the icon for the desired monitor (the **Monitor-2** icon is for the external monitor).
5. Set **Resolution**.
6. Click **Advanced Settings**.
7. Click the **Monitor** tab. Check the monitor information window to ensure that the monitor type is correct. If it is, click **OK** to close the window; otherwise proceed with the following steps.
8. If more than two monitor types are displayed, select **Generic PnP Monitor** or **Generic Non-PnP Monitor**.
9. Click **Properties**. If you are prompted for an administrator password or confirmation, type the password or provide confirmation.
10. Click the **Driver** tab.
11. Click **Update Driver**.
12. Click **Browse my computer for driver software**, and then click **Let me pick from a list of device drivers on my computer**.
13. Clear the **Show compatible hardware** check box.
14. Select **Manufacturer** and **Model** for your monitor. If you cannot find your monitor on the list, stop the installation of this driver and use the driver shipped with your monitor.
15. After updating the driver, click **Close**.
16. For the Windows 7 operating system, to change the color settings, right-click on the desktop, and click **Screen resolution**. Click **Advanced Settings**, select the **Monitor** tab, and then set **Colors**.
17. Click **OK**.

Considerations for connecting an external monitor

- When installing an operating system, you must install the display driver for your monitor that is supplied with the computer, and the monitor INF file that is supplied with the external monitor.
- If you set a resolution higher than the resolution you are using on the computer monitor, and use an external monitor that does not support that resolution, take advantage of the virtual screen function, which enables you to display only a part of the high-resolution screen image your computer produces. You can see other parts of the image by moving the screen with the TrackPoint pointing device or another pointing device.

- If the external monitor you are using is outdated, the resolution and the refresh rate might be limited.

Using a projector

To make presentations, you can connect a projector to your computer through the VGA connector on your computer.

Note: It might take several seconds before the projector displays the image. If you do not see your desktop displayed after 60 seconds, press F7 to switch among different display output locations.

Your projector might have one or more audio-input connectors. To project sound, you will need to attach the combo audio jack on your computer to these connectors, using an audio cable (commercially available).

Using the Extend desktop function

Your computer supports the Extend desktop function. With the Extend desktop function, you can display output on both the computer display and an external monitor. You also can display different desktop images on each monitor.

You can use the Extend desktop function without changing any settings. If the function does not work, refer to “Enabling the Extend desktop function” on page 41.

Considerations for using the Extend desktop function

- If you want to show DOS full-screen while in Extend desktop mode, only the primary display shows DOS; the other display is blacked out.
- If your computer has the Intel® graphics card, you can designate the primary display by doing the following:
 1. Press Ctrl+Alt+Fn+F12. The Intel CUI window opens.
 2. Select **Extended Desktop**.
 3. Change the setting to designate the primary display.
- If your computer has the AMD® graphics card, you can designate the primary display by doing the following:
 1. Right-click on the desktop and then select **Screen resolution**.
 2. Select **Extend these displays** in **Multiple Displays**.
 3. Change the setting to designate the primary display.
- When a program using DirectDraw or Direct3D is running in full-screen mode, only the primary display shows the output.
- You cannot use the display switching function in Extend desktop mode.

Enabling the Extend desktop function

To enable the Extend desktop function, do the following:

1. Connect the external monitor to the monitor connector; then connect the monitor to an electrical outlet.
2. Turn on the external monitor.
3. Press F7 and select **Extend**.

To change the resolution for each monitor, do the following:

1. Right-click on the desktop, and click **Screen resolution**.
2. Click the **Monitor-1** icon (for the primary display, the computer display).
3. Set the resolution for the primary display.

4. Click the **Monitor-2** icon (for the secondary display, the external display).
5. Set the resolution for the secondary display.
6. Place the icons for the monitors so that they touch.

Note: You can set the monitors in any relative position, but the icons must touch each other.

7. Click **OK** to apply the changes.

To change the color settings, right-click on the desktop, and click **Screen resolution**. Click **Advanced Settings**, select the **Monitor** tab, and then set **Colors**

Using audio features

Your computer is equipped with the following:

- Combo audio jack, 1/8 inch (3.5 mm) in diameter
- Built-in stereo speakers
- Built-in digital microphone

Your computer also has an audio chip that enables you to enjoy various multimedia audio features:

- Compliant with Intel High Definition Audio
- Recording and playback of PCM and WAV files in 16-bit or 24-bit format
- Playback of a WAV file at a sample rate of 44.1KHz to 192 KHz
- Playback of MIDI files through a Wave table synthesizer under Microsoft Windows operating systems
- Playback of MP3 files through the Windows Media Player or a software MP3 player
- Recording from various sound sources

Note: The combo audio jack does not support a conventional microphone.

The following table shows which functions of the audio devices attached to the jacks on your computer or the supported ThinkPad OneLink Dock are supported.

Table 3. Audio feature list

Jack	Headset with a 3.5-mm 4-pole plug	Conventional headphone	Conventional microphone
Combo audio jack	Headphone and microphone functions supported	Headphone function supported	Not supported
Combo audio jack of the supported ThinkPad OneLink Dock	Headphone and microphone functions supported	Headphone function supported	Not supported

Configuring for sound recording

To configure the microphone for optimal sound recording , use the SmartAudio program. To start the program, go to Control Panel and click **Hardware and Sound → SmartAudio**.

Using the integrated camera

If your computer has an integrated camera, you can use the camera to preview your video image and take a snapshot of your current image.

To launch the integrated camera and configure the camera settings, do the following:

- For Windows 7: Open the Communication Utility program.
- For Windows 8: Open the Lenovo Settings program, and click **Camera**.

When the camera is started, the camera status indicator turns on.

You also can use the integrated camera with other programs that provide features such as photographing, video capturing, and video conferencing. To use the integrated camera with other programs, open one of the programs and start the photographing, video capturing, or video conferencing function. Then, the camera will start automatically and the camera status indicator turns on green. For more information about using the camera with a program, refer to the documentation that came with the program.

Using the optical drive

Note: Your computer only supports the Multi-Burner drive.

Multi-Burner drive

This drive can read DVD-ROM discs, DVD-R discs, DVD-RAM discs, DVD-RW discs, and all types of CDs, such as CD-ROM discs, CD-RW discs, CD-R discs, and audio CDs. In addition, it can record on DVD-R discs, DVD-RW discs, type II DVD-RAM discs, CD-RW standard and high speed discs, and CD-R discs.

Using a flash media card

Your computer has one media card reader slot.

The media card reader slot supports the following four types of cards:

- Secure Digital (SD) card
- Secure Digital High-Capacity (SDHC) card
- Secure Digital eXtended-Capacity (SDXC) card
- MultiMediaCard (MMC)

Note: While transferring data to or from a flash media card, such as an SD card, do not put your computer into sleep or hibernation mode before the data transfer is complete; otherwise, your data could become damaged.

Inserting a flash media card

Attention: Before you start installing any of the following cards, touch a metal table or a grounded metal object. This action reduces any static electricity from your body. The static electricity could damage the card.

To insert a flash media card, do the following:

1. Locate the appropriate type of slot for your card. See “Locating computer controls, connectors, and indicators” on page 1.
2. Ensure that the notched edge of the card is facing upward and pointing toward to the card slot.
3. Press the card firmly into the card slot. The card might stop before it is completely installed into the slot.

If plug-and-play feature is not enabled, do the following:

1. Go to Control Panel and click **Hardware and Sound → Device Manager**. If you are prompted for an administrator password or confirmation, type the password or provide confirmation.
2. From the **Action** menu, select **Add legacy hardware**. The Add Hardware Wizard starts.

3. Follow the instructions on the screen.

Removing a flash media card

Attention: Before removing a card, stop the card first. Otherwise, data on the card might be corrupted or lost.

To remove a flash media card, do the following:

1. Click the triangular icon in the Windows notification area to show hidden icons.
2. Right-click the **Safely Remove Hardware and Eject Media** icon.
3. Select the corresponding item to eject the card from the Windows operating system.
4. Press the card to eject it from your computer.
5. Remove the card and store it safely for future use.

Note: If you do not remove the card from your computer after you eject the card from the Windows operating system, the card can no longer be accessed. To access the card, you must remove it once, then insert it again.

Chapter 3. You and your computer

This chapter provides information about accessibility, comfort, and travelling with your computer.

Accessibility and comfort

Good ergonomic practice is important to get the most from your personal computer and to avoid discomfort. Arrange your workplace and the equipment you use to suit your individual needs and the kind of work that you perform. In addition, use healthy work habits to maximize your performance and comfort while using your computer.

The following topics provide information about arranging your work area, setting up your computer equipment, and establishing healthy work habits.

Lenovo is committed to providing the latest information and technology to our customers with disabilities. Refer to our accessibility information which outlines our efforts in this area.

Ergonomic information

Working in the virtual office might mean adapting to frequent changes in your environment. For example, adapting to the surrounding light sources, proper seating, and the placement of your computer hardware can help you improve your performance and achieve greater comfort.

This example shows someone in a conventional setting. Even when not in such a setting, you can follow many of these tips. Develop good habits, and they will serve you well.

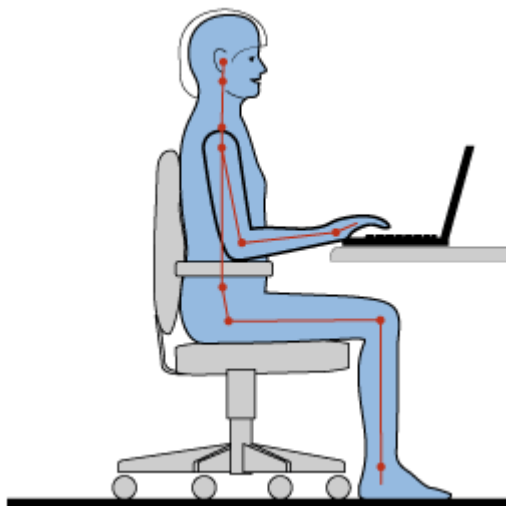

General posture: Make minor modifications in your working posture to deter the onset of discomfort caused by long periods of working in the same position. Frequent, short breaks from your work also help to prevent minor discomfort associated with your working posture.

Display: Position the display to maintain a comfortable viewing distance of 510-760 mm (20-30 inches). Avoid glare or reflections on the display from overhead lighting or outside sources of light. Keep the display screen clean and set the brightness to levels that enable you to see the screen clearly. Press F5 or F6 to adjust display brightness.

Head position: Keep your head and neck in a comfortable and neutral (vertical, or upright) position.

Chair: Use a chair that gives you good back support and seat height adjustment. Use chair adjustments to best suit your desired posture.

Arm and hand position: If available, use chair arm rests or an area on your working surface to provide weight support for your arms. Keep your forearms, wrists, and hands in a relaxed and neutral (horizontal) position. Type with a soft touch without pounding the keys.

Leg position: Keep your thighs parallel to the floor and your feet flat on the floor or on a footrest.

What if you are traveling?

It might not be possible to observe the best ergonomic practices when you are using your computer while on the move or in a casual setting. Regardless of the setting, try to observe as many of the tips as possible. Sitting properly and using adequate lighting, for example, will help you maintain desirable levels of comfort and performance.

Questions about vision?

The visual display screens of ThinkPad notebook computers are designed to meet the highest standards and to provide you with clear, crisp images and large, bright displays that are easy to see, yet easy on the eyes. Of course, any concentrated and sustained visual activity can be tiring. If you have questions on eye fatigue or visual discomfort, consult a vision care specialist for advice.

Comfort

Observe the following guidelines to achieve greater comfort and improve performance.

Active sitting and rest breaks: The longer you sit and work with your computer, the more important it is to observe your working posture. Follow “Ergonomic information” on page 45 and practice “active sitting” to avoid discomfort associated with your working postures. Making minor voluntary postural changes and taking short frequent work breaks are the key ingredients for healthy computing. Your computer is light and mobile; you can easily reposition your working surface to accommodate many posture modifications.

Work area setup options: Familiarize yourself with all of your office furniture so that you know how to adjust your work surface, seat, and other work tools to accommodate your preferences for comfort. If your work area is not in an office setting, be sure to take special note of employing active sitting and taking work breaks. Many ThinkPad product solutions are available to help you modify and expand your computer to best suit your needs. Access the following Web site to view some of these options: <http://www.lenovo.com/accessories/services/index.html>. Explore your options for docking solutions and external products that provide the adjustability and features that you want.

Accessibility information

Lenovo is committed to providing people with disabilities greater access to information and technology. As a result, the following information provides ways to help users that have hearing, vision, and mobility limitations get the most out of their computer experience.

Assistive technologies enable users to access information in the most appropriate way. Some of these technologies are already provided in your operating system. Others can be purchased through vendors, or accessed through the World Wide Web <http://www.lenovo.com/healthycomputing>.

Assistive technologies

Some accessibility technologies are available through the Accessibility Options program. Depending on your operating system, the number of accessibility options available varies. In general, accessibility options enhance the way users with hearing, vision, or mobility limitations navigate and use their computer. For example, some users might not have the fine motor skills required to use a mouse or select key combinations. Other users might require larger fonts or high-contrast display modes. In some cases, magnifiers and built-in speech synthesizers are available. For detailed information about each of these features, consult the Microsoft help information system.

To use the Accessibility Options program, go to Control Panel and click **Ease of Access → Ease of Access Center**.

Screen reader technologies

Screen-reader technologies are primarily focused on software program interfaces, help information systems, and a variety of online documents. However, in the case where a screen reader cannot read documents, the document must first go through a conversion process. One solution converts Adobe PDF files into a format that is read by the screen-reader programs. This solution is a Web-based service provided by Adobe Systems Incorporated. Through <http://access.adobe.com>, Adobe PDF documents can be converted to HTML or plain text in many languages. One conversion option converts PDF documents on the Internet. A second option enables users to submit the URL of an Adobe PDF file through e-mail to convert it to HTML or ASCII text. Adobe PDF files on a local hard disk drive, local CD-ROM, or LAN also can be converted by attaching the Adobe PDF file to an e-mail message.

Traveling with your computer

This topic provides information to help you work with your computer when you are travelling.

Travel tips

Use the following travel tips to travel more confidently and efficiently with your computer.

- Although it is safe to allow your computer to go through the x-ray machines at airport security stations, it is important to keep your eyes on the computer at all times to prevent theft.
- Consider bringing an electrical adapter for use in an airplane or automobile.
- If you carry an ac power adapter, detach the ac cord from it to avoid damaging the cord.

Travel tips on airplanes

If you carry your computer into an airplane, take note of the following tips:

- If you intend to use your computer or wireless services (such as Internet and Bluetooth), check with the airline for restrictions and availability of services before boarding the airplane. If there are restrictions on the use of computers with wireless features on the airplane, you must abide by those restrictions. If necessary, disable wireless features before boarding.
- Be careful about the seat in front of you on airplanes. Angle your computer display so that it does not get caught when the person in front of you leans back.
- When taking off, remember to turn off your computer or put it into hibernation mode.

Travel accessories

The following is a checklist of items to consider packing when you are going to travel:

- ThinkPad ac power adapter
- ThinkPad AC/DC Combo Adapter

- External mouse, if you are accustomed to using one
- Ethernet cable
- Extra battery, charged
- A quality carrying case that provides adequate cushion and protection
- External storage device

If you are traveling to another country, you might want to consider an ac power adapter for the country to which you are travelling.

To purchase travel accessories, go to <http://www.lenovo.com/accessories>.

Chapter 4. Security

This chapter provides information about how to protect your computer from theft and unauthorized use.

- “Attaching a mechanical lock” on page 49
- “Using passwords” on page 49
- “Hard disk security” on page 54
- “Using the fingerprint reader” on page 54
- “Notice on deleting data from your hard disk drive or solid-state drive” on page 56
- “Using firewalls” on page 57
- “Protecting data against viruses” on page 57

Attaching a mechanical lock

You can attach a mechanical lock to your computer, to help prevent it from being removed without your permission.

Attach a mechanical lock to the keyhole of the computer; then secure the chain on the lock to a stationary object. Refer to the instructions shipped with the mechanical lock.

Note: You are responsible for evaluating, selecting, and implementing the locking device and security feature. Lenovo makes no comments, judgments, or warranties about the function, quality, or performance of the locking device and security feature.

Using passwords

By using passwords, you can help prevent your computer from being used by others. Once you set a password, a prompt is displayed on the screen each time you turn on the computer. Enter your password at the prompt. You cannot use the computer unless you type the correct password.

Passwords and sleep mode

If you have set passwords and you put your computer into sleep mode, the procedure for resuming operation is as follows:

- You are not prompted to type the password when resuming operation.
- If any hard disk drive or solid-state drive has a password, it is unlocked automatically when you resume operation.

Note: If a Windows password has been set, you will be prompted to enter it.

Typing passwords



If this icon is displayed, type a power-on password or a supervisor password.



If this icon is displayed, type a user hard disk password. If you want to type a master hard disk password, do the following:

1. Press Fn+F1. The icon changes to this: 

2. Type the master hard disk password.



Note: To return to the icon , press Fn+F1 again.

Note: Press the Backspace key if you enter a wrong password while you are typing your password.

Power-on password

You can set a power-on password to help protect your computer against access by unauthorized users.

If you set a power-on password, the password prompt is displayed on the screen whenever you turn on the computer. You must enter the correct password to start using the computer.

Setting a power-on password

1. Print these instructions.
2. Save all open files, and exit all programs.
3. Turn your computer off and then turn it on again.
4. When the logo screen is displayed, press F1. The ThinkPad Setup program main menu opens.
5. Select **Security**, using the cursor directional keys to move down the menu.
6. Select **Password**.
7. Select **Power-on Password**.
8. In the **Enter New Password** field, type a desired password, and press Enter.
9. In the **Confirm New Password** field, retype the password and press Enter.

Note: You might want to record your password and store it in a safe place. Otherwise, if you forget it, you have to take your computer to a Lenovo reseller or a marketing representative to have the password canceled.

10. In the Setup Notice window that is displayed, press Enter to continue.
11. Press Fn+F10. The Setup Confirmation window opens. Select **Yes** to save configuration changes and exit.

Changing or removing the power-on password

To change the power-on password, follow steps 1 through 7. Enter your current password. When the **Enter New Password** field is displayed, type a new password in the field and then retype it to verify. To remove the password, follow steps 1 through 7. Type your current password. When the **Enter New Password** field is displayed, leave it blank and press Enter twice.

Hard disk passwords

Two types of hard disk passwords help protect the information stored on the hard disk drive:

- User hard disk password
- Master hard disk password, which requires a user hard disk password

If a user hard disk password has been set, but no master hard disk password has been, the user must enter the user hard disk password in order to gain access to files and programs on the hard disk drive.

The master password can be set and used only by a system administrator. Like a master key, it enables the administrator to get access to any hard disk drive in a system. The administrator sets the master password; no one else knows it. Then the administrator sets a user password for each computer in the network, and

tells each user the password for his or her computer. The user can then change the user password as desired, but the administrator still can get access by using the master password.

Note: When a master hard disk password is set, only the administrator can remove the user hard disk password.

Setting a hard disk password

1. Print these instructions.
2. Save all open files, and exit all programs.
3. Turn your computer off and then on again.
4. When the logo screen is displayed, press F1. The ThinkPad Setup program main menu opens.
5. Select **Security**, using the cursor directional keys to move down the menu.
6. Select **Password**.
7. Select **Hard Disk 1 Password**.
8. A password window opens. You are prompted to select **User** or **User + Master**. Select **User** if you want to set only one hard disk password. If you are an administrator or supervisor, you can select **User + Master** to set two passwords. (The user can change the user password later.)
 - If you select **User + Master**, do the following:
 - a. When a window for typing the new user hard disk password opens, type your new password in the **Enter New Password** field. Press Enter.
 - b. In the **Confirm New Password** field, retype the password you just entered to verify it. Press Enter.
 - c. A message window opens and prompts you to set the master hard disk password. Press Enter to continue.
 - d. A window for typing the new master hard disk password opens. Type your new password in the **Enter New Password** field. Press Enter.
 - e. In the **Confirm New Password** field, retype the password you just entered to verify it. Press Enter.
 - If you select **User** only, do the following:
 - a. When a window for typing the new password opens, type your new password in the **Enter New Password** field. Press Enter.

Notes:

- You can set the minimum length of a hard disk password through the **Security** menu.
 - If you set a hard disk password of over seven characters, the hard disk drive can be used only with a computer that can recognize a hard disk password of over seven characters. If you then install the hard disk drive in a computer that cannot recognize a hard disk password that contains more than seven characters, you cannot get access to the drive.
- b. In the **Confirm New Password** field, retype the password you just entered to verify it. Press Enter.

Attention: You might want to note down your passwords and keep them in a safe place. Otherwise, if you forget the user password, or both user and master passwords, Lenovo cannot reset your passwords or recover data from the hard disk drive. You must take your computer to a Lenovo reseller or a marketing representative to have the hard disk drive replaced. Proof of purchase is required, and a fee will be charged for parts and service.

9. In the Setup Notice window that is displayed, press Enter to continue.
10. Press Fn+F10. The Setup Confirmation window opens. Select **Yes** to save configuration changes and exit.

The next time you turn on your computer, you will have to type the user or master hard disk password in order to start your computer and get access to your operating system.

Changing or removing a hard disk password

Follow steps 1 through 7 in “Setting a hard disk password” on page 51, typing your password to get access to the ThinkPad Setup program.

To change or remove the user hard disk password, do the following:

- To change the hard disk password, type the current password in the **Enter Current Password** field. Then type the new password in the **Enter New Password** field, and retype the password you just entered to verify it in the **Confirm New Password** field. Press Enter, and a Setup Notice window is displayed. Press Enter to exit from the Setup Notice window. The user hard disk password will be changed.
- To remove the hard disk password, type the current password in the **Enter Current Password** field. Then leave the **Enter New Password** and **Confirm New Password** fields blank, and press Enter. A Setup Notice window is displayed. Press Enter to exit from the Setup Notice window. The user hard disk password will be removed.

To change or remove the **User + Master** hard disk passwords, select **User HDP** or **Master HDP**.

If you choose **User HDP**, do the following:

- To change the user hard disk password, type the current user hard disk password or the current master hard disk password in the **Enter Current Password** field. Then type the new user hard disk password in the **Enter New Password** field, and retype the password you just entered to verify it in the **Confirm New Password** field. Press Enter, and a Setup Notice window is displayed. Press Enter to exit from the Setup Notice window. The user hard disk password is changed.
- To remove the user hard disk password, type the current master hard disk password in the **Enter Current Password** field. Then leave the **Enter New Password** and **Confirm New Password** fields blank, and press Enter. A Setup Notice window is displayed. Press Enter to exit from the Setup Notice window. Both the user and master hard disk passwords will be removed.

If you choose **Master HDP**, do the following:

- To change the master hard disk password, type the current master hard disk password in the **Enter Current Password** field. Then type the new master hard disk password in the **Enter New Password** field, and retype the password you just entered to verify it in the **Confirm New Password** field. Press Enter, and a Setup Notice window is displayed. Press Enter to exit from the Setup Notice window. The master hard disk password is changed.
- To remove the master hard disk password, type the current master hard disk password in the **Enter Current Password** field. Then leave the **Enter New Password** and **Confirm New Password** fields blank, and press Enter. A Setup Notice window is displayed. Press Enter to exit from the Setup Notice window. Both the user and master hard disk passwords will be removed.

Supervisor password

The supervisor password protects the system information stored in ThinkPad Setup. Without it, no one can change the configuration of the computer. It provides the following security features:

- If a supervisor password is set, a password prompt is displayed when you try to start the ThinkPad Setup program. Unauthorized users cannot get access to configuration data.
- The system administrator can use the supervisor password to get access to a computer even if the user of that computer has set a power-on password. The supervisor password overrides the power-on password.
- If both a supervisor password and a power-on password are set, you can do the following only if you have the supervisor password:

- Deleting the power-on password
- Changing or deleting the supervisor password
- Enabling or disabling the Wake on LAN and Flash over LAN features
- Enabling or disabling the Internal Network Option ROM feature
- Changing date and time
- Enabling or disabling the Lock UEFI BIOS Settings feature
- Enabling or disabling the Password at unattended boot feature
- Specifying the minimum length for power-on passwords and hard disk passwords
- Enabling or disabling the Boot Device List F12 Option feature
- Enabling or disabling the Boot Order Lock feature
- Enabling or disabling the Flash BIOS Updating by End-Users feature
- Enabling or disabling the internal network device
- Enabling or disabling the internal wireless device
- Enabling or disabling the internal Bluetooth device
- Enabling or disabling the internal wireless WAN device
- Enabling or disabling the Security mode
- Enabling or disabling the fingerprint reader priority
- Erasing the fingerprint data

Notes:

- The system administrator can set the same supervisor password on many ThinkPad notebook computers to make administration easier.
- By enabling the Lock UEFI BIOS Settings feature on the **Password** menu when you set the supervisor password, you make it impossible for anyone but you to make changes.

Setting, changing, or removing a supervisor password

Only a system administrator can set, change, or remove a supervisor password.

To set, change, or remove a supervisor password, do the following:

1. Print these instructions.
2. Save all open files, and exit all programs.
3. Turn your computer off and then turn it on again.
4. When the logo screen is displayed, press F1. The ThinkPad Setup program main menu opens.
5. Select **Security**, using the cursor directional keys to move down the menu.
6. Select **Password**.
7. Select **Supervisor Password**.
8. A window opens, prompting you to enter a new password. Depending on your needs, do one of the following:
 - To set a password, do the following:
 - a. In the **Enter New Password** field, type a desired password and press Enter.
 - b. In the **Confirm New Password** field, retype the password and press Enter.
 - To change a password, do the following:
 - a. In the **Enter Current Password** field, type the current supervisor password and press Enter.

- b. In the **Enter New Password** field, type the new supervisor password; then retype the password you just entered to verify it in the **Confirm New Password** field. Press Enter.
- To remove a password, do the following:
 - a. In the **Enter Current Password** field, type the current supervisor password and press Enter.
 - b. Leave the **Enter New Password** and **Confirm New Password** fields blank. Press Enter.

Attention: You might want to note down your password and keep it in a safe place. If you forget your supervisor password, Lenovo cannot reset your password. You must take your computer to a Lenovo reseller or a Lenovo marketing representative to have the system board replaced. Proof of purchase is required, and a fee will be charged for parts and service.

- 9. In the Setup Notice window that is displayed, press Enter to continue.
- 10. Press Fn+F10. The Setup Confirmation window opens. Select **Yes** to save configuration changes and exit.

The next time you open the ThinkPad Setup program, you will be prompted to type your password to proceed.

Hard disk security

To protect passwords from unauthorized security attacks, several of the latest technologies and algorithms are integrated into UEFI BIOS and hardware design of ThinkPad notebook computers.

To maximize security, do the following:

1. Set a power-on password as well as a hard disk password for your internal solid-state drive or hard disk drive. Refer to the procedures in “Power-on password” on page 50 and “Hard disk passwords” on page 50. For security, a longer password is recommended.
2. If a Disk Encryption hard disk drive or a Disk Encryption solid-state drive is installed in your computer, be sure to protect the contents of your computer memory from unauthorized access by use of drive encryption software.
3. Before you dispose of, sell, or hand over your computer, be sure to delete data stored on it. Refer to “Notice on deleting data from your hard disk drive or solid-state drive” on page 56.

Note: The hard disk drive built into your computer can be protected by UEFI BIOS.

Disk Encryption hard disk drive and Encryption solid-state drive

Some models contain the Disk Encryption hard disk drive or Encryption solid-state drive. This feature helps to protect your computer against security attacks on media, NAND flash or device controllers by use of a hardware encryption chip. For the efficient use of the encryption feature, be sure to set a hard disk password for the internal storage device.

Using the fingerprint reader

Your computer might have an integrated fingerprint reader. Fingerprint authentication can replace passwords and enable simple and secure user access. By enrolling your fingerprint and associating it with a Windows password, you can log on to the computer by swiping your finger over the reader, without typing passwords.

Enrolling your fingerprint

To use the integrated fingerprint reader, begin by enrolling your fingerprint as follows:

1. Turn on your computer.
- 2.

- For Windows 7: To start Lenovo Fingerprint software, refer to “Accessing Lenovo programs on the Windows 7 operating system” on page 16.
 - For Windows 8: To start Lenovo Fingerprint software, refer to “Accessing Lenovo programs on the Windows 8 operating system” on page 18.
3. Follow the instructions on the screen to enroll your fingerprint. For details, refer to the help information system for the program.

Swiping your finger over the reader

To swipe your finger over the reader, do the following:

1. Place the ball of your finger (the central part of the fingerprint) on the small circle above the reader. Make sure that the entire top joint of the finger is on the reader.

Note: Your computer keyboard might look different from the illustration above.

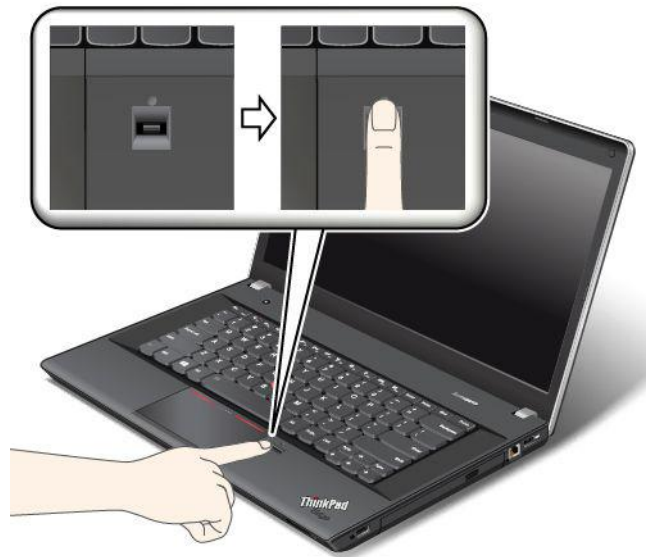

2. Apply light pressure and swipe your finger across the reader in one smooth motion.

Note: Your computer keyboard might look different from the illustration above.

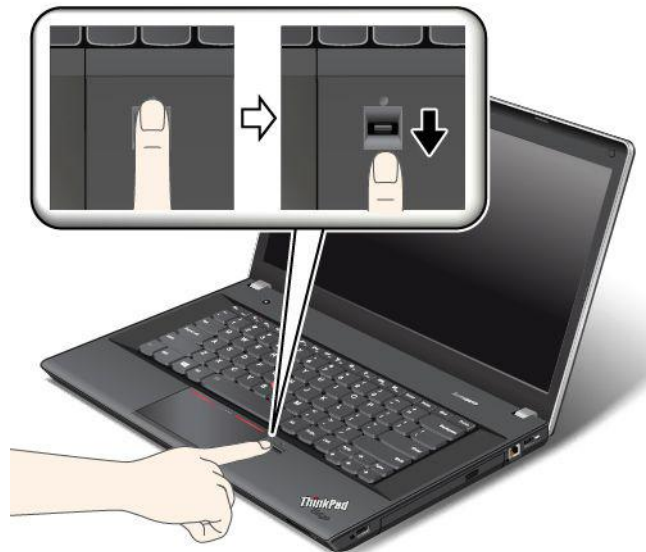

Maintaining the fingerprint reader

The following actions could damage the fingerprint reader or cause it not to work properly:

- Scratching the surface of the reader with a hard, pointed object.
- Scraping the surface of the reader with your fingernail or anything hard.
- Using or touching the reader with a dirty finger.

If you notice any of the following conditions, gently clean the surface of the reader with a dry, soft, lint-free cloth:

- The surface of the reader is dirty or stained.
- The surface of the reader is wet.
- The reader often fails to enroll or authenticate your fingerprint.

If your finger has any of the following conditions, you might not be able to register or authenticate it:

- Your finger is wrinkled.
- Your finger is rough, dry, or injured.
- Your finger is very dry.
- Your finger is stained with dirt, mud, or oil.
- The surface of your finger is very different from when you enrolled your fingerprint.
- Your finger is wet.
- A finger that has not been enrolled is used.

To improve the situation, try the following:

- Clean or wipe your hands to remove any excess dirt or moisture from the fingers.
- Enroll and use a different finger for authentication.
- If your hands are too dry, apply lotion to them.

Notice on deleting data from your hard disk drive or solid-state drive

As computers spread into every corner of life, they process more and more information. The data on your computer, some of which might be sensitive, is stored on a hard disk drive or solid-state drive. Before you dispose of, sell, or hand over your computer, be sure to delete data stored on it.

Handing your computer over to someone else without deleting the loaded software, such as operating systems and program software, might even violate license agreements. You are advised to check the terms and conditions of those license agreements.

There are methods that seem to delete the data:

- Move the data to the recycle bin, and then click **Empty recycle bin**.
- Use the **Delete** option.
- Format your hard disk drive or solid-state drive, using the software for initializing it.
- Using the recovery program to bring the hard disk drive or solid-state drive back to the factory default settings.

These operations, however, only change the file allocation of the data; they do not delete the data itself. In other words, the data retrieval processing is disabled under an operating system such as Windows. The data is still there, even though it seems to be lost. Thus, it is sometimes possible to read the data by use of

special software for data recovery. There is a risk that people of bad faith might read and misuse the critical data on hard disk drives or solid-state drives for unexpected purposes.

To prevent leakage of data, it becomes very important that you take responsibility for deleting all the data from the hard disk drive or solid-state drive when you dispose of, sell, or hand over your computer. You can destroy the data physically by smashing the hard disk drive or solid-state drive with a hammer, or magnetically by means of strong magnetic power, thus making the data unreadable. But we recommend that you make use of the software (payware) or service (pay service) specifically developed for the purpose.

For disposing of data on the hard disk drive or solid-state drive, Lenovo provides the Secure Data Disposal tool. To download the program, go to:
<http://www.lenovo.com/support>

Note: Running either program will take a couple of hours.

Using firewalls

If your system is preinstalled with a firewall program, it protects against computer Internet security threats, unauthorized access, intrusions, and Internet attacks. It also protects your privacy.

For more information about how to use the firewall program, refer to the help information system that comes with the program.

Protecting data against viruses

Your computer is preinstalled with an antivirus program so you can detect and eliminate viruses. The antivirus program is designed to help you detect and eliminate viruses.

Lenovo provides a full version of antivirus software on your computer with a free 30-day subscription. After 30 days, you must renew the license to continue receiving the antivirus software updates.

For more information about how to use your antivirus software, refer to the help information system of your antivirus software.

Chapter 5. Recovery overview

This chapter provides information about the recovery solutions provided by Lenovo.

- “Recovery overview for Windows 7 models” on page 59
- “Recovery overview for Windows 8 models” on page 64

Recovery overview for Windows 7 models

This section provides information about the recovery solutions provided by Lenovo on the Windows 7 operating system.

Notes:

1. There are a variety of methods to choose from when considering how to recover in the event of a software- or hardware-related problem. Some methods vary depending on the type of your operating system.
2. The product on the recovery media might be used only for the following purposes:
 - Restore the product preinstalled on your computer
 - Reinstall the product
 - Modify the product using the Additional Files

Notes: To prevent potential performance risks or unexpected behavior that might be caused by the new hard disk drive technology, it is recommended that you use one of the following back-up software programs:

- Lenovo OneKey Recovery Pro
- Symantec Norton Ghost version 15 or later

Notes: To use this program, do the following:

1. Click **Start → Run**. The Run window opens.
 2. Type `cmd` in the field. Then click **OK**.
 3. Type `ghost -align=1mb` and press Enter.
- Acronis True Image 2010 or later
 - Paragon Backup & Recovery 10 Suit or later, Paragon Backup & Recovery 10 Home or later

Creating and using a recovery media

You can use recovery media to restore the hard disk drive to the factory default settings. Recovery media are useful if you transfer the computer to another area, sell the computer, recycle the computer, or put the computer in an operational state after all other methods of recovery have failed. As a precautionary measure, it is important to create recovery media as early as possible.

Note: The recovery operations you can perform using recovery media vary depending on the operating system from which the recovery media were created. The recovery media might contain a boot medium and a data medium. Your Microsoft Windows license permits you to create only one data medium, so it is important that you store the recovery media in a safe place after you have made them.

Creating recovery media

This section provides instructions on how to create recovery media.

Note: You can create recovery media using discs or external USB storage devices.

To create recovery media, click **Start → All Programs → Lenovo ThinkVantage Tools → Factory Recovery Disks**. Then, follow the instructions on the screen.

Using recovery media

This section provides instructions on how to use recovery media on different operating systems.

- You can use recovery media to restore the computer to the factory default settings only. You can use recovery media to put the computer in an operational state after all other methods of recovery have failed.

Attention: When you use recovery media to restore the computer to the factory default settings, all the files currently on the hard disk drive will be deleted and replaced by the factory default settings.

To use recovery media, do the following:

1. Depending on the type of your recovery media, connect the boot medium (memory key or other USB storage device) to the computer, or insert the boot disc into the optical drive.
2. Repeatedly press and release the F12 key when turning on the computer. When the Boot Menu window opens, release the F12 key.
3. Select the desired startup device and press Enter. The restore process begins.
4. Follow the instructions on the screen to complete the operation.

Notes:

1. After restoring your computer to the factory default settings, you might have to reinstall device drivers for some devices. See “Reinstalling preinstalled programs and device drivers” on page 63.
2. Some computers come with Microsoft Office or Microsoft Works preinstalled. If you need to recover or reinstall your Microsoft Office or Microsoft Works programs, you must use the *Microsoft Office CD* or *Microsoft Works CD*. These discs are provided only with computers preinstalled with Microsoft Office or Microsoft Works.

Performing backup and recovery operations

The OneKey Recovery Pro program enables you to back up all your hard disk drive contents including the operating system, data files, software programs, and personal settings. You can designate where the OneKey Recovery Pro program stores the backup:

- In a protected area of your hard disk drive
- On the secondary hard disk drive if a secondary hard disk drive is installed in your computer
- On an attached external USB hard disk drive
- On a network drive
- On recordable discs (a recordable optical drive is required for this option)

After you have backed up the contents on the hard disk drive, you can restore the complete contents of the hard disk drive, restore only the selected files, or restore only the Windows operating system and programs.

Performing a backup operation

This section provides instructions on how to perform a backup operation using the OneKey Recovery Pro program.

1. From the Windows desktop, click **Start → All Programs → Lenovo ThinkVantage Tools → Enhanced Backup and Restore**. The OneKey Recovery Pro program opens.
2. In the OneKey Recovery Pro main window, click the **Launch advanced OneKey Recovery Pro** arrow.
3. Click **Back up your hard drive** and select backup operation options. Then, follow the instructions on the screen to complete the backup operation.

Performing a recovery operation

This section provides instructions on how to perform a recovery operation using the OneKey Recovery Pro program.

1. From the Windows desktop, click **Start → All Programs → Lenovo ThinkVantage Tools → Enhanced Backup and Restore**. The OneKey Recovery Pro program opens.
2. In the OneKey Recovery Pro program main window, click the **Launch advanced OneKey Recovery Pro** arrow.
3. Click the **Restore your system from a backup** icon.
4. Follow the instructions on the screen to complete the recovery operation.

For more information about performing a recovery operation from the OneKey Recovery Pro workspace, see “Using the OneKey Recovery Pro workspace” on page 61.

Using the OneKey Recovery Pro workspace

The OneKey Recovery Pro workspace resides in a protected, hidden area of your hard disk drive that operates independently from the Windows operating system. This enables you to perform recovery operations even if you cannot start the Windows operating system. You can perform the following recovery operations from the OneKey Recovery Pro workspace:

- **Rescue files from your hard disk drive or from a backup**

The OneKey Recovery Pro workspace enables you to locate files on your hard disk drive and transfer them to a network drive or other recordable media, such as a USB device or a disc. This solution is available even if you did not back up your files or if changes were made to the files since your last backup operation. You also can rescue individual files from a OneKey Recovery Pro backup located on your local hard disk drive, a USB device, or a network drive.

- **Restore your hard disk drive from a OneKey Recovery Pro backup**

If you have backed up your hard disk drive using the OneKey Recovery Pro program, you can restore the hard disk drive from a OneKey Recovery Pro backup, even if you cannot start the Windows operating system.

- **Restore your hard disk drive to the factory default settings**

The OneKey Recovery Pro workspace enables you to restore the complete contents of your hard disk drive to the factory default settings. If you have multiple partitions on your hard disk drive, you have the option to restore the factory default settings to the C: partition and leave the other partitions intact. Because the OneKey Recovery Pro workspace operates independently from the Windows operating system, you can restore the factory default settings even if you cannot start the Windows operating system.

Attention: If you restore the hard disk drive from a OneKey Recovery Pro backup or restore the hard disk drive to the factory default settings, all files on the primary hard disk drive partition (usually drive C:) will be deleted in the recovery process. If possible, make copies of important files. If you are unable to start the Windows operating system, you can use the rescue files feature of the OneKey Recovery Pro workspace to copy files from your hard disk drive to other media.

To start the OneKey Recovery Pro workspace, do the following:

1. Make sure that the computer is turned off.
2. Repeatedly press and release the F11 key when turning on the computer. When you hear beeps or see a logo screen, release the F11 key.
3. If you have set a OneKey Recovery Pro password, type your password when prompted. The OneKey Recovery Pro workspace opens after a short delay.

Note: If the OneKey Recovery Pro workspace fails to open, see “Solving recovery problems” on page 63.

4. Do one of the following:

- To rescue files from your hard disk drive or from a backup, click **Rescue files** and follow the instructions on the screen.
- To restore your hard disk drive from a OneKey Recovery Pro backup or to restore your hard disk drive to the factory default settings, click **Restore your system** and follow the instructions on the screen.

For more information about the features of the OneKey Recovery Pro workspace, click **Help**.

Notes:

1. After restoring your hard disk drive to the factory default settings, you might have to reinstall device drivers for some devices. See “Reinstalling preinstalled programs and device drivers” on page 63.
2. Some computers come with Microsoft Office or Microsoft Works preinstalled. If you need to recover or reinstall your Microsoft Office or Microsoft Works programs, you must use the *Microsoft Office CD* or *Microsoft Works CD*. These discs are provided only with computers preinstalled with Microsoft Office or Microsoft Works.

Creating and using a rescue medium

With a rescue medium, such as a disc or a USB hard disk drive, you can recover the computer from failures that prevent you from gaining access to the OneKey Recovery Pro workspace on your hard disk drive.

Notes:

1. The recovery operations you can perform using a rescue medium vary depending on the operating system.
2. The rescue disc can be started in all types of optical drives.

Creating a rescue medium

This section provides instructions on how to create a rescue medium.

1. From the Windows desktop, click **Start → All Programs → Lenovo ThinkVantage Tools → Enhanced Backup and Restore**. The OneKey Recovery Pro program opens.
2. In the OneKey Recovery Pro main window, click the **Launch advanced OneKey Recovery Pro** arrow.
3. Click the **Create Rescue Media** icon. The Create OneKey Recovery Pro Media window opens.
4. In the **Rescue Media** area, select the type of the rescue medium you want to create. You can create a rescue medium using a disc, a USB hard disk drive, or a secondary internal hard disk drive.
5. Click **OK** and follow the instructions on the screen to create a rescue medium.

Using a rescue medium

This section provides instructions on how to use the rescue medium you have created.

- If you have created a rescue medium using a disc, use the following instructions to use the rescue medium:
 1. Turn off your computer.
 2. Repeatedly press and release the F12 key when turning on the computer. When the Boot Menu window opens, release the F12 key.
 3. In the Boot Menu window, select the desired optical drive as the first boot device. Then, insert the rescue disc into the optical drive and press Enter. The rescue medium starts.
- If you have created a rescue medium using a USB hard disk drive, use the following instructions to use the rescue medium:
 1. Attach the USB hard disk drive to one of the USB connectors on your computer.
 2. Repeatedly press and release the F12 key when turning on the computer. When the Boot Menu window opens, release the F12 key.

3. In the Boot Menu window, select the USB hard disk drive as the first boot device and press Enter. The rescue medium starts.

When the rescue medium starts, the OneKey Recovery Pro workspace opens. The help information for each feature is available from the OneKey Recovery Pro workspace. Follow the instructions to complete the recovery process.

Reinstalling preinstalled programs and device drivers

Your computer has provisions that enable you to reinstall selected factory-installed programs and device drivers.

Reinstalling preinstalled programs

To reinstall selected programs, do the following:

1. Turn on your computer.
2. Go to the C:\SWTOOLS directory.
3. Open the APPS folder. In it are several subfolders named for the various preinstalled programs.
4. Open the subfolder for the program you are reinstalling.
5. Double-click **Setup**, and then follow the on-screen steps to reinstall the program.

Reinstalling preinstalled device drivers

Attention: When you reinstall device drivers, you are changing the current configuration of your computer. Reinstall device drivers only when it is necessary to correct a problem with your computer.

To reinstall a device driver for a factory-installed device, do the following:

1. Turn on your computer.
2. Go to the C:\SWTOOLS directory.
3. Open the DRIVERS folder. Within the DRIVERS folder are several subfolders named for the various devices installed in your computer (for example, AUDIO and VIDEO).
4. Open the subfolder for the device.
5. Reinstall the device driver by one of the following methods:
 - In the subfolder for the device, look for a text file (a file with the extension .txt). The text file contains information on how to reinstall that device driver.
 - If the subfolder for the device contains a file of setup information (a file with the extension .inf), you can use the Add New Hardware program (in the Windows Control Panel) to reinstall the device driver. Not all device drivers can be reinstalled by use of this program. In the Add New Hardware program, when prompted for the device driver you want to install, click **Have Disk** and **Browse**. Then select the device driver file from the device subfolder.
 - In the subfolder for the device, look for the executable file (a file with the extension .exe). Double-click the file, and follow the instructions on the screen.

Attention: If you need updated device drivers, do not download them from the Windows Update Web site. Obtain them from Lenovo. For more information, see “Making sure device drivers are current” on page 120.

Solving recovery problems

If you are unable to access the OneKey Recovery Pro workspace or the Windows environment, do one of the following:

- Use a rescue medium to start the OneKey Recovery Pro workspace. See “Creating and using a rescue medium” on page 62.

- Use recovery media if all other methods of recovery have failed and you need to restore the hard disk drive to the factory default settings. See “Creating and using a recovery media” on page 59.

Note: If you are unable to access the OneKey Recovery Pro workspace or the Windows environment from a rescue medium or recovery media, you might not have the rescue device (an internal hard disk drive, a disc, a USB hard disk drive, or other external devices) set as the first boot device in the startup device sequence. You must first make sure that your rescue device is set as the first boot device in the startup device sequence in the ThinkPad Setup program. See “Startup menu” on page 114 for detailed information about temporarily or permanently changing the startup device sequence.

It is important to create a rescue medium and a set of recovery media as early as possible and store them in a safe place for future use.

Recovery overview for Windows 8 models

This section provides information about the recovery solutions provided on computers preinstalled with the Windows 8 operating system.

Refreshing your computer

If your computer does not perform well and the problem might be caused by a recently installed program, you can refresh your computer without losing your personal files or changing your settings.

Attention: If you refresh your computer, the programs that came with your computer and the programs that you installed from Windows Store will be reinstalled, but all other programs will be removed.

To refresh your computer, do the following:

1. Move your cursor to the bottom right corner of the screen to bring up the charms. Click **Settings** → **Change PC settings** → **General**.
2. In the **Refresh your PC without affecting your files** section, click **Get started**.

Resetting your computer to the factory default settings

You can reset your computer to the factory default settings. Resetting the computer will reinstall the operating system, and reinstall all the programs and settings that came with your computer.

Attention: If you reset your computer, all your personal files and settings will be deleted. To avoid data loss, make a backup copy of all the data that you want to keep.

To reset your computer, do the following:

1. Move your cursor to the bottom right corner of the screen to bring up the charms. Click **Settings** → **Change PC settings** → **General**.
2. In the **Remove everything and reinstall Windows** section, click **Get started**.

Advanced startup options

Advanced startup options enable you to change the startup settings of your Windows operating system, start the computer from an external device, or restore the Windows operating system from a system image.

To use the advanced startup options, do the following:

1. Move your cursor to the bottom right corner of the screen to bring up the charms. Click **Settings** → **Change PC settings** → **General**.
2. In the **Advanced startup** section, click **Restart now** → **Troubleshoot** → **Advanced options**.
3. Restart your computer following the instructions on the screen.

For more details about the recovery solutions provided on computers preinstalled with the Windows 8 operating system, refer to the help information system of the Windows 8 operating system.

Chapter 6. Replacing devices

This chapter provides instructions on how to install or replace hardware for your computer.

- “Static electricity prevention” on page 67
- “Replacing the battery” on page 67
- “Replacing the SIM card” on page 69
- “Replacing the keyboard” on page 70
- “Replacing the hard disk drive or solid-state drive” on page 82
- “Replacing the optical drive” on page 85
- “Replacing a wireless LAN card” on page 89
- “Replacing a wireless WAN card” on page 92
- “Replacing a memory module” on page 94
- “Replacing the backup battery” on page 96

Static electricity prevention

Static electricity, although harmless to you, can seriously damage computer components and options. Improper handling of static-sensitive parts can cause damage to the part. When you unpack an option or a CRU, do not open the static-protective package containing the part until the instructions direct you to install it.

When you handle options or CRUs, or perform any work inside the computer, take the following precautions to avoid static-electricity damage:

- Limit your movement. Movement can cause static electricity to build up around you.
- Always handle components carefully. Handle adapters, memory modules, and other circuit boards by the edges. Never touch exposed circuitry.
- Prevent others from touching components.
- When you install a static-sensitive option or CRU, touch the static-protective package containing the part to a metal expansion-slot cover or other unpainted metal surface on the computer for at least two seconds. This reduces static electricity from the package and your body.
- When possible, remove the static-sensitive part from the static-protective packaging and install the part without setting it down. When this is not possible, place the static-protective packaging on a smooth, level surface and place the part on it.
- Do not place the part on the computer cover or other metal surface.

Replacing the battery

Before you start, print these instructions.

This system supports only batteries specially designed for this specific system and manufactured by Lenovo or an authorized builder. The system does not support unauthorized batteries or batteries designed for other systems. If an unauthorized battery or a battery designed for another system is installed, the system will not charge.

Attention: Lenovo has no responsibility for the performance or safety of unauthorized batteries, and provides no warranties for failures or damage arising out of their use.

Note: If an unauthorized battery is installed, the following message will be displayed: “The battery installed is not supported by this system and will not charge. Please replace the battery with the correct Lenovo battery for this system.”

 **DANGER**

If the rechargeable battery pack is incorrectly replaced, there is danger of an explosion. The battery pack contains a small amount of harmful substances. To avoid possible injury:

- **Replace only with a battery of the type recommended by Lenovo.**
- **Keep the battery pack away from fire.**
- **Do not expose it to excessive heat.**
- **Do not expose it to water or rain.**
- **Do not short-circuit it.**
- **Do not drop, crush, puncture, or subject to strong forces. Battery abuse or mishandling can cause the battery to overheat, which can cause gasses or flame to “vent” from the battery pack or coin cell.**

To replace the battery, do the following:

1. Turn off the computer, or enter hibernation mode. Then disconnect the ac power adapter and all cables from the computer.
2. Close the computer display, and turn the computer over.
3. Unlock the battery latch **1**. Holding the battery lock lever in the unlocked position and remove the battery pack **2**.

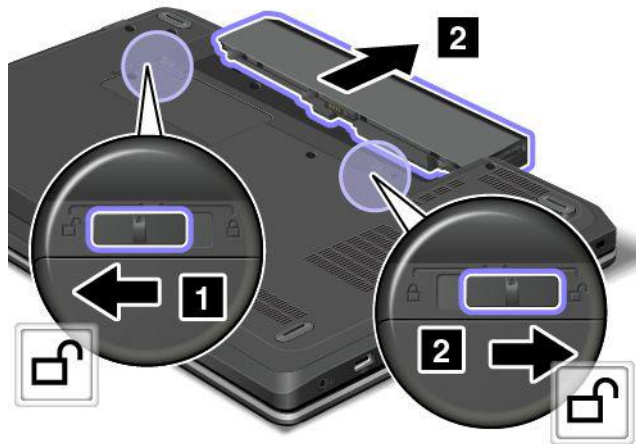

4. Insert a new battery until it clicks into place **1**, and then slide the battery latch to the locked position **2**.

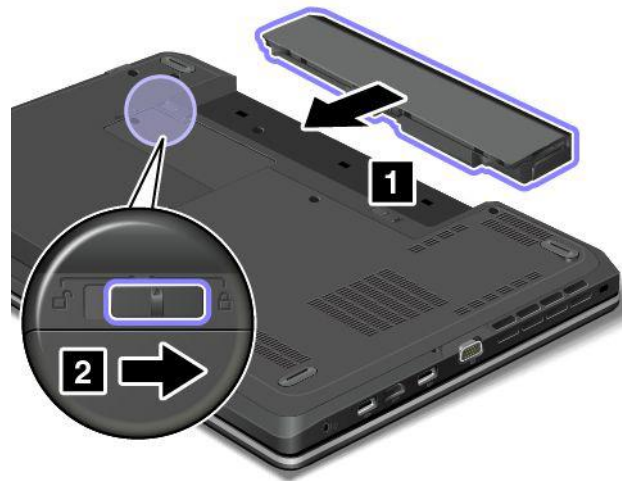

5. Turn the computer over again. Connect the ac power adapter and all cables.

Replacing the SIM card

Before you start, print these instructions.

If your computer is equipped with a SIM card slot, your computer might require a SIM card to establish wireless WAN connections. Depending on the country of delivery, you might need to purchase a SIM card or a SIM card might already be installed in your computer or is part of the shipping contents that come with your computer.

If you find a SIM card included in the shipping contents, a dummy card is installed in the SIM card slot.

Note: The SIM card is identified by the IC chip mounted on one side of the card.

To replace the SIM card, do the following:

1. Turn off the computer; then disconnect the ac power adapter and all cables from the computer. Wait three to five minutes to let the computer cool.
2. Close the computer display, and turn it over.
3. Remove the battery. See “Replacing the battery” on page 67.

4. Locate the SIM card slot inside the battery compartment. Gently push the card to remove it from the computer.

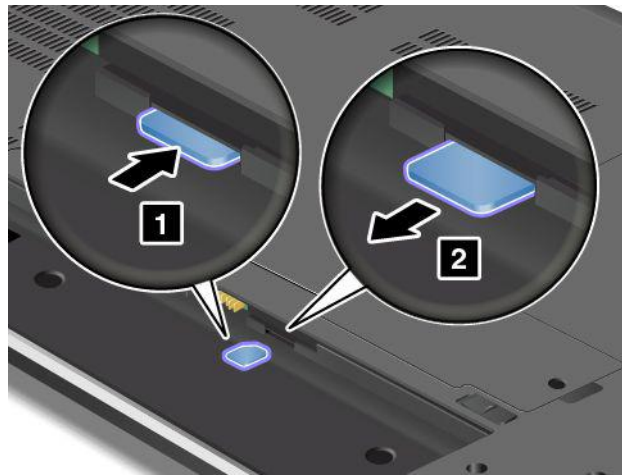

5. Hold the new card with the metal contact facing upward and going into the slot first. Then, insert the card firmly into the slot until you hear a click.

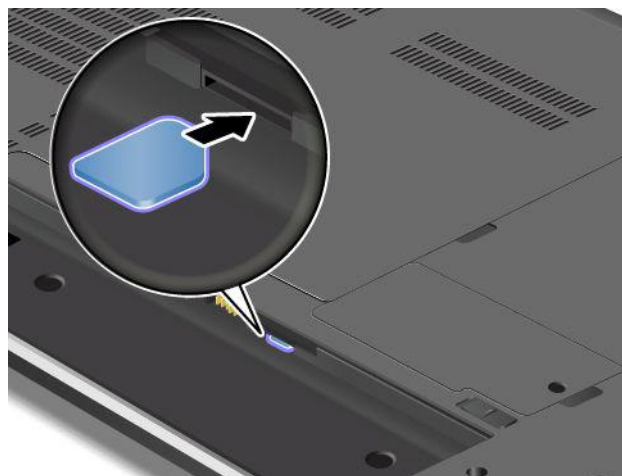

6. Reinstall the battery. See “Replacing the battery” on page 67.
7. Turn the computer over again. Connect the ac power adapter and all cables.

Replacing the keyboard

ThinkPad Edge E431

Before you start, print these instructions.



During electrical storms, do not connect the cable to or disconnect it from the telephone outlet on the wall.



Electric current from power, telephone, and communication cables is hazardous. To avoid shock hazard, disconnect the cables before opening the cover of this slot.

Removing the keyboard

To remove the keyboard, do the following:

1. Find the keyboard multi-tool in the shipping package of the new keyboard.
2. Turn off the computer and then disconnect the ac power adapter and all cables from the computer. Wait three to five minutes to let the computer cool.
3. Close the computer display and turn the computer over.
4. Remove the battery. See “Replacing the battery” on page 67.
5. Unlock the keyboard frame.

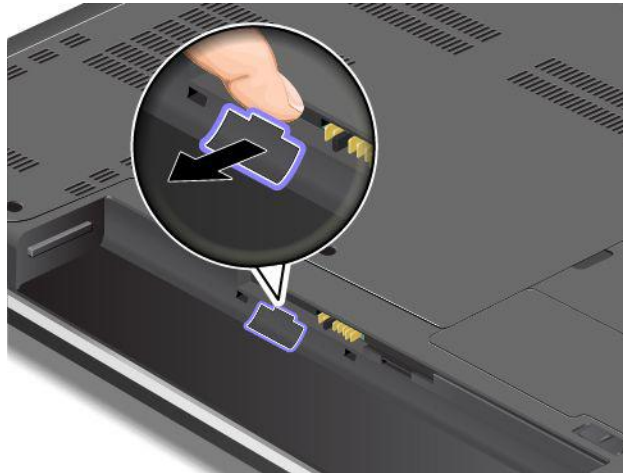

6. To reveal the screw heads beneath the keyboard frame, slide the keyboard frame forward by 2.5 mm (0.1 inch) with the keyboard multi-tool.



7. Loosen the screws that secure the keyboard with the keyboard multi-tool.



8. Pivot the keyboard slightly upward **1** until you can see the connectors on the bottom side of the keyboard. Then turn over the keyboard **2**.



9. Gently put the keyboard on the palm rest and detach the connectors. Then remove the keyboard.

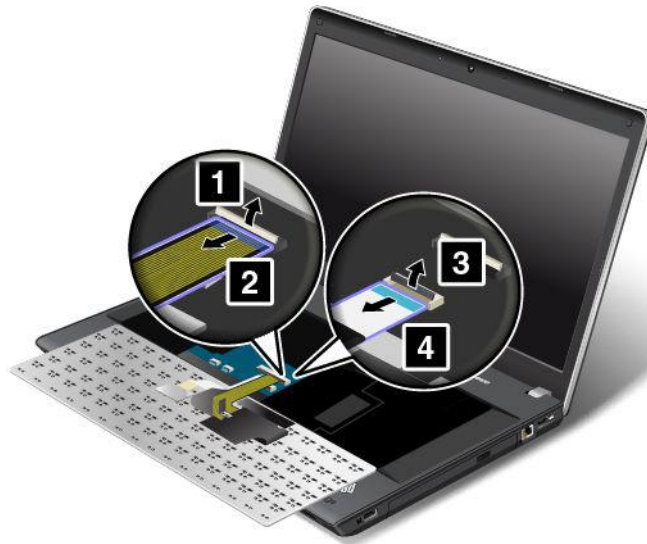

Installing the keyboard

To install the keyboard, do the following:

1. Attach the connectors and then turn over the keyboard.

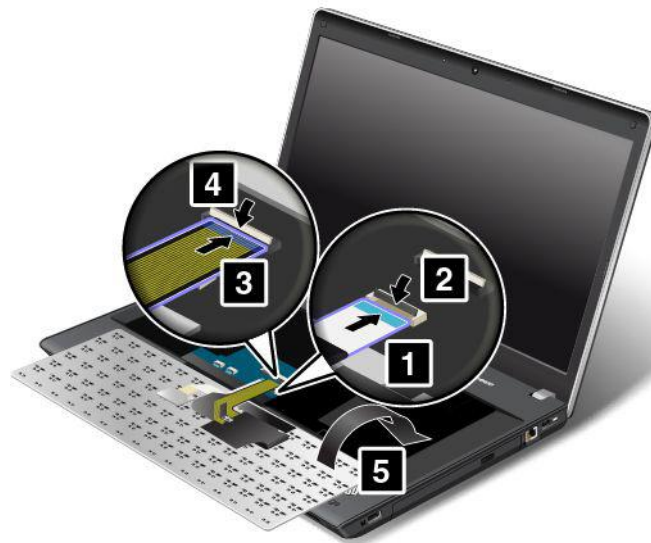

2. Insert the keyboard into the space under the frame of the keyboard bezel as shown.



3. Reveal the screw heads by sliding the keyboard frame forward with the keyboard multi-tool. Ensure that the screw heads are exposed completely.



4. Tighten the screws with the keyboard multi-tool to secure the keyboard in place.



5. Slide the keyboard frame backward by 2.5 mm (0.1 inch) with the keyboard multi-tool. Hide the latches of the keyboard frame under the keyboard bezel by pushing the latches with your finger as shown.



- Adjust the keyboard frame in place with the keyboard multi-tool and ensure that all the latches are secured under the keyboard bezel.



- Turn the computer over and lock the keyboard frame.

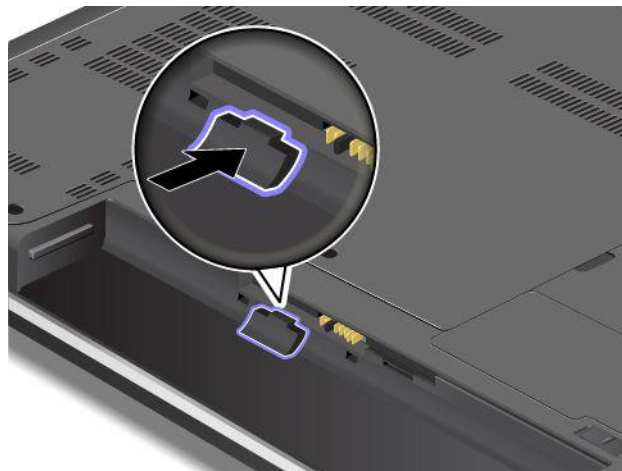

- Reinstall the battery. See “Replacing the battery” on page 67.
- Turn the computer over again. Connect the ac power adapter and all cables.

ThinkPad Edge E531

Before you start, print these instructions.



DANGER

During electrical storms, do not connect the cable to or disconnect it from the telephone outlet on the wall.



Electric current from power, telephone, and communication cables is hazardous. To avoid shock hazard, disconnect the cables before opening the cover of this slot.

Removing the keyboard

To remove the keyboard, do the following:

1. Find the keyboard multi-tool in the shipping package of the new keyboard.
2. Turn off the computer and then disconnect the ac power adapter and all cables from the computer. Wait three to five minutes to let the computer cool.
3. Close the computer display and turn the computer over.
4. Remove the battery. See “Replacing the battery” on page 67.
5. Unlock the keyboard frame.

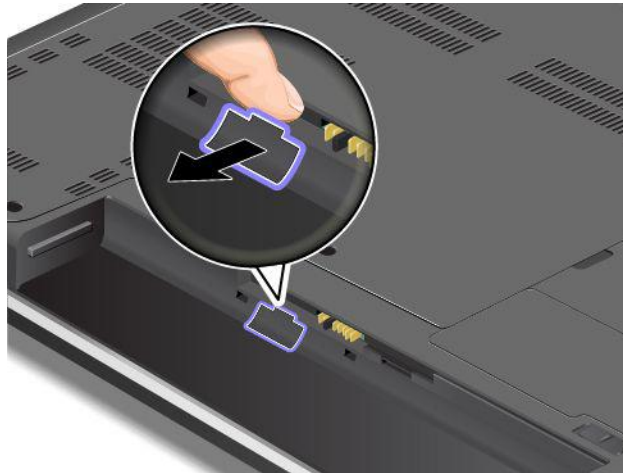

6. To reveal the screw heads beneath the keyboard frame, slide the keyboard frame forward by 2.5 mm (0.1 inch) with the keyboard multi-tool.



7. Loosen the screws that secure the keyboard with the keyboard multi-tool.



8. Pivot the keyboard slightly upward **1** until you can see the connectors on the bottom side of the keyboard. Then turn over the keyboard **2**.



9. Gently put the keyboard on the palm rest and detach the connectors. Then remove the keyboard.

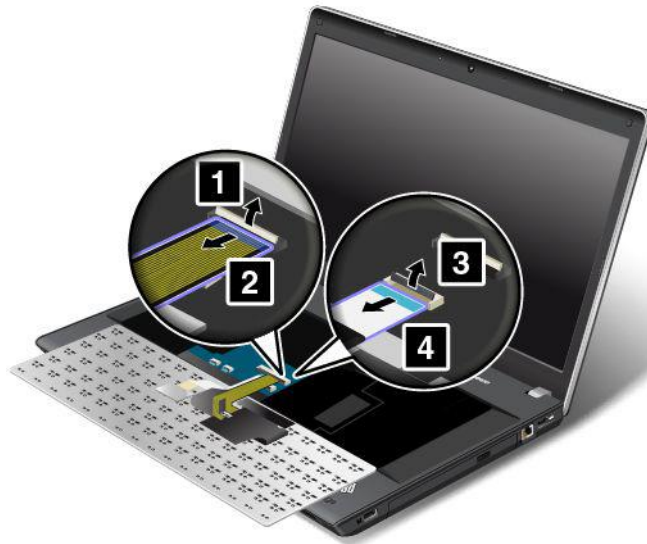

Installing the keyboard

To install the keyboard, do the following:

1. Attach the connectors and then turn over the keyboard.

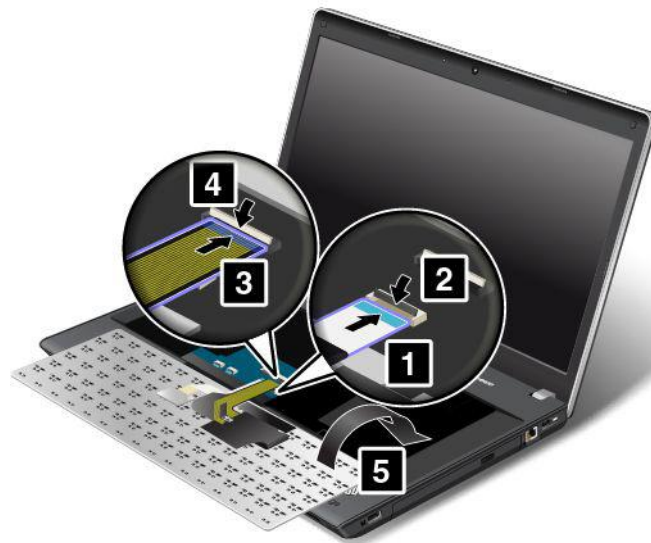

2. Insert the keyboard into the space under the frame of the keyboard bezel as shown.



3. Reveal the screw heads by sliding the keyboard frame forward with the keyboard multi-tool. Ensure that the screw heads are exposed completely.



4. Tighten the screws with the keyboard multi-tool to secure the keyboard in place.



5. Slide the keyboard frame backward by 2.5 mm (0.1 inch) with the keyboard multi-tool. Hide the latches of the keyboard frame under the keyboard bezel by pushing the latches with your finger as shown.



- Adjust the keyboard frame in place with the keyboard multi-tool and ensure that all the latches are secured under the keyboard bezel.



- Turn the computer over and lock the keyboard frame.

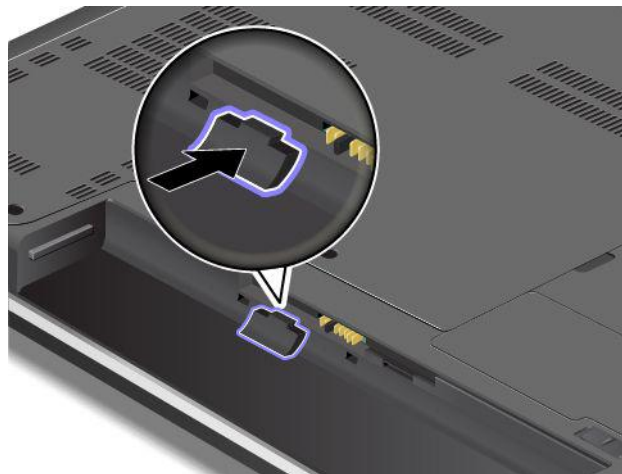

- Reinstall the battery. See “Replacing the battery” on page 67.
- Turn the computer over again. Connect the ac power adapter and all cables.

Replacing the hard disk drive or solid-state drive

Before you start, print these instructions.

Attention: The hard disk drive or solid-state drive is very sensitive. Incorrect handling can cause damage and permanent loss of data. Observe the following guidelines:

- Replace the hard disk drive or solid-state drive only if you upgrade it or have it repaired. The connectors and slot of the hard disk drive or solid-state drive are not designed for frequent changes, or drive swapping.
- Do not drop the drive or subject it to physical shocks. Put the drive on a material, such as soft cloth, that absorbs any physical shocks.
- Do not apply pressure to the cover of the drive.
- Do not touch the connector.

- Before removing the hard disk drive or solid-state drive, make a backup copy of all the information on it, and then turn the computer off.
- Never remove the drive while the computer is operating, in sleep mode, or in hibernation mode.

To replace the hard disk drive or solid-state drive, do the following:

1. Turn off the computer; then disconnect the ac power adapter and all cables from the computer. Wait three to five minutes to let the computer cool.
2. Close the computer display, and turn the computer over.
3. Remove the battery. See “Replacing the battery” on page 67.
4. Loosen the screws **1**, and then remove the cover **2**.

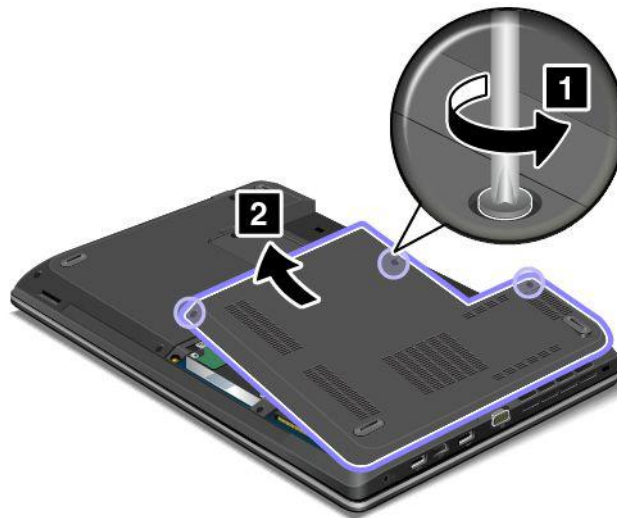

5. Remove the screws **1**, and then slide the hard disk drive or solid-state drive out **2**.

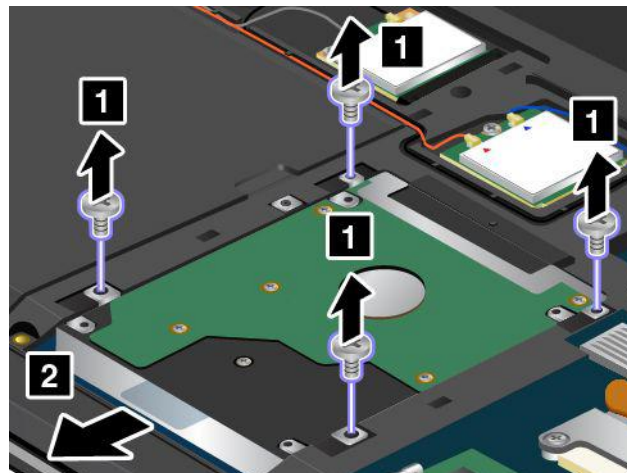

6. Remove the hard disk drive or solid-state drive by lifting the tab.

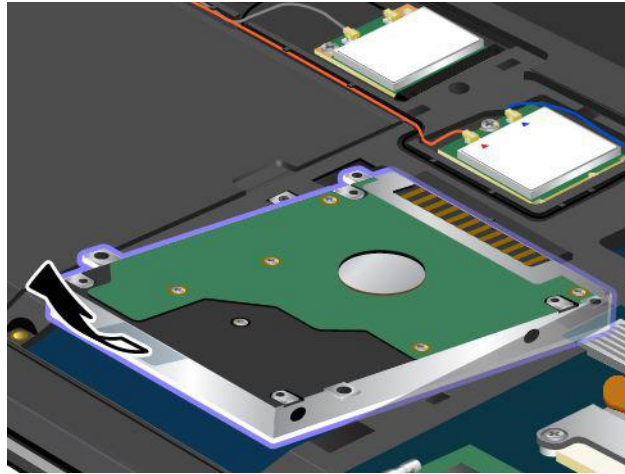

7. Place the new hard disk drive or solid-state drive into the drive bay.

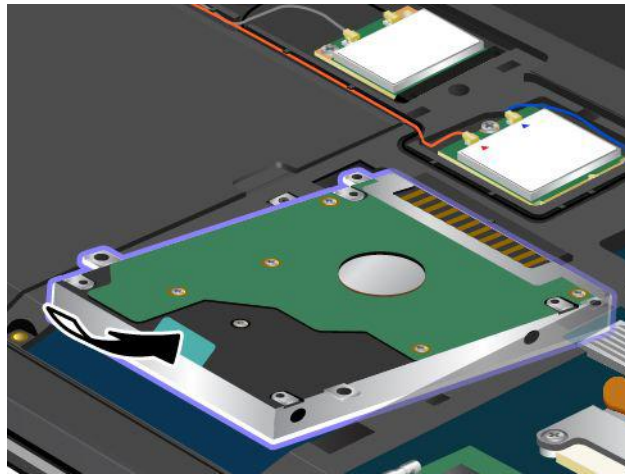

8. Slide the hard disk drive or solid-state drive firmly into the connector **1**, and then reinstall the screws **2**.

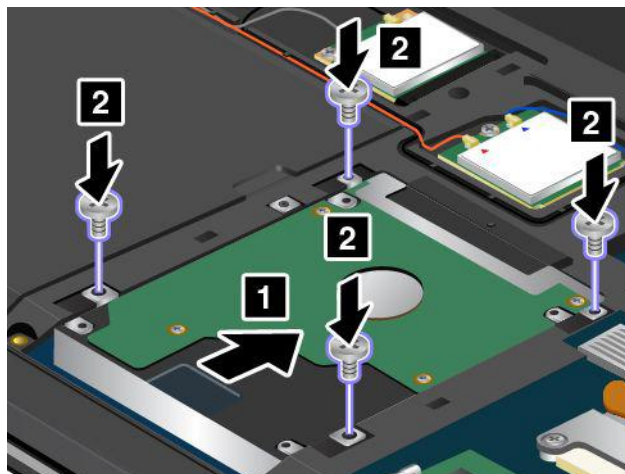

9. Reinstall the computer cover **1**. Then tighten the screws **2**.

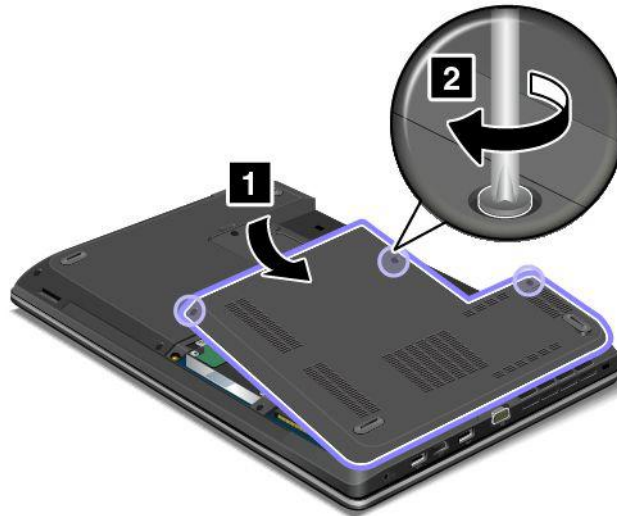

10. Reinstall the battery. See “Replacing the battery” on page 67.
11. Turn the computer over again. Connect the ac power adapter and all cables.

Replacing the optical drive

ThinkPad Edge E431

Before you start, print these instructions.

An optical drive is preinstalled in the optical drive bay. If it needs to be repaired, remove it by doing the following:

1. Turn off the computer; then disconnect the ac power adapter and all cables from the computer. Wait three to five minutes to let the computer cool.
2. Remove the battery. See “Replacing the battery” on page 67.
3. Close the computer display, and turn the computer over.
4. Loosen the screws **1**, and then remove the cover **2**.

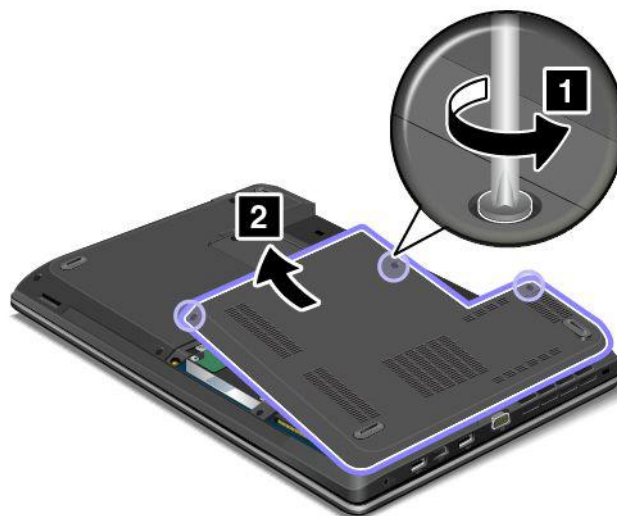

5. Remove the screw.

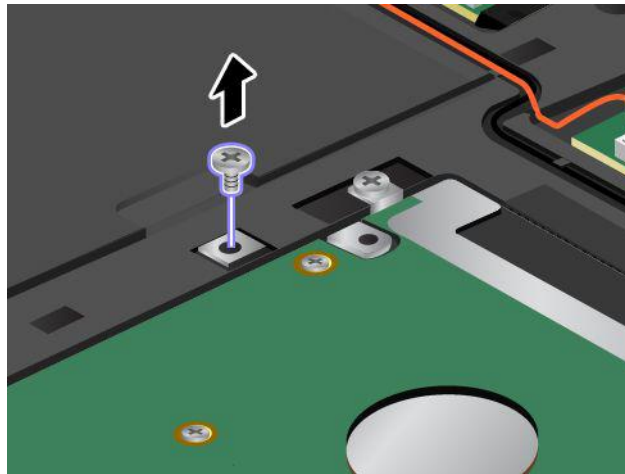

6. Pull out the optical drive.

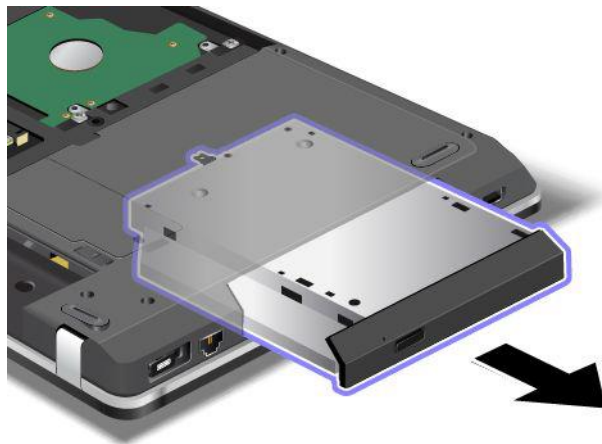

To install a repaired optical drive or a new one, do the following:

1. Insert the optical drive into the optical drive bay, and then press it firmly into the connector.

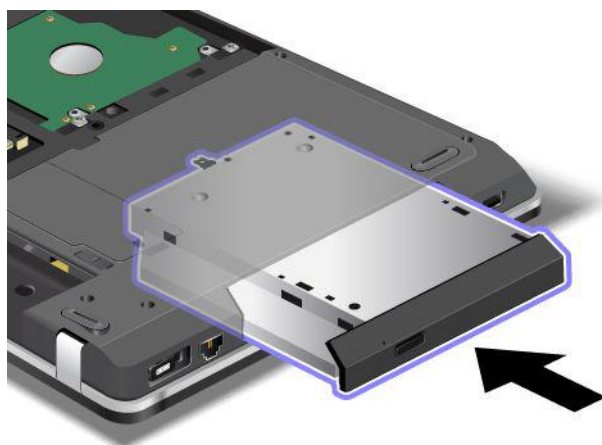

2. Reinstall the screw.

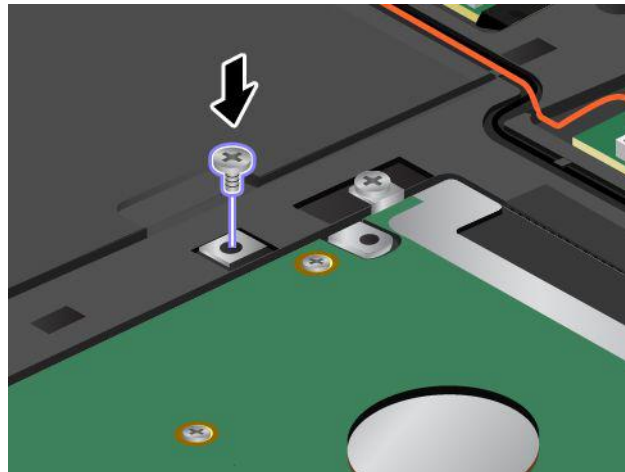

3. Reinstall the computer cover **1**. Then tighten the screws **2**.

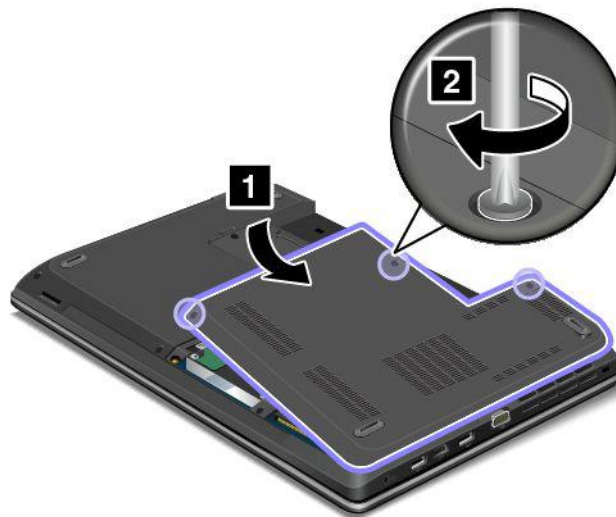

4. Reinstall the battery. See “Replacing the battery” on page 67.
5. Turn the computer over again. Connect the ac power adapter and all cables.

ThinkPad Edge E531

Before you start, print these instructions.

An optical drive is preinstalled in the optical drive bay. If it needs to be repaired, remove it by doing the following:

1. Turn off the computer; then disconnect the ac power adapter and all cables from the computer. Wait three to five minutes to let the computer cool.
2. Remove the battery. See “Replacing the battery” on page 67.
3. Close the computer display, and turn the computer over.

4. Loosen the screw that secures the optical drive and remove it.

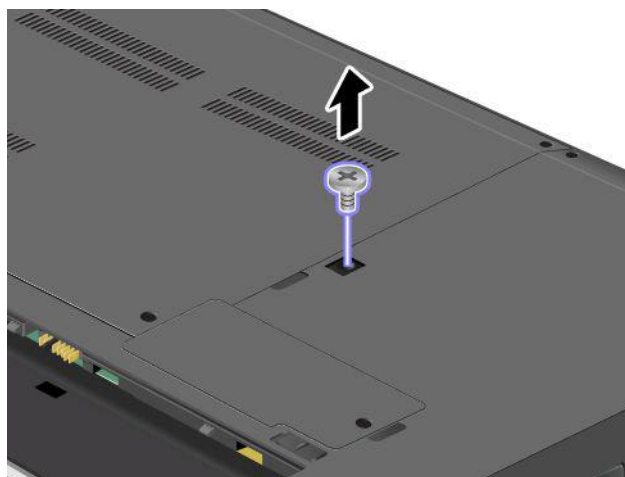

5. Pull out the optical drive.



To install a repaired optical drive or a new one, do the following:

1. Insert the optical drive into the optical drive bay, and then press it firmly into the connector.



2. Reinstall the screw and tighten it.

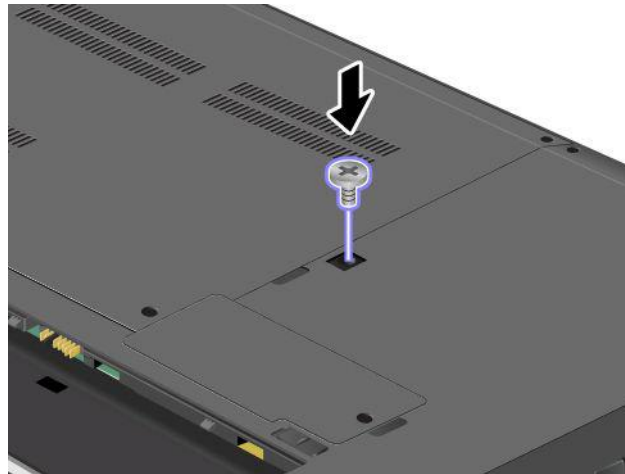

3. Reinstall the battery. See “Replacing the battery” on page 67.
4. Turn the computer over again. Connect the ac power adapter and all cables.

Replacing a wireless LAN card

Before you start, print these instructions.



During electrical storms, do not connect the cable to or disconnect it from the telephone outlet on the wall.



Electric current from power, telephone, and communication cables is hazardous. To avoid shock hazard, disconnect the cables before opening the cover of this slot.

Attention: Before you start installing a wireless LAN card, touch a metal table or a grounded metal object. This action reduces any static electricity from your body. The static electricity could damage the card.

To replace the wireless LAN card, do the following:

1. Turn off the computer; then disconnect the ac power adapter and all cables from the computer. Wait three to five minutes to let the computer cool.
2. Close the computer display, and turn the computer over.
3. Remove the battery. See “Replacing the battery” on page 67.

4. Loosen the screws **1**, and then remove the cover **2**.

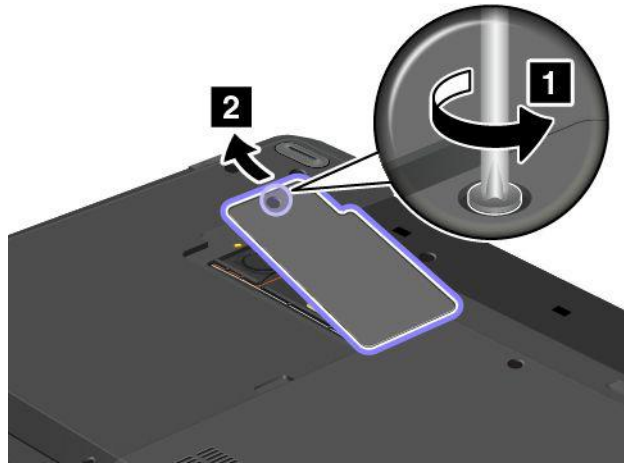

5. If a tool for removing connectors is included in the package with the new card, use it to disconnect the cables from the card. If no such tool is included, disconnect the cables by picking up the connectors with your fingers and gently unplugging them.

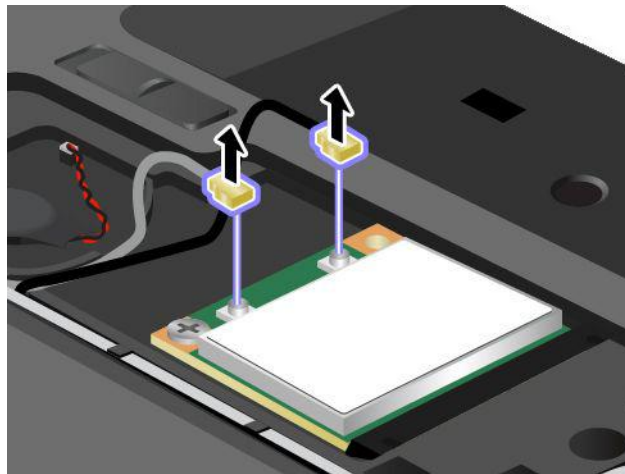

6. Remove the screw **1**. The card pops up. Remove the card **2**.

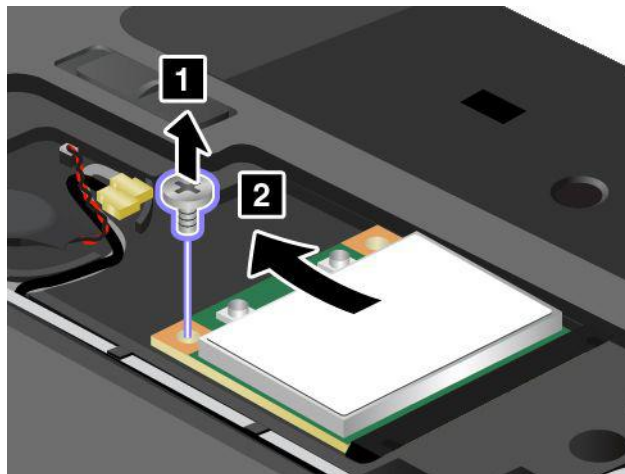

7. Align the contact edge of the new card with the corresponding socket **1**. Pivot the card until you can snap it into place. Secure the card with the screw **2**.

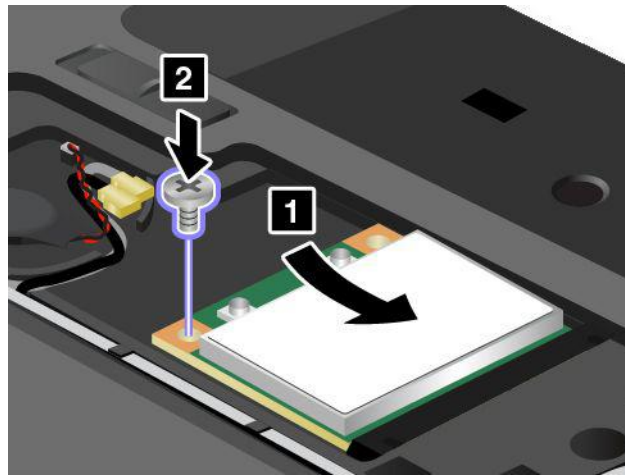

8. Connect the antenna cables to the new card as shown in the drawing.

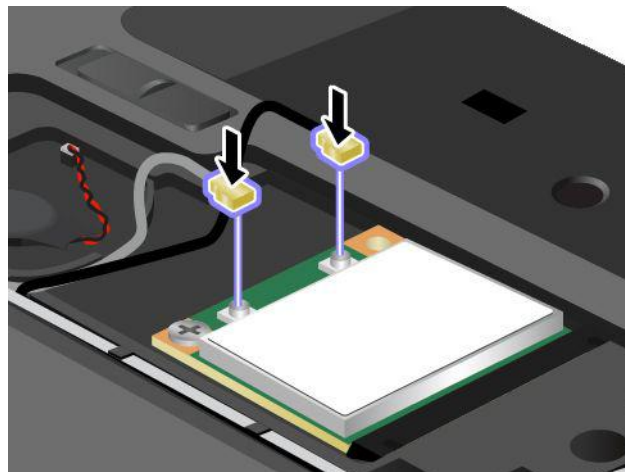

9. Reinstall the computer cover **1**. Then tighten the screws **2**.

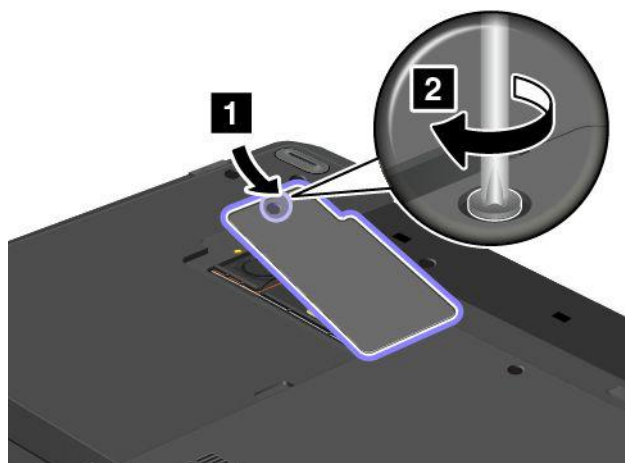

10. Reinstall the battery. See “Replacing the battery” on page 67.
11. Turn the computer over again. Connect the ac power adapter and all cables.

Replacing a wireless WAN card

Before you start, print these instructions.

Prerequisites for replacing or installing the wireless WAN card



During electrical storms, do not connect the cable to or disconnect it from the telephone outlet on the wall.



Electric current from power, telephone, and communication cables is hazardous. To avoid shock hazard, disconnect the cables before opening the cover of this slot.

Attention: Before you start installing a wireless WAN card, touch a metal table or a grounded metal object. This action reduces any static electricity from your body. The static electricity could damage the card.

If your computer is equipped with a wireless WAN card, replace the card by doing the following:

1. Turn off the computer; then disconnect the ac power adapter and all cables from the computer. Wait three to five minutes to let the computer cool.
2. Close the computer display, and turn the computer over.
3. Remove the battery. See “Replacing the battery” on page 67.
4. Loosen the screw **1**, and then remove the cover **2**.

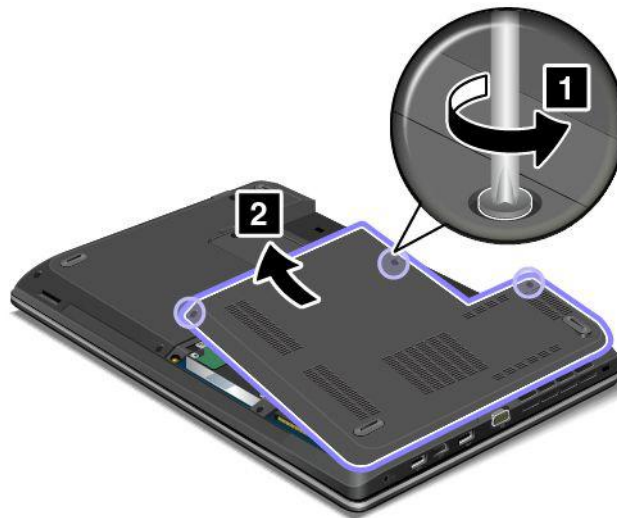

5. If a tool for removing connectors is included in the package with the new card, use it to disconnect the cables from the card. If no such tool is included, disconnect the cables by picking up the connectors with your fingers and gently unplugging them.

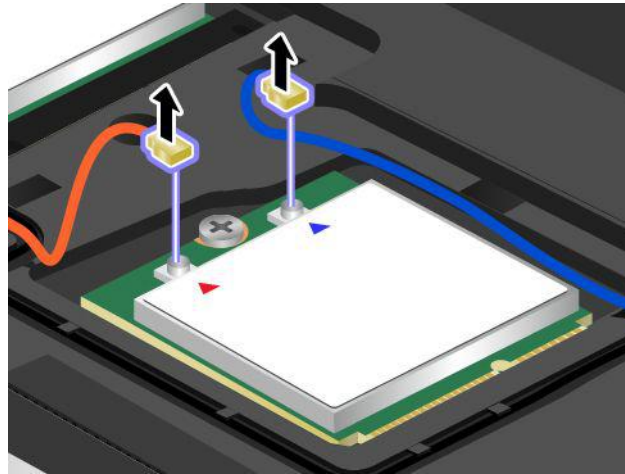

6. Remove the screw **1**. The card pops up. Remove the card **2**.

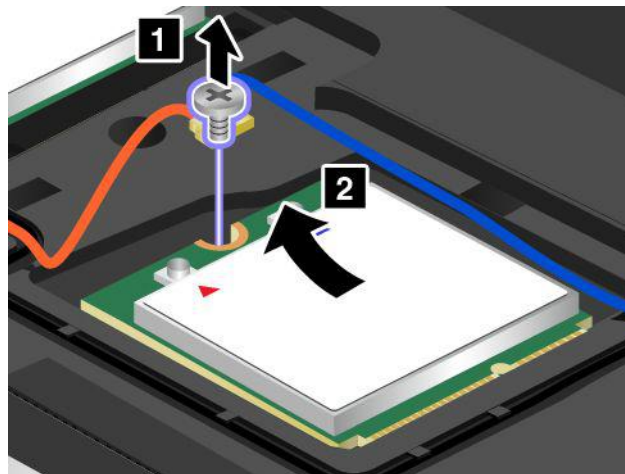

7. Align the contact edge of the new card with the corresponding socket **1**. Pivot the card until you can snap it into place. Secure the card with the screw **2**.

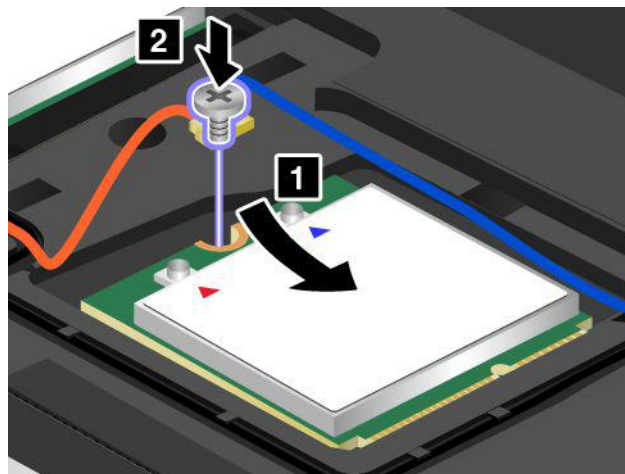

8. Connect the antenna cables to the new card as shown in the drawing.

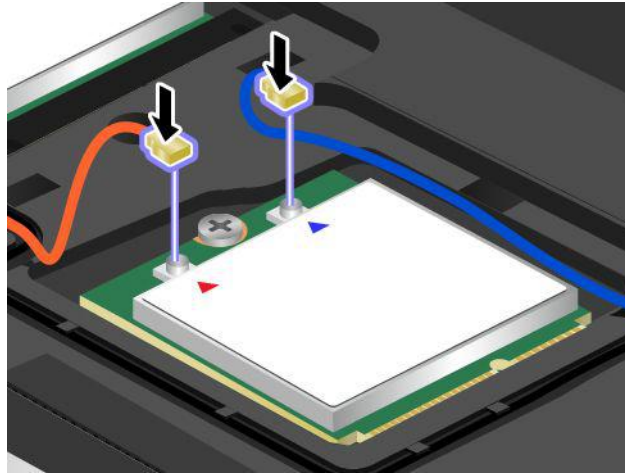

9. Reinstall the computer cover **1**. Then tighten the screw **2**.

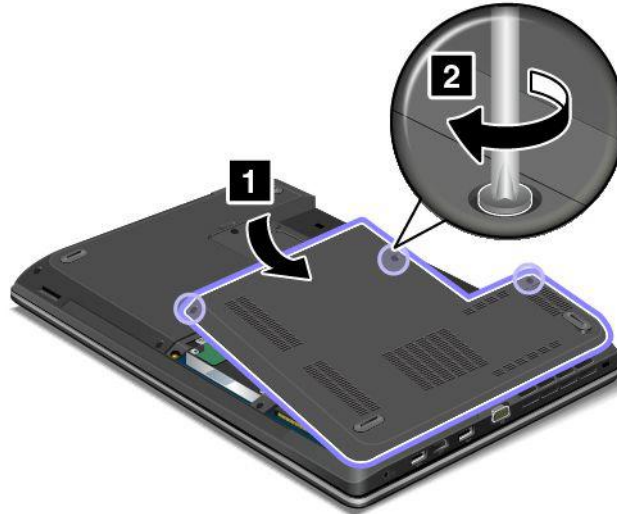

10. Reinstall the battery. See “Replacing the battery” on page 67.

11. Turn the computer over again. Connect the ac power adapter and all cables.

Replacing a memory module

Before you start, print these instructions.

Increasing memory capacity is an effective way to make programs run faster. To replace or add a memory module, read the following prerequisites, and then the instructions.

When replacing a memory module, be sure to follow the precautions.

Note: The operating speed of the memory module has dependency on the system configuration. In some conditions, the memory module in your computer might not be able to operate at the maximum speed.

Attention: Before you start installing a memory module, touch a metal table or a grounded metal object. This action reduces any static electricity from your body. The static electricity could damage the memory module.

Replacing a memory module

To replace a memory module, do the following:

1. Turn off the computer; then disconnect the ac power adapter and all cables from the computer. Wait three to five minutes to let the computer cool.
2. Close the computer display, and turn it over.
3. Remove the battery. See “Replacing the battery” on page 67.
4. Loosen the screws **1**, and then remove the cover **2**.

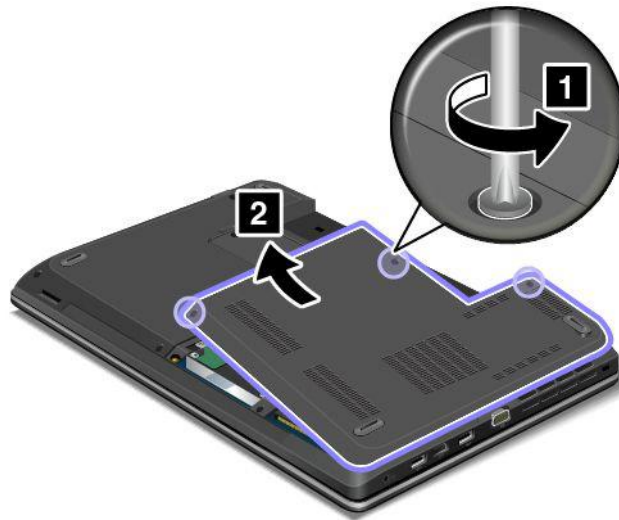

5. If two memory modules are already in the memory slots, press out on the latches on both edges of the socket at the same time **1**, and then remove a memory module **2** to make room for the new one. Save the removed memory module for future use.

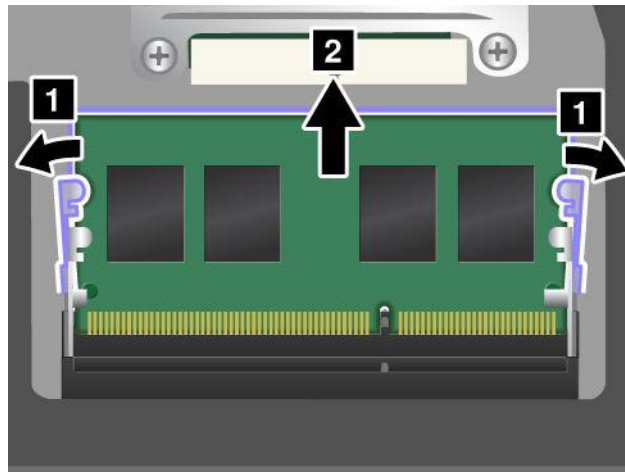

6. Find the notch on the contact edge side of the memory module you are installing.

Attention: To avoid damaging the memory module, do not touch its contact edge.

7. With the notched end of the memory module toward the contact edge side of the socket, insert the memory module into the socket at an angle of about 20 degrees **1**; then press it in firmly **2**.

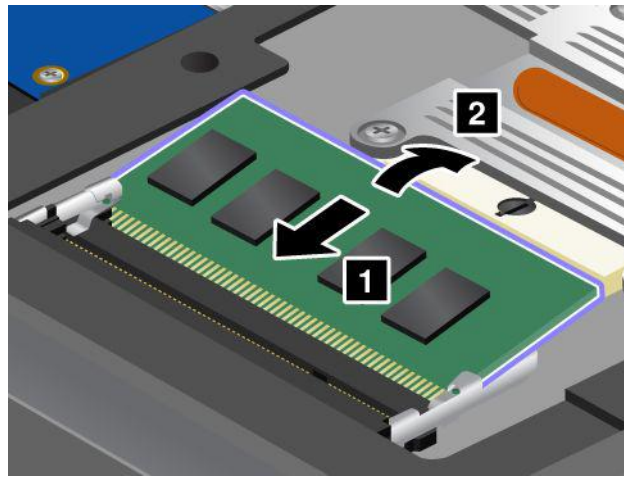

Note: If you install a memory module in only one of the two memory slots, install it in the bottom slot.

8. Pivot the memory module downward until it snaps into place.
9. Make sure that the memory module is firmly installed in the slot and cannot be moved easily.
10. Reinstall the computer cover **1**. Then tighten the screws **2**.

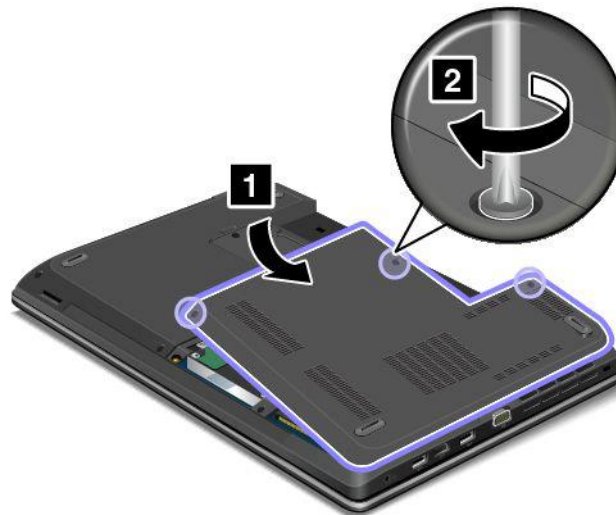

11. Reinstall the battery. See “Replacing the battery” on page 67.
12. Turn the computer over again. Connect the ac power adapter and all cables.

Replacing the backup battery

Before you start, print these instructions.

Prerequisites for the procedure



If the backup battery is incorrectly replaced, there is danger of an explosion. The backup battery contains a small amount of harmful substances. To avoid possible injury:

- Replace only with a battery of the type recommended by Lenovo.
- Keep the battery pack away from fire.
- Do not expose it to excessive heat.
- Do not expose it to water or rain.
- Do not short-circuit it.
- Do not drop, crush, puncture, or subject to strong forces. Battery abuse or mishandling can cause the battery to overheat, which can cause gasses or flame to “vent” from the battery pack or coin cell.

To remove the backup battery, do the following:

1. Turn off the computer; then disconnect the ac power adapter and all cables from the computer. Wait three to five minutes to let the computer cool.
2. Close the computer display, and turn the computer over.
3. Remove the battery. See “Replacing the battery” on page 67.
4. Loosen the screw **1**, and then remove the cover **2**.

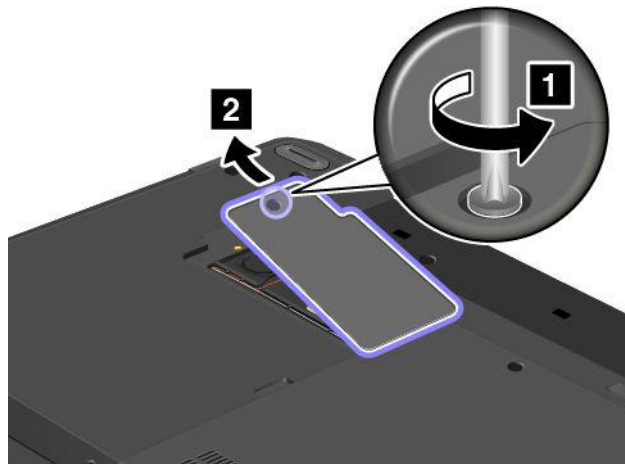

5. Detach the connector **1**. Then remove the backup battery **2**.

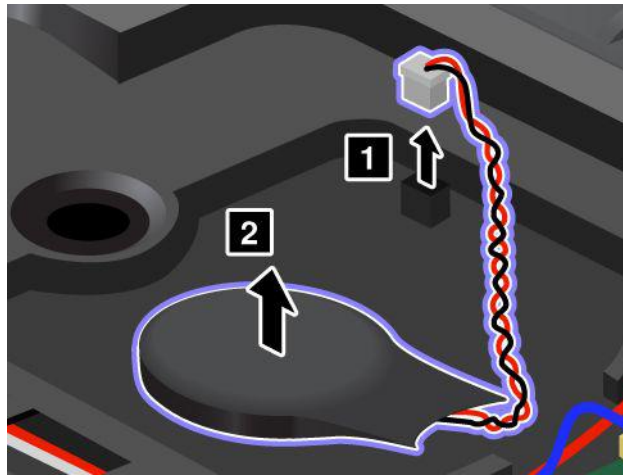

To install the backup battery, do the following:

1. Install the backup battery **1**. Then attach the connector **2**.

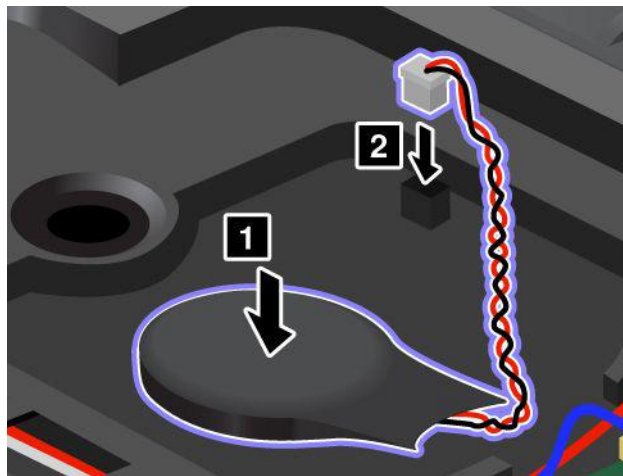

2. Reinstall the computer cover **1**. Then tighten the screw **2**.

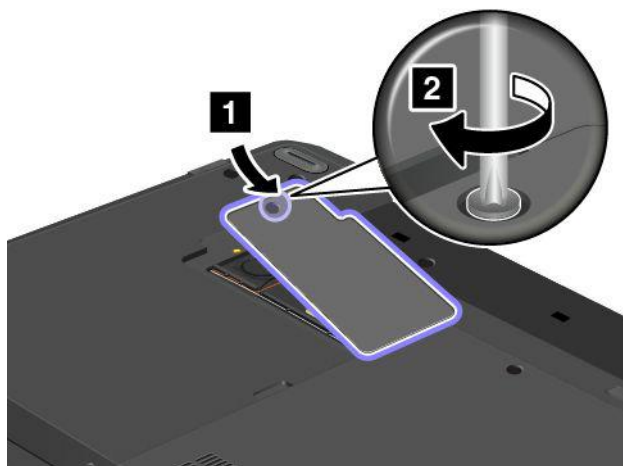

3. Reinstall the battery. See “Replacing the battery” on page 67.

4. Turn the computer over again. Connect the ac power adapter and all cables.

Chapter 7. Advanced configuration

While it is important to protect files, data, and settings that are on the hard disk drive or solid-state drive, you also might need to install a new operating system, install new device drivers, update your system UEFI BIOS, or recover preinstalled software. This information will help you handle your computer with proper care and keep it in top working shape.

- “Installing a new operating system” on page 101
- “Installing device drivers” on page 103
- “ThinkPad Setup” on page 105

Installing a new operating system

If you install a new operating system on your computer, you need to install the supplement files and ThinkPad device drivers for it at the same time.

- If you install a new Windows 7 operating system, the necessary files are located in the following directories on your solid-state drive or hard disk drive:
 - The supplement files for the operating system supported are in the C:\SWTOOLS\OSFIXES directory.
 - The device drivers for the operating system supported are in the C:\SWTOOLS\DRIVERS directory.
 - The preloaded software programs are in the C:\SWTOOLS\APPS directory.

Note: If you cannot find the supplement files, the device drivers, and program software you need on your hard disk drive, or if you want to receive updates and the latest information about them, go to:
<http://www.lenovo.com/Drivers>.

- If you install a new Windows 8 operating system, go to <http://www.lenovo.com/Drivers> to download and install the latest device drivers.

Note: The process of installing a new operating system deletes all the data on your hard disk drive, including backups or images that were stored in a hidden folder by use of a recovery program.

Before you begin

Note: If your computer is equipped with both a hard disk drive and an M.2 solid-state drive, you are not recommended to use the M.2 solid-state drive as a bootable device. The M.2 solid-state drive is designed and developed for the “cache” function purpose only. If you use the M.2 solid-state drive as a bootable device, its reliability is not guaranteed.

Before you install the operating system, do the following:

- If you are going to install a new Windows 7 operating system, copy all the subdirectories and files in the C:\SWTOOLS directory to a removable storage device, to avoid losing files during the installation.
- Print the instructions you will use. Go to the section for the operating system you are using:
 - Installing the Windows 7 operating system
 - Installing the Windows 8 operating system

Notes:

- The UEFI BIOS features are supported on the Windows 7 operating system (64-bit) and the Windows 8 operating system (64-bit).
- Be sure to set a preferred setting for the **UEFI/Legacy Boot** option in ThinkPad Setup.

- After installing the new operation system, you should not change the initial **UEFI/Legacy Boot** setting in ThinkPad Setup. The **UEFI/Legacy Boot** setting must be the same as it was when the Windows operating system image was installed. Otherwise, the new operating system will not boot properly.

For the country or region code required in the installation, use one of the following:

Country or region: Code

China: SC
Denmark: DK
Finland: FI
France: FR
Germany: GR
Italy: IT
Japan: JP
Netherlands: NL
Norway: NO
Spain: SP
Sweden: SV
Taiwan and Hong Kong: TC
United States: US

Installing the Windows 7 operating system

Before you start, print these instructions.

To install the Windows 7 operating system and its related software on your computer, do the following:

1. Start ThinkPad Setup.
2. Select **Startup**.
3. Select **UEFI/Legacy Boot**.
4. Do one of the following:
 - If you are going to install the Windows 7 (32-bit) operating system, select **Legacy Only** or **Both**.
 - If you are going to install the Windows 7 (64-bit) operating system in Legacy mode, select **Legacy Only**.
 - If you are going to install the Windows 7 (64-bit) operating system in UEFI mode, select **UEFI Only**.
5. Press Fn+F10.
6. Insert the Windows 7 operating system installation DVD into the DVD drive, and restart the computer.
7. Restore C:\SWT00LS from the backup copy you made before starting the installation.
8. For models with an Intel CPU, install the Intel Chipset Support for Windows 2000/XP/Vista/7. To do this, run the SETUP.exe file in the C:\SWT00LS\DRIVERS\INTELINF\infinst_autol directory.

For models with an AMD CPU, install the ThinkPad AMD SMBus Driver for Windows 7 and the ThinkPad AMD SATA Controller Driver for Windows 7.
9. Install device drivers. See “Installing other drivers and software on the Windows 7 operating system” on page 104.

Installing the registry patches for Windows 7

Go to <http://www.lenovo.com/support> and install the following registry patches:

- Registry patch enabling Wake Up on LAN from Standby for Energy Star
- Fix for Issue of HDD with HD Detection

Installing the Windows 7 fix module

The Windows 7 fix modules are in the following directory:
C:\SWTOOLS\OSFIXES

The name of each subfolder is the number of a fix module. For information about each fix module, go to the Microsoft Knowledge Base homepage at <http://support.microsoft.com/>, type the number of the fix module you need in the search field, and click **Search**.

To install a fix module, run the EXE file in a subfolder and follow the instructions on the screen.

Note: If you remove the hard disk drive from the computer with a single-core processor and install it on a computer with a dual-core processor, you can get access to the hard disk drive. The opposite, however, is not true: If you remove the hard disk drive from a computer with a dual-core processor and install it on a computer with a single-core processor, you cannot get access to the hard disk drive.

Installing the Windows 8 operating system

Before you start, print these instructions.

To install the Windows 8 operating system and its related software on your computer, do the following:

1. Start ThinkPad Setup.
2. Select **Startup → Boot**.
3. Change the boot priority order to boot your computer from the drive that contains the Windows 8 operating system installer.
4. Press Fn+F10.
5. Connect the drive that contains the Windows 8 operating system installer to your computer, and restart the computer.
6. Install the Intel Chipset Driver for Windows 832/864.
7. Install device drivers. See “Installing device drivers” on page 103.

Installing the Windows 8 fix module

To download and install a Windows 8 fix module, go to the Microsoft Knowledge Base homepage at <http://support.microsoft.com/>, type the number of the fix module you need in the search field, and click **Search**.

Installing device drivers

The device drivers are available at <http://www.lenovo.com/Drivers>. Click your computer product name to view all the device drivers for your computer.

Attention: Always go to <http://www.lenovo.com/Drivers> for the latest device drivers. Do not download them from the Windows Update Web site.

Installing the driver for the 4-in-1 media card reader

To use the 4-in-1 media card reader, you need to download and install the Realtek Card Reader Driver. Go to <http://www.lenovo.com/Drivers>.

Installing the driver for USB 3.0 on the Windows 7 operating system

If your computer supports USB 3.0, and you have reinstalled the operating system, you need to download and install the USB 3.0 driver to use the USB 3.0 by doing the following:

1. Go to <http://www.lenovo.com/support>. Find your model and display the driver links.
2. Select the USB 3.0 driver for the 32-bit or 64-bit operating system and extract it to your local hard disk drive.
3. Double-click the Setup.exe file in the C:\DRIVERS\WIN\USB3.0 directory.
4. Click **Next**. If the device driver is already installed, click **Cancel**. Follow the instructions on the screen until the installation is finished.

Installing the ThinkPad monitor file for Windows 2000/XP/Vista/7 on the Windows 7 operating system

The ThinkPad monitor file for Windows 2000/XP/Vista/7 is in the following directory:
C:\SWTOOLS\DRIVERS\MONITOR

Note: If you cannot find this directory on your hard disk drive or solid-state drive, download the ThinkPad monitor file for Windows 2000/XP/Vista/7 from the ThinkPad Web site at:
<http://www.lenovo.com/Drivers>

Note: Before you install this file, make sure that the correct video driver has been installed.

1. Right-click on the desktop, and click **Personalize**.
2. Click **Display** at the left.
3. Click **Change display settings**.
4. Click **Advanced Settings**.
5. Click the **Monitor** tab.
6. Click **Properties**.
7. Click the **Driver** tab.
8. Click **Update Driver**.
9. Select **Browse my computer for driver software**, and then click **Let me pick from a list of device drivers on my computer**.
10. Click **Have Disk**.
11. Specify path C:\SWTOOLS\DRIVERS\MONITOR to this monitor INF file. Then, click **Open**.
12. Click **OK**.
13. Confirm the correct display type, then click **Next**.
14. When installation completes, click **Close**.
15. Click **Close** to close the Display Properties window.
16. Click **OK** on the **Monitor** tab.
17. Click **OK** and close the Display Settings window.

Installing other drivers and software on the Windows 7 operating system

The device drivers are provided in the C:\SWTOOLS\DRIVERS directory on your hard disk drive. You will also need to install program software, which is provided in the C:\SWTOOLS\APPS directory on your hard disk drive. To do this, refer to the instructions in “Reinstalling preinstalled programs and device drivers” on page 63.

Note: If you cannot find the Supplement files, device drivers, and program software you need on your hard disk drive, or if you want to receive updates and the latest information about them, go to <http://www.lenovo.com/Drivers>.

ThinkPad Setup

Your computer comes with the ThinkPad Setup program to enable you to select various setup parameters.

To start ThinkPad Setup, do the following:

1. Turn on the computer. When the logo screen is displayed, press the F1 key. The ThinkPad Setup program main menu opens.

If you have set a supervisor password, the ThinkPad Setup program main menu will be displayed after you enter the password. You can start ThinkPad Setup by pressing Enter instead of entering the supervisor password. However, you cannot change the parameters that are protected by the supervisor password. For more information, refer to “Using passwords” on page 49.

2. Using the cursor keys, move to an item you want to change. When the item is highlighted, press Enter. A submenu is displayed.
3. Change the items you wish to change. To change the value of an item, press the following keys:

- Fn+F5 or -: Change to a lower value.
- Fn+F6 or the combination of Shift and +: Change to a higher value.

If the item has a submenu, you can display it by pressing Enter.

4. Press Esc to exit from the submenu.
5. If you are on a nested submenu, press Esc repeatedly until you reach the ThinkPad Setup program main menu.

Note: If you need to restore the settings to their original state as of the time of purchase, press Fn+F9 to load the default settings. You also can select an option on the **Restart** submenu to load the default settings or discard the changes.

6. Select **Restart**. Move the cursor to the option you want for restarting your computer; then press **Enter**. Your computer restarts.

Note: Depending on the operating system you are using, some menu items listed in this chapter might not be available on your computer, and some menu items might be slightly different from the actual menu items displayed on your computer.

Main menu

The **Main** menu is the first interface you see after you enter ThinkPad Setup. It displays the following configuration of your computer:

- **UEFI BIOS Version**
- **UEFI BIOS Date (Year-Month-Day)**
- **Embedded Controller Version**
- **Machine Type Model**
- **System-unit serial number**
- **System board serial number**
- **Asset Tag**
- **CPU Type**
- **CPU Speed**
- **Installed memory**
- **UUID**
- **MAC address (Internal LAN)**
- **Preinstalled OS License**

- **UEFI Secure Boot**

Config menu

If you need to change the configuration of your computer, select **Config** from the ThinkPad Setup program main menu.

The following table shows the contents of the **Config** menu.

Notes:

- Some items are displayed on the menu only if the computer supports the corresponding features.
- Default values are in **boldface**.

Table 4. Config menu items

Menu item	Submenu item	Selection	Comments
Network	Wake On LAN	<ul style="list-style-type: none"> • Disabled • AC Only • AC and Battery 	<p>Enable the system to power on when the Ethernet controller receives a magic packet.</p> <p>If you select AC Only, the Wake on LAN function is enabled only when the ac power adapter is attached.</p> <p>If you select AC and Battery, the Wake on LAN function is enabled with any power sources.</p> <p>Note: The magic packet type Wake on LAN requires ac power.</p> <p>Note: The Wake on LAN function does not work when a hard disk password is set.</p>
	Ethernet LAN Option ROM (for UEFI Only boot mode or Both with UEFI first)	<ul style="list-style-type: none"> • Disabled • Enabled 	Loads the Ethernet LAN Option ROM to enable startup from an integrated network device.
	Wireless LAN Radio	<ul style="list-style-type: none"> • On • Off 	If you select On , the internal wireless radio is turned on. If you select Off , the internal wireless radio is turned off.
	UEFI IPv4 Network Stack (for UEFI Only boot mode or Both with UEFI first)	<ul style="list-style-type: none"> • Disabled • Enabled 	Enable or disable Internet Protocol Version 4 (IPv4) network stack for the UEFI environment.
	UEFI IPv6 Network Stack (for UEFI Only boot mode or Both with UEFI first)	<ul style="list-style-type: none"> • Disabled • Enabled 	Enable or disable IPv6 (Internet Protocol Version 6) network stack for UEFI environment.

Table 4. Config menu items (continued)

Menu item	Submenu item	Selection	Comments
	UEFI PXE Boot Priority (for Both with UEFI first boot mode, and IPv6 and IPv4 stacks are both enabled.)	<ul style="list-style-type: none"> • IPv6 First • IPv4 First 	Select network stack priority for UEFI PXE boot.
USB	USB UEFI BIOS Support	<ul style="list-style-type: none"> • Disabled • Enabled 	Enables or disables boot support for USB storage devices.
	Always On USB	<ul style="list-style-type: none"> • Disabled • Enabled 	If you select Disabled , the external USB devices cannot be charged through USB connectors.
	Always On USB Charge in off mode	<ul style="list-style-type: none"> • Disabled • Enabled 	If you select Enabled , the Always On USB connector enables you to charge some mobile digital devices and smartphones when the computer is powered off on the condition that the ac power adapter is connected.
Keyboard/Mouse	Fn and Ctrl Key swap	<ul style="list-style-type: none"> • Disabled • Enabled 	<p>If you select Enabled, the Fn key works as the Ctrl key, and the Ctrl key works as the Fn key.</p> <p>Note: Even when Enabled is selected, you need to press the Fn key to resume the computer from sleep mode to normal operation.</p>
	Change to “F1–F12 keys”	<ul style="list-style-type: none"> • Default • Legacy 	If you select Default , pressing F1–F12 initiates special functions illustrated on each key. If you select Legacy to initiate the special functions illustrated on each key, you need to press Fn and the corresponding key simultaneously.
Display	Boot Display Device	<ul style="list-style-type: none"> • ThinkPad LCD • Analog (VGA) • HDMI 	Select the display device that is to be activated at boot time. This selection is effective for boot time, password prompt, and ThinkPad Setup.
	Graphics Device	<ul style="list-style-type: none"> • Switchable Graphics • Integrated Graphics 	The Integrated Graphics mode provides longer battery life, while the Switchable Graphics mode enhances performance.

Table 4. Config menu items (continued)

Menu item	Submenu item	Selection	Comments
	OS Detection for Switchable Graphics	<ul style="list-style-type: none"> • Disabled • Enabled 	If you select Enabled , the system UEFI automatically switches the graphics device setting to Switchable Graphics mode if the operating system supports this feature, and to Integrated Graphics mode if the operating system does not support this feature.
Power	Intel SpeedStep® technology	<ul style="list-style-type: none"> • Disabled • Enabled 	<p>Select the mode of Intel SpeedStep technology at runtime.</p> <ul style="list-style-type: none"> • Maximum Performance: Always highest speed • Battery Optimized: Always lowest speed • Disabled: No runtime support, lowest speed <p>Note: This sub-menu is not supported in models with an AMD CPU.</p>
	CPU Power Management	<ul style="list-style-type: none"> • Disabled • Enabled 	Unless this power-saving feature is disabled, it stops the processor clock automatically when there is no system activity. You usually do not need to change this function.
	Intel (R) Rapid Start Technology	<ul style="list-style-type: none"> • Disabled • Enabled <p>Enter after:</p> <ul style="list-style-type: none"> • Immediately • 1 minute • 2 minutes • 5 minutes • 10 minutes • 15 minutes • 30 minutes • 1 hour • 2 hours • 3 hours 	<p>Note: To use this feature, a special partition on the M.2 solid-state drive is required.</p> <p>When enabled, the system enters a lower power state after the specified time in sleep state. And it takes only seconds to resume normal operation.</p>

Table 4. Config menu items (continued)

Menu item	Submenu item	Selection	Comments
Beep and Alarm	Password Beep	<ul style="list-style-type: none"> • Disabled • Enabled 	Enable this option to have a beep sound when the system is waiting for a power-on, hard disk, or supervisor password. Different beeps will sound when the entered password matches or does not match the configured password.
	Keyboard Beep	<ul style="list-style-type: none"> • Disabled • Enabled 	Enable this option to have a beep sound when unmanageable key combination are pressed.
Serial ATA (SATA)	SATA Controller Mode Option	<ul style="list-style-type: none"> • Compatibility • AHCI 	Selects SATA controller operation mode. If you select Compatibility mode, SATA controller operates in compatibility mode.
CPU	Core Multi-Processing	<ul style="list-style-type: none"> • Disabled • Enabled 	Enable or disable additional execution core units within a CPU. Note: If you are using a computer with a single-core processor, this item is not available.
	Intel Hyper-Threading Technology	<ul style="list-style-type: none"> • Disabled • Enabled 	Enable or disable additional logical processors within a processor core. Note: This sub-menu is not supported in models with an AMD CPU.

Date/Time menu

If you need to set the current date and time of your computer, select **Date/Time** from the ThinkPad Setup program main menu. The following submenu is displayed:

- System Date
- System Time

To change the date and time, do the following:

1. Using the up and down arrow keys, select the item to change the date or time.
2. Press Tab, Shift+Tab, or Enter to select a field.
3. Type the date or time.

Notes: Another way to adjust the date and time is pressing the following keys:

- Fn+F5 or -: Change to a lower value.
 - Fn+F6 or the combination of Shift and +: Change to a higher value.
4. Press Fn+F10 to save the changes and restart the system.

Security menu

If you need to set the security features of your computer, select **Security** from the ThinkPad Setup program main menu.

The following table shows the contents of the **Security** menu.

Notes:

- Some items are displayed on the menu only if the computer supports the corresponding features.
- Default values are in **boldface**.

Table 5. Security menu items

Menu item	Submenu item	Selection	Comments
Password	Supervisor Password	<ul style="list-style-type: none"> • Disabled • Enabled 	Refer to “Supervisor password” on page 52.
	Lock UEFI BIOS Settings	<ul style="list-style-type: none"> • Disabled • Enabled 	Enables or disables the function that protects items in the ThinkPad Setup program from being changed by a user who does not have the supervisor password. By default, this is set to Disabled . If you set the supervisor password and enable this function, no one but you can change any items in the ThinkPad Setup program.
	Set Minimum Length	<ul style="list-style-type: none"> • Disabled • Password length options 	Specify a minimum length for the power-on password and hard disk password. By default, this is set to Disabled . If you set the supervisor password and specify a minimum length for passwords, no one but you can change the length.
	Password at unattended boot	<ul style="list-style-type: none"> • Disabled • Enabled 	If you select and enable Password at unattended boot , a password prompt is displayed when the computer is turned on, from either a power-off state or hibernation state. If you select Disabled , no password prompt is displayed; the computer goes ahead and loads the operating system. To prevent unauthorized access, set the user authentication on the operating system.

Table 5. Security menu items (continued)

Menu item	Submenu item	Selection	Comments
	Password at restart	<ul style="list-style-type: none"> • Disabled • Enabled 	If you select and enable Password at restart , a password prompt is displayed when you restart the computer. If you select Disabled , no password prompt is displayed; the computer goes ahead and loads the operating system. To prevent unauthorized access, set the user authentication on the operating system.
	Power-On Password	<ul style="list-style-type: none"> • Disabled • Enabled 	Refer to “Power-on password” on page 50.
	Hard Disk1 Password	<ul style="list-style-type: none"> • Disabled • Enabled 	Refer to “Hard disk passwords” on page 50.
Security Chip	Security Chip	<ul style="list-style-type: none"> • Active • Inactive • Disabled 	If you select Active , the security chip is functional. If you select Inactive , the Security Chip option is visible, but the security chip is not functional. If you select Disabled , the Security Chip option is hidden and the security chip is not functional.
	Security Reporting Options	<ul style="list-style-type: none"> • Disabled • Enabled 	Enable or disable the following Security Reporting Options: <ul style="list-style-type: none"> • CMOS Reporting: CMOS data • NVRAM Reporting: NVRAM data • SMBIOS Reporting: SMBIOS data
	Clear Security Chip	<ul style="list-style-type: none"> • Enter 	Clear the encryption key. Note: This item is displayed only if you have selected Active for the Security Chip option.
	Physical Presence for Provisioning	<ul style="list-style-type: none"> • Disabled • Enabled 	This option enables or disables the confirmation message when you change the settings of the security chip.
	Physical Presence for Clear	<ul style="list-style-type: none"> • Disabled • Enabled 	This option enables or disables the confirmation message when you clear the security chip.

Table 5. Security menu items (continued)

Menu item	Submenu item	Selection	Comments
UEFI BIOS Update Option	Flash BIOS Updating by End-Users	<ul style="list-style-type: none"> • Disabled • Enabled 	If you select Enabled , all users can update the UEFI BIOS. If you select Disabled , only the person who knows the supervisor password can update the UEFI BIOS.
	Secure RollBack Prevention	<ul style="list-style-type: none"> • Disabled • Enabled 	If you select Disabled , you can flash the older version UEFI BIOS.
Memory Protection	Execution Prevention	<ul style="list-style-type: none"> • Disabled • Enabled 	Some computer viruses and worms cause memory buffers to overflow by running code where only data is allowed. If the Data Execution Prevention feature can be used with your operating system, then by selecting Enabled you can protect your computer against attacks by such viruses and worms. If after choosing Enabled you find that a program does not run correctly, select Disabled and reset the setting.
Virtualization	Intel Virtualization Technology	<ul style="list-style-type: none"> • Disabled • Enabled 	If you select Enabled , a Virtual Machine Monitor (VMM) can utilize the additional hardware capabilities provided by Virtualization Technology.
	Intel VT-d Feature	<ul style="list-style-type: none"> • Disabled • Enabled 	Intel VT-d is Intel Virtualization Technology for Directed I/O. When enabled, a VMM can utilize the platform infrastructure for I/O virtualization. Note: This sub-menu is not supported in models with an AMD CPU.
I/O Port Access	Ethernet LAN	<ul style="list-style-type: none"> • Disabled • Enabled 	If you select Enabled , you can use the Ethernet LAN device.
	Wireless LAN	<ul style="list-style-type: none"> • Disabled • Enabled 	If you select Enabled , you can use the wireless LAN device.
	Wireless WAN	<ul style="list-style-type: none"> • Disabled • Enabled 	If you select Enabled , you can use the wireless WAN device.

Table 5. Security menu items (continued)

Menu item	Submenu item	Selection	Comments
	Bluetooth	<ul style="list-style-type: none"> • Disabled • Enabled 	If you select Enabled , you can use the Bluetooth devices.
	USB Port	<ul style="list-style-type: none"> • Disabled • Enabled 	If you select Enabled , you can use the USB connectors.
	Optical Drive	<ul style="list-style-type: none"> • Disabled • Enabled 	If you select Enabled , you can use the optical device.
	Memory Card Slot	<ul style="list-style-type: none"> • Disabled • Enabled 	If you select Enabled , you can use the memory card slots.
	Integrated Camera	<ul style="list-style-type: none"> • Disabled • Enabled 	If you select Enabled , you can use the integrated camera.
	Microphone	<ul style="list-style-type: none"> • Disabled • Enabled 	If you select Enabled , you can use the microphones (internal, external, or line-in).
	Fingerprint Reader	<ul style="list-style-type: none"> • Disabled • Enabled 	If you select Enabled , you can use the fingerprint reader.
Anti-Theft	Intel AT Module Activation	<ul style="list-style-type: none"> • Disabled • Enabled • Permanently Disabled 	<p>Enable or disable the UEFI BIOS interface to activate the Intel AT module, which is an optional anti-theft service from Intel.</p> <p>Note: If you set the Intel AT module activation to Permanently Disabled, you will be unable to enable this setting again.</p> <p>Note: This sub-menu is not supported in models with an AMD CPU.</p>
	Computrace Module Activation	<ul style="list-style-type: none"> • Disabled • Enabled • Permanently Disabled 	<p>Enables or disables the UEFI BIOS interface to activate the computrace module. Computrace is an optional monitoring service from Absolute Software.</p> <p>Note: If you set the Computrace module activation to Permanently Disabled, you will be unable to enable this setting again.</p>

Table 5. Security menu items (continued)

Menu item	Submenu item	Selection	Comments
Secure Boot	Secure Boot	<ul style="list-style-type: none"> • Disabled • Enabled 	Enable or disable UEFI Secure Boot feature. Windows 8 operating system requires this feature to be enabled.
	Platform Mode	User Mode	
	Secure Boot Mode	Standard Mode	
	Reset to Setup Mode	<ul style="list-style-type: none"> • Yes • No 	This option is used to clear the current platform key and put the system into setup mode. You can install your own platform key and customize the Secure Boot signature databases in setup mode. Secure Boot mode will be set to custom mode.
	Restore Factory keys	<ul style="list-style-type: none"> • Yes • No 	This option is used to restore all keys and certificates in Secure Boot databases to factory defaults. Any customized Secure Boot settings will be erased, and the default platform key will be re-established along with the original signature databases including certificate for Windows 8 operating system.

Startup menu

You might need to change the startup sequence of your computer. For example, if you have different operating systems on different devices, you can have the system start up from either of them.

Attention: After you change your startup sequence, you must be extremely careful not to specify a wrong device during a copy, a save, or a format operation. If you specify a wrong device, your data and programs might be erased or overwritten.

Attention: If you are using the BitLocker® drive encryption, you should not change the startup sequence. BitLocker drive encryption detects the change of startup sequence and locks the computer from booting.

Changing the startup sequence

Selecting **Startup** to display the **Boot** submenu.

To change the startup sequence, do the following:

1. Select **Boot**; then press Enter.

You can use the **Boot** submenu to specify the startup sequence that runs when you turn on the power. Refer to “Boot submenu” on page 115.

2. Select the device you want to start first.
3. Press Fn+F10 to save the changes and restart the system.

To change the startup sequence temporarily so that the system starts up from a different drive, do the following:

1. Turn off the computer.
2. Turn on the computer; then, while the message “To interrupt normal startup, press Enter” is displayed in the lower left corner of the screen, press F12.
3. Select the device you want to start first from the **Boot** menu.

Note: The **Boot** menu will be displayed when the operating system is not found or when the computer cannot boot from any devices.

Boot submenu

The following list, showing the order in which devices will be started up, is always displayed. Even devices that are not attached to or installed on your computer are listed. For each device that is attached to or installed on the computer, information about it is presented after the colon.

1. USB CD:
2. USB FDD:
3. ATAPI CD0:
4. ATAPI CD1:
5. ATA HDD2:
6. ATA HDD0:
7. ATA HDD1:
8. USB HDD:
9. PCI LAN:

Other items on the Startup menu

The following items also are displayed on the Startup menu of the ThinkPad Setup program:

- **Network Boot:** Specify the top priority boot device to be used when the computer wakes from LAN.
- **UEFI/Legacy Boot:** Select system boot capability.
- **UEFI/Legacy Boot Priority:** Select a boot priority between UEFI and Legacy.
- **Boot Mode:** Enable or disable the diagnostics boot mode.
- **Option Key Display:** Choose whether to display the option key message when the system is booted.
- **Boot device List F12 Option:** Choose whether to display the pop-up list of the boot devices.
- **Boot Order Lock:** Enable or disable the default boot priority or customized boot priority.

The following table shows the contents of the **Startup** menu.

Notes:

- Some items are displayed on the menu only if the computer supports the corresponding features.
- Default values are in **boldface**.

Table 6. Startup menu items

Menu item	Selection	Comments
Boot		Refer to “Changing the startup sequence” on page 114.
Network Boot		Refer to “Boot submenu” on page 115.
UEFI/Legacy Boot	<ul style="list-style-type: none"> • Both • UEFI Only • Legacy Only <p>UEFI/Legacy Boot Priority</p> <ul style="list-style-type: none"> • UEFI First • Legacy First <p>CSM Support (for UEFI Only)</p> <ul style="list-style-type: none"> • No • Yes 	<p>Select system boot capability.</p> <ul style="list-style-type: none"> • Both: The system will boot following the UEFI/Legacy Boot Priority setting. • UEFI Only: The system will boot from the UEFI enabled operating system. • Legacy Only: The system will boot from any operating system other than the UEFI enabled one. <p>Note: If you select UEFI Only, the system cannot boot from the bootable devices that do not have the UEFI enabled operating system.</p> <p>Compatibility Support Module (CSM) is required for booting the legacy operating system. If you select UEFI Only, CSM Support is selectable. For Both or Legacy Only mood, CSM Support is not selectable.</p>
Boot Mode	<ul style="list-style-type: none"> • Quick • Diagnostics 	<p>Screen during the POST:</p> <ul style="list-style-type: none"> • Quick: The ThinkPad Logo screen is displayed. • Diagnostics: Test messages are displayed. <p>Beep at POST completion:</p> <ul style="list-style-type: none"> • Quick: No. Sounds on error cases only. • Diagnostics: Yes. Always sounds. <p>“Ctrl-S” prompt for on-board Ethernet:</p> <ul style="list-style-type: none"> • Quick: No. • Diagnostics: Yes. <p>Memory testing during the POST:</p> <ul style="list-style-type: none"> • Quick: Quick test (or no test). • Diagnostics: Full test. <p>Testing other devices during the POST:</p> <ul style="list-style-type: none"> • Quick: Minimum test (or no test).

Table 6. Startup menu items (continued)

Menu item	Selection	Comments
		<ul style="list-style-type: none"> • Diagnostics: Can perform necessary testing for critical devices. <p>Note: You can also enter Diagnostic mode by pressing Esc during POST.</p>
Option Key Display	<ul style="list-style-type: none"> • Disabled • Enabled 	If you select Disabled , then the message “To interrupt normal startup, press Enter” is not displayed during the POST.
Boot Device List F12 Option	<ul style="list-style-type: none"> • Disabled • Enabled 	If you select Enabled , the F12 key is recognized and the Boot Menu window is displayed.
Boot Order Lock	<ul style="list-style-type: none"> • Disabled • Enabled 	If you select Disabled , your computer will boot using the default priority. If you select Enabled , your computer will boot using the priority you have customized.

Restart menu

If you need to close the ThinkPad Setup program and restart the system, select **Restart** from the ThinkPad Setup program main menu. The following submenu is displayed:

- **Exit Saving Changes:** Restart the system after saving the changes.
- **Exit Discarding Changes:** Restart the system without saving the changes.
- **Load Setup Defaults:** Load the default setting that was in effect at the time of purchase. Enable **OS Optimized Defaults** to meet the Microsoft Windows 8 certification requirements. When you change this setting, some other settings are changed automatically. The affected settings are **CSM Support**, **UEFI/Legacy Boot**, **Secure Boot**, and **Secure RollBack Prevention**.
- **Discard Changes:** Discard the changes.
- **Save Changes:** Save the changes.

Updating your system UEFI BIOS

The Unified Extensible Firmware Interface (UEFI) BIOS is a part of the system programs that make up the basic layer of software built into your computer. The UEFI BIOS translates the instructions from other software layers.

Your computer system board has a module called EEPROM, also referred to as flash memory. You can update the UEFI BIOS and the ThinkPad Setup program by starting your computer with a flash update optical disc or flash update program running in the Windows environment.

In some instances when you add software, hardware, or a device driver, you might be informed that you need to update your UEFI BIOS in order for the new addition to work properly.

To update your UEFI BIOS, go to the following Web site and follow the instructions on the screen:
<http://www.lenovo.com/Drivers>

Chapter 8. Preventing problems

An important part of owning a ThinkPad notebook computer is maintenance. With proper care, you can avoid common problems. The chapter provides information that can help you keep your computer running smoothly.

- “General tips for preventing problems” on page 119
- “Making sure device drivers are current” on page 120
- “Taking care of your computer” on page 121

General tips for preventing problems

1. If your computer is equipped with both a hard disk drive and an M.2 solid-state drive, you are not recommended to use the M.2 solid-state drive as a bootable device. The M.2 solid-state drive is designed and developed for the “cache” function purpose only. If you use the M.2 solid-state drive as a bootable device, its reliability is not guaranteed.
2. Check the capacity of your hard disk drive from time to time. If the hard disk drive gets too full, the Windows operating system will slow down and might produce errors.
To check the hard disk drive capacity, click **Start** → **Computer** on the Windows 7 operating system. For the Windows 8 operating system, open **Windows Explorer** and click **Computer**.
3. Empty your recycle bin on a regular basis.
4. Use disk defragment tool regularly on your hard disk drive to improve data seek and read times.
5. To free up disk space, uninstall unused programs.
Note: You also might want to look for program duplication or overlapping versions.
6. Clean out your Inbox, Sent, and Trash folders from your e-mail client program.
7. Back up your data at least once a week. If critical data is present, it is a good idea to perform a daily backup operation. Lenovo has many backup options available for your computer. Rewritable optical drives are available for most machines and are easily installed.
8. Schedule system restore operations to take a system snapshot periodically. For more information about system restore, see Chapter 5 “Recovery overview” on page 59.
9. Update device drivers and UEFI BIOS when needed.
10. Profile your machine at <http://www.lenovo.com/support> to keep up to date with current drivers and revisions.
11. Ensure device drivers for non-Lenovo peripheral devices are kept up to date. You might want to read the device driver information release notes prior to updating for compatibility or known issues.
12. Keep a log book. Entries might include major hardware or software changes, driver updates, minor issues you have experienced, and how you resolved the minor issues.
13. If you ever need to run a recovery on your computer to return the preload onto the machine, the following tips might help along the way:
 - Remove all external devices such as the printer, keyboard, and so on.
 - Make sure that your battery is charged and that you have the ac power connected.
 - Boot into ThinkPad Setup and load the default settings.
 - Restart the computer and start the recovery operation.
 - If your computer uses discs as the recovery media, do not remove the disc from the drive until prompted to do so.
14. For suspected hard disk drive issues, refer to “Diagnosing problems” on page 125 to run a diagnostic test of the drive before you call the Customer Support Center. If your computer does

not start up, download the files to create a bootable self-test media from the following Web site: <http://www.lenovo.com/hddtest>. Run the test and record any messages or error codes. If the test returns any failing error codes or messages, call the Customer Support Center with the codes or messages and the computer in front of you. A technician will assist you further.

15. If required, you can find your country's Customer Support Center at: <http://www.lenovo.com/support/phone>. When calling the Customer Support Center, make sure that you have your machine model type, serial number, and the computer in front of you. Also, if the computer is producing error codes, it is helpful to have the error screen on or the message written down.

Making sure device drivers are current

Device drivers are programs that contain instructions for the operating system about how to operate or “drive” a certain piece of hardware. Each hardware component on your computer has its own specific driver. If you add a new component, the operating system needs to be instructed on how to operate that piece of hardware. After you install the driver, the operating system can recognize the hardware component and understand how to use it.

Note: Because drivers are programs, like any other file on your computer, they are susceptible to corruption and might not perform correctly if corruption occurs.

It is not always necessary to download the latest drivers. However, you should download the latest driver for a component if you notice poor performance from that component or if you added a new component. This might eliminate the driver as the potential cause of the problem.

Getting the latest drivers from the Web site

You can download and install updated device drivers from the Lenovo Web site by doing the following:

1. Go to <http://www.lenovo.com/Drivers>.
2. Enter the product number of the computer or click **Detect my system** on the screen.
3. Click **Downloads and drivers**.
4. Follow the directions on the screen and install the necessary software.

Getting the latest drivers using System Update

The System Update program helps you keep the software on your system up-to-date. Update packages are stored on Lenovo servers and can be downloaded from the Lenovo Support Web site. Update packages can contain programs, device drivers, UEFI BIOS flashes, or software updates. When the System Update program connects to the Lenovo Support Web site, the System Update program automatically recognizes the machine type and model of your computer, the installed operating system, and the language of the operating system to determine what updates are available for your computer. The System Update program then displays a list of update packages and categorizes each update as critical, recommended, or optional to help you understand the importance. You have complete control of which updates to download and install. After you select the update packages you want, the System Update program automatically downloads and installs the updates without any further intervention from you.

The System Update program is preinstalled on your computer and is ready to run. The only prerequisite is an active Internet connection. You can start the program manually, or you can use the schedule feature to enable the program to search for updates automatically at specified intervals. You also can predefine scheduled updates to search by severity (critical updates, critical and recommended updates, or all updates) so the list you choose from contains only those update types that are of interest to you.

For more information about how to use System Update, refer to “An introduction to Lenovo programs” on page 18.

Taking care of your computer

Although your computer is designed to function reliably in normal work environments, you need to use common sense in handling it. By following these important tips, you will get the most use and enjoyment out of your computer.

Be careful about where and how you work

- Store packing materials safely out of the reach of children to prevent the risk of suffocation from plastic bags.
- Keep your computer away from magnets, activated cellular phones, electrical appliances, or speakers (within 13 cm or 5 inches).
- Avoid subjecting your computer to extreme temperatures (below 5°C/41°F or above 35°C/95°F).
- Some appliances, such as certain portable desktop fans or air purifiers, can produce negative ions. If a computer is close to such an appliance, and is exposed for an extended time to air containing negative ions, it might become electrostatically charged. Such a charge might be discharged through your hands when you touch the keyboard or other parts of the computer, or through connectors on I/O devices connected to it. Even though this kind of electrostatic discharge (ESD) is the opposite of a discharge from your body or clothing to the computer, it poses the same risk of a computer malfunction.

Your computer is designed and manufactured to minimize any effects of electrostatic charge. An electrostatic charge above a certain limit, however, can increase the risk of ESD. Therefore, when using the computer close to an appliance that can produce negative ions, give special attention to the following:

- Avoid directly exposing your computer to the air from an appliance that can produce negative ions.
- Keep your computer and peripherals as far as possible from such an appliance.
- Wherever possible, ground your computer to facilitate safe electrostatic discharge.

Note: Not all such appliances cause a significant electrostatic charge.

Be gentle with your computer

- Avoid placing any objects (including paper) between the display and the keyboard or the palm rest.
- Your computer display is designed to be opened and used at an angle slightly greater than 90 degrees. Do not open the display beyond 135 degrees, as this might damage the computer hinge.
- Do not turn your computer over while the ac power adapter is plugged in. This could break the adapter plug.

Carry your computer properly

- Before moving your computer, be sure to remove any media, turn off attached devices, and disconnect cords and cables.
- When picking up your open computer, hold it by the bottom. Do not pick up or hold your computer by the display.

Handle storage media and drives properly

- If your computer comes with an optical drive, do not touch the surface of a disc or the lens on the tray.
- Wait until you hear the CD or DVD click into the center pivot of the drive before closing the tray.
- When installing the hard disk drive, M.2 solid-state drive, or optical drive, follow the instructions shipped with your hardware, and apply pressure only where needed on the device.
- Turn off your computer if you are replacing the hard disk drive or the M.2 solid-state drive.
- When replacing the hard disk drive, reattach the cover of the drive slot.

- Store your external and removable hard disk drive or optical drives in the appropriate containers or packaging when they are not being used.
- Before you install any of the following devices, touch a metal table or a grounded metal object. This action reduces any static electricity from your body. The static electricity could damage the device.
 - Memory module
 - Mini-PCI card
 - Memory card, such as an SD card, SDHC card, SDXC card, and a MultiMediaCard

Note: Not all listed devices are included in your computer.

This action reduces any static electricity from your body. The static electricity could damage the device.

- While transferring data to or from a flash media card, such as an SD card, do not put your computer into sleep or hibernation mode before the data transfer is complete; otherwise, your data could become damaged.

Take care in setting passwords

- Remember your passwords. If you forget a supervisor or hard disk password, Lenovo will not reset it, and you might have to replace your system board or hard disk drive.

Care for the fingerprint reader

The following actions could damage the fingerprint reader or cause it not to work properly:

- Scratching the surface of the reader with a hard, pointed object.
- Scraping the surface of the reader with your fingernail or anything hard.
- Using or touching the reader with a dirty finger.

If you notice any of the following conditions, gently clean the surface of the reader with a dry, soft, lint-free cloth:

- The surface of the reader is dirty or stained.
- The surface of the reader is wet.
- The reader often fails to enroll or authenticate your fingerprint.

Register your computer

- Register your ThinkPad computer with Lenovo at <http://www.lenovo.com/register>. This can help authorities return your computer to you if it is lost or stolen. Registering your computer also enables Lenovo to notify you about possible technical information and upgrades.

Be sure not to modify your computer

- Only an authorized ThinkPad repair technician should disassemble and repair your computer.
- Do not modify or tape the latches to keep the display open or closed.

Cleaning the cover of your computer

Occasionally clean your computer by doing the following:

1. Prepare a mixture of a gentle kitchen-use detergent (one that does not contain abrasive powder or strong chemicals such as acid or alkaline). Use 5 parts water to 1 part detergent.
2. Absorb the diluted detergent into a sponge.
3. Squeeze excess liquid from the sponge.
4. Wipe the cover with the sponge, using a circular motion and taking care not to let any excess liquid drip.

5. Wipe the surface to remove the detergent.
6. Rinse the sponge with clean running water.
7. Wipe the cover with the clean sponge.
8. Wipe the surface again with a dry, soft, lint-free cloth.
9. Wait for the surface to dry completely and remove any fibers from the cloth.

Cleaning your computer keyboard

To clean the computer keyboard, do the following:

1. Apply some isopropyl rubbing alcohol to a soft, dust-free cloth.
2. Wipe each keytop surface with the cloth. Wipe the keys one by one; if you wipe several keys at a time, the cloth might hook onto an adjacent key and possibly damage it. Make sure that no liquid drips onto or between the keys.
3. Allow to dry.
4. To remove any crumbs or dust from beneath the keys, you can use a camera blower with a brush or cool air from a hair dryer.

Note: Avoid spraying cleaner directly onto the display or the keyboard.

Cleaning your computer display

To clean the computer display, do the following:

1. Gently wipe the display with a dry, soft lint-free cloth. If you see a scratchlike mark on your display, it might be a stain transferred from the keyboard or the TrackPoint pointing stick when the cover was pressed from the outside.
2. Wipe or dust the stain gently with a soft, dry cloth.
3. If the stain remains, moisten a soft, lint-free cloth with water or a 50-50 mixture of isopropyl alcohol and water that does not contain impurities.
4. Wring out as much of the liquid as you can.
5. Wipe the display again; do not let any liquid drip into the computer.
6. Be sure to dry the display before closing it.

Chapter 9. Troubleshooting computer problems

This chapter provides information on what to do if you experience a problem with your computer.

This chapter contains the following topics:

- “Diagnosing problems” on page 125
- “Troubleshooting” on page 125

Diagnosing problems

If you experience problems with your computer, use the Lenovo Solution Center program as a starting point for solving them.

The Lenovo Solution Center program enables you to troubleshoot and resolve computer problems. It combines diagnostic tests, system information collection, security status, and support information, along with hints and tips for maximum system performance.

Notes:

- The Lenovo Solution Center program can be downloaded from <http://www.lenovo.com/diags>.
- If you are using other Windows operating system rather than Windows 7 and Windows 8, go to <http://www.lenovo.com/diags> for the latest information on diagnostics for your computer.

If your computer is installed with the Windows 7 operating system, when you are setting up your computer, the Lenovo Solution Center program prompts you to create recovery media, which you can use to restore the hard disk drive to the factory default state. For more information, see “Creating and using a recovery media” on page 59.

To run the Lenovo Solution Center program, see “Accessing Lenovo programs on the Windows 7 operating system” on page 16.

For additional information, refer to the Lenovo Solution Center help system.

Note: If you are unable to isolate and repair the problem yourself after running the program, save and print the log files. You will need the log files when you speak to a Lenovo technical support representative.

Troubleshooting

If your computer has an error, it typically displays a message or an error code, or a beep sounds when you turn it on. When you experience a problem, refer to the corresponding sections in this topic to try to solve the problem by yourself.

Computer stops responding

Print these instructions now and keep it with your computer for reference later.

If your computer is completely unresponsive (you cannot use the ThinkPad pointing device or the keyboard), do the following:

1. Press and hold the power button until the computer turns off. After the computer is turned off, restart by pressing the power button. If the computer does not turn on, continue with step 2.

Note: Do not remove the battery and the ac power adapter to reset the computer.

2. While the computer is turned off, remove all power sources from the computer (battery and the ac power adapter). Hold down the power button for 10 seconds. Plug in the ac power adapter while keeping the battery out of the computer. If the computer does not turn back on, continue with step 3.

Note: Once the computer starts up and enters the Windows environment, use the proper shutdown procedure to turn the computer off. Once the computer is off, reattach the battery and restart the computer. If the computer does not start with the battery reattached, remove the battery and again start with step 2. If the computer starts with ac power but does not start when the battery is attached, call the Customer Support Center for support.

3. While the computer is off, remove all sources of power (battery and the ac power adapter). Remove all external devices that are attached to your computer (keyboard, mouse, printer, scanner, and so on). Repeat step 2. If step 2 is unsuccessful, continue with step 4.

Note: The following steps involve removing static sensitive components from your computer. Make sure that you are properly grounded and remove all sources of power attached to the computer. If you are uncomfortable or unsure about removing components please call the Customer Support Center for assistance.

4. While the computer is off, remove all sources of power and external hardware. Remove any non-original memory module added to your computer. After removing the extra memory module and reseating the original memory module, repeat step 2. If the computer still does not turn on, consult the user manual for other customer-replaceable components that are attached to your computer.

If the computer still does not start up, call the Customer Support Center and a Customer Support Specialist will assist you.

Spills on the keyboard

With a mobile computer, there are increased chances of spilling liquids on the keyboard. Because most liquids conduct electricity, liquid spilled on the keyboard could create numerous short circuits, potentially causing irreparable damage to your computer.

If you spill something on your computer:

Attention: Ensure that no liquid creates a short circuit between you and the ac power adapter (if in use). Although you might lose some data or work by turning off the computer immediately, leaving the computer on might make your computer unusable.

1. Carefully unplug the ac power adapter immediately.
2. Turn off the computer immediately. If the computer does not turn off, remove the battery. The more quickly you stop the current from passing through the computer the more likely you will reduce damage from short circuits.
3. Wait until you are certain that all the liquid is dry before turning on your computer.

Note: If you want to replace your keyboard, you can purchase a new one.

Error messages

- **Message:** 0177: Bad SVP data, stop POST task.

Solution: Checksum of the supervisor password in the EEPROM is not correct. The system board should be replaced. Have the computer serviced.

- **Message:** 0183: Bad CRC of Security Settings in EFI Variable. Enter ThinkPad Setup.

Solution: Checksum of the Security settings in the EFI Variable is not correct. Enter ThinkPad Setup to check security settings, Press F10 and then press Enter to restart the system. If you still have a problem, have the computer serviced.

- **Message:** 0187: EAIA data access error.

Solution: The access to EEPROM is failed. Have the computer serviced.

- **Message:** 0188: Invalid RFID Serialization Information Area.

Solution: The EEPROM checksum is not correct (block # 0 and 1). The system board should be replaced, and the box serial number needs to be reinstalled. Have the computer serviced.

- **Message:** 0189: Invalid RFID configuration information area.

Solution: The EEPROM checksum is not correct (block # 4 and 5). The system board should be replaced, and the UUID needs to be reinstalled. Have the computer serviced.

- **Message:** 0190: Critical low-battery error.

Solution: The computer turns off, because the battery is low. Connect the ac power adapter to the computer and charge the battery, or replace the battery with a fully charged one.

- **Message:** 0191: System Security - Invalid remote change requested.

Solution: The system configuration change has failed. Confirm the operation and try again. To clear the error, enter the ThinkPad Setup program.

- **Message:** 0199: System Security - Security password retry count exceeded.

Solution: This message is displayed if you enter a wrong supervisor password more than three times. Confirm the supervisor password and try again. To clear the error, enter the ThinkPad Setup program.

- **Message:** 0251: System CMOS checksum bad.

Solution: The system CMOS might have been corrupted by a program. The computer uses the default settings. Run ThinkPad Setup to reconfigure the settings. If you still see the same error code, have the computer serviced.

- **Message:** 0253: EFI Variable Block Data was destroyed.

Solution: The system EFI Variable Block Data might have been corrupted. The computer uses the default settings. Run ThinkPad Setup to reconfigure the settings. If you still see the same error code, have the computer serviced.

- **Message:** 0271: Real time clock error.

Solution: Have the computer serviced.

- **Message:** 1802: Unauthorized network card is plugged in.

Solution: The network card is not supported on this computer. Remove it.

- **Message:** 1820: More than one external fingerprint readers are attached.

Solution: Power off and remove all but the reader that you set up within your main operating system.

- **Message:** 2000: ThinkVantage Active Protection sensor diagnostics failed.

Solution: ThinkVantage Active Protection sensor is not working correctly. Have the computer serviced.

- **Message:** 2100: Detection error on HDD0 (Main HDD).

Solution: The hard disk drive is not working. Have the hard disk drive serviced.

- **Message:** 2101: Detection error on HDD1 (Ultrabay HDD).

Solution: The hard disk drive is not working. Have the hard disk drive serviced.

- **Message:** 2102: Detection error on HDD2 (Mini SATA).

Solution: The Mini SATA device is not working. Have the Mini SATA device serviced.

- **Message:** 2110: Read error on HDD0 (Main HDD).

Solution: The hard disk drive is not working. Have the hard disk drive serviced.

- **Message:** 2111: Read error on HDD1 (Ultrabay HDD)

Solution: The hard disk drive is not working. Have the hard disk drive serviced.

- **Message:** 2112: Read error on HDD2 (Mini SATA)

Solution: The Mini SATA device is not working. Have the Mini SATA device serviced.

- **Message:** 2200: Machine Type and Serial Number are invalid.

Solution: Machine Type and Serial Number are invalid. Have the computer serviced.

- **Message:** 2201: Machine UUID is invalid.

Solution: Machine UUID is invalid. Have the computer serviced.

- **Message:** Fan error

Solution: Cooling fan has failed. Shut down the computer immediately and have the computer serviced.

- **Message:** Thermal sensing error

Solution: The thermal sensor is not functioning correctly. Shut down the computer immediately and have the computer serviced.

- **Message:** This system does not support batteries that are not genuine Lenovo-made or authorized. The system will continue to boot, but may not charge unauthorized batteries. Press the ESC key to continue.
Attention: Lenovo has no responsibility for the performance or safety of unauthorized batteries, and provides no warranties for failures or damage arising out of their use.

Solution: Replace the battery with the correct Lenovo battery for this computer. If you still see the same error message, contact Lenovo service to have the computer serviced.

- **Message:** The battery installed is not supported by this system and will not charge. Please replace the battery with the correct Lenovo battery for this system. Press the ESC key to continue.

Solution: Replace the battery with the correct Lenovo battery for this computer. If you still see the same error message, contact Lenovo service to have the computer serviced.

Errors without messages

- **Problem:** My screen keeps blanking when I do not want it to.

Solution: If you computer is preinstalled with the Windows 7 operating system, you can disable any system timers, such as the LCD turn-off timer or the blank timer by doing the following:

1. Start Power Manager.
2. Click the **Power plan** tab, and then select **Maximum Performance** from the predefined power plans.

- **Problem:** When I turn on the computer, nothing is displayed on the screen and the computer does not beep while starting up.

Note: If you are not sure whether you heard any beeps, turn off the computer by pressing and holding the power button for four seconds or more. Turn it on and listen again.

Solution: Make sure that:

- The battery is installed correctly.
- The ac power adapter is connected to the computer and the power cord is plugged into a working electrical outlet.
- The computer is turned on. (Turn the power button on again for confirmation.)

If a power-on password is set:

- Press any key to display the prompt for the power-on password. If the brightness level of the screen is low, increase it by pressing Home.
- Type the correct password and press Enter.

If these items are correctly set, and the screen remains blank, have the computer serviced.

- **Problem:** When I turn on the computer, only a white cursor is displayed on a blank screen.

Solution: If you have modified a partition on your hard disk drive by using partition software, information about that partition, or the master boot record might have been destroyed.

1. Turn off the computer, and then turn it on again.
2. If you still see only the cursor on the screen, do the following:
 - If you have used the partition software, examine the partition on the hard disk drive by using the software, and recover the partition if required.
 - If your system is installed with the Windows 7 operating system, use either the OneKey Recovery Pro workspace or the recovery discs to restore the system to the factory state.
 - If your system is installed with the Windows 8 operating system, use either the Remove everything and reinstall Windows function or the recovery discs to restore the system to the factory state.

If the problem persists, have the computer serviced.

- **Problem:** My screen goes blank while the computer is on.

Solution: Your screen saver or power management might have been enabled. Do either of the following:

- Touch the TrackPoint pointing device or the touch pad, or press a key to exit the screen saver.
- Press the power button to resume from sleep or hibernation.

Beep errors

Table 7. Beep errors

Problem	Solution
One short beep, pause, three short beeps, pause, three more short beeps, and one short beep	Make sure that memory modules are installed correctly. If they are, and you still hear the beeps, have the computer serviced.
Three short beeps, pause, one short beep, pause, one more short beep, and three short beeps	Power off and remove device from ExpressCard slot. If the beeps persist, have the computer serviced.

Table 7. Beep errors (continued)

One long and two short beeps	The video function has a problem. Have the computer serviced.
Five beeps	The system board has a problem. Have the computer serviced.

Memory module problems

Print these instructions now and keep it with your computer for reference later.

If your memory module is not operating properly, check the following items:

1. Verify that the memory module is installed and seated correctly in your computer.
It might be necessary to remove all added memory modules to test the computer with only the factory-installed memory modules, and then reinstall the memory module one at a time to ensure a proper connection.
2. Check for error messages during startup.
Follow the appropriate corrective actions for power-on self-test (POST) error messages.
3. Verify that the latest UEFI BIOS for your model has been installed.
4. Verify the proper memory configuration and compatibility including the maximum memory size and the memory speed.
5. Run diagnostic programs. See “Diagnosing problems” on page 125.

Networking problems

The following are the most common networking problems:

Ethernet problems

- **Problem:** Your computer cannot connect to the network.

Solution: Make sure that:

- The cable is installed correctly.

The network cable must be securely connected both to the Ethernet connector of your computer and to the RJ45 connector of the hub. The maximum allowable distance from the computer to hub is 100 meters. If the cable is connected and the distance is within acceptable limits but the problem persists, try a different cable.

- You are using the correct device driver.

1. Go to Control Panel and click **Hardware and Sound → Device Manager**. If you are prompted for an administrator password or confirmation, type the password or provide confirmation.
2. If the exclamation mark ! is displayed next to the adapter name under **Network adapters**, you might not be using the correct driver or the driver might have been disabled. To update the driver, right-click the highlighted adapter.
3. Click **Update Driver Software**, and then follow the instructions on the screen.

- The switch port and the adapter have the same duplex setting.

If you configured the adapter for full duplex, make sure that the switch port also is configured for full duplex. Setting the wrong duplex mode can degrade performance, cause data loss, or result in lost connections.

- You have installed all networking software that is necessary for your network environment.

Check with your LAN administrator for the necessary networking software.

- **Problem:** The adapter stops working for no apparent reason.
Solution: The network driver files might be corrupt or missing. Update the driver by referring to the above solution for the procedure to make sure that the correct device driver is installed.
- **Problem:** If your computer is a Gigabit Ethernet model and you use a speed of 1000 Mbps, the connection fails or errors occur.
Solution:
 - Use Category 5 wiring and make sure that the network cable is securely connected.
 - Connect to a 1000 BASE-T hub/switch (not 1000 BASE-X).
- **Problem:** The Wake on LAN feature is not working.
Solution:
 - Make sure that Wake on LAN is enabled in ThinkPad Setup.
 - If it is, check with your LAN administrator for the necessary settings.
- **Problem:** If your computer is a Gigabit Ethernet model, it cannot connect to the network at 1000 Mbps. Instead, it connects at 100 Mbps.
Solution:
 - Try another cable.
 - Make sure that the link partner is set to auto-negotiate.
 - Make sure that the switch is 802.3ab-compliant (gigabit over copper).

A wireless LAN problem

Problem: You cannot connect to the network using the built-in wireless network card.

Solution:

- If your computer is installed with Windows 7 operating system, ensure that:
 - Your wireless LAN driver is the latest version. Check the Web site and confirm that the driver version supported by the Access Connections program is the latest documented in the readme file.
 - Your computer is within range of a wireless access point.
 - The wireless radio is enabled by double-clicking the Access Connections icon on the taskbar.

Note: If you are using the Windows 7 operating system, click **Show hidden icons** on the taskbar. The Access Connections icon is displayed. For more information about the icon, refer to the Access Connections help information system.

Check the Network Name (SSID) and your encryption information. Use the Access Connections program to verify this case-sensitive information.

- If your system is installed with Windows 8 operating system, ensure that:
 - Your wireless LAN driver is the latest version.
 - Your computer is within range of a wireless access point.
 - The wireless radio is enabled.
 - The Airplane mode is off.

A wireless WAN problem

Problem: A message is displayed indicating that an unauthorized WAN card is installed.

Solution: The WAN card is not supported on this computer. Remove it.

Note: Depending on your computer, some models do not have a wireless WAN card.

Bluetooth problems

- **Problem:** Sound does not come from the Bluetooth headset/headphone but comes from the local speaker even though the Bluetooth headset/headphone is connected using a Headset profile or AV profile.

Solution: Do the following:

1. Exit the program that uses the sound device (for example, Windows Media Player).
2. Go to Control Panel and click **Hardware and Sound → Sound → Playback**.
3. If you are using a Headset profile, select **Bluetooth Hands-free Audio** and click the **Set Default** button. If you are using an AV profile, select **Stereo Audio** and click the **Set Default** button.
4. Click **OK** to close the Sound window.

- **Problem:** PIM items sent from the Windows 7 operating systems cannot be received correctly into the address book of any other Bluetooth-enabled device.

Solution: The Windows 7 operating system send PIM items in XML format, but most Bluetooth-enabled devices handle PIM items in vCard format. If another Bluetooth-enabled device can receive a file through Bluetooth, a PIM item sent from the Windows 7 might be saved as a file with the extension .contact.

Problems with the keyboard and other pointing devices

The following are the most common problems with keyboards and other pointing devices.

ThinkPad pointing device problems

- **Problem:** The pointer drifts when the computer is turned on or after it resumes normal operation.

Solution: The pointer might drift when you are not using the TrackPoint pointing device during normal operation. This is a normal characteristic of the TrackPoint pointing device and is not a defect. Pointer drifting might occur for several seconds under the following conditions:

- When the computer is turned on
- When the computer resumes normal operation
- When the TrackPoint pointing device is kept pressed for a long time
- When the temperature changes

- **Problem:** The TrackPoint pointing device or touch pad does not work.

Solution: Make sure that the TrackPoint pointing device or touch pad is enabled in the ThinkPad pointing device setting window.

Note: To open the ThinkPad pointing device window, go to Control Panel and click **Hardware and Sound → Mouse**, and then click the **ThinkPad** tab.

Keyboard problems

- **Problem:** All or some keys on the keyboard do not work.

Solution: If an external numeric keypad is connected:

1. Turn off the computer.
2. Remove the external numeric keypad.
3. Turn on the computer and try using the keyboard again.

If the keyboard problem is resolved, carefully reconnect the external numeric keypad and the external keyboard. Make sure that you have seated the connectors correctly.

If the problem persists, make sure that the correct device driver is installed.

1. Go to Control Panel. Change the view of Control Panel from Category to Large icons or Small icons.
2. Click **Keyboard**.
3. Select the **Hardware** tab. In the **Device Properties** pane, make sure that you see this message:
Device Status: This device is working properly.

If keys on the keyboard still do not work, have the computer serviced.

- **Problem:** All or some keys on the external numeric keypad do not work.
Solution: Make sure that the external numeric keypad is correctly connected to the computer.

Problems with the display and multimedia devices

This topic includes the most common problems with displays and multimedia devices, including the computer display, the external monitor, audio devices, and the optical drive.

Computer screen problems

- **Problem:** The screen is blank.
Solution: Do the following:
 - Press F7 to bring up the image.
 - If you are using the ac power adapter, or using the battery and the battery gauge shows that the battery is not depleted, press F6 to make the screen brighter.
 - If your computer is in sleep mode, press Fn to resume from the sleep mode.
 - If the problem persists, follow the solution for the following problem.

- **Problem:** The screen is unreadable or distorted.

Solution: Make sure that:

- The display device driver is installed correctly.
- The screen resolution and color quality are correctly set.
- The monitor type is correct.

To check these settings, do the following:

1. Right-click on the desktop, and click **Personalize**.
2. Click **Display** at the left.
3. Select **Change display settings**. Check whether the screen resolution is correctly set.
4. Click **Advanced Settings**.
5. Click the **Adapter** tab. Ensure that the correct device driver name is shown in the adapter information window.

Note: The device driver name depends on the video chip that has been installed on your computer.

6. Click the **Properties** button. If you are prompted for an administrator password or confirmation, type the password or provide confirmation. Check the **Device status** box and make sure that the device is working correctly. If not, click the **Troubleshoot** button and follow the instructions on the screen.
7. Click the **Monitor** tab. Ensure that the correct device driver name is shown in the adapter information window.

Note: The device driver name depends on the video chip that has been installed on your computer.

8. Click the **Properties** button. If you are prompted for an administrator password or confirmation, type the password or provide confirmation. Check the **Device status** box and make sure that the device is working correctly. If not, click the **Troubleshoot** button and follow the instructions on the screen.
9. Click the **Color Management** tab. Check whether the color quality is correctly set, and ensure that the other information also is correct. If you are prompted for an administrator password or confirmation, type the password or provide confirmation. Check the **Device status** box and ensure that the device is working correctly. If not, click the **Troubleshoot** button and follow the instructions on the screen.

- **Problem:** Incorrect characters are displayed on the screen.

Solution: Did you install the operating system or program correctly? If they are installed and configured correctly, have the computer serviced.

- **Problem:** The screen stays on even after you turn off your computer.

Solution: Press and hold the power button for four seconds or more to turn off your computer; then turn it on again.

- **Problem:** Missing, discolored, or bright dots appear on the screen every time you turn on your computer.

Solution: This is an intrinsic characteristic of the TFT technology. Your computer display contains multiple thin-film transistors (TFTs). A small number of missing, discolored, or bright dots on the screen might exist all the time.

External monitor problems

- **Problem:** The external monitor is blank.

Solution: To bring up the image, press F7 and select the desired monitor. If the problem persists, do the following:

1. Connect the external monitor to another computer to make sure that it works.
2. Reconnect the external monitor to your computer.
3. Refer to the manual shipped with the external monitor to check the resolutions and refresh rates that are supported.
 - If the external monitor supports the same resolution as the computer display or a higher resolution, view output on the external monitor or on both the external monitor and the computer display.
 - If the external monitor supports a lower resolution than the computer display, view output on the external monitor only. (If you view output on both the computer display and the external monitor, the external monitor screen will be blank or distorted.)

- **Problem:** You cannot set a higher resolution than the present one on your external monitor.

Solution:

- Make sure that the monitor information is correct. Do the following:

1. Right-click on the desktop, and click **Screen resolution**.

Note: If your computer cannot detect the external monitor, click the **Detect** button.

2. Click the icon for the desired monitor (the **Monitor-2** icon is for the external monitor).

3. Click **Advanced Settings**.

4. Click the **Adapter** tab.

5. Make sure that the correct device driver name is shown in the adapter information window.

Note: The device driver name depends on the video chip that has been installed on your computer.

6. Click **OK**.

If the information is incorrect, reinstall the device driver.

- Check the monitor type and, if necessary, update the driver by doing the following:
 1. Connect the external monitor to the monitor connector, and then connect the monitor to an electrical outlet.
 2. Turn on the external monitor and the computer.
 3. Right-click on the desktop, and click **Screen resolution**.

Note: If your computer cannot detect the external monitor, click the **Detect** button.

4. Click the icon for the desired monitor (the **Monitor-2** icon is for the external monitor).
5. Click **Advanced Settings**.
6. Click the **Monitor** tab. Check the monitor information window to make sure that the monitor type is correct. If it is, click **OK** to close the window; otherwise do the following.
7. If more than one monitor type is displayed, select **Generic PnP Monitor** or **Generic Non-PnP Monitor**.
8. Click **Properties**. If you are prompted for an administrator password or confirmation, type the password or provide confirmation.
9. Click the **Driver** tab.
10. Click **Update Driver**.
11. Click **Browse my computer for driver software**, and then click **Let me pick from a list of device drivers on my computer**.
12. Clear the **Show compatible hardware** check box.
13. Select your monitor manufacturer and model.
14. After updating the driver, click **Close**.
15. Set **Resolution**.

Note: To change the color settings, select the **Monitor** tab, then set **Colors**.

16. Click **OK**.

- **Problem:** The screen is unreadable or distorted.

Solution: Make sure that:

- The monitor information is correct and the appropriate monitor type is selected. Refer to the solution to the above problem.
- Make sure that an appropriate refresh rate is selected by doing the following:
 1. Connect the external monitor to the monitor connector, and then connect the monitor to an electrical outlet.
 2. Turn on the external monitor and the computer.
 3. Right-click on the desktop, and click **Screen resolution**.

Note: If your computer cannot detect the external monitor, click the **Detect** button.

4. Click the icon for the desired monitor (the **Monitor-2** icon is for the external monitor).
5. Click **Advanced Settings**.
6. Click the **Monitor** tab.
7. Select the correct screen refresh rate.

- **Problem:** Wrong characters are displayed on the screen.

Solution: Did you follow the correct procedure when installing the operating system or program? If you did, have the external monitor serviced.

- **Problem:** The Extend desktop function does not work.

Solution: Enable the Extend desktop function by doing the following:

1. Connect the external monitor to the monitor connector, and then connect the monitor to an electrical outlet.
2. Turn on the external monitor and the computer.
3. Right-click on the desktop, and click **Screen resolution**.
4. Click the **Monitor-2** icon.
5. Select **Extend these displays** for multiple displays.
6. Click the **Monitor-1** icon (for the primary display, the computer display).
7. Set the resolution for the primary display.
8. Click the **Monitor-2** icon (for the external monitor).
9. Set the screen resolution for the secondary display.
10. Set the relative position of each monitor by dragging its icon. You can set the monitors in any relative position, but the icons must touch each other.
11. Click **OK** to apply the changes.

Note: To change the color settings, right-click on the desktop, and click **Screen resolution**. Click **Advanced Settings**, select the **Monitor** tab, then set **Colors**.

- **Problem:** If you use the Extend desktop function, you cannot set a higher resolution or higher refresh rate on the secondary display.

Solution: Change the resolution and the color depth to lower settings for the primary display. Refer to the solution to the above problem.

- **Problem:** Display switching does not work.

Solution: If you use the Extend desktop function, disable it, and change the display output location. If a DVD movie or a video clip is playing, stop the playback, close the program, and then change the display output location.

- **Problem:** The screen position on the external monitor is incorrect when that monitor is set for a high resolution.

Solution: Sometimes, when you use a high resolution such as 1600x1200, the image is shifted to left or right on the screen. To correct this, first make sure that your external monitor supports the display mode (the resolution and the refresh rate) that you have set. If it does not, set a display mode that the monitor supports. If it does support the display mode you have set, go to the setup menu for the monitor itself and adjust the settings there. Usually the external monitor has buttons for access to the setup menu. For details, see the documentation that comes with the monitor.

Audio problems

- **Problem:** Wave or MIDI sound does not play correctly.

Solution: Make sure that the built-in audio device is configured correctly.

1. Go to Control Panel.
2. Click **Hardware and Sound**.

3. Click **Device Manager**. If you are prompted for an administrator password or confirmation, type the password or provide confirmation.
4. Double-click **Sound, video and game controllers**.
5. Make sure that the following device is enabled and configured correctly:
 - Conexant CX20671 SmartAudio HD

- **Problem:** Recordings made using the microphone input are not loud enough.

Solution: Make sure that the Microphone Boost function is turned on and set by doing the following:

1. Go to Control Panel.
2. Click **Hardware and Sound**.
3. Click **Sound**.
4. Click the **Recording** tab in the Sound window.
5. Select **Microphone**, and click the **Properties** button.
6. Click the **Levels** tab, and move the Microphone Boost slider upwards.
7. Click **OK**.

Note: For details about controlling volume, refer to your Windows online help.

- **Problem:** A volume or balance slider cannot be moved.

Solution: The slider might be grayed out. This means that its position is fixed by the hardware and cannot be changed.

- **Problem:** The volume sliders do not stay in place when some audio programs are used.

Solution: It is normal for the sliders to change position when certain sound programs are used. The programs are aware of the settings in the Volume Mixer window and are allowed to change the settings themselves. An example is the Windows Media Player. Usually the program has sliders available to control the sound from within the program.

- **Problem:** The balance slider cannot completely mute one channel.

Solution: The control is designed to compensate for minor differences in balance and does not completely mute either channel.

- **Problem:** There is no volume control for MIDI sound in the Volume Mixer window.

Solution: Use the hardware volume control. This is because the built-in synthesizer software does not support the control.

- **Problem:** The sound cannot be turned off completely even if you set the Volume Mixer at minimum.

Solution: You still can hear some sound even though you have set the Volume Mixer at minimum. To turn off the sound completely, go to the Volume Mixer by clicking the speaker icon in the taskbar, then click **Mixer**. Click the **Mute speaker** icon.

- **Problem:** When you connect a headphone to your computer while playing sound, a speaker does not produce sound in the MULTI-STREAM mode at SmartAudio.

Solution: Once the headphone is attached, the streaming is automatically redirected to it. If you want to listen to sound from the speakers again, be sure to set those speakers as the default device. The procedure is as follows:

1. Go to Control Panel and click **Hardware and sound**.
2. Click the **SmartAudio** icon. The SmartAudio window opens.

3. Look at the tabs of playback devices. If you have attached a headphone, the headphone will be automatically set as the default device, and the headphone tab icon will be checked.
4. To set a different device as the default, click the speaker tab. Click the **Set Default Device** drop down list box. Select **Set Default Device**. That speaker tab icon will now have a check mark.
5. Play any sound by use of a music program such as Windows Media Player. Make sure that sound comes from the speakers.

For details, refer to the help information system for SmartAudio.

Fingerprint reader problems

- **Problem:** The surface of the reader is dirty, stained, or wet.
Solution: Gently clean the surface of the reader with a dry, soft, lint-free cloth.
- **Problem:** The reader often fails to enroll or authenticate your fingerprint.
Solution: If the surface of the reader is dirty, stained, or wet, gently clean the surface of the reader with a dry, soft, lint-free cloth.

For tips on how to maintain the fingerprint reader, refer to “Maintaining the fingerprint reader” on page 56.

Battery and power problems

This topic contains instructions on troubleshooting battery and power problems.

Battery problems

- **Problem:** The battery pack cannot be fully charged in the standard charge time when the computer is powered off.

Solution: The battery pack might be over-discharged. Do the following:

1. Turn off the computer.
2. Make sure that the over-discharged battery pack is in the computer.
3. Connect the ac power adapter to the computer and let it charge.

If a quick charger is available, use it to charge the over-discharged battery pack.

If the battery pack cannot be fully charged in 24 hours, use a new battery pack.

- **Problem:** Your computer shuts down before the battery status indicator shows empty, or your computer operates after the battery status indicator shows empty.
Solution: Discharge and recharge the battery pack.
- **Problem:** The operating time for a fully charged battery pack is short.
Solution: Discharge and recharge the battery pack. If your battery operating time is still short, use a new battery pack.
- **Problem:** The computer does not operate with a fully charged battery pack.
Solution: The surge protector in the battery pack might be active. Turn off the computer for one minute to reset the protector; then turn on the computer again.
- **Problem:** The battery pack cannot be charged.
Solution: You cannot charge the battery when it is too hot. If the battery feels hot, remove it from the computer and allow it to cool to room temperature. After it cools, reinstall it and recharge the battery. If it still cannot be charged, have it serviced.

An ac power adapter problem

Problem: The ac power adapter is connected to the computer and the working electrical outlet, but the power adapter (power plug) icon is not displayed on the taskbar. Also the ac power indicator does not light up.

Solution: Do the following:

1. Make sure that the connection of the ac power adapter is correct. For instructions on connecting the ac power adapter, see *Safety, Warranty, and Setup Guide* that comes with your computer.
2. If the connection of the ac power adapter is correct, turn off the computer, then disconnect the ac power adapter and remove the main battery.
3. Reinstall the battery and reconnect the ac power adapter, then turn on the computer.
4. If the power adapter icon still is not displayed on the taskbar and the ac power indicator does not light up, have the ac power adapter and your computer serviced.

Note: To display the power adapter (power plug) icon, click **Show hidden icons** on the taskbar.

Power problems

Print these instructions now and keep it with your computer for reference later.

If your computer is getting no power at all, check the following items:

1. Verify the power button. The power button is lit whenever the computer is on.
2. Check all power connections. Remove any power strips and surge protectors to connect the ac power adapter directly to the ac power outlet.
3. Inspect the ac power adapter. Check for any physical damage, and make sure that the power cable is firmly attached to the adapter brick and the computer.
4. Verify the ac power source is working by attaching another device to the outlet.
5. Remove all devices and then test for system power with minimal devices attached.
 - a. Disconnect the ac power adapter and all cables from the computer.
 - b. Close the computer display, and turn the computer over.
 - c. Remove the battery. Refer to “Replacing the battery” on page 67.
 - d. Remove the memory module. Refer to “Replacing a memory module” on page 94.
 - e. Remove the Wireless LAN card and Wireless WAN card. Refer to “Replacing a wireless LAN card” on page 89 and “Replacing a wireless WAN card” on page 92.
 - f. Remove the hard disk drive. Refer to “Replacing the hard disk drive or solid-state drive” on page 82.
 - g. Wait for 30 seconds, and then reinstall the memory module and the known good battery or the ac power adapter to test the computer with minimal devices attached first.
 - h. Reinstall each device one at a time that you have removed in the earlier steps.

If your computer does not run on battery power, check the following items:

1. Remove and reseat the battery to make sure that it is properly connected. Refer to “Replacing the battery” on page 67.
2. Swap batteries with another similar model, if available.

If another similar ThinkPad model is available, then verify that the battery pack works in the other computer and that the battery pack for the other model works in this computer.

A power button problem

Problem: The system does not respond, and you cannot turn off the computer.

Solution: Turn off the computer by pressing and holding the power button for 4 seconds or more. If the system is still not reset, remove the ac power adapter and the battery.

Boot problems

Print these instructions now and keep them with your computer for reference later.

If you receive an error message before the operating system loads, follow the appropriate corrective actions for POST error messages.

If you receive an error message while the operating system is loading the desktop configuration after the POST is completed, check the following items:

1. Go to the Lenovo Support Web site at <http://www.lenovo.com/support> and search for the error message.
2. Go to the Microsoft Knowledge Base homepage at <http://support.microsoft.com/> and search for the error message.

Sleep and hibernation problems

- **Problem:** The computer enters sleep mode unexpectedly.

Solution: If the microprocessor overheats, the computer automatically enters sleep mode to allow the computer to cool and to protect the microprocessor and other internal components. Check the settings for sleep mode.

- **Problem:** The computer enters sleep mode (the sleep indicator turns on) immediately after the power-on self-test.

Solution: Make sure that:

- The battery is charged.
- The operating temperature is within the acceptable range. Refer to “Operating environment” on page 15.

If the battery is charged and the temperature is within range, have the computer serviced.

- **Problem:** A critical low-battery error occurs, and the computer immediately turns off.

Solution: The battery power is getting low. Connect the ac power adapter to the computer and plug it into an electrical outlet, or replace the battery with a charged one.

- **Problem:** The computer display remains blank after you press Fn to return from sleep mode.

Solution: Check whether an external monitor was disconnected or turned off while the computer was in sleep mode. If you disconnected or turned off the external monitor, connect it or turn it on before resuming the computer from the sleep mode. When resuming the computer from the sleep mode without attaching the external monitor or turning it on, and the computer display remains blank, press F7 to bring up the computer display.

- **Problem:** The computer does not return from sleep mode, or the system status indicator (illuminated ThinkPad logo) blinks slowly and the computer does not work.

Solution: If the system does not return from sleep mode, it might have entered sleep or hibernation mode automatically because the battery is depleted. Check the system status indicator (illuminated ThinkPad logo).

- If the system status indicator (illuminated ThinkPad logo) blinks slowly, your computer is in sleep mode. Connect the ac power adapter to the computer; then press Fn.
- If the system status indicator (illuminated ThinkPad logo) is off, your computer is in power-off state or in hibernation mode. Connect the ac power adapter to the computer; then press the power button to resume operation.

If the system still does not return from sleep mode, your system might stop responding and you might not be able to turn off the computer. In this case, you need to reset the computer. If you have not saved your data, it might be lost. To reset the computer, press and hold the power button for 4 seconds or more. If the system is still not reset, remove the ac power adapter and the battery.

- **Problem:** Your computer does not enter sleep or hibernation mode.

Solution: Check whether any option has been selected to disable your computer from entering sleep or hibernation mode.

If your computer tries to enter sleep mode but the request is rejected, the device attached to the USB connector might have been disabled. If this occurs, do a hot-unplug-and-plug operation for the USB device.

- **Problem:** The battery discharges slightly while the computer is in hibernation mode.

Solution: If the wakeup function is enabled, the computer consumes a small amount of power. This is not a defect. For details, refer to “Power-saving modes” on page 32.

Problems with drives and other storage devices

This section includes hard disk drive problems, solid-state drive problems, and optical drive problems.

Hard disk drive problems

- **Problem:** The hard disk drive makes a rattling noise intermittently.

Solution: The rattling noise might be heard:

- When the hard disk drive begins or finishes getting access to data.
- When you carry the hard disk drive.
- When you carry your computer.

This is a normal characteristic of a hard disk drive and is not a defect.

- **Problem:** The hard disk drive does not work.

Solution: On the **Boot** menu of ThinkPad Setup, make sure that the hard disk drive is on the **Boot priority order** list. If it is on the **Excluded from boot order** list, it is disabled. Select the entry for it on the list and press the Shift+1 key. This moves the entry to the **Boot priority order** list.

- **Problem:** After setting a hard disk password on the hard disk drive of the computer, you moved the drive to another computer. Now you cannot unlock the hard disk password.

Solution: Your computer supports an enhanced password algorithm. Computers older than yours might not support such a security function.

A solid-state drive problem

Problem: When you compress files or folders by use of the data compression function in Windows, and then decompress them, the process of writing to or reading from the files or folders is slow.

Solution: Apply the disk defragmentation tool in Windows for faster access to the data.

Optical drive problems

- **Problem:** The optical drive, such as a CD, DVD, or CD-RW drive, does not work.

Solution: Make sure that the computer is turned on and a CD, DVD, or CD-RW is properly loaded on the center pivot of the drive. (You should hear a click.)

Make sure that the drive connector is firmly connected to the computer. If you use an option that has a bay for installing the drive, make sure that the option is firmly connected to the computer and works properly.

Make sure that the drive tray is firmly closed.

Make sure that the device drivers are correctly installed.

- **Problem:** You hear a noise from the drive when the CD, DVD, or CD-RW disc is spinning.

Solution: If the disc is not correctly loaded on the center pivot of the drive, it might rub against the drive cover and make a noise. Make sure that the disc is loaded correctly in the drive.

- **Problem:** The tray does not open even if you press the eject button.

Solution: When your computer is not turned on, pressing the eject button does not cause the drive tray to open. Make sure that the computer is turned on and that the drive connector is firmly connected to the computer.

If the tray still does not open, make sure that the computer is running, and insert the end of a straightened paper clip into the emergency eject hole. The tray will open.

- **Problem:** An optical medium, such as a CD, DVD, or CD-RW disc cannot be read.

Solution: Make sure that the CD, DVD, or CD-RW disc is not dirty. If it is, clean it with a cleaner kit.

Test another CD, DVD, or CD-RW disc. If the computer can read the other disc, the first disc might be defective.

Make sure that the disc is loaded on the center pivot of the drive with the label side up. (You should hear a click.)

Make sure that the disc is in one of the following formats:

- Music CD
- CD-ROM or CD-ROM XA
- Multisession photo CD
- Video CD
- DVD-ROM (DVD-video)

- **Problem:** The computer cannot play a CD, or the sound quality is not good.

Solution: Ensure that the disc meets the standards for your country. Usually, a disc that meets the local standards is marked with a CD logo on the label. If you use a disc that does not meet these standards, we cannot guarantee that it will play, or that, if it does play, the sound quality will be good.

- **Problem:** The **HD DVD** tab in the WinDVD8 program is dimmed and I cannot use it.

Solution: Your computer does not support an HD DVD drive.

A software problem

Problem: A program does not run correctly.

Solution: Make sure that the problem is not being caused by the program.

Check that your computer has the minimum required memory to run the program. Refer to the manuals supplied with the program.

Check the following:

- The program is designed to operate with your operating system.
- Other programs run correctly on your computer.
- The necessary device drivers are installed.

- The program works when it is run on some other computer.

If an error message is displayed while you are using the program, refer to the manuals supplied with the program.

If the program still does not run correctly, contact your place of purchase or a service representative for help.

A USB problem

Problem: A device connected to the USB connector does not work.

Solution: Open the Device Manager window. Make sure that the USB device setup is correct, and that the assignment of computer resource and the installation of the device driver are correct. Go to Control Panel and click **Hardware and Sound → Device Manager**. If you are prompted for an administrator password or confirmation, type the password or provide confirmation.

Chapter 10. Getting support

This chapter provides information about getting help and support from Lenovo.

- “Before you contact Lenovo” on page 145
- “Getting help and service” on page 146
- “Purchasing additional services” on page 148

Before you contact Lenovo

Often, you can solve your computer problems by referring to the information in the explanations of error codes, running diagnostic programs, or by consulting the Lenovo Web site.

Registering your computer

If your computer is installed with the Windows 7 operating system, register your computer with Lenovo at <http://www.lenovo.com/register>. For more information, see “Registering your computer” on page 21.

If your system is installed with the Windows 8 operating system, click **Lenovo Support** from the Start screen. Click **Registration**. Then follow onscreen instructions.

Downloading system updates

Downloading updated software might resolve problems you experience with your computer.

To download updated software, go to the following Web site and follow the instructions on the screen:
<http://www.lenovo.com/support>

Recording information

Before you talk to a Lenovo representative, record the following important information about your computer.

Recording problem symptoms and details

Collect the answers to the questions below before you call for help. Then, you will be able to get help as quickly as possible.

- What is the problem? Is it continuous or intermittent?
- Is there an error message? What is the error code, if any?
- What operating system are you using? Which version?
- Which software programs were running at the time of the problem?
- Can the problem be reproduced? If so, how?

Recording system information

The serial number label is on the bottom of your computer. Record the machine type and the serial number.

- What is the name of your Lenovo product?
- What is the machine type?
- What is the serial number?

Getting help and service

If you need help, service, technical assistance, or just want more information about Lenovo products, you will find a wide variety of sources available from Lenovo to assist you. This section contains information about where to go for additional information about Lenovo and our products, what to do if you experience a problem with your computer, and whom to call for service should it be necessary.

Information about your computer and preinstalled software, if any, is available in the documentation that comes with your computer. That documentation includes printed books, online books, readme files, and help files. In addition, information about Lenovo products is available on the World Wide Web.

Microsoft Service Packs are the latest software source for Windows product updates. They are available through Web download (connection charges might apply) or through disc. For more specific information and links, go to <http://www.microsoft.com>. Lenovo offers technical assistance with installation of, or questions related to, Service Packs for your Lenovo-preloaded Microsoft Windows product. For information, contact the Customer Support Center.

Using diagnostic programs

Many computer problems can be solved without outside assistance. If you experience a problem with your computer, the first place to start is the troubleshooting information of your computer documentation. If you suspect a software problem, see the documentation, including readme files and help information systems, that comes with the operating system or program.

ThinkPad notebook computers come with a set of diagnostic programs that you can use to help you identify hardware problems. See “Diagnosing problems” on page 125 for instructions on using the diagnostic programs.

The troubleshooting information or the diagnostic programs might tell you that you need additional or updated device drivers or other software. You can get the latest technical information and download device drivers and updates from the Lenovo Web site at <http://www.lenovo.com/support>.

Lenovo Support Web site

Technical support information is available on the Lenovo Support Web site at:
<http://www.lenovo.com/support>

This Web site is updated with the latest support information such as the following:

- Drivers and software
- Diagnostic solutions
- Product and service warranty
- Product and parts details
- User guides and manuals
- Knowledge base and frequently asked questions

Calling Lenovo

If you have tried to correct the problem yourself and still need help, during the warranty period, you can get help and information by telephone through the Customer Support Center. The following services are available during the warranty period:

- Problem determination - Trained personnel are available to assist you with determining if you have a hardware problem and deciding what action is necessary to fix the problem.

- Lenovo hardware repair - If the problem is determined to be caused by Lenovo hardware under warranty, trained service personnel are available to provide the applicable level of service.
- Engineering change management - Occasionally, there might be changes that are required after a product has been sold. Lenovo or your reseller, if authorized by Lenovo, will make selected Engineering Changes (ECs) that apply to your hardware available.

The following items are not covered:

- Replacement or use of parts not manufactured for or by Lenovo or nonwarranted parts

Note: All warranted parts contain a 7-character or 10-character identification in the format FRU XXXXXXXX or FRU XXXXXXXXXXXX.

- Identification of software problem sources
- Configuration of UEFI BIOS as part of an installation or upgrade
- Changes, modifications, or upgrades to device drivers
- Installation and maintenance of network operating systems (NOS)
- Installation and maintenance of programs

For the terms and conditions of the Lenovo Limited Warranty that applies to your Lenovo hardware product, see “Warranty information” in the *Safety, Warranty, and Setup Guide* that comes with your computer.

If possible, be near your computer when you make your call in case the technical assistance representative needs to help you resolve a computer problem. Ensure that you have downloaded the most current drivers and system updates, run diagnostics, and recorded information before you call. When calling for technical assistance, have the following information available:

- Machine type and model
- Serial numbers of your computer, monitor, and other components, or your proof of purchase
- Description of the problem
- Exact wording of any error messages
- Hardware and software configuration information for your system

Telephone numbers

For a list of the Lenovo Support phone numbers for your country or region, go to <http://www.lenovo.com/support/phone> or refer to the *Safety, Warranty, and Setup Guide* that comes with your computer.

Note: Phone numbers are subject to change without notice. The latest phone numbers are available at <http://www.lenovo.com/support/phone>. If the number for your country or region is not provided, contact your Lenovo reseller or Lenovo marketing representative.

Finding ThinkPad options

If you want to expand the capabilities of your computer, Lenovo has a number of hardware accessories and upgrades to meet your needs. Options include memory modules, storage devices, network cards, port replicators, batteries, power adapters, printers, scanners, keyboards, mice, and more.

You can shop at Lenovo 24 hours a day, 7 days a week directly over the World Wide Web. All you need is an Internet connection and a credit card.

To shop at Lenovo, go to:

<http://www.lenovo.com/accessories/services/index.html>

Purchasing additional services

During and after the warranty period, you can purchase additional services, such as support for Lenovo and non-Lenovo hardware, operating systems, and programs; network setup and configuration services; upgraded or extended hardware repair services; and custom installations services. Service availability and service name might vary by country.

For more information about these services, go to:

<http://www.lenovo.com/accessories/services/index.html>

Appendix A. Regulatory information

Wireless related information

Wireless interoperability

Wireless LAN PCI Express Mini Card is designed to be interoperable with any wireless LAN product that is based on Direct Sequence Spread Spectrum (DSSS), Complementary Code Keying (CCK), and/or Orthogonal Frequency Division Multiplexing (OFDM) radio technology, and is compliant to:

- The 802.11b/g Standard, 802.11a/b/g or 802.11n draft 2.0 on Wireless LANs, as defined and approved by the Institute of Electrical and Electronics Engineers.
- The Wireless Fidelity (WiFi) certification as defined by the Wi-Fi Alliance.

Your Bluetooth card is compliant with Bluetooth Specification 4.0 as defined by the Bluetooth Special Interest Group SIG. It supports the following profiles:

- Advanced Audio Distribution Profile (A2DP)
- Audio/Video Control Transport Protocol (AVCTP)
- Audio/Video Distribution Transport Protocol (AVDTP)
- A/V Remote Control Profile (AVRCP)
- Basic Imaging Profile (BIP)
- Basic Printing Profile (BPP)
- Dial-Up Networking Profile (DUN)
- File Transfer Profile (FTP)
- Generic Access Profile (GAP)
- Generic A/V Distribution Profile (GAVDP)
- Hardcopy Cable Replacement Profile (HCRP)
- Headset Profile (HSP)
- Hands-Free Profile (HFP)
- Human Interface Device Profile (HID)
- Message Access Profile (MAP)
- Object Exchange Protocol (OBEX)
- Object Push Profile (OPP)
- Personal Area Networking Profile (PAN)
- Phone Book Access Profile (PBAP)
- Service Discovery Protocol (SDP)
- Synchronization Profile (SYNC)
- Video Distribution Profile (VDP)
- Generic Attribute Profile (GATT)
- Proximity Profile
- Find Me Profile
- Immediate Alert Profile

- Battery Status Profile

Usage environment and your health

Integrated wireless cards emit radio frequency electromagnetic energy like other radio devices. However, the level of energy emitted is far much less than the electromagnetic energy emitted by wireless devices like for example mobile phones.

Due to the fact that integrated wireless cards operate within the guidelines found in radio frequency safety standards and recommendations, Lenovo believes they are safe for use by consumers. These standards and recommendations reflect the consensus of the scientific community and result from deliberations of panels and committees of scientists who continually review and interpret the extensive research literature.

In some situation or environment, the use of integrated wireless cards might be restricted by the proprietor of the building or responsible representatives of the organization. These situations and areas might for example include:

- Using the integrated wireless cards on board of airplanes, in hospitals or near petrol stations, blasting areas (with electro-explosive devices), medical implants or body-worn electronic medical devices, such as pace makers.
- In any other environment where the risk of interference to other devices or services is perceived or identified as harmful.

If you are uncertain of the policy that applies to the use of wireless devices in a specific organization (such as airport or hospital), you are encouraged to ask for authorization to use integrated wireless cards prior to turning on the computer.

Location of the UltraConnect wireless antennas

ThinkPad notebook computers feature an integrated UltraConnect™ wireless antenna system built into the display for optimal reception, enabling wireless communication wherever you are.

There are two types of antenna locations. Your computer corresponds to one of the following:

Type 1: Antenna location

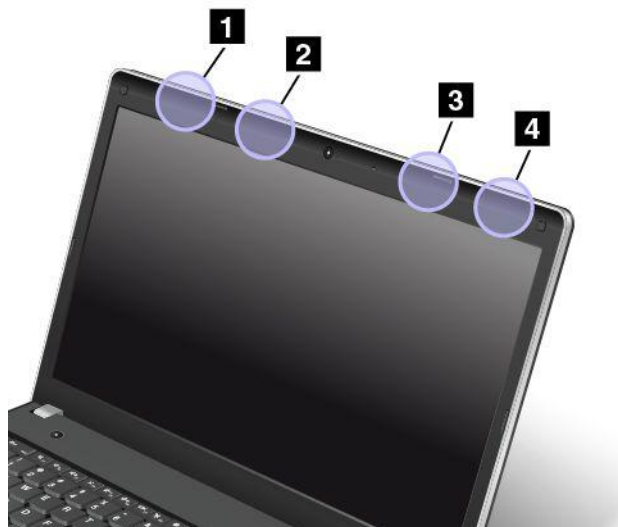

- 1 Wireless LAN antenna (auxiliary)
- 2 Wireless WAN antenna (auxiliary)

- 3 Wireless WAN antenna (main)
- 4 Wireless LAN antenna (main)

Type 2: Antenna location

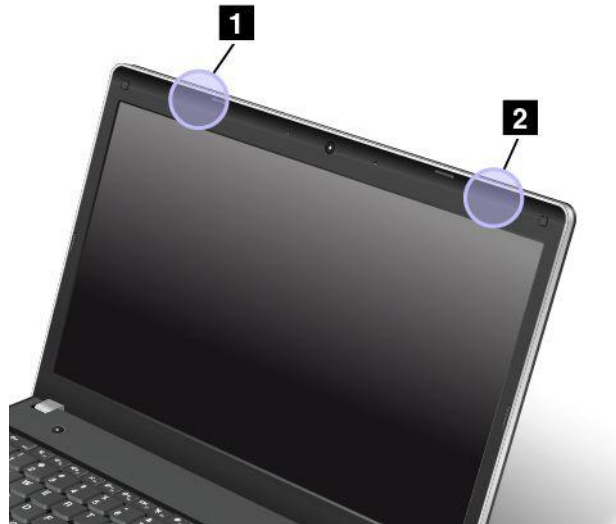

- 1 Wireless LAN antenna (auxiliary)
- 2 Wireless LAN antenna (main)

Locating wireless regulatory notices

For more information about the wireless regulatory notices, refer to the *Regulatory Notice* shipped with your computer.

If your computer is shipped without the *Regulatory Notice*, you can find it on the Web site at:
<http://www.lenovo.com/ThinkPadUserGuides>

Export classification notice

This product is subject to the United States Export Administration Regulations (EAR) and has an Export Classification Control Number (ECCN) of 4A994.b. It can be re-exported except to any of the embargoed countries in the EAR E1 country list.

Electronic emission notices

The following information refers to the ThinkPad Edge E431 and E531, machine type 6277, 6885, 6886, and 6887.

Federal Communications Commission Declaration of Conformity

This equipment has been tested and found to comply with the limits for a Class B digital device, pursuant to Part 15 of the FCC Rules. These limits are designed to provide reasonable protection against harmful interference in a residential installation. This equipment generates, uses, and can radiate radio frequency energy and, if not installed and used in accordance with the instructions, may cause harmful interference to radio communications. However, there is no guarantee that interference will not occur in a particular installation. If this equipment does cause harmful interference to radio or television reception, which can be determined by turning the equipment off and on, the user is encouraged to try to correct the interference by one or more of the following measures:

- Reorient or relocate the receiving antenna.
- Increase the separation between the equipment and receiver.
- Connect the equipment into an outlet on a circuit different from that to which the receiver is connected.
- Consult an authorized dealer or service representative for help.

Lenovo is not responsible for any radio or television interference caused by using other than specified or recommended cables and connectors or by unauthorized changes or modifications to this equipment. Unauthorized changes or modifications could void the user's authority to operate the equipment.

This device complies with Part 15 of the FCC Rules. Operation is subject to the following two conditions: (1) this device may not cause harmful interference, and (2) this device must accept any interference received, including interference that may cause undesired operation.

Responsible Party:

Lenovo (United States) Incorporated
 1009 Think Place - Building One
 Morrisville, NC 27560
 Phone Number: 919-294-5900



Industry Canada Class B emission compliance statement

This Class B digital apparatus complies with Canadian ICES-003.

Cet appareil numérique de la classe B est conforme à la norme NMB-003 du Canada.

European Union - Compliance to the Electromagnetic Compatibility Directive

This product is in conformity with the protection requirements of EU Council Directive 2004/108/EC on the approximation of the laws of the Member States relating to electromagnetic compatibility. Lenovo cannot accept responsibility for any failure to satisfy the protection requirements resulting from a non-recommended modification of the product, including the installation of option cards from other manufacturers.

This product has been tested and found to comply with the limits for Class B Information Technology Equipment according to European Standard EN 55022. The limits for Class B equipment were derived for typical residential environments to provide reasonable protection against interference with licensed communication devices.

EU contact: Lenovo, Einsteinova 21, 851 01 Bratislava, Slovakia



German Class B compliance statement

Deutschsprachiger EU Hinweis:

Hinweis für Geräte der Klasse B EU-Richtlinie zur Elektromagnetischen Verträglichkeit

Dieses Produkt entspricht den Schutzanforderungen der EU-Richtlinie 2004/108/EG (früher 89/336/EWG) zur Angleichung der Rechtsvorschriften über die elektromagnetische Verträglichkeit in den EU-Mitgliedsstaaten und hält die Grenzwerte der EN 55022 Klasse B ein.

Um dieses sicherzustellen, sind die Geräte wie in den Handbüchern beschrieben zu installieren und zu betreiben. Des Weiteren dürfen auch nur von der Lenovo empfohlene Kabel angeschlossen werden. Lenovo übernimmt keine Verantwortung für die Einhaltung der Schutzanforderungen, wenn das Produkt ohne Zustimmung der Lenovo verändert bzw. wenn Erweiterungskomponenten von Fremdherstellern ohne Empfehlung der Lenovo gesteckt/eingebaut werden.

Deutschland:

Einhaltung des Gesetzes über die elektromagnetische Verträglichkeit von Betriebsmitteln

Dieses Produkt entspricht dem „Gesetz über die elektromagnetische Verträglichkeit von Betriebsmitteln“ EMVG (früher „Gesetz über die elektromagnetische Verträglichkeit von Geräten“). Dies ist die Umsetzung der EU-Richtlinie 2004/108/EG (früher 89/336/EWG) in der Bundesrepublik Deutschland.

Zulassungsbescheinigung laut dem Deutschen Gesetz über die elektromagnetische Verträglichkeit von Betriebsmitteln, EMVG vom 20. Juli 2007 (früher Gesetz über die elektromagnetische Verträglichkeit von Geräten), bzw. der EMV EG Richtlinie 2004/108/EC (früher 89/336/EWG), für Geräte der Klasse B.

Dieses Gerät ist berechtigt, in Übereinstimmung mit dem Deutschen EMVG das EG-Konformitätszeichen - CE - zu führen. Verantwortlich für die Konformitätserklärung nach Paragraf 5 des EMVG ist die Lenovo (Deutschland) GmbH, Gropiusplatz 10, D-70563 Stuttgart.

Informationen in Hinsicht EMVG Paragraf 4 Abs. (1) 4:

Das Gerät erfüllt die Schutzanforderungen nach EN 55024 und EN 55022 Klasse B.

Korea Class B compliance statement

B급 기기(가정용 방송통신기자재)
이 기기는 가정용(B급) 전자파적합기기로서 주로 가정에서 사용하는 것을 목적으로 하며, 모든 지역에서 사용할 수 있습니다

Japan VCCI Class B compliance statement

この装置は、クラスB情報技術装置です。この装置は、家庭環境で使用することを目的としていますが、この装置がラジオやテレビジョン受信機に近接して使用されると、受信障害を引き起こすことがあります。

取扱説明書に従って正しい取り扱いをして下さい。

VCCI-B

Japan compliance statement for products which connect to the power mains with rated current less than or equal to 20 A per phase

日本の定格電流が 20A/相 以下の機器に対する高調波電流規制
高調波電流規格 JIS C 61000-3-2 適合品

Lenovo product service information for Taiwan

台灣 Lenovo 產品服務資訊如下：
荷蘭商聯想股份有限公司台灣分公司
台北市信義區信義路五段七號十九樓之一
服務電話：0800-000-702

Appendix B. WEEE and recycling statements

Lenovo encourages owners of information technology equipment to responsibly recycle their equipment when it is no longer needed. Lenovo offers a variety of programs and services to assist equipment owners in recycling their IT products. Information on product recycling offerings can be found on Lenovo's Internet site at http://www.lenovo.com/social_responsibility/us/en/.

Important WEEE information

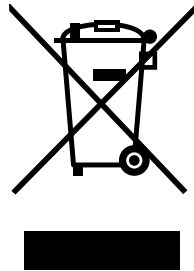

The WEEE marking on Lenovo products applies to countries with WEEE and e-waste regulations (for example, European Directive 2002/96/EC, India E-Waste Management & Handling Rules, 2011). Appliances are labeled in accordance with local regulations concerning waste electrical and electronic equipment (WEEE). These regulations determine the framework for the return and recycling of used appliances as applicable within each geography. This label is applied to various products to indicate that the product is not to be thrown away, but rather put in the established collection systems for reclaiming these end of life products.

Users of electrical and electronic equipment (EEE) with the WEEE marking must not dispose of end of life EEE as unsorted municipal waste, but use the collection framework available to them for the return, recycle, and recovery of WEEE and to minimize any potential effects of EEE on the environment and human health due to the presence of hazardous substances. For additional WEEE information go to: <http://www.lenovo.com/recycling>

Japan recycling statements

Collecting and recycling a disused Lenovo computer or monitor

If you are a company employee and need to dispose of a Lenovo computer or monitor that is the property of the company, you must do so in accordance with the Law for Promotion of Effective Utilization of Resources. Computers and monitors are categorized as industrial waste and should be properly disposed of by an industrial waste disposal contractor certified by a local government. In accordance with the Law for Promotion of Effective Utilization of Resources, Lenovo Japan provides, through its PC Collecting and Recycling Services, for the collecting, reuse, and recycling of disused computers and monitors. For details, visit the Lenovo Web site at: http://www.lenovo.com/services_warranty/jp/ja/recycle/pcrecycle/.

Pursuant to the Law for Promotion of Effective Utilization of Resources, the collecting and recycling of home-used computers and monitors by the manufacturer was begun on October 1, 2003. This service is provided free of charge for home-used computers sold after October 1, 2003. For details, go to http://www.lenovo.com/services_warranty/jp/ja/recycle/personal/.

Disposing of a Lenovo computer components

Some Lenovo computer products sold in Japan may have components that contain heavy metals or other environmental sensitive substances. To properly dispose of disused components, such as a printed circuit board or drive, use the methods described above for collecting and recycling a disused computer or monitor.

Disposing of disused lithium batteries from Lenovo computers

A button-shaped lithium battery is installed on the system board of your Lenovo computer to provide power to the computer clock while the computer is off or disconnected from the main power source. If you want to replace it with a new one, contact your place of purchase or ask for a repair service provided by Lenovo. If you have replaced it by yourself and want to dispose of the disused lithium battery, insulate it with vinyl tape, contact your place of purchase, and follow their instructions. If you use a Lenovo computer at home and need to dispose of a lithium battery, you must comply with local ordinances and regulations.

Disposing of a disused battery pack from Lenovo notebook computers

Your Lenovo notebook computer has a lithium ion battery pack or a nickel metal hydride battery pack. If you are a company employee who uses a Lenovo notebook computer and need to dispose of a battery pack, contact the proper person in Lenovo sales, service, or marketing, and follow that person's instructions. You also can refer to the instructions at <http://www.lenovo.com/jp/ja/environment/recycle/battery/>. If you use a Lenovo notebook computer at home and need to dispose of a battery pack, you must comply with local ordinances and regulations. You also can refer to the instructions at <http://www.lenovo.com/jp/ja/environment/recycle/battery/>.

Recycling information for Brazil

Declarações de Reciclagem no Brasil

Descarte de um Produto Lenovo Fora de Uso

Equipamentos elétricos e eletrônicos não devem ser descartados em lixo comum, mas enviados à pontos de coleta, autorizados pelo fabricante do produto para que sejam encaminhados e processados por empresas especializadas no manuseio de resíduos industriais, devidamente certificadas pelos órgãos ambientais, de acordo com a legislação local.

A Lenovo possui um canal específico para auxiliá-lo no descarte desses produtos. Caso você possua um produto Lenovo em situação de descarte, ligue para o nosso SAC ou encaminhe um e-mail para: reciclar@lenovo.com, informando o modelo, número de série e cidade, a fim de enviarmos as instruções para o correto descarte do seu produto Lenovo.

Battery recycling information for the European Union

EU

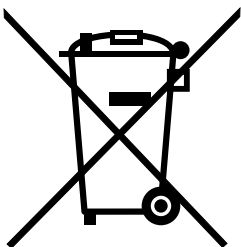

Notice: This mark applies only to countries within the European Union (EU).

Batteries or packaging for batteries are labeled in accordance with European Directive 2006/66/EC concerning batteries and accumulators and waste batteries and accumulators. The Directive determines the framework for the return and recycling of used batteries and accumulators as applicable throughout the European Union. This label is applied to various batteries to indicate that the battery is not to be thrown away, but rather reclaimed upon end of life per this Directive.

In accordance with the European Directive 2006/66/EC, batteries and accumulators are labeled to indicate that they are to be collected separately and recycled at end of life. The label on the battery may also include a chemical symbol for the metal concerned in the battery (Pb for lead, Hg for mercury, and Cd for cadmium). Users of batteries and accumulators must not dispose of batteries and accumulators as unsorted municipal waste, but use the collection framework available to customers for the return, recycling, and treatment of batteries and accumulators. Customer participation is important to minimize any potential effects of batteries and accumulators on the environment and human health due to the potential presence of hazardous substances. For proper collection and treatment, go to:
<http://www.lenovo.com/lenovo/environment>

Battery recycling information for Taiwan



廢電池請回收

Battery recycling information for the United States and Canada



US & Canada Only

Recycling information for China

《废弃电器电子产品回收处理管理条例》提示性说明

联想鼓励拥有联想品牌产品的用户当不再需要此类产品时，遵守国家废弃电器电子产品回收处理相关法律法规，将其交给当地具有国家认可的回收处理资质的厂商进行回收处理。更多回收服务信息，请点击进入<http://support.lenovo.com.cn/activity/551.htm>

Appendix C. ENERGY STAR model information



ENERGY STAR® is a joint program of the U.S. Environmental Protection Agency and the U.S. Department of Energy aimed at saving money and protecting the environment through energy efficient products and practices.

Lenovo is proud to offer our customers products with the ENERGY STAR qualified designation. Lenovo computers of the following machine types, if the ENERGY STAR mark is affixed, have been designed and tested to conform to the ENERGY STAR program requirements for computers.

6277, 6885, 6886, and 6887

By using ENERGY STAR qualified products and taking advantage of the power-management features of your computer, you can help reduce the consumption of electricity. Reduced electrical consumption can contribute to potential financial savings, a cleaner environment, and the reduction of greenhouse gas emissions.

For more information about ENERGY STAR, go to: <http://www.energystar.gov>

Lenovo encourages you to make efficient use of energy an integral part of your day-to-day operations. To help in this endeavor, Lenovo has preset the following power-management features to take effect when your computer has been inactive for a specified length of time:

Power plan: Energy Saver (settings when plugged into ac power)

- Turn off the display: After 10 minutes
- Put the computer into sleep: After 20 minutes
- Advanced power settings:
 - Turn off hard disks: After 15 minutes
 - Hibernate: Never

To awaken your computer from sleep mode, press the Fn key on your keyboard. For more information about these settings, see the Windows Help and Support information on your computer.

The Wake on LAN function is enabled when your Lenovo computer is shipped from the factory, and the setting remains valid even when the computer is in sleep mode. If you do not need to have Wake on LAN enabled while your computer is in sleep mode, you can reduce the power consumption and prolong the time in sleep mode, by disabling the setting of Wake on LAN for sleep mode. To disable the setting of Wake on LAN for sleep mode, do the following:

1. Go to Control Panel.
2. Click **Hardware and Sound** → **Device Manager**.
3. In the Device Manager window, expand **Network adapters**.
4. Right-click your network adapter device, and click **Properties**.

5. Click the **Power Management** tab.
6. Clear the **Allow this device to wake the computer** check box.
7. Click **OK**.

Appendix D. Notices

Lenovo may not offer the products, services, or features discussed in this document in all countries. Consult your local Lenovo representative for information on the products and services currently available in your area. Any reference to a Lenovo product, program, or service is not intended to state or imply that only that Lenovo product, program, or service may be used. Any functionally equivalent product, program, or service that does not infringe any Lenovo intellectual property right may be used instead. However, it is the user's responsibility to evaluate and verify the operation of any other product, program, or service.

Lenovo may have patents or pending patent programs covering subject matter described in this document. The furnishing of this document does not give you any license to these patents. You can send license inquiries, in writing, to:

*Lenovo (United States), Inc.
1009 Think Place - Building One
Morrisville, NC 27560
U.S.A.
Attention: Lenovo Director of Licensing*

LENOVO PROVIDES THIS PUBLICATION "AS IS" WITHOUT WARRANTY OF ANY KIND, EITHER EXPRESS OR IMPLIED, INCLUDING, BUT NOT LIMITED TO, THE IMPLIED WARRANTIES OF NON-INFRINGEMENT, MERCHANTABILITY OR FITNESS FOR A PARTICULAR PURPOSE. Some jurisdictions do not allow disclaimer of express or implied warranties in certain transactions, therefore, this statement may not apply to you.

This information could include technical inaccuracies or typographical errors. Changes are periodically made to the information herein; these changes will be incorporated in new editions of the publication. Lenovo may make improvements and/or changes in the product(s) and/or the application(s) described in this publication at any time without notice.

The products described in this document are not intended for use in implantation or other life support applications where malfunction may result in injury or death to persons. The information contained in this document does not affect or change Lenovo product specifications or warranties. Nothing in this document shall operate as an express or implied license or indemnity under the intellectual property rights of Lenovo or third parties. All information contained in this document was obtained in specific environments and is presented as an illustration. The result obtained in other operating environments may vary.

Lenovo may use or distribute any of the information you supply in any way it believes appropriate without incurring any obligation to you.

Any references in this publication to non-Lenovo Web sites are provided for convenience only and do not in any manner serve as an endorsement of those Web sites. The materials at those Web sites are not part of the materials for this Lenovo product, and use of those Web sites is at your own risk.

Any performance data contained herein was determined in a controlled environment. Therefore, the result obtained in other operating environments may vary significantly. Some measurements may have been made on development-level systems and there is no guarantee that these measurements will be the same on generally available systems. Furthermore, some measurements may have been estimated through extrapolation. Actual results may vary. Users of this document should verify the applicable data for their specific environment.

Trademarks

The following terms are trademarks of Lenovo in the United States, other countries, or both:

- Lenovo
- Access Connections
- Active Protection System
- OneKey
- ThinkPad
- ThinkVantage
- TrackPoint
- UltraConnect

Intel and Intel SpeedStep are trademarks or registered trademarks of Intel Corporation or its subsidiaries in the United States and other countries.

Microsoft, Windows, and BitLocker are trademarks of the Microsoft group of companies.

AMD is a trademark or registered trademark of Advanced Micro Devices, Inc.

Other company, product, and service names may be trademarks or service marks of others.

Appendix E. Restriction of Hazardous Substances Directive (RoHS)

European Union RoHS

Lenovo products sold in the European Union, on or after 3 January 2013 meet the requirements of Directive 2011/65/EU on the restriction of the use of certain hazardous substances in electrical and electronic equipment (“RoHS recast” or “RoHS 2”).

For more information about Lenovo progress on RoHS, go to:
http://www.lenovo.com/social_responsibility/us/en/RoHS_Communication.pdf

China RoHS

产品中有毒有害物质或元素的名称及含量

部件名称	有毒有害物质或元素					
	铅(Pb)	汞(Hg)	镉(Cd)	六价铬(Cr(VI))	多溴连苯(PBB)	多溴二苯醚(PBDE)
印刷电路板组件*	X	O	O	O	O	O
硬盘	X	O	O	O	O	O
光驱	X	O	O	O	O	O
内存	X	O	O	O	O	O
电脑I/O 附件	X	O	O	O	O	O
电源	X	O	O	O	O	O
键盘	X	O	O	O	O	O
鼠标	X	O	O	O	O	O
机箱/ 附件	X	O	O	O	O	O

○:表示该有毒有害物质在该部件所有均质材料中的含量均在SJ/T11363-2006标准规定的限量要求以下
×:表示该有毒有害物质至少在该部件的某一均质材料中的含量超出SJ/T11363-2006标准规定的限量要求
表中标有“×”的所有部件都符合欧盟RoHS 法规。

印刷电路板组件*: 包括印刷电路板及其零部件、电容和连接器
根据型号的不同, 可能不会含有以上的所有部件, 请以实际购买机型为准

 在中华人民共和国境内销售的电子信息产品必须标识此标志, 标志内的数字代表在正常使用状态下的产品的环保使用期限

Turkish RoHS

The Lenovo product meets the requirements of the Republic of Turkey Directive on the Restriction of the Use of Certain Hazardous Substances in Electrical and Electronic Equipment (EEE).

Türkiye EEE Yönetmeliğine Uygunluk Beyanı

Bu Lenovo ürünü, T.C. Çevre ve Orman Bakanlığı'nın “Elektrik ve Elektronik Eşyalarda Bazı Zararlı Maddelerin Kullanımının Sınırlandırılmasına Dair Yönetmelik (EEE)” direktiflerine uygundur.

EEE Yönetmeliğine Uygundur.

Ukraine RoHS

Цим підтверджуємо, що продукція Леново відповідає вимогам нормативних актів України, які обмежують вміст небезпечних речовин

India RoHS

RoHS compliant as per E-Waste (Management & Handling) Rules, 2011.

ThinkPad®