

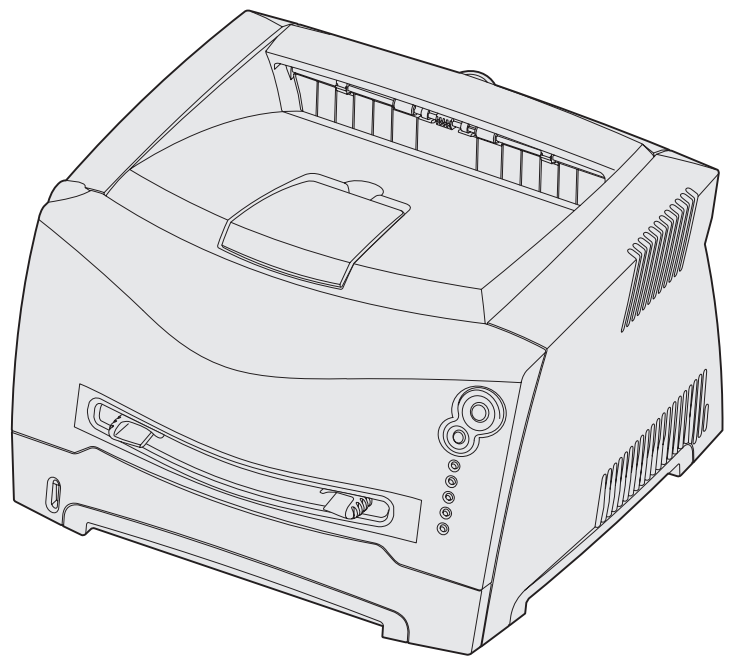

E230, E232, E330, E332n

User's Reference



November 2003

www.lexmark.com

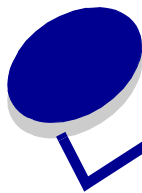

Contents

Notices	6
Edition notice.....	6
Trademarks	6
Licensing notice.....	7
Safety information	7
Laser notice.....	7
The United Kingdom Telecommunications Act 1984	7
Conventions	7
Electronic emission notices	7
Printer energy consumption	9
Statement of Limited Warranty.....	9
Chapter 1: Printer overview	11
Chapter 2: Print media tasks and tips.....	13
What types of print media can be loaded?	14
Where can print media be loaded in the printer?	15
Tips on choosing the right print media	16
Paper	16
Preprinted forms and letterhead	16
Transparencies	16
Envelopes	17
Labels	17
Card stock	18
Tips on storing print media and supplies.....	18
Storing paper	18
Storing supplies	18
Tips on preventing jams	19
How to load the 250-sheet and 550-sheet trays.....	20
Extending the tray for legal or folio size paper	23

How to load the manual feeder	24
How to use the rear exit	25
How to clear paper jams.....	26
Chapter 3: Printing tasks.....	29
How to manually feed a print job	30
How to print on both sides of the paper (manual duplex).....	32
How to print multiple page images on one page (N-up printing)	34
How to print a booklet.....	35
How to print a poster	36
How to print on letterhead	37
How to print using an overlay or a watermark.....	37
Using an overlay	38
Using a watermark	38
How to cancel a print job	39
From the printer operator panel	39
From a Windows computer	39
From a Macintosh computer	39
Chapter 4: How to install options	40
How to access the system board	41
How to reattach the system board cover	44
How to add a memory card	45
How to add a flash card.....	46
How to install a 550-sheet drawer	48
How to get the printer driver to recognize installed options.....	49
Chapter 5: Using the operator panel	50
Overview of the operator panel	51
Understanding the operator panel lights	52
Secondary errors	54
Operator panel codes.....	57
Primary codes	57
Secondary error codes	69
Chapter 6: Understanding the printer configuration menus....	83
Printing the Printer Settings Configuration sheet	83

Configuration menus overview	84
Network menu	85
Parallel menu	86
Setup menu	86
USB menu	87
Utilities menu	87
Chapter 7: Software and network tasks.....	88
How to install drivers for local printing.....	89
Windows	89
Macintosh	91
UNIX/Linux	93
How to print the menu settings and network setup pages.....	94
How to print a test page	94
Windows	94
Macintosh	94
How to configure for TCP/IP.....	95
Assigning a printer IP address	95
Verifying the IP settings	95
How to set up the printer for network printing.....	96
Windows	96
Macintosh	100
UNIX/Linux	102
NetWare	102
Using the printer resident Web page.....	102
Using the Local Printer Setup Utility.....	103
Chapter 8: Supplies information.....	104
What supplies do I need and how do I order them?.....	105
Storing supplies	105
How to conserve supplies	105
How to know when you need new supplies.....	106
Checking the toner and photoconductor levels	106
Recognizing the operator panel light sequences	107
How to change a toner cartridge	108
Lexmark Return Program	111
Refilled toner cartridge notice	111
Recycling Lexmark products	111
How to change a photoconductor kit.....	112

Chapter 9: Troubleshooting 115
 General problems..... 116
 Print quality problems..... 118
 How to clean the printhead lens 122

Index..... 125

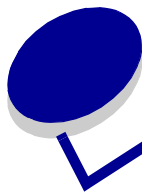

Notices

Section	Page
Edition notice	6
Trademarks	6
Licensing notice	7
Safety information	7
Laser notice	7
The United Kingdom Telecommunications Act 1984	7
Conventions	7
Electronic emission notices	7
Printer energy consumption	9
Statement of Limited Warranty	9

Edition notice

Edition: November 2003

The following paragraph does not apply to any country where such provisions are inconsistent with local law: LEXMARK INTERNATIONAL, INC., PROVIDES THIS PUBLICATION "AS IS" WITHOUT WARRANTY OF ANY KIND, EITHER EXPRESS OR IMPLIED, INCLUDING, BUT NOT LIMITED TO, THE IMPLIED WARRANTIES OF MERCHANTABILITY OR FITNESS FOR A PARTICULAR PURPOSE. Some states do not allow disclaimer of express or implied warranties in certain transactions; therefore, this statement may not apply to you.

This publication could include technical inaccuracies or typographical errors. Changes are periodically made to the information herein; these changes will be incorporated in later editions. Improvements or changes in the products or the programs described may be made at any time.

Comments about this publication may be addressed to Lexmark International, Inc., Department F95/032-2, 740 West New Circle Road, Lexington, Kentucky 40550, U.S.A. In the United Kingdom and Eire, send to Lexmark International Ltd., Marketing and Services Department, Westhorpe House, Westhorpe, Marlow Bucks SL7 3RQ. Lexmark may use or distribute any of the information you supply in any way it believes appropriate without incurring any obligation to you. You can purchase additional copies

of publications related to this product by calling 1-800-553-9727. In the United Kingdom and Eire, call +44 (0)8704 440 044. In other countries, contact your point of purchase.

References in this publication to products, programs, or services do not imply that the manufacturer intends to make these available in all countries in which it operates. Any reference to a product, program, or service is not intended to state or imply that only that product, program, or service may be used. Any functionally equivalent product, program, or service that does not infringe any existing intellectual property right may be used instead. Evaluation and verification of operation in conjunction with other products, programs, or services, except those expressly designated by the manufacturer, are the user's responsibility.

© 2003 Lexmark International, Inc.

All rights reserved.

UNITED STATES GOVERNMENT RIGHTS

This software and any accompanying documentation provided under this agreement are commercial computer software and documentation developed exclusively at private expense.

Trademarks

Lexmark and Lexmark with diamond design are trademarks of Lexmark International, Inc., registered in the United States and/or other countries.

PictureGrade is a trademark of Lexmark International, Inc.

PCL[®] is a registered trademark of the Hewlett-Packard Company. PCL is Hewlett-Packard Company's designation of a set of printer commands (language) and functions included in its printer products. This printer is intended to be compatible with the PCL language. This means the printer recognizes PCL commands used in various application programs, and that the printer emulates the functions corresponding to the commands.

PostScript[®] is a registered trademark of Adobe Systems Incorporated. PostScript 3 is Adobe Systems' designation of a set of printer commands (language) and functions included in its software products. This printer is intended to be compatible with the PostScript 3 language. This means the printer recognizes PostScript 3 commands used in various application programs, and that the printer emulates the functions corresponding to the commands.

Details relating to compatibility are included in the *Technical Reference*.

Other trademarks are the property of their respective owners.

Licensing notice

The printer resident software contains:

- Software developed and copyrighted by Lexmark
- Lexmark modified software licensed under the provisions of the GNU General Public License version 2 and the GNU Lesser General Public License version 2.1
- Software licensed under the BSD license and warranty statements

Click the title of the document you want to review:



The Lexmark modified GNU licensed software is free software; you can redistribute it and/or modify it under the terms of the licenses referenced above. These licenses do not provide you any rights to the Lexmark copyrighted software in this printer.

Since the GNU licensed software that the Lexmark modifications are based upon is supplied explicitly without warranty, use of the Lexmark modified version is similarly provided without warranty. See the warranty disclaimers in the referenced licenses for additional details.

To obtain source code files for the Lexmark modified GNU licensed software, launch the drivers CD that shipped with your printer and click **Contact Lexmark**.

Safety information

- If your product is *not* marked with this symbol , it *must* be connected to an electrical outlet that is properly grounded.
CAUTION: Do not set up this product or make any electrical or cabling connections, such as the power cord or telephone, during a lightning storm.
- The power cord must be connected to an electrical outlet that is near the product and easily accessible.
- Refer service or repairs, other than those described in the operating instructions, to a professional service person.
- This product is designed, tested, and approved to meet strict global safety standards with the use of specific Lexmark components. The safety features of some parts may not always be obvious. Lexmark is not responsible for the use of other replacement parts.
- Your product uses a laser.
CAUTION: Use of controls or adjustments or performance of procedures other than those specified herein may result in hazardous radiation exposure.
- Your product uses a printing process that heats the print media, and the heat may cause the media to release emissions. You must understand the section in your operating instructions that discusses the guidelines for selecting print media to avoid the possibility of harmful emissions.

Laser notice

The printer is certified in the U.S. to conform to the requirements of DHHS 21 CFR Subchapter J for Class I (1) laser products, and elsewhere is certified as a Class I laser product conforming to the requirements of IEC 60825-1.

Class I laser products are not considered to be hazardous. The printer contains internally a Class IIIb (3b) laser that is nominally a 5 milliwatt gallium arsenide laser operating in the wavelength region of 770-795 nanometers. The laser system and printer are designed so there is never any human access to laser radiation above a Class I level during normal operation, user maintenance, or prescribed service condition.

The United Kingdom Telecommunications Act 1984

This apparatus is approved under the approval number NS/G/1234/J/100003 for the indirect connections to the public telecommunications systems in the United Kingdom.

Conventions

Note: A note identifies something that could help you.

CAUTION: A caution identifies something that could cause you harm.

Warning: A warning identifies something that could damage your product hardware or software.

Electronic emission notices

Federal Communications Commission (FCC) compliance information statement

The Lexmark E230, Machine Type 4505-100, Lexmark E232, Machine Type 4505-200, Lexmark E330, Machine Type 4505-300, and Lexmark E332n, Machine Type 4505-310, have been tested and found to comply with the limits for a Class B digital device, pursuant to Part 15 of the FCC Rules. Operation is subject to the following two conditions: (1) this device may not cause harmful interference, and (2) this device must accept any interference received, including interference that may cause undesired operation.

The FCC Class B limits are designed to provide reasonable protection against harmful interference in a residential installation. This equipment generates, uses, and can radiate radio frequency energy and, if not installed and used in accordance with the instructions, may cause harmful interference to radio communications. However, there is no guarantee that interference will not occur in a particular installation. If this equipment does cause harmful interference to radio or television reception, which can be determined by turning the equipment off and on, the user is encouraged to try to correct the interference by one or more of the following measures:

- Reorient or relocate the receiving antenna.
- Increase the separation between the equipment and receiver.
- Connect the equipment into an outlet on a circuit different from that to which the receiver is connected.
- Consult your point of purchase or service representative for additional suggestions.

The manufacturer is not responsible for any radio or television interference caused by using other than recommended cables or by unauthorized changes or modifications to this equipment. Unauthorized changes or modifications could void the user's authority to operate this equipment.

Note: To assure compliance with FCC regulations on electromagnetic interference for a Class B computing device, use a properly shielded and grounded cable such as Lexmark part number 1329605 for parallel attach or 12A2405 for USB attach. Use of a substitute cable not properly shielded and grounded may result in a violation of FCC regulations.

Any questions regarding this compliance information statement should be directed to:

Director of Lexmark Technology & Services
Lexmark International, Inc.
740 West New Circle Road
Lexington, KY 40550
(859) 232-3000

Industry Canada compliance statement

This Class B digital apparatus meets all requirements of the Canadian Interference-Causing Equipment Regulations.

Avis de conformité aux normes de l'industrie du Canada

Cet appareil numérique de la classe B respecte toutes les exigences du Règlement sur le matériel brouilleur du Canada.

European Community (EC) directives conformity

This product is in conformity with the protection requirements of EC Council directives 89/336/EEC and 73/23/EEC on the approximation and harmonization of the laws of the Member States relating to electromagnetic compatibility and safety of electrical equipment designed for use within certain voltage limits.

A declaration of conformity with the requirements of the directives has been signed by the Director of Manufacturing and Technical Support, Lexmark International, S.A., Boigny, France.

This product satisfies the Class B limits of EN 55022 and safety requirements of EN 60950.

Japanese VCCI notice

この装置は、情報処理装置等電波障害自主規制協議会（VCCI）の基準に基づくクラスB情報技術装置です。この装置は、家庭環境で使用することを目的としていますが、この装置がラジオやテレビジョン受信機に近接して使用されると、受信障害を引き起こすことがあります。

取扱説明書に従って正しい取り扱いをして下さい。

Korean MIC statement

If your product includes the following symbol on the regulatory label: the following statement is applicable to your product.



이 기기는 가정용으로 전자파적합등록을 한 기기로서 주거 지역에서는 물론 모든 지역에서 사용할 수 있습니다.

This equipment has undergone EMC registration as a household product. It can be used in any area, including a residential area.

Noise emission levels

The following measurements were made in accordance with ISO 7779 and reported in conformance with ISO 9296.

1-meter average sound pressure, dBA	
Printing	51—Machine types 4505-100, 4505-200, 4546-xxx
	52—Machine types 4505-300, 4505-310, 4547-xxx
Idling	30

ENERGY STAR



The EPA ENERGY STAR Office Equipment program is a partnership effort with office equipment manufacturers to promote the introduction of energy-efficient products and to reduce air pollution caused by power generation.

Companies participating in this program introduce products that power down when they are not being used. This feature will cut the energy used by up to 50 percent. Lexmark is proud to be a participant in this program.

As an ENERGY STAR Partner, Lexmark International, Inc. has determined that this product meets the ENERGY STAR guidelines for energy efficiency.

Printer energy consumption

The following table documents the power consumption characteristics of the printer.

Mode	Description	Power consumption (by Machine Type)	
		4505-100, 4505-200, 4546-xxx	4505-300, 4505-310, 4547-xxx
Printing	Printer is generating hard copy output	370 W	420 W
Ready	Printer is waiting for a print job	65 W	80 W
Power Saver	Printer is in energy saving mode	6 W	7 W
Off	Printer is plugged into a wall outlet, but switch is turned off	0 W	0 W

The power consumption levels listed in the previous table represent time-averaged measurements. Instantaneous power draws may be substantially higher than the average.

Power Saver

As part of the ENERGY STAR program, this printer is designed with an energy-saving mode called Power Saver. The Power Saver Mode is equivalent to the EPA Sleep Mode. The Power Saver Mode saves energy by lowering power consumption during extended periods of inactivity. The Power Saver Mode is automatically engaged after this printer is not used for a specified period of time, called the Power Saver Timeout. The factory default Power Saver Timeout is 15 minutes for the Lexmark E230 and 30 minutes for the Lexmark E232, Lexmark E330, and Lexmark E332n.

By using the printer configuration menus, the Power Saver Timeout can be modified between 1 minute and 240 minutes. Setting the Power Saver Timeout to a low value reduces energy consumption, but may increase the response time of the printer. Setting the Power Saver Timeout to a high value maintains a fast response, but uses more energy.

If the Power Saver Mode is affecting the effective use of this printer, this mode can be disabled from the Local Printer Setup Utility (see page 103) or, if you have a network model, from the printer's resident Web page (see page 102).

Total energy usage

It is sometimes helpful to calculate the total printer energy usage. Since power consumption claims are provided in power units of Watts, the power consumption should be multiplied by the time the printer spends in each mode in order to calculate energy usage. The total printer energy usage is the sum of each mode's energy usage.

Statement of Limited Warranty

Lexmark International, Inc., Lexington, KY

This warranty applies to the United States and Canada. For customers outside the U.S. and Canada, refer to the country-specific warranty information that came with your printer.

Lexmark E230, E232, E330, E332n

This Statement of Limited Warranty applies to this product if it was originally purchased for your use, and not for resale, from Lexmark or a Lexmark remarketer, referred to in this statement as "Remarketer."

Warranty

Lexmark warrants that this product:

- Is manufactured from new parts, or new and serviceable used parts, which perform like new parts
- Is free from defects in material and workmanship
- Conforms to Lexmark's official published specifications
- Is in good working order

If this product does not function as warranted during the warranty period, contact a Remarketer or Lexmark for repair without charge. If this product is a feature or option, this statement applies only when that feature or option is used with the product for which it was designed. To obtain warranty service, you may be required to present the feature or option with the product.

If you transfer this product to another user, warranty service under the terms of this statement is available to that user for the remainder of the warranty period. You should transfer proof of original purchase and this statement to that user.

Warranty service

The warranty period is 12 months and starts on the date of original purchase as shown on the purchase receipt.

To obtain warranty service you may be required to present proof of original purchase. Warranty service will be provided at a Remarketer or a Lexmark designated location. You may be required to deliver your product to the Remarketer or Lexmark, or ship it prepaid and suitably packaged to a Lexmark designated location. You are responsible for loss of, or damage to, a product in transit to the Remarketer or the designated location.

When warranty service involves the exchange of a product or part, the item replaced becomes the property of the Remarketer or Lexmark. The replacement may be a new or repaired item. The replacement item assumes the remaining warranty period of the original product.

Replacement is not available to you if the product you present for exchange is defaced, altered, in need of a repair not included in warranty service, or damaged beyond repair. Also, such product must be free of any legal obligation or restrictions that prevent its exchange.

Before you present this product for warranty service, remove all programs, data, and removable storage media.

For further explanation of your warranty alternatives and the nearest Lexmark authorized servicer in your area, please contact Lexmark at 1-859-232-3000, or on the World Wide Web at <http://support.lexmark.com>.

Remote technical support is provided for this product throughout its warranty period. Lexmark offers a variety of extended warranty programs that include an extension of technical support. For products no longer covered by a Lexmark warranty, technical support may only be available for a fee.

Extent of warranty

We do not warrant uninterrupted or error-free operation of a product.

Warranty service does not include repair of failures caused by:

- Modification or attachments
- Accidents or misuse
- Unsuitable physical or operating environment
- Maintenance by anyone other than Lexmark or a Lexmark authorized servicer
- Operation of a product beyond the limit of its duty cycle
- Failure to have installed a maintenance kit as specified (if applicable)
- Use of printing media outside of Lexmark specifications
- Use of other than Lexmark supplies (such as toner cartridges, inkjet cartridges, and ribbons)
- Use of other than Lexmark product or component

ALL EXPRESS AND IMPLIED WARRANTIES, INCLUDING THE IMPLIED WARRANTIES OF MERCHANTABILITY AND FITNESS FOR A PARTICULAR PURPOSE, ARE LIMITED IN DURATION TO THE WARRANTY PERIOD. NO WARRANTIES, EXPRESS OR IMPLIED, WILL APPLY AFTER THIS PERIOD.

Limitation of liability

Your sole remedy under this Statement of Limited Warranty is set forth in this section. For any claim concerning performance or nonperformance of Lexmark or a Remarketer for this product under this Statement of Limited Warranty, you may recover actual damages up to the limit set forth in the following paragraph.

Lexmark's liability for actual damages from any cause whatsoever will be limited to the greater of 1) \$5,000 or 2) the amount you paid for the product that caused the damages. This limitation of liability will not apply to claims by you for bodily injury or damage to real property or tangible personal property for which Lexmark is legally liable. In no event will Lexmark be liable for any lost profits, lost savings, incidental damage, or other economic consequential damages. This is true even if you advise Lexmark or a Remarketer of the possibility of such damages. Lexmark is not liable for any claim by you based on a third party claim.

This limitation of remedies also applies to any developer of materials supplied to Lexmark. Lexmark's and the developer's limitations of remedies are not cumulative. Such developer is an intended beneficiary of this limitation.

Additional rights

Some states do not allow limitations on how long an implied warranty lasts, or do not allow the exclusion or limitation of incidental or consequential damages. If such laws apply, the limitations or exclusions contained in this statement may not apply to you.

This warranty gives you specific legal rights. You may also have other rights which vary from state to state.

1

Printer overview

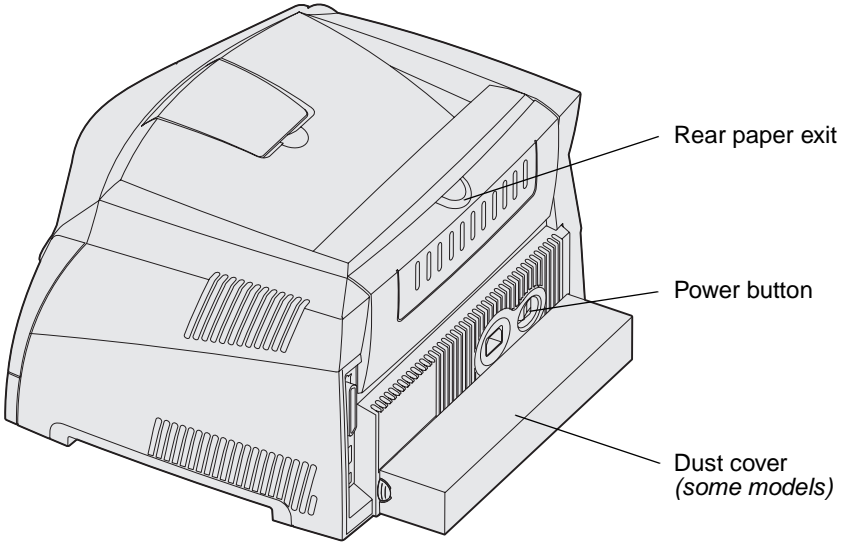
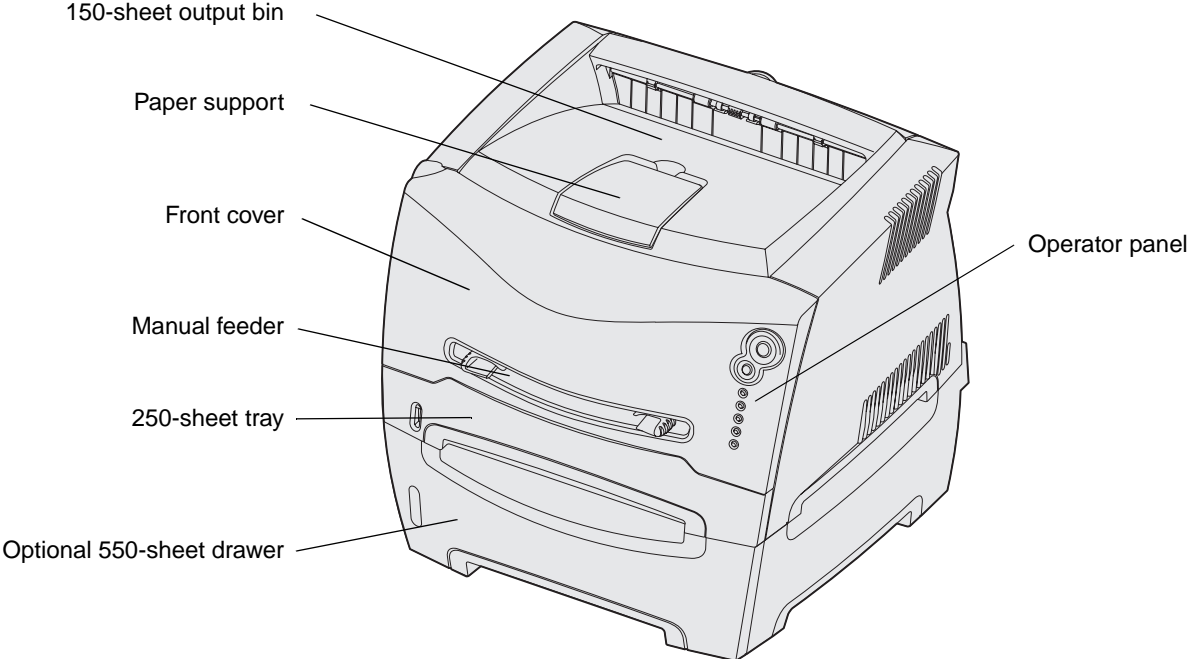

The operator panel has 5 lights and 2 buttons.

Note: The Continue button also functions as a light.

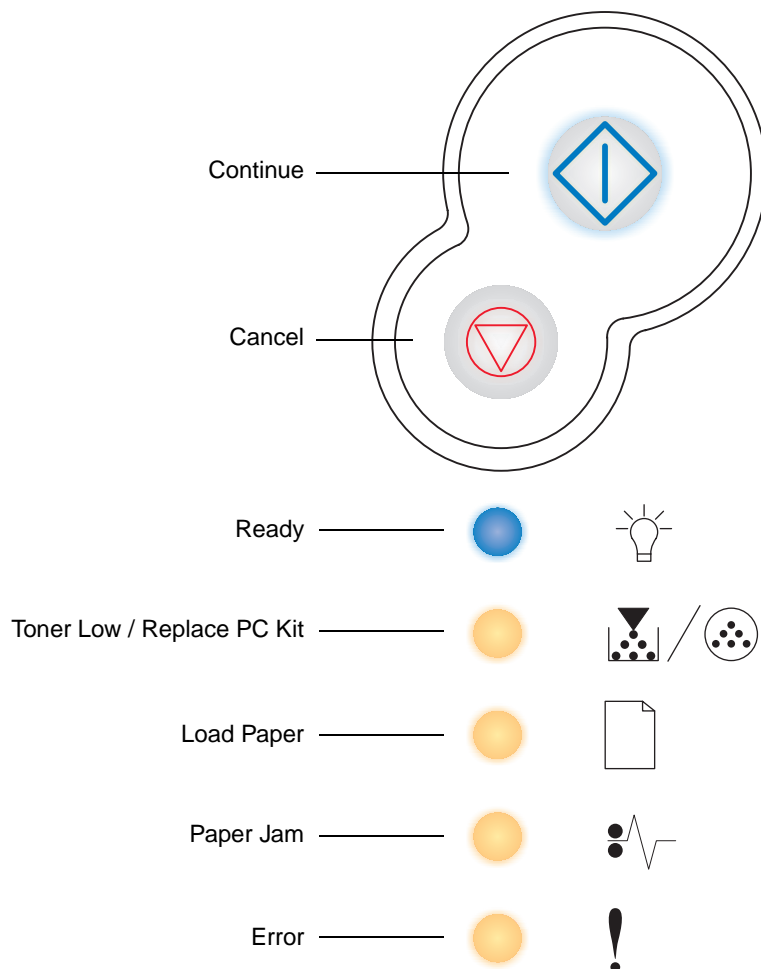

- Press and release **Continue** to resume printing.
- Press and release **Continue** twice quickly to display a secondary error code.
- Press and release **Cancel** to cancel the job currently printing.
- Press and hold **Cancel** until all of the lights come on to reset the printer.

2

Print media tasks and tips

Section	Page
What types of print media can be loaded?	14
Where can print media be loaded in the printer?	15
Tips on choosing the right print media	16
Tips on storing print media and supplies	18
Tips on preventing jams	19
How to load the 250-sheet and 550-sheet trays	20
How to load the manual feeder	24
How to use the rear exit	25
How to clear paper jams	26

What types of print media can be loaded?

Get the most out of your printer by properly loading the trays. Never mix media types within a tray.

Source	Sizes	Types	Weight	Capacity* (sheets)
Tray 1 (250-sheet tray)	A4, A5, JIS B5, letter, legal, executive, folio, statement, Universal‡	Plain paper, transparencies, labels	60–90 g/m ² (16–24 lb)	<ul style="list-style-type: none"> • 250 paper • 50 labels • 50 transparencies
Tray 2 (550-sheet tray)	A4, A5, JIS B5, letter, legal, executive, folio, statement, Universal‡	Plain paper, transparencies, labels	60–163 g/m ² (16–43 lb)	<ul style="list-style-type: none"> • 550 paper • 50 labels • 50 transparencies
Manual feeder	A4, A5, JIS B5, letter, legal, executive, folio, statement, Universal‡	Plain paper, transparencies, labels	60–163 g/m ² (16–43 lb)	1
		Card stock†	<ul style="list-style-type: none"> • 120–163 g/m² (16–90 lb) Index Bristol • 75–163 g/m² (50–100 lb) Tag 	
	7¾, 9, 10, DL, C5, B5	Envelopes	90 g/m ² (24 lb)	

* Capacity for 20 lb print media, unless otherwise noted.

† Grain short is recommended. Use rear exit for best results.

‡ Universal size ranges:

– **Tray 1:** 89–216 x 210–356 mm (3.5–8.5 x 8.27–14.0 in.)

– **Tray 2:** 148–216 x 210–356 mm (5.83–8.5 x 8.27–14.0 in.)

– **Manual feeder:** 76–216 x 127–356 mm (3.0–8.5 x 5.0–14.0 in.) (includes 3 x 5 in. cards)

Where can print media be loaded in the printer?

Your printer has two standard paper sources: an automatic 250-sheet paper feeder (Tray 1) and a single-sheet manual feeder. Use Tray 1 for most print jobs. Use the manual feeder for a single piece of paper, transparency, envelope, paper label, card stock, or index card. You can increase paper capacity by purchasing an optional 550-sheet drawer.

An output bin on top of the printer holds up to 150 sheets. The single-sheet rear exit provides a straight-through paper path to help reduce curling and potential jams. This is especially useful for specialty media, such as transparencies, envelopes, paper labels, card stock, or index cards.

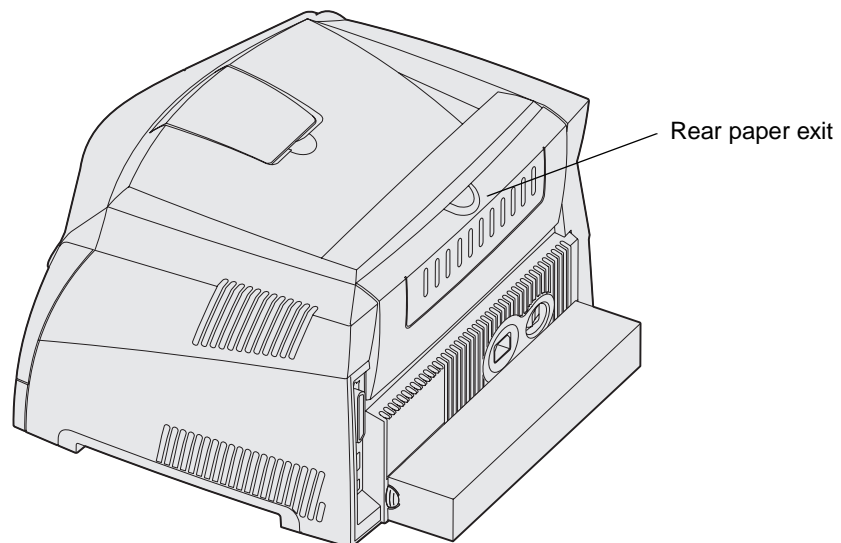
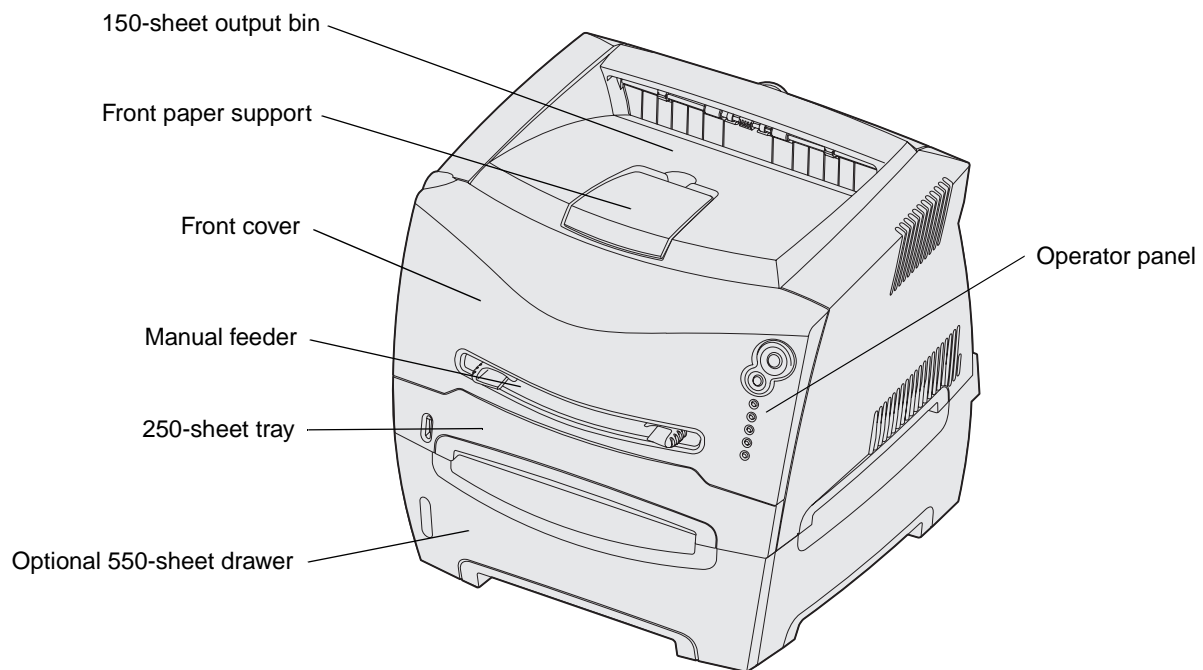

Tips on choosing the right print media

Selecting the right paper or other media reduces printing problems. For best print quality, try a sample of the paper or other media you are considering before buying large quantities.

Refer to the *Card Stock & Label Guide* available on our Lexmark Web site at www.lexmark.com for more information about which paper provides optimum results for your printing environment.

Paper

- For the best print quality, use 20 lb (75 g/m²) xerographic, grain long paper.

The printer can automatically feed paper weights from 60 to 90 g/m² (16 to 24 lb bond) grain long. Paper lighter than 60 g/m² (16 lb) might not be stiff enough to feed properly, causing jams. Paper heavier than 90 g/m² (24 lb) should be fed through the optional 550-sheet tray or the manual feeder.

- The laser printing process heats paper to high temperatures of 170°C (338°F) for non-MICR applications. Use only paper able to withstand these temperatures without discoloring, bleeding, or releasing hazardous emissions. Check with the manufacturer or vendor to determine whether the paper you have chosen is acceptable for laser printers.

Preprinted forms and letterhead

- Use only forms and letterhead printed using an offset lithographic or engraved printing process.
- Choose papers that absorb ink, but do not bleed.
- Avoid papers with rough or heavily textured surfaces.

Use papers printed with heat-resistant inks designed for use in xerographic copiers. The ink must withstand temperatures of 170°C (338°F) without melting or releasing hazardous emissions. Use inks that are not affected by the resin in toner. Inks that are oxidation-set or oil-based should meet these requirements; latex inks might not. If you are in doubt, contact your paper supplier.

Preprinted papers such as letterhead must be able to withstand temperatures up to 170°C (338°F) without melting or releasing hazardous emissions.

Transparencies

- Use transparencies designed specifically for laser printers. Transparencies must be able to withstand temperatures of 170°C (338°F) without melting, discoloring, offsetting, or releasing hazardous emissions.

We recommend Lexmark laser printer transparencies: part number 70X7240 for letter size transparencies; part number 12A5010 for A4 size transparencies.

- To prevent print quality problems, avoid getting fingerprints on the transparencies.

Envelopes

- Use envelopes made from 24 lb (90 g/m²) bond paper.
- Do not use envelopes that:
 - Have excessive curl
 - Are stuck together
 - Are damaged in any way
 - Contain windows, holes, perforations, cutouts, or embossments
 - Use metal clasps, string ties, or metal folding bars
 - Have postage stamps attached
 - Have any exposed adhesive when the flap is in the sealed position
- Use envelopes that can withstand temperatures of 170°C (338°F) without:
 - sealing
 - excessive curling
 - wrinkling
 - releasing hazardous emissions

If you have any doubts about the envelopes you are considering using, check with the envelope supplier.

- A combination of high humidity (over 60%) and the high printing temperatures may seal the envelopes.

Labels

- Do not use labels that have exposed adhesive on the sheets.
- Do not print a large number of labels continuously.
- Do not use vinyl labels.
- Use labels that can withstand temperatures of 170°C (338°F) without sealing, excessive curling, wrinkling, or releasing hazardous emissions. Label adhesives, face sheet (printable stock), and topcoats must also be able to withstand 25 pounds per square inch (psi) (172 kilopascals) pressure.

Card stock

- Preprinting, perforation, and creasing can significantly affect the print quality and cause media handling or jamming problems.
- Avoid using card stock that may release hazardous emissions when heated.
- Do not use preprinted card stock manufactured with chemicals that may contaminate the printer. Preprinting introduces semi-liquid and volatile components into the printer.
- Use card stock with a maximum weight of 163 g/m² and a minimum size of 76 x 127 mm (3 x 5 in.).

Tips on storing print media and supplies

Storing paper

Use the following guidelines to avoid paper feeding problems and uneven print quality.

- Store paper in an environment where the temperature is approximately 21°C (70°F) and the relative humidity is 40%.
- Store cartons of paper on a pallet or shelf rather than directly on the floor.
- If you store individual packages of paper out of the original carton, make sure they rest on a flat surface so the edges do not buckle, curl, or become damaged.
- Do not place anything on top of paper packages.

Storing supplies

Choose a cool, clean storage area for your printer supplies. Store supplies *right side up* in their original packaging until you are ready to use them.

Do not expose supplies to:

- Direct sunlight
- Temperatures above 35°C (95°F)
- High humidity (above 80%)
- Salty air
- Corrosive gases
- Heavy dust

Tips on preventing jams

You can avoid most paper jams by correctly loading paper and specialty media in the printer.

The following hints can help you avoid paper jams:

- Do not load wrinkled, creased, or damp paper.
- Never mix media types within a tray.
- Flex, fan, and straighten paper before you load it.

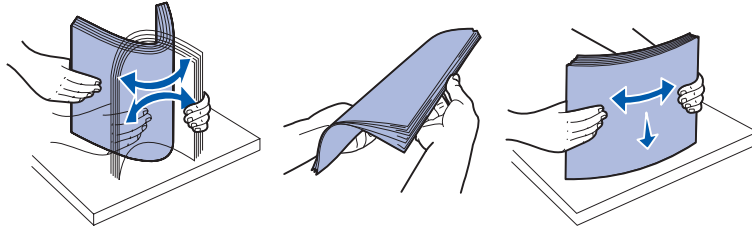

- Do not exceed the maximum stack height.
- Push all trays *firmly* into the printer after loading them.
- Make sure the guides in the trays are positioned snug against the paper or specialty media.
- Do not remove paper trays while a job is printing. Wait for a Load Paper  light sequence (see “**Load media**” on page 61) before you remove the tray.
- Before loading transparencies, fan the stack to prevent sheets from sticking together.
- Do not use envelopes that:
 - Have excessive curl
 - Are stuck together
 - Are damaged in any way
 - Contain windows, holes, perforations, cutouts, or embossments
 - Have metal clasps, string ties, or metal folding bars
 - Have postage stamps attached
 - Have any exposed adhesive when the flap is in the sealed position
- Use only recommended paper. Refer to the *Card Stock & Label Guide* available on our Lexmark Web site at www.lexmark.com for more information about which paper provides optimum results for your printing environment.
- If you need detailed information before purchasing large quantities of customized paper, refer to the *Card Stock & Label Guide*.

How to load the 250-sheet and 550-sheet trays

Follow these instructions to load paper in the 250-sheet tray and 550-sheet tray.

- 1 Remove the tray.

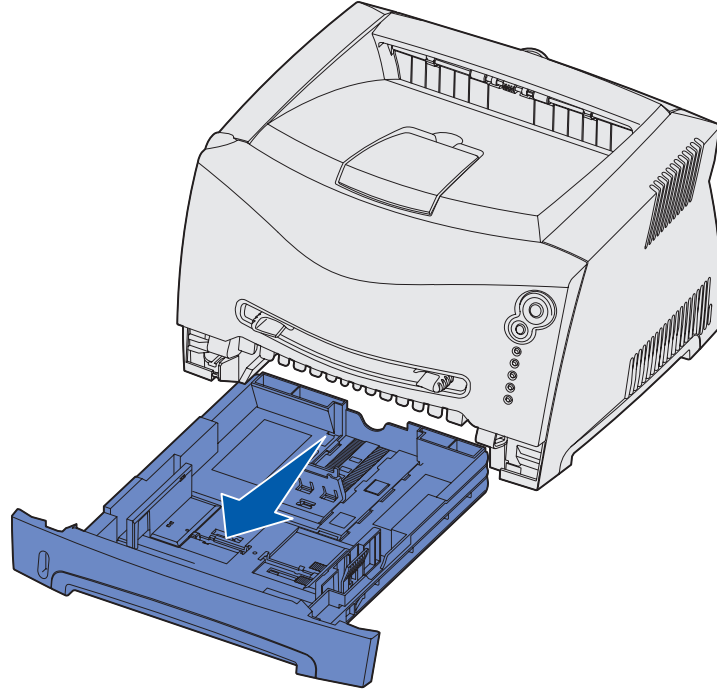

Note: If you are going to load legal or folio size paper, you have to extend the length of the paper tray. See “**Extending the tray for legal or folio size paper**” on page 23 for instructions.

- 2 Prepare a stack of paper for loading by flexing or fanning it back and forth. Straighten the edges on a level surface.

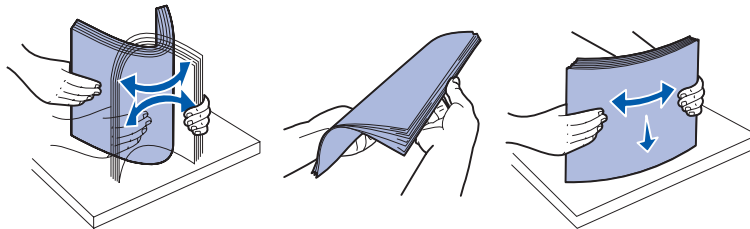

- 3 Load the paper in the tray with the print side facing down.

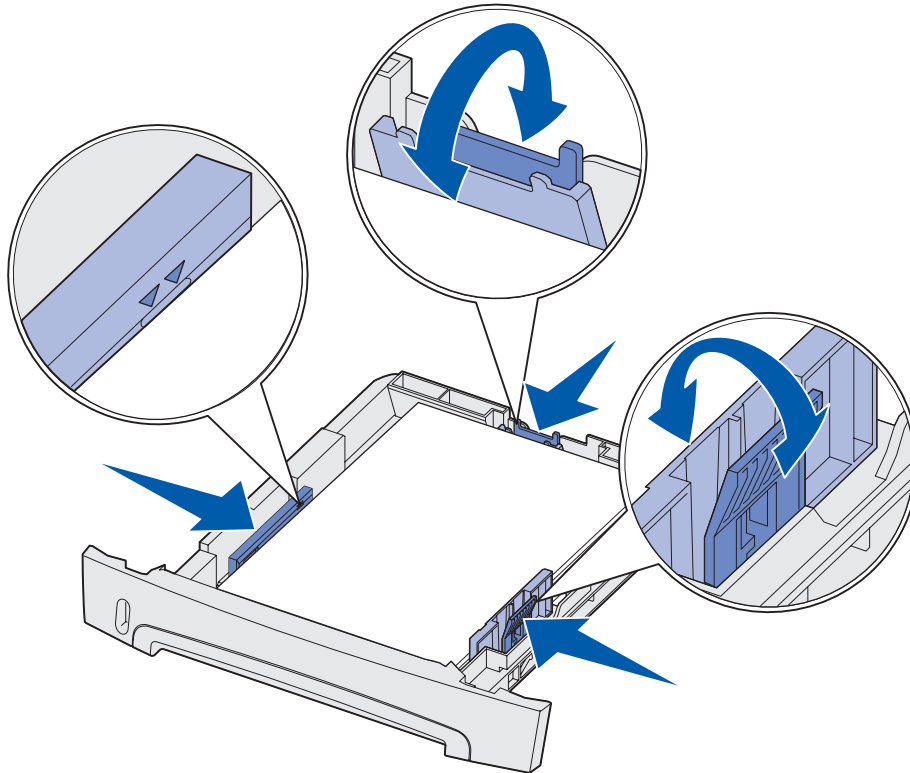

Note: Load letterhead paper with the design side facing down. The top edge of the sheet with the logo should be placed at the front of the tray.

Make sure the paper is below the max fill line on the side guides. Overloading may cause jams.

- 4 Slide the two side guides and the back guide until they fit snugly against the stack of paper.

- 5** Insert the tray.

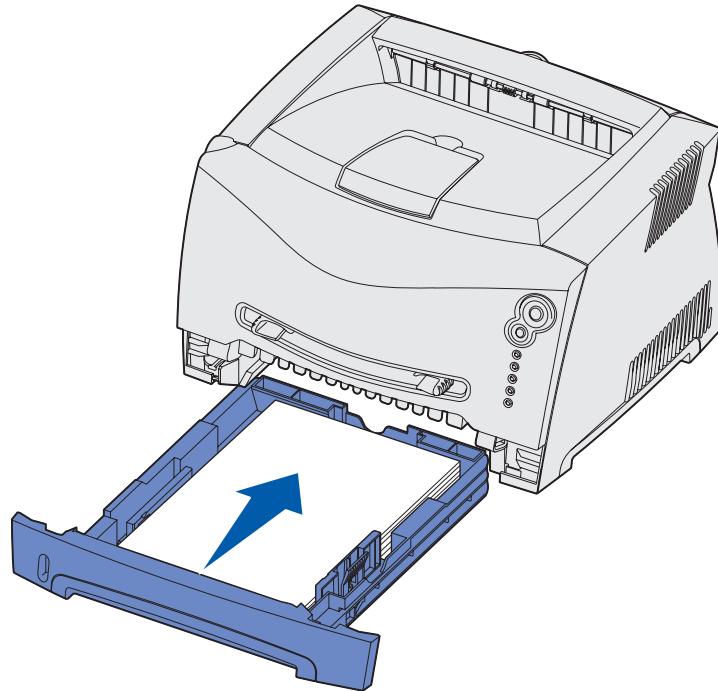

- 6** Extend the paper support on the output bin.

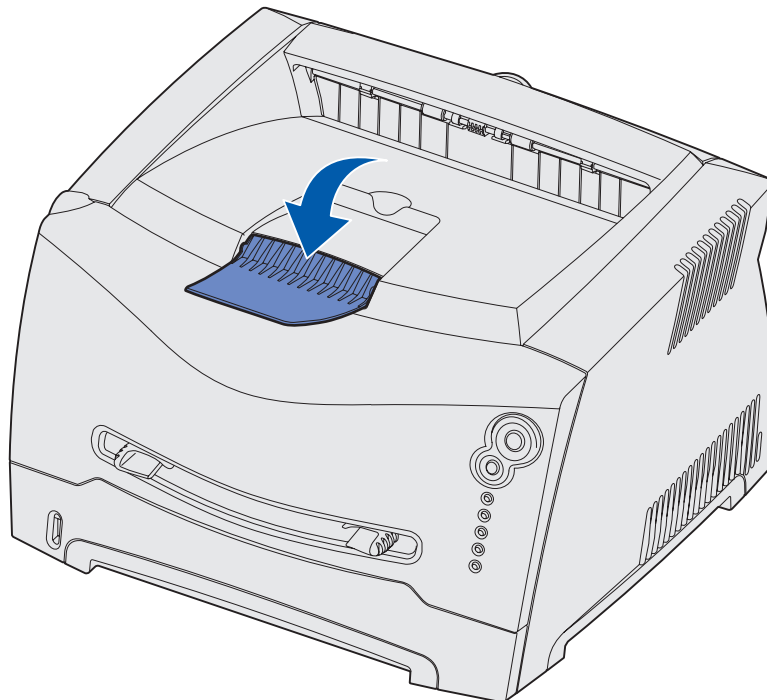

Extending the tray for legal or folio size paper

To load legal or folio size paper, you need to extend the paper tray. You should also attach the dust cover on the back of the printer to protect the tray while it is extended.

- 1 Press down on the latch at the back of the tray.
- 2 Expand the tray until the extender locks into place.

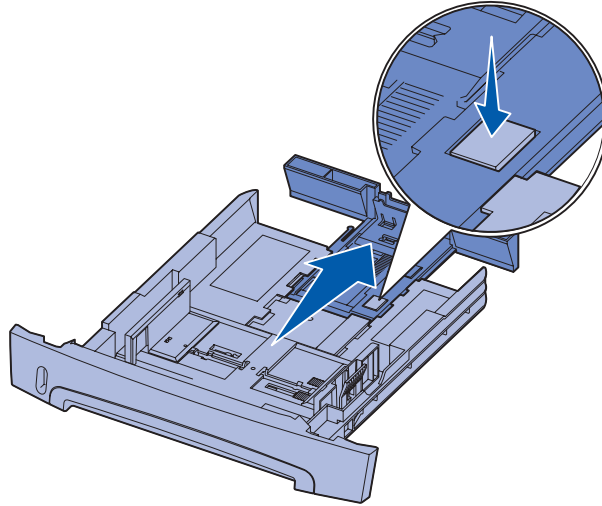

Attaching the dust cover

The dust cover helps protect the paper tray from the environment as well as keep the tray from being knocked out of position while it is extended.

Note: Not all models come with a dust cover.

Attach the dust cover to the back of the printer by aligning the tabs on the cover to the holes on the printer and snap the cover in place.

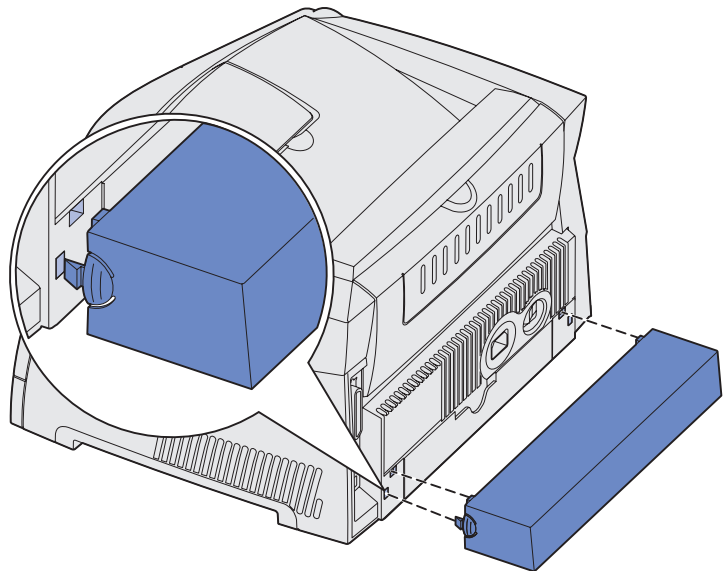

How to load the manual feeder

The manual feeder is located at the front of your printer and can only feed one sheet of print media at a time. You can use the manual feeder to make quick runs of paper types or sizes that are not currently loaded in the paper tray.

For information on acceptable print media to use in the manual feeder, see **“What types of print media can be loaded?” on page 14**. Using only the specified print media helps prevent paper jams and print quality problems.

Note: We recommend that you send your print job to the printer prior to loading the manual feeder. See **“How to manually feed a print job” on page 30** for more information.

To load the manual feeder:

- 1** Place a sheet of the selected print media, print side facing up, at the center of the manual feeder, but only to the point where its leading edge can contact the paper guides. Otherwise, the printer will engage the print media too soon and likely skew the print job.
- 2** Adjust the paper guides to the print media's width.
- 3** Hold both sides of the print media close to the manual feeder and push it into the printer until it automatically engages.

There is a brief pause between the time the printer engages the print media and when it feeds into the printer.

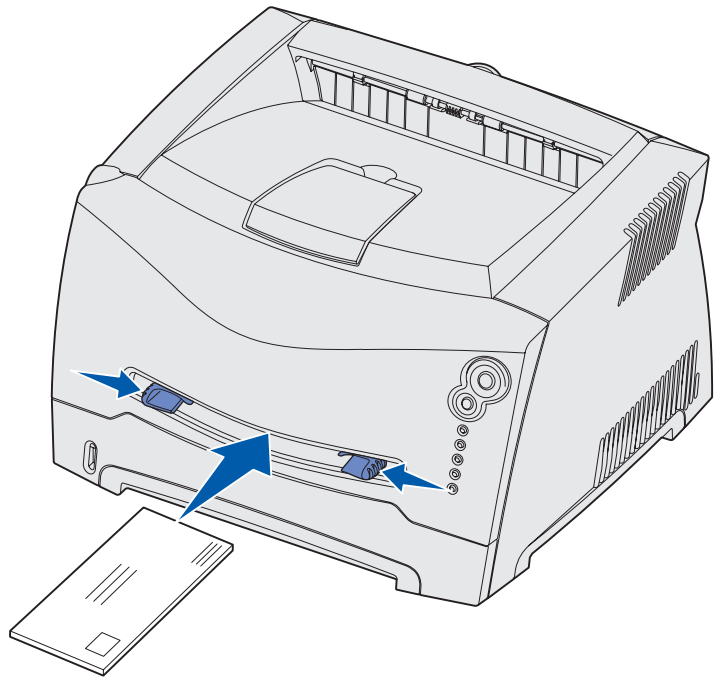

Warning: Do not force the print media into the feeder. Forcing the media causes jams.

- Insert envelopes with the flap side down and with the stamp area as shown.
- Hold transparencies by the edges and avoid touching the print side. Oil from your fingers can affect print quality.
- Load letterhead face-up, with the top of the sheet first.
- If you experience problems with paper feed, turn the paper over.



How to use the rear exit

The single-sheet rear exit provides a straight-through paper path to help reduce curling and potential jams. This is especially useful for specialty media, such as transparencies, envelopes, labels, card stock, or index cards.

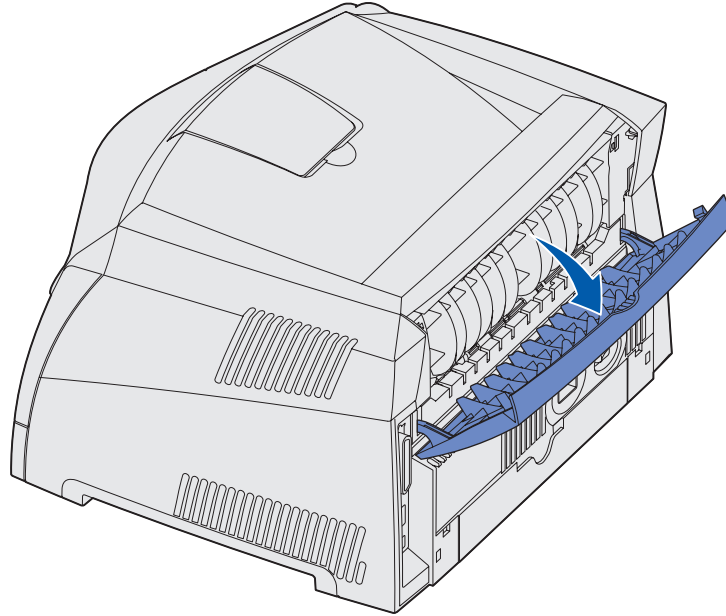
To use the rear exit, simply open the rear exit door. When the rear exit door is open, all print media comes out the rear exit. When closed, all media is sent to the output bin on top of the printer.



How to clear paper jams

When a paper jam occurs, the printer stops and the operator panel's Paper Jam  and Continue  lights come on. Press and release **Continue**  twice quickly to display the specific secondary error paper jam light sequence. See **“Secondary error codes” on page 69** for more information.

We recommend that you clear the entire paper path when a paper jam occurs.

To clear a paper jam:

- 1 If you are feeding paper from a tray, remove the tray, and then remove any jams.

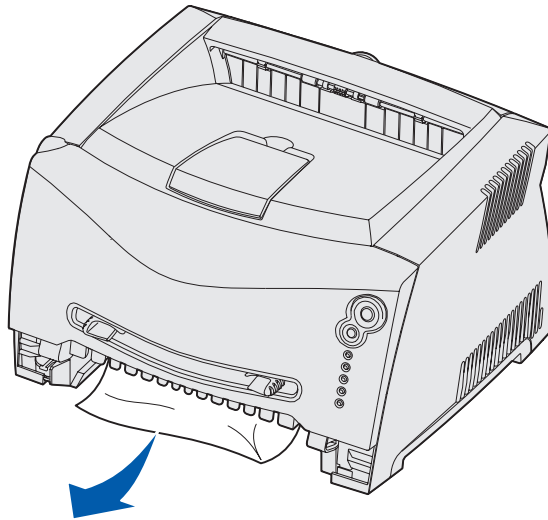

- 2 Open the front cover and remove the print cartridge assembly.

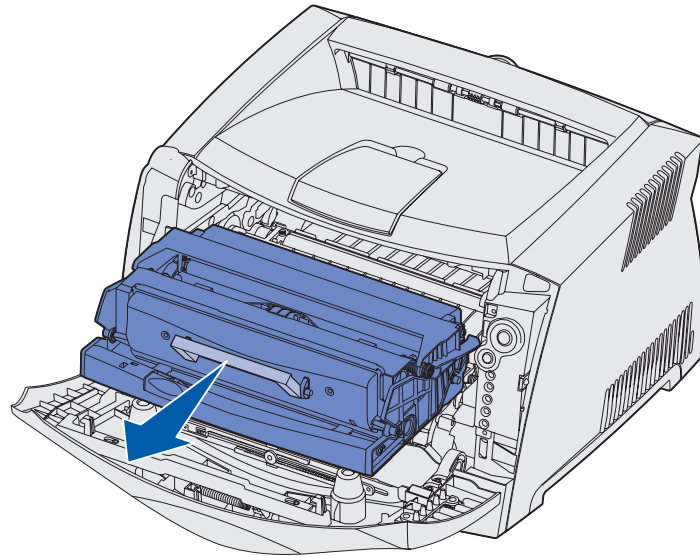

Warning: Do not leave the print cartridge assembly exposed to direct light for an extended period of time. Extended light exposure can cause print quality problems.

- 3 Remove any jams in the area behind the print cartridge assembly.

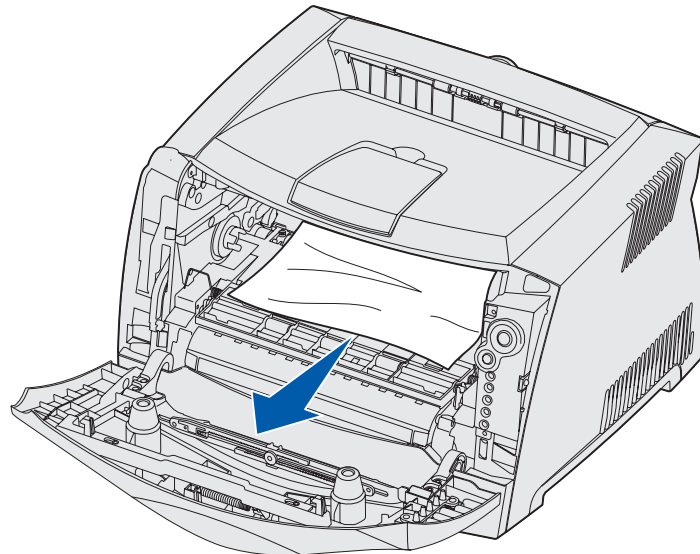

- 4 Lift the flap at the front of the printer and remove any jams beneath the flap.

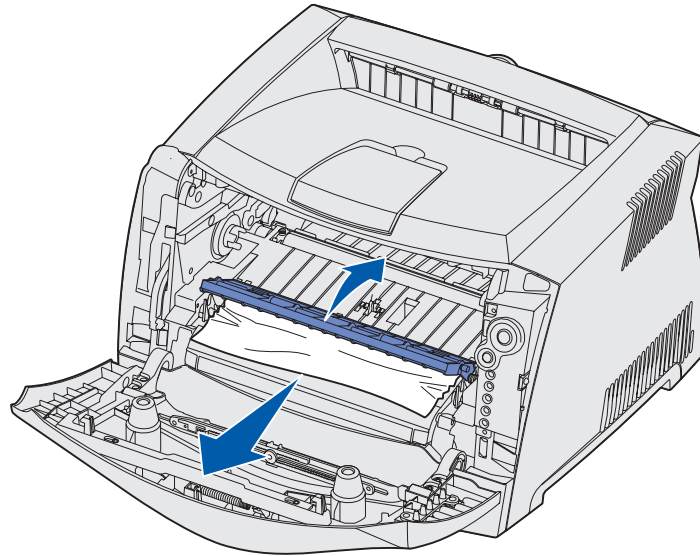

- 5 Open the rear exit and remove any jams.

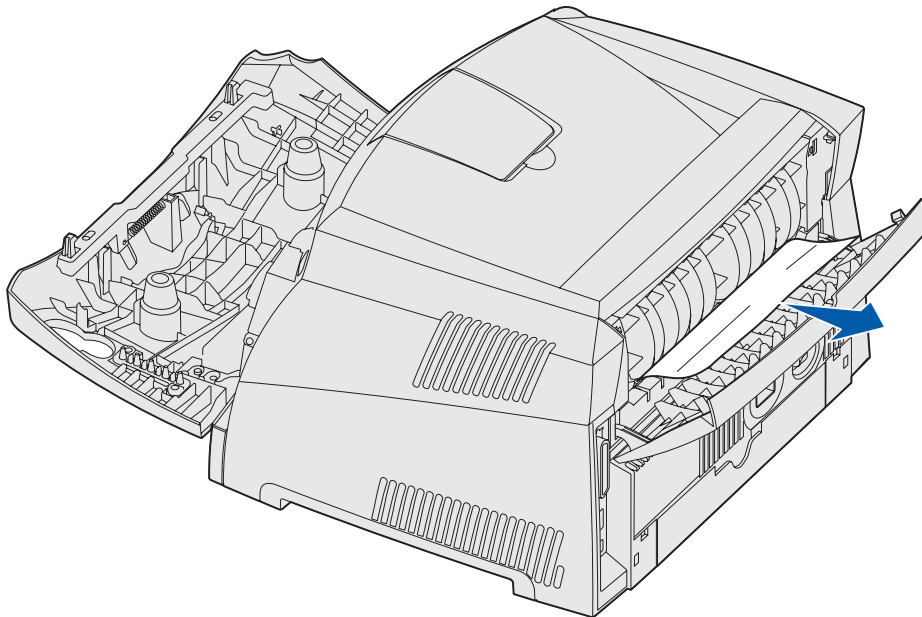

- 6 After you have cleared the jams, reinstall the print cartridge assembly, make sure all printer covers and trays are closed, and then press **Continue**  to resume printing.

Note: The printer reprints the pages that caused the paper jam.

3

Printing tasks

Section	Page
How to manually feed a print job	30
How to print on both sides of the paper (manual duplex)	32
How to print multiple page images on one page (N-up printing)	34
How to print a booklet	35
How to print a poster	36
How to print on letterhead	37
How to print using an overlay or a watermark	37
How to cancel a print job	39

How to manually feed a print job

The manual feeder is located at the front of your printer and can only feed one sheet of print media at a time. For information on acceptable print media to use in the manual feeder, see “**What types of print media can be loaded?**” on page 14.

When using the manual feeder, send the print job to the printer before loading the print media. When the printer is ready, it will display the Load Manual Feeder light sequence, at which point you should load the media.

To manually feed a print job:

- 1** From the computer's software application, select **File** → **Print**.
- 2** Click **Properties** (or **Options**, **Printer**, or **Setup**, depending on the application) to view the printer driver settings.
- 3** Click the **Paper** tab.
- 4** Select **Manual paper** from the Paper tray drop-down list.
- 5** Select the appropriate Paper size and type.
- 6** Click **OK**.
- 7** Click **OK** on the Print window to send the job to print.

The printer displays the Load Manual Feeder light sequence.

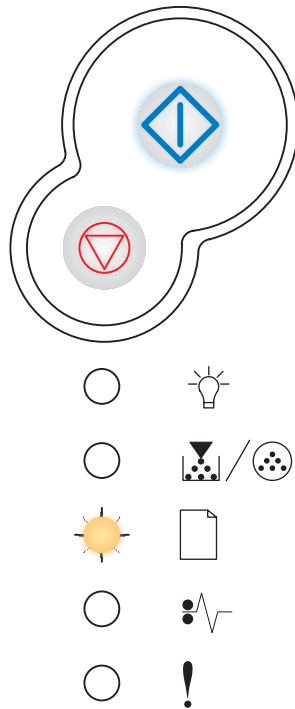

- 8** Place a sheet of the selected print media, print side facing up, at the center of the manual feeder, but only to the point where its leading edge can contact the paper guides.
 - Hold transparencies by the edges and avoid touching the print side. Oil from your fingers can affect print quality.
 - Insert envelopes with the flap side face down and with the stamp area as shown.
 - Load letterhead face up, with the top of the sheet first.
 - If you experience problems with paper feed, turn the paper over.
- 9** Adjust the paper guides to the print media's width.
- 10** Hold both sides of the print media close to the manual feeder and push it into the printer until it automatically engages.

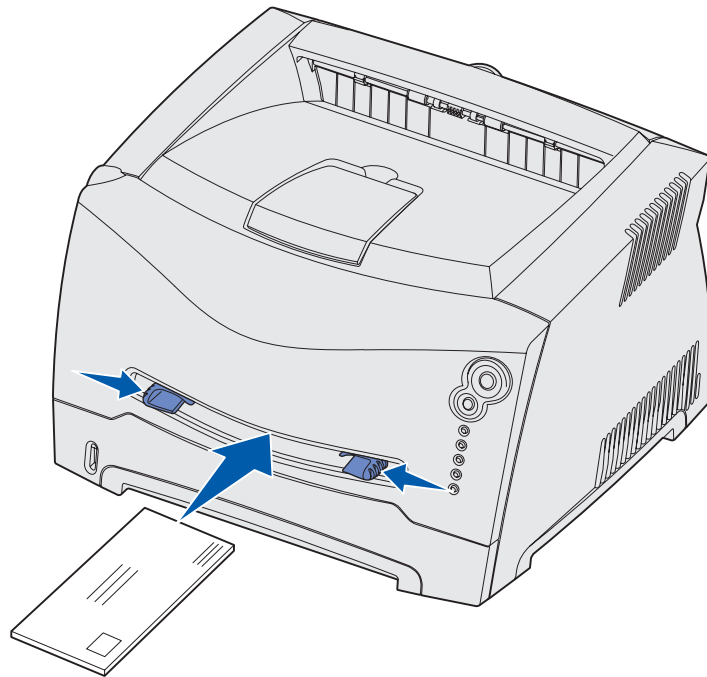

There is a brief pause between the time the printer engages the print media and when it feeds into the printer.

Warning: Do not force the print media into the feeder. Forcing the media causes jams.

How to print on both sides of the paper (manual duplex)

Printing on both sides of the paper reduces printing costs.

Although you can use Tray 1 or the 550-sheet tray to print the first side of the duplex job, only use Tray 1 to print the second side.

You can choose how you want your job duplexed: Long Edge or Short Edge.

- Long Edge means pages are bound along the long edge of the page (left edge for portrait, top edge for landscape).

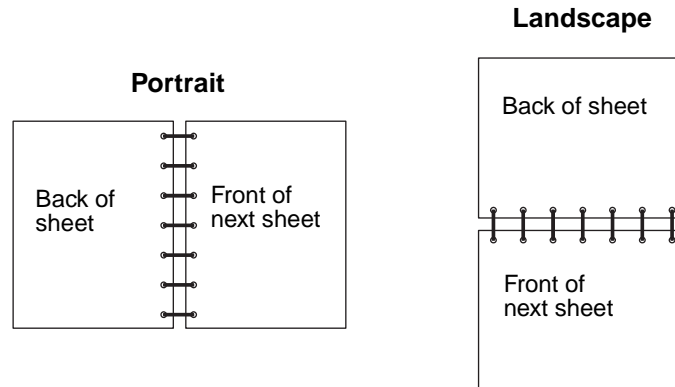

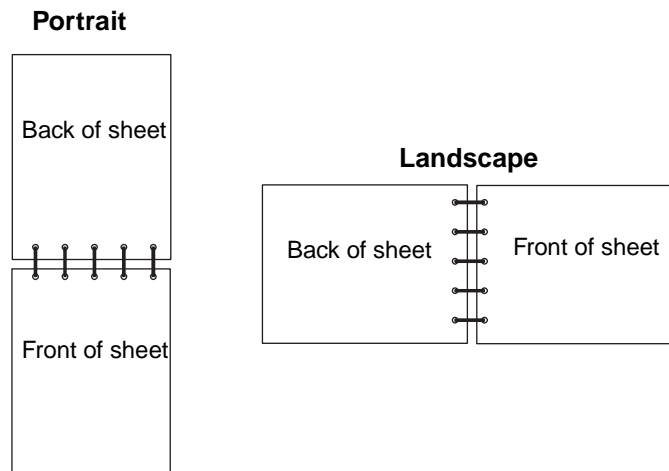

- Short Edge means pages are bound along the short edge of the page.



To manually duplex a print job:

- 1 From the computer's software application, select **File** → **Print**.
- 2 Click **Properties** (or **Options**, **Printer**, or **Setup**, depending on the application) to view the printer driver settings.
- 3 From the Page Layout tab, select **2-sided printing**.

- 4 Select either **Long Edge** or **Short Edge**.
- 5 Select **Manual 2-sided printing**.
- 6 Click the **Paper** tab.
- 7 Select the appropriate **Input options** for your print job.
- 8 Click **OK**.
- 9 Click **OK** on the Print window.

The printer prints every other page of the document first. Once the first side of your job prints, the Load Paper  light comes on and the Continue  light blinks.

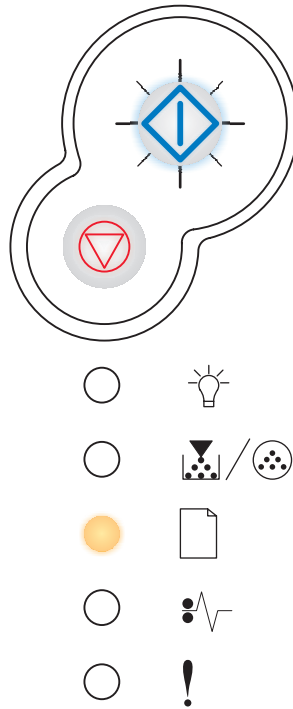

- 10 Load the paper back into the printer with the already-printed side up and the top of the page toward the front of the tray.

How to print multiple page images on one page (N-up printing)

The Multipage Printing (N-up) setting is used to print multiple page images on a single page. For example, 2-Up means two page images are printed on one page, 4-up means four page images are printed on one page, and so on.

The printer uses the Multipage Order, Multipage View, and Multipage Border settings to determine the order and orientation of the page images, and whether a border is printed around each page image.

- 1 From the computer's software application, select **File** → **Print**.
- 2 Click **Properties** (or **Options**, **Printer**, or **Setup**, depending on the application) to view the printer driver settings.
- 3 From the Page Layout tab, select the number of images per sheet (from the Multipage printing section) and the orientation you would like the paper to have.

The positioning depends on the number of images and whether the images are portrait or landscape in orientation.

For example, if you select 4-Up multipage printing and portrait orientation, the results differ depending on the Multipage Order value you select:

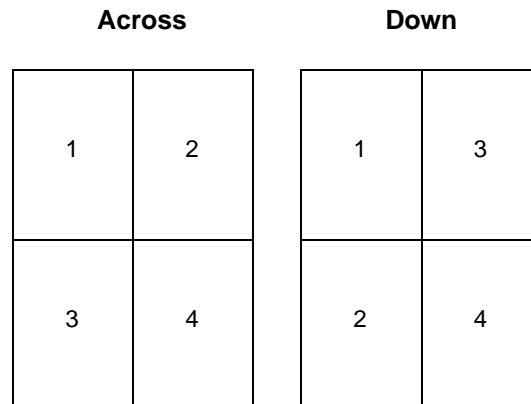

- 4 To print a visible border around each page image, select **Print page borders**.
- 5 Click **OK**.
- 6 Click **OK** on the Print window to send the job to print.

How to print a booklet

The Booklet setting lets you print multiple pages in booklet form without having to re-format your document so the pages print in the proper order. The pages print so that the finished collated document may be folded along the center of each page to form a booklet.

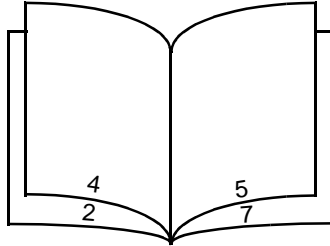

If the document contains many pages, a booklet may have too many pages to fold easily. If you are printing a fairly large booklet, you might want to use the Sheets per Bundle option to specify how many physical pages are put into one bundle. The printer will print the necessary number of bundles, which you can then bind into one booklet. Printing in bundles helps the outside edge of the pages line up more evenly.

You must specify whether or not you want to print using any Duplex printing options before you select to print using the booklet function. Once you choose Print Using Booklet, the controls for the Duplex options are dimmed and remain at the last setting used.

- 1** From the computer's software application, select **File** → **Print**.
- 2** Click **Properties** (or **Options**, **Printer**, or **Setup**, depending on the application) to view the printer driver settings.
- 3** From the Page Layout tab, click **More Page Layout Options**.
- 4** Click **Booklet**.
If your print job is large, you may want to use the **Sheets per Bundle** option.
- 5** Select the appropriate binding edge for your print job.
- 6** To print a visible fold mark on the pages, select **Print fold mark**.
- 7** Click **OK** twice.
- 8** Click **OK** on the Print window to send the job to print.

How to print a poster

The Poster setting lets you print a single image across several pages. Once printed, you can combine the pages to create one large image.

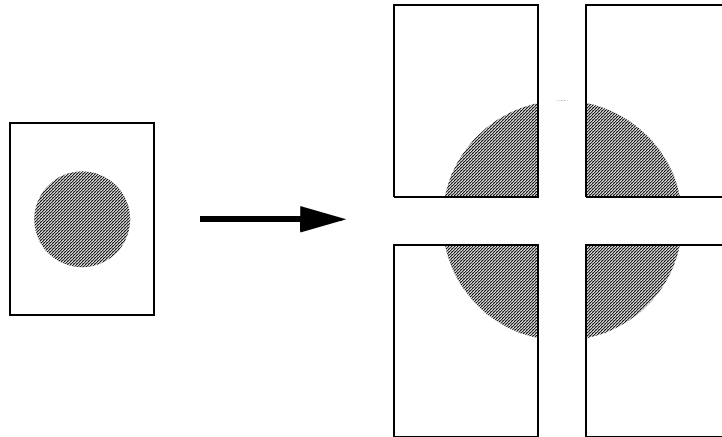

- 1** From the computer's software application, select **File** → **Print**.
- 2** Click **Properties** (or **Options**, **Printer**, or **Setup**, depending on the application) to view the printer driver settings.
- 3** From the Page Layout tab, click **More Page Layout Options**.
- 4** Click **Poster**.
- 5** Select the poster size you want by choosing the number of pages to use in the poster.
- 6** To print crop marks on the pages, select **Print crop marks**.
- 7** Select the amount of overlap you want each page to have.
- 8** Click **OK** twice.
- 9** Click **OK** on the Print window to send the job to print.

How to print on letterhead

To print on letterhead, make sure the paper is loaded with the proper orientation.

- 1 Make sure the letterhead is properly loaded according to the paper source you are using:
 - **Tray 1 or 2**—Load the letterhead paper with the design side facing down. The top edge of the sheet with the logo should be placed at the front of the tray.
 - **Manual feeder**—Load the letterhead paper face-up, with the top of the sheet first.

Note: If you are using the manual feeder, first send the job to print, then load the letterhead when the printer displays the Load Manual Feeder light sequence (see **“How to manually feed a print job” on page 30**).

- 2 From the computer's software application, select **File** → **Print**.
- 3 Click **Properties** (or **Options**, **Printer**, or **Setup**, depending on the application) to view the printer driver settings.
- 4 Click the **Paper** tab.
- 5 Select **Letterhead** from the Paper type drop-down lists.
- 6 Select the appropriate paper size and tray.
- 7 Click **OK**.
- 8 Click **OK** on the Print window to send the job to print.

How to print using an overlay or a watermark

Overlays and watermarks are templates that can be defined and then printed as a background on a form before the data from the current job is printed. Typical examples of overlays include company logos or letterheads, decorative borders, and simulated “preprinted” forms. Overlays can include text, graphics, or images. Watermarks are simple text. You can create overlays and watermarks and then download them directly to the printer, or you can create an overlay or watermark file on your system and then download it to the printer.

Note: To create and download overlays, you must have flash memory installed.

For information about how to create, save, or download an overlay or watermark, refer to the printer driver Help.

Using an overlay

- 1** From the computer's software application, select **File → Print**.
- 2** Click **Properties** (or **Options**, **Printer**, or **Setup**, depending on the application) to view the printer driver settings.
- 3** Click the **Other Options** tab.
- 4** Click **Overlays**.
- 5** Select which pages receive the overlay.
- 6** Select the overlay to use.
- 7** Select whether to place the overlay on top of or underneath the page image in the Overlay placement area.
- 8** Click **OK**.

Using a watermark

- 1** From the computer's software application, select **File → Print**.
- 2** Click **Properties** (or **Options**, **Printer**, or **Setup**, depending on the application) to view the printer driver settings.
- 3** Click the **Other Options** tab.
- 4** Click **Watermark**.
- 5** Select which pages receive the watermark.
- 6** Select the watermark to use.
- 7** Select whether to place the watermark on top of or underneath the page image in the Watermark placement area.
- 8** Click **OK**.

How to cancel a print job

A print job can be canceled from the operator panel or from your computer. The Cancel job light sequence is displayed on the operator panel while the job is being cancelled.

From the printer operator panel

Press and release **Cancel**  to cancel the job currently printing.

From a Windows computer

- 1** Click **Start** → **Settings** → **Printers**.
- 2** Double-click the printer you are using to print the job.
A list of print jobs appears.
- 3** Right-click the document you want to stop printing, and then click **Cancel**.

From a Macintosh computer

When you send a job to print, the printer icon appears on the desktop.

- 1** Double-click the printer icon on your desktop.
A list of print jobs appears.
- 2** Press **Control** and click the print job you want to cancel. Choose **Stop Queue** from the pop-up menu.

4

How to install options

Section	Page
How to access the system board	41
How to add a memory card	45
How to add a flash card	46
How to install a 550-sheet drawer	48
How to get the printer driver to recognize installed options	49

How to access the system board

To install a memory or flash card you must access the printer system board.

CAUTION: Turn the printer off and unplug the power cord before continuing.

- 1** Open the front cover by pressing the button on the left side of the printer and lowering the cover.

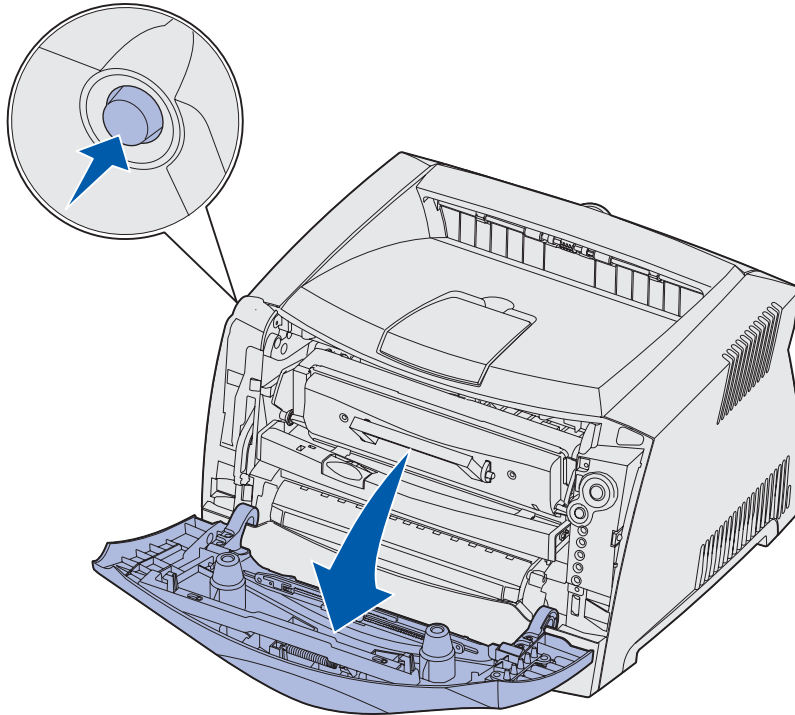

2 Open the rear exit.

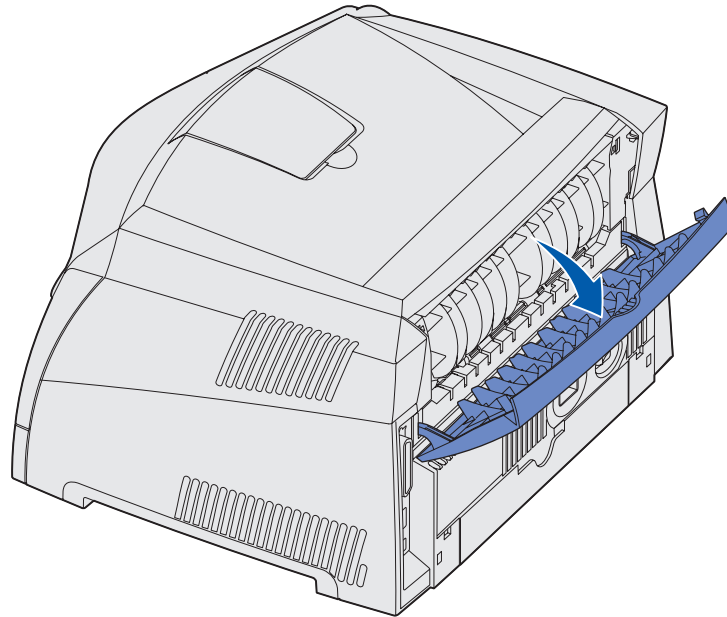

3 Open the side cover by pressing the two detents on the front right side of the machine and swinging the cover back.

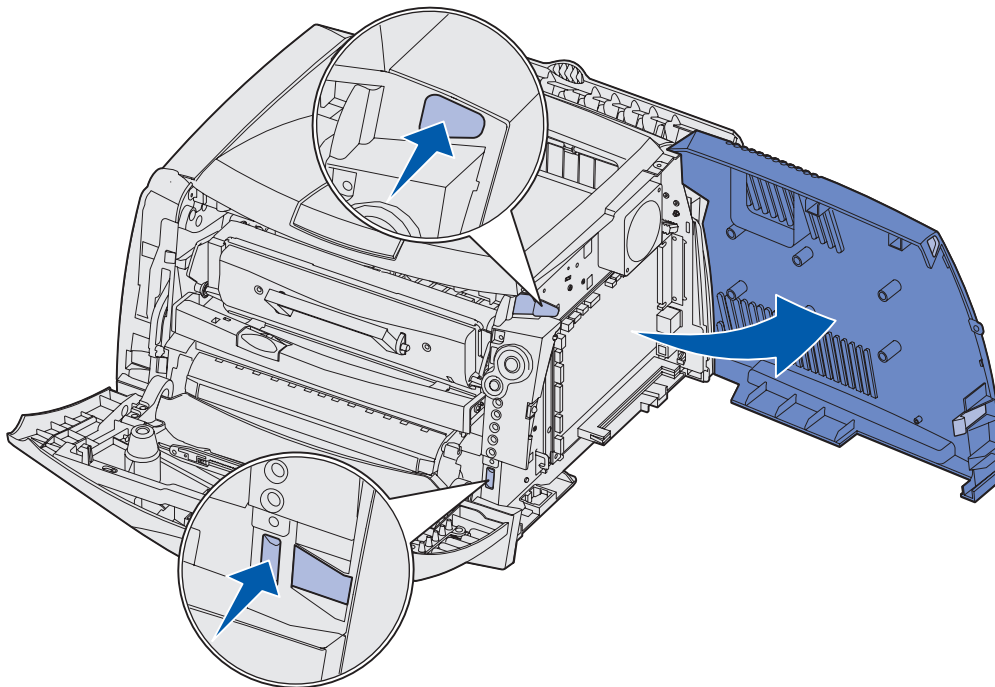

- 4 Remove the two screws at the top and side of the metal plate covering the system board.

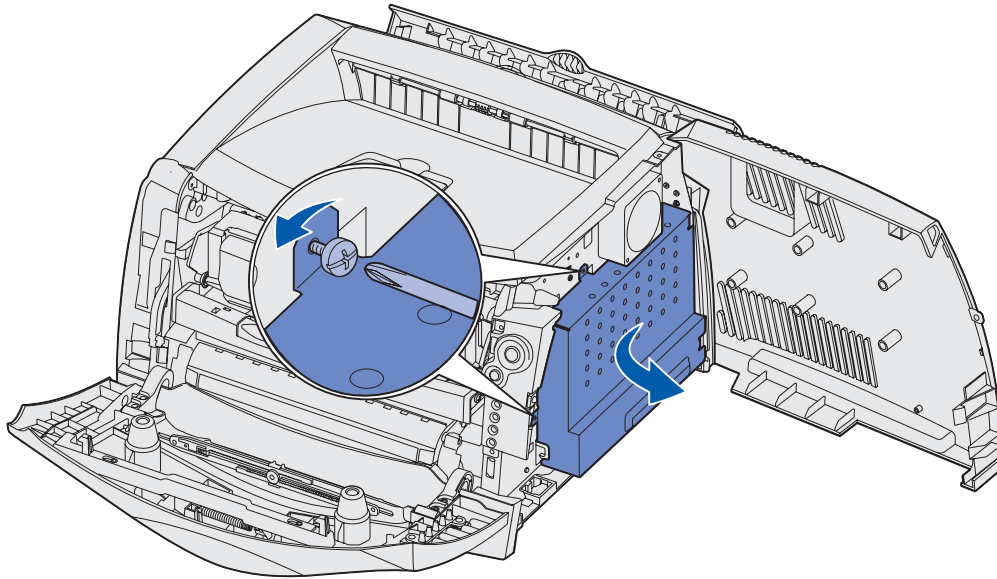

- 5 Remove the metal plate by rotating it towards the front and to the right.

How to reattach the system board cover

When you are finished adding a memory or flash card, be sure to properly reattach the system board's metal cover.

- 1** Insert the two tabs on the right side of the metal plate into the holes toward the back of the system board and rotate the system board until it is flush against the printer.

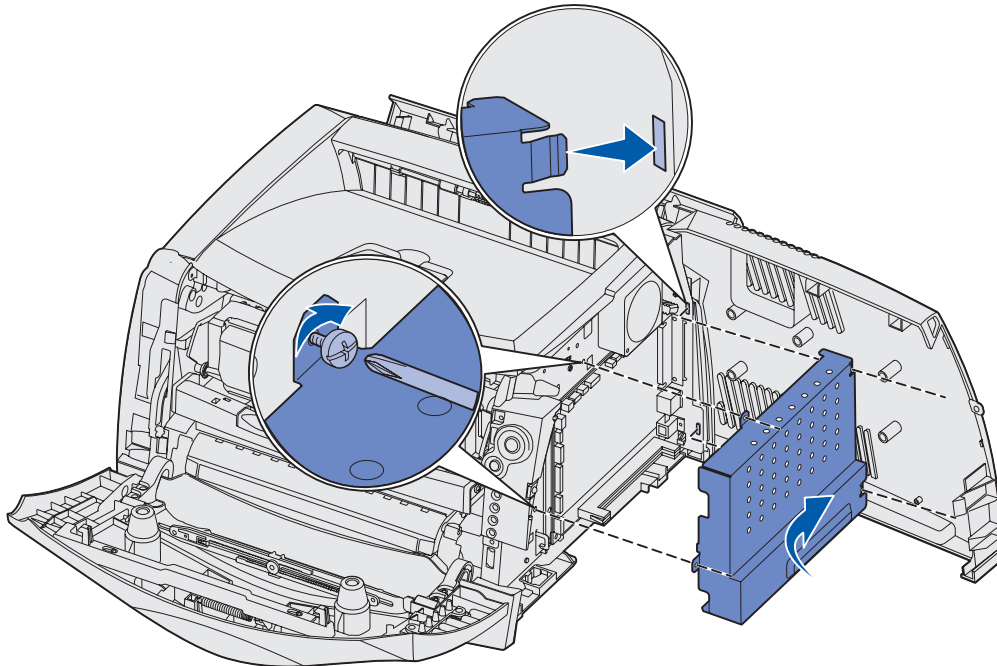

- 2** Screw in the two screws at the top and side of the metal plate.
- 3** Close the side cover.
- 4** Close the rear exit.
- 5** Close the front cover.

How to add a memory card

The system board has one connector for an optional memory card. The printer can support up to 64MB of additional memory (for a total of 80MB) for the Lexmark E232 and up to 128MB (for a total of 160MB) for the Lexmark E330 and Lexmark E332n. The Lexmark E230 does not support additional memory.

CAUTION: If you are installing a memory card after setting up the printer, turn the printer off and unplug the power cord before continuing.

Note: Memory options designed for other Lexmark printers may not work with your printer.

- 1 Access the system board (see [How to access the system board](#)).
- 2 Push open the latches on both ends of the memory connector.
- 3 Unpack the memory card.

Warning: Memory and flash memory cards are easily damaged by static electricity. Touch something metal, such as the printer frame, before you touch a memory card.

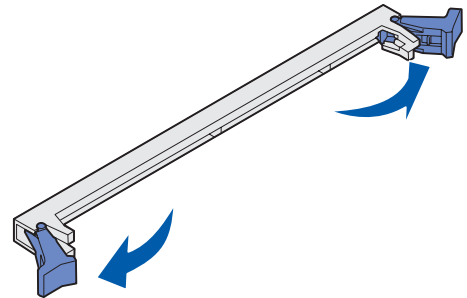

Avoid touching the connection points along the edge of the card.

- 4 Align the notches on the bottom of the card with the notches on the connector.
- 5 Push the memory card firmly into the connector until the latches on either end of the connector *snap* into place.

It may require some force to fully seat the card.

- 6 Make sure each latch fits over the notch on each end of the card.
- 7 Reattach the system board cover (see [How to reattach the system board cover](#)).
- 8 See [How to get the printer driver to recognize installed options](#).

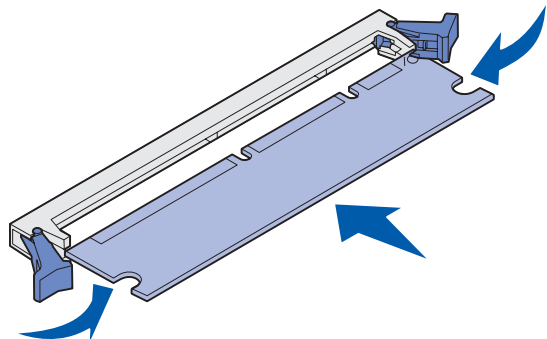

How to add a flash card

The system board has one connector for an optional flash card. The printer can support 16MB and 32MB flash cards.

Note: The Lexmark E230 and Lexmark E232 do not support flash cards.

CAUTION: If you are installing a flash card after setting up the printer, turn the printer off and unplug the power cord before continuing.

Note: Flash cards designed for other Lexmark printers may not work with your printer.

- 1** Access the system board (see **How to access the system board**).
- 2** Unpack the flash card.

Warning: Flash cards are easily damaged by static electricity. Touch something metal, such as the printer frame, before you touch a card.

Avoid touching the metal pins on the bottom of the card.

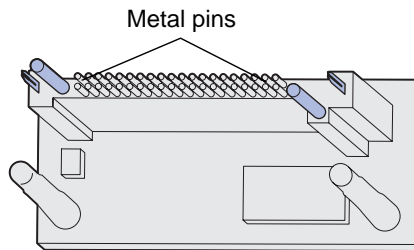

- 3** Holding the card by its sides, align the pins on the card with the holes on the system board.

- 4 Push the flash card firmly into place.

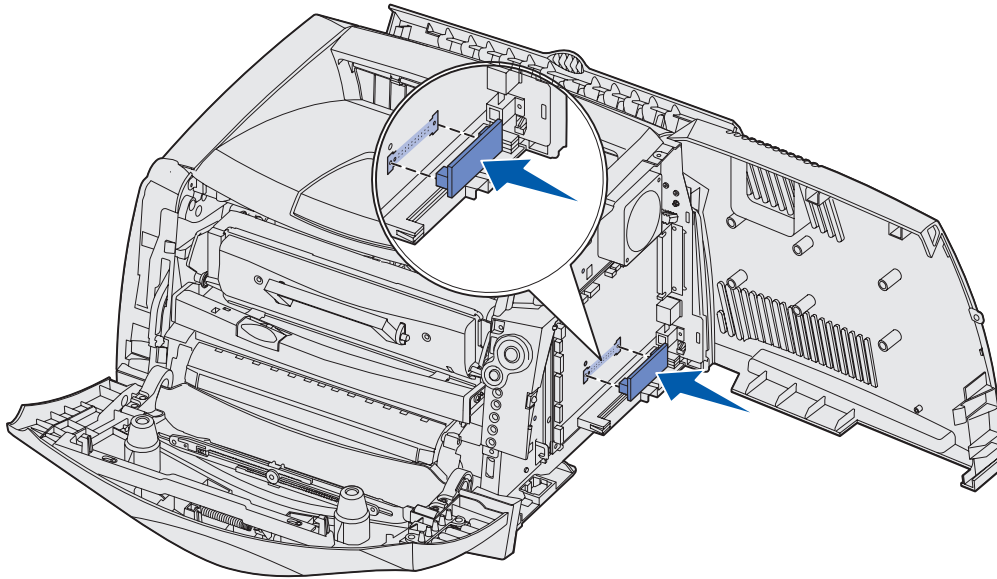

The entire length of the connector on the flash card must touch and be flush against the system board.

Be careful not to damage the connectors.

- 5 Reattach the system board cover (see [How to reattach the system board cover](#)).
- 6 See [How to get the printer driver to recognize installed options](#).

How to install a 550-sheet drawer

Your printer supports one optional drawer that lets you load up to 550 sheets of paper.

Note: The Lexmark E230 does not support a 550-sheet drawer.

CAUTION: If you are installing a 550-sheet drawer after setting up the printer, turn the printer off and unplug the power cord before continuing.

- 1** Unpack the 550-sheet drawer and remove any packing material.
- 2** Place the drawer in the location you have chosen for your printer.
- 3** Align the holes in the printer with the positioning posts on the 550-sheet drawer and lower the printer into place.

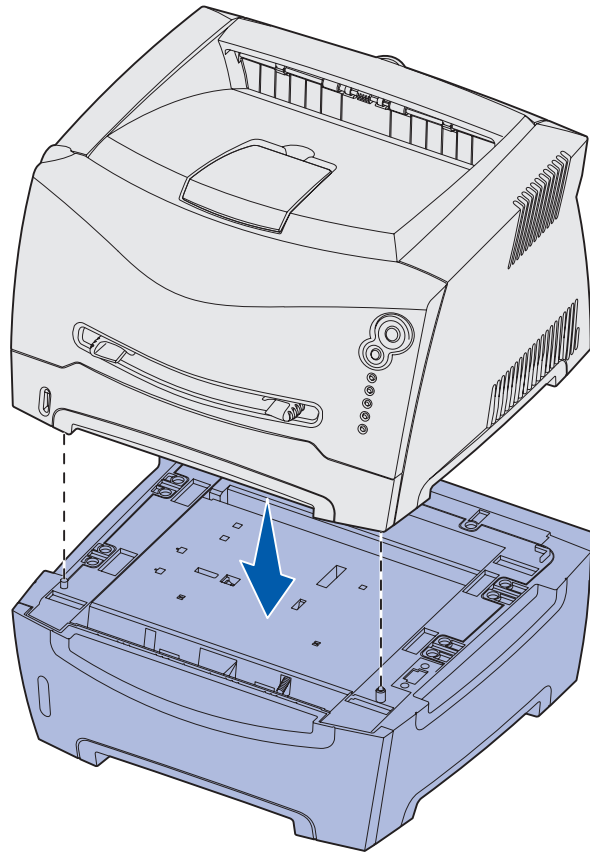

- 4** See **How to get the printer driver to recognize installed options.**

How to get the printer driver to recognize installed options

After the printer is turned on, the printer driver should automatically recognize an option you installed. If it does not, you can add it manually.

Note: If you have not installed your printer driver yet, follow the appropriate instructions under **Software and network tasks**. After you have installed a printer driver, return here to complete these instructions.

- 1** Click **Start** → **Settings** → **Printers**.
- 2** Select the printer's icon.
- 3** Click **File** → **Properties**.
- 4** Click the **Install Options** tab.
- 5** Add the appropriate options to your configuration:
 - **550-Sheet Tray** or **Flash Card**—Select the option you installed from the Available options list and click **Add**.
 - **Memory Card**—Increase the printer memory to the appropriate number.
- 6** Click **OK**.

5

Using the operator panel





Section	Page
Overview of the operator panel	51
Understanding the operator panel lights	52
Operator panel codes	57

Overview of the operator panel

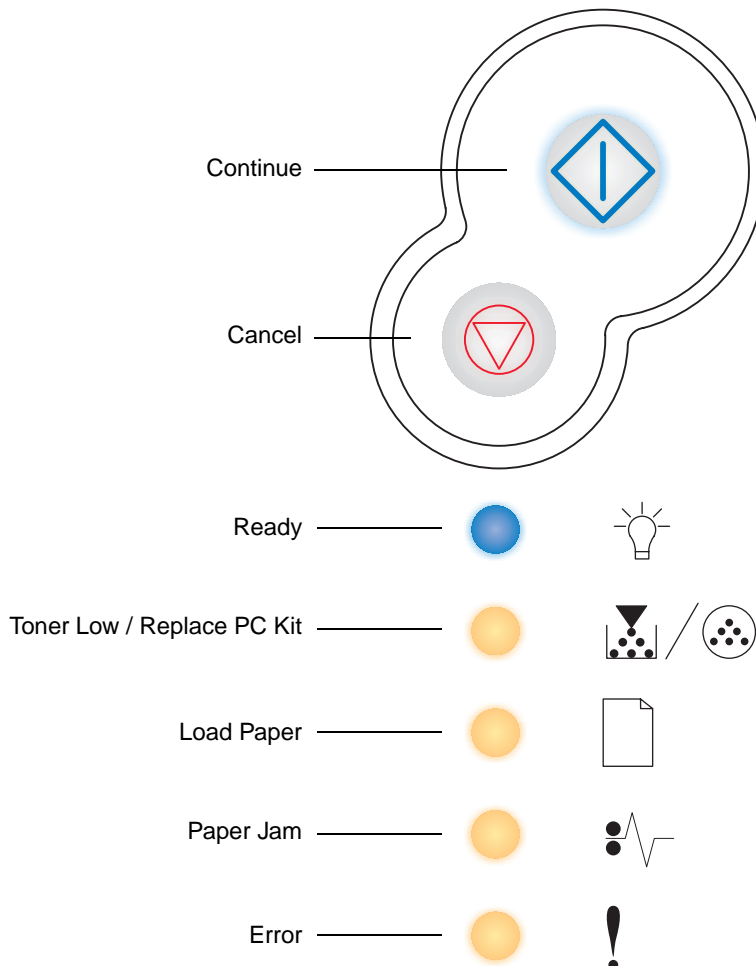
The operator panel has 5 lights and 2 buttons.

Note: The Continue button also functions as a light.

































- Press and release **Continue**  to resume printing.
- Press and release **Continue**  twice quickly to display a secondary error code.
- Press and release **Cancel**  to cancel the job currently printing.
- Press and hold **Cancel**  until all of the lights come on to reset the printer.

Understanding the operator panel lights











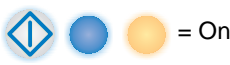
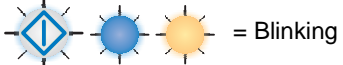
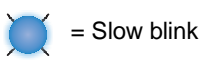

























The operator panel lights mean different things, depending on their sequence. Lights that are off, on, and/or blinking indicate printer conditions such as printer status, intervention, or service.

The following tables show the most common light sequences. Click the indicated page for more information on what it means.



Common light sequences

	   = On	   = Blinking	 = Slow blink	Empty = Off							
Printer condition	Ready / Power Saver	Busy	Hex Trace Ready	Waiting	Flushing / Resolution reduced	Not ready (printer is offline)	Close door	Load media	Load manual feeder	Print side two of a duplex job	Invalid engine code / Invalid network code
Page:	57	58	59	59	60	60	61	61	62	62	63
 Continue											
 Ready											
 Toner Low / Replace PC Kit											
 Load Paper											
 Paper Jam											
 Error											

Common light sequences (continued)

















































	 = On	 = Blinking	 = Slow blink	Empty = Off							
Printer condition	Toner low	Photoconductor kit near full	Replace photoconductor kit	Replace photoconductor kit (printer hard stop)	Unsupported toner cartridge / Toner cartridge is not installed	Change invalid toner cartridge	Programming engine code / Programming system code	Cancel job / Reset printer	Service error	Printer error *	Paper jam printer error *
Page:	63	64	64	65	65	66	66	67	67	68	68
 Continue											
 Ready											
 Toner Low / Replace PC Kit											
 Load Paper											
 Paper Jam											
 Error											
* See "Secondary errors" on page 54 for more information.											

Secondary errors

- When the Error ! and Continue  lights are both on, a secondary error has occurred.
- When the Paper Jam  and Continue  lights are both on, a paper jam secondary error has occurred.

















































Press and release **Continue**  twice quickly to display the secondary error code light sequence. The following table shows what these light sequences mean and where to go for help.

Secondary Error codes

		   = On					   = Blinking			Empty = Off		
Printer condition	Paper jam codes							Complex page	Insufficient printer memory	Insufficient collation area	Font error	Defective flash
	Paper jam at the input sensor *	Paper jam in the manual feeder	Paper jams as it exits the tray into the printer	Paper jams as a printed job exits the printer	Paper jam in Tray 1	Paper jam in Tray 2						
Page:	70	70	71	71	72	72	73	73	74	75	75	
 Continue												
 Ready												
 Toner Low / Replace PC Kit												
 Load Paper												
 Paper Jam												
 Error												

* Paper jams at the input sensor can be either after the paper leaves the tray and enters the printer or in the manual feeder.

Secondary Error codes (continued)

		   = On			   = Blinking			Empty = Off			
Printer condition		Insufficient defrag memory	Network interface errors	Error communicating with the host computer	Host interface disabled	Memory full	Short paper	Flash full	Unformatted flash	Invalid engine code	Invalid network code
Page:	76	76	77	77	78	79	80	81	81	82	
 Continue											
 Ready											
 Toner Low / Replace PC Kit											
 Load Paper											
 Paper Jam											
 Error											

Operator panel codes

Below are explanations of what the primary light sequences, or codes, and secondary error codes mean and what you can do to clear them.

Primary codes

Ready / Power Saver



Light sequence:

- Ready—On

What this light sequence means:

- The printer is ready to receive and process data.
- The printer is in Power Saver mode.

What you can do:

- Send a print job.
- Press **Continue**  to print the menu settings pages for a list of current printer settings.
- Press and hold **Cancel**  to reset the printer.

Note: If you want to change the Power Saver setting, it can only be set from the Local Printer Setup Utility (see [“Using the Local Printer Setup Utility” on page 103](#)).

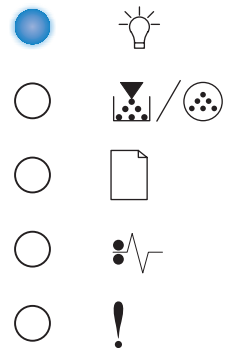
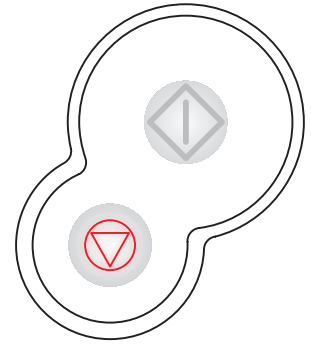

Busy







Light sequence:

- Ready—Blink

What this light sequence means:

- The printer is busy receiving and processing data or printing.
- The printer is defragmenting the flash memory to reclaim storage space occupied by deleted resources.
- The printer is formatting the flash memory.
- The printer is storing resources, such as fonts or macros, in flash memory.
- The printer is printing a directory, font list, menu settings pages, or Print Quality Test Pages.

What you can do:

- Busy:
 - Wait for the message to clear.
 - Press and release **Cancel**  to cancel the print job.
 - Press and hold **Cancel**  to reset the printer.
- Defragmenting flash, formatting flash, or programming flash:
 - Wait for the message to clear.
 - **Warning:** Do not turn the printer off while this message is displayed.
- Printing a directory, a font list, menu settings pages, or Print Quality Test Pages:
 - Wait for the pages to print. The Busy message is displayed as the pages print. The Ready light is on when printing stops.
 - Press and release **Cancel**  to cancel printing.
 - Press and hold **Cancel**  to reset the printer.
- Receiving/processing data from a host interface:
 - Wait for the message to clear.
 - Press and release **Cancel**  to stop processing.
 - Press and hold **Cancel**  to reset the printer.

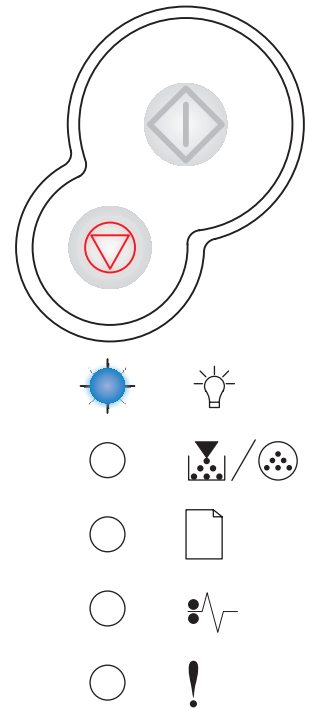

Hex Trace Ready

Light sequence:

- Ready—Slow blink

What this light sequence means:

The printer is in the Ready mode and Hex Trace is active.

What you can do:

- Advanced users can use Hex Trace to help troubleshoot printing problems. After resolving the problem, turn off the printer to exit Hex Trace.
- Press and hold **Cancel**  to reset the printer.

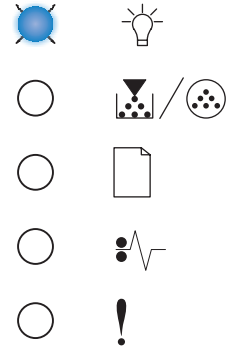
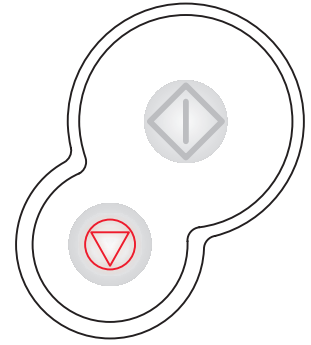

Waiting



Light sequence:

- Continue—On
- Ready—On

What this light sequence means:

The printer is waiting until a print timeout occurs, or until it receives additional data.

What you can do:

- Press **Continue**  to print the contents of the print buffer.
- Press and release **Cancel**  to cancel the print job.
- Press and hold **Cancel**  to reset the printer.

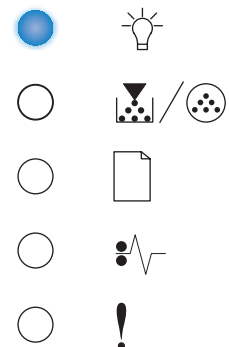
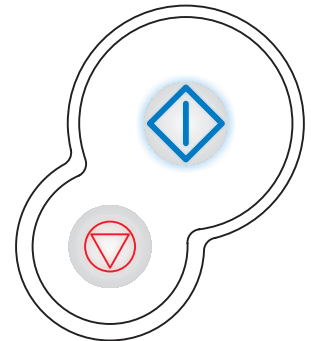

Flushing / Resolution reduced



Light sequence:

- Ready—Blink
- Error—Blink

What this light sequence means:

- The printer is flushing corrupted print data.
- The printer is processing data or printing pages, but the resolution of a page in the current print job is reduced from 600 dots per inch (dpi) to 300 dpi to prevent a memory full error.

What you can do:

- Wait until the operator panel returns to Ready to print other jobs.
- Press and release **Cancel**  to cancel the print job.
- Press and hold **Cancel**  to reset the printer.

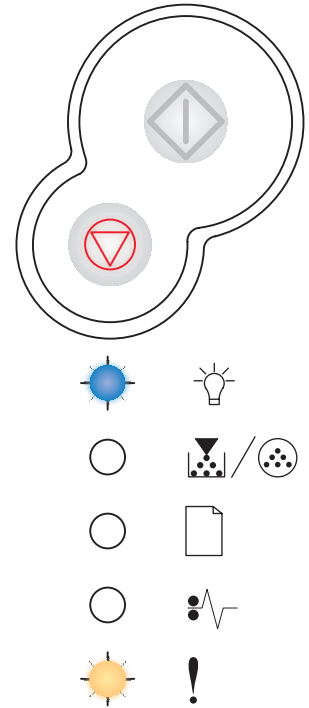

Not ready



Light sequence:

- Continue—On

What this light sequence means:

The printer is not ready to receive or process data, or the printer ports are offline.

What you can do:

- Press **Continue**  to return to the Ready or Busy state.
- Press and release **Cancel**  to cancel the print job.
- Press and hold **Cancel**  to reset the printer.

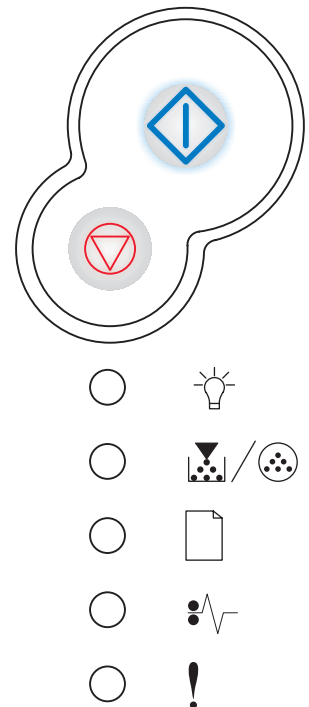

Close door

Light sequence:

- Error—On

What this light sequence means:

The printer door is open.

What you can do:

Close the door.

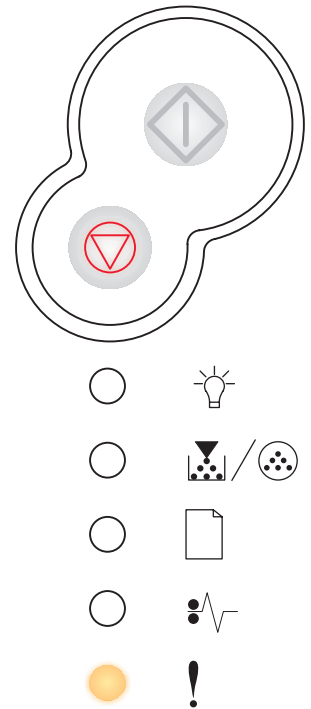

Load media



Light sequence:

- Continue—On
- Load Paper—On

What this light sequence means:

The printer is out of media, or the media did not feed properly.

What you can do:

- Load media into tray 1 or the optional 550-sheet tray and press **Continue**  to resume printing.
- Check that the media is loaded correctly in tray 1 or the optional 550-sheet tray.
- Press **Cancel**  to cancel the print job.

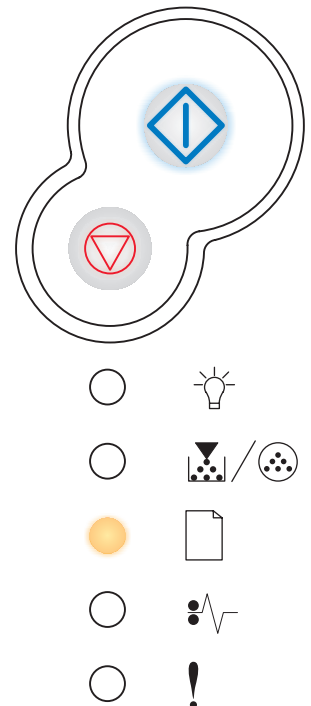

Load manual feeder



Light sequence:

- Continue—On
- Load Paper—Blink

What this light sequence means:

The printer prompts you to load a single sheet of media in the manual feed.

What you can do:

- Load media, with the side to be printed facing the front of the printer, into the manual feed.
- Press **Continue**  to resume printing.
- Press and hold **Cancel**  to reset the printer.

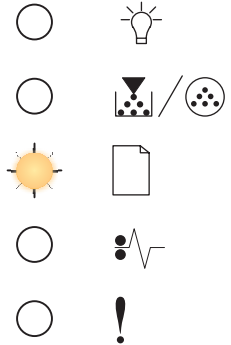
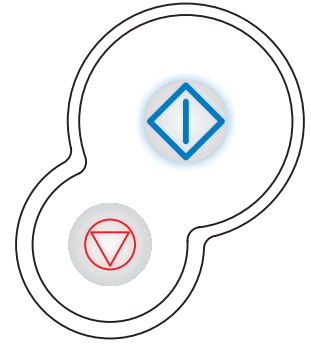

Print side two of a duplex job



Light sequence:

- Continue—Blink
- Load Paper—On

What this light sequence means:

Print the other side of your duplex print job.

What you can do:

- Reinsert your print job in tray 1 using the instructions in the driver pop-up menu to orient the pages correctly. Press **Continue**  to resume printing.
- Press and hold **Cancel**  to reset the printer.

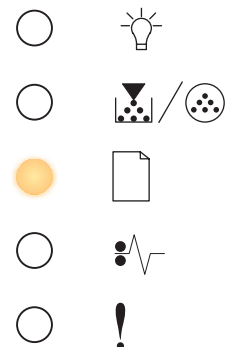
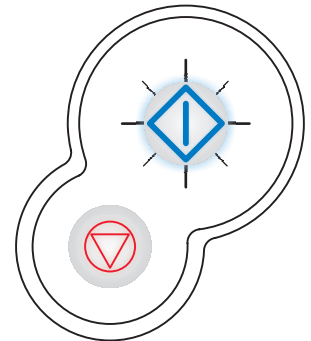

Invalid engine code / Invalid network code

Light sequence:

- Ready—On
- Error—On

What this light sequence means:

The code in an internal print server has not been programmed, or the programmed code is not valid.

What you can do:

Download valid network code to the internal print server. Press

Continue  twice quickly to see the secondary error code. See **“Secondary error codes” on page 69** for more information.

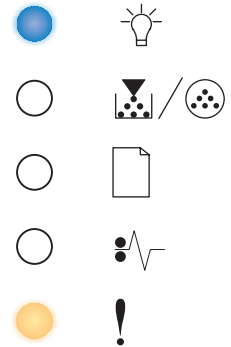
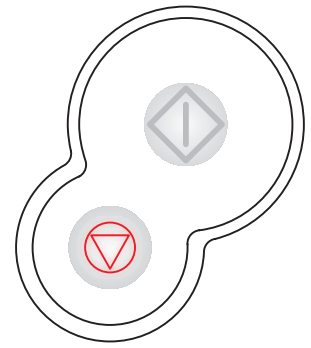

Toner low



Light sequence:

- Toner Low/Replace PC Kit—On

What this light sequence means:

The printer is ready to receive and process data. In addition, the toner in the toner cartridge is getting low.

What you can do:

- Press **Continue**  to print the menu settings page for a list of current printer settings.
- Remove the toner cartridge and shake it to extend the life of the cartridge.
- Replace the toner cartridge. (See **“How to change a toner cartridge” on page 108** for help.)
- Press and hold **Cancel**  to reset the printer.

Note: This light may not come on if the starter toner cartridge is installed in a base printer model.

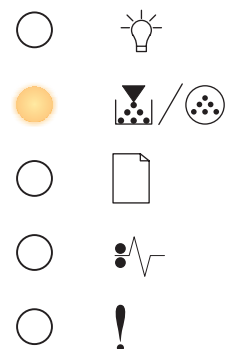
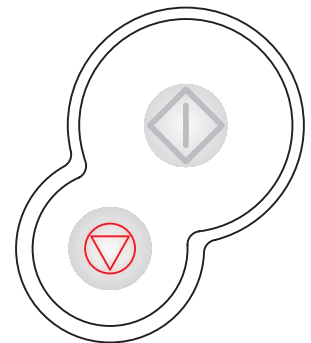

Replace photoconductor kit (printer hard stop)

Light sequence:

- Continue—On
- Toner Low/Replace PC Kit—Blink
- Error—Blink

What this light sequence means:

The photoconductor kit's drum is full and needs replacing. The printer will not print any more pages until the photoconductor kit is replaced.

What you can do:

Replace the photoconductor kit. (See [“How to change a photoconductor kit” on page 112](#) for help.)

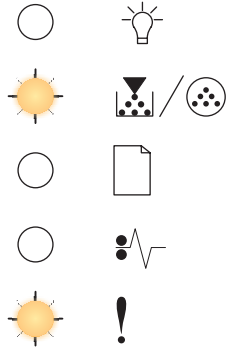
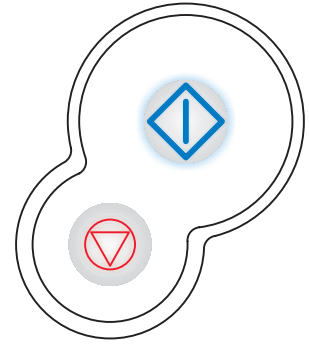

Unsupported toner cartridge / Toner cartridge is not installed

Light sequence:

- Toner Low/Replace PC Kit—On
- Error—On

What this light sequence means:

The toner cartridge is not installed, or the printer detects a toner cartridge error.

What you can do:

- If the toner cartridge is not installed, install it.
- If the toner cartridge is installed, remove it and install a new toner cartridge (see [“How to change a toner cartridge” on page 108](#)).

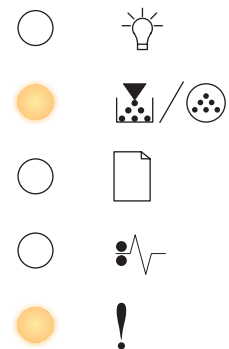
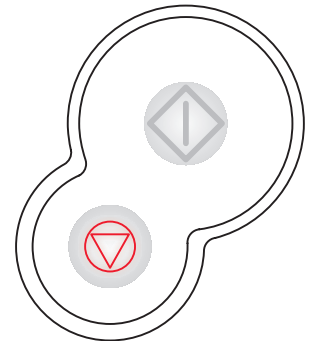

Change invalid toner cartridge

Light sequence:

- Toner Low/Replace PC Kit—On
- Error—Blink

What this light sequence means:

The toner cartridge you are using was not designed for your printer.

What you can do:

Install a toner cartridge made for your printer (see **“What supplies do I need and how do I order them?” on page 105**).

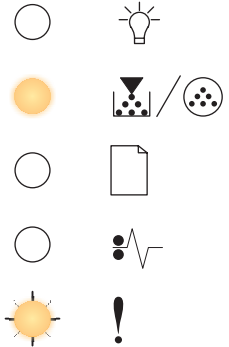
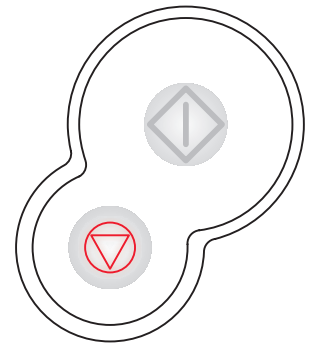

Programming engine code / Programming system code

Light sequence:

- Ready—On
- Toner Low/Replace PC Kit—On
- Load Paper—On

What this light sequence means:

New code is being programmed into the engine or firmware code flash.

What you can do:

Wait for the message to clear. When the printer has finished programming the code, it performs a soft reset.

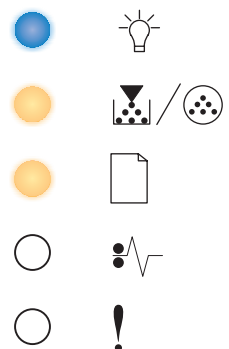
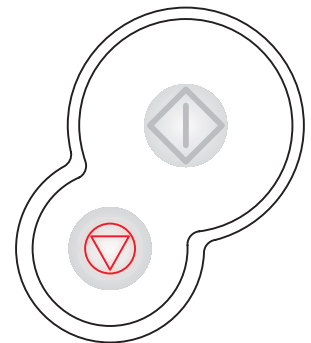

Cancel job / Reset printer

Light sequence:

- Continue—On
- Ready—On
- Toner Low/Replace PC Kit—On
- Load Paper—On
- Paper Jam—On
- Error—On

What this light sequence means:

- The current print job is canceled.
- The printer is resetting to the user default settings. Any active print jobs are canceled. A user default setting remains in effect until you change it or until you restore the factory default settings.

What you can do:

Wait for the message to clear.

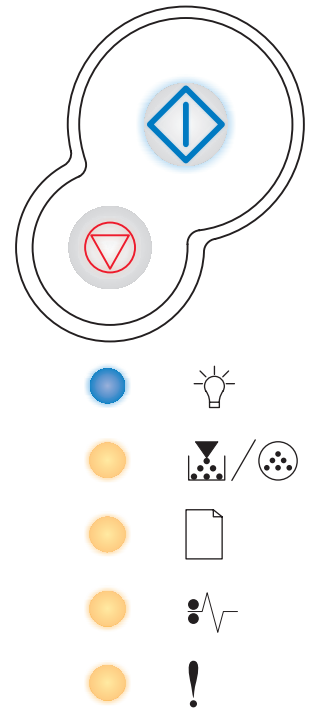

Service error

Light sequence:

- Continue—Blink
- Ready—Blink
- Toner Low/Replace PC Kit—Blink
- Load Paper—Blink
- Paper Jam—Blink
- Error—Blink

What this light sequence means:

The printer has a service error and printing has stopped.

What you can do:

Turn the printer off and back on. If the lights are still blinking, contact the place where you bought your printer.

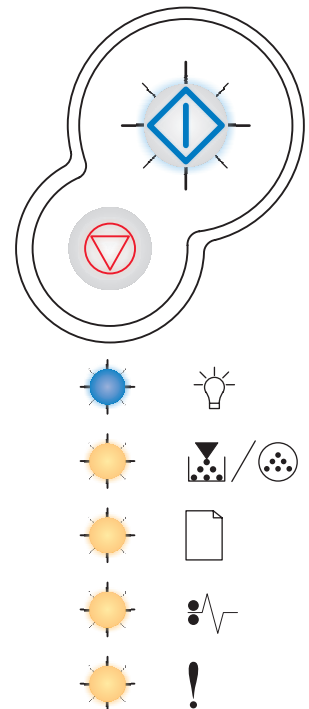

Printer error

Light sequence:



- Continue—On
- Error—On

What this light sequence means:

The printer has one of the following errors:

- Memory is full, insufficient to save what is in the buffer, or insufficient to defragment flash memory.
- A page is too complex to print or is shorter than the set page margins.
- Resolution of a formatted page is reduced to 300 dpi.
- A font error occurred.
- Communication with the host computer is lost.

What you can do:

- Press **Continue**  twice quickly to see the secondary error code. See **“Secondary error codes” on page 69** for more information.
- Press **Continue**  to clear the secondary message.

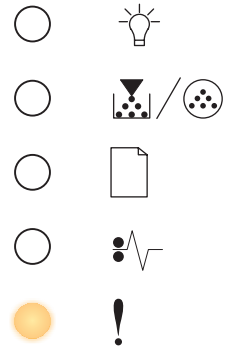
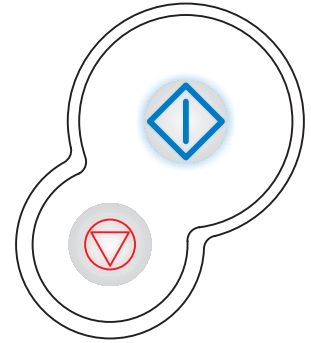

Paper jam printer error



Light sequence:

- Continue—On
- Paper Jam—On

What this light sequence means:



The printer has a paper jam.

What you can do:

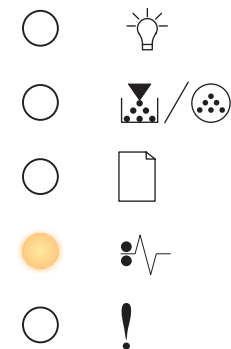
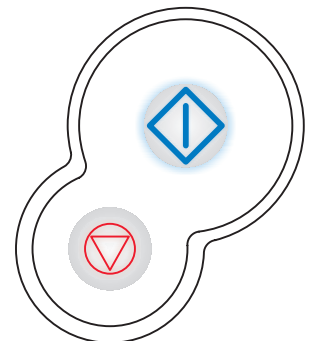
- Press **Continue**  twice quickly to see the secondary error code. See **“Secondary error codes” on page 69** for more information.
- Press **Continue**  to resume printing once all the jammed pages are cleared from the paper path.



Secondary error codes

- When the Error ! and Continue  lights are both on, a secondary error has occurred.
- When the Paper Jam  and Continue  lights are both on, a paper jam secondary error has occurred.

Press and release **Continue**  twice quickly to display the secondary error code light sequence.

Paper jam at the input sensor

Light sequence:

- Continue—On
- Ready—On
- Paper Jam—On

What this light sequence means:

A paper jam has occurred at the input sensor, which can be either after the paper leaves the tray and enters the printer or in the manual feeder.

What you can do:

Clear the paper jam. See [“How to clear paper jams” on page 26](#) for more information.

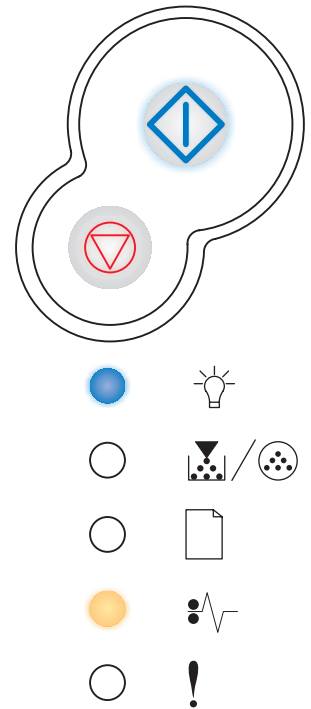

Paper jam in the manual feeder

Light sequence:

- Continue—On
- Ready—Blink
- Paper Jam—On

What this light sequence means:

A paper jam has occurred in the manual feeder.

What you can do:

Clear the paper jam. See [“How to clear paper jams” on page 26](#) for more information.

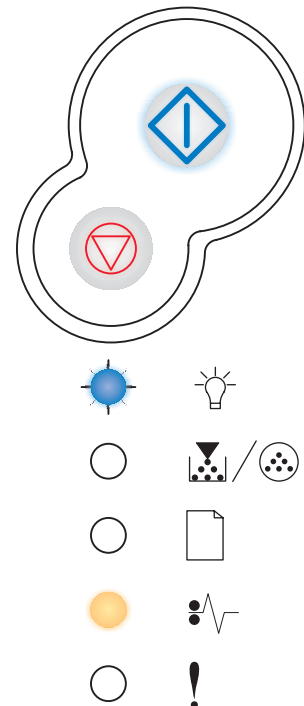

Paper jams as it exits the tray into the printer

Light sequence:

- Continue—On
- Toner Low/Replace PC Kit—On
- Paper Jam—On

What this light sequence means:

A paper jam has occurred as the paper is exiting the paper tray and entering the printer.

What you can do:

Clear the paper jam. See [“How to clear paper jams” on page 26](#) for more information.

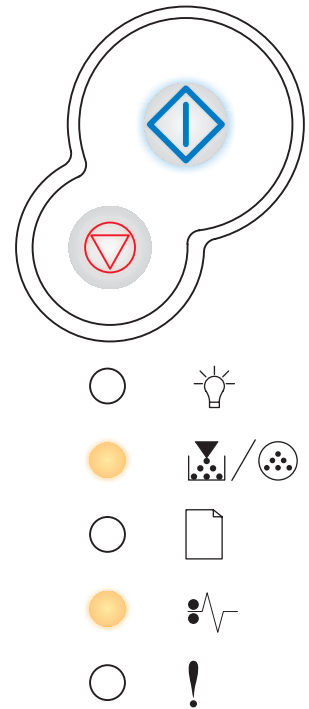

Paper jams as a printed job exits the printer

Light sequence:

- Continue—On
- Load Paper—On
- Paper Jam—On

What this light sequence means:

A paper jam has occurred as the paper is exiting the printer.

What you can do:

Clear the paper jam. See [“How to clear paper jams” on page 26](#) for more information.

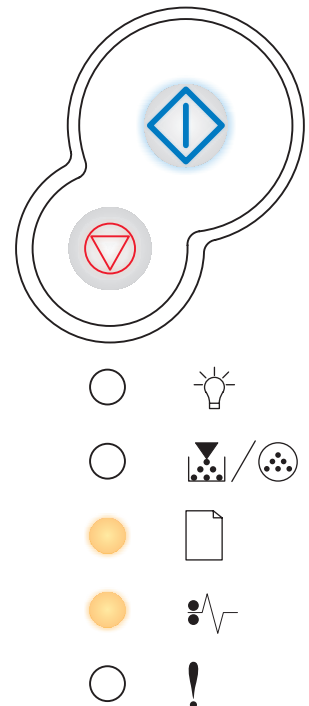

Paper jam in Tray 1

Light sequence:

- Continue—On
- Toner Low/Replace PC Kit—On
- Load Paper—On
- Paper Jam—On

What this light sequence means:

A paper jam has occurred in Tray 1.

What you can do:

Clear the paper jam. See [“How to clear paper jams” on page 26](#) for more information.

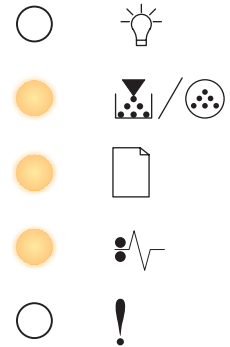
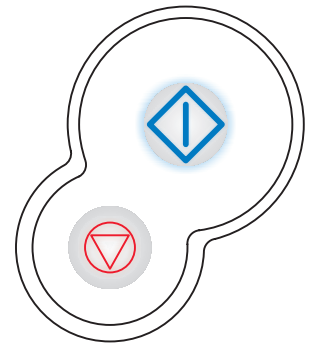

Paper jam in Tray 2

Light sequence:

- Continue—On
- Ready—On
- Load Paper—On
- Paper Jam—On

What this light sequence means:

A paper jam has occurred in Tray 2.

What you can do:

Clear the paper jam. See [“How to clear paper jams” on page 26](#) for more information.

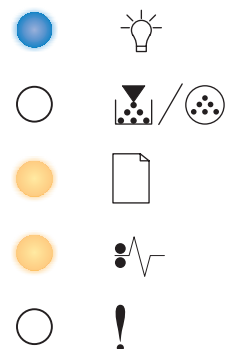
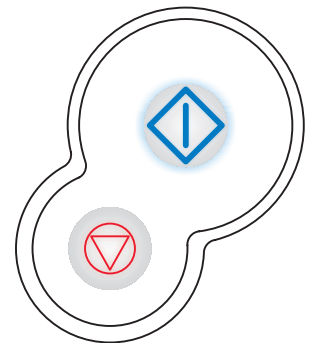

Complex page

Light sequence:

- Continue—On
- Ready—On
- Error—On

What this light sequence means:

The page may not print correctly because the print information on the page is too complex (that is, too large for the printer's memory).

What you can do:

- Press **Continue**  to clear the message and continue processing the print job (some of the print data may be lost).
- To avoid this error in the future:
 - Reduce the complexity of the page by reducing the amount of text or graphics on the page and deleting unnecessary downloaded fonts or macros.
 - Set **Page Protect** to On in the Local Printer Setup Utility.
 - Install additional printer memory (see **“How to add a memory card” on page 45**).

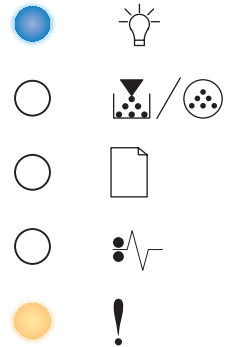
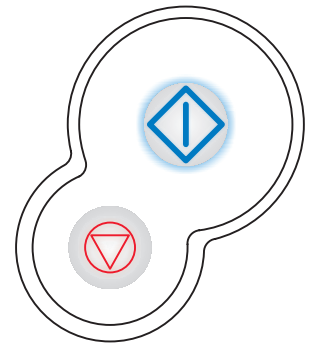

Insufficient printer memory



Light sequence:

- Continue—On
- Ready—Blink
- Error—On

What this light sequence means:

The printer does not have enough memory to save the data in the buffer.

What you can do:

- Install additional memory (see **“How to add a memory card” on page 45**).
- Press **Continue**  to continue printing the job.
- Press **Cancel**  to cancel the print job.

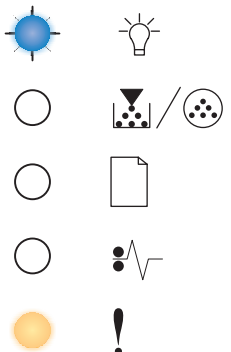
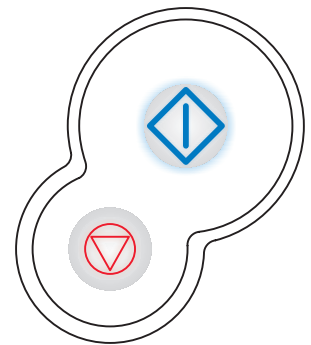

Insufficient collation area

Light sequence:



- Continue—On
- Toner Low/Replace PC Kit—On
- Error—On

What this light sequence means:

The printer memory does not have the free space necessary to collate the print job. This may happen due to one of these errors:

- Memory is full.
- A page is too complex to print.
- A page is shorter than the set page margins.
- Memory is insufficient to save what is in the buffer.

What you can do:

- Press **Continue**  to clear the message and continue printing the job (the job may not print correctly.)
- Press and release **Cancel**  to cancel the print job.
- Press and hold **Cancel**  to reset the printer.
- To avoid this error in the future:
 - Simplify the print job. Reduce the complexity of the page by reducing the amount of text or graphics on the page and deleting unnecessary downloaded fonts or macros.
 - Install additional printer memory (see **“How to add a memory card” on page 45**).

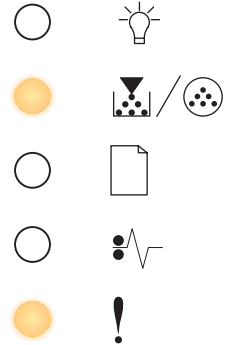
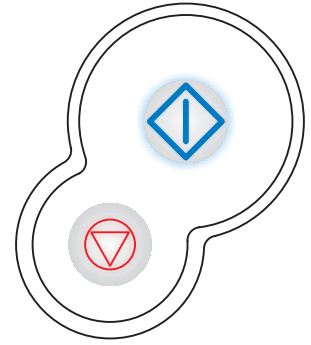

Font error



Light sequence:

- Continue—On
- Toner Low/Replace PC Kit—Blink
- Error—On

What this light sequence means:

The printer has received a request for a PPDS font which is not installed.

What you can do:

- Press and release **Cancel**  to cancel the print job.
- Press and hold **Cancel**  to reset the printer.
- Press **Continue**  to clear the message and continue printing.

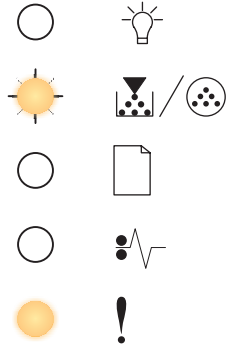
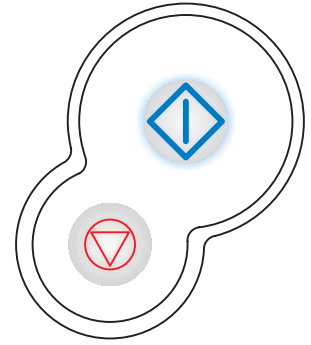

Defective flash

Light sequence:

- Continue—On
- Load Paper—On
- Error—On

What this light sequence means:

The printer detects defective flash memory.

What you can do:

- Press **Continue**  to clear the message and continue printing. Downloaded fonts and macros not previously stored in flash memory are deleted.
- See [“How to add a memory card” on page 45](#) to install flash memory.

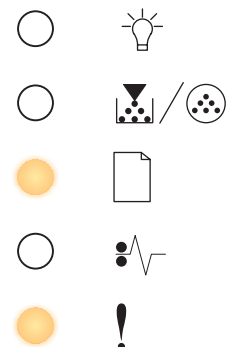
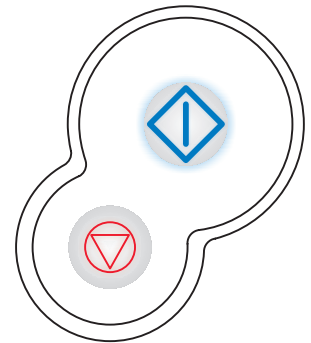

Insufficient defrag memory

Light sequence:

- Continue—On
- Load Paper—Blink
- Error—On

What this light sequence means:

The printer has insufficient memory to free unused space in flash memory.

What you can do:

- Delete fonts, macros, and other data in RAM.
- Install additional printer memory.

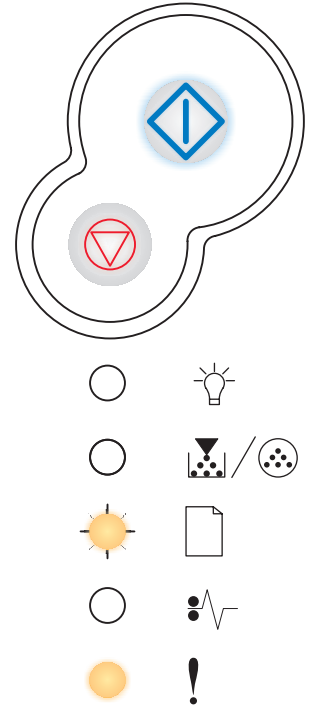

Network interface errors

Light sequence:

- Continue—On
- Paper Jam—On
- Error—On

What this light sequence means:

The printer cannot establish communication with the network.

What you can do:

Press **Continue**  to clear the message and continue printing.
(The job may not print correctly.)

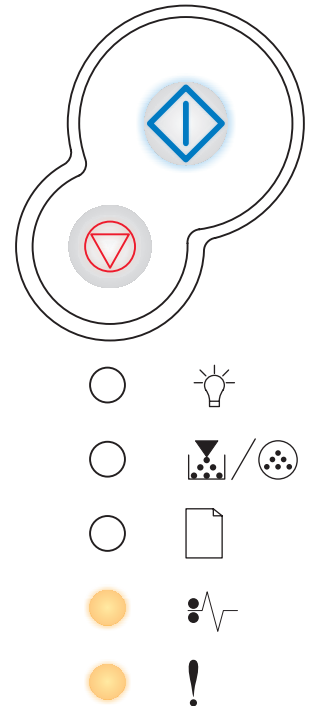

Error communicating with the host computer

Light sequence:

- Continue—On
- Paper Jam—Blink
- Error—On

What this light sequence means:

The printer has lost the connection to an external print server (also called an external network adapter or ENA).

This light sequence is displayed if your printer is connected to the network, but it cannot detect the print server when you turn on the printer.

What you can do:

- Make sure the cable connecting the ENA and the printer is securely attached. Turn the printer off and then on to reset the printer.
- Press and hold **Cancel**  to reset the printer.

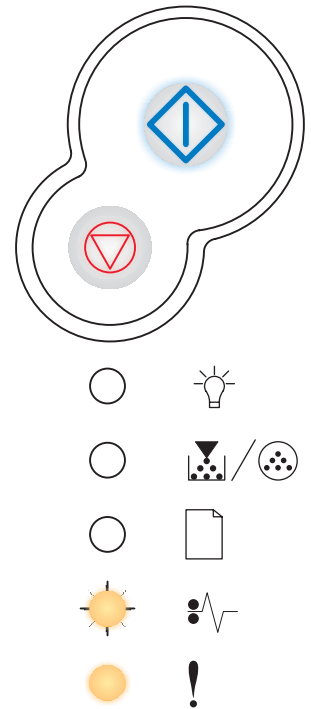

Host interface disabled

Light sequence:

- Continue—On
- Load Paper—Blink
- Paper Jam—Blink
- Error—On

What this light sequence means:

The printer USB or parallel port has been disabled.

What you can do:

- Press **Continue**  to clear the message. The printer discards any print jobs previously sent. Enable the USB or parallel port by selecting a value other than Disabled for the USB Buffer or Parallel Buffer item in the Local Printer Setup Utility (see [Using the Local Printer Setup Utility](#)).

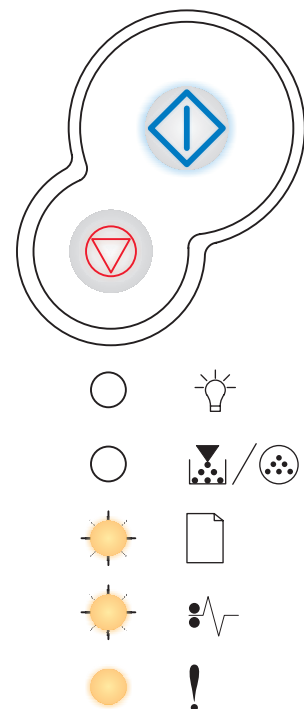

Memory full



Light sequence:

- Continue—On
- Ready—On
- Toner Low/Replace PC Kit—On
- Error—On

What this light sequence means:

The printer is processing data, but the memory used to store pages is full.

What you can do:

- Press **Continue**  to clear the message and continue printing the job (the job may not print correctly).
- Press and release **Cancel**  to cancel the print job.
- Press and hold **Cancel**  to reset the printer.
- To avoid this error in the future:
 - Simplify the print job. Reduce the complexity of the page by reducing the amount of text or graphics on the page and deleting unnecessary downloaded fonts or macros.
 - Install additional printer memory (see **“How to add a memory card” on page 45**).

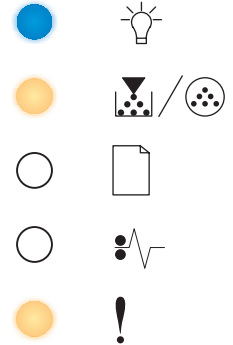
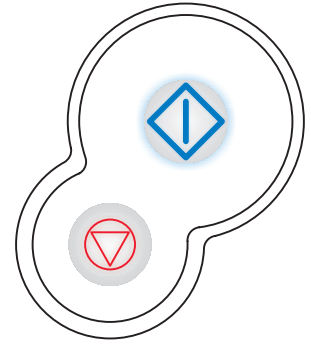

Short paper



Light sequence:

- Continue—On
- Ready—On
- Load Paper—On
- Error—On

What this light sequence means:

The paper length is too short to print the formatted data. This occurs when the printer does not know the media size loaded in the tray, or there is a problem feeding the media.

What you can do:

- Make sure the print media you loaded is large enough.
- Open the front cover, clear the paper path and close the cover to resume printing (see [“How to clear paper jams” on page 26](#)).
- Press **Continue**  to clear the message and continue printing the job.
- Press **Cancel**  to cancel the print job.

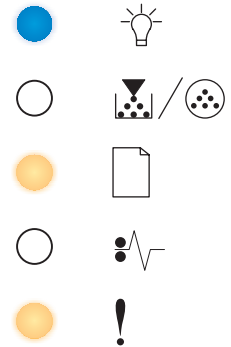
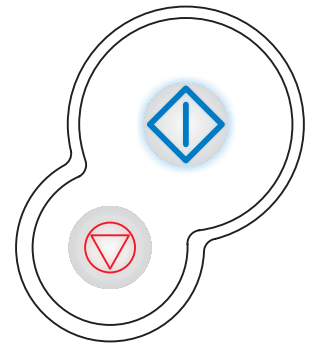

Flash full



Light sequence:

- Continue—On
- Ready—On
- Paper Jam—On
- Error—On

What this light sequence means:

There is not enough free space in the flash memory to store the data you are trying to download.

What you can do:

- Delete fonts, macros, and other data stored on the flash memory to free up space.
- Press **Continue**  to clear the message and continue printing. Downloaded fonts and macros not previously stored in flash memory are deleted.
- Install flash memory with more storage capacity. See **“How to add a memory card” on page 45** for instructions on how to install flash memory.
- Press and release **Cancel**  to cancel the print job.
- Press and hold **Cancel**  to reset the printer.

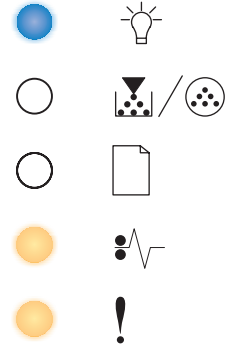
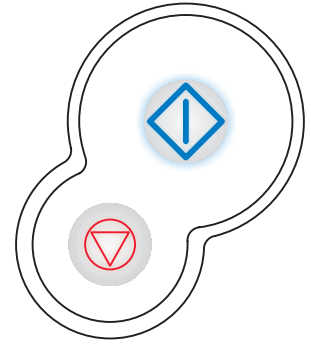

Unformatted flash

Light sequence:

- Continue—On
- Toner Low/Replace PC Kit—On
- Paper Jam—On
- Error—On

What this light sequence means:

The printer detects unformatted flash memory.

What you can do:

- Press **Continue**  to clear the message and continue printing. The job may not print correctly.
- Reformat the flash memory. Refer to the *Technical Reference* on Lexmark's Web site for more information about reformatting flash.
- If the error message remains, the flash memory may be defective and should be replaced.

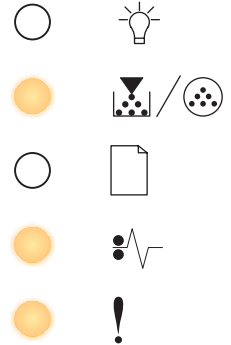
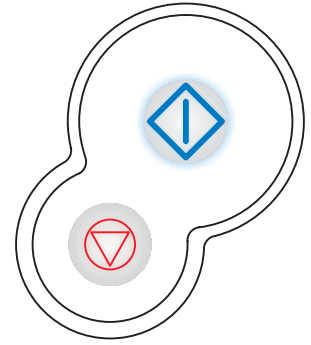

Invalid engine code

Light sequence:

- Ready—On
- Load Paper—On
- Error—On

What this light sequence means:

The code in an internal print server has not been programmed, or the programmed code is not valid.

What you can do:

Download valid engine code to the internal print server.

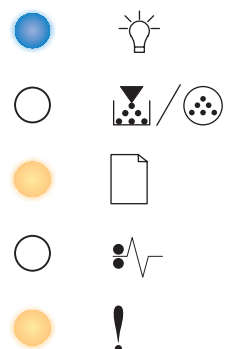
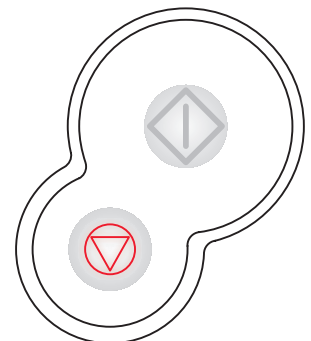

Invalid network code

Light sequence:

- Ready—On
- Load Paper—Blink
- Error—On

What this light sequence means:

The code in an internal print server has not been programmed, or the programmed code is not valid.

What you can do:

Download valid network code to the internal print server.

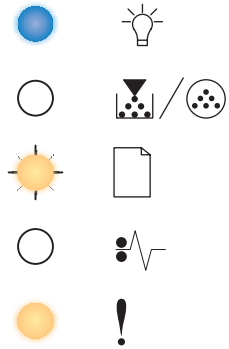
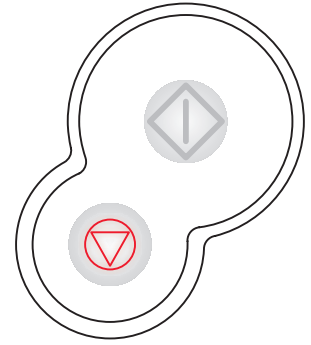

6



Understanding the printer configuration menus

Section	Page
Printing the Printer Settings Configuration sheet	83
Configuration menus overview	84
• Network menu	85
• Parallel menu	86
• Setup menu	86
• USB menu	87
• Utilities menu	87

Printing the Printer Settings Configuration sheet







To help resolve printing problems or to change printer configuration settings, advanced users can print the Printer Settings Configuration sheet for instructions on advancing through the configuration menus to select and save new settings.





To print the Printer Settings Configuration sheet:

- 1 Turn off the printer.
- 2 Open the front cover.
- 3 Press and hold **Continue**  as you turn the printer back on.
All the lights cycle.
- 4 Close the cover. The light sequence that represents the Home menu is displayed.
- 5 To print the Printer Settings Configuration sheet, press and hold **Continue**  until the lights cycle. The sheet prints.

Note: The sheet only prints when the Home menu is displayed.

Configuration menus overview

Menus are represented by **Ready**  , **Toner Low/Replace PC Kit**  /  , **Load Paper**  , and **Paper Jam**  light sequences. Menu items and their settings are indicated by **Error**  and **Continue**  light sequences.

- Press and release **Cancel**  to advance through menus and menu items.
- Press and release **Continue**  to advance to the setting you need.
- Press and hold **Continue**  until all of the lights cycle to save a setting.
- Press and hold **Cancel**  until all of the lights cycle to return to the Home menu.
- Turn off the printer to exit the menus.

Network menu

Use the Network menu to change printer settings on jobs sent through a network port (either Standard Network or Network Opt <x>).

Setting	Use this setting to:	Values
NPA Mode	Send print jobs to the printer and query printer status information simultaneously.	<ul style="list-style-type: none"> • Off • Auto*
MAC Binary PS	Configure the printer to process Macintosh binary PostScript print jobs.	<ul style="list-style-type: none"> • Off—The printer filters PostScript print jobs using standard protocol. • On—The printer processes raw binary PostScript print jobs from computers using the Macintosh operating system. This setting often causes Windows print jobs to fail. • Auto*—The printer processes print jobs from computers using either Windows or Macintosh operating systems.
Set Card Speed	Automatically detect the connection speed of your network. You can disable this setting to set the speed manually.	<ul style="list-style-type: none"> • Auto*—The printer detects current network speed. • 10Mbps[†], Half Duplex—Forces the printer to try to connect to the network only at 10Mbps, Half Duplex. • 10Mbps, Full Duplex—Forces the printer to try to connect to the network only at 10Mbps, Full Duplex. • 100Mbps, Half Duplex—Forces the printer to try to connect to the network only at 100Mbps, Half Duplex. • 100Mbps, Full Duplex—Forces the printer to try to connect to the network only at 100Mbps, Full Duplex.
<p>* Factory default [†] Megabits per second</p>		

Parallel menu

Use the Parallel menu to change printer settings on jobs sent through a parallel port.

Setting	Use this setting to:	Values
NPA Mode	Send print jobs to the printer and query printer status information simultaneously.	<ul style="list-style-type: none">• Off• On• Auto*
Protocol	Receive information at a much higher transmission rate if your printer is set to Fastbytes (if your computer supports Fastbytes) or receive information at a normal transmission rate if your printer is set to Standard.	<ul style="list-style-type: none">• Standard• Fastbytes*
Parallel Mode 2	Determine whether the parallel port data is sampled on the leading (On) or trailing (Off) edge of strobe.	<ul style="list-style-type: none">• Off• On*
MAC Binary PS	Configure the printer to process Macintosh binary PostScript print jobs.	<ul style="list-style-type: none">• Off—The printer filters PostScript print jobs using standard protocol.• On—The printer processes raw binary PostScript print jobs from computers using the Macintosh operating system. This setting often causes Windows print jobs to fail.• Auto*—The printer processes print jobs from computers using either Windows or Macintosh operating systems.

* Factory default

Setup menu

Use the Setup menu to configure how the printer formats the end of a line depending on the computer system being used.

Setting	Use this setting to:	Values
Auto CR after LF	Specify whether the printer automatically performs a carriage return after a line feed control command.	<ul style="list-style-type: none">• Off*• On
Auto LF after CR	Specify whether the printer automatically performs a line feed after a carriage return control command.	<ul style="list-style-type: none">• Off*• On

* Factory default

USB menu

Use the USB menu to change printer settings on jobs sent through a Universal Serial Bus (USB) port.

Setting	Use this setting to:	Values
NPA Mode	Send print jobs to the printer and query printer status information simultaneously.	<ul style="list-style-type: none"> • Off • On • Auto*
MAC Binary PS	Configure the printer to process Macintosh binary PostScript print jobs.	<ul style="list-style-type: none"> • Off—The printer filters PostScript print jobs using standard protocol. • On—The printer processes raw binary PostScript print jobs from computers using the Macintosh operating system. This setting often causes Windows print jobs to fail. • Auto*—The printer processes print jobs from computers using either Windows or Macintosh operating systems.
* Factory default		

Utilities menu

Use the Utilities menu to troubleshoot printer problems.

Setting	Use this setting to:	Values
Reset Factory Defaults	<p>Return your printer settings to the factory default values. Sometimes resetting the printer to the original settings solves formatting problems. All menu items are reset to the factory default values except:</p> <ul style="list-style-type: none"> • Display Language. • All settings in the Parallel menu, Network menu, LocalTalk menu, and USB menu. <p>All downloaded resources (fonts, macros, and symbol sets) in printer memory (RAM) are deleted. Resources in flash memory are unaffected.</p>	
Reset Photoconductor Counter	<p>Return the photoconductor counter to zero.</p> <p>The replace photoconductor message should be cleared <i>only</i> when the photoconductor kit has been replaced.</p>	
Hex Trace	<p>Help isolate printing problems when unexpected characters print or characters are missing. Hex Trace helps you determine if there is a problem with the language interpreter or the cable by telling you what information your printer is receiving. To exit Hex Trace, turn off the printer.</p>	<ul style="list-style-type: none"> • Off* • On
Print Quality Test Pages	<p>Help isolate print quality problems, such as streaking. When you select this setting, three pages print to help you evaluate print quality:</p> <ul style="list-style-type: none"> • A text page with printer information, cartridge information, current margin settings, and a graphic. • Two pages with graphics. 	
* Factory default		

7

Software and network tasks

Section	Page
How to install drivers for local printing	89
How to print the menu settings and network setup pages	94
How to print a test page	94
How to configure for TCP/IP	95
How to set up the printer for network printing	96
Using the printer resident Web page	102
Using the Local Printer Setup Utility	103

How to install drivers for local printing

A local printer is a printer attached to your computer using a USB or parallel cable. The printer driver is software that lets your computer communicate with your printer.

The procedure to install drivers depends on the operating system you are using. Use the following table to find driver installation instructions for your particular operating system. If you need additional help, refer to the documentation that shipped with your computer and your software.

Operating system	Go to page...
Windows	89
Macintosh	91
UNIX/Linux	93

Windows

Some Windows operating systems may already include a printer driver that is compatible with your printer. This may mean that installation will seem automatic in later versions of Windows. System printer drivers work well for simple printing, but they contain less functionality than our enhanced custom printer driver.

Installing a custom driver does not replace the system driver. A separate printer object is created and appears in the Printers folder.

Use the drivers CD that shipped with your printer to install the custom printer driver and obtain all the enhanced printer features and functionality.

Drivers are also available in downloadable software packages on our Lexmark Web site at www.lexmark.com.

Using Windows Server 2003, Windows 2000, Windows XP, and Windows 98/Me

- 1 Insert the drivers CD.

If the CD does not auto launch, click **Start** → **Run**, and then type `D:\setup.exe` in the Run dialog box.

- 2 Click **Install Software**.

Note: Some Windows operating systems require that you have administrative access to install printer drivers on your computer.

- 3 Click **Printer and Software**.
- 4 Click **Agree** to accept the license agreement.
- 5 Select **Suggested**, and then click **Next**.
- 6 Select **Local Attached**, and then click **Next**.

- 7 Follow the instructions on your screen to complete installing the drivers.

Using Windows 95, Windows NT

- 1 Insert the drivers CD.

Note: USB support is not available for Windows 95 or Windows NT operating systems.

If the CD does not auto launch, click **Start** → **Run**, and then type **D:\setup.exe** in the Run dialog box.

- 2 Click **Install Software**.
- 3 Click **Printer and Software**.

Note: You may need administrative access to install printer drivers on your computer.

- 4 Click **Agree** to accept the license agreement.
- 5 Select **Custom**, and then click **Next**.
- 6 Follow the instructions on your screen to complete installing the drivers.

Macintosh

Macintosh OS 8.6 or later is required for USB printing. To print locally to a USB-attached printer, you must create a desktop printer icon (Macintosh 8.6–9.x) or create a queue in Print Center (Macintosh OS X).

Creating a desktop printer icon (Macintosh 8.6–9.x)

1 Install a printer PostScript Printer Description (PPD) file on your computer.

a Insert the drivers CD.

b Double-click **Classic**, and then double-click the installer package for your printer.

Note: A PPD file provides detailed information about the capabilities of a printer to your Macintosh computer.

c Choose the language you want to use, and then click **OK**.

d Click **Accept** after you read the license agreement.

e Click **Continue** after you finish with the Readme file.

f Choose a default paper size.

g On the Easy Install screen, click **Install**. All the necessary files are installed on your computer.

h Click **Quit** when installation is complete.

Note: A PPD for your printer is also available in a downloadable software package on our Lexmark Web site at www.lexmark.com.

2 Do one of the following:

Macintosh 8.6–9.0: Open **Apple LaserWriter**.

Macintosh 9.1–9.x: Open **Applications**, and then click **Utilities**.

3 Double-click **Desktop Printer Utility**.

4 Select **Printer (USB)**, and then click **OK**.

5 In the USB Printer Selection section, click **Change**.

If your printer does not appear in the USB Printer Selection list, make sure the USB cable is properly connected and the printer is turned on.

6 Select the name of your printer, and then click **OK**. Your printer appears in the original Printer (USB) window.

7 In the PostScript Printer Description (PPD) File section, click **Auto Setup**. Make sure your printer PPD now matches your printer.

- 8 Click **Create**, and then click **Save**.
- 9 Specify a printer name, and then click **Save**. Your printer is now saved as a desktop printer.

Creating a queue in Print Center (Macintosh OS X)

- 1 Install a printer PostScript Printer Description (PPD) file on your computer.
 - a Insert the drivers CD.
 - b Double-click **Mac OS X**, and then double-click the installer package for your printer.

Note: A PPD file provides detailed information about the capabilities of a printer to your Macintosh computer.
 - c On the Authorization screen, choose **Click the lock to make changes**.
 - d Enter your password, and then click **OK**.
 - e Click **Continue** on the Welcome screen and again after you view the Readme file.
 - f Click **Agree** to accept the license agreement.
 - g Select a Destination, and then click **Continue**.
 - h On the Easy Install screen, click **Install**. All the necessary files are installed on your computer.
 - i Click **Close** when installation is complete.
- 2 Open Finder, click **Applications**, and then click **Utilities**.
- 3 Double-click **Print Center**.

Note: A PPD for your printer is also available in a downloadable software package on our Lexmark Web site at www.lexmark.com.

- 4 Do one of the following:

If your USB-attached printer appears in the Printer List, you can quit Print Center. A queue has been created for your printer.

If your USB-attached printer does not appear in the Printer List, make sure the USB cable is properly connected and the printer is turned on. After the printer appears in the Printer List, you can quit Print Center.

UNIX/Linux

Local printing is supported on many UNIX and Linux platforms, such as Sun Solaris and Red Hat.

The Sun Solaris and Linux packages are available on the drivers CD and on our Lexmark Web site at **www.lexmark.com**. The *User's Guide* in each package gives detailed instructions for installing and using Lexmark printers in UNIX and Linux environments.

All the printer driver packages support local printing using a parallel connection. The driver package for Sun Solaris supports USB connections to Sun Ray appliances and Sun workstations.

Visit our Lexmark Web site at **www.lexmark.com** for a complete list of supported UNIX and Linux platforms.

How to print the menu settings and network setup pages

To print the menu settings page and network setup page, press the **Continue**  button from the Ready state.

- On the menu settings page:
 - Verify that the options you installed are correctly listed under “Installed Features.”
If an option is not listed under Installed Features, turn off the printer, unplug the power cord, and reinstall the option.
 - Verify the amount of memory installed is correctly listed under “Printer Information.”
 - Verify that the paper trays are configured for the sizes and types of paper you loaded.
- On the network setup page, confirm that Status is “Connected.”
If Status is “Not Connected,” your LAN drop may not be active or your network cable may be malfunctioning. Consult your network support person for a solution, and then print another network setup page to verify that you are connected to your network.

How to print a test page

Windows

- 1** Click **Start** → **Settings** → **Printers**.
- 2** Select your printer.
- 3** Click **File** → **Properties**.
- 4** Click **Print Test Page**.

Macintosh

- 1** From the desktop, double-click your printer icon.
- 2** Double-click **<printer name> Utility**.
- 3** Click the **Print a Test Page** button.

How to configure for TCP/IP

If you have TCP/IP available on your network, we recommend that you assign an IP address to the printer.

Assigning a printer IP address

If your network is using DHCP, an IP address is automatically assigned after you connect the network cable to the printer.

- 1 Look for the address under the “TCP/IP” heading on the network setup page you printed in **“How to print the menu settings and network setup pages” on page 94**.
- 2 Go to **“Verifying the IP settings” on page 95** and begin with step 2.

If your network is not using DHCP, then you must manually assign an IP address to the printer.

An easy way to do this is to use the Print Server TCP/IP Setup Utility.

Detailed instructions about installing and using this utility are located on the drivers CD that shipped with your printer. Launch the CD, click **View Documentation** and then **Network Printer Install**. Look for information about using the Print Server TCP/IP Setup Utility.

To use this utility, you will need to know the printer’s 12-digit physical address or *Universally Administered Address (UAA)*. Look for the UAA entry on the network setup page you printed earlier. You can use either the MSB or canonical form of the UAA.

Verifying the IP settings

- 1 Print another network setup page. Look under the “TCP/IP” heading and make sure the IP address, netmask, and gateway are what you expected.

See **“How to print the menu settings and network setup pages” on page 94** if you need help.

Note: To display a command prompt on a Windows computer, click **Start → Programs → Command prompt** (or **Accessories → Command prompt** if using Windows 2000).

- 2 Ping the printer and verify that it responds. For example, at a command prompt on a network computer type `ping` followed by the new printer IP address (for example, `192.168.0.11`):

If the printer is active on the network, you will receive a confirmation.

How to set up the printer for network printing

After you have assigned and verified the TCP/IP settings (see “How to configure for TCP/IP” on page 95), you are ready to install the printer drivers on each network computer.

Windows

In Windows environments, network printers can be configured for direct printing or shared printing. Both network printing methods require the installation of a printer driver and the creation of a network printer port.

Supported printer drivers

- Windows system printer driver
- Lexmark custom printer driver

System drivers are built into Windows operating systems. Custom drivers are available on the drivers CD.

Updated system and custom drivers are available on our Lexmark Web site at www.lexmark.com.

Supported network printer ports

- Microsoft IP port—Windows NT 4.0, Windows 2000, Windows XP, and Windows Server 2003
- Lexmark network port—Windows 95/98/Me, Windows NT 4.0, Windows 2000, Windows XP, and Windows Server 2003

For basic printer functionality, you can install a system printer driver and use a system network printer port, such as an LPR or a Standard TCP/IP port. The system printer driver and port let you maintain a consistent user interface for use with all the printers on your network. However, using a custom printer driver and network port provides enhanced functionality, such as printer status alerts.

Follow the steps for your printing configuration and operating system to configure your network printer:

Printing configuration	Operating system	Go to page...
Direct Printer is connected directly to the network using a network cable, such as Ethernet. Printer drivers are typically installed on each network computer.	Windows 95/98/Me, Windows NT 4.0, Windows 2000, Windows XP, or Windows Server 2003	97
Shared Printer is connected to one of the computers on the network using a local cable, such as USB. Printer drivers are installed on the computer attached to the printer. During driver installation, the printer is set up to be “shared” so that other network computers can print to it.	Windows NT 4.0, Windows 2000, Windows XP, or Windows Server 2003	97

Direct printing using Windows 95/98, Me, Windows NT 4.0, Windows 2000, Windows XP, and Windows Server 2003

To install a custom printer driver and network port:

- 1 Launch the drivers CD.
- 2 Click **Install Printer and Software**.
- 3 Click **Printer**.
- 4 Click **Agree** to accept the license agreement.
- 5 Select **Quick install**, and then click **Next**.
- 6 Click **Create new port**.
- 7 Click **Add Port**.
- 8 Select **Lexmark TCP/IP Network Port**, and then click **Add**.
- 9 Enter the information to create the port.

- a Assign a logical port name.

This can be any name that you associate with the printer, such as **Color1-lab4**. After the port is created, this name appears in the list of available ports on the Method of Connection screen.

Note: If you don't know the IP address, print a network setup page and look under the TCP/IP heading. For help, see [“How to print the menu settings and network setup pages” on page 94](#).

- b Enter the IP address in the text box.
- c Click **Add Port**.
- 10 Click **Done** until you return to the Method of Connection screen.
- 11 Select the newly-created port from the list, and then select the model of the printer you want to install.
- 12 Click **Finish** to complete the installation.
- 13 Print a test page to verify printer installation (see [“How to print a test page” on page 94](#)).

Shared printing from a server using Windows NT 4.0, Windows 2000, Windows XP, and Windows Server 2003

After connecting your printer to a Windows NT 4.0, Windows 2000, Windows XP, or Windows Server 2003 computer (which will act as a server), follow these steps to configure your network printer for shared printing:

Step 1: Install a custom printer driver

- 1 Insert the drivers CD.

If the CD does not auto launch, click **Start** → **Run**, and then type **D:\setup.exe** in the Run dialog box.

- 2 Click **Install Software**.
- 3 Click **Printer and Software**.
- 4 Click **Agree** to accept the license agreement.
- 5 Select **Suggested**, and then click **Next**.
- 6 Select **Local Attached**, and then click **Next**.
- 7 Follow the instructions on your screen to complete installing the drivers.
- 8 Print a test page to verify printer installation (see **“How to print a test page”** on page 94).

Step 2: Share the printer on the network

- 1 Click **Start** → **Settings** → **Printers**.
- 2 Select the printer you just created.
- 3 Click **File** → **Sharing**.
- 4 Check the **Shared** check box, and then enter a name in the **Shared Name** text box.
- 5 In the Alternate Drivers section, select the operating systems of all the network clients that will print to the printer.
- 6 Click **OK**.

Note: If you are missing files, you may be prompted to provide the server operating system CD.

- 7 Check the following to make sure the printer was successfully shared.
 - The printer object in the Printers folder now has a shared indicator. For example, in Windows NT 4.0, a hand appears under the printer object.
 - Browse Network Neighborhood. Find the host name of the server and look for the shared name you assigned to the printer.

Step 3: Install the printer driver (or subset) on network clients

Using the point and print method

Note: This method is usually the best use of system resources. The server handles driver modifications and the print job processing. This lets network clients return to programs much faster.

With this method, a subset of driver information is copied from the server to the client computer. This is just enough information to send a print job to the printer.

- 1 On the Windows desktop of the client computer, double-click **Network Neighborhood**.
- 2 Locate the host name of the server computer, and then double-click the host name.
- 3 Right-click the shared printer name, and then click **Install**.
- 4 Wait a few minutes for the driver information to be copied from the server computer to the client computer, and for a new printer object to be added to the Printers folder. The time this takes varies based on network traffic and other factors.
- 5 Close Network Neighborhood.
- 6 Print a test page to verify printer installation (see **“How to print a test page” on page 94**).

Using the peer-to-peer method

With this method, the printer driver is fully installed on each client computer. Network clients retain control of driver modifications. The client computer handles the print job processing.

- 1 Click **Start** → **Settings** → **Printers**.
- 2 Click **Add Printer** to launch the Add Printer wizard.
- 3 Click **Network Print Server**.
- 4 Select the network printer from the Shared printers list. If the printer is not listed, enter the path of the printer in the text box.

The path will look similar to the following:

```
\\<server host name>\<shared printer name>
```

Note: If this is a new printer, you may be prompted to install a printer driver. If no system driver is available, then you need to provide a path to available drivers.

The server host name is the name of the server computer that identifies it to the network. The shared printer name is the name assigned during the server installation process.

- 5 Click **OK**.
- 6 Select whether you want this printer to be the default printer for the client, and then click **Finish**.
- 7 Print a test page to verify printer installation (see **“How to print a test page” on page 94**).

Macintosh

Note: A PostScript Printer Description (PPD) file provides detailed information about the capabilities of a printer to your UNIX or Macintosh computers.

To print to a network printer, each Macintosh user must install a custom PostScript Printer Description (PPD) file and either create a desktop printer on the computer (Mac OS 8.6 to 9.x) or create a print queue in Print Center (Mac OS X). Follow the instructions for your operating system.

Mac OS 8.6 to 9.x

Step 1: Install a custom PPD file

Note: Installing the custom PPD is required only if this is the first time the printer has been set up. If the printer was previously installed, go on to **Step 2: Create a desktop printer**.

- 1 Insert the drivers CD.
- 2 Double-click **Classic**.
- 3 Double-click the **Lexmark Installer** icon.
- 4 Select the language of your operating system, and then click **OK**.
- 5 Click **Install** to install the PPD file for your printer.

Step 2: Create a desktop printer

- 1 In the Chooser, select the **LaserWriter 8** driver.
- 2 If you have a routed network, select the default zone from the list. If you don't know which zone to select, look on the Network Setup page under AppleTalk for Zone.
- 3 Select the new printer from the list.
- 4 If you don't know which printer to select, look on the Network Setup page under the AppleTalk heading to find the default name of the printer.
- 5 Click **Create**.
- 6 Make sure there is an icon next to the printer name in the Chooser.
- 7 Close the Chooser window.
- 8 Verify printer installation.
 - a Click the desktop printer icon you just created.
 - b Choose **Printing** → **Change Setup**.

- If the PPD file displayed in the PostScript Printer Description (PPD) file portion of the menu is correct for your printer, then printer setup is complete.
- If the PPD file displayed in the PostScript Printer Description (PPD) file portion of the menu is not correct for your printer, repeat “**Step 1: Install a custom PPD file**” on **page 100**.

Mac OS X version 10.1.2 and later

Step 1: Install a custom PPD file

- 1 Insert the drivers CD.
- 2 Click **Mac OS X → <language>**.
For example, **Mac OS X → English**.
- 3 Double-click the installer icon for your printer to run the installer.

Step 2: Create a print queue in Print Center

- 1 Click **Applications → Utilities → Print Center**.
- 2 Click **Add Printer**.
- 3 Choose **AppleTalk** as your method of connection.
- 4 If you have a routed network, select the zone from the list. If you don't know which zone to select, look on the Network Setup page under AppleTalk for Zone.
- 5 Select the new printer from the list, and then click **Add**.

Note: If you don't know which printer to select, look on the Network Setup page under the AppleTalk heading to find the default name of the printer.

- 6 Verify printer installation:
 - a Click **Applications → TextEdit**.
 - b Choose **File → Print → Summary**. The Summary window shows the PPD installed for your printer.
 - If the PPD file displayed in the Summary window is correct for your printer, then printer setup is complete.
 - If the PPD file displayed in the Summary window is not correct for your printer, delete the print queue from Print Center and repeat **Step 1: Install a custom PPD file**.

UNIX/Linux

Your printer supports many UNIX and Linux platforms, such as Sun Solaris and Red Hat. Visit our Lexmark Web site at **www.lexmark.com** for a complete list of supported UNIX and Linux platforms.

Note: The Sun Solaris and Linux packages are available on the drivers CD and on our Lexmark Web site at **www.lexmark.com**.

Lexmark provides a printer driver package for each supported UNIX and Linux platform. The *User's Guide* in each package gives detailed instructions for installing and using Lexmark printers in UNIX and Linux environments.

You can download these packages from our Lexmark Web site. You may also find the driver package you need on the drivers CD.

NetWare

Your printer supports both Novell Distributed Print Services (NDPS) and regular queue-based NetWare environments. For the latest information about installing a network printer in a NetWare environment, launch the drivers CD and click **View Documentation**.

Using the printer resident Web page

If you have a network model, your printer has a resident Web page, which you can access from your browser. To access the resident Web page, type the printer's IP address in the URL address field of your browser (for example, <http://192.168.236.24>). If you do not know the IP address of your printer, you can find it on the network setup page (for help, see "How to print the menu settings and network setup pages" on page 94).

Some of the resident Web page features include a real-time status window of the printer and details of the printer's configuration, such as current memory and engine code levels. If you have administrative rights, you can also change printer settings.

Using the Local Printer Setup Utility

The Local Printer Setup Utility, located on the drivers CD, lets you change printer settings not available from your printer driver (for example, activating Alarm Control if you want the printer to sound an alarm when it needs attention).

Click **View Documentation** on the drivers CD for instructions on installing and using the Local Printer Setup Utility on your computer.

You can change the following settings using the Local Printer Setup Utility:

Finishing Settings	Paper Settings	Parallel Settings	PCL Emulation Settings
<ul style="list-style-type: none"> • Duplex • Duplex Bind • Copies • Blank Pages • Collation • Separator Sheets • Separator Source • Multipage Print • Multipage Order • Multipage View • Multipage Border 	<ul style="list-style-type: none"> • Paper Source • Paper Size* • Paper Type* • Custom Types† • Substitute Size • Configure MP • Paper Texture‡ • Paper Weight‡ • Paper Loading‡ 	<ul style="list-style-type: none"> • PCL SmartSwitch • PS SmartSwitch • Parallel Buffer • Advanced Status • Honor Init 	<ul style="list-style-type: none"> • Orientation • Lines Per Page • A4 Width • Tray Renumber* • Auto CR after LF • Auto LF after CR
PostScript Settings	Quality Settings	Setup Settings	USB Settings
<ul style="list-style-type: none"> • Print PS Error • Font Priority 	<ul style="list-style-type: none"> • Print Resolution • Toner Darkness • PQET • PictureGrade™ 	<ul style="list-style-type: none"> • Printer Language • Power Saver • Resource Save • Download Target • Print Timeout • Wait Timeout • Auto Continue • Jam Recovery • Page Protect • Print Area • Display Language • Alarm Control • Toner Alarm 	<ul style="list-style-type: none"> • PCL SmartSwitch • PS SmartSwitch • USB Buffer
<p>* Per supported sources † Per custom type number ‡ Per supported media</p>			



Supplies information

Section	Page
What supplies do I need and how do I order them?	105
How to conserve supplies	105
How to know when you need new supplies	106
How to change a toner cartridge	108
Lexmark Return Program	111
Recycling Lexmark products	111
How to change a photoconductor kit	112

What supplies do I need and how do I order them?

There are only two supply items that have to be replaced on a regular basis: the toner cartridge and the photoconductor kit, which together comprise the print cartridge assembly. The photoconductor kit typically lasts up to 30,000 pages (at approximately 5% coverage), whereas the toner cartridge has to be replaced more frequently. How often the toner cartridge needs replacing depends on which cartridge you purchase and the average amount of toner coverage you have on your print jobs.

Within the United States or Canada, you can order Lexmark supplies from any authorized Lexmark supplies dealer. To locate the dealer nearest you, call 1-800-539-6275. In other countries, visit the Lexmark online store at **www.lexmark.com** or contact the place where you bought your printer.

Storing supplies

Choose a cool, clean storage area for your printer supplies. Store supplies *right side up* in their original packaging until you are ready to use them.

Do not expose supplies to:

- Direct sunlight
- Temperatures above 35°C (95°F)
- High humidity (above 80%)
- Salty air
- Corrosive gases
- Heavy dust

How to conserve supplies

Conserving supplies lowers printing costs.

- When printing drafts, conserve toner by changing the Toner Darkness setting in your printer driver. The settings range from 1 (very light) to 10 (very dark), with 8 being the default. Setting the Toner Darkness to 1 conserves the most toner.
- Reduce paper consumption by printing on both sides of the paper.

How to know when you need new supplies

The following sections describe a couple ways to determine when new supplies are needed.

Checking the toner and photoconductor levels

You can determine approximately how much toner is left in your cartridge and how full the photoconductor kit is by printing out a menu settings page. This helps you decide when you might need to order replacement supplies. For help printing a menu settings page, see **“How to print the menu settings and network setup pages” on page 94**.











Also, the **Toner low** light sequence (see page 63) is displayed when the toner cartridge is nearly empty. You can still print for a short time while this sequence is displayed, but print quality begins to decrease as the toner level decreases.

To ensure print quality and to avoid damage to the printer, the printer stops operating after the photoconductor kit has reached a maximum of 40,000 pages. (See **“Replace photoconductor kit (printer hard stop)” on page 107** for the light sequence associated with this stop.) The printer automatically notifies you before the photoconductor reaches this point. To avoid having the printer stop operating, replace the photoconductor kit when you first receive the “Replace photoconductor kit” light sequence.

While the printer may continue to function properly after the photoconductor kit has reached its official end-of-life (approximately 30,000 pages), print quality begins to significantly decrease until the photoconductor stops operating at the maximum of 40,000 pages.

Recognizing the operator panel light sequences

The operator panel displays certain light sequences to let you know when the toner level is low or when it's time to replace the photoconductor kit.

Printer condition	Toner low	Photoconductor kit near full	Replace photoconductor kit	Replace photoconductor kit (printer hard stop)*
For more information, see page:	63	64	64	65
Continue 				
Ready 				
Toner Low/ Replace PC Kit 				
Load Paper 				
Paper Jam 				
Error 				

* If the operator panel lights display this sequence, the printer will not print any more jobs until the photoconductor kit is replaced.

Note: The operator panel may also display other light sequences in conjunction with the “Toner low” and “Replace photoconductor kit” lights.

How to change a toner cartridge

Warning: When replacing a toner cartridge, do not leave the new cartridge exposed to direct light for an extended period of time. Extended light exposure can cause print quality problems.

- 1 Open the front cover by pressing the button on the left side of the printer and lowering the cover.

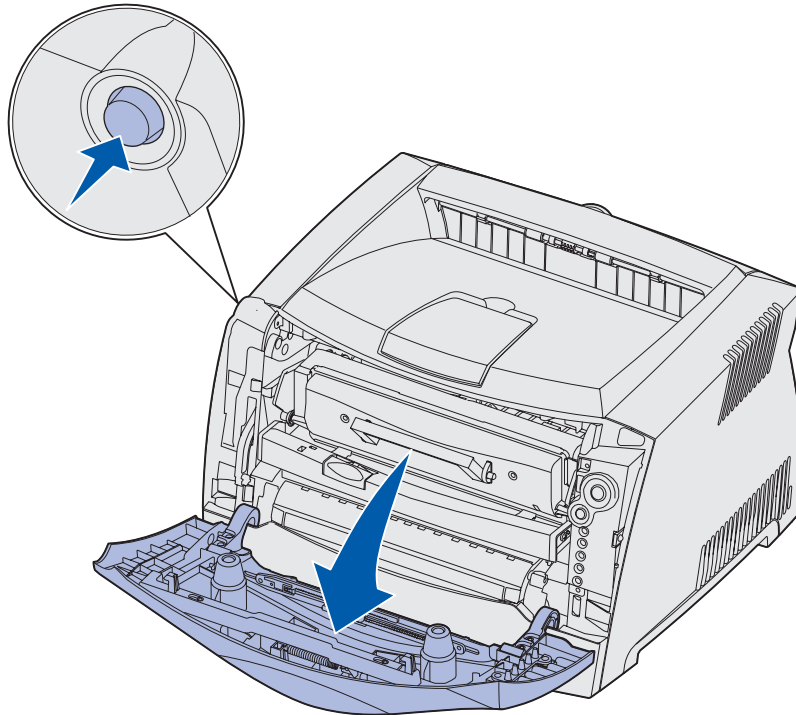

- 2 Remove the toner cartridge:
 - a Press the button on the base of the print cartridge assembly.
 - b Pull the toner cartridge up and out using the handle.

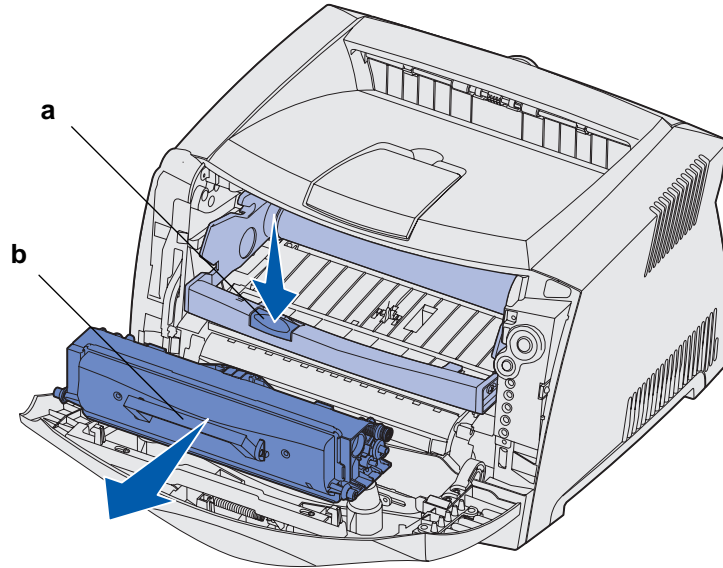

- 3 Unpack the new toner cartridge.

Note: You can use the packing material from the new cartridge to ship the old cartridge back to Lexmark for recycling. See **“Lexmark Return Program”** on page 111 for more information.

- 4 Rotate the cartridge in all directions to distribute the toner.

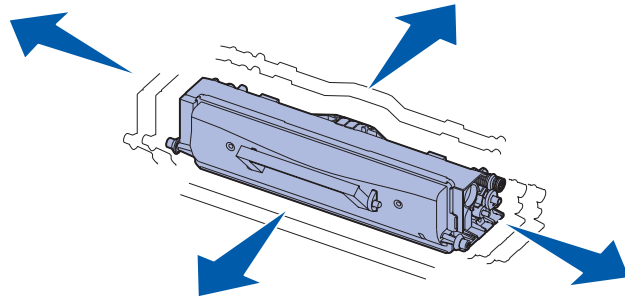

- 5** Install the new toner cartridge by aligning the white rollers on the toner cartridge with the white arrows on the tracks of the photoconductor kit and pushing the toner cartridge in as far as it will go. The cartridge *clicks* into place when correctly installed.

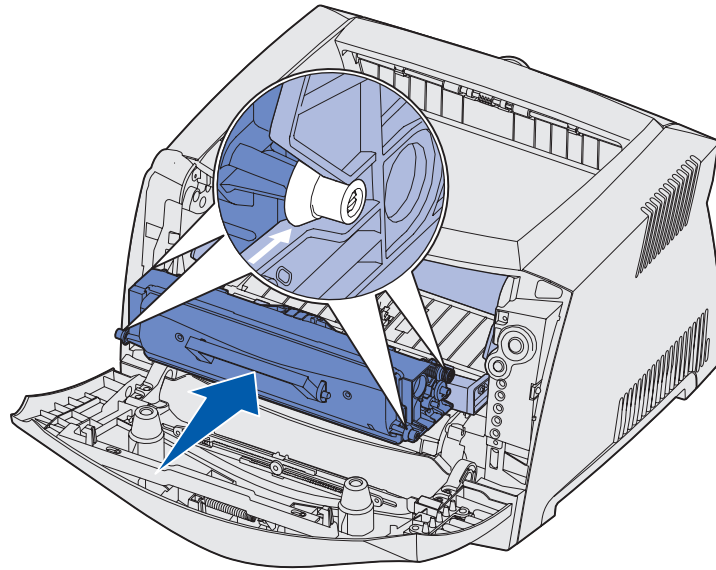

- 6** Close the front cover.

Lexmark Return Program

The Lexmark Return Program is an environmental program in which Lexmark sells new toner cartridges at a special price with the agreement that you will return them, at no cost, only to Lexmark for recycling.

Regular toner cartridges without this agreement are also available.

Note: Regular toner cartridges can also be returned, at no cost, to Lexmark using the Lexmark Cartridge Collection Program. To learn how to return a cartridge at no cost in your country, visit Lexmark's Web site at **www.lexmark.com/recycle**.

Refilled toner cartridge notice

Lexmark Return Program toner cartridges cannot be refilled. Lexmark does not recommend the use of third-party remanufactured cartridges. Lexmark cannot assure the excellent print quality and reliability of its toner cartridges after a toner cartridge has been refilled. A substantial reduction in photoconductor kit life is also likely if refilled toner cartridges are used.

Warning: Toner cartridge leaks due to refilling can cause failure in several areas of your printer. Printer failures caused by third-party remanufactured toner cartridges are not covered by your Lexmark printer warranty, extended warranty, or service agreement.

Recycling Lexmark products

To return your Lexmark products to Lexmark for recycling:

- 1 Visit our Web site:
www.lexmark.com/recycle
- 2 Follow the instructions on your screen.

How to change a photoconductor kit

Warning: When replacing a photoconductor kit, do not leave the toner cartridge or the new photoconductor kit exposed to direct light for an extended period of time. Extended light exposure can cause print quality problems.

- 1 Open the front cover by pressing the button on the left side of the printer and lowering the cover.

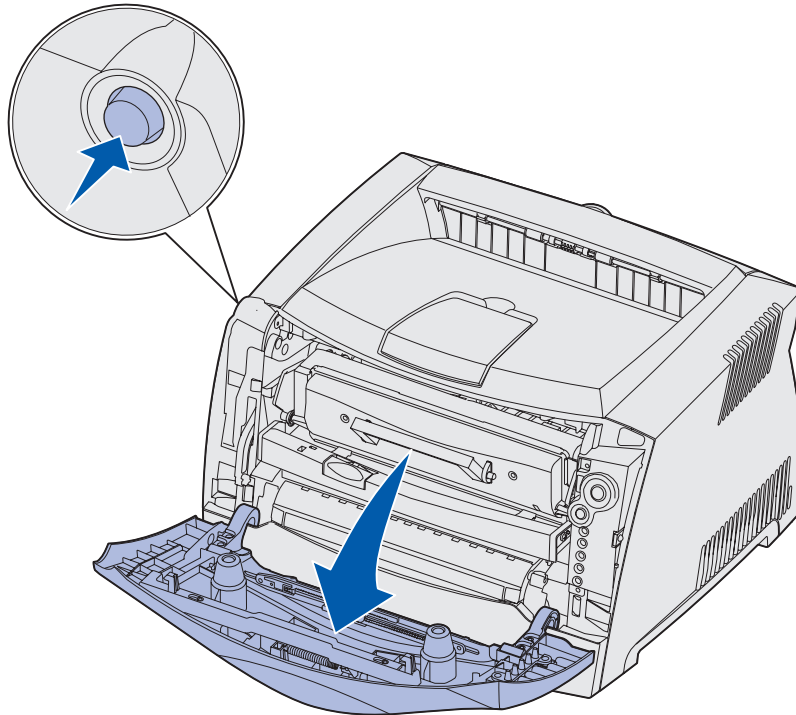

- 2 Pull the print cartridge assembly out of the printer by pulling on the toner cartridge handle.

Note: Do not press the button on the print cartridge assembly.

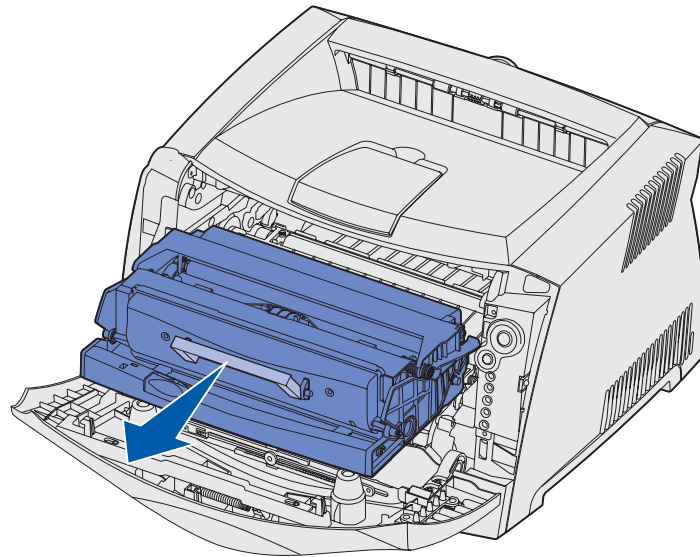

Place the print cartridge assembly on a flat, clean surface.

- 3 Remove the toner cartridge:
 - a Press the button on the base of the print cartridge assembly.
 - b Pull the toner cartridge up and out using the handle.

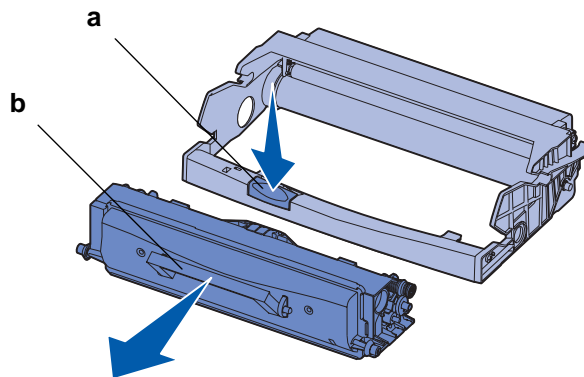

- 4 Unpack the new photoconductor kit.

- 5 Install the toner cartridge into the new print cartridge assembly by aligning the white rollers on the toner cartridge with the white arrows on the tracks of the photoconductor kit and pushing the toner cartridge in as far as it will go. The cartridge *clicks* into place when correctly installed.

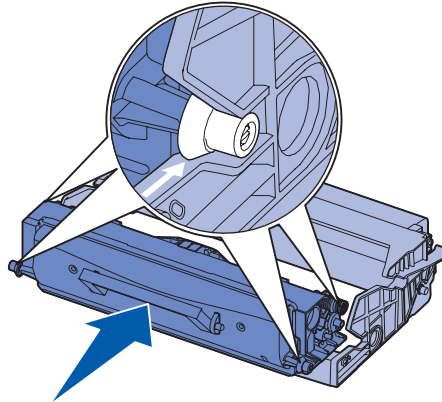

- 6 Install the print cartridge assembly into the printer by aligning the green arrows on the guides of the print cartridge assembly with the green arrows on the tracks in the printer and pushing the print cartridge assembly in as far as it will go.

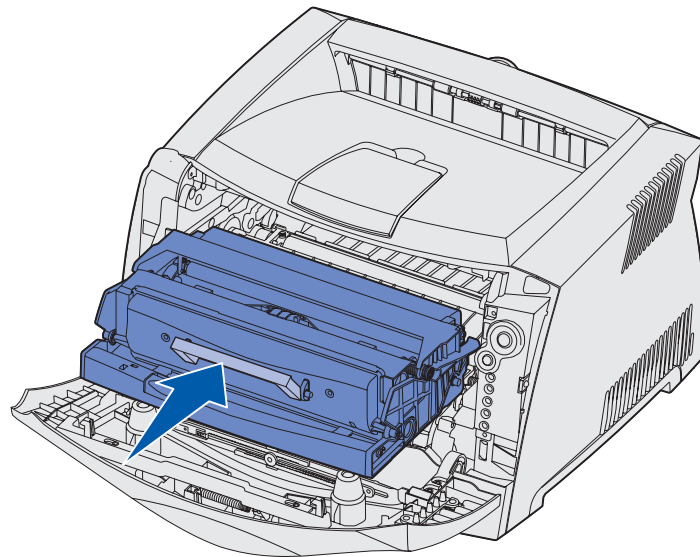

- 7 Close the front cover.

Note: For information about resetting the photoconductor kit's counter, refer to the instruction sheet that shipped with the new kit.



Troubleshooting

Section	Page
General problems	116
Print quality problems	118
• How to clean the printhead lens	122

General problems

Problem / Question	Solution / Answer
What do the blinking lights mean?	See “Understanding the operator panel lights” on page 52 for information about what each light pattern means.
Why am I missing characters when I print on envelopes?	<p>If you see voids (missing characters) when printing envelopes, check your printer driver settings to make sure you selected Envelope from the Paper Type menu.</p> <p>If Envelope is already selected, try changing the texture setting to a rougher setting. Sometimes toner does not adhere well to smooth-textured envelopes. From your printer driver, select Custom 6-Rough Env from the Paper Type menu.</p> <p>To change Custom 6 back to its default settings for Paper Type, Paper Texture, and Paper Weight, use the Local Printer Setup Utility on the drivers CD that shipped with your printer. If you already installed the printer drivers and utilities, skip to step 7.</p> <ol style="list-style-type: none"> 1 Insert the drivers CD into your computer. 2 Click Printer Software. 3 Click Agree. 4 Select Local Printer Install, and then click Next. 5 Select your printer and port, and make sure Local Printer Setup Utility is checked. 6 Click Finish. <p>The Utility will be installed on your computer under Program Files (unless you chose a different directory).</p> <ol style="list-style-type: none"> 7 Open the Local Printer Setup Utility. 8 From the Paper Menu, scroll through the menu items until you see the Custom menu setting. 9 Click Custom. 10 Scroll down to Custom 6 Paper Type. 11 Select envelope for the Custom 6 paper type, heavy for the Custom 6 paper weight, and rough for the Custom 6 paper texture. 12 From the toolbar, click Actions. 13 Click Apply to save the changes you made. 14 Click File → Exit to close the Local Printer Setup Utility.
How do I clear a paper jam?	See “How to clear paper jams” on page 26 for information about clearing jams.
The toner low light sequence is on, but I don't have another cartridge to put in yet. Can I still print with the low cartridge?	<p>Yes, you can still print. To extend the life of you toner cartridge somewhat, remove the cartridge, rotate it in all directions to distribute the toner, then insert it back into the printer.</p> <p>When the toner low light sequence is first displayed, you should still be able to print approximately 1200 pages, based on approximately 5% coverage of pages.</p>
The printer seems to print slower when using the manual feeder.	This is normal. The printer sometimes prints at a slightly slower speed when feeding print media from the manual feeder.

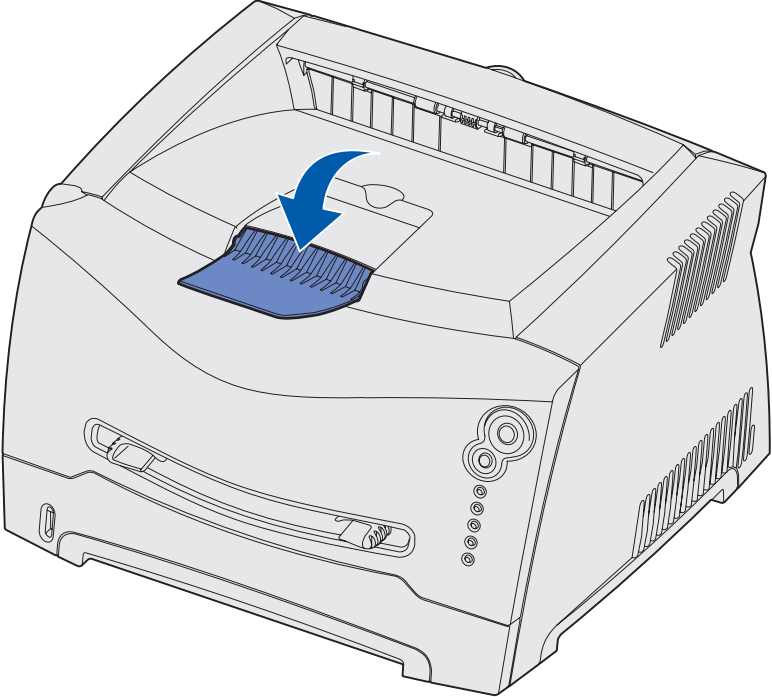
Problem / Question	Solution / Answer
<p>I want to manually duplex card stock, but I'm having trouble getting it to feed.</p>	<p>The problem is that when the printer tries to manually duplex a print job, it always prints side 2 from Tray 1. However, Tray 1 does not support card stock.</p> <p>To achieve the desired effect, you have to send both pages of the print job as separate jobs. After the first page has printed, reload the card stock in the manual feeder. Load the card stock in the feeder with the already-printed side down, with the top of the sheet first.</p>
<p>Paper stacks poorly in the output bin.</p>	<p>Extend the paper support on the output bin.</p> 
<p>Dust is gathering on the paper tray when it is extended.</p>	<p>Attach the dust cover to the back of the printer. This protects the paper tray from the environment as well as keep the tray from being knocked out of position while it is extended.</p>
<p>The paper tray is getting bumped and pushed out the front of the printer when it is extended.</p>	<p>See Attaching the dust cover for information about attaching the dust cover.</p>

Print quality problems

You can solve many print quality problems by replacing a supply or maintenance item that has reached the end of its intended life. Use the following table to find solutions to print quality problems.

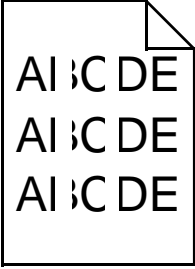
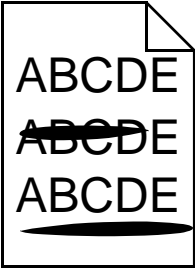
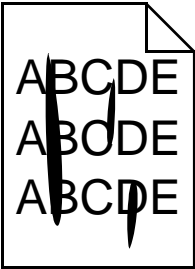
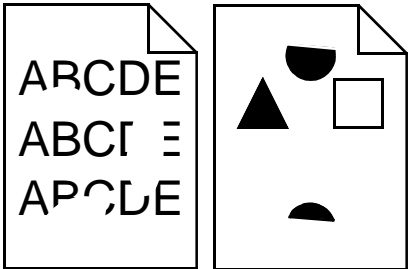
Symptom	Cause	Solution
White lines 	<ul style="list-style-type: none"> The printhead lens is dirty. Either the toner cartridge or the fuser is defective. 	Try the following in this order: <ol style="list-style-type: none"> 1 Clean the printhead lens. (See “How to clean the printhead lens” on page 122.) 2 Replace the toner cartridge. 3 Replace the fuser*.
Streaked horizontal lines 	The toner cartridge or fuser may be defective, empty, or worn.	Replace the toner cartridge or fuser* as needed.
Streaked vertical lines 	<ul style="list-style-type: none"> Toner is smeared before fusing to the paper. The toner cartridge is defective. 	<ul style="list-style-type: none"> If paper is stiff, try feeding from another tray or the manual feeder. Replace the toner cartridge.
Print irregularities 	<ul style="list-style-type: none"> Paper has absorbed moisture due to high humidity. You are using paper that does not meet the printer specifications. The fuser is worn or defective. 	<ul style="list-style-type: none"> Load paper from a fresh package in the paper tray. Avoid textured paper with rough finishes. Make sure the printer driver paper type setting matches the type of paper you are using. Replace the fuser*.

* To replace the fuser, call a service technician.

† This setting can be changed using the Local Printer Setup Utility. See for more information.

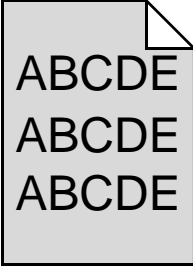
Symptom	Cause	Solution
Print too light	<ul style="list-style-type: none"> The Toner Darkness setting is too light. You are using paper that does not meet the printer specifications. The toner cartridge is low on toner. The toner cartridge is defective. 	<ul style="list-style-type: none"> Select a different Toner Darkness[†] setting from the printer driver before sending the job to print. Load paper from a new package. Avoid textured paper with rough finishes. Make sure the paper you load in the trays is not damp. Replace the toner cartridge.
Print too dark	<ul style="list-style-type: none"> The Toner Darkness setting is too dark. The toner cartridge is defective. 	<ul style="list-style-type: none"> Select a different Toner Darkness[†] setting from the printer driver before sending the job to print. Replace the toner cartridge.
Transparency print quality is poor (Print has inappropriate light or dark spots, toner is smeared, or horizontal or vertical light bands appear.)	<ul style="list-style-type: none"> You are using transparencies that do not meet the printer specifications. The Form Type setting in the printer driver is set to something other than transparency. 	<ul style="list-style-type: none"> Use only transparencies recommended by the printer's manufacturer. Make sure the Form Type setting is set to transparency.
Toner specks	<ul style="list-style-type: none"> The toner cartridge is defective. The fuser is worn or defective. Toner is in the paper path. 	<ul style="list-style-type: none"> Replace the toner cartridge. Replace the fuser*. Call for service.
Toner rubs off the paper easily when you handle the sheets	<ul style="list-style-type: none"> The Paper Texture setting is wrong for the type of paper or specialty media you are using. The Paper Weight setting is wrong for the type of paper or specialty media you are using. The fuser is worn or defective. 	<ul style="list-style-type: none"> Change Paper Texture[†] from Normal to Smooth or Rough. Change Paper Weight[†] from Plain to CardStock (or other appropriate weight). Replace the fuser*.
Gray background 	<ul style="list-style-type: none"> The Toner Darkness setting is too dark. The toner cartridge is defective. 	<ul style="list-style-type: none"> Select a different Toner Darkness[†] setting from the printer driver before sending the job to print. Replace the toner cartridge.

* To replace the fuser, call a service technician.

† This setting can be changed using the Local Printer Setup Utility. See for more information.

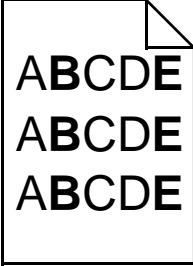
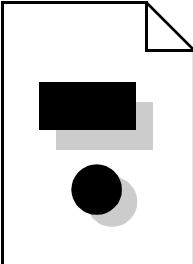
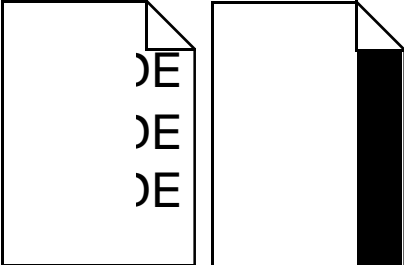
Symptom	Cause	Solution
Uneven print density 	<ul style="list-style-type: none"> The toner cartridge is defective. 	<ul style="list-style-type: none"> Replace the toner cartridge.
Ghost Images 	<ul style="list-style-type: none"> The Form Type setting in the printer driver is set incorrectly. Toner level is low in the toner cartridge. 	<ul style="list-style-type: none"> Make sure the Form Type setting is correct for the paper or specialty media you are using. Replace the toner cartridge.
Uneven printing  (Print only appears on one side of the page.)	<ul style="list-style-type: none"> The toner cartridge is not properly installed. 	<ul style="list-style-type: none"> Remove and then reinsert the toner cartridge.
Incorrect margins	The Form Size setting in the printer driver is different than the size paper that is loaded in the tray. For example, you inserted A4 size paper into the selected tray but did not set the Form Size to A4.	Set the Form Size to A4.
Skewed print (Print is inappropriately slanted.)	<ul style="list-style-type: none"> The guides in the selected tray are not in the correct position for the paper size loaded in the tray. The manual feeder's guides are not in the correct position for the paper size loaded in the feeder. 	<ul style="list-style-type: none"> Move the guides in the tray so that they are snug against the sides of the paper. Move the manual feeder's guides so that they are snug against the sides of the paper.
* To replace the fuser, call a service technician. † This setting can be changed using the Local Printer Setup Utility. See for more information.		

Symptom	Cause	Solution
Blank pages	The toner cartridge is defective or empty.	Replace the toner cartridge.
Solid black pages	<ul style="list-style-type: none"> • The toner cartridge is defective. • Your printer requires servicing. 	<ul style="list-style-type: none"> • Replace the toner cartridge. • Call for service.
Paper curls badly once it prints and exits to the bin	The Paper Texture setting is wrong for the type of paper or specialty media you are using.	Change Paper Texture [†] from Rough to Normal or Smooth.

* To replace the fuser, call a service technician.

† This setting can be changed using the Local Printer Setup Utility. See for more information.

How to clean the printhead lens

You can solve some print quality problems by cleaning the printhead lens.

- 1** Turn the printer off.
- 2** Open the front cover by pressing the button on the left side of the printer and lowering the cover.

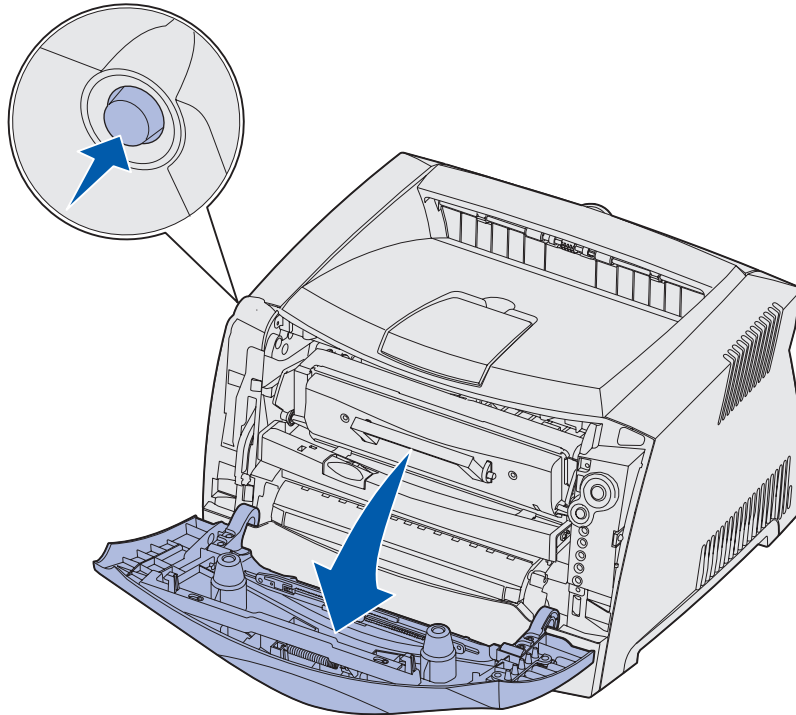

- 3 Remove the print cartridge assembly out of the printer by pulling on the toner cartridge handle.

Note: Do not press the button on the print cartridge assembly.

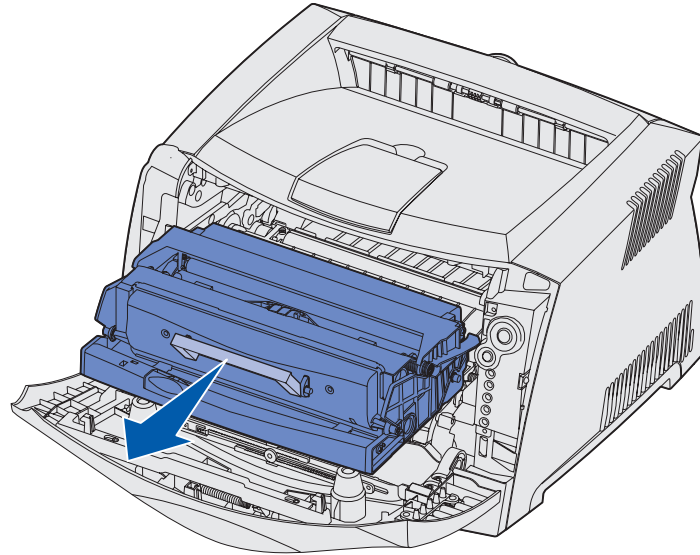

Place the print cartridge assembly on a flat, clean surface.

Warning: Do not leave the print cartridge assembly exposed to direct light for an extended period of time. Extended light exposure can cause print quality problems.

- 4 Locate the glass printhead lens, which is located within the recessed area in the top of the printer.

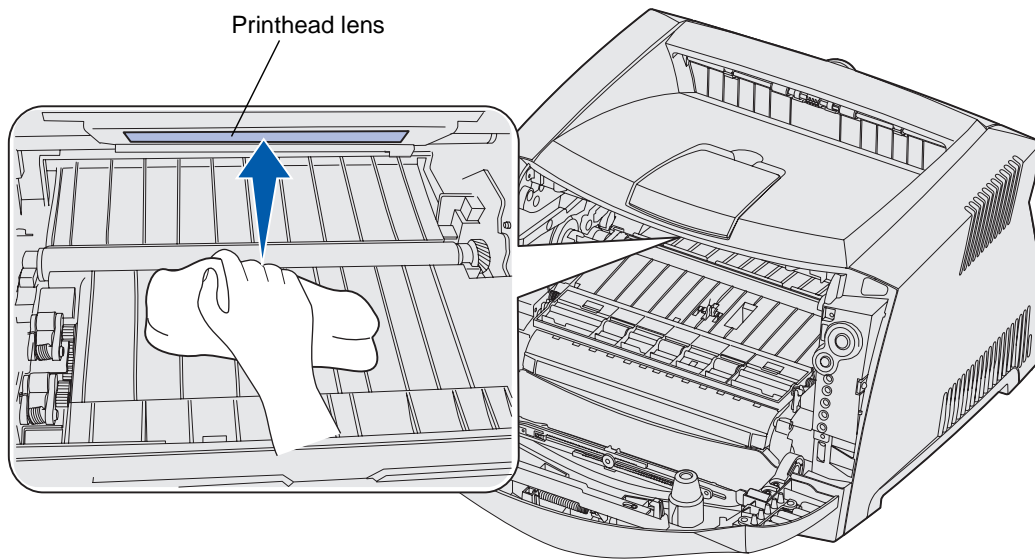

- 5 Gently wipe the printhead lens with a clean, dry, lint-free cloth.

Warning: Not using a clean, dry, lint-free cloth may result in damage to the printhead lens.

- 6 Install the print cartridge assembly into the printer by aligning the green arrows on the guides of the print cartridge assembly with the green arrows on the tracks in the printer and pushing the print cartridge assembly in as far as it will go.

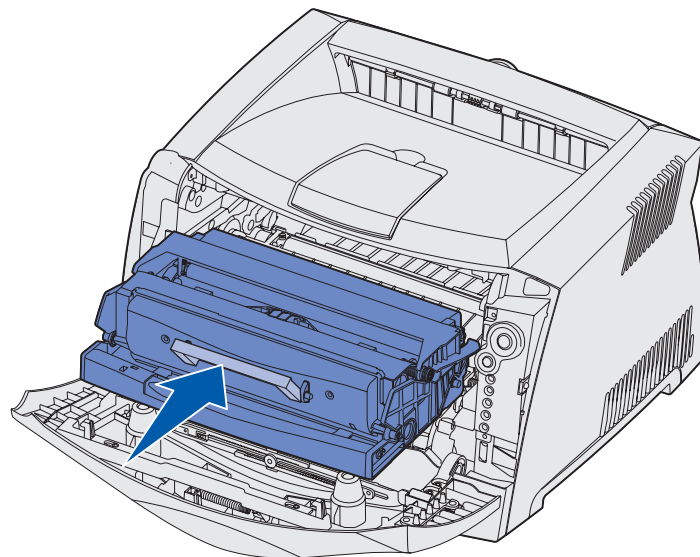

- 7 Close the front cover.
- 8 Turn the printer on.

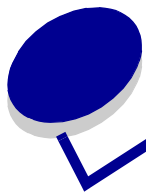

Index

Numerics

550-sheet drawer 48

A

Auto CR after LF (Setup menu) 86

Auto LF after CR (Setup menu) 86

B

booklets 35

Busy light 58

buttons 51

C

canceling a print job 39

card stock 18

cleaning the printhead lens 122

clearing paper jams 26

configuration menus

Network

MAC Binary PS 85

NPA Mode 85

Set Card Speed 85

Parallel

MAC Binary PS 86

Mode 2 86

NPA Mode 86

Protocol 86

printing the Printer Settings

Configuration sheet 83

Setup

Auto CR after LF 86

Auto LF after CR 86

USB

MAC Binary PS 87

NPA Mode 87

Utilities

Hex Trace 87

Print Quality Test

Pages 87

Reset Factory

Defaults 87

Reset Photoconductor

Counter 87

D

duplex 32, 62

dust cover 23

E

electronic emission statement 7

emission statement 7

envelopes 17

Error light 60, 61, 63, 65, 66, 67, 68, 70, 71, 72, 81, 82

secondary error codes 69

See *also* operator panel, secondary error codes

extending trays 23

F

FCC statement 7

flash card 46

folio 23

H

Hex Trace (Utilities menu) 87

I

interfaces

network 85

parallel 86

USB 87

IP address

setting 95

verifying 95

J

jams 26

L

labels 17

legal 23

letterhead 16, 37

Lexmark Cartridge Collection Program 111

Lexmark Return Program 111

lights 51, 52

Linux 93, 102

Load Paper light

manual feeder 62

Tray 1 or 550-sheet tray 61

loading

250-sheet tray (Tray 1) 20

550-sheet tray 20

letterhead 37

manual feeder 24

Local Printer Setup Utility 103

M

MAC Binary PS

Network menu 85

Parallel menu 86

USB menu 87

Macintosh 91, 100

maintaining the printer

cleaning the printhead

lens 122

manual duplex

- light sequence 62
- printing 32
- manual feeder 24, 62
- memory card 45
- menu settings page 94
- menus
 - navigating
 - advancing in 84
 - entering 83
 - exiting 84
 - returning to Home menu 84
 - scrolling through 84
 - Network 85
 - Parallel 86
 - saving settings 84
 - Setup 86
 - USB 87
 - Utilities 87
- messages
 - See operator panel light sequences
- Mode 2 (Parallel menu) 86
- multiple page printing 34

N

- NetWare 102
- Network menu 85
- network setup page 94
- NPA Mode
 - Network menu 85
 - Parallel menu 86
 - USB menu 87
- N-up printing 34

O

- operator panel
 - buttons 51
 - light sequences
 - Busy 58
 - Canceling job 67
 - Change invalid toner cartridge 66
 - Close door 61
 - Defragment flash 58
 - Error 61, 63, 65, 66, 67, 68, 69, 70, 71, 72, 81, 82
 - Flushing data 60

- Formatting flash 58
- Hex Trace Ready 59
- Invalid engine code 63
- Invalid network code 63
- Load manual feeder 62
- Load media 61
- Manual duplex 62
- Not ready 60
- Offline 60
- Photoconductor kit near full 64
- Print side two 62
- Printer error 68
- Printing a directory 58
- Printing a font list 58
- Printing menu settings pages 58
- Printing Print Quality Test Pages 58
- Programming engine code 66
- Programming flash 58
- Programming system code 66
- Ready/Power Saver 57
- Replace photoconductor kit 64, 65
- Resetting printer 67
- Restoring factory defaults 67
- secondary error codes 69
- Service error 67
- Toner low 63
- Unsupported toner cartridge 65
- Waiting 59
- lights 51, 52
- options
 - 550-sheet drawer 48
 - flash card 46
 - memory card 45
- overlays 37

P

- paper 16
 - choosing 16
 - jams 26
 - loading 20, 24

- storing 18
- Parallel menu 86
- photoconductor kit
 - changing 112
 - level 106
 - light sequences 107
 - ordering 105
 - recycling 111
- Photoconductor kit near full light 64
- ports
 - parallel 86
 - USB 87
- posters 36
- print cartridge
 - See toner cartridge
- print quality problems 118
- Print Quality Test Pages (Utilities menu) 87
- Printer Settings Configuration sheet
 - printing 83
- printhead lens, cleaning 122
- printing
 - booklets 35
 - duplex 32
 - letterhead 37
 - multi-page (N-up) 34
 - overlays 37
 - posters 36
 - watermarks 37
- problems
 - print quality 118
- Protocol (Parallel menu) 86

R

- rear exit 25
- recycling supplies 111
- Replace photoconductor kit light 64, 65
- Reset Factory Defaults (Utilities menu) 87
- Reset Photoconductor Counter (Utilities menu) 87

S

- safety information 7
- secondary error codes 69

- Complex page 73
- Defective flash 75
- Error communicating with the host computer 77
- Flash full 80
- Font error 75
- Host interface disabled 77
- Insufficient collation area 74
- Insufficient defrag memory 76
- Insufficient printer memory 73
- Invalid engine code 81
- Invalid network code 82
- Memory full 78
- Network interface errors 76
- Paper jam at the input sensor 70
- Paper jam in the manual feeder 70
- Paper jam in Tray 1 72
- Paper jam in Tray 2 72
- Paper jams as a printed job exits the tray 71
- Paper jams as it exits the tray into the printer 71
- PPDS font error 75
- Short paper 79
- Unformatted flash 81
- service error lights 67
- Set Card Speed (Network menu) 85
- Setup menu 86
- storing
 - paper 18
 - supplies 18, 105
- supplies
 - conserving 105
 - ordering 105
 - recycling 111
 - storing 18, 105
- system board
 - accessing 41
 - reattaching 44
- toner cartridge
 - changing 108
 - error 65
 - light sequences 107
 - ordering 105
 - recycling 111
 - toner level 106
- Toner Low light 63
- transparencies 16
- tray extending 23
- troubleshooting 115
 - print quality 118

U

- UNIX 93, 102
- USB menu 87
- Utilities menu 87

W

- Waiting light 59
- watermarks 37
- Windows 89, 96

T

- TCP/IP 95
- test page 94