



Lexmark™

MS310 Series

User's Guide

June 2017

www.lexmark.com

Machine type(s):

4514

Model(s):

220, 230

Contents

- Safety information..... 5**
 - Conventions..... 5

- Learning about the printer..... 7**
 - Finding information about the printer..... 7
 - Selecting a location for the printer..... 8
 - Printer configurations..... 9
 - Using the printer control panel..... 11
 - Understanding the control panel light sequences..... 12
 - Using the Embedded Web Server..... 15
 - Using the Local Printer Settings Utility..... 15

- Additional printer setup..... 16**
 - Installing hardware options..... 16
 - Setting up the printer software..... 18
 - Networking..... 20
 - Printing a menu settings and network setup page..... 23

- Loading paper and specialty media..... 24**
 - Setting the paper size and type..... 24
 - Configuring Universal paper settings..... 24
 - Using the standard bin and paper stop..... 25
 - Loading trays..... 25
 - Loading the multipurpose feeder..... 30
 - Linking and unlinking trays..... 33

- Paper and specialty media guide..... 36**
 - Paper guidelines..... 36
 - Using specialty media..... 39
 - Storing paper..... 41
 - Supported paper sizes, types, and weights..... 42

- Printing..... 45**
 - Printing documents..... 45
 - Printing from a mobile device..... 46

Canceling a print job.....47

Understanding the printer menus.....48

Menus list.....48

Paper menu.....48

Network/Ports menu.....57

Settings menu.....58

Security menu.....72

Saving money and the environment.....73

Saving paper and toner.....73

Saving energy.....73

Recycling.....76

Securing the printer.....77

Using the security lock feature.....77

Statement of Volatility.....77

Erasing volatile memory.....78

Erasing non-volatile memory.....78

Finding printer security information.....79

Maintaining the printer.....80

Cleaning the printer.....80

Checking the status of parts and supplies.....80

Estimated number of remaining pages.....81

Ordering supplies.....81

Storing supplies.....83

Replacing supplies.....84

Moving the printer.....87

Managing the printer.....89

Finding advanced networking and administrator information.....89

Viewing reports.....89

Configuring supply notifications from the Embedded Web Server.....89

Copying printer settings to other printers.....90

Clearing jams.....91

Avoiding jams.....91

Identifying jam locations.....92

Paper jam in the front door..... 93

Paper jam in the rear door..... 96

Paper jam in the standard bin..... 98

Paper jam in the duplex unit.....99

Paper jam in trays..... 101

Paper jam in the multipurpose feeder.....104

Troubleshooting..... 106

Understanding the printer messages.....106

Solving printer problems.....146

Solving print problems.....151

Embedded Web Server does not open..... 180

Contacting customer support..... 182

Notices..... 183

Product information..... 183

Edition notice..... 183

Power consumption.....187

Index..... 193

Safety information

Conventions

Note: A *note* identifies information that could help you.

Warning: A *warning* identifies something that could damage the product hardware or software.

CAUTION: A *caution* indicates a potentially hazardous situation that could injure you.

Different types of caution statements include:

 **CAUTION—POTENTIAL INJURY:** Indicates a risk of injury.

 **CAUTION—SHOCK HAZARD:** Indicates a risk of electrical shock.

 **CAUTION—HOT SURFACE:** Indicates a risk of burn if touched.

 **CAUTION—TIPPING HAZARD:** Indicates a crush hazard.

 **CAUTION—PINCH HAZARD:** Indicates a risk of being caught between moving parts.

 **CAUTION—POTENTIAL INJURY:** To avoid the risk of fire or electrical shock, connect the power cord to an appropriately rated and properly grounded electrical outlet that is near the product and easily accessible.

 **CAUTION—POTENTIAL INJURY:** Do not use this product with extension cords, multioutlet power strips, multioutlet extenders, or UPS devices. The power capacity of these types of accessories can be easily overloaded by a laser printer and may result in a risk of fire, property damage, or poor printer performance.

 **CAUTION—SHOCK HAZARD:** To avoid the risk of electrical shock, do not place or use this product near water or wet locations.

 **CAUTION—POTENTIAL INJURY:** This product uses a laser. Use of controls or adjustments or performance of procedures other than those specified in the *User's Guide* may result in hazardous radiation exposure.

This product uses a printing process that heats the print media, and the heat may cause the media to release emissions. You must understand the section in your operating instructions that discusses the guidelines for selecting print media to avoid the possibility of harmful emissions.

 **CAUTION—HOT SURFACE:** The inside of the printer might be hot. To reduce the risk of injury from a hot component, allow the surface to cool before touching it.

 **CAUTION—POTENTIAL INJURY:** The lithium battery in this product is not intended to be replaced. There is a danger of explosion if a lithium battery is incorrectly replaced. Do not recharge, disassemble, or incinerate a lithium battery. Discard used lithium batteries according to the manufacturer's instructions and local regulations.

This equipment is not suitable for use in locations where children are likely to be present.

 **CAUTION—POTENTIAL INJURY:** Before moving the printer, follow these guidelines to avoid personal injury or printer damage:

- Turn the printer off using the power switch, and then unplug the power cord from the electrical outlet.

- Disconnect all cords and cables from the printer before moving it.
- If an optional tray is installed, then remove it from the printer. To remove the optional tray, slide the latch on the right side of the tray toward the front of the tray until it *clicks* into place.
- Use the handholds located on both sides of the printer to lift it.
- Make sure your fingers are not under the printer when you set it down.
- Before setting up the printer, make sure there is adequate clearance around it.

Use only the power cord provided with this product or the manufacturer's authorized replacement.

 **CAUTION—SHOCK HAZARD:** If you are accessing the controller board or installing optional hardware or memory devices sometime after setting up the printer, then turn the printer off, and unplug the power cord from the electrical outlet before continuing. If you have any other devices attached to the printer, then turn them off as well, and unplug any cables going into the printer.

 **CAUTION—SHOCK HAZARD:** To avoid the risk of electrical shock, make sure that all external connections (such as Ethernet and telephone system connections) are properly installed in their marked plug-in ports.

This product is designed, tested, and approved to meet strict global safety standards with the use of specific manufacturer's components. The safety features of some parts may not always be obvious. The manufacturer is not responsible for the use of other replacement parts.

 **CAUTION—POTENTIAL INJURY:** Do not cut, twist, bind, crush, or place heavy objects on the power cord. Do not subject the power cord to abrasion or stress. Do not pinch the power cord between objects such as furniture and walls. If any of these things happen, a risk of fire or electrical shock results. Inspect the power cord regularly for signs of such problems. Remove the power cord from the electrical outlet before inspecting it.

Refer service or repairs, other than those described in the user documentation, to a service representative.

 **CAUTION—SHOCK HAZARD:** To avoid the risk of electrical shock when cleaning the exterior of the printer, unplug the power cord from the electrical outlet and disconnect all cables from the printer before proceeding.

 **CAUTION—POTENTIAL INJURY:** To reduce the risk of equipment instability, load each tray separately. Keep all other trays closed until needed.

 **CAUTION—SHOCK HAZARD:** Do not set up this product or make any electrical or cabling connections, such as the fax feature, power cord, or telephone, during a lightning storm.

SAVE THESE INSTRUCTIONS.

Learning about the printer

Finding information about the printer

What are you looking for?	Find it here
Initial setup instructions: <ul style="list-style-type: none"> • Connecting the printer • Installing the printer software 	Setup documentation—The setup documentation came with the printer and is also available at http://support.lexmark.com .
Additional setup and instructions for using the printer: <ul style="list-style-type: none"> • Selecting and storing paper and specialty media • Loading paper • Configuring printer settings • Viewing and printing documents and photos • Setting up and using the printer software • Configuring the printer on a network • Caring for and maintaining the printer • Troubleshooting and solving problems 	<i>User's Guide</i> and <i>Quick Reference Guide</i> —The guides are available at http://support.lexmark.com . Note: These guides are also available in other languages.
Information on setting up and configuring the accessibility features of your printer	<i>Lexmark Accessibility Guide</i> —This guide is available at http://support.lexmark.com .
Help using the printer software	Windows or Mac Help—Open a printer software program or application, and then click Help . Click  to view context-sensitive information. Notes: <ul style="list-style-type: none"> • Help is automatically installed with the printer software. • The printer software is located in the printer program folder or on the desktop, depending on your operating system.

What are you looking for?	Find it here
<p>The latest supplemental information, updates, and customer support:</p> <ul style="list-style-type: none"> • Documentation • Driver downloads • Live chat support • E-mail support • Voice support 	<p>Lexmark support Web site— http://support.lexmark.com</p> <p>Note: Select your country or region, and then select your product to view the appropriate support site.</p> <p>Support telephone numbers and hours of operation for your country or region can be found on the support Web site or on the printed warranty that came with your printer.</p> <p>Record the following information (located on the store receipt and at the back of the printer), and have it ready when you contact customer support so that they may serve you faster:</p> <ul style="list-style-type: none"> • Machine Type number • Serial number • Date purchased • Store where purchased
<p>Warranty information</p>	<p>Warranty information varies by country or region:</p> <ul style="list-style-type: none"> • In the U.S.—See the Statement of Limited Warranty included with this printer, or go to http://support.lexmark.com. • In other countries and regions—See the printed warranty that came with this printer.

Selecting a location for the printer

When selecting a location for the printer, leave enough room to open trays, covers, and doors. If you plan to install any hardware options, then leave enough room for them also. It is important to:

- Set up the printer near a properly grounded and easily accessible electrical outlet.
- Make sure airflow in the room meets the latest revision of the ASHRAE 62 standard or the CEN Technical Committee 156 standard.
- Provide a flat, sturdy, and stable surface.
- Keep the printer:
 - Clean, dry, and free of dust.
 - Away from stray staples and paper clips.
 - Away from the direct airflow of air conditioners, heaters, or ventilators.
 - Free from direct sunlight and humidity extremes.
- Observe the recommended temperatures and avoid fluctuations.

Ambient temperature	16°C to 32°C (60°F to 90°F)
Storage temperature	-20 to 40°C (-4 to 104°F)

- Allow the following recommended amount of space around the printer for proper ventilation:

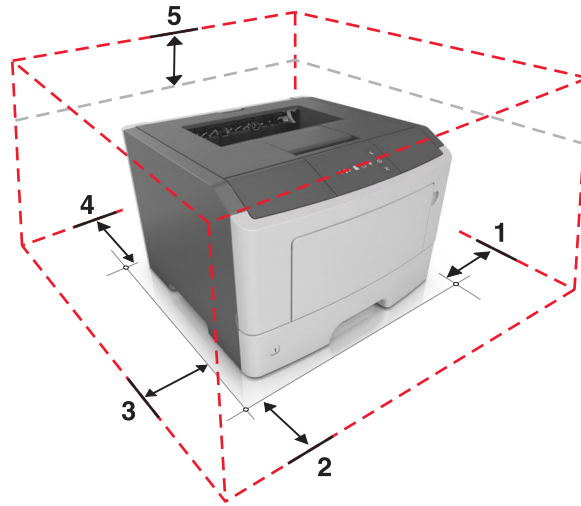

1	Right side	110 mm (4.33 in.)
2	Front	305 mm (12 in.)
3	Left side	65 mm (2.56 in.)
4	Rear	100 mm (3.94 in.)
5	Top	305 mm (12 in.)

Printer configurations

⚠ CAUTION—POTENTIAL INJURY: To reduce the risk of equipment instability, load each tray separately. Keep all trays closed until needed.



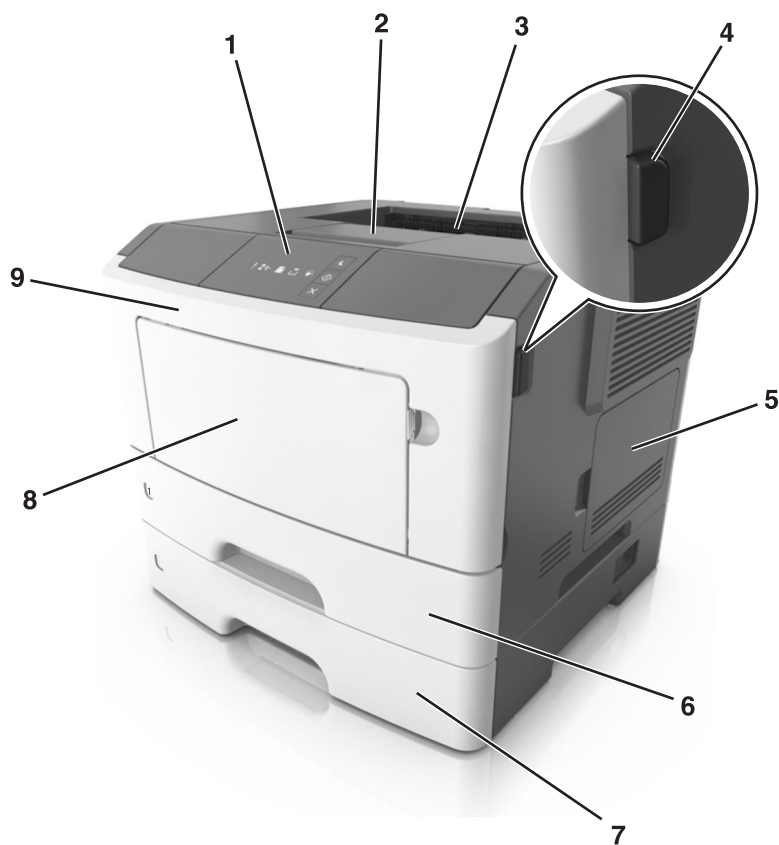



You can configure your printer by adding one optional 250- or 550-sheet tray. For instructions on installing the optional tray, see [“Installing optional trays” on page 16](#).

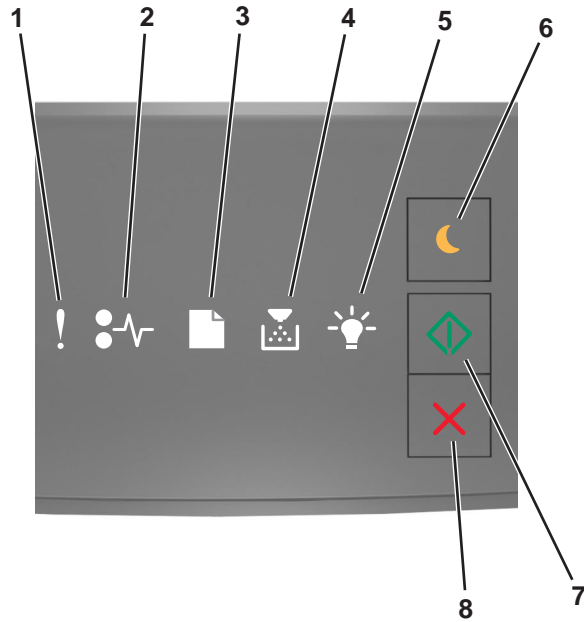

1	Printer control panel
2	Paper stop
3	Standard bin
4	Front door release button
5	Controller board access door
6	Standard 250-sheet tray
7	Optional 250- or 550-sheet tray
8	50-sheet multipurpose feeder
9	Front door



















Using the printer control panel

































	Light or button		Color	Description
1	Error light		Yellow	An error has occurred.
2	Paper jam light		Yellow	A paper jam has occurred.
3	Load or remove paper light		Yellow	Paper must be loaded in the tray or removed from the bin.
4	Toner low or replace imaging unit light		Yellow	The toner cartridge is low on toner, or the imaging unit needs to be replaced.
5	Ready or data light		Green	The printer is in Ready state.
6	Sleep button and light		Amber	Use this to enable Sleep mode or Hibernate mode.
7	Start button and light		Green	Use this to initiate a print job.

	Light or button		Color	Description
8	Stop or cancel button		Red	Use this to cancel a print job.

Understanding the control panel light sequences

On	Blinking	Blinking slowly
		
		
		
		
		
		

Control panel light sequences, error messages, and printer status

Light sequence						Error message or printer status
						
						Close front door
						Replace imaging unit
						Replace unsupported toner cartridge
						Replace unsupported imaging unit
						Toner cartridge, imaging unit mismatch
						Canceling print job
						Flushing buffer
						Resolution reduced

Light sequence						Error message or printer status
The lights blink one at a time from left to right repeatedly.						<u>Non-Lexmark supply type</u>
						<u>Printer had to restart</u>
						<u>Toner cartridge very low</u>
						<u>Imaging unit very low</u>
						<u>Toner cartridge nearly low</u>
						<u>Imaging unit nearly low</u>
						<u>Service error</u>
						<u>Load paper</u>
						<u>Remove paper from standard bin</u>
						<u>Toner cartridge low</u>
						<u>Imaging unit low</u>
						Ready
						Waiting
						Busy
						Not ready

If the light sequence matches a light sequence in the Primary light sequence column of the following table, then press twice. Search for a matching light sequence in the Supplemental light sequence column, and then see the corresponding error message or printer status.

Primary light sequence						Supplemental light sequence						Error message or printer status
												<u>Missing or unresponsive toner cartridge</u>

Primary light sequence						Supplemental light sequence						Error message or printer status
!	⚙️	📄	🖨️	💡	◊	!	⚙️	📄	🖨️	💡	◊	
!			🖨️			!	⚙️			💡		Replace toner cartridge
!			🖨️			!		📄	🖨️			Toner cartridge, printer region mismatch
!			🖨️			!	⚙️		🖨️			Missing or unresponsive imaging unit
!					◊	!	⚙️				◊	Standard network software error
!					◊	!	⚙️				◊	Network [x] software error
!					◊	!			🖨️		◊	Insufficient memory to collate job
!					◊	!			🖨️		◊	PPDS font error
!					◊	!				💡	◊	Complex page
!					◊	!				⚙️	◊	Insufficient memory to support Resource Save feat
!					◊	!	⚙️	📄			◊	Standard parallel port disabled
!					◊	!	⚙️	📄			◊	Rear USB port disabled
!					◊	!		📄	🖨️		◊	Too many trays attached
!					◊	!		📄		💡	◊	Incorrect paper size
!					◊	!			🖨️	💡	◊	Memory full
	⚙️				◊		⚙️	📄			◊	Paper jam, clear standard bin
	⚙️				◊		⚙️	📄			◊	Paper jam, remove standard tray to clear duplex
	⚙️				◊		⚙️		🖨️		◊	Paper jam, open rear door
	⚙️				◊		⚙️			💡	◊	Paper jam, remove standard tray to clear duplex
	⚙️				◊		⚙️			💡	◊	Paper jam, open front door
	⚙️				◊		⚙️	📄	🖨️		◊	Paper jam, remove standard tray

Primary light sequence						Supplemental light sequence						Error message or printer status
!	⦿	📄	📄	💡	⬮	!	⦿	📄	📄	💡	⬮	
	⦿				⬮		⦿	📄		💡	⬮	Paper jam, remove optional tray
	⦿				⬮		⦿		📄	💡	⬮	Paper jam, manual feeder

Using the Embedded Web Server

Note: This functionality is available only in network printers or printers connected to print servers.

Use the Embedded Web Server to:

- Check the status of the printer supplies.
- Configure supply notifications.
- Configure printer settings.
- Configure network settings.
- View reports.

To access the Embedded Web Server for your printer:

- 1 Obtain the printer IP address by printing a network setup page or menu settings page, and then finding the TCP/IP section.

For more information, see [“Printing a menu settings and network setup page” on page 23](#).

Notes:

- An IP address appears as four sets of numbers separated by periods, such as 123.123.123.123.
- If you are using a proxy server, then temporarily disable it to load the Web page correctly.

- 2 Open a Web browser, and then type the printer IP address in the address field.

- 3 Press **Enter**.

Using the Local Printer Settings Utility

- 1 Access the Local Printer Settings Utility from the list of applications or the Start menu to adjust the printer settings.
- 2 Save the changes using the Actions menu.

Note: To distribute the settings to other printers, save the settings in a command file.

Additional printer setup

Installing hardware options

Installing optional trays

⚠ CAUTION—SHOCK HAZARD: If you are accessing the controller board or installing optional hardware or memory devices sometime after setting up the printer, then turn the printer off, and unplug the power cord from the electrical outlet before continuing. If you have any other devices attached to the printer, then turn them off as well, and unplug any cables going into the printer.

- 1 Turn off the printer using the power switch, and then unplug the power cord from the electrical outlet.



- 2 Unpack the tray, and then remove any packing material.
- 3 Remove the tray from the base.

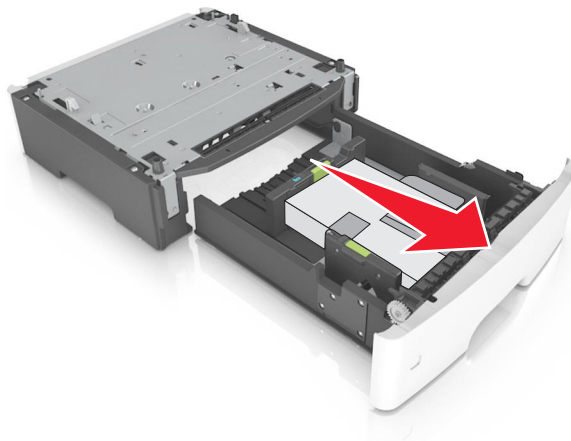

- 4 Remove any packing material from inside the tray.
- 5 Insert the tray into the base.
- 6 Place the tray near the printer.

7 Align the printer with the tray, and then slowly lower the printer into place.

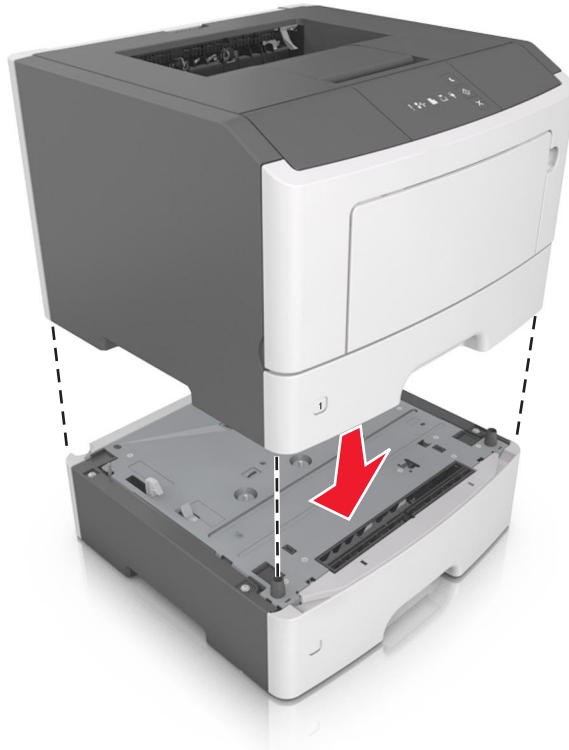

8 Connect the power cord to the printer, then to a properly grounded electrical outlet, and then turn on the printer.



Note: When the printer software and any hardware options are installed, it may be necessary to manually add the options in the printer driver to make them available for print jobs. For more information, see [“Adding available options in the print driver” on page 19](#).

Attaching cables

Connect the printer to the computer using a USB or parallel cable, or to the network using an Ethernet cable.

Make sure to match the following:

- The USB symbol on the cable with the USB symbol on the printer
- The appropriate parallel cable with the parallel port
- The appropriate Ethernet cable with the Ethernet port

Warning—Potential Damage: Do not touch the USB cable, any network adapter, or the printer in the area shown while actively printing. Loss of data or a malfunction can occur.

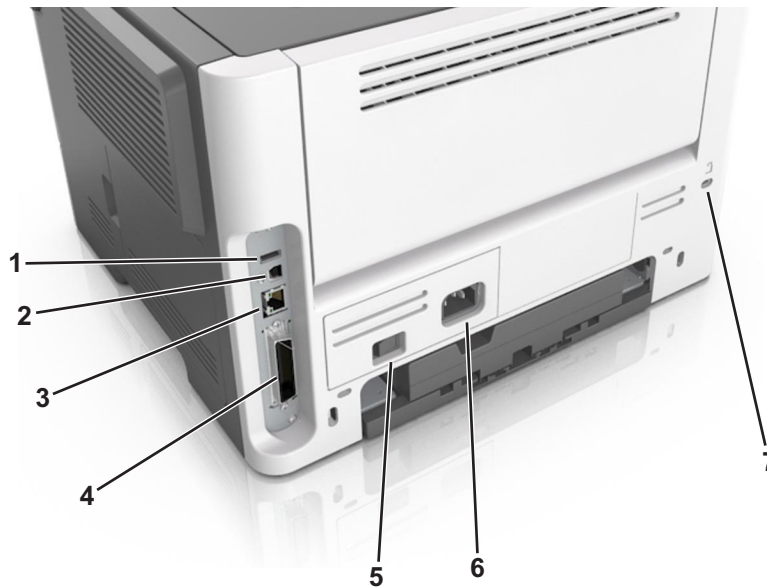

	Use the	To
1	USB port*	Attach an optional wireless network adapter.
2	USB printer port	Connect the printer to a computer.
3	Ethernet port*	Connect the printer to a network.
4	Parallel port*	Connect the printer to a computer.
5	Power switch	Turn on or turn off the printer.
6	Printer power cord socket	Connect the printer to an electrical outlet.
7	Security slot	Attach a lock that will secure the printer in place.

* These ports are available only in select printer models.

Setting up the printer software

Installing the printer software

- 1 Obtain a copy of the software installer package.
 - From the software CD that came with your printer.
 - Go to <http://support.lexmark.com>, and then select your printer and operating system.
- 2 Run the installer, and then follow the instructions on the computer screen.
- 3 For Macintosh users, add the printer.

Note: Obtain the printer IP address from the TCP/IP section in the Network/Ports menu.

Installing the Local Printer Settings Utility

- 1 Visit <http://support.lexmark.com>, and then download the software.
- 2 Double-click the software installer package.
- 3 Select an installation type, and then click **Install**.
- 4 Click **Install** to start the installation.
- 5 Click **Agree** to accept the license agreement.
- 6 Click **Continue**, and then follow the instructions on the computer screen.

Notes:

- Use the Local Printer Settings Utility to change the toner darkness, power saver, and paper size settings for all print jobs. Use the printer software to change these settings for individual print jobs.
- This utility is supported only in select printer models.

Adding available options in the print driver

For Windows users

- 1 Open the printers folder.
- 2 Select the printer you want to update, and then do the following:
 - For Windows 7 or later, select **Printer properties**.
 - For earlier versions, select **Properties**.
- 3 Navigate to the Configuration tab, and then select **Update Now - Ask Printer**.
- 4 Apply the changes.

For Macintosh users

- 1 From System Preferences in the Apple menu, navigate to your printer, and then select **Options & Supplies**.
- 2 Navigate to the list of hardware options, and then add any installed options.
- 3 Apply the changes.

Networking

Notes:

- Purchase a MarkNet™ N8352 wireless network adapter before setting up the printer on a wireless network. For information on installing the wireless network adapter, see the instruction sheet that came with the adapter.
- A *Service Set Identifier* (SSID) is a name assigned to a wireless network. Wired Equivalent Privacy (WEP), Wi-Fi Protected Access (WPA), WPA2, and 802.1X - RADIUS are types of security used on a network.

Preparing to set up the printer on an Ethernet network

To configure your printer to connect to an Ethernet network, organize the following information before you begin:

Note: If your network automatically assigns IP addresses to computers and printers, continue on to installing the printer.

- A valid, unique IP address for the printer to use on the network
- The network gateway
- The network mask
- A nickname for the printer (optional)

Note: A printer nickname can make it easier for you to identify your printer on the network. You can choose to use the default printer nickname, or assign a name that is easier for you to remember.

You will need an Ethernet cable to connect the printer to the network and an available port where the printer can physically connect to the network. Use a new network cable when possible to avoid potential problems caused by a damaged cable.

Preparing to set up the printer on a wireless network

Notes:

- Make sure your wireless network adapter is installed in your printer and working properly. For more information, see the instruction sheet that came with the wireless network adapter.
- Make sure your access point (wireless router) is turned on and is working properly.

Make sure you have the following information before setting up the printer on a wireless network:

- **SSID**—The SSID is also referred to as the network name.
- **Wireless Mode (or Network Mode)**—The mode is either infrastructure or ad hoc.
- **Channel (for ad hoc networks)**—The channel defaults to automatic for infrastructure networks.

Some ad hoc networks will also require the automatic setting. Check with your system support person if you are not sure which channel to select.

- **Security Method**—There are four basic options for Security Method:
 - WEP key
If your network uses more than one WEP key, then enter up to four in the provided spaces. Select the key currently in use on the network by selecting the default WEP transmit key.
 - WPA or WPA2 preshared key or passphrase
WPA includes encryption as an additional layer of security. The choices are AES or TKIP. Encryption must be set for the same type on the router and on the printer, or the printer will not be able to communicate on the network.
 - 802.1X–RADIUS
If you are installing the printer on an 802.1X network, then you may need the following:
 - Authentication type
 - Inner authentication type
 - 802.1X user name and password
 - Certificates
 - No security
If your wireless network does not use any type of security, then you will not have any security information.
Note: We do not recommend using an unsecured wireless network.

Notes:

- If you do not know the SSID of the network that your computer is connected to, then launch the wireless utility of the computer network adapter, and then look for the network name. If you cannot find the SSID or the security information for your network, then see the documentation that came with the access point, or contact your system support person.
- To find the WPA/WPA2 preshared key or passphrase for the wireless network, see the documentation that came with the access point, see the Embedded Web Server associated with the access point, or consult your system support person.

Connecting the printer to a wireless network using the Wi-Fi Protected Setup PIN

The printer supports only the personal identification number (PIN) method of connecting to a wireless network using Wi-Fi Protected Setup (WPS) methods.

Note: Make sure your access point (wireless router) is WPS certified or WPS-compatible. For more information, see the documentation that came with your access point.

- 1 Print a network setup page or menu settings page. For more information, see [“Printing a menu settings and network setup page” on page 23](#).
- 2 Locate the WPS PIN in the Wireless section.
- 3 Open a Web browser, and then type the IP address of your access point in the address field.

Notes:

- The IP address appears as four sets of numbers separated by periods, such as 123.123.123.123.
- If you are using a proxy server, then temporarily disable it to load the Web page correctly.

- 4 Access the WPS settings. For more information, see the documentation that came with your access point.
- 5 Enter the eight-digit WPS PIN, and then save the setting.

Connecting the printer to a wireless network using the printer software

Notes:

- Make sure that your printer is turned on.
- Make sure that a wireless network adapter is installed in your printer. For information, see the instruction sheet that came with the adapter.

Using the Wireless Setup Utility (Windows only)

- 1 Check if the printer software is already installed.
- 2 Use the search command on the Start menu to locate Printer Home.
- 3 Open Printer Home, and then click **Settings > Wireless Setup Utility**.
- 4 Follow the steps on the computer screen.

Using the Wireless Setup Assistant (Macintosh only)

The Wireless Setup Assistant lets you:

- Configure the printer to join an existing wireless network.
- Add a printer to an existing ad hoc network.
- Change the wireless settings after installation.
- Install the printer on additional network computers.

Installing the Wireless Setup Assistant

- 1 Go to the Lexmark support Web site at <http://support.lexmark.com>.
- 2 Download the latest Wireless Setup Assistant application.
- 3 Double-click the downloaded software installer package.
- 4 Follow the instructions on the computer screen.

Launching the Wireless Setup Assistant

Notes:

- Make sure the printer is turned on.
- Make sure a wireless network adapter is installed in your printer and is working properly.

- 1 From the Finder, navigate to:
Applications > select your printer folder
- 2 Double-click **Wireless Setup Assistant**, and then follow the instructions on the computer screen.

Note: If you encounter problems while running the application, then click .

Connecting the printer to a wireless network using the Embedded Web Server

Before you begin, make sure that:

- Your printer is connected temporarily to an Ethernet network.
- A wireless network adapter is installed in your printer and working properly. For more information, see the instruction sheet that came with your wireless network adapter.

1 Open a Web browser, and then type the printer IP address in the address field.

Notes:

- View the printer IP address on the printer control panel. The IP address appears as four sets of numbers separated by periods, such as 123.123.123.123.
- If you are using a proxy server, then temporarily disable it to load the Web page correctly.

2 Click **Settings > Network/Ports > Wireless**.

3 Modify the settings to match the settings of your access point (wireless router).

Note: Make sure to enter the correct SSID.

4 Click **Submit**.

5 Turn off the printer, and then disconnect the Ethernet cable. Then wait for at least five seconds, and then turn the printer back on.

6 To verify if your printer is connected to the network, print a network setup page. Then in the Network Card [x] section, see if the status is Connected.

Printing a menu settings and network setup page

Print a menu settings page to review the current menu settings and to verify if the printer options are installed correctly. The network setup page prints at the same time, containing the current network settings of the printer and levels of supplies.

From the printer control panel, press  for at least four seconds.

Notes:

- If you have not changed any menu settings, then the menu settings page lists all the factory default settings. When you select and save other settings from the menus, they replace the factory default settings as user default settings.
- Make sure to check the first section of the network setup page to see if the status is Connected. If the status is Not Connected, then the LAN drop may not be active, or the network cable may be defective. Contact your system support person for a solution, and then print another network setup page.

Loading paper and specialty media

The selection and handling of paper and specialty media can affect how reliably documents print. For more information, see [“Avoiding jams” on page 91](#) and [“Storing paper” on page 41](#).

Setting the paper size and type

Using the Embedded Web Server

- 1 Open a Web browser, and then type the printer IP address in the address field.

Notes:

- Print a network setup page or menu settings page, and then locate the IP address in the TCP/IP section. The IP address appears as four sets of numbers separated by periods, such as 123.123.123.123.
- If you are using a proxy server, then temporarily disable it to load the Web page correctly.

- 2 Click **Settings > Paper Menu**.

Using the printer settings on the computer

Depending on your operating system, access the Paper menu using the Local Printer Settings Utility or Printer Settings.

Note: The paper size and type settings will be saved until you reset factory default settings.

Configuring Universal paper settings

The Universal paper size setting is a user-defined setting that lets you print on paper sizes that are not preset in the printer menus.

Notes:

- The largest supported Universal size is 216 x 355.6 mm (8.5 x 14 inches).
- The smallest Universal size supported in the multipurpose feeder is 76 x 127 mm (3 x 5 inches). The smallest Universal size supported in the optional tray is 183 x 210 mm (7.2 x 8.3 inches).

Using the Embedded Web Server

- 1 Open a Web browser, and then type the printer IP address in the address field.
- 2 Click **Settings > Paper Menu > Universal Setup**.
- 3 Select the unit of measure, or click **Portrait Width** or **Portrait Height**.
- 4 Change the setting, and then click **Submit**.

Using the printer settings on the computer

- 1 Depending on your operating system, access the Paper menu using the Local Printer Settings Utility or Printer Settings.
- 2 Select the tray containing the Universal paper size, and then select Universal as the paper size.

Using the standard bin and paper stop

The standard bin holds up to 150 sheets of 75-g/m² (20-lb) paper. It collects prints facedown. The standard bin includes a paper stop that keeps paper from sliding out the front of the bin as it stacks.

To open the paper stop, pull it so that it flips forward.

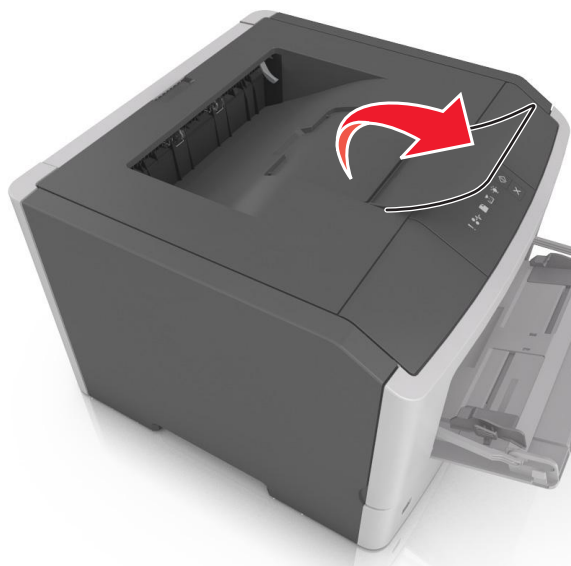

Note: Close the paper stop when moving the printer to another location.

Loading trays

⚠ CAUTION—POTENTIAL INJURY: To reduce the risk of equipment instability, load each tray separately. Keep all other trays closed until needed.

- 1 Pull out the tray completely.

Note: Do not remove trays while a job prints or while the following light sequence appears on the printer control panel. Doing so may cause a jam.



Busy

 - Blinking



2 Squeeze and then slide the width guide tab to the correct position for the size of the paper you are loading.

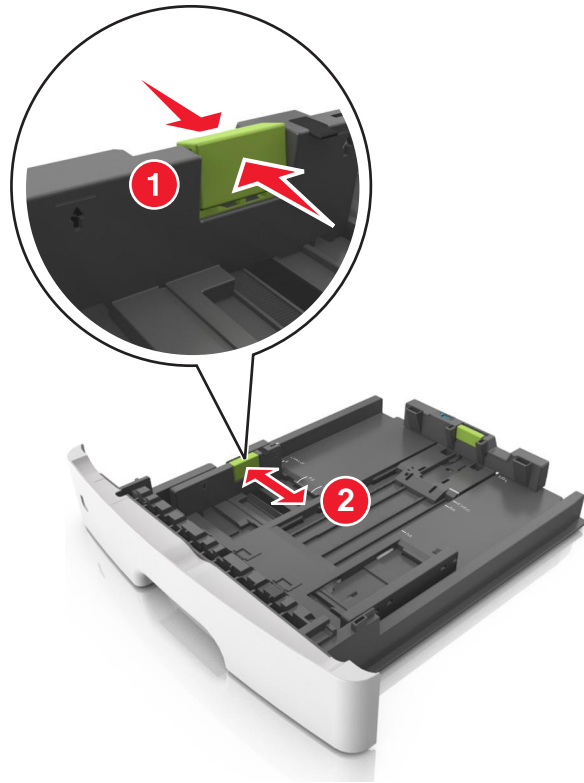

3 Squeeze and then slide the length guide tab to the correct position for the size of the paper you are loading.

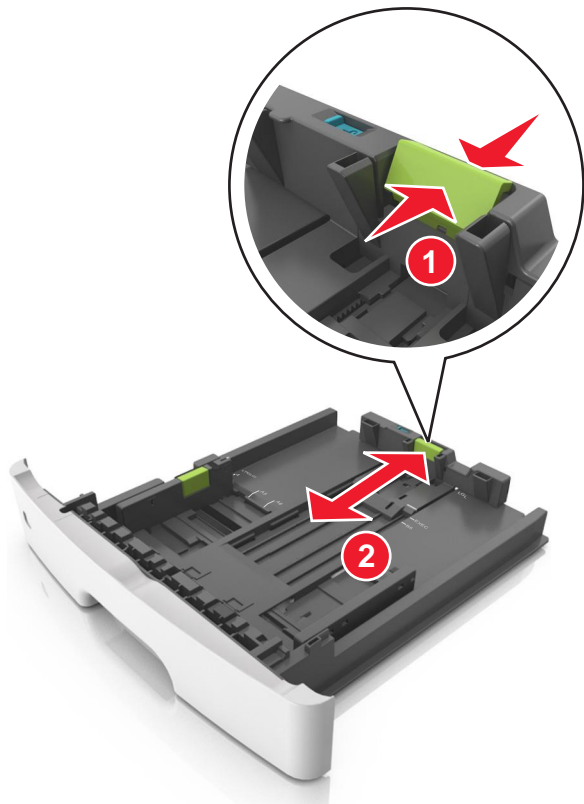

Notes:

- For some paper sizes like letter, legal, and A4, squeeze and slide the length guide tab backward to accommodate their length.
- When loading legal-size paper, the length guide extends beyond the base, leaving the paper exposed to dust. To protect the paper from dust, you can purchase a dust cover separately. For more information, contact customer support.
- If you are loading A6-size paper in the standard tray, then squeeze and slide the length guide tab toward the center of the tray to the A6-size position.
- Make sure the width and length guides are aligned with the paper size indicators on the bottom of the tray.

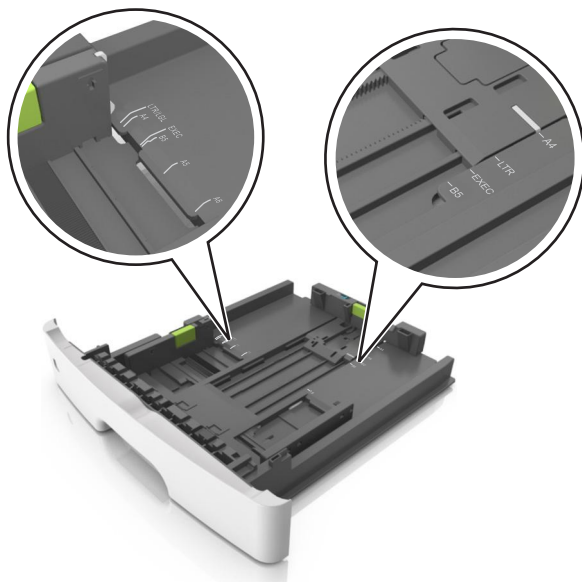

- 4** Flex the sheets back and forth to loosen them, and then fan them. Do not fold or crease the paper. Straighten the edges on a level surface.

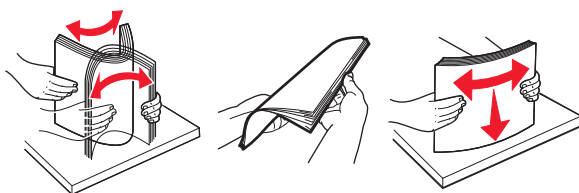

- 5** Load the paper stack.

Note: Make sure the paper is below the maximum fill indicator located on the side of the width guide.

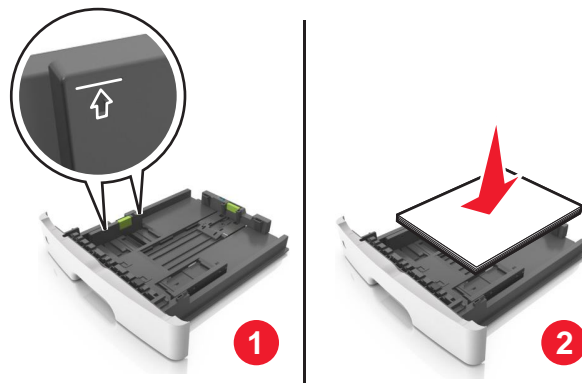
**Notes:**

- Load recycled or preprinted paper with the printable side facedown.
- Load prepunched paper with the holes on the top edge toward the front of the tray.
- Load letterhead facedown, with the top edge of the sheet toward the front of the tray. For two-sided printing, load letterhead faceup with the bottom edge of the sheet toward the front of the tray.

6 Insert the tray.**7** From the Embedded Web Server or your computer, set the paper size and type in the Paper menu to match the paper loaded in the tray.**Notes:**

- If the printer is not connected to a network, then access the Paper menu using Local Printer Settings Utility or Printer Settings, depending on your operating system.
- Set the correct paper size and type to avoid paper jams and print quality problems.

Loading the multipurpose feeder

Use the multipurpose feeder when printing on different paper sizes and types or specialty media, such as card stock, transparencies, paper labels, and envelopes. You can also use it for single-page print jobs on letterhead.

- 1 Open the multipurpose feeder.

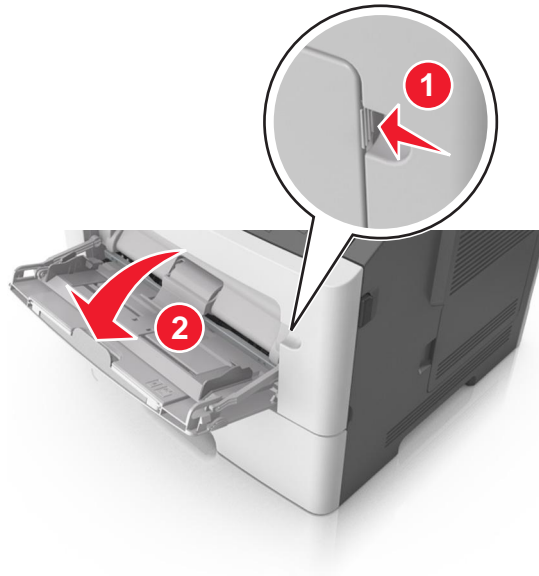

- a Pull the multipurpose feeder extender.



- b Pull the extender gently so that the multipurpose feeder is fully extended and open.



- 2 Squeeze the tab on the left width guide, and then move the guides for the paper you are loading.

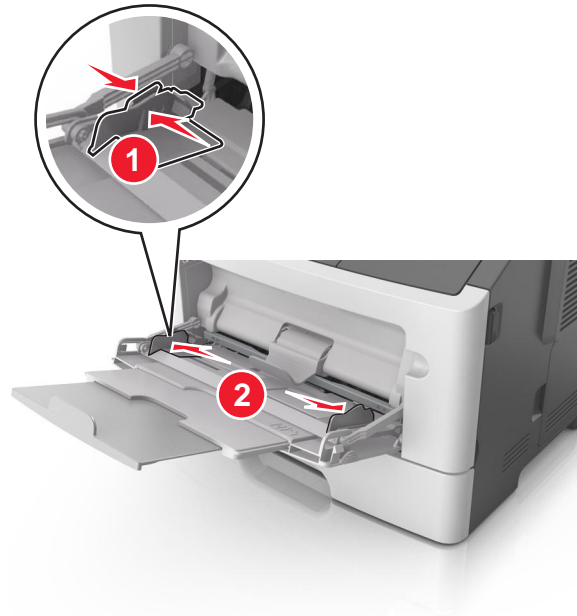

- 3 Prepare the paper or specialty media for loading.

- Flex sheets of paper back and forth to loosen them, and then fan them. Do not fold or crease the paper. Straighten the edges on a level surface.

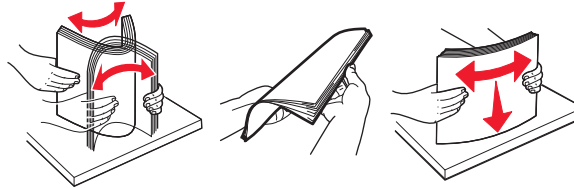

- Hold transparencies by the edges. Flex the stack of transparencies back and forth to loosen them, and then fan them. Straighten the edges on a level surface.

Note: Avoid touching the printable side of the transparencies. Be careful not to scratch them.

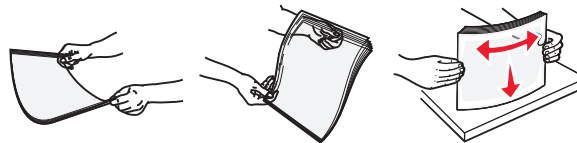

- Flex the stack of envelopes back and forth to loosen them, and then fan them. Straighten the edges on a level surface.



- 4 Load the paper or specialty media.

Notes:

- Do not force paper into the multipurpose feeder. Overfilling may cause paper jams.

- Make sure the paper or specialty media is below the maximum paper fill indicator located on the paper guides.

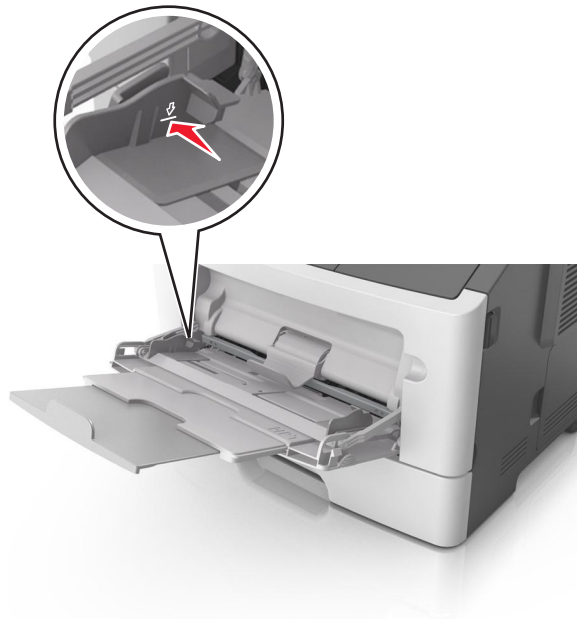

- Load paper, transparencies, and card stock with the recommended printable side faceup and the top edge entering the printer first. For more information on loading transparencies, see the packaging the transparencies came in.



Note: When loading A6-size paper, make sure the multipurpose feeder extender rests lightly against the edge of the paper so that the last few sheets of paper remain in place.

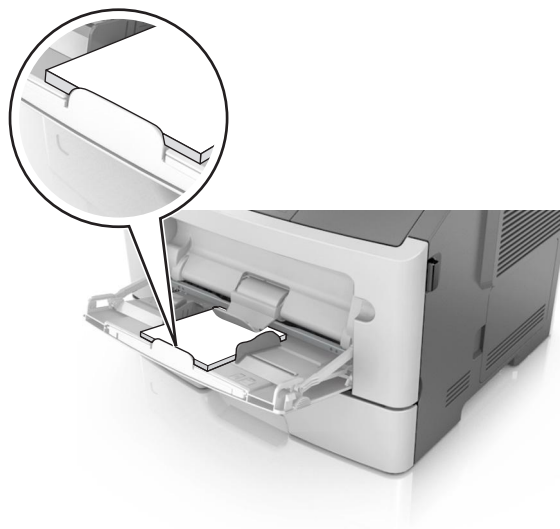

- Load letterhead faceup with the top edge entering the printer first. For two-sided (duplex) printing, load letterhead facedown with the bottom edge of the sheet entering the printer first.



- Load envelopes with the flap on the left side facedown.

Warning—Potential Damage: Never use envelopes with stamps, clasps, snaps, windows, coated linings, or self-stick adhesives. These envelopes may severely damage the printer.



- 5 From the Embedded Web Server or from your computer, set the paper size and paper type in the Paper menu to match the paper loaded in the multipurpose feeder.

Note: Depending on your operating system, access the Paper menu using Local Printer Settings Utility or Printer Settings.

Linking and unlinking trays

The printer links trays when the specified paper size and type are the same. When a linked tray becomes empty, paper feeds from the next linked tray. To prevent trays from linking, assign a unique custom paper type name.

Linking and unlinking trays

Using the Embedded Web Server

- 1 Open a Web browser, and then type the printer IP address in the address field.

Notes:

- Print a network setup page or menu settings page, and then locate the IP address in the TCP/IP section. The IP address appears as four sets of numbers separated by periods, such as 123.123.123.123.

- If you are using a proxy server, then temporarily disable it to load the Web page correctly.

2 Click **Settings > Paper Menu**.

3 From the Tray Configuration section, select a tray, and then change the paper size and type settings.

- To link trays, make sure the paper size and type for the tray match that of the other tray.
- To unlink trays, make sure the paper size or type for the tray does *not* match that of the other tray.

4 Click **Submit**.

Using the printer settings on the computer

Depending on your operating system, access the Paper menu using the Local Printer Settings Utility or Printer Settings.

Warning—Potential Damage: Paper loaded in the tray should match the paper type assigned in the printer. The temperature of the fuser varies according to the specified paper type. Printing issues may occur if settings are not properly configured.

Configuring a custom paper type

Using the Embedded Web Server

1 Open a Web browser, and then type the printer IP address in the address field.

Notes:

- Print a network setup page or menu settings page, and then locate the IP address in TCP/IP section. The IP address appears as four sets of numbers separated by periods, such as 123.123.123.123.
- If you are using a proxy server, then temporarily disable it to load the Web page correctly.

2 Click **Settings > Paper Menu > Custom Types**.

3 Select a custom paper type name, and then select a custom paper type.

Note: Plain Paper is the factory default paper type for all user-defined custom names.

4 Click **Submit**.

Using the printer settings on the computer

Depending on your operating system, access the Custom menu using the Local Printer Settings Utility or Printer Settings.

Assigning a custom paper type

Using the Embedded Web Server

1 Open a Web browser, and then type the printer IP address in the address field.

Notes:

- Print a network setup page or menu settings page, and then locate the IP address in the TCP/IP section. The IP address appears as four sets of numbers separated by periods, such as 123.123.123.123.

- If you are using a proxy server, then temporarily disable it to load the Web page correctly.

2 Click **Settings > Paper Menu**.

3 From the Tray Configuration section, select a paper source, and then select a custom paper type under the paper type column.

4 Click **Submit**.

Using the printer settings on the computer

Depending on your operating system, access the Paper menu using the Local Printer Settings Utility or Printer Settings.

Paper and specialty media guide

Additional information for printing on specialty media may be found in the *Card Stock & Label Guide* available at <http://support.lexmark.com>.

Paper guidelines

Selecting the correct paper or specialty media reduces printing problems. For the best print quality, try a sample of the paper or specialty media before buying large quantities.

Paper characteristics

The following paper characteristics affect print quality and reliability. Consider these characteristics when evaluating new paper stock.

Weight

The printer trays can automatically feed paper weights up to 90-g/m² (24-lb) bond grain long paper. The multipurpose feeder can automatically feed paper weights up to 163-g/m² (43-lb) bond grain long paper. Paper lighter than 60 g/m² (16 lb) might not be stiff enough to feed properly, causing jams. For best performance, use 75-g/m² (20-lb) bond grain long paper. For paper smaller than 182 x 257 mm (7.2 x 10.1 inches), we recommended to use 90 g/m² (24 lb) or heavier paper.

Note: Two-sided printing is supported only for 60–90-g/m² (16–24-lb) bond paper.

Curl

Curl is the tendency for paper to curl at its edges. Excessive curl can cause paper feeding problems. Curl can occur after the paper passes through the printer, where it is exposed to high temperatures. Storing paper unwrapped in hot, humid, cold, or dry conditions, even in the trays, can contribute to paper curling prior to printing and can cause feeding problems.

Smoothness

Paper smoothness directly affects print quality. If paper is too rough, then toner cannot fuse to it properly. If paper is too smooth, then it can cause paper feeding or print quality issues. Always use paper between 100 and 300 Sheffield points; however, smoothness between 150 and 250 Sheffield points produces the best print quality.

Moisture content

The amount of moisture in paper affects both print quality and the ability of the printer to feed the paper correctly. Leave paper in its original wrapper until it is time to use it. This limits the exposure of paper to moisture changes that can degrade its performance.

Store paper in its original wrapper in the same environment as the printer for 24 to 48 hours before printing. Extend the time to several days if the storage or transportation environment is very different from the printer environment. Thick paper may also require a longer conditioning period.

Grain direction

Grain refers to the alignment of the paper fibers in a sheet of paper. Grain is either *grain long*, running the length of the paper, or *grain short*, running the width of the paper.

For 60–90-g/m² (16–24-lb) bond paper, grain long paper is recommended.

Fiber content

Most high-quality xerographic paper is made from 100% chemically treated pulped wood. This content provides the paper with a high degree of stability resulting in fewer paper feeding problems and better print quality. Paper containing fibers such as cotton can negatively affect paper handling.

Unacceptable paper

The following paper types are not recommended for use with the printer:

- Chemically treated papers used to make copies without carbon paper, also known as carbonless papers, carbonless copy paper (CCP), or no carbon required (NCR) paper
- Preprinted papers with chemicals that may contaminate the printer
- Preprinted papers that can be affected by the temperature in the printer fuser
- Preprinted papers that require a registration (the precise print location on the page) less than ± 2.5 mm (± 0.10 inch), such as optical character recognition (OCR) forms

In some cases, registration can be adjusted with a software application to successfully print on these forms:

- Coated papers (erasable bond), synthetic papers, thermal papers
- Rough-edged, rough or heavily textured surface papers, or curled papers
- Recycled papers that fail EN12281:2002 (European)
- Paper weighing less than 60 g/m² (16 lb)
- Multiple-part forms or documents

Selecting paper

Using the appropriate paper prevents jams and helps ensure trouble-free printing.

To help avoid paper jams and poor print quality:

- *Always* use new, undamaged paper.
- Before loading paper, know the recommended printable side of the paper. This information is usually indicated on the paper package.
- *Do not* use paper that has been cut or trimmed by hand.
- *Do not* mix paper sizes, types, or weights in the same tray; mixing results in jams.
- *Do not* use coated papers unless they are specifically designed for electrophotographic printing.

Selecting preprinted forms and letterhead

Use these guidelines when selecting preprinted forms and letterhead:

- Use grain long for 60 to 90 g/m² (16 to 24 lb) weight paper.
- Use only forms and letterhead printed using an offset lithographic or engraved printing process.
- Avoid papers with rough or heavily textured surfaces.

Use papers printed with heat-resistant inks designed for use in xerographic copiers. The ink must be able to withstand temperatures up to 230°C (446°F) without melting or releasing hazardous emissions. Use inks that are not affected by the resin in toner. Inks that are oxidation-set or oil-based generally meet these requirements; latex inks might not. When in doubt, contact the paper supplier.

Preprinted papers such as letterhead must be able to withstand temperatures up to 230°C (446°F) without melting or releasing hazardous emissions.

Using recycled paper and other office papers

As an environmentally conscientious company, Lexmark supports the use of recycled paper produced specifically for use in laser (electrophotographic) printers.

While no blanket statement can be made that all recycled paper will feed well, Lexmark consistently tests papers that represent recycled cut size copier papers available on the global market. This scientific testing is conducted with rigor and discipline. Many factors are taken into consideration both separately and as a whole, including the following:

- Amount of post-consumer waste (Lexmark tests up to 100% post-consumer waste content.)
- Temperature and humidity conditions (Testing chambers simulate climates from all over the world.)
- Moisture content (Business papers should have low moisture: 4–5%.)
- Bending resistance and proper stiffness means optimum feeding through the printer.
- Thickness (impacts how much can be loaded into a tray)
- Surface roughness (measured in Sheffield units, impacts print clarity and how well toner fuses to the paper)
- Surface friction (determines how easily sheets can be separated)
- Grain and formation (impacts curling, which also influences the mechanics of how the paper behaves as it moves through the printer)
- Brightness and texture (look and feel)

Recycled papers are better than ever; however, the amount of recycled content in a paper affects the degree of control over foreign matter. And while recycled papers are one good path to printing in an environmentally responsible manner, they are not perfect. The energy required to de-ink and deal with additives such as colorants and “glue” often generates more carbon emissions than does normal paper production. However, using recycled papers enables better resource management overall.

Lexmark concerns itself with the responsible use of paper in general based on life cycle assessments of its products. To gain a better understanding of the impact of printers on the environment, the company commissioned a number of life cycle assessments and found that paper was identified as the primary contributor (up to 80%) of carbon emissions caused throughout the entire life of a device (from design to end-of-life). This is due to the energy-intensive manufacturing processes required to make paper.

Thus, Lexmark seeks to educate customers and partners on minimizing the impact of paper. Using recycled paper is one way. Eliminating excessive and unnecessary paper consumption is another. Lexmark is well-equipped to help customers minimize printing and copying waste. In addition, the company encourages purchasing paper from suppliers who demonstrate their commitment to sustainable forestry practices.

Lexmark does not endorse specific suppliers, although a converter's product list for special applications is maintained. However, the following paper choice guidelines will help alleviate the environmental impact of printing:

- 1 Minimize paper consumption.
- 2 Be selective about the origin of wood fiber. Buy from suppliers who carry certifications such as the Forestry Stewardship Council (FSC) or the Program for the Endorsement of Forest Certification (PEFC). These certifications guarantee that the paper manufacturer uses wood pulp from forestry operators that employ environmentally and socially responsible forest management and restoration practices.
- 3 Choose the most appropriate paper for printing needs: normal 75 or 80 g/m² certified paper, lower weight paper, or recycled paper.

Unacceptable paper examples

Test results indicate that the following paper types are at risk for use with laser printers:

- Chemically treated papers used to make copies without carbon paper, also known as *carbonless papers*
- Preprinted papers with chemicals that may contaminate the printer
- Preprinted papers that can be affected by the temperature in the printer fuser
- Preprinted papers that require a registration (the precise location on the page) greater than ± 2.3 mm (± 0.9 in.), such as optical character recognition (OCR) forms. In some cases, registration can be adjusted with a software application to successfully print on these forms.)
- Coated papers (erasable bond), synthetic papers, thermal papers
- Rough-edged, rough or heavily textured surface papers or curled papers
- Recycled papers that fail EN12281:2002 (European testing)
- Paper weighing less than 60 g/m² (16 lb)
- Multiple part forms or documents

For more information about Lexmark, visit www.lexmark.com. General sustainability-related information can be found at the **Environmental Sustainability** link.

Using specialty media

Tips on using card stock

Card stock is heavy, single-ply specialty media. Many of its variable characteristics, such as moisture content, thickness, and texture, can significantly impact print quality. Print samples on the card stock being considered for use before buying large quantities.

When printing on card stock:

- Make sure the Paper Type is Card Stock.
- Select the appropriate Paper Texture setting.
- Be aware that preprinting, perforation, and creasing may significantly affect the print quality and cause jams or other paper handling problems.
- Check with the manufacturer or vendor to ensure that the card stock can withstand temperatures up to 240°C (464°F) without releasing hazardous emissions.

- Do not use preprinted card stock manufactured with chemicals that may contaminate the printer. Preprinting introduces semi-liquid and volatile components into the printer.
- Use grain short card stock when possible.

Tips on using envelopes

Print samples on the envelopes being considered for use before buying large quantities.

- Use envelopes designed specifically for laser printers. Check with the manufacturer or vendor to ensure that the envelopes can withstand temperatures up to 230°C (446°F) without sealing, wrinkling, curling excessively, or releasing hazardous emissions.
- For best performance, use envelopes made from 90-g/m² (24-lb bond) paper or 25% cotton. All-cotton envelopes must not exceed 70-g/m² (20-lb bond) weight.
- Use only new envelopes from undamaged packages.
- To optimize performance and minimize jams, do not use envelopes that:
 - Have excessive curl or twist
 - Are stuck together or damaged in any way
 - Have windows, holes, perforations, cutouts, or embossing
 - Have metal clasps, string ties, or folding bars
 - Have an interlocking design
 - Have postage stamps attached
 - Have any exposed adhesive when the flap is in the sealed or closed position
 - Have bent corners
 - Have rough, cockle, or laid finishes
- Adjust the width guides to fit the width of the envelopes.

Note: A combination of high humidity (over 60%) and high printing temperature may wrinkle or seal envelopes.

Tips on using labels

Print samples on the labels being considered for use before buying large quantities.

Note: Use only paper label sheets. Vinyl, pharmacy, and two-sided labels are not supported.

For more information on label printing, characteristics, and design, see the *Card Stock & Label Guide* available at <http://support.lexmark.com>.

When printing on labels:

- Use labels designed specifically for laser printers. Check with the manufacturer or vendor to verify that:
 - The labels can withstand temperatures up to 240°C (464°F) without sealing, excessive curling, wrinkling, or releasing hazardous emissions.
 - Label adhesives, face sheet (printable stock), and topcoats can withstand up to 172-kPa (25-psi) pressure without delaminating, oozing around the edges, or releasing hazardous fumes.
- Do not use labels with slick backing material.
- Use full label sheets. Partial sheets may cause labels to peel off during printing, resulting in a jam. Partial sheets also contaminate the printer and the cartridge with adhesive, and could void the printer and toner cartridge warranties.

- Do not use labels with exposed adhesive.
- Do not print within 1 mm (0.04 inch) of the edge of the label, of the perforations, or between die-cuts of the label.
- Make sure the adhesive backing does not reach to the edge of the sheet. Zone coating of the adhesive should be at least 1 mm (0.04 inch) away from edges. Adhesive material contaminates the printer and could void the warranty.
- If zone coating of the adhesive is not possible, then remove a 2-mm (0.08-inch) strip on the leading and driver edge, and then use a non-oozing adhesive.
- Portrait orientation is recommended, especially when printing bar codes.

Tips on using letterhead

- Use letterhead designed specifically for laser printers.
- Print samples on the letterhead being considered for use before buying large quantities.
- Before loading letterhead, flex, fan, and straighten the stack to prevent sheets from sticking together.
- Page orientation is important when printing on letterhead. For information on how to load letterhead, see:
 - [“Loading trays” on page 25](#)
 - [“Loading the multipurpose feeder” on page 30](#)

Tips on using transparencies

- Print a test page on the transparencies being considered for use before buying large quantities.
- Feed transparencies from the standard tray, or the multipurpose feeder.
- Use transparencies designed specifically for laser printers. Transparencies must be able to withstand temperatures up to 185°C (365°F) without melting, discoloring, offsetting, or releasing hazardous emissions.
Note: If the transparency weight is set to Heavy and the transparency texture is set to Rough in the Paper menu, then transparencies can be printed at a temperature up to 195°C (383°F).
- Avoid getting fingerprints on the transparencies to prevent print quality problems.
- Before loading transparencies, flex, fan, and straighten the stack to prevent sheets from sticking together.

Storing paper

Use these paper storage guidelines to help avoid jams and uneven print quality:

- For best results, store paper where the temperature is 21°C (70°F) and the relative humidity is 40 percent. Most label manufacturers recommend printing in a temperature range of 18–24°C (65–75°F) with relative humidity between 40 and 60 percent.
- Store paper in cartons, on a pallet or shelf, rather than on the floor.
- Store individual packages on a flat surface.
- Do not store anything on top of individual paper packages.
- Take paper out of the carton or wrapper only when you are ready to load it in the printer. The carton and wrapper help keep the paper clean, dry, and flat.

Supported paper sizes, types, and weights

Supported paper sizes

Paper size	Standard tray	Optional 250- or 550-sheet tray	Multipurpose feeder	Duplex mode
A4 210 x 297 mm (8.3 x 11.7 in.)	✓	✓	✓	✓
A5 148 x 210 mm (5.8 x 8.3 in.)	✓	✓	✓	X
A6 105 x 148 mm (4.1 x 5.8 in.)	✓	X	✓	X
JIS B5 182 x 257 mm (7.2 x 10.1 in.)	✓	✓	✓	X
Letter 216 x 279 mm (8.5 x 11 in.)	✓	✓	✓	✓
Legal 216 x 356 mm (8.5 x 14 in.)	✓	✓	✓	✓
Executive 184 x 267 mm (7.3 x 10.5 in.)	✓	✓	✓	X
Oficio (Mexico) 216 x 340 mm (8.5 x 13.4 in.)	✓	✓	✓	✓
Folio 216 x 330 mm (8.5 x 13 in.)	✓	✓	✓	✓
Statement 140 x 216 mm (5.5 x 8.5 in.)	✓	✓	✓	X
Universal^{1, 2} 76.2 x 127 mm (3 x 5 in.) up to 216 x 356 mm (8.5 x 14 in.)	✓	✓	✓	✓
7 3/4 Envelope (Monarch) 98 x 191 mm (3.9 x 7.5 in.)	X	X	✓	X
9 Envelope 98 x 225 mm (3.9 x 8.9 in.)	X	X	✓	X
10 Envelope 105 x 241 mm (4.1 x 9.5 in.)	X	X	✓	X

¹ This size setting formats the page for 216 x 356 mm (8.5 x 14 in.) unless the size is specified by the software application.

² Universal is supported in the standard tray only if the paper size is at least 105 x 148 mm (4.1 x 5.8 in.). Universal is supported in the optional 250- or 550-sheet tray only if the paper size is at least 148 x 210 mm (5.8 x 8.3 in.). Universal is supported in duplex mode only if the width is at least 210 mm (8.3 in.) and the length is at least 279 mm (11 in.). The smallest supported Universal size is supported only in the multipurpose feeder.

Paper size	Standard tray	Optional 250- or 550-sheet tray	Multipurpose feeder	Duplex mode
DL Envelope 110 x 220 mm (4.3 x 8.7 in.)	X	X	✓	X
C5 Envelope 162 x 229 mm (6.4 x 9 in.)	X	X	✓	X
B5 Envelope 176 x 250 mm (6.9 x 9.8 in.)	X	X	✓	X
Other Envelope 229 x 356 mm (9 x 14 in.)	X	X	✓	X

¹ This size setting formats the page for 216 x 356 mm (8.5 x 14 in.) unless the size is specified by the software application.

² Universal is supported in the standard tray only if the paper size is at least 105 x 148 mm (4.1 x 5.8 in.). Universal is supported in the optional 250- or 550-sheet tray only if the paper size is at least 148 x 210 mm (5.8 x 8.3 in.). Universal is supported in duplex mode only if the width is at least 210 mm (8.3 in.) and the length is at least 279 mm (11 in.). The smallest supported Universal size is supported only in the multipurpose feeder.

Supported paper types and weights

The standard tray supports 60–90-g/m² (16–24-lb) paper weights. The optional tray supports 60–120-g/m² (16–32-lb) paper weights. The multipurpose feeder supports 60–163-g/m² (16–43-lb) paper weights.

Paper type	250- or 550-sheet tray	Multipurpose feeder	Duplex mode
Plain paper	✓	✓	✓
Card stock	X	✓	X
Transparencies	✓	✓	X
Recycled	✓	✓	✓
Glossy paper	X	X	X
Paper labels¹	✓	✓	X
Vinyl labels	X	X	X
Bond²	✓	✓	✓
Envelope	X	✓	X
Rough envelope	X	✓	X
Letterhead	✓	✓	✓
Preprinted	✓	✓	✓

Paper type	250- or 550-sheet tray	Multipurpose feeder	Duplex mode
Colored Paper	✓	✓	✓
Light Paper	✓	✓	✓
Heavy Paper²	✓	✓	✓
Rough/Cotton	✓	✓	x

¹ One-sided paper labels designed for laser printers are supported for occasional use. It is recommended to print 20 or fewer pages of paper labels per month. Vinyl, pharmacy, and two-sided labels are not supported.

² Bond and Heavy Paper are supported in duplex mode up to 90-g/m² (24-lb) paper weight.

Printing

Selection and handling of paper and specialty media can affect how reliably documents print. For more information, see [“Avoiding jams” on page 91](#) and [“Storing paper” on page 41](#).

Printing documents

Printing from a computer

Note: For labels, card stock, and envelopes, set the paper size and type in the printer before sending the print job.

- 1 From the document that you are trying to print, open the Print dialog.
- 2 If necessary, adjust the settings.
- 3 Send the print job.

Adjusting toner darkness

Using the Embedded Web Server

- 1 Open a Web browser, and then type the printer IP address in the address field.

Notes:

- Print a network setup page or menu settings page, and then locate the IP address in the TCP/IP section. The IP address appears as four sets of numbers separated by periods, such as 123.123.123.123.
- If you are using a proxy server, then temporarily disable it to load the Web page correctly.

- 2 Click **Settings > Print Settings > Quality Menu**.
- 3 Adjust the toner darkness setting.
- 4 Click **Submit**.

Using the printer settings on the computer

Depending on your operating system, adjust the toner darkness settings using the Local Printer Settings Utility or Printer Settings.

Printing from a mobile device

Note: Make sure that the printer and mobile device share the same wireless network. For information on configuring the wireless settings of your mobile device, see the documentation that came with the device.

Printing from a mobile device using Mopria Print Service

Mopria® Print Service is a mobile printing solution for mobile devices running on Android version 4.4 or later. It allows you to print directly to any Mopria-certified printer.

Note: Before printing, make sure that the Mopria Print Service is enabled.

- 1 From the home screen of your mobile device, launch a compatible application.
- 2 Tap **Print**, and then select the printer.
- 3 Send the print job.

Printing from a mobile device using Google Cloud Print

Google Cloud Print™ is a mobile printing service that allows enabled applications on mobile devices to print to any Google Cloud Print-ready printer.

- 1 From the home screen of your mobile device, launch an enabled application.
- 2 Tap **Print**, and then select the printer.
- 3 Send the print job.

Printing from a mobile device using AirPrint

AirPrint is a mobile printing solution that allows you to print directly from Apple devices to an AirPrint-certified printer.

Note: This application is supported only in some Apple devices.

- 1 From the home screen of your mobile device, launch a compatible application.
- 2 Select an item to print, and then tap the share icon.
- 3 Tap **Print**, and then select the printer.
- 4 Send the print job.

Printing from a mobile device using Lexmark Mobile Print

Lexmark™ Mobile Print allows you to send documents and images directly to a supported Lexmark printer.

- 1 Open the document, and then send or share the document to Lexmark Mobile Print.

Note: Some third-party applications may not support the send or share feature. For more information, see the documentation that came with the application.

- 2 Select a printer.
- 3 Print the document.

Canceling a print job

Canceling a print job from the computer

For Windows users

- 1 Open the printers folder, and then select your printer.
- 2 From the print queue, select the print job you want to cancel, and then delete it.

For Macintosh users

- 1 From System Preferences in the Apple menu, navigate to your printer.
- 2 From the print queue, select the print job you want to cancel, and then delete it.

Understanding the printer menus

To print a menus list, see [“Printing a menu settings and network setup page” on page 23.](#)

To access the printer menus, use:

- The Embedded Web Server if the printer is connected to a network.
- The Local Printer Settings Utility for Windows or Printer Settings for Macintosh if the printer is connected to a computer by USB or parallel cable.

Menus list

Paper Menu

- Default Source
- Paper Size/Type
- Configure MP
- Paper Texture
- Paper Weight
- Paper Loading
- Custom Types

Settings

- General Settings
- Print Settings

Network/Ports

- Standard USB

Security

- Set Date and Time

Paper menu

Default Source menu

Use	To
Default Source Tray [x] MP Feeder Manual Paper Manual Envelope	Set a default paper source for all print jobs. Notes: <ul style="list-style-type: none"> • Tray 1 (standard tray) is the factory default setting. • From the Paper menu, set Configure MP to "Cassette" for MP Feeder to appear as a menu setting. • If two trays contain paper of the same size and type, and the trays have the same settings, then the trays are automatically linked. When one tray is empty, the print job continues using the linked tray.

Paper Size/Type menu

Use	To
<p>Tray [x] Size</p> <ul style="list-style-type: none"> A4 A5 A6 JIS-B5 Letter Legal Executive Oficio (Mexico) Folio Statement Universal 	<p>Specify the paper size loaded in each tray.</p> <p>Notes:</p> <ul style="list-style-type: none"> • Letter is the US factory default setting. A4 is the international factory default setting. • If two trays contain paper of the same size and type, and the trays have the same settings, then the trays are automatically linked. When one tray is empty, the print job continues using the linked tray. • The A6 paper size is supported only in Tray 1 and the multipurpose feeder.
<p>Tray [x] Type</p> <ul style="list-style-type: none"> Plain Paper Transparency Recycled Labels Bond Letterhead Preprinted Colored Paper Light Paper Heavy Paper Rough/Cotton Custom Type [x] 	<p>Specify the type of paper loaded in each tray.</p> <p>Notes:</p> <ul style="list-style-type: none"> • Plain Paper is the factory default setting for Tray 1. Custom Type [x] is the factory default setting for all other trays. • If available, a user-defined name will appear instead of Custom Type [x]. • Use this menu to configure automatic tray linking.
<p>Note: Only installed trays and feeders are listed in this menu.</p>	

Use	To
<p>MP Feeder Size</p> <ul style="list-style-type: none"> A4 A5 A6 JIS B5 Letter Legal Executive Oficio (Mexico) Folio Statement Universal 7 3/4 Envelope 9 Envelope 10 Envelope DL Envelope C5 Envelope B5 Envelope Other Envelope 	<p>Specify the paper size loaded in the multipurpose feeder.</p> <p>Notes:</p> <ul style="list-style-type: none"> • Letter is the US factory default setting. A4 is the international factory default setting. • From the Paper menu, set Configure MP to “Cassette” for MP Feeder Size to appear as a menu. • The multipurpose feeder does not automatically detect paper size. Make sure to set the paper size value.
<p>MP Feeder Type</p> <ul style="list-style-type: none"> Plain Paper Card Stock Transparency Recycled Labels Bond Envelope Rough Envelope Letterhead Preprinted Colored Paper Light Paper Heavy Paper Rough/Cotton Custom Type [x] 	<p>Specify the type of paper loaded in the multipurpose feeder.</p> <p>Notes:</p> <ul style="list-style-type: none"> • Plain Paper is the factory default setting. • From the Paper menu, set Configure MP to “Cassette” for MP Feeder Type to appear as a menu.
<p>Note: Only installed trays and feeders are listed in this menu.</p>	

Use	To
<p>Manual Paper Size</p> <ul style="list-style-type: none"> A4 A5 A6 JIS B5 Letter Legal Executive Oficio (Mexico) Folio Statement Universal 	<p>Specify the paper size being manually loaded.</p> <p>Note: Letter is the US factory default setting. A4 is the international factory default setting.</p>
<p>Manual Paper Type</p> <ul style="list-style-type: none"> Plain Paper Card Stock Transparency Recycled Labels Bond Letterhead Preprinted Colored Paper Light Paper Heavy Paper Rough/Cotton Custom Type [x] 	<p>Specify the paper type being manually loaded.</p> <p>Notes:</p> <ul style="list-style-type: none"> • Plain Paper is the factory default setting. • From the Paper menu, set Configure MP to “Manual” for Manual Paper Type to appear as a menu.
<p>Manual Envelope Size</p> <ul style="list-style-type: none"> 7 3/4 Envelope 9 Envelope 10 Envelope DL Envelope C5 Envelope B5 Envelope Other Envelope 	<p>Specify the envelope size being manually loaded.</p> <p>Note: 10 Envelope is the US factory default setting. DL Envelope is the international factory default setting.</p>
<p>Manual Envelope Type</p> <ul style="list-style-type: none"> Envelope Rough Envelope Custom Type [x] 	<p>Specify the envelope type being manually loaded.</p> <p>Note: Envelope is the factory default setting.</p>
<p>Note: Only installed trays and feeders are listed in this menu.</p>	

Configure MP menu

Use	To
<p>Configure MP</p> <ul style="list-style-type: none"> Cassette Manual First 	<p>Determine when the printer selects paper from the multipurpose feeder.</p> <p>Notes:</p> <ul style="list-style-type: none"> • Cassette is the factory default setting. Cassette configures the multipurpose feeder as the default paper source. • Manual sets the multipurpose feeder only for manual-feed print jobs. • First sets the multipurpose feeder as the primary paper source regardless of settings.

Paper Texture menu

Use	To
<p>Plain Texture</p> <ul style="list-style-type: none"> Smooth Normal Rough 	<p>Specify the relative texture of the plain paper loaded.</p> <p>Note: Normal is the factory default setting.</p>
<p>Card Stock Texture</p> <ul style="list-style-type: none"> Smooth Normal Rough 	<p>Specify the relative texture of the card stock loaded.</p> <p>Notes:</p> <ul style="list-style-type: none"> • Normal is the factory default setting. • The options appear only if card stock is supported.
<p>Transparency Texture</p> <ul style="list-style-type: none"> Smooth Normal Rough 	<p>Specify the relative texture of the transparencies loaded.</p> <p>Note: Normal is the factory default setting.</p>
<p>Recycled Texture</p> <ul style="list-style-type: none"> Smooth Normal Rough 	<p>Specify the relative texture of the recycled paper loaded.</p> <p>Note: Normal is the factory default setting.</p>
<p>Labels Texture</p> <ul style="list-style-type: none"> Smooth Normal Rough 	<p>Specify the relative texture of the labels loaded.</p> <p>Note: Normal is the factory default setting.</p>
<p>Bond Texture</p> <ul style="list-style-type: none"> Smooth Normal Rough 	<p>Specify the relative texture of the bond paper loaded.</p> <p>Note: Rough is the factory default setting.</p>
<p>Envelope Texture</p> <ul style="list-style-type: none"> Smooth Normal Rough 	<p>Specify the relative texture of the envelopes loaded.</p> <p>Note: Normal is the factory default setting.</p>

Use	To
Rough Envelope Texture Rough	Specify the relative texture of the rough envelopes loaded.
Letterhead Texture Smooth Normal Rough	Specify the relative texture of the letterhead loaded. Note: Normal is the factory default setting.
Preprinted Texture Smooth Normal Rough	Specify the relative texture of the preprinted paper loaded. Note: Normal is the factory default setting.
Colored Texture Smooth Normal Rough	Specify the relative texture of the colored paper loaded. Note: Normal is the factory default setting.
Light Texture Smooth Normal Rough	Specify the relative texture of the paper loaded. Note: Normal is the factory default setting.
Heavy Texture Smooth Normal Rough	Specify the relative texture of the paper loaded. Note: Normal is the factory default setting.
Rough/Cotton Texture Rough	Specify the relative texture of the cotton paper loaded.
Custom [x] Texture Smooth Normal Rough	Specify the relative texture of the custom paper loaded. Notes: <ul style="list-style-type: none"> • Normal is the factory default setting. • The options appear only if the custom type is supported.

Paper Weight menu

Use	To
Plain Weight Light Normal Heavy	Specify the relative weight of the plain paper loaded. Note: Normal is the factory default setting.
Card Stock Weight Light Normal Heavy	Specify the relative weight of the card stock loaded. Note: Normal is the factory default setting.

Use	To
Transparency Weight Light Normal Heavy	Specify the relative weight of the transparencies loaded. Note: Normal is the factory default setting.
Recycled Weight Light Normal Heavy	Specify the relative weight of the recycled paper loaded. Note: Normal is the factory default setting.
Labels Weight Light Normal Heavy	Specify the relative weight of the labels loaded. Note: Normal is the factory default setting.
Bond Weight Light Normal Heavy	Specify the relative weight of the bond paper loaded. Note: Normal is the factory default setting.
Envelope Weight Light Normal Heavy	Specify the relative weight of the envelope loaded. Note: Normal is the factory default setting.
Rough Envelope Weight Light Normal Heavy	Specify the relative weight of the rough envelope loaded. Note: Normal is the factory default setting.
Letterhead Weight Light Normal Heavy	Specify the relative weight of the letterhead loaded. Note: Normal is the factory default setting.
Preprinted Weight Light Normal Heavy	Specify the relative weight of the preprinted paper loaded. Note: Normal is the factory default setting.
Colored Weight Light Normal Heavy	Specify the relative weight of the colored paper loaded. Note: Normal is the factory default setting.
Light Weight Light	Specify that the weight of the paper loaded is light.
Heavy Weight Heavy	Specify that the weight of the paper loaded is heavy.

Use	To
Rough/Cotton Weight Light Normal Heavy	Specify the relative weight of the cotton or rough paper loaded. Note: Heavy is the factory default setting.
Custom [x] Weight Light Normal Heavy	Specify the relative weight of the custom paper loaded. Notes: <ul style="list-style-type: none"> • Normal is the factory default setting. • The options appear only when the custom type is supported.

Paper Loading menu

Use	To
Recycled Loading Duplex Off	Determine and set two-sided printing for all print jobs that specify Recycled as the paper type.
Bond Loading Duplex Off	Determine and set two-sided printing for all print jobs that specify Bond as the paper type.
Letterhead Loading Duplex Off	Determine and set two-sided printing for all print jobs that specify Letterhead as the paper type.
Preprinted Loading Duplex Off	Determine and set two-sided printing for all print jobs that specify Preprinted as the paper type.
Colored Loading Duplex Off	Determine and set two-sided printing for all print jobs that specify Colored as the paper type.
Light Loading Duplex Off	Determine and set two-sided printing for all print jobs that specify Light as the paper type.
Heavy Loading Duplex Off	Determine and set two-sided printing for all print jobs that specify Heavy as the paper type.
Notes: <ul style="list-style-type: none"> • Duplex sets two-sided printing as the default for all print jobs unless one-sided printing is set from Printing Preferences or Print dialog. • If Duplex is selected, then all print jobs are sent through the duplex unit, including one-sided jobs. • Off is the factory default setting for all the menus. 	

Use	To
<p>Custom [x] Loading</p> <ul style="list-style-type: none"> Duplex Off 	<p>Determine and set two-sided printing for all print jobs that specify Custom [x] as the paper type.</p> <p>Note: Custom [x] Loading is available only if the custom type is supported.</p>
<p>Notes:</p> <ul style="list-style-type: none"> • Duplex sets two-sided printing as the default for all print jobs unless one-sided printing is set from Printing Preferences or Print dialog. • If Duplex is selected, then all print jobs are sent through the duplex unit, including one-sided jobs. • Off is the factory default setting for all the menus. 	

Custom Types menu

Use	To
<p>Custom Type [x]</p> <ul style="list-style-type: none"> Paper Card Stock Transparency Rough/Cotton Labels Envelope 	<p>Associate a paper or specialty media type with a Custom Type [x] name.</p> <p>Notes:</p> <ul style="list-style-type: none"> • Paper is the factory default setting for Custom Type [x]. • The specialty media type must be supported in the selected tray or feeder in order to print from that source.
<p>Recycled</p> <ul style="list-style-type: none"> Paper Card Stock Transparency Rough/Cotton Labels Envelope Cotton 	<p>Specify a paper type when the Recycled setting is selected in other menus.</p> <p>Notes:</p> <ul style="list-style-type: none"> • Paper is the factory default setting. • The Recycled paper type must be supported in the selected tray or feeder in order to print from that source.

Network/Ports menu

Standard USB menu

Use	To
<p>PCL SmartSwitch</p> <p>On Off</p>	<p>Set the printer to automatically switch to PCL emulation when a print job received through a USB port requires it, regardless of the default printer language.</p> <p>Notes:</p> <ul style="list-style-type: none"> • On is the factory default setting. • If PCL SmartSwitch is enabled, then the printer uses PCL emulation. • If PCL SmartSwitch is disabled, then the printer does not examine incoming data and it uses the default printer language specified in the Setup menu.
<p>PS SmartSwitch</p> <p>On Off</p>	<p>Set the printer to automatically switch to PS emulation when a print job received through a USB port requires it, regardless of the default printer language.</p> <p>Notes:</p> <ul style="list-style-type: none"> • On is the factory default setting. • If PS SmartSwitch is enabled, then the printer uses PostScript emulation. • If PS SmartSwitch is disabled, then the printer does not examine incoming data and it uses the default printer language specified in the Setup menu.
<p>USB Buffer</p> <p>Disabled Auto 3K to [maximum size allowed]</p>	<p>Set the size of the USB input buffer.</p> <p>Notes:</p> <ul style="list-style-type: none"> • Auto is the factory default setting. • Disabled turns off job buffering. • The USB buffer size value can be changed in 1KB increments. • The maximum size allowed depends on the amount of memory in the printer, the size of the other link buffers, and whether Resource Save is set to On or Off. • To increase the maximum size range for the USB Buffer, disable or reduce the size of the parallel, serial, and network buffers. • The printer automatically restarts when the setting is changed. The menu selection is then updated.

Settings menu

General Settings menu

Use	To
Display Language English Francais Deutsch Italiano Espanol Dansk Norsk Nederlands Svenska Portuguese Suomi Russian Polski Greek Magyar Turkce Cesky Simplified Chinese Traditional Chinese Korean Japanese	Set the language of the text that appears on the display. Note: Not all languages are available for all models. You may need to install special hardware for some languages.
Show Supply Estimates Show estimates Do not show estimates	View supplies estimates on the control panel, Embedded Web Server, menu settings, and device statistics reports.
Eco-Mode Off Energy Energy/Paper Paper	Minimize the use of energy, paper, or specialty media. Notes: <ul style="list-style-type: none"> • Off is the factory default setting. This setting resets the printer to its factory default settings. • Setting Eco-Mode to Energy or Paper may affect printer performance, but not print quality.
Quiet Mode Off On	Reduce the printer noise. Note: Off is the factory default setting.
¹ This menu item appears only in touch-screen printer models.	
² This menu item appears only in non-touch-screen printer models.	

Use	To
Run Initial Setup Yes No	Run the setup wizard.
Keyboard¹ Keyboard Type English Francais Francais Canadien Deutsch Italiano Espanol Greek Dansk Norsk Nederlands Svenska Suomi Portuguese Russian Polski Swiss German Swiss French Korean Magyar Turkce Cesky Simplified Chinese Traditional Chinese Japanese Custom Key [x]	Specify a language and custom key information for the keyboard on the display.
Paper Sizes US Metric	Specify the unit of measurement for paper sizes. Notes: <ul style="list-style-type: none"> • US is the factory default setting. • The country or region that you selected in the initial setup wizard determines the initial paper size setting.
¹ This menu item appears only in touch-screen printer models. ² This menu item appears only in non-touch-screen printer models.	

Use	To
<p>Displayed Information¹ Left side Right side</p>	<p>Specify the display information in the upper corners of the home screen. Select from the following options: None IP Address Hostname Contact Name Location Date/Time mDNS/DDNS Service Name Zero Configuration Name Custom Text [x] Model Name</p> <p>Notes:</p> <ul style="list-style-type: none"> • IP Address is the factory default setting for Left side. • Date/Time is the factory default setting for Right side.
<p>Displayed Information¹ Custom Text [x]</p>	<p>Specify the text to display in the upper corners of the home screen. Note: You can type up to 32 characters.</p>
<p>Displayed Information (continued)¹ Black Toner</p>	<p>Specify the display information for Black Toner. Select from the following options: When to display Do not display Display Message to display Default Alternate Default [text entry] Alternate [text entry]</p> <p>Notes:</p> <ul style="list-style-type: none"> • Do not display is the factory default setting for When to display. • Default is the factory default setting for Message to display.

¹ This menu item appears only in touch-screen printer models.
² This menu item appears only in non-touch-screen printer models.

Use	To
<p>Displayed Information (continued)¹ Paper Jam Load Paper Service Errors</p>	<p>Customize the display information for certain menus. Select from the following options:</p> <ul style="list-style-type: none"> Display <ul style="list-style-type: none"> Yes No Message to display <ul style="list-style-type: none"> Default Alternate Default <ul style="list-style-type: none"> [text entry] Alternate <ul style="list-style-type: none"> [text entry] <p>Notes:</p> <ul style="list-style-type: none"> • No is the factory default setting for Display. • Default is the factory default setting for Message to display.
<p>Home screen customization Change Language Search Held Jobs Held Jobs USB Drive Profiles and Solutions¹ Bookmarks¹ Jobs by User¹ Forms and Favorites¹</p>	<p>Change the icons that appear on the home screen. Select from the following options:</p> <ul style="list-style-type: none"> Display Do not display
<p>Date Format¹ MM-DD-YYYY DD-MM-YYYY YYYY-MM-DD</p>	<p>Format the printer date. Note: MM-DD-YYYY is the U.S. factory default setting. DD-MM-YYYY is the international factory default setting.</p>
<p>Time Format¹ 12 hour A.M./P.M. 24 hour clock</p>	<p>Format the printer time. Note: 12 hour A.M./P.M. is the factory default setting.</p>
<p>Screen Brightness¹ 20–100</p>	<p>Specify the brightness of the display. Note: 100 is the factory default setting.</p>
<p>Audio Feedback¹ Button Feedback <ul style="list-style-type: none"> On Off Speaker Volume 1–10</p>	<p>Set button volume and feedback. Notes:</p> <ul style="list-style-type: none"> • On is the factory default setting for Button Feedback. • 5 is the factory default setting for Speaker Volume.

¹ This menu item appears only in touch-screen printer models.

² This menu item appears only in non-touch-screen printer models.

Use	To
<p>Show Bookmarks¹ Yes No</p>	<p>Specify whether to display Bookmarks from the Held Jobs area. Note: Yes is the factory default setting.</p>
<p>Web Page Refresh Rate¹ 30–300</p>	<p>Specify the number of seconds between Embedded Web Server refreshes. Note: 120 is the factory default setting.</p>
<p>Contact Name¹</p>	<p>Specify a contact name for the printer. Note: The contact name is stored on the Embedded Web Server.</p>
<p>Location¹</p>	<p>Specify the printer location. Note: The location is stored on the Embedded Web Server.</p>
<p>Alarms¹ Alarm Control Cartridge Alarm</p>	<p>Set an alarm when the printer requires user intervention. Select from the following options: Off Single Continuous Notes:</p> <ul style="list-style-type: none"> • Single is the factory default setting for Alarm Control. • Off is the factory default setting for Cartridge Alarm.
<p>Timeouts Standby Mode¹ Disabled 1–240</p>	<p>Set the duration of idle time before the printer enters a lower power state. Note: 15 minutes is the factory default setting.</p>
<p>Timeouts Sleep Mode Disabled 1–120</p>	<p>Set the idle time before the printer begins operating in Sleep Mode. Notes:</p> <ul style="list-style-type: none"> • 20 minutes is the factory default setting. • Disabled appears only when Energy Conserve is set to Off. • Lower settings conserve more energy, but may require longer warm-up times.
<p>Timeouts Print with Display Off Allow printing with display off Display on when printing</p>	<p>Print a job with the display turned off. Note: Display on when printing is the factory default setting.</p>
<p>¹ This menu item appears only in touch-screen printer models. ² This menu item appears only in non-touch-screen printer models.</p>	

Use	To
<p>Timeouts</p> <p>Hibernate Timeout</p> <ul style="list-style-type: none"> Disabled 20 minutes 1 hour 2 hours 3 hours 6 hours 1 day 2 days 3 days 1 week 2 weeks 1 month 	<p>Set the time before the printer enters Hibernate mode.</p> <p>Note: 3 days is the factory default setting.</p>
<p>Timeouts</p> <p>Hibernate Timeout on Connection</p> <ul style="list-style-type: none"> Hibernate Do Not Hibernate 	<p>Set the printer to Hibernate mode even if there is an active Ethernet connection.</p> <p>Note: Hibernate is the factory default setting.</p>
<p>Timeouts</p> <p>Screen Timeout</p> <p>15 sec–300 sec</p>	<p>Set the idle time before the display automatically returns to Ready state.</p> <p>Note: 30 seconds is the factory default setting.</p>
<p>Timeouts</p> <p>Prolong Screen Timeout¹</p> <ul style="list-style-type: none"> On Off 	<p>Remain in the same location and reset the Screen Timeout timer instead of returning to the home screen.</p> <p>Note: Off is the factory default setting.</p>
<p>Timeouts</p> <p>Print Timeout</p> <ul style="list-style-type: none"> Disabled 1 sec–255 sec 	<p>Set the printer to end a print job after it has been idle for the specified amount of time.</p> <p>Notes:</p> <ul style="list-style-type: none"> • 90 seconds is the factory default setting. • When the timer expires, any partially printed page still in the printer is printed. • Print Timeout is available only when using PCL emulation.
<p>Timeouts</p> <p>Wait Timeout</p> <ul style="list-style-type: none"> Disabled 15 sec–65535 sec 	<p>Set the time the printer waits to receive data from the host.</p> <p>Notes:</p> <ul style="list-style-type: none"> • 40 seconds is the factory default setting. • Wait Timeout is available only when the printer is using PostScript emulation.

¹ This menu item appears only in touch-screen printer models.

² This menu item appears only in non-touch-screen printer models.

Use	To
<p>Timeouts</p> <p>Job Hold Timeout¹ 5 sec–255 sec</p>	<p>Set the time the printer waits for user intervention before it holds jobs that require unavailable resources.</p> <p>Notes:</p> <ul style="list-style-type: none"> • 30 seconds is the factory default setting. • This menu item appears only when hard disk is installed.
<p>Error Recovery</p> <p>Auto Reboot Reboot when idle Reboot always Reboot never</p>	<p>Set the printer to restart when an error occurs.</p> <p>Note: Reboot always is the factory default setting.</p>
<p>Error Recovery</p> <p>Max Auto Reboots 1–20</p>	<p>Determine the number of automatic reboots that the printer can perform.</p> <p>Note: 2 is the factory default setting.</p>
<p>Print Recovery</p> <p>Auto Continue Disabled 5 sec –255 sec</p>	<p>Let the printer automatically continue printing from certain offline situations when these are not resolved within the specified time period.</p> <p>Note: Disabled is the factory default setting.</p>
<p>Print Recovery</p> <p>Jam Recovery On Off Auto</p>	<p>Specify whether the printer reprints jammed pages.</p> <p>Note: Auto is the factory default setting. The printer reprints jammed pages unless other printer tasks need the memory required to hold the pages.</p>
<p>Print Recovery</p> <p>Jam Assist On Off</p>	<p>Set the printer to check for jammed paper automatically.</p> <p>Note: On is the factory default setting.</p>
<p>Print Recovery</p> <p>Page Protect Off On</p>	<p>Set the printer to print the correct output for a page.</p> <p>Note: Off is the factory default setting.</p>
<p>Accessibility Settings¹</p> <p>Prolong Screen Timeout Off On</p>	<p>Remain in the same location and reset the Screen Timeout timer instead of returning to the home screen.</p> <p>Note: Off is the factory default setting.</p>

¹ This menu item appears only in touch-screen printer models.

² This menu item appears only in non-touch-screen printer models.

Use	To
<p>Accessibility Settings¹</p> <ul style="list-style-type: none"> Speech Rate <ul style="list-style-type: none"> Very Slow Slow Normal Fast Faster Very Fast Rapid Very Rapid Fastest 	<p>Adjust the Voice Guidance speaking rate.</p> <p>Note: Normal is the factory default setting.</p>
<p>Accessibility Settings¹</p> <ul style="list-style-type: none"> Headphone Volume <ul style="list-style-type: none"> 1–10 	<p>Set the headphones volume.</p> <p>Note: 5 is the factory default setting.</p>
<p>Information Sent to Lexmark</p> <ul style="list-style-type: none"> Supplies and Page Usage (Anonymous) <ul style="list-style-type: none"> On Off 	<p>Send anonymous device usage information to Lexmark.</p> <p>Note: The default value depends on what you selected during the initial setup.</p>
<p>Information Sent to Lexmark</p> <ul style="list-style-type: none"> Device Performance (Anonymous) <ul style="list-style-type: none"> On Off 	<p>Send anonymous device function and error information to Lexmark.</p> <p>Note: The default value depends on what you selected during the initial setup.</p>
<p>Information Sent to Lexmark</p> <ul style="list-style-type: none"> Start Send Stop Send 	<p>Set the time for sending anonymous information to Lexmark.</p>
<p>Press Sleep Button</p> <ul style="list-style-type: none"> Do nothing Sleep Hibernate 	<p>Determine how the printer, while in idle state, reacts to a short press of the Sleep button.</p> <p>Note: Sleep is the factory default setting.</p>
<p>Press and Hold Sleep Button</p> <ul style="list-style-type: none"> Do nothing Sleep Hibernate 	<p>Determine how the printer, while in idle state, reacts to a long press of the Sleep button.</p> <p>Note: Do nothing is the factory default setting.</p>

¹ This menu item appears only in touch-screen printer models.

² This menu item appears only in non-touch-screen printer models.

Use	To
Factory Defaults Do Not Restore Restore Now	Restore the printer factory default settings. Notes: <ul style="list-style-type: none"> • Do Not Restore is the factory default setting. • Restore Now returns all printer settings to the factory default settings except Network/Ports menu settings. All downloads stored in the RAM are deleted. Downloads stored in the flash memory or on a hard disk are not affected.
Custom Home Message² Off IP Address Hostname Contact Name Location Zero Configuration Name Custom Text [x]	Select a custom home message that appears as an alternating display of the printer status. Note: Off is the factory default setting.
Export Configuration File¹ Export	Export configuration files to a flash drive.
¹ This menu item appears only in touch-screen printer models. ² This menu item appears only in non-touch-screen printer models.	

Print Settings

Setup menu

Use	To
Printer Language PCL Emulation PS Emulation	Set the default printer language. Notes: <ul style="list-style-type: none"> • PCL Emulation is the factory default setting. • PostScript emulation uses a PostScript interpreter for processing print jobs. • PCL Emulation uses a PCL interpreter for processing print jobs. • Setting a printer language default does not prevent a software program from sending print jobs that use another printer language.

Use	To
<p>Print Area</p> <ul style="list-style-type: none"> Normal Whole Page 	<p>Set the logical and physical printable area.</p> <p>Notes:</p> <ul style="list-style-type: none"> • Normal is the factory default setting. When attempting to print data on the non-printable area defined by the Normal setting, the printer clips the image at the boundary. • Whole Page allows the image to be moved into the non-printable area defined by the Normal setting. This setting affects only pages printed using a PCL 5 interpreter and has no effect on pages printed using the PCL XL or PostScript interpreter.
<p>Download Target</p> <ul style="list-style-type: none"> RAM Flash 	<p>Set the storage location for downloads.</p> <p>Notes:</p> <ul style="list-style-type: none"> • RAM is the factory default setting. Storing downloads in the RAM is temporary. • Storing downloads in a flash memory places them in permanent storage. Downloads remain in the flash memory even when the printer is turned off. • This menu item appears only when an optional flash memory is installed.
<p>Resource Save</p> <ul style="list-style-type: none"> On Off 	<p>Specify how the printer handles temporary downloads, such as fonts and macros stored in the RAM, when the printer receives a print job that requires more than the available memory.</p> <p>Notes:</p> <ul style="list-style-type: none"> • Off is the factory default setting. Off sets the printer to retain downloads only until memory is needed. Downloads are deleted in order to process print jobs. • On sets the printer to retain downloads during language changes and printer resets. If the printer runs out of memory, then Memory Full [38] appears on the printer display, but downloads are not deleted.

Finishing menu

Use	To
<p>Sides (Duplex) 1 sided 2 sided</p>	<p>Specify whether two-sided (duplex) printing is set as the default for all print jobs.</p> <p>Notes:</p> <ul style="list-style-type: none"> • “1 sided” is the factory default setting. • You can set two-sided printing from the software program. <p>For Windows users:</p> <ol style="list-style-type: none"> 1 Click File > Print. 2 Click Properties, Preferences, Options, or Setup. <p>For Macintosh users:</p> <ol style="list-style-type: none"> 1 Choose File > Print. 2 Adjust the settings from the print dialog and pop-up menus.
<p>Duplex Binding Long Edge Short Edge</p>	<p>Define the way two-sided pages are bound and printed.</p> <p>Notes:</p> <ul style="list-style-type: none"> • Long Edge is the factory default setting. Long Edge binds pages along their long edge (left edge for portrait and top edge for landscape). • Short Edge binds pages along their short edge (top edge for portrait and left edge for landscape).
<p>Copies 1–999</p>	<p>Specify the default number of copies for each print job.</p> <p>Note: 1 is the factory default setting.</p>
<p>Blank Pages Do Not Print Print</p>	<p>Specify whether to insert blank pages in a print job.</p> <p>Note: Do Not Print is the factory default setting.</p>
<p>Collate (1,1,1) (2,2,2) (1,2,3) (1,2,3)</p>	<p>Stack the pages of a print job in sequence when printing multiple copies.</p> <p>Note: “(1,2,3) (1,2,3)” is the factory default setting.</p>
<p>Separator Sheets Off Between Copies Between Jobs Between Pages</p>	<p>Specify whether to insert blank separator sheets.</p> <p>Notes:</p> <ul style="list-style-type: none"> • Off is the factory default setting. • Between Copies inserts a blank sheet between each copy of a print job if Collate is set to (1,1,1) (2,2,2). If Collate is set to (1,2,3) (1,2,3), then a blank page is inserted between each set of printed pages, such as after all page 2's and after all page 3's. • Between Jobs inserts a blank sheet between print jobs. • Between Pages inserts a blank sheet between each page of a print job. This setting is useful when printing transparencies or when inserting blank pages in a document.
<p>Separator Source Tray [x] Multi-Purpose Feeder</p>	<p>Specify the paper source for separator sheets.</p> <p>Note: Tray 1 (standard tray) is the factory default setting.</p>

Use	To
<p>Paper Saver</p> <p>Off</p> <p>2-Up</p> <p>3-Up</p> <p>4-Up</p> <p>6-Up</p> <p>9-Up</p> <p>12-Up</p> <p>16-Up</p>	<p>Print multiple-page images on one side of a paper.</p> <p>Notes:</p> <ul style="list-style-type: none"> • Off is the factory default setting. • The number selected is the number of page images that will print per side.
<p>Paper Saver Ordering</p> <p>Horizontal</p> <p>Reverse Horizontal</p> <p>Reverse Vertical</p> <p>Vertical</p>	<p>Specify the positioning of multiple-page images when using Paper Saver.</p> <p>Notes:</p> <ul style="list-style-type: none"> • Horizontal is the factory default setting. • Positioning depends on the number of page images and whether they are in portrait or landscape orientation.
<p>Paper Saver Orientation</p> <p>Auto</p> <p>Landscape</p> <p>Portrait</p>	<p>Specify the orientation of a multiple-page document.</p> <p>Note: Auto is the factory default setting. The printer chooses between portrait and landscape.</p>
<p>Paper Saver Border</p> <p>None</p> <p>Solid</p>	<p>Print a border when using Paper Saver.</p> <p>Note: None is the factory default setting.</p>

Quality menu

Use	To
<p>Print Resolution</p> <p>300 dpi</p> <p>600 dpi</p> <p>1200 dpi</p> <p>1200 Image Q</p> <p>2400 Image Q</p>	<p>Specify the printed output resolution in dots per inch.</p> <p>Note: 600 dpi is the factory default setting.</p>
<p>Pixel Boost</p> <p>Off</p> <p>Fonts</p> <p>Horizontally</p> <p>Vertically</p> <p>Both directions</p>	<p>Enable more pixels to print in clusters for clarity, in order to enhance images horizontally or vertically, or to enhance fonts.</p> <p>Note: Off is the factory default setting.</p>
<p>Toner Darkness</p> <p>1–10</p>	<p>Lighten or darken the printed output.</p> <p>Notes:</p> <ul style="list-style-type: none"> • 8 is the factory default setting. • Selecting a smaller number can help conserve toner.

Use	To
Enhance Fine Lines On Off	Enable a print mode preferable for files such as architectural drawings, maps, electrical circuit diagrams, and flow charts. Notes: <ul style="list-style-type: none"> • Off is the factory default setting. • You can set this option from the printer software. For Windows users, click File > Print, and then click Properties, Preferences, Options, or Setup. For Macintosh users, choose File > Print, and then adjust the settings from the Print dialog and context menus. • To set this option using the Embedded Web Server, type the network printer IP address in the Web browser address field.
Gray Correction Auto Off	Automatically adjust the contrast enhancement applied to images. Note: Auto is the factory default setting.
Brightness -6 to 6	Adjust the printed output either by lightening or darkening it. You can conserve toner by lightening the output. Note: 0 is the factory default setting.
Contrast 0–5	Adjust the contrast of printed objects. Note: 0 is the factory default setting.

PostScript menu

Use	To
Print PS Error On Off	Print a page containing the PostScript error. Note: Off is the factory default setting.

PCL Emul menu

Use	To
PCL Emulation Settings Orientation Portrait Landscape	Specify the orientation of text and graphics on the page. Notes: <ul style="list-style-type: none"> • Portrait is the factory default setting. Portrait prints text and graphics parallel to the short edge of the page. • Landscape prints text and graphics parallel to the long edge of the page.
PCL Emulation Settings Lines per Page 1–255	Specify the number of lines that print on each page. Notes: <ul style="list-style-type: none"> • 60 is the US factory default setting. 64 is the international default setting. • The printer sets the amount of space between each line based on the Lines per Page, Paper Size, and Orientation settings. Set Paper Size and Orientation before setting Lines per Page.

Use	To
<p>PCL Emulation Settings</p> <p>A4 Width</p> <p>198 mm</p> <p>203 mm</p>	<p>Set the printer to print on A4-size paper.</p> <p>Notes:</p> <ul style="list-style-type: none"> • 198 mm is the factory default setting. • The 203-mm setting sets the width of the page to allow printing of eighty 10-pitch characters.
<p>PCL Emulation Settings</p> <p>Auto CR after LF</p> <p>On</p> <p>Off</p>	<p>Specify whether the printer automatically performs a carriage return (CR) after a line feed (LF) control command.</p> <p>Note: Off is the factory default setting.</p>
<p>PCL Emulation Settings</p> <p>Auto LF after CR</p> <p>On</p> <p>Off</p>	<p>Specify whether the printer automatically performs a line feed (LF) after a carriage return (CR) control command.</p> <p>Note: Off is the factory default setting.</p>
<p>Tray Renumber</p> <p>Assign MP Feeder</p> <p>Off</p> <p>None</p> <p>0–199</p> <p>Assign Tray [x]</p> <p>Off</p> <p>None</p> <p>0–199</p> <p>Assign Manual Paper</p> <p>Off</p> <p>None</p> <p>0–199</p> <p>Assign Manual Env</p> <p>Off</p> <p>None</p> <p>0–199</p>	<p>Configure the printer to work with printer software or programs that use different source assignments for trays and feeders.</p> <p>Notes:</p> <ul style="list-style-type: none"> • Off is the factory default setting. • None cannot be selected. It is only displayed when it is selected by the PCL 5 interpreter. It also ignores the Select Paper Feed command. • 0–199 allows a custom setting to be assigned.
<p>Tray Renumber</p> <p>View Factory Defaults</p> <p>MPF Default = 8</p> <p>T1 Default = 1</p> <p>T1 Default = 4</p> <p>T1 Default = 5</p> <p>T1 Default = 20</p> <p>T1 Default = 21</p> <p>Env Default = 6</p> <p>MPaper Default = 2</p> <p>MEnv Default = 3</p>	<p>View the factory default setting assigned to each tray or feeder.</p>

Use	To
Tray Renumber Restore Defaults Yes No	Restore all tray and feeder assignments to the factory default settings.

Security menu

Set Date and Time menu

Use	To
Current Date and Time	View the current date and time settings for the printer.
Manually Set Date and Time [input date/time]	Enter the date and time. Note: Setting the date and time using this menu automatically sets Enable NTP to No.
Time Zone [list of time zones]	Select the time zone. Note: GMT is the factory default setting.
Automatically observe DST On Off	Set the printer to use the applicable daylight saving time (DST) start and end times associated with the printer Time Zone setting. Note: On is the factory default setting.
UTC (GMT) Offset [input time in minutes]	Set the time offset from Coordinated Universal Time or Greenwich Mean Time. Note: The setting applies only if you select “(UTC+user) Custom” as the time zone.
DST Start [list of weeks] [list of days] [list of months] [input time]	Set the DST start time. Note: The setting applies only if you select “(UTC+user) Custom” as the time zone.
DST End [list of weeks] [list of days] [list of months] [input time]	Set DST end time. Note: The setting applies only if you select “(UTC+user) Custom” as the time zone.
DST Offset [input time in minutes]	Set the DST offset time. Note: The setting applies only if you select “(UTC+user) Custom” as the time zone.

Saving money and the environment

Lexmark is committed to environmental sustainability and is continually improving its printers to reduce their impact on the environment. We design with the environment in mind, engineer our packaging to reduce materials, and provide collection and recycling programs. For more information, see:

- The Notices chapter
- The Environmental Sustainability section of the Lexmark Web site at www.lexmark.com/environment
- The Lexmark recycling program at www.lexmark.com/recycle

By selecting certain printer settings or tasks, you may be able to reduce your printer's impact even further. This chapter outlines the settings and tasks that may yield a greater environmental benefit.

Saving paper and toner

Using recycled paper

As an environmentally conscious company, Lexmark supports the use of recycled office paper produced specifically for use in laser/LED printers. For more information on recycled papers that work well with your printer, see [“Using recycled paper and other office papers” on page 38](#).

Conserving supplies

- Print on both sides of the paper.
Note: Two-sided printing is the default setting in the print driver.
- Print multiple pages on a single sheet of paper.
- Use the preview feature to see how the document looks like before printing it.
- Print one copy of the document to check its content and format for accuracy.

Saving energy

To configure the energy settings of your printer, use:

- The Embedded Web Server if it is connected to a network.
- The Local Printer Settings Utility for Windows or Printer Settings for Macintosh if it is connected to a computer by a USB or parallel cable.

Note: Some features are available only in some printer models.

Configuring Sleep and Hibernate modes

Sleep and Hibernate are low-power operating modes.

Notes:

- If your printer is connected directly to a computer, access the Sleep and Hibernate mode settings using the Local Printer Settings Utility or Printer Settings depending on your operating system.
- Three days is the default amount of time before the printer enters Hibernate mode.
- Wake the printer from Hibernate mode before sending a print job. A long press of the Sleep button wakes the printer from Hibernate mode.
- If the printer is in Hibernate mode, then the Embedded Web Server is disabled.

1 Open a Web browser, and then type the printer IP address in the address field.

Notes:

- Print a network setup page or menu settings page, and then locate the IP address in the TCP/IP section.
- If you are using a proxy server, then temporarily disable it to load the Web page correctly.

2 Click **Settings > General Settings > Sleep Button Settings**.

3 From the “Press Sleep Button” or “Press and Hold Sleep Button” menu, select **Sleep** or **Hibernate**.

4 Click **Submit**.

Adjusting Sleep mode

Using the Embedded Web Server

1 Open a Web browser, and then type the printer IP address in the address field.

Notes:

- Print a network setup page or menu settings page, and then locate the IP address in the TCP/IP section.
- If you are using a proxy server, then temporarily disable it to load the Web page correctly.

2 Click **Settings > General Settings > Timeouts**.

3 In the Sleep Mode field, enter the number of minutes you want the printer to wait before it enters Sleep Mode.

4 Click **Submit**.

Using the printer settings on the computer (Windows only)

- Access the Setup menu using the Local Printer Settings Utility.

Setting Hibernate Timeout

Hibernate Timeout lets you set the amount of time the printer waits after a print job is processed before it goes into a reduced power state.

Using the Embedded Web Server

- 1 Open a Web browser, and then type the printer IP address in the address field.

Notes:

- Print a network setup page or menu settings page, and then locate the IP address in the TCP/IP section. The IP address appears as four sets of numbers separated by periods, such as 123.123.123.123.
- If you are using a proxy server, then temporarily disable it to load the Web page correctly.

- 2 Click **Settings > General Settings > Timeouts**.

- 3 From the Hibernate Timeout menu, select the number of hours, days, weeks, or months you want for the printer to wait before it goes into a reduced power state.

- 4 Click **Submit**.

Using the printer settings on the computer

Depending on your operating system, access the Hibernate Timeout menu using the Local Printer Settings Utility or Print Settings.

Using Schedule Power Modes

Schedule Power Modes lets the user schedule when the printer goes into a reduced power state or into the Ready state.

Using the Embedded Web Server

- 1 Open a Web browser, and then type the printer IP address in the address field.

Notes:

- Print a network setup page or menu settings page, and then locate the IP address in the TCP/IP section. The IP address appears as four sets of numbers separated by periods, such as 123.123.123.123.
- If you are using a proxy server, then temporarily disable it to load the Web page correctly.

- 2 Click **Settings > General Settings > Schedule Power Modes**.

- 3 From the Action menu, select the power mode.

- 4 From the Time menu, select the time.

- 5 From the Day(s) menu, select the day or days.

- 6 Click **Add**.

Using the printer settings on the computer (Windows only)

- Access the Schedule Power Modes menu using the Local Printer Settings Utility.

Recycling

Lexmark provides collection programs and environmentally progressive approaches to recycling. For more information, see:

- The Notices chapter
- The Environmental Sustainability section of the Lexmark Web site at www.lexmark.com/environment
- The Lexmark recycling program at www.lexmark.com/recycle

Recycling Lexmark products

To return Lexmark products for recycling:

- 1 Go to www.lexmark.com/recycle.
- 2 Select the product you want to recycle.

Note: Printer supplies and hardware not listed in the Lexmark Collection and Recycling Program may be recycled through your local recycling center.

Recycling Lexmark packaging

Lexmark continually strives to minimize packaging. Less packaging helps to ensure that Lexmark printers are transported in the most efficient and environmentally sensitive manner and that there is less packaging to dispose of. These efficiencies result in fewer greenhouse emissions, energy savings, and natural resource savings. Lexmark also offers recycling of packaging components in some countries or regions. For more information, go to www.lexmark.com/recycle, and then choose your country or region. Information on available packaging recycling programs is included with the information on product recycling.

Lexmark cartons are 100% recyclable where corrugated recycling facilities exist. Facilities may not exist in your area.

The foam used in Lexmark packaging is recyclable where foam recycling facilities exist. Facilities may not exist in your area.

When you return a cartridge to Lexmark, you can reuse the box that the cartridge came in. Lexmark recycles the box.

Returning Lexmark cartridges for reuse or recycling

The Lexmark Cartridge Collection Program allows you to return used cartridges for free to Lexmark for reuse or recycling. One hundred percent of the empty cartridges returned to Lexmark are either reused or demanufactured for recycling. The boxes used to return the cartridges are also recycled.

To return Lexmark cartridges for reuse or recycling, do the following:

- 1 Go to www.lexmark.com/recycle.
- 2 Select the product that you want to recycle.

Securing the printer

Using the security lock feature

The printer is equipped with a security lock feature. Attach a security lock compatible with most laptop computers in the location shown to secure the printer in place.



Statement of Volatility

Your printer contains various types of memory that can store device and network settings, and user data.

Type of memory	Description
Volatile memory	Your printer uses standard <i>random access memory</i> (RAM) to temporarily buffer user data during simple print jobs.
Non-volatile memory	Your printer may use two forms of non-volatile memory: EEPROM and NAND (flash memory). Both types are used to store operating system, device settings, and network information.



Erase the content of any installed printer memory in the following circumstances:

- The printer is being decommissioned.
- The printer is being moved to a different department or location.
- The printer is being serviced by someone from outside your organization.
- The printer is being removed from your premises for service.
- The printer is being sold to another organization.



Erasing volatile memory

The volatile memory (RAM) installed in your printer requires a power source to retain information. To erase the buffered data, simply turn off the printer.

Erasing non-volatile memory

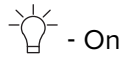
- 1 Turn off the printer.
- 2 Open the front door of the printer and hold down  while turning the printer on. Release  only when the printer control panel light sequence matches the light sequence in the following illustration.



- 3 Press  until the printer control panel light sequence matches the light sequence in the following illustration, and then press .



 - Blinking

 - Blinking

The printer will restart several times during this process.

Note: Wipe All Settings securely removes device settings, jobs, and passwords from the printer memory.

- 4 Close the front door.

Finding printer security information

In high-security environments, it may be necessary to take additional steps to make sure that confidential data stored in the printer cannot be accessed by unauthorized persons. For more information, go to the [Lexmark security Web page](#) or see the *Embedded Web Server—Security: Administrator's Guide* at <http://support.lexmark.com>.

Maintaining the printer

Warning—Potential Damage: Failure to maintain optimum printer performance periodically, or to replace parts and supplies, may cause damage to your printer.

Cleaning the printer

 **CAUTION—SHOCK HAZARD:** To avoid the risk of electrical shock when cleaning the exterior of the printer, unplug the power cord from the electrical outlet and disconnect all cables from the printer before proceeding.

Notes:

- Perform this task after every few months.
- Damage to the printer caused by improper handling is not covered by the printer warranty.

- 1 Turn off the printer, and then unplug the power cord from the electrical outlet.
- 2 Remove paper from the standard bin and multipurpose feeder.
- 3 Remove any dust, lint, and pieces of paper around the printer using a soft brush or vacuum.
- 4 Wipe the outside of the printer with a damp, soft, lint-free cloth.

Notes:

- Do not use household cleaners or detergents, as they may damage the finish of the printer.
- Make sure that all areas of the printer are dry after cleaning.

- 5 Connect the power cord to the electrical outlet, and then turn on the printer.

 **CAUTION—POTENTIAL INJURY:** To avoid the risk of fire or electrical shock, connect the power cord to an appropriately rated and properly grounded electrical outlet that is near the product and easily accessible.

Checking the status of parts and supplies

Checking the status of parts and supplies

Note: Make sure the computer and printer are connected to the same network.

Using the Embedded Web Server

- 1 Open a Web browser, and then type the printer IP address in the address field.

Notes:

- Print a network setup or menu settings page, and then locate the IP address in the TCP/IP section. The IP address appears as four sets of numbers separated by periods, such as 123.123.123.123.
- If you are using a proxy server, then temporarily disable it to load the Web page correctly.

- 2 Click **Device Status > More Details**.

Using the printer control panel

From the printer control panel, press , and then check the supply and part status in the Supply Information section.

Estimated number of remaining pages

The estimated number of remaining pages is based on the recent printing history of the printer. Its accuracy may vary significantly and is dependent on many factors, such as actual document content, print quality settings, and other printer settings.

The accuracy of the estimated number of remaining pages may decrease when the actual printing consumption is different from the historical printing consumption. Consider the variable level of accuracy before purchasing or replacing supplies based on the estimate. Until an adequate print history is obtained on the printer, initial estimates assume future supplies consumption based on the International Organization for Standardization* test methods and page content.

* Average continuous black declared cartridge yield in accordance with ISO/IEC 19752.

Ordering supplies

To order supplies in the U.S., contact Lexmark at 1-800-539-6275 for information about Lexmark authorized supplies dealers in your area. In other countries or regions, go to www.lexmark.com or contact the place where you purchased the printer.

Note: All life estimates for printer supplies assume printing on letter- or A4-size plain paper.

Using genuine Lexmark parts and supplies

Your Lexmark printer is designed to function best with genuine Lexmark supplies and parts. Use of third-party supplies or parts may affect the performance, reliability, or life of the printer and its imaging components. Use of third-party supplies or parts can affect warranty coverage. Damage caused by the use of third-party supplies or parts is not covered by the warranty. All life indicators are designed to function with Lexmark supplies and parts, and may deliver unpredictable results if third-party supplies or parts are used. Imaging component usage beyond the intended life may damage your Lexmark printer or its associated components.

Ordering toner cartridges

Notes:

- The estimated cartridge yield is based on the ISO/IEC 19752 standard.
- Extremely low print coverage for extended periods of time may negatively affect actual yield.

Item	Return Program cartridge
For the United States and Canada	
Toner Cartridge	501
High Yield Toner Cartridge	501H
Extra High Yield Toner Cartridge	501X ¹
Ultra High Yield Toner Cartridge	501U ²
For the European Union, European Economic Area , and Switzerland	
Toner Cartridge	502
High Yield Toner Cartridge	502H
Extra High Yield Toner Cartridge	502X ¹
Ultra High Yield Toner Cartridge	502U ²
For the Asia Pacific Region (includes Australia and New Zealand)	
Toner Cartridge	503
High Yield Toner Cartridge	503H
Extra High Yield Toner Cartridge	503X ¹
Ultra High Yield Toner Cartridge	503U ²
For Latin America (includes Puerto Rico and Mexico)	
Toner Cartridge	504
High Yield Toner Cartridge	504H
Extra High Yield Toner Cartridge	504X ¹
Ultra High Yield Toner Cartridge	504U ²
For Africa, Middle East, Central Eastern Europe, and Commonwealth of Independent States	
Toner Cartridge	505
High Yield Toner Cartridge	505H
Extra High Yield Toner Cartridge	505X ¹
Ultra High Yield Toner Cartridge	505U ²
¹ This cartridge is supported only in MS410d, MS410dn, MS510dn, MS610dn, and MS610de printer models. ² This cartridge is supported only in MS510dn, MS610dn, and MS610de printer models. For more information on countries located in each region, visit www.lexmark.com/regions .	

Item	Regular cartridge
Worldwide	
High Yield Toner Cartridge	500HA ¹
¹ This cartridge is supported only in MS310d and MS310dn printer models. ² This cartridge is supported only in MS410d and MS410dn printer models. ³ This cartridge is supported only in MS510dn, MS610dn, and MS610de printer models.	

Item	Regular cartridge
Extra High Yield Toner Cartridge	500XA ²
Ultra High Yield Toner Cartridge	500UA ³
¹ This cartridge is supported only in MS310d and MS310dn printer models. ² This cartridge is supported only in MS410d and MS410dn printer models. ³ This cartridge is supported only in MS510dn, MS610dn, and MS610de printer models.	

Ordering an imaging unit

Extremely low print coverage for extended periods of time may cause imaging unit parts to fail prior to exhaustion of toner from toner cartridge.

For more information on replacing the imaging unit, see the instruction sheet that came with the supply.

Part name	Lexmark Return Program	Regular
Imaging unit	500Z	500ZA

Storing supplies

Choose a cool, clean storage area for the printer supplies. Store supplies right side up in their original packing until you are ready to use them.

Do not expose supplies to:

- Direct sunlight
- Temperatures above 35°C (95°F)
- High humidity above 80%
- Salty air
- Corrosive gases
- Heavy dust

Replacing supplies

Replacing the toner cartridge

- 1 Press the button on the right side of the printer, and then open the front door.

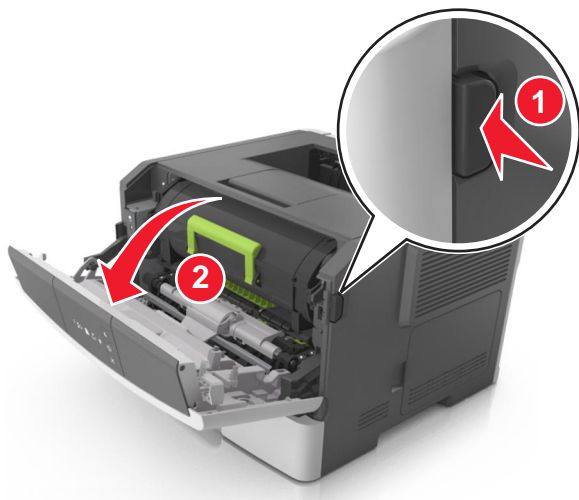

- 2 Pull the toner cartridge out using the handle.



- 3 Unpack the toner cartridge, and then remove all packing materials.

- 4 Shake the new cartridge to redistribute the toner.

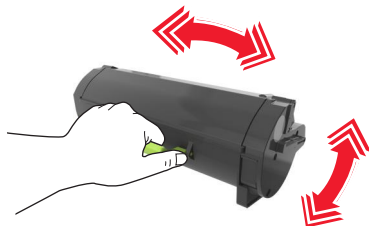

- 5 Insert the toner cartridge into the printer by aligning the side rails of the cartridge with the arrows on the side rails inside the printer.

Warning—Potential Damage: Do not expose the imaging unit to direct light for more than 10 minutes. Extended exposure to light may cause print quality problems.

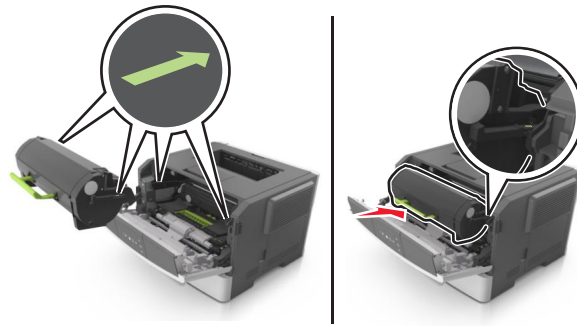

6 Close the front door.

Replacing the imaging unit

1 Press the button on the right side of the printer, and then open the front door.

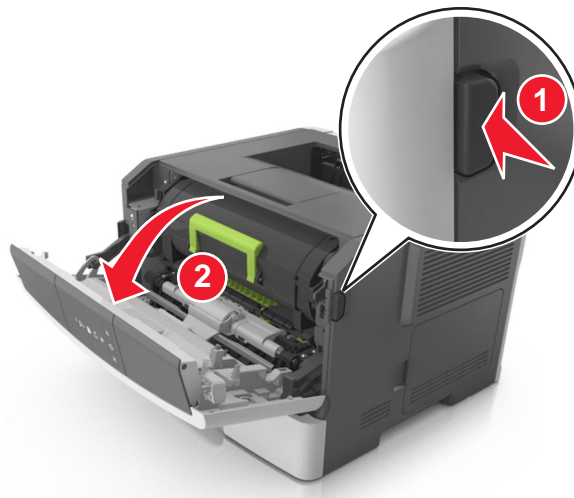

2 Pull the toner cartridge out using the handle.

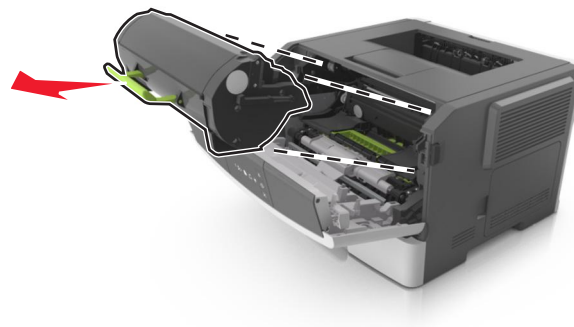

- 3 Lift the green handle, and then pull the imaging unit out of the printer.

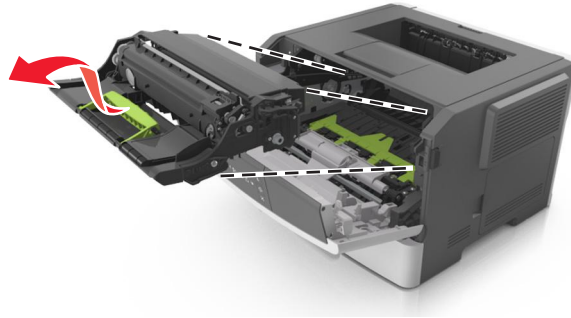

- 4 Unpack the new imaging unit, and then shake it.

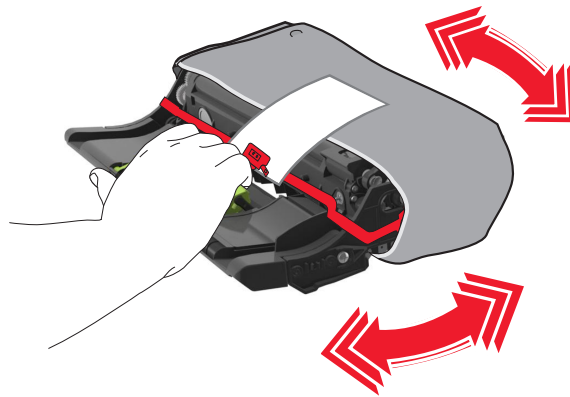

- 5 Remove all packing materials from the imaging unit.

Warning—Potential Damage: Do not expose the imaging unit to direct light for more than 10 minutes. Extended exposure to light may cause print quality problems.

Warning—Potential Damage: Do not touch the photoconductor drum. Doing so may affect the print quality of future print jobs.

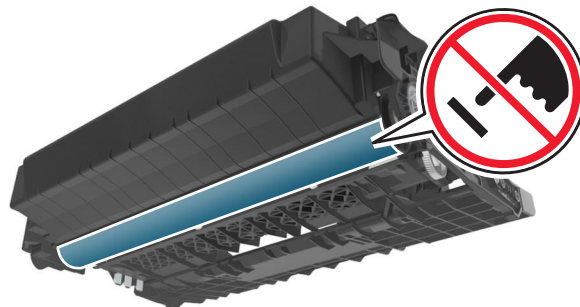

- 6 Insert the imaging unit into the printer by aligning the arrows on the side rails of the imaging unit with the arrows on the side rails inside the printer.

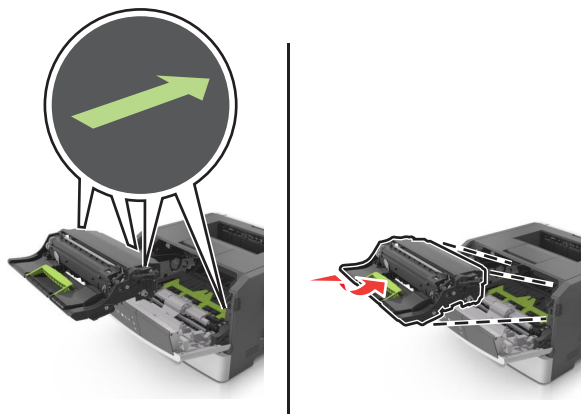

- 7 Insert the toner cartridge into the printer by aligning the side rails of the cartridge with the arrows on the side rails inside the printer.

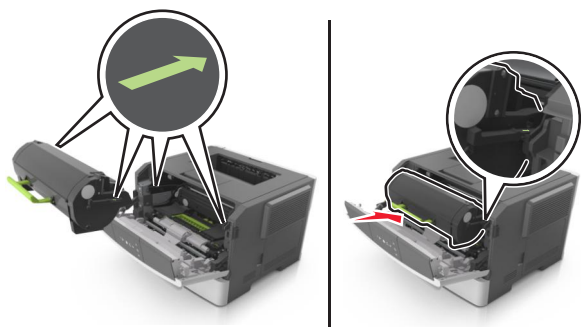

- 8 Close the front door.

Moving the printer

Before moving the printer

⚠ CAUTION—POTENTIAL INJURY: Before moving the printer, follow these guidelines to avoid personal injury or printer damage:

- Turn the printer off using the power switch, and then unplug the power cord from the electrical outlet.
- Disconnect all cords and cables from the printer before moving it.

- If an optional tray is installed, then remove it from the printer. To remove the optional tray, slide the latch on the right side of the tray toward the front of the tray until it *clicks* into place.



- Use the handholds located on both sides of the printer to lift it.
- Make sure your fingers are not under the printer when you set it down.
- Before setting up the printer, make sure there is adequate clearance around it.

Use only the power cord provided with this product or the manufacturer's authorized replacement.

Warning—Potential Damage: Damage to the printer caused by improper moving is not covered by the printer warranty.

Moving the printer to another location

The printer and its hardware options can be safely moved to another location by following these precautions:

- Any cart used to move the printer must have a surface able to support the full footprint of the printer.
- Any cart used to move the hardware options must have a surface able to support the dimensions of the hardware options.
- Keep the printer in an upright position.
- Avoid severe jarring movements.

Shipping the printer

When shipping the printer, use the original packaging.

Managing the printer

This chapter covers basic administrative support tasks using the Embedded Web Server.

Finding advanced networking and administrator information

This chapter covers basic administrative support tasks using the Embedded Web Server. For more advanced system support tasks, see the *Networking Guide* on the *Software and Documentation CD* or the *Embedded Web Server — Security: Administrator's Guide* on the Lexmark support Web site at <http://support.lexmark.com>.

Viewing reports

You can view some reports from the Embedded Web Server. These reports are useful for assessing the status of the printer, the network, and supplies.

- 1 Open a Web browser, and then type the printer IP address in the address field.

Notes:

- Print a network setup page or menu settings page, and then locate the IP address in the TCP/IP section. The IP address appears as four sets of numbers separated by periods, such as 123.123.123.123.
- If you are using a proxy server, then temporarily disable it to load the Web page correctly.

- 2 Click **Reports**, and then click the type of report you want to view.

Configuring supply notifications from the Embedded Web Server

You can determine how you would like to be notified when supplies run nearly low, low, very low, or reach their end-of-life by setting the selectable alerts.

Notes:

- Selectable alerts can be set on the toner cartridge and imaging unit.
- All selectable alerts can be set for nearly low, low, and very low supply conditions. Not all selectable alerts can be set for the end-of-life supply condition. E-mail selectable alert is available for all supply conditions.
- The percentage of estimated remaining supply that prompts the alert can be set on some supplies for some supply conditions.

- 1 Open a Web browser, and then type the printer IP address in the address field.

Notes:

- Print a network setup page or menu settings page, and then locate the printer IP address in the TCP/IP section. The IP address appears as four sets of numbers separated by periods, such as 123.123.123.123.
- If you are using a proxy server, then temporarily disable it to load the Web page correctly.

2 Click **Settings > Print Settings > Supply Notifications**.

3 From the drop-down menu for each supply, select one of the following notification options:

Notification	Description
Off	The normal printer behavior for all supplies occurs.
E-mail Only	The printer generates an e-mail when the supply condition is reached. The status of the supply appears on the menus page and status page.
Warning	The printer displays a warning light sequence and generates an e-mail about the status of the supply. The printer does not stop when the supply condition is reached.
Continuable Stop ¹	The printer stops processing jobs when the supply condition is reached. The user needs to press a button to continue printing.
Non Continuable Stop ^{1,2}	The printer stops when the supply condition is reached. The supply must be replaced to continue printing.
¹ The printer generates an e-mail about the status of the supply when supply notification is enabled. ² The printer stops when some supplies become empty to prevent damage.	

4 Click **Submit**.

Copying printer settings to other printers

Note: This feature is available only in network printers.

1 Open a Web browser, and then type the printer IP address in the address field.

Notes:

- Print a network setup page or menu settings page, and then locate the IP address in the TCP/IP section. The IP address appears as four sets of numbers separated by periods, such as 123.123.123.123.
- If you are using a proxy server, then temporarily disable it to load the Web page correctly.

2 Click the **Copy Printer Settings** tab.

3 If you want to change the language, then select a language from the drop-down menu, and then click **Click here to submit language**.

4 Click the **Printer Settings** tab.

5 Type the IP addresses of the source and target printers in their appropriate fields.

Note: If you want to add or remove a target printer, then click **Add Target IP** or **Remove Target IP**.

6 Click **Copy Printer Settings**.

Clearing jams

Avoiding jams

Load paper properly

- Make sure that the paper lies flat in the tray.

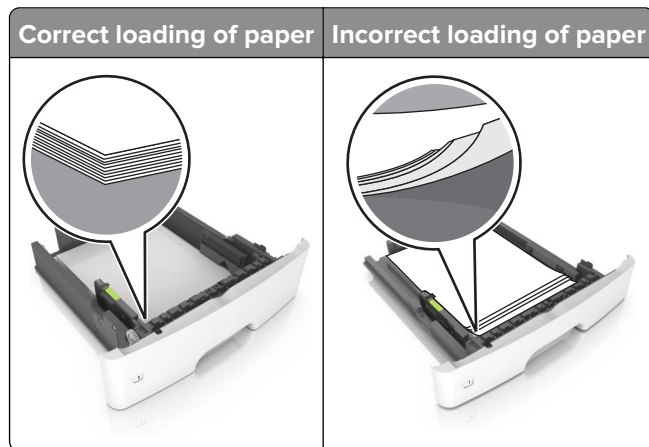

- Do not load or remove a tray while the printer is printing.
- Do not load too much paper. Make sure that the stack height is below the maximum paper fill indicator.
- Do not slide paper into the tray. Load paper as shown in the illustration.



- Make sure that the paper guides are positioned correctly and are not pressing tightly against the paper or envelopes.
- Push the tray firmly into the printer after loading paper.

Use recommended paper

- Use only recommended paper or specialty media.
- Do not load paper that is wrinkled, creased, damp, bent, or curled.
- Flex, fan, and align the paper edges before loading.

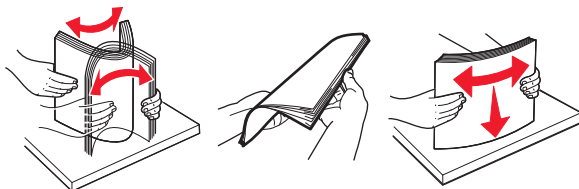

- Do not use paper that has been cut or trimmed by hand.
- Do not mix paper sizes, weights, or types in the same tray.
- Make sure that the paper size and type are set correctly on the computer or printer control panel.
- Store paper according to manufacturer recommendations.

Identifying jam locations

Notes:

- When Jam Assist is set to On, the printer automatically flushes blank pages or pages with partial prints after a jammed page has been cleared. Check your printed output for blank pages.
- When Jam Recovery is set to On or Auto, the printer reprints jammed pages.

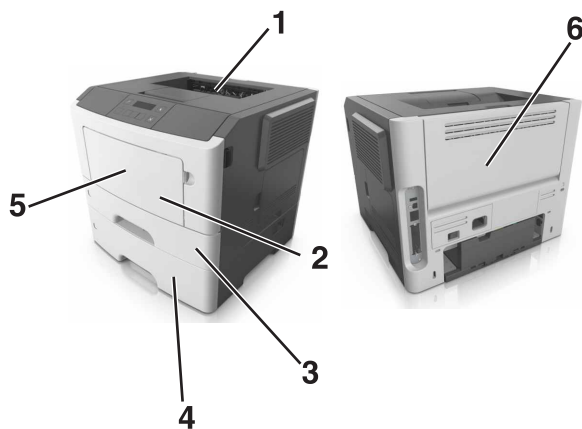

	Jam location
1	Standard bin
2	Multipurpose feeder
3	Tray 1
4	Tray [x]
5	Front door
6	Rear door

Paper jam in the front door





 - On

 - On

If the sequence matches the light sequence in the preceding illustration, then press  twice to see the supplemental light sequence.



 - On

 - On

 - On

If the supplemental light sequence matches the light sequence in the preceding illustration, then do the following.

- 1 Open the front door.

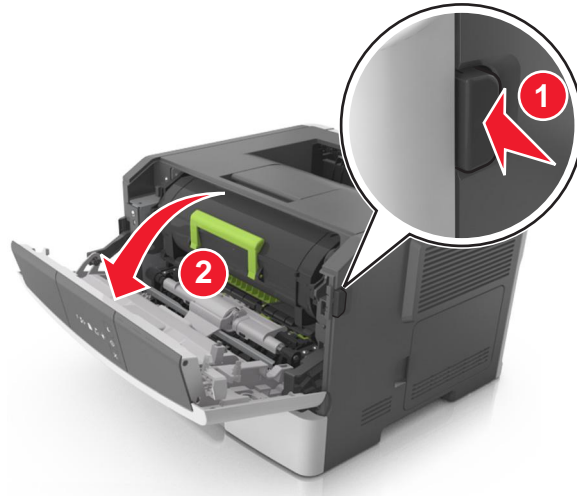

- 2 Remove the toner cartridge.

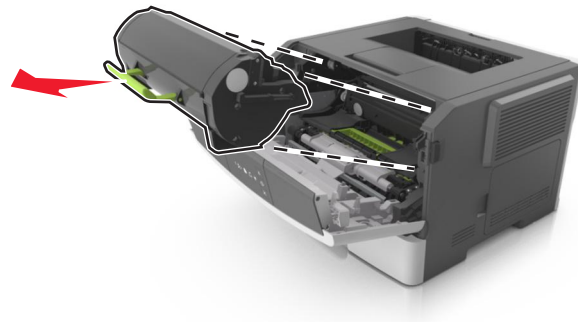

- 3 Remove the imaging unit.

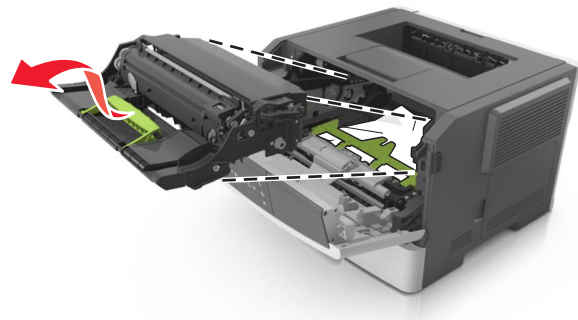

Warning—Potential Damage: Do not expose the imaging unit to direct light for more than 10 minutes. Extended exposure to light may cause print quality problems.

Warning—Potential Damage: Do not touch the photoconductor drum under the imaging unit. Doing so may affect the print quality of future print jobs.

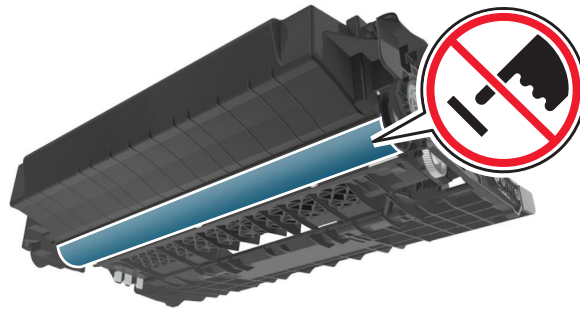

4 Insert the imaging unit.

Note: Use the arrow guides inside the printer.

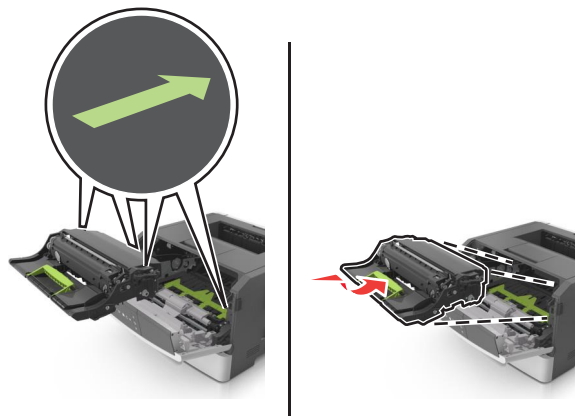

5 Insert the toner cartridge.

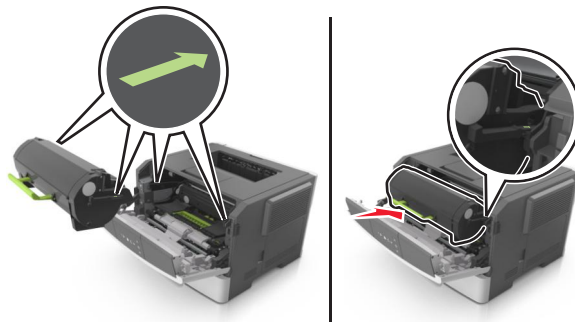

6 Close the front door.

7 From the control panel, press .

Paper jam in the rear door



 - On

 - On

If the light sequence matches the light sequence in the preceding illustration, then press  twice to see the supplemental light sequence.



 - On

 - On

 - On

If the supplemental light sequence matches the light sequence in the preceding illustration, then do the following.

- 1 Open the rear door.

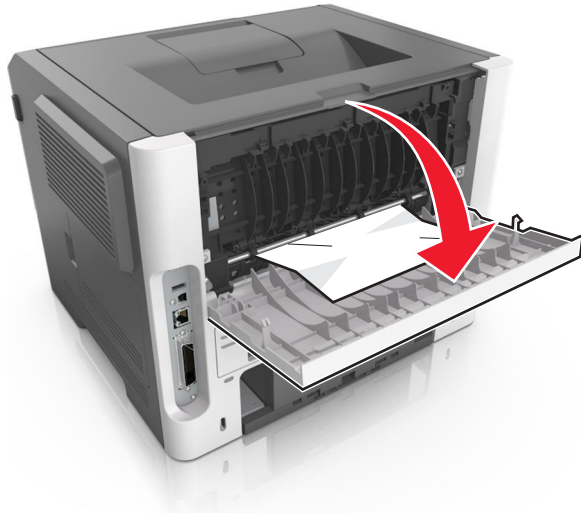

- 2 Remove the jammed paper.

Note: Make sure that all paper fragments are removed.

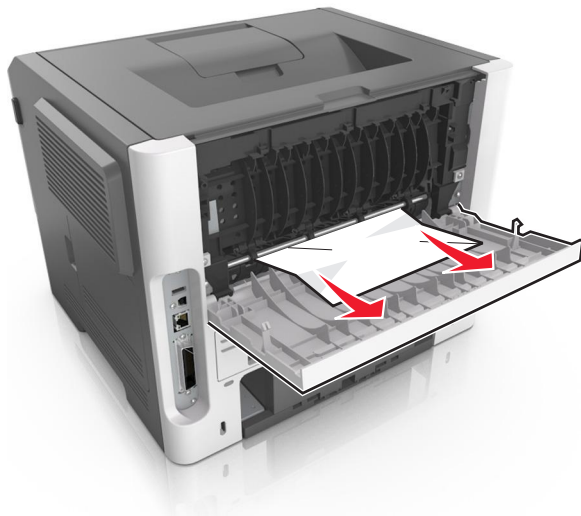

- 3 Close the rear door.

- 4 From the control panel, press .

Paper jam in the standard bin



 - On

 - On

If the light sequence matches the light sequence in the preceding illustration, then press  twice to see the supplemental light sequence.



 - On

 - On

 - On

If the supplemental light sequence matches the light sequence in the preceding illustration, then do the following.

- 1 Remove the jammed paper.

Note: Make sure that all paper fragments are removed.

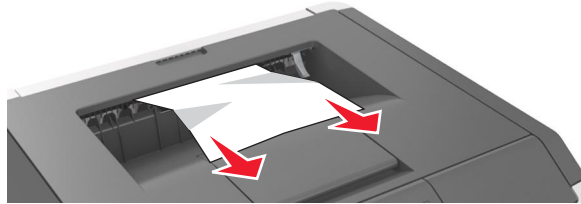

- 2 From the control panel, press .

Paper jam in the duplex unit



 - On

 - On

If the light sequence matches the light sequence in the preceding illustration, then press  twice to see the supplemental light sequence.

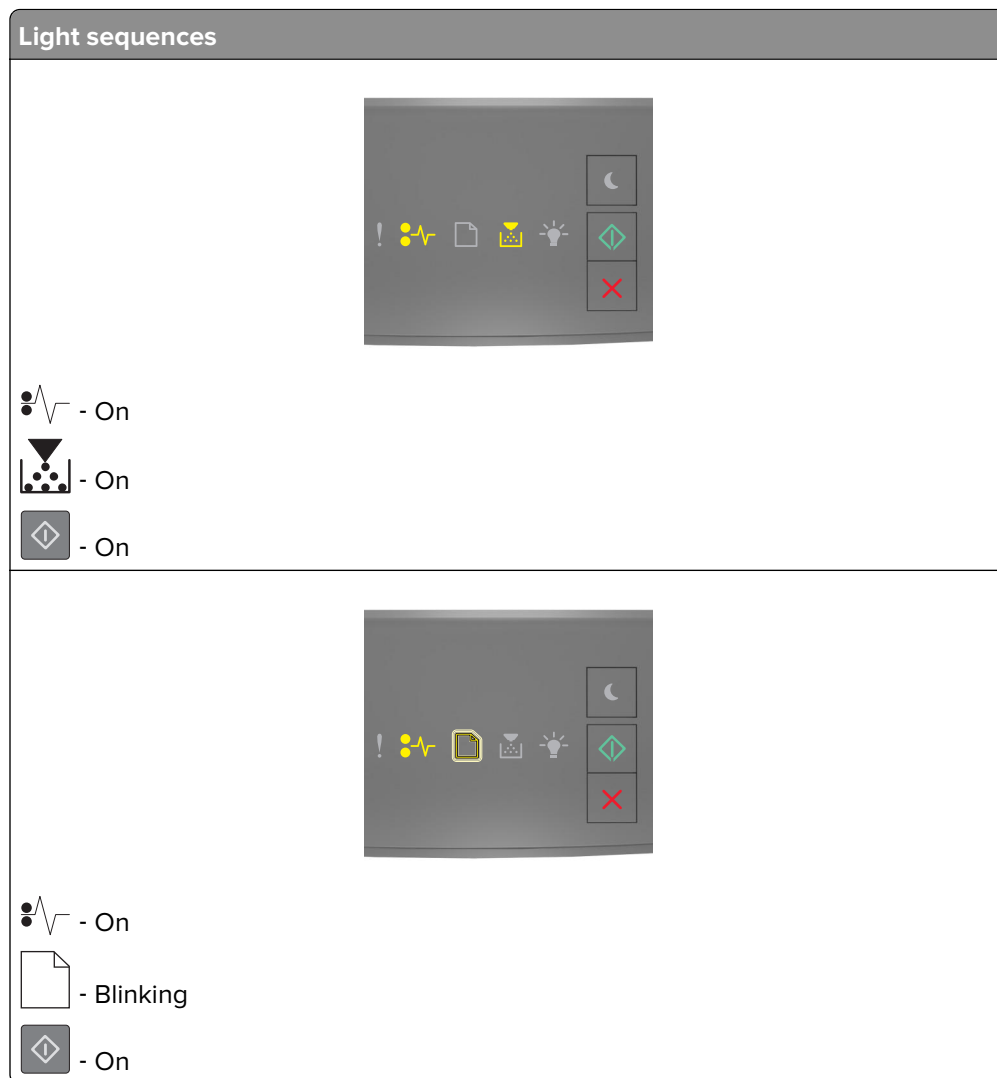

If the supplemental light sequence matches any of the light sequences in the preceding illustrations, then do the following.

- 1 Remove the tray.



- 2 Remove the jammed paper.

Note: Make sure that all paper fragments are removed.



3 Insert the tray.

4 From the control panel, press .

Paper jam in trays



 - On

 - On

If the light sequence matches the light sequence in the preceding illustration, then press  twice to see the supplemental light sequence.

Light sequences



! - On
- On
- On
- On



! - On
- On
- On
- On

The image shows two panels under the heading "Light sequences". Each panel contains a central control panel with a row of five icons: an exclamation mark, a pulse line, a document, a funnel, and a lightbulb. To the right of these icons are three stacked buttons: a moon, a diamond, and a red X. Below each central panel is a list of four items, each with an icon and the text "- On". The first item in both lists is a pulse line icon. The second item is a document icon. The third item is a funnel icon in the top panel and a lightbulb icon in the bottom panel. The fourth item is a diamond icon.

If the supplemental light sequence matches any of the light sequences in the preceding illustrations, then do the following.

- 1 Remove the tray.



- 2 Remove the jammed paper.

Note: Make sure that all paper fragments are removed.

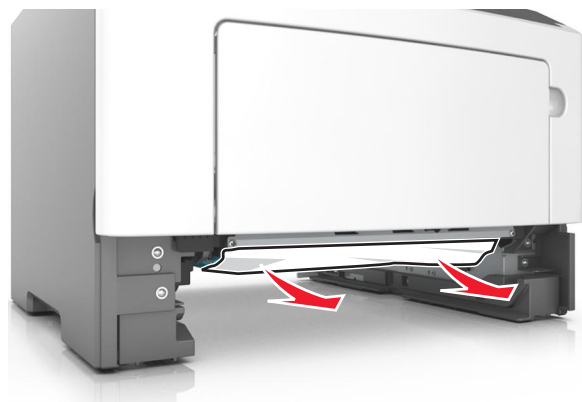

- 3 Insert the tray.

- 4 From the control panel, press .

Paper jam in the multipurpose feeder



 - On

 - On

If the light sequence matches the light sequence in the preceding illustration, then press  twice to see the supplemental light sequence.



 - On

 - On

 - On



- On

If the supplemental light sequence matches the light sequence in the preceding illustration, then do the following.

- 1 Remove the jammed paper.

Note: Make sure that all paper fragments are removed.

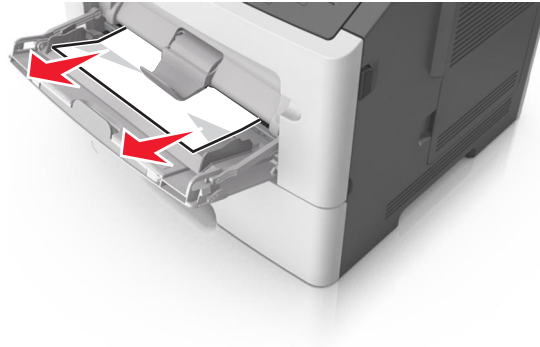

- 2 Flex, fan, and align the paper edges before loading.

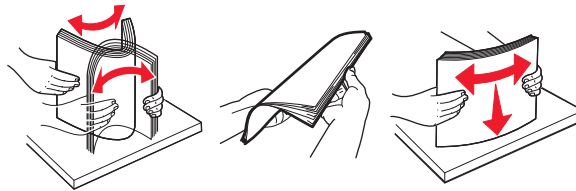

- 3 From the control panel, press .

Troubleshooting

Understanding the printer messages

Toner cartridge messages

Cartridge, imaging unit mismatch [41.xy]



! - On

 - On

If the printer control panel light sequence matches the light sequence in the preceding illustration, then do the following:

- 1 Check if both the toner cartridge and imaging unit are Lexmark-authorized *MICR* (magnetic ink character recognition) or non-*MICR* supplies.
- 2 Change the toner cartridge or imaging unit so that both are Lexmark-authorized *MICR* or non-*MICR* supplies.

Notes:

- For a list of supported supplies, see the “Ordering supplies” section of the *User's Guide* or go to www.lexmark.com.
- For more information on *MICR*, go to www.lexmark.com.

Cartridge low [88.xx]



 - On

 - On

If the printer control panel light sequence matches the light sequence in the preceding illustration, then you may need to order a toner cartridge. If necessary, press  on the printer control panel to continue printing.

Cartridge nearly low [88.xy]



 - Slowly blinking



- On



- On

If the printer control panel light sequence matches the light sequence in the preceding illustration, then press  on the printer control panel, if necessary, to continue printing.

Cartridge very low [88.xy]



! - Blinking



- On



- On

If the printer control panel light sequence matches the light sequence in the preceding illustration, then you may need to replace the toner cartridge very soon. For more information, see the “Replacing supplies” section of the *User’s Guide*.

If necessary, press  on the printer control panel to continue printing.

Replace cartridge, 0 estimated pages remain [88.xy]



! - On

! - On

If the printer control panel light sequence matches the light sequence in the preceding illustration, then press  twice quickly to see the supplemental light sequence.



! - On

! - Blinking

! - On

If the supplemental light sequence matches the light sequence in the preceding illustration, then replace the toner cartridge. For more information, see the instruction sheet that came with the supply or see the “Replacing supplies” section of the *User’s Guide*.

Note: If you do not have a replacement toner cartridge, then see the “Ordering supplies” section of the *User’s Guide* or visit www.lexmark.com.

Replace cartridge, printer region mismatch [42.xy]



- ! - On
-  - On

If the printer control panel light sequence matches the light sequence in the preceding illustration, then press  twice quickly to see the supplemental light sequence.



 - On

 - Blinking

 - On

If the supplemental light sequence matches the light sequence in the preceding illustration, then install a toner cartridge that matches the region number of the printer. *x* indicates the value of the printer region. *y* indicates the value of the cartridge region. *x* and *y* can have the following values.

Printer and toner cartridge regions

Region number (x)	Region (y)
0	Global
1	United States, Canada
2	European Economic Area (EEA), Switzerland
3	Asia Pacific, Australia, New Zealand
4	Latin America
5	Africa, Middle East, rest of Europe
9	Invalid

Notes:

- The *x* and *y* values represent **.xy** in the code that appears on the Embedded Web Server.
- The *x* and *y* values must match for printing to continue.

Reinstall missing or unresponsive cartridge [31.xy]



- ! - On
- ⚠ - On

If the light sequence matches the light sequence in the preceding illustration, then press  twice to see the supplemental light sequence.



- ! - On
- ⚡ - On
- ⚠ - On

If the supplemental light sequence matches the light sequence in the preceding illustration, then try one or more of the following:

- Check if the toner cartridge is missing. If missing, then install the toner cartridge.
For more information, see the instruction sheet that came with the supply.
- If the toner cartridge is installed, then remove and reinstall the unresponsive toner cartridge.

Note: If the message appears after reinstalling the supply, then replace the toner cartridge. The cartridge may be defective or a non-genuine Lexmark supply. For more information, see [“Using genuine Lexmark parts and supplies” on page 81.](#)

Replace unsupported cartridge [32.xy]



! - On

⚡ - On

📄 - On

🖨️ - On

If the light sequence matches the preceding light sequence, then remove the toner cartridge and install a supported one. For more information, see [“Using genuine Lexmark parts and supplies” on page 81.](#)

Notes:

- This error can also be caused by installing a genuine Lexmark cartridge, such as a high yield cartridge, that is not intended to be used in this product.
- If you do not have a replacement toner cartridge, then see the “Ordering supplies” section of the *User’s Guide* or go to www.lexmark.com.

Imaging unit messages

Imaging unit low [84.xy]



 - Blinking

 - On

If the printer control panel light sequence matches the light sequence in the preceding illustration, then you may need to order an imaging unit. If necessary, press  on the printer control panel to continue printing.

Imaging unit nearly low [84.xy]



! - Slowly blinking

 - Blinking

 - On

If the printer control panel light sequence matches the light sequence in the preceding illustration, then press  on the printer control panel, if necessary, to continue printing.

Imaging unit very low [84.xy]



! - Blinking

 - Blinking

 - On

If the printer control panel light sequence matches the light sequence in the preceding illustration, then you may need to replace the imaging unit very soon. For more information, see the “Replacing supplies” section of the *User’s Guide*.

If necessary, press  on the printer control panel to continue printing.

Replace imaging unit, 0 estimated pages remain [84.xy]



! - On

! - Blinking

◇ - On

If the printer control panel light sequence matches the light sequence in the preceding illustration, then replace the imaging unit. For more information, see the instruction sheet that came with the supply.

Note: If you do not have a replacement imaging unit, then see the “Ordering supplies” section of the *User’s Guide* or visit www.lexmark.com.

Reinstall missing or unresponsive imaging unit [31.xy]



! - On

 - Blinking

If the light sequence matches the light sequence in the preceding illustration, then press  twice to see the supplemental light sequence.



! - On

 - On

 - Blinking

If the supplemental light sequence matches the light sequence in the preceding illustration, then try one or more of the following:

- Check if the imaging unit is missing. If missing, then install the imaging unit. For more information, see the instruction sheet that came with the supply.
- If the imaging unit is installed, then remove and reinstall the unresponsive imaging unit.

Note: If the message appears after reinstalling the supply, then replace the imaging unit. The imaging unit may be defective or a non-genuine Lexmark supply. For more information, see [“Using genuine Lexmark parts and supplies” on page 81.](#)

Replace unsupported imaging unit[32.xy]



! - On

⚡ - On

📄 - On

⚠️ - Blinking

If the light sequence matches the preceding light sequence, then remove the imaging unit and install a supported one. For more information, see [“Using genuine Lexmark parts and supplies” on page 81](#).

Notes:

- This error can also be caused by installing a genuine Lexmark imaging unit, such as a MICR unit, that is not intended to be used in this product.
- If you do not have a replacement imaging unit, then see the “Ordering supplies” section of the *User’s Guide* or go to www.lexmark.com.

Non-Lexmark [supply type], see User’s Guide [33.xy]

Note: The supply type can be toner cartridge or imaging unit.

The printer has detected a non-Lexmark supply or part installed in the printer.

Your Lexmark printer is designed to function best with genuine Lexmark supplies and parts. Use of third-party supplies or parts may affect the performance, reliability, or life of the printer and its imaging components. For more information, see [“Using genuine Lexmark parts and supplies” on page 81](#).

All life indicators are designed to function with Lexmark supplies and parts and may deliver unpredictable results if third-party supplies or parts are used. Imaging component usage beyond the intended life may damage your Lexmark printer or associated components.

Warning—Potential Damage: Use of third-party supplies or parts can affect warranty coverage. Damage caused by the use of third-party supplies or parts may not be covered by the warranty.

To accept any and all of these risks and to proceed with the use of non-genuine supplies or parts in your printer, press and hold  and the # button on the control panel simultaneously for 15 seconds.

For non-touch-screen printer models, press  and  on the control panel simultaneously for 15 seconds to clear the message and continue printing.

If you do not want to accept these risks, then remove the third-party supply or part from your printer and install a genuine Lexmark supply or part.

Note: For a list of supported supplies, see the “Ordering supplies” section or go to www.lexmark.com.

Paper loading messages

Incorrect paper size, open [paper source] [34]



! - On

 - On

If the printer control panel light sequence matches the light sequence in the preceding illustration, then press  twice quickly to see the supplemental light sequence.



 - On

 - On

 - On

 - On

If the supplemental light sequence matches the light sequence in the preceding illustration, then try one or more of the following:

- Load the correct size of paper.
- From the printer control panel, press  to clear the light sequence and print using a different tray.
- Check the length and width guides and make sure the paper is loaded properly in the tray.
- Make sure the correct paper size and type are specified in Print Properties or the Print dialog settings.
- Make sure the correct paper size and type are specified in the Paper menu on the printer control panel:
 - If the printer is on a network, then access the Embedded Web Server.
 - 1 Open a Web browser, and then type the printer IP address in the address field.

Notes:

- Print a network setup page or menu settings page, and then locate IP address in TCP/IP section.
 - If you are using a proxy server, then temporarily disable it to load the Web page correctly.
- 2** Click **Settings > Paper Menu**.
- If the printer is connected to a computer by a USB or parallel cable, then access the Paper menu through the Local Printer Settings Utility for Windows or through Printer Settings for Macintosh.

Note: Make sure the paper size is correctly set. For example, if the MP Feeder Size is set to Universal, then make sure the paper is large enough for the data being printed.

Load [paper source] with [custom type name] [orientation]



- On



- On

If the printer control panel light sequence matches the light sequence in the preceding illustration, then try one or more of the following:

- Load the tray or feeder with the correct size and type of paper.
- From the printer control panel, press  to continue printing.

Note: If the printer finds a tray that has the correct size and type of paper, then it feeds from that tray. If the printer cannot find a tray that has the correct size and type of paper, then it prints from the default paper source.

- Press  to cancel the print job.

Load [paper source] with [custom type string] [orientation]

- On



- On

If the printer control panel light sequence matches the light sequence in the preceding illustration, then try one or more of the following:

- Load the tray or feeder with the correct size and type of paper.
- From the printer control panel, press  to continue printing.

Note: If the printer finds a tray that has the correct size and type of paper, then it feeds from that tray. If the printer cannot find a tray that has the correct size and type of paper, then it prints from the default paper source.

- From the printer control panel, press  to cancel the print job.

Load [paper source] with [paper size] [orientation]

If the printer control panel light sequence matches the light sequence in the preceding illustration, then try one or more of the following:

- Load the tray or feeder with the correct size of paper.
- From the printer control panel, press to continue printing.

Note: If the printer finds a tray that has the correct size of paper, then it feeds from that tray. If the printer cannot find a tray that has the correct size of paper, then it prints from the default paper source.

- From the printer control panel, press to cancel the print job.

Load [paper source] with [paper type] [paper size] [orientation]

- On



- On

If the printer control panel light sequence matches the light sequence in the preceding illustration, then try one or more of the following:

- Load the tray or feeder with the correct size and type of paper.
- From the printer control panel, press  to continue printing.

Note: If the printer finds a tray that has the correct size and type of paper, then it feeds from that tray. If the printer cannot find a tray that has the correct size and type of paper, then it prints from the default paper source.

- From the printer control panel, press  to cancel the print job.

Load multipurpose feeder with [custom type name] [orientation]



- On



- On

If the light sequence matches the light sequence in the preceding illustration, then try one or more of the following:

- Load the multipurpose feeder with the correct size and type of paper.
- From the control panel, press  to continue printing.

Note: If no paper is loaded in the feeder, the printer manually overrides the request, and then prints from an automatically selected tray.

- Press  to cancel the print job.

Load multipurpose feeder with [custom type string] [orientation]



- On



- On

If the light sequence matches the light sequence in the preceding illustration, then try one or more of the following:

- Load the multipurpose feeder with the correct size and type of paper.
- From the control panel, press  to continue printing.

Note: If no paper is loaded in the feeder, then the printer manually overrides the request and prints from an automatically selected tray.

- Press  to cancel the print job.

Load multipurpose feeder with [paper size] [orientation]



- On



- On

If the light sequence matches the light sequence in the preceding illustration, then try one or more of the following:

- Load the feeder with the correct paper size.
- From the control panel, press  to continue printing.

Note: If no paper is loaded in the feeder, then the printer manually overrides the request and prints from an automatically selected tray.

- Press  to cancel the print job.

Load multipurpose feeder with [paper type] [paper size] [orientation]

- On



- On

If the light sequence matches the light sequence in the preceding illustration, then try one or more of the following:

- Load the multipurpose feeder with the correct paper size and type.
- From the control panel, press  to continue printing.

Note: If no paper is loaded in the feeder, then the printer manually overrides the request and prints from an automatically selected tray.

- Press  to cancel the print job.

Remove paper from standard output bin



 - Blinking

If the printer control panel light sequence matches the light sequence in the preceding illustration, then do the following:

- 1 Remove the paper stack from the standard output bin.
- 2 From the printer control panel, press  to continue printing.

Printer communication error messages

Network [x] software error [54]



! - On

◊ - On

If the printer control panel light sequence matches the light sequence in the preceding illustration, then press ◊ twice quickly to see the supplemental light sequence.



! - On

⚡ - Blinking

◊ - On

If the supplemental light sequence matches the light sequence in the preceding illustration, then try one or more of the following:

- From the printer control panel, press ◊ to continue printing.
- Unplug the router, then wait for 30 seconds, and then plug the router back again.
- Turn off the printer, wait for about 10 seconds, and then turn the printer back on.
- Update the network firmware in the printer or print server. For more information, visit the Lexmark Web site at <http://support.lexmark.com>.

Standard parallel port disabled [56]



! - On

◇ - On

If the printer control panel light sequence matches the light sequence in the preceding illustration, then press  twice quickly to see the supplemental light sequence.



! - On

 - Slowly blinking

 - Slowly blinking



- On

If the supplemental light sequence matches the light sequence in the preceding illustration, then try one or more of the following:

- From the printer control panel, press  to continue printing.

Note: The printer discards any data received through the parallel port.

- Set the Parallel Buffer to Auto.
 - If the printer is on a network, then access the Embedded Web Server.
 - 1 Open a Web browser, and then type the printer IP address in the address field.

Notes:

- Print a network setup page or menu settings page, and then locate the IP address in the TCP/IP section.
- If you are using a proxy server, then temporarily disable it to load the Web page correctly.

2 Click **Settings > Network/Ports > Parallel.**

3 In the Parallel Buffer field, enter **2.**

4 Click **Submit.**

- If the printer is connected to a computer by a USB or parallel cable, then access the Parallel menu through the Local Printer Settings Utility for Windows or through Printer Settings for Macintosh.

Standard network software error [54]

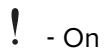

- On



- On

If the printer control panel light sequence matches the light sequence in the preceding illustration, then press  twice quickly to see the supplemental light sequence.



 - On

 - On

 - On

If the supplemental light sequence matches the light sequence in the preceding illustration, then try one or more of the following:

- From the printer control panel, press  to continue printing.
- Turn off the printer, and then turn it back on.
- Update the network firmware in the printer or on the print server. For more information, visit the Lexmark Web site at <http://support.lexmark.com>.

Rear USB port disabled [56]



! - On

◊ - On

If the printer control panel light sequence matches the light sequence in the preceding illustration, then press ◊ twice quickly to see the supplemental light sequence.



! - On

⚡ - Blinking

📄 - Blinking



- On

If the supplemental light sequence matches the light sequence in the preceding illustration, then try one or more of the following:

- From the printer control panel, press  to continue printing.

Note: The printer discards any data received through the USB port.

- Set the USB Buffer to Auto:
 - If the printer is on a network, then access the Embedded Web Server.
 - 1 Open a Web browser, and then type the printer IP address in the address field.

Notes:

- Print a network setup page or menu settings page, and then locate the IP address in the TCP/IP section.
- If you are using a proxy server, then temporarily disable it to load the Web page correctly.

2 Click **Settings > Network/Ports > Standard USB.**

3 In the USB Buffer field, enter **2.**

4 Click **Submit.**

- If the printer is connected to a computer by a USB or parallel cable, then access the USB menu through the Local Printer Settings Utility for Windows.

Insufficient memory error messages

Insufficient memory to collate job [37]

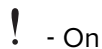

- On



- On

If the printer control panel light sequence matches the light sequence in the preceding illustration, then press  twice quickly to see the supplemental light sequence.





 - On

 - On

 - On

If the supplemental light sequence matches the light sequence in the preceding illustration, then try one or more of the following:

- From the printer control panel, press  to print the portion of the job already stored and begin collating the rest of the print job.
- From the printer control panel, press  to cancel the print job.

Insufficient memory to support Resource Save feature [35]



! - On

◊ - On

If the printer control panel light sequence matches the light sequence in the preceding illustration, then press ◊ twice quickly to see the supplemental light sequence.



! - On

💡 - Blinking

◊ - On

If the supplemental light sequence matches the light sequence in the preceding illustration, then press  on the printer control panel to clear the light sequence.

The job will be printed without using Resource Save.

Memory full [38]



 - On

 - On

If the printer control panel light sequence matches the light sequence in the preceding illustration, then press  twice quickly to see the supplemental light sequence.





! - On

 - On

 - On

 - On

If the supplemental light sequence matches the light sequence in the preceding illustration, then try one or more of the following:

- From the printer control panel, press  to continue printing. A data loss will occur.
- From the printer control panel, press  to cancel the print job.
- Install additional printer memory.
- Decrease the resolution setting.

Miscellaneous messages

Close front door



! - On

If the printer control light sequence matches the light sequence in the preceding illustration, then close the front door of the printer.

Complex page, some data may not have printed [39]



! - On

◊ - On

If the printer control panel light sequence matches the light sequence in the preceding illustration, then press ◊ twice quickly to see the supplemental light sequence.





! - On

💡 - On

◊ - On

If the supplemental light sequence matches the light sequence in the preceding illustration, then try one or more of the following:

- From the printer control panel, press  to continue printing. A data loss may occur.
- From the printer control panel, press  to cancel the print job.
- Install additional printer memory.
- Reduce the number and size of fonts, the number and complexity of images, and the number of pages in the print job.

PPDS font error [50]





! - On

 - On

If the printer control light sequence matches the light sequence in the preceding illustration, then press  twice quickly to see the supplemental light sequence.





 - On

 - Blinking

 - On

If the supplemental light sequence matches the light sequence in the preceding illustration, then try one or more of the following:

- From the printer control panel, press  to continue printing.
- From the printer control panel, press  to cancel the print job.

Printer had to restart. Last job may be incomplete.



! - Blinking

 - Blinking

 - Blinking

 - On

If the printer control panel light sequence matches the light sequence in the preceding illustration, then press  on the printer control panel to continue printing.

For more information, visit <http://support.lexmark.com> or contact customer support.

Service error

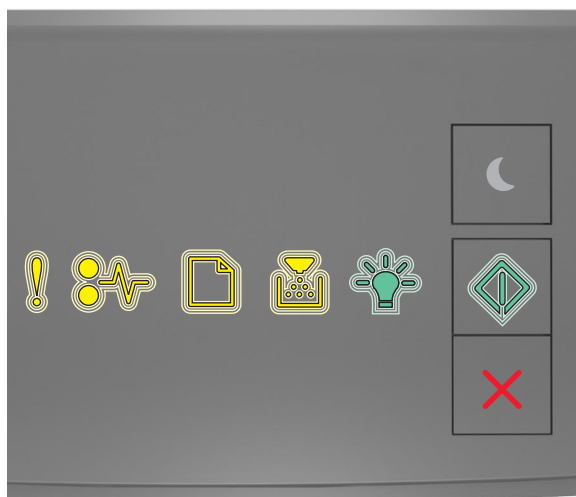

! - Blinking

⚙️ - Blinking

📄 - Blinking

🔹 - Blinking

💡 - Blinking

◊ - Blinking

If the printer control panel light sequence matches the light sequence in the preceding illustration, then turn off the printer, and then turn it back on.

If the lights are still blinking after 10 seconds, then the printer may need to be serviced. Visit <http://support.lexmark.com> or contact your system support person.

Too many trays attached [58]



! - On

◇ - On

If the printer control panel light sequence matches the light sequence in the preceding illustration, then press ◇ twice quickly to see the supplemental light sequence.



! - On

📄 - On

📂 - On



- On

If the supplemental light sequence matches the light sequence in the preceding illustration, then do the following:

- 1 Turn off the printer.
- 2 Unplug the power cord from the electrical outlet.
 - Note:** Optional trays lock together when stacked. Remove stacked trays one at a time from the top to the bottom.
- 3 Remove the extra tray or trays.
- 4 Connect the power cord to a properly grounded electrical outlet.
- 5 Turn the printer back on.

Solving printer problems

Basic printer problems

The printer is not responding

Action	Yes	No
<p>Step 1 Make sure the printer is turned on.</p> <p>Is the printer turned on?</p>	Go to step 2.	Turn on the printer.
<p>Step 2 Check if the printer is in Sleep mode or Hibernate mode.</p> <p>Is the printer in Sleep mode or Hibernate mode?</p>	Press the Sleep button to wake the printer from Sleep mode or Hibernate mode.	Go to step 3.
<p>Step 3 Check if one end of the power cord is plugged into the printer and the other to a properly grounded electrical outlet.</p> <p>Is the power cord plugged into the printer and a properly grounded electrical outlet?</p>	Go to step 4.	Plug one end of the power cord into the printer and the other to a properly grounded electrical outlet.
<p>Step 4 Check other electrical equipment plugged into the electrical outlet.</p> <p>Does other electrical equipment work?</p>	Unplug the other electrical equipment, and then turn on the printer. If the printer does not work, then reconnect the other electrical equipment.	Go to step 5.

Action	Yes	No
<p>Step 5 Check if the cables connecting the printer and the computer are inserted in the correct ports.</p> <p>Are the cables inserted in the correct ports?</p>	Go to step 6.	<p>Make sure to match the following:</p> <ul style="list-style-type: none"> • The USB symbol on the cable with the USB symbol on the printer • The appropriate Ethernet cable with the Ethernet port
<p>Step 6 Make sure the electrical outlet is not turned off by a switch or breaker.</p> <p>Is the electrical outlet turned off by a switch or breaker?</p>	Turn on the switch or reset the breaker.	Go to step 7.
<p>Step 7 Check if the printer is plugged into any surge protectors, uninterruptible power supplies, or extension cords.</p> <p>Is the printer plugged into any surge protectors, uninterruptible power supplies, or extension cords?</p>	Connect the printer power cord directly to a properly grounded electrical outlet.	Go to step 8.
<p>Step 8 Check if one end of the printer cable is plugged into a port on the printer and the other to the computer, print server, option, or other network device.</p> <p>Is the printer cable securely attached to the printer and the computer, print server, option, or other network device?</p>	Go to step 9.	Connect the printer cable securely to the printer and the computer, print server, option, or other network device.
<p>Step 9 Make sure to install all hardware options properly and remove any packing material.</p> <p>Are all hardware options properly installed and all packing material removed?</p>	Go to step 10.	Turn off the printer, remove all packing materials, then reinstall the hardware options, and then turn on the printer.
<p>Step 10 Check if you have selected the correct port settings in the printer driver.</p> <p>Are the port settings correct?</p>	Go to step 11.	Use correct printer driver settings.
<p>Step 11 Check the installed printer driver.</p> <p>Is the correct printer driver installed?</p>	Go to step 12.	Install the correct printer driver.

Action	Yes	No
<p>Step 12</p> <p>Turn off the printer, then wait for about 10 seconds, and then turn the printer back on.</p> <p>Is the printer working?</p>	<p>The problem is solved.</p>	<p>Contact customer support.</p>

Option problems

Cannot detect internal option

Action	Yes	No
<p>Step 1</p> <p>Turn off the printer, then wait for about 10 seconds, and then turn on the printer.</p> <p>Does the internal option operate correctly?</p>	<p>The problem is solved.</p>	<p>Go to step 2.</p>
<p>Step 2</p> <p>Check if the internal option is properly installed in the controller board.</p> <ul style="list-style-type: none"> a Turn off the printer using the power switch, and then unplug the power cord from the electrical outlet. b Make sure the internal option is installed in the appropriate connector in the controller board. c Connect the power cord to the printer, then to a properly grounded electrical outlet, and then turn on the printer. <p>Is the internal option properly installed in the controller board?</p>	<p>Go to step 3.</p>	<p>Connect the internal option to the controller board.</p>
<p>Step 3</p> <p>Print a menu settings page, and then check to see if the internal option is listed in the Installed Features list.</p> <p>Is the internal option listed in the menu settings page?</p>	<p>Go to step 4.</p>	<p>Reinstall the internal option.</p>
<p>Step 4</p> <ul style="list-style-type: none"> a Check if the internal option is selected. It may be necessary to manually add the internal option in the printer driver to make it available for print jobs. For more information, see “Adding available options in the print driver” on page 19. b Resend the print job. <p>Does the internal option operate correctly?</p>	<p>The problem is solved.</p>	<p>Contact customer support.</p>

Tray problems

Action	Yes	No
<p>Step 1</p> <p>a Open the tray and do one or more of the following:</p> <ul style="list-style-type: none"> • Check for paper jams or misfeeds. • Check if the paper size indicators on the paper guides are aligned with the paper size indicators on the tray. • If you are printing on custom-size paper, then make sure that the paper guides rest against the edges of the paper. • Make sure the paper is below the maximum paper fill indicator. • Make sure paper lies flat in the tray. <p>b Check if the tray closes properly.</p> <p>Is the tray working?</p>	The problem is solved.	Go to step 2.
<p>Step 2</p> <p>a Turn off the printer, then wait about 10 seconds, and then turn the printer back on.</p> <p>b Resend the print job.</p> <p>Is the tray working?</p>	The problem is solved.	Go to step 3.
<p>Step 3</p> <p>Check if the tray is installed.</p> <p>Print a menu settings page, and then check if the tray is listed in the Installed Options list.</p> <p>Is the tray listed in the menu settings page?</p>	Go to step 4.	Reinstall the tray. For more information, see the setup documentation that came with the tray.
<p>Step 4</p> <p>Check if the tray is available in the printer driver.</p> <p>Note: If necessary, manually add the tray in the printer driver to make it available for print jobs. For more information, see “Adding available options in the print driver” on page 19.</p> <p>Is the tray available in the printer driver?</p>	Go to step 5.	Manually add the tray in the printer driver.
<p>Step 5</p> <p>Check if the option is selected.</p> <p>a From the application you are using, select the option. For Mac OS X version 9 users, make sure the printer is set up in Chooser.</p> <p>b Resend the print job.</p> <p>Is the tray working?</p>	The problem is solved.	Contact customer support .

Paper feed problems

Paper frequently jams

Action	Yes	No
<p>Step 1</p> <p>a Pull out the tray, and then do one or more of the following:</p> <ul style="list-style-type: none"> • Make sure paper lies flat in the tray. • Check if the paper size indicators on the paper guides are aligned with the paper size indicators on the tray. • Check if the paper guides are aligned against the edges of the paper. • Make sure the paper is below the maximum paper fill indicator. • Check if you are printing on a recommended paper size and type. <p>b Insert the tray properly. If jam recovery is enabled, then the print jobs will reprint automatically.</p> <p>Do paper jams still occur frequently?</p>	Go to step 2.	The problem is solved.
<p>Step 2</p> <p>a Load paper from a fresh package. Note: Paper absorbs moisture due to high humidity. Store paper in its original wrapper until you use it.</p> <p>b Resend the print job.</p> <p>Do paper jams still occur frequently?</p>	Go to step 3.	The problem is solved.
<p>Step 3</p> <p>a Review the tips on avoiding jams. For more information, see “Avoiding jams” on page 91.</p> <p>b Follow the recommendations, and then resend the print job.</p> <p>Do paper jams still occur frequently?</p>	Contact customer support .	The problem is solved.

Paper jam message remains after jam is cleared

Action	Yes	No
<p>Open front door and remove all trays.</p> <p>a Clear any jammed pages. Note: Make sure all paper fragments are removed.</p> <p>b Press  to clear the message and continue printing.</p> <p>Does the paper jam message remain?</p>	Contact customer support .	The problem is solved.

Jammed pages are not reprinted

Actions	Yes	No
<p>a From the Print Recovery menu, set Jam Recovery to Auto or On. To access the Print Recovery menu, try one or more of the following:</p> <ul style="list-style-type: none"> If the printer is on a network, then open a Web browser and type the printer IP address in the address field. Then navigate to Settings > General Settings > Print Recovery. <p>Note: If you do not know the IP address of the printer, then print a network setup page and locate the IP address in the TCP/IP section.</p> <ul style="list-style-type: none"> If the printer is connected to a computer by a USB or parallel cable, then open the Local Printer Settings Utility for Windows or the Printer Settings for Macintosh. <p>b Resend the pages that did not print.</p> <p>Were the jammed pages reprinted?</p>	<p>The problem is solved.</p>	<p>Contact customer support.</p>

Solving print problems

Printing problems

Print jobs do not print

Action	Yes	No
<p>Step 1</p> <p>a From the document you are trying to print, open the Print dialog and check if you have selected the correct printer.</p> <p>Note: If the printer is not the default printer, then you must select the printer for each document that you want to print.</p> <p>b Resend the print job.</p> <p>Do the jobs print?</p>	<p>The problem is solved.</p>	<p>Go to step 2.</p>

Action	Yes	No
<p>Step 2</p> <p>a Check if the printer is plugged in and turned on, and if the printer control panel light sequence matches the light sequence in the following illustration:</p> <div data-bbox="446 462 735 705" style="text-align: center;"> </div> <p>Ready</p> <p> - On</p> <p>b Resend the print job.</p> <p>Do the jobs print?</p>	<p>The problem is solved.</p>	<p>Go to step 3.</p>
<p>Step 3</p> <p>If printer control panel light sequence indicates an error, then clear the message. For more information on printer control panel error light sequences, see “Understanding the printer messages” on page 106.</p> <p>Note: The printer continues to print after clearing the message.</p> <p>Do the jobs print?</p>	<p>The problem is solved.</p>	<p>Go to step 4.</p>
<p>Step 4</p> <p>a Check if the ports (USB, serial, or Ethernet) are working and if the cables are securely connected to the computer and the printer.</p> <p>Note: For more information, see the setup documentation that came with the printer.</p> <p>b Resend the print job.</p> <p>Do the jobs print?</p>	<p>The problem is solved.</p>	<p>Go to step 5.</p>
<p>Step 5</p> <p>a Turn off the printer, then wait for about 10 seconds, and then turn the printer back on.</p> <p>b Resend the print job.</p> <p>Do the jobs print?</p>	<p>The problem is solved.</p>	<p>Go to step 6.</p>

Action	Yes	No
<p>Step 6</p> <p>a Remove and reinstall the printer software. For more information, see “Installing the printer software” on page 18.</p> <p>Note: The printer software is available at http://support.lexmark.com.</p> <p>b Resend the print job.</p> <p>Do the jobs print?</p>	<p>The problem is solved.</p>	<p>Contact customer support.</p>

Printing slows down

Notes:

- When printing using narrow paper, the printer prints at a reduced speed to prevent damage to the fuser.
- The printer speed may be reduced when printing for long periods of time, or printing at elevated temperatures.
- The printer speed may also be reduced when the printed output resolution is set to 1,200 dpi.

Action	Yes	No
<p>Place letter- or A4-size paper in the tray, and then resend the print job.</p> <p>Does the print speed increase?</p>	<p>The problem is solved.</p>	<p>Contact customer support.</p>

Print job takes longer than expected

Action	Yes	No
<p>Step 1</p> <p>Reduce the number and size of fonts, the number and complexity of images, and the number of pages in the print job, and then resend the print job.</p> <p>Does the print job still take longer than expected?</p>	<p>Go to step 2.</p>	<p>The problem is solved.</p>
<p>Step 2</p> <p>From the Print Recovery menu, disable the Page Protect feature. To access the Print Recovery menu, do either of the following:</p> <ul style="list-style-type: none"> • If the printer is on a network, then open a Web browser and type the printer IP address in the address field. Then navigate to Settings > General Settings > Print Recovery. <p>Note: If you do not know the IP address of the printer, then print a network setup page and locate the IP address in the TCP/IP section.</p> <ul style="list-style-type: none"> • If the printer is connected to a computer by a USB or parallel cable, then open the Local Printer Settings Utility for Windows or Printer Settings for Macintosh. <p>Does the print job still take longer than expected?</p>	<p>Go to step 3.</p>	<p>The problem is solved.</p>

Action	Yes	No
<p>Step 3</p> <p>From the Eco-Mode menu, change the environmental settings. To access the Eco-Mode menu, do either of the following:</p> <ul style="list-style-type: none"> • If the printer is on a network, then open a Web browser and type the printer IP address in the address field. Then navigate to Settings > General Settings > Eco-Mode. <p>Note: If you do not know the IP address of the printer, then print a network setup page and locate the IP address in the TCP/IP section.</p> <ul style="list-style-type: none"> • If the printer is connected to a computer by a USB or parallel cable, then open the Local Printer Settings Utility for Windows or Printer Settings for Macintosh. <p>Note: When using the Eco-Mode setting, you may notice a reduction in performance.</p> <p>Does the print job still take longer than expected?</p>	<p>Install additional printer memory.</p> <p>For more information, contact customer support.</p>	<p>The problem is solved.</p>

Job prints from the wrong tray or on the wrong paper

Actions	Yes	No
<p>Step 1</p> <p>a Check if you are printing on paper that is supported by the tray.</p> <p>b Resend the print job.</p> <p>Does the job print from the correct tray or on the correct paper?</p>	<p>The problem is solved.</p>	<p>Go to step 2.</p>
<p>Step 2</p> <p>a From the Paper menu, set the paper size and type to match the paper loaded in the tray. To access the Paper menu, do either of the following:</p> <ul style="list-style-type: none"> • If the printer is on a network, then open a Web browser and type the printer IP address in the address field. Then navigate to Settings > Paper Menu. <p>Note: If you do not know the IP address of the printer, then print a network setup page and locate the IP address in the TCP/IP section.</p> <ul style="list-style-type: none"> • If the printer is connected to a computer by a USB or parallel cable, then open the Local Printer Settings Utility for Windows or Printer Settings for Macintosh. <p>b Resend the print job.</p> <p>Does the job print from the correct tray or on the correct paper?</p>	<p>The problem is solved.</p>	<p>Go to step 3.</p>

Actions	Yes	No
<p>Step 3</p> <p>a Depending on your operating system, open Printing Preferences or the Print dialog, and then specify the paper type.</p> <p>b Resend the print job.</p> <p>Does the job print from the correct tray or on the correct paper?</p>	<p>The problem is solved.</p>	<p>Contact customer support.</p>

Incorrect characters print

Action	Yes	No
<p>Step 1</p> <p>Check if the printer control panel light sequence matches the light sequence in the following illustration:</p> <div data-bbox="427 816 716 1062" style="text-align: center;"> </div> <p>Hex Trace</p> <p> - Slowly blinking</p> <p>Do both light sequences match?</p>	<p>Turn off the printer, and then turn it back on to deactivate Hex Trace mode.</p>	<p>Go to step 2.</p>
<p>Step 2</p> <p>a Open a Web browser, and then type the printer IP address in the address field.</p> <p>b Click Settings > Network/Ports, and then click Standard Network or Network [x].</p> <p>c Select PCL SmartSwitch or PS SmartSwitch, and then click Submit.</p> <p>d Resend the print job.</p> <p>Do incorrect characters print?</p>	<p>Contact customer support.</p>	<p>The problem is solved.</p>

Tray linking does not work

Note: The trays and the multipurpose feeder do not automatically detect the paper size. You must set the size from the Paper Size/Type menu.

Action	Yes	No
<p>a From the Paper menu, set the paper size and type to match the paper loaded in the trays to be linked. To access the Paper menu, do either of the following:</p> <ul style="list-style-type: none"> • If the printer is on a network, then open a Web browser and type the printer IP address in the address field. Then navigate to Settings > Paper Menu. <p>Note: If you do not know the IP address of the printer, then print a network setup page and locate the IP address in the TCP/IP section.</p> <ul style="list-style-type: none"> • If the printer is connected to a computer by a USB or parallel cable, then open the Local Printer Settings Utility for Windows or Printer Settings for Macintosh. <p>Note: The paper size and type must match for trays to be linked.</p> <p>b Resend the print job.</p> <p>Do the trays link correctly?</p>	<p>The problem is solved.</p>	<p>Contact customer support.</p>

Large jobs do not collate

Action	Yes	No
<p>Step 1</p> <p>a From the Finishing menu, set Collate to On. To access the Finishing menu, do either of the following:</p> <ul style="list-style-type: none"> • If the printer is on a network, then open a Web browser and type the printer IP address in the address field. Then, navigate to Settings > Print Settings > Finishing Menu. <p>Note: If you do not know the IP address of the printer, then print a network setup page and locate the IP address in the TCP/IP section.</p> <ul style="list-style-type: none"> • If the printer is connected to a computer by a USB or parallel cable, then open the Local Printer Settings Utility for Windows or Printer Settings for Macintosh. <p>b Resend the print job.</p> <p>Does the job print and collate correctly?</p>	<p>The problem is solved.</p>	<p>Go to step 2.</p>
<p>Step 2</p> <p>a From the printer software, set Collate to On.</p> <p>Note: Setting Collate to Off in the software overrides the setting in the Finishing menu.</p> <p>b Resend the print job.</p> <p>Does the job print and collate correctly?</p>	<p>The problem is solved.</p>	<p>Go to step 3.</p>

Action	Yes	No
<p>Step 3 Reduce the number and size of fonts, the number and complexity of images, and the number of pages in the job.</p> <p>Does the job print and collate correctly?</p>	The problem is solved.	Contact customer support .

Unexpected page breaks occur

Action	Yes	No
<p>Step 1 From the Setup menu, adjust the print timeout setting. To access the Setup menu, do either of the following:</p> <ul style="list-style-type: none"> • If the printer is on a network, then access the Embedded Web Server: <ul style="list-style-type: none"> a Open a Web browser, and then type the printer IP address in the address field. Note: If you do not know the IP address of the printer, then print a network setup page and locate the IP address in the TCP/IP section. b Navigate to: Settings > General Settings > Timeouts > adjust the print timeout setting > Submit • If the printer is connected to a computer by a USB or parallel cable, then open the Local Printer Settings Utility for Windows or Printer Settings for Macintosh. <p>Does the file print correctly?</p>	The problem is solved.	Go to step 2.
<p>Step 2 a Check the original file for manual page breaks. b Resend the print job.</p> <p>Does the file print correctly?</p>	The problem is solved.	Contact customer support .

Print quality problems

Printer is printing blank pages

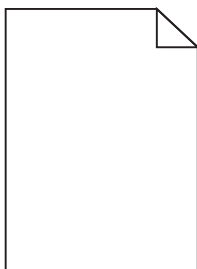

Action	Yes	No
<p>Step 1</p> <p>a Check if there is packing material left on the imaging unit.</p> <ol style="list-style-type: none"> 1 Remove the toner cartridge, and then the imaging unit. 2 Check if the packing material is properly removed from the imaging unit. <p>Warning—Potential Damage: Do not expose the imaging unit to direct light for more than 10 minutes. Extended exposure to light may cause print quality problems.</p> <ol style="list-style-type: none"> 3 Reinstall the imaging unit, and then the cartridge. <p>b Resend the print job.</p> <p>Is the printer still printing blank pages?</p>	Go to step 2.	The problem is solved.
<p>Step 2</p> <p>a Redistribute the toner in the imaging unit.</p> <ol style="list-style-type: none"> 1 Remove the toner cartridge, and then the imaging unit. 2 Firmly shake the imaging unit. <p>Warning—Potential Damage: Do not expose the imaging unit to direct light for more than 10 minutes. Extended exposure to light may cause print quality problems.</p> <ol style="list-style-type: none"> 3 Reinstall the imaging unit, and then the cartridge. <p>b Resend the print job.</p> <p>Is the printer still printing blank pages?</p>	Go to step 3.	The problem is solved.
<p>Step 3</p> <p>Replace the imaging unit, and then resend the print job.</p> <p>Is the printer still printing blank pages?</p>	Contact customer support .	The problem is solved.

Clipped pages or images

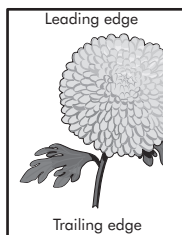
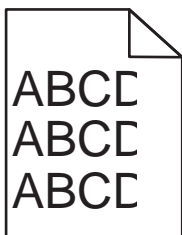

Action	Yes	No
<p>Step 1</p> <p>a Move the width and length guides in the tray to the correct positions for the paper loaded.</p> <p>b Resend the print job.</p> <p>Is the page or image clipped?</p>	Go to step 2.	The problem is solved.
<p>Step 2</p> <p>From the Paper menu, set the paper size and type to match the paper loaded in the tray. To access the Paper menu, do either of the following:</p> <ul style="list-style-type: none"> • If the printer is on a network, then open a Web browser and type the printer IP address in the address field. Then, navigate to Settings > Paper Menu. <p>Note: If you do not know the IP address of the printer, then print a network setup page and locate the IP address in the TCP/IP section.</p> <ul style="list-style-type: none"> • If the printer is connected to a computer by a USB or parallel cable, then open the Local Printer Settings Utility for Windows or Printer Settings for Macintosh. <p>Do the paper size and type settings match the paper loaded in the tray?</p>	Go to step 3.	<p>Do one or more of the following:</p> <ul style="list-style-type: none"> • Specify the correct paper size and type from the tray settings to match the paper loaded in the tray. • Change the paper loaded in the tray to match the paper size and type specified in the tray settings.
<p>Step 3</p> <p>a Depending on your operating system, specify the paper size and type from Printing Preferences or the Print dialog.</p> <p>b Resend the print job.</p> <p>Is the page or image clipped?</p>	Go to step 4.	The problem is solved.
<p>Step 4</p> <p>a Reinstall the imaging unit.</p> <ol style="list-style-type: none"> 1 Remove the toner cartridge. 2 Remove the imaging unit. <p>Warning—Potential Damage: Do not expose the imaging unit to direct light for more than 10 minutes. Extended exposure to light may cause print quality problems.</p> <ol style="list-style-type: none"> 3 Install the imaging unit, and then the cartridge. <p>b Resend the print job.</p> <p>Is the page or image clipped?</p>	Contact customer support .	The problem is solved.

Shadow images appear on prints

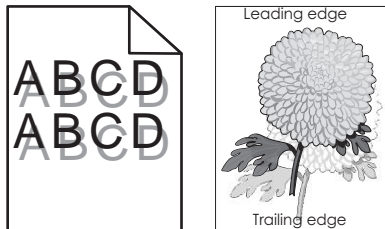

Action	Yes	No
<p>Step 1 Check if the paper loaded in the tray has the correct paper type and weight.</p> <p>Is paper with the correct paper type and weight loaded in the tray?</p>	Go to step 2.	Load paper with the correct paper type and weight in the tray.
<p>Step 2 From the Paper menu, set the paper size and type to match the paper loaded in the tray. To access the Paper menu, do either of the following:</p> <ul style="list-style-type: none"> • If the printer is on a network, then open a Web browser and type the printer IP address in the address field. Then, navigate to Settings > Paper Menu. <p>Note: If you do not know the IP address of the printer, then print a network setup page and locate the IP address in the TCP/IP section.</p> <ul style="list-style-type: none"> • If the printer is connected to a computer by a USB or parallel cable, then open the Local Printer Settings Utility for Windows or Printer Settings for Macintosh. <p>Do the paper type and weight settings match the paper loaded in the tray?</p>	Go to step 3.	Change the paper type and weight to match the paper loaded in the tray.
<p>Step 3</p> <p>a Depending on your operating system, specify the paper type and weight from Printing Preferences or the Print dialog.</p> <p>b Resend the print job.</p> <p>Do shadow images still appear on the prints?</p>	Go to step 4.	The problem is solved.
<p>Step 4 Replace the imaging unit, and then resend the print job.</p> <p>Do shadow images still appear on the prints?</p>	Contact customer support .	The problem is solved.

Gray background on prints

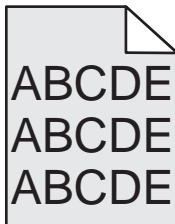

Action	Yes	No
<p>Step 1</p> <p>a From the Quality menu, select a lower number to reduce the toner density. To access the Quality menu, do either of the following:</p> <ul style="list-style-type: none"> If the printer is on a network, then open a Web browser and type the printer IP address in the address field. Then, navigate to Settings > Print Settings > Quality Menu. <p>Note: If you do not know the IP address of the printer, then print a network setup page and locate the IP address in the TCP/IP section.</p> <ul style="list-style-type: none"> If the printer is connected to a computer by a USB or parallel cable, then open the Local Printer Settings Utility for Windows or Printer Settings for Macintosh. <p>Note: 8 is the factory default setting.</p> <p>b Resend the print job.</p> <p>Does the gray background disappear from the prints?</p>	<p>The problem is solved.</p>	<p>Go to step 2.</p>
<p>Step 2</p> <p>Reinstall the imaging unit and the toner cartridge.</p> <p>a Remove the toner cartridge.</p> <p>b Remove the imaging unit.</p> <p>Warning—Potential Damage: Do not expose the imaging unit to direct light for more than 10 minutes. Extended exposure to light may cause print quality problems.</p> <p>c Reinstall the imaging unit, and then the cartridge.</p> <p>d Resend the print job.</p> <p>Does the gray background disappear from the prints?</p>	<p>The problem is solved.</p>	<p>Contact customer support.</p>

Incorrect margins on prints

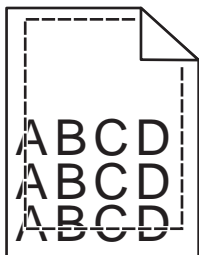

Action	Yes	No
<p>Step 1</p> <p>a Move the width and length guides in the tray to the correct positions for the paper size loaded.</p> <p>b Resend the print job.</p> <p>Are the margins correct?</p>	The problem is solved.	Go to step 2.
<p>Step 2</p> <p>From the Paper menu, check if the paper size setting matches the paper loaded in the tray. To access the Paper menu, do either of the following:</p> <ul style="list-style-type: none"> If the printer is on a network, then open a Web browser and type the printer IP address in the address field. Then, navigate to Settings > Paper Menu. <p>Note: If you do not know the IP address of the printer, then print a network setup page and locate the IP address in the TCP/IP section.</p> <ul style="list-style-type: none"> If the printer is connected to a computer by a USB or parallel cable, then open the Local Printer Settings Utility for Windows or the Printer Settings for Macintosh. <p>Does the paper size setting match the paper loaded in the tray?</p>	Go to step 3.	<p>Do one or more of the following:</p> <ul style="list-style-type: none"> Change the paper size setting to match the paper loaded in the tray. Change the paper loaded in the tray to match the paper size setting.
<p>Step 3</p> <p>a Depending on your operating system, specify the paper size from Printing Preferences or from the Print dialog.</p> <p>b Resend the print job.</p> <p>Are the margins correct?</p>	The problem is solved.	Contact customer support .

Paper curl

Action	Yes	No
<p>Step 1 Move the width and length guides in the tray to the correct positions for the size of the paper loaded.</p> <p>Are the width and length guides positioned correctly?</p>	Go to step 2.	Adjust the width and length guides.
<p>Step 2 From the Paper menu, set the paper size and type to match the paper loaded in the tray. To access the Paper menu, try one or more of the following:</p> <ul style="list-style-type: none"> • If the printer is on a network, then open a Web browser and type the printer IP address in the address field. Then, navigate to Settings > Paper Menu. <p>Note: If you do not know the IP address of the printer, then print a network setup page and locate the IP address in the TCP/IP section.</p> <ul style="list-style-type: none"> • If the printer is connected to a computer by a USB or parallel cable, then open the Local Printer Settings Utility for Windows or the Printer Settings for Macintosh. <p>Do the paper type and weight match the type and weight of the paper in the tray?</p>	Go to step 3.	Change the paper type and weight to match the paper loaded in the tray.
<p>Step 3</p> <p>a Depending on your operating system, specify the paper type and weight from Printing Preferences or from the Print dialog.</p> <p>b Resend the print job.</p> <p>Is the paper still curled?</p>	Go to step 4.	The problem is solved.
<p>Step 4</p> <p>a Remove the paper from the tray, and then turn it over.</p> <p>b Resend the print job.</p> <p>Is the paper still curled?</p>	Go to step 5.	The problem is solved.
<p>Step 5</p> <p>a Load paper from a fresh package.</p> <p>Note: Paper absorbs moisture due to high humidity. Store paper in its original wrapper until you use it.</p> <p>b Resend the print job.</p> <p>Is the paper still curled?</p>	Contact customer support .	The problem is solved.

Print irregularities

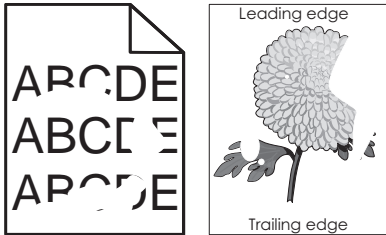

Action	Yes	No
<p>Step 1</p> <p>a Move the width and length guides in the tray to the correct positions for the size of the paper loaded in the tray.</p> <p>b Resend the print job.</p> <p>Do print irregularities still appear?</p>	Go to step 2.	The problem is solved.
<p>Step 2</p> <p>From the Paper menu, set the paper size and type to match the paper loaded in the tray. To access the Paper menu, do either of the following:</p> <ul style="list-style-type: none"> • If the printer is on a network, then open a Web browser and type the printer IP address in the address field. Then navigate to Settings > Paper Menu. <p>Note: If you do not know the IP address of the printer, then print a network setup page and locate the IP address in the TCP/IP section.</p> <ul style="list-style-type: none"> • If the printer is connected to a computer by a USB or parallel cable, then open the Local Printer Settings Utility for Windows or Printer Settings for Macintosh. <p>Do the printer settings match the type and weight of the paper loaded in the tray?</p>	Go to step 3.	Specify the correct paper type and weight to match the paper loaded in the tray.
<p>Step 3</p> <p>a Depending on your operating system, specify the paper type and weight from Printing Preferences or the Print dialog.</p> <p>b Resend the print job.</p> <p>Do print irregularities still appear?</p>	Go to step 4.	The problem is solved.

Action	Yes	No
<p>Step 4 Check if the paper loaded in the tray has texture or rough finishes.</p> <p>Are you printing on textured or rough paper?</p>	<p>From the Paper Texture menu, change the texture settings. To access the Paper Texture menu, do either of the following:</p> <ul style="list-style-type: none"> • If the printer is on a network, then open a Web browser and type the printer IP address in the address field. Then navigate to Settings > Paper Menu > Paper Texture. <p>Note: If you do not know the IP address of the printer, then print a network setup page and locate the IP address in the TCP/IP section.</p> <ul style="list-style-type: none"> • If the printer is connected to a computer by a USB or parallel cable, then open the Local Printer Settings Utility for Windows or Printer Settings for Macintosh. 	<p>Go to step 5.</p>
<p>Step 5</p> <p>a Load paper from a fresh package.</p> <p>Note: Paper absorbs moisture due to high humidity. Store paper in its original wrapper until you use it.</p> <p>b Resend the print job.</p> <p>Do print irregularities still appear?</p>	<p>Go to step 6.</p>	<p>The problem is solved.</p>
<p>Step 6</p> <p>Replace the imaging unit, and then resend the print job.</p> <p>Do print irregularities still appear?</p>	<p>Contact customer support at http://support.lexmark.com or your service representative.</p>	<p>The problem is solved.</p>

Repeating defects appear on prints

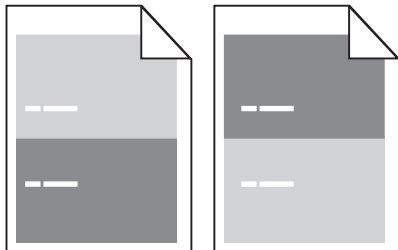

Action	Yes	No
<p>Step 1 Measure the distance between the defects. Check for a distance between the defects that equals:</p> <ul style="list-style-type: none"> • 97 mm (3.82 in.) • 47 mm (1.85 in.) • 38 mm (1.5 in.) <p>Is the distance between defects equal to one of the listed measurements?</p>	<p>Go to step 2.</p>	<p>1 Check if the distance between the defects equal to 80 mm (3.15 in.)</p> <p>2 Take note of the distance, and then contact customer support at http://support.lexmark.com or your service representative.</p>
<p>Step 2 Replace the imaging unit, and then resend the print job.</p> <p>Do the repeating defects still appear?</p>	<p>Contact customer support at http://support.lexmark.com or your service representative.</p>	<p>The problem is solved.</p>

Print is too dark

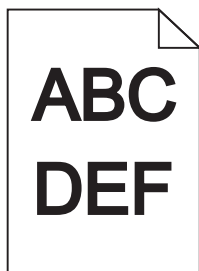

Action	Yes	No
<p>Step 1</p> <p>a From the Quality menu, reduce the toner darkness. To access the Quality menu, do either of the following:</p> <ul style="list-style-type: none"> • If the printer is on a network, then open a Web browser and type the printer IP address in the address field. Then navigate to Settings > Printer Settings > Quality Menu. <p>Note: If you do not know the IP address of the printer, then print a network setup page and locate the IP address in the TCP/IP section.</p> <ul style="list-style-type: none"> • If the printer is connected to a computer by a USB or parallel cable, then open the Local Printer Settings Utility for Windows or Printer Settings for Macintosh. <p>Note: 8 is the factory default setting.</p> <p>b Resend the print job.</p> <p>Is the print still too dark?</p>	<p>Go to step 2.</p>	<p>The problem is solved.</p>
<p>Step 2</p> <p>a From the Paper Menu, check if the paper type, texture, and weight match the paper loaded in the tray. To access the Paper Menu, do either of the following:</p> <ul style="list-style-type: none"> • If the printer is on a network, then open a Web browser and type the printer IP address in the address field. Then navigate to Settings > Paper Menu. <p>Note: If you do not know the IP address of the printer, then print a network setup page and locate the IP address in the TCP/IP section.</p> <ul style="list-style-type: none"> • If the printer is connected to a computer by a USB or parallel cable, then open the Local Printer Settings Utility for Windows or Printer Settings for Macintosh. <p>b Resend the print job.</p> <p>Is the tray set to the type and weight of the paper loaded?</p>	<p>Go to step 3.</p>	<p>Change the paper type, texture, and weight to match the paper loaded in the tray.</p>
<p>Step 3</p> <p>a Depending on your operating system, specify the paper type, texture, and weight from Printing Preferences or the Print dialog.</p> <p>b Resend the print job.</p> <p>Is the print still too dark?</p>	<p>Go to step 4.</p>	<p>The problem is solved.</p>

Action	Yes	No
<p>Step 4</p> <p>Check if the paper loaded in the tray has texture or rough finishes.</p> <p>Are you printing on textured or rough paper?</p>	<p>From the Paper Texture menu, change the texture settings to match the paper you are printing on. To access the Paper Texture menu, do either of the following:</p> <ul style="list-style-type: none"> • If the printer is on a network, then open a Web browser and type the printer IP address in the address field. Then navigate to Settings > Paper Menu > Paper Texture. <p>Note: If you do not know the IP address of the printer, then print a network setup page and locate the IP address in the TCP/IP section.</p> <ul style="list-style-type: none"> • If the printer is connected to a computer by a USB or parallel cable, then open the Local Printer Settings Utility for Windows or Printer Settings for Macintosh. 	<p>Go to step 5.</p>
<p>Step 5</p> <p>a Load paper from a fresh package.</p> <p>Note: Paper absorbs moisture due to high humidity. Store paper in its original wrapper until you use it.</p> <p>b Resend the print job.</p> <p>Is the print still too dark?</p>	<p>Go to step 6.</p>	<p>The problem is solved.</p>

Action	Yes	No
<p>Step 6 Replace the imaging unit, and then resend the print job.</p> <p>Is the print still too dark?</p>	<p>Contact customer support.</p>	<p>The problem is solved.</p>

Print is too light

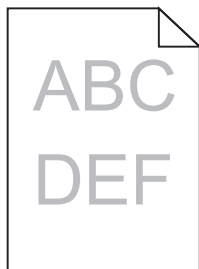

Action	Yes	No
<p>Step 1</p> <p>a From the Quality menu, increase the toner darkness. To access the Quality menu, do either of the following:</p> <ul style="list-style-type: none"> • If the printer is on a network, then open a Web browser and type the printer IP address in the address field. Then navigate to Settings > Printer Settings > Quality Menu. <p>Note: If you do not know the IP address of the printer, then print a network setup page and locate the IP address in the TCP/IP section.</p> <ul style="list-style-type: none"> • If the printer is connected to a computer by a USB or parallel cable, then open the Local Printer Settings Utility for Windows or Printer Settings for Macintosh. <p>Note: 8 is the factory default setting.</p> <p>b Resend the print job.</p> <p>Is the print still too light?</p>	<p>Go to step 2.</p>	<p>The problem is solved.</p>

Action	Yes	No
<p>Step 2</p> <p>a From the Paper Menu, check if the paper type, texture, and weight match the paper loaded in the tray. To access the Paper Menu, do either of the following:</p> <ul style="list-style-type: none"> • If the printer is on a network, then open a Web browser and type the printer IP address in the address field. Then navigate to Settings > Paper Menu. <p>Note: If you do not know the IP address of the printer, then print a network setup page and locate the IP address in the TCP/IP section.</p> <ul style="list-style-type: none"> • If the printer is connected to a computer by a USB or parallel cable, then open the Local Printer Settings Utility for Windows or Printer Settings for Macintosh. <p>b Resend the print job.</p> <p>Is the tray set to the type and weight of the paper loaded?</p>	<p>Go to step 3.</p>	<p>Change the paper type, texture, and weight to match the paper loaded in the tray.</p>
<p>Step 3</p> <p>a Depending on your operating system, specify the paper type, texture, and weight from Printing Preferences or the Print dialog.</p> <p>b Resend the print job.</p> <p>Is the print still too light?</p>	<p>Go to step 4.</p>	<p>The problem is solved.</p>

Action	Yes	No
<p>Step 4 Make sure that the paper has no texture or rough finishes.</p> <p>Are you printing on textured or rough paper?</p>	<p>From the Paper Texture menu, change the texture settings to match the paper you are printing on. To access the Paper Texture menu, do either of the following:</p> <ul style="list-style-type: none"> • If the printer is on a network, then open a Web browser and type the printer IP address in the address field. Then navigate to Settings > Paper Menu > Paper Texture. <p>Note: If you do not know the IP address of the printer, then print a network setup page and locate the IP address in the TCP/IP section.</p> <ul style="list-style-type: none"> • If the printer is connected to a computer by a USB or parallel cable, then open the Local Printer Settings Utility for Windows or Printer Settings for Macintosh. 	<p>Go to step 5.</p>
<p>Step 5</p> <p>a Load paper from a fresh package.</p> <p>Note: Paper absorbs moisture due to high humidity. Store paper in its original wrapper until you use it.</p> <p>b Resend the print job.</p> <p>Is the print still too light?</p>	<p>Go to step 6.</p>	<p>The problem is solved.</p>

Action	Yes	No
<p>Step 6</p> <p>a Shake the imaging unit to redistribute the toner.</p> <ol style="list-style-type: none"> 1 Remove the toner cartridge, and then the imaging unit. 2 Firmly shake the imaging unit. <p>Warning—Potential Damage: Do not expose the imaging unit to direct light for more than 10 minutes. Extended exposure to light may cause print quality problems.</p> <ol style="list-style-type: none"> 3 Reinstall the imaging unit, and then the cartridge. <p>b Resend the print job.</p> <p>Is the print still too light?</p>	Go to step 7.	The problem is solved.
<p>Step 7</p> <p>Replace the imaging unit, and then resend the print job.</p> <p>Is the print still too light?</p>	Contact customer support .	The problem is solved.

Skewed print

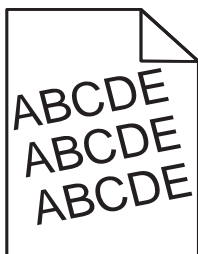

Action	Yes	No
<p>Step 1</p> <p>a Move the width and length guides in the tray to the correct positions for the size of the paper loaded.</p> <p>b Resend the print job.</p> <p>Is the print still skewed?</p>	Go to step 2.	The problem is solved.
<p>Step 2</p> <p>a Check if you are printing on a paper that is supported by the tray.</p> <p>b Resend the print job.</p> <p>Is the print still skewed?</p>	Contact customer support .	The problem is solved.

Printer is printing solid black pages



Action	Yes	No
<p>Step 1</p> <p>a Reinstall the imaging unit.</p> <p>1 Remove the toner cartridge, and then the imaging unit.</p> <p>Warning—Potential Damage: Do not expose the imaging unit to direct light for more than 10 minutes. Extended exposure to light may cause print quality problems.</p> <p>2 Install the imaging unit, and then the cartridge.</p> <p>b Resend the print job.</p> <p>Is the printer printing solid black pages?</p>	Go to step 2.	The problem is solved.
<p>Step 2</p> <p>Replace the imaging unit, and then resend the print job.</p> <p>Is the printer printing solid black pages?</p>	Contact customer support .	The problem is solved.

Transparency print quality is poor

Action	Yes	No
<p>Step 1</p> <p>From the Paper Menu, set the paper type to match the paper loaded in the tray. To access the Paper Menu, do either of the following:</p> <ul style="list-style-type: none"> If the printer is on a network, then open a Web browser and type the printer IP address in the address field. Then navigate to Settings > Paper Menu. <p>Note: If you do not know the IP address of the printer, then print a network setup page and locate the IP address in the TCP/IP section.</p> <ul style="list-style-type: none"> If the printer is connected to a computer by a USB or parallel cable, then open the Local Printer Settings Utility for Windows or Printer Settings for Macintosh. <p>Is the paper type for the tray set to Transparency?</p>	Go to step 2.	Set the paper type to Transparency.

Action	Yes	No
<p>Step 2</p> <p>a Check if you are using a recommended type of transparency.</p> <p>b Resend the print job.</p> <p>Is the print quality still poor?</p>	<p>Contact customer support.</p>	<p>The problem is solved.</p>

Streaked horizontal lines appear on prints

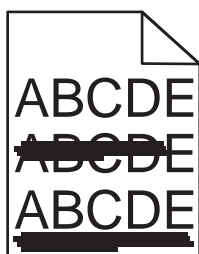

Action	Yes	No
<p>Step 1</p> <p>a Depending on your operating system, specify the tray or feeder from Printing Preferences or the Print dialog.</p> <p>b Resend the print job.</p> <p>Do streaked horizontal lines still appear on prints?</p>	<p>Go to step 2.</p>	<p>The problem is solved.</p>
<p>Step 2</p> <p>From the Paper Menu, set the paper type and weight to match the paper loaded in the tray. To access the Paper Menu, do either of the following:</p> <ul style="list-style-type: none"> If the printer is on a network, then open a Web browser and type the printer IP address in the address field. Then navigate to Settings > Paper Menu. <p>Note: If you do not know the IP address of the printer, then print a network setup page and locate the IP address in the TCP/IP section.</p> <ul style="list-style-type: none"> If the printer is connected to a computer by a USB or parallel cable, then open the Local Printer Settings Utility for Windows or Printer Settings for Macintosh. <p>Do the paper type and weight settings match the paper in the tray?</p>	<p>Go to step 3.</p>	<p>Change the paper type and weight to match the paper loaded in the tray.</p>
<p>Step 3</p> <p>a Load paper from a fresh package.</p> <p>Note: Paper absorbs moisture due to high humidity. Store paper in its original wrapper until you use it.</p> <p>b Resend the print job.</p> <p>Do streaked horizontal lines still appear on prints?</p>	<p>Go to step 4.</p>	<p>The problem is solved.</p>

Action	Yes	No
<p>Step 4</p> <p>a Reinstall the imaging unit.</p> <p>1 Remove the toner cartridge, and then the imaging unit.</p> <p>Warning—Potential Damage: Do not expose the imaging unit to direct light for more than 10 minutes. Extended exposure to light may cause print quality problems.</p> <p>2 Install the imaging unit, and then the cartridge.</p> <p>b Resend the print job.</p> <p>Do streaked horizontal lines still appear on prints?</p>	Go to step 5.	The problem is solved.
<p>Step 5</p> <p>Replace the imaging unit, and then resend the print job.</p> <p>Do streaked horizontal lines still appear on prints?</p>	Contact customer support .	The problem is solved.

Streaked vertical lines appear on prints

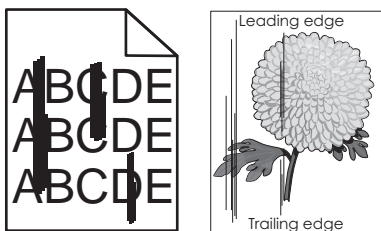

Action	Yes	No
<p>Step 1</p> <p>a Depending on your operating system, specify the paper type, texture, and weight from Printing Preferences or the Print dialog.</p> <p>b Resend the print job.</p> <p>Do streaked vertical lines still appear on prints?</p>	Go to step 2.	The problem is solved.

Action	Yes	No
<p>Step 2</p> <p>From the Paper Menu, set the paper type, texture, and weight to match the paper loaded in the tray. To access the Paper Menu, do either of the following:</p> <ul style="list-style-type: none"> • If the printer is on a network, then open a Web browser and type the printer IP address in the address field. Then navigate to Settings > Paper Menu. <p>Note: If you do not know the IP address of the printer, then print a network setup page and locate the IP address in the TCP/IP section.</p> <ul style="list-style-type: none"> • If the printer is connected to a computer by a USB or parallel cable, then open the Local Printer Settings Utility for Windows or Printer Settings for Macintosh. <p>Do the paper type, texture, and weight match the paper in the tray?</p>	<p>Go to step 3.</p>	<p>Change the paper type, texture, and weight to match the paper in the tray.</p>
<p>Step 3</p> <p>a Load paper from a fresh package.</p> <p>Note: Paper absorbs moisture due to high humidity. Store paper in its original wrapper until you use it.</p> <p>b Resend the print job.</p> <p>Do streaked vertical lines still appear on prints?</p>	<p>Go to step 4.</p>	<p>The problem is solved.</p>
<p>Step 4</p> <p>a Reinstall the imaging unit.</p> <p>1 Remove the toner cartridge, and then the imaging unit.</p> <p>Warning—Potential Damage: Do not expose the imaging unit to direct light for more than 10 minutes. Extended exposure to light may cause print quality problems.</p> <p>2 Install the imaging unit, and then the cartridge.</p> <p>b Resend the print job.</p> <p>Do streaked vertical lines still appear on prints?</p>	<p>Go to step 5.</p>	<p>The problem is solved.</p>
<p>Step 5</p> <p>Replace the imaging unit, and then resend the print job.</p> <p>Do streaked vertical lines still appear on prints?</p>	<p>Contact customer support at http://support.lexmark.com or your service representative.</p>	<p>The problem is solved.</p>

Horizontal voids appear on prints

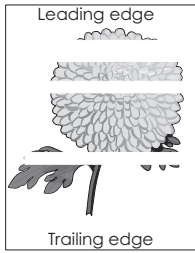

Action	Yes	No
<p>Step 1</p> <ul style="list-style-type: none"> a Make sure your software program is using a correct fill pattern. b Resend the print job. <p>Do horizontal voids appear on prints?</p>	Go to step 2.	The problem is solved.
<p>Step 2</p> <ul style="list-style-type: none"> a Load the specified tray or feeder with a recommended type of paper. b Resend the print job. <p>Do horizontal voids appear on prints?</p>	Go to step 3.	The problem is solved.
<p>Step 3</p> <ul style="list-style-type: none"> a Redistribute the toner in the imaging unit. <ul style="list-style-type: none"> 1 Remove the toner cartridge, and then the imaging unit. 2 Firmly shake the imaging unit. <p>Warning—Potential Damage: Do not expose the imaging unit to direct light for more than 10 minutes. Extended exposure to light may cause print quality problems.</p> 3 Reinstall the imaging unit, and then the cartridge. b Resend the print job. <p>Do horizontal voids appear on prints?</p>	Go to step 4.	The problem is solved.
<p>Step 4</p> <p>Replace the imaging unit, and then resend the print job.</p> <p>Do horizontal voids appear on prints?</p>	Contact customer support .	The problem is solved.

Vertical voids appear on prints

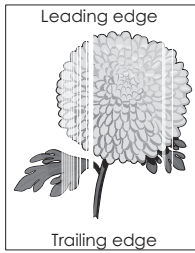

Action	Yes	No
<p>Step 1</p> <p>a Make sure your software program is using a correct fill pattern.</p> <p>b Resend the print job.</p> <p>Do vertical voids still appear on prints?</p>	Go to step 2.	The problem is solved.
<p>Step 2</p> <p>a From the Paper Menu, set the paper type and weight to match the paper loaded in the tray. To access the Paper Menu, do either of the following:</p> <ul style="list-style-type: none"> • If the printer is on a network, then open a Web browser and type the printer IP address in the address field. Then navigate to Settings > Paper Menu. <p>Note: If you do not know the IP address of the printer, then print a network setup page and locate the IP address in the TCP/IP section.</p> <ul style="list-style-type: none"> • If the printer is connected to a computer by a USB or parallel cable, then open the Local Printer Settings Utility for Windows or Printer Settings for Macintosh. <p>b Resend the print job.</p> <p>Do vertical voids still appear on prints?</p>	Go to step 3.	The problem is solved.
<p>Step 3</p> <p>Check if you are using a recommended type of paper.</p> <p>a Load the specified tray or feeder with a recommended type of paper.</p> <p>b Resend the print job.</p> <p>Do vertical voids still appear on prints?</p>	Go to step 4.	The problem is solved.

Action	Yes	No
<p>Step 4</p> <p>a Redistribute the toner in the imaging unit.</p> <ol style="list-style-type: none"> 1 Remove the toner cartridge, and then the imaging unit. 2 Firmly shake the imaging unit. <p>Warning—Potential Damage: Do not expose the imaging unit to direct light for more than 10 minutes. Extended exposure to light may cause print quality problems.</p> <ol style="list-style-type: none"> 3 Reinstall the imaging unit, and then the cartridge. <p>b Resend the print job.</p> <p>Do vertical voids appear on prints?</p>	<p>Contact customer support.</p> <p>Note: The laser scanning unit may be defective.</p>	<p>The problem is solved.</p>

Toner specks appear on prints

Action	Yes	No
<p>Replace the imaging unit, and then resend the print job.</p> <p>Do toner specks appear on prints?</p>	<p>Contact customer support.</p>	<p>The problem is solved.</p>

Toner rubs off

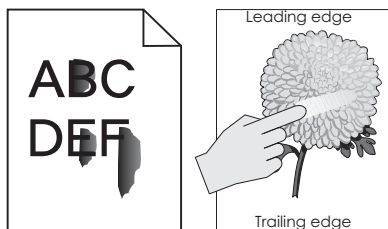

Action	Yes	No
<p>Step 1</p> <p>From the Paper menu on the printer control panel, check the paper type, texture, and weight. To access the Paper Menu, do either of the following:</p> <ul style="list-style-type: none"> • If the printer is on a network, then open a Web browser and type the printer IP address in the address field. Then navigate to Settings > Paper Menu. <p>Note: If you do not know the IP address of the printer, then print a network setup page and locate the IP address in the TCP/IP section.</p> <ul style="list-style-type: none"> • If the printer is connected to a computer by a USB or parallel cable, then open the Local Printer Settings Utility for Windows or Printer Settings for Macintosh. <p>Do the paper type, texture, and weight match the paper loaded in the tray?</p>	<p>Go to step 2.</p>	<p>Specify the paper type, texture, and weight from the tray settings to match the paper loaded in the tray.</p>

Action	Yes	No
<p>Step 2 Resend the print job.</p> <p>Does the toner still rub off?</p>	Contact customer support .	The problem is solved.

Uneven print density

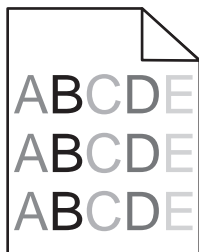

Action	Yes	No
<p>Replace the imaging unit, and then resend the print job.</p> <p>Is the print density uneven?</p>	Contact customer support .	The problem is solved.

Embedded Web Server does not open

Action	Yes	No
<p>Step 1</p> <ul style="list-style-type: none"> a Turn on the printer. b Open a Web browser, and then type the printer IP address. c Press Enter. <p>Does the Embedded Web Server open?</p>	The problem is solved.	Go to step 2.

Action	Yes	No
<p>Step 2 Make sure the printer IP address is correct.</p> <p>a View the printer IP address:</p> <ul style="list-style-type: none"> • From the TCP/IP section in the Network/Ports menu • By printing a network setup page or menu settings page, and then finding the TCP/IP section <p>Note: An IP address appears as four sets of numbers separated by periods, such as 123.123.123.123.</p> <p>b Open a Web browser, and then type the IP address.</p> <p>Note: Depending on the network settings, you may need to type “https://” instead of “http://” before the printer IP address to access the Embedded Web Server.</p> <p>c Press Enter.</p> <p>Does the Embedded Web Server open?</p>	<p>The problem is solved.</p>	<p>Go to step 3.</p>
<p>Step 3 Check if the network is working.</p> <p>a Print a network setup page.</p> <p>b Check the first section of the network setup page and confirm that the status is Connected.</p> <p>Note: If the status is Not Connected, then the connection may be intermittent, or the network cable may be defective. Contact your system support person for a solution, and then print another network setup page.</p> <p>c Open a Web browser, and then type the printer IP address.</p> <p>d Press Enter.</p> <p>Does the Embedded Web Server open?</p>	<p>The problem is solved.</p>	<p>Go to step 4.</p>
<p>Step 4 Check if the cable connections to the printer and print server are secure.</p> <p>a Connect the cables properly. For more information, see the setup documentation that came with the printer.</p> <p>b Open a Web browser, and then type the printer IP address.</p> <p>c Press Enter.</p> <p>Does the Embedded Web Server open?</p>	<p>The problem is solved.</p>	<p>Go to step 5.</p>
<p>Step 5 Temporarily disable the Web proxy servers. Proxy servers may block or restrict you from accessing certain Web sites including the Embedded Web Server.</p> <p>Does the Embedded Web Server open?</p>	<p>The problem is solved.</p>	<p>Contact your system support person.</p>

Contacting customer support

Before contacting customer support, make sure to have the following information:

- Printer problem
- Error message
- Printer model type and serial number

Go to <http://support.lexmark.com> to receive e-mail or chat support, or browse through the library of manuals, support documentation, drivers, and other downloads.

Technical support via telephone is also available. In the U.S. or Canada, call 1-800-539-6275. For other countries or regions, go to <http://support.lexmark.com>.

Notices

Product information

Product name:

Lexmark MS310d, MS310dn

Machine type:

4514

Model(s):

220, 230

Edition notice

June 2017

The following paragraph does not apply to any country where such provisions are inconsistent with local law: LEXMARK INTERNATIONAL, INC., PROVIDES THIS PUBLICATION "AS IS" WITHOUT WARRANTY OF ANY KIND, EITHER EXPRESS OR IMPLIED, INCLUDING, BUT NOT LIMITED TO, THE IMPLIED WARRANTIES OF MERCHANTABILITY OR FITNESS FOR A PARTICULAR PURPOSE. Some states do not allow disclaimer of express or implied warranties in certain transactions; therefore, this statement may not apply to you.

This publication could include technical inaccuracies or typographical errors. Changes are periodically made to the information herein; these changes will be incorporated in later editions. Improvements or changes in the products or the programs described may be made at any time.

References in this publication to products, programs, or services do not imply that the manufacturer intends to make these available in all countries in which it operates. Any reference to a product, program, or service is not intended to state or imply that only that product, program, or service may be used. Any functionally equivalent product, program, or service that does not infringe any existing intellectual property right may be used instead. Evaluation and verification of operation in conjunction with other products, programs, or services, except those expressly designated by the manufacturer, are the user's responsibility.

For Lexmark technical support, visit <http://support.lexmark.com>.

For information on supplies and downloads, visit www.lexmark.com.

© 2012 Lexmark International, Inc.

All rights reserved.

GOVERNMENT END USERS

The Software Program and any related documentation are "Commercial Items," as that term is defined in 48 C.F.R. 2.101, "Computer Software" and "Commercial Computer Software Documentation," as such terms are used in 48 C.F.R. 12.212 or 48 C.F.R. 227.7202, as applicable. Consistent with 48 C.F.R. 12.212 or 48 C.F.R. 227.7202-1 through 227.7207-4, as applicable, the Commercial Computer Software and Commercial Software Documentation are licensed to the U.S. Government end users (a) only as Commercial Items and (b) with only those rights as are granted to all other end users pursuant to the terms and conditions herein.

Trademarks

Lexmark, the Lexmark logo, and MarkNet are trademarks or registered trademarks of Lexmark International, Inc. in the United States and/or other countries.

Google Cloud Print is a trademark of Google Inc.

Mac and the Mac logo are trademarks of Apple Inc., registered in the U.S. and other countries.

Mopria®, the Mopria® logo, and the Mopria® Alliance logo are registered trademarks and service marks of Mopria Alliance, Inc. in the United States and other countries. Unauthorized use is strictly prohibited.

PCL® is a registered trademark of the Hewlett-Packard Company. PCL is Hewlett-Packard Company's designation of a set of printer commands (language) and functions included in its printer products. This printer is intended to be compatible with the PCL language. This means the printer recognizes PCL commands used in various application programs, and that the printer emulates the functions corresponding to the commands.

PostScript is a registered trademark of Adobe Systems Incorporated in the United States and/or other countries.

Windows is either a registered trademark or trademark of the Microsoft group of companies in the United States and other countries.

All other trademarks are the property of their respective owners.

AirPrint and the AirPrint logo are trademarks of Apple, Inc.

Federal Communications Commission (FCC) compliance information statement

This product has been tested and found to comply with the limits for a Class B digital device, pursuant to Part 15 of the FCC Rules. Operation is subject to the following two conditions: (1) this device may not cause harmful interference, and (2) this device must accept any interference received, including interference that may cause undesired operation.

The FCC Class B limits are designed to provide reasonable protection against harmful interference when the equipment is operated in a residential installation. This equipment generates, uses, and can radiate radio frequency energy and, if not installed and used in accordance with the instructions, may cause harmful interference to radio communications. However, there is no guarantee that interference will not occur in a particular installation. If this equipment does cause harmful interference to radio or television reception, which can be determined by turning the equipment off and on, the user is encouraged to try to correct the interference by one or more of the following measures:

- Reorient or relocate the receiving antenna.
- Increase the separation between the equipment and receiver.
- Connect the equipment into an outlet on a circuit different from that to which the receiver is connected.
- Consult your point of purchase or service representative for additional suggestions.

The manufacturer is not responsible for radio or television interference caused by using other than recommended cables or by unauthorized changes or modifications to this equipment. Unauthorized changes or modifications could void the user's authority to operate this equipment.

Note: To assure compliance with FCC regulations on electromagnetic interference for a Class B computing device, use a properly shielded and grounded cable such as Lexmark part number 1021231 for parallel attach or 1021294 for USB attach. Use of a substitute cable not properly shielded and grounded may result in a violation of FCC regulations.

Any questions regarding this compliance information statement should be directed to:

Director of Lexmark Technology & Services
 Lexmark International, Inc.
 740 West New Circle Road
 Lexington, KY 40550
 (859) 232-3000

Licensing notices

All licensing notices associated with this product can be viewed from the root directory of the installation software CD.

Noise emission levels

The following measurements were made in accordance with ISO 7779 and reported in conformance with ISO 9296.

Note: Some modes may not apply to your product.

1-meter average sound pressure, dBA	
Printing	53 (one-sided); 52 (two-sided)
Ready	N/A

Values are subject to change. See www.lexmark.com for current values.

Waste from Electrical and Electronic Equipment (WEEE) directive



The WEEE logo signifies specific recycling programs and procedures for electronic products in countries of the European Union. We encourage the recycling of our products.

If you have further questions about recycling options, visit the Lexmark Web site at www.lexmark.com for your local sales office phone number.

India E-Waste notice

This product complies with the India E-Waste (Management and Handling) Rules, 2011, which prohibit use of lead, mercury, hexavalent chromium, polybrominated biphenyls, or polybrominated diphenyl ethers in concentrations exceeding 0.1% by weight and 0.01% by weight for cadmium, except for the exemption set in Schedule II of the Rules.

Product disposal

Do not dispose of the printer or supplies in the same manner as normal household waste. Consult your local authorities for disposal and recycling options.

Static sensitivity notice

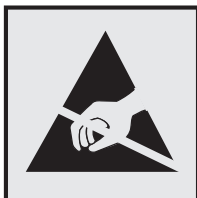

This symbol identifies static-sensitive parts. Do not touch the areas near these symbols without first touching a metal surface in an area away from the symbol.

ENERGY STAR

Any Lexmark product bearing the ENERGY STAR emblem on the product or on a start-up screen is certified to comply with Environmental Protection Agency (EPA) ENERGY STAR requirements as configured when shipped by Lexmark.



Temperature information

Ambient operating temperature	16°C to 32°C (60°F to 90°F)
Shipping temperature	-40 to 43.3°C (-40 to 110°F)
Storage temperature and relative humidity	2 to 35°C (34 to 95°F) 8 to 80% RH

Laser notice

The printer is certified in the U.S. to conform to the requirements of DHHS 21 CFR, Chapter I, Subchapter J for Class I (1) laser products, and elsewhere is certified as a Class I laser product conforming to the requirements of IEC 60825-1: 2014.

Class I laser products are not considered to be hazardous. The printer contains internally a Class IIIb (3b) laser that is nominally a 12-milliwatt gallium arsenide laser operating in the wavelength of 655–675 nanometers. The laser system and printer are designed so there is never any human access to laser radiation above a Class I level during normal operation, user maintenance, or prescribed service condition.

Laser advisory label

A laser notice label may be affixed to this printer as shown:

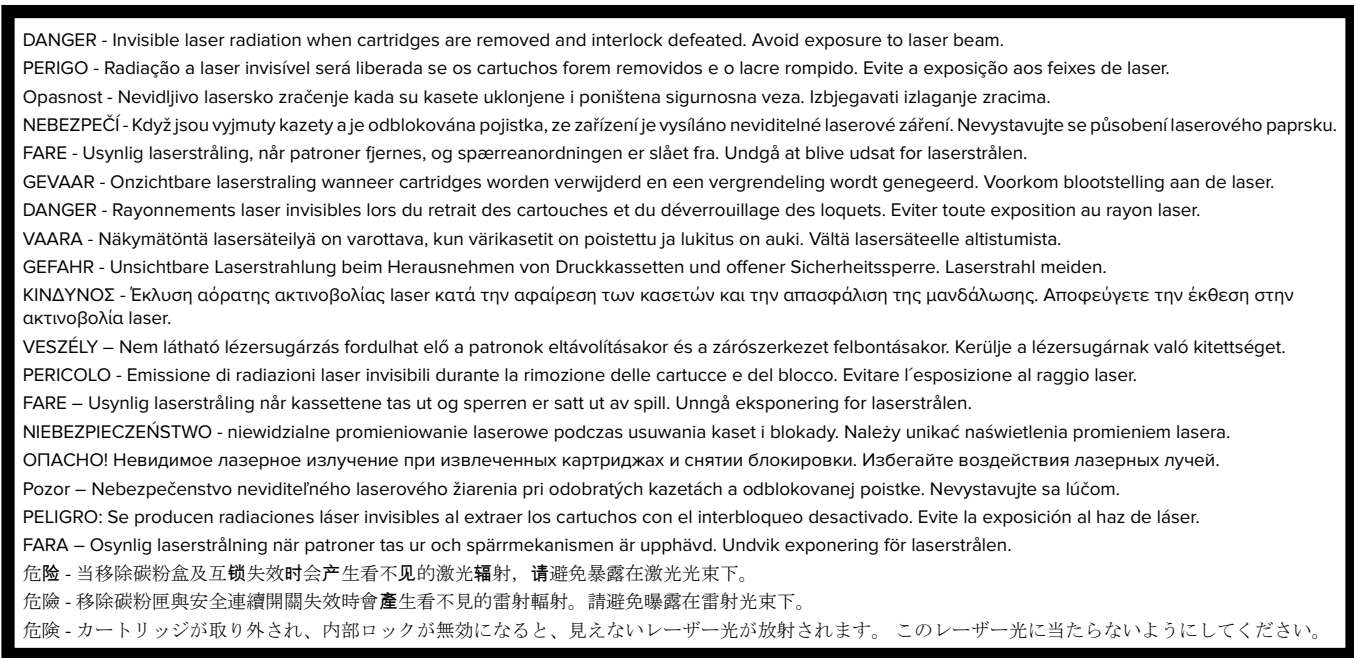

Power consumption

Product power consumption

The following table documents the power consumption characteristics of the product.

Note: Some modes may not apply to your product.

Mode	Description	Power consumption (Watts)
Printing	The product is generating hard-copy output from electronic inputs.	520 (one-sided); 340 (two-sided)
Copy	The product is generating hard-copy output from hard-copy original documents.	N/A
Scan	The product is scanning hard-copy documents.	N/A
Ready	The product is waiting for a print job.	6.5
Sleep Mode	The product is in a high-level energy-saving mode.	3
Hibernate	The product is in a low-level energy-saving mode.	0.5
Off	The product is plugged into an electrical outlet, but the power switch is turned off.	0.0

The power consumption levels listed in the previous table represent time-averaged measurements. Instantaneous power draws may be substantially higher than the average.

Values are subject to change. See www.lexmark.com for current values.

Sleep Mode

This product is designed with an energy-saving mode called *Sleep Mode*. The Sleep Mode saves energy by lowering power consumption during extended periods of inactivity. The Sleep Mode is automatically engaged after this product is not used for a specified period of time, called the *Sleep Mode Timeout*.

Factory default Sleep Mode Timeout for this product (in minutes):	20
---	----

By using the configuration menus, the Sleep Mode Timeout can be modified between 1 minute and 120 minutes. Setting the Sleep Mode Timeout to a low value reduces energy consumption, but may increase the response time of the product. Setting the Sleep Mode Timeout to a high value maintains a fast response, but uses more energy.

Hibernate Mode

This product is designed with an ultra-low power operating mode called *Hibernate mode*. When operating in Hibernate Mode, all other systems and devices are powered down safely.

The Hibernate mode can be entered in any of the following methods:

- Using the Hibernate Timeout
- Using the Schedule Power modes
- Using the Sleep/Hibernate button

Factory default Hibernate Timeout for this product in all countries or regions	3 days
--	--------

The amount of time the printer waits after a job is printed before it enters Hibernate mode can be modified between one hour and one month.

Off mode

If this product has an off mode which still consumes a small amount of power, then to completely stop product power consumption, disconnect the power supply cord from the electrical outlet.

Total energy usage

It is sometimes helpful to calculate the total product energy usage. Since power consumption claims are provided in power units of Watts, the power consumption should be multiplied by the time the product spends in each mode in order to calculate energy usage. The total product energy usage is the sum of each mode's energy usage.

Industry Canada compliance statement

This Class B digital apparatus meets all requirements of the Canadian Interference-Causing Equipment Standard ICES-003.

Avis de conformité aux normes de l'industrie du Canada

Cet appareil numérique de classe B est conforme aux exigences de la norme canadienne relative aux équipements pouvant causer des interférences NMB-003.

日本の VCCI 規定

製品にこのマークが表示されている場合、次の要件を満たしています。



この装置は、クラス B 情報技術装置です。この装置は、家庭環境で使用することを目的としていますが、この装置がラジオやテレビジョン受信機に近接して使用されると、受信障害を引き起こすことがあります。

取扱説明書に従って正しい取り扱いをしてください。

VCCI-B

European Community (EC) directives conformity

This product is in conformity with the protection requirements of EC Council directives 2014/30/EU, 2014/35/EU, 2009/125/EC, and 2011/65/EU on the approximation and harmonization of the laws of the Member States relating to electromagnetic compatibility, safety of electrical equipment designed for use within certain voltage limits, the ecodesign of energy-related products, and on the restrictions of use of certain hazardous substances in electrical and electronic equipment.

The manufacturer of this product is: Lexmark International, Inc., 740 West New Circle Road, Lexington, KY, 40550 USA. The authorized representative is: Lexmark International Technology Hungária Kft., 8 Lechner Ödön fasor, Millennium Tower III, 1095 Budapest HUNGARY. A declaration of conformity to the requirements of the Directives is available upon request from the Authorized Representative or may be obtained at www.lexmark.com/en_us/about/regulatory-compliance/european-union-declaration-of-conformity.html.

This product satisfies the Class B limits of EN 55022 and EN55032 and safety requirements of EN 60950-1.

STATEMENT OF LIMITED WARRANTY FOR LEXMARK LASER PRINTERS, LEXMARK LED PRINTERS, AND LEXMARK MULTIFUNCTION LASER PRINTERS

Lexmark International, Inc., Lexington, KY

This limited warranty applies to the United States and Canada. For customers outside the U.S., refer to the country-specific warranty information that came with your product.

This limited warranty applies to this product only if it was originally purchased for your use, and not for resale, from Lexmark or a Lexmark Remarketer, referred to in this statement as "Remarketer."

Limited warranty

Lexmark warrants that this product:

- Is manufactured from new parts, or new and serviceable used parts, which perform like new parts
- Is, during normal use, free from defects in material and workmanship

If this product does not function as warranted during the warranty period, contact a Remarketer or Lexmark for repair or replacement (at Lexmark's option).

If this product is a feature or option, this statement applies only when that feature or option is used with the product for which it was intended. To obtain warranty service, you may be required to present the feature or option with the product.

If you transfer this product to another user, warranty service under the terms of this statement is available to that user for the remainder of the warranty period. You should transfer proof of original purchase and this statement to that user.

Limited warranty service

The warranty period starts on the date of original purchase as shown on the purchase receipt and ends 12 months later provided that the warranty period for any supplies and for any maintenance items included with the printer shall end earlier if it, or its original contents, are substantially used up, depleted, or consumed. Fuser Units, Transfer/Transport Units, Paper Feed items, if any, and any other items for which a Maintenance Kit is available are substantially consumed when the printer displays a “Life Warning” or “Scheduled Maintenance” message for such item.

To obtain warranty service you may be required to present proof of original purchase. You may be required to deliver your product to the Remarketer or Lexmark, or ship it prepaid and suitably packaged to a Lexmark designated location. You are responsible for loss of, or damage to, a product in transit to the Remarketer or the Lexmark designated location.

When warranty service involves the exchange of a product or part, the item replaced becomes the property of the Remarketer or Lexmark. The replacement may be a new or repaired item.

The replacement item assumes the remaining warranty period of the original product.

Replacement is not available to you if the product you present for exchange is defaced, altered, in need of a repair not included in warranty service, damaged beyond repair, or if the product is not free of all legal obligations, restrictions, liens, and encumbrances.

As part of your warranty service and/or replacement, Lexmark may update the firmware in your printer to the latest version. Firmware updates may modify printer settings and cause counterfeit and/or unauthorized products, supplies, parts, materials (such as toners and inks), software, or interfaces to stop working. Authorized use of genuine Lexmark products will not be impacted.

Before you present this product for warranty service, remove all print cartridges, programs, data, and removable storage media (unless directed otherwise by Lexmark).

For further explanation of your warranty alternatives and the nearest Lexmark authorized servicer in your area contact Lexmark on the World Wide Web.

Remote technical support is provided for this product throughout its warranty period. For products no longer covered by a Lexmark warranty, technical support may not be available or only be available for a fee.

Extent of limited warranty

Lexmark does not warrant uninterrupted or error-free operation of any product or the durability or longevity of prints produced by any product.

Warranty service does not include repair of failures caused by:

- Modification or unauthorized attachments
- Accidents, misuse, abuse or use inconsistent with Lexmark user's guides, manuals, instructions or guidance
- Unsuitable physical or operating environment
- Maintenance by anyone other than Lexmark or a Lexmark authorized servicer
- Operation of a product beyond the limit of its duty cycle
- Use of printing media outside of Lexmark specifications
- Refurbishment, repair, refilling or remanufacture by a third party of products, supplies or parts
- Products, supplies, parts, materials (such as toners and inks), software, or interfaces not furnished by Lexmark

TO THE EXTENT PERMITTED BY APPLICABLE LAW, NEITHER LEXMARK NOR ITS THIRD PARTY SUPPLIERS OR REMARKETERS MAKE ANY OTHER WARRANTY OR CONDITION OF ANY KIND, WHETHER EXPRESS OR IMPLIED, WITH RESPECT TO THIS PRODUCT, AND SPECIFICALLY DISCLAIM THE IMPLIED WARRANTIES OR CONDITIONS OF MERCHANTABILITY, FITNESS FOR A PARTICULAR PURPOSE, AND SATISFACTORY QUALITY. ANY WARRANTIES THAT MAY NOT BE DISCLAIMED UNDER APPLICABLE LAW ARE LIMITED IN DURATION TO THE WARRANTY PERIOD. NO WARRANTIES, EXPRESS OR IMPLIED, WILL APPLY AFTER THIS PERIOD. ALL INFORMATION, SPECIFICATIONS, PRICES, AND SERVICES ARE SUBJECT TO CHANGE AT ANY TIME WITHOUT NOTICE.

Limitation of liability

Your sole remedy under this limited warranty is set forth in this document. For any claim concerning performance or nonperformance of Lexmark or a Remarketer for this product under this limited warranty, you may recover actual damages up to the limit set forth in the following paragraph.

Lexmark's liability for actual damages from any cause whatsoever will be limited to the amount you paid for the product that caused the damages. This limitation of liability will not apply to claims by you for bodily injury or damage to real property or tangible personal property for which Lexmark is legally liable. **IN NO EVENT WILL LEXMARK BE LIABLE FOR ANY LOST PROFITS, LOST SAVINGS, INCIDENTAL DAMAGE, OR OTHER ECONOMIC OR CONSEQUENTIAL DAMAGES.** This is true even if you advise Lexmark or a Remarketer of the possibility of such damages. Lexmark is not liable for any claim by you based on a third party claim.

This limitation of remedies also applies to claims against any Suppliers and Remarketers of Lexmark. Lexmark's and its Suppliers' and Remarketers' limitations of remedies are not cumulative. Such Suppliers and Remarketers are intended beneficiaries of this limitation.

Additional rights

Some states do not allow limitations on how long an implied warranty lasts, or do not allow the exclusion or limitation of incidental or consequential damages, so the limitations or exclusions contained above may not apply to you.

This limited warranty gives you specific legal rights. You may also have other rights that vary from state to state.

Patent acknowledgment

The use of this product or service is subject to the reasonable, non-discriminatory terms in the Intellectual Property Rights (IPR) Disclosure of Certicom Corp. at the IETF for Elliptic Curve Cryptography (ECC) Cipher Suites for Transport Layer Security (TLS) implemented in the product or service.

The use of this product or service is subject to the reasonable, non-discriminatory terms in the Intellectual Property Rights (IPR) Disclosure of Certicom Corp. at the IETF for TLS Elliptic Curve Cipher Suites with SHA-256/382 and AES Galois Counter Mode (GCM) implemented in the product or service.

The use of this product or service is subject to the reasonable, non-discriminatory terms in the Intellectual Property Rights (IPR) Disclosure of Certicom Corp. at the IETF for TLS Suite B Profile for Transport Layer Security (TLS) implemented in the product or service.

The use of this product or service is subject to the reasonable, non-discriminatory terms in the Intellectual Property Rights (IPR) Disclosure of Certicom Corp. at the IETF for Addition of the Camellia Cipher Suites to Transport Layer Security (TLS) implemented in the product or service.

The use of certain patents in this product or service is subject to the reasonable, non-discriminatory terms in the Intellectual Property Rights (IPR) Disclosure of Certicom Corp. at the IETF for AES-CCM ECC Cipher Suites for TLS implemented in the product or service.

The use of this product or service is subject to the reasonable, non-discriminatory terms in the Intellectual Property Rights (IPR) Disclosure of Certicom Corp. at the IETF for IKE and IKEv2 Authentication Using the Elliptic Curve Digital Signature Algorithm (ECDSA) implemented in the product or service.

The use of this product or service is subject to the reasonable, non-discriminatory terms in the Intellectual Property Rights (IPR) Disclosure of Certicom Corp. at the IETF for Suite B Cryptographic Suites for IPsec implemented in the product or service.

The use of this product or service is subject to the reasonable, non-discriminatory terms in the Intellectual Property Rights (IPR) Disclosure of Certicom Corp. at the IETF for Algorithms for Internet Key Exchange version 1 (IKEv1) implemented in the product or service.

Index

Numerics

- 250-sheet tray
 - loading 25
- 550-sheet tray
 - loading 25

A

- accessing the Embedded Web Server 15
- adding hardware options
 - print driver 19
- adding internal options
 - print driver 19
- adjusting toner darkness 45
- administrator settings
 - Embedded Web Server 89
- AirPrint
 - using 46
- assigning custom paper types 34
- attaching cables 17
- avoiding jams 41
- avoiding paper jams 91

B

- buttons
 - control panel 12

C

- cables
 - Ethernet 17
 - parallel 17
 - USB 17
- canceling a print job
 - from a computer 47
- cannot open Embedded Web Server 180
- card stock
 - loading, multipurpose feeder 30
 - tips 39
- Cartridge low [88.xx] 107
- Cartridge nearly low [88.xy] 107
- Cartridge very low [88.xy] 108
- Cartridge, imaging unit mismatch [41.xy] 106
- checking an unresponsive printer 146

- cleaning
 - exterior of the printer 80
 - interior of the printer 80
- cleaning the printer 80
- Close front door 139
- Complex page, some data may not have printed [39] 140
- confidential data
 - information on securing 79
- configuration information
 - wireless network 20
- configurations
 - printer 9
- Configure MP menu 52
- configuring
 - multiple printers 90
- configuring custom paper types 34
- configuring Hibernate mode 74
- configuring Sleep mode 74
- configuring supply notifications 89
- connecting printer to wireless network
 - using Personal Identification Number method 21
- connecting to a wireless network
 - using the Embedded Web Server 23
- conservation settings
 - Hibernate Timeout 75
 - Schedule Power Modes 75
 - Sleep mode 74
- conserving supplies 73
- contacting customer support 182
- control panel
 - light sequences 12
- control panel, printer
 - buttons 11
 - lights 11
- custom paper type
 - assigning 34
 - configuring 34
- Custom Types menu 56
- customer support
 - contacting 182

D

- Default Source menu 48
- documents, printing
 - from a computer 45

E

- Embedded Web Server
 - accessing 15
 - administrator settings 89
 - copying settings to other printers 90
 - functions 15
 - networking settings 89
 - problem accessing 180
 - using 15
- Embedded Web Server — Security: Administrator's Guide
 - where to find 89
- Embedded Web Server— Security: Administrator's Guide
 - where to find 79
- emission
 - notices 184, 185, 188, 189
- envelopes
 - loading, multipurpose feeder 30
 - tips on using 40
- environmental settings
 - Hibernate Timeout 75
 - Schedule Power Modes 75
 - Sleep mode 74
- erasing non-volatile memory 78
- erasing volatile memory 78
- Ethernet network
 - preparing to set up for Ethernet printing 20
- Ethernet port 17
- Ethernet setup
 - preparing for an 20

F

- FCC notices 184
- finding more information about the printer 7
- Finishing menu 68

G

General Settings menu 58
 Google Cloud Print
 using 46
 green settings
 Hibernate Timeout 75
 Schedule Power Modes 75
 Sleep mode 74

H

hardware options, adding
 print driver 19
 Hibernate mode
 configuring 74
 Hibernate Timeout
 setting 75

I

identifying jam locations 92
 imaging unit
 ordering 83
 replacing 85
 Imaging unit low [84.xy] 114
 Imaging unit nearly low
 [84.xy] 114
 Imaging unit very low [84.xy] 115
 Incorrect paper size, open [paper
 source] [34] 119
 installing
 optional tray 16
 installing optional tray 16
 installing software
 Local Printer Settings Utility 19
 installing the printer software 18
 Insufficient memory to collate job
 [37] 135
 Insufficient memory to support
 Resource Save feature [35] 137
 internal options, adding
 print driver 19

J

jams
 avoiding 91
 jams, clearing
 in the front door 93

L

labels, paper
 tips on using 40

letterhead
 loading, multipurpose
 feeder 30
 tips on using 41
 Lexmark Print
 using 46
 light sequences
 control panel 12
 lights
 control panel 12
 linking trays 33
 Load [paper source] with [custom
 type name] 121
 Load [paper source] with [custom
 type string] 122
 Load [paper source] with [paper
 size] 123
 Load [paper source] with [paper
 type] [paper size] 124
 Load Manual Feeder with [paper
 size] [orientation] 127
 Load multipurpose feeder with
 [custom type name]
 [orientation] 125
 Load multipurpose feeder with
 [custom type string]
 [orientation] 126
 Load multipurpose feeder with
 [paper type] [paper size]
 [orientation] 128
 loading
 250-sheet tray 25
 550-sheet tray 25
 multipurpose feeder 30
 Local Printer Settings Utility
 installing 19
 using 15
 locating paper jam 92
 lock, security 77

M

memory
 types installed on printer 77
 Memory full [38] 138
 menu settings
 loading on multiple printers 90
 menu settings page, printing 23
 menus
 Configure MP 52
 Custom Types 56
 Default Source 48
 Finishing 68

General Settings 58
 in Local Printer Settings
 Utility 15
 list of 48
 Paper Loading 55
 Paper Size/Type 49
 Paper Texture 52
 Paper Weight 53
 PCL Emul 70
 PostScript 70
 Quality 69
 Set Date and Time 72
 Setup 66
 Standard USB 57
 menus list 48
 mobile device
 printing from 46
 Mopria Print Service
 using 46
 moving the printer 8, 87, 88
 multipurpose feeder
 loading 30

N

Network [x] software error
 [54] 129
 network settings
 Embedded Web Server 89
 network setup page, printing 23
 Networking Guide
 where to find 89
 noise emission levels 185
 Non-Lexmark [supply type], see
 User's Guide [33.xy] 118
 non-volatile memory 77
 erasing 78
 notices 184, 185, 186, 187, 188,
 189
 number of remaining pages
 estimate 81

O

optional tray
 installing 16
 ordering
 imaging unit 83
 ordering supplies
 toner cartridges 81

P

- paper
 - characteristics 36
 - letterhead 37
 - loading, multipurpose feeder 30
 - preprinted forms 37
 - recycled 38
 - selecting 37
 - setting size 24
 - setting type 24
 - storing 41
 - unacceptable 37, 38
 - using recycled 73
- paper feed troubleshooting
 - message remains after jam is cleared 150
- paper jam in the duplex unit 99
- paper jam in the front door 93
- paper jam in the multipurpose feeder 104
- paper jam in the rear door 96
- paper jam in the standard bin 98
- paper jam in trays 101
- paper jam, clearing
 - in the duplex unit 99
 - in the multipurpose feeder 104
 - in the rear door 96
 - in the standard bin 98
 - in trays 101
- paper jams
 - avoiding 91
- paper labels
 - loading, multipurpose feeder 30
- Paper Loading menu 55
- paper size setting
 - Universal 24
- Paper Size/Type menu 49
- paper sizes
 - supported by the printer 42
- paper stop, using 25
- Paper Texture menu 52
- paper types
 - duplex support 43
 - supported by printer 43
 - where to load 43
- Paper Weight menu 53
- parallel port 17
- parts
 - using genuine Lexmark 81
- PCL Emul menu 70
- Personal Identification Number method
 - using 21
- PostScript menu 70
- PPDS font error [50] 141
- preparing to set up the printer on an Ethernet network 20
- print driver
 - hardware options, adding 19
- print irregularities 164
- print job
 - canceling, from computer 47
- print quality troubleshooting
 - blank pages 157
 - clipped pages or images 158
 - gray background on prints 161
 - horizontal voids appear on prints 177
 - print irregularities 164
 - print is too dark 166
 - print is too light 169
 - printer is printing solid black pages 173
 - repeating print defects appear on prints 166
 - shadow images appear on prints 160
 - skewed print 172
 - streaked horizontal lines appear on prints 174
 - streaked vertical lines 175
 - toner rubs off 179
 - toner specks appear on prints 179
 - transparency print quality is poor 173
 - uneven print density 180
 - white streaks 178
- print troubleshooting
 - incorrect characters print 155
 - incorrect margins on prints 162
 - jammed pages are not reprinted 151
 - job prints from wrong tray 154
 - job prints on wrong paper 154
 - jobs do not print 151
 - large jobs do not collate 156
 - paper curl 163
 - paper frequently jams 150
 - print job takes longer than expected 153
 - printing slows down 153
 - tray linking does not work 155
 - unexpected page breaks occur 157
- printer
 - configurations 9
 - minimum clearances 8
 - moving 8, 87, 88
 - selecting a location 8
 - shipping 88
- printer configurations
 - basic model 9
 - configured model 9
- printer control panel
 - buttons 11
 - lights 11
- Printer had to restart. Last job may be incomplete. 143
- printer information
 - where to find 7
- printer is printing blank pages 157
- printer messages
 - Cartridge low [88.xx] 107
 - Cartridge nearly low [88.xy] 107
 - Cartridge very low [88.xy] 108
 - Cartridge, imaging unit mismatch [41.xy] 106
 - Close front door 139
 - Complex page, some data may not have printed [39] 140
 - Imaging unit low [84.xy] 114
 - Imaging unit nearly low [84.xy] 114
 - Imaging unit very low [84.xy] 115
 - Incorrect paper size, open [paper source] [34] 119
 - Insufficient memory to collate job [37] 135
 - Insufficient memory to support Resource Save feature [35] 137
 - Load [paper source] with [custom type name] 121
 - Load [paper source] with [custom type string] 122
 - Load [paper source] with [paper size] 123
 - Load [paper source] with [paper type] [paper size] 124

- Load Manual Feeder with [paper size] [orientation] 127
- Load multipurpose feeder with [custom type name] [orientation] 125
- Load multipurpose feeder with [custom type string] [orientation] 126
- Load multipurpose feeder with [paper type] [paper size] [orientation] 128
- Memory full [38] 138
- Network [x] software error [54] 129
- Non-Lexmark [supply type], see User's Guide [33.xy] 118
- PPDS font error [50] 141
- Printer had to restart. Last job may be incomplete. 143
- Rear USB port disabled [56] 134
- Reinstall missing or unresponsive cartridge [31.xy] 112
- Reinstall missing or unresponsive imaging unit [31.xy] 116
- Remove paper from standard output bin 129
- Replace cartridge, 0 estimated pages remain [88.xy] 109
- Replace cartridge, printer region mismatch [42.xy] 110
- Replace imaging unit, 0 estimated pages remain [84.xy] 116
- Replace unsupported cartridge [32.xy] 113
- Replace unsupported imaging unit [32.xy] 118
- Service error 144
- Standard network software error [54] 132
- Standard Parallel Port Disabled [56] 131
- Too many trays attached [58] 145
- printer options troubleshooting
 - internal option is not detected 148
 - tray problems 149
- printer problems, solving
 - basic 146
 - printer security
 - information on 79
 - printer software, installing 18
 - printing
 - from a computer 45
 - from a mobile device 46
 - menu settings page 23
 - network setup page 23
 - publications
 - where to find 7
- Q**
 - Quality menu 69
- R**
 - Rear USB port disabled [56] 134
 - recycled paper
 - using 38, 73
 - recycling
 - Lexmark packaging 76
 - Lexmark products 76
 - toner cartridges 76
 - Reinstall missing or unresponsive cartridge [31.xy] 112
 - Reinstall missing or unresponsive imaging unit [31.xy] 116
 - Remove paper from standard output bin 129
 - repeating print defects appear on prints 166
 - Replace cartridge, 0 estimated pages remain [88.xy] 109
 - Replace cartridge, printer region mismatch [42.xy] 110
 - Replace imaging unit, 0 estimated pages remain [84.xy] 116
 - Replace unsupported cartridge [32.xy] 113
 - Replace unsupported imaging unit [32.xy] 118
 - replacing
 - imaging unit 85
 - toner cartridge 84
 - reports
 - viewing 89
- S**
 - safety information 5, 6
 - Schedule Power Modes using 75
 - security lock 77
 - security Web page
 - printer security information 79
 - selecting a location for the printer 8
 - selecting paper 37
 - Service error 144
 - Set Date and Time menu 72
 - setting
 - paper size 24
 - paper type 24
 - setting Hibernate Timeout 75
 - Setup menu 66
 - shipping the printer 88
 - Sleep mode
 - adjusting 74
 - configuring 74
 - standard bin, using 25
 - Standard network software error [54] 132
 - Standard Parallel Port Disabled [56] 131
 - standard tray
 - loading 25
 - Standard USB menu 57
 - statement of volatility 77
 - storing
 - paper 41
 - supplies 83
 - streaked horizontal lines appear on prints 174
 - streaked vertical lines appear on prints 175
 - streaks appear 178
 - supplies
 - checking status 80
 - conserving 73
 - storing 83
 - using genuine Lexmark 81
 - using recycled paper 73
 - supplies, ordering
 - imaging unit 83
 - toner cartridges 81
 - supply notifications
 - configuring 89
 - supported paper sizes 42
 - supported paper types and weights 43
- T**
 - tips
 - card stock 39

- letterhead 41
 - on using envelopes 40
 - on using labels 40
 - transparencies 41
- tips on using envelopes 40
- toner cartridge
 - replacing 84
- toner cartridges
 - ordering 81
 - recycling 76
- toner darkness
 - adjusting 45
- Too many trays attached [58] 145
- transparencies
 - loading, multipurpose feeder 30
 - tips 41
- trays
 - linking 33
 - unlinking 33
- troubleshooting
 - cannot open Embedded Web Server 180
 - checking an unresponsive printer 146
 - solving basic printer problems 146
- troubleshooting, paper feed message remains after jam is cleared 150
- troubleshooting, print
 - incorrect characters print 155
 - incorrect margins on prints 162
 - jammed pages are not reprinted 151
 - job prints from wrong tray 154
 - job prints on wrong paper 154
 - jobs do not print 151
 - large jobs do not collate 156
 - paper curl 163
 - paper frequently jams 150
 - print job takes longer than expected 153
 - printing slows down 153
 - tray linking does not work 155
 - unexpected page breaks occur 157
- troubleshooting, print quality
 - blank pages 157
 - clipped pages or images 158
 - gray background on prints 161

- horizontal voids appear on prints 177
- print irregularities 164
- print is too dark 166
- print is too light 169
- printer is printing solid black pages 173
- repeating print defects appear on prints 166
- shadow images appear on prints 160
- skewed print 172
- streaked horizontal lines appear on prints 174
- streaked vertical lines 175
- toner rubs off 179
- toner specks appear on prints 179
- transparency print quality is poor 173
- uneven print density 180
- white streaks on a page 178

troubleshooting, printer options

- internal option is not detected 148
- tray problems 149

U

- unacceptable paper 37
- uneven print density 180
- Universal paper size
 - setting 24
- unlinking trays 33
- USB port 17
- using
 - Wireless Setup Assistant 22
- using recycled paper 73
- using Schedule Power Modes 75
- using the Embedded Web Server 15
- using Wireless Setup Utility 22

V

- vertical voids appear 178
- viewing
 - reports 89
- voids appear 178
- volatile memory 77
 - erasing 78
- volatility
 - statement of 77

W

- wireless network
 - configuration information 20
- wireless network setup
 - using the Embedded Web Server 23
- Wireless Setup Assistant
 - using 22
- Wireless Setup Utility
 - using 22