

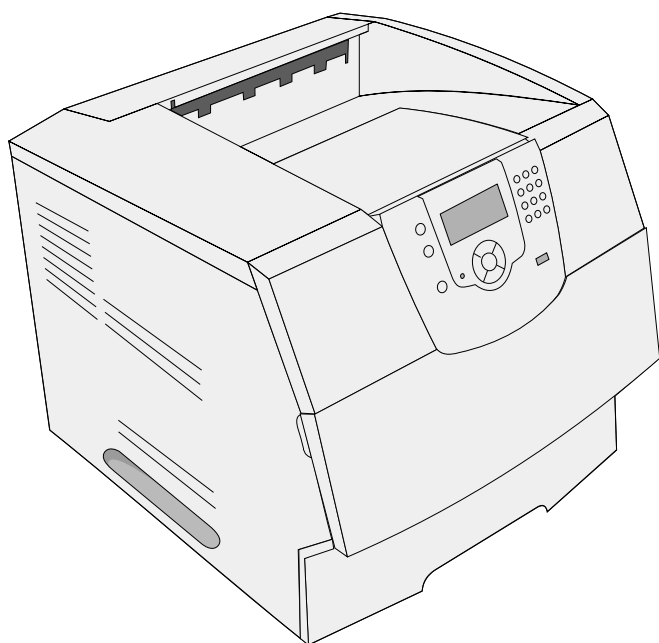

T640, T642, T644

User's Guide



March 2005

www.lexmark.com

Lexmark and Lexmark with diamond design are trademarks of Lexmark International, Inc., registered in the United States and/or other countries.

© 2005 Lexmark International, Inc.

All rights reserved.

740 West New Circle Road
Lexington, Kentucky 40550

Edition: March 2005

The following paragraph does not apply to any country where such provisions are inconsistent with local law: LEXMARK INTERNATIONAL, INC., PROVIDES THIS PUBLICATION "AS IS" WITHOUT WARRANTY OF ANY KIND, EITHER EXPRESS OR IMPLIED, INCLUDING, BUT NOT LIMITED TO, THE IMPLIED WARRANTIES OF MERCHANTABILITY OR FITNESS FOR A PARTICULAR PURPOSE. Some states do not allow disclaimer of express or implied warranties in certain transactions; therefore, this statement may not apply to you.

This publication could include technical inaccuracies or typographical errors. Changes are periodically made to the information herein; these changes will be incorporated in later editions. Improvements or changes in the products or the programs described may be made at any time.

Comments about this publication may be addressed to Lexmark International, Inc., Department F95/032-2, 740 West New Circle Road, Lexington, Kentucky 40550, U.S.A. In the United Kingdom and Eire, send to Lexmark International Ltd., Marketing and Services Department, Westhorpe House, Westhorpe, Marlow Bucks SL7 3RQ. Lexmark may use or distribute any of the information you supply in any way it believes appropriate without incurring any obligation to you. You can purchase additional copies of publications related to this product by calling 1-800-553-9727. In the United Kingdom and Eire, call +44 (0)8704 440 044. In other countries, contact your point of purchase.

References in this publication to products, programs, or services do not imply the manufacturer intends to make these available in all countries in which it operates. Any reference to a product, program, or service is not intended to state or imply that only that product, program, or service may be used. Any functionally equivalent product, program, or service that does not infringe any existing intellectual property right may be used instead. Evaluation and verification of operation in conjunction with other products, programs, or services, except those expressly designated by the manufacturer, are the user's responsibility.

Safety information

- Connect the power cord to a properly grounded electrical outlet that is near the product and easily accessible.
CAUTION: Do not set up this product or make any electrical or cabling connections, such as the power cord or telephone, during a lightning storm.
- Refer service or repairs, other than those described in the operating instructions, to a professional service person.
- This product is designed, tested, and approved to meet strict global safety standards with the use of specific Lexmark components. The safety features of some parts may not always be obvious. Lexmark is not responsible for the use of other replacement parts.
- Your product uses a laser.
CAUTION: Use of controls or adjustments or performance of procedures other than those specified herein may result in hazardous radiation exposure.
- Your product uses a printing process that heats the print media, and the heat may cause the media to release emissions. You must understand the section in your operating instructions that discusses the guidelines for selecting print media to avoid the possibility of harmful emissions..

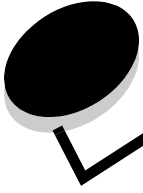

Contents

Chapter 1: Learning about the printer	6
Identifying printers	6
Understanding the printer operator panel	9
Chapter 2: Installing drivers for local printing	11
Windows	11
Macintosh	15
UNIX/Linux	16
Chapter 3: Installing drivers for network printing	17
Printing a network setup page	17
Assigning a printer IP address	17
Verifying the IP settings	18
Windows	18
Macintosh	22
UNIX/Linux	24
NetWare	24
Chapter 4: Installing and removing options	25
Installing input options	25
Installing a duplex unit	27
Installing memory or option cards	28
Accessing the printer system board	28
Installing or removing a memory card	30
Installing or removing a flash memory or firmware card	32
Installing an option card	34
Replacing the shield	35
Chapter 5: Printing	36
Sending a job to print	36
Printing from a USB flash memory device	36
Canceling a print job	38
Printing the menu settings page	39
Printing a network setup page	39
Printing a font sample list	40
Printing a directory list	40
Printing confidential and held jobs	40
Printing on specialty media	43
Loading standard trays and optional trays	44

Contents

Setting the Paper Type and Paper Size	47
Loading the multipurpose feeder	48
Loading the 2000-sheet drawer	53
Loading the envelope feeder	55
Linking trays	57
Identifying and linking output bins	58
Chapter 6: Understanding paper and specialty media guidelines	60
Supported print media	60
Selecting print media	69
Storing print media	72
Avoiding jams	73
Chapter 7: Maintaining the printer	74
Determining the status of supplies	75
Conserving supplies	75
Ordering supplies	76
Recycling Lexmark products	78
Moving the printer	79
Chapter 8: Clearing jams	80
Identifying jams	80
Access doors and trays	81
Understanding jam messages	82
Clearing printer jams	82
Clearing staple jams	93
Chapter 9: Administrative support	96
Adjusting operator panel brightness and contrast	96
Disabling operator panel menus	96
Enabling operator panel menus	97
Restoring factory default settings	97
Adjusting Power Saver	98
Disabling Power Saver	98
Encrypting the disk	99
Setting security using the Embedded Web Server (EWS)	99
Chapter 10: Troubleshooting	103
Understanding printer messages	103
Online technical support	103
Checking an unresponsive printer	103
Printing multi-language PDFs	104
Solving printing problems	104
Solving option problems	106
Solving paper feed problems	109
Solving print quality problems	110

Contents

Notices	114
Trademarks	115
Licensing notice	115
Conventions	116
Static sensitivity notice	116
Electronic emission notices	116
Noise emission levels	118
ENERGY STAR	119
Waste from Electrical and Electronic Equipment (WEEE) directive	120
Laser advisory label	120
Laser notice	120
Statement of limited warranty	120
 Index	 123



Learning about the printer

Identifying printers

Use the following table to determine the features and options of your Lexmark™ T640, T642, or T644 printer.

The illustrations aid you in determining the installation location of options attached to the printer. For more information about installing input options, see **Installing and removing options** or the instructions that came with the option.

Models

The printer is available in three base models. The following table indicates some of the differences between the models.

	T640	T642	T644
Input capacity	250 sheets	500 sheets	500 sheets
Output capacity	250 sheets	500 sheets	500 sheets
Standard memory, non network/network	64MB/64MB	64MB/128MB	128MB/128MB
Maximum memory capacity, non network/network	576MB/576MB	576MB/640MB	640MB/640MB
Option card connectors	1	2	2

CAUTION: Do not set up this product or make any electrical or cabling connections, such as the power cord or telephone, during a lightning storm.

Learning about the printer

Configured models

The following illustrations show a standard network and fully configured printer. If you attach print media handling options to the printer, it may look more like the fully configured model. Items denoted with an asterisk (*) are options.

Standard network

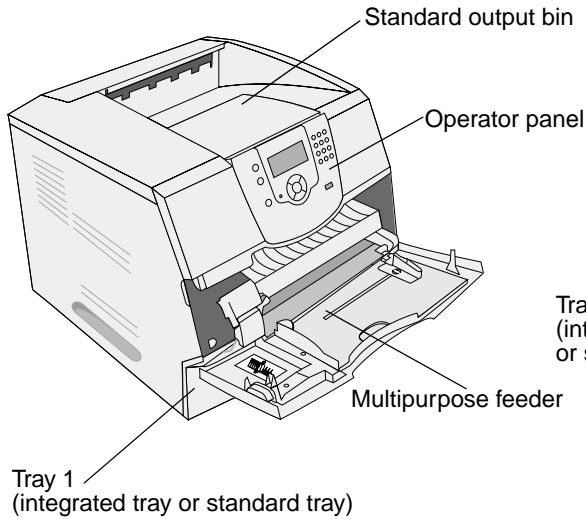

The standard tray holds 250 sheets for the T640 and 500 sheets for the T642 and T644.

Fully configured

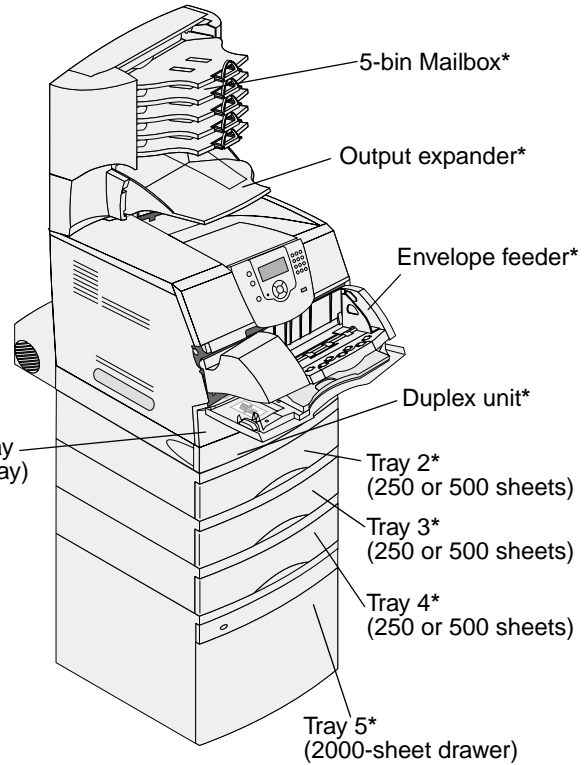

CAUTION: Floor-mounted configurations require additional furniture for stability. You must use either a printer stand or printer base if you are using a 2000-sheet drawer, a duplex unit and an input option, or more than one input option. If you purchased a multifunction printer (MFP) that scans, copies, and faxes, you may need additional furniture. See www.lexmark.com/multifunctionprinters for more information.

Learning about the printer

A number of menus are available to make it easy for you to change printer settings. The diagram shows the menu index on the operator panel and the menus and items available under each menu. For more information about menus and menu items, see the *Menus and Messages* book on the publications CD.

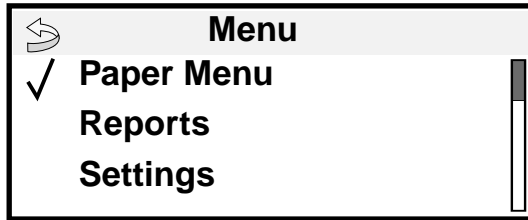

- Paper Menu**
- Default Source
 - Paper Size/Type
 - Configure MP
 - Envelope Enhance
 - Substitute Size
 - Paper Texture
 - Paper Weight
 - Paper Loading
 - Custom Types
 - Universal Setup
 - Bin Setup

- Reports**
- Menu Settings Page
 - Device Statistics
 - Network Setup Page
 - Network <x> Setup Page
 - Profiles List
 - NetWare Setup Page
 - Print Fonts
 - Print Directory

- Settings**
- Setup Menu
 - Finishing Menu
 - Quality Menu
 - Utilities Menu
 - PDF Menu
 - PostScript Menu
 - PCL Emul Menu
 - HTML Menu
 - Image Menu

- Security**
- Max Invalid PIN
 - Job Expiration

- Help**
- Print All
 - Print Quality
 - Printing Guide
 - Supplies Guide
 - Media Guide
 - Menu Map
 - Information Guide
 - Connection Guide
 - Moving Guide



- Network/Ports**
- IPv6
 - TCP/IP
 - Standard Network
 - Network <x>
 - Standard USB
 - USB <x>
 - Parallel
 - Parallel <x>
 - Serial <x>
 - NetWare
 - AppleTalk
 - LexLink

Understanding the printer operator panel

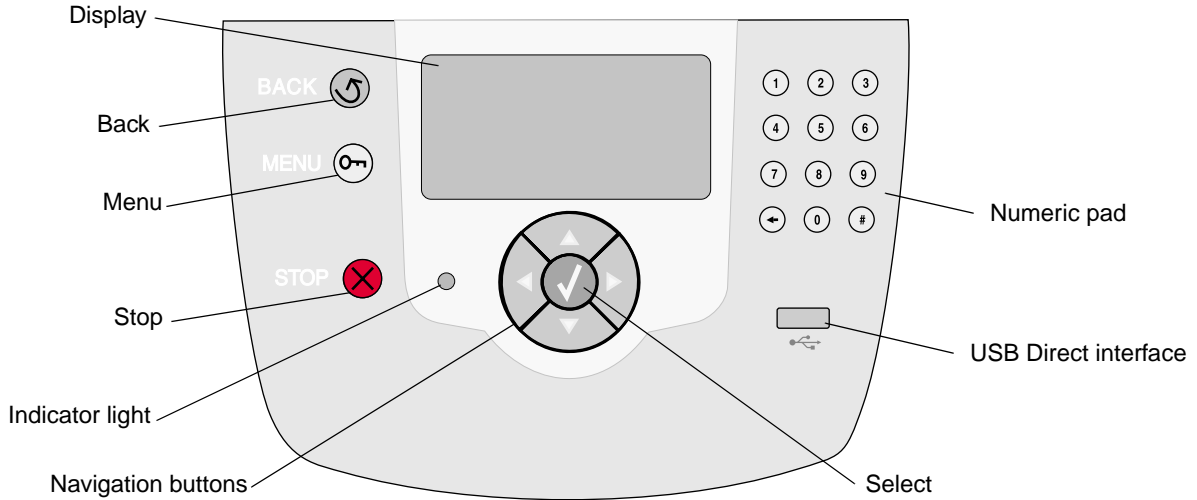

The operator panel on the printer is a 4-line back-lit gray scale display that can show both graphics and text. The Back, Menu, and Stop buttons are located to the left of the display, the navigation buttons are located below the display, and the numeric pad is located to the right of the display.



The use of the buttons and the layout of the display panel are described in the following table.

Button	Function										
Back 	Returns to the last screen you viewed. Note: Changes made on a screen will not be applied if you press the Back button.										
Menu 	Opens the menu index. Note: The printer must be in the Ready state to access the menu index. A message indicating the menus are unavailable will appear if the printer is not ready.										
Stop 	Stops the mechanical operation of the printer. After pressing Stop , the message stopping appears. When the printer has stopped, the status line in the operator panel will show stopped , and a list of options appears.										
Indicator light	A two-tone LED is used on the operator panel, one color is green and the other is red. The lights indicate whether the printer power is on, the printer is busy, idle, processing a job, or requires operator intervention. <table border="0" style="width: 100%;"> <tr> <td style="width: 50%;">Status</td> <td style="width: 50%;">Indicates</td> </tr> <tr> <td>Off</td> <td>Power is off.</td> </tr> <tr> <td>Solid green</td> <td>Printer is on, but idle.</td> </tr> <tr> <td>Blinking green</td> <td>Printer is warming up, processing data, or printing a job.</td> </tr> <tr> <td>Solid red</td> <td>Operator intervention is required.</td> </tr> </table>	Status	Indicates	Off	Power is off.	Solid green	Printer is on, but idle.	Blinking green	Printer is warming up, processing data, or printing a job.	Solid red	Operator intervention is required.
Status	Indicates										
Off	Power is off.										
Solid green	Printer is on, but idle.										
Blinking green	Printer is warming up, processing data, or printing a job.										
Solid red	Operator intervention is required.										

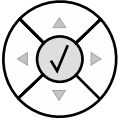
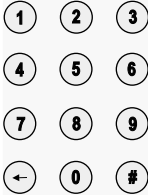
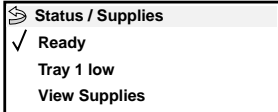
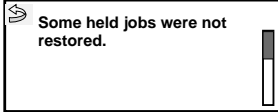
Learning about the printer

Button	Function
<p>Navigation buttons</p> 	<p>The Up or Down buttons are used to move up and down lists.</p> <p>When navigating through a list using the Up or Down button, the cursor moves one line at a time. Pressing the Down button at the bottom of the screen changes the screen to the next whole page.</p>
	<p>The Left or Right buttons are used to move within a screen such as moving from one menu index item to another. They are also used to scroll through text that will not fit on the screen.</p>
	<p>The Select button is used to initiate action on a selection. Press Select when the cursor appears next to the selection you want such as following a link, submitting a configuration item, or when you want to start or cancel a job.</p>
<p>USB Direct interface</p>	<p>The host USB Direct interface on the operator panel is used to plug in a USB flash memory device and print PDF files.</p> <p>Note: A USB port is located on the back of the printer to connect a PC or other peripheral.</p>
<p>Numeric pad</p> 	<p>The numeric pad consists of numbers, a pound '#' sign, and a backspace button. The 5 button has a raised bump for non-visual orientation.</p> <p>The numbers are used to enter numeric values for items like quantities or PINs. The backspace is used to delete the number to the left of the cursor. Pressing the backspace multiple times will delete additional entries.</p> <p>Note: The pound '#' sign is not used.</p>
<p>Display panel</p>  <p>Tell me more screen</p>  <p>Show me screen</p> 	<p>The display panel shows messages and graphics describing the current state of the printer and indicating possible printer problems you must resolve.</p> <p>The top line of the display is the header line. If applicable, it will contain the graphic indicating the Back button can be used. It will also display the current status and the Supplies (Warnings) status. If multiple warnings are present, each warning will be separated by a comma.</p> <p>The other three lines of the display are the body of the screen. This is where you view printer status, supplies messages, show-me screens, and make selections.</p>

2

Installing drivers for local printing

A local printer is a printer attached to the computer using a USB or parallel cable. The local printer is intended to be used by the computer to which it is attached. If attaching a local printer, you must install the printer driver on the computer before setting up the printer.

The printer driver is software that lets the computer communicate with the printer.

The procedure to install drivers depends on the operating system used. Use the following table to find driver installation instructions for the particular operating system. For additional help, see the documentation that shipped with the computer and your software.

Operating system	Go to page
Windows	11
Windows Server 2003, Windows 2000, Windows XP, Windows 98 SE, Windows Me, Windows NT 4.x	11
Windows 95 and Windows 98 (first edition)	12
Serial printing	12
Macintosh	15
UNIX/Linux	16

Windows

Some Windows operating systems may already include a printer driver that is compatible with the printer.

Note: Installing a custom driver will not replace the system driver. A separate printer object will be created and appear in the Printers folder.

Use the drivers CD that shipped with the printer to install the custom printer driver and obtain enhanced printer features and functionality.

Drivers are also available in downloadable software packages on the Lexmark Web site at www.lexmark.com.

Using Windows Server 2003, Windows 2000, Windows XP, Windows 98 SE, Windows Me, or Windows NT

Note: Install the printer software before connecting the USB cable.

- 1 Insert the drivers CD.

If the CD does not launch automatically, click **Start** → **Run**, and type `D:\Setup.exe` in the Run dialog (where D is the letter of the CD-ROM drive).

Note: USB support is not available for Windows NT operating systems. To use a Windows NT operating system, you must have an optional Parallel 1284-B Interface Card installed and use a parallel cable.

Installing drivers for local printing

- 2 Click **Install Printer and Software**.

Note: Some Windows operating systems require administrative access to install printer drivers on the computer.

- 3 Click **Agree** to accept the license agreement.

- 4 Select **Suggested**, and click **Next**.

The Suggested option is the default installation for local and network-attached setup. To install utilities, change settings, or customize device drivers, select **Custom**, and follow the instructions on the screen.

- 5 Select **Local Attach**, and click **Finish**.

Follow the instructions on the screen. It may take some time for the drivers files to load.

- 6 Close the drivers CD installer application.

- 7 Connect the USB cable, and turn on the printer.

The Plug and Play screen appears, and a printer object is created in the Printers folder of your computer.

Note: USB support is not available for Windows NT operating systems. To use a Windows NT operating system, you must have an optional Parallel 1284-B Interface Card installed and use a parallel cable. The Plug and Play screen will not appear for Windows NT.

Using Windows 95 and Windows 98 (first edition)

- 1 Turn on the computer.

- 2 Insert the drivers CD. If the CD launches automatically, click **Exit** to return to the Add Printer Wizard.

- 3 Click **Start** → **Settings** → **Printers**, and double-click **Add Printer**.

Note: USB support is not available for Windows 95 and Windows 98 (first edition) operating systems.

- 4 When prompted, select **Local printer**.

- 5 Click **Have Disk**.

Note: Some Windows operating systems require administrative access to install printer drivers on the computer.

- 6 Specify the location of the custom printer driver on the drivers CD.

The path should be similar to the following:

D:\Drivers\Print\Win_9xMe\<language>

Where D is the letter of the CD-ROM drive.

- 7 Click **OK**.

It may take some time for the drivers to load.

- 8 Close the drivers CD.

Serial printing

With serial printing, data is transferred one bit at a time. Although serial printing is usually slower than parallel printing, it is the preferred option when there is a great deal of distance between the printer and computer, or when a parallel interface is not available.





Note: A serial interface card is required and can be purchased separately.

Installing drivers for local printing

Before you can print, you must establish communication between the printer and computer. To do this:

- 1 Set serial parameters in the printer.
- 2 Install a printer driver on the attached computer.
- 3 Match the serial settings in the COM port.









Setting parameters in the printer

- 1 Press  on the operator panel.
- 2 Press  until  **Reports** appears, and then press .







Note: For information about serial menus and messages, see the publications CD that shipped with the printer.

- 3 Press  until  **Menu Settings Page** appears, and then press .

The printer returns to **Ready**.

- 4 Press .
- 5 Press  until  **Network/Ports** appears, and then press .
- 6 Press  until  **Serial Standard** or  **Serial Option x** appears, and then press .

(x) is the number of the serial port.

- 7 Press  until  **<Parameter>** appears (where **<Parameter>** is the parameter required for a change), and then press .
- 8 Press  until  **<Setting>** appears (where **<Setting>** is the setting required for a change), and then press .

Note the following restrictions:







- Maximum baud rate supported is 115,200.
- Data Bits must be set to 7 or 8.
- Parity must be set to Even, Odd, or None.
- Stop Bits must be set to 2.
- Flow Control recommended protocol setting is Xon/Xoff.

- 9 Press .

The printer returns to **Serial** or **Serial x**.

- 10 Print a Menu Settings page, and verify the serial parameters are correct.

Note: Keep this page for later use.

- a Press  on the operator panel.
- b Press  until  **Reports** appears, and then press .
- c Press  until  **Menu Settings Page** appears, and then press .
- d Look under the Standard Serial (or Serial Option X if a serial interface card is installed) heading to find the serial parameters.

Installing a printer driver

A printer driver must be installed on the computer that is connected to the printer.

Note: Windows 95 and Windows 98 (first edition) users should follow the installation directions in **Using Windows 95 and Windows 98 (first edition)**.

- 1 Insert the drivers CD. It should launch automatically. If the CD does not launch automatically, click **Start → Run**, and type the following in the Run dialog:
D:\Setup.exe
Where D is the letter of the CD-ROM drive.
- 2 Click **Install Printer and Software**.
- 3 Click **Agree** to accept the Printer Software License Agreement.
- 4 Select **Custom**, and click **Next**.
- 5 Select **Components**, and click **Next**.
- 6 Select **Local**, and click **Next**.
- 7 Select the printer from the list, and click **Add Printer**.
- 8 Expand the printer item listed below Selected Components.
- 9 Click **PORT: <LPT1>**, and select the desired communications port (COM1 or COM2).
- 10 Click **Finish** to complete the printer software installation.

Setting parameters in the communications (COM) port

After the printer driver is installed, set the serial parameters in the communications port assigned to the printer driver.

The serial parameters in the communications port must exactly match the serial parameters set in the printer.

- 1 Click **Start → Settings → Control Panel**, and double-click **System**.
- 2 On the **Device Manager** tab, click **+** to expand the list of available ports.
- 3 Select the communications port assigned to the printer (COM1 or COM2).
- 4 Click **Properties**.
- 5 On the **Port Settings** tab, set the serial parameters to the exact same serial parameters in the printer.
Look for the printer settings under the Serial Standard (or Serial Option X) heading on the previously printed Menu Settings page.
- 6 Click **OK**, and close all the windows.
- 7 Print a test page to verify printer installation.
 - a Click **Start → Settings → Printers**.
 - b Select the newly added printer.
 - c Click **File → Properties**.
 - d Click **Print Test Page**. When a test page prints successfully, printer setup is complete.

Note: Your operating system may require different setup procedures. If the test page does not print, see your operating system Help.

Macintosh

Mac OS 9.x or later is required for USB printing. To print locally to a USB-attached printer, create a desktop printer icon (Mac OS 9) or create a queue in Print Center / Printer Setup Utility (Mac OS X).

Creating a queue in Print Center / Printer Setup Utility (Mac OS X)

1 Install a PostScript Printer Description (PPD) file on the computer.

- a Insert the drivers CD.
- b Double-click the installer package for the printer.

Note: A PPD file provides detailed information about the capabilities of a printer to the Macintosh computer.

- c Click **Continue** on the Welcome screen and again after viewing the Readme file.
- d Click **Continue** after viewing the license agreement, and click **Agree** to accept the terms of the agreement.
- e Select a Destination, and click **Continue**.
- f On the Easy Install screen, click **Install**.
- g Enter the password, and click **OK**. All the necessary software is installed on the computer.
- h Click **Close** when installation is complete.

2 Open Finder, click **Applications**, and click **Utilities**.

3 Double-click **Print Center** or **Printer Setup Utility**.

Note: A printer PPD is also available in a downloadable software package on the Lexmark Web site at www.lexmark.com.

4 Do one of the following:

- If the USB-attached printer appears in the Printer List, quit Print Center or Printer Setup Utility. A queue has been created for the printer.
- If the USB-attached printer does not appear in the Printer List, make sure the USB cable is properly connected and the printer is turned on. After the printer appears in the Printer List, quit Print Center or Printer Setup Utility.

Creating a desktop printer icon (Mac OS 9.x)

1 Install a PostScript Printer Description (PPD) file on the computer.

- a Insert the drivers CD.
- b Double-click **Classic**, and double-click the installer package for the printer.

Note: A PPD file provides detailed information about the capabilities of a printer to the Macintosh computer.

- c Choose the appropriate language, and click **Continue**.
- d Click **Continue** after viewing the Readme file.
- e Click **Continue** after viewing the license agreement, and click **Agree** to accept the terms of the agreement.
- f On the Installation Type screen, click **Install**. All the necessary files are installed on the computer.
- g Click **Close** when installation is complete.

Note: A printer PPD is also available in a downloadable software package on the Lexmark Web site at www.lexmark.com.

Installing drivers for local printing

- 2 Do one of the following:
 - *Mac OS 9.0*: Open **Apple LaserWriter**.
 - *Mac OS 9.1–9.x*: Open **Applications**, and click **Utilities**.
- 3 Double-click **Desktop Printer Utility**.
- 4 Select **Printer (USB)**, and click **OK**.
- 5 In the USB Printer Selection section, click **Change**.

If the printer does not appear in the USB Printer Selection list, make sure the USB cable is properly connected, and the printer is turned on.
- 6 Select the name of the printer, and click **OK**. The printer appears in the original Printer (USB) window.
- 7 In the PostScript Printer Description (PPD) File section, click **Auto Setup**. Make sure the printer PPD matches the printer.
- 8 Click **Create**, and click **Save**.
- 9 Specify a printer name, and click **Save**. The printer is now saved as a desktop printer.

UNIX/Linux

Local printing is supported on many UNIX and Linux platforms, such as Sun Solaris and Red Hat.

The Sun Solaris and Linux packages are available on the drivers CD and on the Lexmark Web site at www.lexmark.com. The UNIX/Linux *User's Guide* in each package gives detailed instructions for installing and using Lexmark printers in UNIX and Linux environments.

All the printer driver packages support local printing using a parallel connection. The driver package for Sun Solaris supports USB connections to Sun Ray appliances and Sun workstations.







Visit the Lexmark Web site at www.lexmark.com for a complete list of supported UNIX and Linux platforms.

3

Installing drivers for network printing

Printing a network setup page

If the printer is attached to a network, print a network setup page on the printer to verify the network connection. This page also provides important information to configure the printer for network printing.

- 1 Make sure the printer is on.
- 2 Press  on the operator panel.
- 3 Press  until  **Reports** appears, and then press .
- 4 Press  until  **Network Setup Page** appears, and then press .

Note: If an optional MarkNet™ N8000 series internal print server is installed, **Print Net1 Setup** appears on the display.

- 5 Check the first section on the network setup page, and confirm that Status is “Connected.”



















If Status is “Not Connected,” the LAN drop may not be active, or the network cable may be malfunctioning. Consult a system support person for a solution, and print another network setup page to verify the printer is connected to the network.

Assigning a printer IP address



If the network is using DHCP, an IP address is automatically assigned connecting the network cable to the printer.

- 1 Look for the address under the “TCP/IP” heading on the network setup page printed in **Printing a network setup page**.
- 2 Go to **Verifying the IP settings**, and begin with step 2.

If the network is not using DHCP, then manually assign an IP address to the printer. One of the easiest ways is to use the operator panel:

- 1 Press  on the operator panel.
- 2 Press  until  **Network/Ports** appears, and then press .
- 3 Press  until  **TCP/IP** appears, and then press .
- Standard Network** appears if the printer has a network port on the printer system board. If a MarkNet N8000 series internal print server is installed, you see **Network Option 1**.
- 4 Press  until  **Address** appears, and then press .
- 5 Using the numeric pad, enter the IP address. When the address is entered, press .
- Submitting Selection** appears briefly.
- 6 Press  until  **Netmask** appears, and then press .
- 7 Using the numeric pad, enter the IP netmask. When the address is entered, press .
- Submitting Selection** appears briefly.
- 8 Press  until  **Gateway** appears, and then press .

Installing drivers for network printing

- 9 Using the numeric pad, enter the IP gateway. When the address is entered, press . **submitting selection** appears briefly.
- 10 Press  until the printer returns to **Ready**.

Verifying the IP settings

- 1 Print another network setup page. Look under the “TCP/IP” heading, and make sure the IP address, netmask, and gateway are correct. See **Printing a network setup page** if you need help.
- 2 Ping the printer, and verify that it responds. At a command prompt on a network computer, type `ping` followed by the new printer IP address (for example, `192.168.0.11`).

Note: On Windows computers, click **Start → Programs → Command prompt** (or **Accessories → Command prompt** if using Windows 2000).

If the printer is active on the network, a reply is sent.

After the TCP/IP settings are assigned and verified, install the printer on each network computer.

Windows

In Windows environments, network printers can be configured for direct printing or shared printing. Both network printing methods require the installation of a printer driver and the creation of a network printer port.

Supported printer drivers

- Windows system printer driver
- Lexmark custom printer driver

Updated system and custom drivers are available on the Lexmark Web site at www.lexmark.com.

Custom drivers are available on the drivers CD.

Supported network printer ports

- Microsoft Standard TCP/IP port—Windows 2000, Windows XP, and Windows Server 2003
- LPR—Windows NT 4.0
- Lexmark Enhanced TCP/IP port—Windows 98 SE/Me, Windows NT 4.0, Windows 2000, Windows XP, and Windows Server 2003

For basic printer functionality, install a printer driver, and use a system network printer port, such as an LPR or a Standard TCP/IP port. The printer driver and port let you maintain a consistent user interface for use with all the printers on the network. Using a custom network port provides enhanced functionality, such as printer status alerts.

Installing drivers for network printing

Follow the steps for your printing configuration and operating system to configure the network printer:

Printing configuration	Operating system	Go to page
Direct <ul style="list-style-type: none">Printer is connected directly to the network using a network cable, such as Ethernet.Printer drivers are typically installed on each network computer.	Windows 98 SE, Windows NT 4.0, Windows Me, Windows 2000, Windows XP, or Windows Server 2003	19
Shared <ul style="list-style-type: none">Printer is connected to one of the computers on the network using a local cable, such as USB.Printer drivers are installed on the computer attached to the printer.During driver installation, the printer is set up to be “shared” so that other network computers can print to it.	Windows NT 4.0, Windows 2000, Windows XP, or Windows Server 2003	20

Direct printing using Windows 98 SE, Me, Windows NT 4.0, Windows 2000, Windows XP, or Windows Server 2003

To install a custom printer driver and network port:

- 1 Launch the drivers CD.
- 2 Click **Install Printer and Software**.
- 3 Click **Agree** to accept the license agreement.
- 4 Select **Suggested**, and click **Next**.
- 5 Select **Network Attach**, and click **Next**.
- 6 Select the printer model from the list, and click **Next**.
- 7 Select the printer port from the list, and click **Finish** to complete the installation.

If the printer port is not listed:

- a Click **Add Port**.
- b Select **Lexmark Enhanced TCP/IP Port**, and enter the information to create the port.
- c Enter a port name.
This can be any name to associate with the printer, such as **Monochrome1-1ab4**. After the port is created, this name appears in the list of available ports.
- d Enter the IP address in the text box.

Note: If the IP address is unknown, print a network setup page, and look under the TCP/IP heading. For help, see **Printing a network setup page** and **Verifying the IP settings**.

- 8 Print a test page to verify printer installation.

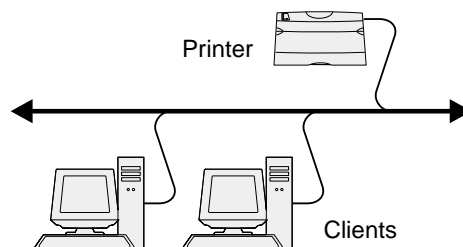

Installing drivers for network printing

Shared printing using Windows NT 4.0, Windows 2000, Windows XP, or Windows Server 2003

Note: Install the printer software before connecting the USB, parallel, or serial cable.

After connecting the printer to a Windows NT 4.0, Windows 2000, Windows XP, or Windows Server 2003 computer (which will act as a server), follow these steps to configure the network printer for shared printing:

- 1 Install a custom printer driver.
 - a Launch the drivers CD.
 - b Click **Install Printer and Software**.
 - c Click **Agree** to accept the license agreement.
 - d Select **Suggested**, and click **Next**.

The Suggested option is the default installation for local and network-attached setup. To install utilities, change settings, or customize device drivers, select **Custom**, and follow the instructions on the screen.

- e Select **Local Attach**, and click **Finish**.

Follow the instructions on the screen. It may take some time for the drivers to load.

- f Close the drivers CD installer application.
 - g Connect the USB cable, and turn on the printer.

The Plug and Play screen appears, and a printer object is created in the Printers folder of the computer. The printer is shared in step 2: "Share the printer on the network."

Note: USB support is not available for Windows NT operating systems. Use a parallel cable instead. The Plug and Play screen will not appear for Windows NT.

- h Print a test page to verify printer installation.

- 2 Share the printer on the network.

- a Click **Start** → **Settings** → **Printers**.
 - b Select the newly added printer.
 - c Click **File** → **Sharing**.
 - d Select the **Shared as** check box, and enter a name in the text box.
 - e In the Alternate Drivers section, select the operating systems of all the network clients that will print to the printer.
 - f Click **OK**.

Note: If files are missing, prompts may appear to request the server operating system CD.

- g Check the following to make sure the printer was successfully shared.

- The printer object in the Printers folder now has a shared indicator. For example, in Windows NT 4.0, a hand appears under the printer object.
- Browse Network Neighborhood. Find the host name of the server, and look for the shared name assigned to the printer.

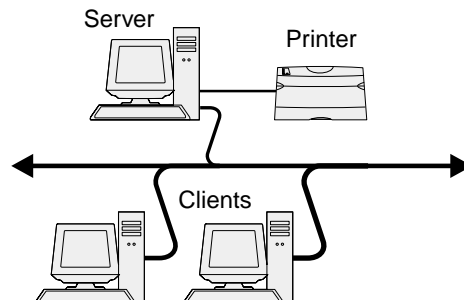

Install the printer driver (or subset) on network clients

Using the point and print method

Note: This method is usually the best use of system resources. The server handles driver modifications and the print job processing. This lets network clients return to applications much faster.

With this method, a subset of driver information is copied from the server to the client computer. This is just enough information to send a print job to the printer.

- 1 Double-click **Network Neighborhood** on the Windows desktop of the client computer.
- 2 Locate the host name of the server computer, and double-click the host name.
- 3 Right-click the shared printer name, and click **Install**.

Wait a few minutes for the driver information to be copied from the server computer to the client computer and for a new printer object to be added to the Printers folder. The time this takes varies based on network traffic and other factors.

- 4 Close **Network Neighborhood**.
- 5 Print a test page to verify printer installation.

Using the peer-to-peer method

With this method, the printer driver is fully installed on each client computer. Network clients retain control of driver modifications. The client computer handles the print job processing.

- 1 Click **Start** → **Settings** → **Printers**.
- 2 Click **Add Printer** to launch the Add Printer wizard.
- 3 Click **Next**.
- 4 Click **Network Printer**, and click **Next**.
- 5 Enter the printer name or URL (if on the Internet or an intranet), and click **Next**.

If the printer name or URL is unknown, leave the text box blank, and click **Next**.

- 6 Select the network printer from the Shared printers list. If the printer is not listed, enter the path of the printer in the text box.

The path looks similar to the following:

```
\\<server host name>\<shared printer name>
```

Note: If this is a new printer, prompts may occur to install a printer driver. If no system driver is available, provide a path to available drivers.

The server host name is the name of the server computer that identifies it to the network. The shared printer name is the name assigned during the server installation process.

- 7 Click **OK**.
- 8 Select whether this printer will be the default printer for the client, and click **Finish**.
- 9 Print a test page to verify printer installation.

Note: Your operating system may require different setup procedures. If the test page does not print, see your operating system Help.

Configuring Drag‘N’Print

Note: Drag‘N’Print™ support is not available for all printers.

For detailed configuration instructions, launch the drivers CD, click **View Documentation**, and click **Software and utilities**.

Macintosh

Note: A PostScript Printer Description (PPD) file provides detailed information about the capabilities of a printer to UNIX or Macintosh computers.

To print to a network printer, each Macintosh user must install a custom PostScript Printer Description (PPD) file, and either create a desktop printer on the computer (Mac OS 9.x) or create a print queue in Print Center (Mac OS X).

Mac OS X

Step 1: Install a custom PPD file

- 1 Install a PostScript Printer Description (PPD) file on the computer.
 - a Insert the drivers CD.
 - b Double-click the installer package for the printer.

Note: A PPD file provides detailed information about the capabilities of a printer to the Macintosh computer.

- c Click **Continue** on the Welcome screen and again after viewing the Readme file.
- d Click **Continue** after viewing the license agreement, and click **Agree** to accept the terms of the agreement.
- e Select a Destination, and click **Continue**.
- f On the Easy Install screen, click **Install**.
- g Enter the password, and click **OK**. All the necessary software is installed on the computer.
- h Click **Close** when installation is complete.

Step 2: Create a print queue in Print Center or Printer Setup Utility

Using AppleTalk Printing

Follow these steps to create a print queue using AppleTalk Printing.

- 1 Open Finder, click **Applications**, and click **Utilities**.
- 2 Double-click **Print Center or Printer Setup Utility**.
- 3 Choose **Add Printer** from the “Printers” menu.
- 4 Choose **AppleTalk** from the pop-up menu.

Note: Look on the network setup page under the “AppleTalk” heading to know which zone or printer to select.

- 5 Select the AppleTalk zone from the list.
- 6 Select the new printer from the list, and click **Add**.

Installing drivers for network printing

- 7 Verify printer installation:
 - a Open Finder, click **Applications**, and click **TextEdit**.
 - b Choose **Print** from the "File" menu.
 - c Choose **Summary** from the "Copies & Pages" pop-up menu.

Note: To know which zone or printer to select, look on the Network Setup page under the "AppleTalk" heading to find the default name of the printer.

- If the PPD file displayed in the Summary window is correct for the printer, then printer setup is complete.
- If the PPD file displayed in the Summary window is not correct for the printer, delete the printer from the printer list in Print Center or Printer Setup Utility, and repeat **Step 1: Install a custom PPD file**.

Using IP Printing

Follow these steps to create a print queue using IP Printing. To create an AppleTalk print queue, see **Step 2: Create a print queue in Print Center or Printer Setup Utility**.

- 1 Open Finder, click **Applications**, and click **Utilities**.
- 2 Double-click **Print Center or Printer Setup Utility**.
- 3 Choose **Add Printer** from the "Printers" menu.
- 4 Choose **IP Printing** from the pop-up menu.
- 5 Enter the IP address or the printer DNS name in the Printer Address box.
- 6 Choose **Lexmark** from the "Printer Model" pop-up menu.
- 7 Select the new printer from the list, and click **Add**.
- 8 Verify printer installation:
 - a Open Finder, click **Applications**, and click **Text Edit**.
 - b Choose **Print** from the "File" menu.
 - c Choose **Summary** from the "Copies & Pages" pop-up menu.
 - d Do one of the following:
 - If the PPD file displayed in the Summary window is correct for the printer, then printer setup is complete.
 - If the PPD file displayed in the Summary window is *not* correct for the printer, delete the printer from the printer list in Print Center or Printer Setup Utility, and repeat **Step 1: Install a custom PPD file**.

Mac OS 9.x

Step 1: Install a custom PPD file

- 1 Insert the drivers CD.
 - a Double-click **Classic**, and double-click the installer package for the printer.

Note: A PPD file provides detailed information about the capabilities of a printer to the Macintosh computer.

- b Choose the appropriate language, and click **Continue**.
- c Click **Continue** after viewing the Readme file.
- d Click **Continue** after viewing the license agreement, and click **Agree** to accept the terms of the agreement.
- e On the Easy Install screen, click **Install**. All the necessary files are installed on the computer.

Installing drivers for network printing

- f Click **Close** when installation is complete.

Note: A printer PPD is also available in a downloadable software package on the Lexmark Web site at www.lexmark.com.

Step 2: Create a desktop printer

- 1 In the Chooser, select the **LaserWriter 8** driver.
- 2 For a routed network, select the default zone from the list. If you don't know which zone to select, look on the Network Setup page under AppleTalk for Zone.
- 3 Select the new printer from the list.
- 4 To know which printer to select, look on the Network Setup page under the "AppleTalk" heading to find the default name of the printer.
- 5 Click **Create**.
- 6 Make sure there is an icon next to the printer name in the Chooser.
- 7 Close the Chooser window.
- 8 Verify printer installation.
 - a Click the newly created desktop printer icon.
 - b Choose **Printing** → **Change Setup**.
 - If the PPD file displayed in the PostScript Printer Description (PPD) file portion of the menu is correct for the printer, printer setup is complete.
 - If the PPD file displayed in the PostScript Printer Description (PPD) file portion of the menu is *not* correct for the printer, repeat **Step 1: Install a custom PPD file**.

UNIX/Linux

The printer supports many UNIX and Linux platforms, such as Sun Solaris and Red Hat. Visit the Lexmark Web site at www.lexmark.com for a complete list of supported UNIX and Linux platforms.

Note: The Sun Solaris and Linux packages are available on the drivers CD and on the Lexmark Web site at www.lexmark.com.

Lexmark provides a printer driver package for each supported UNIX and Linux platform. The *User's Guide* in each package gives detailed instructions for installing and using Lexmark printers in UNIX and Linux environments.

These packages are available for download from the Lexmark Web site. The required driver package is also on the drivers CD.

NetWare

The printer supports Novell Distributed Print Services (NDPS/iPrint). For the latest information about installing a network printer in a NetWare environment, launch the drivers CD, and click **View Documentation**.

4

Installing and removing options

Installing input options

Order of installation

Floor-mounted configurations require additional furniture. You must use either a printer stand or printer base if you are using a 2000-sheet drawer, a duplex unit and an input option, or more than one input option. If you purchased an MFP that scans, copies, and faxes, you may need additional furniture. More information is available on our Lexmark Web site at www.lexmark.com/multifunctionprinters.

Install the printer and any options you have purchased in the following order:

CAUTION: If you are installing options after setting up the printer, turn the printer off and unplug the power cord before continuing.

- Printer stand or printer base
- 2000-sheet drawer
- 250-sheet or 500-sheet drawer
- Duplex unit
- Printer

CAUTION: The printer requires two people to lift it safely.

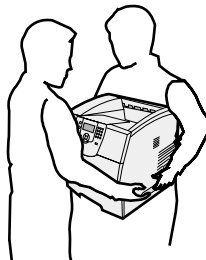

For information on installing a printer stand, printer base, or 2000-sheet drawer, see the instructions included with the option.

Installing a 250-sheet or 500-sheet drawer

Optional drawers attach under the printer and optional duplex unit. The printer automatically recognizes any drawer that is installed.

A drawer consists of a tray and a support unit. The 250-sheet drawer and the 500-sheet drawer are installed the same way.

- 1 Remove the tray from the support unit. Remove all packing material and tape from both the support unit and the tray.

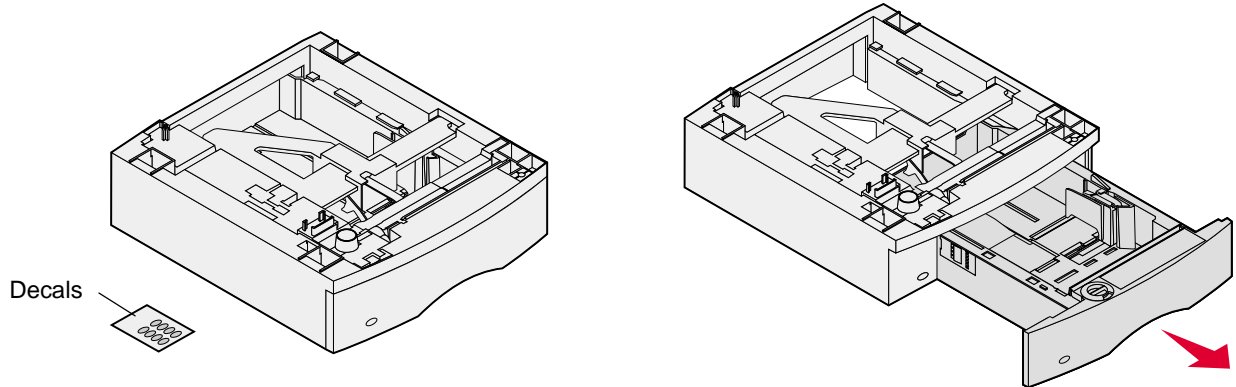

- 2 Place the support unit on top of any previously installed drawers, or the table or printer cabinet where you plan to use the printer.

The tab, round peg, and square holes on top of any drawer help you position the support unit so the edges are aligned properly. Make sure the support unit is securely in place.

- 3 Attach another optional drawer, a duplex unit, or the printer.

You can attach a label to the trays to indicate the tray number.

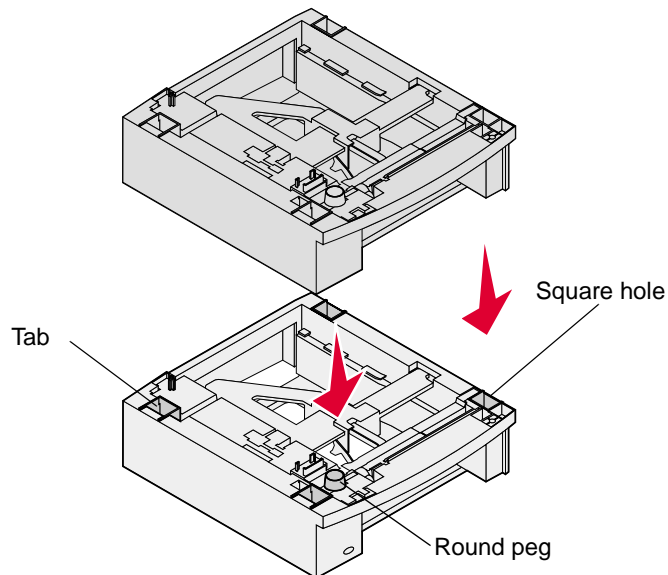

Installing a duplex unit

The duplex unit attaches under the printer, below the standard tray and above any drawers.

Note: Two optional duplex units are available. The 250-sheet duplex unit only works with printers that have a 250-sheet standard tray, and the 500-sheet duplex unit only works with printers that have a 500-sheet standard tray. Make sure you have the appropriate duplex unit for the tray size installed in the printer.

- 1 Place the duplex unit on top of any installed drawers or the table or printer cabinet where you plan to use the printer.

The tab, round peg, and square holes on top of any drawer help you position the duplex unit so the edges are aligned properly. Make sure it is securely in place.

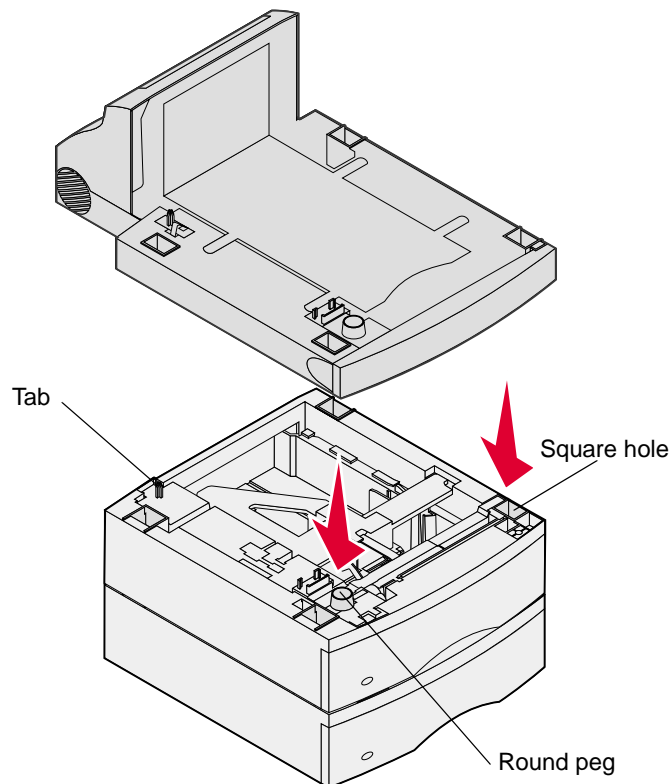

Installing memory or option cards

CAUTION: If you are installing memory or option cards sometime after setting up the printer, turn the printer off and unplug the power cord before continuing.

You can customize the printer memory capacity and connectivity by adding optional cards. The instructions in this section help you install any of the following options:

- Memory cards
 - Printer memory
 - Flash memory
- Firmware cards
 - Bar Code
 - IPDS and SCS/TNe
 - PrintCryption™
- Other options
 - Printer hard disk
 - RS-232 serial interface card
 - Parallel 1284-C interface card
 - MarkNet N8000 series internal print servers (also called internal network adapters or INAs)

Accessing the printer system board

You must access the printer system board to install printer memory, flash memory, a firmware card, or an option card.

Note: Use a Phillips screwdriver to remove the system board access cover.

- 1 Push the release latch, and lower the multipurpose feeder.
- 2 Push the release latch, and open the top front cover.

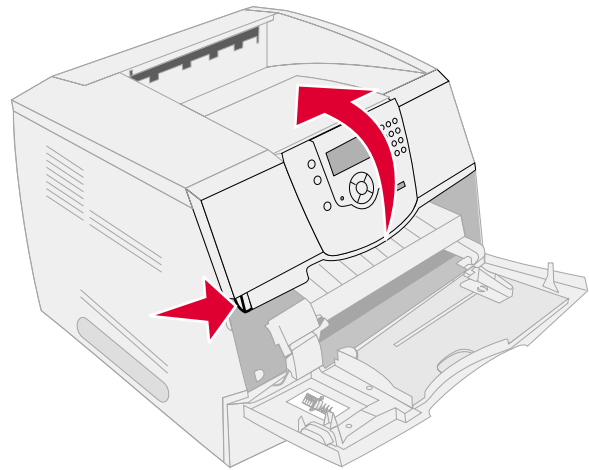
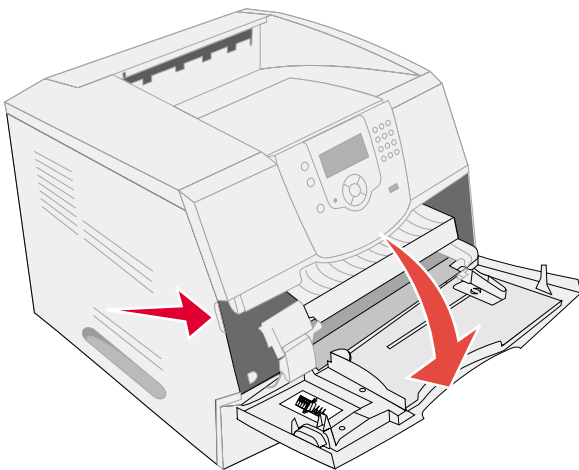

Installing and removing options

- 3 Press both side door latches, and open the side door.
- 4 Loosen, but do not remove, the six screws on the shield.

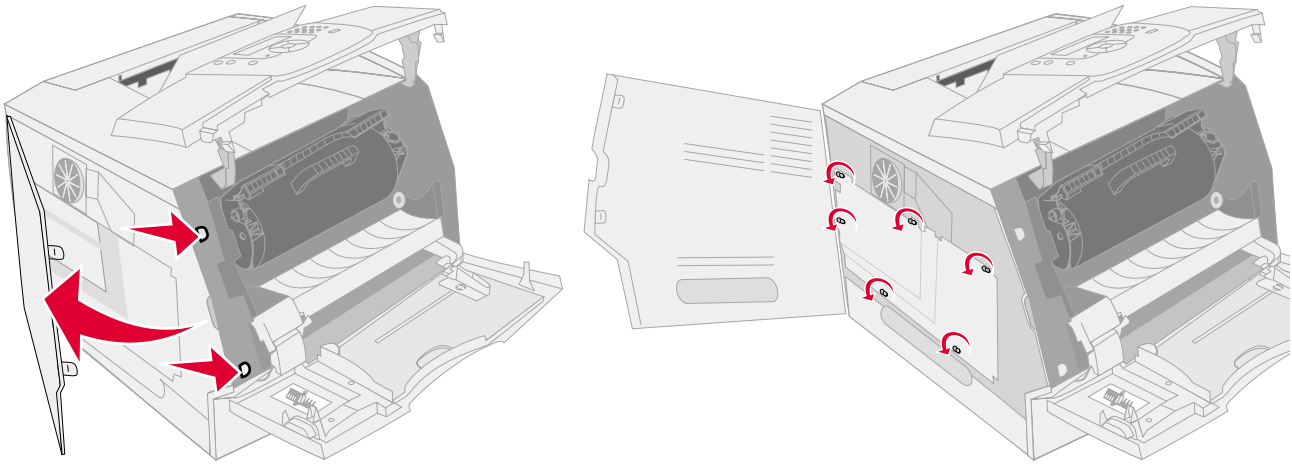

- 5 Slide the shield to the right, and then remove it.

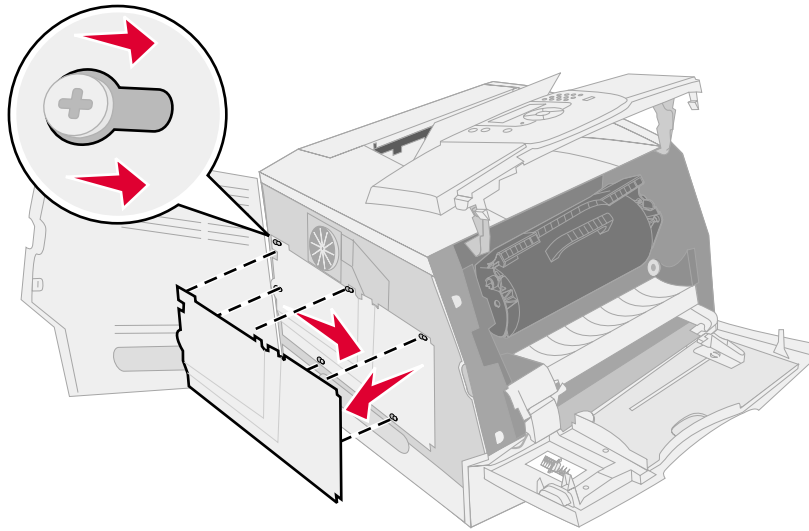

Installing and removing options

- 6 Set the shield aside.

Use the illustration to locate the connector for the card you want to install.

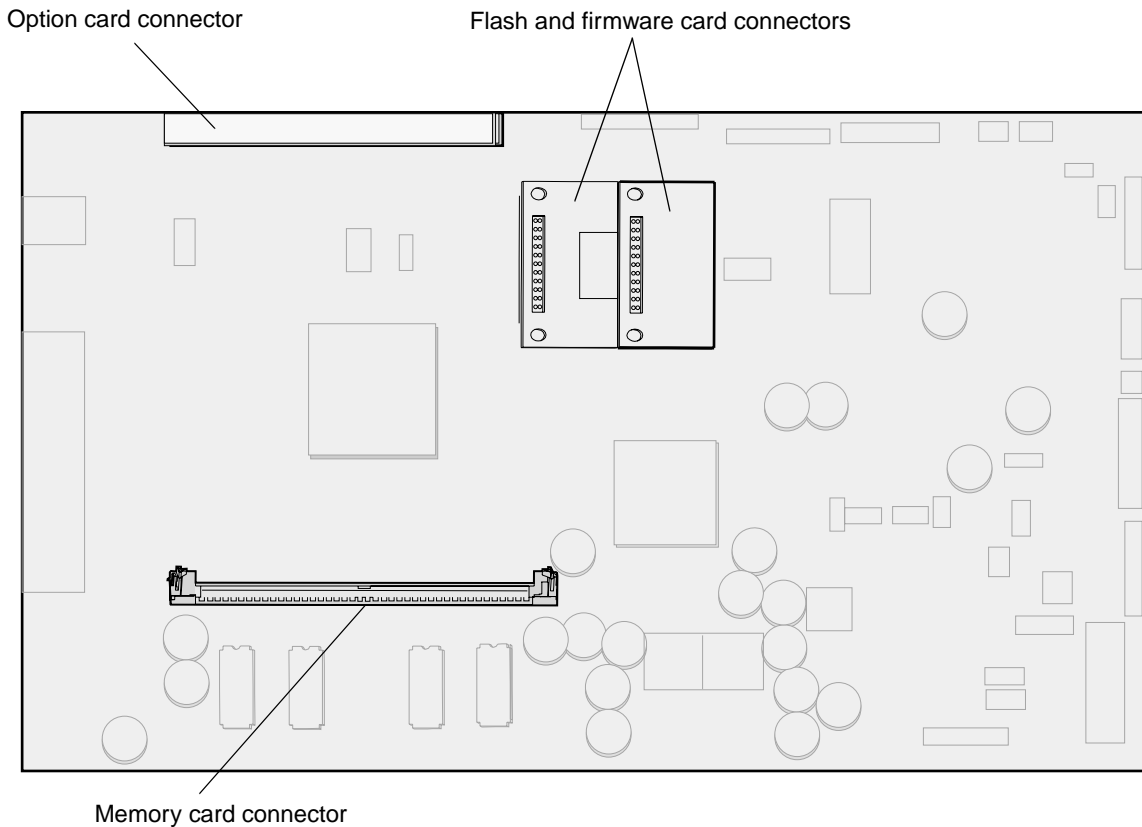

Installing or removing a memory card

Installation

Note: Printer memory cards designed for other Lexmark printers may not work with the printer.

- 1 Remove the system board access cover. (See **Accessing the printer system board.**)

Warning: Printer memory cards are easily damaged by static electricity. Touch something metal such as the printer frame before you touch a memory card.

- 2 Push open the latches on both ends of the memory card connector.
- 3 Unpack the memory card.
Avoid touching the connection points along the edge of the card. Save the packaging.
- 4 Align the notches on the bottom of the card with the notches on the connector.
- 5 Push the memory card firmly into the connector until the latches on either end of the connector *snap* into place.
It may require some force to fully seat the card.

Installing and removing options

- 6 Make sure each latch fits over the notch on the end of the card.

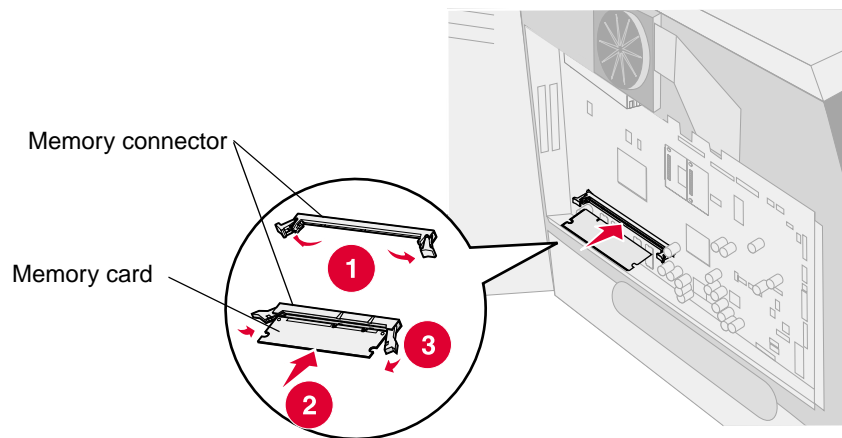

Removal

- 1 Remove the system board access cover. (See **Accessing the printer system board.**)

Warning: Printer memory memory cards are easily damaged by static electricity. Touch something metal such as the printer frame before you touch a memory card.

- 2 Push the latches away from the card on both ends of the memory card connector.
The memory card moves out of the connector as the latches open.
- 3 Pull the memory card out of the connector.
Avoid touching the connection points along the edge of the card.
- 4 Place the card into the original packaging.
If you do not have the original packaging, wrap the card in paper, and store it in a box.
- 5 Close both latches.

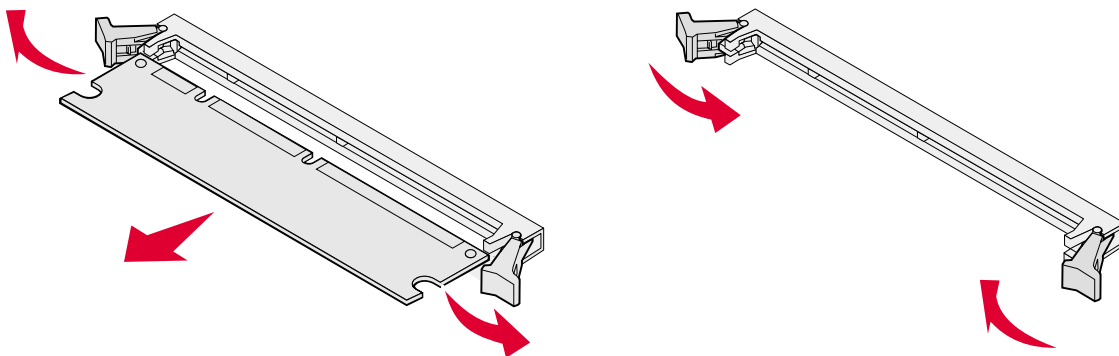

Installing or removing a flash memory or firmware card

Installation

Note: Flash memory or firmware cards designed for other Lexmark printers may not work with the printer.

- 1 Remove the system board access cover. (See **Accessing the printer system board.**)

Note: If an option card has been installed, you may need to remove the option card before installing the flash memory or firmware card.

- 2 Unpack the flash memory or firmware card.
- 3 Holding the flash memory or firmware card by the locking clips, align the plastic pins on the card with the holes on the system board.
- 4 Push the flash memory or firmware card firmly into place, and release the locking clips.

The entire length of the connector on the flash memory or firmware card must touch the system board and be locked into the connector.

Be careful not to damage the connectors.

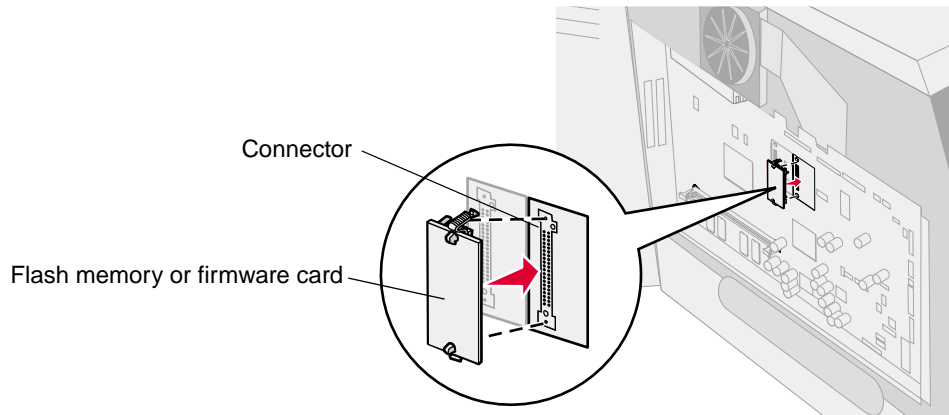

Removal

- 1 Remove the system board access cover. (See **Accessing the printer system board.**)

Note: If an option card has been installed, you may need to remove the option card before removing the flash memory or firmware card.

- 2 Squeeze the flash memory or firmware card locking clips.

- 3 Pull the card out.

Avoid touching the metal pins on the bottom of the card.

- 4 Place the flash memory or firmware card in its original packaging.

If you do not have the original packaging, wrap the flash memory or firmware card in paper, and store it in a box.

- 5 If you removed an option card to access the flash memory or firmware card, reinstall the option card.

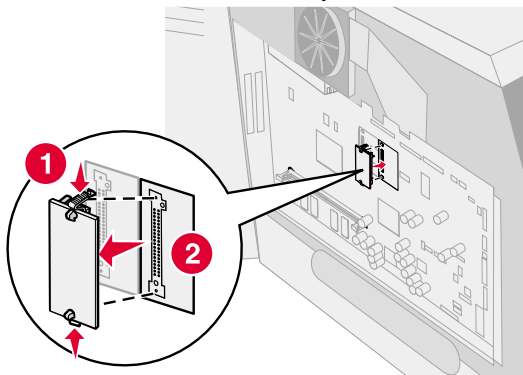

Installing an option card

The printer has two connectors that support the following option cards:

- Hard disk with adapter card
- MarkNet N8000 series internal print server
- RS-232 Serial Interface Card
- Parallel 1284-B Interface Card
- Coax/Twinax Adapter for SCS

Warning: Option cards are easily damaged by static electricity. Touch something metal such as the printer frame before you touch an option card.

- 1 Locate the card connectors on the system board.
- 2 Remove the screw and the cover plate, and save them.

If you are installing a tall card, install it in connector 1. If you are installing two short cards on a model with multiple connectors, use connector 1 first, and then use connector 2.

- 3 Unpack the card. Save the packaging materials.
- 4 Align the connection points on the card with the connector on the system board, and push the card firmly into the system board connector.
- 5 Insert the screw saved from the cover plate (or the extra screw shipped with the card).
- 6 Tighten the screw to secure the card.

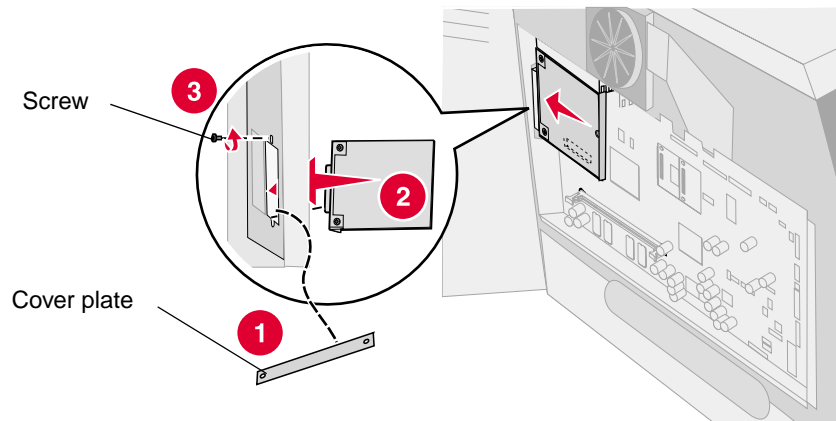

Replacing the shield

After you have installed options on the printer system board, follow these steps to reattach the shield and close the doors.

- 1 Align the keyholes on the shield with the screws on the frame.
- 2 Slide the shield down onto the screws.
- 3 Tighten the screws.

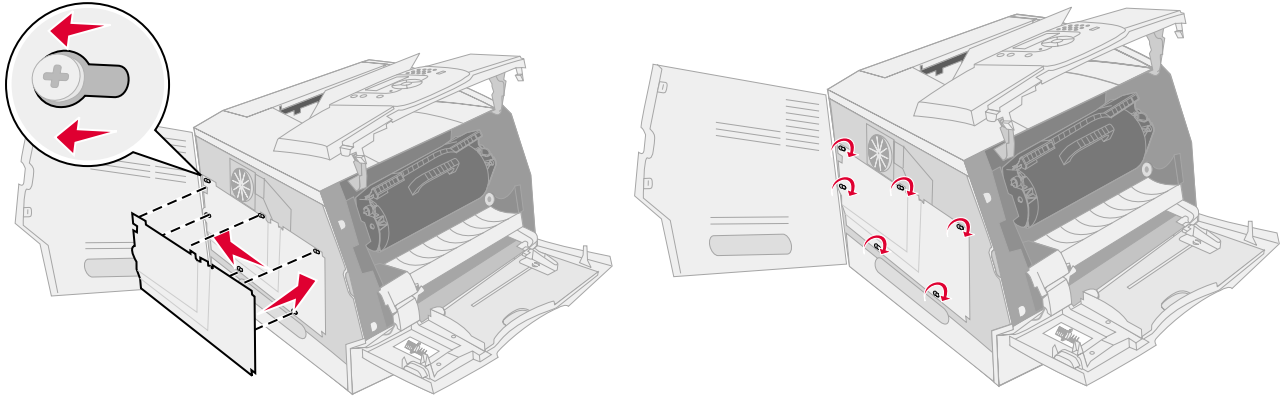

- 4 Close the side door.
- 5 Close the top front cover.
- 6 Close the multipurpose feeder.

5

Printing

This chapter covers information about sending a job to print, printing confidential jobs, canceling a print job, printing a menu settings page, a font list, and a directory list. This chapter also provides information on printing folio and statement size media. For tips on paper jam prevention and print media storage, see **Avoiding jams** or **Storing print media**.

Sending a job to print

A printer driver is software that lets your computer communicate with the printer. When you choose **Print** from a software application, a window representing the printer driver opens. You can then select the appropriate settings for the specific job you are sending to the printer. Print settings selected from the driver override the default settings selected from the printer operator panel.

You may need to click **Properties** or **Setup** from the initial Print dialog to see all of the available printer settings you can change. If you are not familiar with a feature in the printer driver window, open the online Help for more information.

To support all the printer features, use the Lexmark custom printer drivers supplied with the printer. Updated drivers, as well as a complete description of the driver packages and Lexmark driver support, are available from the Lexmark Web site.

To print a job from a typical Windows application:

- 1 Open the file you want to print.
- 2 From the File menu, select **Print**.
- 3 Select the correct printer in the dialog. Modify the printer settings as appropriate (such as the pages you want to print or the number of copies).
- 4 Click **Properties** or **Setup** to adjust printer settings that were not available on the first screen, and then click **OK**.
- 5 Click **OK** or **Print** to send the job to the selected printer.

Printing from a USB flash memory device

A USB Direct interface is located on the operator panel so you can insert a USB flash memory device and print PDF documents. Printing a document from a USB flash memory device is similar to printing a held job.

For information regarding tested and approved USB flash memory devices, see our Lexmark Web site at <http://support.lexmark.com>, and click **KnowledgeBase** to search for Direct USB printing.

Note the following when using a USB flash memory device with the printer USB Direct Interface:

- USB devices must be compatible with the USB 2.0 standard.
- Hi-Speed USB devices must support the Full-Speed standard as well. Devices only supporting USB low speed capabilities are not supported.
- USB devices must use the FAT file system. Devices formatted with NTFS or any other file system are not supported.
- You cannot print encrypted files or files without printing permissions.

Printing

To print from a USB flash memory device:

- 1 Make sure the printer is on and **Ready** or **Busy** appears.
- 2 Insert a USB flash memory device into the USB Direct interface.

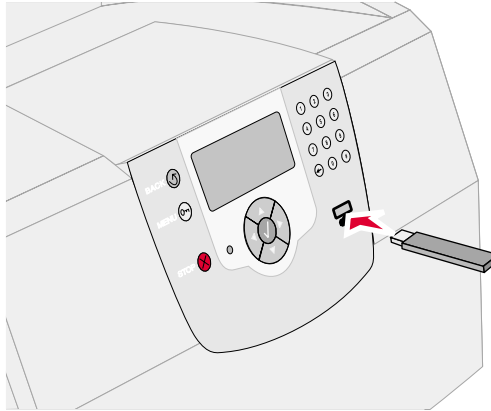

Note:

- If you insert the memory device when the printer requires attention such as when a paper jam has occurred, the printer ignores the memory device.
- If you insert the memory device when the printer is busy printing other jobs, the message **Printer Busy** appears. Select **Continue**, and your job prints after the other jobs finish.

- 3 Press **▼** until the **✓** appears next to the document you want to print, and then press **✓**.

A screen asking the number of copies to be printed will appear.

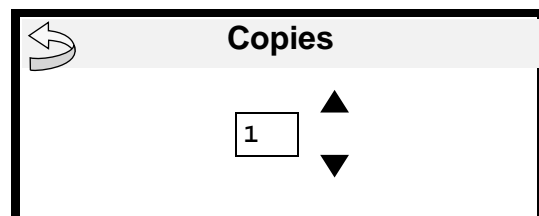
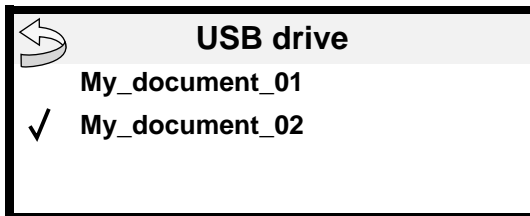

- 4 To print only one copy, press **✓**, or manually input the number of copies with the number pad, then press **✓**.

Note: Do not remove the USB flash memory device from the USB Direct interface until the document has finished printing.

The document will begin printing.

If you leave the device in the printer after exiting the USB drive menu, you can still print PDFs on the device as held jobs. See **Printing confidential and held jobs**.





Canceling a print job





There are several methods for canceling a print job.

- **Canceling a job from the printer operator panel**
- **Canceling a job from a computer running Windows**
 - **Canceling a job from the taskbar**
 - **Canceling a job from the desktop**
- **Canceling a job from a Macintosh computer**
 - **Canceling a print job from a computer running Mac OS 9**
 - **Canceling a job from a computer running Mac OS X**

Canceling a job from the printer operator panel

If the job is formatting or already printing, and **Cancel a Job** appears on the first line of the display:

- 1 Press .
A list of jobs appears.
- 2 Press  until  appears next to the job requiring cancelation, and then press .
The message **Canceling <filename>** appears.

Note: Once a print job is sent, to easily cancel the job, press . The Stopped screen appears. Press  until  **Cancel a job** appears, and then press .

Canceling a job from a computer running Windows

Canceling a job from the taskbar

When you send a job to print, a small printer icon appears in the right corner of the taskbar.

- 1 Double-click the printer icon.
A list of print jobs appears in the printer window.
- 2 Select the job you want to cancel.
- 3 Press the **Delete** key on the keyboard.

Canceling a job from the desktop

- 1 Minimize all programs to reveal the desktop.
- 2 Double-click the **My Computer** icon.

Note: If you do not have the **My Computer** icon, you can access the printers folder by selecting **Start** → **Settings** → **Control Panel**, and then go to **step 4**.

- 3 Double-click the **Printers** icon.
A list of available printers appears.
- 4 Double-click the printer you selected when you sent the job.
A list of print jobs appears in the printer window.
- 5 Select the job you want to cancel.

- 6 Press the **Delete** key on the keyboard.

Canceling a job from a Macintosh computer

Canceling a print job from a computer running Mac OS 9

When you send a job to print, the printer icon for your selected printer appears on the desktop.

- 1 Double-click the printer icon on your desktop.
A list of print jobs appears in the printer window.
- 2 Select the print job you want to cancel.
- 3 Click the trash can button.







Canceling a job from a computer running Mac OS X

When you send a job to print, the printer icon for your selected printer appears in the dock.

- 1 Open **Applications** → **Utilities**, and then double-click **Print Center** or **Printer Setup**.
- 2 Double-click the printer you are printing to.
- 3 In the printer window, select the print job you want to cancel.
- 4 Press **Delete**.







Printing the menu settings page

You can print a menu settings page to review the default printer settings and to verify the printer options are installed correctly.

- 1 Make sure the printer is on.
 - 2 Press  on the operator panel.
 - 3 Press  until the  appears next to **Reports**, and then press .
 - 4 Press  until the  appears next to **Menu Settings Page**, and then press .
- The printer returns to **Ready** after the page prints.











Printing a network setup page

You can print a network setup page to review the default printer settings and to verify the printer options are installed correctly.

- 1 Make sure the printer is on.
 - 2 Press  on the operator panel.
 - 3 Press  until the  appears next to **Reports**, and then press .
 - 4 Press  until the  appears next to **Network Setup Page** or **Network <x> Setup Page**, and then press .
- The printer returns to **Ready**.







Printing a font sample list

To print samples of the fonts currently available for the printer:

- 1 Make sure the printer is on and the **Ready** message appears.
 - 2 Press  on the operator panel.
 - 3 Press  until the  appears next to **Reports**, and then press .
 - 4 Press  until the  appears next to **Print Fonts**, and then press .
 - 5 Press  until the  appears next to **PCL Fonts, PostScript Fonts, or PPDS Fonts**, and then press .
- The printer returns to **Ready**.

Printing a directory list

A directory listing shows the resources stored in flash memory or on the hard disk. To print a listing:

- 1 Make sure the printer is on and the **Ready** message appears.
 - 2 Press  on the operator panel.
 - 3 Press  until the  appears next to **Reports**, and then press .
 - 4 Press  until the  appears next to **Print Directory**, and then press .
- The printer returns to **Ready**.

Printing confidential and held jobs

The term *held job* refers to any type of print job that can be initiated by the user at the printer. This includes a confidential job, a verify print job, a reserve print job, a repeat print job, a bookmark, a profile, or a file on a USB flash memory device. When sending a job to the printer, you can specify in the driver that you want the printer to hold the job in memory. Once your job is stored in printer memory, go to the printer, and use the printer operator panel to specify what you want to do with your print job.

All confidential and held jobs have a user name associated with them. To access confidential or held jobs, you must first select the type of job (confidential or held), and then select your user name from the user name list. Once you select your user name, you can print all your confidential jobs or select an individual print job. You can then choose the number of copies for the print job, or you can delete the print job.

Printing a confidential job

When you send a confidential job to the printer, you must enter a personal identification number (PIN) from the driver. The PIN must be four digits using the numbers 0–9. The job is held in printer memory until you enter the same four-digit PIN from the operator panel and choose to print or delete the job. This ensures the job does not print until you are there to retrieve it. No one else using the printer can print the job without the PIN.

Windows

- 1 From a word processor, spreadsheet, browser, or other application, select **File** → **Print**.
- 2 Click **Properties**. (If there is no Properties button, click **Setup**, and then click **Properties**.)
- 3 Depending on the operating system, you may have to click the **Other Options** tab, and then click **Print and Hold**.

Note: If you have difficulty finding Print and Hold → Confidential Print, click **Help**, see the topic Confidential Print or Print and Hold, and then follow the driver instructions.

Printing

4 Enter a User Name and PIN.

5 Send your job to the printer.

Go to the printer when you are ready to retrieve your confidential print job, and follow the **At the printer** steps.

Macintosh

1 From a word processor, spreadsheet, browser, or other application, select **File** → **Print**.

2 In the **Copies & Pages** or **General** pop-up menu, select **Job Routing**.

a When using Mac OS 9, if Job Routing is not a choice on the pop-up menu, select **Plug-in Preferences** → **Print Time Filters**.

b Turn down the disclosure triangle to the left of **Print Time Filters**, and select **Job Routing**.

c In the pop-up menu, select **Job Routing**.

3 In the radio group, select **Confidential Print**.

4 Enter a User Name and PIN.

5 Send your job to the printer.

Go to the printer when you are ready to retrieve your confidential print job, and follow the **At the printer** steps.

At the printer

1 Press ▼ until the ✓ appears next to **Held jobs**, and then press ✓.

2 Press ▼ until the ✓ appears next to your user name, and then press ✓.

3 Press ▼ until the ✓ appears next to **Confidential jobs**, and then press ✓.

4 Enter your PIN.

For more information, see **Entering a personal identification number (PIN)**.

5 Press ▼ until the ✓ appears next to the job you want to print, and then press ✓.

Note: After your job prints, it is deleted from printer memory.

Entering a personal identification number (PIN)

After you select your user name and Confidential Job, the Enter PIN screen appears.

1 Use the numeric pad to the right of the display to enter the four-digit PIN associated with your confidential job.

Note: As you enter the PIN, asterisks appear on the display to ensure confidentiality.

If you enter an invalid PIN, the Invalid PIN screen appears.

Press ✓ to reenter the PIN, or press ▼ until the ✓ appears next to **Cancel**, and then press ✓.

2 Press ▼ until the ✓ appears next to the job you want to print, and then press ✓.

Note: After your job prints, it is deleted from printer memory.

Printing and deleting held jobs

Held jobs (Verify Print, Reserve Print, or Repeat Print) are printed or deleted from the printer operator panel and do not require a PIN number.

Verify Print

If you send a Verify Print job, the printer prints one copy and holds the remaining copies you requested in printer memory. Use Verify Print to examine the first copy to see if it is satisfactory before printing the remaining copies. Once all copies are printed, the Verify Print job is automatically deleted from printer memory.

Reserve Print

If you send a Reserve Print job, the printer does not print the job immediately. It stores the job in memory so you can print the job later. The job is held in memory until you delete it from the Held Jobs menu. Reserve Print jobs may be deleted if the printer requires extra memory to process additional held jobs.

Repeat Print

If you send a Repeat Print job, the printer prints all requested copies of the job *and* stores the job in memory so you can print additional copies later. You can print additional copies as long as the job remains stored in memory.

Note: Repeat Print jobs are automatically deleted from printer memory when the printer requires extra memory to process additional held jobs.

Windows

- 1 From a word processor, spreadsheet, browser, or other application, select **File → Print**.
- 2 Click **Properties**. (If there is no Properties button, click **Setup**, and then click **Properties**.)
- 3 Depending on the operating system, you may have to click the **Other Options** tab, and then click **Print and Hold**.

Note: If you have difficulty finding Print and Hold → Held Jobs, click **Help**, and see the topic Held Jobs or Print and Hold, then follow the driver instructions.

- 4 Select the type of held job you want, and then send your job to the printer.
Go to the printer when you are ready to retrieve your confidential print job, and follow the **At the printer** steps.

Macintosh

- 1 From a word processor, spreadsheet, browser, or other application, select **File → Print**.
- 2 In the **Copies & Pages** or **General** pop-up menu, select **Job Routing**.
 - a When using Mac OS 9, if Job Routing is not a choice on the pop-up menu, select **Plug-in Preferences → Print Time Filters**.
 - b Turn down the disclosure triangle to the left of **Print Time Filters**, and select **Job Routing**.
 - c In the pop-up menu, select **Job Routing**.
- 3 In the radio group, select the type of held job you want, enter a user name, and then send your job to the printer.
Go to the printer when you are ready to retrieve your confidential print job, and follow the **At the printer** steps.

At the printer

- 1 Press ▼ until the ✓ appears next to **Held jobs**, and then press ⓪.
- 2 Press ▼ until the ✓ appears next to your user name, and then press ⓪.

Printing

- 3 Press ▼ until the ✓ appears next to the type of action you want to perform, and then press ⓧ.

Print All	Delete All
Print A Job	Delete A Job
Print Copies	

If you selected Print A Job, Delete A Job, or Print Copies, press ▼ until the ✓ appears next to the job you want, and then press ⓧ.

The job will print or be deleted according to the type of print job and action you selected.

Printing on specialty media

Media is paper, card stock, transparencies, labels, and envelopes. The last four are sometimes referred to as *specialty media*. Follow these instructions to print on specialty media.

- 1 Load the media as specified for the tray being used. See **Loading standard trays and optional trays** for help.
- 2 From the printer operator panel, set the Paper Type and Paper Size according to the media you loaded. See **Setting the Paper Type and Paper Size** for help.
- 3 From the computer software application, set the paper type, size, and source according to the media you loaded.

Windows

- a From a word processor, spreadsheet, browser, or other application, select **File → Print**.
- b Click **Properties** (or **Options**, **Printer**, or **Setup**, depending on the application) to view the printer driver settings.
- c Click the **Paper** tab.
A paper tray list will appear.
- d Select the tray containing the specialty media.

Note: If you have difficulty, click **Help**, and then follow the driver instructions.
- e Select the media type (transparencies, envelopes, and so on) from the **Paper Type** list box.
- f Select the size of the specialty media from the **Paper Size** list box.
- g Click **OK**, and then send the print job as usual.

Mac OS 9

- a Select **File → Page Setup**.
- b Select the size of the specialty media from the **Paper** pop-up menu, and then click **OK**.
- c Select **File → Print**.
- d With **General** selected on the top pop-up menu, go to the **Paper Source** pop-up menu, and select the tray containing the specialty media or the name of the media.
- e Click **Print**.

Mac OS X

- a Select **File → Page Setup**.
- b Select the printer from the **Format for** pop-up menu.
- c Select the size of the specialty media from the **Paper** pop-up menu, and then click **OK**.

- d Select **File** → **Print**.
- e On the **Copies & Pages** pop-up menu, select **Imaging**.
- f Select the specialty media on the **Paper Type** pop-up menu.
- g On the **Imaging** pop-up menu, select **Paper Feed**.
- h Select the tray containing the specialty media from the **All pages from** or **First page from / Remaining from** pop-up menus.
- i Click **Print**.

Loading standard trays and optional trays

The printer has a 250-sheet or 500-sheet standard tray, depending on the model you purchased. You may have also purchased one or more 250-sheet or 500-sheet optional trays or a 2000-sheet drawer. The steps for loading a 250-sheet tray or 500-sheet tray are the same.

Note: The steps for loading a 2000-sheet drawer are different than the steps for loading a 250-sheet tray or 500-sheet tray.

To load print media:

Note: Do not remove a tray when a job is printing or when the operator panel indicator light is blinking. Doing so may cause a jam.

- 1 Remove the tray from the printer, and place it on a flat, level surface.
- 2 Squeeze the side guide tab, and slide the guide to the outer edge of the tray.

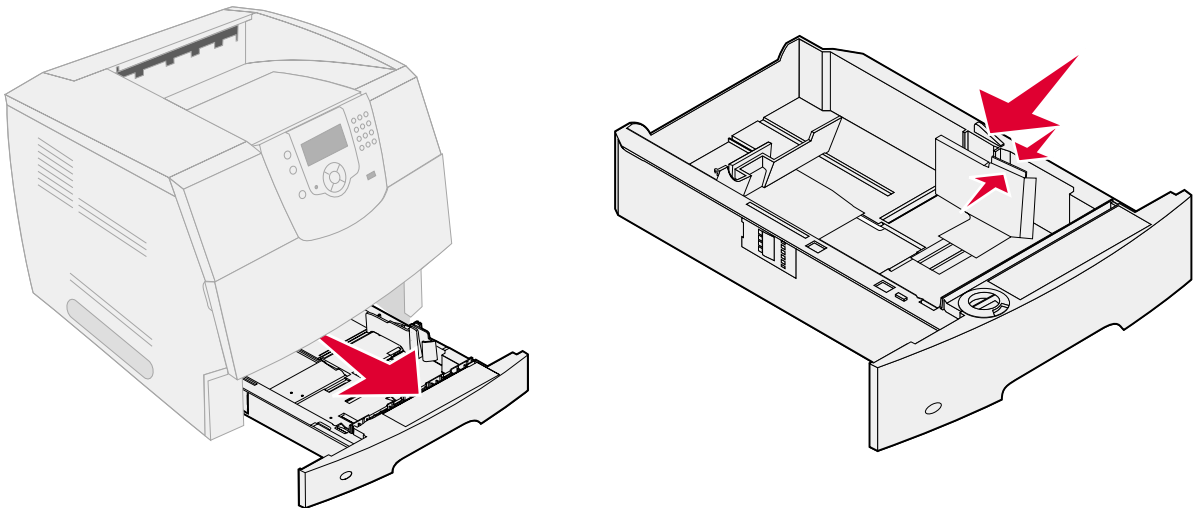

Printing

- 3 Squeeze the rear guide tab, and slide the guide to the correct position for the size media you are loading.
- 4 Flex the sheets back and forth to loosen them, then fan them. Do not fold or crease the print media. Straighten the edges on a level surface.

Size indicators

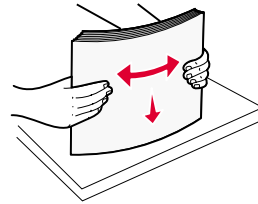
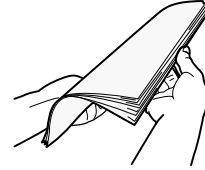
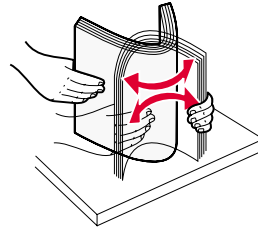
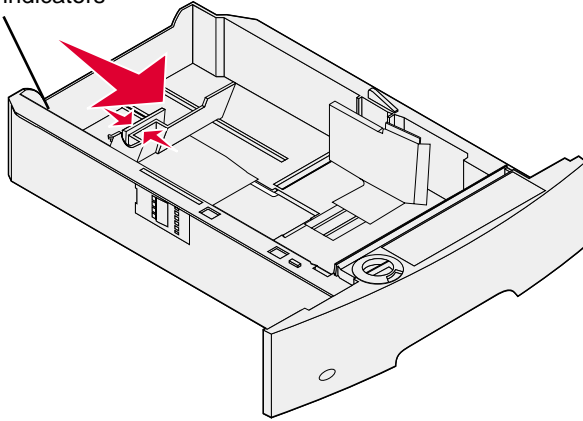

Printing

5 Place the print media in the tray:

Note: Paper must be loaded differently in the trays, depending on the options you have installed.

- Print side face-down for *simplex* (single-sided) printing
- Print side face-up for duplex printing

Note: Do not fill paper above the load line. Overfilling the tray may cause jams.

Without an optional finisher

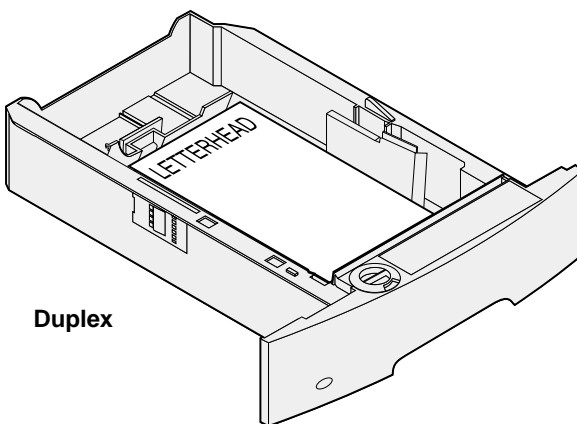
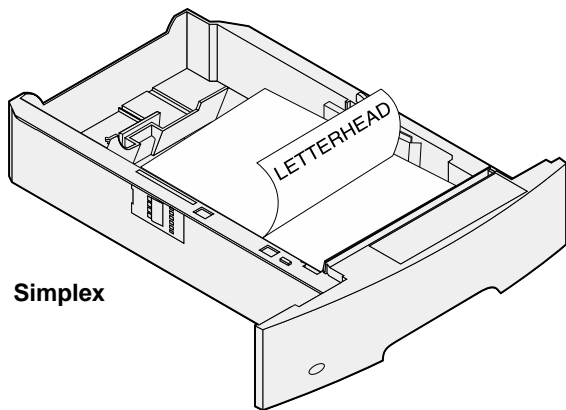

With an optional finisher

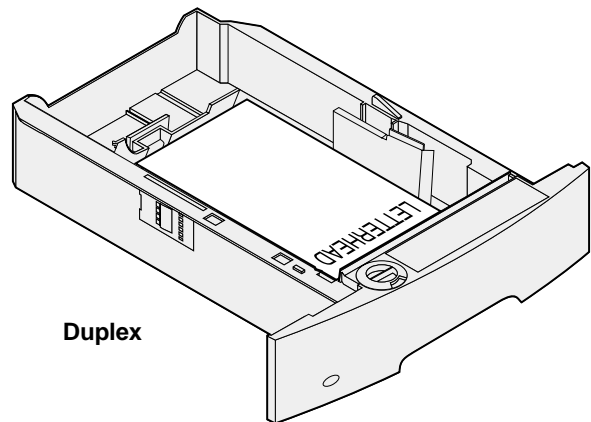
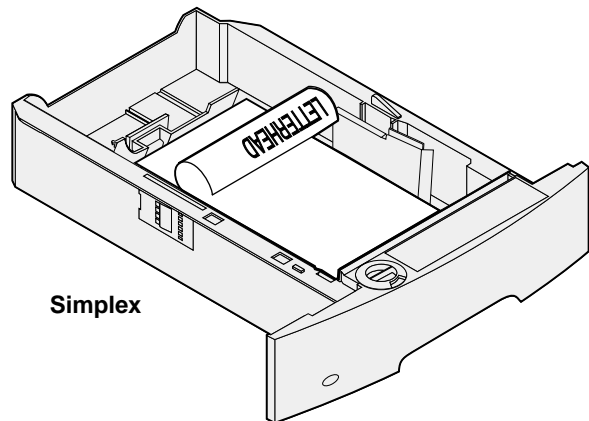

- 6 Squeeze the side guide tab, and slide the guide toward the inside of the tray until it lightly rests against the edge of the media.
- 7 Insert the tray into the printer.

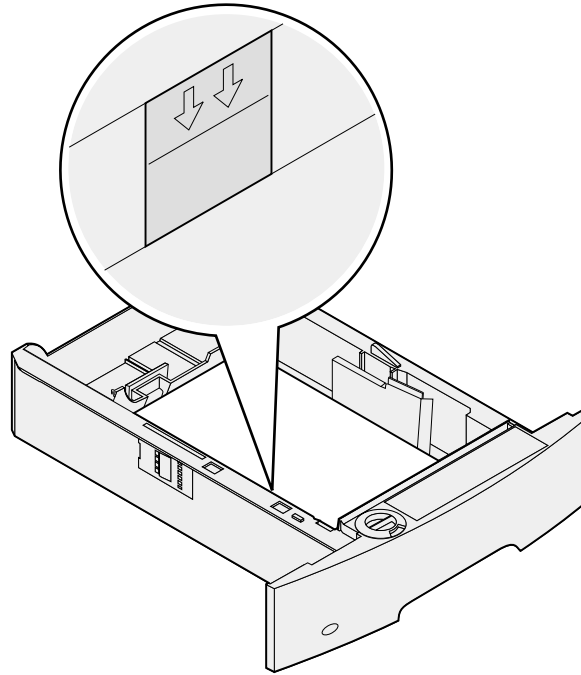

















Setting the Paper Type and Paper Size

After setting the Paper Type and Paper Size to the correct values for the type and size used in the trays, then any trays containing the same size and type are automatically linked by the printer.

Note: If the size of the media you are loading is the same size of the media previously loaded, do not change the Paper Size setting.

To change the Paper Size and Paper Type setting:

- 1 Make sure the printer is on.
- 2 Press  on the operator panel.
- 3 Press  until the  appears next to **Paper Menu**, and then press .
- 4 Press  until the  appears next to **Paper Size/Type**, and then press .
- 5 Press  until the  appears next to the input source you want to use, and then press .
- 6 Press  until the  appears next to the paper size you want to use, and then press .
- 7 Press  until the  appears next to the paper type you want to use, and then press .

This saves this setting as the new user default, and the printer returns to **Ready**.

Loading the multipurpose feeder

The multipurpose feeder can hold several sizes and types of print media, such as transparencies, postcards, note cards, and envelopes. It can be used for single-page or manual printing or as an additional tray.

Note: If you install an optional envelope feeder, you can still use the multipurpose feeder.

The multipurpose feeder can hold approximately:

- 100 sheets of 75 g/m² (20 lb) paper
- 10 envelopes
- 75 transparencies

The multipurpose feeder accepts print media within the following dimensions:

- Width—69.85 mm (2.75 in.) to 215.9 mm (8.5 in.)
- Length—127 mm (5 in.) to 355.6 mm (14 in.)

The icons on the multipurpose feeder show you how to load the multipurpose feeder with paper, how to turn an envelope for printing, and how to load letterhead paper for simplex and duplex printing. A finisher affects how letterhead documents should be loaded for duplexing. You can print simplex jobs on letterhead (or other preprinted media) that has been *loaded specifically for duplex printing* by changing the value in the Paper Loading menu.



Printing

To load print media:

Note: Do not add or remove print media when the printer is printing from the multipurpose feeder or when the operator panel indicator light is blinking. Doing so may cause a jam.

- 1 Push the release latch, and lower the multipurpose feeder.
- 2 Pull the tray extension out.

Note: Do not place objects on the multipurpose feeder. Also, avoid pressing down or applying excessive force on it.

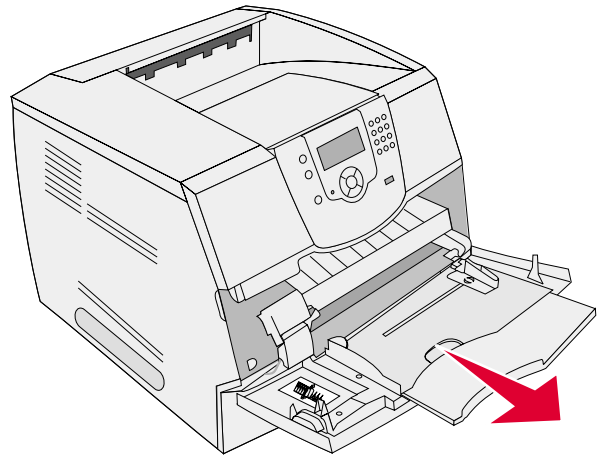
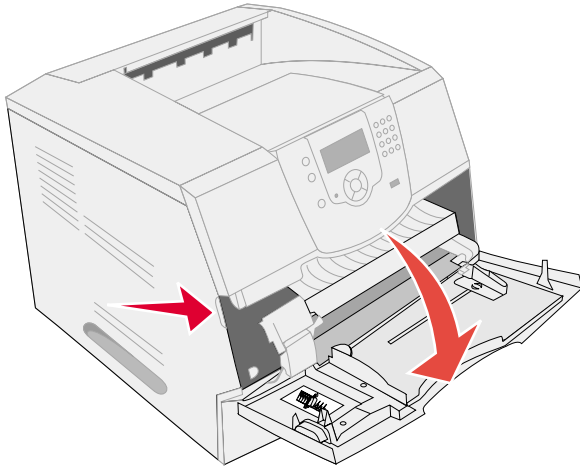

- 3 Slide the width guide to the far right.
- 4 Flex the sheets or envelopes back and forth to loosen them, then fan them. Do not fold or crease the print media. Straighten the edges on a level surface.

Note: Hold transparencies by the edges and avoid touching the print side. Fan the stack of transparencies to prevent jams. Be careful not to scratch or leave fingerprints on the transparencies.

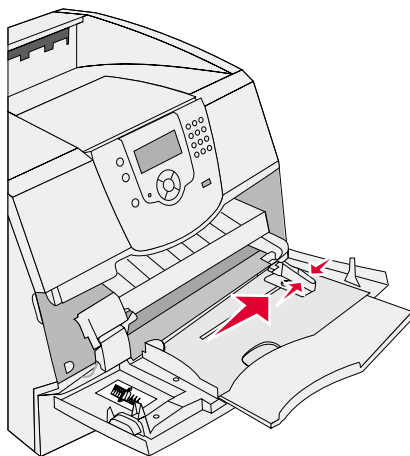

Paper

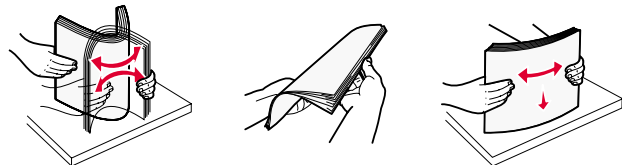

Envelopes



Transparencies

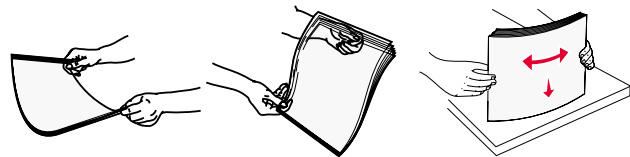

5 Load the media in the tray.

Use the stack height label as a guide for stack height when loading print media.

Loading paper, transparencies, or envelopes

Note: Letterhead or other preprinted paper must be loaded differently depending on the options you have installed.

- Load paper or transparencies with the left edge of the stack against the stack height label and with the recommended print side face-up.
- Load envelopes flap side down with the stamp area and flap on the left. The end of the envelope with the stamp area enters the multipurpose feeder first.

Never use envelopes with stamps, clasps, snaps, windows, coated linings, or self-stick adhesives. These envelopes may severely damage the printer.

Note: Load only one size and type of print media at a time in the multipurpose feeder. *Do not* mix sizes and types in the same tray.

Printing

Loading letterhead or preprinted paper

- Follow the illustrations for loading the paper according to your options.
- Do not fill paper above the load line. Overfilling the tray may cause jams.

Without a finisher attached

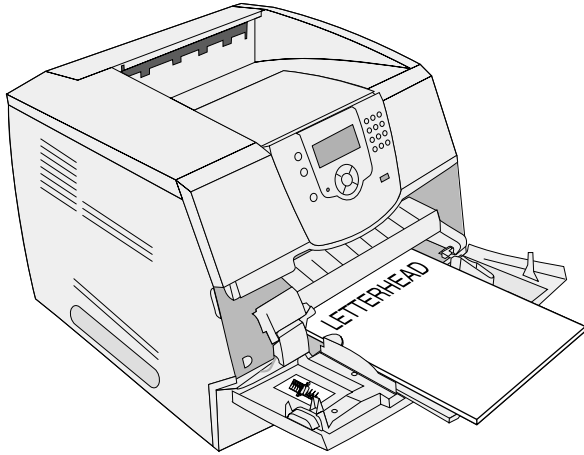

Simplex (single sided)

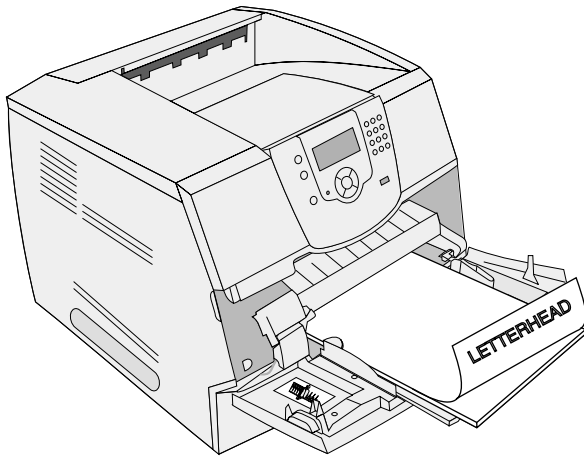

Duplex

With a finisher attached

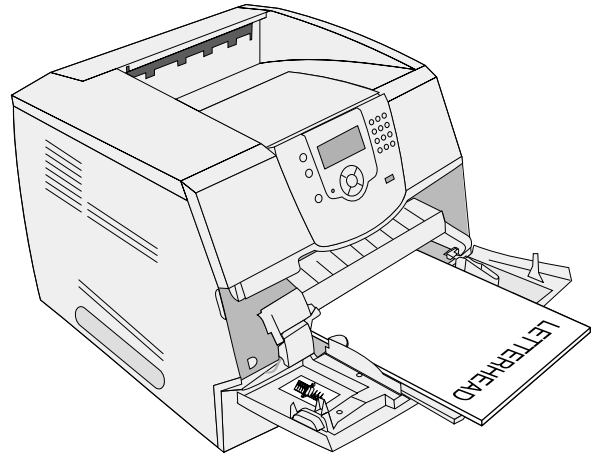

Simplex (single sided)

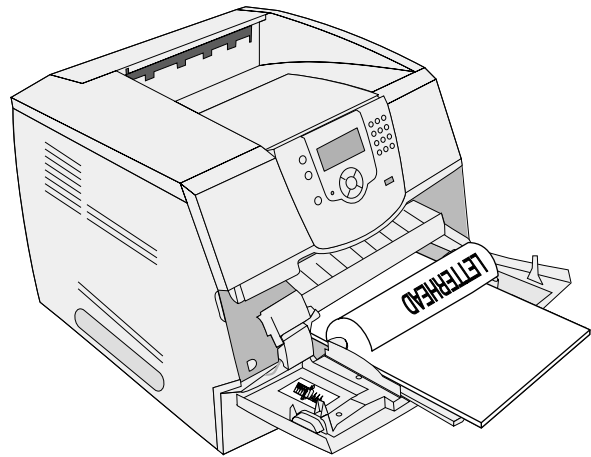







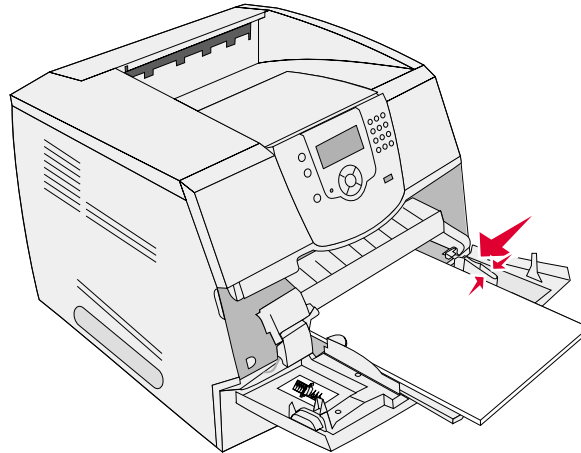











Duplex

Printing

- Slide the side guide toward the inside of the tray until it lightly rests against the edge of the media.



- Set the Paper Size and Paper Type for the multipurpose feeder (MP Feeder Size and MP Feeder Type) to the correct value for the print media you loaded.

- Press  on the operator panel.
- Press  until the  appears next to **Paper Menu**, and then press .
- Press  until the  appears next to **Paper Size/Type**, and then press .
- Press  until the  appears next to **MP Feeder Size/Type**, and then press .
- Press  until the  appears next to the media size you loaded, and then press .
- Press  until the  appears next to **MP Feeder Size/Type**, and then press .
- Press  until the  appears next to the media type you loaded, and then press .

The printer returns to **Ready**.

Closing the multipurpose feeder

- Remove print media from the multipurpose feeder.
- Push the extension tray in.
- Close the multipurpose feeder cover.

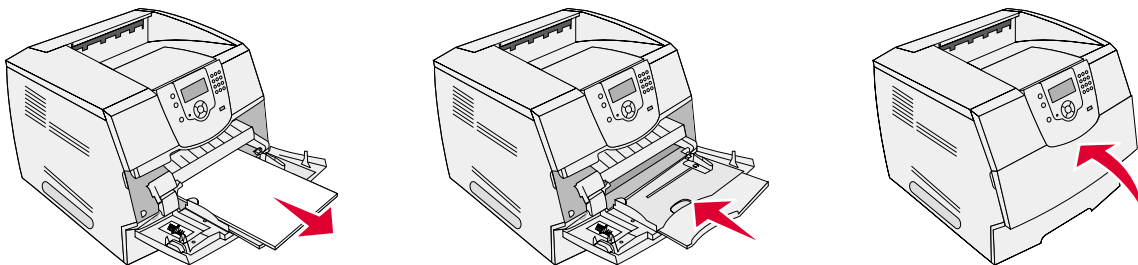

Loading the 2000-sheet drawer

The optional 2000-sheet drawer can be used for plain paper, letterhead or other preprinted paper, labels, or transparencies. For trouble-free printing, make sure you:

- Do not load print media above the load line.
- Do not fold or crease the paper.
- Do not mix sizes or weights in the same source.
- Do not open the door or remove any print media when a job is printing or when the operator panel indicator light is blinking. Doing so may cause a jam.

Note: Before loading print media in the drawer, you should know the recommended print side of the paper you are using. This information is usually on the paper package.

To load the 2000-sheet drawer:

- 1 Open the loading door. If the elevator tray is not already in the lowered position, push the elevator button to lower the tray.
- 2 Flex the sheets back and forth to loosen them, then fan them. Do not fold or crease the print media. Straighten the edges on a level surface.

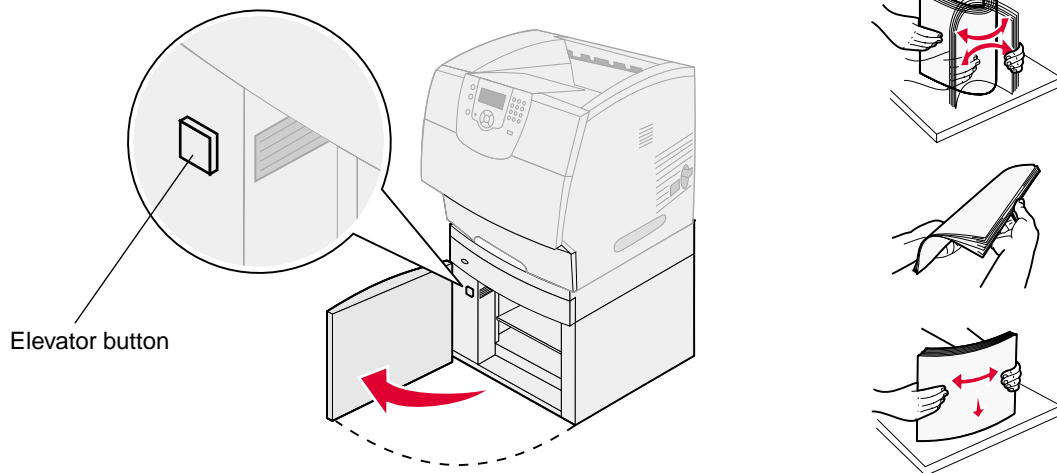

Printing

- 3 Slightly bend the stack of print media as shown, and place it on the elevator tray with the preferred print side facing down. Align the stack of print media to the back of the drawer.

Note: For duplex printing, letterhead or other preprinted paper must be loaded differently.

Carefully align each stack as you load it to ensure a smooth edge where the stacks meet. Do not load print media above the load line.

Note: When loading more than one ream of paper, we recommend you remove the top and bottom sheet.

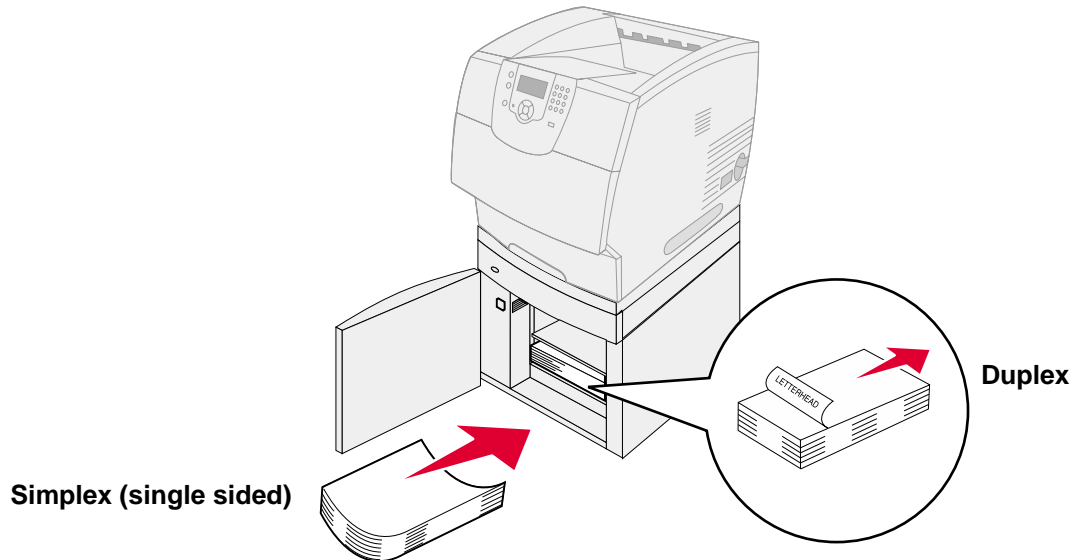

- 4 Close the loading door.

Loading the envelope feeder

The optional envelope feeder can accept a variety of envelope sizes. However, the envelope feeder must be adjusted correctly to ensure trouble-free printing. To load the envelope feeder:

- 1 Adjust the envelope support for the length of envelope you are loading.
 - Fully closed (pushed in toward the printer) for short envelopes
 - Extended to the middle position for medium-length envelopes
 - Fully open (extended to its full length) for long envelopes

Warning: Do not place objects on the envelope feeder. Avoid pressing down on it or applying excessive force.

- 2 Lift the envelope weight back toward the printer. It stays in place.

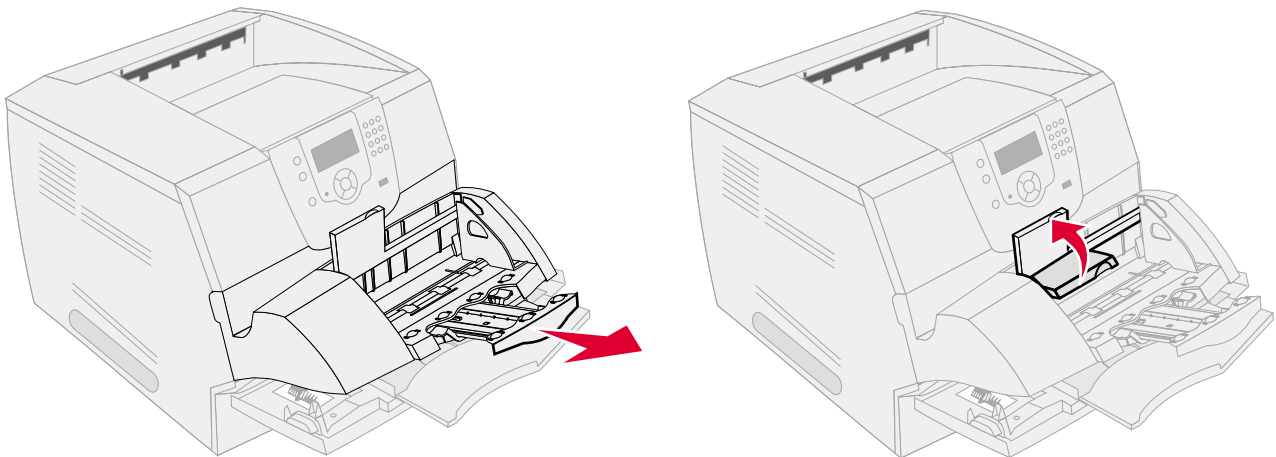

- 3 Slide the width guide to the far right.
- 4 Flex a stack of envelopes back and forth, and then straighten the edges on a level surface. Press down the corners to flatten them.

Fan the envelopes. This prevents the edges of the envelopes from sticking together and helps them feed properly.

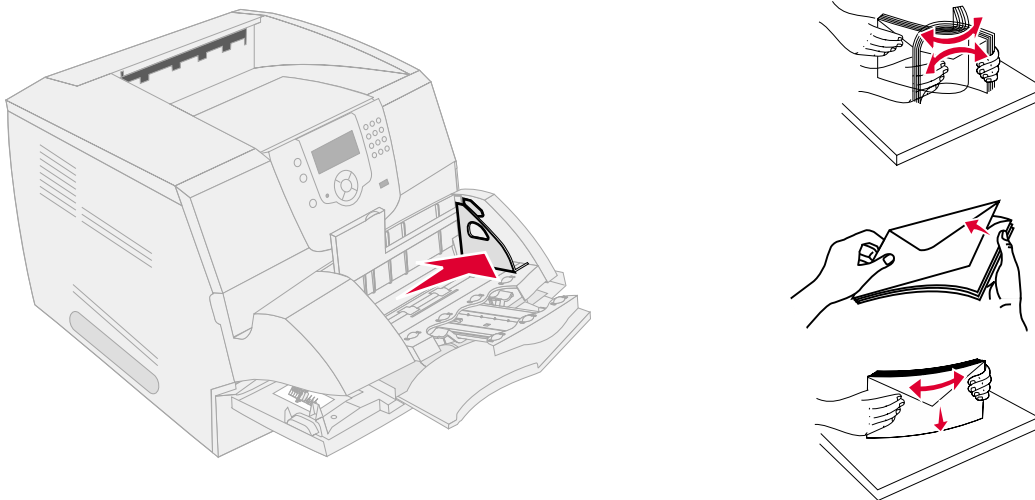

Printing

- 5 Load the stack of envelopes flap side down with the stamp area and the flap on the left. The end of the envelopes with the stamp area enters the envelope feeder first.

Let the envelopes at the bottom of the stack slide into the envelope feeder slightly more than the ones at the top of the stack.

Warning: Never use envelopes with stamps, clasps, snaps, windows, coated linings, or self-stick adhesives. These envelopes may severely damage the printer.

Note: When you load envelopes, do not exceed the maximum stack height. Use the stack height label as a guide for the correct stack height when loading. Do not try to load more envelopes indicated by the stack height label; overloading can cause jams.



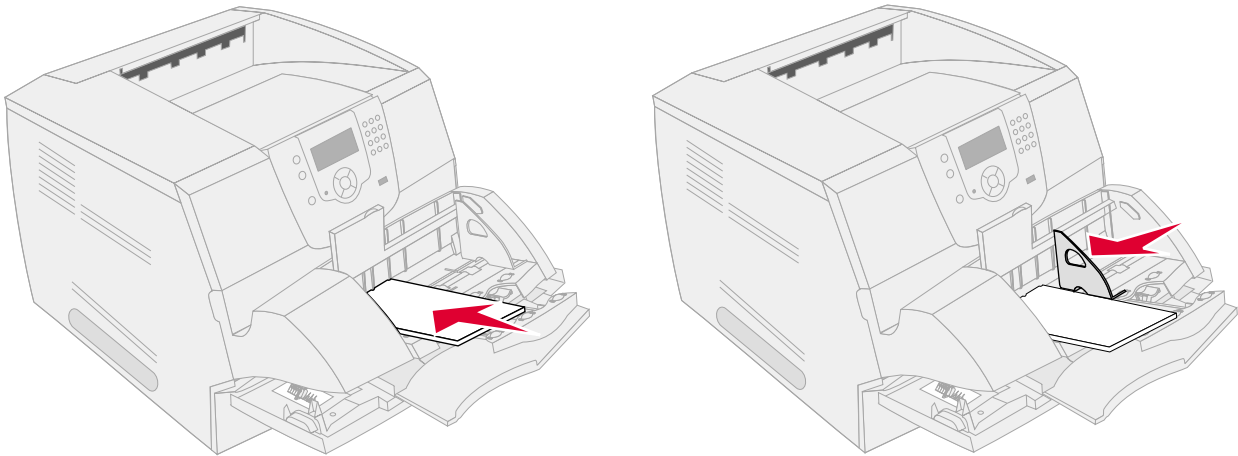



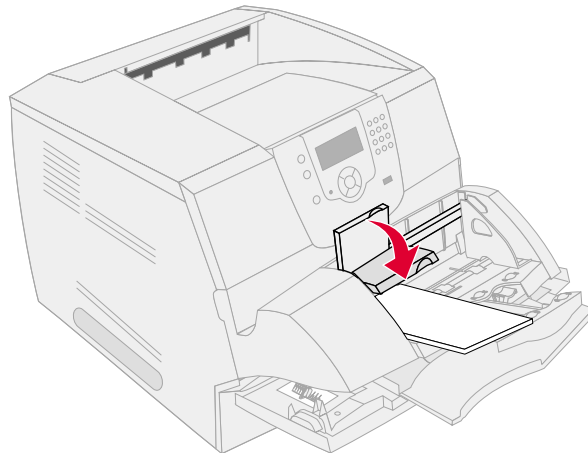











- 6 Slide the width guide to the left until it lightly touches the stack. Make sure the envelopes do not buckle.



- 7 Lower the envelope weight to touch the stack.



- 8 Set the Paper Size and Paper Type for the envelope feeder (envelope Feeder Size and envelope Feeder Type) to the correct value for the print media you loaded.

- a Press  on the operator panel.
- b Press  until the  appears next to **Paper Menu**, and then press .
- c Press  until the  appears next to **Paper Size/Type**, and then press .
- d Press  until the  appears next to **Envelope Feeder Size/Type**, and then press .
- e Press  until the  appears next to the envelope size you loaded, and then press .
- f Press  until the  appears next to **Envelope Feeder Size/Type**, and then press .
- g Press  until the  appears next to the envelope type you loaded, and then press .

The printer returns to **Ready**.

Linking trays











Tray linking enables the automatic linking feature for trays when you load the same size and type of print media in multiple sources. The printer automatically links the trays; when one tray is empty, print media feeds from the next linked tray.

For example, if you have the same size and type of print media loaded in tray 2 and tray 4, the printer selects print media from tray 2 until it becomes empty, and then the printer automatically feeds print media from the next linked tray—tray 4.

By linking all trays (standard and optional), you effectively create a single source with a capacity of up to 4,100 sheets.

Make sure you load the same size and type of print media in each tray in order to link the trays.

Set the paper size and type for each tray, to set the paper type or size:

- 1 Press  on the operator panel.
- 2 Press  until the  appears next to **Paper Menu**, and then press .
- 3 Press  until the  appears next to **Paper Size/Type**, and then press .
- 4 Press  until the  appears next to **Tray <x> Size/Type**, and then press .
- 5 Press  until the  appears next to the paper size you loaded, and then press .
- 6 Press  until the  appears next to **Tray <x> Size/Type**, and then press .
- 7 Press  until the  appears next to the paper type you loaded, and then press .

The printer returns to **Ready**.

To disable tray linking, set the Paper Type to a unique value in each one of the trays. If all the trays do not have the same type of print media when they are linked, you could mistakenly print a job on the wrong paper type.

Identifying and linking output bins

There is one standard output bin on all printer models. Depending on the model you selected, your output bin capacity is 250 or 500 sheets. If you need additional output capacity, there are several optional output bins available for the printer.

If you have multiple output bins, you can link them into a single output source. Linking output bins lets the printer automatically switch output to the next available bin.

Output bins available

The following table provides information on standard and optional output bin capability and connectivity.

Note: Not all output bins support every paper and envelope size.

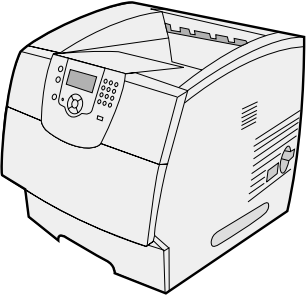
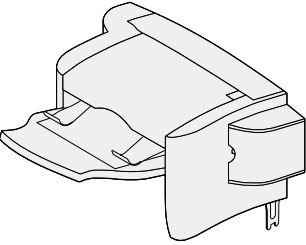
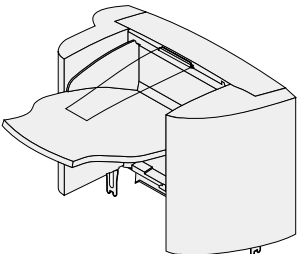
Output bin name	Each bin accommodates		How many can be installed on the printer	Bin is allowed to connect with	Illustration of output bin
	Print media	Printer Models			
Standard bin	<ul style="list-style-type: none"> 250 sheets (75 g/m²) of plain paper 150 transparencies 100 labels 25 envelopes (75 g/m²) 	T640	N/A — one is standard on the printer and located on top of the printer	Any of the options in combinations as follows in this column	
Standard bin	500 sheets (75 g/m ²) of plain paper 300 transparencies 200 labels <ul style="list-style-type: none"> 50 envelopes (75 g/m²) 	T642 T644			
Finisher	Sheets of 75 g/m ² of plain paper (maximum number of stapled jobs is 40) T640 500 sheets T642 750 sheets T644 750 sheets	T640 T642 T644	1	1 output expander or 1 5-bin mailbox*	
High-capacity output stacker	<ul style="list-style-type: none"> 1850 sheets (75 g/m²) of plain paper Envelopes (Capacity will vary, depending on the media weight.) 	T640 T642 T644	1	1 output expander*	

* See the instructions that came with the option for information on how to install options in relation to each other.

Printing

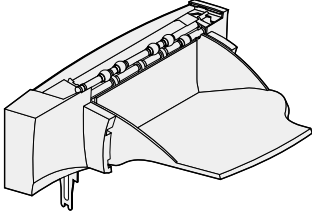
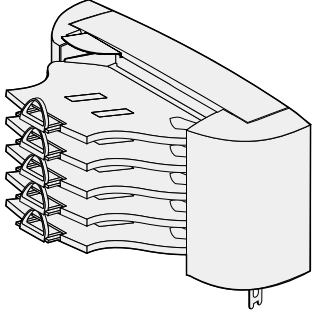
Output bin name	Each bin accommodates		How many can be installed on the printer	Bin is allowed to connect with	Illustration of output bin
	Print media	Printer Models			
Output expander	<ul style="list-style-type: none"> 650 sheets (75 g/m²) of plain paper 50 envelopes (75 g/m²) 	T640 T642 T644	3	1 5-bin mailbox, 1 high-capacity output stacker, or 1 finisher*	
5-bin mailbox	120 sheets (75 g/m ²) of plain paper for each of the five bins for a total of 600 for all bins	T642 T644	2	1 output expander or 1 finisher*	













* See the instructions that came with the option for information on how to install options in relation to each other.

Linking output bins

Linking output bins lets you create a single output source so the printer can automatically switch output to the next available bin. You can also set the output type for media such as card stock or envelope sizes that cannot be sent to an optional output bin. For more information on the values available to configure your output bins, see the *Menus and Messages Guide*.

Note: The bin sequence for linking always starts with the Standard Bin and proceeds from the bin nearest to the floor to the bin farthest from the floor.

To link output bins:

- 1 Press  on the operator panel.
- 2 Press  until the  appears next to **Paper Menu**, and then press .
- 3 Press  until the  appears next to **Bin Setup**, and then press .
- 4 Press  until the  appears next to **Configure Bins**, and then press .
- 5 Press  until the  appears next to **Link**, and then press .

The printer returns to **Ready**.

6

Understanding paper and specialty media guidelines

Print media is paper, card stock, transparencies, labels, and envelopes. The printer provides high quality printing on a variety of print media. You must consider a number of things concerning print media before you print. This chapter provides information to help you make print media selections.

- **Supported print media**
- **Selecting print media**
- **Storing print media**
- **Avoiding jams**

For more details about the types of paper and specialty media the printer supports, see the *Card Stock & Label Guide* available on our Lexmark Web site at www.lexmark.com.

We recommend that you try a limited sample of any paper or specialty media you are considering using with the printer before purchasing large quantities.

Supported print media

The following tables provide information on standard and optional sources for both input and output trays and bins.

- **Print media sizes**
- **Print media types**
- **Print media weights**
- **Media weights supported in optional output bins**
- **Media sizes supported in the finisher**
- **Media weights supported in the finisher**

Note: If you use a print media size not listed, select the next larger size.

Understanding paper and specialty media guidelines

Print media sizes

Legend ✓ — indicates support		T640 250-sheet tray	T642, T644 500-sheet tray	250-sheet drawer (option)	500-sheet drawer (option)	Multipurpose feeder	2000-sheet drawer (option)	Envelope feeder (option)	Duplex unit (option)	Standard output bin	Output expander (option)	5-bin mailbox (option)	High-capacity output stacker (option)
Print media size	Dimensions												
A4	210 x 297 mm (8.27 x 11.7 in.)	✓	✓	✓	✓	✓	✓		✓	✓	✓	✓	✓
A5	148 x 210 mm (5.83 x 8.27 in.)	✓	✓	✓	✓	✓	✓		✓	✓	✓		✓
JIS B5	182 x 257 mm (7.17 x 10.1 in.)	✓	✓	✓	✓	✓	✓		✓	✓	✓	✓	✓
Letter	215.9 x 279.4 mm (8.5 x 11 in.)	✓	✓	✓	✓	✓	✓		✓	✓	✓	✓	✓
Legal	215.9 x 355.6 mm (8.5 x 14 in.)	✓	✓	✓	✓	✓	✓		✓	✓	✓	✓	✓
Executive	184.2 x 266.7 mm (7.25 x 10.5 in.)	✓	✓	✓	✓	✓	✓		✓	✓	✓	✓	✓
Folio ¹	216 x 330 mm (8.5 x 13 in.)	✓	✓	✓	✓	✓			✓	✓	✓	✓	✓
Statement ¹	139.7 x 215.9 mm (5.5 x 8.5 in.)	✓	✓	✓	✓	✓				✓	✓		✓
Universal ²	139.7 x 210 mm to 215.9 x 355.6 mm (5.5 x 8.27 in. to 8.5 x 14 in.)	✓	✓	✓	✓	✓				✓	✓		✓
	69.85 x 127 mm to 215.9 x 355.6 mm (2.75 x 5 in. to 8.5 x 14 in.)					✓				✓	✓		✓
	69.85 x 127 mm to 229 x 355.6 mm (2.75 x 5 in. to 9.01 x 14 in.)	✓	✓	✓	✓	✓			✓	✓	✓		✓
	148 x 182 mm to 215.9 x 355.6 mm (5.83 x 7.17 in. to 8.5 x 14 in.)	✓	✓	✓	✓	✓			✓	✓	✓		✓
7 ¾ Envelope	98.4 x 190.5 mm (3.875 x 7.5 in.)					✓		✓		✓	✓		✓

¹ This size does not appear in the Paper Size menu until Tray Size Sensing is turned off. See “Printing folio and statement sizes” for more information.

² This size setting formats the page for 215.9 x 355.6 mm (8.5 x 14 in.) unless the size is specified by the software application.

Understanding paper and specialty media guidelines

Print media sizes (continued)

Legend ✓ — indicates support		T640 250-sheet tray	T642, T644 500-sheet tray	250-sheet drawer (option)	500-sheet drawer (option)	Multipurpose feeder	2000-sheet drawer (option)	Envelope feeder (option)	Duplex unit (option)	Standard output bin	Output expander (option)	5-bin mailbox (option)	High-capacity output stacker (option)
Print media size	Dimensions												
9 Envelope	98.4 x 225.4 mm (3.875 x 8.87 in.)					✓		✓		✓	✓		✓
10 Envelope	104.8 x 241.3 mm (4.12 x 9.5 in.)					✓		✓		✓	✓		✓
DL Envelope	110 x 220 mm (4.33 x 8.66 in.)					✓		✓		✓	✓		✓
B5 Envelope	176 x 250 mm (6.93 x 9.84 in.)					✓		✓		✓	✓		✓
C5 Envelope	162 x 229 mm (6.38 x 9.01 in.)					✓		✓		✓	✓		✓
Other Envelope ¹	98.4 x 162 mm to 176 x 250 mm (3.87 x 6.38 in. to 6.93 x 9.84 in.)					✓		✓		✓	✓		✓
	98.4 x 162 mm to 229 x 342 mm (3.87 x 6.38 in. to 9.01x 12.76 in.)					✓		✓		✓	✓		✓

¹ This size does not appear in the Paper Size menu until Tray Size Sensing is turned off. See “Printing folio and statement sizes” for more information.

² This size setting formats the page for 215.9 x 355.6 mm (8.5 x 14 in.) unless the size is specified by the software application.

Understanding paper and specialty media guidelines

Print media types

Print media	T640	T642, T644	250-sheet drawer	500-sheet drawer	Multipurpose feeder	2000-sheet drawer	Envelope feeder	Duplex unit	Standard output bin	Output expander	5-bin mailbox	High-capacity output stacker	Finisher		
													Standard	Offset	Stapled
Paper	✓	✓	✓	✓	✓	✓		✓	✓	✓	✓	✓	✓	✓	✓
Card stock	✓	✓	✓	✓	✓			✓	✓	✓		✓	✓	✓	✓
Transparencies	✓	✓	✓	✓	✓				✓	✓		✓	✓	✓	✓
Vinyl labels*	✓	✓	✓	✓					✓	✓		✓	✓		
Paper labels*	✓	✓	✓	✓					✓	✓		✓	✓		
Polyester label*	✓	✓	✓	✓					✓	✓		✓	✓		
Dual-web and integrated labels*	✓	✓	✓	✓					✓	✓		✓	✓		

* Printing label applications on the printer requires a special label fuser cleaner. The label fuser cleaner is included with a special label cartridge for label applications. See **Ordering supplies** for more information on obtaining a label fuser cleaner.

Understanding paper and specialty media guidelines

Print media weights

Print media	Type	Print media weight		
		Integrated tray and optional 500-sheet drawer	Multipurpose feeder and optional 250-sheet drawer	Envelope feeder
Paper	Xerographic or business paper	60 to 176 g/m ² grain long (16 to 47 lb bond)	60 to 135 g/m ² grain long (16 to 36 lb bond)	n/a
Card stock— maximum (grain long) ¹	Index Bristol	163 g/m ² (90 lb)	120 g/m ² (67 lb)	
	Tag	163 g/m ² (100 lb)	120 g/m ² (74 lb)	
	Cover	176 g/m ² (65 lb)	135 g/m ² (50 lb)	
Card stock— maximum (grain short) ¹	Index Bristol	199 g/m ² (110 lb)	163 g/m ² (90 lb)	n/a
	Tag	203 g/m ² (125 lb)	163 g/m ² (100 lb)	
	Cover	216 g/m ² (80 lb)	176 g/m ² (65 lb)	
Transparencies	Laser printer	138 to 146 g/m ² (37 to 39 lb bond)	138 to 146 g/m ² (37 to 39 lb bond)	
Labels—maximum ⁴	Paper	180 g/m ² (48 lb bond)	163 g/m ² (43 lb bond) Note: Not supported in the multipurpose feeder.	n/a
	Dual-web paper	180 g/m ² (48 lb bond)	163 g/m ² (43 lb bond) Note: Not supported in the multipurpose feeder.	
	Polyester	220 g/m ² (59 lb bond)	220 g/m ² (59 lb bond) Note: Not supported in the multipurpose feeder.	
	Vinyl ⁵	300 g/m ² (92 lb liner)	260 g/m ² (78 lb liner) Note: Not supported in the multipurpose feeder.	

¹ Grain short is preferred for papers over 135 g/m².

² Includes envelopes fed from the multipurpose feeder only.

³ 28 lb bond envelopes are limited to 25% cotton content.

⁴ Printing label applications on the printer requires a special label fuser cleaner. See **Ordering supplies** for more information on obtaining a fuser cleaner.

⁵ Information on whether your vinyl label converter has passed Lexmark criteria is available at the Lexmark Web site (www.lexmark.com); search for "converter list." You can also check the Lexmark Automated Fax system (LEXFAXSM).

Understanding paper and specialty media guidelines

Print media weights (continued)

Print media	Type	Print media weight		
		Integrated tray and optional 500-sheet drawer	Multipurpose feeder and optional 250-sheet drawer	Envelope feeder
Integrated forms	Pressure-sensitive area (must enter the printer first)	140 to 175 g/m ²	140 to 175 g/m ²	
	Paper base (grain long)	75 to 135 g/m ² (20 to 36 lb bond)	75 to 135 g/m ² (20 to 36 lb bond)	
Envelopes 100% cotton content maximum weight—24 lb	Sulfite, wood-free, or up to 100% cotton bonds	Not recommended	60 to 105 g/m ² (16 to 28 lb bond) ^{2, 3}	60 to 105 g/m ² (16 to 28 lb bond) ³
			Note: 28 lb envelopes are limited to 25% cotton content.	
<p>¹ Grain short is preferred for papers over 135 g/m².</p> <p>² Includes envelopes fed from the multipurpose feeder only.</p> <p>³ 28 lb bond envelopes are limited to 25% cotton content.</p> <p>⁴ Printing label applications on the printer requires a special label fuser cleaner. See Ordering supplies for more information on obtaining a fuser cleaner.</p> <p>⁵ Information on whether your vinyl label converter has passed Lexmark criteria is available at the Lexmark Web site (www.lexmark.com); search for “converter list.” You can also check the Lexmark Automated Fax system (LEXFAXSM).</p>				

Media weights supported in optional output bins

Print media weight—optional output bins					
Print media	Type	5-bin mailbox	Output expander	High-capacity output stacker	Finisher
Paper (grain long)	Xerographic or business paper	60 to 90 g/m ² (16 to 24 lb bond)	60 to 176 g/m ² (16 to 47 lb bond)	60 to 176 g/m ² (16 to 47 lb bond)	See separate Finisher media weight table.
Card stock— maximum (grain long)	Index Bristol	Not recommended	163 g/m ² (90 lb)	163 g/m ² (90 lb)	
	Tag		163 g/m ² (100 lb)	163 g/m ² (100 lb)	
	Cover		176 g/m ² (65 lb)	176 g/m ² (65 lb)	
Card stock— maximum (grain short)	Index Bristol		199 g/m ² (110 lb)	199 g/m ² (110 lb)	
	Tag		203 g/m ² (125 lb)	203 g/m ² (125 lb)	
	Cover		216 g/m ² (80 lb)	216 g/m ² (80 lb)	
Transparencies	Laser printer		138 to 146 g/m ² (37 to 39 lb bond)	138 to 146 g/m ² (37 to 39 lb bond)	

Understanding paper and specialty media guidelines

Media weights supported in optional output bins (continued)

Print media weight—optional output bins					
Print media	Type	5-bin mailbox	Output expander	High-capacity output stacker	Finisher
Labels—maximum	Paper	Not recommended	180 g/m ² (48 lb bond)	180 g/m ² (48 lb bond)	See separate Finisher media weight table.
	Dual-web paper		180 g/m ² (48 lb bond)	180 g/m ² (48 lb bond)	
	Polyester		220 g/m ² (59 lb bond)	220 g/m ² (59 lb bond)	
	Vinyl		300 g/m ² (92 lb liner)	300 g/m ² (92 lb liner)	
Integrated forms	Pressure sensitive area (must enter the printer first)	Not recommended	140 to 175 g/m ² (up to 47 lb bond)	140 to 175 g/m ² (up to 47 lb bond)	See separate Finisher media weight table.
	Paper base (grain long)		75 to 135 g/m ² (20 to 36 lb bond)	75 to 135 g/m ² (20 to 36 lb bond)	
Envelopes	Sulfite, wood-free or up to 100% cotton bond		60 to 105 g/m ² (16 to 28 lb bond)	60 to 105 g/m ² (16 to 28 lb bond)	Not recommended

Media sizes supported in the finisher

Size	Dimensions	Finisher output support		
		Standard ¹	Offset	Stapled
A4	210 x 297 mm (8.27 x 11.7 in.)	✓	✓	✓
A5	148 x 210 mm (5.83 x 8.27 in.)			
JIS B5	182 x 257 mm (7.17 x 10.1 in.)	✓		
Letter	215.9 x 279.4 mm (8.5 x 11 in.)	✓	✓	✓
Legal	215.9 x 355.6 mm (8.5 x 14 in.)	✓	✓	✓
Executive	184.2 x 266.7 mm (7.25 x 10.5 in.)	✓		
Folio ²	216 x 330 mm (8.5 x 13 in.)	✓	✓	✓
Statement ²	139.7 x 215.9 mm (5.5 x 8.5 in.)			

¹ Paper passes to the finisher bin without being stapled or offset.

² This size does not appear in the Paper Size menu until Tray Size Sensing is turned off. See **Printing folio and statement sizes** for more information.

Understanding paper and specialty media guidelines

Media sizes supported in the finisher (continued)

Size	Dimensions	Finisher output support		
		Standard ¹	Offset	Stapled
7 ¾ Envelope	98.4 x 190.5 mm (3.875 x 7.5 in.)			
9 Envelope	98.4 x 225.4 mm (3.875 x 8.9 in.)			
10 Envelope	104.8 x 241.3 mm (4.12 x 9.5 in.)			
DL Envelope	110 x 220 mm (4.33 x 8.66 in.)			
C5 Envelope	162 x 229 mm (6.38 x 9.01 in.)	✓		
B5 Envelope	176 x 250 mm (6.93 x 9.84 in.)	✓		
Other Envelope	98.4 x 162 mm to 176 x 250 mm (3.87 x 6.38 in. to 6.93 x 9.84 in.)			
	98.4 x 162 mm to 229 x 342 mm (3.87 x 6.38 in. to 9.01x 12.76 in.)	✓		

¹ Paper passes to the finisher bin without being stapled or offset.

² This size does not appear in the Paper Size menu until Tray Size Sensing is turned off. See **Printing folio and statement sizes** for more information.

Media weights supported in the finisher

Print media	Type	Finisher media weight		
		Standard*	Offset	Stapled
Paper	Xerographic or business paper	60 to 176 g/m ² (16 to 47 lb bond)	60 to 90 g/m ² (16 to 24 lb bond)	60 to 90 g/m ² (16 to 24 lb bond)
Card stock— maximum (grain long)	Index Bristol	163 g/m ² (90 lb bond)	Not recommended	Not recommended
	Tag	163 g/m ² (100 lb bond)		
	Cover	Not recommended		
Card stock— maximum (grain short)	Index Bristol	199 g/m ² (110 lb bond)	Not recommended	Not recommended
	Tag	203 g/m ² (125 lb bond)		
	Cover	216 g/m ² (80 lb bond)		

* Paper passes to the finisher bin without being stapled or jogged.

Understanding paper and specialty media guidelines

Media weights supported in the finisher (continued)

Print media	Type	Finisher media weight		
		Standard*	Offset	Stapled
Transparencies	Laser printer	138 to 146 g/m ² (37 to 39 lb bond)	138 to 146 g/m ² 37 to 39 lb bond)	Not recommended
Integrated forms	Pressure sensitive area	140 to 175 g/m ² (up to 47 lb bond)	Not recommended	Not recommended
	Paper base (grain long)	75 to 135 g/m ² (20 to 36 lb bond)		
Labels — upper limit	Paper	180 g/m ² (48 lb bond)	Not recommended	Not recommended
	Dual-web paper	180 g/m ² (48 lb bond)		
	Polyester	220 g/m ² (59 lb bond)		
	Vinyl	300 g/m ² (92 lb bond)		
Envelopes	Sulfite, wood-free, or up to 100% cotton bond	60 to 105 g/m ² (16 to 28 lb bond)	Not recommended	Not recommended

* Paper passes to the finisher bin without being stapled or jogged.

Selecting print media

Selecting the appropriate print media for the printer helps you avoid printing problems. The following sections contain guidelines for choosing the correct print media for the printer.

- Paper
- Envelopes
- Card stock
- Transparencies
- Labels

Paper

For the best print quality, use 75 g/m² (20 lb) xerographic, grain long paper. Try a sample of any paper you are considering using with the printer before buying large quantities.

When loading paper, note the recommended print side on the paper package, and load paper accordingly. See **Loading standard trays and optional trays**, **Loading the multipurpose feeder**, or **Loading the 2000-sheet drawer** for detailed tray-loading instructions.

Paper characteristics

The following paper characteristics affect print quality and reliability. We recommend that you follow these guidelines when evaluating new paper stock.

For detailed information, see the *Card Stock & Label Guide* located on the Lexmark Web site at www.lexmark.com.

The laser printing process heats paper to high temperatures of 230°C (446°F). For Magnetic Ink Character Recognition (MICR) applications and for non-MICR applications, use only paper able to withstand these temperatures without discoloring, bleeding, or releasing hazardous emissions. Check with the manufacturer or vendor to determine whether the paper you have chosen is acceptable for laser printers.

Weight

The printer can automatically feed paper weights from 60 to 176 g/m² (16 to 47 lb bond) grain long in the integrated and optional 500-sheet trays and paper weights from 60 to 135 g/m² (16 to 36 lb bond) grain long in the multipurpose feeder and optional 250-sheet trays. Paper lighter than 60 g/m² (16 lb) might not be stiff enough to feed properly, causing jams. For best performance, use 75 g/m² (20 lb bond) grain long paper. When using paper narrower than 182 x 257 mm (7.2 x 10.1 in.), make sure the weight is greater than or equal to 90 g/m² (24 lb bond).

Unacceptable paper

The following papers are not recommended for use with the printer:

- Some chemically treated papers used to make copies without carbon paper, also known as carbonless papers, carbonless copy paper (CCP), or no carbon required (NCR) paper (see the *Card Stock & Label Guide* located on the Lexmark Web site at www.lexmark.com for supported chemically treated papers)
- Preprinted papers with chemicals that may contaminate the printer
- Preprinted papers that can be affected by the temperature in the printer fuser
- Preprinted papers that require a *registration* (the precise print location on the page) greater than ±0.09 in., such as optical character recognition (OCR) forms

In some cases, you can adjust registration with your software application to successfully print on these forms.

- Coated papers (erasable bond), synthetic papers, thermal papers
- Rough-edged, rough or heavily textured surface papers or curled papers
- Recycled papers containing more than 25% post-consumer waste that do not meet DIN 19 309
- Recycled paper having a weight less than 60 g/m² (16 lb)

- Multiple-part forms or documents

Transparencies

You can feed transparencies from the standard tray (250-sheet tray for the T640 or 500-sheet tray for the T642 and T644), optional 250- or 500-sheet trays, or the multipurpose feeder. Try a sample of any transparencies you are considering using with the printer before buying large quantities.

When printing on transparencies:

- Be sure to set the Paper Type to Transparency from the printer driver to avoid damaging the printer.
- In Macintosh, be sure to set the Paper Type to Transparency in the Print dialog on the Imaging choice in the Copies & Pages pop-up menu.
- Use transparencies designed specifically for laser printers. Transparencies must be able to withstand temperatures of 230°C (446°F) without melting, discoloring, offsetting, or releasing hazardous emissions.
- To prevent print quality problems, avoid getting fingerprints on the transparencies.
- Before loading transparencies, fan the stack to prevent sheets from sticking together.

Selecting transparencies

The printer can print directly on transparencies designed for use in laser printers. Print quality and durability depend on the transparency used. Always print samples on the transparencies you are considering before buying large quantities.

The Paper Type setting should be set to Transparency to help prevent jams. Check with the manufacturer or vendor to determine whether your transparencies are compatible with laser printers that heat transparencies to 230°C (446°F). Use only transparencies that are able to withstand these temperatures without melting, discoloring, offsetting, or releasing hazardous emissions. For detailed information, see the *Card Stock & Label Guide*, which is available on the Lexmark Web site at www.lexmark.com.

Transparencies can be fed automatically from the multipurpose feeder and all standard and optional trays, except the 2000-sheet drawer. See **Identifying and linking output bins** for information about transparency compatibility with optional output bins.

Be careful when you handle transparencies. Fingerprints on the surface of the transparency cause poor print quality.

Envelopes

You can load up to 10 envelopes in the multipurpose feeder and 85 envelopes in the envelope feeder. Try a sample of any envelopes you are considering using with the printer before buying large quantities. See **Loading the multipurpose feeder** and **Loading the envelope feeder** for instructions on loading envelopes.

When printing on envelopes:

- To achieve the best possible print quality, use only high-quality envelopes that are designed for use in laser printers.
- Set the Paper Size/Type in the Paper menu to MP Feeder, Manual Env, or Env Feeder depending on the source you are using. Set the paper type to Envelope, and select the correct envelope size from the operator panel, the printer driver, the Local Printer Setup Utility, or from MarkVision™.
- For best performance, use envelopes made from 75 g/m² (20 lb bond) paper. You can use up to 105 g/m² (28 lb bond) weight for the multipurpose feeder or 105 g/m² (28 lb bond) weight for the envelope feeder as long as the cotton content is 25% or less. Envelopes with 100% cotton content must not exceed 90 g/m² (24 lb bond) weight.
- Use only new, undamaged envelopes.
- For best performance and to minimize jams, do not use envelopes that:
 - Have excessive curl or twist.
 - Are stuck together or damaged in any way.
 - Contain windows, holes, perforations, cutouts or embossing.
 - Use metal clasps, string ties, or metal folding bars.
 - Have an interlocking design.

Understanding paper and specialty media guidelines

- Have postage stamps attached.
- Have any exposed adhesive when the flap is in the sealed or closed position.
- Have nicked edges or bent corners.
- Have rough, cockle, or laid finishes.
- Use envelopes that can withstand temperatures of 230°C (446°F) without sealing, excessive curling, wrinkling, or releasing hazardous emissions. If you have any doubts about the envelopes you are considering using, check with the envelope supplier.
- Load only one size of envelope at a time in the envelope feeder.
- A combination of high humidity (over 60%) and the high printing temperatures may seal the envelopes.

Labels

The printer can print on many labels designed for use with laser printers. These labels are supplied in letter size, A4 size, and legal size sheets. Label adhesives, face sheet (printable stock), and topcoats must be able to withstand temperatures of 230°C (446°F) and pressure of 25 pounds per square inch (psi).

Try a sample of any labels you are considering using with the printer before purchasing a large quantity.

For detailed information on label printing, characteristics, and design, see the *Card Stock & Label Guide* available on the Lexmark Web site at www.lexmark.com/publications.

Note: Labels are one of the most difficult print media for laser printers. All printer models require a special fuser cleaner for label applications to optimize feed reliability. See **Ordering supplies** for information on obtaining a label fuser cleaner.

After printing approximately 10,000 pages of labels (or each time you replace the print cartridge), complete the following steps to maintain printer feeding reliability:

- 1 Print five sheets of paper.
- 2 Wait approximately five seconds.
- 3 Print five more sheets of paper.

When printing on labels:

- Set the Paper Size/Type menu item to Labels in the Paper menu. You can set the Paper Size/Type from the printer operator panel, the printer driver, the Local Printer Setup Utility, or from MarkVision.
- Feed vinyl labels from the standard 250- or 500-sheet trays or the optional 250- or 500-sheet drawers. For vinyl labels, set the Paper Type to Labels, the Labels Texture to Smooth, and the Label Weight to Heavy or set the Paper Type to vinyl labels and the texture and weight to normal.
- Do not load labels with paper or transparencies in the same source; mixing print media can cause feeding problems and print quality problems.
- Do not use label sheets with a slick backing material.
- Use full label sheets. Partial sheets may cause labels to peel off during printing, resulting in a jam. Partial sheets also contaminate the printer and your cartridge with adhesive, and could void the printer and cartridge warranties.
- Use labels that can withstand temperatures of 230°C (446°F) without sealing, excessive curling, wrinkling, or releasing hazardous emissions.
- Do not print within 1 mm (0.04 in.) of the edge of the label, of the perforations, or between die-cuts of the label.
- Do not use label sheets that have adhesive to the edge of the sheet. We recommend zone coating of the adhesive at least 1 mm (0.04 in.) away from edges. Adhesive material contaminates the printer and could void the warranty.
- If zone coating of the adhesive is not possible, a 1.6 mm (0.1 in.) strip should be removed on the leading and driver edge, and a non-oozing adhesive should be used.
- Remove a 1.6 mm (0.1 in.) strip from the leading edge to prevent labels from peeling inside the printer.
- Portrait orientation is preferred, especially when printing bar codes.

- Do not use labels that have exposed adhesive.

Card stock

Card stock is single ply, and has a large array of properties, such as the moisture content, thickness, and texture, that can significantly affect print quality. See **Supported print media** for information on the preferred weight and for the grain direction of print media.

Try a sample of any card stock you are considering using with the printer before purchasing a large quantity.

After printing approximately 10,000 pages of card stock (or each time you replace the print cartridge), complete the following steps to maintain printer feeding reliability:

- 1 Print five sheets of paper.
- 2 Wait approximately five seconds.
- 3 Print five more sheets of paper.

When printing on card stock:

- Set the Paper Type menu item in the Paper menu to Card Stock from the operator panel, from the printer driver, in the Local Printer Setup Utility, or from MarkVision.
- Be aware that preprinting, perforation, and creasing can significantly affect the print quality and cause print media handling or jamming problems.
- Avoid using card stock that may release hazardous emissions when heated.
- Do not use preprinted card stock manufactured with chemicals that may contaminate the printer. Preprinting introduces semi-liquid and volatile components into the printer.
- We recommend the use of grain short card stock.

Storing print media

Use the following guidelines to avoid paper feeding problems and uneven print quality.

- Store paper in an environment where the temperature is approximately 21°C (70°F) and the relative humidity is 40%.
- Store cartons of paper on a pallet or shelf rather than directly on the floor.
- If you store individual packages of paper out of the original carton, make sure they rest on a flat surface so the edges do not buckle or curl.
- Do not place anything on top of paper packages.
- Store paper in its original wrapper until you load it into the printer.

Avoiding jams

Use appropriate print media (paper, transparencies, labels, and card stock) to help ensure trouble-free printing. See **Supported print media** for more information.

Note: Try a limited sample of any print media you are considering using with the printer before purchasing large quantities.

By selecting the appropriate print media and loading it properly, you can avoid most jams. See **Loading standard trays and optional trays**, **Loading the multipurpose feeder**, or **Loading the 2000-sheet drawer** for detailed tray-loading instructions.

The following hints can help you avoid jams:

- Use only recommended print media.
- Do not overload the print media sources. Make sure the stack height does not exceed the maximum height indicated by the stack line on the labels in the sources.
- Do not load wrinkled, creased, damp, or curled print media.
- Flex, fan, and straighten print media before you load it. If jams do occur with print media, try feeding one sheet at a time through the multipurpose feeder.
- Do not use print media that you have cut or trimmed yourself.
- Do not mix print media sizes, weights, or types in the same print media source.
- Make sure the recommended print side is loaded in the source according to your simplex or duplex needs.
- Keep print media stored in an acceptable environment. See **Storing print media**.
- Do not remove trays during a print job.
- Push all trays in firmly after loading them.
- Make sure the guides in the trays are properly positioned for the size of print media you have loaded. Make sure the guides are not placed too tightly against the stack of print media.
- If a jam occurs, clear the entire media path. See **Clearing jams** for more information.

Note: If you have a recurring paper jam, see **Paper frequently jams** for more information.

7

Maintaining the printer

Periodically, you need to complete certain tasks to maintain optimum print quality. These tasks are covered in this chapter.

If several people are using the printer, you may want to designate a key operator to do the setup and maintenance of the printer. Refer printing problems and maintenance tasks to this key operator.

In the U.S., contact Lexmark at 1-800-539-6275 for information about Lexmark Authorized Supplies Dealers in your area. In other countries or regions, visit the Lexmark Web site at www.lexmark.com, or contact the place where you bought the printer.

Storing supplies

Choose a cool, clean storage area for the printer supplies. Store supplies right side up in their original packaging until you are ready to use them.

Do not expose supplies to:

- Direct sunlight
- Temperatures above 35°C (95°F)
- High humidity (above 80%)
- Salty air
- Corrosive gases
- Heavy dust

Determining the status of supplies

The printer operator panel alerts you once a supply item or maintenance is required. You can also view the status of supplies in the printer on the operator panel unless the printer is printing or in a busy state. The header or gray area at the top of the display will indicate the printer is **Ready** and lets you know if any trays are low. Selecting **status / Supplies** on the display will open the **status / Supplies** screen where you can view the status of the various trays and open the **View Supplies** screen to view the current status of your print cartridge.

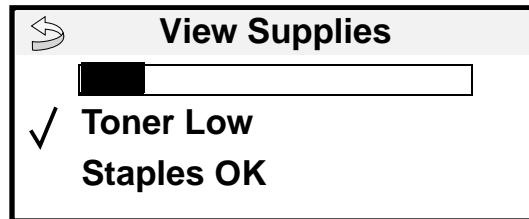
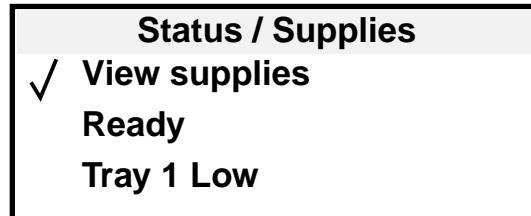
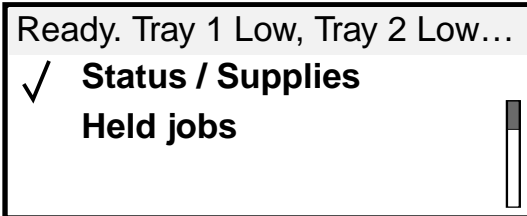

Conserving supplies

Several settings in your application software or on the display let you conserve toner and paper. For more information on changing these settings, see the *Menus and Messages Guide* on the publications CD.

Supply	Menu selection item	What the setting does
Toner	Toner Darkness in the Settings → Quality Menu	Lets you adjust the level of toner released on a sheet of print media. The values range from 1 (lightest setting) to 10 (darkest setting). Note: When toner is low, firmly shake the cartridge to redistribute any remaining toner. See Ordering a print cartridge for more information.
Print media	Multipage Print in the Settings → Finishing Menu	Causes the printer to print two or more page images on one side of a sheet. Values for Multipage Print are 2 Up, 3 Up, 4 Up, 6 Up, 9 Up, 12 Up, and 16 Up. Combined with the duplex setting, Multipage Print lets you print up to 32 pages on one sheet of paper (16 images on the front and 16 on the back).
	Duplex in the Settings → Finishing Menu	Duplex printing is available when you install an optional duplex unit. It lets you print on both sides of a sheet of paper.
	Use your software application or printer driver to send a Verify Print job.	Lets you examine the first copy of a multiple-copy job to be sure it is satisfactory before you print the other copies. If the job is unsatisfactory, you can cancel the job. See Printing and deleting held jobs for more information about a Verify Print job.

Ordering supplies

To order supplies in the U.S., contact Lexmark at 1-800-539-6275 for information about Lexmark Authorized Supplies Dealers in your area. In other countries or regions, visit the Lexmark Web site at www.lexmark.com, or contact the place where you bought the printer.

Ordering a print cartridge

When the 88 Toner is message appears or when you experience faded print, remove the toner cartridge. Firmly shake it side-to-side and front-to-back several times to redistribute the toner, then reinsert it and continue printing. Repeat this procedure multiple times until the print remains faded. When the print remains faded replace the print cartridge.

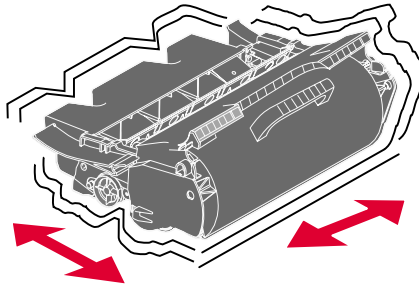

Have a new cartridge available when the current one no longer prints satisfactorily.

The recommended print cartridges specifically designed for the printer are:

Part number	Description	Average cartridge yield ¹	T640	T642	T644
For the Americas²					
64015SA	Return Program Print Cartridge	6,000 standard pages	X	X	X
64015HA	High Yield Return Program Print Cartridge	21,000 standard pages	X	X	X
64415XA	Extra High Yield Return Program Print Cartridge	32,000 standard pages			X
64004HA	High Yield Return Program Print Cartridge for Label Applications	21,000 standard pages	X	X	X
64404XA	Extra High Yield Return Program Print Cartridge for Label Applications	32,000 standard pages			X
Other available print cartridges					
64035SA	Print Cartridge	6,000 standard pages	X	X	X
64035HA	High Yield Print Cartridge	21,000 standard pages	X	X	X
64435XA	Extra High Yield Print Cartridge	32,000 standard pages			X
For Europe, the Middle East and Africa³					
64016SE	Return Program Print Cartridge	6,000 standard pages	X	X	X
¹ Declared yield value in accordance with ISO/IEC 19752. ² Designed for use only in the Americas. ³ Designed for use only in Europe, Middle East, and Africa. ⁴ Designed for use only in Asia Pacific Region, Australia, and New Zealand.					

Maintaining the printer

Part number	Description	Average cartridge yield ¹	T640	T642	T644
64016HE	High Yield Return Program Print Cartridge	21,000 standard pages	X	X	X
64416XE	Extra High Yield Return Program Print Cartridge	32,000 standard pages			X
64004HE	High Yield Return Program Print Cartridge for Label Applications	21,000 standard pages	X	X	X
Other available print cartridges					
64036SE	Print Cartridge	6,000 standard pages	X	X	X
64036HE	High Yield Print Cartridge	21,000 standard pages	X	X	X
64436XE	Extra High Yield Print Cartridge	32,000 standard pages			X
For the Asia Pacific Region⁴					
64017SR	Return Program Print Cartridge	6,000 standard pages	X	X	X
64017HR	High Yield Return Program Print Cartridge	21,000 standard pages	X	X	X
64417XR	Extra High Yield Return Program Print Cartridge	32,000 standard pages			X
64004HR	High Yield Return Program Print Cartridge for Label Applications	21,000 standard pages	X	X	X
64404XR	Extra High Yield Return Program Print Cartridge for Label Applications	32,000 standard pages			X
Other available print cartridges					
64037SR	Print Cartridge	6,000 standard pages	X	X	X
64037HR	High Yield Print Cartridge	21,000 standard pages	X	X	X
64437XR	Extra High Yield Print Cartridge	32,000 standard pages			X
¹ Declared yield value in accordance with ISO/IEC 19752. ² Designed for use only in the Americas. ³ Designed for use only in Europe, Middle East, and Africa. ⁴ Designed for use only in Asia Pacific Region, Australia, and New Zealand.					

You can use the packing material from the new cartridge to ship the old cartridge back to Lexmark for recycling. See **Recycling Lexmark products** for more information.

Ordering a maintenance kit

80 Scheduled maintenance advised appears on the display after 300,000 pages have printed to let you know it is time to replace printer maintenance items. Order a maintenance kit when **80 Scheduled maintenance advised** first appears on the display. The maintenance kit contains all the items necessary to replace the pick rollers, the charge roll, transfer roller, and the fuser.

Note: Using certain types of media may require more frequent replacement of the maintenance kit. Although the charge roll, transfer roller, and pick rollers are contained within the maintenance kit, they should also be individually ordered and replaced as necessary.

Maintaining the printer

See the following table for the maintenance kit part number for your specific printer.

Maintenance kit for	Part numbers
T640, T642, and T644	40X0102 (100 V) 40X0100 (110 V) 40X0101 (220 V)

Replacement of the fuser must be performed by an authorized service technician.

For finisher maintenance information, see the *StapleSmart™ Reference* that came with your finisher.

Ordering charge rolls

We recommend ordering new charge rolls when toner fog or background shading appears on printed pages. Order Lexmark part number 40X0127.

Ordering a transfer roller

Order Lexmark part number 40X0130.

Ordering pick rollers

Order Lexmark part number 40X0070. Order new pick rolls when the paper fails to properly feed from the tray.

When ordering pick rollers, you need one set per input tray excluding the multipurpose feeder.

Ordering a label fuser cleaner

A special label fuser cleaner should be used for label applications to optimize feeding reliability. To order this item, visit our Web site at www.lexmark.com, or contact your Lexmark representative.

Label fuser cleaners are not recommended for duplex printing.

Ordering staple cartridges

Staple cartridges hold 3,000 staples. Use part number 11K3188 to order a pack of three staple cartridges. For information on clearing a staple jam, see

When **staples Low** or **staples Empty** appears on the operator panel display, insert a new staple cartridge in the finisher. See the illustrations inside the stapler access door for more information.

If Staple Alarm is set to Single or Continuous, the alarm is sounded, the printer stops printing, and the **Load staples** message appears. Install a new staple cartridge, or press  to clear the message and continue printing.

Recycling Lexmark products

To return Lexmark products to Lexmark for recycling:

- 1 Visit our Web site:
www.lexmark.com/recycle

- 2 Follow the instructions on the computer screen.

Moving the printer

Follow these guidelines to move the printer within the office or to prepare the printer for shipment.

CAUTION: Follow these guidelines to avoid injuring yourself or damaging the printer.

- Always use at least two people to lift the printer.
- Always turn off the printer using the power switch.
- Disconnect all cords and cables from the printer before attempting to move the printer.
- Failure to repackage the printer properly for shipment can result in damage to the printer not covered by the printer warranty.
- Damage to the printer caused by improper moving is not covered by the printer warranty.

Moving the printer within the office

The printer can be safely moved from one location within an office to another following these precautions:

- The printer must remain in an upright position.
- Any cart used to move the printer should have a surface able to support the full footprint of the printer.
- Severe jarring movements may cause damage to the printer and must be avoided.

Preparing the printer for shipment

To transport the printer by vehicle or by commercial carrier, the printer must be repackaged for shipment using the proper packaging. The printer package must be securely fastened to its pallet. Do not use a shipping or transport method that requires the printer to be shipped without a pallet. The printer must stay upright throughout the shipment. If you do not have all the original packaging, contact your local service representative to order the repackaging kit. Additional instructions for repackaging the printer are provided in the repackaging kit.

8

Clearing jams

By carefully selecting print media and loading it properly, you should be able to avoid most paper jams. For more information on avoiding paper jams, see **Avoiding jams**. If jams do occur, follow the steps outlined in this section.

To resolve the paper jam messages, you must clear the entire paper path and then press  to clear the message and resume printing. The printer prints a new copy of the page that jammed if Jam Recovery is set to On or Auto; however, the Auto setting does not guarantee the page will print.

Identifying jams

If the printer jams, the appropriate jam message will be displayed on the printer operator panel. If you select **Show areas** on the operator panel, you can view one or more images to help you clear the jam.

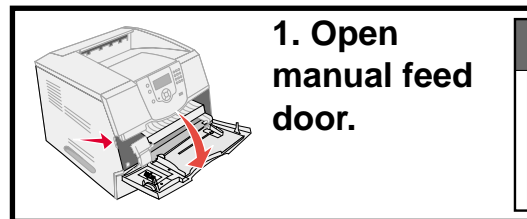
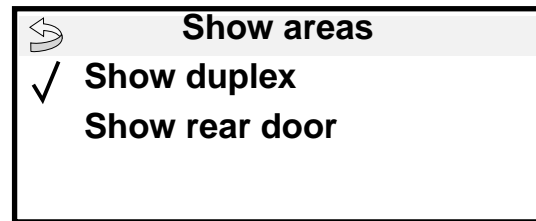
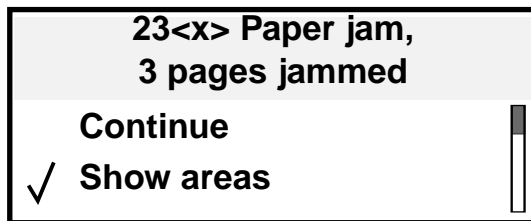

See the diagram on **page 81** for an overview of the paper path and areas where jams may occur. The path varies depending on the paper source and output bins.

Access doors and trays

The following illustration shows the path that print media travels through the printer. The path varies depending on the input source (trays, multipurpose feeder, envelope feeder) and output bins (finisher, stacker, expander, mailbox) you are using.

The numbers in following illustration indicate the numbers that can appear on the operator panel and designate the general area of a paper jam.

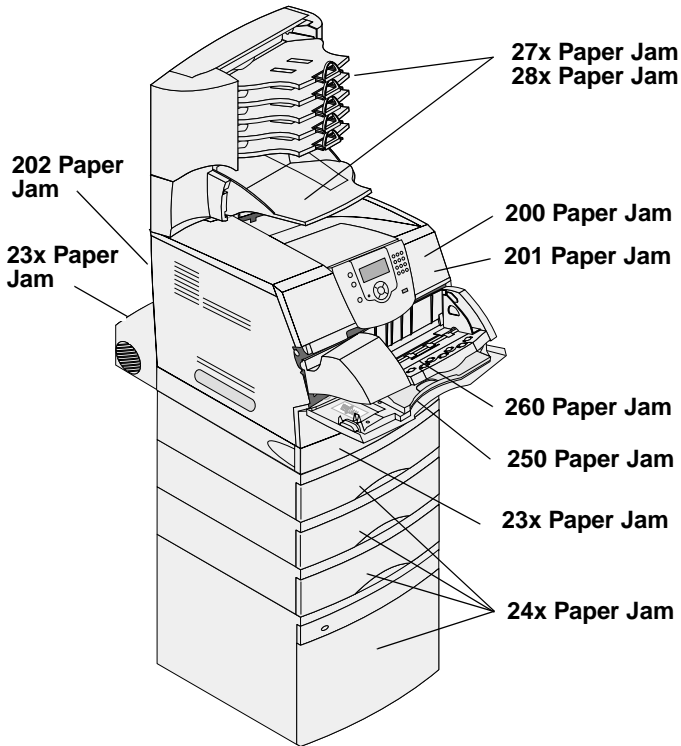

Doors and trays

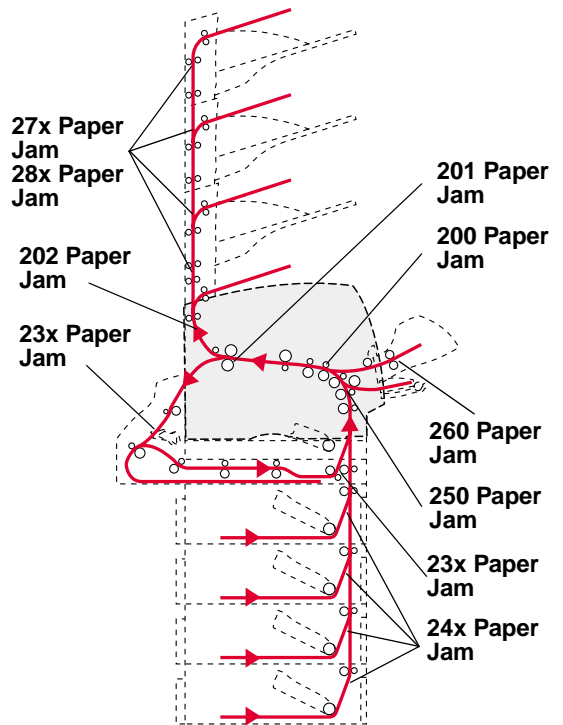

Path and locations

Understanding jam messages

The following table lists the jam messages that can occur and the action necessary to clear the message. The jam message indicates the area where the jam occurred. However, it is best to clear the entire paper path to ensure you have cleared all possible jams.

Message	What to do*
200 and 201 Paper Jam Remove Cartridge	Open the top front cover, remove the print cartridge, and remove the jam.
202 Paper Jam Open Rear Door	Open the rear door on the printer, and remove the jam.
23x Paper Jam Check Duplex	Remove the duplex tray from the duplex unit, raise duplex deflector, and remove the jam. Open rear duplex door, and remove the jam.
24x Paper Jam Check Tray <x>	Open each tray, and remove any jammed media.
250 Paper Jam Check MP Feeder	Remove all media from the multipurpose feeder, flex and stack the media, reload the multipurpose feeder, and adjust the guide.
260 Paper Jam Check Env Feeder	Lift the envelope weight, remove all envelopes, flex and stack the envelopes, reload the envelope feeder, and adjust the guide.
27x Paper Jam Check Bin x	Open the output bin rear doors and then remove the jam.
28x Paper Jam Check Finisher	Open the finisher top cover and then remove the jam. Open the finisher rear door, then remove the jam.
28x Staple Jam	Open the stapler door, remove the staple holder, remove the staple sheet, clear the jam, reinsert the staples and staple holder, and then close the stapler door.
* After clearing the jam, press  to resume printing.	

Clearing printer jams

Although there are several places a jam can occur, clearing the paper path is fairly easy depending on the jam message or messages displayed on the operator panel.

Paper jams can occur in three areas: the front of the printer, inside the printer, and at the rear of the printer. Jams in the front of the printer occur in the input options or the duplex tray. Jams inside the printer occur in two locations and require the removal of the print cartridge. Jams can also occur at the rear of the printer or in one of the output options.

Note: The following clearing jam instructions may seem out of numerical sequence. However, they have been grouped to help you quickly clear the print path. To go to a specific jam, see **Understanding jam messages**.

250 Paper Jam Check MP Feeder

- 1 Remove the paper from the multipurpose feeder.
- 2 Flex, fan, and restack the media, and place it into the multipurpose feeder.
- 3 Load the print media.
- 4 Slide the side guide toward the inside of the tray until it lightly rests against the edge of the media.
- 5 Press .

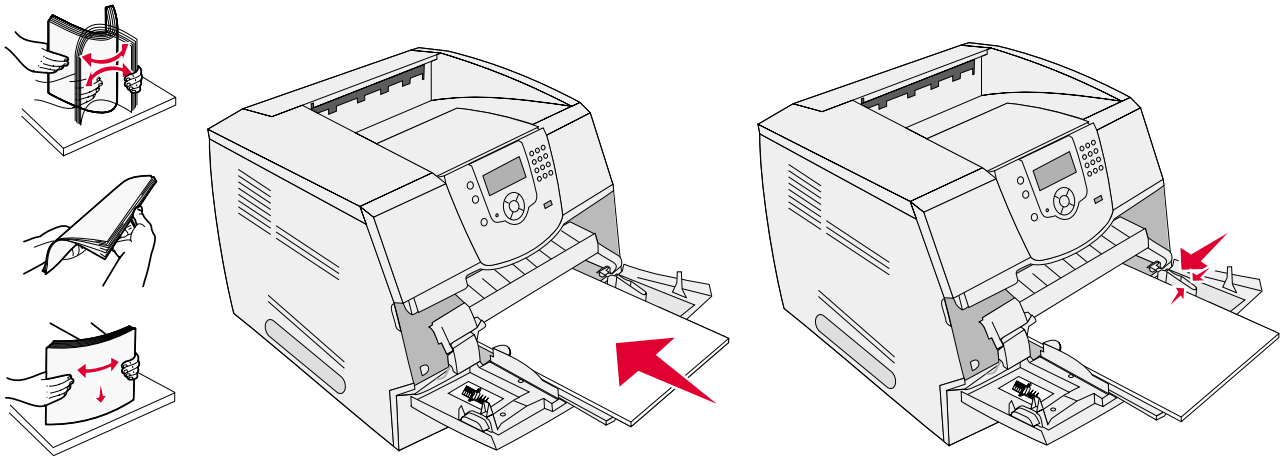

260 Paper Jam Check Env Feeder

The envelope feeder feeds envelopes from the bottom of the stack; the bottom envelope will be the one that is jammed.

- 1 Lift the envelope weight.
- 2 Remove all envelopes.
If the jammed envelope has entered the printer and cannot be pulled out, remove the envelope feeder.
 - a Lift the envelope feeder up out of the printer, and then set it aside.
 - b Remove the envelope from the printer.

Note: If you cannot remove the envelope, the print cartridge will have to be removed. See **200 and 201 Paper Jam Remove Cartridge** for more information.

- c Reinstall the envelope feeder. Make sure it *snaps* into place.

Clearing jams

- 3 Flex and stack the envelopes.

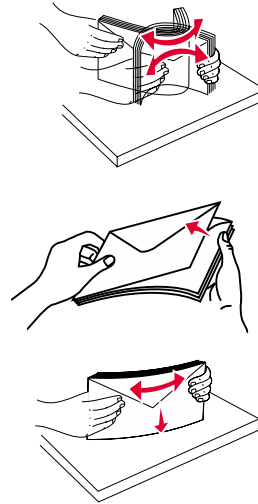
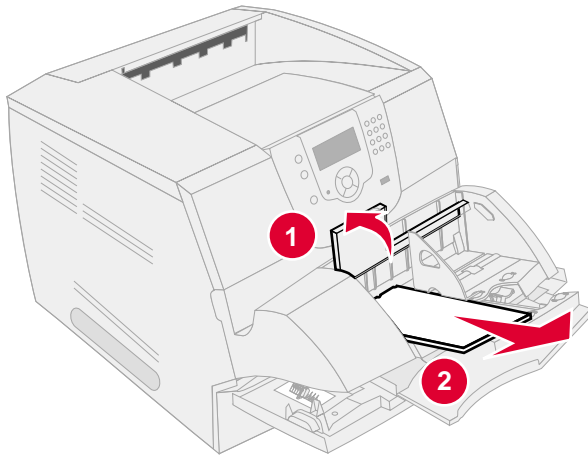

- 4 Load the envelope feeder.
5 Adjust the guide.
6 Lower the envelope weight.
7 Press .

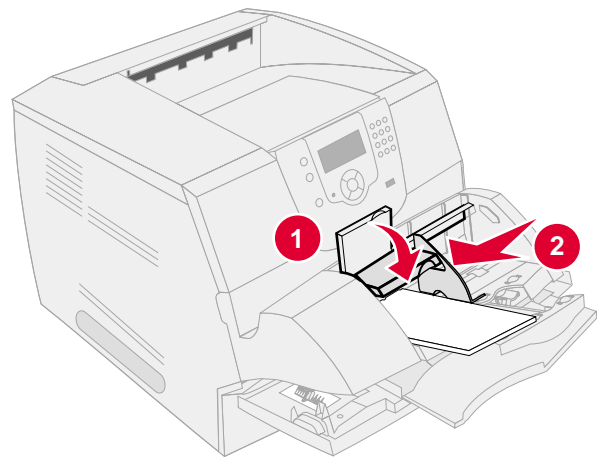
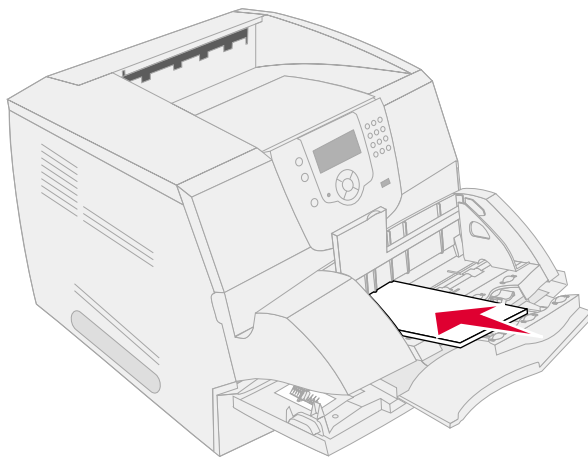

Clearing jams

23x and 24x jams

Paper jams in these areas can occur on the incline surface of a tray or across more than one tray. To clear these areas:

- 1 Open the printer paper tray, and remove any jammed media.

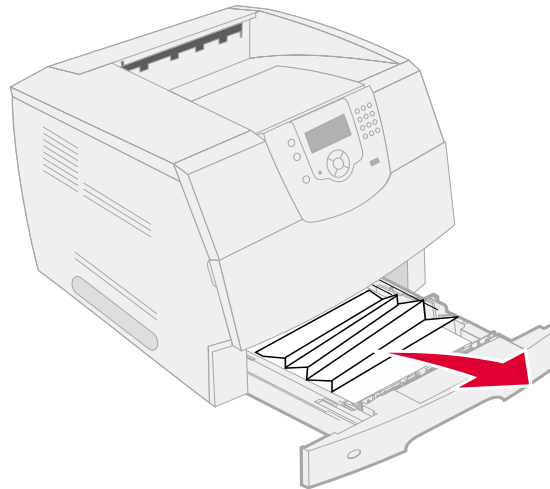

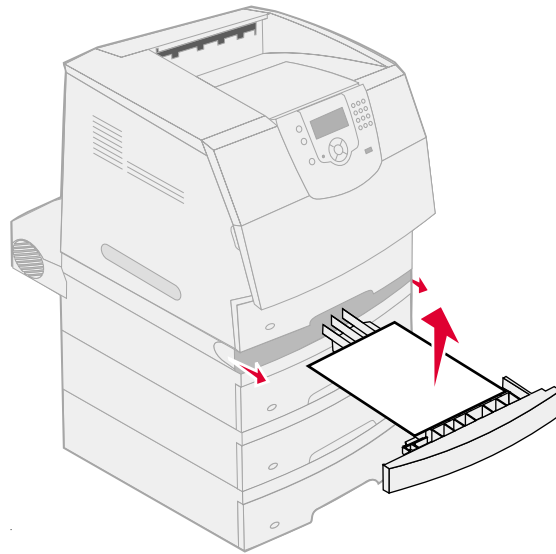
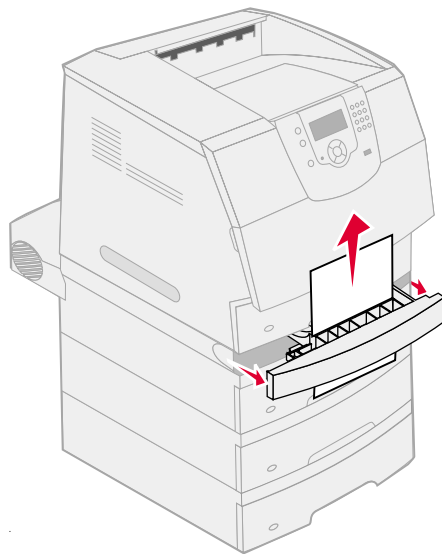

- 2 Open the duplex tray.
To remove the media, pull up.

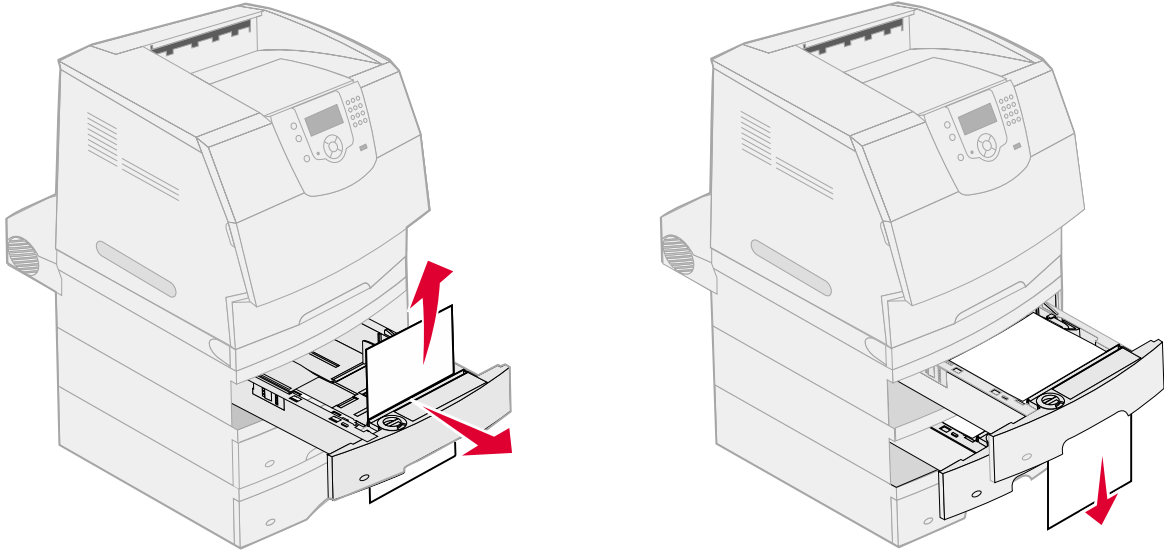

Clearing jams

- 3** Open any optional trays beginning at the top, and remove any jammed media.
Pull the print media either up or down. If it does not pull easily one way, try the other way.



- 4** If you have an optional 2000-sheet feeder, open the front door, press the elevator button to lower the tray, remove the jam, and make sure the stack of print media is neat and aligned.
5 Press .

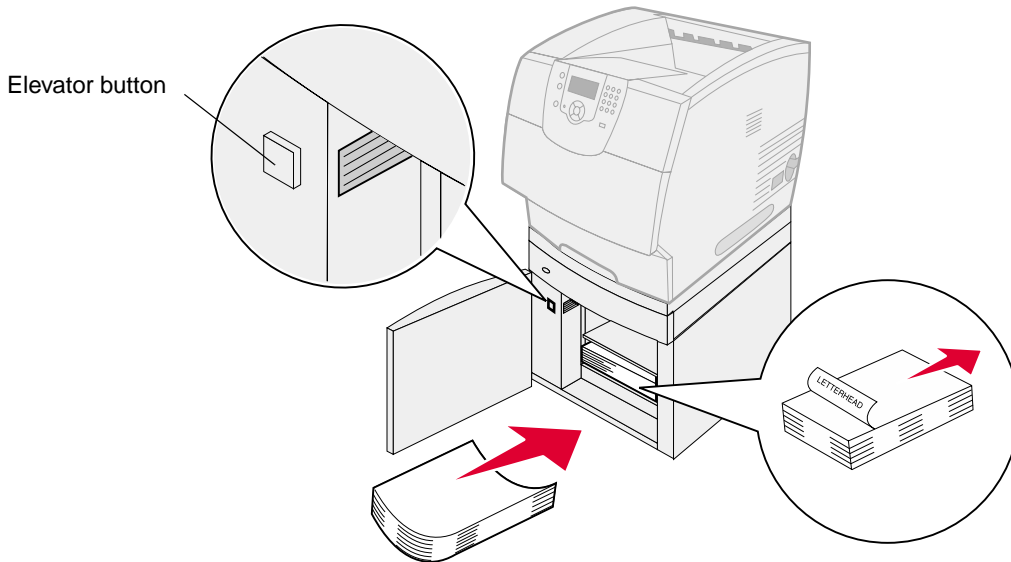

Clearing jams

200 and 201 Paper Jam Remove Cartridge

- 1 Push the release latch, and lower the multipurpose feeder.
- 2 Push the release latch, and open the top front cover.

CAUTION: The inside of the printer may be hot. Allow the printer to cool before touching any internal components.

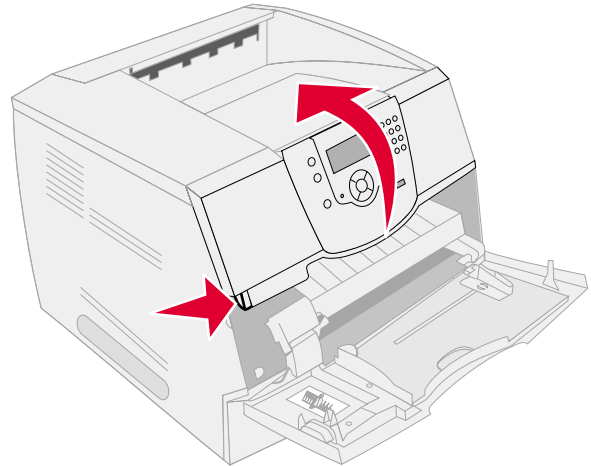
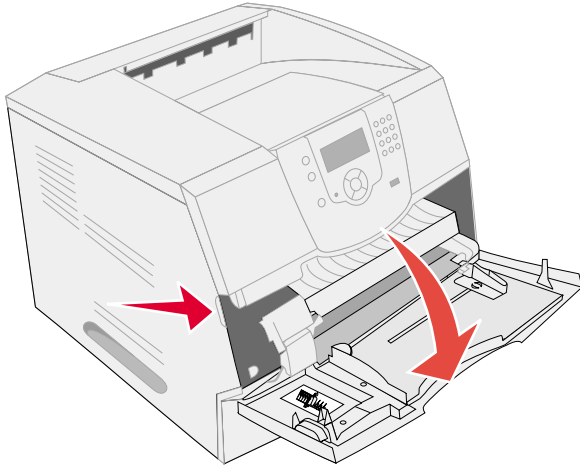

- 3 Lift and pull the print cartridge out of the printer.

Warning: Do not touch the photoconductor drum on the underside of the cartridge. Use the cartridge handle whenever you are holding the cartridge.

- 4 Place the print cartridge aside.

Note: Do not leave the cartridge exposed to light for extended periods.

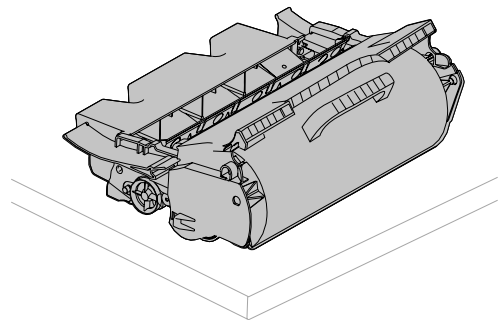
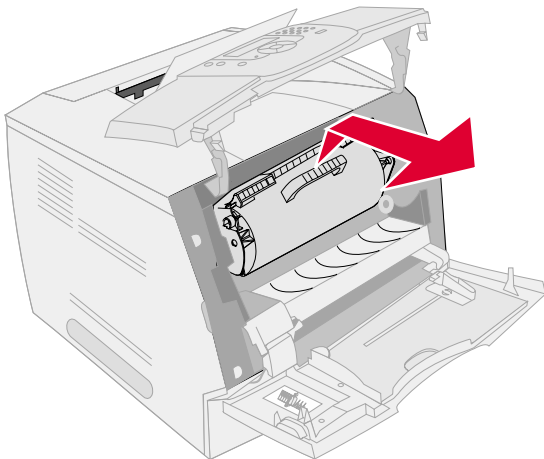

Note: The print media may be covered with unfused toner, which can stain garments and skin.

Clearing jams

- 5 Pull the print media up and toward you.

CAUTION: Do not use any pointed objects to remove the paper. This could cause personal injury or damage to the printer.

Warning: If the print media does not move immediately when you pull, stop pulling. You need to access the print media from the printer rear door.

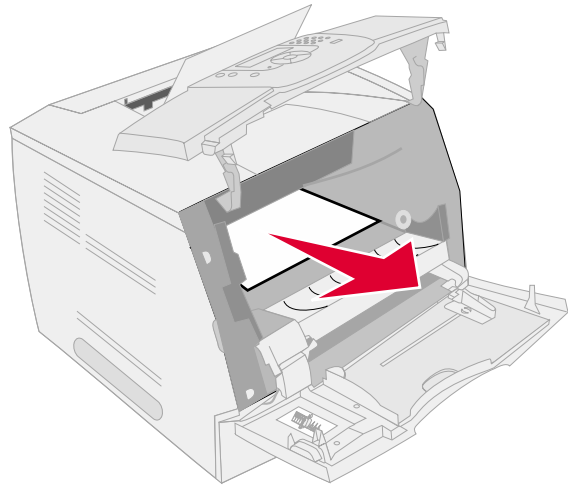
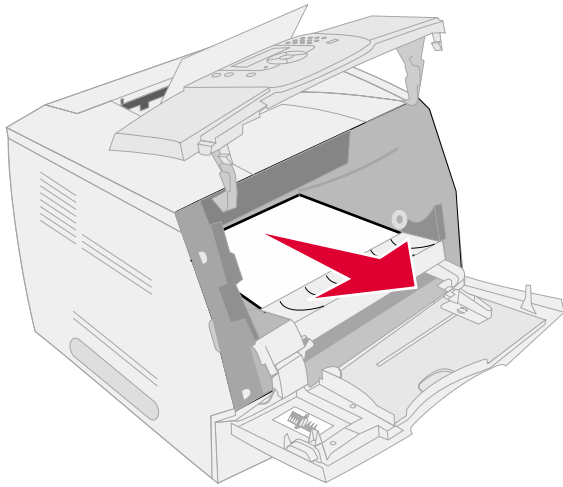

- 6 Align and reinstall the toner cartridge.
7 Close the top front cover.
8 Close the multipurpose feeder.
9 Press .

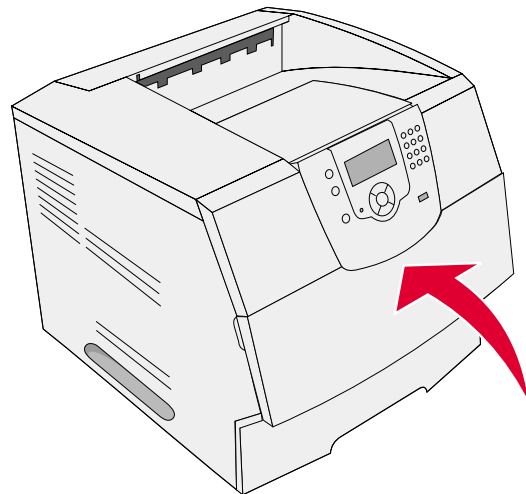
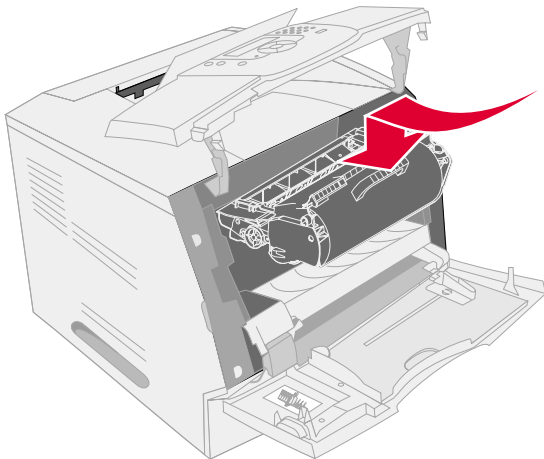

Clearing jams

202 Paper Jam Open Rear Door

- 1 If the paper is exiting the printer, pull the media straight out, and press . Otherwise, continue with step 2.
- 2 Open the printer rear door.

CAUTION: The inside of the printer may be hot. Allow the printer to cool before touching any internal components.

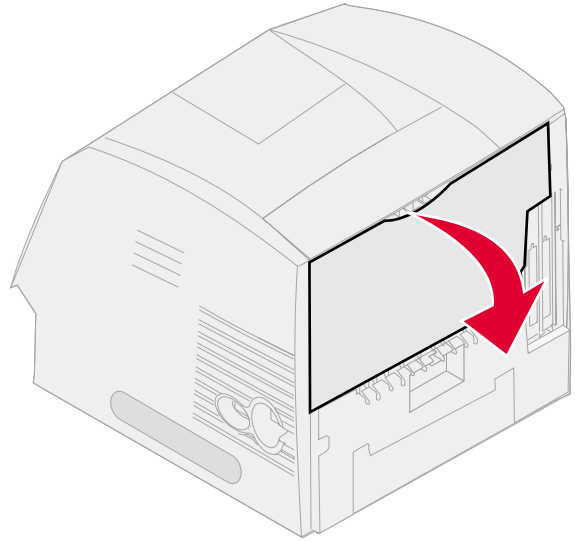
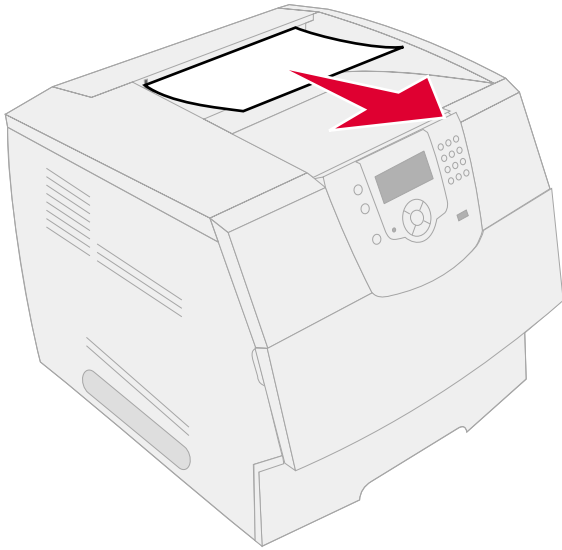

CAUTION: Do not use any pointed objects to remove the paper. This could cause personal injury or damage to the printer.

- 3 Remove the jammed media.
- 4 Close the rear door.
- 5 Press .

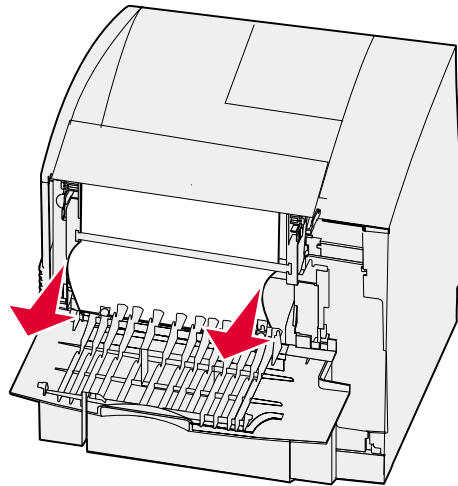
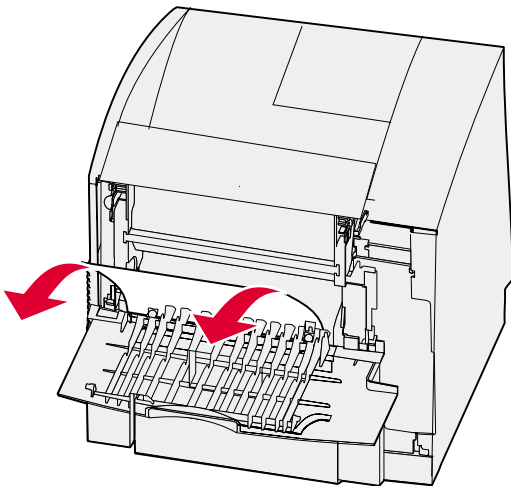

Clearing jams

23x Paper Jam Open Duplex Rear Door

- 1 Open the duplex rear door.

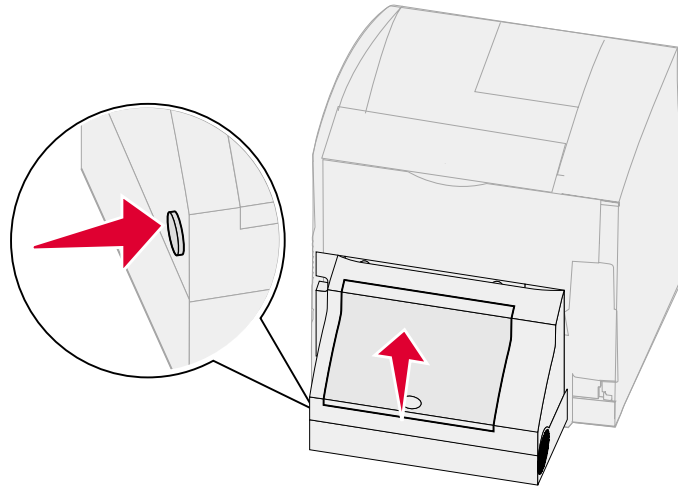

- 2 Remove the jammed media.

Depending on the media location, pull the media either up or down.

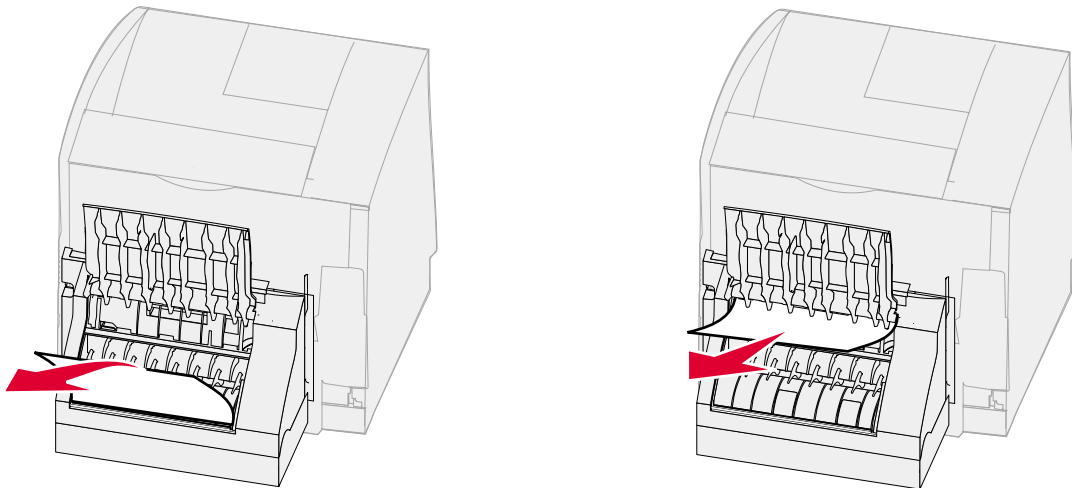

Clearing jams

- 3 Close the duplex rear door. Make sure it *snaps* into place.
- 4 Press .

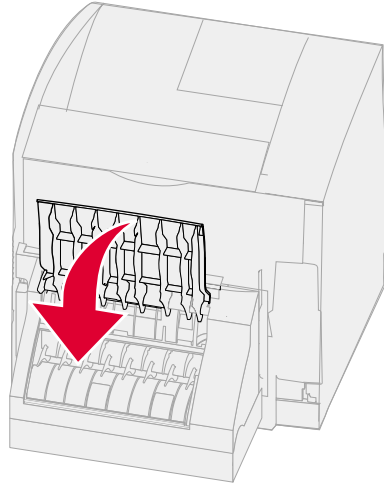

270 and 280 Paper jams

Paper jams in this group have been divided into 27x and 28x groups. If you have an output expander, high-capacity output stacker, or the 5-bin mailbox, see **27x Paper Jam Check Bin x**. If you have a finisher, see **28x Paper Jam Check Finisher**.

27x Paper Jam Check Bin x

To clear a jam in the output expander, high-capacity output stacker, or the 5-bin mailbox:

- 1 If the paper is exiting into the bin or finisher, pull the media straight out, and press . Otherwise, continue with step 2.
- 2 Push the output bin rear door latches in toward the center. The rear doors will open and drop down.

Note: If you only have one output option, you may only have one rear door.

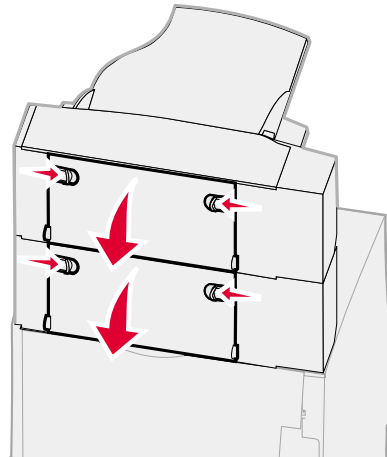
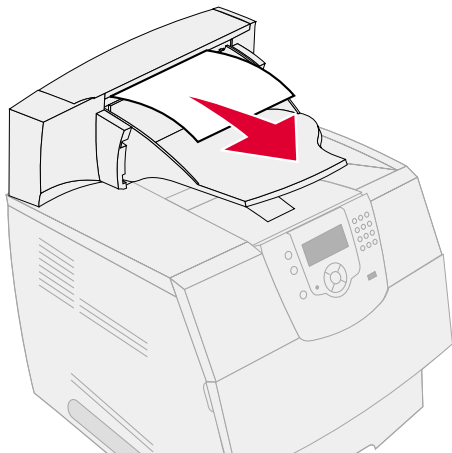

Clearing jams

- 3 Remove the jammed media.
- 4 Close the output bin rear doors, and make sure all doors are secure.
- 5 Press .

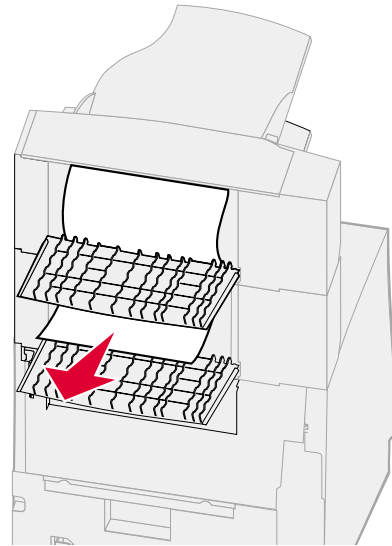
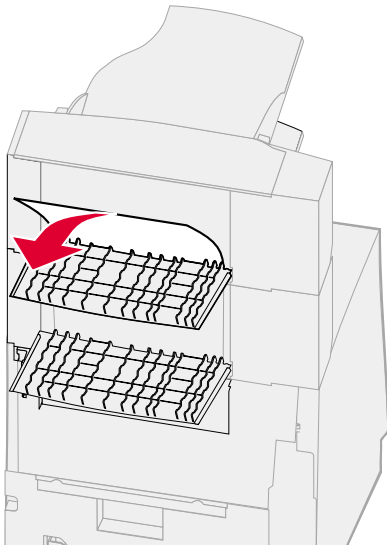

28x Paper Jam Check Finisher

To clear a jam in the finisher:

- 1 Push the finisher rear door latches in toward the center. The rear door will open and drop down.
- 2 Remove the jammed media.
- 3 Close the rear door, and make sure the door is secure.

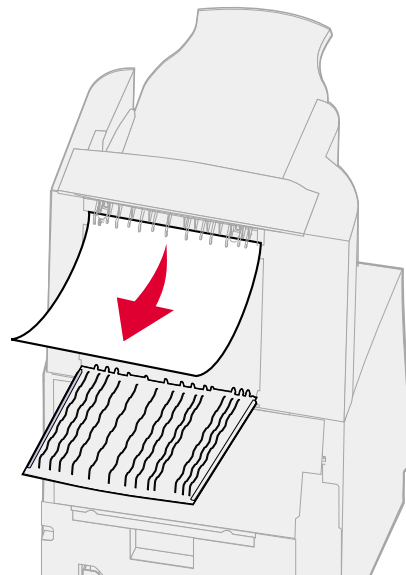
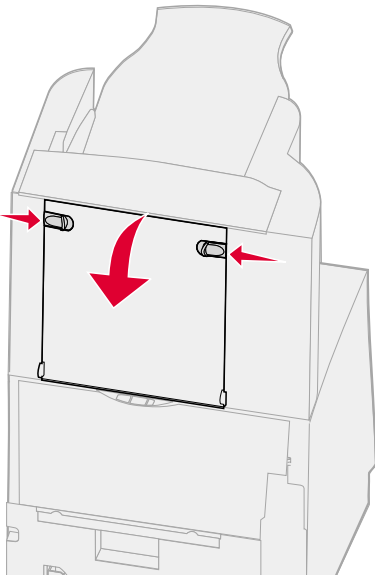

Clearing jams

- 4 Lift the front edge of the finisher output bin cover until it locks into position.
- 5 Remove the stack of print media.
- 6 Close the finisher output bin cover.
- 7 Press .

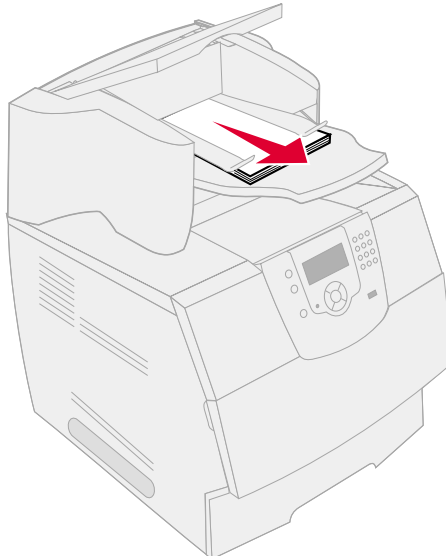
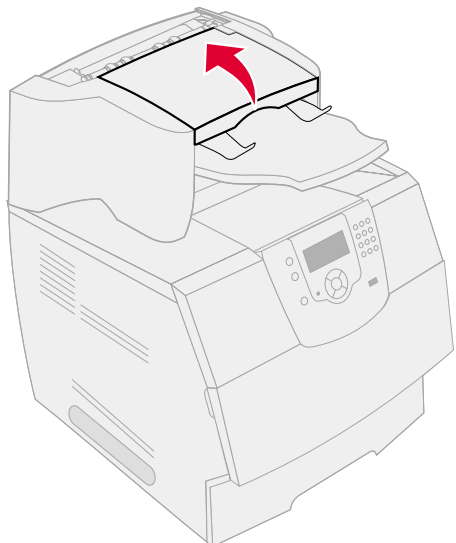

Clearing staple jams

A **28x Stapler Jam** message indicates staples are jammed in the stapler. This requires removing the staple cartridge holder from the printer.

- 1 Lift the front edge of the finisher output bin cover until it locks into position.
- 2 Remove the print media.

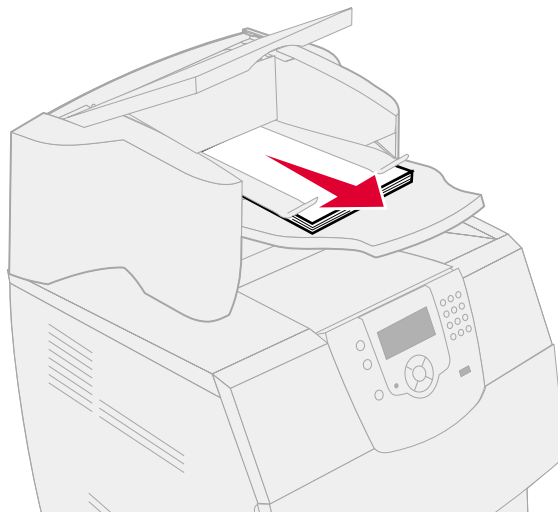
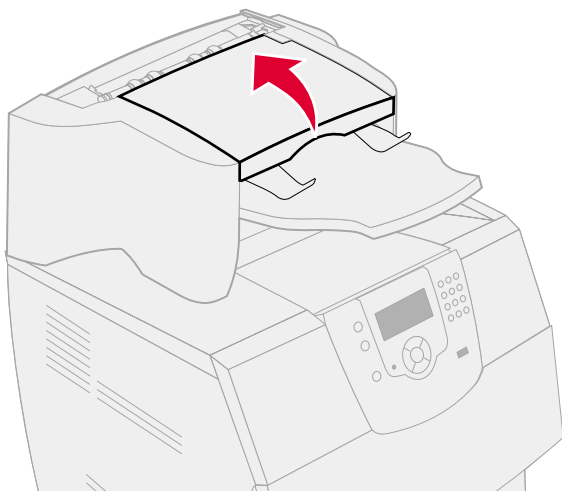

Clearing jams

- 3 Press the latch to open the stapler access door.
- 4 Firmly pull the colored tab to remove the staple cartridge holder from the stapler.

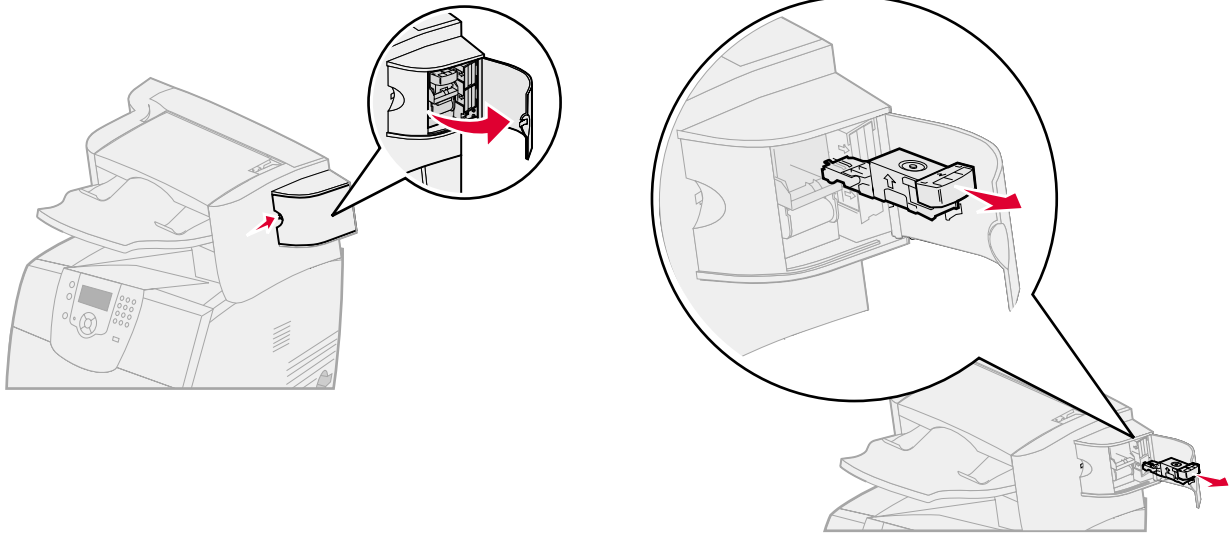

- 5 Use the metal tab to lift the staple guard, and then pull out the sheet of staples. Discard the entire sheet.
- 6 Remove any loose staples from the staple guard.
- 7 Look through the clear covering on the bottom of the cartridge holder to make sure no staples are jammed in the entry throat.
- 8 Press down on the staple guard until it *snaps* securely into place.

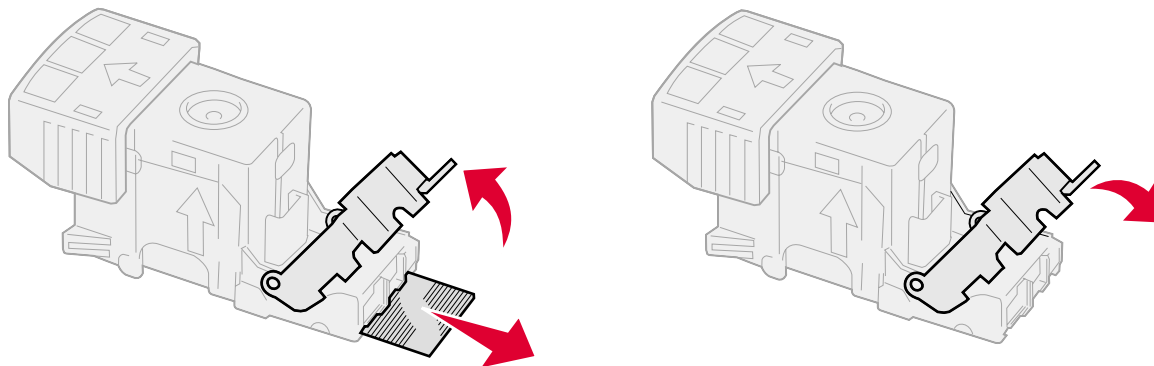

Clearing jams

- 9 Push the cartridge holder firmly into the stapler until the cartridge holder *clicks* into place.
- 10 Close the stapler access door.
- 11 Close the finisher output bin cover.

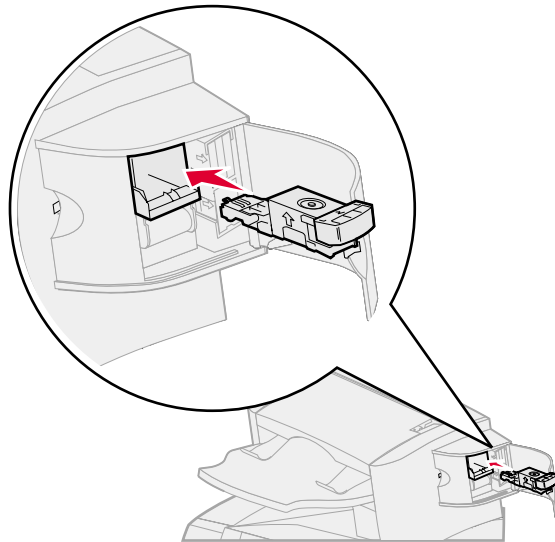













9

Administrative support

Adjusting operator panel brightness and contrast

If you are having trouble reading your operator panel display, the LCD contrast and brightness can be adjusted through the utilities menu.

The LCD Brightness and LCD Contrast settings are adjusted separately. To change the LCD Brightness or LCD Contrast settings:

- 1 Make sure the printer is on.
- 2 Press  on the operator panel.
- 3 Press  until the  appears next to **Settings**, and then press .
- 4 Press  until the  appears next to **Utilities Menu**, and then press .
- 5 Press  until the  appears next to the LCD setting you want to change, and then press .
- 6 Press  to increase the brightness or contrast, or press  to decrease the brightness or contrast.
- 7 When the adjustment is complete, press .

This saves this setting as the new user default, and the printer returns to **Ready**.









Disabling operator panel menus

Since many people could be using the printer, an administrator may choose to lock the operator panel menus to keep others from changing menu settings from the operator panel.

To disable the operator panel menus so that changes cannot be made to the printer default settings:



- 1 Turn the printer off.

Note: Disabling the operator panel menus does not prevent access to Print and Hold functionality.

- 2 Press and hold  and  while turning the printer on.
 - 3 Release the buttons when you see a clock.
- CONFIG MENU appears on the first line of the display.
- 4 Press  until the  appears next to **Panel Menus**, and then press .
 - 5 Press  until the  appears next to **Disable**, and then press .











The following messages appear briefly: **Submitting selection** and **Disabling Menus**.

The operator panel returns to **Panel Menus**.

- 6 Press  until the  appears next to **Exit Config Menus**, and then press .

Activating Menu Changes appears. The menus are disabled, and the printer returns to **Ready**.

Enabling operator panel menus

- 1 Turn the printer off.
- 2 Press and hold  and  while turning the printer on.
- 3 Release the buttons when you see a clock.
CONFIG MENU appears on the first line of the display.
- 4 Press  until the  appears next to **Panel Menus**, and then press .
- 5 Press  until the  appears next to **Enable**, and then press .
The following messages appear briefly in succession: **Submitting selection** and **Enabling Menus**.
The operator panel returns to **Panel Menus**.
- 6 Press  until the  appears next to **Exit Config Menus.**, and then press .
Activating Menu Changes appears. The menus are enabled, and the printer returns to **Ready**.













Restoring factory default settings

When you first enter the printer menus from the operator panel, you may notice an asterisk (*) to the left of a value in the menus. This asterisk indicates the *factory default setting*. These settings are the original printer settings. (Factory defaults may vary for different regions.)

When you select a new setting from the operator panel, **submitting selection** appears. When the Submitting Selection message disappears, an asterisk appears next to the setting to identify it as the current *user default setting*. These settings are active until new ones are stored or the factory defaults are restored.

To restore the original printer factory default settings:

Warning: All downloaded resources (fonts, macros, and symbol sets) in printer memory (RAM) will be deleted. (Resources residing in flash memory or on the optional hard disk remain unaffected.)

- 1 Make sure the printer is on and **Ready** appears on the display.
- 2 Press  on the operator panel.
- 3 Press  until the  appears next to **Settings**, and then press .
- 4 Press  until the  appears next to **Setup Menu**, and then press .
- 5 Press  until the  appears next to **Factory Defaults**, and then press .
- 6 Press  until the  appears next to **Restore Now**, and then press .











The message **Restoring Factory Defaults** appears, followed by the **Ready** message.

When you select Restore:

- No other button actions are available on the operator panel while **Restoring Factory Defaults** appears.
- All menu settings return to the factory default values, except:
 - The operator panel Display Language setting in the Setup menu.
 - All settings in the Parallel menu, Serial menu, Network menu, and USB menu.

Adjusting Power Saver

To adjust the **Power Saver** setting:

- 1 Make sure the printer is on and **Ready** appears on the display.
- 2 Press  on the operator panel.
- 3 Press  until the  appears next to **Settings**, and then press .
- 4 Press  until the  appears next to **Setup Menu**, and then press .
- 5 Press  until the  appears next to **Power Saver**, and then press .
- 6 Using the numeric pad or the right and left arrows on the operator panel, enter the number of minutes for the printer to wait before entering Power Saver.

The settings available range from 1–240 minutes. If you want to turn Power Saver off, see **Disabling Power Saver**.





















- 7 Press .

submitting Selection appears.

Note: You can also adjust the Power Saver setting by issuing a Printer Job Language (PJL) command. For more information, see the *Technical Reference* available on our Lexmark Web site at www.lexmark.com.

Disabling Power Saver

Disabling Power Saver is two step process. First, you must turn the variable on, then select the variable. To disable Power Saver:















- 1 Turn the printer off.
- 2 Press and hold  and  while turning the printer on.
- 3 Release the buttons when you see a clock.
CONFIG MENU appears on the first line of the display.
- 4 Press  until the  appears next to **Energy Conserve**, and then press .
- 5 Press  until the  appears next to **Off**.
submitting Selection appears.
The operator panel returns to **Energy Conserve**.
- 6 Press  until the  appears next to **Exit Config Menus**, and then press .
- 7 **Resetting the Printer** appears briefly followed by a clock. The operator panel then returns to **Ready**.
- 7 Make sure **Ready** appears.
- 8 Press  on the operator panel.
- 9 Press  until the  appears next to **Settings**, and then press .
- 10 Press  until the  appears next to **Setup Menu**, and then press .
- 11 Press  until the  appears next to **Power Saver**, and then press .
- 12 Use either the numeric keypad or the up and down arrows to enter **0** (zero). After **Disabled** appears, press .

submitting selection appears. Power Saver is now disabled.















Encrypting the disk

Warning: All resources on the hard disk will be deleted. (Resources residing in flash memory or in RAM remain unaffected.)

Note: This setting is only available when a hard disk is installed.

- 1 Turn the printer off.
 - 2 Press and hold  and  while turning the printer on.
 - 3 Release the buttons when you see a clock.
CONFIG MENU appears on the first line of the display.
 - 4 Press  until the  appears next to **Disk Encryption**, and then press .
 - 5 Press  until the  appears next to **Enable**, and then press .
 - 6 **Contents will be lost. Continue?** appears. Press  until the  appears next to **Yes**, and then press .
- The Encrypting Disk progress bar appears.
- 7 When disk encryption has finished, press .
 - 8 Press  until the  appears next to **Exit Config Menus**, and then press .

To disable disk encryption:

- 1 Turn the printer off.
- 2 Press and hold  and  while turning the printer on.
- 3 Release the buttons when you see a clock.
CONFIG MENU appears on the first line of the display.
- 4 Press  until the  appears next to **Disk Encryption**, and then press .
- 5 Press  until the  appears next to **Disable**, and then press .
- 6 **Contents will be lost. Continue?** appears. Press  until the  appears next to **Yes**.
- 7 Press . The Encrypting Disk progress bar appears.
- 8 When disk encryption has finished, click the back arrow.
- 9 Press  until the  appears next to **Exit Config Menu**, and then press .

Setting security using the Embedded Web Server (EWS)

You can enhance the security of network communications and device configuration by using the advanced security options. These features are available through the Web page of the device.

Setting the system password

Setting the system password protects configuration of the Embedded Web Server. A system password is also required for Secure mode and confidential communication with MVP.

To set the system password:

- 1 Open your Web browser. In the address line, enter the IP address of the printer you want to configure using the format: *http://ip_address/*.
- 2 Click **Configuration**.

- 3 Under Other Settings, click **Security**.
- 4 Click **Create Password** if one has not been set previously. If a password has been set before, click **Change or Remove Password**.

Using the secure Embedded Web Server

The SSL (Secure Sockets Layer) allows for secure connections to the Web server within the print device. You can connect to the Embedded Web Server more securely by connecting to the SSL port instead of the default HTTP port. The SSL port connection will encrypt all Web server network communications between the PC and the printer. To connect to the SSL port:

Open your Web browser. In the address line, enter the IP address of the printer you want to configure using the format: *https://ip_address/*.

Supporting SNMPv3 (Simple Network Management Protocol version 3)

SNMPv3 protocol allows for encrypted and authenticated network communications. It also lets the administrator select a desired level of security. Prior to use, at least one user name and password must be established from the settings page. To configure for SNMPv3 through the Embedded Web Server of the printer:

- 1 Open your Web browser. In the address line, enter the IP address of the printer you want to configure using the format: *http://ip_address/*.
- 2 Click **Configuration**.
- 3 Under Other Settings, click **Network/Ports**.
- 4 Click **SNMP**.

SNMPv3 authentication and encryption has three levels of support:

- No authentication and no encryption
- Authentication with no encryption
- Authentication and encryption

Note: Only the selected level and later may be used to communicate.

Supporting IPSec (Internet Protocol Security)

IP Security protocol provides authentication and encryption of communications at the network layer allowing all application and network communications over the IP protocol to be secure. IPSec can be set up between the printer and up to five hosts, using both IPv4 and IPv6. To configure IPSec through the Embedded Web Server:

- 1 Open your Web browser. In the address line, enter the IP address of the printer you want to configure using the format: *http://ip_address/*.
- 2 Click **Configuration**.
- 3 Under Other Settings, click **Network/Ports**.
- 4 Click **IPSec**.

Two types of authentication are supported for IPSec:

- **Shared Key Authentication**—Any ASCII phrase shared among all the participating hosts. This is the easiest way to configure when only a few hosts on the network use IPSec.
- **Certificate Authentication**—Allows any hosts or subnet of hosts to authenticate for IPSec. Each host must have a public/private key pair. *Validate Peer Certificate* is enabled by default, requiring each host to have a signed

certificate and the certificate authority certificate must be installed. Each host must have its identifier in the *Subject Alternate Name* of the signed certificate.

Note: After a device is configured for IPSec with a host, IPSec is required for any IP communication to take place.

Using Secure mode

You can configure the TCP and UDP ports to one of three modes:

- **Disabled**—Never allows network connections to this port
- **Secure and Unsecure**—Allows the port to remain open, even in Secure mode
- **Unsecured Only**—Allows the port to only open when the printer is not in Secure mode

Note: A password must be set to enable Secure mode. Once enabled, only the ports set to Secure and Unsecure will be open.

To configure the Secure mode for TCP and UDP ports from the Embedded Web Server:

- 1 Open your Web browser. In the address line, enter the IP address of the printer you want to configure using the format: *http://ip_address/*.
- 2 Click **Configuration**.
- 3 Under Other Settings, click **Network/Ports**.
- 4 Click **TCP/IP Port Access**.

Note: Disabling ports will disable function on the printer.

Using 802.1x Authenticating

802.1x port authentication allows the printer to join networks that require authentication before allowing access. 802.1x port authentication can be used with the WPA (Wi-Fi Protected Access) feature of an optional internal wireless print server to provide WPA-Enterprise security support.

Support for 802.1x requires the establishment of credentials for the printer. The printer must be known to the Authentication Server (AS). The AS will allow network access to devices presenting a valid set of credentials which typically involves a name/password combination and possibly a certificate. The AS will allow network access to printers presenting a valid set of credentials. You can manage the credentials by using the Embedded Web Server of the printer. To use certificates as part of the credentials:

- 1 Open your Web browser. In the address line, enter the IP address of the printer you want to configure using the format: *http://ip_address/*.
- 2 Click **Configuration**.
- 3 Under Other Settings, click **Network/Ports**.
- 4 Click **Certificate Management**.

To enable and configure 802.1x on the Embedded Web Server after installing the required certificates:

- 1 Open your Web browser. In the address line, enter the IP address of the printer you want to configure using the format: *http://ip_address/*.
- 2 Click **Configuration**.
- 3 Under Other Settings, click **Network/Ports**.

- 4 Click **802.1x Authentication**.

Note: If an optional internal wireless print server is installed, click **Wireless** instead of **802.1x Authentication**.

Locking the operator panel menus

Operator Panel Menu Lockout lets you create a PIN number and choose specific menus to lock. Each time a locked menu is selected, the user will be prompted to enter the correct PIN at the operator panel. The PIN does not affect any access through the EWS. To lock operator panel menus:

- 1 Open your Web browser. In the address line, enter the IP address of the printer you want to configure using the format: *http://ip_address/*.
- 2 Click **Configuration**.
- 3 Under Other Settings, click **Security**.
- 4 Click **Menu Lockout Setup**.

Printing Lockout

Printing Lockout lets you lock or unlock a printer using an assigned PIN. When locked, every job the printer receives will buffer to the hard disk. A user can print jobs only by entering the correct PIN on the operator panel. You can assign a PIN through the Web page of the device.

Note: This setting is only available when a hard disk is installed.

Note: Back channel data will be processed while the printer is locked. Reports such as user or event logs can be retrieved from a locked printer.

To set Printing Lockout:

- 1 Open your Web browser. In the address line, enter the IP address of the printer you want to configure using the format: *http://ip_address/*.
- 2 Click **Configuration**.
- 3 Under Other Settings, click **Security**.
- 4 Click **Printer Lockout PIN**.

Confidential Print Setup

Confidential Print Setup lets you designate a maximum number of PIN entry attempts and set an expiration time for print jobs. When a user exceeds a specific number of PIN entry attempts, all of that user's print jobs are deleted. When a user has not printed their jobs within a designated time period, the print jobs are deleted. To activate Confidential Print Setup:

Note: This feature is only available on network models.

- 1 Open your Web browser. In the address line, enter the IP address of the printer you want to configure using the format: *http://ip_address/*.
- 2 Click **Configuration**.
- 3 Under Other Settings, click **Security**.
- 4 Click **Confidential Print Setup**.

Understanding printer messages

The printer displays three types of messages: status messages, attendance messages, and service messages. Status messages provide information about the current state of the printer. They require no action on your part. Attendance messages alert you to printer problems that require your intervention. Service messages also alert you to problems that require intervention. However the printer will stop printing and the errors are non-recoverable. It may be possible to power the printer off and back on to temporarily recover from the service message error condition. For more information about printer messages, see the *Menus and Messages* book on the publications CD.

If you receive the following message, see **Ordering a print cartridge**.

Message	Action
42.xy Cartridge region mismatch Note: x = the printer region, y = the cartridge region	Install the correct cartridge for the printer region. Region codes are: 0 = Worldwide 1 = Americas 2 = EMEA 3 = Asia 9 = Undefined

Online technical support

Technical support is available on our Lexmark Web site at www.lexmark.com.

Checking an unresponsive printer

If the printer is not responding, first make sure:



- The power cord is plugged into the printer and a properly grounded electrical outlet.
- The electrical outlet is not turned off by any switch or breaker.
- The printer is not plugged into any surge protectors, uninterrupted power supplies, or extension cords.
- Other electrical equipment plugged into the outlet is working.
- The printer is turned on.
- The printer cable is securely attached to the printer and the host computer, print server, option, or other network device.

Once you have checked each of these possibilities, turn the printer off and back on. This often fixes the problem.

Printing multi-language PDFs

Symptom	Cause	Solution
Some documents do not print.	The documents contain unavailable fonts.	<ol style="list-style-type: none"> 1 Open the document you want to print in Adobe Acrobat. 2 Click the printer icon. The Print dialog appears. 3 Check the Print as image box. 4 Click OK.

Solving printing problems

Symptom	Cause	Solution
The operator panel display is blank or displays only diamonds.	The printer self test failed.	<p>Turn the printer off, wait about 10 seconds, and turn the printer back on.</p> <p>If the Ready message does not appear, turn the printer off and call for service.</p>
The message USB device unsupported appears when using a USB device.	The USB device you are using may not be supported or has an error. Only specific USB flash memory devices are supported.	For information regarding tested and approved USB flash memory devices, see our Lexmark Web site at http://support.lexmark.com and click on KnowledgeBase to search for Direct USB printing.
Jobs do not print.	The printer is not ready to receive data.	Make sure Ready or Power Saver appears on the display before sending a job to print. Press  to return the printer to the Ready state.
	The specified output bin is full.	Remove the stack of paper from the output bin, and then press  .
	The specified tray is empty.	Load paper in the tray.
	You are using the wrong printer driver or are printing to a file.	<ul style="list-style-type: none"> • Verify you are using the printer driver associated with the printer. • If you are using a USB port, make sure you are running Windows 98/Me, Windows 2000, Windows XP, or Windows Server 2003 and using a Windows 98/Me, Windows 2000, Windows XP, or Windows Server 2003 compatible printer driver.
	Your MarkNet N8000 series internal print server is not set up properly or is not connected properly.	<p>Verify that you have properly configured the printer for network printing.</p> <p>See the drivers CD or the Lexmark Web site for information.</p>
	You are using the wrong interface cable, or the cable is not securely connected.	<p>Make sure you are using a recommended interface cable.</p> <p>Make sure the connection is secure.</p>

Troubleshooting

Symptom	Cause	Solution
Held jobs do not print.	A formatting error has occurred.	<ul style="list-style-type: none"> Print the job. (Only part of the job may print.) Delete the job. Free up additional printer memory by scrolling through the list of held jobs and deleting others you have sent to the printer.
	The printer has insufficient memory.	
	The printer has received invalid data.	Delete the job.
Job takes longer than expected to print.	The job is too complex.	Reduce the complexity of your print job by eliminating the number and size of fonts, the number and complexity of images, and the number of pages in the job.
	Page Protect is set to On.	Set Page Protect to Off from the Setup Menu . For more information, see the <i>Menus and Messages Guide</i> .
Job prints from the wrong tray or on the wrong paper or specialty media.	The operator panel menu settings do not match the media loaded in the tray.	Make sure the Paper Size and Paper Type specified in the printer driver match the paper size and type in the tray.
Incorrect characters print.	You are using an incompatible parallel cable.	If you are using a parallel interface, make sure you are using an IEEE 1284-compliant parallel cable. We recommend Lexmark part number 1329605 (10 ft) or 1427498 (20 ft) for the standard parallel port.
	The printer is in Hex Trace mode.	If Ready Hex appears on the display, you must exit Hex Trace mode before you can print your job. Turn the printer off and back on to exit Hex Trace mode.
Tray linking does not work.	Tray linking is not configured properly.	<ul style="list-style-type: none"> Make sure both the size and type of media are the same in both trays. Make sure the paper guides in the trays are set for the correct size media. Make sure the menu values for both size and type are set correctly in the Paper Menu. See Linking trays, or see the <i>Menus and Messages Guide</i> for more information.
Large jobs do not collate.	Collate is not set to On.	Set Collation to on in the Finishing Menu or through the printer driver. Note: Setting Collation to off in the driver overrides the setting in the Finishing Menu . See the <i>Menus and Messages Guide</i> for more information.
	The job is too complex.	Reduce the complexity of the print job by eliminating the number and size of fonts, the number and complexity of images, and the number of pages in the job.
	The printer does not have enough memory.	Add printer memory or an optional hard disk.
Unexpected page breaks occur.	The job has timed out.	Set Print Timeout to a higher value from the Setup Menu . See the <i>Menus and Messages Guide</i> for more information.

Solving option problems

If an option does not operate correctly after it is installed or if it quits working:

- Turn the printer off, wait for about 10 seconds, and turn the printer on. If this does not fix the problem, unplug the printer, and check the connection between the option and printer.
- Print the menu settings page and check to see if the option is listed in the Installed Options list. If the option is not listed, reinstall it. See **Printing the menu settings page** for more information.
- Make sure the option is selected in the software application you are using.

The following table lists printer options and suggested corrective actions for related problems. If the suggested corrective action does not fix the problem, call your service representative.

Option	Action
5-bin mailbox	Make sure the connection between each 5-bin mailbox or the connection between the 5-bin mailbox and the printer is secure. If the 5-bin mailbox is listed on the menu settings page, but print media jams when it exits the printer and enters the mailbox, it may not be properly installed. Reinstall each 5-bin mailbox.
Drawers	<ul style="list-style-type: none"> • Make sure the connection between drawers (250-sheet drawer, 500-sheet drawer, or 2000-sheet drawer), or the connection between a drawer and a duplex unit or the printer is secure. • Make sure the print media is loaded correctly. See Loading standard trays and optional trays for more details.
Duplex unit	<ul style="list-style-type: none"> • Make sure the connection between the duplex unit and the printer is secure. If the duplex unit is listed on the menu settings page, but print media jams when it enters or exits the duplex unit, the printer and duplex unit may not be properly aligned. • Make sure the duplex front access cover is securely installed.
Envelope feeder	<ul style="list-style-type: none"> • Make sure the connection between the envelope feeder and the printer is secure. • Make sure the Paper Size setting is correct in both the Paper Menu and in the software application. • Make sure the envelopes are loaded correctly. See Loading the envelope feeder for more details.
Finisher	<ul style="list-style-type: none"> • Make sure the connection between the finisher and the printer is secure. If the finisher is listed on the menu settings page, but print media jams when it exits the printer and enters the finisher, it may not be properly installed. Reinstall the finisher. • Make sure you are using a print media size compatible with your optional output bins. See Supported print media. <p>Note: The maximum number of sheets for stapling cannot exceed 25-sheets.</p>
Flash memory	Make sure flash memory is securely connected to the printer system board.
Hard disk with adapter	Make sure the hard disk is securely connected to the hard disk adapter card. Also, make sure the hard disk adapter card is securely connected to the printer system board.
High-capacity output stacker	Make sure the connection between the output stacker and the printer is secure. If the high-capacity output stacker is listed on the menu settings page, but print media jams when it exits the printer and enters the output stacker, it may not be properly installed. Reinstall the high-capacity output stacker.
Infrared adapter	<p>If infrared communication stops or does not occur, make sure:</p> <ul style="list-style-type: none"> • The distance between the two infrared ports is 1 meter (39 in.) or less. If communication does not occur between ports, move the ports closer together. • Both ports are stable. • The computer and the printer are on a level surface. • The angle of communication between the two infrared ports is within 15 degrees of either side of an imaginary line drawn between the two infrared ports. • No bright light, such as direct sunlight, is interfering with communication. • No objects are placed between the two infrared ports.

Troubleshooting

Option	Action
Internal print server	<ul style="list-style-type: none">• Make sure the internal print server (also called an internal network adapter or INA) is securely connected to the printer system board.• Make sure you are using the correct cable, that it is securely connected, and the network software is correctly set up. See the drivers CD that shipped with the printer for more details.
Large capacity feeder (2000-sheet drawer)	See Solving 2000-sheet drawer problems .
Output expander	Make sure the connection between each output expander or the connection between the output expander and the printer is secure. If the output expander is listed on the menu settings page, but print media jams when it exits the printer and enters the output expander, it may not be properly installed. Reinstall each output expander.
Printer memory	Make sure printer memory is securely connected to the printer system board.
USB/Parallel interface	<ul style="list-style-type: none">• Make sure the USB/parallel interface card is securely connected to the printer system board.• Make sure you are using the correct cable and that it is securely connected.

Troubleshooting

Solving 2000-sheet drawer problems



Problem	Solution
The elevator tray does not raise when the loading door is closed, or the elevator tray does not lower when the door is opened and the elevator button is pushed.	Check the following: <ul style="list-style-type: none">• The printer is properly attached to the 2000-sheet drawer.• The printer is powered on.• The power cord is plugged firmly into the back of the 2000-sheet drawer.• The power cord is plugged into an outlet.• The outlet has power.
The elevator tray lowers unexpectedly.	Check to see if the printer is out of print media or has a jam.
More than one sheet of print media is fed, or a sheet is fed improperly.	Remove the print media in the printer paper path, and check the stack to ensure the print media has been loaded properly. Be sure to remove the top and bottom sheets of each ream of paper that is loaded.
A jam occurs.	
Rubber feed rollers do not turn to advance print media.	Check the following: <ul style="list-style-type: none">• The power cord is plugged firmly into the back of the 2000-sheet drawer.• The power cord is plugged into an outlet.• The outlet has power.
Consistent misfeeds or jams in the drawer	Try the following: <ul style="list-style-type: none">• Flex the paper.• Turn the print media over. Check the following: <ul style="list-style-type: none">• Drawer is properly installed.• Print media is loaded correctly.• Print media is not damaged.• Print media meets specifications.• Guides are positioned correctly for the print media size selected.
Service messages	A service message indicates printer failure that may require service. Turn the printer off, wait about 10 seconds, and then turn the printer on. If the error recurs, write down the error number, the problem, and a detailed description. Call for service.

Solving paper feed problems



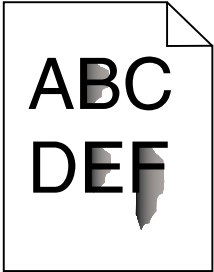
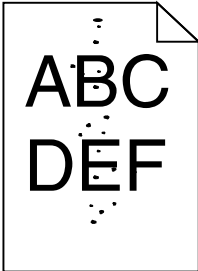

Symptom	Cause	Solution
Paper frequently jams.	You are using paper that does not meet the printer specifications.	Use recommended paper and other specialty media. See the <i>Card Stock & Label Guide</i> available on our Lexmark Web site at www.lexmark.com for detailed specifications. See Avoiding jams for information that can help prevent jams from occurring.
	You have loaded too much paper or too many envelopes.	Make sure the stack of paper you load does not exceed the maximum stack height indicated in the tray or on the multipurpose feeder.
	Guides in the selected tray are not set to the appropriate position for the size paper loaded.	Move the guides in the tray to the correct position.
	The paper has absorbed moisture due to high humidity.	Load paper from a fresh package. Store paper in its original wrapper until you load it. See Storing print media for more information.
	The pick rolls may be worn.	Replace the pick rolls. See Ordering pick rollers for more information.
The Paper Jam message remains after you remove the jammed paper.	You have not pressed Go or have not cleared the entire paper path.	Clear paper from the entire paper path, and then press  . See Clearing jams for more information.
The page that jammed does not reprint after you clear the jam.	Jam Recovery in the Setup menu is set to Off.	Set Jam Recovery to Auto or On. See the <i>Menus and Messages Guide</i> for more information.
Blank pages feed into the output bin.	An incorrect media type is loaded in the tray being printed from.	Load the correct type media for your print job, or change the Paper Type to match the type of media loaded. See the <i>Menus and Messages Guide</i> for more information.

Solving print quality problems

The information in the following table may help you solve print quality problems. If these suggestions still do not correct the problem, call for service. You may have a printer part that requires adjustment or replacement.

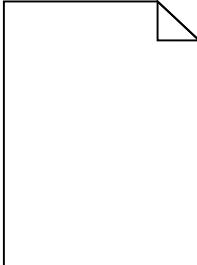
Problem	Action
<p>Print is too light.</p> 	<ul style="list-style-type: none"> • The toner may be low. To utilize the remaining toner, remove the cartridge by gripping the handles with both hands. With the cartridge arrows pointing downward, firmly shake the print cartridge side-to-side and front-to-back several times to redistribute the toner. Reinstall the cartridge and then press . Repeat this procedure multiple times until the print remains faded. When the print remains faded replace the print cartridge. • Change the Toner Darkness setting in the Quality menu. • Change the Brightness setting in the Quality menu. • Change the Contrast setting in the Quality menu. • If you are printing on an uneven print surface, change the Paper Weight and Paper Texture settings in the Paper menu. • Verify the correct print media is being used.
<p>Toner smears or print comes off the page.</p> 	<ul style="list-style-type: none"> • If you are printing on an uneven print surface, change the Paper Weight and Paper Texture settings in the Paper menu. • Verify the print media is within the printer specifications. See Understanding paper and specialty media guidelines for more details. <p>If the problem continues, contact the Lexmark Customer Support Center at 1-800-Lexmark (1-800-539-6275) or http://support.lexmark.com.</p>
<p>Toner appears on the back of the printed page.</p>	<p>Toner is on the transfer roll. To help prevent this, do not load print media that is smaller than the page size of the job to be printed.</p> <p>Open and close the printer top front cover to run the printer setup cycle and clean the transfer roll.</p>
<p>Toner fog or background shading appears on the page.</p> 	<ul style="list-style-type: none"> • Check the print cartridge to make sure it is installed correctly. • Replace the print cartridge.

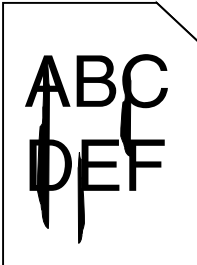
Troubleshooting

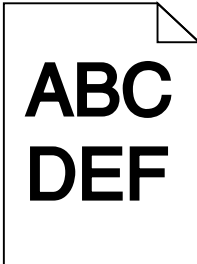
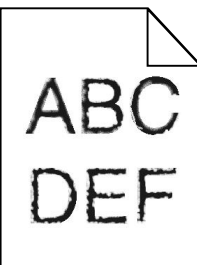
Problem	Action
<p>Entire page is white.</p> 	<ul style="list-style-type: none"> • Make sure the packaging material is removed from the print cartridge. • Check the print cartridge to be sure it is installed correctly. • The toner may be low. To utilize the remaining toner, remove the cartridge by gripping the handles with both hands. With the cartridge arrows pointing downward, firmly shake the print cartridge side-to-side and front-to-back several times to redistribute the toner. Reinstall the cartridge and then press . Repeat this procedure multiple times until the print remains faded. When the print remains faded replace the print cartridge.
<p>Streaks appear on the page.</p> 	<ul style="list-style-type: none"> • The toner may be low. To utilize the remaining toner, remove the cartridge by gripping the handles with both hands. With the cartridge arrows pointing downward, firmly shake the print cartridge side-to-side and front-to-back several times to redistribute the toner. Reinstall the cartridge and then press . Repeat this procedure multiple times until the print remains faded. When the print remains faded replace the print cartridge. • If you are using preprinted forms, make sure the ink can withstand temperatures of 230°C (446°F).
<p>Printing is too dark.</p> 	<ul style="list-style-type: none"> • Change the Toner Darkness setting in the Quality menu. • Change the Brightness setting in the Quality menu. • Change the Contrast setting in the Quality menu. <p>Note: Macintosh computer users should make sure the lines per inch (lpi) setting is not set too high in the software application.</p>
<p>Characters have jagged or uneven edges.</p> 	<ul style="list-style-type: none"> • Change the Print Resolution setting in the Quality menu to 600 dpi, 1200 Image Q, 1200 dpi, or 2400 Image Q. • Enable Enhance Fine Lines. <p>See the tables on page 113 for more settings information.</p> <ul style="list-style-type: none"> • If you are using downloaded fonts, verify the fonts are supported by the printer, the host computer, and the software application.

Troubleshooting

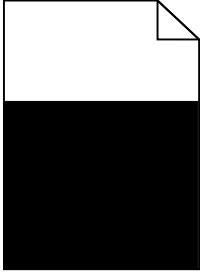
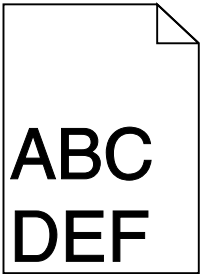
Problem	Action
<p>Part or all of the page is printed in black.</p> 	<p>Check the print cartridge to see if it is installed correctly.</p>
<p>The job prints, but the top and side margins are incorrect.</p> 	<ul style="list-style-type: none"> • Make sure the Paper Size setting in the Paper menu is correct. • Make sure the margins are set correctly in your software application.
<p>Ghost images appear.</p>	<ul style="list-style-type: none"> • Make sure the Paper Type setting in the Paper menu is correct. • Replace the photoconductor kit.
<p>Gray background prints.</p>	<ul style="list-style-type: none"> • The Toner Darkness setting may be too dark. Change the Toner Darkness setting in the quality menu. • Adjust the Brightness setting darker. • Adjust the Contrast setting lighter. • See the tables on page 113 for more settings information. • The print cartridge may be defective. Replace the print cartridge.
<p>Some of the print is cut off on the sides, top, or bottom of the media.</p>	<p>Move the guides in the tray to the proper positions for the size loaded.</p>
<p>Print is skewed or inappropriately slanted.</p>	
<p>Transparency print quality is poor.</p>	<ul style="list-style-type: none"> • Use only transparencies recommended by the printer manufacturer. • Make sure the Paper Type setting in the Paper menu is set to Transparency.

Troubleshooting

The quality menu operator panel options can be adjusted to help improve print quality.

Menu selection	Purpose	Values†	
Print Resolution	To select printed output resolution	600 dpi* 1200 Image Q 1200 dpi 2400 Image Q	
Toner Darkness	Lightens or darkens printed output and conserves toner	1–10	8* is the default setting. Select a lower number to lighten the printed output or save toner.
Brightness	Adjusts the gray value of printed objects	-6 – +6	0* is the default setting.
Contrast	Adjusts the contrast of printed objects	0–5	0* is the default setting.
† Values marked by an asterisk (*) are the factory default settings.			

In addition, the Enhance Fine Lines and Gray Correction options can be enabled to improve print quality. These settings are available on the driver and on the printer Embedded Web Server (EWS) interface. For more information about these options, see the driver Help.

Driver option	Purpose	Values†	
Enhance Fine Lines	A selection to enable a print mode preferable for certain files containing fine line detail, such as architectural drawings, maps, electronic circuit diagrams, and flow charts	On	In the driver, enable the check box.
		Off*	In the driver, disable the check box.
Gray Correction	Automatically adjusts the contrast enhancement applied to images	Auto	In the driver, enable the check box.
		Off*	In the driver, disable the check box.
† Values marked by an asterisk (*) are the factory default settings.			

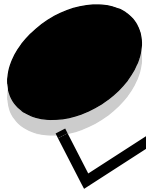

Notices

- Trademarks
- Licensing notice
- Conventions
- Electronic emission notices
- Noise emission levels
- ENERGY STAR
- Waste from Electrical and Electronic Equipment (WEEE) directive
- Laser notice
- Statement of limited warranty

Trademarks

Lexmark and Lexmark with diamond design, Drag'N'Print, MarkNet, and MarkVision are trademarks of Lexmark International, Inc. PrintCryption and StapleSmart are trademarks of Lexmark International, Inc., registered in the United States and/or other countries.

LEXFAX is a service mark of Lexmark International, Inc.

PCL[®] is a registered trademark of the Hewlett-Packard Company. PCL is Hewlett-Packard Company's designation of a set of printer commands (language) and functions included in its printer products. This printer is intended to be compatible with the PCL language. This means the printer recognizes PCL commands used in various application programs, and the printer emulates the functions corresponding to the commands.

PostScript[®] is a registered trademark of Adobe Systems Incorporated. PostScript 3 is Adobe Systems' designation of a set of printer commands (language) and functions included in its software products. This printer is intended to be compatible with the PostScript 3 language. This means the printer recognizes PostScript 3 commands used in various application programs, and the printer emulates the functions corresponding to the commands.

Details relating to compatibility are included in the *Technical Reference*.

Other trademarks are the property of their respective owners.

© 2005 Lexmark International, Inc.
All rights reserved.

UNITED STATES GOVERNMENT RIGHTS

This software and any accompanying documentation provided under this agreement are commercial computer software and documentation developed exclusively at private expense.

Licensing notice

The printer resident software contains software developed and copyrighted by Lexmark.

In addition, the printer resident software may contain:

- Lexmark modified software licensed under the provisions of the GNU General Public License version 2 and the GNU Lesser General Public License version 2.1
- Software licensed under the BSD license and warranty statements
- Software licensed under other licenses

Click the title of the document you want to review:

- **BSD License and Warranty statements**
- **GNU General Public License**
- **Other licenses**

The Lexmark modified third-party software covered by these third-party licenses is free software; you can redistribute it and/or modify it under the terms of the licenses referenced above. These licenses do not provide you any rights to the Lexmark copyrighted software in this printer.

Since the third-party licensed software the Lexmark modifications are based on is supplied explicitly without warranty, use of the Lexmark modified version is similarly provided without warranty. See the warranty disclaimers in the referenced licenses for additional details.

To obtain source code files for the Lexmark modified GNU licensed software, launch the drivers CD that shipped with the printer and click Contact Lexmark.

For source code that is required to be made available with the product, see the publications CD in the en\OpenSource\ directory.

Conventions

Note: A *note* identifies something that could help you.

CAUTION: A *caution* identifies something that could cause you harm.

Warning: A *warning* identifies something that could damage your product hardware or software.

Static sensitivity notice



Warning: This symbol identifies static-sensitive parts. Do not touch in the areas near these symbols without first touching the metal frame of the printer.

Electronic emission notices

Federal Communications Commission (FCC) compliance information statement

The Lexmark family base printers, Types 4061-000, 4061-200, and 4061-400, and network printers, Types 4061-010, 4061-210, and 4061-410, have been tested and found to comply with the limits for a Class B digital device, pursuant to Part 15 of the FCC Rules. Operation is subject to the following two conditions: (1) this device may not cause harmful interference, and (2) this device must accept any interference received, including interference that may cause undesired operation.

The FCC Class B limits are designed to provide reasonable protection against harmful interference in a residential installation. This equipment generates, uses and can radiate radio frequency energy and, if not installed and used in accordance with the instructions, may cause harmful interference to radio communications. However, there is no guarantee that interference will not occur in a particular installation. If this equipment does cause harmful interference to radio or television reception, which can be determined by turning the equipment off and on, the user is encouraged to try to correct the interference by one or more of the following measures:

- Reorient or relocate the receiving antenna.
- Increase the separation between the equipment and receiver.
- Connect the equipment into an outlet on a circuit different from that to which the receiver is connected.
- Consult your point of purchase or service representative for additional suggestions.

The manufacturer is not responsible for any radio or television interference caused by using other than recommended cables or by unauthorized changes or modifications to this equipment. Unauthorized changes or modifications could void the user's authority to operate this equipment.

Note: To assure compliance with FCC regulations on electromagnetic interference for a Class B computing device, use a properly shielded and grounded cable such as Lexmark part number 1329605 for parallel attach or 12A2405 for USB attach. Use of a substitute cable not properly shielded and grounded may result in a violation of FCC regulations.

Notices

Any questions regarding this compliance information statement should be directed to:

Director of Lexmark Technology & Services
Lexmark International, Inc.
740 West New Circle Road
Lexington, KY 40550
(859) 232-3000

Industry Canada compliance statement

This Class B digital apparatus meets all requirements of the Canadian Interference-Causing Equipment Regulations.

Avis de conformité aux normes de l'industrie du Canada

Cet appareil numérique de la classe B respecte toutes les exigences du Règlement sur le matériel brouilleur du Canada.

European Community (EC) directives conformity

This product is in conformity with the protection requirements of EC Council directives 89/336/EEC and 73/23/EEC on the approximation and harmonization of the laws of the Member States relating to electromagnetic compatibility and safety of electrical equipment designed for use within certain voltage limits.

A declaration of conformity with the requirements of the directives has been signed by the Director of Manufacturing and Technical Support, Lexmark International, S.A., Boigny, France.

This product satisfies the Class B limits of EN 55022 and safety requirements of EN 60950.

Japanese VCCI notice

If this symbol appears on your product, the accompanying statement is applicable.



この装置は、情報処理装置等電波障害自主規制協議会(VCCI)の基準に基づくクラスB情報技術装置です。この装置は、家庭環境で使用することを目的としていますが、この装置がラジオやテレビジョン受信機に近接して使用されると、受信障害を引き起こすことがあります。取扱説明書に従って正しい取り扱いをしてください。

Korean MIC statement

If this symbol appears on your product, the accompanying statement is applicable.



이 기기는 가정용으로 전자파적합등록을 한 기기로서 주거지역에서는 물론 모든 지역에서 사용할 수 있습니다.

This equipment has undergone EMC registration as a household product. It can be used in any area, including a residential area.

Notices

Exposure to radio frequency radiation

The radiated output power of this device is far below the FCC radio frequency exposure limits. A minimum separation of 20 cm (8 inches) must be maintained between the antenna and any persons for this device to satisfy the RF exposure requirements of the FCC.

The United Kingdom Telecommunications Act 1984

This apparatus is approved under the approval number NS/G/1234/J/100003 for the indirect connections to the public telecommunications systems in the United Kingdom.

Noise emission levels

Hinweis zum GS-Zeichen

Modell: T640, T642, T644

Gerätetyp: 061-000, 4061-200, 4061-400, 4061-010, 4061-210, and 4061-410

Postanschrift

Lexmark Deutschland GmbH

Postfach 1560

63115 Dietzenbach

Adresse

Lexmark Deutschland GmbH

Max-Planck-Straße 12

63128 Dietzenbach

Telefon: 0180 - 564 56 44 (Produktinformationen)

Telefon: 01805 - 51 25 11 (Technischer Kundendienst)

E-Mail: internet@lexmark.de

Die folgenden Messungen wurden gemäß ISO 7779 durchgeführt und gemäß ISO 9296 gemeldet.

Durchschnittlicher Schallpegel (dB(A)) in 1 m Umkreis			
	T640	T642	T644
Drucken	53	55	55
Leerlauf	30	30	30

German GS mark notice

Model: T640, T642, T644

Machine types: 061-000, 4061-200, 4061-400, 4061-010, 4061-210, and 4061-410

Mailing address

Lexmark Deutschland GmbH
Postfach 1560
63115 Dietzenbach

Physical address

Lexmark Deutschland GmbH
Max-Planck-Straße 12
63128 Dietzenbach

Phone: 0180 - 564 56 44 (Product Information)

Phone: 01805 - 51 25 11 (Technical Support)

E-mail: internet@lexmark.de

The following measurements were made in accordance with ISO 7779 and reported in conformance with ISO 9296.

1-meter average sound pressure, dBA			
	T640	T642	T644
Printing	53	55	55
Idling	30	30	30

ENERGY STAR



The EPA ENERGY STAR Office Equipment program is a partnership effort with office equipment manufacturers to promote the introduction of energy-efficient products and to reduce air pollution caused by power generation.

Companies participating in this program introduce products that power down when they are not being used. This feature will cut the energy used by up to 50 percent. Lexmark is proud to be a participant in this program.

As an ENERGY STAR Partner, Lexmark International, Inc. has determined that this product meets the ENERGY STAR guidelines for energy efficiency.

Waste from Electrical and Electronic Equipment (WEEE) directive



The WEEE logo signifies specific recycling programs and procedures for electronic products in countries of the European Union. We encourage the recycling of our products. If you have further questions about recycling options, visit the Lexmark Web site at www.lexmark.com for your local sales office phone number.

Laser advisory label

A laser notice label may be affixed to this printer.

LUOKAN 1 LASERLAITE

VAROITUS! Laitteen käyttäminen muulla kuin tässä käyttöohjeessa mainitulla tavalla saattaa altistaa käyttäjän turvallisuusluokan 1 ylittävälle näkymättömälle lasersäteilylle.

KLASS 1 LASER APPARAT

WARNING! Om apparaten används på annat sätt än i denna bruksanvisning specificerats, kan användaren utsättas för osynlig laserstrålning, som överskrider gränsen för laserklass 1.

Laser notice

The printer is certified in the U.S. to conform to the requirements of DHHS 21 CFR Subchapter J for Class I (1) laser products, and elsewhere is certified as a Class I laser product conforming to the requirements of IEC 60825-1.

Class I laser products are not considered to be hazardous. The printer contains internally a Class IIIb (3b) laser that is nominally a 5 milliwatt gallium arsenide laser operating in the wavelength region of 770-795 nanometers. The laser system and printer are designed so there is never any human access to laser radiation above a Class I level during normal operation, user maintenance, or prescribed service condition.

Statement of limited warranty

Lexmark International, Inc., Lexington, KY

This limited warranty applies to the United States and Canada. For customers outside the U.S., see the country-specific warranty information that came with your product.

This Statement of Limited Warranty applies to this product if it was originally purchased for your use, and not for resale, from Lexmark or a Lexmark remarketer, referred to in this statement as "Remarketer."

Warranty

Lexmark warrants that this product:

- Is manufactured from new parts, or new and serviceable used parts, which perform like new parts
- Is free from defects in material and workmanship

Notices

If this product does not function as warranted during the warranty period, contact a Remarketer or Lexmark for repair or replacement (at Lexmark's option).

If this product is a feature or option, this statement applies only when that feature or option is used with the product for which it was designed. To obtain warranty service, you may be required to present the feature or option with the product.

If you transfer this product to another user, warranty service under the terms of this statement is available to that user for the remainder of the warranty period. You should transfer proof of original purchase and this statement to that user.

Limited warranty service

The warranty period starts on the date of original purchase and ends 12 months later as shown on the purchase receipt provided that the warranty period for any supplies and for any maintenance items included with the printer shall end earlier if it, or its original contents, are substantially used up, depleted, or consumed. Fuser Units, Paper Feed items, and any other items for which a Maintenance Kit is available are substantially consumed when the printer displays a "Life Warning" or "Scheduled Maintenance" message for such item.

To obtain warranty service you may be required to present proof of original purchase. You may be required to deliver your product to the Remarketer or Lexmark, or ship it prepaid and suitably packaged to a Lexmark designated location. You are responsible for loss of, or damage to, a product in transit to the Remarketer or the Lexmark designated location.

When warranty service involves the exchange of a product or part, the item replaced becomes the property of the Remarketer or Lexmark. The replacement may be a new or repaired item.

The replacement item assumes the remaining warranty period of the original product.

Replacement is not available to you if the product you present for exchange is defaced, altered, in need of a repair not included in warranty service, damaged beyond repair, or if the product is not free of all legal obligations, restrictions, liens, and encumbrances.

Before you present this product for warranty service, remove all print cartridges, programs, data, and removable storage media (unless directed otherwise by Lexmark).

For further explanation of your warranty alternatives and the nearest Lexmark authorized servicer in your area, contact on the World Wide Web at <http://support.lexmark.com>.

Remote technical support is provided for this product throughout its warranty period. For products no longer covered by a Lexmark warranty, technical support may not be available or only be available for a fee.

Extent of limited warranty

Lexmark does not warrant uninterrupted or error-free operation of any product or the durability or longevity of prints produced by any product.

Warranty service does not include repair of failures caused by:

- Modification or unauthorized attachments
- Accidents, misuse, abuse or use inconsistent with Lexmark user's guides, manuals, instructions or guidance.
- Unsuitable physical or operating environment
- Maintenance by anyone other than Lexmark or a Lexmark authorized servicer
- Operation of a product beyond the limit of its duty cycle
- Use of printing media outside of Lexmark specifications
- Modification, refurbishment, repair, refilling or remanufacture of products by a third party, supplies or parts
- Products, supplies, parts, materials (such as toners and inks), software, or interfaces not furnished by Lexmark

TO THE EXTENT PERMITTED BY APPLICABLE LAW, NEITHER LEXMARK NOR ITS THIRD PARTY SUPPLIERS OR REMARKETERS MAKE ANY OTHER WARRANTY OR CONDITION OF ANY KIND, WHETHER EXPRESS OR IMPLIED, WITH RESPECT TO THIS PRODUCT, AND SPECIFICALLY DISCLAIM THE IMPLIED WARRANTIES OR CONDITIONS OF MERCHANTABILITY, FITNESS FOR A PARTICULAR PURPOSE, AND SATISFACTORY QUALITY. ANY WARRANTIES THAT MAY NOT BE DISCLAIMED UNDER APPLICABLE LAW ARE LIMITED IN DURATION TO THE WARRANTY PERIOD. NO WARRANTIES, EXPRESS OR IMPLIED, WILL APPLY AFTER THIS PERIOD. ALL INFORMATION, SPECIFICATIONS, PRICES, AND SERVICES ARE SUBJECT TO CHANGE AT ANY TIME WITHOUT NOTICE.

Limitation of liability

Notices

Your sole remedy under this limited warranty is set forth in this document. For any claim concerning performance or nonperformance of Lexmark or a Remarketer for this product under this limited warranty, you may recover actual damages up to the limit set forth in the following paragraph.

Lexmark's liability for actual damages from any cause whatsoever will be limited to the amount you paid for the product that caused the damages. This limitation of liability will not apply to claims by you for bodily injury or damage to real property or tangible personal property for which Lexmark is legally liable. IN NO EVENT WILL LEXMARK BE LIABLE FOR ANY LOST PROFITS, LOST SAVINGS, INCIDENTAL DAMAGE, OR OTHER ECONOMIC OR CONSEQUENTIAL DAMAGES. This is true even if you advise Lexmark or a Remarketer of the possibility of such damages. Lexmark is not liable for any claim by you based on a third party claim.

This limitation of remedies also applies to claims against any Suppliers and Remarketers of Lexmark. Lexmark's and its Suppliers' and Remarketers' limitations of remedies are not cumulative. Such Suppliers and Remarketers are intended beneficiaries of this limitation.

Additional rights

Some states do not allow limitations on how long an implied warranty lasts, or do not allow the exclusion or limitation of incidental or consequential damages, so the limitations or exclusions contained above may not apply to you.

This limited warranty gives you specific legal rights. You may also have other rights that vary from state to state.

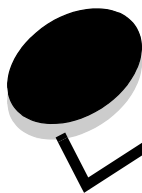

Index

Numerics

2000-sheet drawer 7
250 sheet drawer 7
42.xy Cartridge region mismatch 103
500 sheet drawer 7
5-bin Mailbox 7

A

adjust paper tray 44, 45
adjusting
 Power Saver 98
automatic size sensing 57
automatic tray linking 57

B

Back button 9
brightness, LCD 96
button
 back 9
 menu 9
 stop 9

C

canceling a print job 38
card stock
 guidelines 72
 loading 44
cartridge region mismatch 103
characteristics, paper 69
characteristics, print media 69
 paper 69
charge roll 78
clearing jams 80
confidential jobs 40
 entering a PIN 40
 sending 40
Configured models 7
contrast, LCD 96

D

disabling operator panel menus 96
Duplex unit 7

E

edition notice 2
electrical emission statement 116

Embedded Web Server
 setting security 99
 using secured 100
emission statement 116
enabling operator panel menus 97
Envelope feeder 7
envelopes
 guidelines 70
 loading
 envelope feeder 55

F

FCC statement 116

G

guidelines
 print media 69

H

held jobs
 confidential jobs 40
 entering a PIN 40

I

Identifying printers 6
integrated forms 65, 68
Internet Protocol Security 100

J

jams
 avoiding 73
 clearing 80

L

label fuser cleaner 78
labels
 guidelines 71
laser notices 120
LCD brightness 96
LCD contrast 96
letterhead
 loading
 input tray 46, 50, 54
Lexmark Authorized Supplies Dealers 74
linking 57
 trays 57
Linux 16, 24

- load line 46, 51
- loading print media
 - card stock 44
 - envelopes
 - envelope feeder 55
 - letterhead
 - input tray 46, 50, 54
 - paper
 - input tray 44
 - multipurpose feeder 48
 - transparencies
 - input tray 44

M

- Macintosh 11, 15, 22, 23, 38, 39, 41, 42, 43, 70, 111
- maintaining the printer 74
 - ordering a print cartridge 76
- maintenance
 - staple cartridge 78
- maximum sheets for stapling 106
- maximum stack height 50
- Menu button 9
- models 6
- multipurpose feeder
 - closing 52
 - guidelines 48
 - icons 48
 - print media
 - loading 50
 - transparencies 49

N

- NetWare 24
- network setup page 17
- notice, edition 2

O

- operator panel 17
 - brightness 96
 - contrast 96
 - disabling menus 96
 - enabling menus 97
- ordering, print cartridge 76

P

- paper
 - characteristics 69
 - supported media 60
 - understanding 60
 - unsatisfactory 69
 - weight 69
- paper tray adjustment 44, 45
- paper unacceptable 69
- photoconductor kit
 - recycling 78
- pick rollers 78

- PIN
 - entering at the printer 41
 - entering from the driver 40
 - for confidential jobs 40
- Power Saver, adjusting 98
- print cartridge
 - ordering 76
- print media
 - guidelines 69
 - paper 69
 - transparencies
 - guidelines 70
- Print media guidelines 69
- print media jams
 - avoiding 73
- print media specifications
 - characteristics 69
 - sizes 61
 - types 63
 - weight 64
- Printing 36
- problems
 - incorrect characters print 105
 - job didn't print 104
 - job prints 105
 - from wrong tray 105
 - on wrong paper or specialty media 105
 - large jobs do not collate 105
 - operator panel 104
 - blank 104
 - displays black diamonds 104
 - paper feed
 - blank pages in output bin 109
 - frequent jams 109
 - jammed page does not reprint 109
 - Paper Jam message remains after clearing jam 109
 - print time seems long 105
 - tray linking does not work 105
 - unexpected page breaks 105
- publications
 - Card Stock & Label Guide* 60

R

- recycling supplies 78
- repeat print 42
- replacing
 - staple cartridge 78
- reserve print 42

S

- safety information 2
- Secure mode 101
- security
 - 802.1x Authenticating 101
 - Confidential Print Setup 102
 - locking operator panel menus 102

- printing lockout 102
- Secure mode 101
- setting
 - system password 99
 - using Embedded Web Server 99
- supporting
 - IPSec 100
 - Simple Network Management Protocol 100
 - using secure Embedded Web Server 100
- Sending a job to print 36
- side guide 44, 45
- Simple Network Management Protocol, security 100
- standard tray 7
- staple and offset unit
 - replacing staples 78
- staple cartridge, replacing 78
- StapleSmart
 - replacing staples 78
- stapling, maximum number 106
- Stop button 9
- supplies
 - label fuser cleaner 78
 - maintenance kit 77
 - print cartridge 76
 - recycling 78

T

- toner cartridge
 - recycling 78
- transfer roller 78
- transparencies
 - loading
 - input tray 44
- tray linking 57

U

- UNIX 16, 24
- USB Direct interface 36
- USB flash memory device 36

V

- verify print 42

W

- warranty 120
- weight, paper 69
- width guide 44, 45
- Windows 11, 18