



***msi***<sup>™</sup>

**Z77A-GD65**

**series**

MS-7751 (v2.x) Mainboard

G52-77511XC

## Copyright Notice

---

The material in this document is the intellectual property of **MICRO-STAR INTERNATIONAL**. We take every care in the preparation of this document, but no guarantee is given as to the correctness of its contents. Our products are under continual improvement and we reserve the right to make changes without notice.

## Trademarks

---

All trademarks in this manual are properties of their respective owners.

- MSI® is registered trademark of Micro-Star Int'l Co.,Ltd.
- NVIDIA® is registered trademark of NVIDIA Corporation.
- ATI® is registered trademark of AMD Corporation.
- AMD® is registered trademarks of AMD Corporation.
- Intel® is registered trademarks of Intel Corporation.
- Windows® is registered trademarks of Microsoft Corporation.
- AMI® is registered trademark of American Megatrends Inc.
- Award® is a registered trademark of Phoenix Technologies Ltd.
- Sound Blaster® is registered trademark of Creative Technology Ltd.
- Realtek® is registered trademark of Realtek Semiconductor Corporation.
- JMicron® is registered trademark of JMicron Technology Corporation.
- Netware® is registered trademark of Novell, Inc.
- Lucid® is trademark of LucidLogix Technologies, Ltd.
- VIA® is registered trademark of VIA Technologies, Inc.
- ASMedia® is registered trademark of ASMedia Technology Inc.
- iPad, iPhone, and iPod are trademarks of Apple Inc.

## Revision History

---

Revision	Revision History	Date
V2.0	First release	2011/12
V2.1	Add PCIe x16 support table	2012/01
V2.2	Update specification	2012/02

## Technical Support

---

If a problem arises with your system and no solution can be obtained from the user's manual, please contact your place of purchase or local distributor. Alternatively, please try the following help resources for further guidance.

- ☐ Visit the MSI website for technical guide, BIOS updates, driver updates, and other information: <http://www.msi.com/service/download>
- ☐ Contact our technical staff at: <http://support.msi.com>

## Safety Instructions

---

- Always read the safety instructions carefully.
- Keep this User's Manual for future reference.
- Keep this equipment away from humidity.
- Lay this equipment on a reliable flat surface before setting it up.
- The openings on the enclosure are for air convection hence protects the equipment from overheating. **DO NOT COVER THE OPENINGS.**
- Make sure the voltage of the power source is at 110/220V before connecting the equipment to the power inlet.
- Place the power cord such a way that people can not step on it. Do not place anything over the power cord.
- Always Unplug the Power Cord before inserting any add-on card or module.
- All cautions and warnings on the equipment should be noted.
- Never pour any liquid into the opening that can cause damage or cause electrical shock.
- If any of the following situations arises, get the equipment checked by service personnel:
  - The power cord or plug is damaged.
  - Liquid has penetrated into the equipment.
  - The equipment has been exposed to moisture.
  - The equipment does not work well or you can not get it work according to User's Manual.
  - The equipment has been dropped and damaged.
  - The equipment has obvious sign of breakage.
- **DO NOT LEAVE THIS EQUIPMENT IN AN ENVIRONMENT ABOVE 60°C (140°F), IT MAY DAMAGE THE EQUIPMENT.**

## FCC-B Radio Frequency Interference Statement

This equipment has been tested and found to comply with the limits for a Class B digital device, pursuant to Part 15 of the FCC Rules. These limits are designed to provide reasonable protection against harmful interference in a residential installation. This equipment generates, uses and can radiate radio frequency energy and, if not installed and used in accordance with the instructions, may cause harmful interference to radio communications. However, there is no guarantee that interference will not occur in a particular installation. If this equipment does cause harmful interference to radio or television reception, which can be determined by turning the equipment off and on, the user is encouraged to try to correct the interference by one or more of the measures listed below.



- Reorient or relocate the receiving antenna.
- Increase the separation between the equipment and receiver.
- Connect the equipment into an outlet on a circuit different from that to which the receiver is connected.
- Consult the dealer or an experienced radio/television technician for help.

### Notice 1

The changes or modifications not expressly approved by the party responsible for compliance could void the user's authority to operate the equipment.

### Notice 2

Shielded interface cables and A.C. power cord, if any, must be used in order to comply with the emission limits.

VOIR LA NOTICE D'INSTALLATION AVANT DE RACCORDER AU RESEAU.

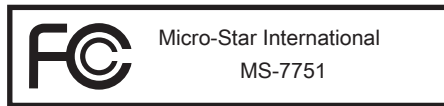

This device complies with Part 15 of the FCC Rules. Operation is subject to the following two conditions:

- 1) this device may not cause harmful interference, and
- 2) this device must accept any interference received, including interference that may cause undesired operation.



## Battery Information

---



European Union:

Batteries, battery packs, and accumulators should not be disposed of as unsorted household waste. Please use the public collection system to return, recycle, or treat them in compliance with the local regulations.



Taiwan:

For better environmental protection, waste batteries should be collected separately for recycling or special disposal.

廢電池請回收

California, USA:

The button cell battery may contain perchlorate material and requires special handling when recycled or disposed of in California.

For further information please visit:

<http://www.dtsc.ca.gov/hazardouswaste/perchlorate/>

**CAUTION:** There is a risk of explosion, if battery is incorrectly replaced.

Replace only with the same or equivalent type recommended by the manufacturer.

## Chemical Substances Information

---

In compliance with chemical substances regulations, such as the EU REACH Regulation (Regulation EC No. 1907/2006 of the European Parliament and the Council), MSI provides the information of chemical substances in products at:

[http://www.msi.com/html/popup/csr/evmtprrt\\_pcm.html](http://www.msi.com/html/popup/csr/evmtprrt_pcm.html)

## BSMI EMI 聲明

---

警告使用者:

這是甲類資訊產品，在居住的環境中使用時，可能會造成無線電干擾，在這種情況下，使用者會被要求採取某些適當的對策。

## WEEE (Waste Electrical and Electronic Equipment) Statement

### ENGLISH

To protect the global environment and as an environmentalist, MSI must remind you that...



Under the European Union ("EU") Directive on Waste Electrical and Electronic Equipment, Directive 2002/96/EC, which takes effect on August 13, 2005, products of "electrical and electronic equipment" cannot be discarded as municipal wastes anymore, and manufacturers of covered electronic equipment will be obligated to take back such products at the end of their useful life. MSI will comply with the product take back requirements at the end of life of MSI-branded products that are sold into the EU. You can return these products to local collection points.

### DEUTSCH

Hinweis von MSI zur Erhaltung und Schutz unserer Umwelt

Gemäß der Richtlinie 2002/96/EG über Elektro- und Elektronik-Altgeräte dürfen Elektro- und Elektronik-Altgeräte nicht mehr als kommunale Abfälle entsorgt werden. MSI hat europaweit verschiedene Sammel- und Recyclingunternehmen beauftragt, die in die Europäische Union in Verkehr gebrachten Produkte, am Ende seines Lebenszyklus zurückzunehmen. Bitte entsorgen Sie dieses Produkt zum gegebenen Zeitpunkt ausschliesslich an einer lokalen Altgerätesammelstelle in Ihrer Nähe.

### FRANÇAIS

En tant qu'écologiste et afin de protéger l'environnement, MSI tient à rappeler ceci...

Au sujet de la directive européenne (EU) relative aux déchets des équipement électriques et électroniques, directive 2002/96/EC, prenant effet le 13 août 2005, que les produits électriques et électroniques ne peuvent être déposés dans les décharges ou tout simplement mis à la poubelle. Les fabricants de ces équipements seront obligés de récupérer certains produits en fin de vie. MSI prendra en compte cette exigence relative au retour des produits en fin de vie au sein de la communauté européenne. Par conséquent vous pouvez retourner localement ces matériels dans les points de collecte.

### РУССКИЙ

Компания MSI предпринимает активные действия по защите окружающей среды, поэтому напоминаем вам, что...

В соответствии с директивой Европейского Союза (ЕС) по предотвращению загрязнения окружающей среды использованным электрическим и электронным оборудованием (директива WEEE 2002/96/ЕС), вступающей в силу 13 августа 2005 года, изделия, относящиеся к электрическому и электронному оборудованию, не могут рассматриваться как бытовой мусор, поэтому производители вышеперечисленного электронного оборудования обязаны принимать его для переработки по окончании срока службы. MSI обязуется соблюдать требования по приему продукции, проданной под маркой MSI на территории ЕС, в переработку по окончании срока службы. Вы можете вернуть эти изделия в специализированные пункты приема.

## ESPAÑOL

MSI como empresa comprometida con la protección del medio ambiente, recomienda: Bajo la directiva 2002/96/EC de la Unión Europea en materia de desechos y/o equipos electrónicos, con fecha de rígor desde el 13 de agosto de 2005, los productos clasificados como "eléctricos y equipos electrónicos" no pueden ser depositados en los contenedores habituales de su municipio, los fabricantes de equipos electrónicos, están obligados a hacerse cargo de dichos productos al termino de su período de vida. MSI estará comprometido con los términos de recogida de sus productos vendidos en la Unión Europea al final de su periodo de vida. Usted debe depositar estos productos en el punto limpio establecido por el ayuntamiento de su localidad o entregar a una empresa autorizada para la recogida de estos residuos.

## NEDERLANDS

Om het milieu te beschermen, wil MSI u eraan herinneren dat...

De richtlijn van de Europese Unie (EU) met betrekking tot Vervuiling van Electriche en Electronische producten (2002/96/EC), die op 13 Augustus 2005 in zal gaan kunnen niet meer beschouwd worden als vervuiling. Fabrikanten van dit soort producten worden verplicht om producten retour te nemen aan het eind van hun levenscyclus. MSI zal overeenkomstig de richtlijn handelen voor de producten die de merknaam MSI dragen en verkocht zijn in de EU. Deze goederen kunnen geretourneerd worden op lokale inzamelingspunten.

## SRPSKI

Da bi zaštitili prirodnu sredinu, i kao preduzeće koje vodi računa o okolini i prirodnoj sredini, MSI mora da vas podesti da...

Po Direktivi Evropske unije ("EU") o odbačenju eelektronskoj i električnoj opremi, Direktiva 2002/96/EC, koja stupa na snagu od 13. Avgusta 2005, proizvodi koji spadaju pod "elektronsku i električnu opremu" ne mogu više biti odbačeni kao običan otpad i proizvođači ove opreme biće prinuđeni da uzmu natrag ove proizvode na kraju njihovog uobičajenog veka trajanja. MSI će poštovati zahtev o preuzimanju ovakvih proizvoda kojima je istekao vek trajanja, koji imaju MSI oznaku i koji su prodati u EU. Ove proizvode možete vratiti na lokalnim mestima za prikupljanje.

## POLSKI

Aby chronić nasze środowisko naturalne oraz jako firma dbająca o ekologię, MSI przypomina, że...

Zgodnie z Dyrektywą Unii Europejskiej ("UE") dotyczącą odpadów produktów elektrycznych i elektronicznych (Dyrektywa 2002/96/EC), która wchodzi w życie 13 sierpnia 2005, tzw. "produkty oraz wyposażenie elektryczne i elektroniczne" nie mogą być traktowane jako śmieci komunalne, tak więc producenci tych produktów będą zobowiązani do odbierania ich w momencie gdy produkt jest wycofywany z użycia. MSI wypełni wymagania UE, przyjmując produkty (sprzedawane na terenie Unii Europejskiej) wycofywane z użycia. Produkty MSI będzie można zwracać w wyznaczonych punktach zbiorczych.

## TÜRKÇE

Çevreci özelliğiyle bilinen MSI dünyada çevreyi korumak için hatırlatır:

Avrupa Birliği (AB) Kararnamesi Elektrik ve Elektronik Malzeme Atığı, 2002/96/EC Kararnamesi altında 13 Ağustos 2005 tarihinden itibaren geçerli olmak üzere, elektrikli ve elektronik malzemeler diğer atıklar gibi çöpe atılmayacak ve bu elektronik cihazların üreticileri, cihazların kullanım süreleri bittikten sonra ürünleri geri toplamakla yükümlü olacaktır. Avrupa Birliği'ne satılan MSI markalı ürünlerin kullanım süreleri bittiğinde MSI ürünlerin geri alınması isteği ile işbirliği içerisinde olacaktır. Ürünlerinizi yerel toplama noktalarına bırakabilirsiniz.

## ČESKY

Záleží nám na ochraně životního prostředí - společnost MSI upozorňuje...

Podle směrnice Evropské unie ("EU") o likvidaci elektrických a elektronických výrobků 2002/96/EC platné od 13. srpna 2005 je zakázáno likvidovat "elektrické a elektronické výrobky" v běžném komunálním odpadu a výrobci elektrických výrobků, na které se tato směrnice vztahuje, budou povinni odebírat takové výrobky zpět po skončení jejich životnosti. Společnost MSI splní požadavky na odebírání výrobků značky MSI, prodávaných v zemích EU, po skončení jejich životnosti. Tyto výrobky můžete odevzdat v místních sběrnách.

## MAGYAR

Annak érdekében, hogy környezetünket megvédjük, illetve környezetvédőként fellépve az MSI emlékezteti Önt, hogy ...

Az Európai Unió („EU”) 2005. augusztus 13-án hatályba lépő, az elektromos és elektronikus berendezések hulladékairól szóló 2002/96/EK irányelve szerint az elektromos és elektronikus berendezések többé nem kezelhetőek lakossági hulladékként, és az ilyen elektronikus berendezések gyártói köteleessé válnak az ilyen termékek visszavételére azok hasznos élettartama végén. Az MSI betartja a termékvisszavétellel kapcsolatos követelményeket az MSI márkanev alatt az EU-n belül értékesített termékek esetében, azok élettartamának végén. Az ilyen termékeket a legközelebbi gyűjtőhelyre viheti.

## ITALIANO

Per proteggere l'ambiente, MSI, da sempre amica della natura, ti ricorda che....

In base alla Direttiva dell'Unione Europea (EU) sullo Smaltimento dei Materiali Elettrici ed Elettronici, Direttiva 2002/96/EC in vigore dal 13 Agosto 2005, prodotti appartenenti alla categoria dei Materiali Elettrici ed Elettronici non possono più essere eliminati come rifiuti municipali: i produttori di detti materiali saranno obbligati a ritirare ogni prodotto alla fine del suo ciclo di vita. MSI si adegnerà a tale Direttiva ritirando tutti i prodotti marchiati MSI che sono stati venduti all'interno dell'Unione Europea alla fine del loro ciclo di vita. È possibile portare i prodotti nel più vicino punto di raccolta

# CONTENTS

Copyright Notice .....	ii
Trademarks .....	ii
Revision History.....	ii
Technical Support.....	iii
Safety Instructions.....	iii
FCC-B Radio Frequency Interference Statement.....	iv
Battery Information .....	v
Chemical Substances Information.....	v
BSMI EMI 聲明 .....	v
WEEE (Waste Electrical and Electronic Equipment) Statement .....	vi
<b>Chapter 1 Getting Started.....</b>	<b>1-1</b>
Packing Contents .....	1-2
Optional Accessories .....	1-2
Assembly Precautions.....	1-3
Mainboard Specifications .....	1-4
Connectors Quick Guide.....	1-6
Back Panel Quick Guide .....	1-8
CPU (Central Processing Unit) .....	1-10
Mounting Screw Holes .....	1-14
Power Supply .....	1-15
Memory .....	1-16
Expansion Slots .....	1-18
Video/ Graphics Cards .....	1-19
Internal Connectors.....	1-24
Buttons .....	1-32
Jumpers .....	1-34
Switch.....	1-35
LED Status Indicators .....	1-36
<b>Chapter 2 BIOS Setup.....</b>	<b>2-1</b>
Entering.....	2-2
Overview .....	2-2
Boot device priority bar .....	2-3
Operation .....	2-4
SETTINGS .....	2-5
OC.....	2-10

ECO .....	2-17
BROWSER.....	2-18
Installing Winki .....	2-18
UTILITIES .....	2-19
Updating the BIOS with Live Update.....	2-21
SECURITY .....	2-22
<b>Appendix A Realtek Audio.....</b>	<b>A-1</b>
Installing the Realtek HD Audio Driver.....	A-2
Software Configuration.....	A-3
Hardware Default Setting.....	A-5
<b>Appendix B Intel RAID.....</b>	<b>B-1</b>
Introduction .....	B-2
Using Intel Rapid Storage Technology Option ROM.....	B-3
Installing Driver .....	B-10
Degraded RAID Array .....	B-12
System Acceleration (optional) .....	B-14
RST Synchronization (optional) .....	B-16

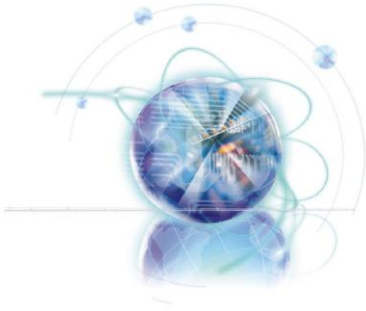

## Chapter 1

# Getting Started

Thank you for choosing the **Z77A-GD65** Series (MS-7751 v2.X) ATX mainboard. The Series mainboards are based on **Intel® Z77** chipset for optimal system efficiency. Designed to fit the advanced **Intel® LGA1155** processor, the **Z77A-GD65** Series mainboards deliver a high performance and professional desktop platform solution.

## Packing Contents

---

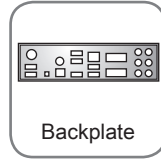

## Optional Accessories

---

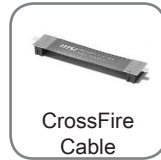

\* These pictures are for reference only and may vary without notice.

\* The packing contents may vary according to the model you purchased.

\* If you need to purchase the optional accessories or request part numbers, please visit the MSI website at <http://www.msi.com/index.php> or consult the dealer.



## Assembly Precautions

---

- The components included in this package are prone to damage from electrostatic discharge (ESD). Please adhere to the following instructions to ensure successful computer assembly.
- Always turn off the power supply and unplug the power cord from the power outlet before installing or removing any computer component.
- Ensure that all components are securely connected. Loose connections may cause the computer to not recognize a component or fail to start.
- Hold the mainboard by the edges to avoid touching sensitive components.
- It is recommended to wear an electrostatic discharge (ESD) wrist strap when handling the mainboard to prevent electrostatic damage. If an ESD wrist strap is not available, discharge yourself of static electricity by touching another metal object before handling the mainboard.
- Store the mainboard in an electrostatic shielding container or on an antistatic pad whenever the mainboard is not installed.
- Before turning on the computer, ensure that there are no loose screws or metal components on the mainboard or anywhere within the computer case.
- Do not use the computer in a high-temperature environment.
- Do not boot the computer before installation is completed. This could cause permanent damage to the components as well as injury to the user.
- If you need help during any installation step, please consult a certified computer technician.

### **Important**

*A screwdriver (not included) may be required for computer assembly.*

## Mainboard Specifications

---

### Processor Support

- 3rd Generation Intel® Core™ i7 / Core™ i5 / Core™ i3 / Pentium® / Celeron® processors in an LGA 1155 socket  
(For the latest information about CPU, please visit <http://www.msi.com/service/cpu-support>)

### Chipset

- Intel® Z77 chipset

### Memory Support

- 4x DDR3 DIMMs support DDR3 2667\*(OC)/ 2400\*(OC)/ 2133\*(OC)/ 1866\*(OC)/ 1600/ 1333/ 1066 DRAM (32GB Max)
- Supports Dual-Channel mode  
(\*OC = OverClocking, for more information on compatible components, please visit <http://www.msi.com/service/test-report>)

### LAN

- Supports LAN 10/100/1000 Fast Ethernet by Intel® 82579V

### Audio

- Integrated HD audio codec by Realtek® ALC898
- 8-channel audio with jack sensing
- Compliant with Azalia 1.0 Spec

### SATA

- 4x SATA 6Gb/s ports
  - (SATA1~2) by Intel® Z77
  - (SATA7~8) by Asmedia® ASM1061\*\*
  - (\*\*If you set external SATA 6Gb/s ports to AHCI mode, we highly recommend that you install Windows 7.)
- 4x SATA 3Gb/s ports
  - (SATA3~6) by Intel® Z77

### RAID

- SATA1~6 support Intel® Rapid Storage Technology enterprise (AHCI/ RAID 0/ 1/ 5/ 10) by Intel® Z77

### USB 3.0

- 2x USB 3.0 rear IO ports by Intel® Z77
- 1x USB 3.0 onboard connector by Intel® Z77

### Multi-GPU





- Supports ATI® CrossFire™ Technology
- Supports NVIDIA® SLI™ Technology
- Supports Lucid® Virtu Universal MVP

## Connectors & Buttons

- Back panel
  - 1x PS/2 keyboard/ mouse port
  - 1x Clear CMOS button
  - 1x Coaxial S/PDIF-out port
  - 1x Optical S/PDIF-out port
  - 4x USB 2.0 ports
  - 2x USB 3.0 ports
  - 1x LAN port
  - 6x audio ports
  - 1x HDMI® port\*\*\*, supporting a maximum resolution of 1920x1200
  - 1x DVI-D port\*\*\*, supporting a maximum resolution of 1920x1200
  - 1x VGA port\*\*\*
  - \*\*\* This platform supports dual-display function by any two output ports (HDMI+DVI, DVI+VGA or VGA+HDMI).
- On-Board
  - 3x USB 2.0 connectors
  - 1x USB 3.0 connector
  - 1x IEEE 1394 connector
  - 1x Multi BIOS Switch
  - 1x TPM Module connector
  - 1x Front Panel Audio connector
  - 1x Chassis Intrusion connector
  - 1x Voice Genie connector (optional)
  - 1x MultiConnect Panel connector (optional)
  - 1x V-Check Points Set

## Slots

- 3x PCIe 3.0 x16 slots

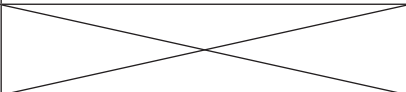
PCIe x16 slots support table	
When installing 3rd Gen Intel® Core™ i7/ Core™ i5/ Core™ i3/ Pentium®/ Celeron® processors	When installing 2nd Gen Intel® Core™ i7/ Core™ i5/ Core™ i3/ Pentium®/ Celeron® processors
16/0/0 	16/0/X 
8/8/0 	8/8/X 
8/4/4 	

- 4x PCIe 2.0 x1 slots

## Form Factor

- ATX (30.5 cm X 24.5 cm)

## Mounting Screw Holes

- 9x mounting holes

# Connectors Quick Guide

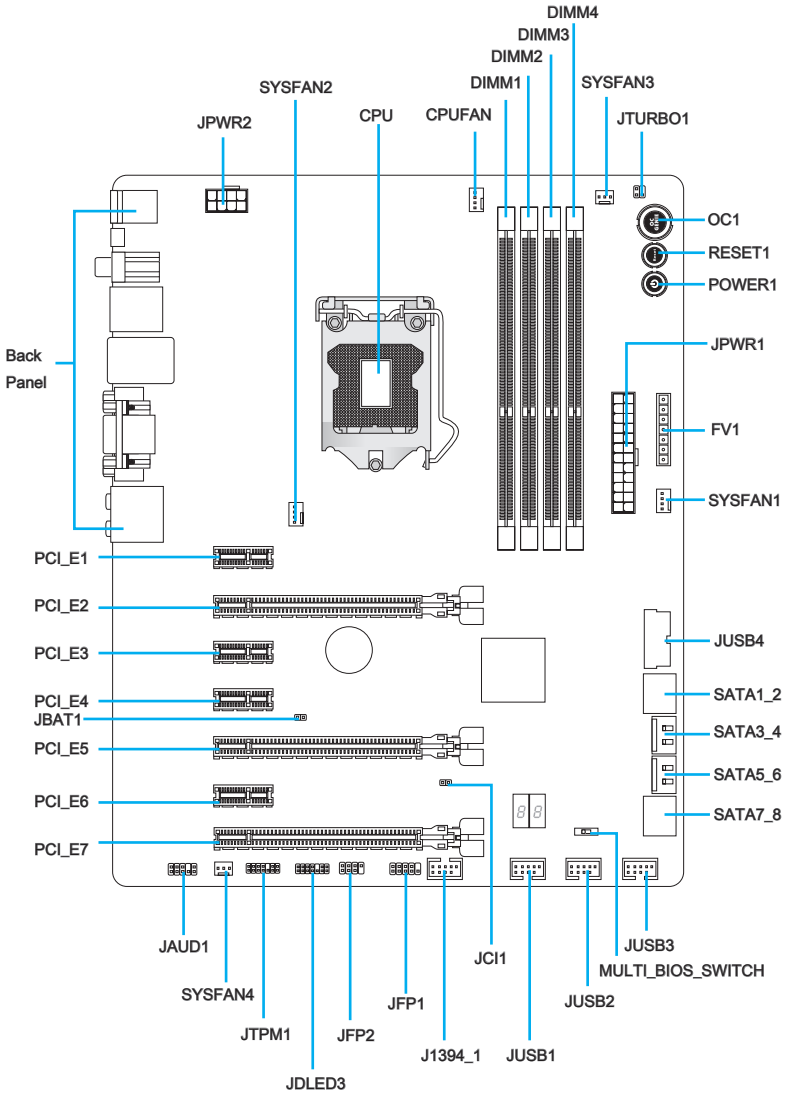

## Connectors Reference Guide

Port Name	Port Type	Page
Back Panel		1-8
CPU	LGA1155 CPU Socket	1-10
CPUFAN,SYSFAN1~4	Fan Power Connectors	1-25
DIMM1~4	DDR3 Memory Slots	1-16
FV1	Voltage Checkpoints Connector	1-31
J1394_1	IEEE1394 Expansion Connector	1-30
JAUD1	Front Panel Audio Connector	1-26
JBAT1	Clear CMOS Jumper	1-34
JCI1	Chassis Intrusion Connector	1-28
JDLED3	Voice Genie Connector	1-29
JFP1, JFP2	Front Panel Connectors	1-26
JPWR1	ATX 24-pin Power Connector	1-15
JPWR2	ATX 8-pin Power Connector	1-15
JTPM1	TPM Module connector	1-29
JTURBO1	MultiConnect Panel Connector	1-30
JUSB1~3	USB 2.0 Expansion Connectors	1-27
JUSB4	USB 3.0 Expansion Connector	1-28
MULTI BIOS SWITCH	Multi BIOS Switch	1-35
OC1	OC Genie Button	1-32
PCI_E2, 5, 7	PCIe x16 Expansion Slots	1-18
PCI_E1, 3, 4, 6	PCIe x1 Expansion Slots	1-18
POWER1	Power Button	1-33
RESET1	Reset Button	1-33
SATA1~2, 7~8	SATA 6Gb/s Connectors	1-24
SATA3~6	SATA 3Gb/s Connectors	1-24

## Back Panel Quick Guide

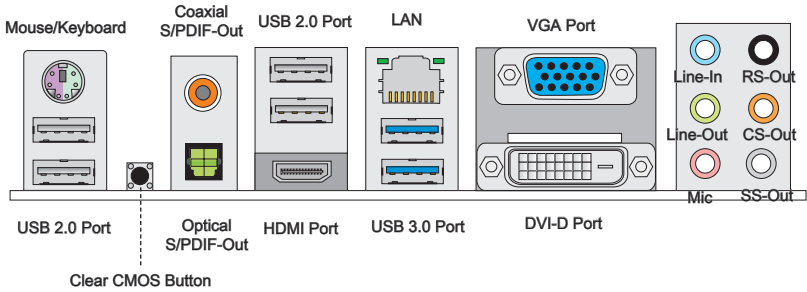

### ▶ Mouse/Keyboard

A combination PS/2® mouse/keyboard DIN connector for a PS/2® mouse/keyboard.

### ▶ Clear CMOS Button

There is CMOS RAM present on board that is powered by an external battery to store system configuration data. Using CMOS RAM, the system can automatically boot into the operating system (OS) every time it is turned on. If you wish to clear the system configuration, press the button to clear the data.

### ▶ Coaxial S/PDIF-Out

This S/PDIF (Sony & Philips Digital Interconnect Format) connector is provided for digital audio transmission to external speakers through an coaxial cable.

### ▶ Optical S/PDIF-Out

This S/PDIF (Sony & Philips Digital Interconnect Format) connector is provided for digital audio transmission to external speakers through an optical fiber cable.

### ▶ USB 2.0 Port

The USB 2.0 port is for attaching USB 2.0 devices such as keyboard, mouse, or other USB 2.0-compatible devices.

### ▶ USB 3.0 Port

USB 3.0 port is backward-compatible with USB 2.0 devices. It supports data transfer rate up to 5 Gbit/s (SuperSpeed).

## **Important**

*In order to use USB 3.0 devices, you must connect to a USB 3.0 port. If a USB cable is used, it must be USB 3.0 compliant.*

### ► LAN

The standard RJ-45 LAN jack is for connecting to a Local Area Network (LAN).

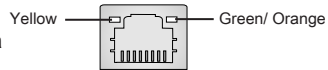

LED	Color	LED State	Condition
Left	Yellow	Off	LAN link is not established.
		On(Steady)	LAN link is established.
		On(flashing)	The computer is communicating with another computer on the network.
Right	Green	Off	10 Mbits/sec data rate
		On	100 Mbits/sec data rate
	Orange	On	1000 Mbits/sec data rate

## HDMI™

HIGH-DEFINITION MULTIMEDIA INTERFACE

### ► HDMI Port

The High-Definition Multimedia Interface (HDMI) is an all-digital audio-video interface that is capable of transmitting uncompressed streams. HDMI supports all types of TV formats, including standard, enhanced, or high-definition video, plus multi-channel digital audio on a single cable.

### ► VGA Port

The DB15-pin female connector is provided for monitor.

### ► DVI-D Port

The DVI-D (Digital Visual Interface- Digital) connector can be connected to a LCD monitor, or a CRT monitor with an adapter. To connect a monitor, please refer to the monitor's manual for more information.

### **Important**

*This platform supports dual-display function by any two output ports (HDMI+DVI, DVI+VGA or VGA+HDMI).*

	HDMI+DVI	DVI+VGA	VGA+HDMI
Extend mode (Extend the desktop to the second monitor)	○	○	○
Clone mode (Two monitors have the same screen)	○	○	○

### ► Audio Ports

These connectors are used for audio devices. The color of the jack refers to the function of the connector.

- Blue-Line in: Used for connecting external audio outputting devices.
- Green- Line out: Used as a connector for speakers or headphone.
- Pink- Mic: Used as a connector for a microphone.
- Black- RS-Out: Rear surround sound line out in 4/ 5.1/ 7.1 channel mode.
- Orange- CS-Out: Center/ subwoofer line out in 5.1/ 7.1 channel mode.
- Gray- SS-Out: Side surround sound line out in 7.1 channel mode.

## CPU (Central Processing Unit)

### Introduction to the LGA 1155 CPU

The surface of the LGA 1155 CPU has two alignment keys and a yellow triangle to assist in correctly lining up the CPU for mainboard placement. The yellow triangle is the Pin 1 indicator.

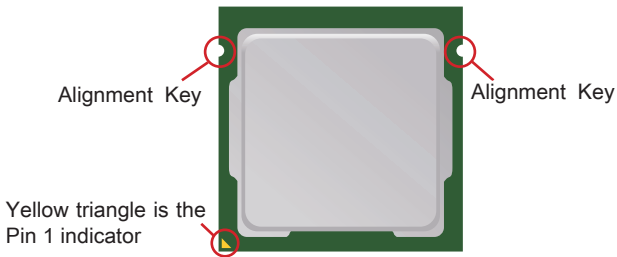

### **Important**

#### **Overheating**

Overheating can seriously damage the CPU and mainboard. Always make sure the cooling fans work properly to protect the CPU from overheating. Be sure to apply an even layer of thermal paste (or thermal tape) between the CPU and the heatsink to enhance heat dissipation.

#### **Replacing the CPU**

When replacing the CPU, always turn off the system's power supply and unplug the power supply's power cord to ensure the safety of the CPU.

#### **Overclocking**

This mainboard is designed to support overclocking. Before attempting to overclock, please make sure that all other system components can tolerate overclocking. Any attempt to operate beyond product specifications is not recommend. MSI does not guarantee the damages or risks caused by inadequate operation beyond product specifications.



## CPU & Cooler Installation

When installing a CPU, always remember to install a CPU cooler. A CPU cooler is necessary to prevent overheating and maintain system stability. Follow the steps below to ensure correct CPU and CPU cooler installation. Wrong installation can damage both the CPU and the mainboard.

1. Unhook and lift the loading lever to the fully open position.
2. The loading plate should automatically lift up as the loading lever is pushed to the fully open position. **Do not touch any of the CPU socket pins.**

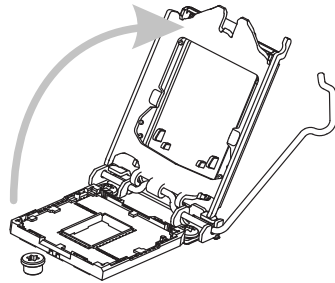
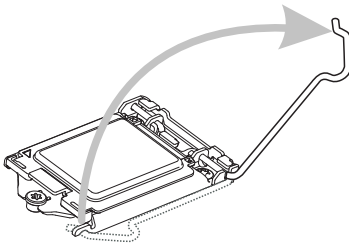

3. Line up the CPU to fit the CPU socket. Be sure to hold the CPU by the base with the metal contacts facing downward. The alignment keys on the CPU will line up with the edges of the CPU socket to ensure a correct fit.
4. Close the loading plate and remove the plastic protective cap.

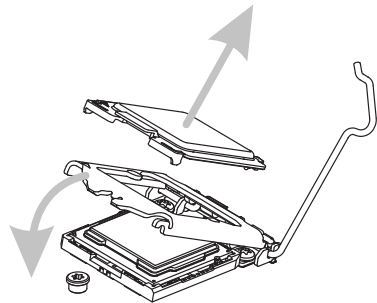
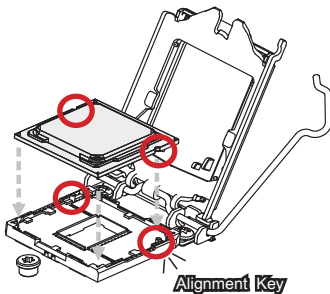

## Getting Started

5. Inspect the CPU to check if it is properly seated in the socket. Press the loading lever down and lock it under the retention tab.

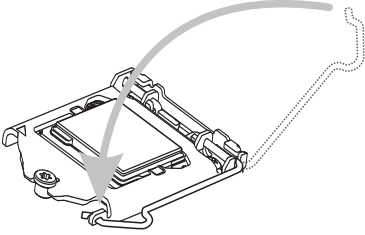

6. Evenly spread a thin layer of thermal paste (or thermal tape) on the top of the CPU. This will help in heat dissipation and prevent CPU overheating.

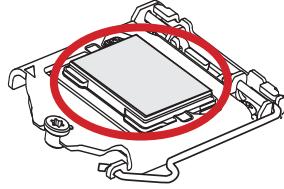

7. Locate the CPU fan connector on the mainboard.

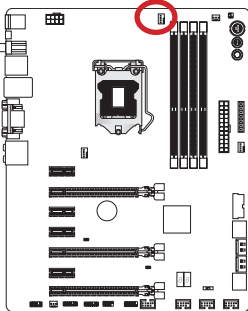

8. Place the heatsink on the mainboard with the fan's wires facing towards the fan connector and the hooks matching the holes on the mainboard.

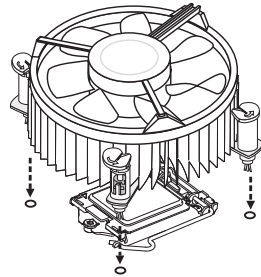

9. Push down on the heatsink until the four clips get wedged into the holes on the mainboard. Press the four hooks down to fasten the cooler. As each hook locks into position a click should be heard.
10. Inspect the mainboard to ensure that the clip-ends have been properly locked in place.

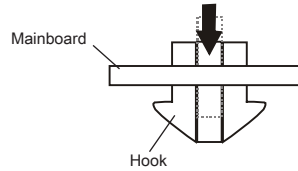
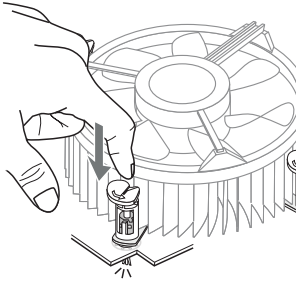

11. Finally, attach the CPU fan cable to the CPU fan connector on the mainboard.

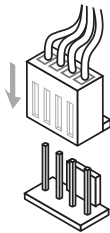

### **Important**

- Do not touch the CPU socket pins.
- Confirm that the CPU cooler has formed a tight seal with the CPU before booting your system.
- Whenever the CPU is not installed, always protect the CPU socket pins by covering the socket with the plastic cap.
- Please refer to the documentation in the CPU cooler package for more details about CPU cooler installation.

## Mounting Screw Holes

When installing the mainboard, first install the necessary mounting stands required for an mainboard on the mounting plate in your computer case. If there is an I/O back plate that came with the computer case, please replace it with the I/O backplate that came with the mainboard package. The I/O backplate should snap easily into the computer case without the need for any screws. Align the mounting plate's mounting stands with the screw holes on the mainboard and secure the mainboard with the screws provided with your computer case. The locations of the screw holes on the mainboard are shown below. For more information, please refer to the manual that came with the computer case.

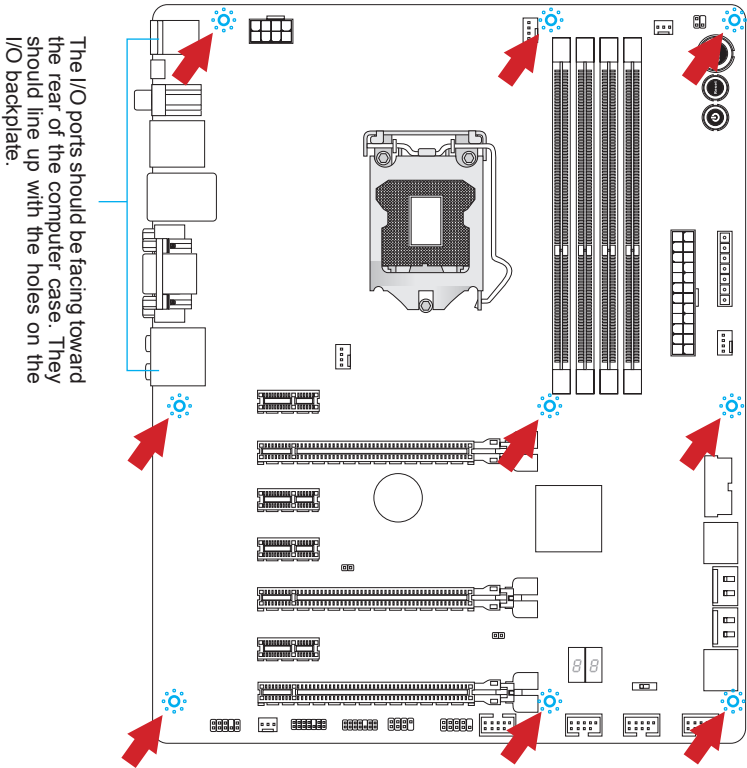

### **Important**

- Install the mainboard on a flat surface free from unnecessary debris.
- To prevent damage to the mainboard, any contact between the mainboard circuitry and the computer case, except for the mounting stands, is prohibited.
- Please make sure there are no loose metal components on the mainboard or within the computer case that may cause a short circuit of the mainboard.

## Power Supply

### JPWR1: ATX 24-pin Power Connector

This connector allows you to connect an ATX 24-pin power supply. To connect the ATX 24-pin power supply, align the power supply cable with the connector and firmly press the cable into the connector. If done correctly, the clip on the power cable should be hooked on the mainboard's power connector.

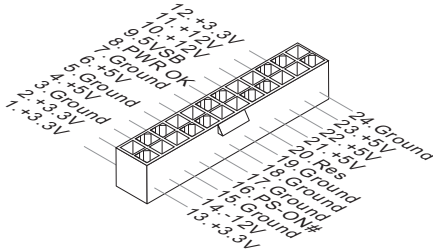
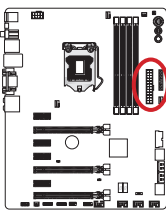

### JPWR2: ATX 8-pin Power Connector

This connector provides 12V power to the CPU.

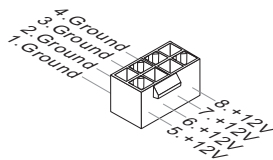
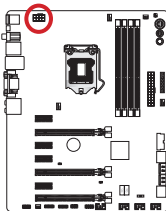

### **Important**

*Make sure that all the power cables are securely connected to a proper ATX power supply to ensure stable operation of the mainboard.*

# Memory

These DIMM slots are used for installing memory modules. For more information on compatible components, please visit <http://www.msi.com/service/test-report>

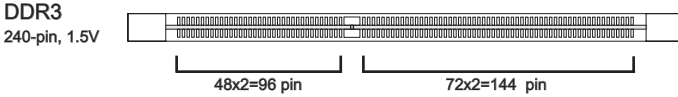

## Dual-Channel mode Population Rule

In Dual-Channel mode, the memory modules can transmit and receive data with two data bus channels simultaneously. Enabling Dual-Channel mode can enhance system performance. The following illustrations explain the population rules for Dual-Channel mode.

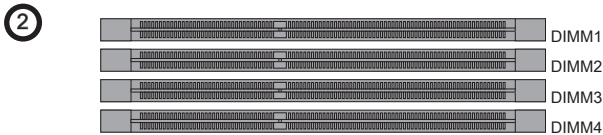
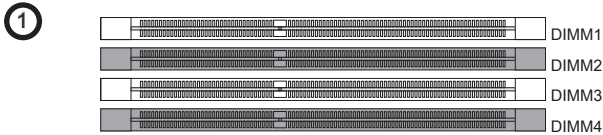

### Important

- *DDR3 memory modules are not interchangeable with DDR2, and the DDR3 standard is not backward compatible. Always install DDR3 memory modules in DDR3 DIMM slots.*
- *To ensure system stability, memory modules must be of the same type and density in Dual-Channel mode.*
- *Due to chipset resource usage, the system will only detect up to 31+ GB of memory (not full 32 GB) when all DIMM slots have 8GB memory modules installed.*

## Installing Memory Modules

1. Unlock the DIMM slot by pushing the mounting clips to the side. Vertically insert the memory module into the DIMM slot. The memory module has an off-center notch on the bottom that will only allow it to fit one way into the DIMM slot.
2. Push the memory module deep into the DIMM slot. The plastic clips at each side of the DIMM slot will automatically close when the memory module is properly seat and an audible click should be heard.
3. Manually check if the memory module has been locked in place by the DIMM slot's side clips.

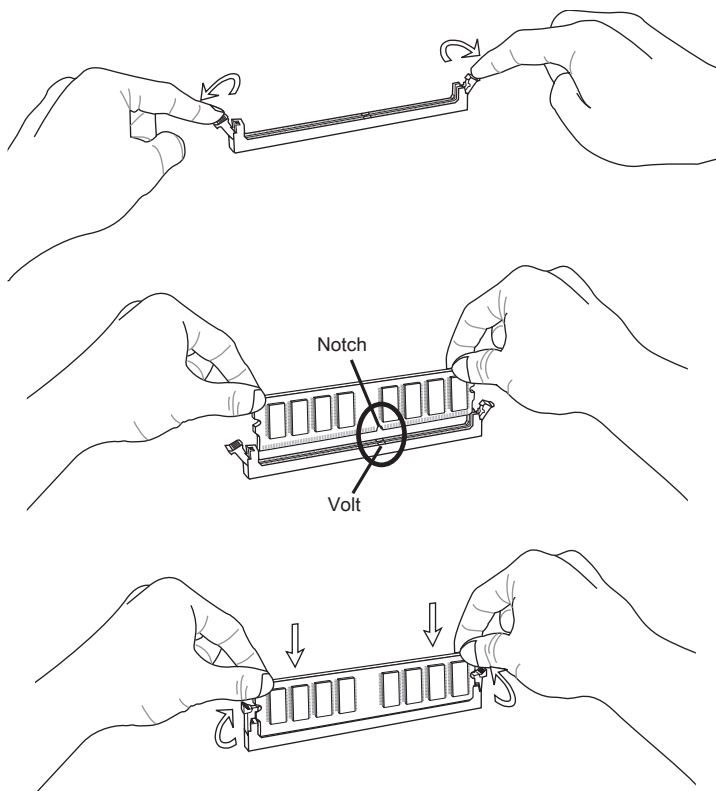

## Expansion Slots

---

This mainboard contains numerous ports for expansion cards, such as discrete graphics or audio cards.

### PCIe (Peripheral Component Interconnect Express) Slot

The PCIe slot supports the PCIe interface expansion card.

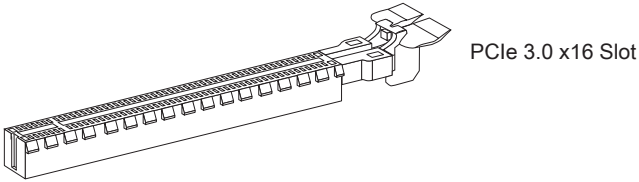

### **Important**

*When adding or removing expansion cards, always turn off the power supply and unplug the power supply power cable from the power outlet. Read the expansion card's documentation to check for any necessary additional hardware or software changes.*



## Video/ Graphics Cards

If available, this mainboard takes advantage of the CPU's integrate graphics processor, but discrete video cards can be installed by way of the mainboard's expansion slots. Adding on one or more discrete video cards will significantly boost the system's graphics performance. For best compatibility, MSI graphics cards are recommended.

### Single Video Card Installation

1. Determine what type of expansion slot(s) the video card will use. Locate the expansion slot(s) on the mainboard. Remove any protective expansion slot covers from the computer case.
2. Line up the video card on top of the expansion slot(s) with the display ports facing out of the computer case. For a single video card installation, using the PCI\_E2 slot is recommended.
3. Push the video card into its expansion slot(s). Depending on the expansion slot(s) used, there should be clip(s) on the expansion slot(s) that will lock in place.
4. If needed, screw the edge of the graphics card to the computer case. Some video cards might require a power cable directly from the power supply.
5. Please consult your video card's manual for further instructions regarding driver installation or other special settings.

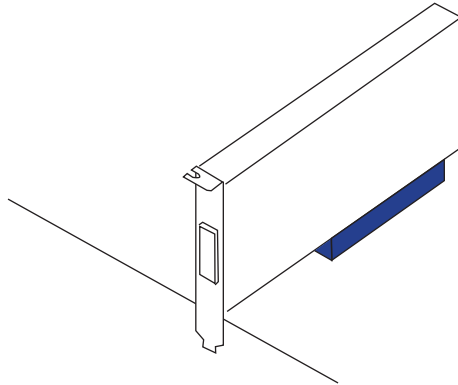

## AMD CrossFire™ (Multi-GPU) Technology

AMD CrossFire™ is a multi-GPU performance gaming platform. By linking together two or more discrete GPUs, CrossFire™ can significantly improve system graphics performance. It allows the ability to scale a system's graphics power as needed, making it the most scalable gaming platform. This mainboard will automatically detect CrossFire™ technology and make changes in the BIOS as needed. Follow the instructions below to ensure a successful two-way CrossFire™ installation.

1. Install two AMD Radeon™ HD graphics cards into the PCI\_E2 & PCI\_E5 expansion slots.
2. With the two cards installed, two CrossFire™ Video Link cables are required to connect the graphics cards. Attach one side of the cable on each of the cards by way of the metal contacts (please refer to the picture below). Please note that although two graphics cards have been installed, only the display ports on the graphics card installed in the first PCIe x16 slot will work. All displays should be connected to this graphics card.

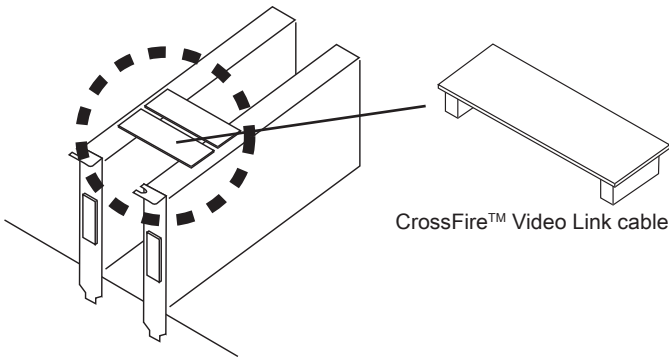

### **Important**

- Please ensure that all graphics cards used in CrossFire™ mode are of the same brand and specifications. For best compatibility with the mainboard, MSI graphics cards are recommended.
- Make sure to connect an adequate power supply to the power connectors on the graphics cards to ensure stable operation.
- Only Windows® XP with Service Pack 2 (SP2), Windows™ XP Professional x64 Edition, Windows™ Vista, & Windows™ 7 will support CrossFire™ mode.

3. Boot up the computer and install the drivers and software included in your video card package. For more information, please refer to the manual that came with your video card.
4. After all of the hardware and software has been properly installed, reboot the system. After entering the operating system (OS), right click on the desktop and choose the “Catalyst Control Center II”.

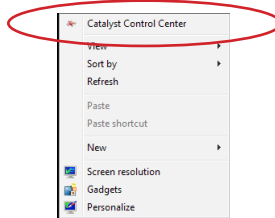

5. The CrossFire™ setting must be enabled to allow CrossFire™ mode to operate. The follow screen appears in the Catalyst Control Center II. Depending on your operating system, the screen may look different.

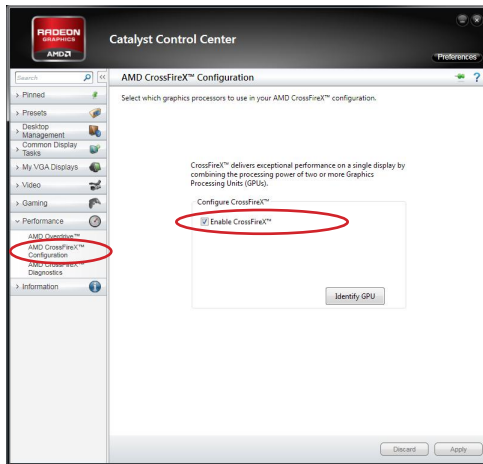

### **Important**

A CrossFire™ system has four possible display modes:

- SuperTiling
- Scissor Mode
- Alternate Frame Rendering
- Super Anti-aliasing.

For more details, please consult the graphics card manual.

## NVIDIA® SLI Technology

NVIDIA's SLI (Scalable Link Interface) technology allows two or more GPUs to run in tandem within a system to achieve significant graphics performance gains. To utilize this technology, the GPU cards must be connected by an SLI Video Link.

If you intend to use SLI mode, please follow the instructions below to properly set up SLI mode. The instructions below are meant for a two video card SLI configuration.

1. Install two NVIDIA graphics cards in the PCI\_E2 and the PCI\_E5 slots.
2. With the two cards installed, a SLI Video Link cable is required to connect the graphics cards. Attach one side of the cable on each of the cards by way of the metal contacts (please refer to the picture below). Please note that although two graphics cards have been installed, only the display ports on the graphics card installed in the first PCIe x16 slot will work. All displays should be connected to this graphics card.

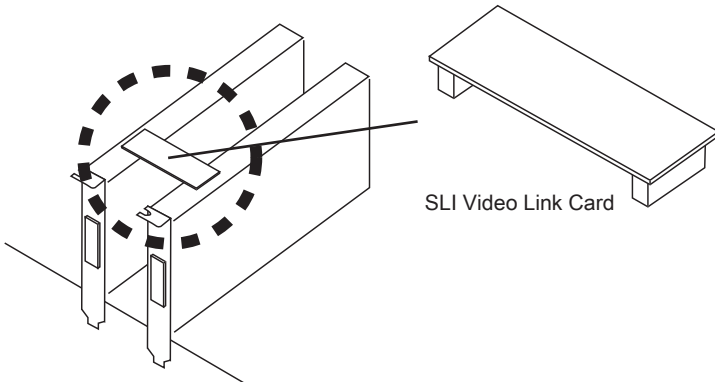

3. Boot up the computer and install the drivers and software included in your video card package. For more information, please refer to the manual that came with your video card.

- After all of the hardware and software has been properly installed, reboot the system. After entering the operating system (OS), right click on the desktop and choose the “NVIDIA Control Panel”.

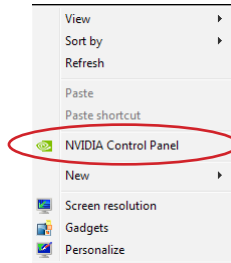

- Enter the NVIDIA Control Panel. Choose the “Maximize 3D Performance” setting to enable SLI mode. The configuration screen is shown below. Depending on your operating system, the screen may look different.

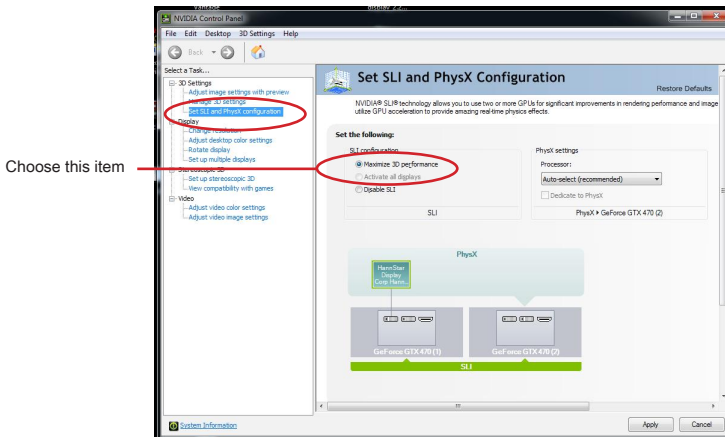

### **Important**

- Please ensure that all graphics cards used in SLI mode are of the same brand and specifications. For best compatibility with the mainboard, MSI graphics cards are recommended.
- Make sure to connect an adequate power supply to the power connectors on the graphics cards to ensure stable operation.
- If you wish to remove one graphics card and quit the SLI function, make sure the “Maximize 3D Performance” function is disabled before removing the graphics card.

## Internal Connectors

### SATA1~8: SATA Connector

This connector is a high-speed SATA interface port. Each connector can connect to one SATA device. SATA devices include disk drives (HDD), solid state drives (SSD), and optical drives (CD / DVD / Blu-Ray).

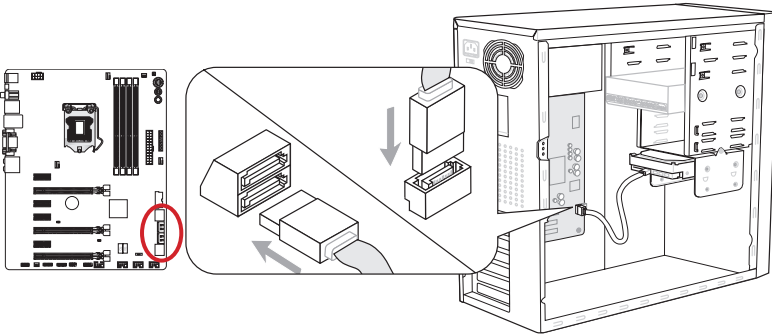

\* The MB layout in this figure is for reference only.

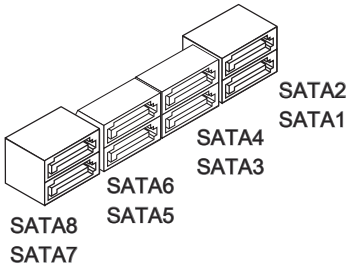

SATA1~2 (6Gb/s, by Intel® Z77)

SATA3~6 (3Gb/s, by Intel® Z77)

SATA7~8 (6Gb/s, by Asmedia® ASM1061)

### **Important**

- Many SATA devices also need a power cable from the power supply. Such devices include disk drives (HDD), solid state drives (SSD), and optical drives (CD / DVD / Blu-Ray). Please refer to the device's manual for further information.
- Many computer cases also require that large SATA devices, such as HDDs, SSDs, and optical drives, be screwed down into the case. Refer to the manual that came with your computer case or your SATA device for further installation instructions.
- Please do not fold the SATA cable at a 90-degree angle. Data loss may result during transmission otherwise.
- SATA cables have identical plugs on either sides of the cable. However, it is recommended that the flat connector be connected to the mainboard for space saving purposes.

## CPUFAN, SYSFAN1~4: Fan Power Connectors

The fan power connectors support system cooling fans with +12V. If the mainboard has a System Hardware Monitor chipset on-board, you must use a specially designed fan with a speed sensor to take advantage of the CPU fan control. Remember to connect all system fans. Some system fans may not connect to the mainboard and will instead connect to the power supply directly. A system fan can be plugged into any available system fan connector.

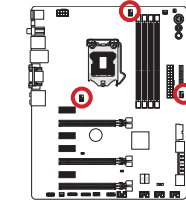

CPUFAN/ SYSFAN1/  
SYSFAN2

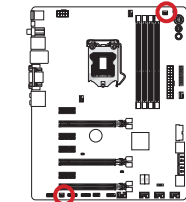
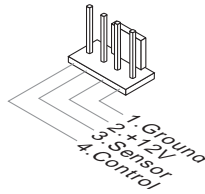

SYSFAN3/ SYSFAN4

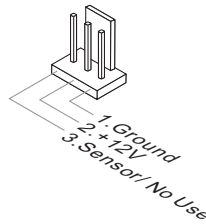

### **Important**

- Please refer to your processor's official website or consult your vendor to find recommended CPU cooling fans.
- The CPUFAN, SYSFAN1, SYSFAN2 connectors support Smart Fan Control with liner mode. The Control Center II utility can be installed to automatically control the fan speeds according to the CPU's and system's temperature.
- If there are not enough ports on the mainboard to connect all system fans, adapters are available to connect a fan directly to a power supply.
- Before first boot up, ensure that there are no cables impeding any fan blades.

### JFP1, JFP2: Front Panel Connectors

These connectors connect to the front panel switches and LEDs. The JFP1 connector is compliant with the Intel® Front Panel I/O Connectivity Design Guide. When installing the front panel connectors, please use the enclosed mConnectors to simplify installation. Plug all the wires from the computer case into the mConnectors and then plug the mConnectors into the mainboard.

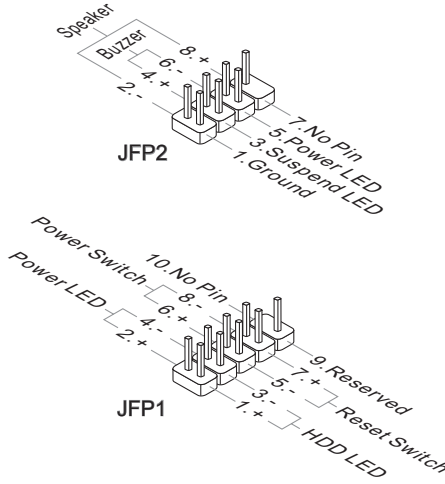
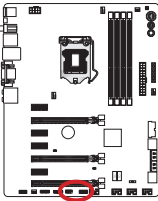

### Important

- On the connectors coming from the case, pins marked by small triangles are positive wires. Please use the diagrams above and the writing on the mConnectors to determine correct connector orientation and placement.
- The majority of the computer case's front panel connectors will primarily be plugged into JFP1.

### JAUD1: Front Panel Audio Connector

This connector allows you to connect the front audio panel located on your computer case. This connector is compliant with the Intel® Front Panel I/O Connectivity Design Guide.

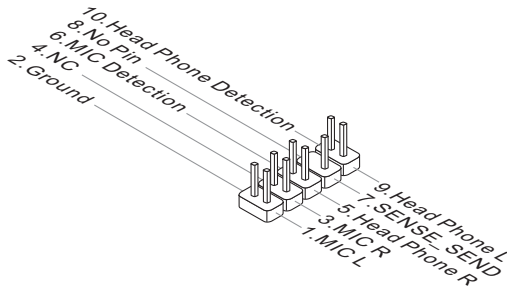
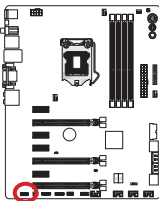



## JUSB1~3: USB 2.0 Expansion Connectors

This connector is designed for connecting high-speed USB peripherals such as USB HDDs, digital cameras, MP3 players, printers, modems, and many others.

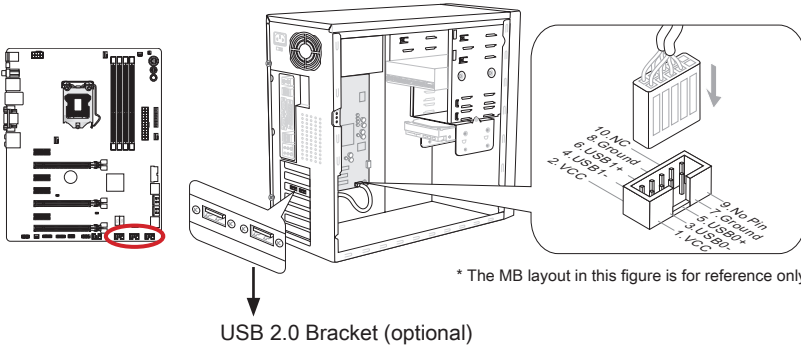

The JUSB1 (red mark) connector supports MSI's new SuperCharger technology which provides quicker USB charging of your cellular phone or other USB-powered devices. To enable this feature, please install the MSI SuperCharger application on your computer. When the SuperCharger application is turned on, the JUSB1 connector will convert data channels to extra power channels to quickly charge your connected device. Please note that when the SuperCharger application is turned on, data transmission and synchronization over the JUSB1 connector will not function. To enable the JUSB1 connector to function as a normal USB 2.0 connector, please turn off the SuperCharger application. When the computer is in stand-by or hibernation mode (S3/ S4/ S5) SuperCharger mode will automatically be enabled.

### Important

- Note that the VCC and GND pins must be connected correctly to avoid possible damage.
- Please only connect one device per USB port to ensure stable charging.
- SuperCharger Technology is only available on select MSI mainboard models. Please refer to the MSI website to check if your mainboard has SuperCharger technology.
- For iPad, JUSB1 (red mark) can still charge iPad in S3, S4, S5 state.
- We recommend that don't disconnect the device when you charge it in S1 state.

### JUSB4: USB 3.0 Expansion Connector

The USB 3.0 port is backwards compatible with USB 2.0 devices. It supports data transfer rates up to 5Gbits/s (SuperSpeed).

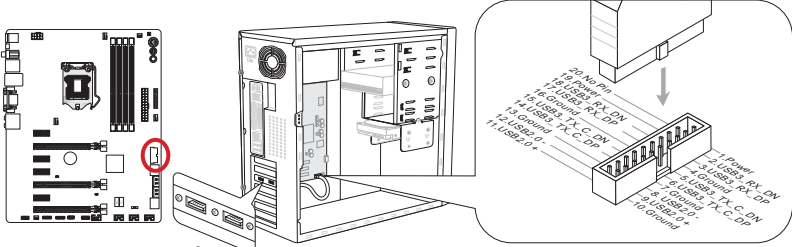

\* The MB layout in this figure is for reference only.

USB 3.0 Bracket (optional)

### **Important**

- Note that the VCC and GND pins must be connected correctly to avoid possible damage.
- To use a USB 3.0 device, you must connect the device to a USB 3.0 port through an optional USB 3.0 compliant cable.

### JCI1: Chassis Intrusion Connector

This connector connects to the chassis intrusion switch cable. If the computer case is opened, the chassis intrusion mechanism will be activated. The system will record this intrusion and a warning message will flash on screen. To clear the warning, you must enter the BIOS utility and clear the record.

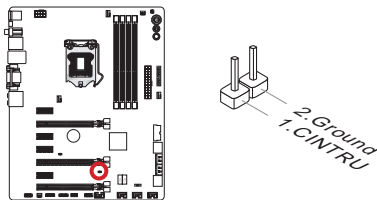

## JTPM1: TPM Module connector

This connector connects to a TPM (Trusted Platform Module). Please refer to the TPM security platform manual for more details and usages.

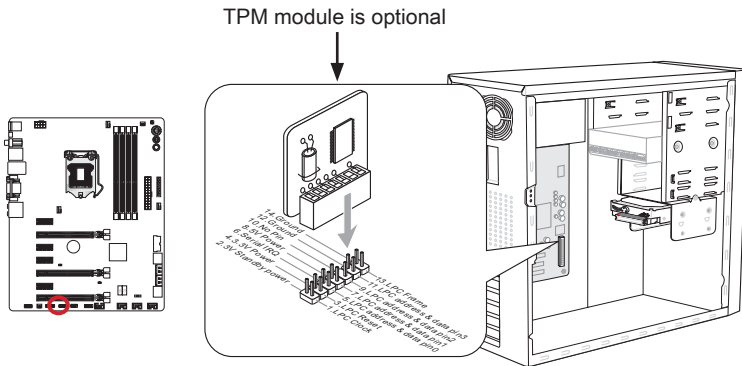

\* The MB layout in this figure is for reference only.

## JDLED3: Voice Genie Connector (optional)

This connector is used to link to the voice control module (optional). Please refer to its user guide for more details and usages.

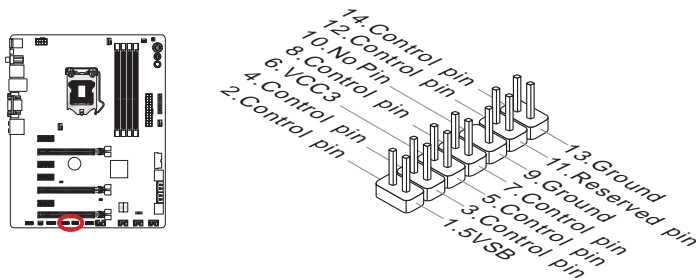

### JTURBO1: MultiConnect Panel Connector (optional)

This connector is used to connect an optional front panel for controlling the OC Genie and some additional functions. Please refer to its user guide for more details and usages.

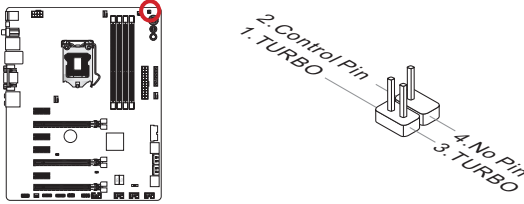

### J1394\_1: IEEE1394 Expansion Connector

This connector allows you to connect an IEEE 1394 device via an optional IEEE 1394 expansion bracket.

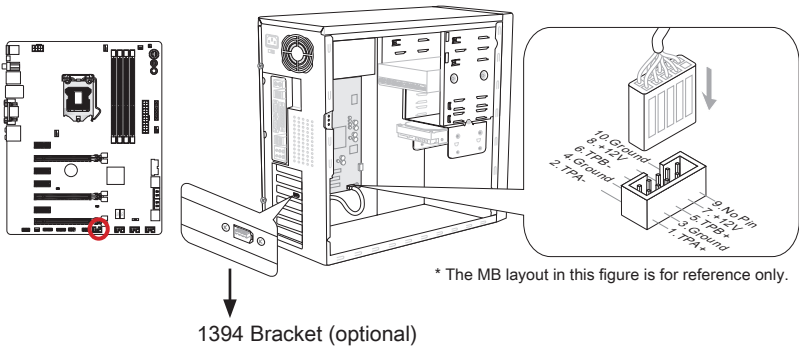

\* The MB layout in this figure is for reference only.

## FV1: Voltage Checkpoints Connector

These voltage checkpoints are used to measure the current system voltages. A multimeter (not included) will be required to check voltages. To check the voltage, please use the included voltage checkpoint cables included in the mainboard package. Attach the positive lead of the multimeter to the voltage checkpoint cable and the negative lead to the ground connector.

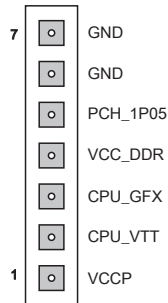
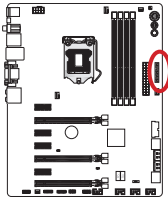

Point	Description
GND (pin 6, pin 7)	Ground
PCH_1P05 (pin 5)	PCH 1.5 voltage. The PCH voltage is the voltage supplied to the Platform Controller Hub.
VCC_DDR (pin 4)	Memory voltage. The DDR memory voltage is the voltage supplied to the DDR memory modules on the mainboard. Lower memory timings may require higher voltages to maintain system stability.
CPU_GFX (pin 3)	The CPU_GFX voltage is the voltage supplied to the integrated graphics processor located on the CPU.
CPU_VTT (pin 2)	CPU IO voltage (Uncore). The CPU IO voltage is the voltage supplied to the Uncore on the CPU. Higher overlocks may require a higher CPU IO voltage to maintain stability.
VCCP (pin 1)	CPU core voltage. The CPU voltage is the voltage supplied to the CPU core. Higher overlocks may require higher CPU core voltages to maintain stability.

## Buttons

---

The mainboard has numerous on-board buttons to control various functions. This section will explain how to change your mainboard's functions through the use of these on-board buttons.

### OC1: OC Genie Button

This button is used to automatically overclock the system. Press this button once while the system is off to enable OC Genie. The button will lock remain depressed until it is pushed again to disable OC Genie. On the next boot, the OC Genie utility will automatically overclock the CPU settings to optimal performance values. To disable OC Genie, power off the system and press the OC Genie button again. The button will depress and the CPU configuration settings will return to normal values.

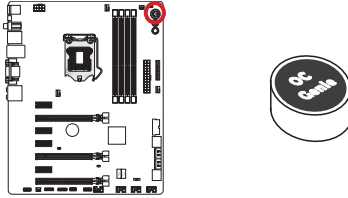

### **Important**

- *Please install DDR3 1333 or faster memory and equip a better heatsink/cooler to use the OC Genie function.*
- *We do not guarantee the OC Genie overclocking range or the damages/risks caused by overclocking behavior.*
- *It is possible to disable the OC Genie function in the BIOS setup. Please refer to the BIOS section of the manual for instructions on how to turn off OC Genie from the BIOS.*
- *The usage of OC Genie is at the user's own risk. Overclocking is never guaranteed by MSI.*
- *To ensure successfully OC Genie usage, MSI components are recommended.*

## POWER1: Power Button

This button is used to turn-on and turn-off the system. Press the button once to turn-on or turn-off the system.

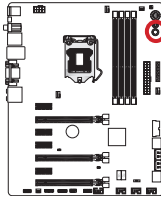

---

## RESET1: Reset Button

This reset button is used to reset the system. Press the button to reset the system.

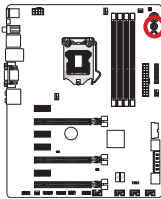

## Jumpers

### JBAT1: Clear CMOS Jumper

There is CMOS RAM onboard that is external powered from a battery located on the mainboard to save system configuration data. With the CMOS RAM, the system can automatically boot into the operating system (OS) every time it is turned on. If you want to clear the system configuration, set the jumpers to clear the CMOS RAM.

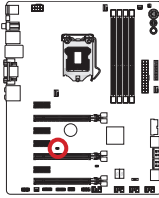

Keep Data



Clear Data

### **Important**

*You can clear the CMOS RAM by shorting this jumper while the system is off. Afterwards, open the jumper . Do not clear the CMOS RAM while the system is on because it will damage the mainboard.*



## Switch

### MULTI BIOS SWITCH: Multi BIOS Switch

This mainboard has two built-in BIOS ROMs (Labeled A and B, default BIOS ROM is A). If one is crashed, you can shift to the other for booting by sliding the switch. In addition, these two BIOS ROMs have the Multi BIOS Auto Update feature. You can access BIOS → SECURITY → "Multi BIOS Auto Update" item and set the feature to enable or disable. Once enabled, the new BIOS version will automatically reflash the older one. If you disable it, you can update each BIOS by yourself.

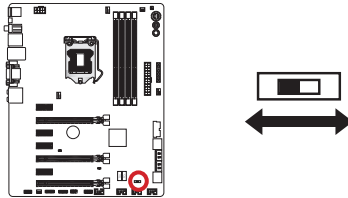

### **Important**

*Do not use the Multi BIOS Switch when the system is powered on.*

## LED Status Indicators

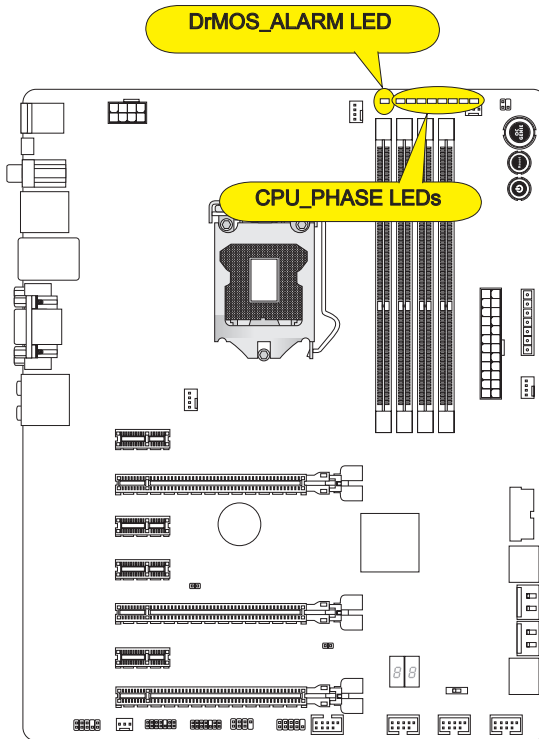

### CPU\_PHASE LEDs

These LEDs will change according to CPU loading. The higher the power phase number, the more reliable the power flow to the processor.

### DrMOS\_ALARM LED

This LED will light red when DrMOS overheat.

## Debug LED Panel

Please refer to the table below to get more information about the Debug LED message.

Post	Status
02,07	Power on CPU Initialization
03,08	Power on North Bridge Initialization
04,09	Power on South Bridge Initialization
0B	Power on Cache Initialization
11~14,32~36,56~5A	Early CPU Initialization
15~18,37~3A	Early North Bridge Initialization
19~1C,3B~3E	Early South Bridge Initialization
1D~2F,31,3F~4E,50~55	Early Memory Initialization
63~67,D0	Late CPU Initialization
69~6F,D1	Late North Bridge Initialization
70~77,D2	Late South Bridge Initialization
92~96,B5,D4	PCI bus Initialization
97,98,99,B2,D5~D7	Console Output/Input devices/Console initialization and Load Option ROM (VGA, RAID, parallel ports, serial ports.....)
9A~A7,B4	Onboard devices Initialize and Detect (USB/ SATA/ SCSI.....)
A8,A9,AB	Start of Setup. BIOS setup if needed/ requested.
AD/AE	Ready To Boot event/Legacy Boot event
A0	Enter OS (Windows® 7 or Windows® XP).



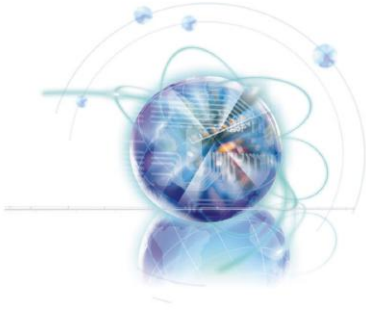

## Chapter 2

# BIOS Setup

CLICK BIOS II is a revolutionary UEFI interface that allows you to setup and configure your system for optimum use. Using your mouse and keyboard, users can change BIOS settings, monitor CPU temperature, select the boot device priority and view system information such as the CPU name, DRAM capacity, the OS version and the BIOS version. Users can import and export parameter data for backup or for sharing with friends. By connecting to the Internet within CLICK BIOS II, users can browse webpages, check mail and use Live Update your system.

## Entering

Power on the computer and the system will start the Power On Self Test (POST) process. When the message below appears on the screen, please <DEL> key to enter CLICK BIOS II:

### Press DEL key to enter Setup Menu, F11 to enter Boot Menu

If the message disappears before you respond and you still need to enter CLICK BIOS II, restart the system by turning the computer OFF then back ON or pressing the RESET button. You may also restart the system by simultaneously pressing <Ctrl>, <Alt>, and <Delete> keys.

### Important

The items under each BIOS category described in this chapter are under continuous update for better system performance. Therefore, the description may be slightly different from the latest BIOS and should be held for reference only.

## Overview

After entering Click BIOS II, the following screen is displayed.



### Important

The pictures in this guide are for reference only and may vary from the product you purchased. Please refer to the actual screens of your system for detailed information.

#### ► Temperature monitor

This block shows the temperature of the processor and the mainboard.

### ► System information

This block shows the time, date, CPU name, CPU frequency, DRAM frequency, DRAM capacity and the BIOS version.

### ► BIOS menu selection

The following options are available:

- **SETTINGS** - Use this menu to specify your settings for chipset features and boot devices.
- **OC** - This menu contains items of the frequency and voltage adjustments. Increasing the frequency can get better performance, however high frequency and heat can cause instability, we do not recommend general users to over-clock.
- **ECO** - This menu is related to energy-saving settings.
- **BROWSER** - This feature is used to enter the MSI Winki web browser.
- **UTILITIES** - This menu contains utilities for backup and update.
- **SECURITY** - The security menu is used to keep unauthorized people from making any changes to the settings. You can use these security features to protect your system.

### ► Boot device priority bar

You can move the device icons to change the boot priority.

#### ► Boot menu

This button is used to open a boot menu. Click the item to boot the system from the device instantly.

#### ► Mode selection

This feature allows you to load presets of energy saving or overclocking.

#### ► Menu display

This area provides BIOS settings and information to be configured.

## Boot device priority bar

This bar shows the priority of the boot devices. The lighted icons indicate that the devices are available.



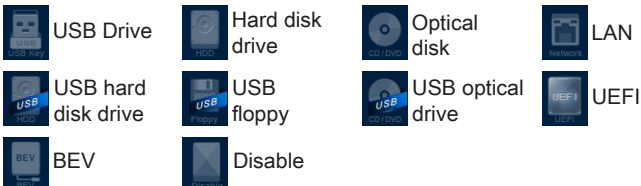

Click and draw the icon to left or right to specify the boot priority.

#### ■ Boot device icon list

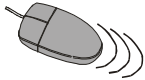
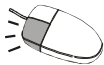

## Operation

CLICK BIOS II allows you to control BIOS settings with the mouse and the keyboard. The following table lists and describes the hot keys and the mouse operations.

Hot key	Mouse	Description
<↑↓←→>	 Move the cursor	Select Item
<Enter>	 Click/ Double-click the left button	Select Icon/ Field
<Esc>	 Click the right button	Jump to the Exit menu or return to the previous from a submenu
<+>	X	Increase the numeric value or make changes
<->		Decrease the numeric value or make changes
<F1>		General Help
<F4>		CPU Specifications
<F5>		Enter Memory-Z
<F6>		Load optimized defaults
<F10>		Save Change and Reset
<F12>		Save a screenshot to a FAT/FAT32 USB drive

### Sub-Menu

If you find a point symbol to the left of certain fields, that means a sub-menu can be launched for additional options. You can use the arrow keys or mouse to highlight the field and press <Enter> or double-click the left mouse button to enter the sub-menu. If you want to return to the previous menu, just press <Esc> or click the right mouse button.

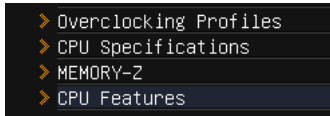

### General Help

The General Help screen lists the appropriate keys to use for navigation. You can call up this screen from any menu by simply pressing <F1>. Press <Esc> to exit the Help screen.



## SETTINGS

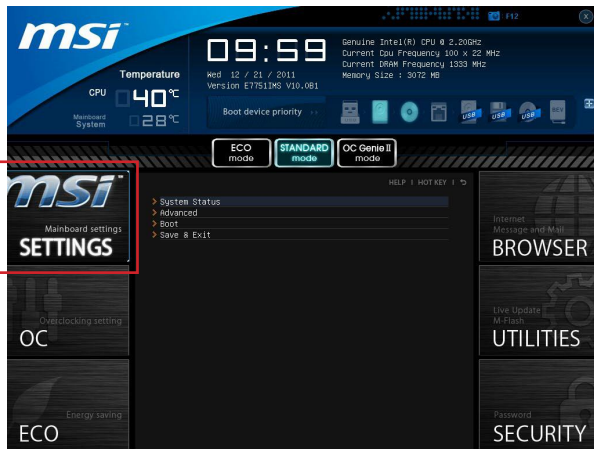

### System Status

#### ► System Date

This allows you to set the system date that you want (usually the current date). The format is <day> <month> <date> <year>.

day	Day of the week, from Sun to Sat, determined by BIOS. Read-only.
month	The month from Jan. through Dec.
date	The date from 1 to 31 can be keyed by numeric function keys.
year	The year can be adjusted by users.

#### ► System Time

This allows you to set the system time that you want (usually the current time). The time format is <hour> <minute> <second>.

#### ► SATA Port1~6

Shows devices connected to specific SATA ports.

### **Important**

*If your device is not displayed, turn off computer and re-check SATA cable and power cable connections to the device.*

#### ► System Information

Shows detailed system information, including CPU type, BIOS version, and Memory (read only).

## Advanced

### ▶ PCI Subsystem Settings

Press <Enter> to enter the sub-menu.

#### ▶ PCIE GEN3

When set to [Enabled], the feature allows PCIe 3.0 slots support expansion cards with PCIe generation 3.0 link speed. To avoid PCIe 1.0, 2.0 card compatibility problems, you can set to [Disabled].

#### ▶ PCI Latency Timer

Controls how long each PCI device can hold the bus before another takes over.

When set to higher values, every PCI device can conduct transactions for a longer time and thus improve the effective PCI bandwidth.

### ▶ ACPI Settings

Press <Enter> to enter the sub-menu.

#### ▶ ACPI Standby State

Specifies the power saving mode for ACPI function

[S1] Sleep Mode. Hardware remains on.

[S3] Suspend to RAM. Turns off hardware. (Recommended)

#### ▶ Power LED

Configures how the system uses power LEDs on the case to indicate sleep/suspend state.

[Single] The power LED turns off during the sleep/suspend mode.

[Dual] The power LED changes its color to indicate the sleep/suspend state.

[Blinking] The power LED blinks to indicate the sleep/suspend state.

### ▶ Integrated Peripherals

Press <Enter> to enter the sub-menu.

#### ▶ Onboard LAN Controller

This item allows you to enable/ disable the onboard LAN controller.

#### ▶ LAN Option ROM

This item is used to decide whether to invoke the Boot ROM of the onboard LAN.

#### ▶ Onboard IEEE1394 Controller

This item allows you to enable/ disable the onboard IEEE1394 controller.

#### ▶ SATA Mode

This item is used to specify RAID/ IDE/ AHCI mode for SATA port.

## **Important**

*You cannot switch between AHCI and IDE if you already have your operating system installed. If you have installed your OS using AHCI and you clear your BIOS/reset to default settings, you will need to change this function back to AHCI to ensure proper functionality.*

▶ **Port 1~6 Hot Plug**

These items are used to enable/ disable the SATA ports hot plug support.

▶ **External SATA 6GB/s Controller Mode**

This item is used to specify IDE/ AHCI mode for external SATA 6GB/s ports.

▶ **HD Audio Controller**

This item allows you to enable/ disable the HD audio controller.

▶ **HPET**

The HPET (High Precision Event Timers) is a component that is part of the chipset. You can enable it, and will provide you with the means to get to it via the various ACPI methods.

▶ **Integrated Graphics Configuration**

Press <Enter> to enter the sub-menu.

▶ **Virtu Technology**

Enable or Disable Virtu GPU Switching Technology (if supported).

[i-Mode] Provides power saving features and special processor functionality

[d-Mode] Uncompromised 3D performance from the discrete GPU

▶ **Initiate Graphic Adapter**

Choose which adapter you wish to make the primary option

[PEG] PCI-Express Graphics Device

[IGD] Integrated Graphics Display

▶ **Integrated Graphics Share Memory**

The system shares memory to the integrated graphics. This setting controls the exact memory size shared to the integrated graphics.

▶ **DVMT Memory**

Specify the size of DVMT memory to allocate for video memory.

▶ **IGD Multi-Monitor**

Enables both integrated and discrete graphics at the same time. When disabled, it will default to Initiated Graphics Adapter selection.

▶ **Intel(R) Rapid Start Technology**

Press <Enter> to enter the sub-menu.

▶ **Intel(R) Rapid Start Technology**

This feature can make your system fast start up from hibernation. This item allows you to enable/ disable Intel Rapid Start Technology.

▶ **USB Configuration**

Press <Enter> to enter the sub-menu.

▶ **USB Controller**

This item allows you to enable/ disable the integrated USB 2.0 controller.

▶ **Legacy USB Support**

Enable or disable support for USB keyboards, mice and floppy drives. You will be able to use these devices with operating systems that do not support USB.

### ▶ Hardware Monitor

Press <Enter> to enter the sub-menu.

#### ▶ CPU Smart Fan Target

Controls CPU fan speed automatically depending on the current temperature and to keep it with a specific range. If the current CPU temperature reaches the target value, the smart fan function will be activated.

#### ▶ SYS Fan1/ 2 Control

These items allow users to select how percentage of speed for the SYSFAN1/ 2.

#### ▶ CPU/ System Temperature, CPU FAN/ SYS FAN 1/ 2 Speed

These items show the current status of all of the monitored hardware devices/ components such as CPU temperature/ system temperature and all fans' speeds.

### ▶ Power Management Setup

Press <Enter> to enter the sub-menu.

#### ▶ EuP 2013

Energy Using Products Lot 6 2013 (EUP) reduces power consumption when system is off or in standby mode.

Note: When enabled, the system will not support RTC wake up event functions.

#### ▶ Restore after AC Power Loss

This item specifies whether your system will reboot after a power failure or interrupt occurs. Settings are:

[Power Off] Always leaves the computer in the power off state.

[Power On] Always leaves the computer in the power on state.

[Last State] Restore the system to the status before power failure or interrupt occurred.

### ▶ Wake Up Event Setup

Press <Enter> to enter the sub-menu.

#### ▶ Wake Up Event By

Setting to [BIOS] activates the following fields, and use the following fields to set the wake up events. Setting to [OS], the wake up events will be defined by OS.

#### ▶ Resume By RTC Alarm

The field is used to enable or disable the feature of booting up the system on a scheduled time/date.

#### ▶ Date/ HH:MM:SS

If Resume By RTC Alarm is set to [Enabled], the system will automatically resume (boot up) on a specific date/hour/minute/second specified in these fields (using the <+> and <-> to select the date & time settings).

#### ▶ Resume By PCI-E Device

When set to [Enabled], the feature allows your system to be awakened from the power saving modes through any event on PCIe device.

#### ▶ Resume By Onboard LAN

This item determine whether the system will be awakened from what power saving modes when input signal of LAN is detected.

▶ **Resume From S3 by USB Device**

The item allows the activity of the USB device to wake up the system from S3 (Suspend to RAM) sleep state.

▶ **Resume From S3/S4/S5 by PS/2 Mouse/ Keyboard**

These items determine whether the system will be awakened from what power saving modes when input signal of the PS/2 mouse/ keyboard is detected.

## Boot

▶ **Full Screen Logo Display**

This item enables this system to show the company logo on the boot-up screen. [Enabled] Shows a still image (logo) on the full screen at boot.

[Disabled] Shows the POST messages at boot.

== Boot Option Priorities==

▶ **1st~9th Boot**

These items are used to prioritize the installed boot devices.

▶ **Hard Disk Drive BBS Priorities/ CD/DVD ROM Drive BBS Priorities/ USB HardDisk Drive BBS Priorities/ UEFI Boot Drive BBS Priorities**

▶ **1st~8th Boot**

These items are used to prioritize the installed Hard Disk Drive/ CD/DVD ROM Drive/ USB HardDisk drives/ UEFI boot drives.

## Save & Exit

▶ **Discard Changes and Exit**

Use this item to abandon all changes and exit setup.

▶ **Save Changes and Reboot**

Use this item to save changes and reset the system.

▶ **Save Changes**

Use this item to save changes.

▶ **Discard Changes**

Use this item to abandon all changes.

▶ **Restore Defaults**

Use this item to load the optimized default values set by the BIOS vendor.

== **Boot Override** ==

The installed storage devices will appear on this menu, you can select one of them be a boot device.

▶ **Built-in EFI Shell**

Use this item to enter the EFI Shell.

# OC

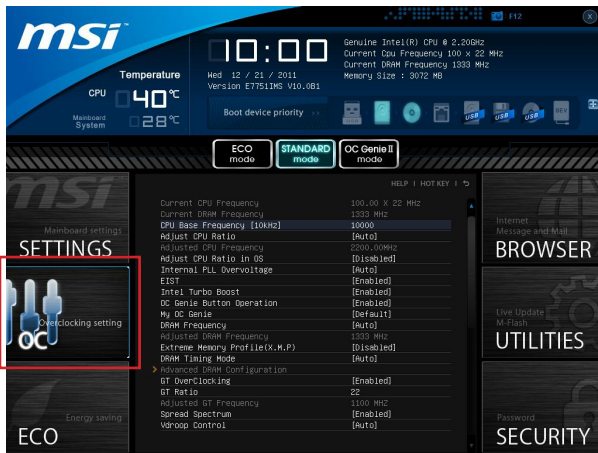

## **Important**

- *Overclocking your PC manually is only recommended for advanced users.*
- *Overclocking is not guaranteed, and if done improperly, can void your warranty or severely damage your hardware.*
- *If you are unfamiliar with overclocking, we advise you to use OC Genie for easy overclocking.*

### ► **Current CPU / DRAM Frequency**

These items show the current clocks of CPU and Memory speed. Read-only.

### ► **CPU Base Frequency [10KHz]**

Allows you to set the CPU Base clock (in 10KHz increments). You may overclock the CPU by adjusting this value. Please note that overclocking behavior and stability is not guaranteed.

### ► **Adjust CPU Ratio**

Controls the multiplier that is used to determine internal clock speed of the processor. This feature can only be changed if the processor supports this function.

### ► **Adjusted CPU Frequency**

It shows the adjusted CPU frequency. Read-only.

### ► **Adjust CPU Ratio in OS**

Enable this item to allow CPU ratio changes in the OS by using MSI Control Center.

### ► **Internal PLL Overvoltage**

This item is used to adjust the PLL voltage.

**▶ EIST**

Enhanced Intel SpeedStep technology allows you to set the performance level of the microprocessor whether the computer is running on battery or AC power. This field only appears with installed CPUs that support this technology.

**▶ Intel Turbo Boost**

Enables or disables Intel Turbo Boost which automatically boosts CPU performance above rated specifications (when applications requests the highest performance state of the processor).

**▶ OC Genie Button Operation**

This item is used to enable/disable the OC Genie button operation.

**▶ My OC Genie**

This item is used to select whether OC Genie parameters are customized by user. Setting to [MSI] OC Genie will use default OC related parameters to overclock the system. Selecting [Customize] allows you to configure the following related "My OC Genie option" sub-menu manually for OC Genie.

**▶ My OC Genie option**

Press <Enter> to enter the sub-menu.

**▶ Customize CPU Ratio**

This item allows you to specific the CPU ratio for OC Genie function.

**▶ My GT Overclock**

This item allows you to enable/ disable the overclocking of integrated graphics for OC Genie function.

**▶ GT Ratio**

This item allows you to specific the GT ratio for OC Genie function.

**▶ Adjusted my GT Ratio**

It shows the iGPU frequency when OC Genie is started. Read-only.

**▶ Customize DRAM Frequency**

This item allows you to specific the DRAM frequency for OC Genie function.

**▶ Adjusted My DRAM Frequency**

It shows the adjusted DRAM frequency when OC Genie is started. Read-only.

**▶ Extreme Memory Profile (X.M.P)**

This item is used to enable/disable the Intel Extreme Memory Profile (XMP) when OC Genie is started.

**▶ My OC Genie Intel C-State**

This item is used to enable/disable the Intel C-State when OC Genie is started.

**▶ My OC Genie Package C State limit**

This field allows you to specific the C-state mode for OC Genie function.

**▶ My OC Genie Long duration power limit**

This field allows you to customize Long duration power limit for OC Genie function.

### ▶ My OC Genie Long duration maintained

This field allows you to customize Long duration maintained for OC Genie function.

### ▶ My OC Genie Short duration power limit

This field allows you to customize Short duration power limit for OC Genie function.

### ▶ My CPU Core Voltage/ My OC Genie CPU I/O Voltage/ My OC Genie DRAM Voltage/ My OC Genie GPU Voltage

These items are used to specify the voltage of CPU, Memory, GPU and chipset for OC Genie function.

### ▶ Current CPU Core Voltage/ Current CPU I/O Core Voltage/ Current DRAM Voltage/ Current GPU Voltage

These items show current CPU/ CPU I/O/ DRAM/ GPU voltage. Read-only.

### ▶ DRAM Reference Clock

This item allows you to specify the DRAM Reference Clock for CPU. Please note the overclocking behavior is not guaranteed.

### ▶ DRAM Frequency

This item allows you to adjust the DRAM frequency. Please note the overclocking behavior is not guaranteed.

### ▶ Adjusted DRAM Frequency

It shows the adjusted DRAM frequency. Read-only.

### ▶ Extreme Memory Profile (X.M.P)

This item is used to enable/disable the Intel Extreme Memory Profile (XMP). For further information please refer to Intel's official website.

### ▶ DRAM Timing Mode

Select whether DRAM timing is controlled by the SPD (Serial Presence Detect) EEPROM on the DRAM module. Setting to [Auto] enables DRAM timings and the following "Advanced DRAM Configuration" sub-menu to be determined by BIOS based on the configurations on the SPD. Selecting [Link] or [Unlink] allows users to configure the DRAM timings for each channel and the following related "Advanced DRAM Configuration" sub-menu manually.

### ▶ Advanced DRAM Configuration

Press <Enter> to enter the sub-menu.

#### ▶ Command Rate

This setting controls the DRAM command rate.

#### ▶ tCL

Controls CAS latency which determines the timing delay (in clock cycles) of starting a read command after receiving data.

#### ▶ tRCD

Determines the timing of the transition from RAS (row address strobe) to CAS (column address strobe). The less clock cycles, the faster the DRAM performance.



**▶ tRP**

Controls number of cycles for RAS (row address strobe) to be allowed to pre-charge. If insufficient time is allowed for RAS to accumulate before DRAM refresh, the DRAM may fail to retain data. This item applies only when synchronous DRAM is installed in the system.

**▶ tRAS**

Determines the time RAS (row address strobe) takes to read from and write to memory cell.

**▶ tRFC**

This setting determines the time RFC takes to read from and write to a memory cell.

**▶ tWR**

Determines minimum time interval between end of write data burst and the start of a pre-charge command. Allows sense amplifiers to restore data to cell.

**▶ tWTR**

Determines minimum time interval between the end of write data burst and the start of a column-read command; allows I/O gating to overdrive sense amplifiers before read command starts.

**▶ tRRD**

Specifies the active-to-active delay of different banks.

**▶ tRTP**

Time interval between a read and a precharge command.

**▶ tFAW**

This item is used to set the tFAW (four activate window delay) timing.

**▶ tWCL**

This item is used to set the tWCL (Write CAS Latency) timing.

**▶ tCKE**

This item is used to set the Pulse Width for DRAM module.

**▶ tRTL**

This item is used to set Round Trip Latency settings.

**▶ Advanced Channel 1/ 2 Timing Configuration**

Press <Enter> to enter the sub-menu. And you can set the advanced memory timing for each channel.

**▶ GT OverClocking**

This item allows you to enable/ disable the overclocking of integrated graphics.

**▶ GT Ratio**

This setting controls the ratio of integrated graphics frequency to enable the integrated graphics to run at different frequency combinations.

**▶ Adjusted GT Frequency**

It shows the iGPU frequency. Read-only.

▶ **Spread Spectrum**

This function reduces the EMI (Electromagnetic Interference) generated by modulating clock generator pulses.

**Important**

- *If you do not have any EMI problem, leave the setting at [Disabled] for optimal system stability and performance. But if you are plagued by EMI, select the value of Spread Spectrum for EMI reduction.*
- *The greater the Spread Spectrum value is, the greater the EMI is reduced, and the system will become less stable. For the most suitable Spread Spectrum value, please consult your local EMI regulation.*
- *Remember to disable Spread Spectrum if you are overclocking because even a slight jitter can introduce a temporary boost in clock speed which may just cause your overclocked processor to lock up.*

▶ **Vdroop Control**

This item is used to select the VDroop control mode.

▶ **CPU Core OCP Expander**

This item is used to expand the limitation of CPU Over Current Protection. The higher expanding value indicates less CPU protection. So please adjust the CPU voltage carefully if needed.

▶ **CPU Core Engine Speed**

This item allows you to increase the PWM working speed to stabilize CPU Core voltage and minimize ripple range. Increasing the PWM working speed will cause higher temperature of MOSFET. So please make sure a cooling solution is well-prepared for MOSFET before you increase the value.

▶ **CPU Core Voltage/ DRAM Voltage/ GPU Voltage/ System Agent Voltage (SA)/ CPU PLL Voltage/ DDR\_VREF\_CA\_A/ DDR\_VREF\_CA\_B/ DDR\_VREF\_DA\_A/ DDR\_VREF\_DA\_B/ PCH 1.05**

These items are used to adjust the voltage of CPU, Memory, GPU and chipset.

▶ **Current CPU Core Voltage/ Current DRAM Voltage/ Current GPU Voltage**

These items show current CPU/ DRAM/ GPU voltage. Read-only.

▶ **Overclocking Profiles**

Press <Enter> to enter the sub-menu.

▶ **Overclocking Profile 1/ 2/ 3/ 4/ 5/ 6**

Press <Enter> to enter the sub-menu.

▶ **Set Name for Overclocking Profile 1/ 2/ 3/ 4/ 5/ 6**

Give a name by typing in this item.

▶ **Save Overclocking Profile 1/ 2/ 3/ 4/ 5/ 6**

Save the current overclocking settings to ROM for selected profile.

▶ **Load/ Clear Overclocking Profile 1/ 2/ 3/ 4/ 5/ 6**

Load/ Clear the stored profile settings from ROM.

**▶ OC Profile Save to USB**

Save the current overclocking settings to USB drive.

**▶ OC Profile Load from USB**

Load the stored settings from USB drive.

**▶ CPU Specifications**

Press <Enter> to enter the sub-menu. This sub-menu highlights all the key features of your CPU. The information will vary by model and is read-only. You can also access this information at any time by pressing [F4]. Press <Enter> to enter the sub-menu.

**▶ CPU Technology Support**

Press <Enter> to enter the sub-menu. The sub-menu shows the installed CPU technologies. Read only.

**▶ MEMORY-Z**

Press <Enter> to enter the sub-menu. This sub-menu highlights all the settings and timings of your DIMMs. This information will vary by model and is read-only. You can also access this information at any time by pressing [F5]. Press <Enter> to enter the sub-menu.

**▶ DIMM1~4 Memory SPD**

Press <Enter> to enter the sub-menu. The sub-menu displays the informations of installed memory.

**▶ CPU Features**

Press <Enter> to enter the sub-menu.

**▶ Active Processor Cores**

This item allows you to select the number of active processor cores.

**▶ Limit CPUID Maximum**

It is designed to limit the listed speed of the processor to older operating systems.

**▶ Execute Disable Bit**

Can prevent certain classes of malicious “buffer overflow” attacks where worms can try to execute code to damage your system. It is recommended you keep this enabled always.

**▶ Intel Virtualization Tech**

Enhances virtualization and allows the system to act as multiple virtual systems. See Intel's official website for more information.

**▶ Intel VT-D Tech**

This item is used to enable/disable the Intel VT-D technology. For further information please refer to Intel's official website.

**▶ Power Technology**

This item allows you to select the Intel Dynamic Power technology mode.

**▶ C1E Support**

Enable system to reduce CPU power consumption while idle. Not all processors support Enhanced Halt state (C1E).

**▶ OverSpeed Protection**

Monitors current CPU draw as well as power consumption; if it exceeds a certain

level, the processor automatically reduces its clock speed. For overclocking, it is recommended this feature is disabled.

▶ **Intel C-State**

C-state is a power management state that detects when the system is idle and lowers power consumption accordingly.

▶ **Package C State limit**

This field allows you to select a C-state mode.

▶ **Long duration power limit (W)**

This field allows you to adjust the TDP power limit for the long duration.

▶ **Long duration maintained (s)**

This field allows you to adjust the maintaining time for long duration power limit.

▶ **Short duration power limit (W)**

This field allows you to adjust the TDP power limit for the short duration.

▶ **Primary/ Secondary plane turbo power limit (W)**

These fields allow you to adjust the TDP limit for the primary/ secondary plane turbo.

▶ **1/2/3/4-Core Ratio Limit**

These fields show the 1/2/3/4 core ratio limit of CPU.

## ECO

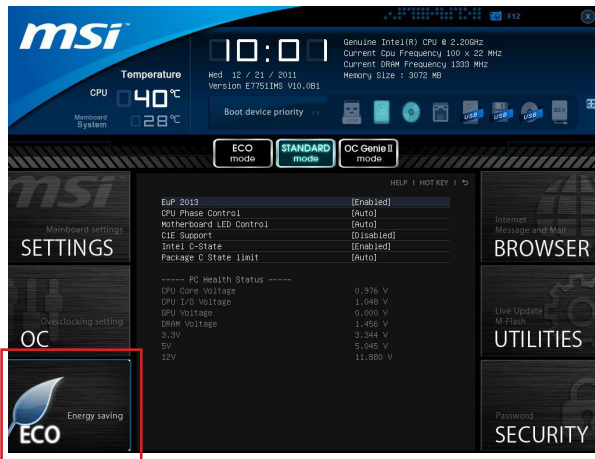
**Important**

Once you click the "ECO" button in the pre-set area, some items in ECO menu will be fixed and un-adjustable.

▶ **EuP 2013**

Energy Using Products Lot 6 2013 (EUP) reduces power consumption when system is off or in standby mode.

Note: When enabled, the system will not support RTC wake up event functions.

▶ **CPU Phase Control**

These items allow you to enable (Auto)/ disable (disabled) the CPU power phase switch feature to reach the best power saving.

▶ **Motherboard LED Control**

This item allows you to enable (Auto)/ disable (disabled) the mainboard phase LED.

▶ **C1E Support**

To enable this item to reduce the CPU power consumption while idle. Not all processors support Enhanced Halt state (C1E).

▶ **Intel C-State**

C-state is a power management state that detects when the system is idle and lowers power consumption accordingly.

▶ **Package C State limit**

This field allows you to select a C-state mode.

▶ **CPU Core Voltage/ CPU I/O Voltage/ GPU Voltage/ DRAM Voltage/ 3.3V/ 5V/ 12V**

These items show the amperages. Read only.

## BROWSER

Please install the MSI "Winki" application first in the Windows operating system with the MSI Driver Disc before using the browser. Then you can click the BROWSER to access the Internet, e-mail and instant messaging.



## Installing Winki

To install Winki, follow the steps below:



1. Power on your computer and enter Windows operating system.
2. Insert MSI Driver Disc into the optical drive. The setup screen will automatically appear.
3. Click Driver tab.
4. Click OTHERS button.
5. Select Winki to start installing.
6. When finished, restart your computer.

## UTILITIES

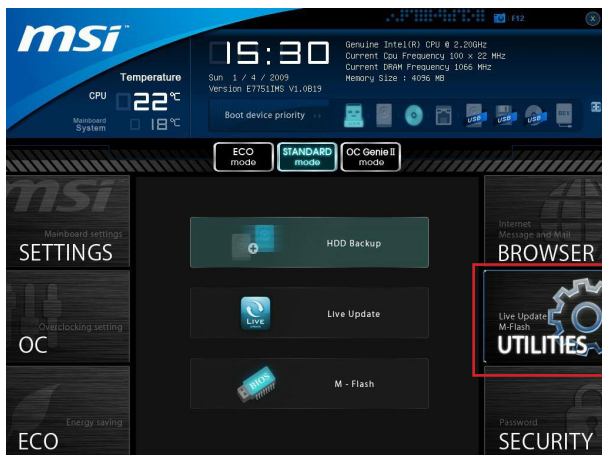

### ► HDD Backup

Hard disk storage backups and restoring is one of the most common and important tasks. Use this utility to create an image of your HDD partitions and re-load them when necessary.

### Important

The HDD Backup can't back up (/restore) image to (/from) a partition where itself was installed, so it's strongly recommended to divide HDD into 2 partitions at least (1st for OS; 2nd for data).

For HDD with single partition only, the requirements for HDD Backup are:

1. An additional partition from another HDD (ex. USB HDD) for HDD Backup to back up (/restore) image to (/from) it.
2. Executing Winki stored in USB flash drive/ MSI Driver Disc by pressing <F11> to choose boot device during POST.

### ► Live Update

This tool can detect and update your BIOS online so that you won't need to spend time searching manually.

### Important

HDD Backup and Live Update request Winki, please install the "Winki" software application from MSI Driver Disc in Windows first. And then you can access these two utilities by clicking their respective buttons.

### ► M-Flash

#### ► BIOS Boot Function

This allows you to enable/ disable the system to boot from the BIOS file inside USB drive (FAT/ 32 format only).

#### ► Select UEFI file to boot from

When the BIOS Boot function as sets to [Enabled], this item is selectable. This item allows to select particular BIOS file from the USB/ Storage (FAT/ 32 format only) drive. And the system will boot from selected BIOS file.

#### ► Save current UEFI rom to file

Please setup a specific folder in specific USB/ Storage drive to save BIOS file from BIOS ROM chip data. Note: it only supports FAT/ 32 file system drive.

#### ► Select UEFI file to flash

This item allows you to select a particular BIOS file from the USB/ Storage (FAT/ 32 format only) drive for updating BIOS.





## Updating the BIOS with Live Update

This section tells you how to update the BIOS by using the Live Update utility before entering Operating System. Live Update will update the BIOS automatically when connecting to the Internet. To update the BIOS with the Live Update utility:

1. Click Live Update button  on the BIOS UTILITIES menu. (The Winki must be installed).



2. Setup the connection by click the setting button  if necessary.
3. Click the next button .
4. Live Update will automatically detect the version of BIOS and download the appropriate file.

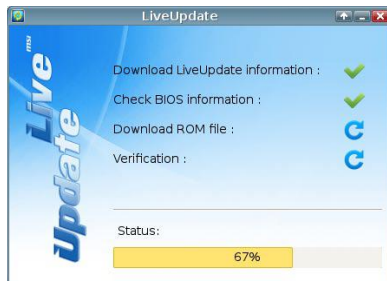

5. Click the confirm button  to update the BIOS.



### **Important**

*Do not unplug or shut off your system during BIOS Flash. Incorrect BIOS flashing can cause the motherboard to not POST. Please ensure you have the correct version and model of your motherboard BIOS when updating.*

# SECURITY

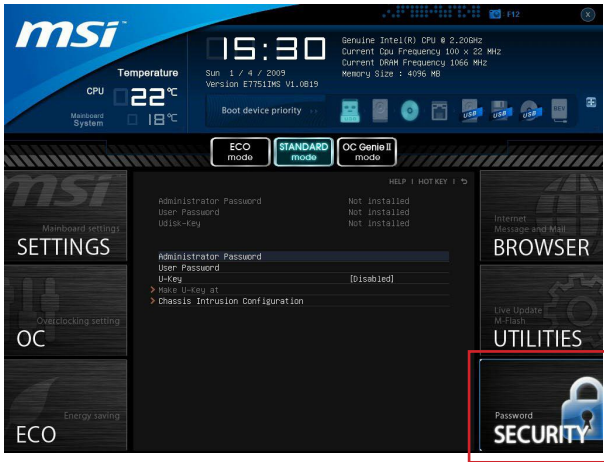

► **Administrator Password**

Set the administrative password that will be required to enter the BIOS.

► **User Password**

Set the user password that will be required to enter the operating system.

**Important**

When selecting the Administrative / User Password items, a password box will appear on the screen. Type the password then press <Enter>. The password typed now will replace any previous set password from CMOS memory. You will be prompted to confirm the password. You may also press <Esc> to abort the selection.

To clear a set password, press <Enter> when you are prompted to enter a new password. A message will confirm the password is being disabled. Once the password is disabled, you can enter the setup and OS without authorization.

► **U-Key**

Enable or disable USB driver device as key. This requires the USB device to be plugged in for access to the computer..

► **Make U-Key at**

When the “U-Key” as sets to [Enabled], this item is selectable. This item allows you to specify the USB drive.

### ► Multi BIOS Auto Update

When “Enabled”, and the primary BIOS has failed, the system will allow the secondary BIOS to reflash the primary BIOS for booting successfully, and the screen will show the progress message as below.

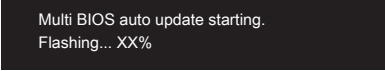
A black rectangular box containing white text that reads: "Multi BIOS auto update starting." followed by "Flashing... XX%".

```
Multi BIOS auto update starting.  
Flashing... XX%
```

Do not press any buttons to shutdown or restart the computer during the BIOS flashing operation.

### ► Chassis Intrusion Configuration

Press <Enter> to enter the sub-menu.

#### ► Chassis Intrusion

Enables or disables the feature of recording the chassis intrusion status and issuing a warning message if opened. To clear the warning logs, set the field to [Reset]. The setting of the field will return to [Enabled] later.



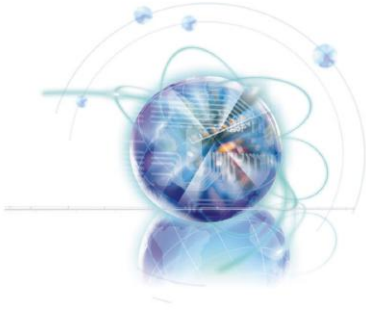

## *Appendix A*

# *Realtek Audio*

The Realtek audio provides 10-channel DAC that simultaneously supports 7.1 sound playback and 2 channels of independent stereo sound output (multiple streaming) through the Front-Out-Left and Front-Out-Right channels.

## Installing the Realtek HD Audio Driver

You need to install the HD audio driver for Realtek audio codec to function properly before you can get access to 2-, 4-, 6-, 8- channel or 7.1+2 channel audio operations. Follow the procedures described below to install the drivers for different operating systems.

### Installation for Windows®

For Windows® XP, you must install Windows® XP Service Pack3 or later before installing the driver.

The following illustrations are based on Windows®7 environment and could look slightly different if you install the drivers in different operating systems.

1. Insert the application DVD into the DVD-ROM drive. The setup screen will automatically appear.
2. Click Driver tab.
3. Click AUDIO button.



4. Select Realtek HD Audio Drivers to start installing the drivers.
5. Click Next to install the Realtek High Definition Audio Driver.
6. Follow the on-screen instructions to install drivers.
7. Click Finish to restart the system.

### **Important**

*The HD Audio Configuration software utility is under continuous update to enhance audio applications. Hence, the program screens shown here in this section may be slightly different from the latest software utility and shall be held for reference only.*

## Software Configuration

After installing the audio driver, the “Realtek HD Audio Manager” icon will appear at the notification area (lower right of the screen). You may double click the icon and the GUI will pop up accordingly.



It is also available to enable the audio driver by clicking the Realtek HD Audio Manager from the Control Panel.

## Software panel overview

The following figure describes the function of the Realtek HD Audio Manager panel.

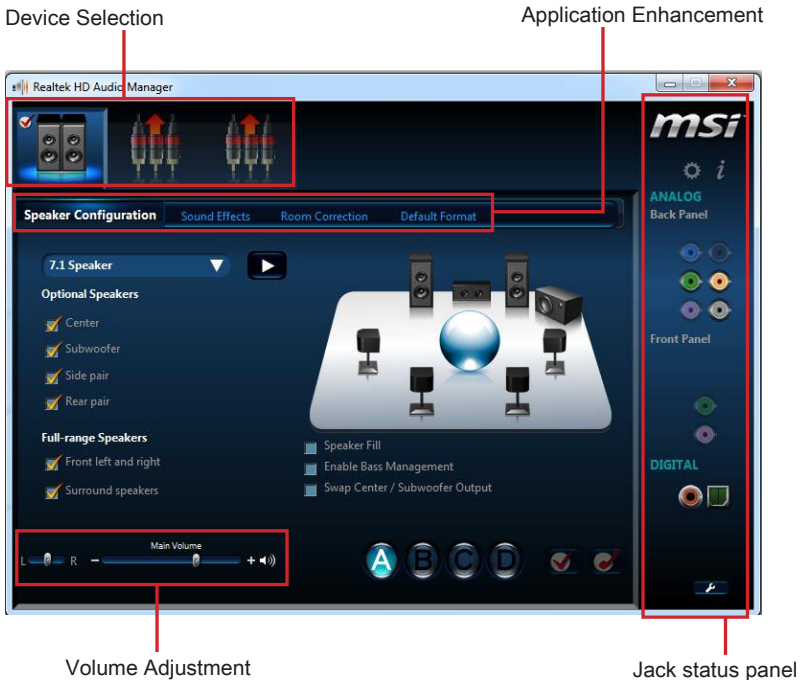

■ **Device Selection**

Here you can select a audio output source to change the related options. The “check” sign (in orange) indicates the devices as default.

■ **Volume Adjustment**

You can control the volume or balance the right/left side of the speakers that you plugged in front or rear panel by adjust the bar.

■ **Application Enhancement**

The array of options will provide you a complete guidance of anticipated sound effect for both output and input device.

■ **Jack status panel**

This panel depicts all render and capture devices currently connected with your computer.

### Auto popup dialog

When you plug into the device at the jack, a dialogue window will pop up asking you which device is current connected.



As you know, each jack corresponds to its default setting, you can refer to the next section “Hardware Default Setting”.



## Hardware Default Setting

The following diagrams are audio back panel default setting.

- Backpanel audio jacks to 2-channel speakers diagram

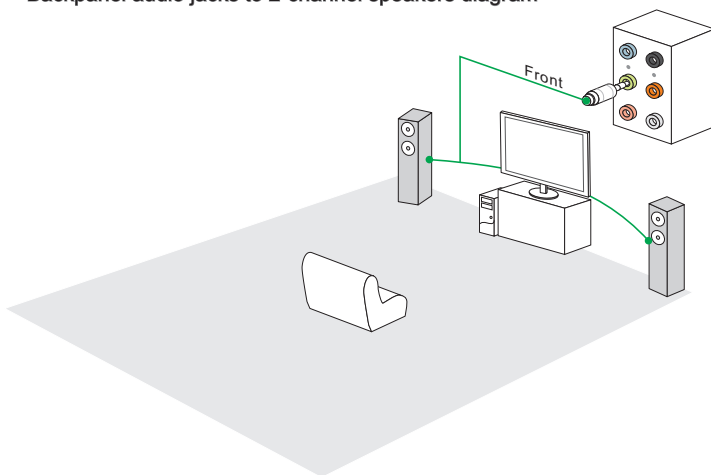

- Backpanel audio jacks to 4-channel speakers diagram

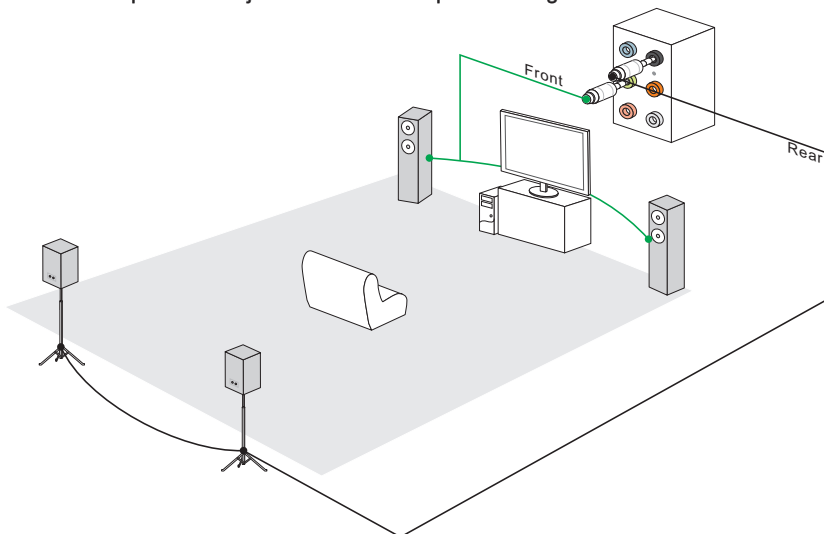

■ Backpanel audio jacks to 6-channel speakers diagram

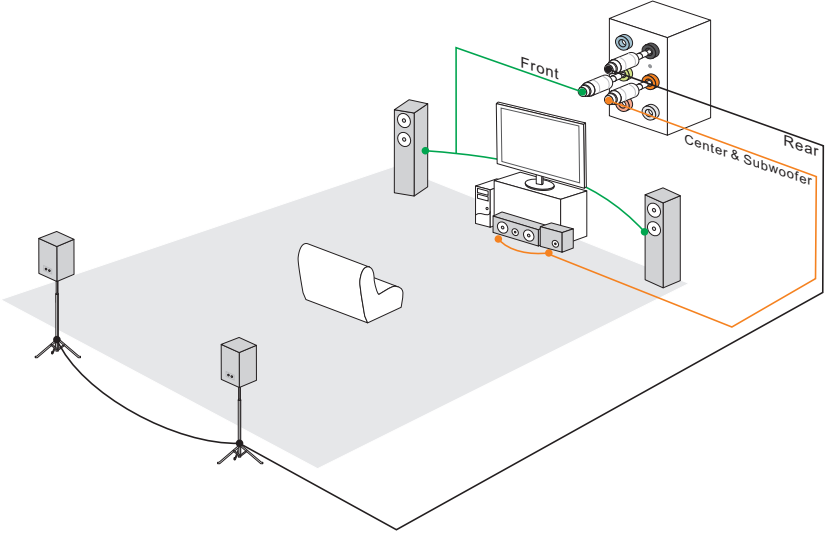

■ Backpanel audio jacks to 8-channel speakers diagram

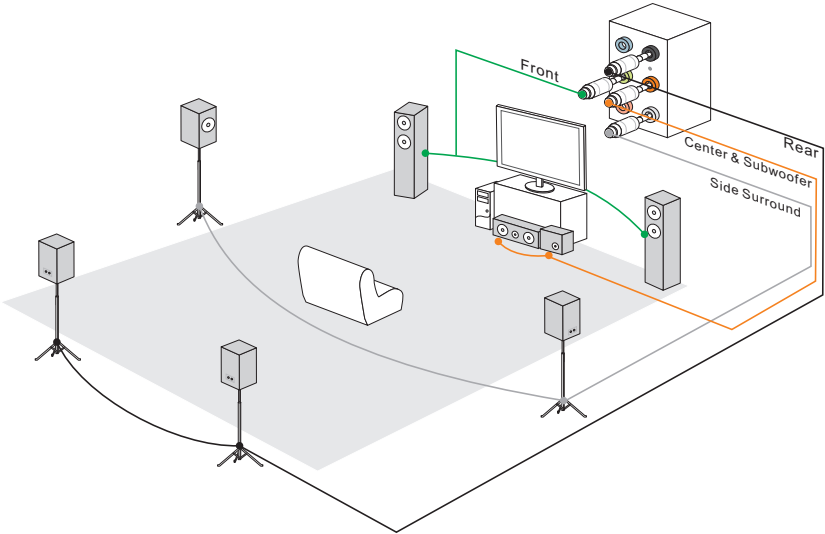



## ***Appendix B***

# ***Intel RAID***

This appendix will assist users in configuring and enabling RAID functionality and accelerating system on platforms

## Introduction

---

The mainboard comes with the Intel RAID controller that allows you to configure SATA hard drives as RAID sets.

SATA hard drives deliver blistering transfer speeds up to 6 Gb/s. Serial ATA uses long, thin cables, making it easier to connect your drive and improving the airflow inside your PC. The most outstanding features are:

1. Supports 3 Gb/s or 6 Gb/s transfers with CRC error checking.
2. Supports Hot-plug-n-play feature.
3. Data handling optimizations including tagged command queuing, elevator seek and packet chain command.

Intel® RAID controller offers RAID level 0 (Striping), RAID level 1 (Mirroring and Duplexing), RAID level 5 (Block Interleaved Distributed Parity), RAID level 10 (A Stripe of Mirrors) , Intel® Rapid Storage Technology.

RAID 0 breaks the data into blocks which are written to separate hard drives. Spreading the hard drive I/O load across independent channels greatly improves I/O performance.

RAID 1 provides data redundancy by mirroring data between the hard drives and provides enhanced read performance.

RAID 5 Provides data striping at the byte level and also stripe error correction information. This results in excellent performance and good fault tolerance. Level 5 is one of the most popular implementations of RAID.

RAID 10 Not one of the original RAID levels, multiple RAID 1 mirrors are created, and a RAID 0 stripe is created over these.

Intel® Rapid Storage Technology is the advanced ability for two RAID volumes to share the combined space of two hard drives being used in unison.

Intel® Rapid Storage Technology utilizes RAID 1 functionality to copy data from a designated Master drive to a designated Recovery drive. The size of the Master drive must be less than or equal to the size of the Recovery drive. When a Recovery volume is created, complete capacity of the Master drive will be used as the Master volume. Only one Recovery Volume can exist on a system. There are 2 methods of updating the data on the Master to the Recovery drive. They are Continuous Update Policy and On Request Update Policy.

### **Important**

*The least number of hard drives for RAID 0, RAID 1, Recovery or Matrix mode is 2. The least number of hard drives for RAID 10 mode is 4. And the least number of hard drives for RAID 5 mode is 3.*

*All the information/ volumes/ pictures listed in your system might differ from the illustrations in this appendix.*

## Using Intel Rapid Storage Technology Option ROM

The Intel Rapid Storage Technology Option ROM should be integrated with the system BIOS on all mainboards with a supported Intel chipset. The Intel Rapid Storage Technology Option ROM is the Intel RAID implementation and provides BIOS and DOS disk services. Please use <Ctrl> + <I> keys to enter the "Intel® RAID for Serial ATA" status screen, which should appear early in system boot-up, during the POST (Power-On Self Test). Also, you need to enable the RAID function in BIOS to create, delete and reset RAID volumes.

### Creating, Deleting and Resetting RAID Volumes:

The Serial ATA RAID volume may be configured using the RAID Configuration utility stored within the Intel RAID Option ROM. During the Power-On Self Test (POST), the following message will appear for a few seconds.

### **Important**

The "Device Model", "Serial #" and "Size" in the following example might be different from your system.

```

RAID Volumes
None defined.

Physical Disks:
Port  Device Model      Serial #           Size           Type/Status(Vol ID)
1     XXXXXXXXXXXXXXXX  XXXXXXXXXXXXXXXX  XXX.XGB       Non-RAID Disk
2     XXXXXXXXXXXXXXXX  XXXXXXXXXXXXXXXX  XXX.XGB       Non-RAID Disk

Press <CTRL-I> to enter Configuration Utility..

```

After the above message shows, press <Ctrl> and <I> keys simultaneously to enter the Intel Rapid Storage Technology Option ROM.

### **Important**

The following procedure is only available with a newly-built system or if you are reinstalling your OS. It should not be used to migrate an existing system to RAID.

After pressing the <Ctrl> and <I> keys simultaneously, the following window will appear:

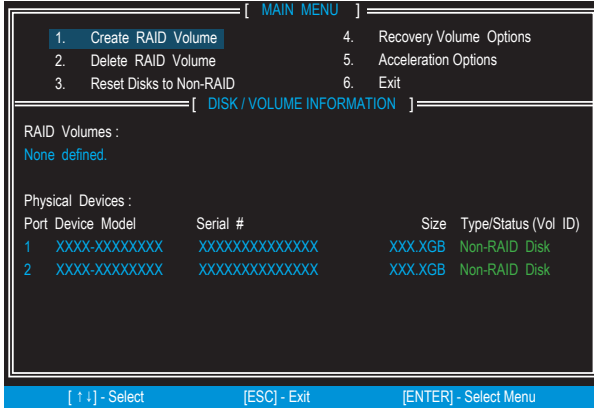

■ Create RAID Volume

1. Select option 1 "Create RAID Volume" and press <Enter> key. The following screen appears. Then in the Name field, specify a RAID Volume name and then press the <TAB> or <Enter> key to go to the next field.
2. Use the arrow keys to select the RAID level best suited to your usage model in RAID Level.

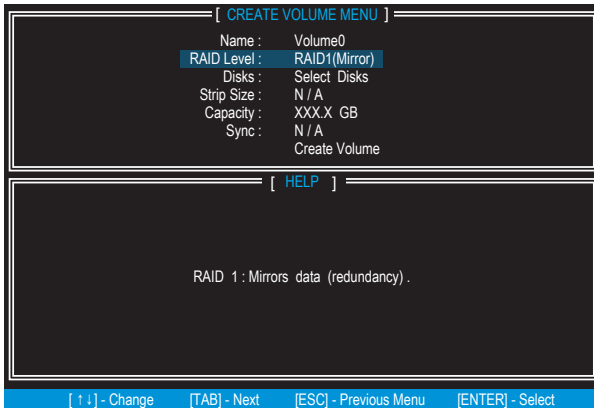

3. In the Disk field, press <Enter> key and use <Space> key to select the disks you want to create for the RAID volume, then click <Enter> key to finish selection. This field will become available according to the selected RAID level.
4. Then select the strip size for the RAID array by using the “upper arrow” or “down arrow” keys to scroll through the available values, and pressing the <Enter> key to select and advance to the next field. The available values range from 4KB to 128 KB in power of 2 increments. The strip size should be chosen based on the planned drive usage. Here are some typical values: RAID0 -128KB / RAID10 - 64KB / RAID5 - 64KB. This field will become available according to the selected RAID level.
5. Then select the capacity of the volume in the Capacity field. The default value is the maximum volume capacity of the selected disks.

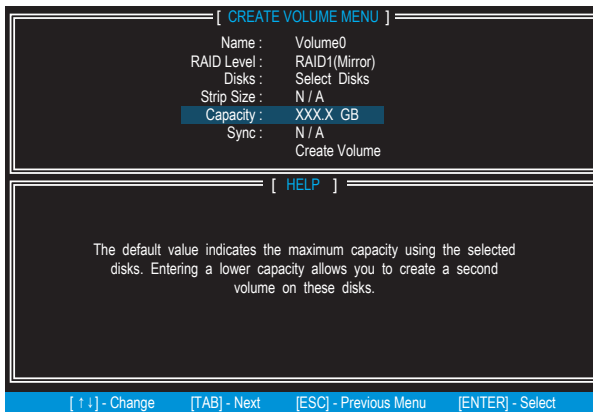

### **Important**

Since you want to create two volumes, this default size (maximum) needs to be reduced. Type in a new size for the first volume. As an example: if you want the first volume to span the first half of the two disks, re-type the size to be half of what is shown by default. The second volume, when created, will automatically span the remainder of two hard drives.

- Go to the Create Volume field and press <Enter>, the following screen appears for you to confirm if you are sure to create the RAID volume. Press <Y> to continue.

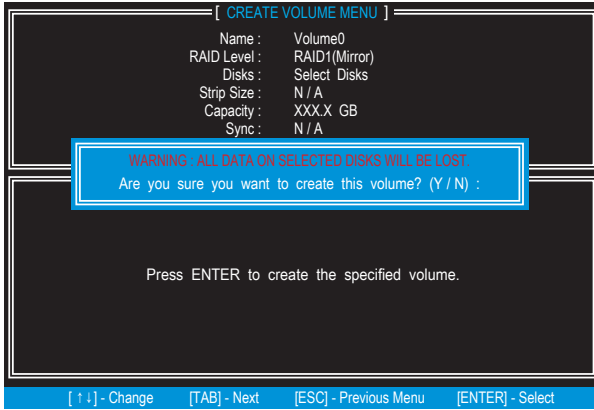

- Then the following screen appears to indicate that the creation is finished.

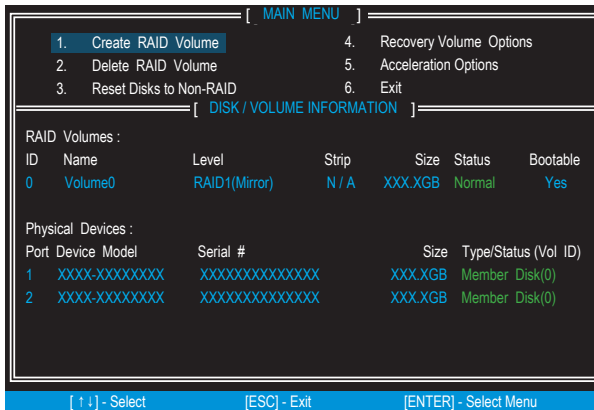



## ■ Delete RAID Volume

Here you can delete the RAID volume, but please be noted that all data on RAID drives will be lost.

### **Important**

*If your system currently boots to RAID and you delete the RAID volume in the Intel RAID Option ROM, your system will become un-bootable.*

Select option 2 **Delete RAID Volume** from the main menu screen and press <Enter> key to select a RAID volume for deletion. Then press <Delete> key to delete the selected RAID volume. The following screen appears.

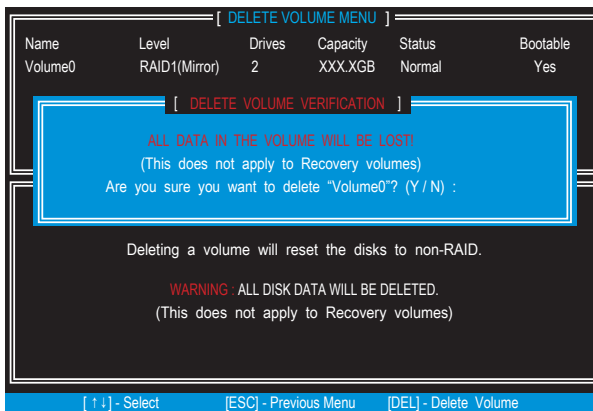

Press <Y> key to accept the volume deletion.

■ **Reset Disks to Non-RAID**

Select option 3 Reset Disks to Non-RAID and press <Enter> to delete the RAID volume and remove any RAID structures from the drives. The following screen appears:

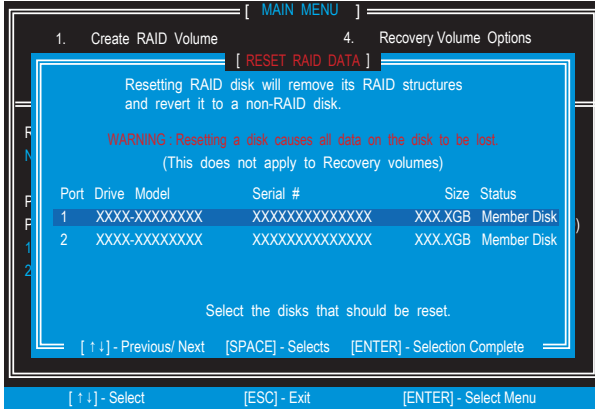

Use the <Space> key to select the disks and press <Enter> key. A confirmation sentence will appear below, and then press <Y> key to accept the selection.

**Important**

- You will lose all data on the RAID drives and any internal RAID structures when you perform this operation.
- Possible reasons to “Reset Disks to Non-RAID” could include issues such as incompatible RAID configurations or a failed volume or failed disk.

## ■ Recovery Volume Options

Select option 4 Recovery Volume Options and press <Enter> to change recovery volume mode. The following screen appears:

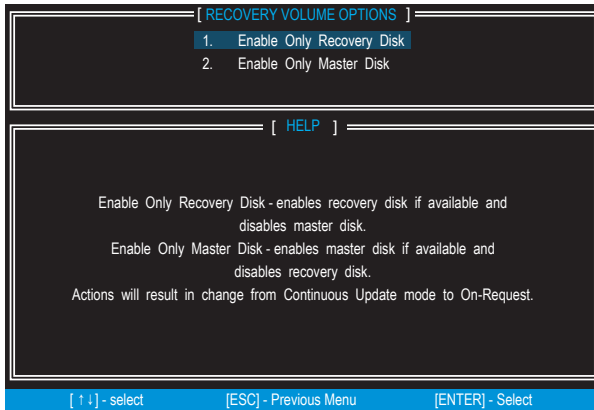

Recovery mode will change from Continuous Update to On-Request after you enable "Only Recovery Disk" or "Only Master Disk".

## Installing Driver

---

### ■ New Windows 7/ Windows Vista / Windows XP Installation

The following details the installation of the drivers while installing operating system.

1. When you start installing Windows XP, you may encounter a message stating, "Setup could not determine the type of one or more mass storage devices installed in your system". If this is the case, then you are already in the right place and are ready to supply the driver. If this is not the case, then press F6 when prompted at the beginning of Windows setup.
2. Press the "S" key to select "Specify Additional Device".
3. You should be prompted to insert a floppy disk containing the Intel® RAID driver into the A: drive.

Note: For Windows XP, you can use the USB floppy drive only.

For Windows Vista/ Windows 7 you can use CD/ DVD/ USB drive.

### **Important**

*Please follow the instruction below to make an "Intel® RAID Driver" for yourself.*

- Insert the MSI DVD into the DVD-ROM drive.
  - Click the "Browse CD" on the Setup screen.
  - Copy all the contents in `\\Storage\Intel\PCH\6floppy-x86` or `6floppy-x64` to a formatted floppy diskette.
  - The driver diskette for Intel® RAID Controller is done.
4. For Windows Vista/ Windows 7:  
During the Operating system installation, after selecting the location to install Vista / Windows 7 click on "Load Driver" button to install a third party SCSI or RAID driver.
  5. When prompted, insert the floppy disk or media (CD/DVD or USB) you created in step 3 and press Enter.
  6. You should be shown a list of available SCSI Adapters.
  7. Select the appropriate Intel RAID controller and press ENTER.
  8. The next screen should confirm that you have selected the Intel® RAID controller. Press ENTER again to continue.
  9. You have successfully installed the Intel® Rapid Storage Technology driver, and Windows setup should continue.
  10. Leave the disk in the floppy drive until the system reboots itself. Windows setup will need to copy the files from the floppy again after the RAID volume is formatted, and Windows setup starts copying files.

**■ Existing Windows Driver Installation**

1. Insert the MSI DVD into the DVD-ROM drive.
2. The DVD will auto-run and the setup screen will appear.
3. Under the Driver tab, click on Intel RAID Drivers.
4. The drivers will be automatically installed.

**■ Confirming Windows Driver Installation**

1. From Windows, open the Control Panel from My Computer followed by the System icon.
2. Choose the Hardware tab, then click the Device Manager tab.
3. Click the "+" in front of the SCSI and RAID Controllers hardware type. The driver Intel(R) SATA RAID Controller should appear.

## Degraded RAID Array

A RAID 1, RAID 5 or RAID 10 volume is reported as degraded when one of its hard drive members fails or is temporarily disconnected, and data mirroring is lost. As a result, the system can only utilize the remaining functional hard drive member. To re-establish data mirroring and restore data redundancy, refer to the procedure below that corresponds to the current situation.

### Missing Hard Drive Member

1. Make sure the system is powered off.
2. Reconnect the hard drive.
3. Reboot the system to Windows; the rebuild will occur automatically.

### Failed Hard Drive Member

1. Make sure the system is powered off.
2. Replace the failed hard drive with a new one that is of equal or greater capacity.
3. Reboot the system to Intel RAID Option ROM by press <Ctrl> and <I> keys simultaneously during the Power-On Self Test (POST).

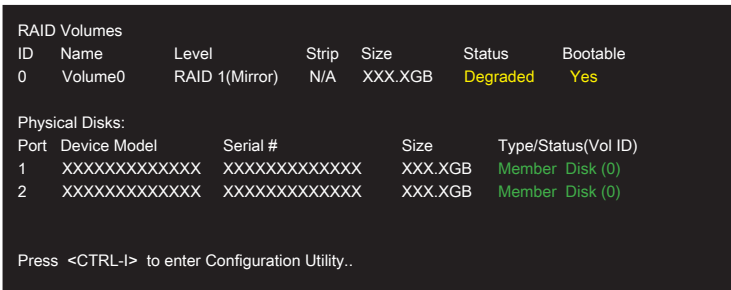

4. Select the port of the destination disk for rebuilding, and then press ENTER.

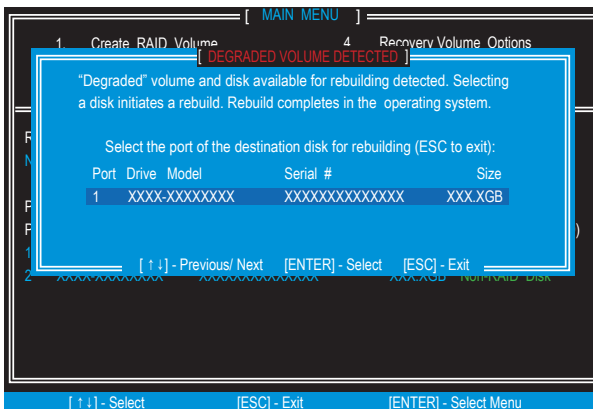

5. Exit Intel RAID Option ROM, and then reboot to Windows system.
6. When prompted to rebuild the RAID volume, click 'Yes'.
7. The Intel Rapid Storage Technology application will be launched. Right-click the new hard drive and select 'Rebuild to this Disk'. The 'Rebuild Wizard' will be launched which will guide you through the process of rebuilding to the new hard drive.

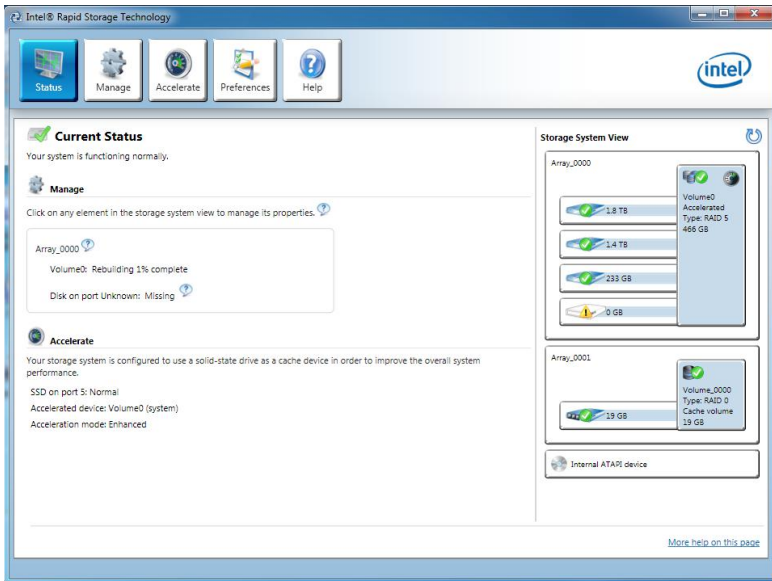

## System Acceleration (optional)

Intel® Rapid Storage Technology use a SSD as a cache. Which can store frequently used data without having to use a slow virtual disk or depend on RAM. The SSD cache with the advantages of high-speed read/write and non-volatile memory to accelerate the system performance.

### Important

*Check your SSD manufacturer's website, upgrade firmware in order to support Intel® Rapid Storage Technology.*

Intel® Rapid Storage Technology can only work with RAID mode. Even though there is only one hard drive, you must set the SATA Mode to RAID in BIOS. The OS must be installed in the RAID ready disk in order to use the SSD caching.

Follow these steps to enable system acceleration. If Windows has been installed in RAID mode, skip to the step 5.

1. Reboot and enter the BIOS setup.
2. Set the SATA Mode to RAID in BIOS.
3. Install Intel® RAID controller driver. Please refer to the section "Installing Driver".
4. Install Windows operating system.
5. Powered off.
6. Connect the SSD.
7. Reboot the system to Windows.
8. Insert the MSI DVD into the DVD-ROM drive.



9. Click the "STORAGE" on the Setup screen.



10. Click the "Intel RAID Driver" to install Intel® Rapid Storage Technology application.



11. Run Intel® Rapid Storage Technology application.
12. Click "Enable acceleration" under Accelerate.

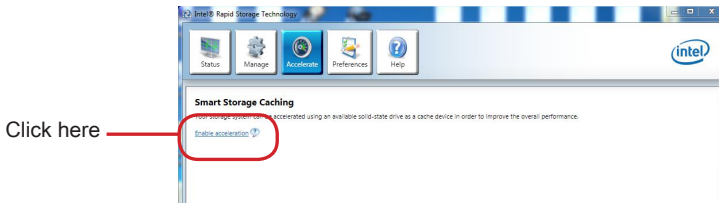

13. Select the acceleration options.

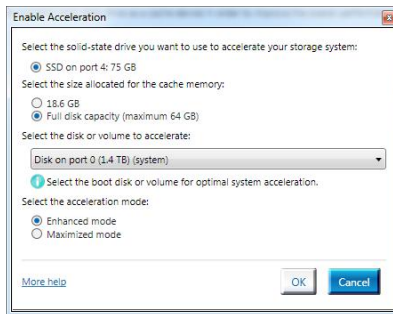

14. Click OK and reboot the system.

The page refreshes and reports the new acceleration configuration in the Acceleration View.

### **Important**

You can click "More help on this page" or "More help" of the Intel® Rapid Storage Technology application to view more information.

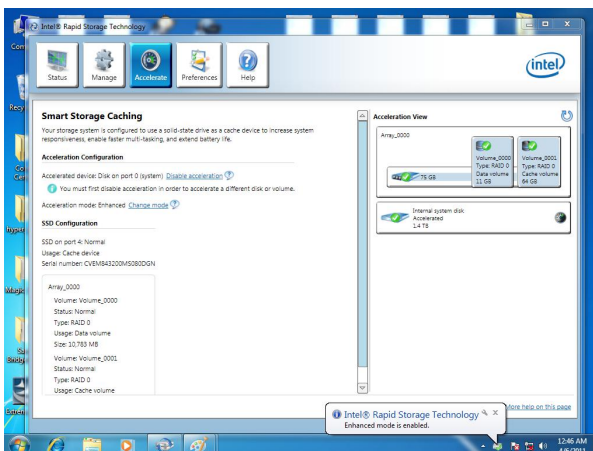

## RST Synchronization (optional)

If you are using Maximized mode as the Acceleration mode, the data on the hard disk is not always synchronized with the data in the SSD cache. In some situations, you may want to manually sync the disks for avoiding data loss.

Follow these steps to sync manually.

1. Reboot system, during the Power-On Self Test (POST) press, press <Ctrl> and <I> keys simultaneously to enter the Intel Rapid Storage Technology Option ROM.
2. Select option 5 "Acceleration Options" and press <Enter> key. The following screen appears.

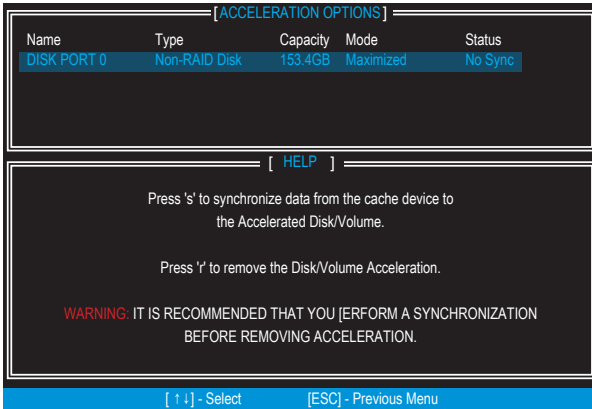

3. Press <S> to synchronize data.

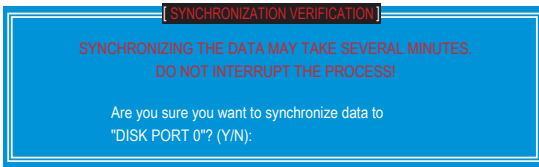

4. When prompted, press <Y> to confirm.

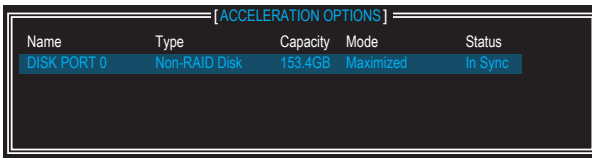

5. Once synchronization is complete, the status will change to In Sync.