

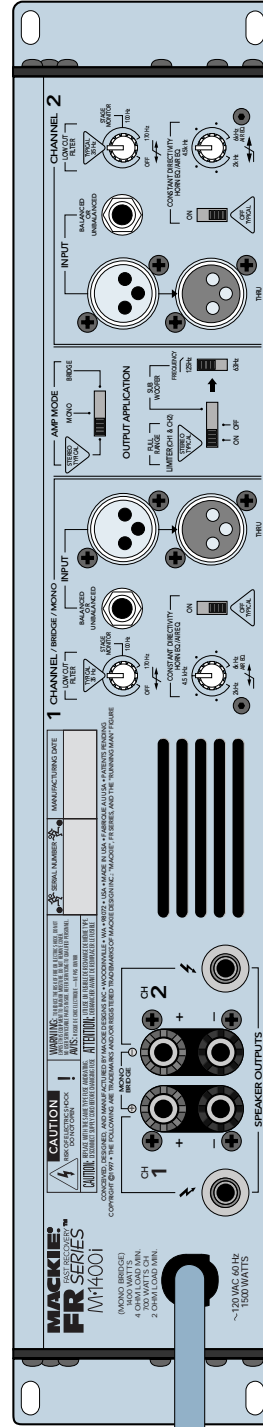
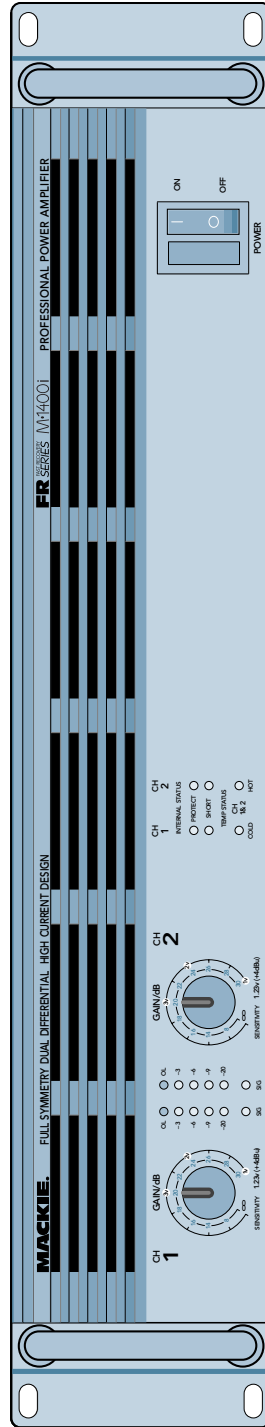

MACKIE®

M•1400i OWNER'S MANUAL AND WARRANTY REGISTRATION

FAST RECOVERY
FR SERIES™

HIGH-CURRENT POWER AMPLIFIER



 <div style="background-color: black; color: white; padding: 5px; font-weight: bold; font-size: 1.2em;">CAUTION AVIS</div> <div style="text-align: center;"> <p>RISK OF ELECTRIC SHOCK DO NOT OPEN</p> <p>RISQUE DE CHOC ELECTRIQUE NE PAS OUVRIR</p> </div> 
<p>CAUTION: TO REDUCE THE RISK OF ELECTRIC SHOCK DO NOT REMOVE COVER (OR BACK) NO USER-SERVICEABLE PARTS INSIDE REFER SERVICING TO QUALIFIED PERSONNEL</p> <p>ATTENTION: POUR EVITER LES RISQUES DE CHOC ELECTRIQUE, NE PAS ENLEVER LE COUVERCLE. AUCUN ENTRETIEN DE PIECES INTERIEURES PAR L'USAGER. CONFIER L'ENTRETIEN AU PERSONNEL QUALIFIE.</p> <p>AVIS: POUR EVITER LES RISQUES D'INCENDIE OU D'ELECTROCUTION, N'EXPOSEZ PAS CET ARTICLE A LA PLUIE OU A L'HUMIDITE</p>



The lightning flash with arrowhead symbol within an equilateral triangle is intended to alert the user to the presence of uninsulated "dangerous voltage" within the product's enclosure, that may be of sufficient magnitude to constitute a risk of electric shock to persons.

Le symbole éclair avec point de fleche à l'intérieur d'un triangle équilatéral est utilisé pour alerter l'utilisateur de la présence à l'intérieur du coffret de "voltage dangereux" non isolé d'ampleur suffisante pour constituer un risque d'électrocution.



The exclamation point within an equilateral triangle is intended to alert the user of the presence of important operating and maintenance (servicing) instructions in the literature accompanying the appliance.

Le point d'exclamation à l'intérieur d'un triangle équilatéral est employé pour alerter les utilisateurs de la présence d'instructions importantes pour le fonctionnement et l'entretien (service) dans le livret d'instruction accompagnant l'appareil.

SAFETY INSTRUCTIONS

- 1. Read Instructions** — All the safety and operation instructions should be read before this Mackie product is operated.
- 2. Retain Instructions** — The safety and operating instructions should be kept for future reference.
- 3. Heed Warnings** — All warnings on this Mackie product and in these operating instructions should be followed.
- 4. Follow Instructions** — All operating and other instructions should be followed.
- 5. Water and Moisture** — This Mackie product should not be used near water — for example, near a bathtub, washbowl, kitchen sink, laundry tub, in a wet basement, near a swimming pool, swamp or salivating St. Bernard dog, etc.
- 6. Ventilation** — This Mackie product should be situated so that its location or position does not interfere with its proper ventilation. For example, the Component should not be situated on a bed, sofa, rug, or similar surface that may block any ventilation openings, or placed in a built-in installation such as a bookcase or cabinet that may impede the flow of air through ventilation openings.
- 7. Heat** — This Mackie product should be situated away from heat sources such as radiators, or other devices which produce heat.

PORTABLE CART WARNING	
	<p>Carts and stands - The Component should be used only with a cart or stand that is recommended by the manufacturer.</p> <p>A Component and cart combination should be moved with care. Quick stops, excessive force, and uneven surfaces may cause the Component and cart combination to overturn.</p>

8. Power Sources — This Mackie product should be connected to a power supply only of the type described in these operation instructions or as marked on this Mackie product.

9. Power Cord Protection — Power supply cords should be routed so that they are not likely to be walked upon or pinched by items placed upon or against them, paying particular attention to cords at plugs, convenience receptacles, and the point where they exit this Mackie product.

10. Object and Liquid Entry — Care should be taken so that objects do not fall into and liquids are not spilled into this Mackie product.

11. Damage Requiring Service — This Mackie product should be serviced only by qualified service personnel when:

- The power-supply cord or the plug has been damaged; or
- Objects have fallen, or liquid has spilled into this Mackie product; or
- This Mackie product has been exposed to rain; or
- This Mackie product does not appear to operate normally or exhibits a marked change in performance; or
- This Mackie product has been dropped, or its chassis damaged.

12. Servicing — The user should not attempt to service this Mackie product beyond those means described in this operating manual. All other servicing should be referred to the Mackie Service Department.

13. To prevent electric shock, do not use this polarized plug with an extension cord, receptacle or other outlet unless the blades can be fully inserted to prevent blade exposure.

Pour prévenir les chocs électriques ne pas utiliser cette fiche polarisée avec un prolongateur, un prise de courant ou une autre sortie de courant, sauf si les lames peuvent être insérées à fond sans laisser aucune partie à découvert.

14. Grounding or Polarization — Precautions should be taken so that the grounding or polarization means of this Mackie product is not defeated.

15. This apparatus does not exceed the Class A/Class B (whichever is applicable) limits for radio noise emissions from digital apparatus as set out in the radio interference regulations of the Canadian Department of Communications.

ATTENTION — Le présent appareil numérique n'émet pas de bruits radioélectriques dépassant les limites applicables aux appareils numériques de class A/de class B (selon le cas) prescrites dans le règlement sur le brouillage radioélectrique édicté par les ministere des communications du Canada.



This product has been tested and complies with the following standards and directives as set forth by the European Union:

- | | |
|------------|------------------------------|
| • EN 50013 | 1990 Emissions |
| • EN 50020 | 1988 Immunity |
| • EN 60065 | 1994 and IEC 65: 1985 Safety |

WARNING — To reduce the risk of fire or electric shock, do not expose this appliance to rain or moisture.



Lend Me Your Ears

Exposure to extremely high noise levels may cause permanent hearing loss.

Individuals vary considerably in susceptibility to noise-induced hearing loss, but nearly everyone will lose some hearing if exposed to sufficiently intense noise for a period of time. The U.S. Government's Occupational Safety and Health Administration (OSHA) has specified the permissible noise level exposures shown in this chart.

Duration Per Day In Hours	Sound Level dBA, Slow Response	Typical Example
8	90	Duo in small club
6	92	
4	95	Subway Train
3	97	
2	100	Very loud classical music
1.5	102	
1	105	Lori screaming at Ron about deadlines
0.5	110	
0.25 or less	115	Loudest parts at a rock concert

According to OSHA, any exposure in excess of these permissible limits could result in some hearing loss. To ensure against potentially dangerous exposure to high sound pressure levels, it is recommended that all persons exposed to equipment capable of producing high sound pressure levels (such as this amplification system) use hearing

protectors while this unit is in operation. Ear plugs or protectors in the ear canals or over the ears must be worn when oper-

ating this amplification system in order to prevent a permanent hearing loss if exposure is in excess of the limits set forth here.

INTRODUCTION

Thank you for choosing a Mackie Designs power amplifier! We appreciate your vote of confidence for the folks in Woodinville who specialize in awesome and affordable audio. The Mackie Designs M•1400i power amplifier is designed to fulfill the amplification needs of almost any type of application. It boasts a wealth of features you'd expect to pay extra for — like subwoofer filtering, constant directivity equalization, speaker-protecting limiter, and gobs of ultra-clean power, to name a few.

Perhaps the most important feature of the FR Series™ Power Amplifiers is the attention to detail in every aspect of the design. At Mackie, we know what it takes to be roadworthy. After all, our mixers have traveled all over the world under the worst of conditions, and we've applied what we've learned to the mechanical design of our amplifiers.

Roadworthiness is only part of the picture. We know that reliability is paramount to sound reinforcement. That's why we use double-sided thru-hole-plated fiberglass printed circuit boards. That's why our engineers have subjected the amplifier to the most rigorous and punishing tests imaginable, to fine-tune the design and extend its limits beyond those of ordinary amplifiers.

Fast Recovery — where the "FR" comes from — is more than a buzzword. It is based on real, proven design principles. The result is an amplifier that performs better than conventional designs when presented with adverse conditions. One of the most difficult things for a power

amplifier to handle is clipping. Conventional designs use lots of negative feedback to provide stability and lower distortion. When clipping occurs, this "feedback" causes high-frequency sticking, keeping the amplifier "latched" in the clipping state longer than necessary. This results in painfully audible distortion. Our Fast Recovery design eliminates this high-frequency sticking and allows the amplifier to remain stable when powering highly reactive loads at high volume levels.

You may wonder why a power amp even needs an owner's manual. After all, you just plug in a few cables and power it up. Well, it's almost that simple. There's just a few things that we'd like you to be aware of, and we'll discuss those right away — please see the **Quick Start 1** on the next page.

Then go ahead and read the entire manual. The M•1400i amplifier has a wealth of useful features, and each of them is explained in detail.

Please write your serial number here for future reference (i.e., insurance claims, tech support, return authorization, etc.):

Purchased at:

Date of purchase:



READ THIS PAGE!

1 QUICK START

I got ants in my pants and I got to dance!



INSTALLATION

You can mount the M•1400i amp in any standard rack system (see 25), or place it horizontally on a floor or table. The heavier internal components are located towards the front of the chassis to make it easier to hold the amp by its front handles.



IMPORTANT: The M•1400i amp draws its ventilation air in from the front and out through the side panels. It needs plenty of fresh air

to stay cool.

DO NOT BLOCK THE VENTILATION PORTS (see 26).

CONNECTIONS AND SETTINGS

1. Be sure the POWER 9 switch is off before making connections.
2. Turn the GAIN 3 controls fully down (counterclockwise) for now.
3. Set both LOW CUT FILTER 14 controls to their TYPICAL marks (35Hz).
4. Set both CONSTANT DIRECTIVITY 15 switches OFF (unless you're using constant directivity horns with compression drivers).
5. Set the LIMITER 22 switch on.

Note: If you're using the M•1400i to power a subwoofer, you probably do not need an external crossover. Please see 23 for details.

6. Determine which AMP MODE 17 is best for your application:

- STEREO mode (separate left and right inputs, separate left and right outputs) is the typical setup for amplifying stereo signals.
- MONO mode (sometimes called Dual-Mono mode – one mono input, two mono outputs) is for sending a mono signal to two different speaker sets, with separately-adjustable level controls.
- BRIDGE mode (sometimes called Bridged-Mono – one mono input, one mono output) uses both sides of the amp to double the power to one speaker set. An M•1400i power amplifier, set to BRIDGE mode, delivers 1400 watts (into 4 ohms). Garsh!

Note: 4 ohms is the minimum impedance you should connect to the amplifier in BRIDGE mode. If you connect a lower impedance load in BRIDGE mode, the SHORT 7 LEDs may light, putting the amplifier into PROTECT 6 mode.

Set the AMP MODE 17 switch accordingly.

7. In STEREO mode, connect line-level cables from your signal source to the M•1400i's INPUT 12 jacks, either XLR or TRS:
 - The XLR and TRS inputs for each channel are wired in parallel.
 - The balanced XLR inputs are wired pin 2 = hot (+), pin 3 = cold (-) and pin 1 = shield (ground).

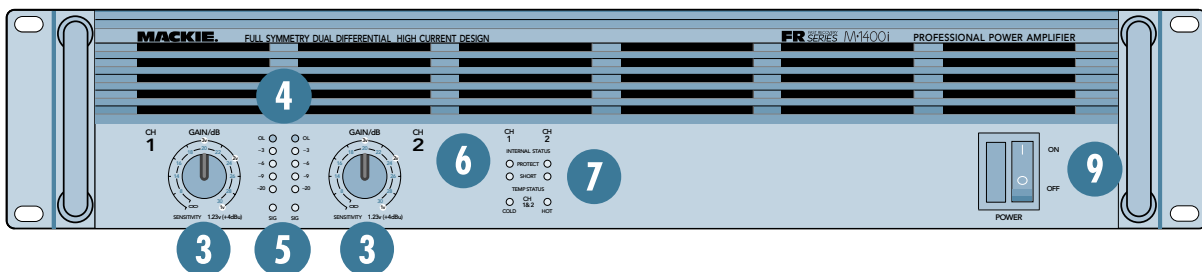

- The 1/4" TRS inputs are wired tip = hot (+), ring = cold (-) and sleeve = shield (ground), and can accept either balanced (TRS) or unbalanced (TS) cables.
- In MONO and BRIDGE modes, connect an input cable to CHANNEL 1's INPUT only, and nothing into CHANNEL 2's INPUT. (You could plug into CHANNEL 2's input, it just won't do anything.)
 - In STEREO and MONO modes, connect speaker cables to the SPEAKER OUTPUTS 11, either binding post or 1/4" TS:
 - The binding post connectors are wired red = hot (+) and black = cold (-).
 - The 1/4" TS connectors are wired tip = hot (+) and sleeve = cold (-).
 - In BRIDGE mode, connect the binding post cable like this: the hot (+) side goes in the CHANNEL 1 SPEAKER OUTPUTS 11 red post and the cold (-) side goes in CHANNEL 2's red post. Plug nothing into the black posts or the 1/4" TS jacks.
 - Connect the other ends of the speaker cables to your loudspeakers.
 - Plug the amp's power cord 10 into a 3-prong AC outlet capable of delivering at least 15 amps.
 - Make sure your signal source (the cables feeding the M•1400i's inputs) is powered up and delivering signal to the amp.
 - Turn the M•1400i's POWER 9 switch on and verify that the signal present (SIG) LEDs are blinking.

- Slowly turn both GAIN 3 controls up:

You should hear the music and see the SIG 5 and meter 4 LEDs flashing. If the topmost LEDs (named OL, for OverLoad) are flashing, turn down either the GAIN controls on the amp or the source signal's output level controls (i.e., master faders). The point is: The OL LEDs should never light up.
- For quieter listening, it is preferable to adjust the amp's GAIN 3 controls rather than the source signal's output level (unless you have the source's control all the way up!).
- Start dancing, but don't let the ants out of your pants.

Things You Must Remember:



- Never plug amplifier outputs into anything except speakers (unless you have an outboard box specifically designed to handle speaker-level signals).
- Before making connections to an amp or reconfiguring an amp's routing, turn the amp's level (GAIN) controls down, turn the power off, make the changes, turn the power back on, and then turn the level controls back up.
- If you shut down your equipment, turn off the amplifiers first. When powering up, turn on the amplifiers last.
- Save the shipping boxes! You may need them someday, and you probably don't want to have to pay for them again.

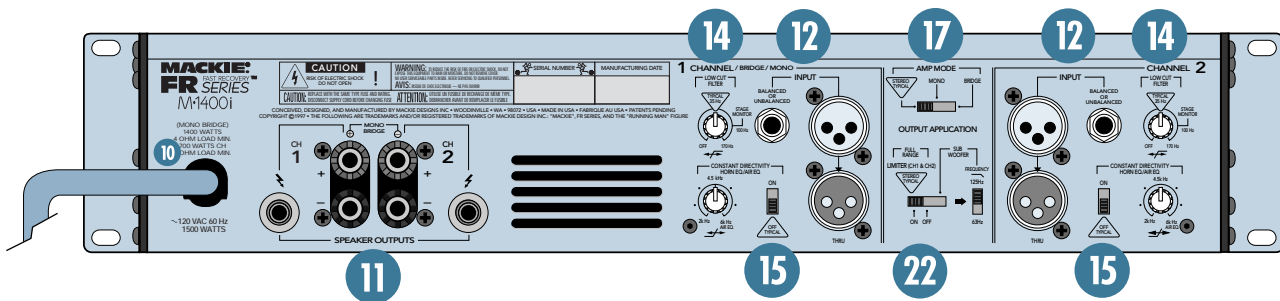

HOW TO USE THIS MANUAL

APPLICATION DIAGRAMS

Mackie's gang of illustrators have created easy-to-understand diagrams of popular studio and live-sound setups. Your setup will probably be different in some way, but these diagrams will help you see the big picture so you can add your own finishing touches.

FEATURE DESCRIPTIONS: MIND BOGGLING DETAILS

Each and every knob, switch, and connector on the M•1400i power amplifier is explained in depth here. Throughout this section you'll find illustrations, with each feature numbered like this ③. If you're curious about a feature, simply locate it on the appropriate illustration, note the number attached to it, and find that number in the nearby paragraphs.



This icon marks information that is critically important or unique to the M•1400i. For your own good, read them and remember them. We may call you someday and quiz you.



This icon leads you to in-depth explanations of features and practical tips. While not mandatory, they'll have some valuable information.

GENERAL PRECAUTIONS AND CONSIDERATIONS

This section discusses important things to keep in mind when installing and using the M•1400i, including rack mounting, AC power, and wiring.

THE GLOSSARY: A HAVEN OF NON-TECHINESS FOR THE NEOPHYTE

Just in case you're new to the audio world, we've included a fairly comprehensive dictionary of pro audio terms. If terms like "clipping," "noise floor," or "unbalanced" leave you blank, flip to the glossary at the back of this manual for a quick explanation.

A PLUG FOR THE CONNECTORS SECTION

Also at the back of this manual is a section on connectors: XLR, TRS, Binding Post connectors, balanced connectors, unbalanced connectors, and special hybrid connectors. If you plan on wiring your own cables, please visit this section before you start.

ARCANE MYSTERIES ILLUMINATED

Almost last but not least, we've included an appendix entitled *Arcane Mysteries Illuminated*. This section discusses some of the down 'n' dirty practical realities of signal transmission, balancing a sound system, grounding, and balanced versus unbalanced lines. It's a gold mine for the neophyte and even the seasoned pro might learn a thing or two.

TECHNICAL INFO

This section is for you tech-heads who like to use a calculator and read specifications. You'll find it all here.

CONTENTS

1	QUICK START	4
2	APPLICATION DIAGRAMS	8
	FEATURE DESCRIPTIONS	11
3	GAIN	11
4	METERS	12
5	SIG	13
6	PROTECT	13
7	SHORT	13
8	TEMP STATUS	14
9	POWER	14
10	POWER CORD	15
11	SPEAKER OUTPUTS	15
12	INPUT	16
13	THRU	18
14	LOW CUT FILTER	18
15	CONSTANT DIRECTIVITY	18
16	CD FREQUENCY	19
17	AMP MODE	19
18	STEREO	20
19	MONO	20
20	BRIDGE	20
21	OUTPUT APPLICATION	20
22	LIMITER	20
23	SUBWOOFER	21
24	FREQUENCY	21
	GENERAL PRECAUTIONS AND CONSIDERATIONS	23
25	RACK MOUNTING	23
26	THERMAL CONSIDERATIONS	23
27	AC POWER CONSIDERATIONS	23
28	INPUT WIRING	24
29	OUTPUT WIRING	24
30	70V DISTRIBUTION SYSTEMS	25
	APPENDIX A: Service Info	26
	TROUBLESHOOTING	26
	REPAIR	27
	APPENDIX B: Glossary	28
	APPENDIX C: Connectors	33
	APPENDIX D: Arcane Mysteries Illuminated	35
	Balanced Lines	35
	"Do's" and "Don'ts" of Fixed Installations	35
	Grounding	36
	Optimizing Sound System Levels	36
	Biampified and Triampified Systems	38
	APPENDIX E: Technical Info	39
	DO THE MATH: OHMS, LOADS AND SUCH	39
	SPECIFICATIONS	40
	BLOCK DIAGRAM	42
	COLOPHON	42
	M•1400i LIMITED WARRANTY	43
	PRODUCT REGISTRATION CARD	Attached to back cover



2 APPLICATION DIAGRAMS

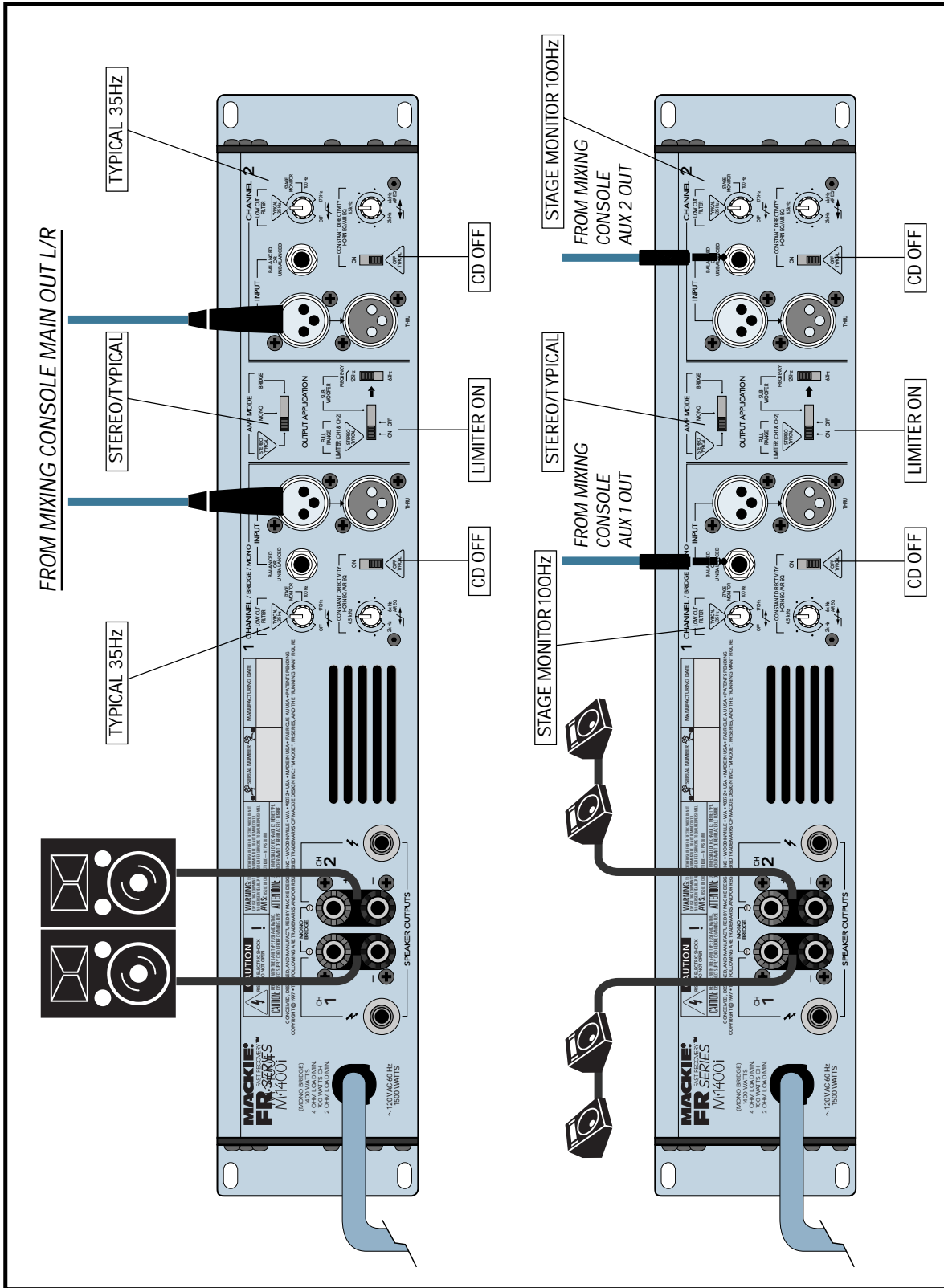

TWO M•1400iS: MAIN SPEAKERS AND STAGE MONITORS

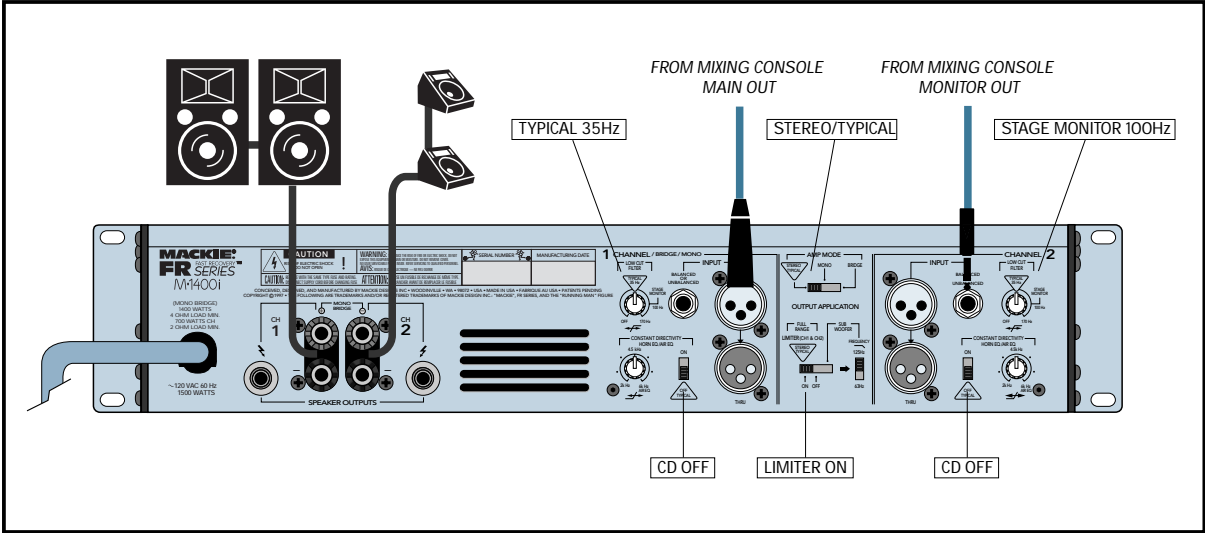

M-1400i: MAIN SPEAKERS AND STAGE MONITORS WITH ONE AMPLIFIER

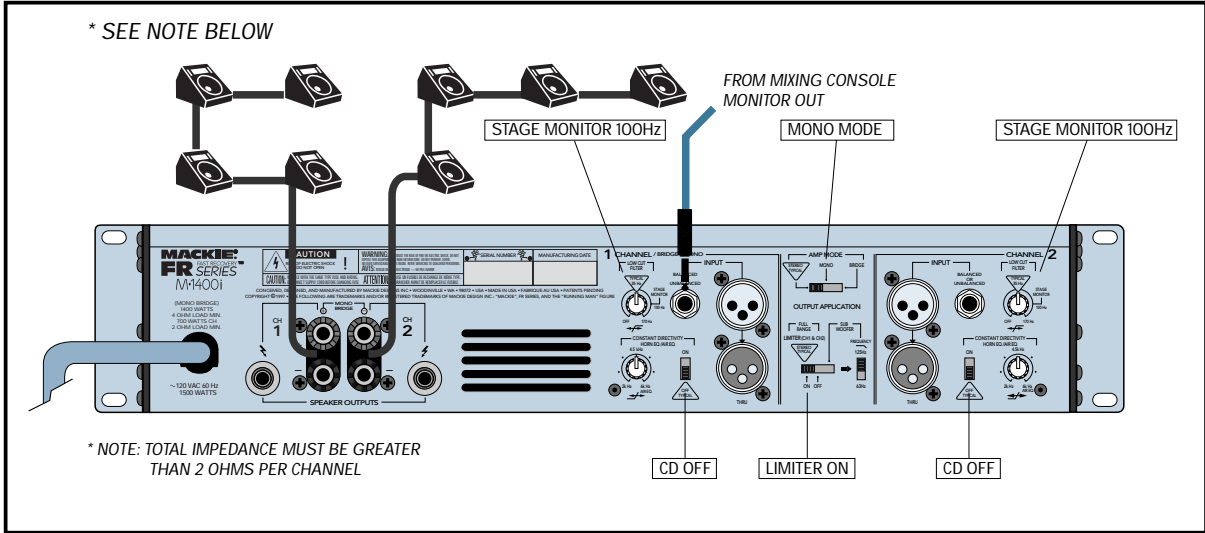

M-1400i: EIGHT MONITOR SPEAKERS

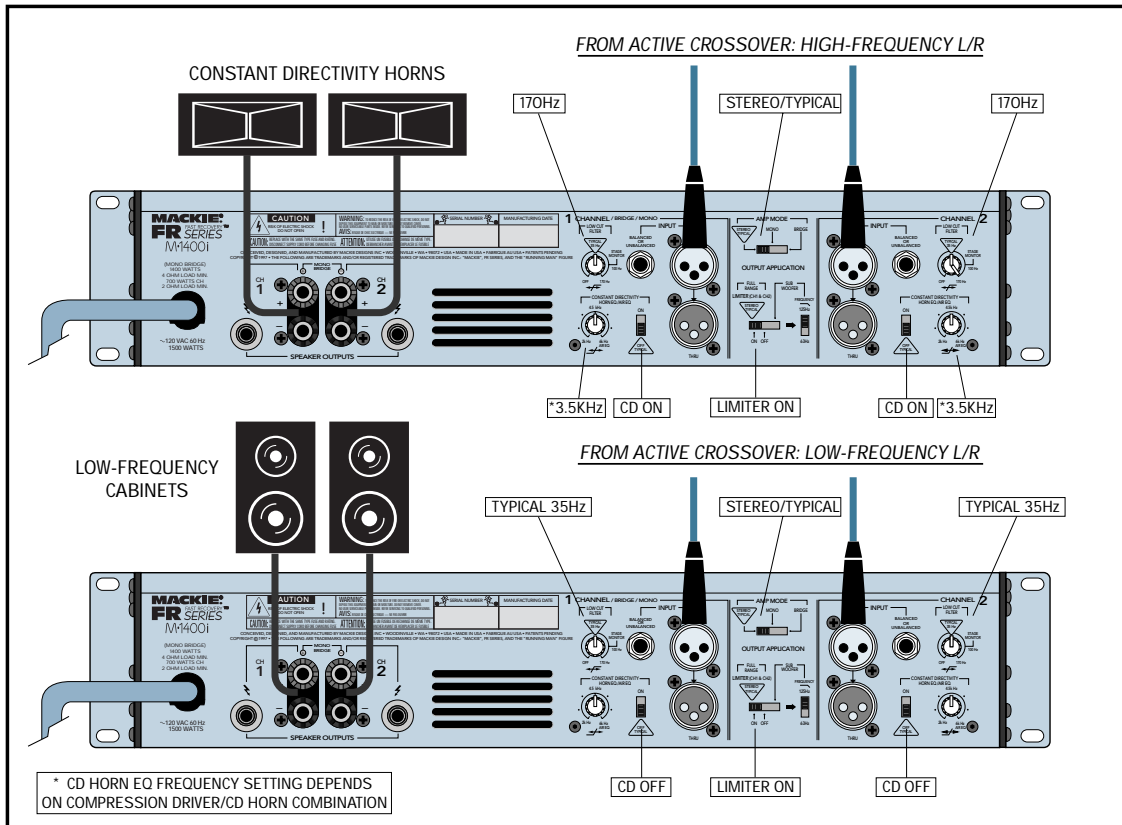

M•1400i: STEREO SYSTEM WITH CD HORNS

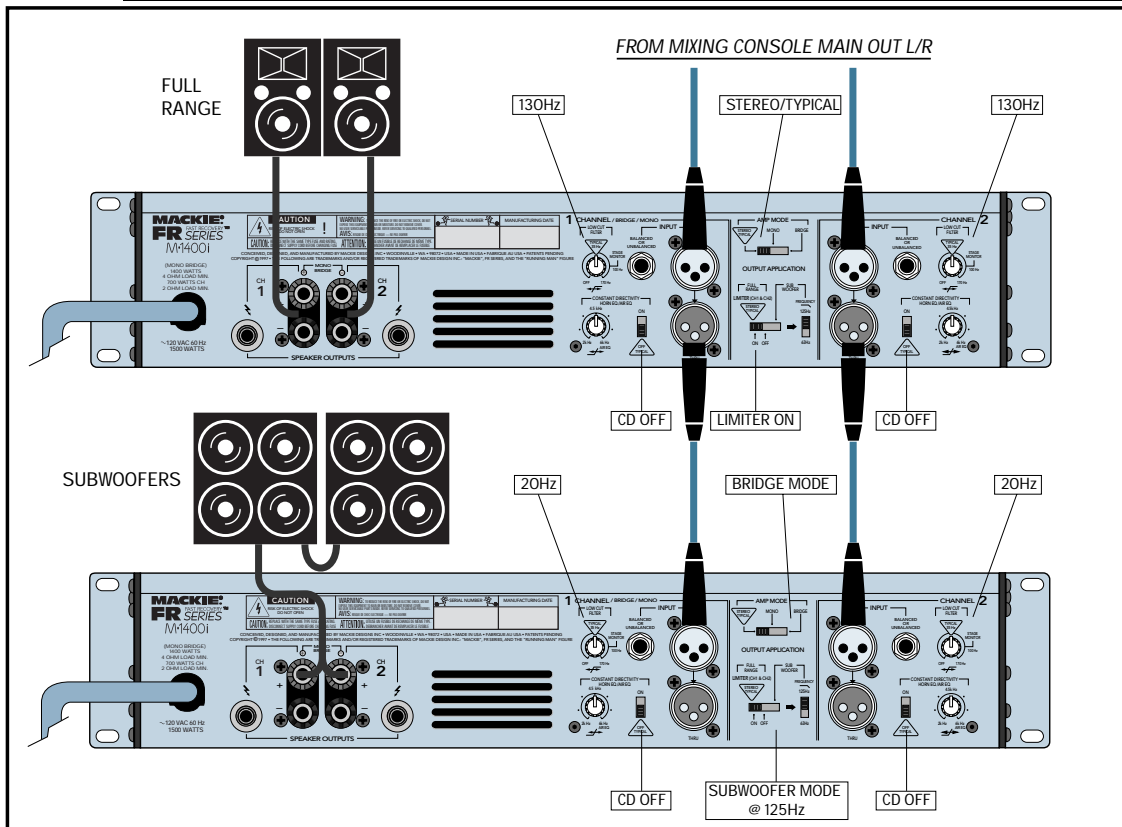

M•1400i: STEREO SYSTEM WITH BRIDGED SUBWOOFER

FEATURE DESCRIPTIONS

3 GAIN

These giant knobs control the levels to the output section of the M•1400i amplifier. You'll notice that their travel is detented, meaning there are 40 built-in "resting points" so you can easily set both controls to the same level. Usually, these controls are set all the way up.

The gain structure of the amplifier is designed so that a +4 dBu (1.23V rms) input signal drives the amplifier to full rated power into 4 ohms (41.23V rms @ 4 ohms = 425 watts). This is how the sensitivity of an amplifier is defined. In this case, it equates to a voltage gain of about 30 dB (okay, 30.51 dB for those of you sittin' there with your calculator!).

The graphics around the knob depict two different methods for setting the gain. The inner circle is marked in dB, calibrated from off (∞) to 30. This represents the amount of voltage gain from input to output. When using professional equipment with +4 dBu output levels, set the GAIN control all the way up to 30.

The outer circle is labeled in volts, with indications of 1V, 2V, and 3V. These correspond to the input sensitivity of the amplifier. With the GAIN control all the way up (fully clockwise), the input sensitivity is 1.23V, which works well with professional equipment operating at a nominal +4 dBu level.

On the other hand, you may want your listening level to be quieter than the M•1400i's maximum level. For instance, if you're using the M•1400i as a control room amp, and your control room is the size of a telephone booth, you'll probably never want to hear the amp at its maximum level.



You can set the GAIN controls as low as you like. However, reducing the GAIN controls requires an increased input level to reach full power at the amplifier's output. See the sidebar "Constant Gain vs. Constant Sensitivity" for a better understanding of how this works.

Like all amplifier controls, you'll typically determine the optimal settings during installation or sound check, then leave them alone, using your signal source (usually a mixer) to control listening levels as you work. Or play.

Constant Gain vs. Constant Sensitivity

There are two viewpoints, or philosophies, regarding the gain structure of power amplifiers — constant gain and constant sensitivity.

Constant gain means that regardless of the output power of the amplifier, the gain from input to output remains the same. (By the way, this refers to the full gain of the amplifier, with the gain or level controls all the way up.)

Within a product line of constant gain power amplifiers, as the output power rating of an amplifier increases, the level of the input voltage must also increase.

For example, if an amplifier is rated at 100W into an 8-ohm load, and it has 26 dB of gain, it requires an input signal of 1.4V rms to drive it to full power. This is about +5 dBu, a reasonable operating point for professional gear.

Now take an amplifier rated at 200W into an 8-ohm load. If it also has a gain of 26 dB, it requires an input signal of 2.0V rms to drive it to full power, or +8 dBu.

This can become problematic as the power of the amplifier increases. What if you have a power amp rated at 800W into 8 ohms? This will require an input signal of 4.0V rms to drive it to full power. This equates to a whopping +14.3 dBu!! You've just robbed your mixer of 10 dB of headroom. You'll either have to have a good limiter to keep the transient peaks down, or turn down the level from the mixer and not use all the power available from the amplifier.

Constant sensitivity means that regardless of the output power of the amplifier, the input sensitivity of the amplifier (the input voltage required to attain full output power) remains the same. As the output power of an amplifier increases, the gain of the amplifier must also increase.

Referring back to the previous example, an amplifier rated at 100W into 8 ohms with a gain of 26 dB requires an input signal of 1.4V rms to drive it to full power. It has an input sensitivity of 1.4V rms. In order for the 200W amplifier to reach full power into 8 ohms with a 1.4V rms input signal, it must have a gain of 29 dB. And the 800W amplifier will require a gain of 35 dB to reach full power with a 1.4V input signal.

Continued on page 12

So what are the pros and cons of these two approaches? The reason some amplifier manufacturers use the constant gain approach is because the noise specification looks better. It's a fact of physics that as the gain of the amplifier increases, the circuit noise is amplified and increases too. By maintaining a constant gain, the noise spec for an 800W amplifier can look as good as the noise spec for a 100W amplifier. The downside to this is that you have to crank up your mixer level feeding the input of the amplifier, losing headroom and possibly increasing the noise level from the mixer (unless you have a Mackie mixer with low-noise VLZ circuitry!).

Conversely, constant sensitivity demands that as the power increases, so must the gain. Yes, the output noise of the amplifier will increase, but you maintain the critical headroom available from your mixer. The additional noise is generally not a problem in live sound reinforcement situations. If it is, you can turn down the GAIN control a few clicks to find a happy compromise between noise floor and headroom available (see "Optimizing Sound System Levels" in *Appendix D*). As an added benefit, you can drive multiple amplifiers with the same signal and get the maximum power available from all of them.

Mackie subscribes to the philosophy of constant sensitivity. Our amplifiers can be driven to full power with an input level of +4 dBu (1.23V rms).



You may wonder why we didn't use just one stereo control to control both sides. That's in case your application requires a left/right imbalance (due to an irregularly shaped room) or if you're using the two sides for completely different purposes (monitor in channel 1 and side-fill in channel 2, for instance). Besides, they look cool.

4 METERS

The M•1400i's meters indicate the relative output level of the amplifier referenced to full power. The numbers next to the meter's LEDs are in dB below full power.

Ideally, the M•1400i's -20, -9, -6, and -3 LEDs will flicker at normal signal levels, while the OL LED may flicker occasionally during peak moments.

OL is short for Overload. Overloading, or clipping, occurs when the output voltage no longer linearly follows the input voltage and simply stops. This causes a sine wave to "square off," or get "clipped off." Thus, the term clipping. Fear not — this scenario is quite unlikely. Even with the GAIN controls fully up, the M•1400i amplifier easily accepts professional "+4 dBu" operating levels.



If the OL (Overload) LED is blinking frequently or continuously, turn down the source signal (i.e. the mixer's master faders).

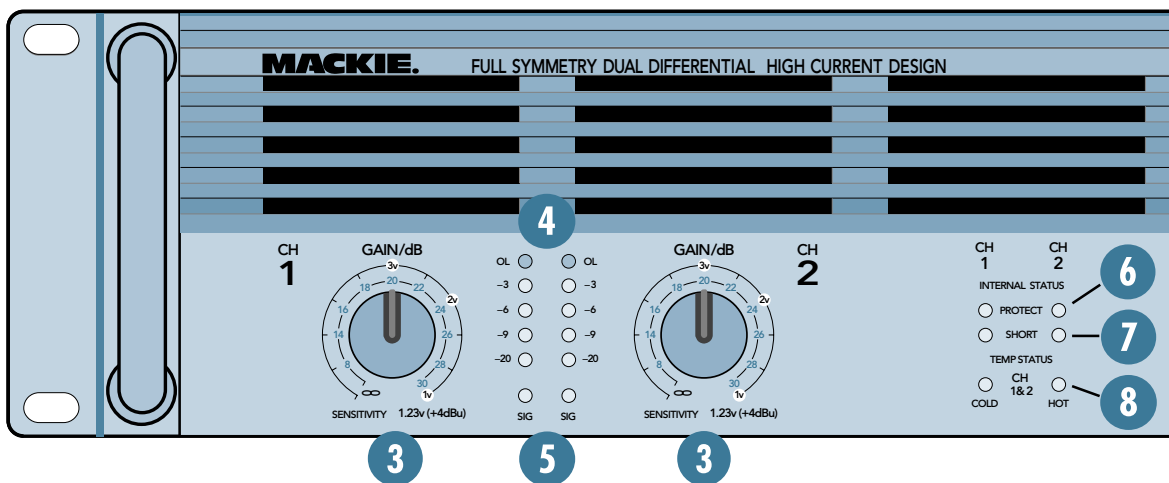

5 SIG

SIG (short for “signal present”) is the lowest step in the meters’ 4 ladder. It senses the signal prior to the GAIN control, so when SIG is lit, you know the M•1400i is receiving signal. If it’s the only meter LED lit (meaning the other meter LEDs are not lit), the M•1400i is receiving a very weak signal (below -20 dB).

6 PROTECT

If the PROTECT LEDs are on, the M•1400i’s output section has shut down. That, of course, means you won’t hear anything until you rectify the situation. Three things can cause the PROTECT circuit to engage:

1. Powering up the M•1400i. A built-in delay circuit saves your speakers (and ears) from the thumps or pops that can sometimes occur when powering up a system. During this 3 second delay, the PROTECT LEDs light up.
2. A short circuit (or near short) in either of the outputs. Both the PROTECT and the SHORT 7 LEDs light up.
3. The temperature in the M•1400i has risen to an unsafe level. The PROTECT and the TEMP STATUS HOT LEDs 8 light up.



The M•1400i amp draws its ventilation air in from the front and out through the side panels. The amp needs plenty of fresh air to stay cool. **DO NOT BLOCK THE VENTILATION PORTS.** See “Thermal Considerations” 26.

7 SHORT

If this LED comes on, the M•1400i has detected a short circuit in either of the outputs, meaning that the hot (+) and cold (-) speaker wires are touching, or a speaker itself is shorted out. Such a condition causes the M•1400i to engage its PROTECT 6 mode (when a signal is present), muting all signals at the amp’s outputs.

This short-circuit LED is a Mackie exclusive (until the other guys “borrow” the idea) and can save precious minutes of your troubleshooting time. Without it, you’d still have speaker and amp protection (via the PROTECT circuit), but you wouldn’t be able to determine the source of the problem. But with the SHORT LED, the M•1400i comes right out and tells you!

WARNING: The SHORT LEDs indicate an unsafe condition for the power amplifier. When the short-circuit protection is activated, the SHORT LED lights, then the PROTECT LED lights and the SHORT LED turns off. After about four seconds, the protection circuit turns off and the amplifier resumes normal operation. If it senses the shorted condition again, the cycle repeats until you fix the problem.

Typical causes for a “short” indication would be either a shorted speaker cable or too many speaker cabinets connected to the amplifier (i.e., the load impedance is too low). If a “short” is indicated, please check your cables. If the cabling is OK, then reduce the number of cabinets driven by the amplifier.

Note: When using the amplifier in BRIDGE mode, one or both SHORT LEDs may light under shorted or low impedance conditions. Regardless of whether one or both LEDs light, it’s an indication of a problem that requires further investigation.

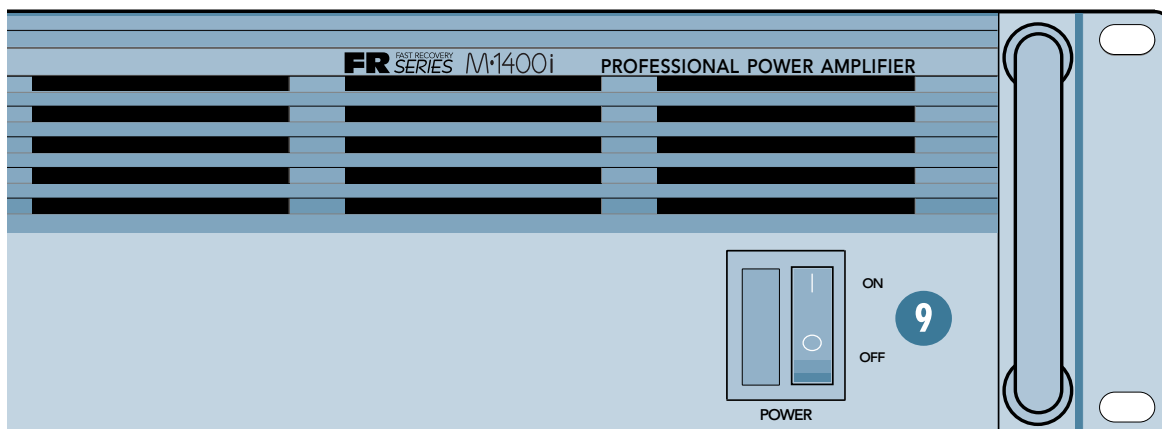

8 TEMP STATUS

TEMP (short for temperature) is another feature designed to keep your mind at ease. Normally the COLD LED is lit, indicating that the M•1400i is working normally. Under extreme conditions the amplifier may overheat. You may ask, “What kind of extreme conditions?”

Overheating problems are usually caused by one of the following situations: improper ventilation, high ambient temperatures, overdriving the amplifier into clipping, driving the amplifier hard into low impedance loads, frayed or partially shorted speaker cables, or defective or internally shorted speakers.

The heaviest load the M•1400i can tolerate is 2 ohms per channel (4 ohms in bridged mode). If you’ve got a set of speakers wired in parallel, be sure the load isn’t adding up to less than 2 ohms. Anything below 2 ohms can cause the SHORT 7 LED to light and trigger the PROTECT mode.



Remember: As the load gets “heavier,” its value in ohms goes down. For instance, a 2-ohm speaker load is twice as “heavy” as a 4-ohm load.

Please see “Do The Math: Ohms, Loads and Such” in *Appendix E* to learn about speaker loads.

As the internal temperature of the amplifier rises, the fan kicks into high speed. This occurs at 60°C (140°F). More air moves through the constant temperature gradient cooling tunnel to remove additional heat from the output transistors. However, if the internal temperature of the amplifier should exceed 80°C (176°F), the COLD LED turns off, the HOT LED turns on, and both PROTECT LEDs shine.

The output of the amplifier is muted — at this point the amplifier is in Standby mode and remains there until the internal temperature cools off to a safe level (55°C or 131°F). When this occurs, the HOT LED and PROTECT LEDs turn off, the COLD LED turns on and normal operation resumes.



Be Aware: If the HOT LED comes on frequently, something is overworking the M•1400i or it’s not properly ventilated. Look at each of the “extreme conditions” described above and try to determine what is causing the amplifier to overheat. Refer to “Thermal Considerations” on page 23 or to the “Troubleshooting” section in *Appendix A* for more help.



What’s that? Why doesn’t the fan just go fast all the time? Well, if it did, you might actually hear it whirring during your quiet moments (there are quiet moments in your life, aren’t there?). While this whirring would be of no concern in most live-sound situations, it could become annoying in a control room environment. So, when the M•1400i is not working hard, the fan goes slow; when the music gets loud and puts the amp to work, the fan goes fast.

9 POWER

To make the amp operate, push the top half of the POWER switch. It clicks into place and a soothing green light adjacent to it glows. To turn the amp off, push the lower half. It’ll click again and the green light will extinguish.

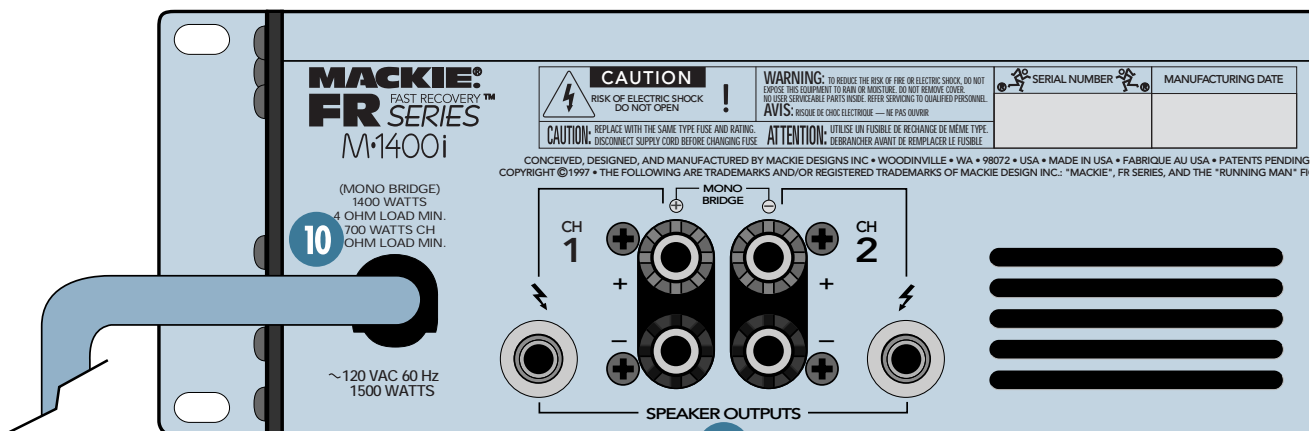

M•1200 Rear Panel

When you power up the M•1400i, a built-in delay circuit prevents any pops or thumps from being transmitted to the speakers due to turn-on instability in the system. *Be sure the signal driving the amplifier is turned down when you first power up the system.* There are few things as rude as 3 seconds of silence followed by 225 watts of full-blast stereo sound! (Well, maybe 225 kilowatts of accordian music...)



If you shut down your system, turn off your amplifiers first. When powering up, turn on your amplifiers last. This way, equipment feeding the amp won't "pop" or "thud" when it's powered up or down.

10 POWER CORD

We all know what a power cord is. The M•1400i has a big beefy cord built in. Plug the power cord into a 3-prong outlet that is capable of delivering 120VAC at 15 amps.



For current-delivery purposes, the M•1400i's voltage source (wall outlet, extension cords, or power strips) must be capable of continuously delivering 15 amps. And for safety reasons, that source must be a "3-prong" outlet with hot, neutral, and ground terminals. We're dealing with some big-time electricity here — don't mess with it. See "AC Power Considerations" 27.

11 SPEAKER OUTPUTS

Some call them "GR" jacks, others call them "Banana" jacks, but we prefer to call them "Binding Posts." You can call them whatever you like (except late for supper). These terminals are your standard fare.

To use the binding post outputs, you can terminate your speaker cables with single or double banana plugs, spade lugs, or leave them unterminated: Unscrew the amp's binding posts enough to reveal the holes on their sides, then insert your stripped wires (stripped about 3/8" back) into the holes and retighten the posts (finger tight is fine — please don't reef on them with a wrench!). Be careful that no runaway strands touch the chassis or other terminals.

The red posts are labeled "+," which means positive. The black posts are labeled "-" for negative. You probably know the importance of getting these terms correct — if one side is hooked up "in phase" and the other side is "out of phase," you'll be "out of work." (By the way, although everyone says "phase" in this situation, the correct word is "polarity"... but it's not as much fun to say.)

Using high-quality stranded speaker cable (16 gauge or thicker), connect the positive outputs of the M•1400i to the positive inputs of your speakers, and the negative outputs to the negative inputs. The exception: If you're using the M•1400i in BRIDGE 20 mode, this does not apply. Please read on.

In addition to the binding posts, the M•1400i also has 1/4" TS (tip-sleeve) SPEAKER OUTPUTS, so you can use speaker cables with 1/4" TS plugs. The tip is positive (+) and the shield is negative (-). They're wired in parallel with the binding posts and behave exactly the same (except they can't be used in BRIDGE 20 mode).

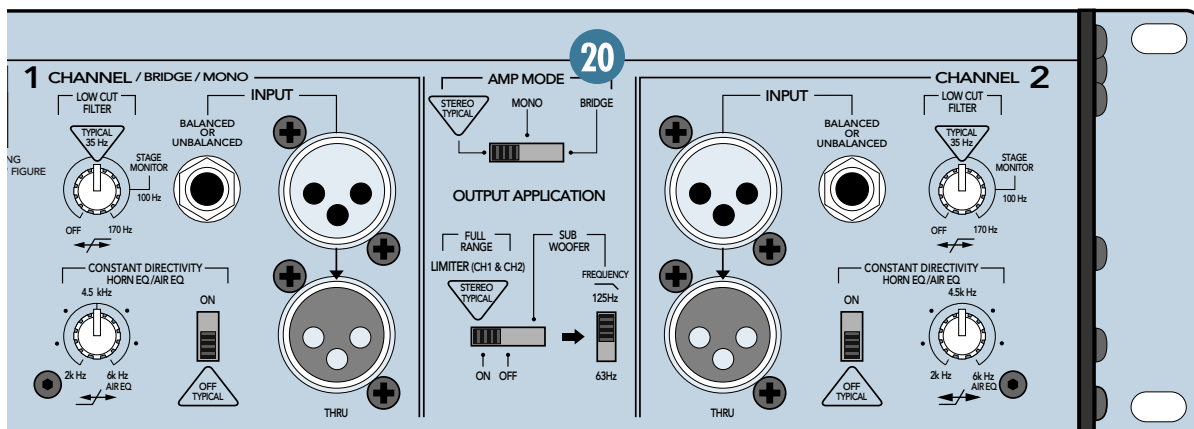

In fact, you can use both the 1/4" jacks and the binding posts simultaneously. Just remember that doing so creates two parallel loads. Please see “Do The Math: Ohms, Loads and Such” in *Appendix E* to learn about speaker loads.



Be Aware: Should you choose to terminate your speaker cables with the 1/4" TS plugs, make sure nobody confuses these cables with line-level cables, (i.e., guitar cables). *Guitar cords are not designed to handle the high current output of power amplifiers.* And line-level inputs (like the signal input on a mixer) are not designed to handle speaker-level voltages.

If you're using low impedance loads at high power levels, we recommend that you use the binding post speaker outputs rather than the 1/4" TS jacks. Although 1/4" jacks and plugs are convenient and easy to use, they were not designed to handle high-level currents.



Before making connections to an amp or reconfiguring an amp's signal routing, turn the amp's GAIN **3** controls down, turn the POWER **9** off, make the changes, turn the POWER back on, and then turn the GAIN controls back up. Although the M•1400i amplifier can handle “opens” (no connection) and “shorts” (positive and negative signal lines in direct contact), you don't want the speaker ends of live cables to zap every piece of equipment they touch as they're being dragged across the stage.



Ordinarily, applying a positive voltage to a speaker's positive input and negative voltage to the negative input results in an outward excursion of the woofer. But some woofers are built with reverse polarity, meaning that the above conditions result in an inward excursion.

If you're not sure which type of speakers you have, take a look at their literature. If you're still not sure, here is a simple test: take a 1.5V flashlight battery and connect the positive terminal of the battery to the positive (+) input of the speaker, and connect the negative terminal of the battery to the negative (-) input of the speaker. Observe the motion of the speaker cone. It should move out when voltage is applied, and return to rest when voltage is removed. Make sure all the speakers in the system move in the same direction (there are a few exceptions — some speakers are deliberately designed with reverse-polarity woofers).

12 INPUT

The M•1400i amplifier gives you a choice — it has the traditional XLR inputs, as well as 1/4" TRS (tip-ring-sleeve) input jacks. Sonically (and electrically) they're identical, so choose either one. Since these two inputs are in parallel (the THRU **13** jacks are in parallel with the inputs as well), you shouldn't connect more than one source to the SIGNAL INPUT jacks. Each can be used with either balanced or unbalanced signals.

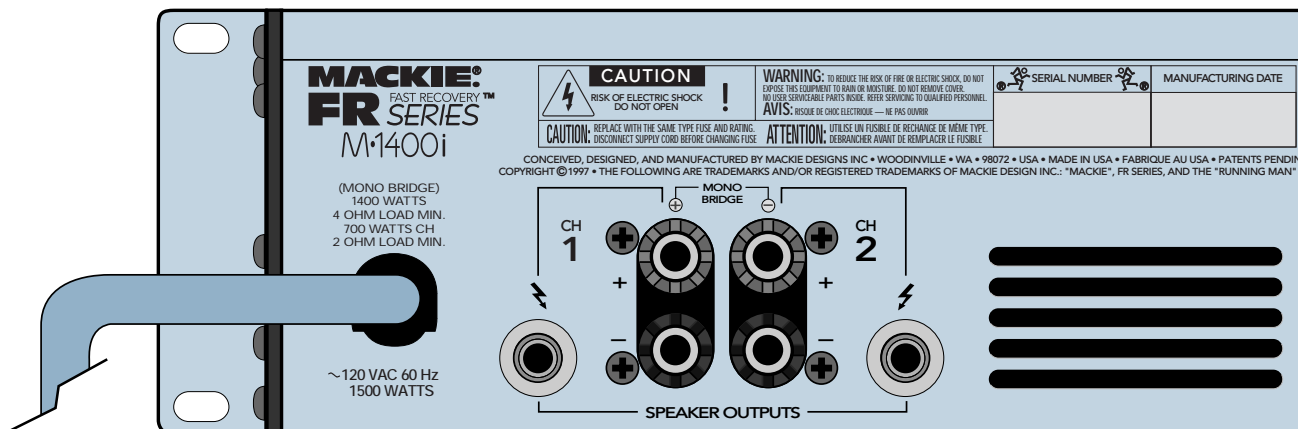

M•1400 Rear Panel

When connecting a balanced signal using the XLR or 1/4" jacks, they're wired thusly, per AES (Audio Engineering Society) standards:

	XLR	TRS
Hot (+)	Pin 2	Tip
Cold (-)	Pin 3	Ring
Shield (Ground)	Pin 1	Shield

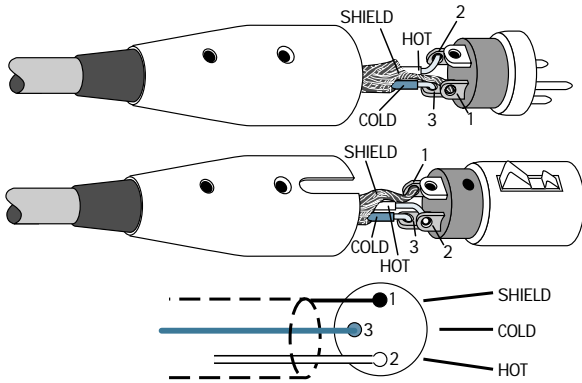

Balanced XLR Connectors

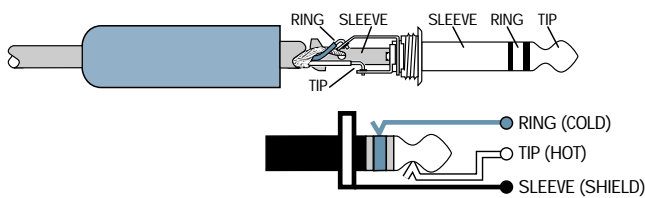

Balanced 1/4" TRS Plug

Unbalanced TS (tip-sleeve) lines can be accommodated via the TRS jack. Make sure the cord terminates with a TS plug (like a guitar plug), or if it's a TRS plug (like a headphone plug), make sure the ring is tied to the shield, preferably at the source.

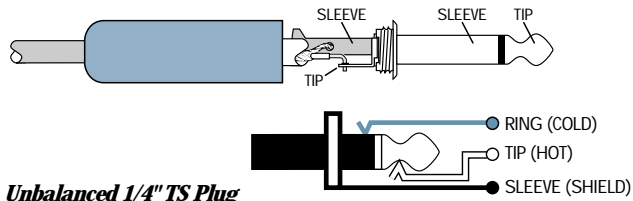

Unbalanced 1/4" TS Plug

You can connect an unbalanced XLR cable to the M•1400i, although this would be unusual — as unusual as an unbalanced XLR output. However, if you have an unbalanced XLR connection to make, refer to the “Connectors” section (*Appendix C*) at the back of this manual for more information.

The M•1400i amp expects to see a nominal signal level anywhere between the -10dBV “semipro” and +4 dBu “pro” standards, meaning almost any line-level mixer or other device can be plugged into the amp’s INPUTs. Use the GAIN 3 controls to adjust the gain of the amplifier to match the signal level you’re using.



If you set the AMP MODE 17 switch in MONO or BRIDGE, use the CHANNEL 1 inputs only — the CHANNEL 2 inputs are disabled in this case.

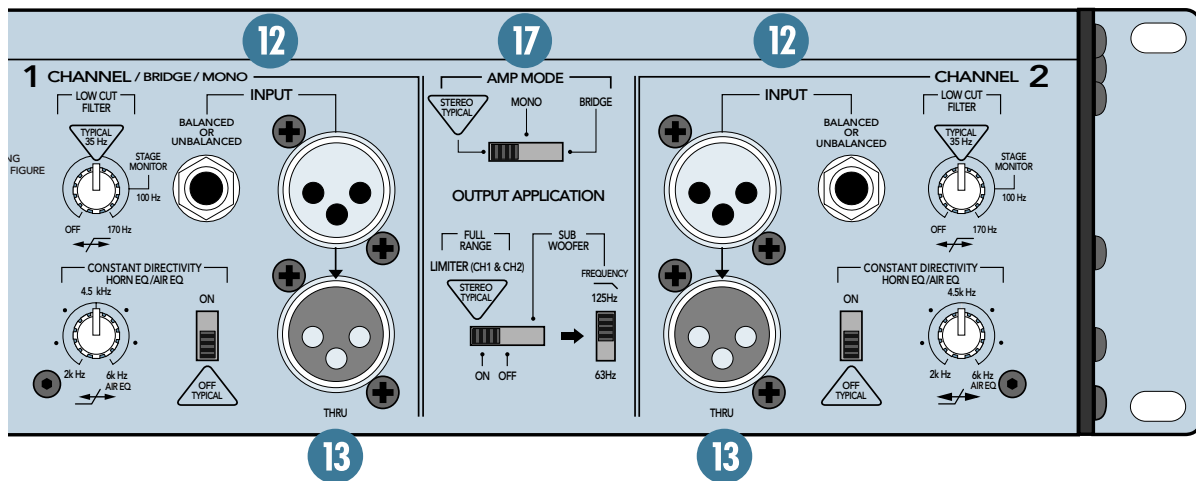

13 THRU

Someday you'll do a show at Carnegie Hall and realize that one M•1400i amplifier is just not going to do the job — you'll need a six-foot-high rack full of 'em. That's what the THRU jack is for. Simply plug the signal source outputs into the first amp's INPUTs 12, patch from that amp's THRU jacks to the next amp's INPUTs, and so on, daisy-chaining as many amps as you can afford (assuming your console has low-impedance outputs).

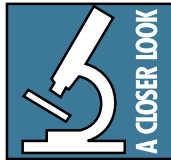

A general rule of thumb is to maintain a load impedance 10 times or more than the source impedance to prevent excessive loading. If your console has an output impedance of 100 ohms, then you can daisy-chain up to twenty M•1200/M•1400 amplifiers, which presents a load of 1000 ohms to the console (input impedance of 20 kohms divided by 20 amplifiers = 1000 ohms).

The THRU jacks can also be used to relay the signal on to other devices such as a DAT or cassette recorder, enabling you to record exactly what the audience is hearing. The THRU jacks are wired straight from the XLR and TRS INPUTs 12 — there is no electronic circuitry between — so the signal going into the amp is exactly the same as the signal coming out of the THRU jacks.



You can use the THRU jack as an input, if necessary, since it's wired in parallel with the other input connectors. You can also use the 1/4" TRS INPUT jacks as THRU jacks. Simply connect the 1/4" TRS INPUT jacks on the first amplifier to the TRS 1/4" INPUT jacks on the second amplifier using 3-conductor shielded cables with TRS plugs on both ends.

Warning: If you use a regular guitar cord with 2-conductor TS plugs, you'll unbalance the signal at the XLR input by grounding the low side (-) of the signal (pin 3).

14 LOW CUT FILTER

Every woofer has frequency response specifications. It's usually expressed in Hertz (or cycles per second), like "40Hz–300Hz." The "40Hz" refers to the low-frequency point (usually, but not always) where the speaker's output drops by 3 dB, and will "roll off" completely as the frequency goes down. There is no point in sending a woofer any frequencies it

can't reproduce — you can't hear it, and worse yet, it's a waste of amplifier power that can be better used reproducing frequencies you *can* hear.

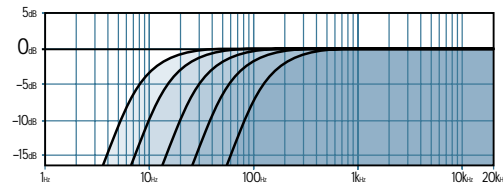

Low Cut Filter Frequency Response

In order to match the output bandwidth with your particular speaker system, the M•1400i amplifier has a tunable LOW CUT FILTER. The frequencies are clearly marked along the knob's travel 14:

- Fully counterclockwise, the frequency is below 10Hz, effectively bypassing the filter.
- Center detent is 35Hz and labeled TYPICAL, since precious few woofers actually go below that.
- 3/4 of the way up is labeled STAGE MONITOR, 100Hz, perfect for, well, stage monitors (they seldom reproduce below 100Hz; besides, it prevents low-frequency "leakage" into the house).
- Fully clockwise is labeled 170Hz.

So, grab your woofer's spec sheet and find the low roll-off spec. Then set the M•1400i's LOW CUT FILTER 14 at the same frequency.

If you do this correctly (and make sure the meters 4 are happy), you'll never again see your woofer moving sporadically without audible signal. Your system will play louder and cleaner, and you may never blow another woofer again!

15 CONSTANT DIRECTIVITY

Compression drivers mounted on constant-directivity horns require compensation, in the form of a high-frequency boost, with its "knee" set somewhere between 2kHz and 6kHz. Until now, you'd have to resort to external crossovers or worse yet, graphic EQ modules. Both of these are fraught with limitations, not to mention adding cost, rack space requirements and complexity to your system.

The M•1400i power amplifier eliminates the need for any of these external devices — it has the compensation circuitry already built in. And using it is a breeze.

16 CD Frequency

Your compression drivers' spec sheet should have a suggested frequency for compensation boost. If so, just turn the CONSTANT DIRECTIVITY switch ON and set its knob to match that frequency. If your spec sheet doesn't have that information, you can simply adjust the Frequency knob by ear, preferably using the same music as the actual performance (3.5kHz is a good place to start).

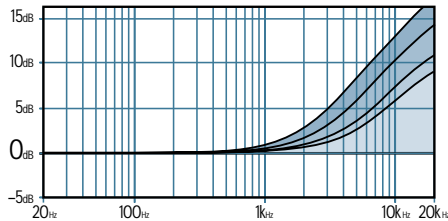

Constant Directivity EQ

Wait, there's more: If you don't have constant directivity horns, you can forget all this, and leave the switch OFF.

Or, better yet, you can use this CONSTANT DIRECTIVITY feature to enhance your EQ curve. By setting the Frequency knob fully clockwise, you introduce a very high frequency boost to the signal (above 6kHz). And in Mackie-land, this gentle boost has a name: AIR, as seen on our SR series of consoles. By boosting these high frequencies, AIR will breathe life into your mix, making cymbals brighter and vocals silkier.

Speaking of Mackie SR consoles: If you use both the AIR feature on an SR console as well as the AIR feature just described on the M•1400i, you may be overdoing it. You won't hyperventilate or anything, but it might cause your audience to experience ear fatigue from too much high-frequency content. Too much of a good thing, perhaps.

More on Constant Directivity Horns



Back in the early '70s, radial horns were the common mechanism for reproducing high frequencies. Radial horns had a serious problem, though. The high frequencies

tended to beam straight ahead, so if you moved away from front and center (off-axis), the brilliance and sizzle quickly diminished to a muffled blur. Constant Directivity horns were designed to spread the higher frequencies evenly throughout the horn's dispersion pattern.

This was accomplished by using a smaller opening to the horn, using straight sidewalls in both the horizontal and vertical planes (radial horns typically have curved vertical sections that cause beaming), and providing a flare at the mouth of the horn to disperse the mid to high frequencies.

All high-frequency compression drivers have an inherent roll-off of about 6 dB per octave above about 3kHz. The exact frequency at which the roll-off occurs (called the mass breakpoint) depends on the materials used, the mass of the moving parts (diaphragm and voice coil) and the strength of the magnet. The CONSTANT DIRECTIVITY HORN EQ control on the M•1400i compensates for this natural roll-off in the power response of the compression driver coupled to a CD horn, with the end result of flat-frequency response (constant) with a wide coverage angle (directivity).

17 AMP MODE

This three-way switch, along with the OUTPUT APPLICATION's 21 three-way switch, determines what kind of amplifier you want the M•1400i to be (or not to be — what was the question?).

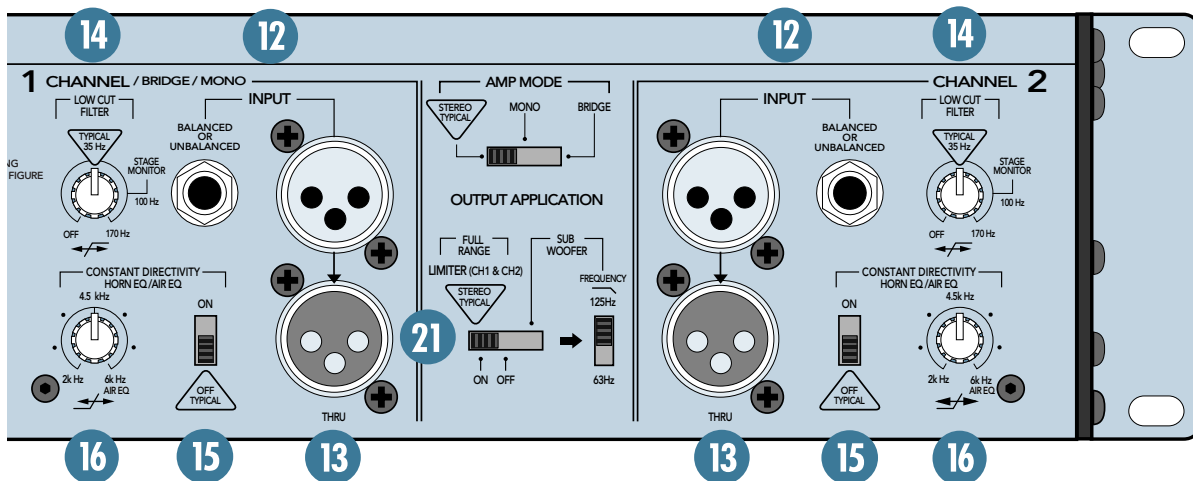

The AMP MODE switch determines the input signal routing within the M•1400i amplifier. Shipped from the factory, the switch is set to STEREO. This is correct for about 90% of the applications using an amp like this (hence the TYPICAL indicator near it). But you may be in the 10% bracket, requiring special input routing within the amp.

AMP MODE should be configured before operation — if you must change it during performance, turn down the GAIN 3 controls as a precaution to protect the speakers from any inadvertent pops or thumps.

STEREO 18 mode (separate left and right inputs, separate left and right outputs) is the typical setup for amplifying stereo signals.

MONO 19 mode (sometimes called Dual-Mono – one mono input, two mono outputs) is for sending a mono signal to two different speaker sets, with separately-adjustable GAIN 3 controls.

BRIDGE 20 mode (sometimes called Bridged-Mono – one mono input, one mono output) uses both sides of the amp to double the power to one speaker set. With two M•1400i power amplifiers, each set to BRIDGE mode, you can deliver as much as 1400 watts per amplifier.



If you set the AMP MODE 17 switch to MONO or BRIDGE, use the CHANNEL 1 inputs only — the CHANNEL 2 inputs go nowhere in this case.

Note: There is one exception to this rule. If you have the OUTPUT APPLICATION switched to SUBWOOFER, the inputs to Channels 1 and 2 are summed regardless of the AMP MODE setting (see 23). Also, BRIDGE 20 mode requires special connections at the SPEAKER OUTPUTS 11.

20 BRIDGE

In STEREO mode, the M•1400i Power Amplifier can deliver 700 watts per side into 2 ohms. If that's not enough, you can use two M•1400i's, each in BRIDGE mode, and deliver 1400 watts per amplifier into 4 ohms. Or, you can use one amp in BRIDGE mode to power a monaural system. Finally, BRIDGE mode is also popular for subwoofer applications — but please see SUBWOOFER 23 for a special subwoofer surprise.

To use all the M•1400i's power to drive one speaker cabinet using BRIDGE mode, you'll have to do four things:

1. Turn off the power to the M•1400i.
2. Set the AMP MODE 17 switch to BRIDGE.
3. Connect the positive side of the speaker cable to the Channel 1 red (+) binding post.
4. Connect the negative side of the speaker cable to the Channel 2 red (+) binding post.
5. (Okay, make that five things!) Use only the CHANNEL 1 INPUT 12 (unless you're using the SUBWOOFER OUTPUT APPLICATION).

The CHANNEL 1 GAIN control adjusts the output level of the amplifier. The CHANNEL 2 GAIN control has no effect.

Once again: Before making connections to an amp or reconfiguring an amp's routing, turn the power off, make the changes, then turn the power back on.

21 OUTPUT APPLICATION

The OUTPUT APPLICATION switch should be configured before you turn on the amplifier. This switch allows you to choose between three different configurations:

LIMITER ON (TYPICAL). This is the normal configuration: full-bandwidth audio with protective limiting (please see 22).

LIMITER OFF is also full bandwidth audio, but without protective limiting (please see 22).

SUBWOOFER mode, with built-in low-pass filter, no protective limiting (please see 23).

22 LIMITER

The LIMITER is not designed to alter your sound — it's just there to protect your speakers from the effects of clipping. Its effect is virtually transparent, meaning you probably won't even notice any audible difference. We recommend that you leave it engaged (via OUTPUT APPLICATION 21), hence the TYPICAL label below it.

If you're working at quiet levels all the time, or you've already placed a compressor/limiter in the signal path, or if you just hate compression, you can leave the LIMITER out of the circuit (via OUTPUT APPLICATION 21).



The LIMITER is channel independent; that is, it works independently on each channel. It senses when the amplifier channel is about to be overdriven and attenuates the overall level just enough to keep the signal from clipping. Clipping occurs when the output voltage no

longer linearly follows the input voltage and simply stops. This causes a sine wave to “square off,” and the average power going into the speaker is roughly double that of a sine wave. Square waves sound awful, and could possibly damage your speakers and/or your reputation.

The LIMITER is especially handy when you’re working with loud output levels. Having the signal spikes (kick drum, for instance) attenuated a bit can actually increase the apparent loudness of the overall mix without diminishing the “power” behind the spikes.



Be Forewarned: With the LIMITER engaged, you can still overdrive the amplifier into clipping and cause distortion. It just takes a stronger signal to do it. So even with the LIMITER turned on, you should still pay attention to the OL LEDs 4.

23 SUBWOOFER

Here’s a special surprise: If you bought the M•1400i amplifier to power a subwoofer system, you just saved yourself the cost of a crossover! The M•1400i amp has an active SUBWOOFER filter built in. You can use it, along with the variable LOW CUT FILTER 14 in a second M•1400i, to reproduce the function of a crossover.

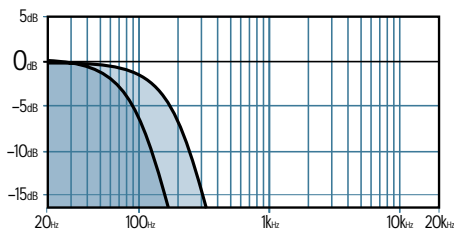

Subwoofer Filter

Since most low-frequency energy is monophonic (the same in both channels), the subwoofer circuit takes the signal from both Channels 1 and 2 and sums them together. This summed signal is then directed to both power amplifier output stages. It doesn’t matter whether the AMP MODE 17 switch is set to STEREO, MONO, or BRIDGE, it will sum the inputs when the OUTPUT APPLICATION switch is set to SUBWOOFER.

Here’s how to configure it:

1. Turn the M•1400i’s POWER 9 off.
2. Set the OUTPUT APPLICATION 21 switch to SUBWOOFER.
3. Select a rolloff point, via the FREQUENCY 24 switch: At “125Hz,” you’ll get the low sub-harmonics on up to the audible bass range. At “63Hz,” you’ll get just the lowest frequencies, more to be felt than heard. You’ll probably want to try this switch both ways.
4. Connect your cords and speaker cables as usual (see “Quick Start” 1). Set the AMP MODE 17 to either STEREO, MONO, or BRIDGE, depending on your application. (STEREO and MONO operate the same with SUBWOOFER activated).
5. Turn the M•1400i’s POWER on. Woof!

If you want to use a second M•1400i to reproduce the rest of the audio range, follow this procedure:

1. Connect the THRU 13 jacks on the first subwoofer amplifier to the INPUT 12 jacks on the second amplifier.
2. With POWER off, set the OUTPUT APPLICATION 21 switch on the second amplifier to FULL RANGE (LIMITER either ON or OFF).

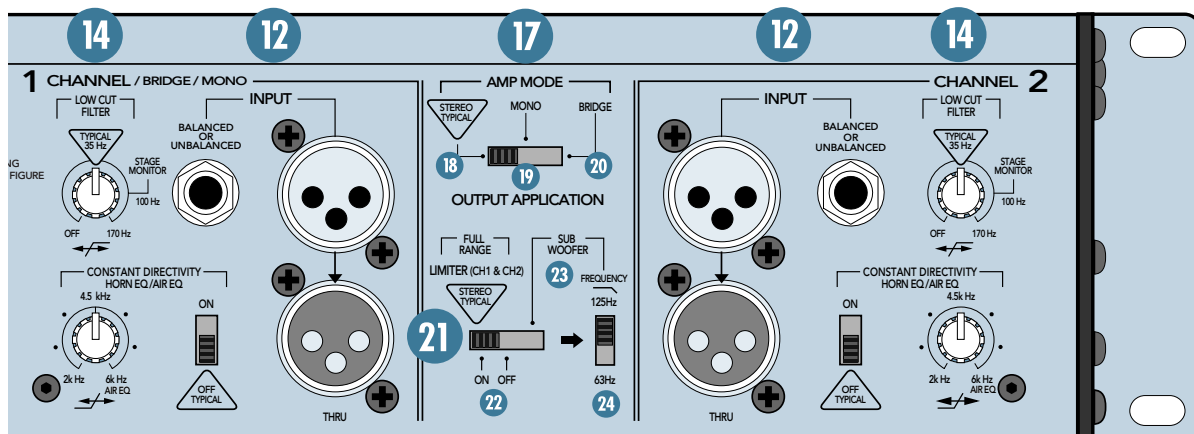

3. Set the LOW CUT FILTER **14** frequency control to either 63Hz or 125Hz, depending on the cutoff frequency selected in the subwoofer amplifier **24**.

Since these exact frequencies are not labeled on the amplifier, you can guesstimate the position of the knob. 63Hz is located at about 1 o'clock and 125Hz is about 4 o'clock.

If you want to be really accurate, you will need to use a variable-frequency signal generator along with a frequency counter and a voltmeter or oscilloscope to find the exact position for the knob. The voltmeter or o'scope should be capable of measuring low frequencies accurately (down to 60Hz).

1. Connect the signal generator to the INPUT **12** of the amplifier and monitor the SPEAKER OUTPUT **11** with the voltmeter or o'scope.

2. Adjust the signal generator level so you measure 1V rms output at 1kHz. (You should turn down the GAIN knobs on the amplifier about halfway.)
3. Change the frequency of the signal generator to 63Hz or 125Hz, whichever you're using as your subwoofer crossover frequency. You may need to use a frequency counter for accuracy.
4. Adjust the LOW CUT FILTER **14** frequency control until the voltmeter or o'scope reads 0.707VAC rms. This is the -3 dB point, and means you have now matched the LOW CUT FILTER frequency cut-off point to the SUBWOOFER FREQUENCY switch setting (either 63Hz or 125Hz).

After you've completed this exercise, you should mark the position of the control with a stick-on arrow or label so you don't have to repeat it should the control accidentally get moved.

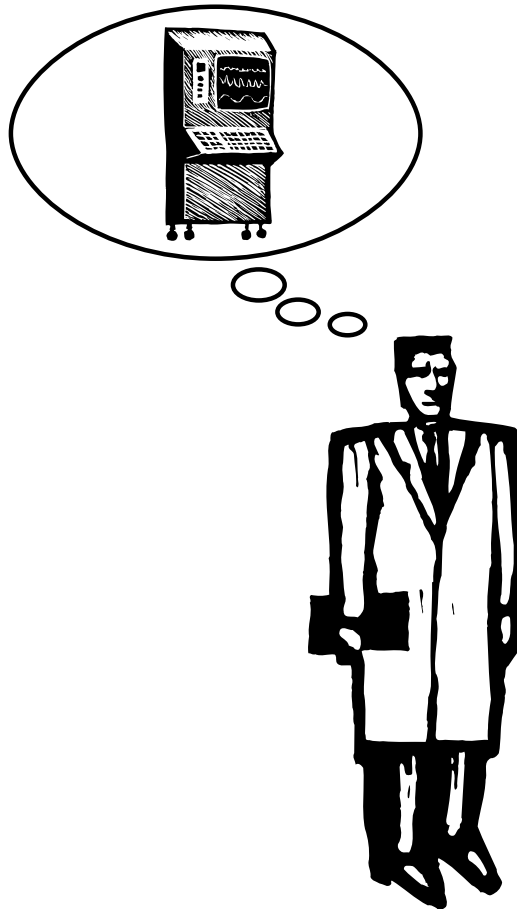

GENERAL PRECAUTIONS AND CONSIDERATIONS

25 RACK MOUNTING

The M•1400i amp requires two rack space units (2U = 3.5"). It also requires 16.25" depth inside the rack, including the rear supports. When designing your rack, put the heavier items at the bottom and the lighter items toward the top.

Secure the front panel of the amplifier to the front of the rack using four screws with soft washers to prevent scratching the panel. In addition, because of the weight of the amplifier, you must secure the rear support brackets of the amplifier to the back of the rack. You could use a support rail or shelf across the back of the rack, or angle brackets attached between the rear support brackets and the rear rails of the rack. This is recommended for all components mounted in a rack that is going to be moved frequently (or thrown in the back of a pickup truck and transported down a bumpy gravel road to that outdoor festival!).

26 THERMAL CONSIDERATIONS

The M•1400i amp is fan-cooled and brings air in through the front and out through the sides. Make sure that cool air is available at the front of the amplifier, and that there is room on each side for the warm air to exit from the amplifier and dissipate. If rack-mounted, make sure there is room for the warm air to circulate around the side and out through the rear of the rack. In a typical rack, there will be a space of 1 to 2 inches on either side of the amplifier. This is adequate to allow the warm air to exit from the amplifier.

The M•1400i's unique T-Design Constant Gradient Cooling Tunnel provides substantially better cooling for the output transistors than conventional designs that simply blow air through the chassis, getting dust and other contaminants over all the internal components. The Cooling Tunnel provides a shorter, more directed path so the cool air concentrates on the heat produced by the output devices. This results in increased reliability and longevity for the amplifier.

27 AC POWER CONSIDERATIONS

Be sure the M•1400i is plugged into an outlet that is able to supply 120VAC at high current. If the voltage should drop below 116VAC, the M•1400i will no longer be able to supply rated power. (It will continue to operate down to 50% of the rated voltage, but it just won't be able to reach full rated power.)

Be sure the AC outlet can supply enough current to allow full power operation of all the amplifiers plugged into it. The outlet should be a three-prong socket that matches the power cord.

WARNING: Bypassing the plug's ground pin can be dangerous. Please don't do it.

The AC current demand of an amplifier varies depending on several factors, including the crest factor and the duty cycle of the program material. Under typical conditions reproducing rock music where musical peaks are just below clipping, the M•1400i requires the following average currents:

Amplifier Loading	Average Current Required	Peak Current Required
2 ohms per side or 4 ohms bridged	8A	25A
4 ohms per side or 8 ohms bridged	5A	16A
8 ohms per side or 16 ohms bridged	3.2A	10A

It is recommended that a stiff supply of AC power be used because the amplifier places high current demands on the AC line. The more power that is available on the line, the louder the amplifier will play and the more peak output power will be available for cleaner, punchier bass.

We realize that in many applications a standard 15A service may be all that is available. Under typical conditions, reproducing rock music where musical peaks are just below the clipping point, you can safely connect more than one amplifier to a 15A service. Use the table below as a guideline:

Amplifier Loading	Maximum Number of Amplifiers on a 15A Service
2 ohms per side or 4 ohms bridged	2
4 ohms per side or 8 ohms bridged	3
8 ohms per side or 16 ohms bridged	5

Due to in-rush current, however, you should avoid turning them all on at the same time. Rather, sequence them on, one at a time, to prevent popping the circuit breaker.

The extension cord used to supply power to the “amp rack” should have a third wire safety ground to avoid presenting a safety hazard. We also recommend using a cord that has conductors large enough to avoid severely limiting the amplifier’s ability to supply high currents on transients. With this in mind, we recommend using the following for a fully loaded 15A service:

Extension Cord Length	Wire Gauge
25 feet	14 AWG
50 feet	12 AWG
100 feet	10 AWG



Power amplifiers can have momentary peak current requirements many times above the nominal average current draw. According to

Ohm’s Law, the greater the resistance of the linecord, the more input power is lost between the AC outlet and the power amplifier (across the linecord). And to further aggravate the matter, this relationship is nonlinear. The amount of power lost across the linecord increases exponentially as the current demand increases. So if the current demand doubles momentarily because of an exceptionally loud bass note, the amount of AC input power lost across the linecord increases four times. You can see that it is very important to keep the resistance of the linecord to a minimum. That’s why we recommend using a heavy gauge extension cord (like 14 gauge or bigger). Remember, wire gets thicker as the gauge number gets smaller (10 gauge is thicker than 14 gauge).

AC Power Distribution

The majority of AC outlets encountered in homes and clubs are served by a 240VAC center-tapped service entrance transformer. This provides two phases of AC power on either side of the center tap at 120V each.

In order to minimize ground loops, the safety grounds for all the outlets should be connected

to a common (“star”) grounding point, and the distance between the outlets and the common grounding point should be as short as possible.

If lighting is used in a show, it is preferable to power the lights from one leg of the service, and power the audio equipment from the other leg. This will help minimize noise from the lights coupling into the audio (particularly if SCRs are used).

When setting up for a show, oftentimes you are plugging into an AC power distribution system you know nothing about. You may even be faced with 2-wire outlets that are missing the third safety ground pin. It’s a good idea to have a three-wire AC outlet tester in your toolbox so you can check the outlets yourself to make sure they are wired correctly. These testers will tell you if the polarity of the hot and neutral wires is reversed and if the safety ground is disconnected. *Don’t use an outlet if it is wired improperly!* This is to protect yourself as well as your equipment.

If you find that you must plug into a two-wire outlet, you will need to use a two-wire to three-wire adapter (cheater plug). These come with a metal tab that you put underneath the center screw that holds the AC outlet faceplate in place. This center screw should be grounded. You can check it by connecting the adapter to the outlet and then plugging in your AC outlet tester.

28 INPUT WIRING

Use a high-quality 3-conductor shielded cable to connect the signal between the signal source (mixing console, equalizer, etc.) and the balanced inputs to the amplifier. If you’re using the unbalanced inputs, use a high-quality 2-conductor shielded cable. Your Mackie Dealer can recommend a suitable cable for your application.

If you want to build your own cables, refer to the “Connectors” section in *Appendix C*.

29 OUTPUT WIRING

Use heavy gauge, stranded wire for connecting speakers to the M•1400i amplifier’s SPEAKER OUTPUT 11 terminals. As the distance between the amplifier and the speakers increases, the thickness of the wire should also increase. Speaker wire has resistance, and when electricity passes through a resistor, power is lost. The thicker the wire, the less resistance it offers, and the more power actually gets to the speakers.

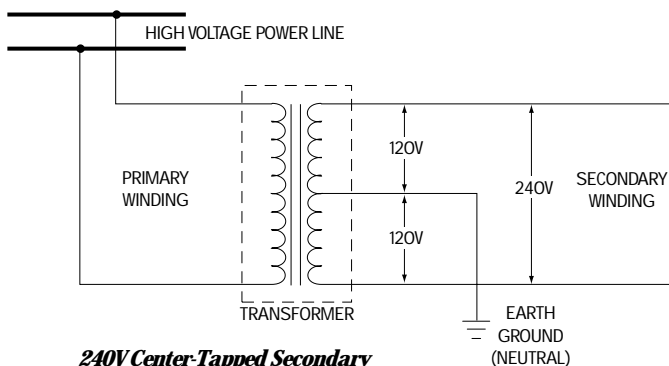

The thickness of wire is rated in gauges. Use the chart below to determine the correct gauge of wire to use according to the distance between the speakers and the amplifier, and the impedance of the load the amplifier is driving. This ensures that the power lost across the speaker wire is less than 0.5 dB.

Wire Length	Load Impedance	Gauge of Wire
Up to 25 ft.	2Ω	14 gauge
	4Ω	16 gauge
	8Ω	18 gauge
Up to 40 ft.	2Ω	12 gauge
	4Ω	14 gauge
	8Ω	18 gauge
Up to 60 ft.	2Ω	10 gauge
	4Ω	12 gauge
	8Ω	16 gauge
Up to 100 ft.	2Ω	8 gauge
	4Ω	10 gauge
	8Ω	14 gauge
Up to 150 ft.	2Ω	6 gauge
	4Ω	8 gauge
	8Ω	12 gauge
Up to 250 ft.	2Ω	4 gauge
	4Ω	6 gauge
	8Ω	10 gauge

30 70V DISTRIBUTION SYSTEMS

A distributed sound system uses a constant-voltage, high-impedance network that feeds a number of tapped transformers which, in turn, deliver power to individual speakers. Each tap is rated in watts, so you can select the amount of power delivered to the speaker. Developed for distributed paging and public address systems, one benefit of such a system is that it eliminates complicated impedance calculations

when setting up a multi-speaker system. You just add up the total wattages of all the speakers in the system and make sure that it doesn't exceed the total power rating of the amplifier (allowing at least 10% for insertion losses). Another benefit is that by using high voltage and low current, losses in the speaker distribution wiring are kept to a minimum. Standard voltage levels include 25V, 70V, and 100V, but 70V systems are most commonly used in commercial sound distribution systems in the U.S.

Because of the high power capability of the M•1400i amplifier, it can be used to directly drive 70V constant-voltage distribution systems without the use of a step-up transformer. When the M•1400i amplifier is operated in BRIDGE mode, it can produce 850 watts into 8 ohms, or 82.5V. This is slightly higher than the standard 70.7V for which the system was designed. You can recalculate the actual power delivered to each tap by multiplying the tap's rated wattage by a correction factor (K). The correction factor is P_1/P_2 , where P_1 is the power delivered by the amplifier into 8 ohms (BRIDGE mode), and P_2 is the power delivered by 70.7V into 8 ohms (625W).

M•1400i: $K = 850W/625W = 1.36$. Thus, a 2.5W tap becomes 3.4W, a 5W tap becomes 6.8W and a 10W tap becomes 13.6W.

CAUTION: A characteristic of many tapped transformers is that they saturate at very low frequencies, which causes their impedance to decrease, approaching the DC resistance of the copper wire. This can result in overloading the amplifier if the signal contains lots of low frequencies. When using an M•1400i amplifier in a 70V distribution system, set the LOW CUT FILTER 14 to 100Hz or higher. In addition, install an RC network at the SPEAKER OUTPUT 11 of the amplifier, as shown in the figure below.

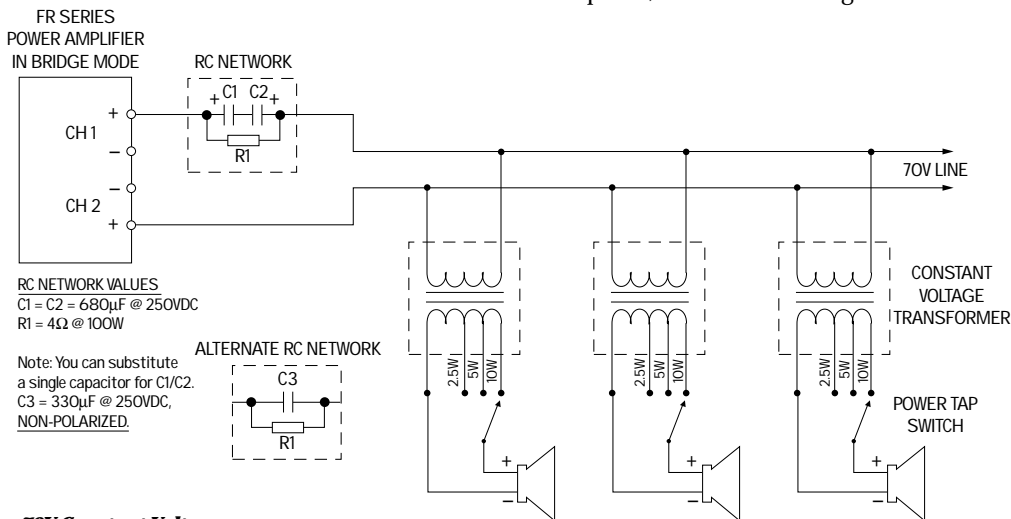

70V Constant Voltage Distribution System

APPENDIX A: Service Info

WARRANTY SERVICE

Details concerning Warranty Service are spelled out on the Warranty Card included with your amplifier (if it's missing, let us know and we'll rush one to you).

If you think your amplifier has a problem, please do everything you can to confirm it before calling for service, including reading through the following Troubleshooting section. Doing so might save you from the deprivation of your amplifier and the associated suffering.

Of all Mackie products returned for service (which is hardly any at all), roughly 50% are coded "CND" — Could Not Duplicate, which usually means the problem lay somewhere else in the system. These may sound obvious to you, but here are some things you can check:

TROUBLESHOOTING

No power!

- Our favorite question: Is it plugged in? Make sure the AC outlet is live (check with a tester or lamp).
- Our next favorite question: Is the POWER switch 9 on? If not, try turning it on.
- Is the green light next to the power switch illuminated? If not, make sure the AC outlet is live. If so, refer to "No Sound" below.
- The AC line fuse inside the cabinet is blown. *This is not a user-serviceable part.* Refer to "Repair" on the next page to find out how to proceed.

No sound!

- Are the GAIN 3 controls turned all the way down? Slowly turn them up and see if you hear anything.
- Is the signal source turned up? Make sure the signal level from the mixing console (or whatever device immediately precedes the amplifier) is high enough to produce sound in the amplifier. The SIG 5 LEDs should be blinking to indicate that signal is present.
- If the speakers are wired for BRIDGE mode, make sure the AMP MODE 17 switch is set to BRIDGE 20.

- If the OUTPUT APPLICATION 21 switch is set to SUBWOOFER 23, make sure the LOW CUT FILTER 14 frequency control is set to OFF or nearly OFF. If it is turned up above the subwoofer cutoff frequency, the output from the amplifier will be diminished.
- Is the SHORT 7 LED lit? Turn the POWER off, check the speaker connections and make sure that there are no strands of wire shorting across the speaker terminals.
- Is the HOT TEMP STATUS 8 LED lit? Make sure there is cool air available at the front of the amplifier. Make sure there is room at the sides of the amplifier for warm air to exit. Allow the amplifier to cool off.
- Are there fuses in the speaker or in-line fuses in the speaker wire? Check 'em to see if they're blown.
- Make sure the speakers are working properly.

One side is way louder than the other!

- Do the M•1400i's meters 4 read the same on both sides? If not, your source signal may be delivering an out-of-balance stereo signal.
- Are both GAIN 3 knobs set to the same position?
- Are the speaker(s) impedances matched? (See *Appendix E* — "Do The Math: Ohms, Loads and Such.")
- Try swapping sides: Turn off the amp, swap the speaker cables at the amp, turn the amp back on. If the same side is still louder, the problem is with your speakers or speaker cabling. If the other side is louder now, the problem is with the mixer, the amp, or the line-level cabling.

The stereo music sounds kind of sideways, and the bass frequencies diminish when standing center, but get louder as you approach one side!

- Check the polarity of the speaker cable connections. You may have your positive and negative connections reversed at one end of one speaker cable.

As soon as the music gets loud, the amp shuts down!

- Check the M•1400i's meters ④. Be sure that OL is not lighting up frequently or continuously.
- Can the amp breathe? The M•1400i amps draw their ventilation air in from the front and out through the side panels. They need plenty of fresh air to stay cool.
Do not block the ventilation ports.
- Is the SHORT ⑦ LED lit? If so, you've got a dead short somewhere in your speaker setup, or the total impedance of the load is too low. Turn the amp off and rectify that right away.

Something's missing in the mid and high frequencies!

- If you're using horns with compression drivers, please read CONSTANT DIRECTIVITY ⑮.

It hurts when I touch my arm, or my leg, or even my head!

- You have a broken finger.

Bad sound!

- Is it loud and distorted? Turn down the signal coming from the mixer or signal source.
- Is the input connector plugged completely into the jack? Check the speaker connections and verify that all connections are tight and that there are no stray strands of wire shorting across the speaker terminals.
- If possible, listen to the signal source with headphones plugged into the console. If it sounds bad there, the problem's not in the amplifier.

Noise/Hum

- Check the signal cable between the mixer and the amplifier. Make sure all connections are good and sound.
- Make sure the signal cable is not routed near AC cables, power transformers, or other EMI-inducing device.
- Is there a light dimmer or other SCR-based device on the same AC circuit as the monitor? Use an AC line filter or plug the amplifier into a different AC circuit.
- If possible, listen to the signal source with headphones plugged into the console. If it sounds noisy there, the problem's not in the amplifier.
- Refer to "Grounding" in *Appendix D*.

REPAIR

Service for the M•1400i amplifier is available only from one of our authorized domestic service stations or at the factory, located in sunny Woodinville, Washington. (Service for amplifiers living outside the United States can be obtained through local dealers or distributors.) If your amplifier needs service, follow these instructions:

1. Review the preceding troubleshooting suggestions. Please.
2. Call Tech Support at 1-800-258-6883, 8am to 5pm PST, to explain the problem and request an RA (Return Authorization) number. Have your amplifier's serial number ready. **You must have an RA number before you can obtain service at the factory or an authorized service center.**
3. Keep this owner's manual. We don't need it to repair the amplifier.
4. Pack the amplifier in its original package, including endcaps and box. This is *very important*. When you call for the RA number, please let Tech Support know if you need new packaging. **Mackie is not responsible for any damage that occurs due to non-factory packaging.**
5. Include a legible note stating your name, shipping address (no P.O. boxes), daytime phone number, RA number, and a detailed description of the problem, including how we can duplicate it.
6. Write the RA number in **BIG PRINT** on top of the box.
7. Ship the amplifier to us. We recommend United Parcel Service (UPS). We suggest insurance for all forms of cartage. Ship to this address:

**Mackie Designs
SERVICE DEPARTMENT
16220 Wood-Red Rd. NE
Woodinville, WA 98072**

8. We'll try to fix the amplifier within three business days. Ask Tech Support for current turn-around times when you call for your RA number. We normally send everything back prepaid using UPS BLUE (Second Day Air). However, if you rush your amplifier to us by Air Shipment, we'll treat it in kind by letting it jump to the head of the line, and we'll also ship it back to you UPS RED (Next Day Air). This paragraph does not necessarily apply to non-warranty service.

APPENDIX B: Glossary

This Glossary contains brief definitions of many of the audio and electronic terms used in discussions of sound mixing and recording. Many of the terms have other meanings or nuances or very rigorous technical definitions which we have sidestepped here because we figure you already have a lot on your mind. If you'd like to get more information, you can call Mix Bookshelf at 1-800-233-9604. We recommend the following titles: *The Audio Dictionary*, by Glenn White; *Tech Terms*, by Peterson & Oppenheimer; *Handbook for Sound Engineers*, by Glen Ballou; *Mackie Mixer Book* by Rudy Trubitt; and *Sound Reinforcement Handbook*, by Gary Davis.

balanced

In a classic, balanced audio circuit, the two legs of the circuit (+ and -) are isolated from the circuit ground by exactly the same impedance. Additionally, each leg may carry the signal at exactly the same level but with opposite polarity with respect to ground. In some balanced circuits, only one leg actually carries the signal, but both legs exhibit the same impedance characteristics with respect to ground. Balanced input circuits can offer excellent rejection of common-mode noise induced into the line and also make proper (no ground loops) system grounding easier. Usually terminated with ¼" TRS or XLR connectors.

bandwidth

The band of frequencies that pass through a device with a loss of less than 3 dB, expressed in Hertz or in musical octaves. Also see *Q*.

bus

An electrical connection common to three or more circuits. In mixer design, a bus usually carries signals from a number of inputs to a mixing amplifier, just like a city bus carries people from a number of neighborhoods to their jobs.

channel

A functional path in an audio circuit: an input channel, an output channel, a recording channel, the left channel, and so on.

clipping

A cause of severe audio distortion that is the result of excessive gain requiring the peaks of the audio signal to rise above the capabilities of the amplifier circuit. Seen on an oscilloscope, the audio peaks appear clipped off. To avoid distortion, reduce the system gain in or before the gain stage in which the clipping occurs. See also *headroom*.

console

A term for a sound mixer, usually a large desk-like mixer.

crest factor

The ratio of the peak value to the RMS value. Musical signals can have peaks many times higher than the RMS value. The larger the transient peaks, the larger the crest factor.

dB

See *decibel*.

dBA

Sound Pressure Level (SPL) measured with an "A" weighting filter.

dBm

A unit of measurement of audio signal level in an electrical circuit, expressed in decibels referenced to 1 milliwatt. The "m" in dBm stands for "milliwatt." In a circuit with an impedance of 600 ohms, this reference (0 dBm) corresponds to a signal voltage of 0.775 VRMS (because 0.775 V across 600 ohms equals 1mw).

dBu

A unit of measurement of audio signal level in an electrical circuit, expressed in decibels referenced to 0.775 VRMS into any impedance. Commonly used to describe signal levels within a modern audio system.

dBv

A unit of measurement equal to the dBu but no longer in use. It was too easy to confuse a dBv with a dBV, to which it is not equivalent.

dBV

A unit of measurement of audio signal level in an electrical circuit, expressed in decibels

referenced to 1 VRMS across any impedance. Commonly used to describe signal levels in consumer equipment. To convert dBV to dBu, add 2.2 dB.

decibel (dB)

The dB is a ratio of quantities measured in similar terms using a logarithmic scale. Many audio system parameters measure over such a large range of values that the dB is used to simplify the numbers. A ratio of 1000V:1V=60 dB. When one of the terms in the ratio is an agreed-upon standard value such as 0.775V, 1V, or 1mw, the ratio becomes an absolute value, i.e., +4 dBu, -10dBV, or 0 dBM.

detent

A point of slight physical resistance (a click-stop) in the travel of a knob or slide control, used in Mackie mixers to indicate unity gain.

diffraction

The bending of sound waves around an obstacle (Huygens Principle). The longer the wavelength in comparison to the obstacle, the more the wave will diffract around it.

dipping

The opposite of peaking, of course. A dip is an EQ curve that looks like a valley, or a dip. Dipping with an equalizer reduces a band of frequencies. See guacamole.

dry

Usually means without reverberation, or without some other applied effect like delay or chorusing. Dry is not wet, i.e. totally unaffected.

duty cycle

The ratio of pulse width to total cycle time.

dynamic

In sound work, dynamic refers to the class of microphones that generates electrical signals by the movement of a coil in a magnetic field. Dynamic microphones are rugged, relatively inexpensive, capable of very good performance and do not require external power.

dynamic range

The range between the maximum and minimum sound levels that a sound system can handle. It is usually expressed in decibels as the difference between the level at peak clipping and the level of the noise floor.

EMI

Electro Magnetic Interference. This refers to current induced into the signal path as a result of an external magnetic field. In audio systems, this is usually manifested as a 60Hz or 120Hz hum or buzz. The source of this noise can be from a ground loop or from the signal wire coming too close to a strong magnetic field such as a transformer or high-current linecord.

EQ curve

A graph of the response of an equalizer, with frequency on the x (horizontal) axis and amplitude (level) on the y (vertical) axis. Equalizer types and effects are often named after the shape of the graphed response curve, such as peak, dip, shelf, notch, knee, and so on.

equalization

Equalization (EQ) refers to purposefully changing the frequency response of a circuit, sometimes to correct for previous unequal response (hence the term, equalization), and more often to add or subtract level at certain frequencies for sound enhancement, to remove extraneous sounds, or to create completely new and different sounds.

Bass and treble controls on your stereo are EQ; so are the units called parametrics and graphics and notch filters.

A lot of how we refer to equalization has to do with what a graph of the frequency response would look like. A flat response (no EQ) is a straight line, a peak looks like a hill, a dip is a valley, a notch is a really skinny valley, and a shelf looks like a plateau (or a shelf). The slope is the grade of the hill on the graph.

Graphic equalizers have enough frequency slider controls to form a graph of the EQ right on the front panel. Parametric EQs let you vary several EQ parameters at once. A filter is simply a form of equalizer that allows certain frequencies through unmolested while reducing or eliminating other frequencies.

Aside from the level controls, EQs are probably the second most powerful controls on any mixer (no, the power switch doesn't count!).

fader

Another name for an audio level control. Today, the term refers to a straight-line slide control rather than a rotary control.

filter

A simple equalizer designed to remove certain ranges of frequencies. A low-cut filter

(also called a high-pass filter) reduces or eliminates frequencies below its cutoff frequency. There are also high-cut (low-pass) filters, bandpass filters (which cut both high and low frequencies but leave a band of frequencies in the middle untouched), and notch filters (which remove a narrow band but leave the high and low frequencies alone).

frequency

The number of times an event repeats itself in a given period. Sound waves and the electrical signals that represent sound waves in an audio circuit have repetitive patterns that range from a frequency of about 20 repetitions per second to about 20,000 repetitions per second. Sound is the vibration or combination of vibrations in this range of 20 to 20,000 repetitions per second, which gives us the sensation of pitch, harmonics, tone, and overtones. Frequency is measured in units called Hertz (Hz). One Hertz is one repetition or cycle per second.

gain

The measure of how much a circuit amplifies a signal. Gain may be stated as a ratio of input to output values, such as a voltage gain of 4, or a power gain of 1.5, or it can be expressed in decibels, such as a line amplifier with a gain of 10 dB.

gain stage

An amplification point in a signal path, within either a system or a single device. Overall system gain is distributed between the various gain stages.

graphic EQ

A graphic equalizer uses slide pots for its boost/cut controls, with its frequencies evenly spaced through the audio spectrum. In a perfect world, a line drawn through the centers of the control shafts would form a graph of the frequency response curve. Get it? Or, the positions of the slide pots give a graphic representation of boost or cut levels across the frequency spectrum.

ground

Also called earth. Ground is defined as the point of zero voltage in a circuit or system, the reference point from which all other voltages are measured. In electrical systems, ground connections are used for safety purposes, to keep equipment chassis and controls at zero voltage and to provide a safe path for errant currents. This is called a safety ground.

Maintaining a good safety ground is always essential to prevent electrical shock. Follow manufacturer's suggestions and good electrical practices to ensure a safely grounded system. Never remove or disable the grounding pin on the power cord.

In computer and audio equipment, tiny currents and voltages can cause noise in the circuits and hamper operation. In addition to providing safety, ground provisions in these situations serve to minimize the pickup, detection and distribution of these tiny noise signals. This type of ground is often called technical ground.

Quality audio equipment is designed to maintain a good technical ground and also operate safely with a good safety ground. If you have noise in your system due to technical grounding problems, check your manual for wiring tips or call technical support. Never disable the safety ground to reduce noise problems.

ground loop

A ground loop occurs when the technical ground within an audio system is connected to the safety ground at more than one place. Two or more connections will allow tiny currents to flow in the loops created, possibly inducing noise (hum) in the audio system. If you have noise in your system due to ground loops, check your manual for wiring tips or call technical support. Never disable the safety ground to reduce noise problems.

headroom

The difference between nominal operating level and peak clipping in an audio system. For example, a mixer operating with a nominal line level of +4 dBu and a maximum output level of +22 dBu has 18 dB of headroom. Plenty of room for surprise peaks.

Hertz

The unit of measure for frequency of oscillation, equal to 1 cycle per second. Abbreviated Hz. KHz (pronounced "kay-Hertz") is an abbreviation for kilohertz, or 1000 Hertz.

Hz

See *Hertz*.

impedance

The AC resistance/capacitance/inductance in an electrical circuit, measured in ohms. In audio circuits (and other AC circuits) the impedance in ohms can often be very different than the circuit resistance as measured by a DC ohmmeter.

Maintaining proper circuit impedance relationships is important to avoid distortion and minimize added noise. Mackie input and output impedances are designed to work well with the vast majority of audio equipment.

knee

A knee is a sharp bend in an EQ response curve not unlike the sharp bend in your leg. Also used in describing dynamics processors.

level

Another word for signal voltage, power, strength, or volume. Audio signals are sometimes classified according to their level. Commonly used levels are: microphone level (–40 dBu or lower), instrument level (–20 to –10 dBu), and line level (–10 to +30 dBu).

line level

A signal whose level falls between –10 dBu and +30 dBu.

master

A control affecting the final output of a mixer. A mixer may have several master controls, which may be slide faders or rotary controls.

mixer

An electronic device used to combine various audio signals into a common output. Different from a blender, which combines various fruits into a common libation.

monaural

Literally, pertaining to or having the use of only one ear. In sound work, monaural has to do with a signal which, for purposes of communicating audio information, has been confined to a single channel. One microphone is a mono pickup; many microphones mixed to one channel is a mono mix; a mono signal played through two speakers is still mono, since it only carries one channel of information. Several monaural sources, however, can be panned into a stereo (or at least two-channel, if you are going to be picky) mix. Monaural sound reinforcement is common for environments where stereo sound reinforcement would provide an uneven reproduction to the listener.

monitor

In sound reinforcement, monitor speakers (or monitor headphones or in-the-ear monitors) are those speakers used by the per-

formers to hear themselves. Monitor speakers are also called foldback speakers. In recording, the monitor speakers are those used by the production staff to listen to the recording as it progresses. In zoology, the monitor lizard is the lizard that observes the production staff as the recording progresses. Keep the lizard out of the mixer.

noise

Whatever you don't want to hear. Could be hum, buzz, or hiss; could be crosstalk or digital hash or your neighbor's stereo; could be white noise or pink noise or brown noise; or it could be your mother-in-law reliving the day she had her gallstone removed.

noise floor

The residual level of noise in any system. In a well-designed product, the noise floor will be a very quiet hiss, which is the thermal noise generated by bouncing electrons in the transistor junctions. The lower the noise floor and the higher the headroom, the more usable dynamic range a system has.

parametric EQ

A "fully" parametric EQ is an extremely powerful equalizer that allows smooth, continuous control of each of the three primary EQ parameters (frequency, gain, and bandwidth) in each section independently. "Semi" parametric EQs allow control of fewer parameters, usually frequency and gain (i.e., they have a fixed bandwidth, but variable center frequency and gain).

peaking

The opposite of dipping, of course. A peak is an EQ curve that looks like a hill, or a peak. Peaking with an equalizer amplifies a band of frequencies.

phone jack

Ever see those old telephone switchboards with hundreds of jacks and patch cords and plugs? Those are phone jacks and plugs, now widely used with musical instruments and audio equipment. A phone jack is the female connector, and we use them in 1/4" two-conductor (TS) and three-conductor (TRS) versions.

phone plug

The male counterpart to the phone jack. See above.

Q

A way of stating the bandwidth of a filter or equalizer section. An EQ with a Q of .75 is broad and smooth, while a Q of 10 gives a narrow, pointed response curve. To calculate the value of Q, you must know the center frequency of the EQ section and the frequencies at which the upper and lower skirts fall 3 dB below the level of the center frequency. Q equals the center frequency divided by the difference between the upper and lower -3 dB frequencies. A peaking EQ centered at 10kHz whose -3 dB points are 7.5kHz and 12.5kHz has a Q of 2.

RFI

Radio Frequency Interference. High frequency radiation that often results from sparking circuits. This can be manifested in a number of ways in audio systems, but is usually evident as a high-frequency buzz or hash sound.

RMS

An acronym for root mean square, a conventional way to measure AC voltage and audio signal voltage. Most AC voltmeters are calibrated to read RMS volts. Other conventions include average volts, peak volts, and peak-to-peak volts.

shelving

A term used to describe the shape of an equalizer's frequency response. A shelving equalizer's response begins to rise (or fall) at some frequency and continues to fall (or rise) until it reaches the shelf frequency, at which point the response curve flattens out and remains flat to the limits of audibility. If you were to graph the response, it would look like a shelf. At least, more like a shelf than a hiking boot. The EQ controls on your stereo are usually shelving equalizers. See also *peaking* and *dipping*.

stereo

Believe it or not, stereo comes from a Greek word that means solid. We use stereo or stereophonic to describe the illusion of a continuous, spacious soundfield that is seemingly spread around the listener by two or more related audio signals. In practice, stereo often is taken to simply mean two channels.

sweep EQ

An equalizer that allows you to "sweep" or continuously vary the affected frequency of one or more sections.

TRS

Acronym for Tip-Ring-Sleeve, a scheme for connecting three conductors through a single plug or jack. 1/4" phone plugs and jacks and 1/8" mini phone plugs and jacks are commonly wired TRS. Since the plug or jack can carry two signals and a common ground, TRS connectors are often referred to as stereo or balanced plugs or jacks. Another common TRS application is for insert jacks, used for inserting an external processor into the signal path. In Mackie mixers, the tip is send, ring is return, and sleeve is ground.

TS

Acronym for Tip-Sleeve, a scheme for connecting two conductors through a single plug or jack. 1/4" phone plugs and jacks and 1/8" mini phone plugs and jacks are commonly wired TS. Sometimes called mono or unbalanced plugs or jacks. A 1/4" TS phone plug or jack is also called a standard phone plug or jack.

unbalanced

An electrical circuit in which the two legs of the circuit are not balanced with respect to ground. Usually, one leg will be held at ground potential. Unbalanced circuit connections require only two conductors (signal "hot" and ground). Unbalanced audio circuitry is less expensive to build but under certain circumstances is more susceptible to picking up noise.

unity gain

A circuit or system that has its voltage gain adjusted to be one, or unity. A signal will leave a unity gain circuit at the same level at which it entered. In Mackie mixers, unity gain is achieved by setting all variable controls to the marked "U" setting. Mackie mixers are optimized for best headroom and noise figures at unity gain.

volume

Electrical or sound level in an audio system. Perhaps the only thing that some bands have too much of.

XLR connector

A three-pin connector used in audio for transmitting a balanced signal. Sometimes referred to as a Cannon connector, named for the manufacturer who first popularized the three-pin connector.

APPENDIX C: Connectors

“XLR” CONNECTORS

Mackie amplifiers use 3-pin female “XLR” connectors on each input, with pin 1 wired to the grounded (earthed) shield, pin 2 wired to the “high” (“hot” or positive polarity) side of the audio signal, and pin 3 wired to the “low”

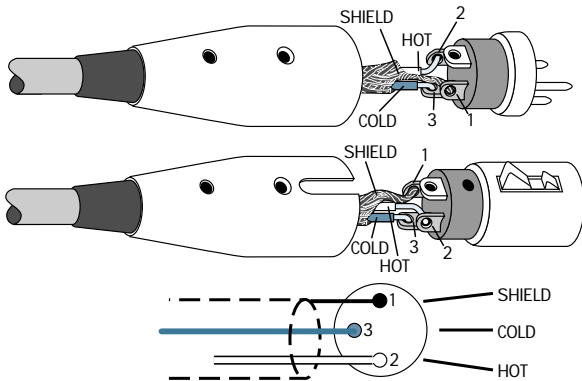

Figure A: XLR Connectors

(“cold” or negative polarity) side of the signal (Figure A). All totally above-board and in full accord with the hallowed standards dictated by the AES (Audio Engineering Society).

Use a male “XLR”-type connector, usually found on the nether end of what is called a “mic cable,” to connect to a female XLR jack.

1/4" TRS PHONE PLUGS AND JACKS

“TRS” stands for Tip-Ring-Sleeve, the three connections available on a “stereo” 1/4” or “balanced” phone jack or plug (Figure B). TRS jacks and plugs are used in several different applications:

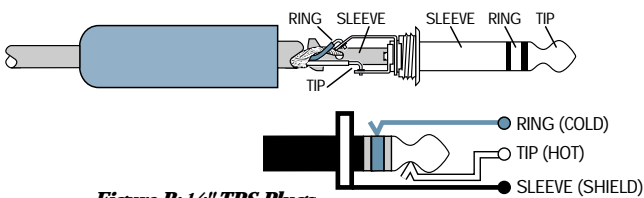

Figure B: 1/4" TRS Plugs

- Stereo Headphones, stereo microphones and stereo line connections. When wired for stereo, a 1/4" TRS jack or plug is connected tip to left, ring to right and sleeve to ground (earth).

- Unbalanced Send/Return circuits. When wired as a send/return “Y” connector, a 1/4" TRS jack or plug is connected tip to signal send

(output from mixer), ring to signal return (input back into mixer), and sleeve to ground (earth).

- Balanced mono circuits. When wired as a balanced connector, a 1/4" TRS jack or plug is connected tip to signal high (hot), ring to signal low (cold), and sleeve to ground (earth). This is the application used for the inputs to Mackie amplifiers.

1/4" TS PHONE PLUGS AND JACKS

“TS” stands for Tip-Sleeve, the two connections available on a “mono” 1/4" phone jack or plug (Figure C). TS jacks and plugs are used in many different applications, always unbalanced. The tip is connected to the audio signal and the sleeve to ground (earth). Some examples:

- Unbalanced microphones
- Electric guitars and electronic instruments
- Unbalanced line-level or speaker-level connections

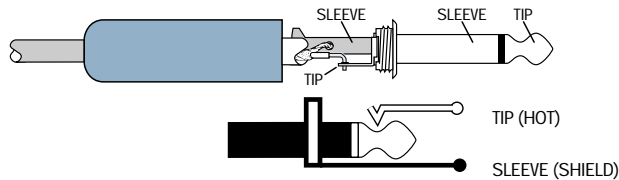

Figure C: TS Plug

UNBALANCING A LINE

In most studio, stage, and sound reinforcement situations, there is a combination of balanced and unbalanced inputs and outputs on the various pieces of equipment. This usually will not be a problem in making connections.

- When connecting a balanced output to an unbalanced input, be sure the signal high (hot) connections are wired to each other, and that the balanced signal low (cold) goes to the ground (earth) connection at the unbalanced input. In most cases, the balanced ground will also be connected to the ground at the unbalanced input. If there are ground-loop problems, this connection may be left disconnected at the balanced end.

- When connecting an unbalanced output to a balanced input, be sure that the signal high (hot) connections are wired to each other. The unbalanced ground (earth) connection should be wired to the low and the ground connections of the balanced input. If there are ground-loop problems, try connecting the unbalanced ground connection only to the input low connection, and leaving the input ground connection disconnected.
- In some cases, you will have to make up special adapters to interconnect your equipment. For example, you may need a balanced XLR female connected to an unbalanced 1/4" TS phone plug. The balanced-to-unbalanced connection has been anticipated in the wiring of Mackie jacks. A 1/4" TS plug inserted into a 1/4" TRS balanced input, for example, automatically unbalances the input and makes all the right connections. Conversely, a 1/4" TRS plug inserted into a 1/4" unbalanced input automatically ties the ring (low or cold) to ground (earth).

BINDING POSTS

Binding posts provide a number of different methods for connecting speaker wire to the outputs of the amplifier. For fixed installations, you can use bare wire (Figure D), or wire terminated with spade lugs (Figure E).

For portable applications, the binding posts accept single or double banana plugs (Figure F). They provide a method of quickly connecting and disconnecting speaker cables to and from the amplifier. Double banana plugs have a tab on one side to indicate the ground (GND) side of the connector. This side connects to the black (-) binding post terminals on the amplifier.

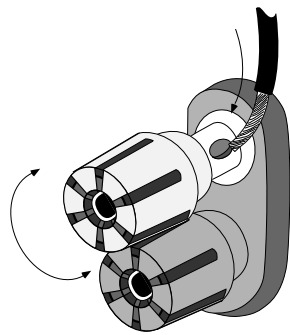

Figure D: Binding Posts with Bare Wire

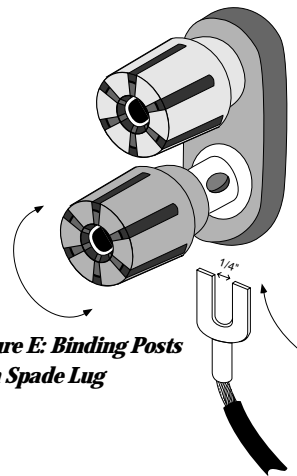

Figure E: Binding Posts with Spade Lug

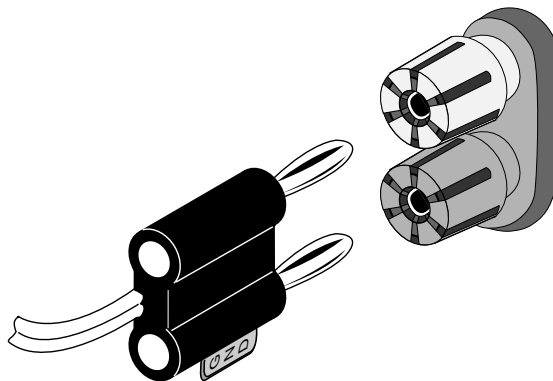

Figure F: Binding Posts with Double Banana Plug

APPENDIX D: Arcane Mysteries Illuminated

Balanced Lines

Balanced lines offer increased immunity to external noise (specifically, hum and buzz). Because a balanced system is able to minimize noise, it is the preferred interconnect method, especially in cases where very long lengths of cable are being used. A long unbalanced cable carries with it more opportunity for noise to get into a system — having balanced inputs means very little noise will enter the system via snakes and other cables that typically must run a long length.



A balanced line is a three-wire system where two wires carry the signal and the third is a ground wire that shields the inner conductors from EMI. The two inner conductors carry the same signal, but with opposite polarity. The balanced input amplifies only the difference between the two conductors. But a signal that is common to both conductors, and in phase, is rejected (canceled out) at the balanced input. This includes hum from AC lines or other EMI induced noise.

An unbalanced line does not have this noise-rejecting capability because it has only two conductors. One conductor carries the signal and the other is a ground wire that shields the inner conductor. Any hum or EMI noise that gets through the shield is added to the signal and amplified at the unbalanced input. Often the hum can be louder than the signal itself!

“Do’s” and “Don’ts” of Fixed Installations

If you install sound systems into fixed installations, there are a number of things that you can do to make your life easier and increase the likelihood of the sound system operating in a predictable manner. Even if you don’t do fixed installations, these are good practices for any sound system.

1. Do use foil-shielded snake cable for long cable runs. Carefully terminate each end, minimizing the amount of shielding removed. Protect the exposed foil shield with shrink sleeving or PVC sleeving. Prevent adjacent shields from contacting each other (electrically). Use insulating

sleeving on the drain wire (the one that connects to pin 1) to prevent it from contacting the connector shell.

2. Don’t connect the XLR connector shell to pin 1 of the XLR connector (unless necessary for RFI shielding). Doing so is an invitation for a ground loop to come visiting.
3. Do ensure that your speaker lines and AC power lines are physically separated from your microphone lines.
4. If you use floor pockets, use separate pockets for inputs and speakers, or put the connectors on opposite sides of the box so that they may be shielded separately.
5. If your speaker lines run in the open, they should be twisted pairs, at least 6 twists per foot. Otherwise, run the speaker lines in their own conduit. (Of course, conduit is not too practical for portable systems, heh-heh.)
6. Minimize the distance between the power amplifiers and the speakers.
7. Use heavy gauge, stranded wire for speaker lines. Ideally, the wire resistance should be less than 6% (0.5 dB power loss) of the load impedance. Remember that the actual run is twice as long as the physical length of the run. See below.

Maximum wire run for 0.5dB power loss in feet

wire gauge	res. per 1000 ft.	2 Ω	4 Ω	8 Ω
10	1.00	60	120	240
12	1.59	40	75	150
14	2.5	24	48	95
16	4.02	15	30	60

8. Ensure that the electrician uses the star-ground system for the safety grounds in your electrical system. All of the audio system grounds should terminate at the same physical point. No other grounds may come in contact with this ground system.
9. Ensure that the AC power feeds are connected to the same transformer, and ideally, the same circuit breaker.
10. Walk outside — look at the horizon. See any radio towers? Locate potential sources

of RF interference and plan for them before you begin construction. Know the frequency, transmitter power, etc. You can get this information by calling the station. Remember that many broadcast stations change the antenna coverage pattern and transmitter power at night.

11. Don't use hardware-store light dimmers.
12. Don't allow for anything other than microphone inputs at stage/altar locations. Supplying line inputs at these locations is an invitation for misuse. Make all sources look like microphones to the console.
13. Balance (or at least impedance balance) all connections that are remote from the console's immediate location.
14. If you bridge an amplifier, don't use 1/4" phone plugs for speaker connectors.

Grounding

Grounding exists in your audio system for two reasons: product safety and noise reduction. The third wire on the power cord exists for product safety. It provides a low-resistance path back to the electrical service to protect the users of the product from electrical shock. Hopefully, the resistance to ground through the safety ground (third wire) is lower than that through the user/operator to ground. If you remove this connection (by breaking or cutting the pin off, or by using a 'ground cheater'), this alternate ground path ceases to exist, which is a safety hazard.

The metal chassis of the product, the ground connections provided by the various connectors, and the shields within your connecting cables provide a low-potential point for noise signals. The goal is to provide a lower impedance path to ground for noise signals than through the signal wiring. Doing so helps minimize hum, buzz, and other extraneous non-audio signals.

Many "authorities" tell you that shields should be connected only at one end. Sometimes this can be true, but for most (99%) audio systems, it is unnecessary. If you do everything else correctly, you should be able to connect every component of your audio system using standard, off-the-shelf connecting cables that are available at any music store.

Here are some guidelines:

1. Use balanced lines if at all possible. They provide better immunity to induced noise and ground loops. Remember that you can balance a line by inserting in-line a piece of equipment that has a balanced output.
2. Avoid using three-phase power lines since they are usually used for air conditioning and other heavy power equipment. If using 240VAC single phase with center-ground power, connect all audio equipment to one side of the AC power, and all lighting and other equipment to the other side.
3. Be sure all AC outlet safety grounds are connected to one common point in a star ground arrangement. This common ground point should then tie back to earth ground at the service entrance by one heavy stranded wire, #2 gauge or larger.
4. Don't cut the third pin off the power cord. Carry some ground-lifter adapters and use them only if you have to plug into an ancient two-wire outlet.
5. Cables that are too long are less likely to pick up hum if you uncoil them in their entirety, and then find a place to stow the excess. Leaving the excess coiled only helps the cable pick up hum more efficiently.
6. If you bundle your cables together, don't bundle AC wiring and audio wiring together. Bundle them separately.
7. If your sound system insists on humming, you may need to teach it the words.

Optimizing Sound System Levels

In a full-blown (not fully blown) sound system, the signal level can be controlled or adjusted at many different points throughout the signal chain. The best system performance is achieved when the dynamic range of the system is maximized, thus reducing noise and allowing a nominal signal level to be used with maximum headroom. Whatzat!?

Dynamic range is the difference between the noise floor and the maximum undistorted signal level capability of the component. The greater the dynamic range, the better the signal to noise ratio, because the nominal signal level can be set at a higher amplitude and the noise tends to get buried underneath the signal. Headroom is the difference between the maximum undistorted signal level capability of

the component and the nominal signal level. It is important to maintain a reasonable amount of headroom so that the dynamic transient peaks of the musical program can be reproduced without clipping. 10 dB of headroom is usually adequate, but some program material may require up to 20 dB.

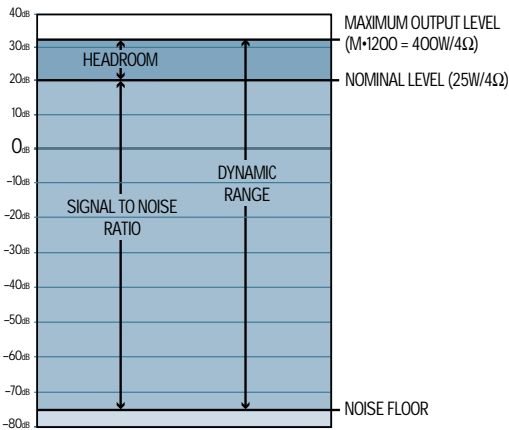

Dynamic Range

The best way to accomplish this goal is to optimize the input and output levels for each component in the system. It is best to start at the beginning of the chain (the microphone) and work your way to the end (the speakers). The following procedure details how to optimize a sound system with 10 dB of headroom.

A microphone is connected to the mic input on the mixing console. The gain of the mic preamp circuit, sometimes called Mic Trim, should be adjusted so that the loudest microphone signal is just below the overload point of the preamp. Most mixing consoles provide a mic preamp clipping indicator or level metering of some kind to optimize the mic preamp.

Next comes the output level of the channel, controlled by a fader or rotary gain control. Faders usually have an indication in the graphics that shows the normal or nominal setting for the fader. This setting is usually 10 or 12 dB below the maximum output level of the channel. This provides the headroom needed to reproduce the transient peaks associated with music. If the channel has a meter, you can use that to visually confirm that the nominal output level of the channel is around "0" on the meter.

Next set the master output level (fader) control on the mixer to the nominal level indication next to the control. Again, this should be at least 10 dB below the maximum output level of the mixer. You can double check the actual output signal level if there is an output meter on the mixer. On most professional equipment, this nominal output level will be +4 dBm (1.23V rms into 600 ohms).

The output of the mixer may drive a power amplifier directly, or it may go through a signal processor first (i.e., equalizer, compressor limiter, crossover). Determine the maximum output capability of the signal processor. Hopefully, it can produce at least +14 dB to maintain the required 10 dB of headroom. Chances are it can produce considerably more than that (like +20 dB to +24 dB). If 10 dB of headroom is not available, you'll have to introduce a resistive pad between the mixer and the signal processor to reduce the signal level from the mixer so it is at least 10 dB below the maximum output of the processor.

If the processor has enough headroom, set the level controls to unity gain, so with a +4 dB input it produces a +4 dB output. Keep in mind that if this is an equalizer, and you've boosted several frequency bands, the nominal output level may be more than +4 dB because of the extra energy the processor is adding to those frequencies. It may be necessary, in that case, to reduce the level controls a few dB below unity.

The M•1400i amp is designed to accept a nominal +4 dB input signal. Set the GAIN controls fully clockwise. This will provide the best signal-to-noise ratio and available headroom for the amplifier.

Biamplified and Triamplified Systems

Most speaker systems in use today are of the two-way or three-way variety. Cone speakers are good at reproducing low and mid-range frequencies, but not high frequencies. Likewise, compression drivers are good at reproducing high frequencies, but definitely not low frequencies. This is why two-way, three-way and even four-way speaker systems were developed — to improve the efficiency of each individual driver by requiring it to reproduce only the frequencies that it reproduces best.

One method of accomplishing this is through the use of a passive crossover network between the amplifier and the speaker(s). Often the passive crossover is built into the cabinet along with the various drivers. The crossover divides the high-level speaker signal into frequency bands, which are then directed to the appropriate driver. There are some drawbacks to this method, however. The passive crossover adds reactance to the load that the amplifier sees, which can affect the damping. Power is wasted as heat across the resistors in the crossover, reducing the amount of amplifier power available to the drivers themselves.

Biamplified and triamplified systems use separate power amplifiers to power each individual low-frequency and high-frequency driver. An electronic crossover (a.k.a. active crossover) is located between the signal source and the power amplifier. The advantages of this method include 1) increased headroom available from each amplifier, since they're amplifying only a portion of the entire audio spectrum; 2) improved damping factor because the amplifier output is connected directly to the driver; 3) improved efficiency because there are no passive resistors to dissipate heat; and 4) flexibility to choose the optimum crossover frequency and crossover slope for the individual drivers in the system.

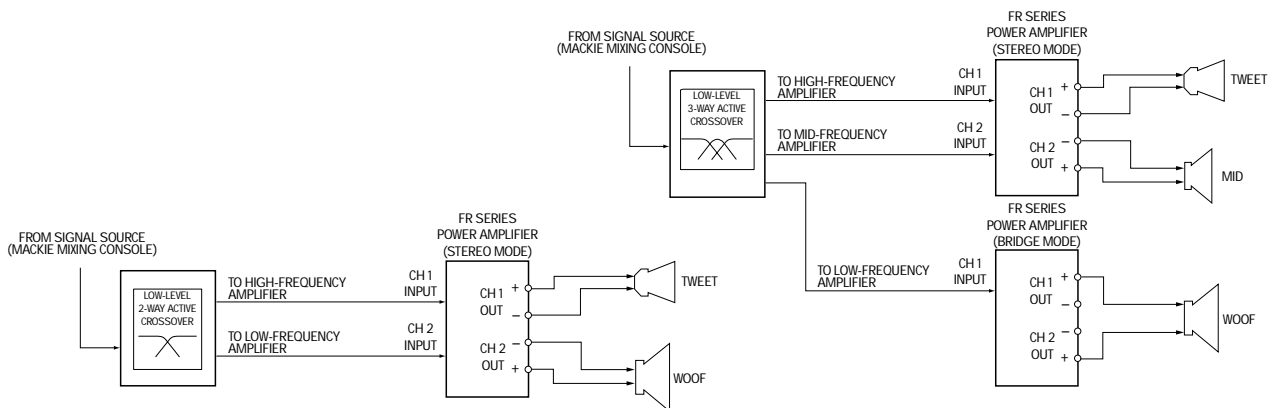
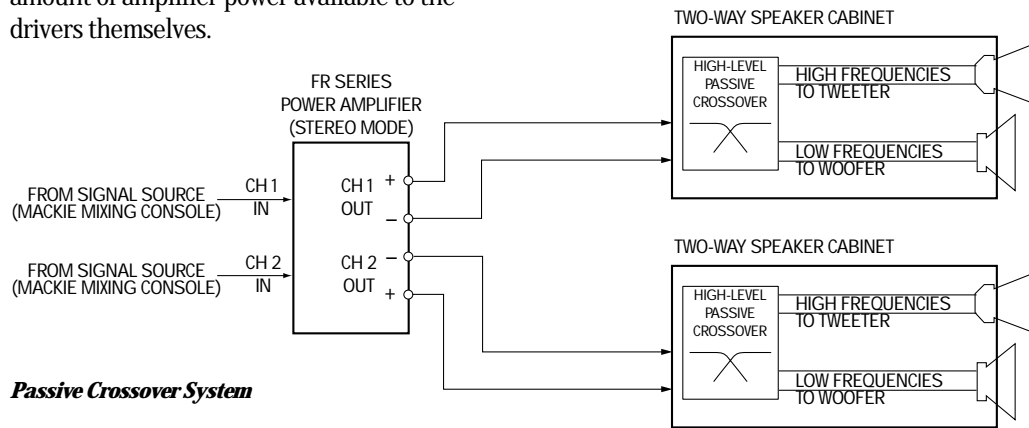

Triamplified System with Active Crossover

APPENDIX E: Technical Info

DO THE MATH: OHMS, LOADS AND SUCH

Remember: As the load gets “heavier,” its value in ohms goes down. For instance, a 2-ohm speaker load is twice as “heavy” as a 4-ohm load. An ohm is a unit of resistance — the more ohms, the more resistance (impedance). The more the resistance, the less the power. It can all seem backwards at first. Just remember that a dead short means no resistance at all, or zero ohms.

Since you’re in the biz (or you are now, since you just bought an amp), you probably own a volt/ohm meter (or DVM, for Digital Volt Meter). It’s an indispensable tool for anyone working with speakers and such. If you don’t own a meter, go out and get one right now — we’ll wait.

If you’re just dealing with one speaker (or cabinet) per output, the load in ohms will be printed on it somewhere. That’s your load. You can confirm this with the volt/ohm meter you just bought — set it for ohms, set it for the lowest range (unless it’s an autoranging meter) and measure across the speaker terminals. It may not agree exactly; a speaker rated at eight ohms may read between 5 and 7 ohms. (If it’s a multiple-driver speaker with a built-in passive crossover, this method won’t work.)

If you’re driving an assortment of speakers (or cabinets), things can get complicated. There are two basic ways of linking multiple loads (speakers in this case): series and parallel.

“Series” means that the positive amp output connects to the first speaker’s positive terminal, the first speaker’s negative terminal connects to the second speaker’s positive terminal, the second speaker’s negative terminal goes to the third, and so on, until the chain ends at the amp’s negative output. Series connections are not normally used in PA applications because it ruins the amplifier’s ability to damp (control) the speakers.

Doing load calculations with series configurations is easy — just add the loads. For instance, four 8-ohm speakers, connected in series, will equal 32 ohms ($8 + 8 + 8 + 8 = 32$).

“Parallel” means that the positive amp output connects to the positive terminals of all the speakers, and the negative amp output connects to the negative terminals of all the speakers. If one speaker fails in a parallel configuration, the others will still work, but the load will change. That lets you breathe a little easier (the show will go on), except that you may have a dead speaker and not even know it.

Calculating parallel loads is also easy, as long as each speaker has the same value — just divide the value by the number of speakers. For instance, four 8-ohm speakers, connected in parallel, will equal 2 ohms ($8 / 4 = 2$). If the loads aren’t all the same, the formula gets a little more complicated, but nothing that you can’t do with a simple calculator:

$$Z_T = \frac{1}{\frac{1}{Z_1} + \frac{1}{Z_2} + \frac{1}{Z_3} + \dots}$$

There are other, more complicated configurations, like series-parallel (using a combination of series and parallel links to arrive at a desired load) and parallel configurations of unmatched loads (usually not recommended). But rather than get too deep into this, let’s just summarize the basics, as they apply to you and your M•1400i power amplifier:

- As a load gets “heavier,” its impedance in ohms decreases.
- The lower the impedance (ohms), the higher the power: The M•1400i has 630 watts (per side) with a 2-ohm load, 425 watts with 4 ohms, and 250 watts with 8 ohms.
- Do not connect a load of under 2 ohms (in STEREO and MONO mode) or 4 ohms (in BRIDGE mode).
- Never plug amplifier outputs into anything except speakers (unless you have an outboard box designed to accept speaker levels).
- Never play good music through bad speakers. You may, however, play bad music through good speakers (but only on odd-numbered Fridays).

SPECIFICATIONS

M•1400i

Continuous Sine Wave Average Output Power, both channels driven:

250 watts per channel into 8 ohms from 20Hz to 20kHz, with no more than 0.012% THD

425 watts per channel into 4 ohms from 20Hz to 20kHz, with no more than 0.025% THD

630 watts per channel into 2 ohms from 20Hz to 20kHz, with no more than 0.050% THD

Bridged mono operation:

850 watts into 8 ohms from 20Hz to 20kHz, with no more than 0.025% THD

1260 watts into 4 ohms from 20Hz to 20kHz, with no more than 0.050% THD

Maximum Power at 1% THD:

280 watts per channel into 8 ohms

480 watts per channel into 4 ohms

700 watts per channel into 2 ohms

960 watts into 8 ohms bridged

1400 watts into 4 ohms bridged

Note: Power ratings are specified at 120VAC line voltages.

The M•1400i power amplifier draws large amounts of current from the AC line with continuous sine wave testing. Accurate measurement of power requires a steady and stable AC supply. This means the line impedance must be very low to insure that the peak AC line voltage does not sag to less than 97% of its value.

If driving highly reactive loads, we recommend that the limiter circuit be engaged.

Power Bandwidth:

20Hz to 70kHz (+0, -3 dB)

Frequency Response:

20Hz to 40kHz (+0, -1 dB)

10Hz to 70kHz (+0, -3 dB)

Distortion:

THD, SMPTE IMD, TIM < 0.025% @ 8Ω

< 0.050% @ 4Ω

< 0.150% @ 2Ω

Signal-to-Noise Ratio:

> 107 dB below rated power into 4 ohms

Channel Separation:

> 80 dB @ 1kHz

Damping Factor:

> 350 from 0 to 400Hz

Input Impedance:

20kΩ balanced bridging

Input Sensitivity:

1.23 volts (+4 dBu) for rated power into 4 ohms

Gain:

30.25 dB (32.5V/V)

Maximum Input Level:

9.75 volts (+22 dBu)

Rise Time:

< 4.4μs

Slew Rate:

Voltage Slew Rate > 50V/μs

> 100V/μs bridged

Current Slew Rate > 32A/μs at 2Ω

CMRR:

> 40 dB, 20Hz to 20kHz

Load Angle:

8(±jx) time independent at 8Ω

4(±jx) time dependent, T > 6 min. at 4Ω

2(1±jx) time dependent, T > 2 min. at 2Ω

Transient Recovery:

< 1μs for 20 dB overdrive @ 1kHz

High Frequency Overload and Latching:

No latch up at any frequency or level.

High Frequency Stability:

Unconditionally stable driving any reactive or capacitive load.

Turn On Delay:

3 seconds

Variable Low-Cut Filter:

10Hz (Off) to 170Hz, 2nd Order Bessel

Subwoofer Low-Pass Filter:

Switched: 63Hz/125Hz, 3rd Order Bessel

Constant Directivity High Frequency Boost:

2kHz to 6kHz (+3 dB points)
6 dB/octave high-frequency shelving filter,
(shelving occurs at approximately 30kHz)

Limiter Section:

Complementary Positive and Negative Peak Detecting

Indicators:

6 meter LEDs per channel
SIG (Signal Present), -20, -9, -6, -3, OL (Overload)
CH 1 & 2
PROTECT LEDs
SHORT LEDs
TEMP STATUS
COLD/HOT LEDs

Power Consumption:

65 watts at idle	0.9A
550 watts with musical program fully loaded (4 ohms per side, or 8 ohms bridged)	6.7A
900 watts with musical program fully loaded (2 ohms per side, or 4 ohms bridged)	10.5A
850 watts at full power into 8 ohms (continuous sine wave)	9.6A
1500 watts at full power into 4 ohms (continuous sine wave)	15.6A
2500 watts at full power into 2 ohms (continuous sine wave)	24.8A

AC Line Power:

120VAC, 60Hz

AC Drop-out Voltage:

At approximately 50% of rated line voltage

Physical:

Height	3.5 inches (89mm)
Width	19.0 inches (483mm)
Depth	15.25 inches (387mm)
Overall Depth	16.25 inches (413mm)
Handle Depth	1.25 inches (32mm)
Weight	36 pounds (16.3kg)

Since we are always striving to make our products better by incorporating new and improved materials, components, and manufacturing methods, we reserve the right to change these specifications at any time without notice.

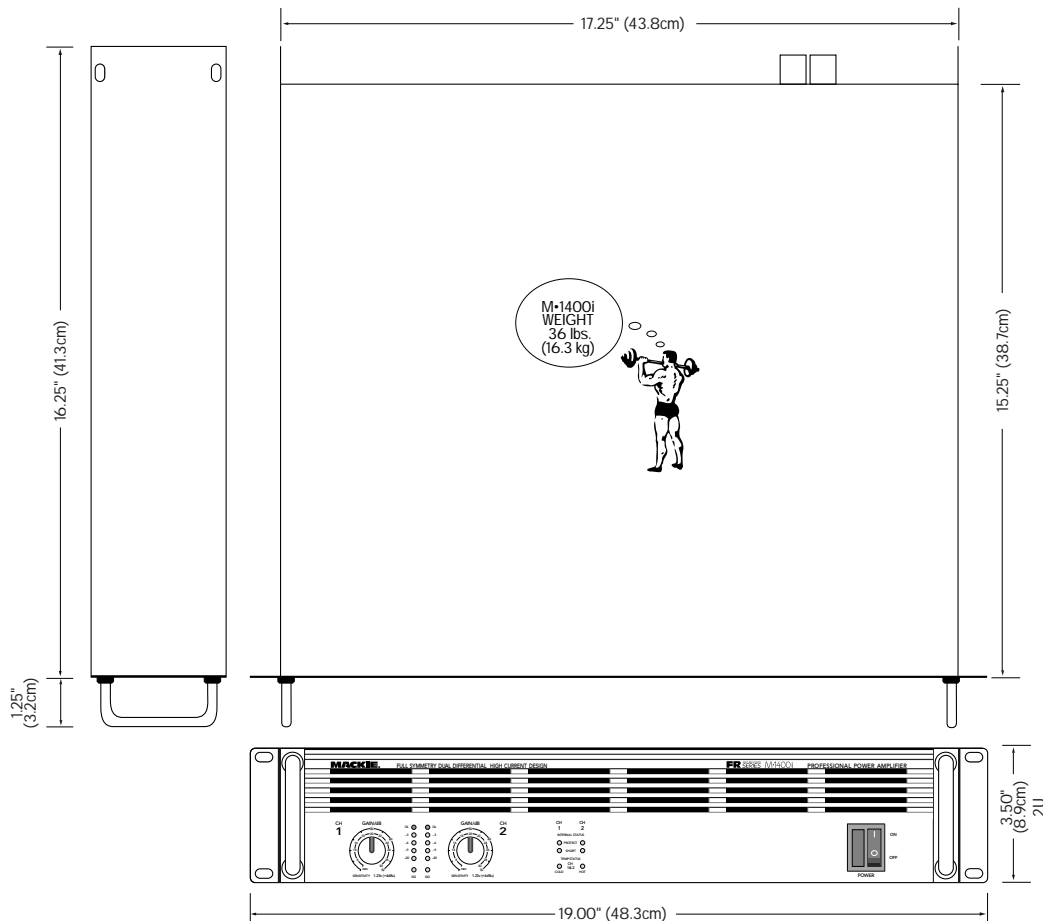

BLOCK DIAGRAM M•1400i

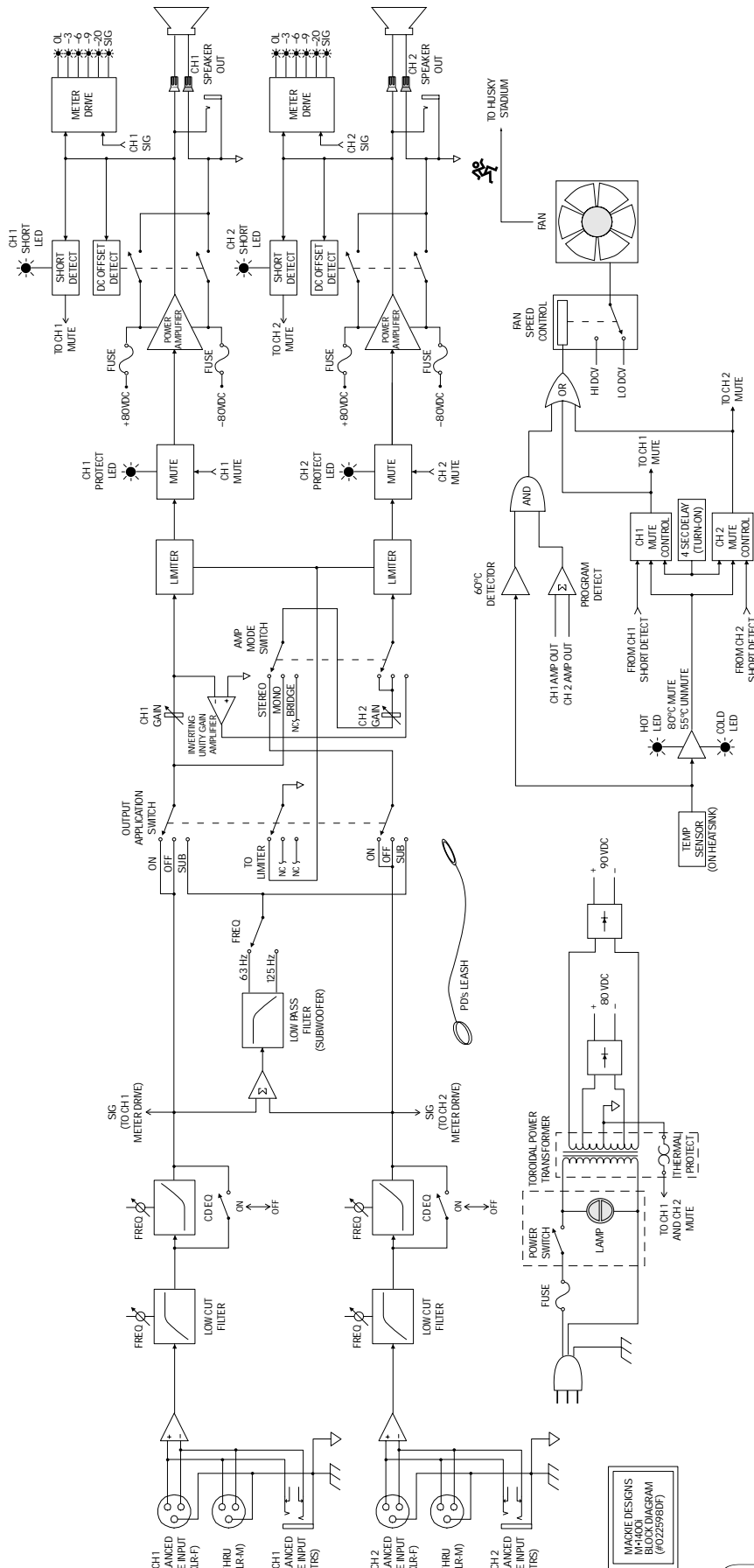

COLOPHON

Manual written by Jeff Gilbert and Dave Franzwa, with tidbits borrowed from almost everywhere, including huge chunks of technically baffling text contributed by Rick Chinn. Manual then defaced with proofreading pens in the hands of Mackie's legendary Tech Support staff (Paul Larson), New Products Engineering staff (Cal Perkins and Cameron Jones), and our incomparable Art Department (Sara Delahan). Back cover collage composed by Jayme Delma.

Manual composed with No. 4 blue sidewalk chalk on the banks of beautiful Sammamish Slough by Mackie's notorious Technical Writing staff, then converted to this amazing piece of work using a 13-story 1000 gigawatt Macintosh, powered by its own dedicated AC supply with extensive voltage regulation and noise filtering to insure pure, undistorted text. Please, feel free to let us know if you find an error or stumble over a confusing paragraph. Thank you for reading the entire manual (we know you have, or you wouldn't be here).

Mackie, The Running Man, and FR Series are either trademarks or registered trademarks of Mackie Designs Inc.

All other brand names mentioned are registered trademarks or trademarks of their respective holders, and are hereby acknowledged.

©1998 Mackie Designs Inc.
All Rights Reserved.
Printed in the U.S.A.



MACKIE DESIGNS
BLOCK DIAGRAM
#0225981F



M•1400i LIMITED WARRANTY

Please keep your sales receipt in a safe place.

A. Mackie warrants all materials, workmanship and proper operation of this FR Series product for a period of three years from the original date of purchase. If you complete the optional questionnaire portion of the Product Registration Card, the warranty will be extended for an additional two years. If any defects are found in the materials or workmanship or if the product fails to function properly during the applicable warranty period, Mackie, at its option, will repair or replace the product. **This warranty applies only to equipment sold and delivered within the U.S. by Mackie or its authorized dealers.**

B. Failure to return the card will not void the 3-year warranty.

C. Service and repairs of Mackie products are to be performed **only** at the factory (see D below) OR at an Authorized Mackie Service Center (see E below). Unauthorized service, repairs or modification will void this warranty.

D. To obtain factory service:

1. Call Mackie at 800/258-6883, 8AM to 5PM Monday through Friday (Pacific Time) to get a Return Authorization (RA). Products returned without an RA number will be refused.

2. Pack the FR Series product in its original shipping carton. If you do not have the carton, just ask for one when you get your RA number, and we'll send a shipping carton out promptly. More information on packing can be found in the *Service* section of the appropriate manual. Also include a note explaining exactly how to duplicate the problem, a copy of the sales receipt with price and date showing, and your return street address (no P.O. boxes or route numbers, please!). If we cannot duplicate the problem at the Mackie Factory or establish the starting date of your Limited Warranty, we may, at our option, charge for service time.

3. Ship the product in its original shipping carton, *freight prepaid* to:

**Mackie Designs Inc.
16220 Wood-Red Road NE
Woodinville, WA, 98072, USA**

IMPORTANT: Make sure that the RA number is plainly written on the shipping carton.

E. To obtain service from an Authorized Mackie Service Center:

1. Call Mackie at 800/258-6883, 8AM to 5PM Monday through Friday (Pacific Time) to get 1) the name and address of your nearest Mackie Authorized Service Center and 2) a repair authorization (RA). You must have an RA number before taking your unit to a service center.

2. Make sure that you have a copy of your FR Series sales receipt from the store where you bought the product. It is necessary to establish purchase date and thus determine whether or not your FR Series product is still under warranty. If you can't find it, the Authorized Service Center may charge you for repairs even if your FR Series product is still covered by Mackie's 1-Year Limited Warranty.

3. Make sure that the problem can be duplicated. If you bring your FR Series product to an Authorized Service Center and they can't find

anything wrong with it, you may be charged a service fee.

4. If the Mackie Authorized Service Center is located in another city, pack the FR Series product in its original shipping carton. More information on packing can be found in the *Service* section of the appropriate manual.

5. Contact the Mackie Authorized Service Center to arrange service or bring the FR Series product to them.

F. Mackie and Mackie Authorized Service Centers reserve the right to inspect any products which may be the subject of any warranty claims before repair or replacement is carried out. Mackie and Mackie Authorized Service Centers may, at their option, require proof of the original date of purchase in the form of a dated copy of the original dealer's invoice or sales receipt. Final determination of warranty coverage lies solely with Mackie Designs Inc. or its Authorized Service Centers.

G. Mackie FR Series products returned to Mackie and deemed eligible for repair or replacement under the terms of this warranty will be repaired or replaced within thirty days of receipt by Mackie at our rainforest factory complex. Products returned to Mackie which do not meet the terms of this Warranty will be repaired and returned C.O.D. with billing for labor, materials, return freight and insurance. Products repaired under warranty at Mackie's factory will be returned freight prepaid by Mackie to any location within the boundaries of the USA.

H. Mackie assumes no responsibility for the quality or timeliness of repairs performed by Mackie Authorized Service Centers.

I. This warranty is extended to the original purchaser and to anyone who may subsequently purchase this product within the applicable warranty period.

J. This is your sole warranty. Mackie does not authorize any third party, including any dealer or sales representative, to assume any liability on behalf of Mackie Designs or to make any warranty for Mackie Designs.

K. THIS IS THE ONLY WARRANTY GIVEN BY MACKIE AND IS IN LIEU OF ALL OTHER WARRANTIES. ALL IMPLIED WARRANTIES, INCLUDING WARRANTIES OF MERCHANTABILITY AND FITNESS FOR ANY PARTICULAR PURPOSE, SHALL BE STRICTLY LIMITED IN DURATION TO ONE YEAR FROM THE DATE OF ORIGINAL PURCHASE FROM A DEALER. UPON EXPIRATION OF THE 1-YEAR WARRANTY PERIOD, MACKIE SHALL HAVE NO FURTHER WARRANTY OBLIGATION OF ANY KIND, EXPRESSED OR IMPLIED. MACKIE SHALL IN NO EVENT BE OBLIGATED FOR ANY INCIDENTAL OR CONSEQUENTIAL DAMAGES THAT MAY RESULT FROM ANY DEFECT OR WARRANTY CLAIM, EXPRESSED OR IMPLIED. Some states do not allow exclusion or limitation of incidental or consequential damages or limitation on how long implied warranties last, so some of the above limitations and exclusions may not apply to you. This warranty provides specific legal rights. The purchaser has implied warranty rights and you may also have other rights which vary from state to state.