

# MACKIE®

## SR24•4 & SR32•4 OWNER'S MANUAL

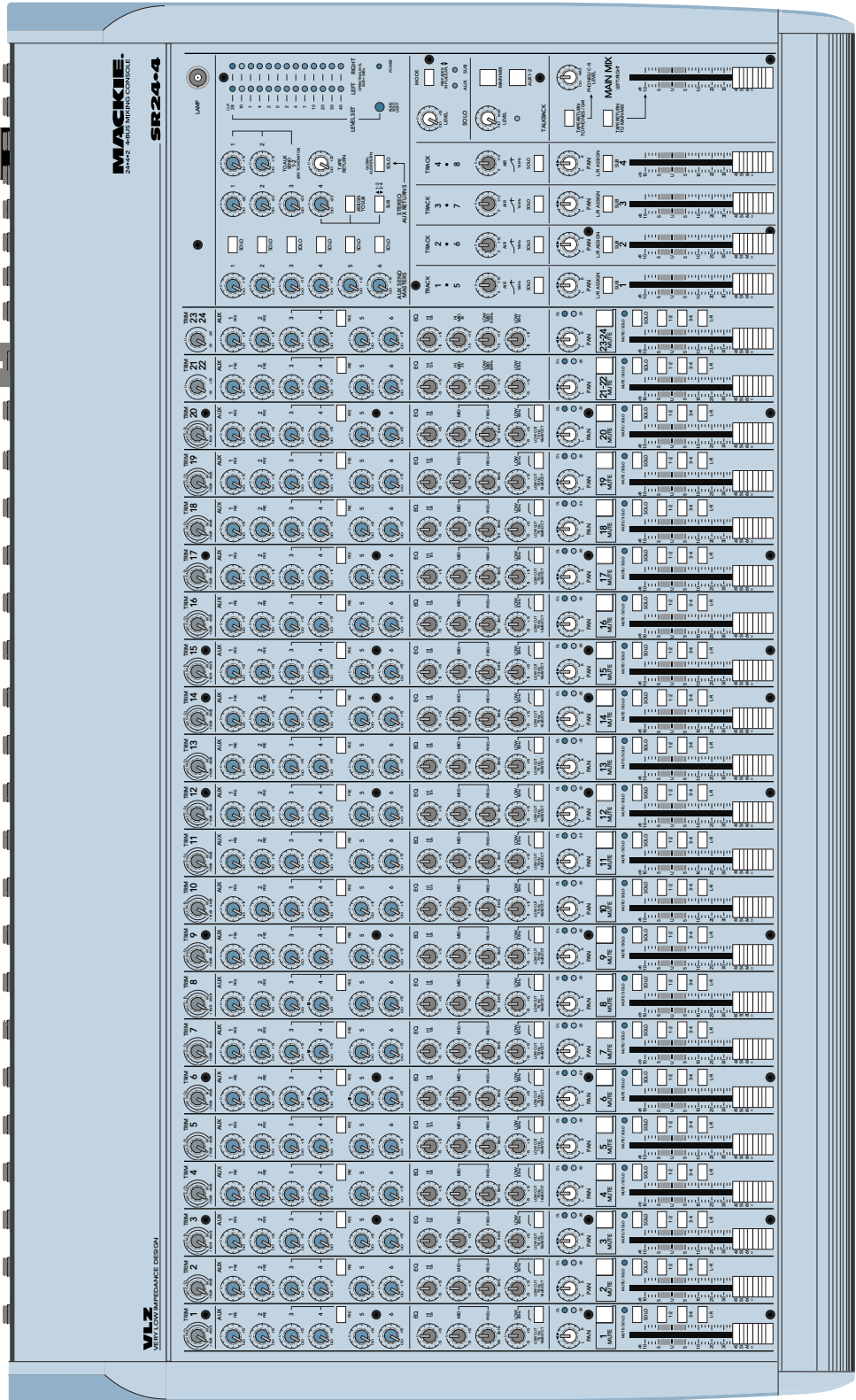

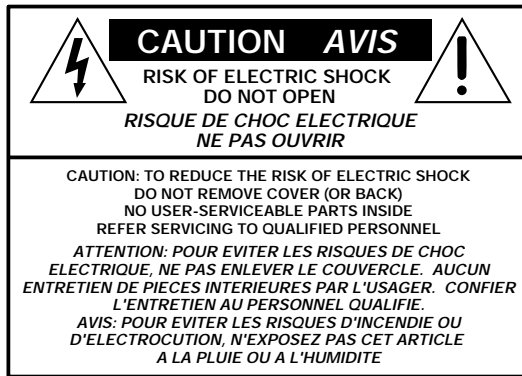

The lightning flash with arrowhead symbol within an equilateral triangle is intended to alert the user to the presence of uninsulated "dangerous voltage" within the product's enclosure, that may be of sufficient magnitude to constitute a risk of electric shock to persons.

*Le symbole éclair avec point de flèche à l'intérieur d'un triangle équilatéral est utilisé pour alerter l'utilisateur de la présence à l'intérieur du coffret de "voltage dangereux" non isolé d'ampleur suffisante pour constituer un risque d'électrocution.*



The exclamation point within an equilateral triangle is intended to alert the user of the presence of important operating and maintenance (servicing) instructions in the literature accompanying the appliance.

*Le point d'exclamation à l'intérieur d'un triangle équilatéral est employé pour alerter les utilisateurs de la présence d'instructions importantes pour le fonctionnement et l'entretien (service) dans le livret d'instruction accompagnant l'appareil.*

## SAFETY INSTRUCTIONS

1. Read Instructions — Read all the safety and operation instructions before operating the SR24•4 or SR32•4 Audio Mixer.
2. Retain Instructions — Keep the safety and operating instructions for future reference.
3. Heed Warnings — Follow all warnings on the SR24•4 and SR32•4 Audio Mixers and in these operating instructions.
4. Follow Instructions — Follow all operating and other instructions.
5. Water and Moisture — Do not use the SR24•4 or SR32•4 Audio Mixer near water — for example, near a bathtub, washbowl, kitchen sink, laundry tub, in a wet basement, in the rain, near a swimming pool or salivating St. Bernard dog, etc.
6. Heat — Locate the SR24•4 or SR32•4 Audio Mixer away from heat sources such as radiators, compost pits or other devices that produce heat.
7. Power Sources — Connect the SR24•4 or SR32•4 Audio Mixer only to a power supply of the type described in these operation instructions or as marked on the SR24•4 or SR32•4 Audio Mixer.
8. Power Cord Protection — Route power supply cords so that they are not likely to be walked upon or pinched by items placed upon or against them, paying particular attention to cords at plugs, convenience receptacles, and the point where they exit the SR24•4 or SR32•4 Audio Mixer.

9. Object and Liquid Entry — Do not drop objects or spill liquids into the inside of the SR24•4 or SR32•4 Audio Mixer.

10. Damage Requiring Service — The SR24•4 and SR32•4 Audio Mixers should be serviced only by qualified service personnel when:

- A. SR24•4 or SR32•4 Audio Mixer power-supply cord or the plug has been damaged; or
- B. Objects have fallen onto, or liquid has spilled into the SR24•4 or SR32•4 Audio Mixer; or
- C. The SR24•4 or SR32•4 Audio Mixer has been exposed to rain; or
- D. The SR24•4 or SR32•4 Audio Mixer does not appear to operate or exhibits a marked change in performance; or
- E. The SR24•4 or SR32•4 Audio Mixer has been dropped, or its chassis damaged.

11. Servicing — Do not attempt to service the SR24•4 or SR32•4 Audio Mixer beyond those means described in this operating manual. All other servicing should be referred to the Mackie Tech Support Department.

12. To prevent electric shock, do not use the SR24•4 or SR32•4 Audio Mixer polarized plug with an extension cord, receptacle or other outlet unless the blades can be fully inserted to prevent blade exposure.

*Pour prévenir les chocs électriques ne pas utiliser cette fiche polarisée avec un prolongateur, un prise de courant ou une autre sortie de courant, sauf si les lames peuvent être insérées à fond sans laisser aucune partie à découvert.*

13. Grounding or Polarization — Do not defeat the grounding or polarization of the SR24•4 or SR32•4 Audio Mixer.

This apparatus does not exceed the Class A/Class B (whichever is applicable) limits for radio noise emissions from digital apparatus as set out in the radio interference regulations of the Canadian Department of Communications.

*ATTENTION — Le présent appareil numérique n'émet pas de bruits radioélectriques dépassant les limites applicables aux appareils numériques de class A/de class B (selon le cas) prescrites dans le règlement sur le brouillage radioélectrique édicté par les ministere des communications du Canada.*

WARNING — To reduce the risk of fire or electric shock, do not expose this appliance to rain or moisture.



### PLEASE! SAVE THE SHIPPING BOX!

#### Top Ten Reasons for saving your shipping box:

10. It's here.
9. It's yours.
8. It's paid for.
7. It's strong and sturdy.
6. It fits your mixer perfectly.
5. You will need it if you ever ship your mixer.
4. We may have to sell you another one if you need to ship your mixer and you don't have it.
3. It will impress your friends who have no lives when they see it in your basement.
2. It's the ecologically sound thing to do.
1. It's the Mackie sound thing to do.

#### Top Ten Reasons for *not* saving your shipping box:

10. Your cat has already used it.
9. You stole the mixer out of a Karaoke bar.
8. Your Mackie mixer will never break.
7. You will never move again.
6. You wrote a song on it and are considering framing it.
5. You have cut off the top and are using it as an equipment rack.
4. You really hate planning ahead because it never works out anyway.
3. It fits some other manufacturer's product, which is broken, perfectly.
2. You have kept all the boxes of all the other equipment you have ever bought and you have never used one of them ever.
1. You are afraid of corrugated products.

Please put your serial number here for future reference (i.e. insurance claims, tech support, return authorization, etc.):

Purchased at:

Date of purchase:

- INTRODUCTION
- MAKING SOUND COME OUT RIGHT NOW
- PANEL LAYOUT AND FUNCTION
- APPLICATIONS
- APPENDICES



### TABLE OF CONTENTS

<b>Section 1: Introduction</b> .....	2
Sensitivity Adjustment Procedure .....	3
<b>Section 2: Making sound come out right now</b> ..	4
Hookup Diagrams .....	7
<b>Section 3: Panel layout</b> .....	12
Front Panel .....	12
Channel Strips 1-20 .....	12
Stereo Channel Strips 21/22 & 23/24 .....	18
Output Section .....	20
Subs 1-4 .....	20
Master Left Right Fader .....	22
Tape Return .....	22
Aux Send Masters .....	23
Stereo Aux Returns .....	23
Solo Master Section .....	24
Talkback .....	25
Meters .....	25
Power Indicator .....	26
Rude Solo Light .....	26
Lamp Connector .....	26
Rear Panel .....	27
Input Connectors 1-20 .....	27
Phantom Power .....	27
Stereo Input Connectors 21/22 & 23/24 ...	28
Sub Outs .....	29
Sub Inserts .....	29
Main Mix Outputs .....	30
Main Inserts .....	31
Aux Sends .....	31
Stereo Aux Returns .....	32
Tape In and Out .....	32
Control Room Out .....	33
Phones 1 and 2 .....	33
Talkback Mic .....	33
Power .....	33
<b>Section 4: Applications</b> .....	34
Sound Reinforcement .....	34
Recording .....	37
<b>Appendix A:</b> .....	
General Information .....	39
<b>Appendix B:</b> .....	
Glossary .....	42
<b>Appendix C:</b> .....	
Connections .....	50
<b>Appendix D:</b> .....	
Grounding, phantom power, etc. ....	53
<b>Appendix E:</b> .....	
Specifications and block diagram .....	57
<b>Appendix F:</b> .....	
Modifications .....	60
<b>Appendix G:</b> .....	
Service, free T-shirt offer & Track Sheet .....	62

# SECTION 1: INTRODUCTION

Okay, it sounds patronizing and everyone does it at the beginning of a manual, but here goes our version anyway: *“Thanks for buying a Mackie Designs mixer. You’ve chosen well.”*

**NOTE:** This manual covers both the SR24•4 and the SR32•4. Since they are identical, — except, of course, that the SR24•4 has 24 inputs and the SR32•4 has 32 — we will normally refer only to the SR24•4. When there is a difference, it will be noted. You SR32•4 owners should not feel so superior (though you may very well be).

The Mackie SR24•4 is designed for use in sound reinforcement (SR) or recording applications. The SR24•4 has four submix buses plus Main L/R, and six auxiliary buses. It can blend, combine and control a variety of audio input sources, including microphones, electronic instruments and other audio devices such as CD players and analog or digital sound recorders. Through the mixer’s output buses, these sounds can be routed to different loudspeaker power amplifiers, recording channels, effects units or other devices.

## IF YOU IGNORE MANUALS...

So you want to jump right off into the unknown, eh? Just bash on your SR24•4 (or 32•4) with your guitar for a while and see what happens.

(All the blood has left the Warranty Manager’s face as he reads these lines. Too late, bud, we’ve already printed and shipped thousands of manuals. We’ll put you on the Manual Review Committee next time.)

But seriously now, we know that a lot of people just plug things right in and wait until something doesn’t work right before they even take the manual out of the bag. Then they only look up the 800 number and call Customer Service.

Well, we can’t be your mother here... but if you’ve gotten this far, at least turn to the next section, ***Making Sound Come Out Right Now!***, ‘specially written for people in a big hurry. You might also skim through the Guided Tour in ***Section 3***, look at the block diagram and stop to read the paragraphs marked VERY IMPORTANT. We’ve put a few new twists and turns in the signal routing that you should check out before you hurt somebody.

This icon:



marks information which is absolutely critical or is unique to the SR24•4 (or 32•4).

In addition, sections tagged with this icon:



include both in-depth information and touching expressions of our sturdy Woodinville philosophy of Audio-as-Bowling. They’re not mandatory reading but can be instructive and illuminating.

And if you are one of those people who actually likes to read manuals, or at least feels vaguely guilty if you don’t, or whose boss made you read it, well then, march on! We love that! Have we got a manual for you! We’ll try to make it accurate, fun, informative and, of course, safe.



## IMPORTANT SENSITIVITY ADJUSTMENT PROCEDURE!

This procedure is **SO IMPORTANT** it gets top billing. Even if you don't read manuals, read this page. (Then again, if you don't read manuals, you wouldn't be reading this either.)

To fully achieve the SR24•4's impressive headroom and sonic specs, **DO NOT** use the old way: turning things up until they clip and then backing off. **DO** use the following Sensitivity Adjustment Procedure.

### FOLLOW THIS PROCEDURE FOR EACH CHANNEL IN USE

1. Set ALL faders all the way off.  
Set the **PHONES/CR LEVEL** about half way up (12:00).  
Set the **SOLO LEVEL** to the center "U" detent.  
Set the **SOLO MODE** switch to the UP position (PRE-FADER).
2. If you'd like to hear what you're doing, plug your headphones into either of the **PHONES OUT** jacks, or hook up your control room amp system to the **CONTROL ROOM OUTPUTS**.
3. Set the channel strip you've chosen as follows:  
**TRIM** control fully **down**.  
**MUTE** switch **up**. (That channel's **MUTE/SOLO LED** should be **off**.)  
**SOLO** switch **down**. (Now that channel's **MUTE/SOLO LED** should be flashing.)  
**EQ** controls at center detents.  
**TRIM** controls fully counterclockwise (**off**).
4. Apply an audio signal to that channel's input. The audio content and level you use should be representative of what you will really be doing when the tape starts rolling, or the crowd starts dancing. (For instance, make sure vocalists don't whisper during the sound check, forcing you to set the gain high, only to have them scream during the show, causing an overload emergency.)
5. That channel's **-20dB LED** should flicker. The L/R meters will show the actual level of that channel's audio signal. Now it's time to optimize that level.  
Adjust that channel's **TRIM** control until the peaks hit around 0dB on the L/R meters. For "+4" line-level audio sources, you may not need to turn it up at all. For "-10" sources, you'll probably adjust the **TRIM** a bit higher. For microphone sources, the **TRIM** control may wind up near the clockwise end (full gain).
6. If you plan to use the **EQ** on this channel, set the **EQ** controls roughly where you'll want them and repeat Step 5.
7. Return that channel's **SOLO** switch to the **up** position.
8. Repeat steps 1–7 on all channels that you're using.
9. When you're done setting levels, you can put all your controls back the way you want them, or have a sandwich first. But don't chop off the crust — it's good for you.



## SECTION 2: MAKING SOUND COME OUT RIGHT NOW!

Making  
Sound Come  
Out Right  
Now

This is the fast track, plug-it-in and ring-it-out section for the frantically behind and the terminally impatient. We've even included some typical applications diagrams (pgs. 9–13) for those who only read manuals for the pictures. Those of you with a little time and self-control can mosey on through the rest of the lavishly illustrated manual at your leisure. Runners, on your marks.

### FIRST, NORMALIZE THE MIXER

In every **input strip**,

- Set the **TRIM** and **AUX** controls to minimum (fully counterclockwise).
- Set all the **EQ** and **PAN** knobs straight up.
- Be sure every switch is up: **PRE**, **LO-CUT**, **MUTE**, **SOLO** and all of the assignment switches next to the faders.
- Pull all the faders all the way down to the (infinity or **off**) mark.

In the **Output/Monitor Section**,

- Be sure every switch is up (not pushed in).
- Be sure every knob is turned fully counterclockwise (**except** the four sub **PAN** controls; they should be set straight up).
- Pull the **SUB** and **MASTER** faders all the way down.



### 60 SECONDS TO AMPLIFIED SOUND

After you've **normalized** your mixer... grab your stopwatch and go.

This procedure will require a set of headphones.

1. Plug in the SR24•4 (or 32•4) and turn it on.
2. Set the **SOLO** master control to "U." This control is the small white knob on the right under the meters.
3. Plug your headphones into the **PHONES 1** jack on the back.
4. Plug a microphone into the **MIC 1** connector on the back. On the front, make the following settings on channel strip 1:
  - **MUTE** button up (the red **MUTE/SOLO** LED should not be lit)
  - **SOLO** button pushed (now the **MUTE/SOLO** and **RUDE SOLO** LEDs should start blinking).
5. Make sure that the **PFL/AFL Solo Mode** switch is in the **up** position.
6. Put the headphones on and carefully turn up the **PHONES/C-R LEVEL** control to about half. You will probably hear very little.
7. Now adjust the **TRIM** knob on channel strip 1 clockwise while you (or your appointed assistant) speak into the microphone. You should hear this in the headphones, see the green "-20" LED in the input channel strip flicker, and observe the level indicated in the main **LEFT** and **RIGHT** meters. Yes?

OK, your SR24•4 (or 32•4) works and you have pumped sound through it. Take channel 1 out of solo so you won't forget about it and confuse yourself later.

Go to the next page for the next "can't wait" sequence.





## SOUND REINFORCEMENT: THE FIVE-MINUTE MIXER

First, do the **60-Second Exercise** on the previous

page. This will assure you that your mixer works and has no hum or buzz coming in on the wiring. Now reset your stopwatch and begin.

1. Make sure all the faders and controls and switches are still normalled. Basically, this means all controls and faders off, all switches up. Leave the **SOLO** master and the **PHONES/C-R LEVEL** controls where they were set in the 60-Second Exercise.
2. Connect the outputs of the **RIGHT MAIN MIX** and the **LEFT MAIN MIX** to the inputs of your main house amplifier;

— or —

if you have a monaural main house amplifier, connect the **MONO MAIN MIX** output to the amp.

3. Connect the speakers to the amplifier, turn on the mixer and the amp and go listen to one of the speakers. You should not hear buzz, hum, a radio station or an ultimatum from orbiting space aliens. If you do hear anything more than a little pristine hiss or white noise, you have a wiring or grounding problem. Sorry, go directly to **Appendices A–D**. Do not collect \$200.
4. Now we need something to listen to while we proceed. Here are two choices: the microphone you plugged into input channel strip 1 for the 60-Second Exercise, or some source of music like a cassette deck or a CD player.

Let's pretend you have a CD player: plug the outputs of the CD player into the SR24•4 inputs labeled 23 and 24 (or 32•4 inputs 31 and 32). Put in a CD and press Play. Turn the 23–24 **TRIM** knob up until you see the green “–20” LED flicker. You can listen to the CD in your headphones and see the signal on the main meters by pushing the channel **SOLO** switch. OK? Now depress **SOLO**.

For the rest of this section, when we ask you to turn up your sound source, or mute it or something, you can use either the microphone

in your SR24•4's channel strip 1 or the CD or cassette player in channel strip 23–24 (31–32 on the 32•4), whichever you've chosen. We think you should use the tape or CD and that you put on some music you really love and which will always remind you of what a positive experience you had on your first day with your SR24•4. Meanwhile...

5. Push the SR24•4 channel strip fader that has the CD input up to the “U” mark. Engage the **L/R** button on the channel strip.
6. Now push up the **MAIN MIX** fader slowly. Depending upon the gain of your house amplifier, it could be really loud. You should hear your source coming clearly through the main house speakers. OK? Now pull down the **MAIN MIX** fader.
7. Next, if you have stage monitors, connect the input of your stage monitor *amplifier* to **AUX SEND 1** on the back of the SR24•4. Connect the monitor speakers to the amplifier, turn the amp on and listen for the dreaded hum or buzz. If it's quiet and clean, move on. If not, it's time for **Appendices A–D**.
8. Turn the **AUX 1** control on the channel strip to the “U” mark.
9. Now turn up the **AUX SEND MASTER** control slowly. Depending upon the gain of your monitor amplifier, it could be really loud. You should hear your source coming clearly through the stage monitor speakers. OK? Now turn down **AUX SEND MASTER 1**.  
If you want to use a second set of stage monitors with a different monitor mix, repeat the previous steps with the second system using **AUX SEND 2**.
10. If you want to use an auxiliary effect such as a reverb unit, patch **AUX SEND 5** into the input of the reverb. Connect the outputs of the reverb to **STEREO AUX RETURN 1 L** and **R**.
11. Set **AUX SEND MASTER 5** and **STEREO AUX RETURN 1** to “U” and then turn up the source channel strip's **AUX 5** until you hear the amount of reverb you like.
12. Stop your stopwatch and note time, repeat steps 1–11 until you break the 30-second mark.

Making  
Sound Come  
Out Right  
Now

Making  
Sound Come  
Out Right  
Now



## STEREO MIXDOWN: THE FIVE-MINUTE MUSIC MASTER

Be sure you do the **60-Second Exercise** first to set

everything up. This will assure you that your mixer works and has no hum or buzz coming in on the wiring. Reset your stopwatch one last time and begin.

1. It is preferable to plug the powercords of all your gear – Mixer, DAT, Power Amp, etc. into the same powerstrip. Make sure the powerstrip is properly grounded.
2. Make sure all the faders and controls and switches are still normalled. Leave the **SOLO** master control up, where it was set in the 60-Second Exercise, but turn the **PHONES/C-R LEVEL** control down.
3. Connect the outputs of the **RIGHT MAIN MIX** and the **LEFT MAIN MIX** to the inputs of your stereo tape deck or DAT recorder.
4. Connect the outputs of your stereo tape deck or DAT recorder to the **TAPE IN L** and **TAPE IN R** RCA jacks on the rear of the SR24•4.
5. Connect **CONTROL ROOM OUT L** and **R** to the left and right inputs of your control room monitor power amplifier.
6. Connect the monitor speakers to the amplifier, turn the amp on, and go listen to one of the speakers. You should not hear buzz, hum or tiny voices urging you to immediately go out and buy several hot fudge sundaes. If you do hear anything more than a little pristine hiss or white noise, you have a wiring or grounding problem. Sorry; go directly to **Appendices A–D**.
7. Now, let's assume you are mixing down a recording made on an eight-track recorder. Connect the eight outputs of the recorder to the first eight **LINE IN** jacks on the SR24•4 rear panel.
8. Engage the **L/R** buttons and set the faders in channel strips 1–8. Then adjust the **MAIN MIX** fader to approximate "Unity" on the mixdown deck level indicators.
9. Start your tape machine and play the session you'd like to mix.
10. Decide which tape track is the busiest; which track has the most constant activity and highest levels. Now, on the channel strip for that track, press the **SOLO** button and turn the **TRIM** control clockwise until you get a good level on the SR24•4 main meters. (A "good level" might be average meter readings of perhaps –7dB to 0dB, with occasional peak readings of +4dB to +7dB. See **Sensitivity Adjustment Procedure**, page 5.) Now release the **SOLO** switch.
11. Set the **TRIM** controls on the other seven active channel strips to the same point on their dials.
12. Now turn up the **PHONES/C-R LEVEL** control slowly. Depending upon the gain of your control room monitor amplifier, it could be really loud. You should hear your tape track (s) coming clearly through the monitor speakers. OK?
13. For analog recorders put your two-track recorder in **Source** or **Record Ready**, set the record input level controls so that the tape machine's meters read the same as the SR24•4 meters. For digital recorders use the 24•4 metering to make sure your DAT is receiving enough signal.
14. If you want to use an auxiliary effect such as a reverb unit, patch **AUX SEND 5** into the input of the reverb. Connect the outputs of the reverb to **STEREO AUX RETURN 1 L** and **R**.
15. Set **AUX SEND MASTER 5 LEVEL** and **STEREO AUX RETURN 1 LEVEL** to "U" and then turn up the source channel strip **AUX 5** until you hear the amount of reverb you like.
16. Now try a mix: set the channel strip faders, **PAN** pots and **EQ** controls wherever it sounds good, watch your levels on the main meters and put your two-track recorder into Record.
17. To check the two-track playback, press the **TAPE RETURN TO PHONES/CR** switch, and adjust the playback level with the **TAPE RETURN** control (located up by the main meters).

This concludes our "express" instructions for the chronically impatient. We resume our normally-paced, lavishly illustrated manual on the next page.



# Band in a Club

See page 35 for details

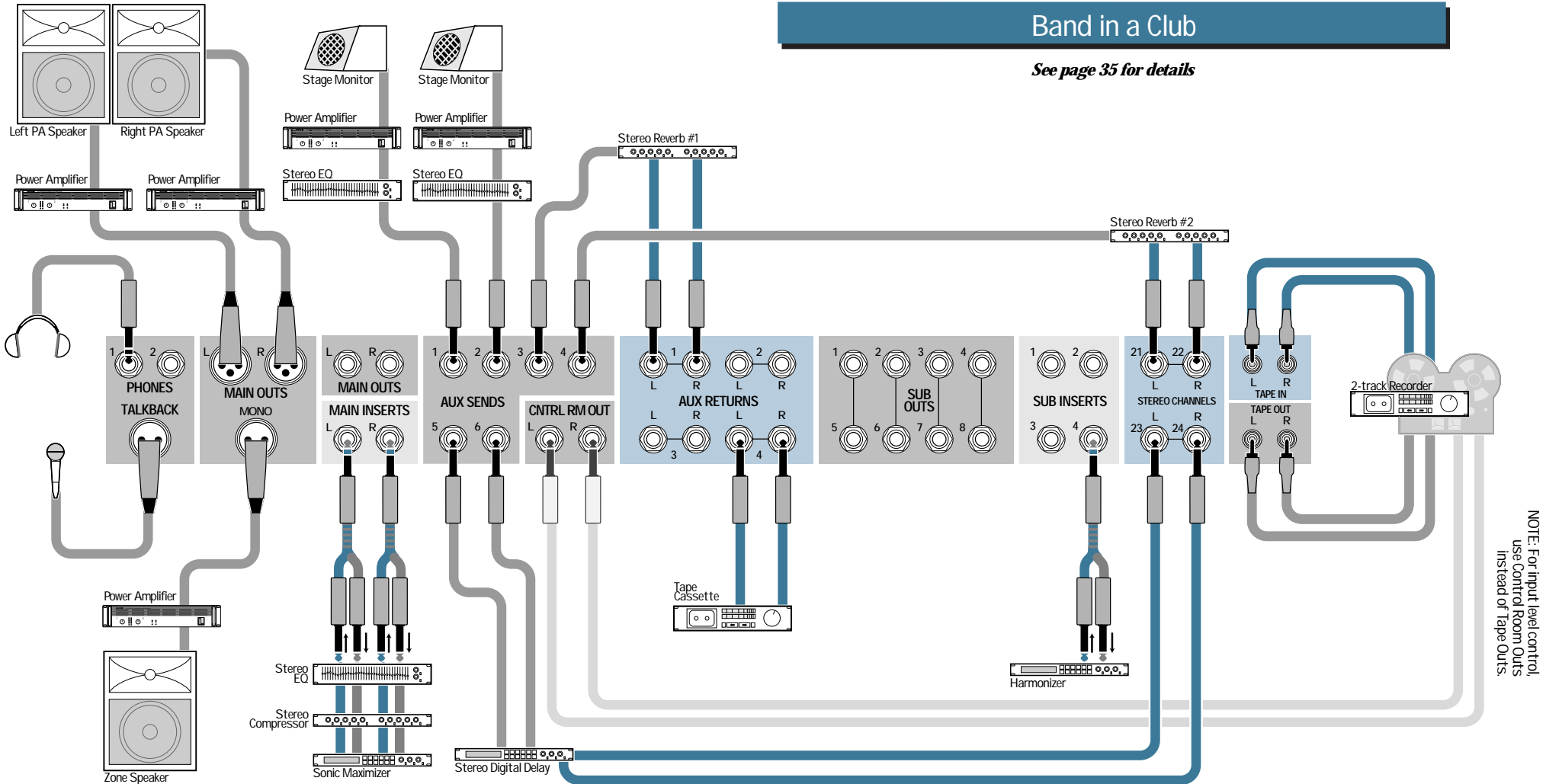

NOTE: For input level control, use Control Room Outs instead of Tape Outs.

7

ch.	device	input	insert	assignment	ch.	device	input	insert	assignment	ch.	device	input	insert	assignment
1	kick	mic	gate	submix 1	9	bass mic	line		submix 2	16	keyboard submix L	line		L/R bus
2	snare	mic	gate	submix 1	10	bass direct	line		submix 2	17	keyboard submix R	line		L/R bus
3	hi hat	mic		submix 1	11	guitar mic	mic	compressor	submix 3	18	vocal mic 1	mic		Submix 4
4	tom 1	mic	gate	submix 1	12	guitar direct	line	compressor	submix 3	19	vocal mic 2	mic		Submix 4
5	tom 2	mic	gate	submix 1	13	Acoustic guitar	mic		submix 3	20	vocal mic 3	mic		Submix 4
6	tom 3	mic		submix 1	14	piano low	mic		L/R bus	21-22*	stereo reverb			L/R mix
7	drum overhead mic L	mic		submix 1	15	piano high	mic		L/R bus	23-24†	stereo delay			Submix 4
8	drum overhead mic R	mic	compressor	submix 1										

\* 29-30 on the SR32•4 † 31-32 on the SR32•4

# Church Installation

See page 36 for details

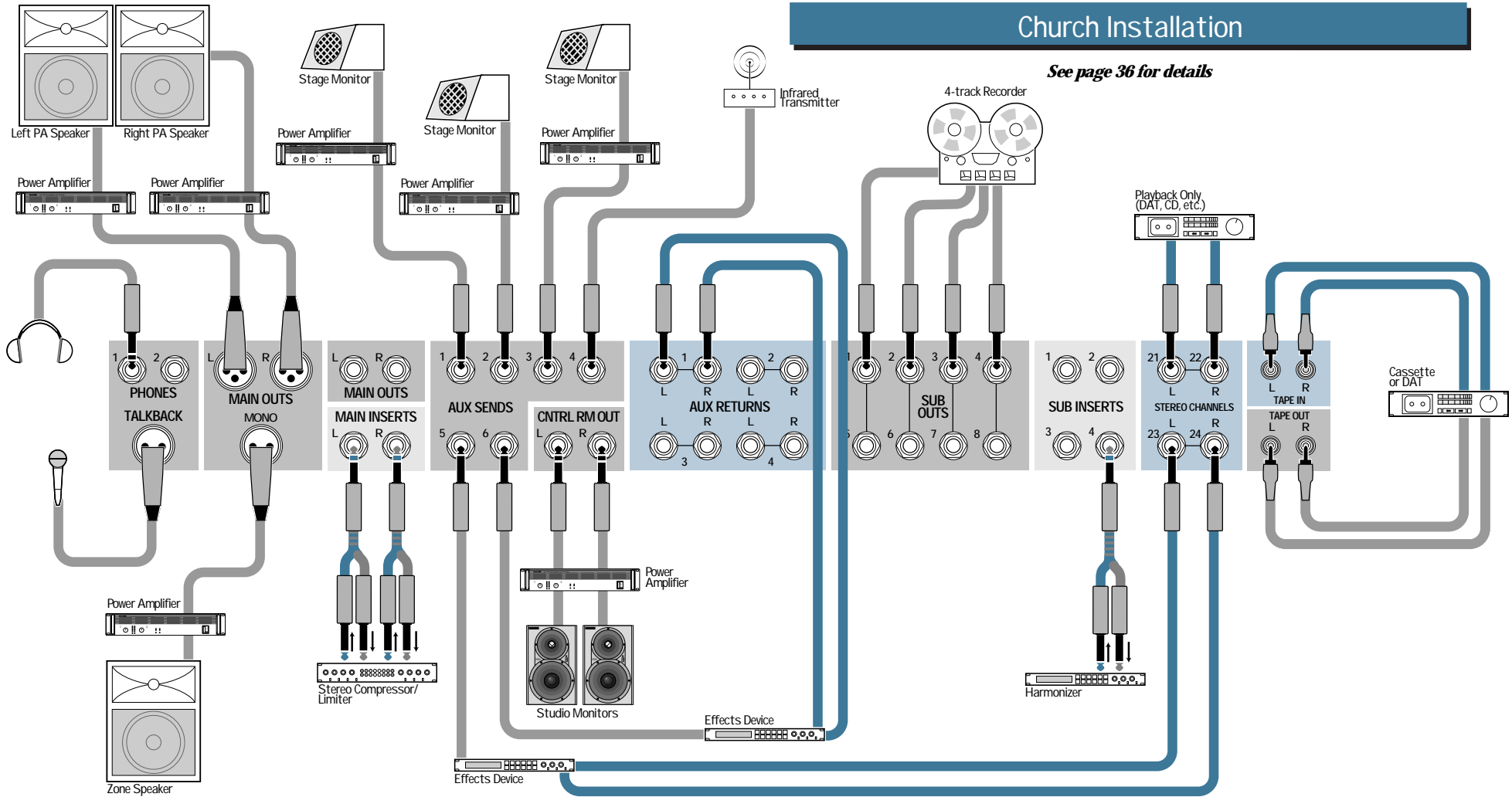

ch.	device	input	insert	assignment	ch.	device	input	insert	assignment	ch.	device	input	insert	assignment
1	kick	mic	all optional	submix 1-2	9	worship team vocal 1	mic	all optional	submix 3-4	15	wireless lavalier mic 1	line	all optional	L/R bus
2	snare	mic		submix 1-2	10	worship team vocal 2	mic		submix 3-4	16	wireless lavalier mic 2	line		L/R bus
3	drum overhead mic L	mic		submix 1-2	11	worship team vocal 3	mic		submix 3-4	17	wireless hand-held mic 1	line		L/R bus
4	drum overhead mic R	mic		submix 1-2	12	choral L	mic		submix 3-4	18	lectern mic 1	mic		L/R bus
5	bass direct	line		submix 1-2	13	choral center	mic		submix 3-4	19	lectern mic 2	mic		L/R bus
6	guitar mic	mic		submix 1-2	14	choral R	mic		submix 3-4	20	alter mic	mic		L/R bus
7	piano PZM mic	mic		submix 1-2						21-22*	CD player			L/R bus
8	synth direct	line		submix 1-2						23-24†	digital effect stereo return			L/R bus

\* 29-30 on the SR32•4 † 31-32 on the SR32•4

# 8-Track Recording

See page 37 for details

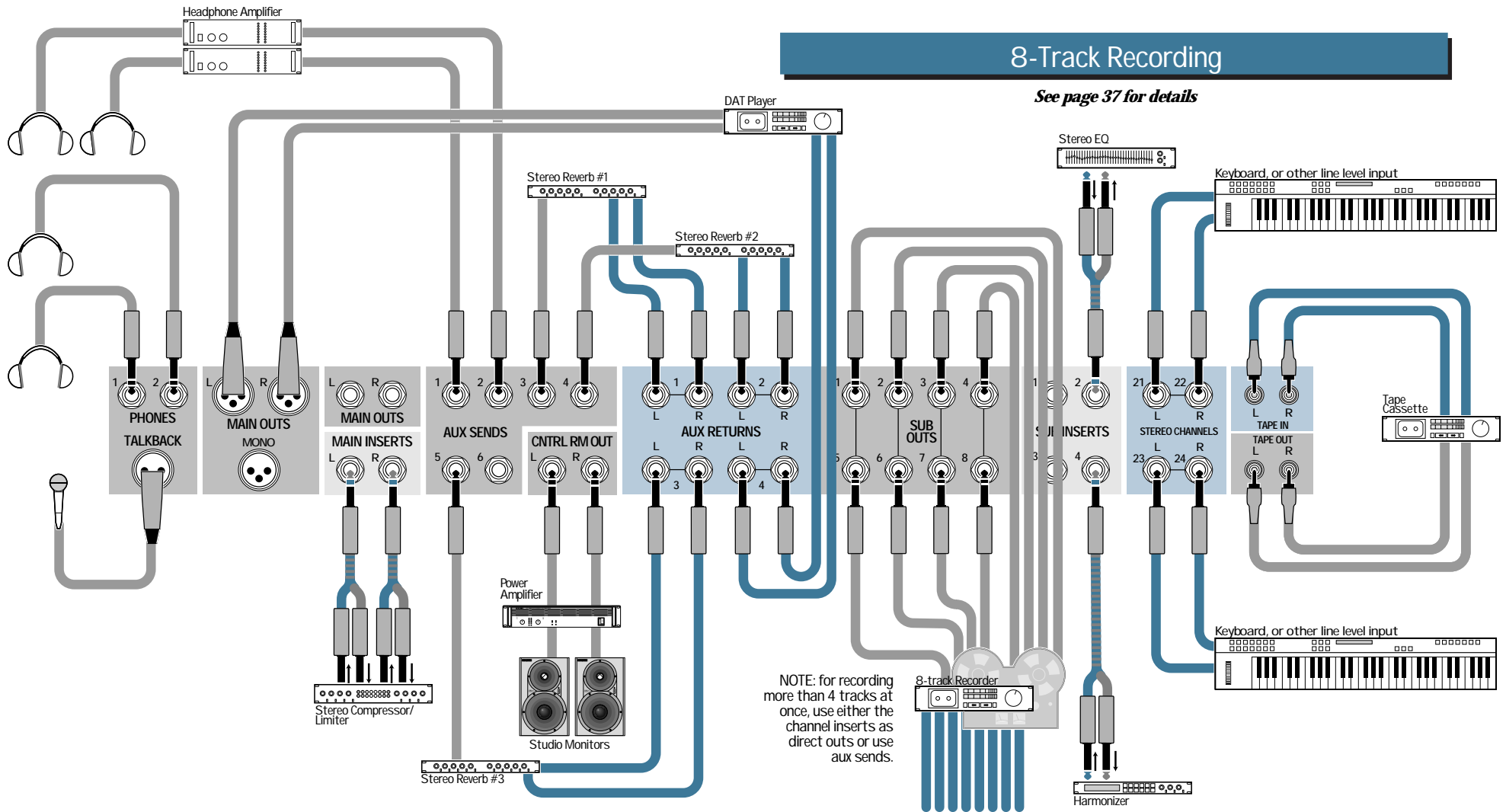

NOTE: for recording more than 4 tracks at once, use either the channel inserts as direct outs or use aux sends.

6

ch.	device	input	insert	assignment	ch.	device	input	insert	assignment	ch.	device	input	insert	assignment
1	kick	mic	gate	submix 1-2	8	bass	mic	EQ	submix 4	15	digital multitrack 3	line		L/R bus
2	snare	mic	gate	submix 1-2	9	bass direct	line	compressor	submix 4	16	digital multitrack 4	line		L/R bus
3	hi hat	mic		submix 1-2	10	guitar close mic	mic	gate	aux 6 or dir.	17	digital multitrack 5	line		L/R bus
4	hi tom	mic	gate	submix 1-2	11	guitar distant mic	mic	gate	L/R bus	18	digital multitrack 6	line		L/R bus
5	lo tom	mic	gate	submix 1-2	12	scratch vocal	mic		L/R bus	19	digital multitrack 7	line		L/R bus
6	drum overhead mic L	mic		submix 3	13	digital multitrack 1	line		L/R bus	20	digital multitrack 8	line		L/R bus
7	drum overhead mic R	mic		submix 3	14	digital multitrack 2	line		L/R bus	21-22	MIDI keyboard 1 (stereo)	line		L/R bus
										23-24	MIDI keyboard 2 (stereo)	line		L/R bus

\* 29-30 on the SR32\*4 † 31-32 on the SR32\*4



# Monitor Mix Configuration

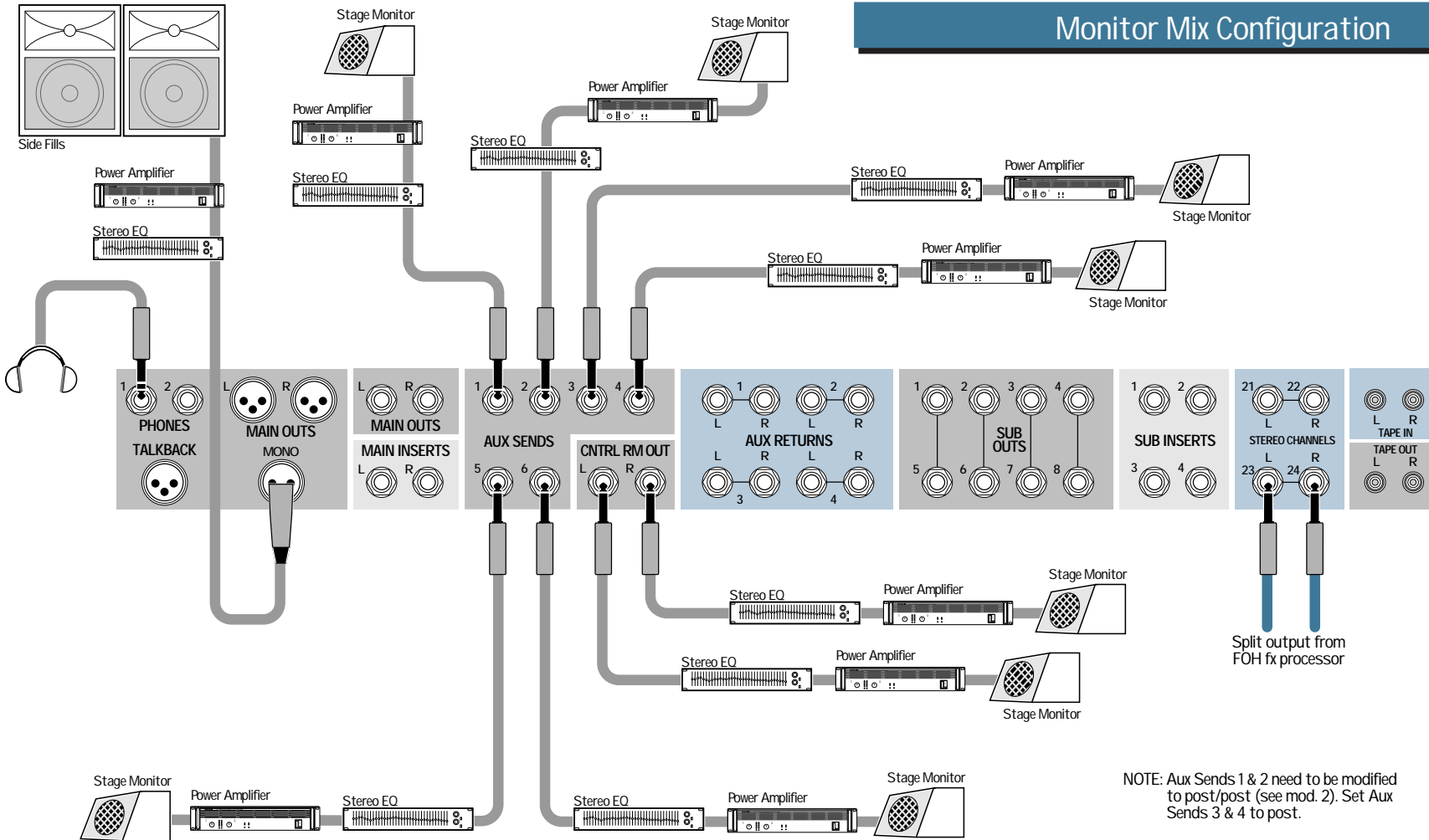

NOTE: Aux Sends 1 & 2 need to be modified to post/post (see mod. 2). Set Aux Sends 3 & 4 to post.

11

ch.	device	input	insert	assignment	ch.	device	input	insert	assignment	ch.	device	input	insert	assignment
1	talk back mic	mic			8	from splitter snake	line			15	from splitter snake	line		
2	from splitter snake	line			9	from splitter snake	line			16	from splitter snake	line		
3	from splitter snake	line			10	from splitter snake	line			17	from splitter snake	line		
4	from splitter snake	line			11	from splitter snake	line			18	from splitter snake	line		
5	from splitter snake	line			12	from splitter snake	line			19	from splitter snake	line		
6	from splitter snake	line			13	from splitter snake	line			20	from splitter snake	line		
7	from splitter snake	line			14	from splitter snake	line							

# SECTION 3: OFFICIAL GUIDED TOUR — PANEL LAYOUT & FUNCTION

## Layout and Function

Those of you with a lot of sound mixing experience can see that the Mackie SR24•4 (and 32•4, obviously) has a pretty straightforward layout, and you may not need to take the detailed Guided Tour which follows. However, we've built a few tricks into the SR24•4, and you might want to take particular notice of the solo mode switch, the various EQ curves and some of the special switching in the Monitor/Output Section. Check for the VERY IMPORTANT icons.

Everyone else, the tour leaves at the next paragraph in about 5 seconds. Shirts and shoes are recommended but not mandatory; cameras and recorders are allowed. Please, please do not feed the Chihuahua, no matter how much it begs.

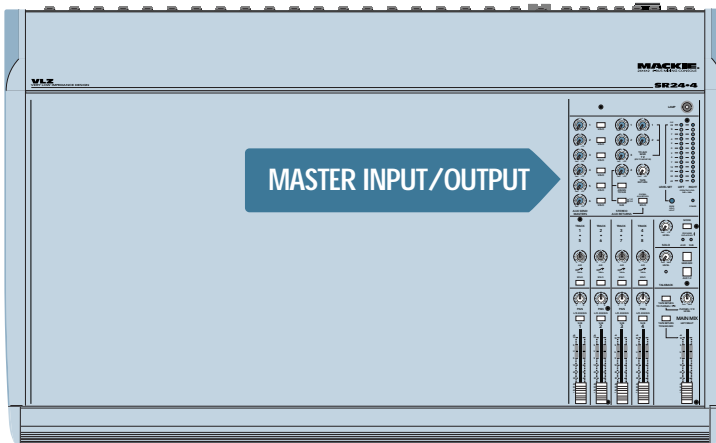
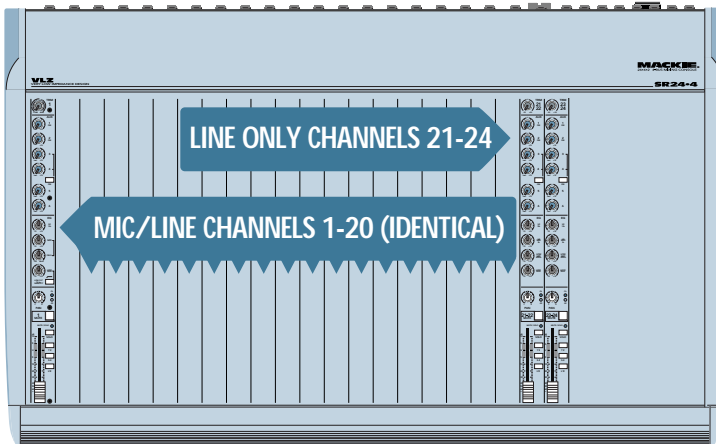

## FRONT PANEL

Most of the Mackie SR24•4 front panel consists of the 22 channel strips for the mixer inputs (30 on the 32•4). You'll notice that Channel Strips 1–20 (or 1–28) are identical (MOTTO: **Learn one and you learn them all**) and that the strips numbered 21–22 and 23–24 (or 29–30 and 31–32) are almost the same, but in stereo (MOTTO: **Learn one and you learn both**). You can already see this promises to be painless.

To the right of the channel strips is an area which we can call the Monitor/Output Section and be right most of the time. This is where you set and meter the overall volume level, make adjustments to solo, auxiliary and headphone levels and accomplish other miscellaneous essential tasks.

## CHANNEL STRIPS 1–20

The channel strip (also called the input channel or input module) is where most of the work of sound mixing is done. The first 20 channel strips on the Mackie SR24•4 (28 on the SR32•4) contain all of the level, assignment and equalization controls for each mono input channel. This section describes the controls and functions of each feature on a channel strip in detail.

**NOTE:** Remember, Stereo Channel Strips are slightly different from the rest. We'll look at the differences later in the tour.

## CHANNEL FADER

The SR24•4 channel fader [1] is 60 millimeters long, with a precise logarithmic taper and channel gain or attenuation markings screened along the slot for precise and repeatable level adjustments. The "log taper" part refers to the fact that gain increase and reduction are smooth along the fader's travel. It doesn't go silent at about –30dB the way cheaper D-taper faders do. When you fade



down, there's still sound until just before you reach the infinity (off) marking.

About 2/3 of the way up the slot you will see a "U" on the panel which stands for unity gain. The fader markings are calibrated in dB (decibels) from 10dB above unity gain to 60dB below unity gain, and finally to infinity (or off).

**VERY IMPORTANT:** Unity gain is the point at which no level is added to or subtracted from the nominal signal. Many level controls on a Mackie mixer have a unity gain "U" mark and a *detent*, a little "bump" in the otherwise silky-smooth travel of the control. The unity gain point can be very helpful in setting levels throughout the SR24•4 for best headroom and noise figures. See *Important Sensitivity Adjustment Procedure!* in the *Introduction* and *Setting Levels With Solo*



later in this section.

The channel fader is your main mixing tool, like the brush in an artist's hand. Everything which passes through the channel strip (with the exception of pre-aux sends) is controlled by the channel fader.

### THE MUTE SWITCH

Next up is the **MUTE** switch [2], which lives up to its name by muting its channel strip. When the **MUTE** switch is depressed, the signal in that channel strip is removed from the main left/right mix buses and the submix buses, the solo buses (both PFL and AFL) and from any aux buses selected.

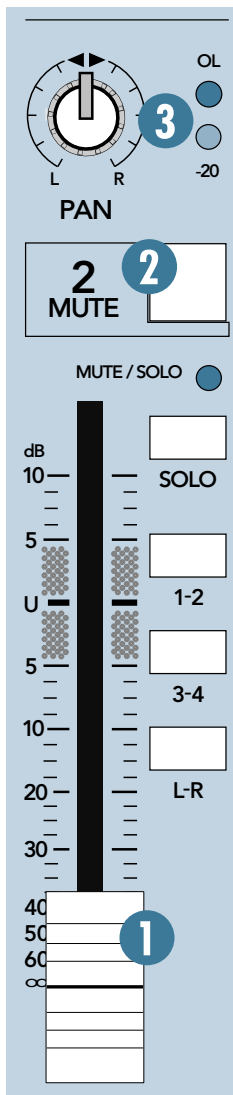

Even though the channel is muted, there can still be audio within the channel strip. The -20 LED might light and signal will still be available at the output of the **INSERT** jack.

The red **MUTE/SOLO LED** just below the **MUTE** switch will glow steadily when the **MUTE** switch is depressed.

### OL AND -20 LEDs

The red LED [3] above the **MUTE** switch is marked **OL**, and that stands for OverLoad. The channel strip overload circuit constantly checks at a critical point in the channel strip, just after the EQ circuit. If the channel strip amplifiers are being driven too loud into overload, the **OL** light will flash bright red.

This is to be avoided. Overloading a mixer circuit forces the audio signal to clip and seriously distort the sound. When the **OL** light flashes, it means something is too loud. It could be the level from the microphone or tape track plugged into the SR24•4 input connection or a device you plugged into the **INSERT** jack; maybe you have the **TRIM** control turned too high or an extreme amount of EQ (which lifts the gain in certain frequency ranges). You need to find out which source is too high and make things right. Start by turning down the **TRIM** control until the **OL** LED no longer lights. That will lower the level of all the circuitry that follows. Also, if you have a processor plugged into that channel's **INSERT** jack, temporarily unplug it. The level should remain about the same. If not, the processor's level needs to come down, too.

The green LED is marked **-20**, and it will light whenever there is a signal level in the channel strip that has a level at or more than 20dB below the nominal circuit level (0dBu). In practice, this LED will flicker or light almost constantly when there is activity in that channel, and it basically serves as a convenient indicator for you, a way of figuring out who's singing now or what's plugged into where. Whether it lights rarely or is on all the time is not really important; it's just to reassure you that there is some audio in the channel. Some days that may be all the reassurance you get.

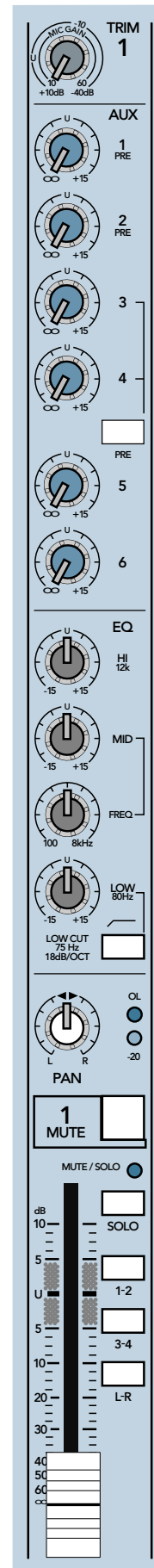

**NOTE:** There is a much more accurate way to measure your channel strip levels: see *Input Sensitivity Procedure: Setting Levels With Solo* a little further on.

### PAN

The **PAN** control [4] (or **PAN pot**, as the more timeworn among us are used to saying) determines where the channel strip signal ends up in the left-to-right stereo image (or soundstage) you are creating. It works in conjunction with the **SOLO**, **1-2**, **3-4** and **L-R** bus assignment switches next to the fader below.

When turned fully to the left (counterclockwise), the **PAN** pot routes the signal completely to the left or odd-numbered bus assigned: bus 1, bus 3 or the L (left) mix bus, depending on the assignment switch selection.

Likewise, when turned fully to the right (clockwise), the **PAN** pot routes the signal completely to the right or even-numbered bus assigned: bus 2, bus 4 or the R (right) mix bus.

When centered at the detent or in some other intermediate position, the **PAN** pot sends the signal to both of the selected pairs of buses, and the sound in the stereo image seems to come from a point between left and right.

The **PAN** pot also pans the signal across the **SIP** (Solo In-Place) solo buses in the same way.

**NOTE:** A signal panned hard left (or right), measuring 0dB at a left (or right) output, will

drop about 4.5dB when the **PAN** pot is turned to the center. That's the whole idea behind the concept of "constant loudness."

### MIX AND SUBMIX BUS ASSIGN

In conjunction with the **PAN** pot, the **bus assignment switches** [5] next to the fader route the signal out of the channel strip.

With no assignment switches depressed, it doesn't make any difference which way you have the signal panned. It doesn't go anywhere (unless you have some Aux sends turned up). Sometimes this is a good thing, if you are using the **INSERT** jack as a direct output and want to keep the signal out of the main mix, for example.

But most of the time, you will want the signal to go to either the Main Mix or one (or more) of the submix buses. For stereo, you will want to depress the assignment switch on the subgroups you want and then pan the signal to its rightful place on the soundstage.

You may want to operate the four submixes as four mono buses. In that case, use the assign switches with the **PAN** pot panned completely to the **L** or **R** mark. This will allow you to select submix buses 1, 2, 3 or 4 independently.

### SOLO

A solo function on a mixer allows you to listen to (and on a Mackie mixer, to observe on the meters) any input or combination of inputs without affecting the main or auxiliary outputs of the mixer. In other words, you can push a solo button to check something out just about any time without ruining your sound reinforcement or recording feed.

In the SR24•4, each **SOLO** switch [6] assigns its signal to two different types of solo circuits (PFL and SIP) at the same time. Using the solo **MODE** switch (which is in the Monitor/Output Section and which we'll talk about later) you can choose the one you'd like to listen to.

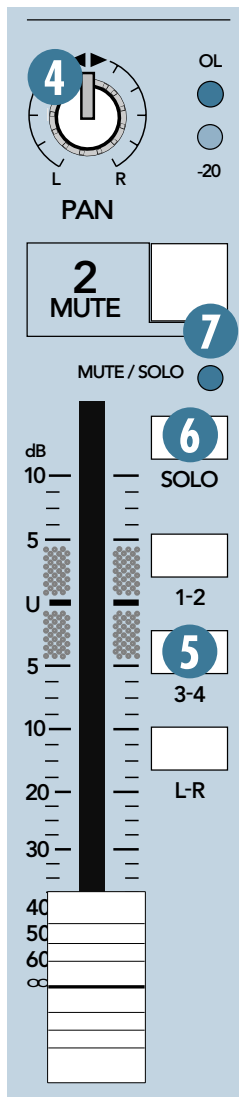

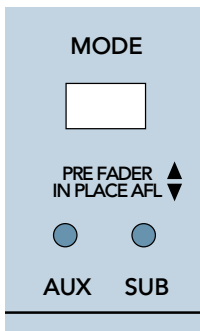

## PFL SOLO

(When the Solo **MODE** button in the Monitor/Output section is **up**.) PFL stands for pre-fade listen, also referred to as **PRE FADER** on the solo **MODE** switch in the Monitor/Output Section.

The channel strip **SOLO** switch routes the channel audio to the PFL solo bus from a point in the circuit after the EQ and **MUTE** switch but before the fader. PFL is handy for checking a signal at its full level, before it's affected by the fader and pan control.

Remember, pressing a **SOLO** switch does not affect any of the SR24•4 main or auxiliary outputs. It is safe to use at any time.

## SOLO IN PLACE (SIP)

(When the Solo **MODE** button in the Monitor/Output section is pressed **in**.) Solo-in-place signals are taken at the channel's output; after the EQ, Mute switch, fader and pan pot. Some mixers call this AFL (After-Fade-Listen) which is why we added that to the graphics.

In addition to the routing for PFL mentioned above, the **SOLO** switch on each SR24•4 channel strip also assigns the signal in that channel to the stereo solo-in-place buses. This solo signal is tapped off after the pan control, the channel fader and the EQ circuits, and will be affected by all these settings.

Once again, pressing a **SOLO** switch does not affect any of the SR24•4 main or auxiliary outputs. It is safe to use at any time.

## MUTE/SOLO LED

When a **SOLO** switch is pressed, the channel **MUTE/SOLO LED** [7] will blink to indicate the channel's solo status. So, steady on **MUTE/SOLO LED** means mute; blinking **MUTE/SOLO LED** means solo. OK? As an additional clue, soloing a channel will also start the **RUDE SOLO LIGHT** in the Monitor/Output Section to blinking madly. More explicit details about the **RUDE SOLO LIGHT** later.

**NOTE:** The channel's MUTE switch must be in the **up** position for the **SOLO** switch to function.

## SETTING LEVELS WITH SOLO

Each **SOLO** switch also triggers circuitry which disconnects the meters and the control room and phones outputs from their normal duties and reconnects them all to the output of the solo buses. Not only can you listen to the soloed tracks but you can measure them precisely on the 13-segment main meters.

In fact, **this is the recommended way to adjust input levels**. As you are initially setting up an input, put the SR24•4 into PFL mode and push the **SOLO** button. Now set the input level to the range you want (probably by tweaking TRIM, since your other controls should start out around unity gain) simply by checking out the main meters.

And, of course, depressing any **SOLO** switch anywhere on the mixer will set in motion a complicated chain of events deep in the unfathomable silicon heart of the SR24•4 involving multivibrators and algorithms and Mandelbrot sets and who knows what else — culminating in the grave and solemn pulsing illumination of... the **RUDE SOLO LIGHT**.

**NOTE:** Also see *Important Sensitivity Adjustment Procedure!* repeated several times in this manual.

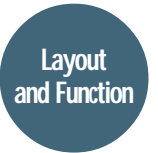

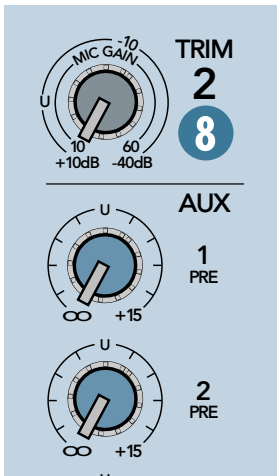

**TRIM CONTROL**

The white knob at the top of the channel strip is the **TRIM** control [8]. **TRIM** sets the gain (volume level) of the SR24•4 input amplifier, and is labeled with gain sensitivity markings for both **LINE** (the outer circle) and **MIC**

inputs (the inner circle marked **MIC GAIN**). Proper setting of the **TRIM** control is essential for good noise and headroom performance.

Since you might be using your SR24•4 to mix dynamic or condenser microphones, electronic keyboards or even guitar amplifier heads, the signals connected to the channel inputs could vary from extremely small to very large. With the **TRIM** level adjusted correctly, the Mackie input amplifier can accept a wide range of input levels. See *Setting Levels With Solo* just above, and *Important Sensitivity Adjustment Procedure!* in the *Introduction*.

**EQ SECTION**

Channels 1–20 (1–28 on the SR32•4) each have a three-band EQ (Equalizer) plus a switchable **LOW CUT** filter.

When any **HI**, **MID** or **LOW** EQ knob is set at its Unity Gain “U” detent, it does not affect the signal.

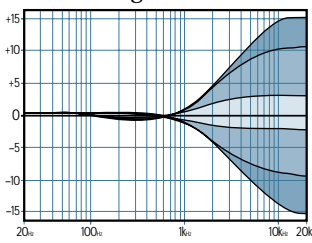

**HI EQ**

The **HI** section [9] is a fixed 12kHz shelving EQ with ±15dB of equalization

available. This is a great treble control, with the same range as the HI EQ in the Mackie 8•Bus console.

Shelving equalizers work on a very broad range of frequencies and consequently are very “musical.” In a 12kHz shelf like this section, that means that all the upper harmonics of a sound are raised evenly, basically keeping their original musical relationship to each other. A high-frequency shelving EQ is great for putting shimmer into acoustic guitar and piano tracks or sizzle into vocals and recordings of eggs frying.

**MID EQ**

The **MID** section [10] is a sweepable peaking/dipping EQ with a fixed bandwidth of 1.5 octaves (Q=0.9). The **FREQ** knob sweeps the EQ over a range from 100Hz to 8kHz, and the **MID** knob selects up to ±15dB of equalization.

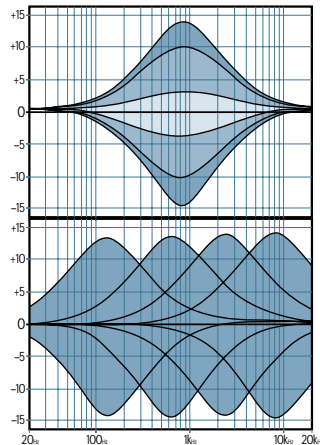

It’s true you can’t get along very well without high or low EQ, but mid-range EQ often seems to be the most powerful. Much of the essential character of a voice or instrument is determined by

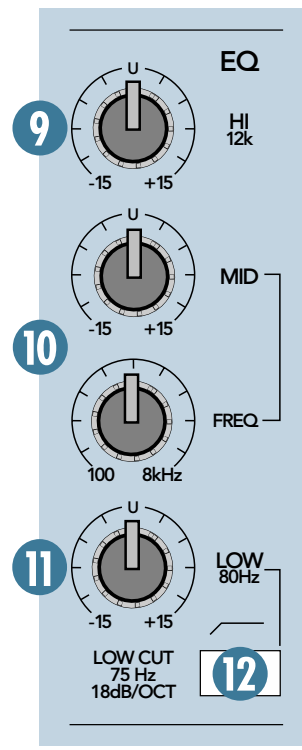

the blend of the frequencies in the midrange, where most of the fundamental frequencies and most of the stronger harmonics lie.

Be subtle with midrange EQ. A small boost or dip is often all you'll need; too much will completely change the sound. Of course, if what you want is to completely change the sound, go for it.

Since the **MID EQ** on the SR24•4 is variable across a range of frequencies, you must decide which area you would like to adjust. Here's an idea: set the peak or dip to maximum ( $\pm 15\text{dB}$ ) and sweep the frequency knob across its range. What you will hear may not be pleasant, but it will often show you what tones you hate (so dip them) or love (so boost them, but perhaps not this much).

Try combinations of EQ on different inputs. A small boost at the particular frequency on one instrument combined with a small dip in the same area on a second instrument can greatly help blend the mix (similar to volume adjustments).

### LOW EQ

The **LOW** section [11] is a fixed 80Hz shelving EQ with  $\pm 15\text{dB}$  of equalization available. It's a fine bass control, with the same range as the LO EQ in the Mackie 8•Bus console.

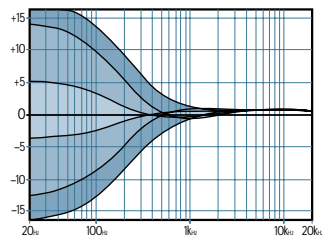

A low frequency shelving equalizer will add or remove bass in a smooth, musical fashion.

Good for working on bass drum and bass guitar, fattening up (or thinning out) a piano or contouring an entire mix.

### LO CUT

The **LO CUT** switch [12] inserts an 18dB/octave low-cut (high-pass) filter with a cut-off frequency of 75Hz into the signal path.

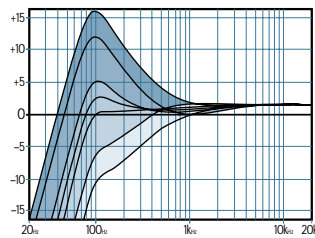

A low-cut filter is handy to get rid of room rumble, traffic noise, wind noise, P-popping and other un-

wanted very-low-frequency sounds. It also saves amplifier power, which might be useful if you don't have a 100,000-watt quint-amplified PA system. LO CUT can also be combined with LO EQ boosts to produce interesting bass curves, as shown above.

It is highly recommended that this switch be engaged for closely held vocal microphones, especially in a live SR situation. It will minimize the bassy "proximity effect" of many cardioid microphones, and also reduce handling noise and breath noise.

### AUX SENDS

The auxiliary (aux) sends tap off the channel signal to an aux send bus in order to route it to one or more auxiliary devices. Aux sends are generally used to provide mixes for stage monitors, headphone cueing duties, and for effects sends. Aux send settings do not directly affect the signal routed to the main and submix buses. (See Aux Returns.)

The SR24•4 has six mono AUX Send controls (routed to six Aux Send buses) on every channel strip.



**NOTE: All of the SR24•4 AUX sends have a very wide range of gain. The first half of the control's rotation reaches from the off position to unity gain ("U"). This first half of the control's range corresponds to the full range of most non-Mackie mixers.**

The second half of the control's rotation provides you with even more gain, from unity to +15dB. For example, when you want a sound very "wet" (mostly reverb), this extra gain allows you to bring the channel fader down (and the AUX send way up) so that the sound is composed of predominantly reverb with just a touch of "dry" signal.



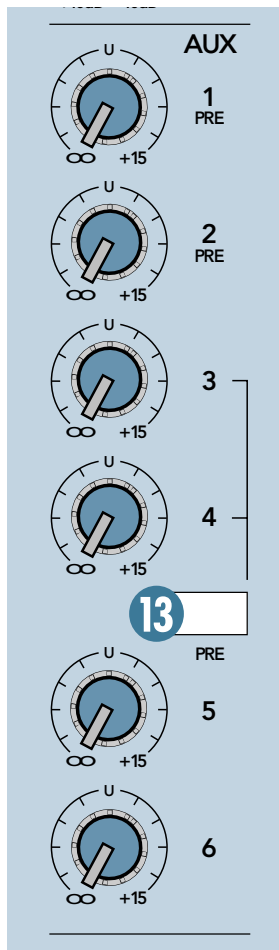

**AUX** sends 1 & 2 are both wired **pre**-fader, with the channel signal tapped off after the input amplifier, INSERT jack and MUTE switch but before the equalizer and fader.

Sends 5 & 6 are wired **post**-fader, with the signal coming from a point in the circuit just after the channel fader.

**AUX** sends 3 & 4 are normally **post**-fader (like Sends 5 & 6), but can be switched as a pair to **pre**-fader (like Sends 1 & 2) by depressing the **PRE** switch [13] in the **AUX** section of the channel strip.

Pre-fader sends are generally more useful as monitor or headphone sends, while post-fader sends are usually routed to reverb, echo and other effects devices.



Don't worry about having mono effects sends: most effects units, mono or stereo, have mono inputs. Even

if there are two input jacks on the effects unit labeled "LEFT" and "RIGHT," they are often combined into mono. In the cases when an effect actually has true stereo inputs it is often more convenient to ignore that and treat it as mono anyway. If you really need to send in stereo, just use two aux sends from the SR24•4. For example, use Aux 5 to send the stereo instrument's left channel to the effects unit's left input and Aux 6 for the right channel. Then adjust the stereo perspective by favoring one send or the other. Presto!

### STEREO CHANNEL STRIPS 21–22 and 23–24

You'll remember we promised to talk about the differences between channel strips 1–20 and channel strips 21–22 and 23–24. The primary difference is that while Strips 1–20 are mono (one input channel per strip), Strips 21–22 and 23–24 are stereo: they each have **two** input channels. Also, the stereo channel strips have **only line-level inputs**. (On the SR32•4, channel 1–28 are mono and 29–30 and 31–32 are stereo.)

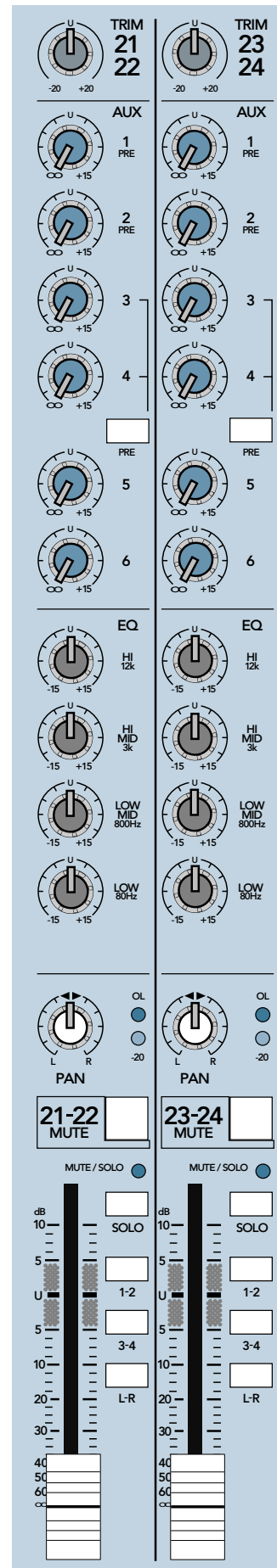



## STEREO TRIM, FADER, SOLO, AUX

All the controls on each of the stereo channel strips are stereo. The **TRIM** control is a dual-channel trim and the channel fader is dual-channel (stereo). The solo buses and each of the aux sends are wired to tap signal from both the right and left sides of the stereo channel audio.

### STEREO EQ SECTION

The EQ on Channels 21–24 is stereo, too, working its magic on both sides of the signal at the same time. (That's 29–32 on the SR32•4.)



*The design of the EQ is slightly different from the mono channel strips as well, with two separate fixed-frequency equalizers replacing the sweepable equalizer in the MID EQ range.*

#### HI EQ

The **HI EQ** section [14] is a 12kHz shelving equalizer, similar to the mono channel strip HI EQ section.

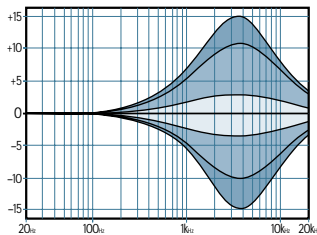

#### HI MID EQ

The **HI MID EQ** section [15] is a peaking/dipping equalizer with a fixed center frequency of 3kHz, a bandwidth of 1 octave ( $Q = 1.4$ ) and a range of  $\pm 15$ dB. A bit of added 3kHz will increase clarity or bite. If you have an input that sounds harsh or nasal, pull out a little at 3k and you can smooth the sound out.

#### LOW MID EQ

The **LOW MID EQ** section [16] is a peaking/dipping equalizer with a fixed center frequency of 800Hz and a range of  $\pm 15$ dB. Adding a little EQ at this frequency can put

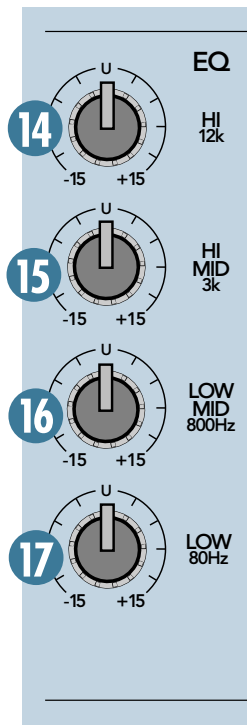
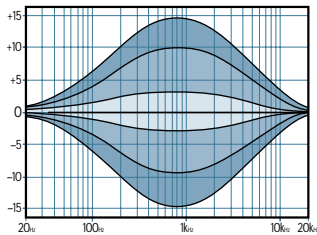

warmth and fullness into vocals and instruments. Cutting can really help some sounds by reducing boxy and boomy tones.

#### LOW EQ

The **LOW EQ** section [17] is an 80Hz shelving equalizer, exactly the same as the mono channel strip LOW EQ section.

#### LOW CUT (lack thereof)

There are no Low Cut filters in the stereo channel strips.

### STEREO PAN (BALANCE) CONTROL

In the stereo channel strips there is a **stereo PAN** control [18]. In effect, it functions as a balance control rather than a mono PAN pot. In a mono PAN pot, such as channels 1–20, a mono signal is actually sent to a dual level control. In the stereo channels of the SR24•4, the right signal is sent to the right part of the control and the left part of the signal to the left part of the control. With the stereo **PAN** set at the center detent, you'll get the same 4.5dB loss of level described earlier.

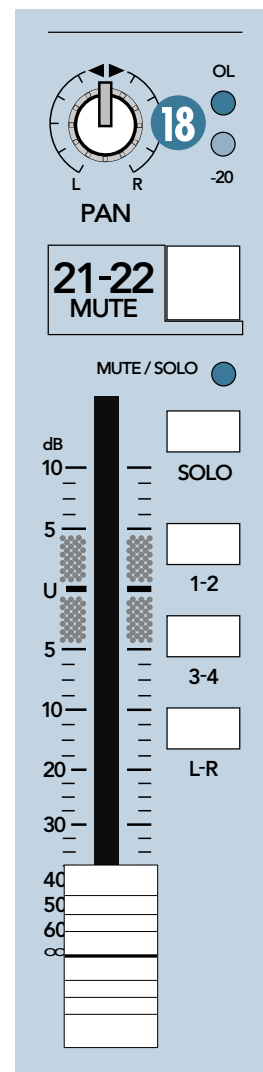

Layout and Function

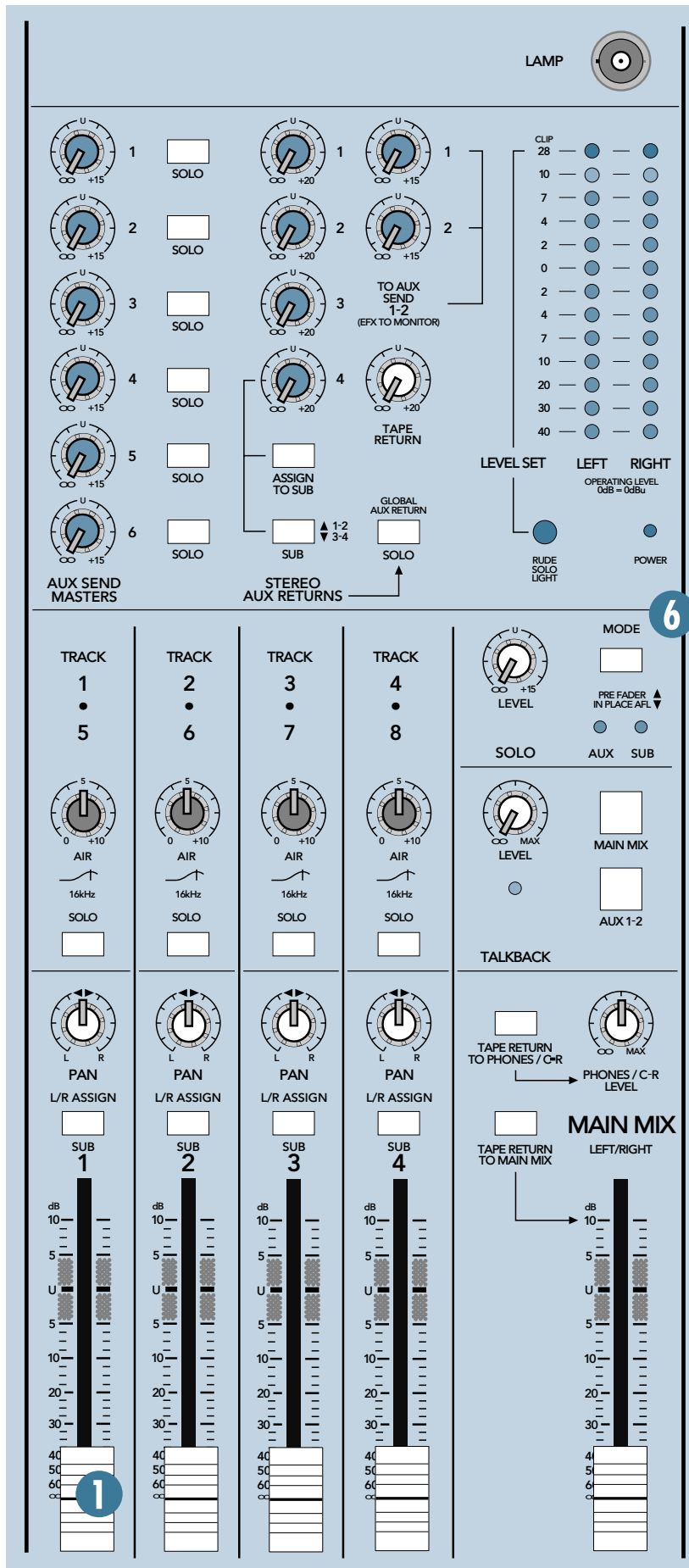

**NOTE:** It is possible to use a stereo channel strip on the SR24•4 as a mono input.

(See *Stereo Input Connectors: Stereo Or Mono Patching* in the *Rear Panel* section coming up next.) When there is a mono signal applied equally to both of the stereo signal paths in this manner, the stereo PAN control acts just like a mono pan pot, automatically! Brings tears to one's eyes, it's so beautiful.

## OUTPUT SECTION

The Output section on the right side of the SR24•4 contains the bus output controls, including master controls for submix buses 1–4, the main left and right mix buses, and the six Aux Send Buses. Also included are **STEREO AUX RETURN** controls, **LEFT** and **RIGHT** meters, and **SOLO**, **TALKBACK** and **TAPE RETURN** controls.

### SUBS 1–4

#### SUB(mix) FADER

At the bottom of the output panel are the master faders for each of the four submix buses [1]. Each fader controls the level of its mix bus, with precise dB markings and a unity gain point screened on the panel. The fader is located in the circuit after the bus insert jack but before the final line amplifier.

## L/R ASSIGN

There is a **L/R ASSIGN** switch [2] above each bus fader. The submix bus audio signal is always routed to the SUB OUT jacks on the rear panel. Additionally, the **L/R ASSIGN** switch [2] on the SUB strip can assign the submix audio to the main Left/Right Buses. This allows you to submix several channel strips to one fader for easier control, and then re-assign that bus into your final mix.

## PAN

When the **L/R ASSIGN** switch is pressed, the **PAN** control [3] allows you to position the submix signal at any point in the L/R stereo field. As with all Mackie pan pots, there is a detent at the top of the control for center positioning.

## SOLO

The **SOLO** button [5] solos the submix in the same manner as the channel **SOLO**

switch. The **SUB SOLO LED** [6] (near the **SOLO** level control) flashes when this **SOLO** is used.

As in the channel strips, the **SUB SOLO** mode can be switched from PFL to Solo-in-Place (SIP) via the solo **MODE** switch. There's a catch, though: in SIP mode, submixes cannot be soloed until you depress the **L/R ASSIGN** switch.

## AIR



Here's a nifty new Mackie feature. As usual Greg couldn't stand to leave too much blank space on the front panel.

First he held a contest among the Mackie engineering staff to decide what to fill it with. Entries ranged from a combination ash tray/nut dish to a tiny crystal pyramid (to keep razor blades sharp). After rehabilitating his engineering staff, Greg added a feature he's wanted to

put on a console ever since his TAPCO days: **Factory Air**.

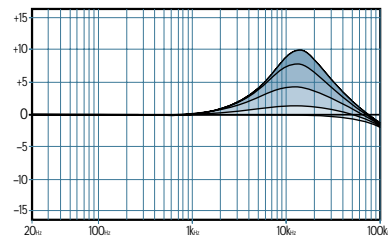
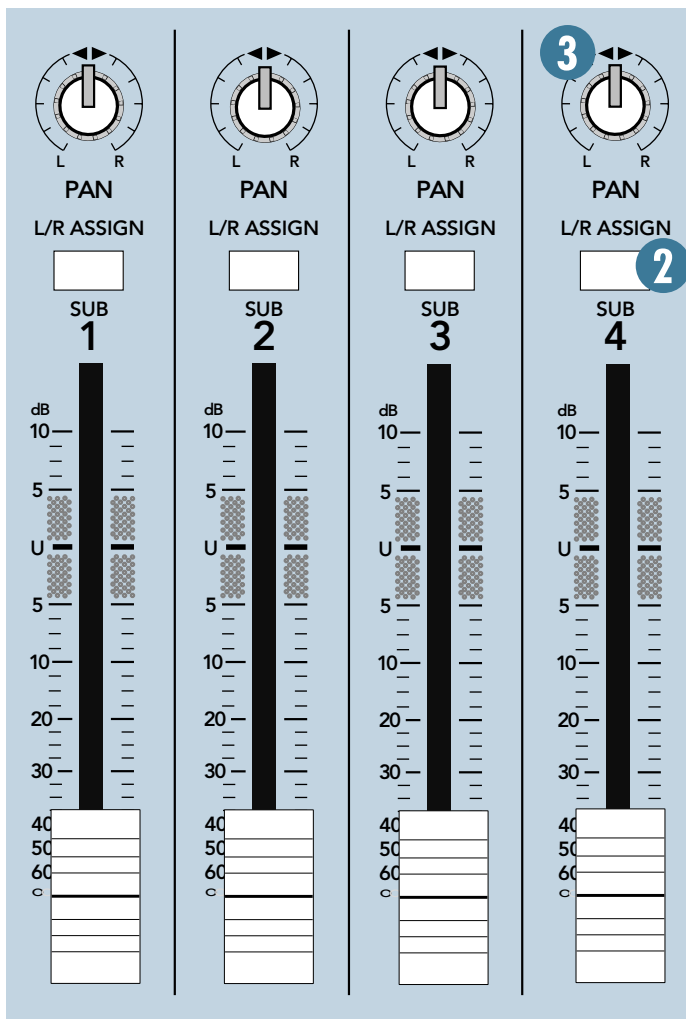
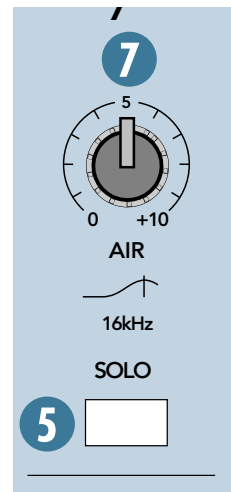

The **AIR** control [7] is a special form of EQ set into the submix masters, a smooth, broad hill of shiny hyper-treble centered at 16kHz, with gossamer skirts extending as low as 12kHz and wafting as high as 20kHz. When **AIR** is set at 0, it is effectively **out** of the signal path and the submix bus has a flat response. But when you need a little more "air" in your sound, just a hint of high treble to add that atmospheric breathiness to your vocalists or that brand-new-string jangle to your guitar, give the **AIR** knob a twist. We think you'll like it.

## MASTER LEFT/RIGHT FADER

The **MAIN MIX LEFT/RIGHT** fader [8] is a stereo fader located at the far right of the console. The fader controls the level of the main L/R mix bus, with precise dB markings and a unity gain point marked on the panel. This fader, like the bus faders, is located in the circuit after the bus insert jack but before the final line amplifier.

## PHONES/C-R LEVEL

For SR (sound reinforcement) work, the SR24•4 has dual stereo headphone jacks on the rear panel to enable the sound engineer to monitor the mix; for recording use there are

jacks to feed a stereo control room monitor amplifier. Both of these sets of outputs carry the main Left/Right mix, the output of the solo buses or the tape return signal, depending on switch positions.

The signal level sent to these outputs is adjusted by the **PHONES/C-R LEVEL** control [9], the small white knob just above the **MAIN MIX** fader.

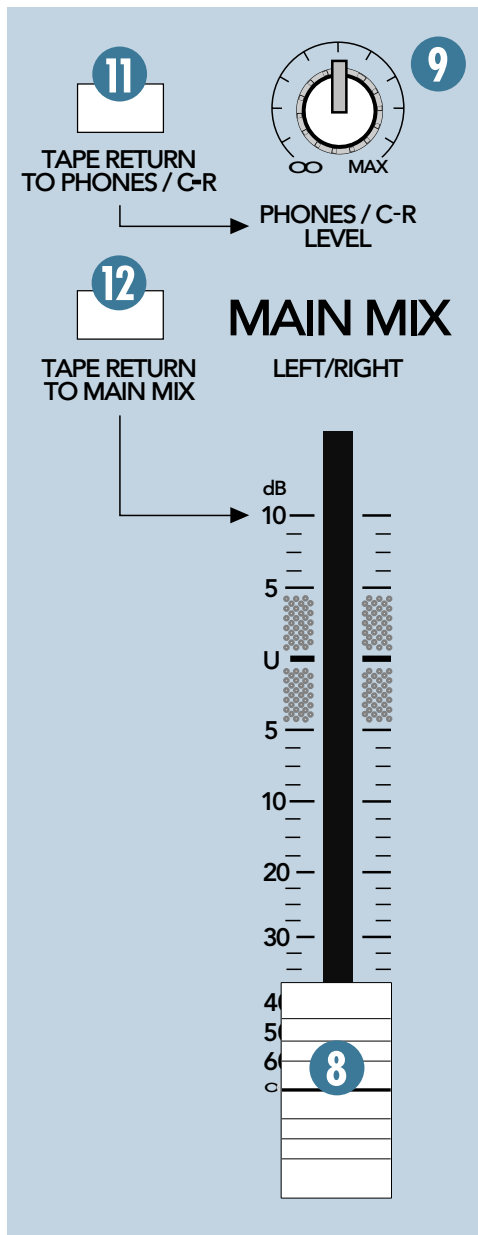

## TAPE RETURN

The SR24•4 provides easy monitoring of your stereo tape recorder, whether you are using it in a studio mixing situation, you're recording a live gig while you do the SR mix, or if you just want to play a little music through the system between sets.

The **TAPE RETURN** knob [10] just to the left of the meters adjusts the level of the tape playback.

The **TAPE RETURN TO PHONES/C-R** [11] button next to the **PHONES/C-R LEVEL** routes the tape playback

signal into the monitor system and meters. This allows you to listen to the playback signal off tape and to check the playback levels on the SR24•4 meters, even while you are recording.

The **TAPE RETURN TO MAIN MIX** switch [12] next to the **MAIN MIX** fader actually routes the tape playback signal into the main Left/Right mix circuits, before the bus insert jacks and the master fader.



**VERY IMPORTANT! This switch also disconnects everything else coming up the L/R buses from the master fader and outputs.**

**So, when you push TAPE RETURN TO MAIN MIX you get only the tape playback out the main L/R buses.**

This feature is designed as a quick and easy way to play a tape on the main speakers in a live SR application.

**ALSO VERY IMPORTANT! If your recorder allows monitoring of its input, assigning the tape return to master could cause a VERY nasty feedback loop.** Be sure that your tape machine is not in **Record**, **Record-Ready** or **Input** mode.

**Handy Trick:** If you have nothing plugged into the **TAPE IN** jacks, or have the **TAPE RETURN TO** control fully down, you can use the **TAPE RETURN TO MAIN MIX** as an oddly-named **MAIN MIX MUTE** switch!

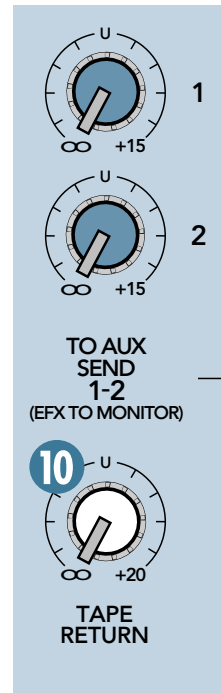

## AUX SEND MASTERS

The six auxiliary buses each have a master level control on this panel [13]. Like any level control, turning the knob turns the volume up or down. However, the gain of the aux sends is optimal at the unity setting and should not normally need adjustment beyond the “U” mark.

The output of each bus is available at its **AUX SEND** jack on the rear panel.

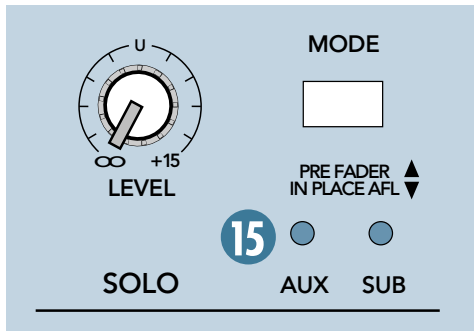

The **SOLO** button [14] next to each level control solos that send and allows you to check the send level in the main meters. The aux sends are each mono signals, and they are soloed in mono. **SOLO** is non-destructive — it doesn't harm your main outputs or laundry.

Soloing any of the Aux sends causes the **AUX** solo LED [15] (located near the **SOLO LEVEL** control) to flash.

## STEREO AUX RETURNS

The stereo aux returns provide four additional stereo and/or mono inputs to the SR24•4 for return from effects processors and line-level signal sources. The returns have switches to allow easy assignment to headphones. When any return is soloed, the **AUX** solo LED in the solo mode area lights.

For extra flexibility, the aux returns have been designed with an extremely wide range of available gain, offering as much as 20dB boost over unity.

The return jacks are wired to provide both stereo and mono operation. See *Stereo Aux Returns: Stereo Or Mono Patching* under *Rear Panel* later in this section for the details.

## STEREO AUX RETURNS 1, 2

Aux Returns 1 & 2 [16 & 17] are special. Not only do they feed into the Main Mix (via the corresponding **LEVEL** control), but each return has one additional control, too.



**TO AUX SEND 1-2 (EFX TO MONITOR) Controls**

*These you-said-a-mouthful controls [18 & 19] feed the correspondingly numbered Aux Sends. They work independently of the Aux Return's own level control. TO AUX SEND 1-2 are valuable tools in SR applications. They allow you to send return signals (such as delay and reverb) to the stage monitors* (some jaded sound

Layout and Function

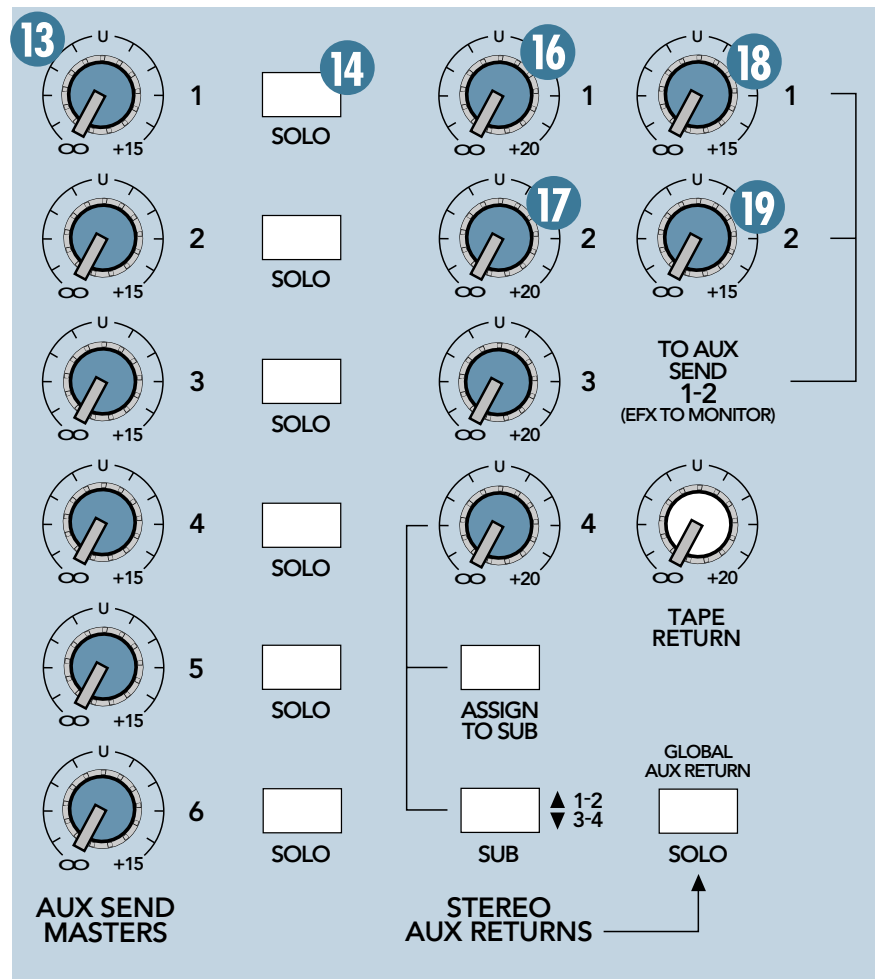

Layout and Function

persons refer to this as a “talent enhancer”) See the **Band in a Club** application in section 4 for more details.

**STEREO AUX RETURN 3**

This one’s easy. It has a **LEVEL** control [20] to set the amount of return signal to the main mix.

**RETURN 4**

Stereo Aux Return 4 has a stereo **LEVEL** control [21] and **ASSIGN TO SUB** [22] and [23] **SUB** switches to re-route the return signals. When the **ASSIGN TO SUB** button is up, Aux Return 4 is assigned to the L/R Mix Buses. When **ASSIGN TO SUB** is pushed down, Return 4 is routed to Submix Buses 1 & 2 or Submix Buses 3 & 4, depending on the position of the **SUB** switch. The left channel of the return is always routed to the odd-numbered bus, and the right channel to the even-numbered bus.

**GLOBAL AUX RETURN SOLO**

The Stereo Aux Returns have one solo switch which globally solos all four returns. First, this is useful to check the returns. But there’s still more. When you are soloing an input track and you want to hear the reverb applied to that track as well, simply push the **GLOBAL AUX RETURN SOLO** [24] switch to add all the effects returns to your solo mix.

**SOLO MASTER SECTION**

**LEVEL**

The solo **LEVEL** control is the master for the solo buses, and it sets the volume for the solo signals routed to the phones/control room monitor section. When the **LEVEL** control is set to the unity gain detent, the solo level you hear will match the level of the soloed signals to the same signals unsoloed. Solo **LEVEL** does not affect the meter levels observed while in solo.

**NOTE:** You should use the **LEFT** and **RIGHT** meters as a trustworthy guide to input level-setting in solo no matter how loud you are monitoring.

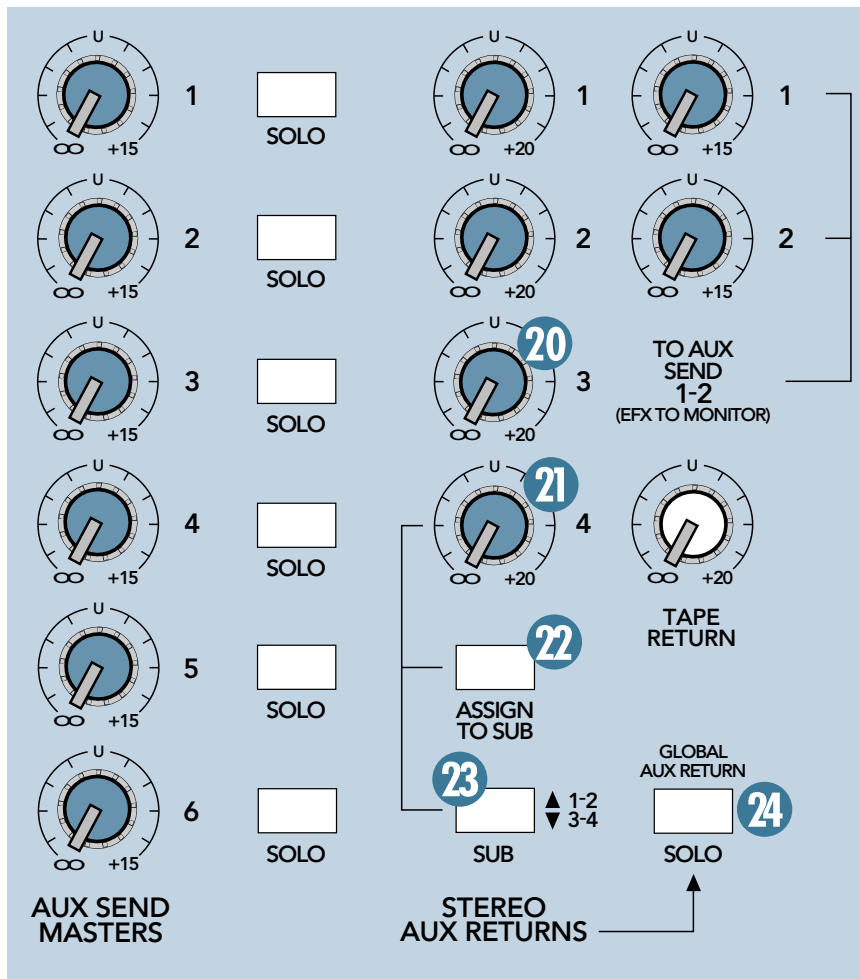



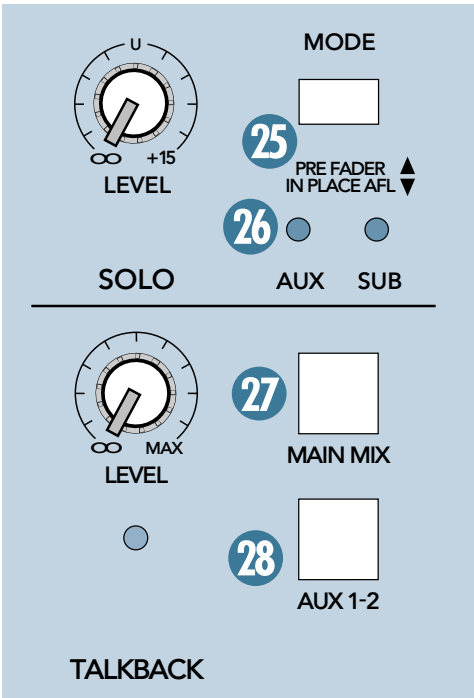

**MODE**

The solo **MODE** switch [25] selects one of two master solo modes, labeled **PREFADER** and **IN PLACE AFL**.

In **PREFADER** mode (**MODE** switch *up*), any input channel strip or submix bus soloed will have the solo signal tapped off *before* the channel or submix fader. This is a *mono* solo mode, and all soloed signals will appear as monaural, centered on both monitor channels. This mode is also referred to as Pre-Fade-Listen or PFL mode.

In **IN PLACE AFL** mode (**MODE** switch *down*), the signal from any circuit soloed will be tapped off *after* the circuit's fader or level control. This is a *stereo* solo mode, and all stereo soloed signals will appear as stereo, soloed in place between the left and right monitor channels. This mode is also referred to as After-Fade-Listen (AFL) or Solo-In-Place mode. See page 17 for a further reiteration on this feature.

**AUX and SUB LEDs**

There are two red indicator LEDs [26] in the master solo section. The **AUX** LED lights when any aux send or aux return is soloed. The **SUB** LED lights whenever one or more of the four submix buses are in solo.

**TALKBACK**

Using talkback, you can communicate with musicians or other personnel, and you can also record comments or slates on your recordings. First, plug a dynamic microphone into the **TALKBACK MIC** connector on the rear panel, hit the appropriate switch and speak into it when you have something to say. Engaging either switch will light the yellow LED in the TALKBACK area, so you don't accidentally leave it on.

The **MAIN MIX** talkback button [27] assigns the talkback signal to the main **LEFT** and **RIGHT** output buses. In an SR situation, this allows you to put your voice on the main house speakers. When you are recording, the **MAIN MIX** switch would be used to "slate" your recording by putting song titles and take numbers on the tape, for instance.

The **AUX 1-2** talkback button assigns the talkback signal to Aux Send buses 1 and 2. Since Aux 1 and 2 are usually used for stage monitor sends or headphone monitor sends, the **AUX 1-2** switch allows you to communicate with the performers privately. **NOTE:** Don't try to communicate with performers via **MAIN MIX** talkback and your main house speaker system. Always use the **AUX 1-2** talkback to communicate with band members through their monitors.



**METERS**

The **LEFT** and **RIGHT** LED meter ladders serve triple purposes on the SR24•4. In normal operation, the meters indicate the signal level at the output of the main left and right buses. However, when any solo button is depressed, the meters are removed from the left and right buses and are connected to the output of the solo buses. This is an easy way to

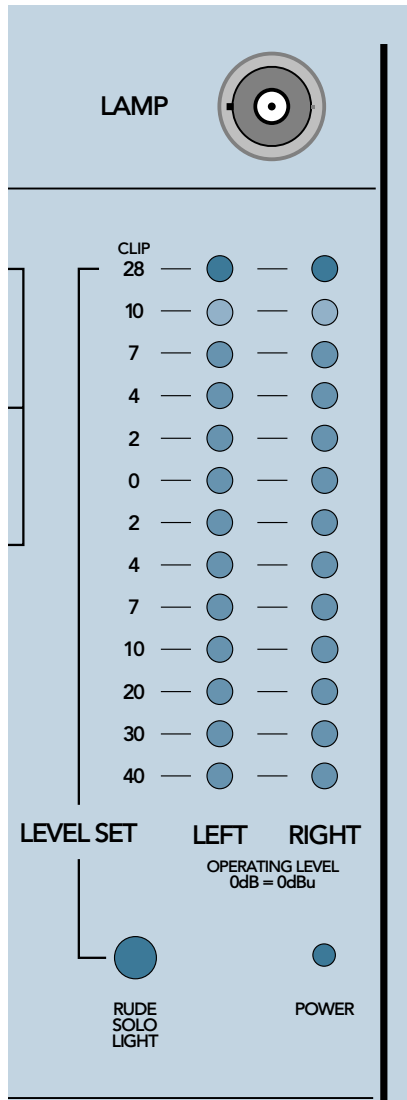

check input, aux send, aux return and submix levels. Also, if you have engaged the **TAPE TO PHONES/C-R** switch, the meters will show the tape levels. Whatever you hear in the monitor speakers or headphones when you solo you will also see on the meters (the meters are also affected by the solo **MODE** switch.)

In fact, using SOLO is the recommended way to set level. See the section titled *Important Sensivity Adjustment Procedure!* We feel strongly about it.

Each meter has 13 LED segments displaying levels from -40dB through +28dB. The +10dB segment is yellow and the +28dB segments are red to give you a clear notice when the audio levels are high. The meters are calibrated so that a 0dB meter reading indicates a 0dBu signal level at the main output jacks.

### POWER INDICATOR

The small green LED under the meters is the **POWER** indicator, and glows whenever the **POWER** switch on the rear panel is switched on and the SR24•4 is receiving proper mains power voltage.

### RUDE SOLO LIGHT

The **RUDE SOLO LIGHT** is the large red LED under the meters. The **RUDE SOLO LIGHT** is the closest thing to a tradition that we have here at Mackie. It's kind of a small and stupid tradition, we admit, but we're a young company and you have to start somewhere. And it does get its point across: if anything on the entire SR24•4 is in solo, the **RSL** will certainly let you know.

The **RUDE SOLO LIGHT** blinks and flashes so brilliantly it will cast a shadow of your head across the room. It elbows in on your

thoughts and sleepy daydreams and jerks you back from the edge of unconsciousness screaming **"SOLO! SOLO! YOU'RE IN SOLO, YOU FOOL! THAT'S WHY YOU CAN'T HEAR ANYTHING!"**

Most of us need that kind of help every now and then. If you don't, and the peace and grace of your own Magic Mixing Moments are disturbed by the **RSL**, you can order a Mackie **RUDE SOLO LIGHT-OBSCURING OCCULTANT/ ATTENUATOR KIT** — hand-woven from Pygmy African Hedgehog underhair — and tape it right over that bright, blinking sucker.

A note about all this flashing. As the **RSL** flashes, the channel(s) that you soloed will also flash. If the channel(s) is muted, the **SOLO** function will not operate — but the channel **MUTE/SOLO** LED will pulsate to let you know that something is goofy.



### LAMP CONNECTOR

There was quite a bit of discussion in our Mackie Engineering Meetings as to whether or not we should place the **LAMP** connector where it is. One group of engineers felt some users would think it was another **TRIM** knob; another faction feared it would be mistaken for an extra **AUX ZEN MASTER**. But we realized that we have very intelligent customers and that no one would mistake the **LAMP** connector for a knob after they had tried to turn it a few times. The pokey little bayonets on the sides would give it away.

The **LAMP** connector is a female BNC connector with 12 volts AC on the center pin. It is designed to mate with and power a small gooseneck mixer lamp. Mackie doesn't offer lamps, but most dealers do. We recommend the Littlite #12G or #12G-HI (a high-intensity version).

(This connector is not found on the SR32•4.)

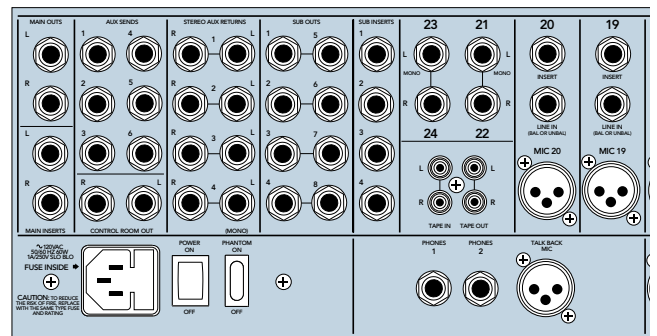

## REAR PANEL

All the audio and power connectors for the SR24•4 are mounted on the rear panel, along with the **POWER** and **PHANTOM** switches.

### INPUT CONNECTORS 1–20

Input channel strips 1–20 (1–28 on the SR32•4) are identical, and so are their input and output connections. Each of these channels has a microphone input connector, a line input jack and a channel insert jack.

### MIC INPUTS

The microphone input to each channel strip is made through a standard 3-pin female MIC connector (sometimes called an XLR or a Cannon connector), which is the largest of the three connectors for each channel strip [1]. This is a balanced input which will accept levels from –60dBu to +14dBu, depending on the TRIM control setting. Input clipping is at a level of 14dB. This input is *not* for line-level devices.

Phantom power for powering condenser microphones is available on every microphone input. The global **PHANTOM** switch near

the power cord connector turns phantom power on or off for all 20 mic inputs. See Appendix D for more info.

Pin 1 is connected to ground, pin 2 is signal “hot” (or “high” or “+”), and pin 3 is signal “cold” (or “low” or “–”). See Figure A.

### LINE INPUTS

The **LINE IN** connection [2] for each channel strip is located just above the MIC connector, and is made through a 1/4" TRS (tip-ring-sleeve) phone jack. This is a balanced line input which will accept input levels from –40dBu to +22dBu, depending on the TRIM control setting. Input clipping is at a level of 22dB. As with all of our balanced inputs, the SR24•4's line inputs are just as happy receiving an unbalanced signal (tip-sleeve, guitar-type plug).

The sleeve of the jack is connected to ground, the tip is signal “hot” (or “high” or “+”), and the ring is signal “cold” (or “low” or “–”). See Figure B.

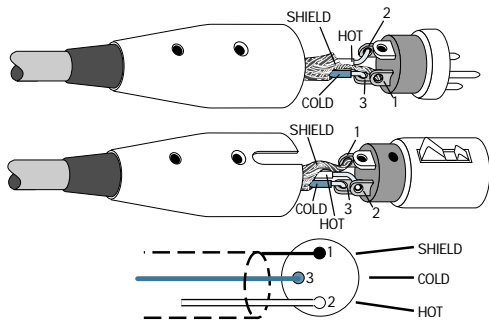
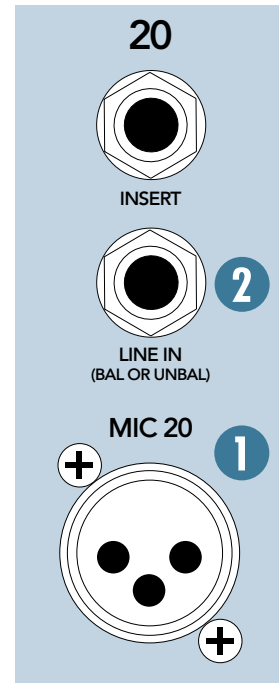

Figure A: Balanced XLR Connectors

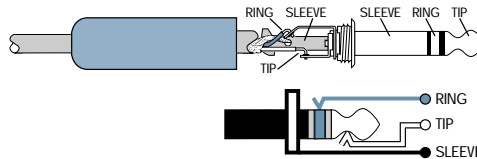
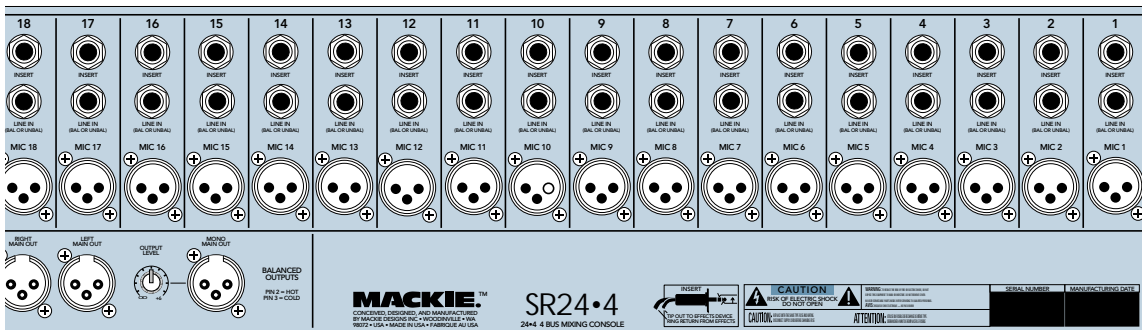
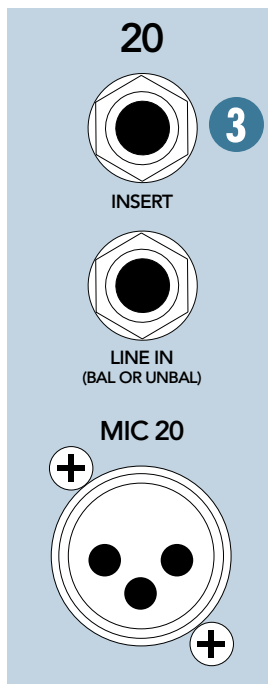

Figure B: Tip-Ring-Sleeve (TRS) Stereo Connector





## CHANNEL INSERTS

Above each **LINE IN** jack is the channel **INSERT** [3] jack. This patch point allows you to insert a compressor, equalizer or any other serial processing device into any of the SR24•4 input channel strips. The insert point is after the microphone/line preamplifier, but before the **MUTE** switch and EQ.

The inserts for each channel strip are made through a 1/4" TRS (tip-ring-sleeve) phone jack (Figure B). The inserts offer both an unbalanced channel send and a return on the same jack. The nominal insert send and return level is 0dBu, and the insert return clipping point is +22dBu.

The sleeve of the jack is connected to ground. The tip is the insert send signal; the ring is the insert return signal.



**NOTE:** These inserts can be used as pre-fader direct outputs, using an unbalanced 1/4" (TS) mono phone

plug (Figure C) in one of two ways shown in Figure D below:

Insert the plug just to the **FIRST "click."** Do not push the plug all the way in. This connection allows you to tap a direct out without interrupting the channel strip signal; or

**Figure D:** Insert options with TS & TRS connectors

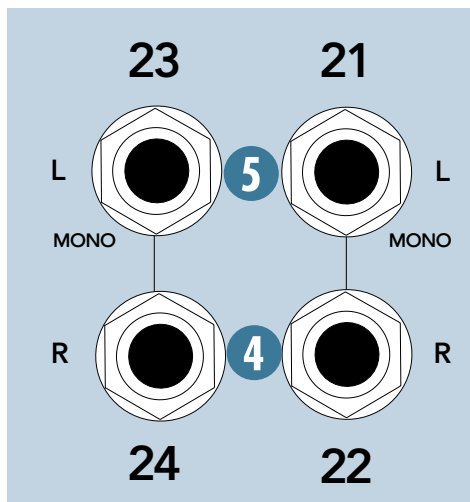
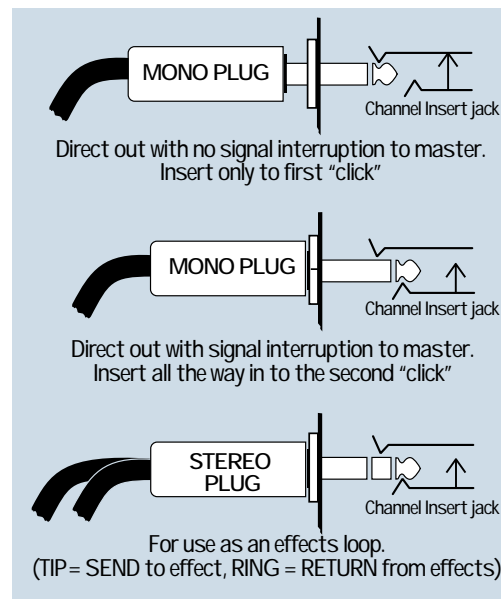

**Insert the plug all the way in to the SECOND click (as far as it will go). This also provides a direct out connection, but the channel strip signal is interrupted at that point.**

**There is no third click. We're working on it.**

## STEREO INPUT CONNECTORS 21–22 and 23–24

Stereo input channel strips 21–22 and 23–24 (29–30 and 31–32 on the SR32•4) are identical, and so are their input and output connections. Each of these channels has a left and right line input jack [4].

The line inputs to each stereo channel strip are made through a pair of 1/4" TRS (tip-ring-sleeve) phone jacks. These are balanced line inputs which will accept input levels from -20dBu to +20dBu, depending on the channel's **TRIM** control setting. Input clipping is at a level of 22dB.

The sleeve of each jack is connected to ground, the tip is signal "hot" (or "high" or "+"), and the ring is signal "cold" (or "low" or "-").

**NOTE:** There are no microphone inputs or channel inserts for the stereo channel strips.

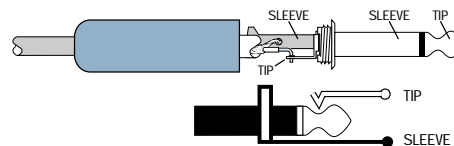

**Figure C:** Tip-Sleeve (TS) Mono Connector

### STEREO OR MONO PATCHING

For stereo operation in channels 21–24, (29–32) just plug balanced 1/4" TRS (tip-ring-sleeve) or unbalanced 1/4" TS (tip-sleeve) left and right phone plugs into the left and right jacks. If you only have a mono source, insert that plug into the “L (MONO)” input jack [5]. With no plug in the “R” jack, an internal jack switch will automatically route the signal (normalled) in the “L” jack to both the left and right circuits of the channel strip for mono operation.

### SUB OUTS

The four submix buses of the SR24•4 appear at the eight **SUB OUT** jacks [6]. Each submix bus is wired to two jacks: Bus 1 to jacks 1 and 5, Bus 2 to jacks 2 and 6, Bus 3 to jacks 3 and 7, and Bus 4 to jacks 4 and 8.

The **SUB OUT** jacks are impedance-balanced 1/4" TRS (tip-ring-sleeve) phone jacks, with tip wired to “hot” (or “high” or “+”), ring to “cold” (or “low” or “-”) and sleeve to ground. These jacks are also wired to accommodate unbalanced 1/4" TS connections. The nominal line level at the **SUB OUT** jacks is 0dBu.



**A CLOSER LOOK:** Why are there 8 submix output jacks on a 4 submix mixer? This is called “double-bussing.” When you send a signal to submix 1, for instance, it will appear at **SUB OUT 1** and

**SUB OUT 5.** The tracks on your multitrack recorder which are in **RECORD** mode will accept the signal, while the tracks in **SAFE** mode won't. That way, you can feed an 8-track recorder without having to constantly repatch your input cables.

### SUB INSERTS

To the right of the **SUB OUT** jacks are the submix **INSERT** jacks [7]. These patch points allow you to insert a processing device, such as a compressor or an equalizer, into any of the SR24•4 submix circuits. The insert point is after the AIR control but before the submix fader.

Just like the channel insert, each submix insert is made through a 1/4" TRS phone jack. The inserts offer both an unbalanced channel send or out, and an unbalanced channel return on the same jack. The nominal insert send and return level is 0dBu, and the insert return clipping point is +22dBu.

The sleeve of the jack is connected to ground and is also the common ground connection for both insert send and return signals. The tip is the insert send signal and the ring is the insert return signal.



**NOTE:** *These inserts can be used as pre-fader submix outputs, using an unbalanced 1/4" (TS) phone plug in one of these two ways:*

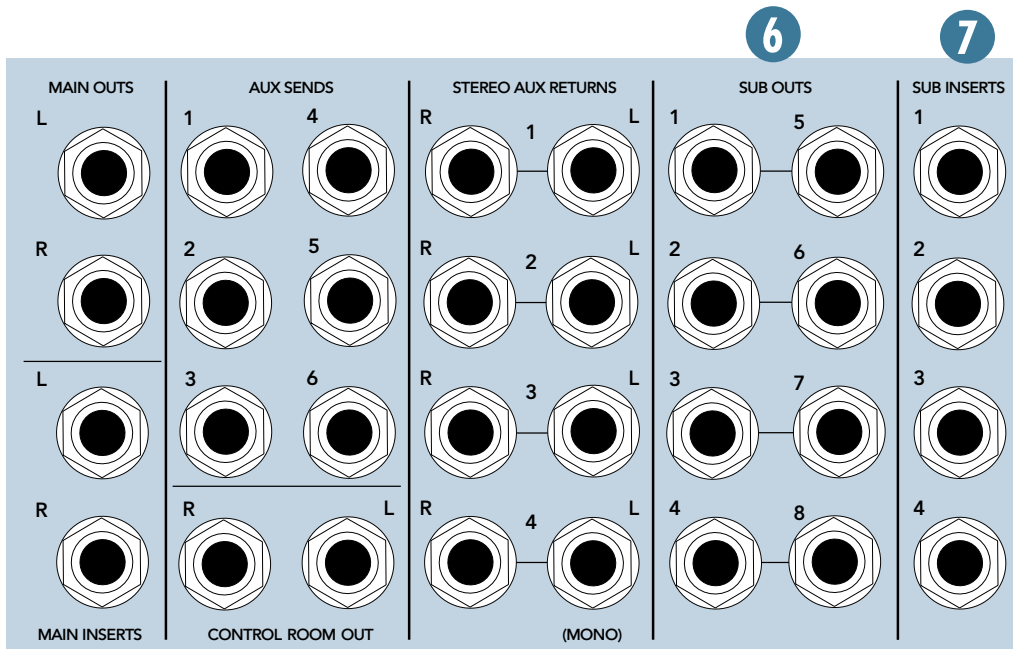





**Insert the plug just to the FIRST click. Do not push the plug all the way in. This connection allows you to tap a direct out without interrupting**

**the submix bus signal; or**

**Insert the plug all the way in to the SECOND click. This also provides a submix out connection, but the submix signal is interrupted at that point.**

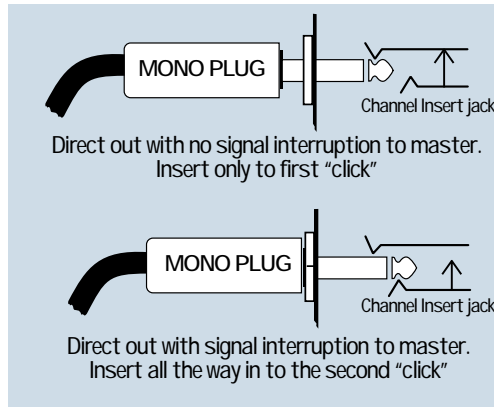

### MAIN MIX OUTPUTS

The main SR24•4 outputs appear at several places on the rear panel for your mixing pleasure. Near the middle of the panel you will find the **LEFT**, **RIGHT** and **MONO MAIN** outputs. To the left and up a little are **TAPE OUT L** and **R**, and up in the left corner are **MAIN OUTS L** and **R**. **All of these outputs are derived from the main left and right mix buses.**

### RIGHT & LEFT MAIN OUT

The stereo **MAIN OUTS** outputs [8] appear on the two connectors near the center of the mixer labeled, appropriately enough, **RIGHT MAIN OUT** and **LEFT MAIN OUT**. These are male XLR-type connectors, designed to mate with a standard mic cable.

The **RIGHT** main out and **LEFT** main out outputs are electronically balanced, with pin 1 connected to ground, pin 2 to signal “hot” (or “high” or “+”) and pin 3 to signal “cold” (or “low” or “-”). With the master fader at unity, nominal output level is +4dBu.

### MONO MAIN OUT

The **MONO MAIN OUT** output [9] is a sum of the left and right mix buses, buffered with its own electronically balanced output amplifiers. Like the right main mix and left main mix, the **MONO MAIN OUT** appears on a male XLR-type connector near the center of the rear panel. Pin 1 is ground, pin 2 is “hot” (or “high” or “+”) and pin 3 is “cold.”

There is an **OUTPUT LEVEL** control [10] to trim the level of the **MONO MAIN OUT** signal level. With the master fader at unity, nominal output level is +4dBu.

### MAIN OUTS L & R

The main mix outputs also appear at the **MAIN OUTS L** and **R** 1/4" TRS jacks near the upper left corner of the rear panel [11]. These jacks carry the same signals as the **RIGHT** main mix and **LEFT** main mix connectors.

**MAIN OUTS L** and **R** are impedance balanced 1/4" TRS (tip-ring-sleeve) phone jacks with ground wired to sleeve, signal “hot” (or “high” or “+”) to the tip and signal “cold” (or “low” or “-”) wired to the ring. You can connect either balanced or unbalanced inputs to these outputs. Nominal level is 0dBu.

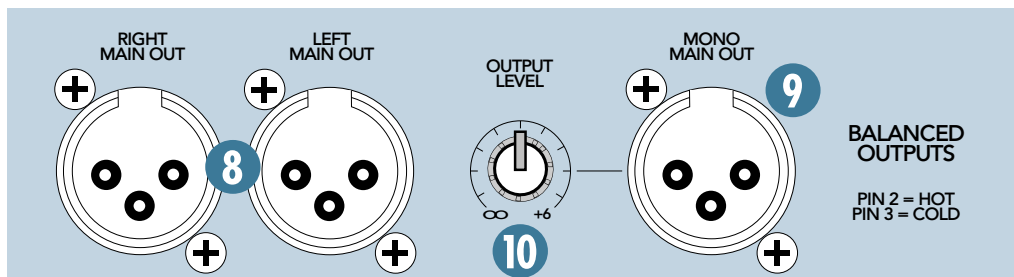



## MAIN INSERTS L & R

Just below the **MAIN OUTS** jacks [11] at the left of the rear panel are the **MAIN INSERT L** and **R** jacks [12]. Like the channel and submix inserts, these patch points allow you to insert a processing device, such as a compressor or an equalizer, into the main left and right mix buses. Any processing you do at this point will affect your entire mix. The insert point is after the bus mixing amplifiers but before the master fader.

The **MAIN INSERT** jacks are wired in the same way as the other insert jacks on the SR24•4. The inserts are made through a 1/4" TRS (tip-ring-sleeve) phone jack, and offer both an unbalanced main send or **output** and an unbalanced main **return** on the same jack. The nominal insert send and return level is 0dBu, and the insert return clipping point is +22dBu.

The sleeve of the jack is connected to ground for both insert send and return signals. The tip is the insert send signal, and the ring is the insert return signal.



**NOTE: These inserts can be used as pre-fader direct outputs, using an unbalanced 1/4" (TS) phone plug in one of these two ways:**

**Insert the plug just to the FIRST click. Do not push the plug all the way in. This connection allows you to tap a direct out without interrupting the channel strip signal; or**

**Insert the plug all the way in to the SECOND click. This also provides a direct out connection, but the channel strip signal is interrupted at that point.** See Figure D on page 30.

## AUX SENDS

Here is where many boards fall short when it comes to sound reinforcement purposes. The SR24•4 offers SIX (6) independent auxiliary sends. The outputs of each are capable of driving a balanced line. **This means that you no longer have to use balancing transformers to get your monitor sends to the stage.** Just plug in a balanced TRS plug into one of the Aux outputs and run a line to the monitor graphic EQ. Voila!

The six auxiliary send buses of the SR24•4 appear at the six numbered 1/4" **AUX SEND** jacks, located near the rear panel's left side [13].

The **AUX SEND** connections are impedance balanced 1/4" TRS (tip-ring-sleeve) phone jacks, with sleeve connected to ground, tip to signal "hot" (or "high" or "+"), and to ring to signal "cold" (or "low" or "-"). These jacks are also wired to accommodate unbalanced 1/4" TS

Layout  
and Function

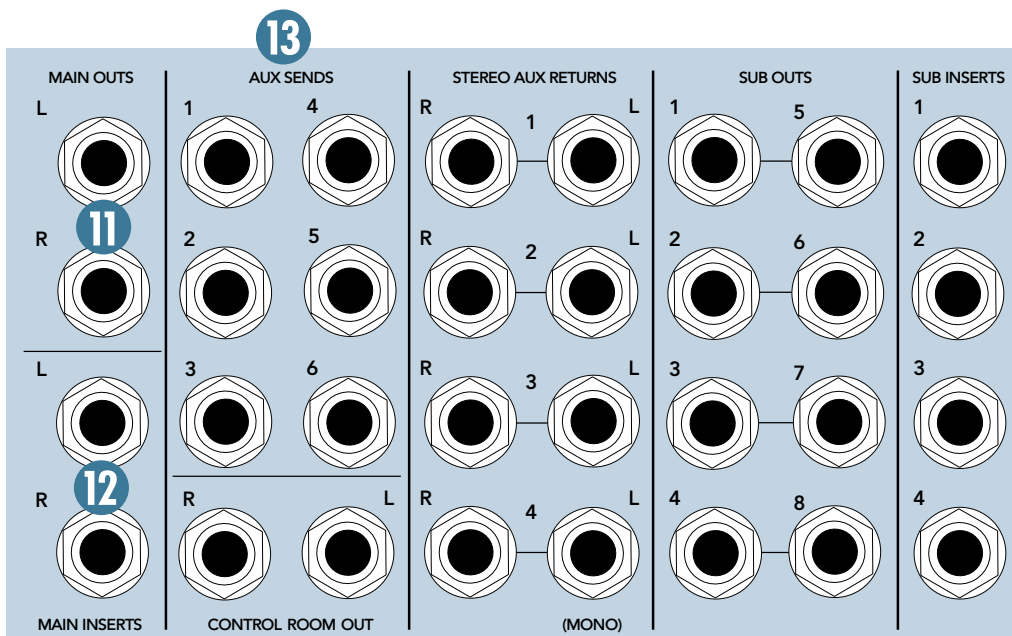

(tip-sleeve) connections. The nominal line level at the **AUX SEND** jacks is 0dBu.

Depending on how you have decided to use your aux functions, you could connect the **AUX SEND** to headphone amplifier inputs, monitor speaker amplifier inputs, reverb, delay or other effects inputs, and so on.

### STEREO AUX RETURNS

If you are using effects such as delay or reverb, you must first send a signal to the effect with an aux send, and then remix the output of the effect back into your final mix. The SR24•4 provides four stereo auxiliary return inputs for this purpose.

The inputs to each stereo aux return are made through a pair of 1/4" TRS (tip-ring-sleeve) phone jacks [14]. These are balanced line inputs which will accept input levels from -10dBu to +22dBu, and will also accept unbalanced cables. Return input clipping is at a level of 22dB.

The sleeve of each jack is connected to ground, the tip is signal "hot" (or "high" or "+"), and the ring is signal "cold" (or "low" or "-").

### AUX RETURN ROUTING OPTIONS

You have several routing options with the Aux returns. Please see "STEREO AUX RETURNS" on page 21.

If you need even more assignment flexibility, you can use one of the stereo line inputs.

Please read the **TO AUX SEND 1-2** controls section on page 21 for more information on the special tricks that these jacks can do.

**NOTE:** A very common arrangement is to use a line input (mono or stereo) for effects returns. This neat trick allows you to EQ your EFX returns, route EFX to monitors, and assign EFX to any output.

### STEREO OR MONO PATCHING

For stereo operation, just plug balanced 1/4" TRS (tip-ring-sleeve) or unbalanced 1/4" TS (tip-sleeve) left and right phone plugs into the left and right jacks. If you only have a mono effects return, insert that plug into the "L" input jack. With no plug in the "R" jack, an internal jack switch will automatically route the signal in the "L" jack to both the left and right circuits of the aux return for mono operation.

**NOTE:** The numbering systems for the aux sends (1-6) and the aux returns (1-4) have no correspondence with each other. In other words, there is no reason that you must send to a particular effects device with Aux Send 1 and then return that device in Stereo Aux Return 1. As long as you can keep track of what is where, you are free to intermix send and return numbers. Send on 1, return on 4; send on 5, return on 3, etc.

### TAPE IN and OUT

For convenience, the main mixer outputs that appear at the **RIGHT** and **LEFT MAIN OUTS** (XLR) and **MAIN OUTS L & R** (1/4" connectors) are also provided on unbalanced RCA-type jacks for connection to tape recorder inputs [16]. Nominal level is 0dBu.

14

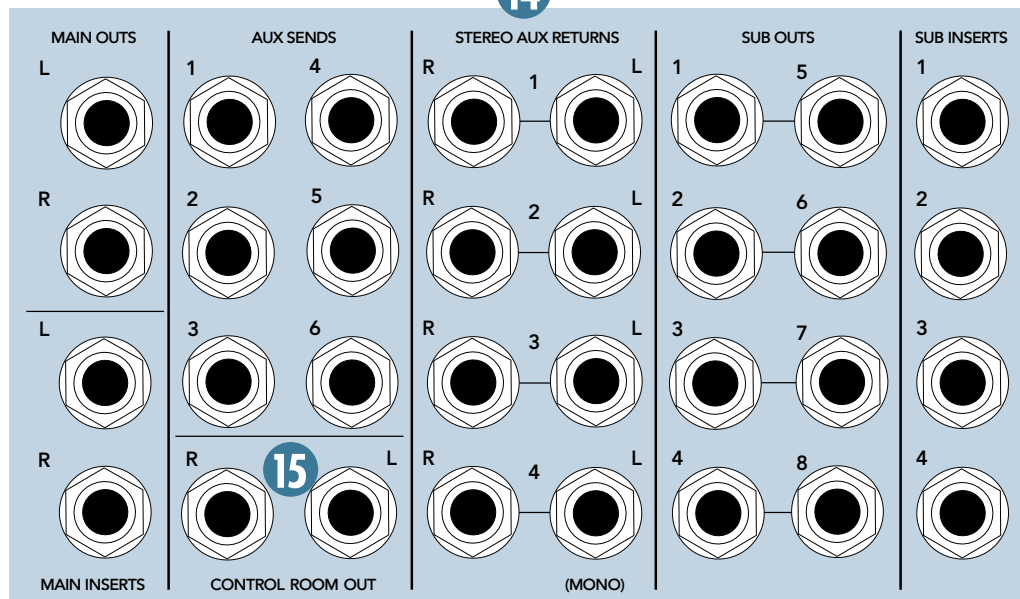

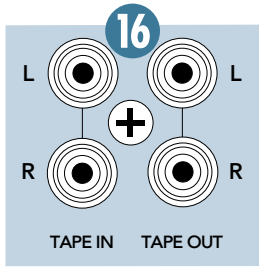

For even more convenience, there are two more RCA jacks labeled **TAPE IN**. Connect your tape playback to the **TAPE IN** jacks and you'll be able to quickly

monitor your tape recorder with the **TAPE RETURN** switches on the front panel. The **TAPE IN** jacks are unbalanced RCA inputs with a nominal level of 0dBu.

**Caution: Assigning the TAPE RETURN MAIN MIX could cause a several-megaton feedback loop. Stick to control room/phones monitoring while in record mode on your tape deck.**

### CONTROL ROOM OUT

The **CONTROL ROOM OUT L** and **R** jacks [15] carry the monitoring signal controlled by the **PHONES/C-R LEVEL** knob on the front panel, and should be connected to the inputs of your control room monitor power amplifier.

**CONTROL ROOM OUT L** and **R** are impedance balanced 1/4" TRS (tip-ring-sleeve) phone jacks with ground wired to the sleeve, signal "hot" (or "high" or "+") to the tip and signal "cold" (or "low" or "-") wired to the ring. You can connect either balanced or unbalanced inputs to these outputs. Nominal level is 0dBu.

### PHONES 1 & 2

The **PHONES** jacks [17] carry the same signals as the **CONTROL ROOM OUT L** and **R** jacks, with extra amplification to drive stereo headphones. Careful; they're loud!

The connections are 1/4" TRS (tip-ring-sleeve) stereo phone jacks wired for standard stereo phones with common (ground) connected to the sleeve, left channel to the tip and right channel wired to the ring.

**PHONES 1** and **PHONES 2** are parallel and provide the same signals.

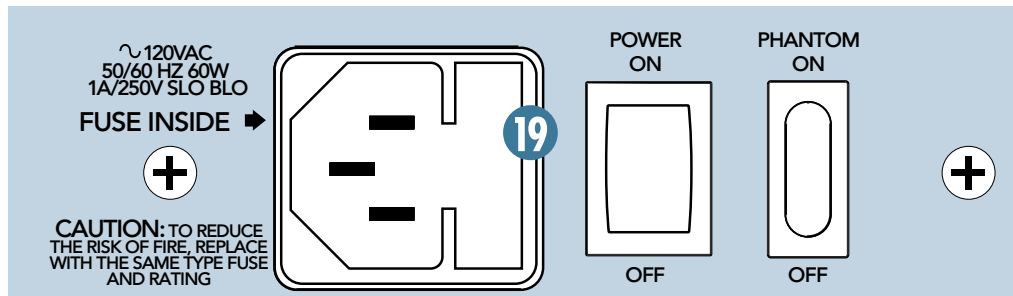

You'll get maximum smoke with 60-ohm headphones. (See *tinnitus* in the Glossary.)

### TALKBACK MIC

Remember the talkback function we talked about before? Here is where you plug in the microphone. This is a balanced mic input [18] using a standard XLR-type mic connector which will accept a wide range of microphone levels and impedances.

**NOTE: There is no phantom power available at the TALK BACK MIC input.**

**ADDITIONAL NOTE: Engaging talkback to AUX 1/2 or MAIN MIX will attenuate control room out by 20dB.**



### POWER

Main power is provided through the IEC connector at the lower left of the rear panel [19]. An IEC power cord of relatively generous length is provided with the SR24•4. Replacement cords are available anywhere (try making *that* statement when you only ship a lame wall wart with a mixer...).

A **mains power fuse** is located in a tiny compartment in the power cord connector housing. Replace only with the correct fuse. It's a very good idea to carry spares.

Just to the right of the power cord connector is the main power switch. Turn this switch **ON** for normal operation and **OFF** for silent (ultra-ultra-low noise) mode.

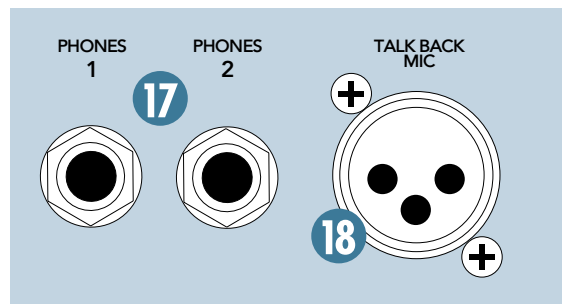

Layout and Function

## SECTION 4: APPLICATIONS – SR & RECORDING

### Applications

The Mackie SR24•4 (and 32•4) mixing console was designed from the ground up as a mixer for either sound reinforcement (SR) or recording, or even both together. Section 4 will help you make the right patches to set up the SR24•4 for both applications and also offers a few tips on how to approach each job.

About three-quarters of the staff at Mackie are musicians or sound engineers or at least knew a musician or sound engineer once, and they all seem to put in their two cents' worth whether we want it or not. It's true, this open policy has provided us with some highly inappropriate suggestions from time to time, but we've tried to weed most of those out and give you something useful here. In fact, if you would like to put in your three cents' worth, just write down your unique SR24•4 application (rotor pitch control in turbine-powered helicopters?) and mail it in to Technical Support. We'll try to keep the Chihuahua away from it.

If you are not yet familiar with your Mackie SR24•4, or if you haven't turned it on yet, run through the drills in *Section 2: Making Sound Come Out Now!* That way you can be sure that everything is functioning properly and that you have no grounding problems. Then read through *Section 3: Panel Layout*, which should give you a good idea of what all the knobs and switches do.

You may also want to look at Appendices A, B and C, which provide background information on general subjects, Mackie connections and the wacky world of proper grounding.

### SOUND REINFORCEMENT

The SR24•4 was definitely designed with sound reinforcement in mind. Figured out where we came up with the name yet?

Here in Section 4 we'll give you the basic plan and some specific ideas for connecting the SR24•4 for sound reinforcement.

Take a look at the diagrams starting on page 9. They represent the most common "generic" typical SR hook-ups.

In general, sound reinforcement connections follow this pattern:

- Microphones, wireless mics, electronic instruments and other sources are connected to the MIC or LINE inputs on the SR24•4 rear panel.
- Main speaker (house) amplifiers are connected to the LEFT and RIGHT MASTER jacks (or sometimes the MONO MASTER jack).
- Monitor or other speaker amplifier inputs are connected to AUX SENDS 1, 2, 3 or 4.
- Reverb and delay device inputs are connected to AUX SENDS 3, 4, 5 or 6.
- Reverb and delay device outputs are connected to STEREO AUX RETURNS 1, 2, 3 or 4.
- Tape recorders are connected to the TAPE IN and TAPE OUT jacks.

Take a little time to set everything up sensibly. It's good to group your inputs and submix buses by instruments, stage position or whatever else suits you. Try to keep the drum mics next to each other, the vocals together and so on. Label your cables, color-code your windcreens, lay tape (to write on) across the bottom of the faders, make a cheat sheet, give yourself a break. It can be confusing enough mixing a big production without wondering which channel is which.

Frankly, it's impossible to predict, describe and diagram all of the possible connection schemes that are possible with the SR24•4. Its flexibility is limited only by your ingenuity. However, we've taken a stab at taking you through a few typical set-ups: *Band in a Club*, *Church Installation* and *8-Track Recording*. We also threw in dedicated monitor mixer and audio/video configurations to sweeten the pie.

## BAND IN A CLUB

Here's the situation: you've got a four-piece band with drums, bass, guitar and keyboards. Three of the band members sing. They want mono mains, two monitor feeds (the drummer has his own wireless in-the-ear setup), a recording of the performance and a few other tricks. This is how we'll set it up. (Please refer to the graphic on page 9.)

There will be eight drum microphones: kick, snare, hi-hat, three tom mics and two overheads.

We will bring the bass in on two channels: one will be a mic on the bass amp, the other direct injection from a direct box on the stage.

The guitar will also have two feeds: one a mic on the amp, the other from a direct output on the guitar amp head. Plus, the guitarist wants an additional mic ready for his acoustic 12-string guitar. Each of the three vocalists will have one microphone, plus there will be a wireless mic for the keyboardist.

The keyboards include an acoustic piano with two mics under the lid, and a stack of synthesizers which the keyboard player is submixing at the stage on a Mackie SR24•4. He will provide you with a stereo line-level feed.

You've also got a stereo compressor, an outboard parametric EQ, two digital reverb/delay effects units and two noise gates.

The drums, bass, guitar and vocals each are submixed. This allows you to set a good balance between the mics and then simply move the whole section up and down with one fader (the submix fader). Push the L/R ASSIGN button on each submix strip and leave the PAN straight up. This is a mono mix.

The keyboard inputs, which are pretty much pre-mixed before they come to you, are assigned directly to the left and right buses.

Carefully raise the MAIN MIX fader until you have the overall level that you desire in the main house speakers. You can now start mixing with the channel faders and submix faders.

Use the AUX 1 controls on the channel strips to develop a mix for the stage monitor speakers. Use the AUX 2 controls for the drummer's custom mix.

Use the AUX 3 through 6 controls on the channel strips to develop effects for both the monitors and the main house speakers.

The AUX SEND 3 feeds effects unit 1, which is then returned to STEREO AUX RETURN 1. Use the effects to monitor control 1 to bring effects to monitor 1! If you want to

add this same effect to the main house speakers, you can independently adjust the AUX RETURN 1 control.

Use AUX SENDS 4 through 6 on channels 1–20 to set up house effects mixes. These effects are returned through stereo channels 21–24 (29–32 on SR32•4) and can be routed to the subgroups or mains by engaging the bus assignment switches on these channels. You can also route these to monitor sends using AUX 1 and 2 controls on channels 21–24 (or 29–32).

**NOTE:** Do not turn up the volume on AUX 4 through 6 on channels 21–24 in this configuration, you'll give birth to the nasty feedback monster.

If you are making a simultaneous recording of the mix, you have a couple of options. One is to simply patch in a tape recorder (DAT) as shown in the chart above and set the input levels so that the tape recorder meters read the same as the SR24•4 main meters.

If you want to make a custom mix for the recording, unaffected by the submix or master faders, you can connect the input of the tape recorder to AUX SENDS 3 and 4 and use the channel AUX SENDS 3 and 4 as a left-right pair of mixing controls. Be sure to push the PRE switch in the Aux section on each channel. This way every channel fader movement you make won't affect your record levels.

When you'd like to play the recording back to check it, just push the TAPE RETURN TO PHONES/C-R switch. If you'd like to play your recording (or some other tape) over the main speakers, push the TAPE RETURN TO MASTER switch.



### ***BAND IN A CLUB output connections***

Connection	Destination
LEFT MAIN MIX .....	Mains power amplifier left input
RIGHT MAIN MIX .....	Mains power amplifier right input
TAPE OUT L .....	DAT recorder left input
TAPE OUT R .....	DAT recorder right input
TAPE IN L .....	DAT recorder left output
TAPE IN R .....	DAT recorder right output
AUX SEND 1 .....	Stage monitor amplifier input
AUX SEND 2 .....	Stage monitor amplifier input
AUX SEND 3 .....	Digital effects unit 1 input
AUX SEND 4 .....	Digital effects unit 2 input
AUX SEND 5 .....	Digital effects unit 3 L input
AUX SEND 6 .....	Digital effects unit 3 R input
AUX RETURN 1 L .....	Digital effects unit 1 left output
AUX RETURN 1 R .....	Digital effects unit 1 right output
AUX RETURN 4 L .....	Cassette L output
AUX RETURN 4 R .....	Cassette R output
MAIN INSERT L .....	Stereo effects chain left input & output
MAIN INSERT R .....	Stereo effects chain right input & output



## CHURCH INSTALLATION

Here's a very different situation: you are to mix a church service in a large sanctuary featuring a worship team with drums, bass, guitar, piano, synthesizer and three vocalists. The band would like two stage monitor mixes. There will be two ministers, each with a wireless lavalier mic, occasional speaking from the congregation (using a wireless handheld mic), music playback before the service from a CD player, and a special performance by the women's chorale. You will also need to provide infrared transmission to wireless headphones for the hard-of-hearing, a cry room feed and a stereo recording feed. (Please refer to the graphic on page 10.)

Also, there are three fixed microphones: one on each of the two lecterns or pulpits, and one on the altar. This is how we'll set it up:

As you can see on page 10 the worship team band is routed to submix buses 1 & 2 and the three vocalists to submix buses 3 & 4. This allows you to set a good stereo balance on the music and then simply move the whole group up and down with a couple of (submix) faders. Use the L/R ASSIGN button on the submix strips to re-assign the worship team back into your main stereo mix.

All the rest of the mics and sources are assigned directly to the main Left/Right buses.

Aux 1 is used as a monitor send to the pulpit. Aux 2 and 3 provide two different monitor submixes for the worship team or the chorale. Aux 4 sends a mix to the infrared hearing-aid transmitter/emitter.

The reverb sent on Aux 5 is being returned into stereo line inputs 23–24. You could simply bring the reverb back through a stereo aux return, but using a line input gives you EQ and more flexibility in routing.

See the table on this page for your output connections.

Set all the faders and the AUX SEND MASTERS to "U." Depress the solo MODE switch to activate IN PLACE AFL. Now solo each input and adjust the TRIM control to obtain a good reading on the main meters. If you'd like to hear the channels as you solo them, you must use headphones or connect an amplifier and speakers to the CONTROL ROOM OUT jacks.

Carefully raise the MASTER fader until you have the overall level that you desire in the main sanctuary speakers. You can now start mixing with the channel faders and submix faders.

Use the AUX 1, 2 and 3 controls on the channel strips to develop a mix for the monitor speakers. Use the AUX 4 and mono output level controls for the infrared and cry room mixes.

Set the stereo line input fader on channel strip 23–24 (31–32 on SR32•4) to "U," this is your effects return master. Use the AUX 5 controls on each channel (in conjunction with the controls on the digital effects units) to adjust the reverb or delay to the setting you prefer.

The four-track multitrack recorder is just an optional rehearsal deck, good for allowing the choir members to assess their polytonality.

### **CHURCH INSTALLATION output connections**

Connection	Destination
LEFT MASTER .....	Mains power amplifier left input
RIGHT MASTER .....	Mains power amplifier right input
MONO MASTER .....	Mono "fill zone" power amp input
TAPE OUT L .....	Cassette recorder left input
TAPE OUT R .....	Cassette recorder right input
TAPE IN L .....	Cassette recorder left output
TAPE IN R .....	Cassette recorder right output
AUX SEND 1 .....	Pulpit monitor amplifier input
AUX SEND 2 .....	Stage monitor 1 amplifier input
AUX SEND 3 .....	Stage monitor 2 amplifier input
AUX SEND 4 .....	Infrared transmitter/emitter input
AUX SEND 5 .....	Digital effects (reverb) input
AUX SEND 6 .....	Digital effects (reverb) input
MAIN INSERT L .....	Compressor/limiter
MAIN INSERT R .....	Compressor/limiter
SUB 4 INSERT .....	Compressor/limiter



## RECORDING

The SR 24•4 (and SR 32•4) is a great recording and mixing console for a four- or eight-track project studio.

Below you'll find the basic plan for connecting the SR 24•4 for recording and some specific ideas for multitrack sessions in *Tracking on an Eight-Track*. (Please refer to the graphic on page 11.)

In general, recording connections follow this pattern:

- Microphones, electronic instruments, four- or eight-track tape playback tracks and other sources are connected to the MIC or LINE inputs on the SR 24•4 rear panel.
- Four- or eight-track recorder inputs are connected to the SUB OUT 1–8 jacks.
- Two-track mixdown recorder inputs are connected to the LEFT and RIGHT MASTER jacks.
- Two-track recorder outputs are connected to the TAPE IN L and R jacks.
- Control room monitor speaker amplifiers are connected to the CONTROL ROOM OUT L and R jacks.
- Musician headphone cue amplifier inputs are connected to AUX SENDS 1, 2, 3 or 4.
- Reverb and delay device inputs are connected to AUX SENDS 3, 4, 5 or 6.
- Reverb and delay device outputs are connected to STEREO AUX RETURNS 1, 2, 3 or 4, or to spare line inputs.

As mentioned in the sound reinforcement section, take a little time to set everything up sensibly. It's good to group your inputs and submix buses by instruments, stereo mix position or whatever else suits you. Try to keep the drum mics next to each other, the vocals together and so on. Label your cables, number your auxiliary devices right on the front panels, lay tape (to write on) across the bottom of the faders, make a track log, give yourself a break. It can be confusing enough mixing a complicated song without wondering which channel is which.

## TRACKING ON AN EIGHT-TRACK

Here's the situation: we'll imagine you've got a multitrack recorder. For basic tracks you will have a three-piece band with drums, bass, and guitar. The lead singer will put down a scratch vocal, and later all three of the band members will overdub vocals. They want two different headphone mixes during basics, and a rough mix on DAT to take home right after the overdub session. You will eventually fill the eight tracks with stereo drums, guitar, and bass plus 4 tracks of vocals. You will use the recorder's time code to drive a MIDI sequencer program which will play another 2 MIDI voices in the final mixdown. This is how we'll set it up:

The drums will be miked with seven mics, and recorded in stereo.

We will bring the bass in on two lines: one will be a mic on the bass amp, the other direct injection from a direct box.

The guitar will also have two feeds: one a mic close to the amp, the second mic a few feet further away.

The guitarist will sing into one microphone for the scratch track.

SR 24•4 channel strips 13–20 will be used to provide a monitor mix of your eight multitrack channels.

The MIDI voices will come in on stereo line inputs 21–22 and 23–24.

Although the SR 24•4 has only four submix buses, for convenience each bus has two outputs: Bus 1 feeds SUB OUT 1 and 5, Bus 2 feeds SUB OUT 2 and 6 and so on. This allows you to feed any track on an eight-track recorder, selecting the track by submix assignment and by the record assignment on the recorder. If you need to record 5 or more tracks at once, you will need to temporarily re-patch a recorder input or two, using a spare AUX SEND output or a channel strip insert as a direct out.

Your output connections can be seen on the table on the next page.

For the basic tracks, you will be recording on five tracks at once, but the SR 24•4 has only four submix buses. One easy solution is to route the scratch vocal mic through Aux Send 6, which in our setup is unused. Don't assign the scratch vocal to any of the main or submix



buses; temporarily patch the Send 6 output to the track 5 input. This gives you another output bus with complete EQ and fader control on the channel strip.

If you don't have an extra Aux Send available (cause you're just crazy with headphone sends and effects boxes), another way to record a fifth track would be to temporarily patch the input to track 5 directly to the scratch vocal microphone channel strip by pushing the plug into the channel strip 12 INSERT jack to the first click (see Appendix B: Connections). This will act as a sort of direct output (with no EQ or fader control). Use the TRIM control to set a decent level on the signal to tape. When you are finished with the scratch vocal, re-patch track 5 input back into SUB OUT 5.

You will be doing all your monitoring through the multitrack recorder and the Left/Right buses. Do not assign any of your recording inputs to the Left/Right buses, but only to the Submix buses shown. You will be able to listen to the recording inputs through the tape recorder outputs on channel strips 13–20.

You provide your headphone cueing mixes via AUX 1 and AUX 2. AUX 3, AUX 4 and AUX 5 will be used as reverb and delay sends, with the returns coming back on STEREO AUX RETURNS 1, 2 and 3.

You are also listening to all your MIDI synthesizer voices as you record. To save tape tracks, they will not be recorded but will be played by your sequencer in real time.

When you have finished your basic tracks, record the final vocals and erase the scratch vocal track.

When the vocals are done, you're ready to mix. Just tweak up your monitor mix, adjust the reverb and push Record on the DAT machine. Viola! A rough mix to take home. In fact, if you are really *on* that night, a final mix for mastering.

**TRACKING ON AN EIGHT-TRACK  
output connections**

Connection	Destination
SUB OUT 1 .....	Multitrack input 1
SUB OUT 2 .....	Multitrack input 2
SUB OUT 3 .....	Multitrack input 3
SUB OUT 4 .....	Multitrack input 4
SUB OUT 5 * .....	Multitrack input 5 *
SUB OUT 6 .....	Multitrack input 6
SUB OUT 7 .....	Multitrack input 7
SUB OUT 8 .....	Multitrack input 8
LEFT MASTER .....	DAT recorder left input
RIGHT MASTER .....	DAT recorder right input
TAPE IN L .....	DAT recorder left output
TAPE IN R .....	DAT recorder right output
AUX SEND 1 .....	Headphone cue amp 1 input
AUX SEND 2 .....	Headphone cue amp 2 input
AUX SEND 3 .....	Digital effects 1 input
AUX SEND 4 .....	Digital effects 2 input
AUX SEND 5 .....	Digital effects 3 input
AUX SEND 6 .....	(input #5)*
AUX RETURN 1 L .....	Digital effects 1 left output
AUX RETURN 1 R .....	Digital effects 1 right output
AUX RETURN 2 L .....	Digital effects 2 left output
AUX RETURN 2 R .....	Digital effects 2 right output
AUX RETURN 3 L .....	Digital effects 3 left output
AUX RETURN 3 R .....	Digital effects 3 right output
MAIN INSERT L .....	Stereo compressor L input & output
MAIN INSERT R .....	Stereo compressor R input & output
CONTROL ROOM OUT L .....	C-R monitor amplifier left input
CONTROL ROOM OUT R .....	C-R monitor amplifier right input

# APPENDIX A: GENERAL INFORMATION

Many of you reading this manual have a lot of experience in using mixers and mixing consoles. For you battle-scarred pros, Section 3 and the Block Diagram will probably be all that you need to look at.

For those of you who are either new to using mixers or just like to read even larger quantities of our glib prose, we've provided this short section that discusses the basic concepts and procedures used in recording, mixing and sound reinforcement work. If you can make some sense of it, you can check out your application and patching in Section 4 and start plugging things in.

Here is a primer covering a few important ideas you should be on good terms with before you sit down to a mixer.

## LEVELS

Microphones have low output signals. Line amplifiers have high output signals. One of the functions of a mixer is to amplify or attenuate these signal levels properly. Since it's easy to degrade the signal by not handling levels well, and since it's your hand on the knobs, you should be sure you know how much gain to apply and where to apply it. The Level Diagram in Appendix E is a good place to start. It isn't as complicated as it looks and is very educational.

***NOTE: No matter what combination of cable adapters you may have at hand, never connect the output of a power amplifier to the input of a mixer.***

## NOISE

Every electronic circuit produces noise or hiss or hash or buzz, and any noise present on the input of an electronic circuit will be faithfully passed through. Turn it up high enough, and you will hear the noise.

## HEADROOM

Every electronic circuit also has a point of overload, a clip point, where the voltage simply cannot rise any higher, no matter what the input signal and your fader move would like. This overload, or clipping, will show up as tooth-grinding distortion.

Somewhere between the noise and the clipping is an optimum level for your signal: high enough above the noise floor to render the hiss inaudible, and far enough below the distortion point to allow range for loud peaks of music to pass without clipping. This safe operating zone might be called operating level or nominal level or zero or perhaps line level. The range between your operating level and clipping is called headroom, which defines just how tall your signal can be without having to duck for the rafters.

Your mission as a designated Master of the Levels is to get the low level signals up to line level as soon as possible and to keep them there as much as possible. But don't turn them up too loud.

## UNITY GAIN

If you haven't already, please read *"Important Sensitivity Adjustment Procedure"* on page 5.

## METERING

A meter is an aid, a window looking onto part of the dynamic range of your signal, and it will tell you if your level is in the ballpark, so to speak.

Try to keep your signals in the middle range of the meters, for the most part. If the signal is always very low, you may not be getting the best signal-to-noise ratio you can. If the meter LEDs are always solidly lit from bottom to top, you are likely distorting both the console and your recording tape regularly. Keep the signal in the middle, around 0 VU. Remember, the top yellow LED of the meter represents a level of +10dBu, and the SR24•4

doesn't clip until +28dBu (balanced). Even pegging the meters hard, you still have around 12dB of headroom for your peaks.

But, if your music is sounding good, don't worry if you're in the yellow a lot or if some parts of the track hardly read at all. You'll quickly get a feel for what works for you, when you can get away with really smacking the tape or the electronics too much.

## BUSES

More often than not, the goal in a mixing console is to mix two or more inputs into one output. Like a coach who has two or more players to get to the same ballgame, console designers use a bus. Even Webster's Unabridged Dictionary agrees, defining the word **bus** in electronics as "a conductor serving as a common connector for three or more circuits."

The Mackie SR24•4 has 15 audio buses. The four suggested in the name (SUBs 1–4) are important, but there are also the main LEFT and RIGHT buses, six AUX buses and three SOLO buses. We will try to be clear just what bus we are talking about when we do talk about buses.

## SENDS AND RETURNS

Sends are buses fed to outputs, and returns are inputs. So why don't we call them outputs and inputs?

Well, actually, the terms **send** and **return** can mean many things, but the way they are generally used in mixing console parlance is to refer to send buses, which tap off a little of a signal to send to some effects device (like a reverb unit), and return inputs, which function to return that reverb back into the mix.

Sends are also used to tap some mix of signal from a collection of channels for a headphone cue mix. For that matter, sends can be used as additional mix buses, if needed.

In the same way, if you don't need them for reverb or effects, returns can be used as additional line-level inputs to your mix.

Incidentally, the terms send and return also apply to insert jacks. The only difference is that they process the entire signal, not just tap a little bit of it.

## SOLO

**Solo** is a standard console function which allows you to listen to one or more sources all by themselves (soloed).

You can check EQ, possible distortion or buzz, or just listen to see if a particular mic is open or not. When soloing more than one source, you can listen to the blend of just part of your mix: only the sopranos, for example, or just the tom mics on the drums.

The solo circuits are designed not to interrupt the recording process. The solo bus signal is sent directly to the control room monitors without affecting any of the inputs, outputs or recording buses.

## EQUALIZATION

Everybody knows what EQ is, but just in case you'd like a refresher, we'll put a few paragraphs in here.

Equalization (EQ) refers to purposefully changing the frequency response of a circuit, sometimes to correct for previous unequal response (hence the term, equalization), and more often to add or subtract level at certain frequencies for a pleasing effect.

Bass and treble controls on your stereo are EQ; so are the units called parametrics and graphics and notch filters.

A lot of how we refer to equalization has to do with what a graph of the frequency response would look like. A flat response (no EQ) is a straight line; a peak looks like a hill, a dip is a valley, a notch is a really skinny valley, and a shelf looks like a plateau (or a shelf). The slope is the grade of the hill on the graph.

Graphic equalizers have enough frequency slider controls to form a graph of the EQ right on the front panel. Parametric EQs let you vary several EQ parameters at once. And a filter is simply a form of equalizer which allows certain frequencies through unmolested and other frequencies reduced or not at all. Passport, please?

The equalizers on the SR24•4 use four different types of EQ in various places.

The **LOW** and **HI** sections of the EQ are shelving equalizers, with a family of curves shown at right. As you can see, shelving EQs lift or lower the entire range of frequencies above or below a certain point. Most tone controls on home stereos are shelving EQs, often set at 100Hz for the bass and 10kHz for the treble. The **LOW** EQ on the SR24•4 is at

80Hz and the **HI** is at 12kHz, and can vary the treble and bass by 15dB. We picked these frequencies because they make a more musical and pleasing equalizer; they give you more punch and more sizzle without making the mix muddy or harsh.

The **MID** EQ section is a peaking/dipping equalizer with a bell-shaped response curve. The frequency is sweepable from 100Hz to 8kHz and the bandwidth is fixed at 1.5 octaves.

The **AIR** controls on **SUBs 1-4** are bandpass equalizers with the center set at 16kHz. The **AIR** controls are set for boost only, not for cut.

## CONNECTORS

If you've used a Mackie mixer, you're familiar with the various kinds of connectors used. If you're new to the whole thing, we have a whole appendix of info on connectors coming up right after this Station ID.

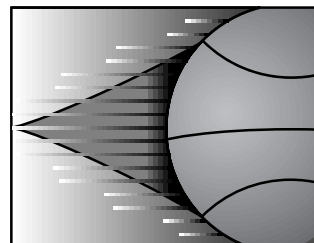
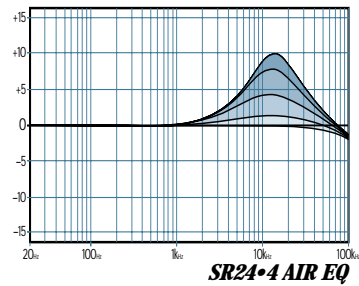
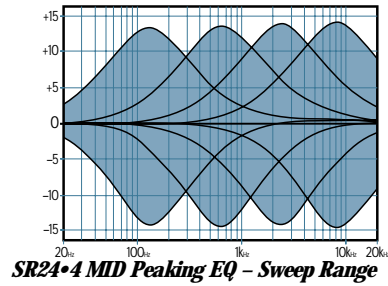
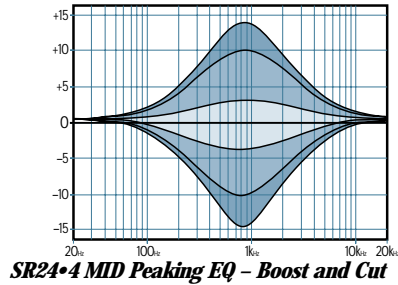
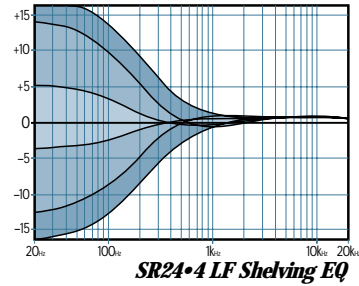
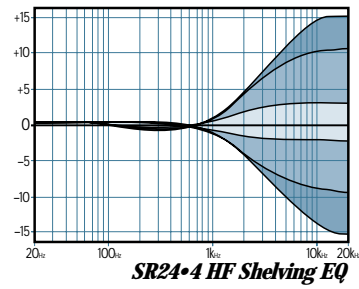



## APPENDIX B: GLOSSARY

This Glossary contains brief definitions of many of the audio and electronic terms used in discussions of sound mixing and recording. Many of the terms have other meanings or nuances or very rigorous technical definitions which we have sidestepped here because we figure you already have a lot on your mind. If you'd like to get more information, you can call Mix Bookshelf at 1-800-233-9604. We recommend the following titles: *The Audio Dictionary*, by Glenn White; *Tech Terms*, by Peterson & Oppenheimer; and *Handbook for Sound Engineers*, by Glen Ballou.

### **AFL**

An acronym for after fade listen, which is another way of saying post-fader solo function. AFL is one of two popular solo modes used in Mackie mixers, and in the SR24•4 AFL is enabled by depressing the SOLO MODE switch to the IN PLACE AFL position. AFL is usually a stereo monitoring mode (vs. mono PFL).

### **assign**

In sound mixers, assign means to switch or route a signal to a particular signal path or combination of signal paths.

### **attenuate**

To reduce or cut down.

### **aux**

See next entry.

### **auxiliary**

In sound mixers, supplemental equipment or features which provide additional capabilities to the basic system. Examples of auxiliary equipment include specialized equalizers, compressors, limiters, gates and reverberation and delay devices. Most mixers have aux send buses and aux return inputs to accommodate auxiliary equipment.

### **balanced**

In a classic balanced audio circuit, the two legs of the circuit (+ and -) are isolated from the circuit ground by exactly the same impedance. Additionally, each leg may carry the signal at exactly the same level but with opposite polarity, with respect to ground. In some balanced circuits only one leg actually carries the signal but both legs exhibit the same impedance characteristics with respect to ground. Balanced input circuits can offer excellent rejection of common-mode noise induced into the line

and also make proper (no ground loops) system grounding easier. Usually terminated with 1/4" TRS or XLR connectors.

### **bandwidth**

The band of frequencies that pass through a device with a loss of less than 3dB, expressed in Hertz or in musical octaves. Also see Q.

### **bus**

An electrical connection common to three or more circuits. In mixer design, a bus usually carries signals from a number of inputs to a mixing amplifier, just like a city bus carries people from a number of neighborhoods to their jobs.

### **Cannon**

A manufacturer of electrical connectors who first popularized the three-pin connector now used universally for balanced microphone connections. In sound work, a Cannon connector is taken to mean a Cannon XLR-3 mic connector or any compatible connector.

### **cardioid**

Means heart-shaped. In sound work, cardioid refers to the shape of the sensitivity pattern of some directional microphones.

### **channel**

A functional path in an audio circuit: an input channel, an output channel, a recording channel, the left channel and so on.

### **channel strip**

The physical representation of an audio channel on the front panel of a mixer; usually a long, vertical strip of controls.

### **chorusing**

An effect available in some digital delay effects units and reverbs. Chorusing involves a number of moving delays and pitch shifting, usually panned across a stereo field. Depending on how used, it can be lovely or grotesque.

### **clipping**

Is a cause of severe audio distortion which is the result of excessive gain requiring the peaks of the audio signal to rise above the capabilities of the amplifier circuit. Seen on an oscilloscope, the audio peaks appear clipped off. To avoid distortion, reduce the system gain in or before the gain stage in which the clipping occurs. See also headroom.

### **condenser**

Is another term for the electronic component generally known as a capacitor. In audio,



condenser usually refers to a design of microphone which uses a capacitor as the sound pickup element. Condenser microphones require electrical power to run internal amplifiers and maintain an electrical charge on the capacitor. They are typically powered by internal batteries or "phantom power" supplied by an external source, such as a mixing console.

### **console**

A term for a sound mixer, usually a large desk-like mixer.

### **cueing**

In broadcast, stage and post-production work, to "cue up" a sound source (a record, a sound effect on a CD, a song on a tape) means to get it ready for playback by making sure you are in the right position on the "cue," making sure the level and EQ are all set properly. This requires a special monitoring circuit which only the mixing engineer hears and does not go out on the air or to the main mixing buses. This "cueing" circuit is the same as pre-fader (PFL) solo on a Mackie mixer, and often the terms are interchangeable.

### **dB**

See decibel

### **dBm**

A unit of measurement of audio signal level in an electrical circuit, expressed in decibels referenced to 1 milliwatt. The "m" in dBm stands for "milliwatt." In a circuit with an impedance of 600 ohms, this reference (0dBm) corresponds to a signal voltage of 0.775 VRMS (because 0.775 V across 600 ohms equals 1mw).

### **dBu**

A unit of measurement of audio signal level in an electrical circuit, expressed in decibels referenced to 0.775 VRMS into any impedance. Commonly used to describe signal levels within a modern audio system.

### **dBv**

A unit of measurement equal to the dBu but no longer in use. It was too easy to confuse a dBv with a dBV, to which it is not equivalent.

### **dBV**

A unit of measurement of audio signal level in an electrical circuit, expressed in decibels referenced to 1 VRMS across any impedance. Commonly used to describe signal levels in consumer equipment. To convert dBV to dBu, add 2.2dB.

### **decibel (dB)**

The dB is a ratio of quantities measured in similar terms using a logarithmic scale. Many audio system parameters measure over such a

large range of values that the dB is used to simplify the numbers. A ratio of 1000V:1V=60dB. When one of the terms in the ratio is an agreed upon standard value such as 0.775V, 1V or 1mw, the ratio becomes an absolute value, i.e., +4dBu, -10dBV or 0dBm.

### **delay**

In sound work, delay usually refers to an electronic circuit or effects unit whose purpose it is to delay the audio signal for some short period of time. Delay can refer to one short repeat, a series of repeats or the complex interactions of delay used in chorusing or reverb. When delayed signals are mixed back with the original sound, a great number of audio effects can be generated, including phasing and flanging, doubling, Haas-effect positioning, slap or slapback, echo, regenerative echo, chorusing and hall-like reverberation. Signal time delay is central to many audio effects units.

### **detent**

A point of extra physical resistance (a click-stop) in the travel of a knob or slide control, used in Mackie mixers to indicate unity gain.

### **dipping**

Is the opposite of peaking, of course. A dip is an EQ curve which looks like a valley, or a dip. Dipping with an equalizer reduces a band of frequencies. (See guacamole.)

### **doubling**

A delay effect, where the original signal is mixed with a medium (20 to 50 msec) delay. When used carefully, this effect can simulate double-tracking (recording a voice or instrument twice).

### **dry**

Usually means without reverberation, or without some other applied effect like delay or chorusing. Dry is not wet, i.e. totally unaffected.

### **dynamic**

In sound work, dynamic refers to class of microphones which generate electrical signals by the movement of a coil in a magnetic field. Dynamic microphones are rugged, relatively inexpensive, are capable of very good performance and do not require external powering.

### **dynamic range**

The range between the maximum and minimum sound levels that a sound system can handle. It is usually expressed in decibels as the difference between the level at peak clipping and the level of the noise floor.

**echo**

Echo is the reflection of sound from a surface such as a wall or a floor. Reverberation and echo are terms which can be used interchangeably, but in audio parlance a distinction is usually made: echo is considered to be a distinct, recognizable repetition (or series of repetitions) of a word, note, phrase or sound, whereas reverberation is a diffuse, continuously smooth decay of sound. Echo and reverberation can be added in sound mixing by sending the original sound to an electronic (or electronic/acoustic) system which mimics natural echoes, and then some. The added echo is returned to the blend through additional mixer inputs. Highly echoic rooms are called live; rooms with very little echo are called dead. A sound source without added echo is dry; one with reverb or echo added is wet.

**effects devices**

External signal processors used to add reverb, delay, spatial or psychoacoustic effects to an audio signal. An effects processor may be used as an insert processor on a particular input or subgroup, or it may be used via the aux send/return system. See also echo, reverb.

**EQ**

See equalization

**EQ curve**

A graph of the response of an equalizer, with frequency on the x (horizontal) axis and amplitude (level) on the y (vertical) axis. Equalizer types and effects are often named after the shape of the graphed response curve, such as peak, dip, shelf, notch, knee and so on.

**equalization**

Equalization (EQ) refers to purposefully changing the frequency response of a circuit, sometimes to correct for previous unequal response (hence the term, equalization), and more often to add or subtract level at certain frequencies for sound enhancement, to remove extraneous sounds, or to create completely new and different sounds.

Bass and treble controls on your stereo are EQ; so are the units called parametrics and graphics and notch filters.

[A lot of] how we refer to equalization has to do with what a graph of the frequency response would look like. A flat response (no EQ) is a straight line; a peak looks like a hill, a dip is a valley, a notch is a really skinny valley, and a shelf looks like a plateau (or a shelf). The slope is the grade of the hill on the graph.

Graphic equalizers have enough frequency slider controls to form a graph of the EQ right on the front panel. Parametric EQs let you vary several EQ parameters at once. And a filter is simply a form of equalizer which allows certain frequencies through unmolested and other frequencies reduced or not at all.

Aside from the volume control, EQs are probably the second most powerful controls on any mixer (no, the power switch doesn't count!).

**fader**

Another name for an audio level control. Today, the term refers to a straight-line slide fader rather than a rotary control.

**family of curves**

A composite graph, showing on one chart several examples of possible EQ curves for a given equalizer or equalizer section.

**filter**

A simple equalizer designed to remove certain ranges of frequencies. A low cut filter (also called a high pass filter) reduces or eliminates frequencies below its cutoff frequency. There are also high cut (low pass) filters, bandpass filters, which cut both high and low frequencies but leave a band of frequencies in the middle untouched, and notch filters, which remove a narrow band but leave the high and low frequencies alone.

**flanging**

A term for phasing. Before digital delay effects units, phasing could be accomplished by playing two tape machines in synchronization, then delaying one slightly by rubbing a finger on the reel flange. Get it?

**FOH**

An acronym for Front Of House. See house and main house speakers.

**frequency**

Frequency is the number of times an event repeats itself in a given period. Sound waves and the electrical signals which represent sound waves in an audio circuit have repetitive patterns which range from a frequency of about 20 repetitions per second to about 20,000 repetitions per second. Sound is the vibration or combination of vibrations in this range of 20 to 20,000 repetitions per second which gives us the sensation of pitch, harmonics, tone and overtones. Frequency is measured in units called Hertz (Hz). One Hertz is one repetition or cycle per second.

**fully balanced**

See balanced.

## **gain**

Gain is the measure of how much a circuit amplifies a signal. Gain may be stated as a ratio of input to output values, such as a voltage gain of 4, or a power gain of 1.5, or it can be expressed in decibels, as a line amplifier with a gain of 10dB.

## **gain stage**

An amplification point in a signal path, either within a system or a single device. Overall system gain is distributed between the various gain stages.

## **graphic EQ**

A graphic equalizer uses slide pots for its boost/cut controls, with its frequencies evenly spaced through the audio spectrum. In a perfect world, a line drawn through the centers of the control shafts would form a graph of the frequency response curve. Get it? Or, the positions of the side dots give a graphic representation of boost or cut levels across the frequency spectrum.

## **ground**

Ground is also called earth. Ground is defined as the point of zero voltage in a circuit or system, the point from which all other voltages are measured. In electrical systems, ground connections are used for safety purposes, to keep equipment chassis and controls at zero voltage and to provide a safe path for errant currents. This is called a safety ground.

In computer and audio equipment, tiny currents and voltages can cause noise in the circuits and hamper operation. In addition to providing safety, ground provisions in these situations serve to minimize the pickup, detection and distribution of these tiny noise signals. This type of ground is often called technical ground.

Maintaining a good safety ground is always essential to prevent electrical shock. Follow manufacturer's suggestions and good electrical practices to ensure a safely grounded system. Never remove or disable the grounding pin on the power cord.

Quality audio equipment is designed to maintain a good technical ground and also operate safely with a good safety ground. If you have noise in your system due to technical grounding problems, check you manual for wiring tips or call technical support. *Never disable the safety ground to reduce noise problems.*

## **ground loop**

A ground loop occurs when the technical ground within an audio system is connected

to the safety ground at more than one place. Two or more connections will allow tiny currents to flow in the loops created, possibly inducing noise (hum) into the audio system. If you have noise in your system due to ground loops, check your manual for wiring tips or call technical support. *Never disable the safety ground to reduce noise problems.*

## **Haas effect**

A psychoacoustic effect in which the time of arrival of a sound to the left and right ears affects our perception of direction. If a signal is presented to both ears at the same time at the same volume, it appears to be directly in front of us. But if the signal to one ear, still at the same volume, is delayed slightly (0 to 5 msec), the sound appears to be coming from the earlier (non-delayed) side.

## **headroom**

The difference between nominal operating level and peak clipping in an audio system. For example, a mixer operating with a nominal line level of +4dBu and a maximum output level of +22dBu has 18dB of headroom. Plenty of room for surprise peaks.

## **Hertz**

The unit of measure for frequency of oscillation, equal to 1 cycle per second. Abbreviated Hz. KHz is pronounced "kay-Hertz" and is an abbreviation for kilohertz, or 1000 Hertz.

## **house**

In SR parlance, "house" refers to the systems (and even persons) responsible for the primary sound reinforcement in a given hall, building, arena or "house." Hence we have the house mixer or house engineer, the house mix, the house mix amps, the main house speakers and so on.

## **Hz**

See Hertz.

## **impedance**

The A.C. resistance/capacitance/inductance in an electrical circuit, measured in ohms. In audio circuits (and other AC circuits) the impedance in ohms can often be much different from the circuit resistance as measured by a DC ohmmeter.

Maintaining proper circuit impedance relationships is important to avoid distortion and minimize added noise. Mackie input and output impedances are set to work well with the vast majority of audio equipment available.

## **impedance balanced**

An audio circuit technique used to gain much of the advantage of a fully balanced

output circuit without the use (and expense) of additional amplifiers or transformers. See also balanced.

### **input module**

A holdover from the days when the only way that real consoles were built was in modular fashion, one channel per module. See channel strip.

### **knee**

A knee is a sharp bend in an EQ response curve not unlike the sharp bend in your leg. Also used in describing dynamics processors.

### **level**

Another word for signal voltage, power, strength or volume. Audio signals are sometimes classified according to their level. Commonly used levels are: microphone level (−40dBu or lower), instrument level (−20 to −10dBu), and line level (−10 to +30dBu).

### **line level**

A signal whose level falls between −10dBu and +30dBu.

### **main house speakers**

The main loudspeakers for an SR system. These are usually the largest and loudest loudspeakers, and are usually positioned so that their sound seems to come from the area of the main stage.

### **mains**

See main house speakers.

### **master**

A control affecting the final output of a mixer. A mixer may have several master controls, which may be slide faders or rotary controls.

### **mic amp**

See mic preamp.

### **mic level**

The typical level of a signal from a microphone. A mic level signal (usually but not always coming from a microphone) is generally below −30dBu. With a very quiet source (a pin dropping?) the signal can be −70dBu or lower. It is also possible for some microphones to deliver more signal than this; in which case it may be referred to as a “hot” mic level. Alternately, you can just say, “Boy, is that loud!”

### **mic pre**

See mic preamp.

### **mic preamp**

Short for microphone preamplifier. An amplifier which functions to bring the very low signal level of a microphone (approximately −50dBu) up to line level (approximately 0dBu). Mic preamps often have their own volume control, called a trim control, to properly

set the gain for a particular source. Setting the mic preamp gain correctly with the trim control is an essential step in establishing good noise and headroom for your mix.

### **mixer**

An electronic device used to combine various audio signals together into a common output. Different from a blender, which combines various fruits together into a common libation.

### **monaural**

Literally, pertaining to or having the use of only one ear. In sound work, a monaural has to do with a signal which, for purposes of communicating audio information, has been confined to a single channel. One microphone is a mono pickup; many microphones mixed to one channel is a mono mix; a mono signal played through two speakers is still mono, since it only carries one channel of information. Several monaural sources, however, can be panned into a stereo (or at least two-channel, if you are going to be picky) mix. Monaural SR is common for environments where stereo SR would provide an uneven reproduction to the listener.

### **monitor**

In sound reinforcement, monitor speakers (or monitor headphones or in-the-ear monitors) are those speakers used by the performers to hear themselves. Monitor speakers are also called foldback speakers. In recording, the monitor speakers are those used by the production staff to listen to the recording as it progresses. In zoology, the monitor lizard is the lizard which observes the production staff as the recording progresses. Keep the lizard out of the mixer.

### **mono**

Short for monaural.

### **mult**

Probably short for multiple. In audio work, a mult is a parallel connection in a patch bay or made with patch cords to feed an output to more than one input. A “Y” cable is a type of mult connection. Also a verb, as in “Why did you mult the flanger into every input in the board?”

### **noise**

Whatever you don’t want to hear. Could be hum, buzz or hiss; could be crosstalk or digital hash or your neighbor’s stereo; could be white noise or pink noise or brown noise.

### **noise floor**

The residual level of noise in any system. In a well designed mixer, the noise floor will be a quiet hiss which is the thermal noise gener-

ated by bouncing electrons in the transistor junctions. The lower the noise floor and the higher the headroom, the more usable dynamic range a system has.

### **pan, pan pot**

Short for panoramic potentiometer. A pan pot is used to position (or even move back and forth) a monaural sound source in a stereo mixing field by adjusting the source's volume between the left and right channels. Our brains sense stereo position by hearing this difference in loudness when the sound strikes each ear, and also take into account time delay, spectrum, ambient reverberation and other cues.

### **parametric EQ**

A "fully" parametric EQ is an extremely powerful equalizer which allows smooth, continuous control of each of the three primary EQ parameters (frequency, gain, and bandwidth) in each section independently. "Semi" parametric EQs allow control of fewer parameters, usually frequency and gain, i.e., they have a fixed bandwidth, but variable center frequency and gain.

### **peaking**

Is the opposite of dipping, of course. A peak is an EQ curve which looks like a hill, or a peak. Peaking with an equalizer amplifies a band of frequencies.

### **PFL**

An acronym for Pre Fade Listen, or PRE FADER on the SR24•4. Broadcasters would call it cueing. Sound folks call it being able to solo a channel with the fader down.

### **phantom power**

A system of providing electrical power for condenser microphones (and some electronic pickup devices) from the sound mixer. The system is called phantom because the power is carried on standard microphone audio wiring in a way which is "invisible" to ordinary dynamic microphones. Mackie mixers use standard +48 volt DC power, switchable on or off. Most quality condenser microphones are designed to use +48 VDC phantom power. Check with the manufacturer's recommendations.

Generally, phantom power is safe to use with non-condenser microphones as well, especially dynamic microphones. *However, unbalanced microphones and equipment, some electronic equipment (such as some wireless microphone receivers) and some ribbon microphones can*

*short out the phantom power and can be severely damaged. Check the manufacturer's recommendations and be careful!*

### **phasing**

A delay effect, where the original signal is mixed with a short (0 to 10 msec) delay. The time of the delay is slowly varied, and the combination of the two signals results in a dramatic moving comb-filter effect. Phasing is sometimes imitated by sweeping a comb-filter EQ across a signal. A comb filter can be found in your back pocket.

### **phone jack**

Ever see those old telephone switchboards with hundreds of jacks and patch cords and plugs? Those are phone jacks and plugs, now used widely with musical instruments and in audio equipment. A phone jack is the female connector, and we use them in 1/4" two-conductor (TS) and three-conductor (TRS) versions.

### **phone plug**

The male counterpart to the phone jack, right above.

### **phono jack**

See RCA phono jack.

### **phono plug**

See RCA phono plug.

### **post-fader**

A term used to describe an aux send (usually) that is connected so that it is affected by the setting of the associated channel fader. Sends connected this way are typically (but not always) used for effects. See pre-fader.

### **pot, potentiometer**

In electronics, a variable resistor, which varies the potential, or voltage. In audio, any rotary or slide control.

### **pre-fader**

A term used to describe an aux send (usually) that is connected so that it is not affected by the setting of the associated channel fader. Sends connected this way are typically (but not always) used for monitors (foldback). See post-fader.

### **proximity effect**

The property of many directional microphones to accentuate their bass response when the source-to-mic distance is small, typically three inches or less. Singers generally like this effect, even more than singing in the shower.



**Q**

Q is a way of stating the bandwidth of a filter or equalizer section. An EQ with a Q of .75 is broad and smooth, while a Q of 10 gives a narrow, pointed response curve. To calculate the value of Q, you must know the center frequency of the EQ section and the frequencies at which the upper and lower skirts fall 3dB below the level of the center frequency. Q equals the center frequency divided by the difference between the upper and lower -3dB frequencies. A peaking EQ centered at 10kHz whose -3dB points are 7.5kHz and 12.5kHz has a Q of 2.

**RCA phono jack—or RCA jack or phono jack**

An RCA phono jack is an inexpensive connector (female) introduced by RCA and originally used to connect phonographs to radio receivers and phono preamplifiers. The phono jack was (and still is) widely used on consumer stereo equipment and video equipment but was quietly fading into obscurity in the professional and semi-professional sound world. Then phono jacks began cropping up in early project-studio multitrack recorders, which (unfortunately) gave them a new lease on life; and since so many stereo recorders are fitted with them we decided we'd have to put a couple on the SR24•4 for your convenience. But make no mistake: the only thing that the phono jack (or plug) has going for it is low cost.

**RCA phono plug**

The male counterpart to an RCA phono jack. See above.

**regeneration**

Also called recirculation. A delay effect created by feeding the output of a delay back into itself to cause a delay of the delay of the delay. You can do it right on the front panel of many effects units, or you can route the delay return back into itself on your mixer. Can be a great deal of fun at parties.

**return**

A return is a mixer line input dedicated to the task of returning processed or added sound from reverb, echo and other effects devices. Depending on the internal routing of your mixer and your own inclination, you could use returns as additional line inputs, or you could route your reverb outputs to ordinary line inputs rather than the returns.

**reverberation**

Reverberation (or reverb) is the sound remaining in a room after the source of sound is

stopped. It's what you hear in a large tiled room immediately after you've clapped your hands. Reverberation and echo are terms which can be used interchangeably, but in audio parlance a distinction is usually made: reverberation is considered to be a diffuse, continuously smooth decay of sound, whereas echo is a distinct, recognizable repetition of a word, note, phrase or sound. Reverberation and echo can be added in sound mixing by sending the original sound to an electronic (or electronic/acoustic) system which mimics natural reverberation, or worse. The added reverb is returned to the blend through additional mixer inputs. Highly reverberant rooms are called live; rooms with very little reverberation are called dead. A sound source without added reverb is dry; one with reverb or echo added is wet.

**RMS**

An acronym for *root mean square*, a conventional way to measure AC voltage and audio signal voltage. Most AC voltmeters are calibrated to read RMS volts. Other conventions include *average* volts, *peak* volts and *peak-to-peak* volts.

**send**

A term used to describe a secondary mix and output of the input signals, typically used for foldback monitors, headphone monitors or for effects devices. Mackie mixers call it an Aux Send.

**shelving**

A term used to describe the shape of an equalizer's frequency response. A shelving equalizer's response begins to rise (or fall) at some frequency, and continues to fall (or rise) until it reaches the shelf frequency, at which point the response curve flattens out and remains so to the limits of audibility. If you were to graph the response, it would look like a shelf. Or more like a shelf than a hiking boot. The EQ controls on your stereo are usually shelving equalizers. See also peaking and dipping.

**slap, slapback**

A single-delay echo without any repeats. Also see echo.

**solo**

Italian for alone. In audio mixers, a solo circuit allows the engineer to listen to individual channels, buses or other circuits singly, or in combination with other soloed signals. In Mackie mixers, activating a solo function never interferes with or interrupts any of the main or



auxiliary mixing circuits (even in Italy).

### **SR**

SR is an acronym for Sound Reinforcement, which refers to a system of amplifying acoustic and electronic sounds from a performance or speech so that a large audience can hear clearly. Or, in popular music, so that a large audience can be excited, stunned or even partially deafened by the tremendous amplification. Means essentially the same thing as PA (Public Address).

### **stereo**

Believe it or not, stereo comes from a Greek word which means solid. We use stereo or stereophony to describe the illusion of a continuous, spacious soundfield which is seemingly spread around the listener by two or more related audio signals. In practice, stereo often is taken to simply mean two channel.

### **sweep EQ**

A sweep EQ is an equalizer which allows you to “sweep” or continuously vary the frequency of one or more sections. The mid-range EQs in the SR24•4 channels 1–20 are sweep EQs (channels 1–28 on the SR24•4).

### **symmetrically balanced**

See balanced.

### **tinnitus**

The ringing in the ears that is produced with prolonged exposure to high volumes. A sound in the ears, as buzzing, ringing, or whistling, caused by volume knob abuse!

### **trim**

In audio mixers, the gain adjustment for the first amplification stage of the mixer. The trim control helps the mixer cope with the widely varying range of input signals that come from real-world sources. It is important to set the trim control correctly; its setting determines the overall noise performance in that channel of the mixer. See mic preamp.

### **TRS**

An acronym for Tip-Ring-Sleeve, a scheme for connecting three conductors through a single plug or jack. 1/4" phone plugs and jacks and 1/8" mini phone plugs and jacks are commonly wired TRS. Since the plug or jack can carry two signals with a common ground, TRS connectors are often referred to as stereo or balanced plugs or jacks. Another common TRS application is for insert jacks, used for inserting an external processor into the signal path. In Mackie mixers the tip is send, ring is return, and sleeve is ground.

### **TS**

An acronym for Tip-Sleeve, a scheme for connecting two conductors through a single plug or jack. 1/4" phone plugs and jacks and 1/8" mini phone plugs and jacks are commonly wired TS. Sometimes called mono or unbalanced plugs or jacks. A 1/4" TS phone plug or jack is also called a standard phone plug or jack.

### **unbalanced**

An electrical circuit in which the two legs of the circuit are not balanced in respect to ground. Usually, one leg will be held at ground potential. Unbalanced circuit connections require only two conductors (signal “hot” and ground). Unbalanced audio circuitry is less expensive to build but under certain circumstances is more susceptible to noise pickup.

### **unity gain**

Unity gain describes a circuit or system which has its voltage gain adjusted to be one, or unity. A signal will leave a unity gain circuit at the same level at which it entered. In Mackie mixers, unity gain is achieved by setting all variable controls to the marked “U” setting. Mackie mixers are optimized for best headroom and noise figures at unity gain.

### **VLZ**

An acronym for very low impedance. One of the most important reasons why inherent noise levels on the 24•4 are so miniscule. Thermal noise is something that’s created by all circuitry and usually transistors and resistors are the worst culprits. The basic rule with thermal noise is: the higher the impedance, the more the noise. Mackie’s design reduces thermal noise by making internal impedances as low as possible in as many places as possible within the console. VLZ is achieved by scaling down resistor values by a factor of three or four – resulting in a corresponding reduction in thermal noise. This is especially true for the console’s mixing buses.

### **volume**

Electrical or sound level in an audio system. Perhaps the only thing that some bands have too much of.

### **VRMS**

See RMS.

### **wet**

Wet means with added reverberation or other effect like echo, delay or chorusing.

### **XLR connector**

See Cannon.

# APPENDIX C: CONNECTIONS

## “XLR” CONNECTORS

Mackie mixers use 3-pin female “XLR” connectors on all microphone inputs, with pin 1 wired to the grounded (earthed) shield, pin 2 wired to the “high” (“hot” or positive polarity) side of the audio signal and pin 3 wired to the “low” (“cold” or negative polarity) side of the signal (Figure A). All totally aboveboard and in full accord with the hallowed standards dictated by the AES (Audio Engineering Society).

Use a male “XLR”-type connector, usually found on the nether end of what is called a “mic cable,” to connect to these inputs.

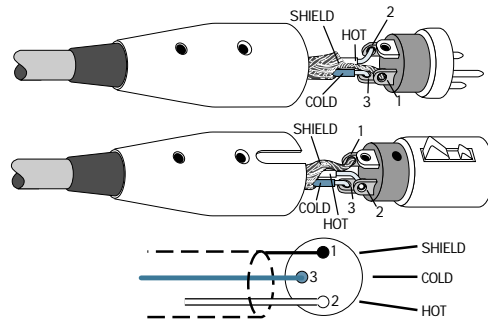
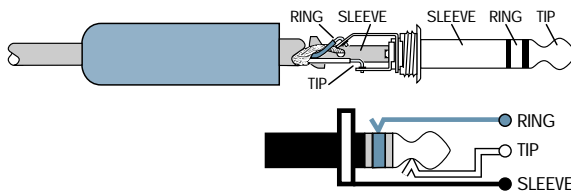

**Figure A: XLR Connectors**

## 1/4" TRS PHONE PLUGS AND JACKS

“TRS” stands for Tip-Ring-Sleeve, the three connections available on a “stereo” 1/4" or “balanced” phone jack or plug. See Figure B. TRS jacks and plugs are used in several different applications:

- Stereo Headphones, and rarely, stereo microphones and stereo line connections.



**Figure B: 1/4" TRS plugs**

When wired for stereo, a 1/4" TRS jack or plug is connected tip to left, ring to right and sleeve to ground (earth). Mackie mixers do not directly accept 1-plug-type stereo microphones. They must be separated into a left cord and a right cord which are plugged into the two mic preamps.

You can cook up your own adapter for a stereo microphone adapter: “Y” two cables out of a female 1/4" TRS jack to two male XLR plugs, one for the Right signal and one for the Left.

- Balanced mono circuits. When wired as a balanced connector, a 1/4" TRS jack or plug is connected tip to signal high (hot), ring to signal low (cold), and sleeve to ground (earth).
- Unbalanced Send/Return circuits. When wired as send/return “Y” connector, a 1/4" TRS jack or plug is connected tip to signal send (output from mixer), ring to signal return (input back into mixer), and sleeve to ground (earth).

## 1/4" TS PHONE PLUGS AND JACKS

“TS” stands for Tip-Sleeve, the two connections available on a “mono” 1/4" phone jack or plug (Figure C). TS jacks and plugs are used in many different applications, always unbalanced. The tip is connected to the audio signal and the sleeve to ground (earth). Some examples:

- Unbalanced microphones
- Electric guitars and electronic instruments
- Unbalanced line-level connections

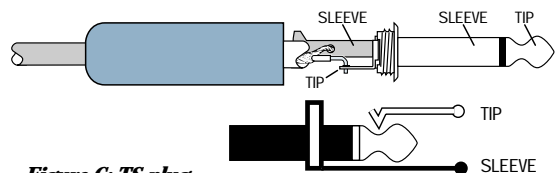

**Figure C: TS plug**





**NOTE:** All the 1/4" inputs on the SR24•4 are designed to accept both balanced and unbalanced sources.

**Note:** All the 1/4" TRS outputs on the SR24•4 implement "impedance balancing". The tip carries the signal while the ring is tied to ground through a resistor whose value mimics the output impedance of the tip circuit. When you plug a balanced cord into one of these outputs, both the tip and ring conductors have equal impedance, significantly improving the common mode characteristics.

### SWITCHED 1/4" PHONE JACKS

Switches can be incorporated into 1/4" phone jacks which are activated by inserting the plug. These switches may open an insert loop in a circuit, change the input routing of the signal or serve other functions. The Mackie SR24•4 uses switches in the channel insert and bus insert jacks, input jacks and AUX returns. See **Special Mackie Connections** farther on. We also use these switches to ground the line-level inputs when nothing is plugged into them.

In most cases, the plug must be inserted fully to activate the switch. Mackie takes advantage of this in some circuits, specifying circumstances where you are to insert the plug only partially. Once again, see **Special Mackie Connections**, later in this section.

### RCA PLUGS AND JACKS

RCA-type plugs (also known as phono plugs) and jacks are often used in home stereo and video equipment and in many other applications (Figure D). They are unbalanced, and electrically identical to a 1/4" TS phone plug or jack. Connect the signal to the center post and the ground (earth) or shield to the surrounding "basket." There are Tape In and Tape Out RCA jacks on the Mackie SR24•4.

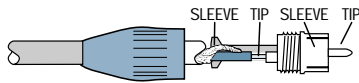

**Figure D: RCA plug**

### UNBALANCING A LINE

In most studio, stage and sound reinforcement situations, there is a combination of balanced and unbalanced inputs and outputs on the various pieces of equipment. This usually will not be a problem in making connections.

- When connecting a *balanced output* to an *unbalanced input*, be sure the signal high (hot) connections are wired to each other, and that the balanced signal low (cold) goes to the ground (earth) connection at the unbalanced input. In most cases, the balanced ground (earth) will also be connected to the ground (earth) at the unbalanced input. If there are hum or radio frequency ground-loop problems, this connection may be left disconnected at the balanced end.
- When connecting an unbalanced output to a balanced input, be sure that the signal high (hot) connections are wired to each other. The unbalanced ground (earth) connection should be wired to the low (cold) and the ground (earth) connections of the balanced input. If there are ground-loop problems, try connecting the unbalanced ground (earth) connection only to the input low (cold) connection, and leaving the input ground (earth) connection disconnected.

In some cases, you will have to make up special adapters to interconnect your equipment. For example, you may need a balanced XLR female connected to an unbalanced 1/4" TS phone plug.

### SPECIAL MACKIE CONNECTIONS

The balanced-to-unbalanced connection has been anticipated in the wiring of the Mackie SR24•4 jacks. A 1/4" TS plug inserted into a 1/4" TRS balanced input, for example, will automatically unbalance the input and make all the right connections. Conversely, a 1/4" TRS plug inserted into a 1/4" unbalanced input will automatically tie the ring (low or cold) to ground (earth).

### TRS Send/Receive Insert Jacks

The insert jacks on the SR24•4's input channels 1–20 (1–28 on the SR32•4), the SUBS and MAIN MIX L/R are the three-conductor, TRS type 1/4" phone. They are



unbalanced, but have both the mixer output (send) and the mixer input (return) signals in one connector (See Figures B and F).

The sleeve is the common ground (earth) for both signals. The send from the mixer to the external unit is carried on the tip, and the return from the unit to the mixer is on the ring.

### Using the Send Only on an Insert Jack

If you insert a TS (mono) 1/4" plug only partially (to the first click) into an SR24•4 insert jack, the plug will not activate the jack switch and will not open the insert loop in the circuit (thereby allowing the channel signal to continue on its merry way through the mixer).

This allows you to tap out the channel or bus signal at that point in the circuit without interrupting normal operation.

If you push the 1/4" TS plug in to the second click, you will open the jack switch and create a direct out, which *does* interrupt the signal in that channel. See Figure F.



**NOTE: Do not overload or short-circuit the signal you are tapping from the mixer. That will affect the internal signal in the SR24•4.**

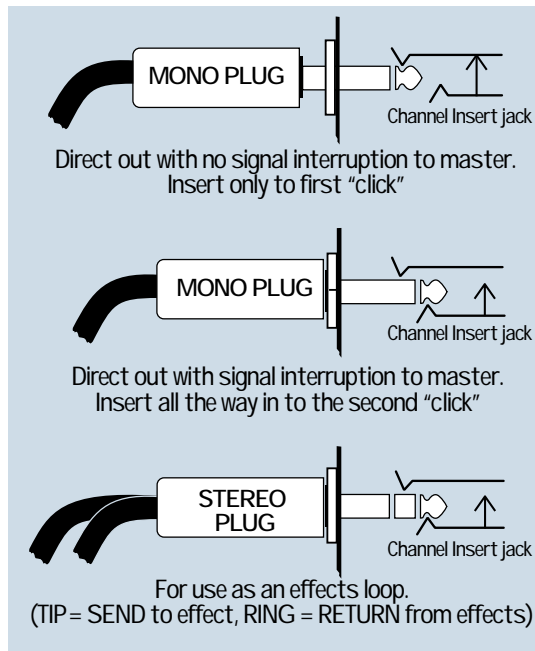

Figure E

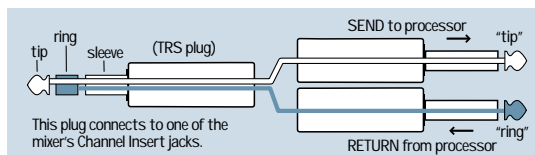

Figure F

## MACKIE STEREO INPUTS AND RETURNS: Mono, Stereo, Whatever

The SR24•4 stereo line inputs and stereo AUX returns are a fine example of the Mackie philosophy (which we just made up) of Maximum Flexibility with Minimum Headache. The inputs and returns will automatically be mono or stereo, depending upon how you use the jacks. Here's how it works:

A mono signal should be patched into the input or return jack labeled Left (MONO). The signal will be routed to both the left and right sides of the return circuit, and will show up in the center of the stereo pair of buses it's assigned to, or can be "panned" with the Balance control.

A stereo signal, having two plugs, should be patched into the Left (MONO) and the RIGHT input or return jacks. A jack switch in the RIGHT jack will disable the mono function, and the signals will show up in stereo.

A mono signal connected to the RIGHT jack will show up in the right bus only. You probably will only want to use this sophisticated effect for special occasions (weddings, bar mitzvahs, Rush Limbaugh's birthday party, etc.)

## MULTS AND "Y"s

A mult or "Y" connector allows you to route one output to two or more inputs by simply providing parallel wiring connections. You can make "Y"s and mults for the outputs of both unbalanced and balanced circuits.

**Remember: Only mult or "Y" an output into several inputs. If you need to combine several outputs into one input, you must use a mixer, not a mult or a "Y."**

Example: Let's say you're engineering a show. You have two monitor mixes but only one reverb device. You want to send some of this reverb to each monitor mix, but the SR24•4 doesn't seem to allow this. It's Y-CORD time.

From the reverb outputs, plug the left reverb into AUX RETURN 1 left and, via the Y-cord, AUX RETURN 2 left. Do the same for the right.

Now, AUX RETURN 1 and 2 will act independently, even though they receive the same signal!

# APPENDIX D: PHANTOM POWERING, GROUNDING AND OTHER ARCAINE MYSTERIES

## Phantom Powering and Microphones

### History

Condenser (capacitor) microphones differ from dynamic and ribbon microphones because they are not self-generating. That is, they cannot generate electricity in response to an impinging sound wave. A condenser microphone modifies an external source of electricity to reflect the effects of a sound wave striking its diaphragm.

Dynamic and ribbon microphones use magnetism to generate electricity in response to a sound wave: they are self-generating. Furthermore, both of these types of microphones are inherently low impedance devices. It is possible to connect a dynamic microphone element directly to a balanced, low-impedance mixer input. Many commercially made dynamic microphones do just that.

On the other hand, a condenser microphone is an inherently high-impedance device. How high? Verrrrrry high. On the order of a billion ohms (1 Gigaohm). This is high enough that the inherent capacitance of a foot of shielded cable would audibly reduce the output of the microphone. All condenser microphones have an impedance converter, in the form of a vacuum tube or field-effect transistor (FET), built into the microphone, and located extremely close to the microphone element. The impedance converter and the microphone element itself require an external power source.<sup>1</sup>

### What is it, exactly?

The obvious external power source for any modern microphone is a battery. About the only electronic advantage that a battery has is that its output is pure DC. The only other advantage (to the battery company) is that you have to keep on buying them.

Tube microphones require several different voltages for operation. This invariably means a multi-conductor cable and non-standard (not XLR) connectors. A tube microphone will always have an associated external power supply.

In the late 1960's, Neumann (you know, the folks that brought you the U47 and U87

microphones) converted its microphones to solid-state, adopting a system of remote powering that they called, and trademarked, Phantom Powering. Because of the trademark, some manufacturers use terms like Simplex Powering, etc. Over the years, the trademark has become genericized and now refers to any device that is powered according to DIN standard 45 596 (or maybe it's DIN standard 45 595, we're not exactly sure...).

So, why "Phantom" Powering? Because (like the Phantom in the old comic strip) it's there when you need it, and invisible when you don't. This technology is not new, it actually predates rocket science. Like many other things in audio, it was brought to you by the telephone company, who used it to get an extra circuit from a pair of wires. In effect, so does your phantom powered microphone.

What is important is: phantom powering is a compatible system. Your dynamic/ribbon microphones as well as your condenser microphones work side-by-side, from the same microphone inputs, without further thought on your part.

Technically speaking, phantom powering refers to a system where the audio signal is applied to the balanced line in differential-mode, and the DC power is applied common-mode. The audio travels via pins 2 and 3, and the power travels between pins 2 and 3 simultaneously and pin 1.

Microphones that do not require power simply ignore the DC present between pin 2, pin 3, and pin 1. If you measure with a voltmeter between pin 2 and pin 3, you will read 0 Volts DC. This is what your dynamic microphone sees. Measuring between pin 2 and pin 1, or between pin 3 and pin 1, you will read the phantom power voltage, usually 48V, without a microphone connected. The dynamic microphone, as well as your balanced mixer input, ignores this voltage.

Lately, the term phantom power has been perverted to refer to any remote powering

<sup>1</sup>To be strictly correct, electret condenser microphones are a bit different as the microphone element does not require a power source for operation (it is more-or-less permanently self-polarized). Regardless, the impedance converter still requires an external source of power.



system. In the strict sense of the DIN standard, this is not true. Furthermore, microphones or transducers that claim to use this system are not compatible with the DIN standard and will almost certainly be damaged if connected into such a system. Fortunately, these systems use tip-ring-sleeve phone plugs or miniature XLR connectors and they are usually associated with instrument pickup applications<sup>2</sup>.

Phantom powering is defined in DIN standard 45 596 or IEC standard 268–15A. Your Mackie Designs mixer conforms to this standard.

**What works?**

To be compatible in a phantom powered system, a device (microphone, preamp with a microphone-style output, or direct box) must have a balanced and floating, low-impedance output. This includes all microphones commonly used for sound reinforcement and recording such as the Shure SM58, SM57, Electro-Voice RE-15, RE-16, RE-20, ND series, Beyer M160, M500, AKG D224, D12, D112, and MANY others.

If you are fortunate enough to own any tube condenser microphones, such as the AKG C12, Neumann U47 or U67, these microphones may be connected in a phantom powered system and will operate without regard to the presence or absence of phantom power. They will always require their external power supply (which must be plugged in and turned on).

<sup>2</sup>There is another remote powering system called A-B or T-system powering. It uses pins 2 and 3 to carry both power and audio. It is not compatible with dynamic microphones or phantom powered microphones.

**What doesn't work?**

The list is short:

1. Microphones with unbalanced outputs.
2. Microphones with grounded center-tapped outputs. Many old ribbon microphones were supplied connected this way. Have a technician lift the ground from the center tap.
3. High-impedance microphones.
4. Microphones that exhibit leakage between pin 2 or pin 3 and pin 1. These microphones will sputter and crackle when phantom power is applied and will work fine when you turn off the phantom power. Get the microphone repaired.

**Do's and Don'ts of Fixed Installations**

If you install sound systems into fixed installations, there are a number of things that you can do to make your life easier and that increase the likelihood of the sound system operating in a predictable manner. Even if you don't do fixed installations, these are good practices for any sound system, installed.

1. Do use foil-shielded snake cable for long cable runs. Carefully terminate each end, minimizing the amount of shielding removed. Protect the exposed foil shield with shrink sleeving or PVC sleeving. Prevent adjacent shields from contacting each other (electrically). Use insulating sleeving on the drain wire (the one that connects to pin 1) to prevent it from contacting the connector shell.

<b>DO &amp; DON'T CHART</b>	
<b>DO</b>	<b>DON'T</b>
If you are plugging in a condenser microphone, do verify that your microphone can be phantom powered.	Worry about your other microphones as long as their output is balanced and floating.
Ensure that the microphone's output is low impedance, balanced and floating. This is especially important for vintage ribbon microphones like the RCA 44BX and 77DX.	Connect microphones or devices that do not conform to the DIN 45 596 standard.
Mute the sound system when turning the phantom power on or off, or when connecting or disconnecting microphones. If you forget, the resulting loud, nasty POP may be your last.	Don't connect A-B or T-system microphones (another remote powering system) without suitable adaptors.

2. Don't connect the XLR connector shell to pin 1 of the XLR connector (unless necessary for RFI shielding). Doing so is an invitation for a ground loop to come visiting.
3. Do ensure that your speaker lines are physically separated from your microphone lines.
4. If you use floor pockets, use separate pockets for inputs and speakers, or put the connectors on opposite sides of the box, so that they may be shielded separately.
5. If your speaker lines run in the open, they should be twisted pairs, at least 6 twists per foot. Otherwise, run the speaker lines in their own conduit. (Of course, conduit is not too practical for portable systems, heh-heh).
6. Minimize the distance between the power amplifiers and the speakers.
7. Use heavy gauge, stranded wire for speaker lines. Ideally, the wire resistance should be less than 6% (0.5dB power loss) of the load impedance. Remember that the actual run is twice as long as the physical length of the run. See below.

#### Maximum wire run for 0.5dB power loss

wire gauge	res. per 1000 ft.	2 $\Omega$	4 $\Omega$	8 $\Omega$
10	1.00	60	120	240
12	1.59	40	75	150
14	2.5	24	48	95
16	4.02	15	30	60

6. Ensure that the electrician uses the star-ground system for the safety grounds in your electrical system. All of the audio system grounds should terminate at the same physical point. No other grounds may come in contact with this ground system.
7. Ensure that the AC power feeds are connected to the same transformer, and ideally, the same circuit breaker.
8. Walk outside – look in the horizon, see any radio towers? Locate potential sources of RF interference and plan for them before you begin construction. Know what frequency, transmitter power, etc. You can get this information by calling the station. Remember that many broadcast stations change antenna coverage pattern and transmitter power at night.

9. Don't use hardware-store light dimmers.
10. Don't allow for anything other than microphone inputs at stage/altar locations. Supplying line inputs at these locations is an invitation for misuse. Make all sources look like microphones to the console.
11. Balance (or at least impedance balance) all connections that are remote from the console's immediate location.
12. If you bridge an amplifier, don't use 1/4-inch phone plugs for speaker connectors.

## Grounding

Grounding exists in your audio system for two reasons: product safety and noise reduction. The third wire on the power cord exists for product safety. It provides a low-resistance path back to the electrical service to protect the users of the product from electrical shock. Hopefully, the resistance to ground through the safety ground (third wire) is lower than that through the user/operator to ground. If you remove this connection (by breaking or cutting the pin off, or by using a 'ground cheater'), this alternate ground path ceases to exist, which is a safety hazard.

The metal chassis of the product, the ground connections provided by the various connectors, and the shields within your connecting cables provide a low potential point for noise signals. The goal is to provide a lower impedance path to ground for noise signals than through the signal wiring. Doing so helps minimize hum, buzz, and other extraneous non-audio signals.

Many "authorities" tell you that shields should only be connected at one end. Sometimes this can be true, but for most (99%) audio systems, it is unnecessary. If you do everything else correctly, you should be able to connect every component of your audio system using standard, off-the-shelf connecting cables that are available at any music store.

Here are some guidelines:

1. All return lines to the stage should be balanced. At a minimum, they should be impedance balanced. Remember that you can balance a line by inserting a piece of equipment inline that has a balanced output.
2. Run your own AC power wiring from the stage for the mixer and related equipment. Don't use the "conveniently located" receptacle thoughtfully provided by the management for your use. You have no idea how it's wired or grounded.

3. Carry an outlet tester; available at any well-stocked hardware store. Use it to tell you if the outlet you're about to plug into is wired correctly. Consider it cheap insurance.
4. If you carry enough equipment that you need to wire directly into the electrical service, then use a voltmeter to ensure that the line voltage is correct, then use the outlet tester mentioned in #3, above. Do this before you connect any of your audio equipment. Chances are that your 120V gear won't be too happy if it sees 220V for any length of time.
5. Cables that are too long are less likely to pick up hum if you uncoil them in their entirety, and then find a place to stow the excess. Leaving the excess coiled only helps the cable pick up hum more efficiently.
6. Don't run unbalanced lines to or from the stage. It's not the impedance, it's the fact that they're unbalanced. It's a good idea to use a direct box to make the unbalanced source look like a microphone.
7. For really extreme cases, you may need to insert 1:1 or isolation transformers into each return line from the front-of-house location to your amp racks.
8. **Don't cut the third pin off of the power cord.** Carry some ground-lifter adapters and use them only when you have to plug into an ancient two-wire outlet.
9. If you bundle your cables together, don't bundle AC wiring and audio wiring together. Bundle them separately.
10. If your sound system insists on humming, you may need to teach it the words.

# APPENDIX E: SPECIFICATIONS: TECH STUFF

## SR24•4 and SR32•4 Specifications

**Noise** (20Hz to 20kHz bandwidth, Line inputs to Main L/R outputs, all channels assigned, panned L/R):

Master fader down, Ch. gains down	-94.7dBu
Master fader @ unity, Ch. gains down	-87.4dBu
Master fader @ unity, Ch. gains @ unity	-83.5dBu

**Total Harmonic Distortion**

(1KHz @ +14dBu 20Hz-20kHz, Channel input):

Any output	below .004%
------------	-------------

**Crosstalk** (1kHz @ 0dBu, 20Hz to 20Khz bandwidth, channel in to Main Left outputs):

Channel fader down, channels at Unity	-89.5dB
Channel muted, channels 2-16 at Unity	-88.7dB

**Frequency Response** (any input to any output):

20Hz to 50KHz	+0/-1dB
20Hz to 100KHz	+0/-3dB

**Maximum Levels**

Mic preamp input	+14dBu
All other inputs	+22dBu
Balanced XLR outputs	+28dBu
All other outputs	+22dBu

**Impedances**

Mic preamp input	1.5kΩ
All other inputs	>10kΩ
All outputs	120kΩ

**Equalization**

Lo EQ	Shelving	80Hz	±15dB
Mid EQ	(mono ch) Peak	100-8kHz	±15dB
Hi EQ	Shelving	12kHz	±15dB

**Microphone Preamp**

E.I.N. (150Ω terminated, max gain):	-129.5dBm
-------------------------------------	-----------

**Power Requirements**

60 watts

**Weight**

SR24•4	31 lbs. (14 kg.)
SR32•4	40.7 lbs. (18.8 kg.)



**SR24•4 and SR32•4 Gain Path Diagram — all levels in dBu**

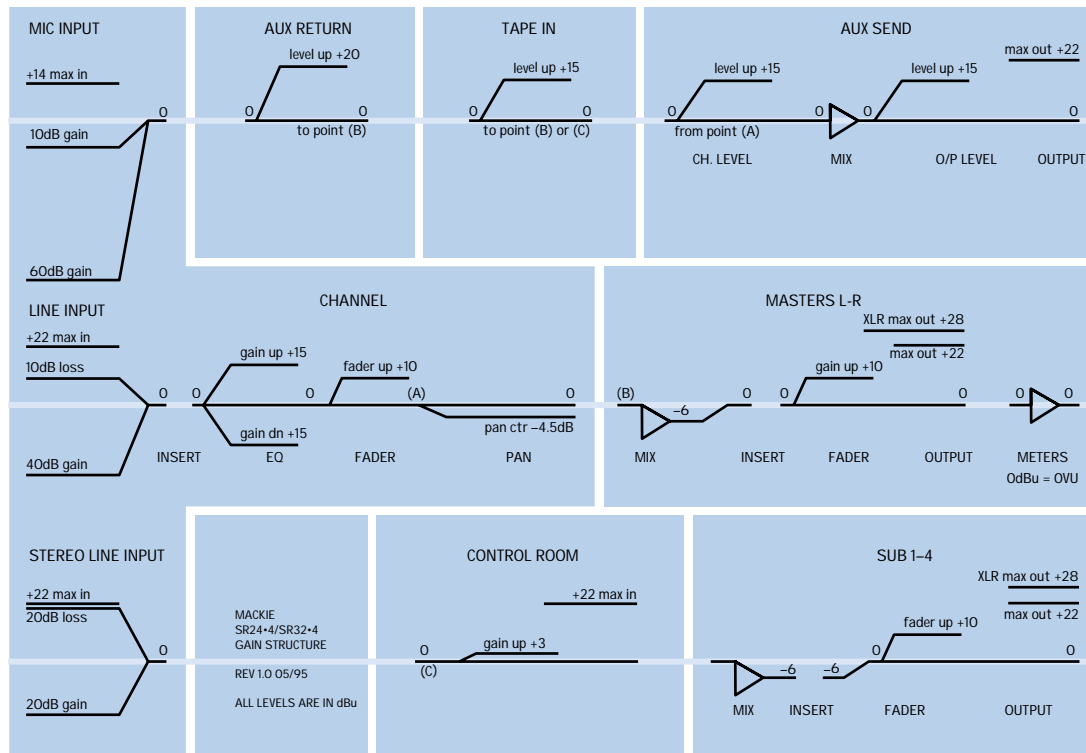

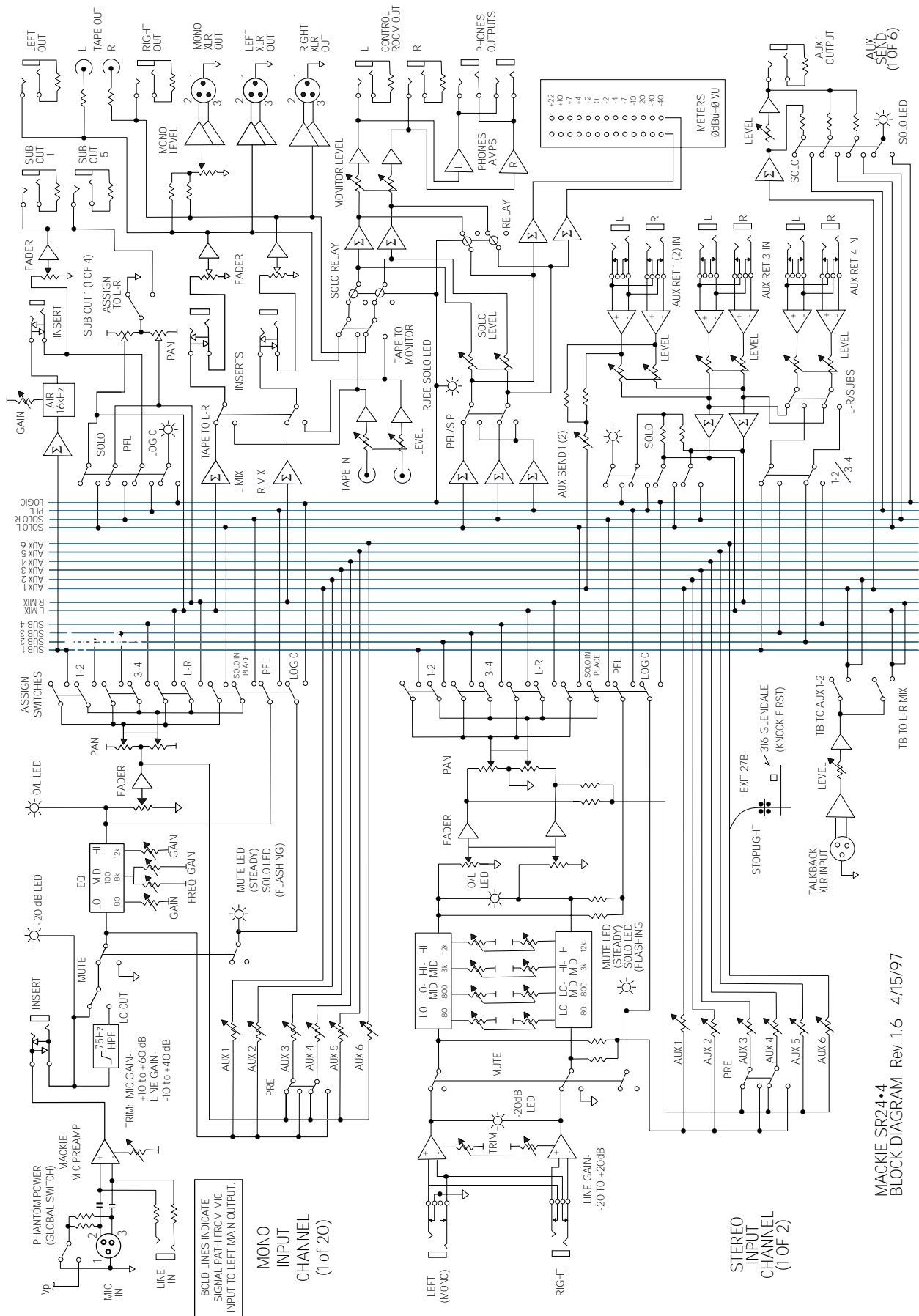

MACKIE SR24.4  
BLOCK DIAGRAM Rev. 1.6 4/15/97



**MACKIE® SR24•4**  
 24x4x2x1 4 BUS MIXING CONSOLE  
 V.1.0 7/94 ©1995 MACKIE DESIGNS INC.™

SR24•4  
 WEIGHT  
 31 lbs.

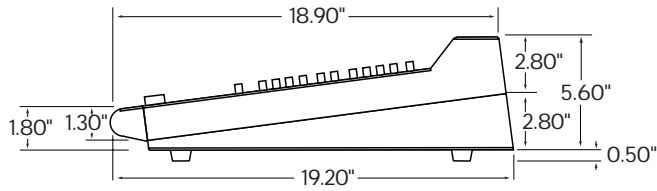
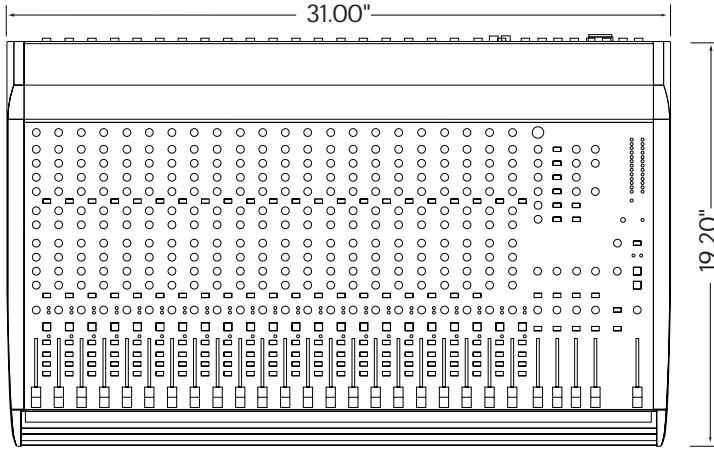

Appendices

**MACKIE® SR32•4**  
 32x4x2x1 4 BUS MIXING CONSOLE  
 V.1.0 8/95 ©1995 MACKIE DESIGNS INC.™

SR32•4  
 WEIGHT  
 41 lbs.

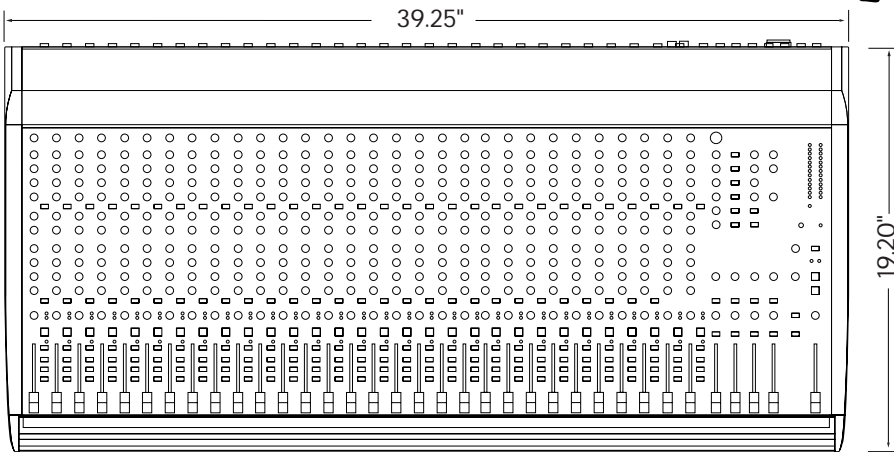

# APPENDIX F: Modifications

**CAUTION** — These modification instructions are for use by qualified personnel only. To avoid electric shock, do not perform any servicing other than changing the fuse unless you are qualified to do so. Refer all servicing and modifying to qualified personnel.

We have included step-by-step instructions for three different SR24•4 console modifications. (They can also be done on the SR32•4.) Before we go any farther, consider that performing ANY modification will place your factory warranty in jeopardy. Here is the Official Mackie Statement:

## Official Disclaimer

**Any modification of any Mackie Designs product must be done by a competent electronic technician. Mackie Designs, Inc., accepts no responsibility for any damages or injuries caused by any modification, regardless of the source of the modification instructions or the qualifications of the technician performing them. In the case of such damages, Mackie Designs may declare warranty privileges void. BE CAREFUL!**

## To clarify...

These modifications are extremely easy, relative to what a real technician is used to doing. However, they are extremely difficult and dangerous for the inexperienced. If you're not a qualified, experienced technician, don't even think about considering the possibility of conceiving of doing these mods yourself.

Ask around to find a decent repair/modification shop that guarantees its own work in writing (even then, your Mackie Limited Warranty can be in jeopardy). Better yet, wait until the Warranty expires.

## A note about adding jumpers during these modifications

When a jumper or jumpers are called for, they should NOT go into holes in the PCB. Rather, they should be soldered to the flat, tinned area around the hole (called a pad) and bowed slightly over to the other pad (see Figure below). Make sure the ends of those jumpers do not extend beyond the pad.

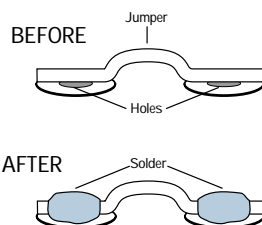
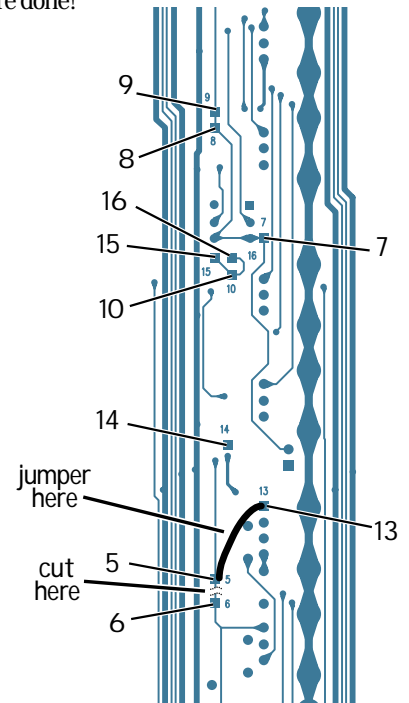

Figure 7

## Modification 1 — Aux Sends 1, 2, 3, and 4 to Pre-fader, Post-EQ

This modification converts Aux 1, Aux 2, Aux 3, and Aux 4 into pre-fader, post-EQ monitor sends. Aux 3 and Aux 4 are pre-fader, pre-EQ when the pre switch is down and post-fader, post-EQ when the pre switch is up. This modification can be done on any or all of channels 1–20 (1–28 on the SR32•4).

1. Remove all cords from the SR24•4 and place it face down.
2. Remove the five screws from the two plastic end caps on both sides of the mixer.
3. Remove the end caps.
4. Remove the 20 bottom and side screws from the bottom of the mixer. Be careful not to remove the transformer screws which sit below the surface of the bottom piece.
5. Remove the bottom piece and set it aside.
6. Cut the trace between pad 5 and pad 6.
7. Add a jumper wire between pad 5 and pad 13 taking care to not smash the wires down on the circuit board. Let them arch above if possible.
8. Replace the bottom piece and reattach it to the mixer with the proper screws.
9. Replace the plastic end caps.
10. Hooray, you're done!



## Modification 2 — Aux Sends 1 and 2 to Post-fader, Post-EQ

This modification converts Aux 1 and Aux 2 into post-fader, post-EQ effects sends. This modification can be done on any or all of channels 1–20 (1–28 on the SR32•4).

1. Remove all cords from the SR24•4 and place it face down.
2. Remove the five screws from the two plastic end caps on both sides of the mixer.
3. Remove the end caps.
4. Remove the 20 bottom and side screws from the bottom of the mixer. Be careful not to remove the transformer screws which sit below the surface of the bottom piece.
5. Remove the bottom piece and set it aside.
6. Cut the trace between pad 8 and pad 9.
7. Add a jumper wire between pad 10 and pad 9 taking care to not smash the wires down on the circuit board. Let them arch above if possible.
8. Replace the bottom piece and reattach it to the mixer with the proper screws.
9. Replace the plastic end caps.
10. Hooray, you're done!

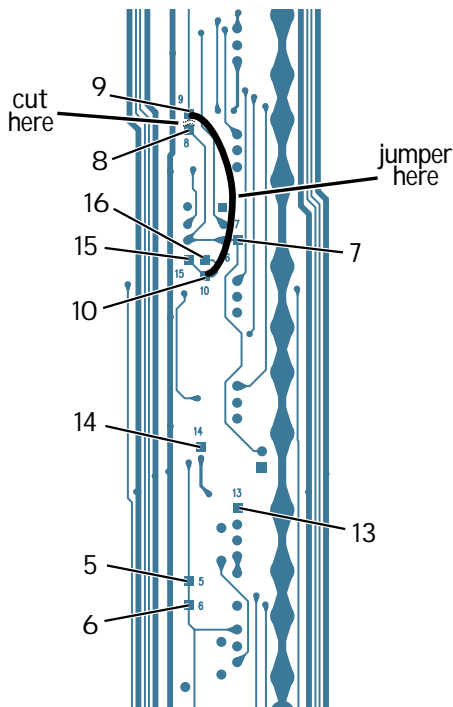

## Modification 3 — Aux Sends 5 and 6 to Pre-fader, Pre-EQ

This modification converts Aux 5 and Aux 6 into pre-fader, pre-EQ monitor sends.

1. Remove all cords from the SR24•4 and place it face down.
2. Remove the five screws from the two plastic end caps on both sides of the mixer.
3. Remove the end caps.
4. Remove the 20 bottom and side screws from the bottom of the mixer. Be careful not to remove the transformer screws which sit below the surface of the bottom piece.
5. Remove the bottom piece and set it aside.
6. Cut the trace between pad 10 and pad 16.
7. Add a jumper wire between pad 16 and pad 7 taking care to not smash the wires down on the circuit board. Let them arch above if possible.
8. Replace the bottom piece and reattach it to the mixer with the proper screws.
9. Replace the plastic end caps.
10. Hooray, you're done!

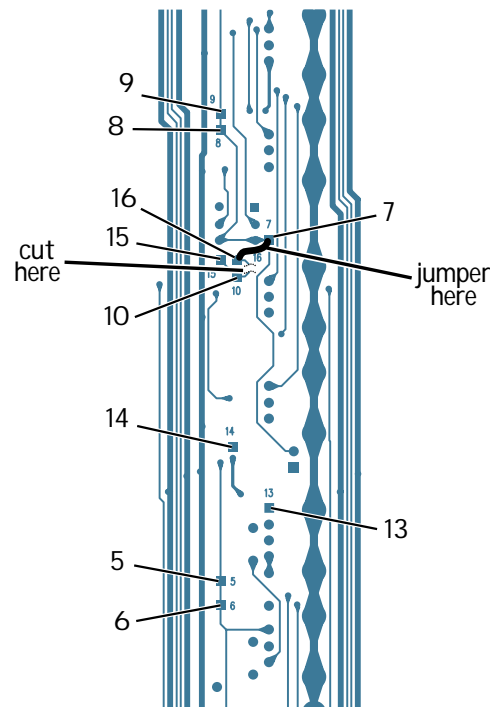

# APPENDIX G: Service

## PLEASE! SAVE THE SHIPPING BOX!

Yes, we know that it's slightly larger than the suitcase you're living out of, but you will need the entire carton and internal foam if your mixer ever needs service at some time in the future.

If your kids make the box into a gerbil palace and cut holes in it — or if you stuff it in the dumpster of the fast-food place next door to your studio, we may have to sell and ship you another packing box later on.

Don't end up buying an empty box!

## SERVICE

Mackie mixing systems are notoriously bullet-proof and reliable. But, hey... stuff happens. Any electronic product with as many parts as an audio mixer can occasionally have a minor casualty somewhere inside.

And even if we could build our products to never break, there are those acts of nature that tend to visit mixing boards on occasion: spilled coffee, toppling monitors, lizard infestations, etc. This section covers how to get your Mackie SR24•4 mixer healthy again.

## TROUBLESHOOTING

It benefits everyone if you do a bit of basic troubleshooting in advance of panicking and sending the unit back. Some low-key detective work will determine whether or not your mixer is really malfunctioning. First, it saves you downtime and embarrassment if, for example, you discover that the only thing wrong is an unplugged power cord. Second, it will save money. If you ship your mixer to Mackie and we can't duplicate the problem, you may get slapped with a service charge (plus shipping costs).

We could write a whole manual on troubleshooting, but our main point is that there are a few obvious things you can easily look for:

**Power connections.** This sounds insultingly simple, but if the whole mixer is completely

dead, it's time to make sure that: the power cable is connected into a live source of power; the mixer is turned on, the fuse is OK, etc.

**Intermittent signal problems.** Faulty plugs and cables are often the culprits. A TRS plug can sit in a socket for months doing its job and then suddenly decide (based on the phase of the moon and barometric pressure) to short or stop conducting. If you're having trouble with an individual channel, send or return, for gosh sakes swap cables before sending the mixer in for service.

**Check patching and switch positions.** The SR24•4 is not a Boeing 777 (the Glass Cockpit pride of the Northwest) but it *is* possible to have a switch in the wrong position and not notice it. How about the TAPE TO MASTER switch? Or, have you plugged something into a channel or bus Insert jack?

Finally, ***it doesn't hurt to call our Technical Support Department at 800/258.6883 (8:00 AM–5:00 PM Pacific Time) to see if they have any ideas as to what might be wrong.***

## WHERE IT GETS FIXED

Service and repairs of Mackie SR24•4 mixers are to be performed *only* at our high-tech, rainforest factory.

*Unauthorized service, repairs or modification will void your warranty.*

## TO OBTAIN FACTORY SERVICE:

1. Call Mackie Customer Service at 800/258-6883 (Monday through Friday 8:00 AM–5:00 PM Pacific Time) to get a Return Authorization Number (RA number). ***Please have your serial number ready.***  
***Products returned without an RA number will be refused.***



2. Pack the mixer in its original shipping carton. If you do not have the carton, request one when you get your RA number, and we'll send a shipping carton out promptly. There may be a charge, however—we put those huge “SAVE THE BOX” warnings in this manual for a reason. Make sure that you encase the mixer in its plastic wrapper and insert all the foam blocks to properly protect the mixer.



**Ultra Important:**

Move all the faders to their “up” position before packing the mixer in the shipping carton. This will prevent damage to the faders during shipment.

3. When packing the mixer, include:
  - A. a note explaining exactly how to duplicate the problem.
  - B. a *copy* of the sales receipt showing price and date. If we cannot duplicate the problem at the Mackie factory or establish the starting date of your Limited Warranty, we may, at our option, charge for service time.
  - C. your complete return street address (no P.O. boxes or route numbers, please!) and DAYTIME phone number.
4. **Write the RA number plainly on the outside of the shipping carton in BIG print (those huge stinky sign markers work well for this).**
5. Ship the product in its original shipping carton, freight prepaid to:

**Mackie Designs**  
**attn: Service**  
**16220 Woodinville-Redmond Road NE**  
**Woodinville, WA 98072**  
**U.S.A.**

### A FREE T-SHIRT OFFER

We love to hear what folks have created using our mixers. If you use your SR24•4 to track or mix (or track and mix) a CD or cassette that is commercially released, we'll trade you a copy for a genuine Mackie T-shirt.

If you send us some notes as to when and where and how the production was accomplished, a picture of your cassette or CD, a short caption will probably end up in our monthly newsletter.

Also Greg Mackie listens to most of 'em.

By “commercially released,” we mean “offered for sale,” even if it's just being sold in your local area, during band breaks at clubs or via mail order.

No hand-lettered dubs, please. Save those for our infrequent Mixed on a Mackie contests.

To get your genuine 100% cotton, Made in USA, Mackie celebrity T-shirt, send your cassette or CD to:

**Mackie Designs**  
**FREE T-SHIRT OFFER**  
**attn: Communications Department**  
**16220 Woodinville-Redmond Road NE**  
**Woodinville, WA 98072**

Make sure to specify L, XL or XXL size.

If you prefer a small or medium size, just request a Large and run it through a hot dryer several times.

Allow several weeks for delivery. We're always busier than a carrion fly at a Rottweiler convention.

### Bouquets and brickbats

This manual was primarily written by Dave Matthew, with additional scribbles by Ron Koliha and a cool appendix on phantom power and grounding and stuff by on-staff mega-SR guru Rick Chinn. It was all viciously scribbled up with red pens by the Mackie Technical Support Department and by Manufacturing Engineering Honcho, Jeff Gilbert. Valiant attempts at proof-reading by Linn Compton. Composed on souped-up Mac™s in PageMaker™ 5.0 by the galley slaves in the Mackie Digital Mosh Pit.

As is invariably the case, there are mistakes and fuzzy parts that need correction. Feel free to write us with your comments and criticisms. We *do* respond to outside input — except for the occasional priggish letters that take us to task for our lighthearted writing style. Since comments run 100-to-1 FOR our non-stuffy style, we tend to ignore comments about how smart-alecky we are and secretly hope that the letter writers are condemned to what is probably a pleasant lifetime of reading other companies' often dry or incomprehensible manuals.

Mackie and the Running Man figure are trademarks or registered trademarks of Mackie Designs Inc. All other brand names mentioned are trademarks or registered trademarks of their respective holders, and are hereby acknowledged.

©1997 Mackie Designs Inc.  
 All rights reserved.  
 Printed in the U.S.A.





# SR24•4/SR32•4 Track Sheet A

TRIM 18	AUX	EQ	PAN	MUTE/SOLO
TRIM 17	AUX	EQ	PAN	MUTE/SOLO
TRIM 16	AUX	EQ	PAN	MUTE/SOLO
TRIM 15	AUX	EQ	PAN	MUTE/SOLO
TRIM 14	AUX	EQ	PAN	MUTE/SOLO
TRIM 13	AUX	EQ	PAN	MUTE/SOLO
TRIM 12	AUX	EQ	PAN	MUTE/SOLO
TRIM 11	AUX	EQ	PAN	MUTE/SOLO
TRIM 10	AUX	EQ	PAN	MUTE/SOLO
TRIM 9	AUX	EQ	PAN	MUTE/SOLO
TRIM 8	AUX	EQ	PAN	MUTE/SOLO
TRIM 7	AUX	EQ	PAN	MUTE/SOLO
TRIM 6	AUX	EQ	PAN	MUTE/SOLO
TRIM 5	AUX	EQ	PAN	MUTE/SOLO
TRIM 4	AUX	EQ	PAN	MUTE/SOLO
TRIM 3	AUX	EQ	PAN	MUTE/SOLO
TRIM 2	AUX	EQ	PAN	MUTE/SOLO
TRIM 1	AUX	EQ	PAN	MUTE/SOLO

Notes:

# SR24•4/SR32•4 Track Sheet B

**MACKIE.**  
32•4•2 4-BUS MIXING CONSOLE

Session: \_\_\_\_\_ Date: \_\_\_\_\_

**SR32•4**  
VERY LOW IMPEDANCE DESIGN

**STEREO RETURNS**

**AUX SEND MASTERS**

**AUX RETURN**

**LEVEL SET LEFT RIGHT**

**POWER**

**MODE**

**REFERENCE LEVEL**

**PHONES/C-R LEVEL**

**MAIN MIX**

**TRACK 1 • 5**

**TRACK 2 • 6**

**TRACK 3 • 7**

**TRACK 4 • 8**

**TRACK 19 MUTE**

**TRACK 20 MUTE**

**TRACK 21 MUTE**

**TRACK 22 MUTE**

**TRACK 23 MUTE**

**TRACK 24 MUTE**

**TRACK 25 MUTE**

**TRACK 26 MUTE**

**TRACK 27 MUTE**

**TRACK 28 MUTE**

**TRACK 29-30 MUTE**

**TRACK 31-32 MUTE**