

®

MACKIE

SR40•8/SR56•8 OWNER'S MANUAL

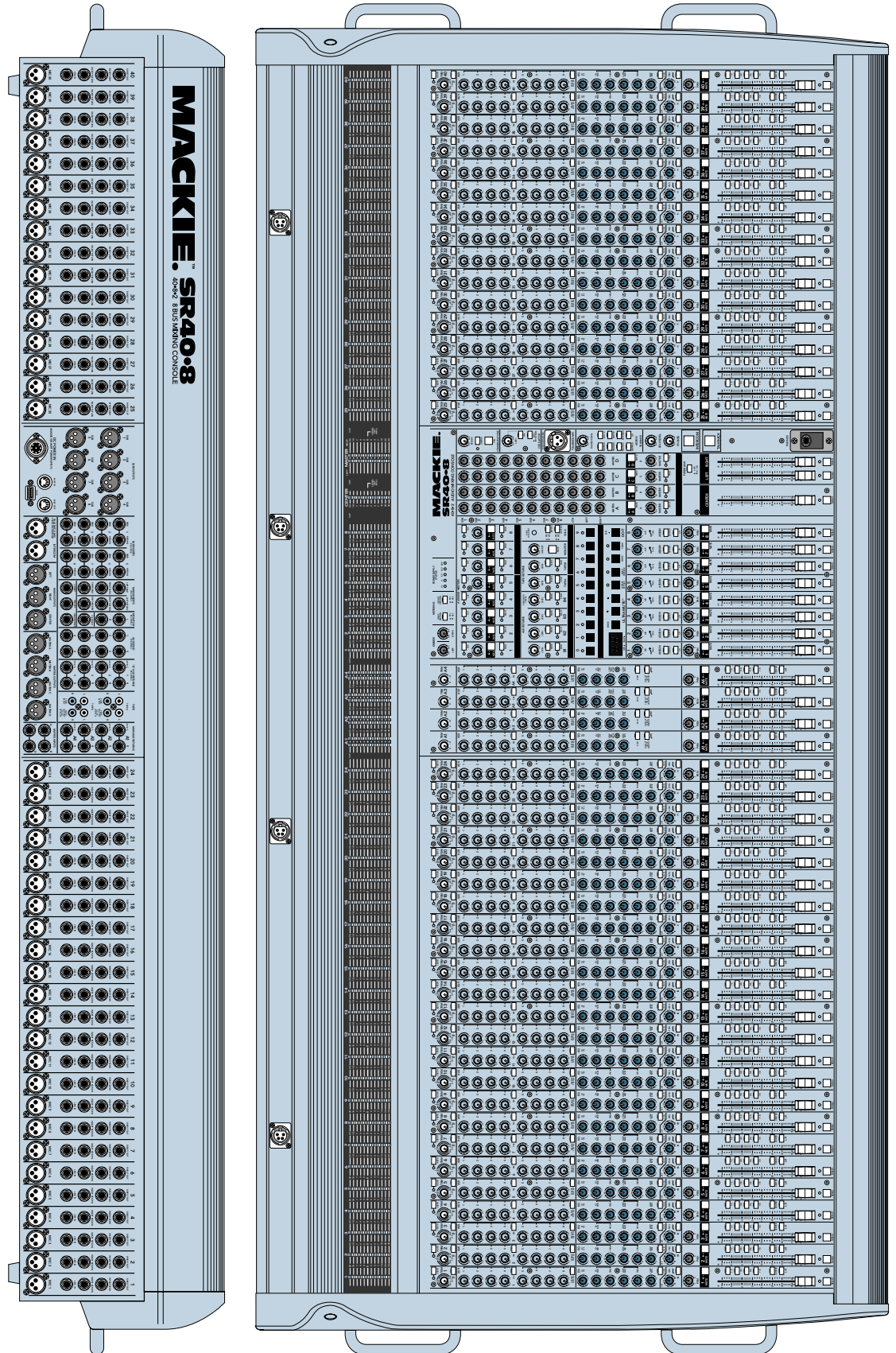



The lightning flash with arrowhead symbol within an equilateral triangle is intended to alert the user to the presence of uninsulated "dangerous voltage" within the product's enclosure, that may be of sufficient magnitude to constitute a risk of electric shock to persons.

Le symbole éclair avec point de flèche à l'intérieur d'un triangle équilatéral est utilisé pour alerter l'utilisateur de la présence à l'intérieur du coffret de "voltage dangereux" non isolé d'ampleur suffisante pour constituer un risque d'électrocution.



The exclamation point within an equilateral triangle is intended to alert the user of the presence of important operating and maintenance (servicing) instructions in the literature accompanying the appliance.

Le point d'exclamation à l'intérieur d'un triangle équilatéral est employé pour alerter les utilisateurs de la présence d'instructions importantes pour le fonctionnement et l'entretien (service) dans le livret d'instruction accompagnant l'appareil.

SAFETY INSTRUCTIONS

1. Read Instructions — All the safety and operation instructions should be read before this Mackie product is operated.
2. Retain Instructions — The safety and operating instructions should be kept for future reference.
3. Heed Warnings — All warnings on this Mackie product and in these operating instructions should be followed.
4. Follow Instructions — All operating and other instructions should be followed.
5. Water and Moisture — This Mackie product should not be used near water — for example, near a bathtub, washbowl, kitchen sink, laundry tub, in a wet basement, near a swimming pool, swamp or salivating St. Bernard dog, etc.
6. Heat — This Mackie product should be situated away from heat sources such as radiators, or other devices which produce heat.
7. Power Sources — This Mackie product should be connected to a power supply only of the type described in these operation instructions or as marked on this Mackie product.
8. Power Cord Protection — Power supply cords should be routed so that they are not likely to be walked upon or pinched by items placed upon or against them, paying particular attention to cords at plugs, convenience receptacles, and the point where they exit this Mackie product.
9. Object and Liquid Entry — Care should be taken so that objects do not fall into and liquids are not spilled into the inside of this Mackie product.

10. Damage Requiring Service — This Mackie product should be serviced only by qualified service personnel when:

- A. The power-supply cord or the plug has been damaged; or
- B. Objects have fallen, or liquid has spilled into this Mackie product; or
- C. This Mackie product has been exposed to rain; or
- D. This Mackie product does not appear to operate normally or exhibits a marked change in performance; or
- E. This Mackie product has been dropped, or its chassis damaged.

11. Servicing — The user should not attempt to service this Mackie product beyond those means described in this operating manual. All other servicing should be referred to the Mackie Service Department.

12. To prevent electric shock, do not use this polarized plug with an extension cord, receptacle or other outlet unless the blades can be fully inserted to prevent blade exposure.

Pour prévenir les chocs électriques ne pas utiliser cette fiche polarisée avec un prolongateur, un prise de courant ou une autre sortie de courant, sauf si les lames peuvent être insérées à fond sans laisser aucune partie à découvert.

13. Grounding or Polarization — Precautions should be taken so that the grounding or polarization means of this Mackie product is not defeated.

14. This apparatus does not exceed the Class A/Class B (whichever is applicable) limits for radio noise emissions from digital apparatus as set out in the radio interference regulations of the Canadian Department of Communications.

ATTENTION — Le présent appareil numérique n'émet pas de bruits radioélectriques dépassant les limites applicables aux appareils numériques de class A/de class B (selon le cas) prescrites dans le règlement sur le brouillage radioélectrique édicté par les ministere des communications du Canada.

15. To prevent hazard or damage, ensure that only microphone cables and microphones designed to IEC 268-15A are connected.

WARNING — To reduce the risk of fire or electric shock, do not expose this appliance to rain or moisture.

This equipment has been tested and found to comply with the limits for a Class A digital device, pursuant to part 15 of the FCC rules. These limits are designed to provide reasonable protection against harmful interference when the equipment is operated in a commercial environment. This equipment generates, uses, and can radiate radio energy and, if not installed properly and used in accordance with the instruction manual, may cause harmful interference to radio communications. Operation of this equipment in a residential area is likely to cause harmful interference in which case the user will be required to correct the interference at his own expense.

READ THIS PAGE!!!

We realize that you must have a powerful hankerin' to try out your new SR40•8. Or you might be one of those people who never read manuals. Either way, all we ask is that you read this page *now*, and the rest can wait until you're good and ready. But do read it — you'll be glad you did.

1 LEVEL-SETTING PROCEDURE

There isn't too much to setting levels. No rocket science here (well... maybe a bit). Here's what you need to do:



Hyper-Quick-Turbo Method

1. Set the TRIM **47** controls at minimum (fully counter-clockwise).
2. Set the METERING: INPUT SECTION switch to PFL mode **126** so your Fader settings won't affect your input meter readings.
3. Set the METERING: OUTPUT SECTION switch to AFL mode **127** so that the Meters reflect the actual output levels.
4. Set all of the Faders to their "U" markings.
5. Ask the musicians to start playing.
6. Set a rough mix, using the TRIM controls. The goal is to get Meter readings at or around 0dB for all of the inputs.
7. Once you've adjusted the input levels, use the Channel Faders to set the Channel levels, and leave the TRIM controls alone.
8. If the overall level gets too loud, bring the overall LEFT and RIGHT level down a bit, 10dB at the most. You may need to reduce the TRIM settings further.

Alternate Method

This method results in the faders being in a straight line across the board.

1. Set the METERING: INPUT SECTION switch to PFL mode **126** so your Fader settings won't affect your input meter readings.
2. Set the METERING: OUTPUT SECTION switch to AFL mode **127** so that the Meters reflect the actual output levels.
3. While the musicians are playing, watch each Channel Meter and adjust the TRIM **47** control so that level is near 0dB as read on the Channel's Meter.
4. After setting the Channel EQ, you will probably want to readjust the TRIM control slightly to bring the Meter back to near the 0dB reading.
5. As the mix comes together, readjust the TRIM control down so that the Channel Fader can be set at its "U" (unity gain) setting.
6. You can also SOLO the Channel and monitor its level via the LEFT, RIGHT, and CENTER Meters in the output section.

Other Nuggets of Wisdom

Before plugging or unplugging a cord from a Channel or a MAIN AUX RETURN (A1-A4), be sure to engage the MUTE switch first.

If you shut down your equipment, turn off your amplifiers first. When powering up, turn on your amplifiers last.

Save the shipping boxes! We're sure that you can find an empty airport hanger or boat moorage to store them. You may need them someday, and you don't want to have to pay for them again.



Please write your serial numbers here for future reference (i.e., insurance claims, tech support, return authorization, etc.):

Console

Power Supply

Purchased at:

Date of purchase:

INTRODUCTION

Thank you! You have voted with your wallet for the folks in Woodinville who specialize in mixing. The SR40•8 and SR56•8 Large Format Sound Reinforcement Consoles are designed to fulfill the mixing needs of almost any type of sound reinforcement application, and it boasts a wealth of features for which you'd expect to pay a lot more. Although you may be familiar with these features, your investment will pay for itself much faster if you take the time to read this manual. (If reading manuals is not your style, please do it anyway, just don't tell anyone you did.)

HOW TO USE THIS MANUAL

In order to simplify things throughout the rest of the manual we refer to the console as the SR40•8, but rest assured that all the features described herein are identical to the features you will find on the SR56•8.

Overview: The SR40•8 In A Nutshell

If you're new to mixing, or unfamiliar with some of the features on the SR40•8, check out the Overview section and Hookup Diagrams. They provide a quick summary of the basic functions of your SR40•8.

Feature Descriptions: Mind-boggling Details

Each and every knob, button and connector on the SR40•8 is explained in depth here including the points before and after in the signal chain. This is to give you a better sense of exactly where in the signal path a particular control or connector is located. Each feature is described in order of where it is physically located on the console's top or rear panel. These descriptions are divided into three sections, just as your mixer is organized into three distinct zones:

1. **PATCH PANEL:** The zillion jacks on the back "pod."
2. **CHANNEL:** The 40 Channel strips on the left and right. The Main Aux Return strips contain many similar features.
3. **OUTPUT SECTION:** The output section in the center.

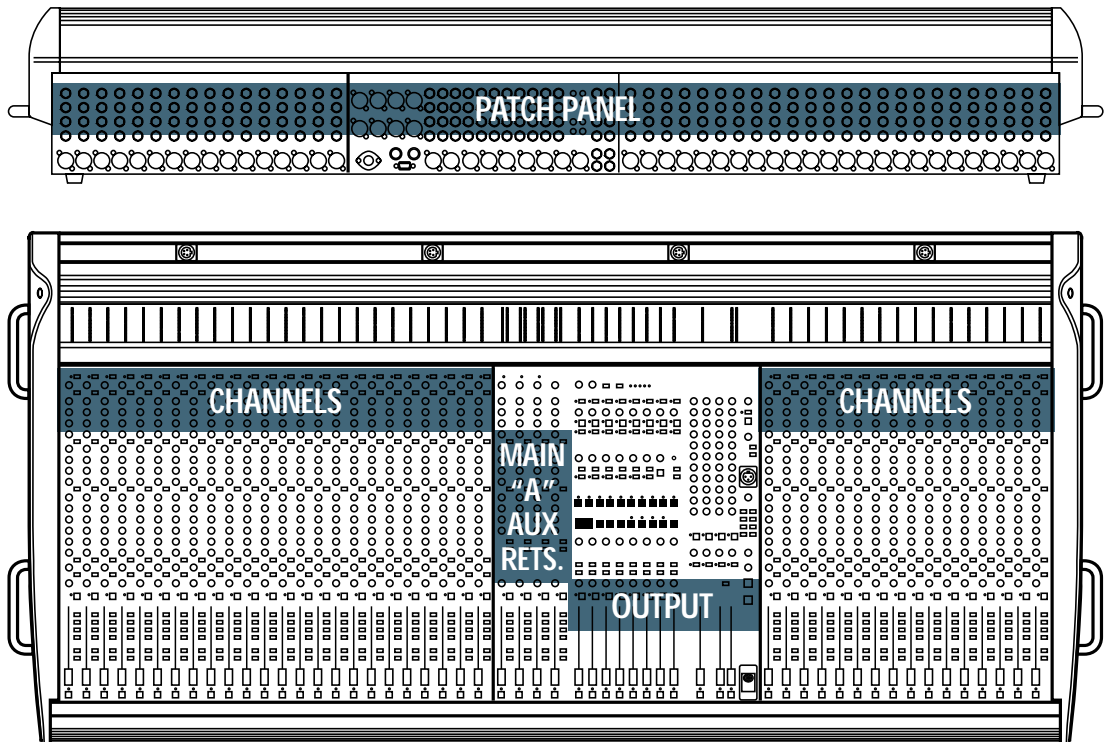

Special Icons

Throughout these chapters you'll find illustrations, with each feature numbered. If you're curious about a feature, simply locate it on the appropriate illustration, note the number attached to it, and find that number in the nearby paragraphs.



This icon marks information that is critically important or unique to the SR40•8. For your own good, read these sections and remember them.



This icon will lead you to in-depth explanations of features and practical tips. While not mandatory, they'll have some valuable information.

The Glossary: A Haven Of Non-techiness For The Neophyte

Just in case you're new to the audio world, we've included a fairly comprehensive dictionary of pro audio terms. If terms like "clipping," "noise floor," or "unbalanced" leave you blank, flip to the glossary at the back of this manual for a quick explanation.

A Plug For The Connectors Section

Also at the back of this manual is a section on connectors: XLR, TRS and RCA connectors, balanced connectors, unbalanced connectors, special hybrid connectors. If you plan on wiring your own cables, please visit this section before you start.

Arcane Mysteries Illuminated

Last but not least, we've included an appendix titled "Balanced Lines, Phantom Powering, Grounding and Other Arcane Mysteries." This section discusses some of the down 'n' dirty practical realities of microphones, fixed installations, grounding and balanced versus unbalanced lines. It's a gold mine for the neophyte, and even the seasoned pro might learn a thing or two.

CONTENTS

READ THIS PAGE!!!	3	49 EQ	21
1 LEVEL-SETTING PROCEDURE	3	51 HI 12K	21
HYPER-QUICK-TURBO METHOD	3	52 HI MID AND 53 FREQ	21
ALTERNATE METHOD	3	54 LOW MID AND 55 FREQ	22
OTHER NUGGETS OF WISDOM	3	56 LOW 80HZ	22
INTRODUCTION	4	57 EQ IN	22
2 SR40•8 HOOKUP EXAMPLES	8	58 HPF AND 59 FREQ	22
OVERVIEW: THE SR40•8 IN A NUTSHELL	10	61 CHANNEL OUTPUT CONTROLS	23
3 MIXING	10	62 MUTE	23
4 MATRIX	10	63 FADER	24
5 STAGE MONITORS & EFFECTS	10	64 A CLEAN FADE	24
6 MONITORING, SOLO & METERING	11	65 PAN	24
7 TALKBACK & INTERCOM	11	66 CONSTANT LOUDNESS	24
8 ULTRA MUTE™	11	67 1-2, 3-4, 5-6, 7-8, L-R (ASSIGN)	24
9 SWITCH POSITIONS	11	68 CENTER (ASSIGN)	25
11 PATCH PANEL	12	69 SOLO	25
12 E-Z INTERFACE	12	71 METER	26
13 MIC INPUT	12	72 AUX SEND	26
14 LINE IN	13	73 PRE switch (AUX 1–4)	26
15 INSERT SEND AND RETURN	13	74 PRE FDR/POST EQ (AUX SENDS 5–8) ...	27
16 DIRECT OUT	13	75 MAIN AUX RETURNS (A1–A4)	27
17 MAIN AUX RETURNS (A1–A4)	14	76 TRIM	27
18 “B” AUX RETURNS	14	77 HPF	27
19 TAPE INPUT	15	78 EQ	27
21 TAPE A OUTPUT	15	79 PAN	28
22 TAPE B OUTPUT	15	81 1-2, 3-4, 5-6, 7-8, L-R (ASSIGN)	28
23 AUX SEND	15	82 CENTER (ASSIGN)	28
24 MAIN OUTPUTS	16	83 SOLO	28
25 MAIN INSERTS	16	84 METER	28
26 SUB OUTPUTS	16	85 AUX SEND	28
27 SUB INSERTS	17	86 OUTPUT SECTION	29
28 29 HEADPHONES	17	87 LEFT/RIGHT/CENTER MIXES	29
31 L-INSERT, R-INSERT (HEADPHONES)	17	88 LEFT FADER	29
32 MONITOR	18	89 RIGHT FADER	29
33 TALKBACK	18	91 FADER LINK	29
34 35 TALKBACK MIC INPUT	18	92 CENTER FADER	30
36 INTERCOM	19	93 SOLO	30
37 MATRIX OUTPUTS	19	94 SUBS (SUB 1-8 MIXES)	31
38 MATRIX INPUTS	19	95 FADER	31
39 DC POWER IN	19	96 MUTE	31
41 MIDI IN/OUT	19	97 PAN	31
42 DATA	19	98 L-R (ASSIGN)	31
43 CHANNEL	20	99 CENTER (ASSIGN)	31
44 “U” LIKE UNITY GAIN	20	101 SOLO	32
45 CHANNEL INPUT CONTROLS	20	102 AIR	32
46 +48 PH (PHANTOM POWER)	20	103 METERS	32
47 TRIM	20	104 “B” AUX RETURNS and 105 TAPE RETURNS ...	33
48 Ø (POLARITY REVERSAL)	20	106 LEVEL	33
		107 MUTE	33
		108 SOLO	33

109	AUX SEND MASTERS	34	152	ULTRA MUTE™ AUTOMATION	42
111	FLIP	34		TYPICAL APPLICATIONS	42
112	LEVEL	34		IMPORTANT TIDBITS AND TITLES	43
113	MUTE	35		OPERATION	44
114	SOLO	35		GROUP MODE	44
115	SOLO MASTER CONTROLS	35	153	NUMERIC DISPLAY	44
116	INPUTS PFL/AFL	35		SNAPSHOT MODE	46
117	OUTPUTS PFL/AFL	35		ULTRA MUTE SUMMARY	48
118	SOLO LEVEL	36	154	MODE	48
119	RUDE SOLO LIGHT	36	155	ARROW UP/DOWN BUTTONS	48
121	PHONES LEVEL	36	156	SYSTEM BYPASS	48
122	MONITOR	37	157	MUTE PREVIEW	48
123	LINE OUT (LEVEL)	37	158	STORE	49
124	MUTE	37	159	CLEAR	49
125	LEFT/RIGHT/CENTER METERS	37	160	DO IT	49
	METERING	37	161	NUMBER BUTTONS (0-9)	49
126	INPUT SECTION PFL/AFL	37		MIDI IMPLEMENTATION	50
127	OUTPUT SECTION PFL/AFL	38		MIDI SYSEX NUMBERS	51
	DIMMER	38		MIDI IMPLEMENTATION SUMMARY	52
128	LAMP	38	162	MIDI IMPLEMENTATION CHART	53
129	METER	38	163	TABLE OF MIDI NOTE MESSAGES	54
131	POWER SUPPLY STATUS	38	164	SR40•8 BLOCK DIAGRAM	56
132	TALKBACK SECTION	38	165	SR40•8 GAIN STRUCTURE DIAGRAM	58
133	TALKBACK	38	166	SPECIFICATIONS	60
134	TALKBACK LEVEL	38		APPENDIX A: Service Info	62
135	ASSIGN	39		TROUBLESHOOTING	62
136	OSCILLATOR SECTION	39		APPENDIX B: Glossary	63
137	400HZ/PINK NOISE	39		APPENDIX C: Connections	72
138	LEVEL	39		APPENDIX D: Balanced Lines, Phantom Powering, Grounding, and Other Arcane Mysteries	75
139	ON	40		APPENDIX E: Track Sheets	80
141	COMMUNICATIONS	40			
142	INTERCOM	40			
143	RECEIVE LEVEL	40			
144	IGNORE	40			
145	CALL	40			
146	MATRIX	41			
147	INPUT LEVEL	41			
148	MUTE	41			
149	MASTER LEVEL	41			
151	SOLO	41			

2 SR40•8 HOOKUP EXAMPLES

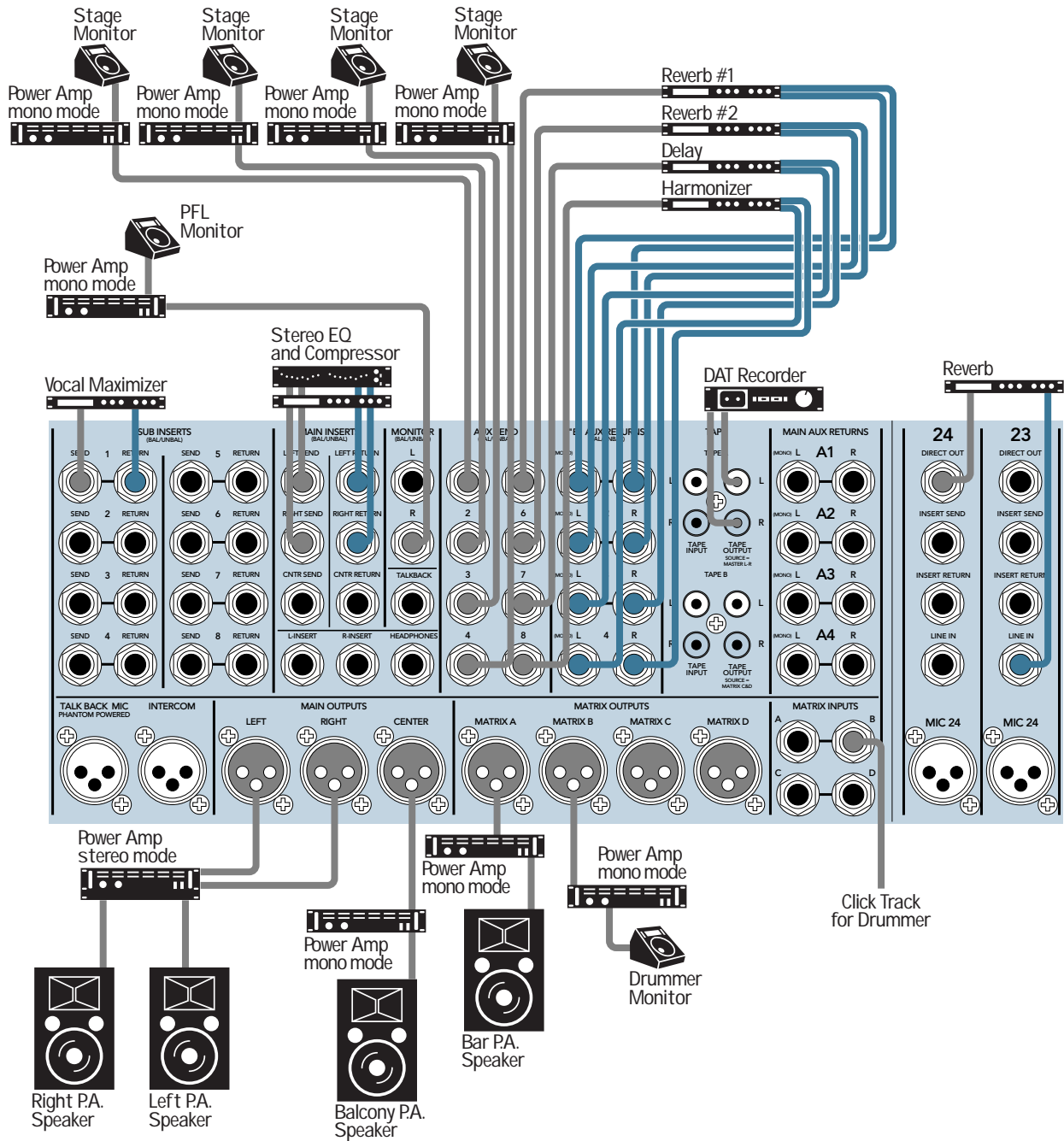

SR40•8/SR56•8 BAND IN A CLUB

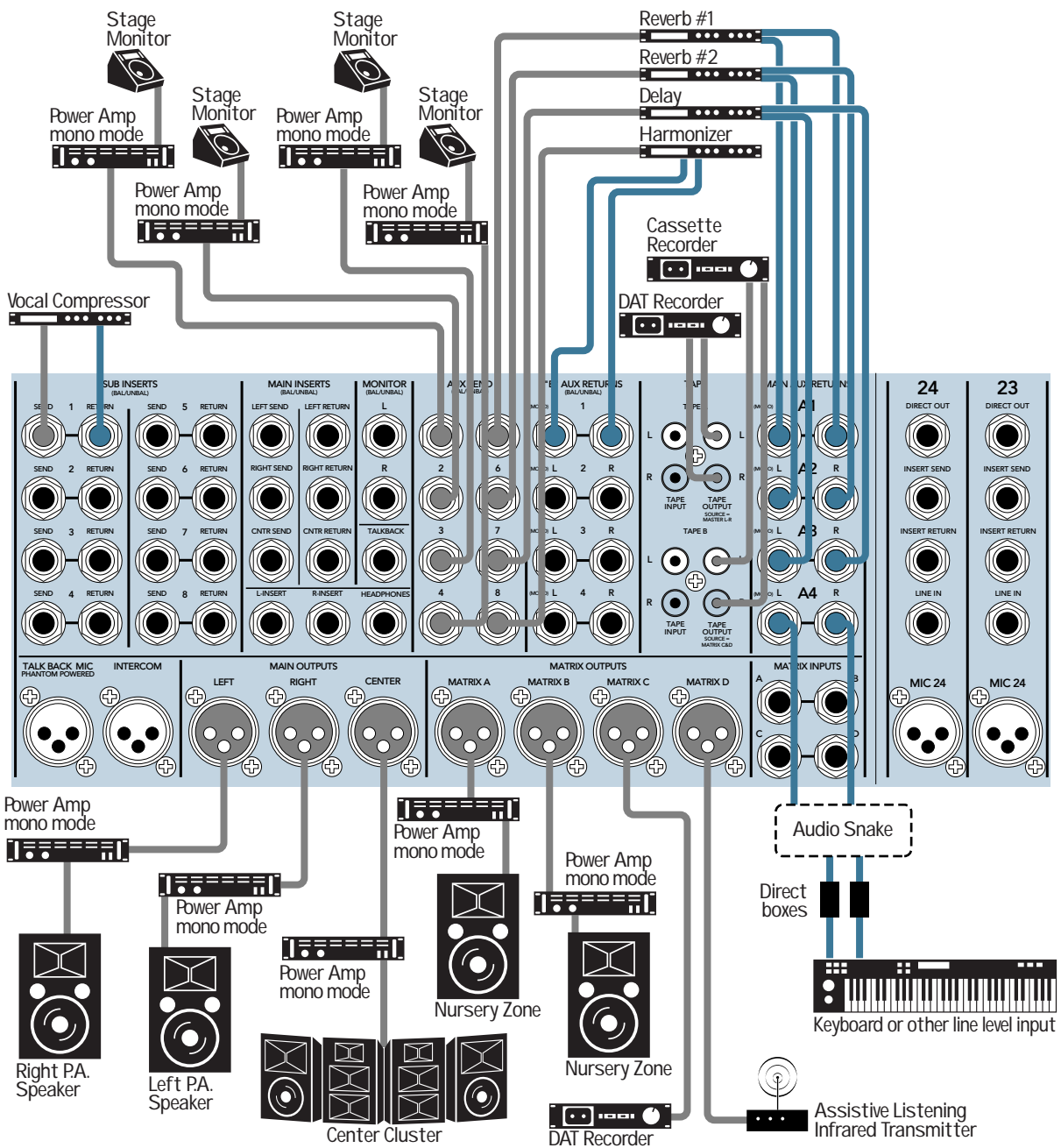

SR40•8/SR56•8 HOUSE OF WORSHIP

OVERVIEW: THE SR40•8 IN A NUTSHELL

This section provides a quick summary of the SR40•8's major features. It is not intended to be a dissertation on how to use a mixer, especially the SR40•8, where the possibilities are endless. Just the same, it's a good place to get started.

3 MIXING

Channel controls manipulate mic/line signals in this order: phantom power, trim, polarity, low cut filter, insert, EQ, mute, fader, pan, and assignment switches. These signals are then assigned to the left, right and/or center mix, or to one of the eight subs.

The main mix (left, right and center) typically feeds the main sound system. The left/right mix can be controlled by individual faders or switched to share one fader. Subs 1-8 can be assigned to the left/right or center mix, enabling them to be used as master faders for submixes of channels. Alternatively, the subs can be used for secondary speaker systems. More output routing options involve the matrix, discussed below.

4 MATRIX

The SR40•8 has 11 primary mix buses: left, right, center, and 8 subs. Via the channel's assignment switching, signals can be distributed among these buses. If a situation demands a unique destination for each mix, the dedicated outputs for each of these mixes will suffice.

More likely, a situation will demand that these 11 mixes be recombined in some way, to feed off-site systems, delay towers, assistive listening systems, or special mixes for recording or broadcast. Enter the Matrix.

The matrix is simply four separate 12 x 1 mixers. Its inputs include: left, right, center, subs 1-8 and an external input at the patch panel. Each matrix strip has a level control for each of the eleven internal inputs as well as master level, solo and mute controls.

5 STAGE MONITORS & EFFECTS

Every channel, as well as each of the four main aux returns (A1–A4), has eight aux send controls. Per channel, aux sends 1–4 can be switched to be post-fader (for effects sends) or pre-EQ/pre-fader (for stage monitors). Aux sends 5–8 have a similar switch, post-fader (for effects sends) or post-EQ/pre-fader (for stage monitors with EQ).

In the output section, aux sends can be routed in one of two ways. Normally, these aux mixes are controlled by the rotary master level control and mute switch, and then sent to TRS output jacks. This method is fine for effects sends or small applications. Larger installations may demand more flexibility for the stage mixes. Enter the *flip* switch.

Each aux send master has a flip switch. This removes an aux mix from its dedicated mute switch and level control, and diverts it to the like-numbered sub routing. This way, an aux send designated for stage cueing will have its own dedicated 100mm fader, "Air" EQ, insert, and balanced XLR output. Meanwhile, a flipped aux send also diverts the sub signal to the original aux send master controls and TRS output, ensuring that sub assignments can still be used.

When used for effects, aux sends are patched into the inputs of parallel effects devices, like reverb and delay units. The outputs of these devices are the origin of aux return signals. Aux return signals, or any stereo line-level signals, can be injected into either the main aux returns or the "B" aux returns (or into pairs of channels). The main aux returns provide most of the controls present in the channels: trim, high-pass filter, EQ, mute, pan, and assign. "B" aux returns B1, B2, and B3 are dedicated to the left/right mix and offer only rotary level and mute switch controls. (Aux return B4 is dedicated to the center mix.) Additionally, there are two stereo line-level RCA tape returns, dedicated to the left/right mix, with level control and mute switch.

6 MONITORING, SOLO, & METERING

Usually an engineer listens to the left/right mix (with the center mix blended in), just as the audience is hearing it. Signals available for monitoring by the engineer are available via either of the high-powered headphone outputs, with level control, or a line-level monitor (control room) output, also with level control.

There is a stereo insert dedicated to the phones mix, to allow a delay device to synchronize the distance delay present in large halls.

To audition individual signals or groups of signals, there are solo switches on every channel, main aux return, aux send master, matrix A–D, tape return, and sub 1–8, as well as the left/right/center faders. The engineer behind an SR40•8 can listen to any signal, individually or in groups, without disturbing the content of any of the console's primary outputs. Input signals (channels, main aux returns, "B" aux returns, tape A, and tape B) can be globally switched PFL (pre-fader-listen) or AFL (after-fader-listen, stereo-in-place). Output signals (main/left/right, subs 1–8, aux send masters, and matrix A–D) have a similar switch.

There are 59 twelve-segment LED-ladder meter displays on the SR40•8, one for each channel and sub, two for each stereo main aux return, and one each for the left/right/center main mixes. Input and output meters can each be globally switched PFL or AFL. During solo, described earlier, the left/right/center meters automatically display the solo levels: AFL on the left/right meters and PFL on the center.

7 TALKBACK & INTERCOM

The SR40•8's extensive talkback section allows the engineer to speak into several outputs via a master talkback switch, with assignment switches for aux 1–4, aux 5–8, L/R mix, an external talkback output, and one switch for each matrix (A–D). Talkback microphones are patched into either of the two phantom powered XLR inputs and regulated by a level control. Additionally, the talkback signal may be replaced by a 400Hz sine wave for checking levels, or pink noise for quickly checking frequency response.

The Clear-Com® Intercom System is already standard equipment in most large facilities. It allows all crew members to share a "party line," so they may communicate at will, without

having to toggle between send and receive. The Mackie SR40•8 takes that a step farther by allowing the engineer to join in at his/her discretion using the talkback microphone and phones outputs: No separate intercom headset is required for the engineer.

8 ULTRA MUTE™

Almost every signal path in the SR40•8 has an electronically-controlled mute switch, including the channels, main aux return, sub-groups, aux sends, and matrices. These mutes may be activated in four ways: By pressing the local mute switch included for each path, by assigning paths to a mute group, by assigning paths to a mute snapshot, or by external MIDI and RS232 commands. Using just the local switches and mute groups, an engineer can quickly mute or un-mute large groups of signal paths. Using an external sequencer to generate MIDI muting commands, complicated muting moves can be made automatically, with no user intervention.

When a channel or main aux return is muted, the entire channel is muted, including the assign outputs, pre- and post-fader aux sends, and direct out. The insert send remains active, as do the channel's PFL meters and PFL solo outputs.

9 SWITCH POSITIONS

You may have noticed the white lines printed just above most of the push-button switches on your SR40•8. We've put them there to make it easier for you to see if the switch is engaged (down). Here's how they work:

Assuming you are sitting in front of the console, when a switch is disengaged (up), its button hides the white line from your field of vision. When you engage the switch, the line suddenly appears. Although it may not seem obvious at first, you'll soon find that the indicator line really helps you determine switch positions at a glance. Clever, ain't it?

11 PATCH PANEL

At the risk of stating the obvious, this is where you plug everything in: microphones, instruments, effects, headphones, and the ultimate destination for your sound: PA system, tape recorder and the like.



12 E-Z INTERFACE

Concerned about levels, balancing, impedances, polarity, or other interface goblins? Don't be. On your

SR40•8, you can patch anything almost anywhere, with nary a care. Here's why:

- Every input and output is balanced (except single-jack inserts, phones and RCA jacks), using close-tolerance components to ensure noise-free performance.
- Every input and output will also accept unbalanced lines (except floating-ring cables into XLR inputs — just tie the cable's ring to the shield first).
- Every input is designed to accept virtually any output impedance.
- The XLR outputs can deliver 28dBu into a 600 ohm load.
- All the other outputs can deliver 22dBu into a 600 ohm load.
- All the outputs are polarity-correct with the inputs.

All we ask is that you perform the **Level-Setting Procedure** 1 every time you patch in a new sound source. So stop worrying, and start mixing!

13 MIC INPUT

Point Before: *Balanced microphone-level cable with male XLR connector (pin 2 = hot, pin 3 = cold, pin 1 = shield).*

Point After: *Channel 43.*

The female XLR input can accept almost any type of microphone — dynamic, condenser, ribbon or tube condenser. +48 PH (phantom power) 46 is switchable per Channel. Radio frequency interference (RFI) is eliminated by means of close-tolerance balanced circuitry, input filtering and the SR40•8's steel chassis. Mic-level signals can be boosted by as much as 60dB.

Do not use this input simultaneously with its associated LINE IN 14. Turn TRIM 47 down and engage MUTE 62 before inserting or removing mic cables. Do not insert unbalanced single-ended cables (signal on pin 2, pin 3 open) unless pin 3 is first tied to ground (pin 1), and the +48 PH 46 is switched off.

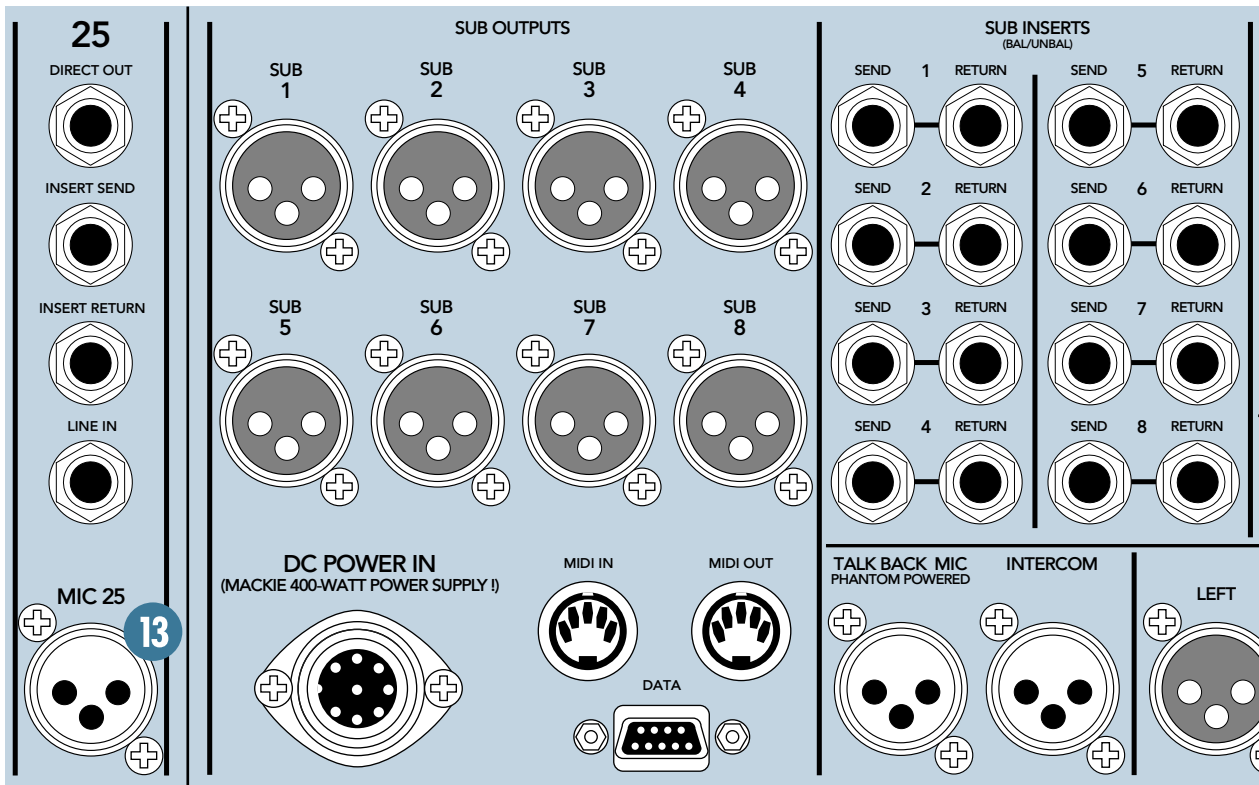

14 LINE IN

Point Before: *Balanced or unbalanced mic- or line-level cable with 1/4" TRS or TS connector; (tip = hot, ring = cold, sleeve = shield).*

Point After: Channel 43.

This input is similar to the MIC 13 input, but without phantom power. Both signals mix together at the mic preamp. Mic-level signals can be accommodated here with up to 40dB of gain. The LINE IN is 20dB less sensitive than the MIC input.

Do not use this input simultaneously with its associated MIC 13 input. Turn TRIM 47 down and engage MUTE 62 before inserting or removing line cables. Do not use open-ended TRS cables (signal on tip, ring open) unless the ring is first tied to ground (sleeve). It won't hurt anything, it will just work better if you ground the sleeve. Although you can connect a microphone to this input, there will be less noise when connected to the MIC 13 input jack.

15 INSERT SEND AND RETURN

Point Before: *Channel mic/line preamp, TRIM 47, 0 (Polarity Reversal) 48, HPF 58.*

Point After: EQ 49.

Both the INSERT SEND and INSERT RETURN jacks are balanced, and can also accommodate unbalanced TS cables. Signal feeding the INSERT SEND jack is also sent to

the INSERT RETURN jack's normalling pins. With nothing plugged into the INSERT RETURN jack, the (dry) send signal will be passed along to the rest of the channel path (this is called half-normalled).

To insert a serial effects device, simply patch from the INSERT SEND jack to the effect's input, and from the effect's output to the INSERT RETURN jack, using either balanced TRS or unbalanced TS cables.

Since using the INSERT SEND jack by itself does not interrupt the channel's signal path, it may also be used as a pre-EQ/pre-Fader direct output, in addition to the post-Fader DIRECT OUT 16.

16 DIRECT OUT

Point Before: *Channel signal, EQ 49, Channel Fader 63, MUTE 62.*

Point After: *Balanced or unbalanced cable with 1/4" TRS or TS connector.*

The DIRECT OUT's signal is the same as the output of the Channel, except that the PAN 65 control has no effect.

These jacks can be used to feed multitrack recorder inputs, as a one-channel effects send, as a secondary sound source's trigger command, or for any other purpose that requires the post-Fader signal of an individual Channel. Using this jack does not interrupt the Channel's signal path to the output section.

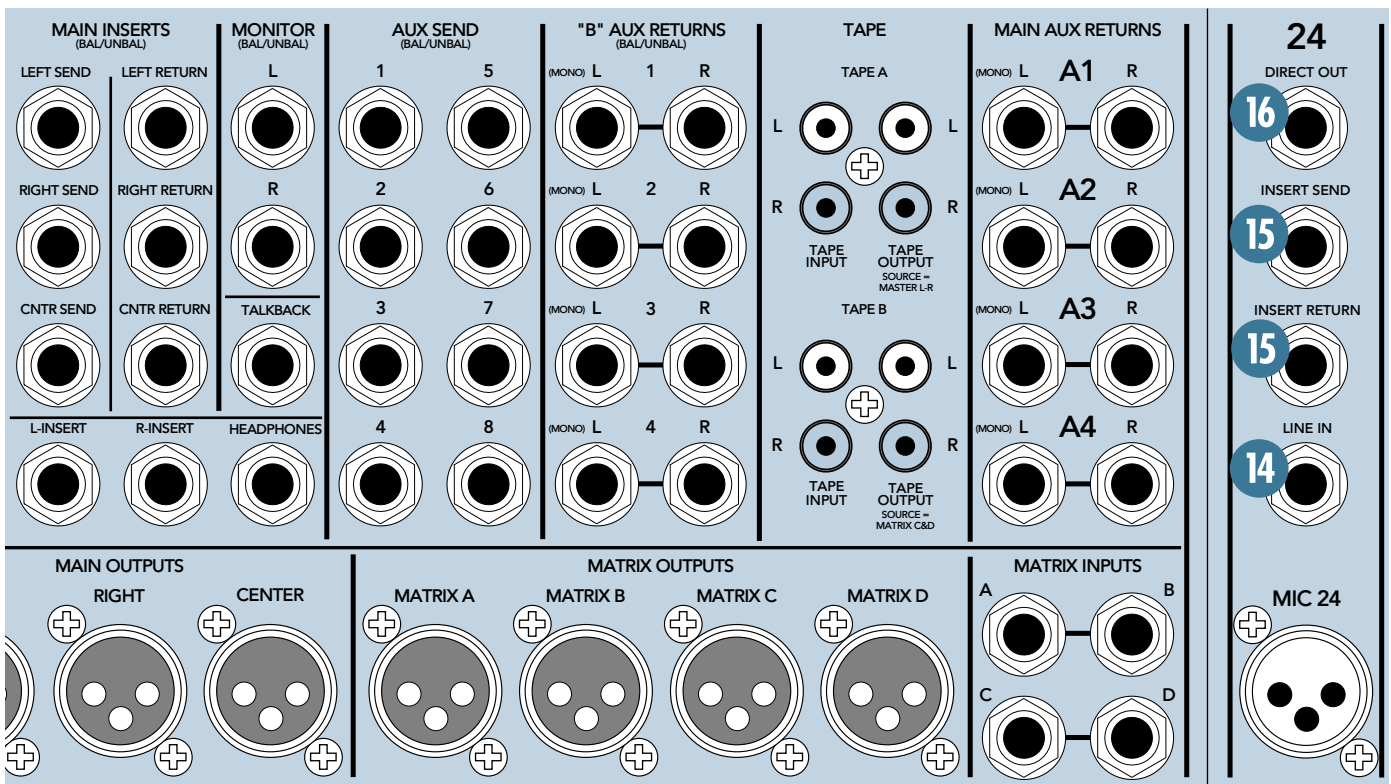

17 MAIN AUX RETURNS (A1–A4)

Point Before: *Balanced or unbalanced line-level cable with ¼" TRS or TS connector; (tip = hot, ring = cold, sleeve = shield).*

Point After: MAIN AUX RETURNS (A1–A4) 75.

The left jack's signal is normalled to the right jack — a mono signal, patched into the left jack only, appears on the left and right sides.

Since the MAIN AUX RETURNS (A1–A4) are actually stereo channels with full routing and EQ, patch in the outputs of your essential effects devices (or any line-level signals) here. These signals can be sent to any mix, including the AUX SEND MASTERS 109, making them ideal for sending effects to the stage monitors. Similarly, essential mono effects outputs (one cable) should be patched into a mono Channel.

18 "B" AUX RETURNS

Point Before: *Balanced or unbalanced line-level cable with ¼" TRS or TS connector; (tip = hot, ring = cold, sleeve = shield).*

Point After: "B" AUX RETURNS 104.

The left jack's signal is normalled to the right jack — a mono signal, patched into the left jack only, will appear on the left and right sides.

Since AUX RETURNS B1, B2 and B3 can be assigned only to the LEFT/RIGHT mix, and B4 only to the CENTER mix, patch the outputs of effects devices (or any line-level signals) that need to go only to these destinations. If you need full routing but you've already used all four of the MAIN AUX RETURNS (A1–A4), you can also patch into two Channels, panning one left and the other right.

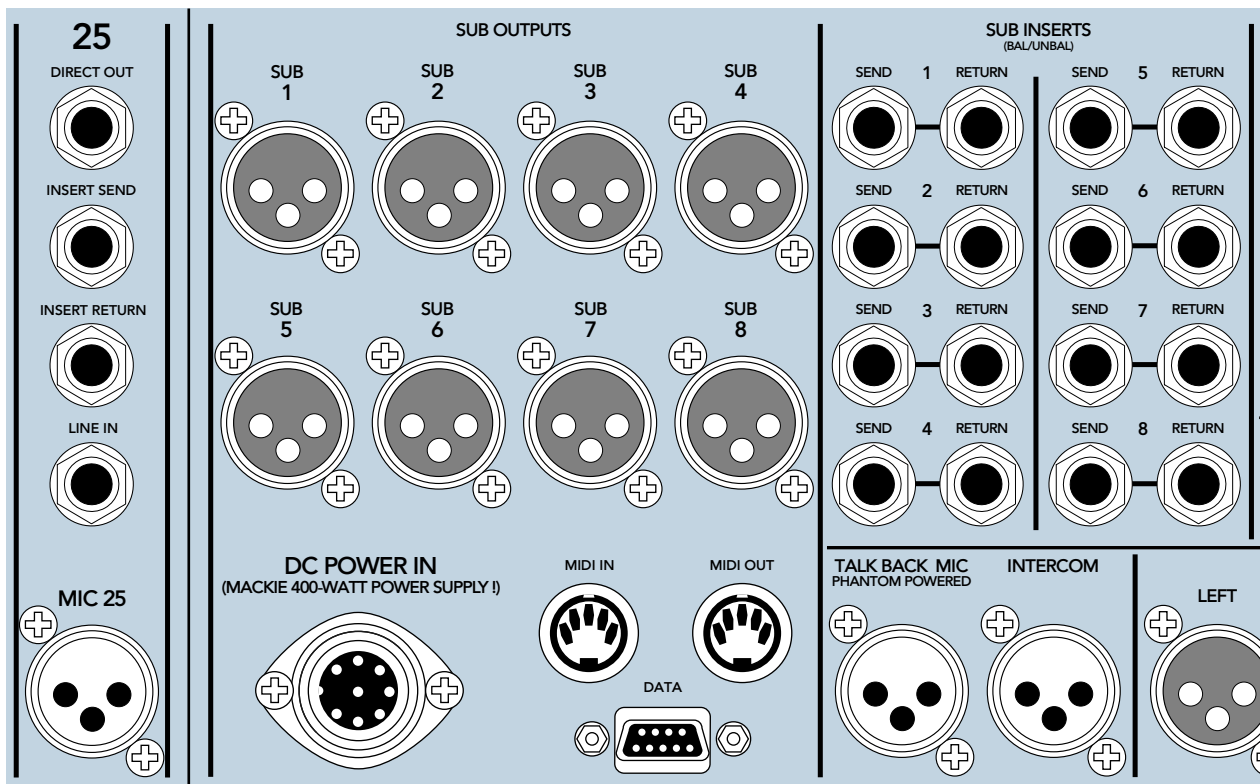

19 TAPE INPUT

Point Before: Unbalanced line-level cable with RCA connector.

Point After: TAPE RETURNS 105.

RCA jacks, bless their little hearts, have no normalling — if you need a mono signal to appear on both sides, that will require a Y-splitter so that both jacks can be patched.

This is a good place to patch in a tape deck or CD player intended for music between sets. TAPE RETURNS are dedicated to the LEFT and RIGHT mix 87.

21 TAPE A OUTPUT

Point Before: MAIN OUTPUTS 24.

Point After: Unbalanced line-level cable with RCA connector.

These jacks have a $3k\Omega$ output impedance, enabling you to combine the left and right outputs (using a Y-cord adapter), thereby creating a mono signal. Do not attempt this on any of the SR40•8's TRS or XLR outputs.

Patch these outputs to the inputs of a 2-track recording device and you'll record exactly the same signals present at the left and right MAIN OUTPUTS 24.

22 TAPE B OUTPUT

Point Before: MATRIX OUTPUTS 37, left from MATRIX C output, right from MATRIX D output.

Point After: Unbalanced line-level cable with RCA connector.

These jacks have a $3k\Omega$ output impedance, enabling you to combine the left and right outputs (using a Y-cord adapter), thereby creating a mono signal. Do not attempt this on any of the SR40•8's TRS or XLR outputs.

Patch these outputs to the inputs of a 2-track recording device and you'll record exactly the same signals present at the MATRIX OUTPUTS' 37 C and D XLR jacks.

23 AUX SEND

Point Before: AUX SEND MASTERS 109.

Point After: Balanced or unbalanced cable with $\frac{1}{4}$ " TRS or TS connector.

Patch these outputs to the inputs of your effects devices or stage monitor amps. Remember that if FLIP 111 is engaged, these outputs deliver the like-numbered SUB OUTPUTS 26 instead of AUX SEND outputs.

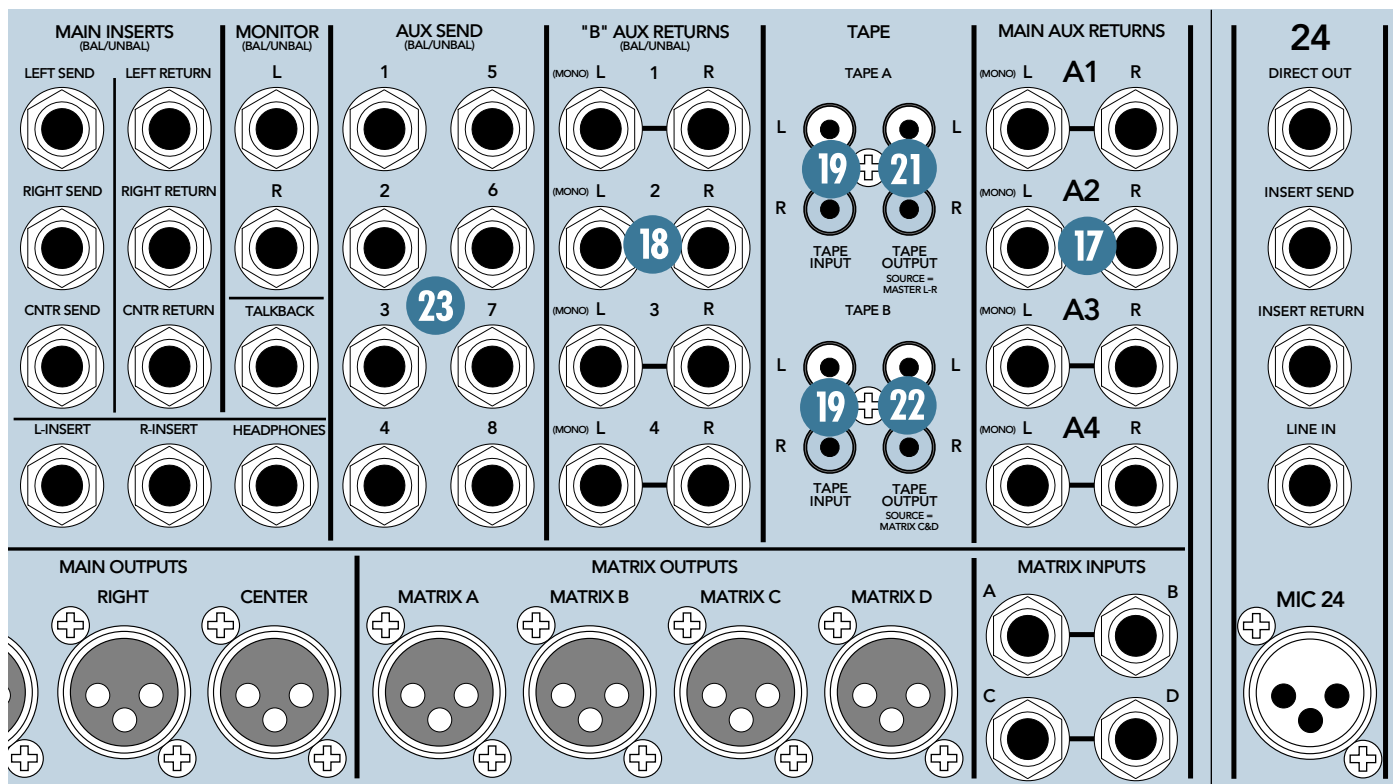

24 MAIN OUTPUTS

Point Before: LEFT/RIGHT/CENTER *mixes* 87, MAIN INSERTS 25, LEFT/RIGHT/CENTER *Faders* 88 89 92.

Point After: *Balanced or unbalanced cable with female XLR connector (pin 2 = hot, pin 3 = cold, pin 1 = shield).*

Unless you've created an elaborate main mix using the MATRIX 146, patch these outputs to your primary sound system's amplifier inputs. Be aware that if you have no Channels 43 or MAIN AUX RETURNS (A1-A4) 75 assigned to the CENTER mix, patching the CENTER output jack is unnecessary.

25 MAIN INSERTS

Point Before: LEFT/RIGHT/CENTER *mix* 87.

Point After: LEFT/RIGHT/CENTER *Faders* 88 89 92.

Both the SEND and RETURN jacks are balanced, but can accommodate unbalanced TS cables. Signal feeding the SEND jack is also sent to the RETURN jack's normalling pins. With nothing plugged into the RETURN jack, the (dry) SEND signal gets passed along to the rest of the mix output's path.

To insert a serial processor (such as a graphic equalizer or compressor/limiter), simply patch from the SEND jack to the effect's input, and from the effect's output to the RETURN jack, using either balanced TRS or unbalanced TS cables. Since using the SEND jack by itself does not interrupt the mix signal path, it may also be used as a pre-Fader direct output.

26 SUB OUTPUTS

Point Before: SUBS (SUB 1-8 *mixes*) 94, SUB INSERTS 27, *Subgroup Fader* 95.

Point After: *Balanced or unbalanced cable with female XLR connector (pin 2 = hot, pin 3 = cold, pin 1 = shield).*

If necessary, patch these outputs to the amplifier inputs of secondary speaker systems, unless you've chosen to use the MATRIX OUTPUTS 37 for this task. The Subgroups are also essential for recording to multitrack.

In the event that you have engaged any FLIP 111 switches, the signals at these outputs will not be the Subgroup signals — they will be the like-numbered AUX SEND outputs. (For instance, if the FLIP switch on AUX SEND MASTER 1 is engaged, AUX SEND 1's output will appear at Subgroup 1's output jack, and vice versa.)

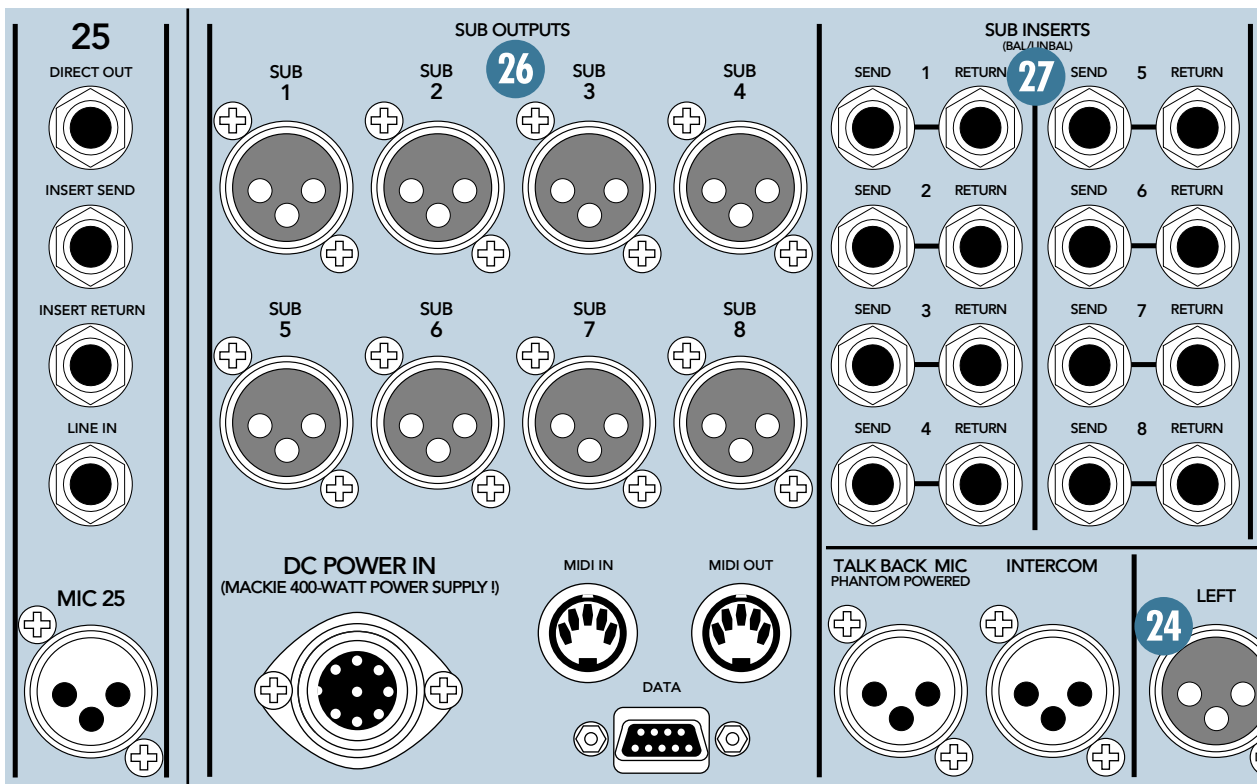

27 SUB INSERTS

Point Before: SUB 1–8 mixes 94, AIR 102, FLIP 111.

Point After: SUBS 1–8 Faders 95.

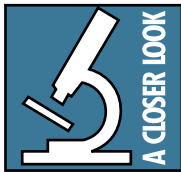

Both the SEND and RETURN jacks are balanced, but can accommodate unbalanced TS cables. Signal feeding the SEND jack is also sent to the RETURN jack's normalizing pins. With nothing plugged into the RETURN jack, the (dry) SEND signal gets passed along to the rest of the mix output's path. (The jacks are half-normalled.)

To insert a serial processor (such as a graphic equalizer or compressor/limiter), simply patch from the SEND jack to the effect's input, and from the effect's output to the RETURN jack, using either balanced TRS or unbalanced TS cables. Since using the SEND jack by itself does not interrupt the mix signal path, it may also be used as a pre-Fader direct output.

28 29 HEADPHONES

Point Before: INSERT (HEADPHONES) 31.

Point After: Your favorite headphones (one set only per jack, conventionally wired: tip = left, ring = right, sleeve = shield.)



WARNING: The SR40•8's stereo phones jack will drive any standard headphone to very loud levels. When we say the headphone amp is loud, we're not kidding. It can cause permanent ear damage. Even intermediate levels may be painfully loud with some earphones. **BE CAREFUL!**

Always turn the PHONES level 121 all the way down before connecting headphones. Keep it down until you've put the phones on. Then turn it up slowly. Why? "Engineers who fry their ears find themselves with short careers."

The SR40•8's headphone amplifiers will drive headphones of any impedance, but for best results (loudest volume), use 60-ohm headphones.

31 L-INSERT, R-INSERT (HEADPHONES)

Point Before: PHONES level 121.

Point After: HEADPHONES 28 29 and MONITOR outputs 32.

Per side, these unbalanced inserts share the send and return on the same jack; tip = send (to device), ring = return (from device), sleeve = common ground.

This particular pair of insert points has only one function: Patch in a digital delay here and adjust the delay time so it matches the delay caused by the distance between the console and the stage speakers. This eliminates the slap-back effect of hearing the console first and then the speakers.

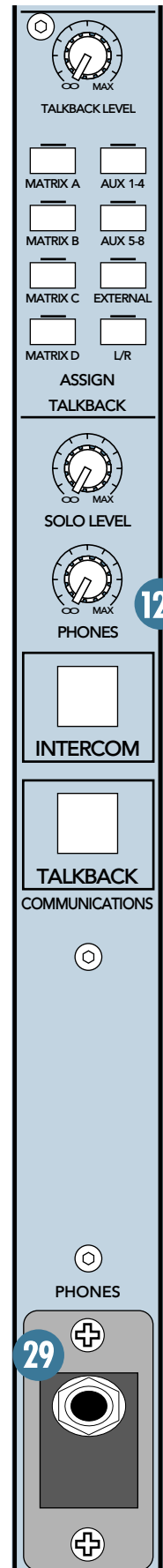
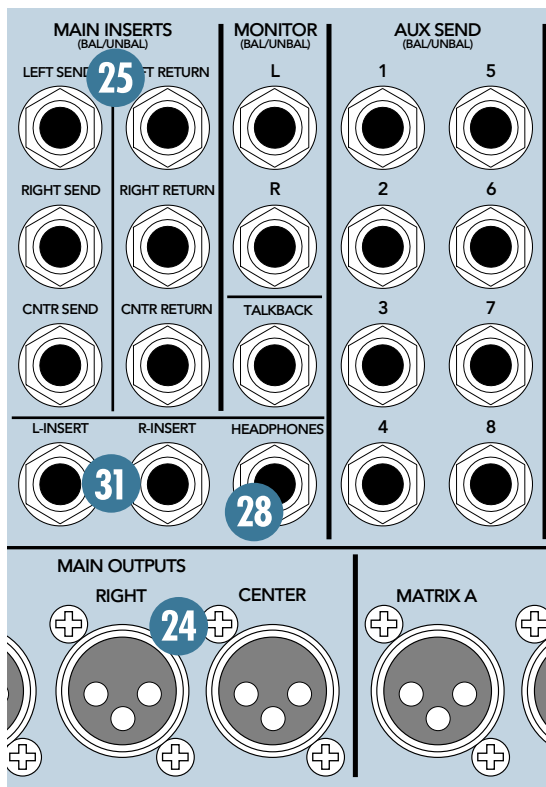

32 MONITOR

Point Before: INSERT (HEADPHONES) 31.

Point After: *Balanced or unbalanced cable with 1/4" TRS or TS connector.*

Patch these outputs to an amp's inputs, and patch the amp's outputs to speakers mounted at the console. Alternatively, the MONITOR outputs can deliver the FOH (front-of-house) headphone mix to an engineer operating a secondary stage monitor console.

If you want to drive several pairs of headphones via an outboard amplifier, patch these outputs to that amp.

If the console is in a soundproof room, as in live sound-studio work or studio recording/mix-down, patch these outputs to your control room amplifier and speakers. Be aware: the intercom signals 36 141 do not appear at these jacks.

33 TALKBACK

Point Before: ASSIGN 135 (EXTERNAL)

Point After: *Balanced or unbalanced cable with 1/4" TRS or TS connector.*

If you want the TALKBACK signal to be routed somewhere other than the AUX SEND MASTERS, LEFT/RIGHT mix, or MATRIX A–D, patch this output to that device. Similar to the MONITOR outputs, this jack is generally not required, but can be a lifesaver in unusual situations.

You can use the EXTERNAL switch (ASSIGN 135) to deliver the TALKBACK (and OSCILLATOR) signal to a second console, such as a monitor console. Simply patch from the FOH (front-of-house) console's TALKBACK 33 output to a line-level Channel input of the monitor console. Then use that Channel's AUX sends to deliver the TALKBACK signals to the stage monitors.

34 35 TALKBACK MIC INPUT

Point Before: *Balanced microphone-level cable with male XLR connector (pin 2 = hot, pin 3 = cold, pin 1 = shield). This connector has 48-volt phantom power permanently engaged.*

Point After: TALKBACK section 132.

Patch one dynamic or condenser microphone to either jack to enable the TALKBACK functions (there is no built-in microphone). The two phantom-powered jacks are wired in parallel, feeding a balanced mic preamp, then controlled by the TALKBACK LEVEL 134 control.

Since these jacks are wired in parallel, only one should be used at a time.

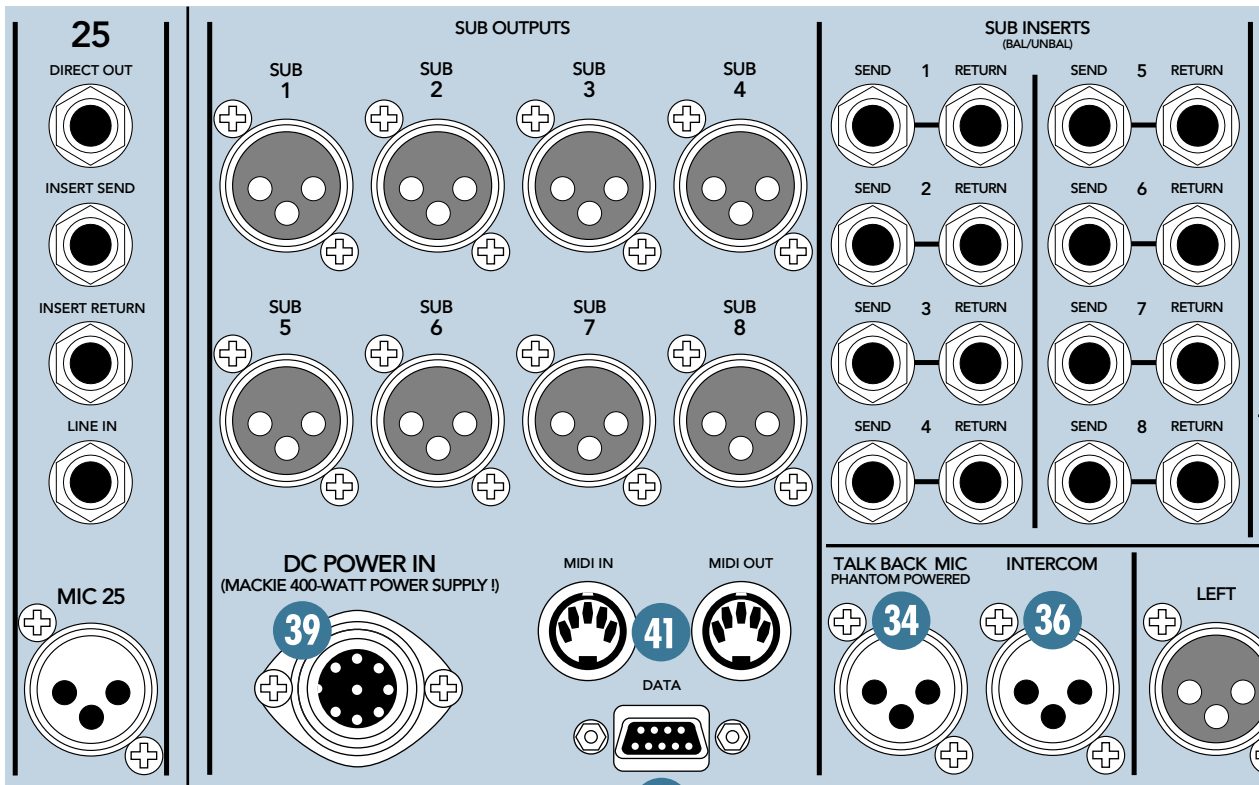

36 INTERCOM

Point Before: Externally supplied Clear-Com™ or compatible party-line intercom line, with power.

Point After: SR40•8 intercom interface, headphone amplifiers, and talkback system.

This connector accepts a 3-pin male XLR connector connected to a Clear-Com or compatible party-line intercom system. This system uses the following wiring: pin 1 = ground/0V, Pin 3 = audio + DC signalling, pin 2 = 28–30VDC. The ground pin of this connector is isolated from the SR40•8's ground system.

37 MATRIX OUTPUTS

Point Before: MATRIX 146, MASTER level 149.

Point After: Balanced or unbalanced cable with female XLR connector (pin 2 = hot, pin 3 = cold, pin 1 = shield).

If necessary, patch these outputs to the amplifier inputs of additional speaker systems or use for other applications requiring composite mixes.

38 MATRIX INPUTS

Point Before: Balanced or unbalanced line-level cable with 1/4" TRS or TS connector, (tip = hot, ring = cold, sleeve = shield).

Point After: MATRIX 146.

Signals injected into these jacks are fed directly to their respective MATRIX 146 outputs, governed only by the MATRIX section's MASTER levels 149.

39 DC POWER IN

Arguably the most important connector on any console, the SR40•8 will not work until you've connected its power cable here. POWER SUPPLY STATUS 131 LEDs in the output section will confirm that the console is fully powered.

41 MIDI IN/OUT

This is where you interface the SR40•8 with an external sequencer or other MIDI device, to enable ULTRA MUTE™ 152 to perform complex automated muting moves. Connect the MIDI OUT of the sequencer to the MIDI IN of the SR40•8, and the MIDI OUT of the SR40•8 to the MIDI IN of the sequencer.

42 DATA

This connector allows you to connect the SR40•8 with an external computer via an RS-232 connector, to enable remote control of the ULTRA MUTE™ 152 system. If your application requires RS-422, use an external protocol adapter.

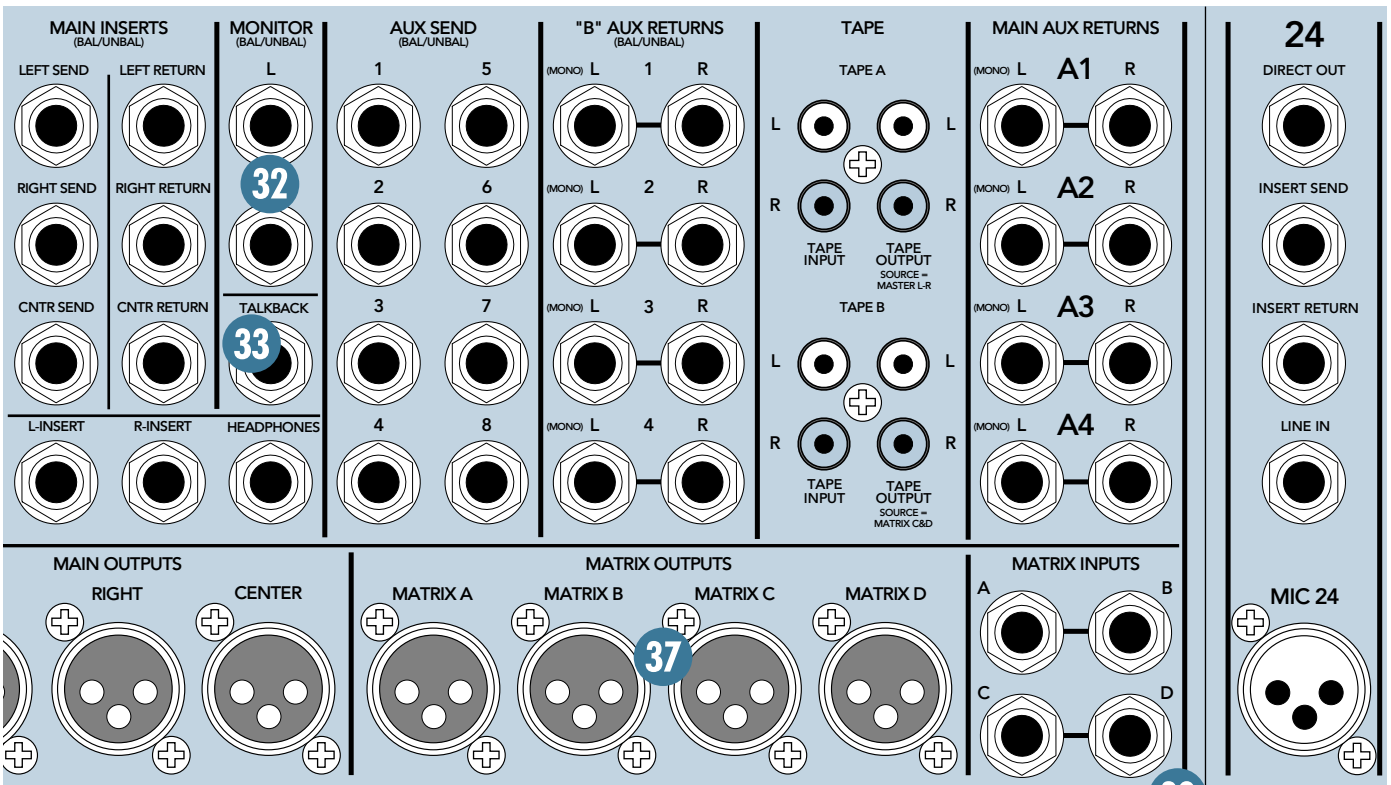
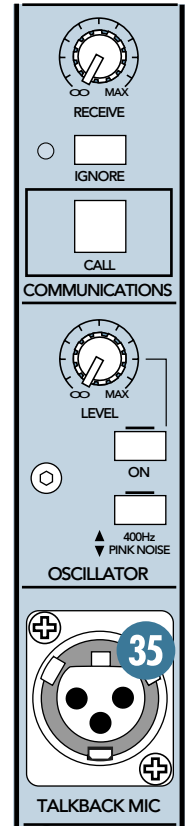

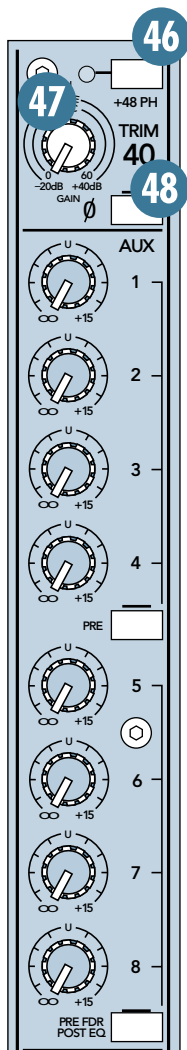

43 CHANNEL

The forty Channel strips placed on either side of the console look alike and function identically. They're loaded with professional features. Let's start at the top of a Channel and work our way down, but save the AUX send (72) section for later.



44 "U" LIKE UNITY GAIN

Mackie consoles have a "U" symbol on almost every level control. This "U" stands for "unity gain," meaning no boost or cut in signal level. Once you have performed the **Level-Setting Procedure** (1), you can set every control at "U" and your signals will travel through the mixer at optimal levels. What's more, all the labels on our controls are measured in decibels (dB), so you'll know what you're doing level-wise if you choose to change a control's settings.

Be aware that unity gain is also reliant on the position of the PAN (65) knob. When panned center, there will be about 4dB of attenuation on each side to preserve "constant loudness" (66).

45 CHANNEL INPUT CONTROLS

A Channel's input controls manipulate the signal just after the MIC (13) and LINE IN (14). From there, a line-level signal is sent on to the Channel output controls (61).

46 +48 PH (PHANTOM POWER)

Point Before: 48VDC power supply for condenser microphones.

Point After: MIC input (13).

This one's easy. If you have a condenser microphone plugged in, or any mic that requires 48VDC phantom power, engage this switch. If you have a dynamic microphone, or any mic that does not require phantom power, leave this switch up, although it won't do any harm if it's down (as long as you're using good quality balanced cables). The LED next to the switch glows when the power is on.

47 TRIM

Point Before: MIC (13) and LINE IN (14) jacks, summed at mic preamp input.

Point After: Channel path, at \emptyset (polarity reversal) (48) switch.

Have you read the **Level-Setting Procedure** yet? If not, go to item (1) right now and read it — it's at the beginning of this manual. That procedure is basically "How to Use the Trim Control." We ask that you commit that procedure to memory. You'll be glad you did — it assures your incoming signal of being treated to the highest headroom and lowest noise possible.

Signals entering through the MIC (13) XLR jack have unity gain (no level boost or attenuation) with the knob fully down, and a 60dB boost fully up.

Through the LINE IN (14) TRS jack, there is 20dB of attenuation fully down and a 40dB boost fully up, with a "U" (unity gain) mark at 9:00.

This 20dB of attenuation can be very handy when you are inserting a signal that is very hot, or adding a lot of EQ gain, or both. Without this "virtual pad," a scenario like this might lead to clipping (which is an automatic 15 yard penalty in the NFL).

48 \emptyset (POLARITY REVERSAL)

Point Before: MIC (13) and LINE IN (14) preamp output.

Point After: HPF (58), Channel INSERT SEND and RETURN (15), EQ (49).

Engaging this switch inverts the polarity of the incoming MIC or LINE IN signal. Although you'll want to start off with this switch disengaged (up), there's no right way or wrong way to set this switch — it's all based on which way sounds better, especially when auditioning the signal with its partner signals.

For instance, by engaging the SOLO (69) switches on all the drum Channels, you can experiment with polarity reversal of the overhead mics, the snare drum's underside mic, and so forth until you hit upon the right combination of settings.

You'll want to make the "up" position the default setting for this switch so all the signals will have correct polarity (also known as "in phase") — and only reverse the polarity of Channels that you deem necessary.

49 EQ

Point Before: Channel mic/line preamp, Channel INSERT SEND and RETURN 15.

Point After: MUTE 62, PFL feed to Channel Meter 71 and SOLO 69.

The SR40•8 has a 4-band, dual-mid-sweep equalization: HI shelving at 12kHz; HI-MID bandpass, swept from 500Hz to 15kHz; LOW-MID bandpass, swept from 45Hz to 3kHz; and LOW shelving at 80Hz. Chances are, it's all the equalization you'll ever need. Shelving means that the circuitry boosts or cuts all frequencies past the specified frequency. For example, the SR40•8's LOW shelving EQ boosts (or cuts) bass frequencies starting at 80Hz, and all frequencies below. Bandpass means that gain levels form a "hill" around the center frequency.

With too much equalization, you can screw things up royally. We've designed a lot of boost and cut into each equalizer circuit because we know everyone will occasionally need that. But if you max the EQ on every Channel, you'll get mix mush. Equalize subtly and use the left sides of the knobs (cut), as well as the right (boost). If you find yourself repeatedly using full boost or cut, consider altering the sound source, such as placing a mic differently, trying a different kind of mic, changing the strings, or gargling.

Be aware: The HI-MID and LOW-MID frequencies can be set to the same frequencies as the HI and LOW shelving EQs. This is usually not a problem, but it is unnecessary by virtue of being redundant, and can sometimes cause clipping. For instance, if you fully boost the LOW-MID, with the FREQ set at 80Hz, and fully boost the LOW shelving, preset at 80Hz, you'll be asking for 30dB of gain at 80Hz! If you started out with signal with a 0dB level at that frequency, you'd be clipping for sure.

51 HI 12K

The HI EQ provides up to 15dB boost or cut at 12kHz, and is flat (no boost or cut) at the detent. Use it to add sizzle to cymbals, an overall sense of transparency, or an edge to keyboards, vocals, guitar, and bacon frying. Turn it down a little to reduce sibilance, minimize high frequency leakage, or to mask hiss caused by a frugal client's fifty-cent cassette tape.

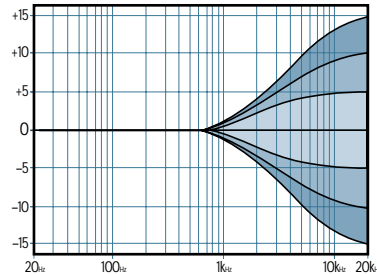

52 HI MID and 53 FREQ

The HI-MID EQ has a fixed bandwidth of 1.5 octaves. The HI-MID knob sets the amount of boost or cut up to 15dB, and is flat at the center detent. The FREQ knob sets the center frequency, sweepable from 500Hz to 15kHz.

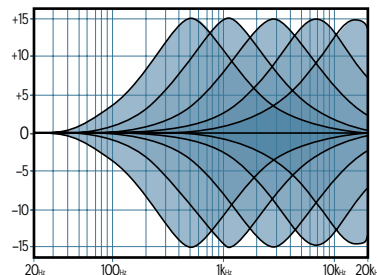
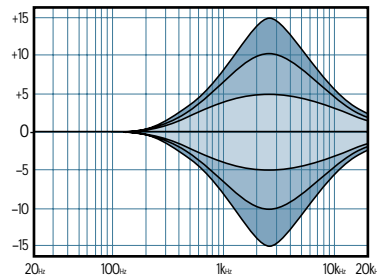

Most of the root and lower harmonics that define a sound are located in the 100Hz–10kHz frequency range, and you can create drastic changes with these four midrange knobs. Many engineers use mid EQ to cut midrange frequencies, not boost them. One popular trick is to set mid gain fully up, turn the associated FREQ knob until you find a point where it sounds just terrible, then back the mid down into the cut range, causing those terrible frequencies to disappear. Sounds silly, but it works. Sometimes.

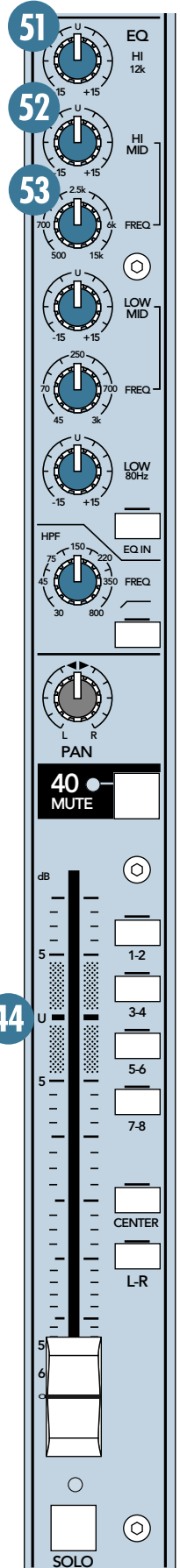

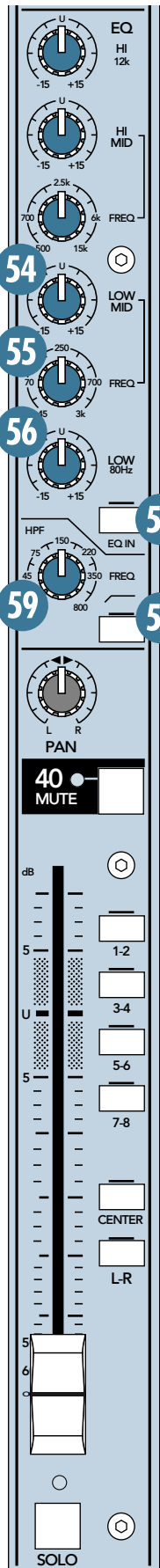

54 LOW MID and 55 FREQ

The LOW-MID EQ has a fixed bandwidth of 1.5 octaves. The LOW-MID knob sets the amount of boost or cut up to 15dB, and is flat at the center detent. The FREQ knob sets the center frequency, sweepable from 45Hz to 3kHz.

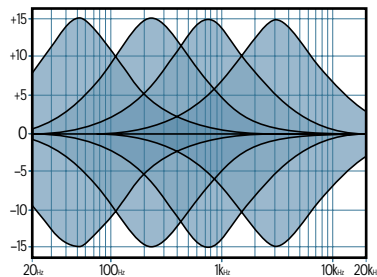
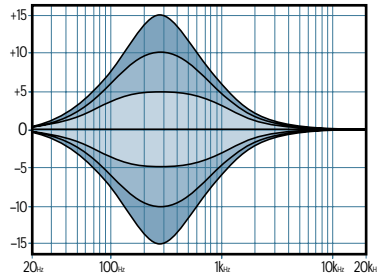

56 LOW 80HZ

The LOW EQ provides up to 15dB boost or cut at 80Hz and is flat at the center detent position. This frequency represents the punch in bass drums, bass guitar, fat synth patches, and some really serious male singers.

Used in conjunction with HPF 58, you can boost the LOW EQ without injecting a ton of infrasonic debris into the mix. In fact, we recommend using the HPF feature on all Channels at all times.

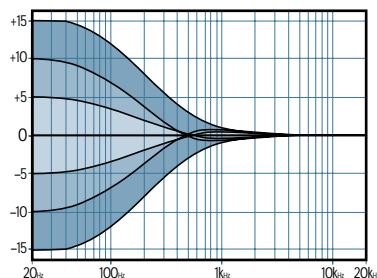

57 EQ IN

Point Before: INSERT 15 RETURN (switch up), EQ output (switch down)

Point After: MUTE 62 switch, PFL to Channel Meter 71 and SOLO 69.

If the switch is up, the EQ won't work. If it's engaged (down), the EQ will work. The favorite use of an EQ switch is to compare a signal modified by EQ to the unmodified signal, to determine if your EQ settings are taking you where you want to go. As mentioned earlier, the EQ boost/cut controls are all flat (no boost or cut) at their center detents, so this switch could actually be engaged all the time.

Be aware that the HPF 58 feature is switched independently of this EQ IN switch.

58 HPF and 59 FREQ

Point Before: Channel mic/line preamp, Ø (polarity reversal) 48.

Point After: Channel path at INSERT SEND 15, PRE switch (AUX 1-4) 73.

Be aware that signal path placement of the HPF circuit is not as it might appear by looking at the console's controls. It's actually right after the MIC/LINE IN preamp and before the INSERT (outboard gear also appreciates the effects of HPF), but we feel strongly about using HPF as part of your EQ arsenal. That's why the HPF controls are in the EQ section.

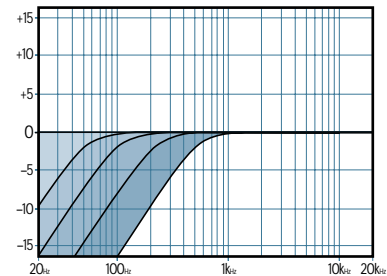

The HPF (high pass filter) switch, often referred to as a low cut filter, cuts bass frequencies at a rate of 12dB per octave below a swept-select point, ranging from 30Hz–800Hz. Using HPF will clean out the “mud” in your mix, can help reduce the possibility of feedback in live situations, and help to conserve amplifier power.

We recommend that you use low cut on every sound source, and adjust the frequency point to match the characteristics of the signal. For instance, if the signal is a kick drum, bass guitar, bassy synth patches, or recordings of earthquakes, set the FREQ knob fully down at 30Hz. The difference will be virtually inaudible and your amplifiers will love you for it.

Almost all other signals call for higher HPF frequency points (at least 80Hz). With these signals, there isn't much below 80Hz that you want to hear, and filtering it out gives the low stuff you do want much more definition.

With HPF, you can safely boost LOW EQ and LOW-MID EQ. Many times bass shelving EQ can really benefit voices. Trouble is, adding LOW shelving EQ also boosts the infrasonic debris: stage rumble, mic handling clunks, wind noise, and breath pops. HPF removes all that debris so you can boost the LOW EQ without frying a woofer.

61 CHANNEL OUTPUT CONTROLS

Now that we've made it through the Channel's input controls, we have a signal that has been level-corrected, polarity-adjusted, HPF-ized, and beautifully shaded with EQ. It's ready to go out and meet the audience. The Channel output controls offer many ways to get this signal out of the console. Just to get a handle on things, we'll stick to the basic tried-and-true methods and leave the wild routing schemes up to you.

62 MUTE

Point Before: EQ IN *switch* 57.

Point After: Fader 63, PRE *switch* (AUX 1-4) 73.

Muting a Channel removes the signal from these output paths: LEFT/RIGHT/CENTER mixes 37 and SUBS (SUB 1-8 mixes) 94, AUX SEND MASTERS 109, AFL SOLO, and AFL Channel Meters. The INSERT SEND, PFL SOLO, and PFL Meter paths are not affected.

Unlike the "latching" switches, which live in an up-or-down position, the MUTE switch is "momentary" — when you press it, it comes right back up. Pressing the switch toggles the electronic mute relay in the signal path's circuitry. If the Channel is muted, pressing the switch un-mutes it, and vice versa. An LED adjacent to the switch glows when a Channel is muted.

The reason this switch is of the momentary persuasion is to enable you to change mute settings by other means, namely ULTRA MUTE™ 152. With ULTRA MUTE™, up to 100 different mute groups can be configured, enabling you to mute several signals at once. Not only that, but you can automate the muting of Channels (and other signal paths) via an external MIDI sequencer or the DATA 42 port. We'll discuss all this in excruciating detail later on 152.

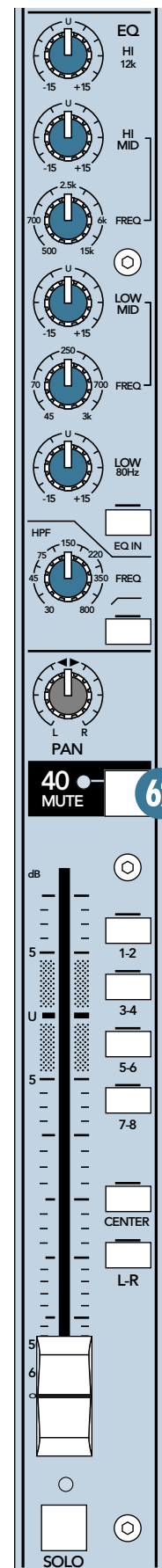

63 FADER

Point Before: MUTE 62.

Point After: PAN 65, CENTER (ASSIGN) 68, DIRECT OUT 16, AUX 72 (with PRE switch 73 74 up), AFL CHANNEL METER 71.

The Fader is almost the last control in a Channel's signal path. It's placed after the EQ and the MUTE controls but before the PAN control. The "U" mark, about three-quarters of the way up, indicates unity gain, meaning no increase or decrease of signal level. All the way up provides an additional 10dB, should you need to boost a section of a song. If you find that the overall level is too quiet or too loud with a Fader near unity, you'll want to confirm the trim setting by keeping an eye on the Channel Meter 71 (with the METERING: INPUT SECTION PFL/AFL switch 126 in the "up" position), or performing the **Level-Setting Procedure** 1.

64 A CLEAN FADE



Fader mechanics are not rocket science — a Fader operates by dragging a metal pin (the wiper) across a carbon-based strip (the track). Despite the elaborate dust barriers built into the SR40•8's Faders, it is still remotely possible for airborne crud to land on the track. Should that happen, you may hear scratchy noises or signal dropouts as the wiper stumbles over the crud. Do all you can to keep airborne crud out of your profession. Avoid smoking near the mixer, keep food and drink away from the mixer, and for pity's sake, never put the mixer in the kitchen! We also recommend "exercising" the Faders — give them a few full-travel excursions once a week or so, and that will help scare the crud away. We do not recommend spray cleaners.

65 PAN

Point Before: Channel Fader 63.

Point After: 1-2, 3-4, 5-6, 7-8 (assignment switches) 67, SOLO (in AFL mode) 69.

PAN adjusts the amount of Channel signal sent to the left versus the right outputs. PAN determines the fate of the LEFT/RIGHT mix, Subgroups, and SOLO (in AFL mode). With the PAN knob hard left, the signal feeds the LEFT mix, SUBs 1, 3, 5 and 7, and the left AFL SOLO (assuming their assignment switches are engaged). With the PAN knob hard right, the signal

feeds the RIGHT mix, SUBs 2, 4, 6, and 8, and the right AFL SOLO. With the PAN knob set somewhere in between left and right, the signal is divided between the left and right buses.

Be aware: Since CENTER 68 assignment occurs before the PAN control, it will receive the same level as the Fader output, regardless of the PAN position.

With stereo sources your life will be easier if you follow this standard convention: When patching stereo sound sources into Channels, always plug the left signal into an "odd" Channel (1, 3, 5, etc.) and the right signal into the adjacent "even" Channel (2, 4, 6, etc.). Then PAN the odd Channel hard left and the even Channel hard right.

66 CONSTANT LOUDNESS



The SR40•8's PAN controls employ a design called "constant loudness". It has nothing to do with living next to a freeway. As you turn the PAN knob from left to right (thereby causing the sound to move from left to center to right), you want the sound to move, but the volume (loudness) must stay the same. To accomplish this trick, the SR40•8 has a constant loudness pan circuit, meaning the signal level dips down about 4dB on each side when panned center. Without this trick, the sound would appear louder when panned center.

67 1-2, 3-4, 5-6, 7-8, L-R (assignment switches)

Point Before: PAN 65.

Point After: LEFT/RIGHT mixes 87 and SUB 1-8 mixes 94.

Alongside each Channel Fader are five buttons labeled 1-2, 3-4, 5-6, 7-8, and L-R. These are collectively referred to as stereo assignment switches. 1, 3, 5, 7, and L are the left sides of these stereo pairs, and 2, 4, 6, 8, and R are the right sides. Used in conjunction with the Channel's PAN 65 control, these switches determine the destination of a Channel's signal: With the PAN knob set at the center detent, the left and right sides receive equal signal levels. To feed only one side or the other, turn the PAN knob accordingly.

If you're doing a conventional stereo mix (with no center Channel), simply engage the L-R switch on each Channel that you want to hear and they'll be sent to the main

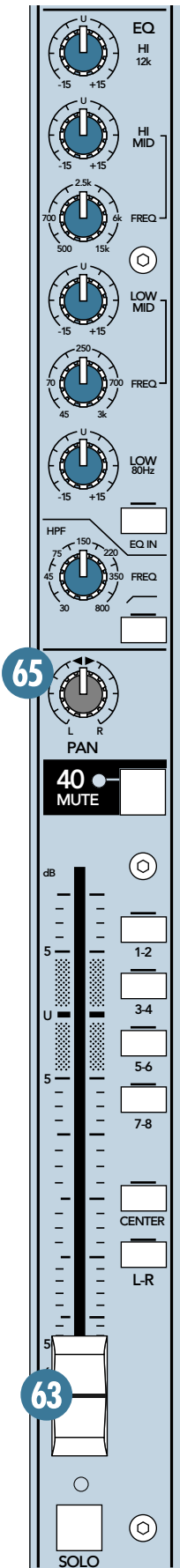

LEFT/RIGHT mix **67**. If you want to create a Subgroup of certain Channels, engage one of the numbered switches instead of the L-R, and the signals from those Channels are sent to the appropriate Subgroup Fader **95**. From there, the Subgroups can be sent back to the main LEFT/RIGHT mix **87**, allowing you to use the Subgroup Faders as a master control for those Channels.

68 CENTER (assignment)

Point Before: Fader **63**.

Point After: CENTER mix **87**.

This switch works the same way as the other assignment switches — engage the switch and that Channel's signal is sent to that mix — but it is not a stereo destination. Since the CENTER assignment occurs before the PAN control, it will receive the same level as the Fader output, regardless of the PAN position.

Be aware: If you're using the LEFT/RIGHT MAIN OUTPUTS but not the CENTER OUTPUT, and you want a Channel's signal to appear in the center of the main LEFT/RIGHT mix, engage the L-R switch and set the PAN control to the center. Don't use the CENTER assignment switch — it won't go anywhere, but it will appear in the PHONES mix, and that could mislead you into thinking it actually is in the main LEFT/RIGHT mix.

If you want to create a LEFT/RIGHT/CENTER mix for your main feed, and also a LEFT/RIGHT mix with CENTER blended in for a secondary feed, you'll want to use the MATRIX **146** section. Use MATRIX A for the LEFT and MATRIX B for the RIGHT secondary mix outputs. Turn MATRIX A's LEFT knob and MATRIX B's RIGHT knob to their "U" markings. On MATRIX A and B, turn their CENTER knobs about one-third of the way up (10:00 position).

69 SOLO

PFL Point Before: EQ IN **57** switch.

PFL Point After: PFL mix (mono) SOLO (of LEFT/RIGHT/CENTER Faders) **115**.

AFL Point Before: PAN **65**.

AFL Point After: AFL mix (stereo) SOLO (of LEFT/RIGHT/CENTER Faders) **115**.

SOLO allows you to audition signals through your headphones without having to assign them to any of the LEFT/RIGHT/CENTER mixes **87** or Subgroup (SUB 1–8 mixes) **94**. You can simultaneously SOLO as many Channels (and other signals) as you like. The SR40•8 features nondestructive solo: Engaging SOLO does not interrupt any of the other Channels, buses, or outputs. Not only that, via the INPUTS PFL/AFL **116** and OUTPUTS PFL/AFL **117** switches in the output section, the SOLO system comes in two flavors: PFL (Pre-Fader-Listen) and AFL (After-Fader-Listen, solo-in-place).

PFL is the key player in the all-important **Level-Setting Procedure** **1**. It'll send the Channel's actual internal levels to the HEADPHONES **28** **29**, Channel Meters **71** and SOLO LEFT/RIGHT/CENTER Meters **125** so you'll know just what's going on level-wise. This procedure should be performed every time a new sound source is patched into a Channel's MIC or LINE IN jacks.

PFL is often the preferred mode in SR (Sound Reinforcement, or live sound), to preview Channels before they are assigned into the mix. It won't give you stereo placement, but will give you signal even if the Fader is pulled down.

Remember, PFL taps the Channel signal before the Fader. If you have a Channel's Fader set way below "U" (unity gain), the SOLO mix won't know that and will send a unity gain signal to the HEADPHONES and Meters. That may result in a startling level boost at these outputs, depending on the position of SOLO LEVEL **118**.

In AFL mode, the soloed Channel's signal is sent directly to the HEADPHONES and Meters just as it would sound to the Channel's stereo assignment switches: post-EQ, post-Fader and post-PAN. AFL works regardless of the Channel's assignment settings, and that makes it handy for auditioning a Channel before you assign it to a mix.

AFL is the preferred mode during mixdown: If the Channel has some midrange boost at 4.26kHz, is panned 20.3 degrees to the left, and its Fader is at -5.38dB, that's exactly what you'll hear if you solo during AFL-SIP mode. It's just as if you took the time to mute all the other signals.

Be aware: INPUTS SOLO has precedence over OUTPUTS SOLO — you can't combine these signals. For instance, if you have SUB 1 (an output signal) in SOLO, then you engage SOLO on Channel 15 (an input signal), the SUB 1 signal will be removed and replaced by the Channel 15 signal.

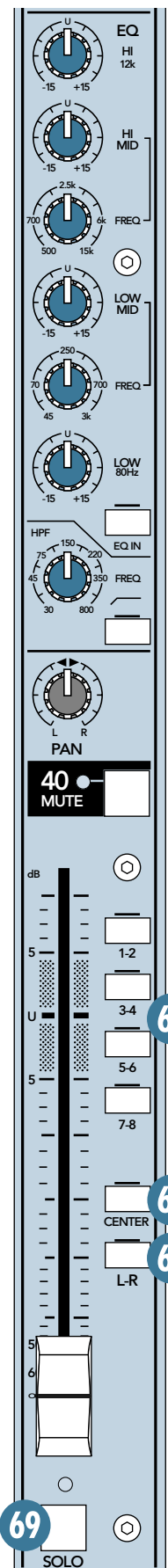

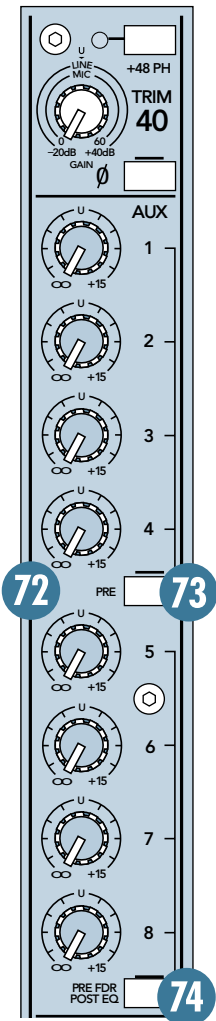

Be further aware: If this happens, remember that you still have the Subgroup 1 SOLO switched engaged, even though you can't hear it. In this situation, to get out of SOLO mode you'll have to disengage all the SOLO switches, even the ones you can't hear.

71 METER

Point Before: EQ IN *switch* 57 (*with* METERING: INPUT SECTION PFL/AFL *switch* 126 *up*), Channel Fader 63 (*with* METERING: INPUT SECTION PFL/AFL *switch* 126 *down*).

These individual Channel Meters give you constant visual information about the signal level in that Channel. In fact, with the METERING: INPUT SECTION PFL/AFL 126 switch set to PFL (up), you may use these Meters for a quick signal check without even engaging SOLO. With that switch down, the Meters will display the post-MUTE/post-Fader/pre-PAN output of the Channel.

You may already be an expert in the world of “+4” (+4dBu=1.23V) and “-10” (-10dBV=0.32V) operating levels. Basically, what makes a mixer one or the other is the relative 0dB VU (or 0VU) chosen for the Meters. A “+4” mixer, with a +4dBu signal pouring out the back, will actually read 0VU on the Meters. A “-10” mixer, with a -10dBV signal trickling out, will also read 0VU on its Meters. So when does 0VU actually equal 0dBu? Right now!

At the risk of creating another standard, Mackie has done away with the two standards just mentioned in favor of a simpler one: 0dBu at the output equals 0VU on the Meters. What could be easier? (By the way, the most wonderful thing about standards is that there are so many to choose from.)

72 AUX SEND

These eight rotary controls tap a portion of each Channel's signal, mix them together, and send them to the AUX SEND outputs 23 outputs (or the SUB OUTPUTS 26 if FLIP 111 is engaged). They are off when turned fully down, deliver unity gain at the center detent, and provide 15dB of gain turned fully up.

The AUX SEND outputs are then patched to stage monitor amp inputs (pre-Fader) or parallel effects processor inputs (post-Fader). In the output section, overall levels are adjusted by the AUX SEND MASTERS' level 112 (or Subgroup Fader 95 if FLIP 111 is engaged).

AUX sends can also be used to generate separate mixes for recording or “mix-minuses” for broadcast. By using AUX sends in the PRE modes 73 74, these mix levels can be obtained independently of a Channel's Fader settings.

We recommend going into a stereo reverb in mono and returning in stereo. We have found that most “stereo” reverbs' second input just ties up an extra aux send and adds nothing to the sound. There are exceptions, so try it both ways.

73 PRE switch (AUX 1-4)

Point Before: Channel Fader 63 (*switch up*), HPF 58 (*switch down*).

Point After: AUX sends 1-4 72.

This switch determines the tap point of AUX sends 1-4. Generally, *post* sends are used to feed effects devices, and *pre* sends are used to feed your stage monitors.

In *post* mode (switch up), AUX sends 1-4 will follow the EQ, HPF, Fader and MUTE settings. If you fade the Channel, you fade the AUX send. This is a must for effects sends, since you want the levels of your “wet” signals to follow the level of the “dry” signal.

In *PRE* mode (switch down), AUX sends 1-4 follow the TRIM, 0 (polarity), HPF and MUTE settings only. EQ, PAN and Fader set-

tings have no effect on the PRE sends. This is a popular method for setting up stage monitor feeds — they'll be controlled independently of the Fader moves.

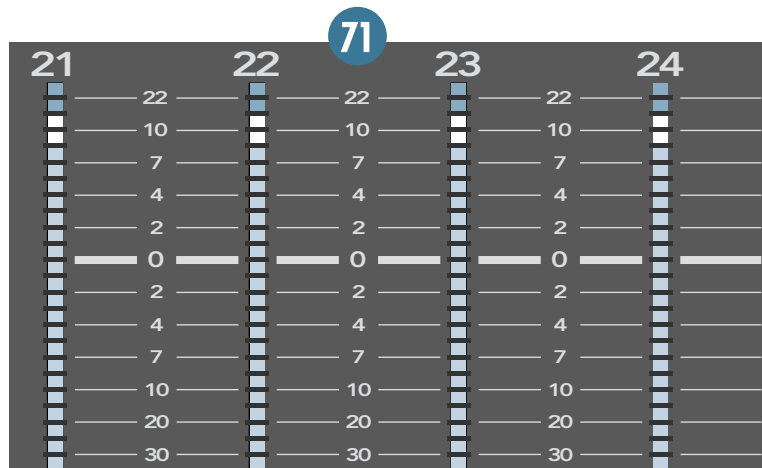

74 PRE FDR/POST EQ (AUX SENDS 5–8)

Point Before: Fader **63** (switch up), EQ IN **57** (switch down).

Point After: AUX sends 5–8 **72**.

This switch has one difference from the PRE switch for AUX sends 1–4: In the PRE mode (named POST EQ), the tap point is still before the Channel Fader, but after the EQ, instead of before. If you prefer that your stage monitor mixes have EQ, use these AUX sends with this switch down. If you prefer no EQ, use AUX sends 1–4 with the PRE switch down.

Main Aux Returns (A1–A4)

Top to bottom: High Shelving, High-Mid Peaking, Low-Mid Peaking, Low Shelving, High Pass Filter.

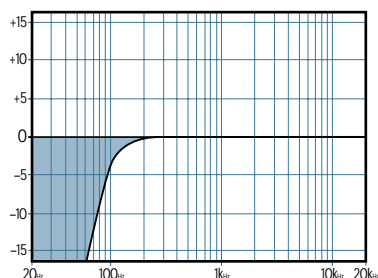
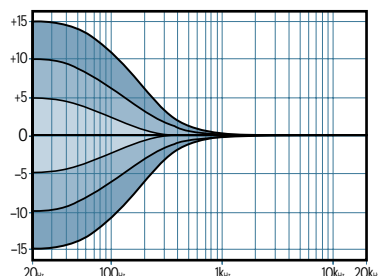
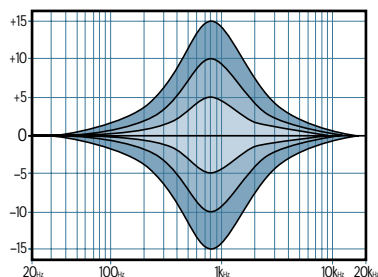
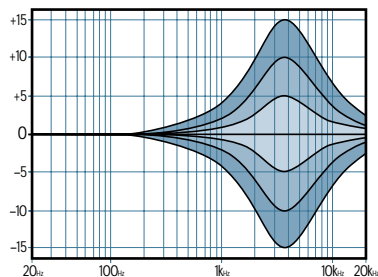
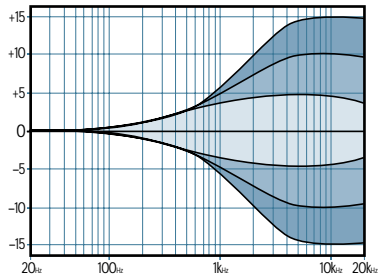

75 MAIN AUX RETURNS (A1–A4)

You've no doubt noticed that the MAIN AUX RETURNS (A1–A4) look suspiciously like the Channels. That's because they *are* Channels, but they're stereo instead of mono, with full routing to the LEFT/RIGHT/CENTER and Sub-group mixes, AUX sends and SOLO. We'll just cover the things that are different.

76 TRIM

The only difference between the Channel TRIM **47** and this one is the gain range (and the fact that this one is stereo). With the control fully down there will be 10dB of attenuation. With the control fully up, 10dB of boost.

Perform the **Level-Setting Procedure 1** every time you patch in a new sound source to these stereo Channels, to assure maximum headroom and minimum noise.

77 HPF

This operates the same way as it does on the Channels — engage the switch to activate the HPF (high pass filter). The difference is that the frequency is not adjustable — it's pre-set at 150Hz, with a 18dB per octave curve.

We recommend that you leave the HPF engaged at all times unless the signal has important ultra-low-frequency content that would be diminished by using a 150Hz HPF. However, these stereo Channels are designed to handle AUX return signals, and those signals rarely have this ultra-low-frequency content.

78 EQ

The MAIN AUX RETURNS (A1–A4) have 4-band EQ, but the two midrange bands do not have frequency sweep controls. The frequencies are fixed at 12kHz (HI shelving), 3kHz (HI-MID bandpass), 800Hz (LOW-MID bandpass), and 80Hz (LOW shelving).

Using HPF **77** with EQ allows you to boost the LOW EQ without boosting the subsonic debris, cleaning up your mix and conserving amplifier power. We highly recommend its use.

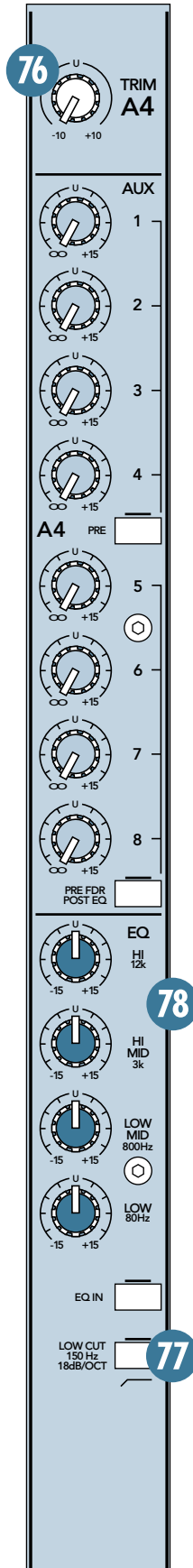

85

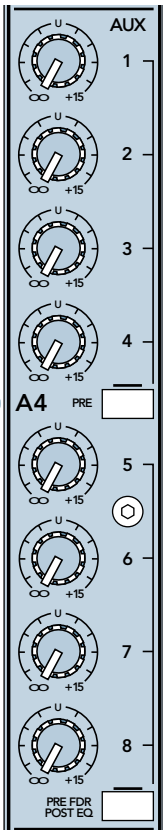

79 PAN

Being that these are stereo Channels, their PAN controls are similar to a balance control on a home stereo — if you turn it to the right, you attenuate the left signal and if you turn left, you attenuate the right signal. The only difference is that when PAN is centered, there is 4dB of attenuation on each side to maintain “constant loudness” 66.

81 1-2, 3-4, 5-6, 7-8, L-R (ASSIGN)

Rather than routing a mono signal to a left mix, a right mix, or somewhere in between, these stereo aux returns always send the left signal to the left mixes (1, 3, 5, 7, and LEFT) and the right signal to the right mixes (2, 4, 6, 8, and RIGHT), depending on PAN position and assignment switch positions.

82 CENTER (ASSIGN)

The CENTER assignment on the MAIN AUX RETURNS (A1–A4) operates the same as it does on the Channels, except that it takes both the LEFT and RIGHT signals, mixes them together, and then sends that mono signal to the CENTER mix 87.

83 SOLO

This works just like the Channel SOLO 69, with one exception: In PFL mode, the LEFT and RIGHT signals are mixed together to form a combined mono PFL signal.

Be aware: Just as INPUTS SOLO has precedence over OUTPUTS SOLO, so do aux returns have precedence over aux sends — you can’t combine these signals. For instance, if you have AUX SEND 1 (an output signal) in SOLO, then you engage SOLO on AUX RETURN A1 (an input signal), the AUX SEND 1 signal will be removed and replaced by the AUX RETURN A1 signal.

84 METER

These operate just like the Channel Meter 71, except that there are two LED columns per MAIN AUX RETURN and just one column per mono Channel.

85 AUX

The AUX sends on the MAIN AUX RETURNS (A1–A4) operate the same as they do on the Channels, except that they take both the left and right signals, mix them together, and then send that mono signal to each AUX SEND MASTER.

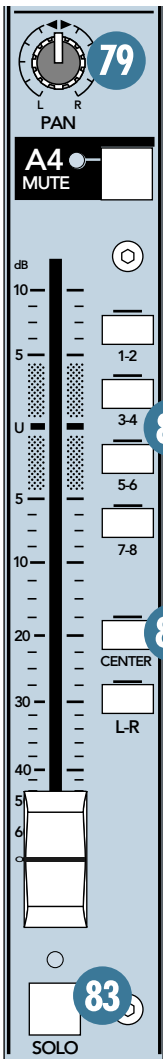

86 OUTPUT SECTION

You've just learned about the Channels and MAIN AUX RETURNS (A1–A4), and how the signals get in and out. In the output section, things get a bit more complicated, so put on your thinking cap.

87 LEFT/RIGHT/CENTER MIXES

This is where everything assigned via the 1-2, 3-4, 5-6, 7-8, L-R, 67 or CENTER 68 assignment switches gets mixed together. Just after the mix stage, the signals are sent out to the MAIN INSERTS 25, then they come back to their respective Faders.

88 LEFT FADER

Point Before: MAIN INSERTS 25.

Point After: MAIN OUTPUTS 24.

The left mix is off with this Fader fully down, the “U” marking is unity gain, and fully up provides 10dB additional gain.

89 RIGHT FADER

Point Before: MAIN INSERTS 25.

Point After: MAIN OUTPUTS 24.

The right mix is off with this Fader fully down, the “U” marking is unity gain, and fully up provides 10dB additional gain.

To ride a stereo left/right mix, operate both Faders together, side by side, as if they were one. If a special application calls for some imbalance in levels, create that by offsetting the left and right Faders and riding that. For an even easier solution, see the following section, FADER LINK.

91 FADER LINK

Some engineers prefer to have the left and right sides of the main mix travel through separate Faders, as described above. Others prefer the accuracy and simplicity of one stereo Fader. This switch allows you to set up the LEFT and RIGHT mix Faders either way.

With the FADER LINK switch up, the left mix travels through the LEFT Fader, and the right through the RIGHT Fader. With the switch down, the left mix is diverted over to the “other half” of the RIGHT Fader (actually a stereo Fader) and the LEFT Fader is out of the circuit. It'll sound the same either way, there's no performance penalty either way, and it's completely up to you. Go for it.

To actually have fun with this switch, first engage it, making the RIGHT Fader control both the left and right levels while rendering the LEFT Fader useless. Now tell the producer or road manager that he's free to adjust the mix balance by tweaking the LEFT Fader to his heart's content.

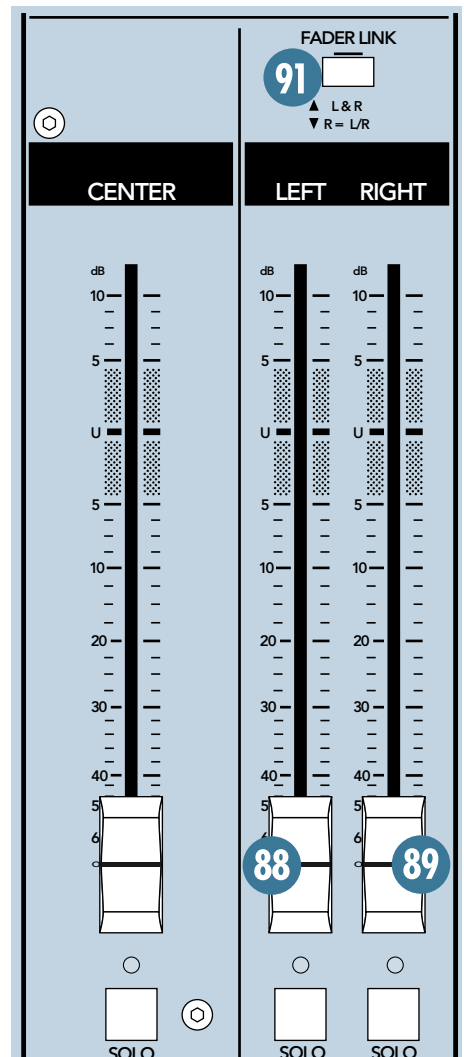

92 CENTER FADER

Point Before: MAIN INSERTS **25**.

Point After: MAIN OUTPUTS **24**.

The CENTER mix is off with this Fader fully down, the "U" marking is unity gain, and fully up provides 10dB additional gain.

Remember that the CENTER mix is not actually related to the LEFT and RIGHT mix (except that they usually wind up singing to the same audience). Ride the CENTER Fader as needed, regardless of the position of the FADER LINK switch and LEFT and RIGHT Faders.

93 SOLO

PFL Point Before: LEFT, RIGHT *and* CENTER mix **87**.

PFL Point After: PFL mix (mono) **115**.

AFL Point Before: LEFT, RIGHT *and* CENTER Faders **88 89 92**.

AFL Point After: AFL mix (stereo) **115**.

SOLO allows you to audition signals through your headphones. You can simultaneously SOLO as many signals as you like. The SR40•8 features nondestructive solo: Engaging SOLO does not interrupt any of the other Channels, buses, or outputs. Not only that, the SOLO system comes in two flavors: PFL (Pre-Fader Listen) and AFL (After-Fader Listen, Solo-In-Place).

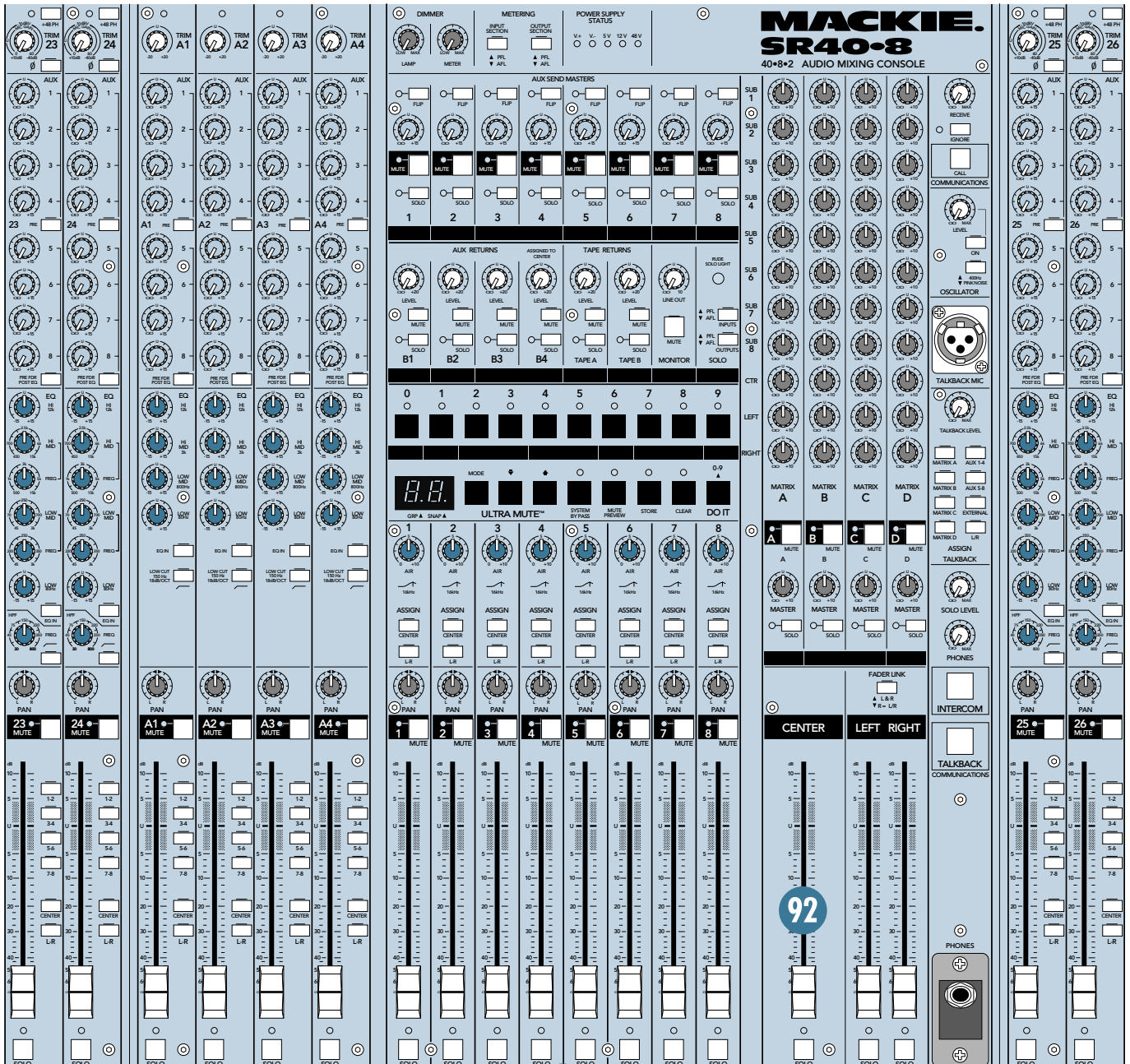

Remember: INPUTS SOLO has precedence over OUTPUTS SOLO — you can't combine these signals.

94 SUBS (SUB 1-8 MIXES)

This is where everything assigned via the 1-2, 3-4, 5-6, and 7-8 [67](#) Channel assignment switches gets mixed together. Just after the mix stage, the signals are sent out to the SUB INSERTS [27](#), then they come back to their respective Subgroup Faders.

Be aware: If the signal path of a subgroup appears to have been mysteriously replaced by its like-numbered AUX SEND MASTER, it's because that AUX SEND MASTER's FLIP switch is engaged. See [111](#) for more details.

95 FADER

Point Before: SUB INSERTS [27](#).

Point After: MUTE [96](#).

A SUB mix is off with this Fader fully down, the "U" marking is unity gain, and fully up provides 10dB additional gain.

96 MUTE

Point Before: Fader [95](#).

Point After: SUB OUTPUTS [26](#), PAN [97](#), CENTER (assignment) [99](#), respective MATRIX [146](#) inputs.

Muting a SUB removes the signal from these output paths: SUB OUTPUTS, SUB CENTER/L-R (ASSIGN), AFL SOLO, and the respectively-numbered MATRIX input. The INSERT, PFL SOLO, and PFL Meter paths are not affected.

Pressing the switch toggles the electronic mute relay in the signal path's circuitry. If the signal is muted, pressing the switch unmutes it, and vice versa. An LED adjacent to the switch glows when it is muted.

With ULTRA MUTE™, up to ten Banks of ten different Mute Groups can be configured, enabling you to mute several signal paths at once. Not only that, but you can automate the muting of all the signal paths via an external MIDI sequencer or via the RS-232 DATA [42](#) port connected to a computer. We'll discuss all this in detail later on [152](#).

97 PAN

Point Before: MUTE [96](#).

Point After: L-R (ASSIGN) [98](#).

PAN does not affect a subgroup's dedicated SUB OUTPUT. PAN adjusts the amount of signal sent to the LEFT versus the RIGHT mixes via the L-R (ASSIGN) switch and the SOLO balance (in AFL mode). With the PAN knob hard left, the signal feeds the LEFT mix [87](#) and the left AFL SOLO (assuming their assignment switches are engaged). With the knob hard right, the signal feeds the RIGHT mix [87](#) and the right AFL SOLO. With the PAN knob set somewhere in between left and right, the signal is divided between the LEFT and RIGHT buses.

98 L-R (ASSIGN)

Point Before: PAN [97](#).

Point After: LEFT/RIGHT mixes [87](#).

If you're doing a conventional stereo mix and using the Subgroups as master controls for groups of Channels before they enter the LEFT/RIGHT mix (by assigning these Channels to the Subgroup only [67](#)), simply engage the Subgroup's L-R switch, and the signal will be sent to the LEFT/RIGHT mix. With the PAN knob set at the center detent, the left and right sides receive equal signal levels. To feed only one side or the other, turn the PAN knob accordingly.

99 CENTER (ASSIGN)

Point Before: MUTE [96](#).

Point After: CENTER mix [87](#).

This switch works the same way as the Subgroup's L-R assignment switch — engage the switch and that signal is sent to the CENTER mix — but it is not a stereo signal. Since the CENTER assignment occurs before the PAN control [97](#), it receives the same level as the Fader output regardless of the PAN position.

Be aware: If you're using the LEFT and RIGHT MAIN OUTPUTS but not the CENTER OUTPUT, and you want a subgroup's signal to appear in the center of the main LEFT/RIGHT mix, engage the L-R switch [98](#) and set the PAN control [97](#) to the center. Don't use the CENTER ASSIGN switch — It won't go anywhere, but it will appear in the PHONES mix, and that could mislead you into thinking it actually is in the LEFT/RIGHT mix.

If you want to create a LEFT/RIGHT/CENTER mix for your main feed, and also a LEFT/RIGHT mix with CENTER blended in for

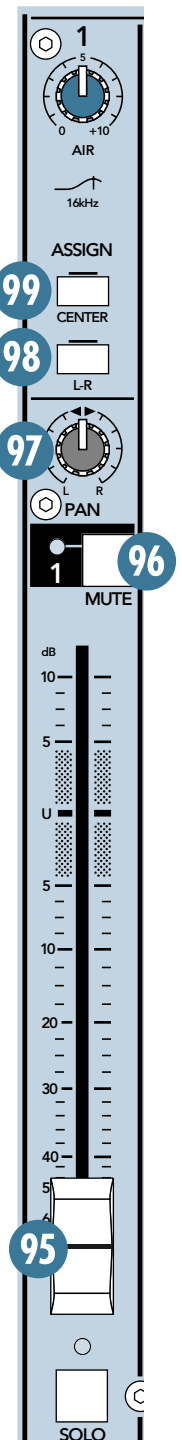

a secondary feed, you'll want to use the MATRIX [146](#) section. Use MATRIX A for the LEFT and MATRIX B for the RIGHT secondary mix outputs. Turn MATRIX A's LEFT knob and MATRIX B's RIGHT knob to their "U" markings. On MATRIX A and B, turn their CENTER knobs about one-third of the way up (10:00 position).

101 SOLO

PFL Point Before: SUB INSERTS [27](#).

PFL Point After: SOLO (LEFT/RIGHT/CENTER Faders) [115](#) PFL *mix (mono)*.

AFL Point Before: PAN [97](#).

AFL Point After: SOLO (LEFT/RIGHT/CENTER Faders) [115](#) AFL *mix (stereo)*.

SOLO allows you to audition signals through your headphones. You can simultaneously SOLO as many signals as you like. The SR40•8 features nondestructive solo: Engaging SOLO does not interrupt any of the other Channels, buses, or outputs. Not only that, the SOLO system comes in two flavors: PFL (Pre-Fader Listen) and AFL (After-Fader Listen, Solo-In-Place).

Remember: INPUTS SOLO has precedence over OUTPUTS SOLO — you can't combine these signals.

102 AIR

Point Before: FLIP [111](#).

Point After: SUB INSERTS [27](#).

The AIR control is a special form of EQ set into the submix masters, a smooth, broad hill of shiny hyper-treble centered at 16kHz, with gossamer skirts extending as low as 12kHz and wafting as high as 20kHz. When AIR is set at 0, it is effectively out of the signal path and the submix bus has a flat response. But when you need a little more "air" in your sound, just a hint of high treble to add that atmospheric breathiness to your vocalists or that brand-new-string jangle to your guitar, give the AIR knob a twist. We think you'll like it.

103 METERS

Point Before: SUB INSERTS [27](#) (METERING: OUTPUT SECTION PFL/AFL [127](#) *switch up*), MUTE [96](#), (METERING: OUTPUT SECTION PFL/AFL [127](#) *switch down*).

Each individual Meter gives you constant visual information about the signal level in the corresponding subgroup. In fact, with the METERING: OUTPUT SECTION PFL/AFL [127](#) switch set to PFL (up), you can use these Meters for a quick signal check without even engaging SOLO. With that switch down, the Meters will display the post-MUTE/post-Fader/pre-PAN output of the subgroups.

A 0dB reading on the Meters represents a 0dBu balanced output signal, when the METERING: OUTPUT SECTION PFL/AFL [127](#) switch is engaged (AFL). In other words, 0VU=0dBu at a balanced output, and 0VU=-6dBu at an unbalanced output.

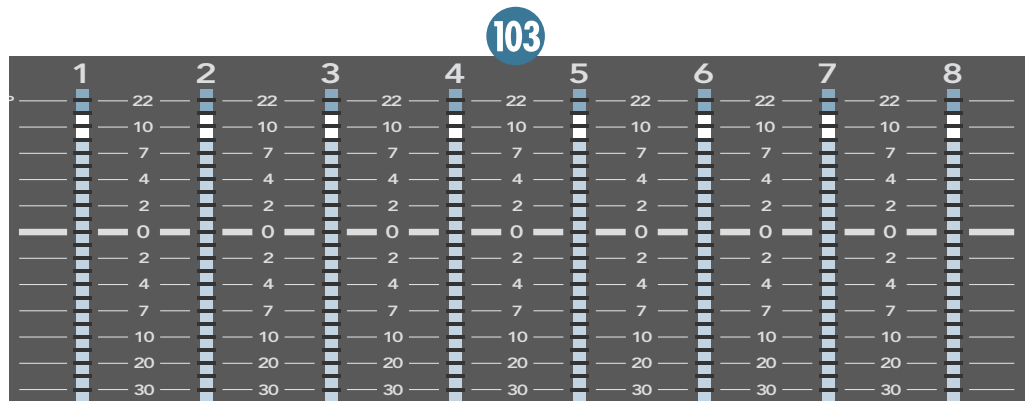
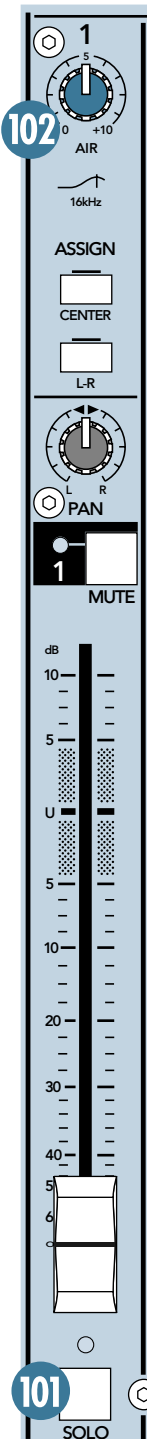

**104 "B" AUX RETURNS AND
105 TAPE RETURNS**

The four "B" AUX RETURNS and the two TAPE RETURNS are basically the same, but with different input hardware **18** **19**. They're your basic, no-frills, stereo Channels. AUX RETURNS B1, B2, B3, TAPE A and TAPE B are dedicated to the LEFT/RIGHT mix, and AUX RETURN B4 is dedicated to the CENTER mix. Equipped with LEVEL, MUTE and SOLO controls, they're perfect for getting reverb and delay signals to the main mixes. If you need to send these signals to the monitors (via AUX SENDS) or to the SUBS, patch them into the MAIN AUX RETURNS (A1–A4) **75** instead.

106 LEVEL

Point Before: "B" AUX RETURNS **18**, TAPE INPUT **19**.

Point After: MUTE **107**.

The signal is off with the rotary LEVEL control turned fully counterclockwise, unity gain is at the center "U" detent, and turned fully up provides 15dB gain.

107 MUTE

Point Before: LEVEL **106**.

Point After: LEFT/RIGHT *mix* (AUX RETURN B1, B2, B3, TAPE A, TAPE B); CENTER *mix* (AUX RETURN B4).

Muting removes the signal from the dedicated LEFT/RIGHT/CENTER mixes and AFL SOLO. The PFL SOLO and PFL Meter paths will not be affected. The signal is muted with the switch engaged (down). "B" AUX RETURNS and TAPE A and TAPE B do not have momentary MUTE switches or associated LEDs and are not controllable via ULTRA MUTE™ **152**.

108 SOLO

PFL Point Before: "B" AUX RETURNS **18**, TAPE INPUT **19**.

PFL Point After: SOLO (LEFT/RIGHT/CENTER *Faders*) **115** PFL *mix (mono)*.

AFL Point Before: LEVEL **106**.

AFL Point After: SOLO (LEFT/RIGHT/CENTER *Faders*) **115** AFL *mix (stereo)*.

SOLO allows you to audition signals through your headphones without having to assign them to any of the LEFT/RIGHT/CENTER mixes **87** or subgroups (SUB 1–8 mixes) **94**. You can simultaneously SOLO as many signals as you like. The SR40•8 features nondestructive solo: Engaging SOLO does not interrupt any of the other Channels, buses or outputs. Not only that, the SOLO system comes in two flavors: PFL (Pre-Fader Listen) and AFL (After-Fader Listen, Solo-In-Place).

Remember: AUX SENDS SOLO has precedence over AUX RETURNS SOLO — you can't combine these signals.

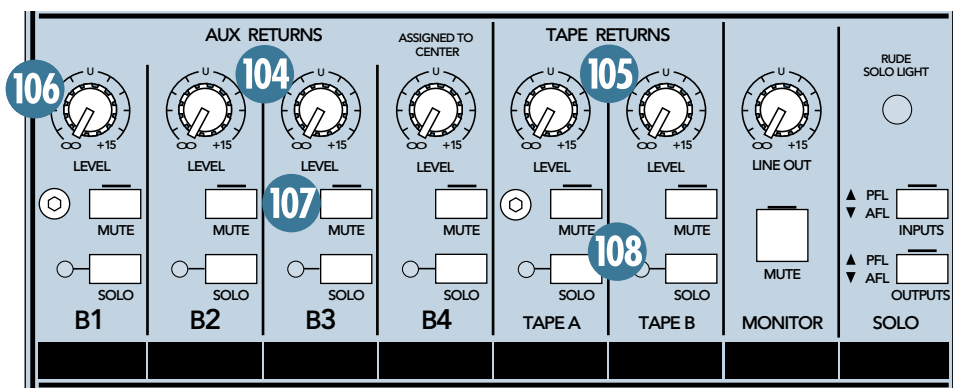

109 AUX SEND MASTERS

The AUX SEND MASTERS, as with all the signal paths in the SR40•8, are fully equipped with LEVEL, MUTE, and SOLO controls. Using the FLIP 111 feature, AUX SEND MASTERS can be routed through the subgroups (SUB 1–8 mixes) 94 circuitry instead, providing the engineer with more control over these signals, which exit via XLR jacks.

Be aware: If the signal path of an AUX SEND MASTER appears to have been mysteriously replaced by its like-numbered subgroup, it's because that AUX SEND MASTER's FLIP 111 switch is engaged. Read on.

111 FLIP

Point Before: Subgroups (SUB 1–8 mixes) 94, AUX SEND MASTERS 109.

Point After: AIR 102, (AUX SEND MASTER) LEVEL 112.

Each AUX SEND MASTER has a FLIP switch and an associated LED. The FLIP switch removes an AUX SEND MASTER mix from its dedicated MUTE and LEVEL controls and diverts it to the like-numbered Subgroup routing. The FLIP switch makes the SR40•8 an ideal stage monitor console. A flipped AUX SEND MASTER will have its own dedicated 100mm Fader, AIR EQ, INSERT, and balanced XLR output. Meanwhile, a flipped AUX SEND MASTER also diverts the Subgroup signal to the original AUX SEND MASTER controls and TRS output. Confused? Try it this way:

This is the path of an AUX SEND MASTER signal with its FLIP switch disengaged (up): Channel AUX level control, AUX SEND MASTER mix, AUX SEND MASTERS: LEVEL, AUX SEND MASTERS: MUTE, and the signal exits via the AUX SEND's TRS jacks.

This is the path of a Subgroup signal with its associated AUX SEND MASTER FLIP switch disengaged (up): Channel assignment and PAN controls, Subgroup mix, Subgroup AIR, SUB INSERT, Subgroup Fader, Subgroup MUTE, and the signal exits via the SUB OUTPUTS XLR jacks.

This is the path of an AUX SEND MASTER signal with its FLIP switch engaged (down): Channel AUX level control, AUX SEND MASTER mix, Subgroup AIR, SUB INSERT, Subgroup Fader, Subgroup MUTE, and the signal exits via the SUB OUTPUTS XLR jacks.

This is the path of a Subgroup signal with its associated AUX SEND MASTER FLIP switch engaged (down): Channel assignment and PAN controls, Subgroup mix, AUX SEND MASTERS LEVEL, AUX SEND MASTERS MUTE, and the signal exits via the AUX SEND TRS jacks.

112 LEVEL

Point Before: FLIP 111.

Point After: MUTE 113.

The signal is off with the rotary LEVEL control turned fully counterclockwise, unity gain is at the center "U" detent, and turned fully up provides 10dB gain. These controls are useful for riding the levels of AUX SEND MASTERS sent to the stage monitors. However, should these mixes require a lot of riding, consider engaging FLIP 111, as that will allow you to use Faders instead of rotary controls.

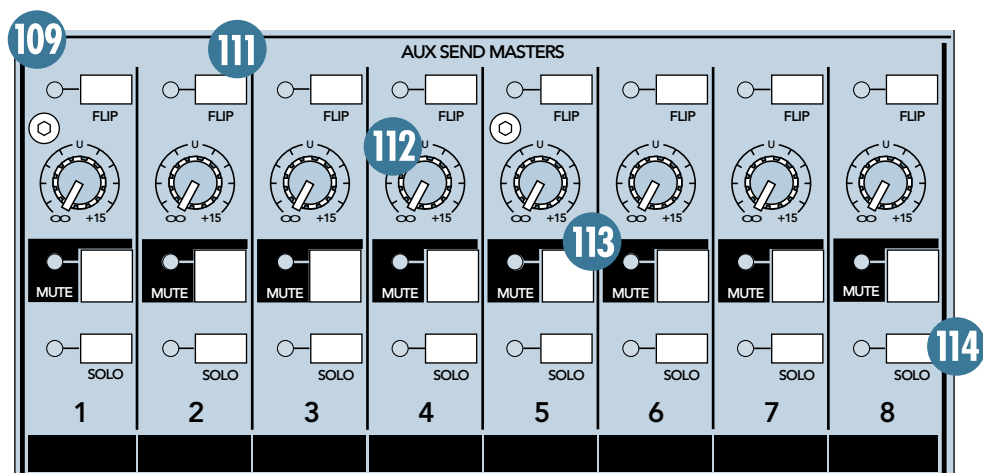

113 MUTE

Point Before: LEVEL 112.

Point After: AUX SEND 23.

Muting removes the signal from its AUX SEND output and AFL SOLO. The PFL SOLO and PFL Meter paths are not affected.

Pressing the switch toggles the electronic mute relay living in the signal path's circuitry. If the signal is muted, pressing the switch unmutes it, and vice-versa. An LED adjacent to the switch glows when muted.

With ULTRA MUTE™, up to ten Banks of ten different Mute Groups can be configured, enabling you to mute several signal paths at once. Not only that, but you can automate the muting of all the signal paths via an external MIDI sequencer or via the RS-232 DATA 42 port connected to a computer. We'll discuss all this in detail later on 152.

114 SOLO

PFL Point Before: AUX SEND MASTERS 109.

PFL Point After: SOLO (LEFT/RIGHT/CENTER Faders) 115 PFL mix (mono).

AFL Point Before: MUTE 113.

AFL Point After: SOLO (LEFT/RIGHT/CENTER Faders) [115] AFL mix (stereo).

SOLO allows you to audition signals through your headphones without having to assign them to any of the LEFT/RIGHT/CENTER mixes 87 or subgroups (SUB 1–8 mixes) 94. You can simultaneously SOLO as many signals as you like. The SR40•8 features nondestructive solo: Engaging SOLO does not interrupt any of the other Channels, buses, or outputs. Not only that, the SOLO system comes in two flavors: PFL (Pre-Fader Listen) and AFL (After-Fader Listen, Solo-In-Place).

Remember: INPUTS SOLO (including AUX SENDS) has precedence over OUTPUTS SOLO — you can't combine these signals.

115 SOLO MASTER CONTROLS

To audition individual signals, or groups of signals, there are SOLO switches on every Channel, MAIN AUX RETURN (A1–A4), "B" AUX RETURN, TAPE A, TAPE B, AUX SEND MASTERS, MATRIX, and Subgroup, as well as the LEFT/RIGHT/CENTER mixes. The engineer behind an SR40•8 can listen to any signal, individually or in groups, without disturbing the content of any of the console's primary outputs. Input signals (Channels, MAIN AUX RETURNS (A1–A4), "B" AUX RETURNS, TAPE A and TAPE B) can be globally switched PFL (Pre-Fader Listen) or AFL (stereo-in-place, After-Fader Listen). Output signals (MAIN LEFT/RIGHT, SUB 1–8, AUX SEND MASTERS 1–4 and MATRIX A–D) have a similar switch.

116 INPUTS PFL/AFL

This switch determines the SOLO mode for these signals: Channels, MAIN AUX RETURNS (A1–A4), "B" AUX RETURNS, TAPE A and TAPE B. To audition PFL (pre-Fader) signals, leave the switch up. Engage the switch (down) for AFL (After-Fader Listen, Solo-In-Place) auditioning.

Whenever SOLO is active, the LEFT/RIGHT/CENTER Meters 125 show the PFL levels on the CENTER Meter and the AFL levels on the LEFT/RIGHT Meters, regardless of the position of this INPUTS PFL/AFL switch.

117 OUTPUTS PFL/AFL

This switch determines the SOLO mode for these signals: SUB 1–8, AUX SEND MASTER, MATRIX A–D, and the LEFT/RIGHT/CENTER mixes. To audition PFL (Pre-Fader Listen) signals, leave the switch up. Engage the switch (down) for AFL (after-Fader listen, Solo-In-Place) auditioning.

Whenever SOLO is active, the LEFT/RIGHT/CENTER Meters 125 will show the PFL levels on the CENTER Meter and the AFL levels on the LEFT/RIGHT Meters, regardless of the position of the OUTPUTS PFL/AFL switch.

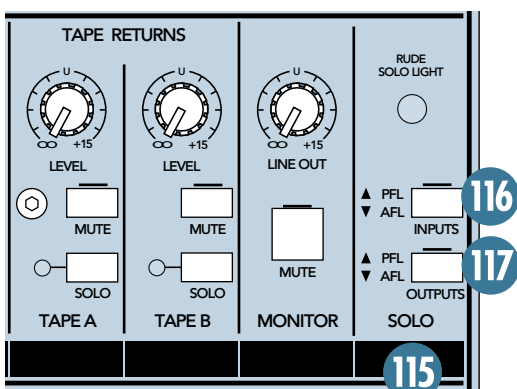

118 SOLO LEVEL

Point Before: INPUTS PFL/AFL 116 and OUTPUTS PFL/AFL 117 switches.

Point After: HEADPHONES 28 29 and MONITOR 32.

This controls the signal level of all SOLO signals, be they from the INPUTS, OUTPUTS, PFL, or AFL. The signal is off when turned fully counterclockwise, with 10dB gain turned fully clockwise.

Remember, PFL signals are tapped before the circuit's level control. For instance, when soloing a Channel in PFL mode, the signal will be tapped before the Channel's Fader. If you have a Channel's Fader set way below "U" (unity gain), SOLO won't know that and will send a unity gain signal to the PHONES. That may result in a startling level boost, depending on the position of the SOLO LEVEL control. In other words, you may find yourself tweaking this control quite often — that's why we put it next to your right hand.

119 RUDE SOLO LIGHT

This flashing LED serves two purposes — to remind you that you're in solo, and to let you know that you're mixing on a Mackie. No other company is so concerned about your level of solo awareness. In addition to this huge LED, each SOLO switch has a local LED adjacent to it, to help you find that pesky soloed Channel right away.

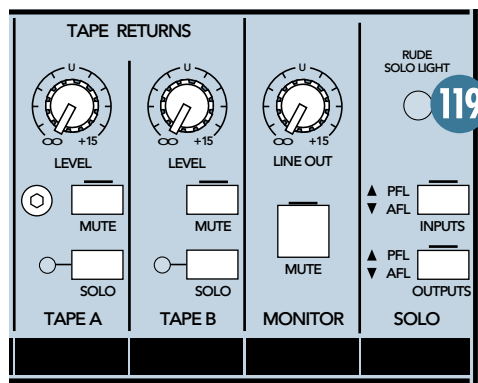

121 PHONES LEVEL

Point Before: LEFT/RIGHT/CENTER mixes 87 post-Fader outputs

Point After: HEADPHONES 28 29 and MONITOR 32.

Unless the SR40•8 is in SOLO, the HEADPHONES always receive the LEFT/RIGHT mix, with the CENTER mix blended into each side. This control sets the level for those signals only. SOLO signals are controlled by SOLO LEVEL only — PHONES LEVEL has no effect on SOLO signals, even though they are being sent to the headphones. This is so you can tailor the "mix level" (non-SOLO signals) and the SOLO LEVEL independently.



WARNING: The SR40•8's stereo phones jack will drive any standard headphone to very loud levels. When we say the headphone amp is loud, we're not kidding. It can cause permanent ear damage. Even intermediate levels may be painfully loud with some earphones. BE CAREFUL!

Always turn the PHONES level 121 all the way down before connecting headphones. Keep it down until you've put the phones on. Then turn it up slowly. Why? "Engineers who fry their ears find themselves with short careers."

The SR40•8's headphone amplifiers will drive headphones of any impedance, but for best results (highest volume), use 60-ohm headphones.

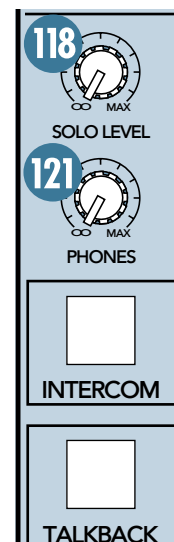

122 MONITOR

MONITOR signals are a line-level equivalent of the HEADPHONES output. The TRS MONITOR 32 outputs are designed for special situations such as these:

You can use these jacks to deliver the FOH (front-of-house) headphone mix to an engineer operating a secondary stage monitor console.

If you want to drive several pairs of headphones via an outboard amplifier, patch these outputs to that amp.

If the console is in a soundproof room, as in live sound-studio work or studio recording/mixdown, patch the MONITOR 32 outputs to your control room amplifier and speakers.

123 LINE OUT (LEVEL)

Point Before: INSERT (HEADPHONES) 31.

Point After: MONITOR 32 outputs.

Just like the HEADPHONES, the MONITOR outputs always receive the LEFT/RIGHT mix, with the CENTER mix blended into each side. This control sets the level for those signals, and it follows the PHONES level control, meaning that the level at these outputs is controlled twice — by the PHONES level and by the LINE OUT control.

SOLO signals to the MONITOR outputs are controlled by SOLO LEVEL and this MONITOR LINE OUT level — the PHONES level has no effect on SOLO signals. This is so you can tailor the “mix level” (non-SOLO signals) and the SOLO LEVEL independently.

124 MUTE

This switch is your garden-variety DPDT (double-pole, double-throw) switch. Engage it and the line-level MONITOR outputs become silent. The MONITOR MUTE is not a member of the ULTRA MUTE™ system and therefore cannot be remotely controlled.

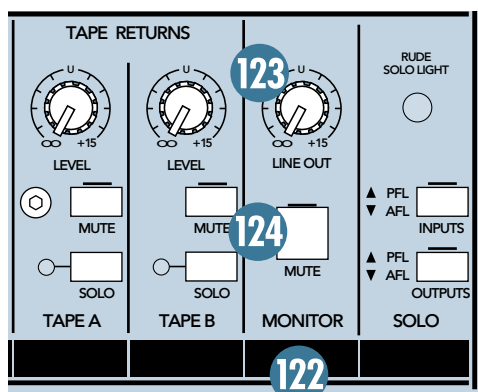

125 LEFT/RIGHT/CENTER METERS

These individual Meters give you constant visual information about the signal level in that mix. With the METERING: OUTPUT SECTION PFL/AFL 127 switch set to PFL (up), the Meters display the pre-Fader signal of the mix. With the switch down, the Meters display the post-Fader output of the mix.

These three Meters, unlike the other fifty-six, have a secondary purpose — to display SOLO levels. Whenever SOLO is engaged, all three Meters' inputs change from the LEFT/CENTER/RIGHT mix signals to the SOLO signals. The PFL SOLO signal will appear on the CENTER Meter and the AFL signals appear on the LEFT/RIGHT Meters.

A 0dB reading on the Meters represents a 0dBu output signal, when the METERING: OUTPUT SECTION PFL/AFL 127 switch is engaged (AFL). In other words, 0VU=0dBu.

METERING

126 INPUT SECTION PFL/AFL

This switch determines the Meter's source signal for the Channels and the MAIN AUX RETURN (A1–A4). With the switch up, in PFL mode (Pre-Fader Listen), signals are sent to the Meters pre-Fader, pre-MUTE, and pre-PAN. In fact, in PFL mode, these Meters may save you the time of having to use SOLO, if all you need is a signal confirmation. With the switch down, in AFL mode, signals will be sent to the Meters post-Fader, representing the output of the circuit.

With this switch set to PFL, you can perform on-the-fly TRIM 47 settings, as explained in the **Turbo Method** of the **Level-Setting Procedure** 1.

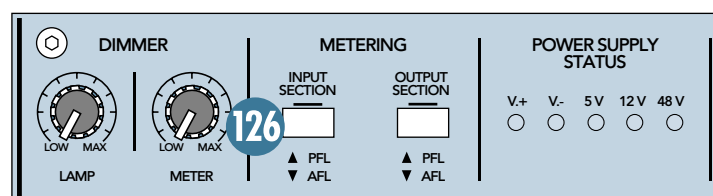

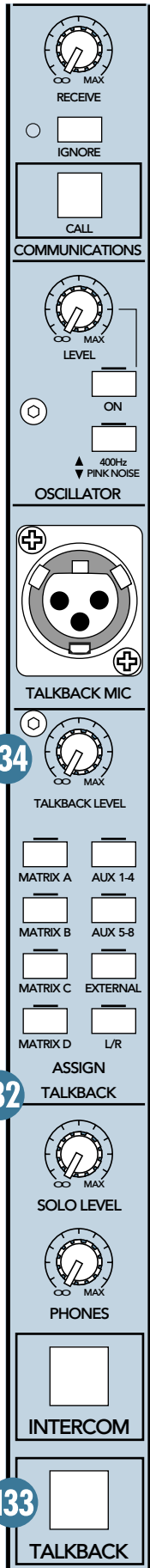

127 OUTPUT SECTION PFL/AFL

This switch determines the Meter's source signal for the MAIN/LEFT/RIGHT and SUB Meters. With the switch up, in PFL mode (Pre-Fader Listen), signals are sent to the Meters pre-Fader, pre-MUTE, and pre-PAN. In fact, in PFL mode, these Meters may save you the time of having use SOLO, if all you need is a signal confirmation. With the switch down, in AFL mode, signals are sent to the Meters post-Fader, representing the output of the circuit.

DIMMER

128 LAMP

This control adjusts the brightness of the 4-pin XLR Littlite® lamps, which are available at a music store near you.

Littlite Part Number	Description
12X-HI-4	12" Hi-intensity lamp with 4-pin XLR
18X-HI-4	18" Hi-intensity lamp with 4-pin XLR

129 METER

This control adjusts the brightness of the LED Meters.

Note: When the METER DIMMER is turned all the way down to LOW, the amber LEDs (+4 to +10) may appear to be off. This is normal, and due to the varying current requirements of the different colored LEDs to produce equal brightness. Adjust the control to suit your taste.

131 POWER SUPPLY STATUS

These five LEDs let you know that each of the SR40•8's essential power supply voltages are present. V.+ and V.- are the positive and negative power rails that power the audio circuitry. 5 V is a 5-volt DC supply that powers the logic, like the ULTRA MUTE™ computer and SOLO relays. 12 V powers the 4-pin XLR lamp sockets. 48 V is the PHANTOM power supply.

On the off chance that one of these status LEDs doesn't glow, indicating a problem, be sure to power down as continued use could cause further damage.

132 TALKBACK SECTION

The SR40•8's extensive TALKBACK section allows the engineer to speak into several outputs via a master TALKBACK switch, with separate assignment switches for AUX 1-4, AUX 5-8, L/R mix, an EXTERNAL talkback output, and one switch for each MATRIX (A-D). Talkback microphones are patched into either of the two phantom-powered XLR inputs and regulated by a LEVEL control. Additionally, the talkback signal may be replaced by a 400Hz sine wave for checking levels, or PINK NOISE for quickly checking frequency response.

133 TALKBACK

Point Before: OSCILLATOR 136 *switch.*

Point After: ASSIGN 135 *switches.*

This switch is enormous, glows in the dark, and is located right in your face, by the LEFT/RIGHT Faders. To speak to the crew and/or talent, simply engage the switch and your voice will be sent to all the destinations you've assigned.

If you're using the intercom system, this switch stops glowing and the intercom switch glows to indicate that someone is calling you.

134 TALKBACK LEVEL

Point Before: TALKBACK MIC *inputs' preamp*

Point After: OSCILLATOR 136.

This controls the signal level from the TALKBACK MIC inputs. The signal is off when turned fully counterclockwise, with more than enough gain turned fully clockwise. Set it so everyone can hear you comfortably, probably near the center detent.

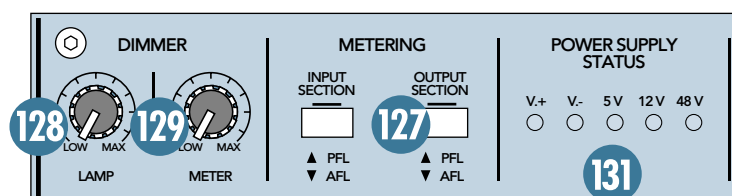

135 ASSIGN

Point Before: TALKBACK *switch*

Point After: (per switch): AUX 1–4, AUX 5–8, EXTERNAL, L/R, MATRIX A, MATRIX B, MATRIX C *and* MATRIX D.

Engage the switches for locations you want to receive TALKBACK (or OSCILLATOR) signals. For instance, if your stage monitors are being fed by AUX SEND MASTERS 1–4 and you want to talk to the talent, leave the AUX 1–4 switch engaged, and toggle the TALKBACK switch on and off as needed.

You can use the EXTERNAL switch to deliver the TALKBACK (and OSCILLATOR) signal to a second console, such as a monitor console. Simply patch from the FOH (front-of-house) console's TALKBACK 33 output to a line-level Channel input of the monitor console. Then use that Channel's aux sends to deliver the TALKBACK signals to the stage monitors.

136 OSCILLATOR SECTION

The SR40•8's TALKBACK signal may be replaced by either of two on-board sound sources — a 400Hz sine wave for checking levels, or a PINK NOISE generator for quickly checking the frequency response of your amp/speaker systems.

137 400HZ/PINK NOISE

Point Before: 400Hz *and* PINK NOISE *oscillators*.

Point After: LEVEL (OSCILLATOR) 138.

With the switch up (disengaged), the oscillator delivers a 400Hz sine wave, typically used for calibrating and matching levels with external devices. With the switch down (engaged), it delivers a modified PINK NOISE. PINK NOISE is used for performing quick frequency response checks.

If your talent is performing that Beatles' classic, "I Want You (She's So Heavy)," you can use the PINK NOISE along with the oscillator LEVEL control to emulate that horrendous ocean sound that builds up and takes over towards the end.

138 LEVEL

Point Before: 400HZ/PINK NOISE 137 *switch*.

Point After: ON (OSCILLATOR) 139 *switch*.

This controls the signal level of all OSCILLATOR signals, be it the 400Hz sine wave or the PINK NOISE generator. The signal is off when turned fully counterclockwise, with plenty of gain turned fully clockwise.

In 400Hz sine mode, you may want to send out a calibrated level (via the TALKBACK ASSIGN switches.) To do this, engage the appropriate ASSIGN switch, then engage one SOLO switch in the selected circuit.

For instance, to calibrate while sending out to AUX SEND MASTER 1–4, engage the TALKBACK ASSIGN: AUX 1–4 switch and then engage SOLO on one (and only one) of those AUX SEND MASTERS. The OSCILLATOR level appears on the CENTER (PFL) Meter.

Be aware: This does not mean that all outputs delivering the sine wave are calibrated, as their levels may be dependent on their own master level controls. But it does mean that the sine wave level is calibrated as it's fed to its ASSIGN switches.



The PINK NOISE/400HZ oscillator cannot be assigned directly to the CENTER MAIN output 24. One easy way to accomplish this is to connect a patch cable between the TALKBACK OUT 33 jack on the rear panel and the left input of one of the MAIN AUX RETURNS 17, A1 for example. Press EXTERNAL in the TALKBACK ASSIGN section, and assign AUX RETURN A1 to the center channel. Alternatively, AUX RETURN B4 18 can be used, since it is specifically assigned to the center channel.

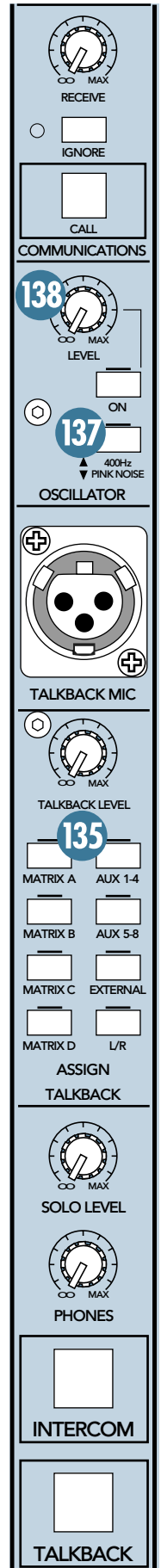

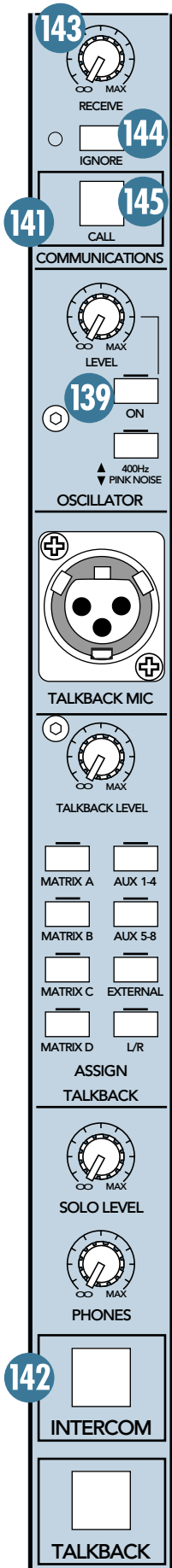

139 ON

Point Before: TALKBACK LEVEL 134, (OSCILLATOR) LEVEL 138.

Point After: TALKBACK 133 switch.

Engaging this switch replaces the microphone TALKBACK signals with an OSCILLATOR signal, either 400Hz sine wave or PINK NOISE, depending on the 400Hz/PINK NOISE switch position. Be aware that engaging this switch turns the OSCILLATOR on, whether or not the TALKBACK 133 switch is engaged.

With the OSCILLATOR ON switch disengaged (up), both the 400Hz and PINK NOISE generators are put to sleep to ensure that absolutely no leakage from these generators will appear at any of the SR40•8's outputs. That's why there's a short delay when you turn the 400Hz oscillator on, to allow the circuit to ramp up and stabilize first. So please be polite — do not disturb the oscillators when they're trying to sleep. The last thing you want during your show is a cranky oscillator.

141 COMMUNICATIONS

If your system uses the Clear-Com® Intercom System, then you certainly have chosen the right console — The SR40•8 provides a Clear-Com®-compatible interface. Furthermore, the interface is transformer-isolated to prevent any nasty ground loops from showing up in the audio.

If you already have the Clear-Com® Intercom System, you probably already know how it works, so we'll just discuss how it affects the engineer sitting behind an SR40•8.

142 INTERCOM

All you have to do is press this big switch and you'll be on a party line with all the other Clear-Com® participants.

143 RECEIVE LEVEL

This adjusts the incoming level of the other Clear-Com® participants. Simply set the knob as desired.

144 IGNORE

When you want to remove all those voices in your head, specifically the ones coming in via the Clear-Com® system, press this switch and your station will be effectively removed from the party line.

This switch will be automatically defeated when a CALL signal is received from another Clear-Com® participant. Furthermore, if the INTERCOM switch is pressed, IGNORE will be defeated for thirty seconds. To reengage IGNORE sooner, simply double-click the IGNORE switch.

145 CALL

Pressing this switch sends a visual alert signal to all other Clear-Com® participants. Their systems' CALL LEDs will glow, urging them to put their headphones back on.

If they try to call you, the INTERCOM 142 switch glows and the TALKBACK 133 switch stops glowing. This also bypasses the IGNORE 144 switch for as long as their CALL switch is pressed. Tell your crew that they can talk to you when their CALL button is pressed (assuming you have your headphones on).

146 MATRIX

The MATRIX can be used to create special mixes for recording, delay towers, lobby, backstage, nursery “cry” rooms, audio-for-video feeds, ADA systems, and the like. Think of it as a “mixer within a mixer.”

Although it may look complicated, the MATRIX is simply four separate 12 x 1 mixers. Its inputs include the eleven mixes: LEFT, RIGHT, CTR, and SUBS 1–8. Additionally, each MATRIX has an external MATRIX INPUT [38](#). Each MATRIX strip has an input level control for each of the 11 internal inputs as well as MASTER level, MUTE and SOLO controls. The external MATRIX INPUTS have no independent level controls, but *are* controlled by the MATRIX’s MASTER level.

147 INPUT LEVEL

Point Before: *Respective mix outputs (LEFT/RIGHT/CENTER mixes [87](#) and SUB 1–8 mixes [94](#).)*

Point After: MATRIX mixes A, B, C, and D.

Each MATRIX has a column of 11 rotary controls. Adjacent to each of MATRIX A’s controls is the name of the mix output feeding each MATRIX: SUB 1, SUB 2, SUB 3, SUB 4, SUB 5, SUB 6, SUB 7, SUB 8, CTR, LEFT, and RIGHT. (CTR is an abbreviation for “CENTER.”) Each control is off with the knob turned fully counterclockwise, with unity gain at the “U” center detent, and provides 10dB gain turned fully up.

Creating a MATRIX mix couldn’t be easier. Simply adjust the input level controls as needed for each mix as it feeds each MATRIX. For instance, using MATRIX A and MATRIX B to create a stereo mix, use the MATRIX A controls for all the “left” mixes (usually LEFT, SUB 1, SUB 3, SUB 5, and SUB 7) and the MATRIX B controls for the “right” mixes (usually RIGHT, SUB 2, SUB 4, SUB 6, and SUB 8).

If the ultimate destination for a MATRIX output is a device with RCA inputs, like a cassette deck, we suggest that you use MATRIX C and MATRIX D, since they have RCA outputs (TAPE B OUTPUT [22](#)), in addition to the XLR outputs.

148 MUTE

Point Before: MATRIX *mix*.

Point After: MATRIX MASTER level [149](#).

Muting removes the signal from its MATRIX OUTPUT and AFL SOLO. The PFL SOLO and PFL Meter paths are not affected.

Pressing the switch toggles the electronic mute relay in the signal path’s circuitry. If the signal is muted, pressing the switch unmutes it, and vice versa. An LED adjacent to the switch glows when muted.

With ULTRA MUTE™, up to ten Banks of ten different Mute Groups can be configured, enabling you to mute several signal paths at once. Not only that, but you can automate the muting of all the signal paths via an external MIDI sequencer or via the RS-232 DATA [42](#) port connected to a computer. We’ll discuss all this in detail later on [152](#).

149 MASTER LEVEL

Point Before: MUTE [148](#) switch.

Point After: MATRIX OUTPUTS [37](#), (AFL) SOLO [151](#).

Use this control to set or ride the overall level of each MATRIX. The signal is off with the rotary MASTER level control turned fully counterclockwise, unity gain is at the center “U” detent, and turned fully up provides 10dB gain.

151 SOLO

PFL Point Before: MATRIX *mix*.

PFL Point After: SOLO (MASTER controls)

[115](#) PFL *mix (mono)*.

AFL Point Before: MASTER level [149](#).

AFL Point After: SOLO (MASTER controls)

[115](#) AFL *mix (stereo)*.

SOLO allows you to audition signals through your headphones without having to assign them to any of the LEFT/RIGHT/CENTER mixes [87](#) or subgroups (SUB 1–8 mixes) [94](#). You can simultaneously SOLO as many signals as you like. The SR40•8 features nondestructive solo: Engaging SOLO does not interrupt any of the other Channels, buses, or outputs. Not only that, the SOLO system comes in two flavors: PFL (Pre-Fader Listen) and AFL (After-Fader Listen, Solo-In-Place).

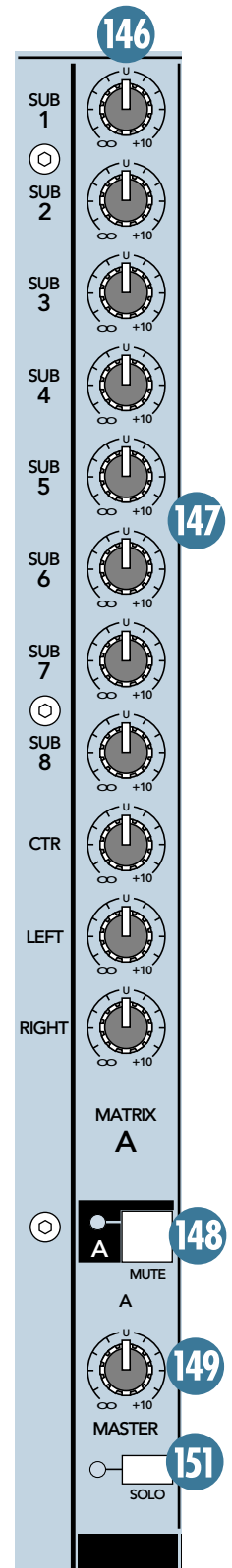

152 ULTRA MUTE™ AUTOMATION

Almost every signal path in the SR40•8 and SR56•8 has an electronically-controlled MUTE switch, including all channels, MAIN AUX RETURNS (A1-A4), SUBS 1-8, AUX SEND MASTERS, and MATRIX A-D. Thanks to the on-board microprocessor-based ULTRA MUTE system, these MUTE switches can be activated in four different ways:

- By pressing a signal path's local MUTE switch.
- By assigning signal paths to one or more Mute Groups. There are 9 Sets of 10 Groups. Any combination of Groups (up to ten) within a Set can be in effect at any one time. Mute Groups allow you to mute related signals (e.g., horns, background vocals, drums) with the push of a button, and are useful in live sound when you need to mute groups of channels “on the fly.”
- By assigning signal paths to a Mute Snapshot. Snapshots differ from Mute Groups in that they take a “picture” of all MUTE switch settings at a given moment. Recalling a Snapshot causes all MUTE switch settings to revert to the setting they were in when the Snapshot was taken. Consequently, only one Snapshot may be in effect at a time. Snapshots are typically used in theatrical applications, where mute settings do not change within one cue, but do change from event to event, or scene to scene.
- Via the MIDI 41 or DATA 42 jacks, any sequencer can be used to control complex muting cues. A sequencer is a computer program that is used to create and edit MIDI files. On playback, the sequencer does all the work. All mute nodes (except AUX RETURNS B1-B4, TAPE RETURNS A and B, and MONITOR) are accessible via MIDI or DATA using a Note On Channel Message for each signal path, where the note number corresponds to a mute node. Snapshots can be changed using Program Change Messages.

Typical Applications

From the board point of view:

Group Mode works best to mute groups of instruments or voices. For example, within one Set you might assign all the drum mics to one Group, all the horns to another Group, background vocals to a third Group, keyboards to a fourth, and other electric instruments to a fifth (Group, that is!).

In a show with several different bands performing, you can assign Set 1 to the first band, with 10 different Groups available for them, Set 2 to the second band, with 10 different Groups available for them, etc.

Snapshot Mode works best with theater or choreographed acts where timing is essential, and the show is repeated in exactly the same manner. You can create a sequence of Snapshots that mute the unused microphones during each act or scene, and simply increment the Snapshot in ULTRA MUTE at each scene change. You can even automate this with a sequencer via the MIDI or DATA ports using Program Change messages.

From a MIDI point of view:

Use Note On Channel Messages to turn on and off mute nodes for individual channels. In addition, you can record mute sequences from the board into a sequencer, which can later be played back along with a band.

Note Messages can also turn on and off Groups 0 – 9 within each Set. You might use a remote MIDI controller to turn Groups on and off from a remote location.

Note: Set numbers can't be changed via MIDI, only the Group numbers within each Set. Use Program Change Messages to change Snapshots.

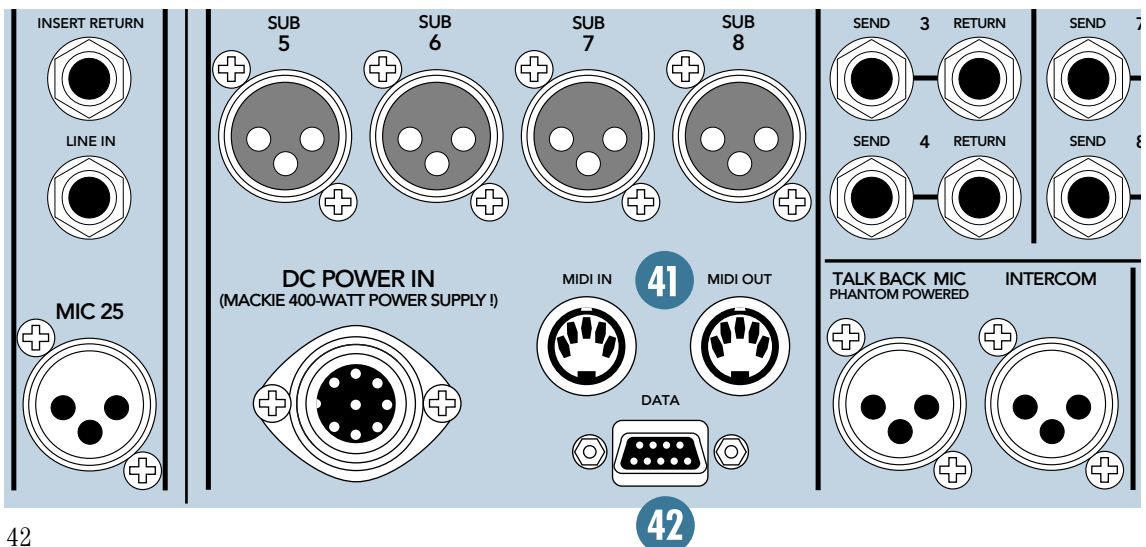

Use Sysex Messages for backup. We're going to repeat that in case you weren't paying attention. USE SYSEX MESSAGES TO BACKUP YOUR SNAPSHOTS AND GROUPS!!! We can't stress the importance of this enough. If you create a series of mute configurations for a show or band, back it up to disk, or at least to your computer's hard drive. This can save you hours of work in the event that something (or everything) accidentally gets erased from ULTRA MUTE's memory. See page 50 for more information on using System Exclusive Messages.

IMPORTANT Tidbits and Tittles

- When you mute a Channel or MAIN AUX RETURN (A1-A4), the entire path is muted, including the assignment outputs, pre- and post-Fader AUX SENDs, and DIRECT OUT. The INSERT SEND remains active, as do the PFL meters and PFL SOLO outputs.
- When you mute a Subgroup, all channels assigned to that Subgroup are muted from that point on. All of the individual channel's functions (i.e., DIRECT OUT, pre- and post-Fader AUX SENDs, INSERT points, and assignment outputs) are still active.
- *When you turn the console on, ULTRA MUTE loads Snapshot 00 into the console, then starts up in SYSTEM BYPASS mode.* The LED above the SYSTEM BYPASS 156 button lights, and all of the other ULTRA MUTE buttons are disabled. Simply press the SYSTEM BYPASS button to enable ULTRA MUTE. The BYPASS LED goes off and the Numeric Display 153 comes alive, indicating either Set 1 (if ULTRA MUTE was last in Group mode) or Snapshot 00 (if ULTRA MUTE was last in Snapshot mode).
- ULTRA MUTE comes from the factory preprogrammed with Snapshot 00 as "All Mutes Off" and Snapshot 99 as "All Mutes On." You can reprogram these Snapshots if you wish. Since Snapshot 00 is loaded into the console when it is first powered up, you

may want to reprogram Snapshot 00 with certain channels muted to neutralize the console at startup.

Note: During power-up a number briefly appears in the numeric display. This is the version number of the on-board ROM.

- BYPASS can be turned on at any time. It disables ULTRA MUTE — turns it off, so all automation is inactive. The MIDI and DATA inputs are ignored in Bypass mode. (*Exception:* Sysex messages are still acknowledged.) The mute configuration of the console remains as it was when BYPASS was engaged. Any further changes you wish to make in the mute configuration must be done manually or by turning BYPASS off to reactivate ULTRA MUTE.
- The MODE 154 button toggles back and forth between Group mode and Snapshot mode. In Snapshot mode, both digits and the last decimal point in the Numeric Display light up. In Group mode, only the left digit and decimal point are lit.
- The decimal point LED not only indicates the mode of operation (i.e. Group or Snapshot), but also indicates whether or not the current mute state of the console corresponds to the selected Group or Snapshot. If the mute configuration of the console exactly matches the configuration of the selected Group or Snapshot, the decimal point LED lights steadily. If the mute configuration of the console differs in some way, the decimal point LED blinks.
- Remember, if you push an AUX SEND FLIP switch, its signal is routed to the corresponding SUB OUT. To mute it, you need to push the SUB MUTE switch, and to mute the SUB signal you need to push the AUX SEND MUTE switch. Refer to the Block Diagram on page 56 to gain a better understanding of the signal flow when the FLIP switch is engaged.

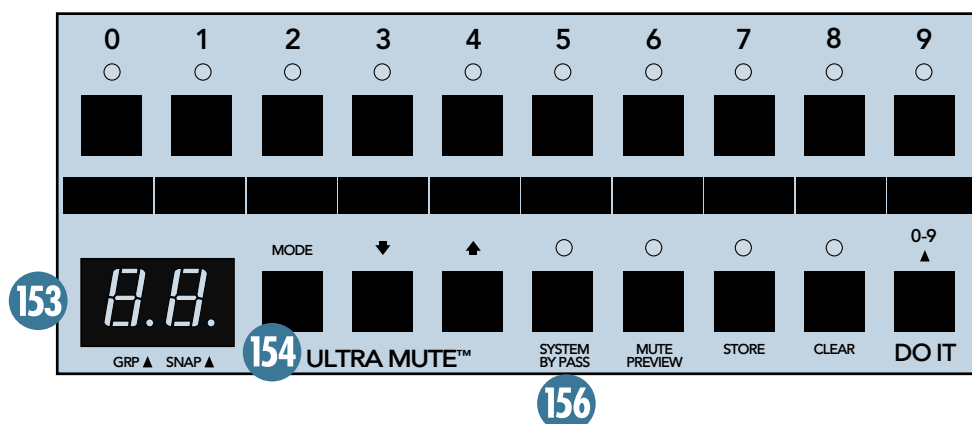

OPERATION

Some of the buttons in the ULTRA MUTE section of the console behave differently depending on whether you are in Group or Snapshot mode. Let's look at how the buttons work in each mode of operation separately.

GROUP MODE

Programming Mute Groups

1. Before creating and storing a Mute Group, you may want to “clear the board” of any active mutes. One easy way to do this is to press and hold the CLEAR **159** button for two seconds, or engage Snapshot 00 if it is programmed with “no mutes.”
2. Make sure you are in Group mode (only the left digit and decimal point is displayed). Use the Up/Down Arrow **155** buttons to select the Set that you want to program. There are nine Sets, represented by the numbers 1 through 9 in the Numeric Display **153**.
3. Using the local MUTE switches, mute the signal paths that you want included in the Group. For instance, if you want Channels 1, 2, 3, and 4 to be included, press the MUTE switches on those channels. Notice that as soon as a Channel is muted the decimal point LED in the Numeric Display **153** begins to blink. This indicates that you have manually changed the muting configuration of the console.
4. The STORE **158** button saves a mute configuration in a Group. If the Group had been previously programmed, the store operation erases and overwrites the old mute configuration with the new one. Press STORE **158**. The LED above this button begins blinking. The Group LEDs also light to indicate whether or not their corresponding Groups are programmed. If the Group LED lights steadily, it already contains a mute configuration. If the LED blinks, that Group is empty.
5. Select the Group number in which you wish to store the present mute configuration by pressing one of the number buttons 0 through 9 **161**. At this point the STORE LED turns off, the LED above the number lights, the decimal point LED lights steadily, and the mute configuration you selected is now stored in that Group.

6. You can exit STORE mode by pressing the CLEAR **159** button at any time. If you had muted any channels, you can either manually turn off the MUTE switches or press and hold the CLEAR button to unmute all channels and outputs.

Clearing Individual Mute Groups

1. Be sure ULTRA MUTE is in Group mode.
2. Press and hold the CLEAR **159** button for two seconds. The LEDs for any Groups that have been programmed in the selected set light up.
3. While still holding the CLEAR button, press the button for the Group you want to clear. Its LED turns off and the memory location corresponding to that Group is cleared.
4. You may clear any and all Groups in a single Set using this method.

Globally clearing all Mute Groups from memory



The following procedure completely and irretrievably erases all of the Groups programmed into ULTRA MUTE. You may want to save the Group configuration to external memory using the MIDI **41** or DATA **42** ports prior to performing this procedure, if there is a chance you will want to use any of the programmed Groups again. See “Using The MIDI Ports” on page 10 or “Using The DATA Port” on page 12.

1. Be sure ULTRA MUTE is in Group mode.
2. Press and hold the CLEAR **159** and MODE **154** buttons for 2 seconds. ULTRA MUTE consecutively cycles through all the Groups in each Set, clearing each memory location. The LEDs for each Group light up as they are cleared. You may release the buttons as soon as the cycle begins. When the cycle ends, you are ready to reprogram the Groups.

Selecting Mute Groups

There are 9 Sets, each of which contains 10 Groups. When you first enter Group mode by pressing the MODE **154** button, the Set that was last selected comes up in the display, but no Group is selected.

Within a particular Set, you can select any combination of Groups to be active at any one time by pressing the number button for each Group you wish to select. When the Group is engaged, the LED above the Group number lights.

The mute configurations of each Group add together (if you're Boolean-savvy, this is a logical OR function). For example, if Group 1 mutes Channels 1 and 2, and Group 2 mutes Channels 3 and 4, engaging both Groups 1 and 2 mutes Channels 1 through 4. Deselecting Group 2 unmutes Channels 3 and 4, while Channels 1 and 2 remain muted.

You cannot have a Group from two different Sets engaged at the same time. In fact, in order to change from one Set to another, all the Groups must be turned off by either deselecting them individually (by pressing the number button) or by pressing the CLEAR 159 button. Then the Up/Down Arrow 155 buttons become active and you can select a new Set.



One caveat: If the same channel appears in two different Groups, turning off one Group turns off (unmutes) the shared muted channel even if the other Group is engaged. For example, if Group 3 mutes Channels 5 and 6, and Group 4 mutes Channels 6 and 7, engaging both Groups mutes Channels 5 through 7. Deselecting Group 4 unmutes Channels 6 and 7, leaving only Channel 5 muted in Group 4. To reset Group 4 back to normal, deselect and reselect it, or, if you don't want to unmute the channels that are muted, use Preview mode to deselect and reselect it (see "Previewing Mute Groups" below). To avoid this scenario, you should refrain from assigning the same channel to different Groups. However, there may be situations where this is useful, so we leave it to you to make this choice.

Previewing Mute Groups

Preview mode lets you see the mute configuration of a Group without actually engaging it. This gives you the option of "looking ahead" at a forthcoming change in the

mute configuration of the console to be sure that it is the one you really want.

1. Select a Group.
2. Press the MUTE PREVIEW 157 button. The LED above the MUTE PREVIEW button lights.
3. Select a different Group. The MUTE PREVIEW LED begins to blink, and the MUTE LEDs for the channels assigned to the selected Group light. You are only previewing the Group – the channels are not actually muted. You can deselect the current Group. The MUTE LEDs for the channels assigned to the Group turn off. Don't be alarmed! The channels that were muted prior to entering Preview mode remain muted, even if their LEDs are turned off. Remember, in Preview mode the MUTE LEDs are just showing you what might be if you decide to DO IT, not what actually is. You can go to a different Set by deselecting all the Groups in the current Set, and pressing the Up/Down Arrow 155 buttons to proceed to a different Set. You now have all the Groups in the new Set available to preview. You can manually add a channel to the Preview by pressing its MUTE button. Its MUTE LED lights, but it's not actually muted yet.
4. Once you've decided on a new Group or modified a Group configuration, press DO IT 160 and the new Group(s) plus any manually muted channels engage.
5. Notice that the PREVIEW LED is still lit. You are still in Preview mode, and free to preview another Group if you so desire. Otherwise, press MUTE PREVIEW 157 to exit Preview mode.

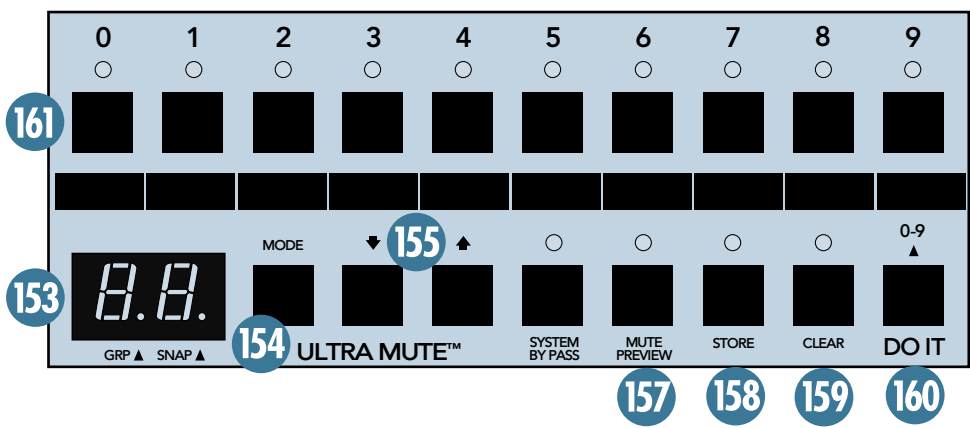

SNAPSHOT MODE

Programming Snapshots

1. Before creating and storing a Snapshot, you may want to “clear the board” of any active mutes. One easy way to do this is by pressing and holding the CLEAR **159** button for two seconds, or engage Snapshot 00 if it is preprogrammed with “no mutes.”
2. Make sure you are in Snapshot mode (both digits and the right decimal point are displayed). Use the Up/Down Arrow **155** buttons or the 0-9 buttons **161** to select the Snapshot that you want to program. The Numeric Display **153** begins blinking when you arrow up or down to a Snapshot that isn't currently engaged. There are 100 Snapshots available, represented by the numbers 00 through 99 in the Numeric Display.

You can engage the Snapshot you've selected by pressing the DO IT **160** button. If the Snapshot had been programmed before, the mute configuration stored in its memory engages. Otherwise, it defaults to “no mutes.”

3. Using the local MUTE switches, mute the signal paths you want included in the Snapshot. For instance, if you want Channels 1, 2, 3, and 4 included, press the MUTE switches on those channels.
4. The STORE **158** button saves a mute configuration as a Snapshot. If the Snapshot had been previously programmed, the store operation erases and overwrites the old mute configuration and the new one is written to memory.

Press STORE **158**. The LED above this button begins blinking. The decimal point LED lights steadily. The Numeric Display begins blinking (if it wasn't blinking already).

5. At this point, you can still make changes in the mute configuration by either adding mutes or turning mutes off. You can also use the Up/Down Arrow **155** buttons or the 0-9 buttons **161** to select a different Snapshot number in which to store the mute configuration.
6. Press STORE **158** again. The STORE LED turns off, the Numeric Display stops flashing and the mute configuration you selected is now stored in the Snapshot.
7. You can exit STORE mode by pressing the CLEAR **159** button at any time. If you had muted some channels, the Numeric Display continues blinking. You can either manually turn off the MUTE switches or press

and hold the CLEAR button to unmute all the channels, or you can select a different Snapshot by pressing the Up/Down Arrow **155** button and then pressing the DO IT **160** button.

Clearing all Snapshots from memory.



The following procedure completely and irretrievably erases *all* of the Snapshots programmed into ULTRA MUTE. You may want to save the Snapshot configuration to external memory using the MIDI **41** or DATA **42** ports prior to performing this procedure, if there is a chance you will want to use any of the programmed Snapshots again. See “Using The MIDI Ports” on page 10 or “Using The DATA Port” on page 12.

1. Be sure ULTRA MUTE is in Snapshot mode.
2. Press and hold the CLEAR **159** and MODE **154** buttons for 2 seconds. ULTRA MUTE cycles through all the Snapshots, clearing each memory location. You may release the buttons as soon as the cycle begins. When the cycle ends, you are ready to reprogram the Snapshots.

Selecting Snapshots

There are 100 Snapshots available. You can only select one Snapshot at a time. When you first enter Snapshot mode by pressing the MODE **154** button, the Snapshot number that was last selected comes up in the display. The decimal point LED in the display blinks, indicating that the current mute state of the console is different than the selected Snapshot (unless the current state coincidentally happens to match the selected Snapshot, in which case the decimal point LED lights steadily). You must press DO IT **160** to engage the Snapshot — it doesn't automatically engage when you first enter Snapshot mode. This is a fail-safe measure to prevent someone from inadvertently changing the mute configuration if the MODE **154** button is pressed by mistake.

You can select a different Snapshot by pressing the Up/Down Arrow **155** buttons. You can press and hold the Arrow Up or Down buttons to quickly scan through the Snapshots. The Snapshot you select will not engage until you press the DO IT **160** button. At that point the Numeric Display stops blinking and the new mute configuration is written to the console.

Another method for selecting Snapshots is to enter the Snapshot number using the number buttons **161**. For example, if you're at Snapshot 10 and you want to jump to Snapshot

45, press 4 and then 5, followed by the DO IT button. If you're at Snapshot 45 and you want to jump to Snapshot 3, press 0 and then 3, followed by the DO IT button. If you make a mistake, simply press the CLEAR button and reenter the number, or just enter the new numbers.

You can scroll through Snapshots and have them become engaged as soon as the number appears in the display. Press and hold the DO IT button while you press the Up or Down Arrow button.

Another method for selecting and engaging Snapshots is to put ULTRA MUTE into Auto-Increment mode (a.k.a. *Load-and-Go* mode, or *Show* mode). This is useful when you have a sequence of Snapshots to engage during a scene or act. To initiate this mode, press and hold the CLEAR button followed by the Up Arrow button for two seconds. The display begins to blink, indicating that ULTRA MUTE is ready to engage the next Snapshot. Press the DO IT button to advance the display to the next Snapshot number. Press DO IT again to engage the next Snapshot and the display advances to the next Snapshot number. (Remember, a blinking display tells you that the Snapshot in the display is not engaged, but ready to be engaged as soon as you DO IT.) To end Auto-Increment mode and return to Normal mode, press and hold the CLEAR button followed by the Arrow Down button for two seconds.

Previewing Snapshots

Preview mode lets you see the mute configuration of a Snapshot without actually engaging it. This gives you the option of “looking ahead” at a forthcoming change in the mute configuration of the console to be sure that it is the one you really want. It also allows you to edit an existing Snapshot prior to engaging it.

1. Select a Snapshot.
2. Press the MUTE PREVIEW button. The LED above the MUTE PREVIEW button lights.

3. Select a different Snapshot by using either the Up/Down Arrow buttons or directly entering the Snapshot number via the number buttons. The MUTE LEDs for the channels assigned to the selected Snapshot will light and the Numeric Display will blink to let you know that you are only previewing the Snapshot and the channels are not actually muted. The channels that were muted prior to entering Preview mode remain muted, even if their LEDs are turned off. Remember, in Preview mode the MUTE LEDs are just showing you what might be should you decide to DO IT, not what actually is.

You can manually add a channel to the Preview by pressing its MUTE button. Its MUTE LED blinks to let you know that it's not actually muted yet.

4. Once you've decided on a new Snapshot or modified Snapshot configuration, press DO IT and the new Snapshot, plus any manually muted channels, will engage.
5. Notice that the PREVIEW LED is still lit. You are still in Preview mode, and free to preview another Snapshot if you so desire. Otherwise, press MUTE PREVIEW again to exit Preview mode.
6. To exit Preview mode without making any changes to the current mute configuration, simply press the MUTE PREVIEW button again to turn it off. The MUTE LEDs revert back to indicating the current mute configuration of the console. Any mute switches selected during Preview are canceled.

Note: The Numeric Display continues to blink and indicates the last number selected while in Preview mode. If you want the display to return to the Snapshot number currently engaged, either enter the number directly using the number buttons or use the Up/Down Arrow buttons. When the correct Snapshot number is in the display, the decimal point LED in the display stops blinking. Press the DO IT button to return the display to normal.

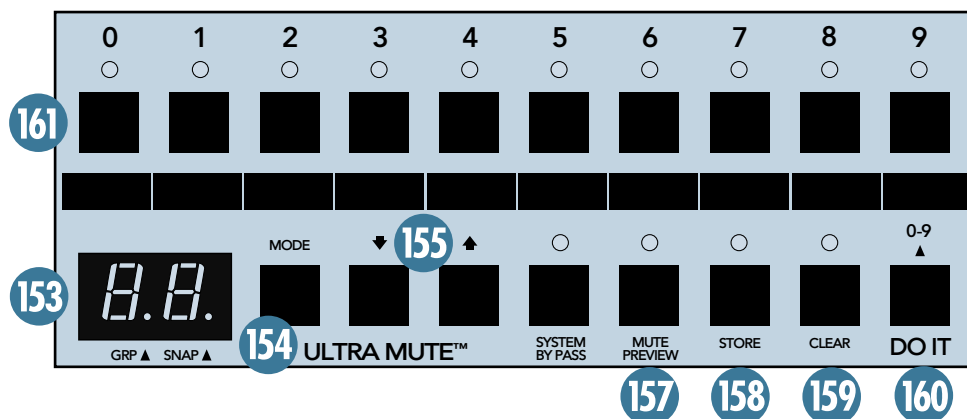

ULTRA MUTE SUMMARY

GENERAL

- There are 9 Sets of 10 Groups each, for a total of 90 Groups. Up to 10 Groups can be active at a time within a Set.
- There are 100 Snapshots (00-99). Only one Snapshot can be active at a time.
- Snapshot 00 is loaded into the console when it is first powered up. Factory default is all mutes off.

154 MODE

- Toggles between Group Mode and Snapshot Mode.
- When going from Group Mode to Snapshot Mode, you should press DO IT to engage the Snapshot in the Numeric Display.
- When going from Snapshot to Group Mode, you must press CLEAR for two seconds to clear the Snapshot's mute configuration from the board. Then select the Group you want to engage using the 0-9 buttons.

155 ARROW UP/DOWN BUTTONS

- In Group Mode, increments and decrements the Set Number in the Numeric Display (all Groups must be OFF).
- In Snapshot Mode, increments and decrements Snapshots in the Numeric Display.
- In Snapshot Mode, press and hold the CLEAR and Arrow Up buttons to enter Auto-Increment (Load-and-Go) mode. Then press DO IT to engage consecutively increasing Snapshots.
- Press and hold the CLEAR and Arrow Down buttons to exit Auto-Increment mode.

156 SYSTEM BYPASS

- Turns off ULTRA MUTE. Disables all automation, including all MIDI commands received through the MIDI or DATA ports.
Note: Sysex messages are still recognized while in Bypass mode. A Sysex data move does not affect the console's current mute status.

157 MUTE PREVIEW

- In Group or Snapshot Mode, allows viewing the mute configuration of programmed Snapshots or Groups without engaging them. Press DO IT to engage a previewed Snapshot or Group.
- Press MUTE PREVIEW again to exit Preview Mode.

To create a Group:

1. Press the MODE switch to enter Group mode (one digit lights in the numeric display).
2. Select the Set in which to store the Group by pressing the Arrow Up/Down buttons.
3. Activate all the mute switches you wish to store in the Group.
4. Press STORE.
5. Press a number button 0-9 to select the Group in which to store the current mute configuration.

158 STORE

- In Group Mode, press STORE followed by a number button (0-9) to store a mute configuration in ULTRA MUTE's memory.
- In Snapshot Mode, press STORE twice to store a mute configuration in ULTRA MUTE's memory.
- Press CLEAR to exit Store mode without saving.

159 CLEAR

- In Group Mode, used to turn off all active Groups. Press and hold CLEAR for two seconds, then release to turn off all mutes on the console. This also indicates which Groups have been programmed (programmed Groups' LEDs light up, unprogrammed Groups' LEDs do not).
- In Group Preview Mode, clears all Groups currently being previewed.

- In Snapshot Mode, press and hold for two seconds to turn off all mutes on the console.
- In Snapshot Preview Mode, clears Snapshot currently being previewed.
- In Snapshot Mode, press and hold the CLEAR and Arrow Up buttons to enter Auto-Increment (Load-and-Go) Mode. Then press DO IT to engage consecutive Snapshots.
- Press and hold the CLEAR and Arrow Down buttons to exit Auto-Increment Mode.
- Press to abort a store procedure.
- To clear all programmed mutes, in Group or Snapshot Mode, press and hold the CLEAR and MODE buttons for two seconds.

160 DO IT

- In Snapshot Mode, press DO IT to engage the Snapshot selected in the Numeric Display.
- In Auto-Increment Mode, press to advance to the next Snapshot.
- In Preview Mode, press DO IT to engage the Group or Snapshot selected.

161 NUMBER BUTTONS (0-9)

- In Group Mode, press number buttons to select Groups to engage, preview, or program.
- In Snapshot Mode, press number buttons to select a two-digit Snapshot number to engage, preview or program. For example, to select Snapshot 5, press "0" and "5." To select Snapshot 38, press "3" and "8."

To create a Snapshot:

1. Press the MODE switch to enter Snapshot mode (both digits light in the numeric display).
2. Select the Snapshot number in which to store the mute configuration by pressing the Arrow Up/Down buttons, or by selecting the number using the number buttons 0-9.
3. Activate all mute switches you wish to store in the Snapshot.
4. Press STORE *twice*.

MIDI IMPLEMENTATION

Using the MIDI Ports

There are three types of MIDI messages that can be used to control ULTRA MUTE: MIDI Note Messages, Program Change Messages, and MIDI System Exclusive (Sysex) Messages. The standard MIDI implementation table is located in **APPENDIX A**.



Note: The letter “h” following a number indicates that the number is in hexadecimal format. The ULTRA MUTE firmware is fixed at MIDI channel 16 and cannot be changed by the end user.

MIDI Note Messages

MIDI Note Messages are used to change the state of a single mute node.

The mute nodes in the SR40•8 are turned on and off using the Note On command and respond to data on MIDI channel 16 (Status Byte = 10011111 = 9Fh).

The structure of the message is as follows:

Byte 1	Byte 2	Byte 3
9Fh	0kkkkkkk	0vvvvvvv
9 = Status (Note On)		
F = MIDI Channel 16		
0kkkkkkk = mute node number (see <i>Appendix B</i>)		
vvvvvvv = value (0 = mute off, 1-127 = mute on)		

Since mute nodes are either ON or OFF, a Value of 0 is recognized as mute off, and a value of 1-127 (any non-zero number) is recognized as mute on. ULTRA MUTE uses the value 40h (64 decimal) to represent mute on.

Program Change Messages

Program Change Messages are used to change Snapshots in ULTRA MUTE, which responds to data on MIDI channel 16 (Status Byte = 11001111 = CFh).

The structure of the message is as follows:

Byte 1	Byte 2
CFh	0ppppppp
C = Status (Program Change)	
F = MIDI Channel 16	
0ppppppp = Snapshot number (00-99=00-63h)	

Note: ULTRA MUTE must be in Snapshot mode to respond to Program Change Messages.

System Exclusive Messages (Sysex)

Sysex messages can be used to transmit data between a MIDI device and ULTRA MUTE. You can transfer all or part of the data in ULTRA MUTE’s memory to a MIDI controller or sequencer, or transfer data from the controller into ULTRA MUTE, using MIDI Sysex messages.

Note: Sysex messages do not change the current state of the console, but only transfer data to and from ULTRA MUTE’s memory. When a Sysex Request is made, two horizontal bars appear in the Numeric Display while data is being transferred (usually only noticeable during longer data transfers). Once the transfer is complete, use MIDI Note Messages or Program Change Messages to implement new Groups or Snapshots.

The structure of the message is as follows:

<F0> <00 00 66> <03> <0F> <NN> <F7>
↓
03 = SR40•8
04 = SR56•8

ULTRA MUTE recognizes certain Message Numbers to move data between its memory and the host (computer). See the table on page 11 for descriptions and examples of the messages recognized by ULTRA MUTE.

NN is the position within the Sysex Message where the Message Number and data is located (underlined sections in the table).



Snapshot Sysex requests and dumps are sent and received with Snapshot number first, followed by the mute node data. All Snapshot mute node data is nibblized low-high. When several Snapshot Sysex dumps are sent at a time to the SR40•8/SR56•8, *there must be a 50 millisecond or greater time interval between each Snapshot*.

Group Sysex requests and dumps are sent and received with Set numbers first, followed by the Group number and the mute node data. All Group Mute node data is nibblized low-high. When several Group Sysex dumps are sent at a time to the SR40•8/SR56•8, *there must be a 50 millisecond or greater time interval between each Set*.

MIDI SYSEX MESSAGE NUMBERS

Msg No.	Description	Examples	
00h	requests the SR40•8/SR56•8 to send all its Snapshots to the host	[F0 00 00 66 03 0F <u>00 00</u> F7] for SR40•8, send all at once. [F0 00 00 66 04 0F <u>00 01</u> F7] for SR56•8, send all, one at a time.	
01h	requests the SR40•8/SR56•8 to send one Snapshot to the host	To request Snapshot 5: [F0 00 00 66 03 0F <u>01 05</u> F7] for SR40•8 [F0 00 00 66 04 0F <u>01 05</u> F7] for SR56•8	
02h	requests the SR40•8/SR56•8 to send all its Mute Group memory to the host	[F0 00 00 66 03 0F <u>02 00</u> F7] for SR40•8, send all at once. [F0 00 00 66 04 0F <u>02 01</u> F7] for SR56•8, send all, one at a time.	
03h	requests the SR40•8/SR56•8 to send only Mute Group memories within a Set to the host	To request Mute Groups in Set 2 ¹ : [F0 00 00 66 03 0F <u>03 01</u> F7] for SR40•8 [F0 00 00 66 04 0F <u>03 01</u> F7] for SR56•8	Note: Sets 1-9 are identified as 00h-08h.
04h	requests the SR40•8/SR56•8 to send its system status	[F0 00 00 66 03 0F <u>04</u> F7] for SR40•8 [F0 00 00 66 04 0F <u>04</u> F7] for SR56•8 ² See below for System Status Flags.	
05h	requests the SR40•8/SR56•8 to send its current mute status	[F0 00 00 66 03 0F <u>05</u> F7] for SR40•8 [F0 00 00 66 04 0F <u>05</u> F7] for SR56•8	
06h	requests the SR40•8/SR56•8 to send its system mute LED status	[F0 00 00 66 03 0F <u>06</u> F7] for SR40•8 [F0 00 00 66 04 0F <u>06</u> F7] for SR56•8	
40h	dump several Snapshots to SR40•8/SR56•8	To write Snapshot 10 and 11 to ULTRA MUTE: [F0 00 00 66 03 0F <u>40 0A</u> {DATA} 0B {DATA} F7] for SR40•8 [F0 00 00 66 04 0F <u>40 0A</u> {DATA} 0B {DATA} F7] for SR56•8	
41h	dump one Snapshot to SR40•8/SR56•8	To write Snapshot 20 to Ultra Mute: [F0 00 00 66 03 0F <u>41 14</u> {DATA} F7] for SR40•8 [F0 00 00 66 04 0F <u>41 14</u> {DATA} F7] for SR56•8	
42h	dump all Mute Groups to SR40•8/SR56•8	To write Mute Groups 0-9 to ¹ Set 6: [F0 00 00 66 03 0F <u>42 05 00</u> {DATA} 01 {DATA} ... 09 {DATA} F7] for SR40•8 [F0 00 00 66 04 0F <u>42 05 00</u> {DATA} 01 {DATA} ... 09 {DATA} F7] for SR56•8	
43h	dump only Mute Groups in one set to SR40•8/SR56•8	To Write Mute Groups to Set 7 ¹ : [F0 00 00 66 03 0F <u>43 06</u> {DATA} F7] for SR40•8 [F0 00 00 66 04 0F <u>43 06</u> {DATA} F7] for SR56•8	
44h	console system status	[F0 00 00 66 03 0F <u>44 0F</u> {System Status Flag ² } F7] for SR40•8 [F0 00 00 66 04 0F <u>44 0F</u> {System Status Flag ² } F7] for SR56•8	
45h	send console mute node data to SR40•8/SR56•8	[F0 00 00 66 03 0F <u>45</u> {DATA} F7] for SR40•8 [F0 00 00 66 04 0F <u>45</u> {DATA} F7] for SR56•8	
46h	send console mute LED data to SR40•8/SR56•8	[F0 00 00 66 03 0F <u>46</u> {DATA} F7] for SR40•8 [F0 00 00 66 04 0F <u>46</u> {DATA} F7] for SR56•8	

³See below for DATA Structure

¹Sets 1-9 are identified as 0-8h.

² System Status Flags:

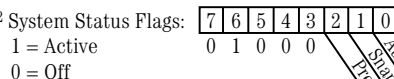

- 40h = Mute Group Mode
- 42h = Snapshot Mode
- 43h = Snapshot + Auto-Increment Mode
- 44h = Mute Group + Preview Mode
- 46h = Snapshot + Preview Mode
- 47h = Snapshot + Auto-Increment + Preview Mode

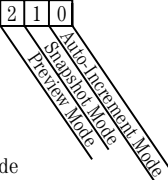

³ DATA Structure: SR40•8 = 18 bytes, nibblized low-high.
SR56•8 = 20 bytes, nibblized low-high.

- 0 = Mute OFF; 1 = Mute ON.
- {[0000 N1] [0000 N2] [0000 N3] ... [0000 N18 or N20]}
- N1 = Channels 1-4 [4 3 2 1]
- N2 = Channels 5-8 [8 7 6 5]
- N3 = Channels 9-12 [12 11 10 9]
- N4 = Channels 13-16 [16 15 14 13]
- N5 = Channels 17-20 [20 19 18 17]
- N6 = Channels 21-24 [24 23 22 21]
- N7 = AUX RETURN B1-B4 [B4 B3 B2 B1]
- N8 = Channels 25-28 [28 27 26 25]
- N9 = Channels 29-32 [32 31 30 29]
- N10 = Channels 33-36 [36 35 34 33]
- N11 = Channels 37-40 [40 39 38 37]
- N12 = AUX SEND 1-4 [4 3 2 1]
- N13 = AUX SEND 5-8 [8 7 6 5]
- N14 = SUB 1-4 [4 3 2 1]
- N15 = SUB 5-8 [8 7 6 5]
- N16 = MATRIX A-D [D C B A]
- N17 = Future Use [0 0 0 0]
- N18 = Future Use [0 0 0 0]

- N17 (SR56•8) = Channels 41-44 [44 43 42 41]
- N18 (SR56•8) = Channels 45-48 [48 47 46 45]
- N19 (SR56•8) = Channels 49-52 [52 51 50 49]
- N20 (SR56•8) = Channels 53-56 [56 55 54 53]

Using the DATA Port

The DATA port on the SR40•8/56•8 mirrors the MIDI ports, transferring MIDI information between an external computer's RS-232 serial port and ULTRA MUTE. The only difference between using the DATA and MIDI ports is the rate of transmission of the data and the general physical hardware (9-pin Sub D vs. 5-pin DIN, respectively). The actual data transferred is the same.

The DATA port provides two-way communication of data between devices. Pin 2 is RXD (receiving line), pin 3 is TXD (transmitting line) and pin 5 is ground (shield).

If your computer has an RS-232 port, the connecting cable should be wired as follows:

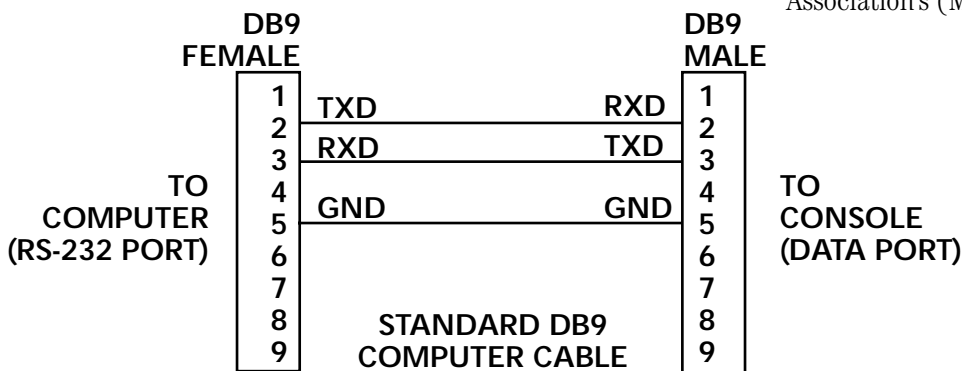

Use the following serial communications parameters when using the DATA port:

Baud rate	19.2k ¹
Parity	None
Data bits	8
Stop bits	1

¹ The RS-232 serial port is configured to operate at 19.2k baud at the factory. An internal jumper provides the option of changing the baud rate to 9600 baud or 38.4k baud. Please refer to the SR40•8/SR56•8 Service Manual, or contact Mackie Technical Support at 1-800-258-6883 (8am to 5pm PST), for details.

Note: The MIDI port operates at 31.25k baud, as defined by the MIDI Manufacturers Association's (MMA) MIDI Specification.



MIDI IMPLEMENTATION SUMMARY

- When you first power up the console, a number briefly appears in ULTRA MUTE's numeric display. This is the version number of the firmware stored in the ROM memory. Version 1.2 was installed in the first shipments of the SR40•8 console. See next column for notes regarding version 1.2 of the firmware.
- Use MIDI Note Messages to turn on and off individual mute nodes or to recall individual mute groups within a set (refer to Appendix B). ULTRA MUTE must be in group mode.
- Use Program Change Messages to recall individual snapshots. ULTRA MUTE must be in snapshot mode.
- Use Sysex Messages to backup ULTRA MUTE's memory (refer to MIDI Sysex chart on page 11). Sysex Messages are recognized in any mode, including system bypass.

Notes regarding version 1.2 of the firmware:

1. MIDI Sysex Message number "00 00" (requests all snapshots, all at once) may encounter errors due to buffer problems in some sequencing software. If you are unable to successfully execute this request, use "00 01" (requests all snapshots, one at a time).
2. MIDI Sysex Message numbers "02 00" (requests all groups, all at once) and "02 01" (requests all groups, one at a time) do not work in this version. Sets 1-8 are transferred, but not Set 9. A suggested workaround is to create a string using message request number "03" to request groups from each of the nine sets. For example:

Product: SR40•8/56•8
MIDI Implementation Chart

Date: 1/03/97
Version: 1.2

Function		Transmitted	Recognized	Remarks
Basic Channel	Default Changed	16	16	Channel 16 only
Mode	Default Messages Altered	X X X	X X X	Not Applicable
Note Number	Mute Node	O	O	See Appendix B
Velocity	Note ON Note OFF	O O	O O	See Appendix B
Aftertouch	Keys Ch's	X X	X X	
Pitch Bend		X	X	
Control Change		X	X	
Program Change		O	O	0-99 (100-127 ignored)
System Exclusive		O	O	See MIDI Sysex Detail on pages 10-11
System Common	Song Pos Song Sel Tune	X X X	X X X	
System Real-time Clock	Clock Commands	X X	X X	
Aux Messages	Local On/Off All Notes Off Active Sensing System Reset	X X X X	X X X X	

O: Yes
X: No

Use the multiple string

F0 00 00 66 03 0F 03 00 F7 (request groups from Set 1)
 F0 00 00 66 03 0F 03 01 F7 (request groups from Set 2)
 F0 00 00 66 03 0F 03 02 F7 (request groups from Set 3)
 F0 00 00 66 03 0F 03 03 F7 (request groups from Set 4)
 F0 00 00 66 03 0F 03 04 F7 (request groups from Set 5)
 F0 00 00 66 03 0F 03 05 F7 (request groups from Set 6)
 F0 00 00 66 03 0F 03 06 F7 (request groups from Set 7)
 F0 00 00 66 03 0F 03 07 F7 (request groups from Set 8)
 F0 00 00 66 03 0F 03 08 F7 (request groups from Set 9)

to replace the single string

F0 00 00 66 03 0F 02 01 F7

for backing up all groups via MIDI.

We solicit your feedback. If there is anything about the operation of the SR40•8/SR56•8 console or ULTRA MUTE that you think could be improved, feel free to write us

with your comments and suggestions. The more input we get from you, the better we can provide you with the tools you need to get the job done.

163 TABLE OF MIDI NOTE MESSAGES

Parameter No.	Parameter Name	MIDI Note Message (Hex)		NOTE*
		MUTE ON	MUTE OFF	
1	Channel 1	9F 00 40	9F 00 00	C-1
2	Channel 2	9F 01 40	9F 01 00	C#-1
3	Channel 3	9F 02 40	9F 02 00	D-1
4	Channel 4	9F 03 40	9F 03 00	D#-1
5	Channel 5	9F 04 40	9F 04 00	E-1
6	Channel 6	9F 05 40	9F 05 00	F-1
7	Channel 7	9F 06 40	9F 06 00	F#-1
8	Channel 8	9F 07 40	9F 07 00	G-1
9	Channel 9	9F 08 40	9F 08 00	G#-1
10	Channel 10	9F 09 40	9F 09 00	A-1
11	Channel 11	9F 0A 40	9F 0A 00	A#-1
12	Channel 12	9F 0B 40	9F 0B 00	B-1
13	Channel 13	9F 0C 40	9F 0C 00	C0
14	Channel 14	9F 0D 40	9F 0D 00	C#0
15	Channel 15	9F 0E 40	9F 0E 00	D0
16	Channel 16	9F 0F 40	9F 0F 00	D#0
17	Channel 17	9F 10 40	9F 10 00	E0
18	Channel 18	9F 11 40	9F 11 00	F0
19	Channel 19	9F 12 40	9F 12 00	F#0
20	Channel 20	9F 13 40	9F 13 00	G0
21	Channel 21	9F 14 40	9F 14 00	G#0
22	Channel 22	9F 15 40	9F 15 00	A0
23	Channel 23	9F 16 40	9F 16 00	A#0
24	Channel 24	9F 17 40	9F 17 00	B0
25	Channel 25	9F 20 40	9F 20 00	G#1
26	Channel 26	9F 21 40	9F 21 00	A1
27	Channel 27	9F 22 40	9F 22 00	A#1
28	Channel 28	9F 23 40	9F 23 00	B1
29	Channel 29	9F 24 40	9F 24 00	C2
30	Channel 30	9F 25 40	9F 25 00	C#2
31	Channel 31	9F 26 40	9F 26 00	D2
32	Channel 32	9F 27 40	9F 27 00	D#2
33	Channel 33	9F 28 40	9F 28 00	E2
34	Channel 34	9F 29 40	9F 29 00	F2
35	Channel 35	9F 2A 40	9F 2A 00	F#2
36	Channel 36	9F 2B 40	9F 2B 00	G2
37	Channel 37	9F 2C 40	9F 2C 00	G#2
38	Channel 38	9F 2D 40	9F 2D 00	A2
39	Channel 39	9F 2E 40	9F 2E 00	A#2
40	Channel 40	9F 2F 40	9F 2F 00	B2
41	Channel 41	9F 50 40	9F 50 00	G#5
42	Channel 42	9F 51 40	9F 51 00	A5
43	Channel 43	9F 52 40	9F 52 00	A#5
44	Channel 44	9F 53 40	9F 53 00	B5

Parameter No.	Parameter Name	MIDI Note Message (Hex)		
		MUTE ON	MUTE OFF	NOTE*
45	Channel 45	9F 54 40	9F 54 00	C6
46	Channel 46	9F 55 40	9F 55 00	C#6
47	Channel 47	9F 56 40	9F 56 00	D6
48	Channel 48	9F 57 40	9F 57 00	D#6
49	Channel 49	9F 58 40	9F 58 00	E6
50	Channel 50	9F 59 40	9F 59 00	F6
51	Channel 51	9F 5A 40	9F 5A 00	F#6
52	Channel 52	9F 5B 40	9F 5B 00	G6
53	Channel 53	9F 5C 40	9F 5C 00	G#6
54	Channel 54	9F 5D 40	9F 5D 00	A6
55	Channel 55	9F 5E 40	9F 5E 00	A#6
56	Channel 56	9F 5F 40	9F 5F 00	B6
57	Aux Return A1	9F 18 40	9F 18 00	C1
58	Aux Return A2	9F 19 40	9F 19 00	C#1
59	Aux Return A3	9F 1A 40	9F 1A 00	D1
60	Aux Return A4	9F 1B 40	9F 1B 00	D#1
61	Sub 1	9F 38 40	9F 38 00	G#3
62	Sub 2	9F 39 40	9F 39 00	A3
63	Sub 3	9F 3A 40	9F 3A 00	A#3
64	Sub 4	9F 3B 40	9F 3B 00	B3
65	Sub 5	9F 3C 40	9F 3C 00	C4
66	Sub 6	9F 3D 40	9F 3D 00	C#4
67	Sub 7	9F 3E 40	9F 3E 00	D4
68	Sub 8	9F 3F 40	9F 3F 00	D#4
69	Aux Send 1	9F 30 40	9F 30 00	C3
70	Aux Send 2	9F 31 40	9F 31 00	C#3
71	Aux Send 3	9F 32 40	9F 32 00	D3
72	Aux Send 4	9F 33 40	9F 33 00	D#3
73	Aux Send 5	9F 34 40	9F 34 00	E3
74	Aux Send 6	9F 35 40	9F 35 00	F3
75	Aux Send 7	9F 36 40	9F 36 00	F#3
76	Aux Send 8	9F 37 40	9F 37 00	G3
77	Matrix A	9F 40 40	9F 40 00	E4
78	Matrix B	9F 41 40	9F 41 00	F4
79	Matrix C	9F 42 40	9F 42 00	F#4
80	Matrix D	9F 43 40	9F 43 00	G4
81	Mute Group 0	9F 60 40	9F 60 00	C7
82	Mute Group 1	9F 61 40	9F 61 00	C#7
83	Mute Group 2	9F 62 40	9F 62 00	D7
84	Mute Group 3	9F 63 40	9F 63 00	D#7
85	Mute Group 4	9F 64 40	9F 64 00	E7
86	Mute Group 5	9F 65 40	9F 65 00	F7
87	Mute Group 6	9F 66 40	9F 66 00	F#7
88	Mute Group 7	9F 67 40	9F 67 00	G7
89	Mute Group 8	9F 68 40	9F 68 00	G#7
90	Mute Group 9	9F 69 40	9F 69 00	A7

*Note: Middle C = C4 (standard), not C3 (Yamaha).

164 SR40•8 BLOCK DIAGRAM

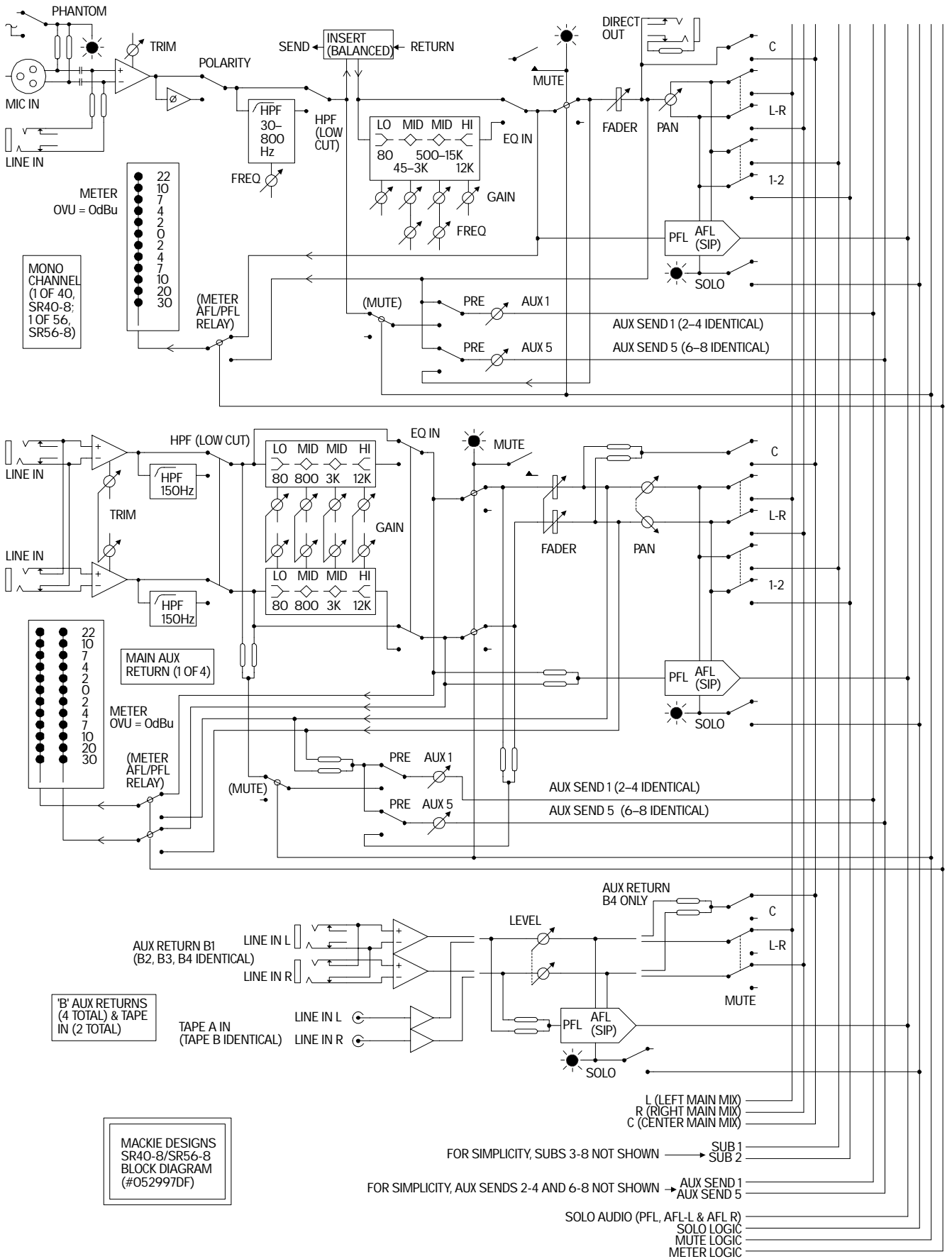

MACKIE DESIGNS
SR40-8/SR56-8
BLOCK DIAGRAM
(#052997DF)

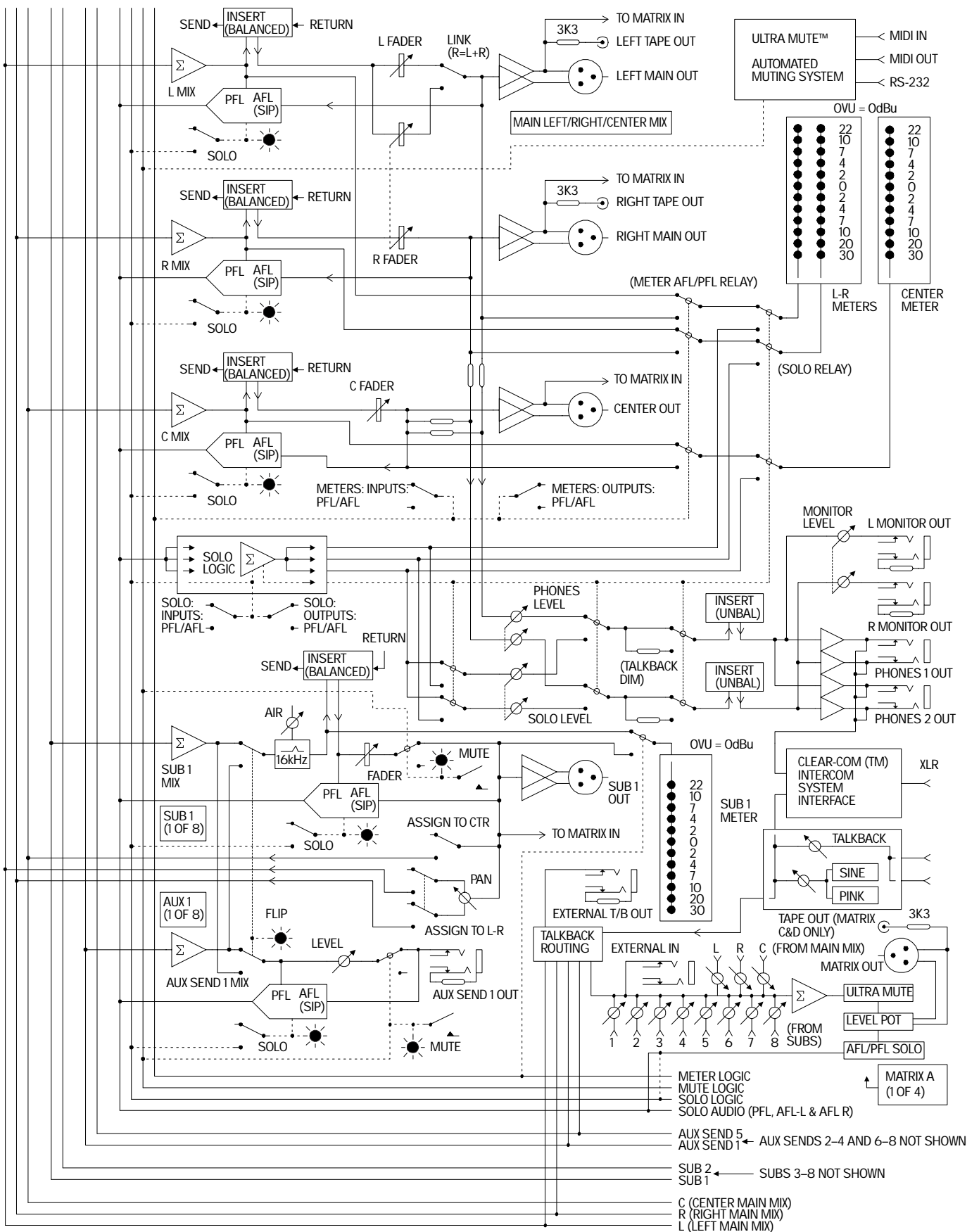

165 SR40•8 GAIN STRUCTURE DIAGRAM

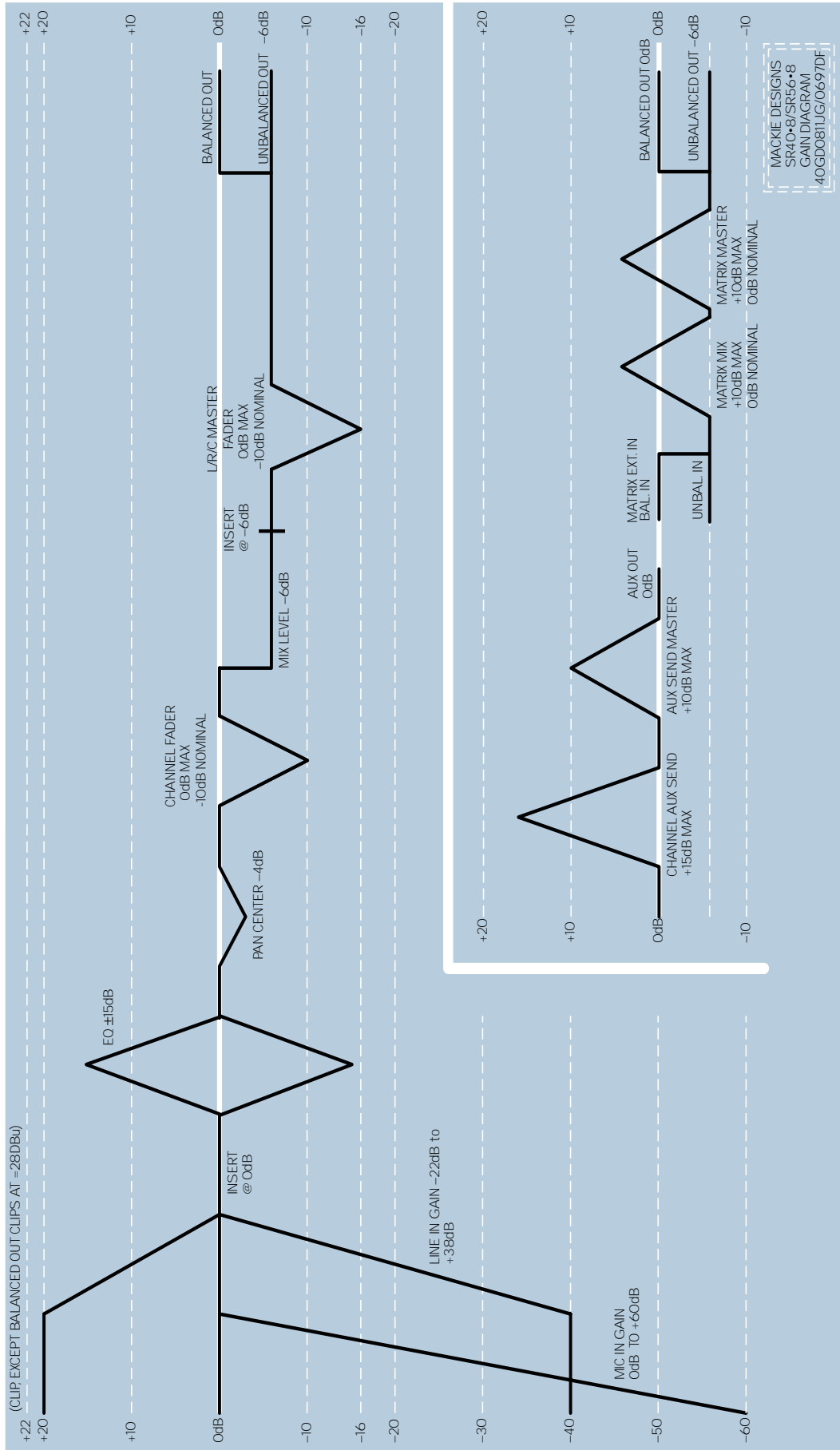

**This page was intentionally left blank
until we put this message on it!**

166 SR40•8 SPECIFICATIONS

Noise

Master Fader @ Unity, channel gains down	-90dBu
Master Fader @ Unity, channel gains @ Unity	-86dBu
Signal to Noise Ratio (ref +4)	≥90dB
Total Harmonic Distortion	Below 0.005%

Crosstalk

Channel Fader down, channels @ Unity	-95dBu
Channel muted, other channels @ Unity	-95dBu

Frequency Response

20Hz to 60kHz	+0/-1dB
10Hz to 100kHz	+0/-3dB

Maximum Levels

Mic preamp input	+22dBu
All other inputs	+22dBu
Balanced XLR outputs	+28dBu
All other outputs	+22dBu

Impedances

Mic preamp input	2.4kΩ
All other inputs (except inserts): bal.	>10kΩ
RCA outputs	3.3kΩ
All other outputs:	
balanced	240Ω
unbalanced	120Ω

Since we are always striving to make our stuff better at Mackie Designs by incorporating new and improved materials, components and manufacturing methods, we reserve the right to change these specifications at any time without notice.

Equalization

Low EQ, shelving	±15dB, 80Hz
Low Mid EQ, 1.5 octave bandwidth	
Mono channels: sweepable	±15dB, 45Hz-3kHz
Stereo channels: fixed	±15dB, 800Hz
Hi Mid EQ, 1.5 octave bandwidth	
Mono channels: sweepable	500Hz-15kHz
Stereo channels: fixed	±15dB, 3kHz
Hi EQ, shelving	±15dB, 12kHz
High Pass Filter	
Mono channels: sweepable	12dB/octave, 30-800Hz
Stereo channels: fixed	18dB/octave, 150Hz

Microphone Preamp

E.I.N.	-129.5dBm (20Hz-20kHz)
--------	------------------------

Power Requirement

SR40•8/SR56•8 400-Watt Power Supply (sold separately)

Weight

SR40•8	110 lbs.
SR56•8	145 lbs.

Dimensions (Power Supply)

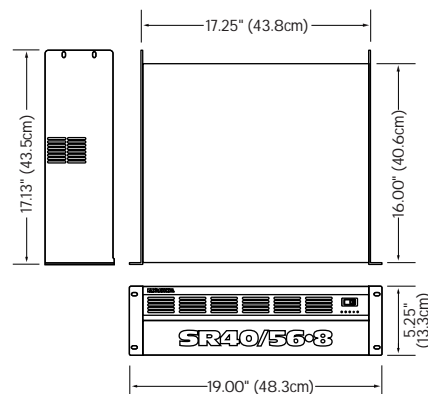

Dimensions (Consoles)

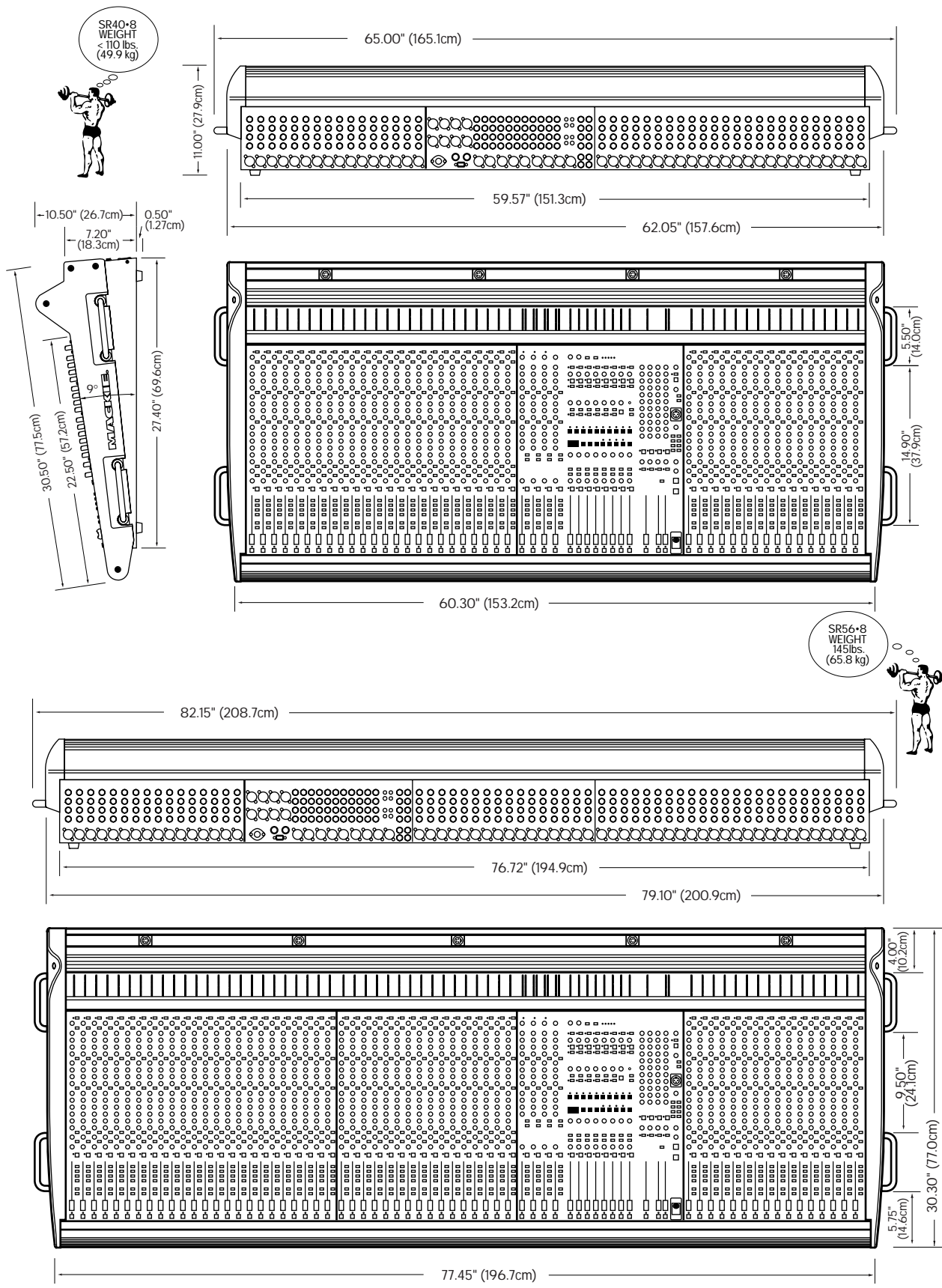

APPENDIX A: Service Info

Details concerning Warranty Service are spelled out on the Warranty Card included with your mixer (if it's missing, let us know and we'll rush one to you).

If you think your mixing board has a problem, please do everything you can to confirm it before calling for service. Doing so might save you from the deprivation of your mixer and the associated suffering.

Of all Mackie products returned for service (which is hardly any at all), roughly 50% are coded "CND" — Could Not Duplicate, which usually means the problem lay somewhere other than the mixer. These may sound obvious to you, but here's some things you can check:

TROUBLESHOOTING

Bad Channel

- Is the mute switch in the correct position?
- Is the gain turned up?
- Try unplugging any insert devices.
- Try the same source signal in another channel, set up exactly like the suspect channel.

Bad Output

- Is the associated level knob (if any) turned up?
- If it's an aux send or sub problem, is the FLIP switch set correctly?
- If it's a stereo pair, try switching them around. For example, if a left output is presumed dead, switch the left and right cords, at the mixer end. If the problem switches sides, it's not the mixer.

Noise

- Mute the channels and aux returns one by one. If the sound disappears, it's either that channel or whatever is plugged into it, so unplug whatever that is. If the noise disappears, it's from your whatever.

Power

- Our favorite question: Is the power switch on?
- Are all of the status LEDs on?
- Check the fuses. Please refer to the power supply documentation to change the fuse.

REPAIR

Service for the U.S. versions of our mixers is available only from one of our authorized domestic service stations or at the factory, lo-

cated in sunny Woodinville, Washington. (Service for mixers living outside the United States can be obtained through local dealers or distributors.) If your mixer needs service, follow these instructions:

1. Review the preceding troubleshooting suggestions. Please.
2. Call Tech Support at 1-800-258-6883, 8am to 5pm PST, to explain the problem and request an RA number. Have your mixer's serial number ready. ***You must have a Return Authorization number; before you can obtain service at the factory or an authorized service center.***
3. Set aside the power cord, owner's manual, or anything else that you'll ever want to see again. We are responsible for the return of the mixer only.
4. Pack the mixer in its original package, including endcaps and box. This is ***VERY IMPORTANT.*** When you call for the RA number, please let Tech Support know if you need new packaging. Mackie is not responsible for any damage that occurs due to non-factory packaging.
5. Include a legible note stating your name, shipping address (no P.O. boxes), daytime phone number, RA number and a detailed description of the problem, including how we can duplicate it.
6. Write the RA number in **BIG PRINT** on top of the box.
7. Ship the mixer to us. We recommend United Parcel Service (UPS). We suggest insurance for all forms of cartage. Ship to this address:

**Mackie Designs
SERVICE DEPARTMENT
16220 Wood-Red Rd. NE
Woodinville, WA 98072**

8. We'll try to fix the mixer within three business days. Ask Tech Support for current turn-around times when you call for your RA number. We normally send everything back prepaid using UPS BLUE (Second Day Air). However, if you rush your mixer to us by Air Shipment, we'll treat it in kind by letting it jump to the head of the line, and we'll also ship it back to you UPS RED (Next Day Air). This paragraph does not necessarily apply to non-warranty service.

APPENDIX B: Glossary

This Glossary contains brief definitions of many of the audio and electronic terms used in discussions of sound mixing and recording. Many of the terms have other meanings or nuances or very rigorous technical definitions which we have sidestepped here because we figure you already have a lot on your mind. If you'd like to get more information, you can call Mix Bookshelf at 1-800-233-9604. We recommend the following titles: *The Audio Dictionary*, by Glenn White; *Tech Terms*, by Peterson & Oppenheimer; *Handbook for Sound Engineers*, by Glen Ballou; *Mackie Mixer Book* by Rudy Trubitt and *Sound Reinforcement Handbook*, by Gary Davis.

AFL

An acronym for After Fade Listen, which is another way of saying post-fader solo function.

assign

In sound mixers, *assign* means to switch or route a signal to a particular signal path or combination of signal paths.

attenuate

To reduce or make quieter.

aux

See next entry.

auxiliary

In sound mixers, supplemental equipment or features that provide additional capabilities to the basic system. Examples of auxiliary equipment include: serial processors (equalizers, compressors, limiters, gates) and parallel devices (reverberation and delay). Most mixers have aux send buses and aux return inputs to accommodate auxiliary equipment.

balanced

In a classic balanced audio circuit, the two legs of the circuit (+ and -) are isolated from the circuit ground by exactly the same impedance. Additionally, each leg may carry the signal at exactly the same level but with opposite polarity with respect to ground. In some balanced circuits, only one leg actually carries the signal but both legs exhibit the same impedance characteristics with respect to ground. Balanced input circuits can offer excellent rejection of common-mode noise induced into the line and also make proper (no ground loops) system grounding easier. Usually terminated with ¼" TRS or XLR connectors.

bandwidth

The band of frequencies that pass through a device with a loss of less than 3dB, expressed in Hertz or in musical octaves. Also see *Q*.

bus

An electrical connection common to three or more circuits. In mixer design, a bus usually carries signals from a number of inputs to a mixing amplifier, just like a city bus carries people from a number of neighborhoods to their jobs.

Cannon

A manufacturer of electrical connectors who first popularized the three-pin connector now used universally for balanced microphone connections. In sound work, a Cannon connector is taken to mean a Cannon XLR-3 mic connector or any compatible connector.

cardioid

Means heart-shaped. In sound work, cardioid refers to the shape of the sensitivity pattern of some directional microphones.

channel

A functional path in an audio circuit: an input channel, an output channel, a recording channel, the left channel and so on.

channel strip

The physical representation of an audio channel on the front panel of a mixer; usually a long, vertical strip of controls.

chorusing

An effect available in some digital delay effects units and reverbs. Chorusing involves a number of moving delays and pitch shifting, usually panned across a stereo field. Depending on how used, it can be lovely or grotesque.

clipping

A cause of severe audio distortion that is the result of excessive gain requiring the peaks of the audio signal to rise above the capabilities of the amplifier circuit. Seen on an oscilloscope, the audio peaks appear clipped off. To avoid distortion, reduce the system gain in or before the gain stage in which the clipping occurs. See also *headroom*.

condenser

Another term for the electronic component generally known as a capacitor. In audio, condenser usually refers to a type of microphone that uses a capacitor as the sound pickup element. Condenser microphones require electrical power to run internal amplifiers and maintain an electrical charge on the capacitor. They are typically powered by internal batteries or “phantom power” supplied by an external source, such as a mixing console.

console

A term for a sound mixer, usually a large desk-like mixer.

cueing

In broadcast, stage and post-production work, to “cue up” a sound source (a record, a sound effect on a CD, a song on a tape) means to get it ready for playback by making sure you are in the right position on the “cue,” making sure the level and EQ are all set properly. This requires a special monitoring circuit that only the mixing engineer hears. It does not go out on the air or to the main mixing buses. This “cueing” circuit is the same as pre-fader (PFL) solo on a Mackie mixer, and often the terms are interchangeable.

dB

See *decibel*.

dBm

A unit of measurement of audio signal level in an electrical circuit, expressed in decibels referenced to 1 milliwatt. The “m” in dBm stands for “milliwatt.” In a circuit with an impedance of 600 ohms, this reference (0dBm) corresponds to a signal voltage of 0.775 VRMS (because 0.775 V across 600 ohms equals 1mw).

dBu

A unit of measurement of audio signal level in an electrical circuit, expressed in decibels referenced to 0.775 VRMS into any impedance. Commonly used to describe signal levels within a modern audio system.

dBv

A unit of measurement equal to the dBu but no longer in use. It was too easy to confuse a dBv with a dBV, to which it is not equivalent.

dBV

A unit of measurement of audio signal level in an electrical circuit, expressed in decibels referenced to 1 VRMS across any impedance. Commonly used to describe signal levels in consumer equipment. To convert dBV to dBu, add 2.2dB.

decibel (dB)

The dB is a ratio of quantities measured in similar terms using a logarithmic scale. Many audio system parameters measure over such a large range of values that the dB is used to simplify the numbers. A ratio of 1000V:1V=60dB. When one of the terms in the ratio is an agreed upon standard value such as 0.775V, 1V or 1mw, the ratio becomes an absolute value, i.e., +4dBu, -10dBV or 0dBm.

delay

In sound work, delay usually refers to an electronic circuit or effects unit whose purpose it is to delay the audio signal for some short period of time. Delay can refer to one short repeat, a series of repeats or the complex interactions of delay used in chorusing or reverb. When delayed signals are mixed back with the original sound, a great number of audio effects can be generated, including phasing and flanging, doubling, Haas-effect positioning, slap or slapback, echo, regenerative echo, chorusing and hall-like reverberation. Signal time delay is central to many audio effects units.

detent

A point of slight physical resistance (a click-stop) in the travel of a knob or slide control, used in Mackie mixers to indicate unity gain.

dipping

The opposite of peaking, of course. A dip is an EQ curve that looks like a valley, or a dip. Dipping with an equalizer reduces a band of frequencies. See *guacamole*.

doubling

A delay effect, where the original signal is mixed with a medium (20 to 50 msec) delay. When used carefully, this effect can simulate double-tracking (recording a voice or instrument twice).

dry

Usually means without reverberation, or without some other applied effect like delay or chorusing. Dry is not wet, i.e. totally unaffected.

dynamic

In sound work, dynamic refers to the class of microphones that generate electrical signals by the movement of a coil in a magnetic field. Dynamic microphones are rugged, relatively inexpensive, capable of very good performance and do not require external power.

dynamic range

The range between the maximum and minimum sound levels that a sound system can handle. It is usually expressed in decibels as the difference between the level at peak clipping and the level of the noise floor.

echo

The reflection of sound from a surface such as a wall or a floor. Reverberation and echo are terms that can be used interchangeably, but in audio parlance a distinction is usually made: echo is considered to be a distinct, recognizable repetition (or series of repetitions) of a word, note, phrase or sound, whereas reverberation is a diffuse, continuously smooth decay of sound. Echo and reverberation can be added in sound mixing by sending the original sound to an electronic (or electronic/acoustic) system that mimics natural echoes, and then some. The added echo is returned to the blend through additional mixer inputs. Highly echoic rooms are called live; rooms with very little echo are called dead. A sound source without added echo is dry; one with reverb or echo added is wet.

effects devices

External signal processors used to add reverb, delay, spatial or psychoacoustic effects to an audio signal. An effects processor may be used as an insert processor (serial) on a particular input or subgroup, or it may be used via the aux send/return system (parallel). See also **echo, reverb.**

EIN

Equivalent Input Noise. Specification that helps measure the “quietness” of a gain stage by deriving the equivalent input noise voltage necessary to obtain a given preamp’s output noise. Typically ranges from -125 to -129.5 dBm.

EQ

See **equalization.**

EQ curve

A graph of the response of an equalizer, with frequency on the x (horizontal) axis and amplitude (level) on the y (vertical) axis. Equalizer types and effects are often named after the shape of the graphed response curve, such as peak, dip, shelf, notch, knee and so on.

equalization

Equalization (EQ) refers to purposefully changing the frequency response of a circuit, sometimes to correct for previous unequal response (hence the term, equalization), and more often to add or subtract level at certain frequencies for sound enhancement, to remove extraneous sounds, or to create completely new and different sounds.

Bass and treble controls on your stereo are EQ; so are the units called parametrics and graphics and notch filters.

A lot of how we refer to equalization has to do with what a graph of the frequency response would look like. A flat response (no EQ) is a straight line; a peak looks like a hill, a dip is a valley, a notch is a really skinny valley, and a shelf looks like a plateau (or a shelf). The slope is the grade of the hill on the graph.

Graphic equalizers have enough frequency slider controls to form a graph of the EQ right on the front panel. Parametric EQs let you vary several EQ parameters at once. A filter is simply a form of equalizer that allows certain frequencies through unmolested while reducing or eliminating other frequencies.

Aside from the level controls, EQs are probably the second most powerful controls on any mixer (no, the power switch doesn’t count!).

fader

Another name for an audio level control. Today, the term refers to a straight-line slide control rather than a rotary control.

family of curves

A composite graph showing on one chart several examples of possible EQ curves for a given equalizer or equalizer section.

filter

A simple equalizer designed to remove certain ranges of frequencies. A low-cut filter (also called a high-pass filter) reduces or eliminates frequencies below its cutoff frequency. There are also high-cut (low-pass) filters, bandpass filters, which cut both high and low frequencies but leave a band of frequencies in the middle untouched, and notch filters, which remove a narrow band but leave the high and low frequencies alone.

flanging

A term for phasing. Before digital delay effects units, phasing could be accomplished by playing two tape machines in synchronization, then delaying one slightly by rubbing a finger on the reel flange. Get it?

FOH

An acronym for Front Of House. See *house* and *main house speakers*.

frequency

The number of times an event repeats itself in a given period. Sound waves and the electrical signals that represent sound waves in an audio circuit have repetitive patterns that range from a frequency of about 20 repetitions per second to about 20,000 repetitions per second. Sound is the vibration or combination of vibrations in this range of 20 to 20,000 repetitions per second, which gives us the sensation of pitch, harmonics, tone and overtones. Frequency is measured in units called Hertz (Hz). One Hertz is one repetition or cycle per second.

gain

The measure of how much a circuit amplifies a signal. Gain may be stated as a ratio of input to output values, such as a voltage gain of 4, or a power gain of 1.5, or it can be expressed in decibels, such as a line amplifier with a gain of 10dB.

gain stage

An amplification point in a signal path, either within a system or a single device. Overall system gain is distributed between the various gain stages.

graphic EQ

A graphic equalizer uses slide pots for its boost/cut controls, with its frequencies evenly spaced through the audio spectrum. In a perfect world, a line drawn through the centers of the control shafts would form a graph of the frequency response curve. Get it? Or, the positions of the slide pots give a graphic representation of boost or cut levels across the frequency spectrum.

ground

Also called earth. Ground is defined as the point of zero voltage in a circuit or system, the reference point from which all other voltages are measured. In electrical systems, ground connections are used for safety purposes, to keep equipment chassis and controls at zero voltage and to provide a safe path for errant currents. This is called a safety ground.

Maintaining a good safety ground is always essential to prevent electrical shock. Follow manufacturer's suggestions and good electrical practices to ensure a safely grounded system. Never remove or disable the grounding pin on the power cord.

In computer and audio equipment, tiny currents and voltages can cause noise in the circuits and hamper operation. In addition to providing safety, ground provisions in these situations serve to minimize the pickup, detection and distribution of these tiny noise signals. This type of ground is often called technical ground.

Quality audio equipment is designed to maintain a good technical ground and also operate safely with a good safety ground. If you have noise in your system due to technical grounding problems, check your manual for wiring tips or call technical support. Never disable the safety ground to reduce noise problems.

ground loop

A ground loop occurs when the technical ground within an audio system is connected to the safety ground at more than one place. Two or more connections will allow tiny currents to flow in the loops created, possibly inducing noise (hum) in the audio system. If you have noise in your system due to ground loops, check your manual for wiring tips or call technical support. Never disable the safety ground to reduce noise problems.

Haas effect

A psychoacoustic effect in which the time of arrival of a sound to the left and right ears affects our perception of direction. If a signal is presented to both ears at the same time at the same volume, it appears to be directly in front of us. But if the signal to one ear, still at the same volume, is delayed slightly (0 to 5 msec), the sound appears to be coming from the earlier (non-delayed) side.

headroom

The difference between nominal operating level and peak clipping in an audio system. For example, a mixer operating with a nominal line level of +4dBu and a maximum output level of +22dBu has 18dB of headroom. Plenty of room for surprise peaks.

Hertz

The unit of measure for frequency of oscillation, equal to 1 cycle per second. Abbreviated Hz. KHz is pronounced “kay-Hertz” and is an abbreviation for kilohertz, or 1000 Hertz.

house

In Sound Reinforcement parlance, “house” refers to the systems (and even persons) responsible for the primary sound reinforcement in a given hall, building, arena or “house.” Hence we have the house mixer or house engineer, the house mix, the house mix amps, the main house speakers and so on.

Hz

See *Hertz*.

impedance

The A.C. resistance/capacitance/inductance in an electrical circuit, measured in ohms. In audio circuits (and other AC circuits) the impedance in ohms can often be much different from the circuit resistance as measured by a DC ohmmeter.

Maintaining proper circuit impedance relationships is important to avoid distortion and minimize added noise. Mackie input and output impedances are set to work well with the vast majority of audio equipment.

input module

A holdover from the days when the only way that real consoles were built was in modular fashion, one channel per module. See *channel strip*.

knee

A knee is a sharp bend in an EQ response curve not unlike the sharp bend in your leg. Also used in describing dynamics processors.

level

Another word for signal voltage, power, strength or volume. Audio signals are sometimes classified according to their level. Commonly used levels are: microphone level (–40dBu or lower), instrument level (–20 to –10dBu), and line level (–10 to +30dBu).

line level

A signal whose level falls between –10dBu and +30dBu.

main house speakers

The main loudspeakers for a sound reinforcement system. These are usually the largest and loudest loudspeakers, and are usually positioned so that their sound seems to come from the area of the main stage.

mains

See *main house speakers*.

master

A control affecting the final output of a mixer. A mixer may have several master controls, which may be slide faders or rotary controls.

mic amp

See *mic preamp*.

mic level

The typical level of a signal from a microphone. A mic level signal (usually but not always coming from a microphone) is generally below –30dBu. With a very quiet source (a pin dropping?) the signal can be –70dBu or lower. It is also possible for some microphones to deliver more signal than this, in which case it may be referred to as a “hot” mic level. Alternatively, you can just say, “Boy, is that loud!”

mic pre

See *mic preamp*.

mic preamp

Short for microphone preamplifier. An amplifier that functions to bring the very low signal level of a microphone (approximately –50dBu) up to line level (approximately 0dBu). Mic preamps often have their own volume control, called a trim control, to properly set the gain for a particular source. Setting the mic preamp gain correctly with the trim control is an essential step in establishing good noise and headroom for your mix.

mixer

An electronic device used to combine various audio signals into a common output. Different from a blender, which combines various fruits into a common libation.

monaural

Literally, pertaining to or having the use of only one ear. In sound work, monaural has to do with a signal which, for purposes of communicating audio information, has been confined to a single channel. One microphone is a mono pickup; many microphones mixed to one channel is a mono mix; a mono signal played through two speakers is still mono, since it only carries one channel of information. Several monaural sources, however, can be panned into a stereo (or at least two-channel, if you are going to be picky) mix. Monaural sound reinforcement is common for environments where stereo sound reinforcement would provide an uneven reproduction to the listener.

monitor

In sound reinforcement, monitor speakers (or monitor headphones or in-the-ear monitors) are those speakers used by the performers to hear themselves. Monitor speakers are also called foldback speakers. In recording, the monitor speakers are those used by the production staff to listen to the recording as it progresses. In zoology, the monitor lizard is the lizard that observes the production staff as the recording progresses. Keep the lizard out of the mixer.

mono

Short for monaural.

mult

Probably short for multiple. In audio work, a mult is a parallel connection in a patch bay or a connection made with patch cords to feed an output to more than one input. A "Y" cable is a type of mult connection. Also a verb, as in "Why did you mult the flanger into every input in the board?"

noise

Whatever you don't want to hear. Could be hum, buzz or hiss; could be crosstalk or digital hash or your neighbor's stereo; could be white noise or pink noise or brown noise; or it could be your mother-in-law reliving the day she had her gallstone removed.

noise floor

The residual level of noise in any system. In a well designed mixer, the noise floor will be a quiet hiss, which is the thermal noise generated by bouncing electrons in the transistor junctions. The lower the noise floor and the higher the headroom, the more usable dynamic range a system has.

pan, pan pot

Short for panoramic potentiometer. A pan pot is used to position (or even move back and forth) a monaural sound source in a stereo mixing field by adjusting the source's volume between the left and right channels. Our brains sense stereo position by hearing this difference in loudness when the sound strikes each ear, taking into account time delay, spectrum, ambient reverberation and other cues.

parametric EQ

A "fully" parametric EQ is an extremely powerful equalizer that allows smooth, continuous control of each of the three primary EQ parameters (frequency, gain, and bandwidth) in each section independently. "Semi" parametric EQs allow control of fewer parameters, usually frequency and gain (i.e., they have a fixed bandwidth, but variable center frequency and gain).

peaking

The opposite of dipping, of course. A peak is an EQ curve that looks like a hill, or a peak. Peaking with an equalizer amplifies a band of frequencies.

PFL

An acronym for Pre Fade Listen. Broadcasters would call it cueing. Sound folks call it being able to solo a channel with the fader down.

phantom power

A system of providing electrical power for condenser microphones (and some electronic pickup devices) from the sound mixer. The system is called phantom because the power is carried on standard microphone audio wiring in a way that is "invisible" to ordinary dynamic microphones. Mackie mixers use standard +48 volt DC power, switchable on or off. Most quality condenser microphones are designed to use +48 VDC phantom power. Check the manufacturer's recommendations.

Generally, phantom power is safe to use with non-condenser microphones as well, especially dynamic microphones. However, unbalanced microphones, some electronic equipment (such as some wireless microphone receivers) can short out the phantom power and be severely damaged. Check the manufacturer's recommendations and be careful!

phasing

A delay effect, where the original signal is mixed with a short (0 to 10 msec) delay. The time of the delay is slowly varied, and the combination of the two signals results in a dramatic moving comb-filter effect. Phasing is sometimes imitated by sweeping a comb-filter EQ across a signal. A comb filter can be found in your back pocket.

phone jack

Ever see those old telephone switchboards with hundreds of jacks and patch cords and plugs? Those are phone jacks and plugs, now used widely with musical instruments and audio equipment. A phone jack is the female connector, and we use them in ¼" two-conductor (TS) and three-conductor (TRS) versions.

phone plug

The male counterpart to the phone jack, right above.

phono jack

See *RCA phono jack*.

phono plug

See *RCA phono plug*.

post-fader

A term used to describe an aux send (usually) that is connected so that it is affected by the setting of the associated channel fader. Sends connected this way are typically (but not always) used for effects. See *pre-fader*.

pot, potentiometer

In electronics, a variable resistor that varies the potential, or voltage. In audio, any rotary or slide control.

pre-fader

A term used to describe an aux send (usually) that is connected so that it is not affected by the setting of the associated channel fader. Sends connected this way are typically (but not always) used for monitors (foldback). See *post-fader*.

proximity effect

The property of many directional microphones to accentuate their bass response when the source-to-mic distance is small, typically three inches or less. Singers generally like this effect even more than singing in the shower.

Q

A way of stating the bandwidth of a filter or equalizer section. An EQ with a Q of .75 is broad and smooth, while a Q of 10 gives a narrow, pointed response curve. To calculate the value of Q, you must know the center frequency of the EQ section and the frequencies at which the upper and lower skirts fall 3dB below the level of the center frequency. Q equals the center frequency divided by the difference between the upper and lower -3dB frequencies. A peaking EQ centered at 10kHz whose -3dB points are 7.5kHz and 12.5kHz has a Q of 2.

RCA phono jack—or RCA jack or phono jack

An RCA phono jack is an inexpensive connector (female) introduced by RCA and originally used to connect phonographs to radio receivers and phono preamplifiers. The phono jack was (and still is) widely used on consumer stereo equipment and video equipment but was quietly fading into obscurity in the professional and semiprofessional sound world. Then phono jacks began cropping up in early project-studio multitrack recorders, which (unfortunately) gave them a new lease on life. Since so many stereo recorders are fitted with them, we decided we'd have to put a couple on our mixers for your convenience. But make no mistake: the only thing that the phono jack (or plug) has going for it is low cost.

RCA phono plug

The male counterpart to an RCA phono jack. See above.

regeneration

Also called recirculation. A delay effect created by feeding the output of a delay back into itself to cause a delay of the delay of the delay. You can do it right on the front panel of many effects units, or you can route the delay return back into itself on your mixer. Can be a great deal of fun at parties.

return

A return is a mixer line input dedicated to the task of returning processed or added sound from reverb, echo and other effects devices. Depending on the internal routing of your mixer and your own inclination, you could use returns as additional line inputs, or you could route your reverb outputs to ordinary line inputs rather than the returns.

reverberation, reverb

The sound remaining in a room after the source of sound is stopped. It's what you hear in a large tiled room immediately after you've clapped your hands. Reverberation and echo are terms that can be used interchangeably, but in audio parlance a distinction is usually made: reverberation is considered to be a diffuse, continuously smooth decay of sound, whereas echo is a distinct, recognizable repetition of a word, note, phrase or sound. Reverberation and echo can be added in sound mixing by sending the original sound to an electronic (or electronic/acoustic) system that mimics natural reverberation, or worse. The added reverb is returned to the blend through additional mixer inputs. Highly reverberant rooms are called live; rooms with very little reverberation are called dead. A sound source without added reverb is dry; one with reverb or echo added is wet.

RMS

An acronym for root mean square, a conventional way to measure AC voltage and audio signal voltage. Most AC voltmeters are calibrated to read RMS volts. Other conventions include average volts, peak volts and peak-to-peak volts.

send

A term used to describe a secondary mix and output of the input signals, typically used for foldback monitors, headphone monitors, or effects devices. Mackie mixers call it an Aux Send.

shelving

A term used to describe the shape of an equalizer's frequency response. A shelving equalizer's response begins to rise (or fall) at some frequency and continues to fall (or rise) until it reaches the shelf frequency, at which point the response curve flattens out and remains flat to the limits of audibility. If you were to graph the response, it would look like a shelf. Or more like a shelf than a hiking boot. The EQ controls on your stereo are usually shelving equalizers. See also *peaking* and *dipping*.

slap, slapback

A single-delay echo without any repeats. Also see *echo*.

solo

Italian for alone. In audio mixers, a solo circuit allows the engineer to listen to individual channels, buses or other circuits singly or in combination with other soloed signals.

SR

An acronym for Sound Reinforcement, which refers to a system of amplifying acoustic and electronic sounds from a performance or speech so that a large audience can hear clearly. Or, in popular music, so that a large audience can be excited, stunned or even partially deafened by the tremendous amplification. Means essentially the same thing as PA (Public Address).

stereo

Believe it or not, stereo comes from a Greek word that means solid. We use stereo or stereophony to describe the illusion of a continuous, spacious soundfield that is seemingly spread around the listener by two or more related audio signals. In practice, stereo often is taken to simply mean two channels.

sweep EQ

An equalizer that allows you to "sweep" or continuously vary the frequency of one or more sections.

symmetrically balanced

See *balanced*.

tinnitus

The ringing in the ears that is produced with prolonged exposure to high volumes. A sound in the ears, such as buzzing, ringing, or whistling, caused by volume knob abuse!

trim

In audio mixers, the gain adjustment for the first amplification stage of the mixer. The trim control helps the mixer cope with the widely varying range of input signals that come from real-world sources. It is important to set the trim control correctly; its setting determines the overall noise performance in that channel of the mixer. See *mic preamp*.

TRS

Acronym for Tip-Ring-Sleeve, a scheme for connecting three conductors through a single plug or jack. ¼" phone plugs and jacks and ⅛" mini phone plugs and jacks are commonly wired TRS. Since the plug or jack can carry two signals and a common ground, TRS connectors are often referred to as stereo or balanced plugs or jacks. Another common TRS application is for insert jacks, used for inserting an external processor into the signal path. In Mackie mixers, the tip is send, ring is return, and sleeve is ground.

TS

Acronym for Tip-Sleeve, a scheme for connecting two conductors through a single plug or jack. ¼" phone plugs and jacks and ⅛" mini phone plugs and jacks are commonly wired TS. Sometimes called mono or unbalanced plugs or jacks. A ¼" TS phone plug or jack is also called a standard phone plug or jack.

unbalanced

An electrical circuit in which the two legs of the circuit are not balanced with respect to ground. Usually, one leg will be held at ground potential. Unbalanced circuit connections require only two conductors (signal "hot" and ground). Unbalanced audio circuitry is less expensive to build but under certain circumstances is more susceptible to noise pickup.

unity gain

A circuit or system that has its voltage gain adjusted to be one, or unity. A signal will leave a unity gain circuit at the same level at which it entered. In Mackie mixers, unity gain is achieved by setting all variable controls to the marked "U" setting. Mackie mixers are optimized for best headroom and noise figures at unity gain.

VLZ

Acronym for very low impedance. (Impedance is measured in ohms represented by the Ω symbol, which is the last letter of the Greek alphabet. This is how the letter Z is used instead of I.) VLZ is one of the most important reasons why inherent noise levels on Mackie mixing boards are so minuscule. Thermal noise is something that's created by all circuitry and usually transistors and resistors are the worst culprits. The basic rule with thermal noise is: the higher the impedance, the more the noise. Mackie's VLZ design reduces thermal noise by making internal impedances as low as possible in as many places as possible within the console. VLZ is achieved by scaling down resistor values by a factor of three or four – resulting in a corresponding reduction in thermal noise. This is especially true for the console's mixing buses.

volume

Electrical or sound level in an audio system. Perhaps the only thing that some bands have too much of.

VRMS

See *RMS*.

wet

With added reverberation or other effect like echo, delay or chorusing.

XLR connector

See *Cannon*.

APPENDIX C: Connections

“XLR” CONNECTORS

Mackie mixers use 3-pin female “XLR” connectors on all microphone inputs, with pin 1 wired to the grounded (earthed) shield, pin 2 wired to the “high” (“hot” or positive polarity) side of the audio signal and pin 3 wired to the “low” (“cold” or negative polarity) side of the signal (Figure A). All totally aboveboard and in full accord with the hallowed standards dictated by the AES (Audio Engineering Society).

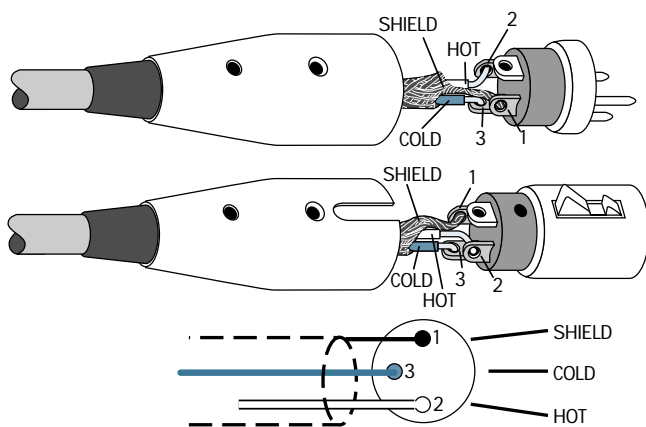

Figure A: XLR Connectors

Use a male “XLR”-type connector, usually found on the nether end of what is called a “mic cable,” to connect to a female XLR jack.

1/4" TRS PHONE PLUGS AND JACKS

“TRS” stands for Tip-Ring-Sleeve, the three connections available on a “stereo” 1/4" or “balanced” phone jack or plug. See Figure B. TRS jacks and plugs are used in several different applications:

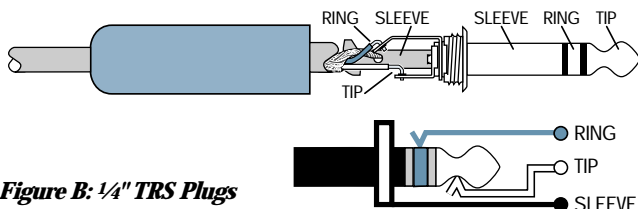

Figure B: 1/4" TRS Plugs

- Stereo Headphones, and rarely, stereo microphones and stereo line connections. When wired for stereo, a 1/4" TRS jack or plug is connected tip to left, ring to right and sleeve to ground (earth). Mackie mixers do not directly accept 1-plug-type stereo microphones. They must be separated into a left cord and a right cord, which are plugged into the two mic preamps.

You can cook up your own adapter for a stereo microphone adapter. “Y” two cables out of a female 1/4" TRS jack to two male XLR plugs, one for the Right signal and one for the Left.

- Balanced mono circuits. When wired as a balanced connector, a 1/4" TRS jack or plug is connected tip to signal high (hot), ring to signal low (cold), and sleeve to ground (earth).
- Unbalanced Send/Return circuits. When wired as send/return “Y” connector, a 1/4" TRS jack or plug is connected tip to signal send (output from mixer), ring to signal return (input back into mixer), and sleeve to ground (earth).

1/4" TS PHONE PLUGS AND JACKS

“TS” stands for Tip-Sleeve, the two connections available on a “mono” 1/4" phone jack or plug (Figure C). TS jacks and plugs are used in many different applications, always unbalanced. The tip is connected to the audio signal and the sleeve to ground (earth). Some examples:

- Unbalanced microphones
- Electric guitars and electronic instruments
- Unbalanced line-level connections

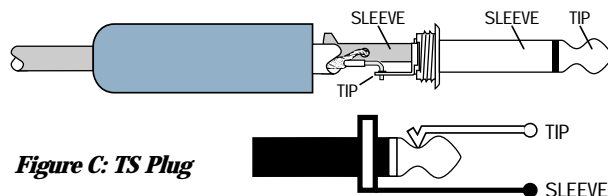

Figure C: TS Plug

SWITCHED 1/4" PHONE JACKS

Switches can be incorporated into 1/4" phone jacks, which are activated by inserting the plug. These switches may open an insert loop in a circuit, change the input routing of the signal or serve other functions. Mackie uses switches in the channel insert and bus insert jacks, input jacks and AUX returns. We also use these switches to ground the line-level inputs when nothing is plugged into them.

In most cases, the plug must be inserted fully to activate the switch. Mackie takes advantage of this in some circuits, specifying circumstances where you are to insert the plug only partially. See **Special Mackie Connections**, later in this section.

RCA PLUGS AND JACKS

RCA-type plugs (also known as phono plugs) and jacks are often used in home stereo and video equipment and in many other applications (Figure D). They are unbalanced and electrically identical to a 1/4" TS phone plug or jack (See Figure C). Connect the signal to the center post and the ground (earth) or shield to the surrounding "basket."

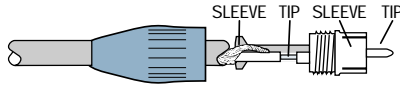

Figure D: RCA Plug

UNBALANCING A LINE

In most studio, stage and sound reinforcement situations, there is a combination of balanced and unbalanced inputs and outputs on the various pieces of equipment. This usually will not be a problem in making connections.

- When connecting a balanced output to an unbalanced input, be sure the signal high (hot) connections are wired to each other, and that the balanced signal low (cold) goes to the ground (earth) connection at the unbalanced input. In most cases, the balanced ground (earth) will also be connected to the ground (earth) at the unbalanced input. If there are ground-loop problems, this connection may be left disconnected at the balanced end.
- When connecting an unbalanced output to a balanced input, be sure that the signal high (hot) connections are wired to each other. The unbalanced ground (earth) connection should be wired to the low (cold) and the ground (earth) connections of the balanced input. If there are ground-loop problems, try connecting the unbalanced ground (earth) connection only to the input low (cold) connection, and leaving the input ground (earth) connection disconnected.

In some cases, you will have to make up special adapters to interconnect your equipment. For example, you may need a balanced XLR female connected to an unbalanced 1/4" TS phone plug.

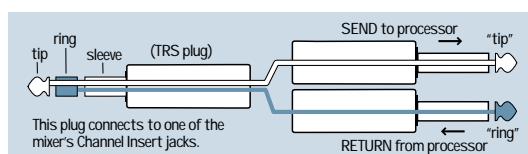

Figure F

SPECIAL MACKIE CONNECTIONS

The balanced-to-unbalanced connection has been anticipated in the wiring of Mackie jacks. A 1/4" TS plug inserted into a 1/4" TRS balanced input, for example, will automatically unbalance the input and make all the right connections. Conversely, a 1/4" TRS plug inserted into a 1/4" unbalanced input will automatically tie the ring (low or cold) to ground (earth).

TRS Send/Receive Insert Jacks

Mackie's dual-jack inserts are balanced TRS 1/4" jacks and will also accept TS (unbalanced) lines. The Send signal is normalled to the Return jacks. If you insert a plug into the Return jack, the Send signal is interrupted (and replaced by the Return line's signal).

Mackie's single-jack inserts (only appear as HEADPHONES L-INSERT and R-INSERT jacks on the SR40•8 or SR56•8) are the three-conductor, TRS-type 1/4" phone jacks. They are unbalanced, but have both the mixer output (send) and the mixer input (return) signals in one connector (See Figure F).

The sleeve is the common ground (earth) for both signals. The send from the mixer to the external unit is carried on the tip, and the return from the unit to the mixer is on the ring.

Using the Send Only on an Insert Jack

If you insert a TS (mono) 1/4" plug only partially (to the first click) into a Mackie insert jack, the plug will not activate the jack switch and will not open the insert loop in the circuit (thereby allowing the channel signal to continue on its merry way through the mixer).

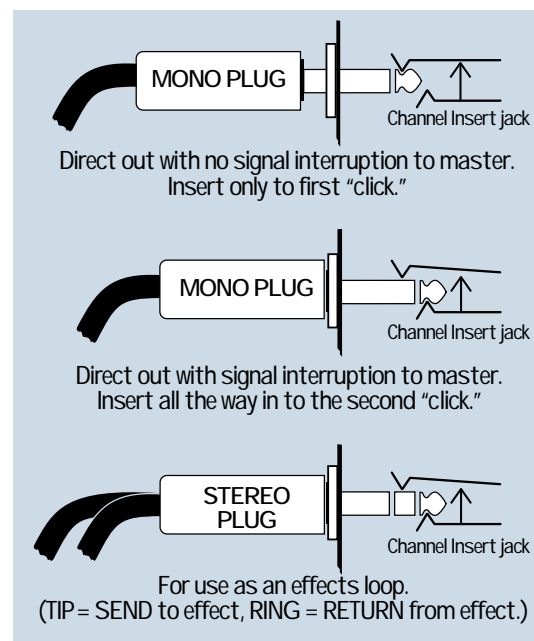

Figure E

This allows you to tap out the channel or bus signal at that point in the circuit without interrupting normal operation.

If you push the ¼" TS plug in to the second click, you will open the jack switch and create a direct out, which does interrupt the signal in that channel. See Figure E.



NOTE: Do not overload or short-circuit the signal you are tapping from the mixer. That will affect the internal signal.

MACKIE STEREO INPUTS AND RETURNS: Mono, Stereo, Whatever

Stereo line inputs and stereo AUX returns are a fine example of the Mackie philosophy (which we just made up) of Maximum Flexibility with Minimum Headache. The inputs and returns will automatically be mono or stereo, depending upon how you use the jacks. Here's how it works:

A mono signal should be patched into the input or return jack labeled Left (MONO). The signal will be routed to both the left and right sides of the return circuit, and will show up in the center of the stereo pair of buses it's

assigned to, or it can be "panned" with the Balance control.

A stereo signal, having two plugs, should be patched into the LEFT (MONO) and the RIGHT input or return jacks. A jack switch in the RIGHT jack will disable the mono function, and the signals will show up in stereo.

A mono signal connected to the RIGHT jack will show up in the right bus only. You probably will only want to use this sophisticated effect for special occasions (weddings, bar mitzvahs, Rush Limbaugh's birthday party, etc.)

MULTS AND "Y"s

A mult or "Y" connector allows you to route one output to two or more inputs by simply providing parallel wiring connections. You can make "Y"s and mults for the outputs of both unbalanced and balanced circuits.



Remember: Only mult or "Y" an output into several inputs. If you need to combine several outputs into one input, you must use a mixer, not a "Y."

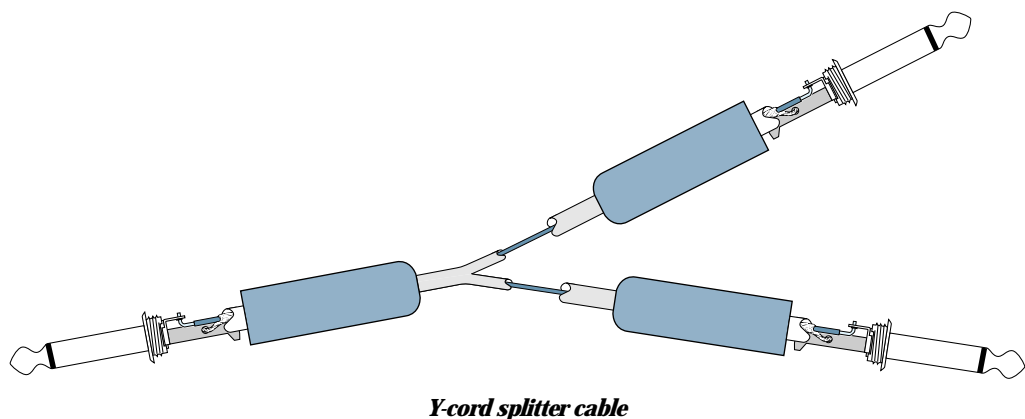
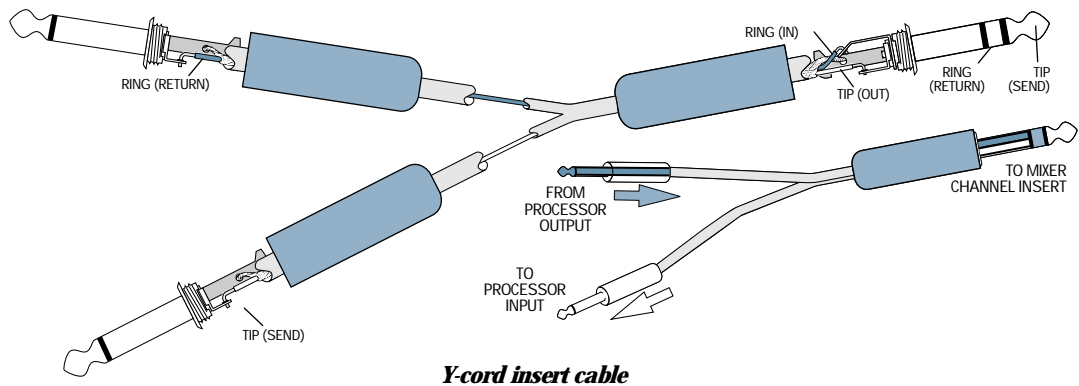

APPENDIX D: Balanced Lines, Phantom Powering, Grounding, and Other Arcane Mysteries

Balanced Lines

Balanced lines offer increased immunity to external noise (specifically, hum and buzz). Because a balanced system is able to minimize noise, it is the preferred interconnect method, especially in cases where very long lengths of cable are being used. A long unbalanced cable carries with it more opportunity for noise to get into a system — having balanced inputs means very little noise will enter the system via snakes and other cables that typically must run a long length. But regardless of length, balanced lines are best.

Phantom Powering and Microphones

History

Condenser (capacitor) microphones differ from dynamic and ribbon microphones because they are not self-generating. That is, they cannot generate electricity in response to an impinging sound wave. A condenser microphone modifies an external source of electricity to reflect the effects of a sound wave striking its diaphragm.

Dynamic and ribbon microphones use magnetism to generate electricity in response to a sound wave: they are self-generating. Furthermore, both of these types of microphones are inherently low-impedance devices. It is possible to connect a dynamic microphone element directly to a balanced, low-impedance mixer input. Many commercially made dynamic microphones do just that.

On the other hand, a condenser microphone is an inherently high-impedance device. How high? Verrrrrry high. On the order of a billion ohms (1 Gigaohm). This is high enough that the inherent capacitance of a foot of shielded cable would audibly reduce the output of the microphone. All condenser microphones have an impedance converter, in the form of a vacuum tube or field-effect transistor (FET), built into the microphone and located extremely close to the microphone element. The impedance converter and the microphone element itself require an external power source.¹

¹ To be strictly correct, electret condenser microphones are a bit different, as the microphone element does not require a power source for operation (it is more or less permanently self-polarized). Regardless, the impedance converter still requires an external source of power.

What is it, exactly?

The obvious external power source for any modern microphone is a battery. About the only electronic advantage that a battery has is that its output is pure DC. The only other advantage is to the battery company — you have to keep on buying them.

Tube microphones require several different voltages for operation. This invariably means a multiconductor cable and nonstandard (not XLR) connectors. A tube microphone will always have an associated external power supply.

In the late 1960's, Neumann (you know, the folks that brought you the U47 and U87 microphones) converted its microphones to solid-state, adopting a system of remote powering that they called, and trademarked, Phantom Powering. Because of the trademark, some manufacturers use terms like Simplex Powering, etc. Over the years, the trademark has become genericized and now refers to any device that is powered according to DIN standard 45 596 (or maybe it's DIN standard 45 595, we're not exactly sure...).

So, why "Phantom" Powering? Because (like the Phantom in the old comic strip) it's there when you need it, and invisible when you don't. This technology is not new; it actually predates rocket science. Like many other things in audio, it was brought to you by the telephone company, who used it to get an extra circuit from a pair of wires. In effect, so does your phantom powered microphone.

What is important is: phantom powering is a compatible system. Your dynamic/ribbon microphones as well as your condenser microphones work side-by-side, from the same microphone inputs, without further thought on your part.

Technically speaking, phantom powering refers to a system in which the audio signal is applied to the balanced line in differential-mode, and the DC power is applied common-mode. The audio travels via pins 2 and 3, the power travels between pins 2 and 3 simultaneously, and pin 1 is the ground for both audio and power.

PHANTOM POWER DO & DON'T CHART	
DO	DON'T
If you are plugging in a condenser microphone, do verify that your microphone can be phantom powered.	Don't worry about your other microphones as long their outputs are balanced and floating.
Ensure that the microphone's output is low impedance, balanced and floating. This is especially important for vintage ribbon microphones like the RCA 44BX and 77DX.	Don't connect microphones or devices that do not conform to the DIN 45 596 standard.
Mute the sound system when turning the phantom power on or off, or when connecting or disconnecting microphones. If you forget, the resulting loud, nasty POP may be your last.	Don't connect A-B or T-system microphones (another remote powering system) without suitable adaptors.

Microphones that do not require power simply ignore the DC present between pin 2/pin 3 and pin 1. If you measure with a voltmeter between pin 2 and pin 3, you will read 0 Volts DC. This is what your dynamic microphone sees. Measuring between pin 2 and pin 1, or between pin 3 and pin 1, you will read the phantom power voltage, usually 48V, without a microphone connected. The dynamic microphone, as well as your balanced mixer input, ignores this voltage.

Lately, the term phantom power has been perverted to refer to any remote powering system. In the strict sense of the DIN standard, this is not true. Furthermore, microphones or transducers that claim to use this system are not compatible with the DIN standard and will almost certainly be damaged if connected into such a system. Fortunately, these systems use tip-ring-sleeve phone plugs or miniature XLR connectors and they are usually associated with instrument pickup applications².

Phantom powering is defined in DIN standard 45 596 or IEC standard 268-15A. Your Mackie Designs mixer conforms to this standard.

What works?

To be compatible in a phantom powered system, a device (microphone, preamp with a microphone-style output, or direct box) must have a balanced and floating, low-impedance

output. This includes all microphones commonly used for sound reinforcement and recording, such as the Shure SM58, SM57, Electro-Voice RE-15, RE-16, RE-20, ND series, Beyer M160, M500, AKG D224, D12, D112, and *many* others.

If you are fortunate enough to own any tube condenser microphones, such as the AKG C12, Neumann U47 or U67, these microphones may be connected in a phantom powered system and will operate without regard to the presence or absence of phantom power. They will always require their external power supply (which must be plugged in and turned on).

What doesn't work?

The list is short:

1. Microphones with unbalanced outputs.
2. Microphones with grounded center-tapped outputs. Many old ribbon microphones were supplied connected this way. Have a technician lift the ground from the center tap.
3. High-impedance microphones.
4. Microphones that exhibit leakage between pin 2 or pin 3 and pin 1. These microphones will sputter and crackle when phantom power is applied and will work fine when you turn off the phantom power. Get the microphone repaired.

² There is another remote powering system called A-B or T-system powering. It uses pins 2 and 3 to carry both power and audio. It is not compatible with dynamic microphones or phantom-powered microphones.

Do's and Don'ts of Fixed Installations

If you install sound systems into fixed installations, there are a number of things that you can do to make your life easier and that increase the likelihood of the sound system operating in a predictable manner. Even if you don't do fixed installations, these are good practices for any sound system, installed.

1. Do use foil-shielded snake cable for long cable runs. Carefully terminate each end, minimizing the amount of shielding removed. Protect the exposed foil shield with shrink sleeving or PVC sleeving. Prevent adjacent shields from contacting each other (electrically). Use insulating sleeving on the drain wire (the one that connects to pin 1) to prevent it from contacting the connector shell.
2. Don't connect the XLR connector shell to pin 1 of the XLR connector (unless necessary for RFI shielding). Doing so is an invitation for a ground loop to come visiting.
3. Do ensure that your speaker lines and AC power lines are physically separated from your microphone lines.
4. If you use floor pockets, use separate pockets for inputs and speakers, or put the connectors on opposite sides of the box so that they may be shielded separately.
5. If your speaker lines run in the open, they should be twisted pairs, at least 6 twists per foot. Otherwise, run the speaker lines in their own conduit. (Of course, conduit is not too practical for portable systems, heh-heh.)
6. Minimize the distance between the power amplifiers and the speakers.
7. Use heavy gauge, stranded wire for speaker lines. Ideally, the wire resistance should be less than 6% (0.5dB power loss) of the load impedance. Remember that the actual run is twice as long as the physical length of the run. See below.

Maximum wire run for 0.5dB power loss in feet

wire gauge	res. per 1000 ft.	2 Ω	4 Ω	8 Ω
10	1.00	60	120	240
12	1.59	40	75	150
14	2.5	24	48	95
16	4.02	15	30	60

8. Ensure that the electrician uses the star-ground system for the safety grounds in your electrical system. All of the audio system grounds should terminate at the same physical point. No other grounds may come in contact with this ground system.
9. Ensure that the AC power feeds are connected to the same transformer, and ideally, the same circuit breaker.
10. Walk outside – look at the horizon, see any radio towers? Locate potential sources of RF interference and plan for them before you begin construction. Know the frequency, transmitter power, etc. You can get this information by calling the station. Remember that many broadcast stations change antenna coverage pattern and transmitter power at night.
11. Don't use hardware-store light dimmers.
12. Don't allow for anything other than microphone inputs at stage/altar locations. Supplying line inputs at these locations is an invitation for misuse. Make all sources look like microphones to the console.
13. Balance (or at least impedance balance) all connections that are remote from the console's immediate location.
14. If you bridge an amplifier, don't use ¼" phone plugs for speaker connectors.

Grounding

Grounding exists in your audio system for two reasons: product safety and noise reduction. The third wire on the power cord exists for product safety. It provides a low-resistance path back to the electrical service to protect the users of the product from electrical shock. Hopefully, the resistance to ground through the safety ground (third wire) is lower than that through the user/operator to ground. If you remove this connection (by breaking or cutting the pin off, or by using a 'ground cheater'), this alternate ground path ceases to exist, which is a safety hazard.

The metal chassis of the product, the ground connections provided by the various connectors, and the shields within your connecting cables provide a low potential point for noise signals. The goal is to provide a lower impedance path to ground for noise signals than through the signal wiring. Doing so helps minimize hum, buzz, and other extraneous non-audio signals.

Many “authorities” tell you that shields should only be connected at one end. Sometimes this can be true, but for most (99%) audio systems, it is unnecessary. If you do everything else correctly, you should be able to connect every component of your audio system using standard, off-the-shelf connecting cables that are available at any music store.

Here are some guidelines:

- 1.** All return lines to the stage should be balanced. At a minimum, they should be impedance balanced. Remember that you can balance a line by inserting a piece of equipment in-line that has a balanced output.
- 2.** Run your own AC power wiring from the stage for the mixer and related equipment. Don't use the “conveniently located” receptacle thoughtfully provided by the management for your use. You have no idea how it's wired or grounded.
- 3.** Carry an outlet tester, available at any well-stocked hardware store. Use it to tell you if the outlet you're about to plug into is wired correctly. Consider it cheap insurance.
- 4.** If you carry enough equipment that you need to wire directly into the electrical service, then use a voltmeter to ensure that the line voltage is correct, then use the outlet tester mentioned in #3, above. Do this before you connect any of your audio equipment. Chances are that your 120V gear won't be too happy if it sees 220V for any length of time.
- 5.** Cables that are too long are less likely to pick up hum if you uncoil them in their entirety, and then find a place to stow the excess. Leaving the excess coiled only helps the cable pick up hum more efficiently.
- 6.** Don't run unbalanced lines to or from the stage. It's not the impedance, it's the fact that they're unbalanced. It's a good idea to use a direct box to make the unbalanced source look like a microphone.
- 7.** For really extreme cases, you may need to insert 1:1 or isolation transformers into each return line from the front-of-house location to your amp racks.
- 8.** Don't cut the third pin off of the power cord. Carry some ground-lifter adapters and use them only when you have to plug into an ancient two-wire outlet.
- 9.** If you bundle your cables together, don't bundle AC wiring and audio wiring together. Bundle them separately.
- 10.** If your sound system insists on humming, you may need to teach it the words.

FREE T-SHIRT OFFER

We love to hear what folks have created using our mixers. If you use your SR40•8 to track and/or mix a live or studio performance onto CD that is commercially released, we'll trade you a disc for a genuine Mackie T-Shirt! By "commercially released," we mean "offered for sale," even if it's just being sold out the back door of a local Karaoke joint. No hand-lettered covers, please and thank you. Furthermore, if you send us an interesting story or photograph about your production we might just include it in our monthly newsletter! To get your genuine 100% cotton Mackie Celebrity T-Shirt, send your CD (and optional story or photo) to:

Mackie Designs

FREE T-SHIRT OFFER

**attn: Communications Department
16220 Wood-Red Rd. NE
Woodinville , WA 98072**

(Roll credits please) Manual written by Jeff Gilbert, with tidbits borrowed from almost everywhere. Manual then defaced with proofreading pens in the hands of Mackie's legendary Tech Support staff and New Products Engineering staff, not to mention a nameless Marketing Weenie. Manual composed on a cocktail napkin, then converted to this amazing piece of work using a 13-story 1000 gigawhopper Macintosh operated by Mackie's notorious Advertising staff, most notably Sara Delahan. Huge chunks of technically baffling text contributed by Rick Chinn and Dave Franzwa. Please, feel free to let us know if you find an error or stumble over a confusing paragraph. Thank you for reading the entire manual (we know you have, or you wouldn't be here).

Mackie Designs is always striving to improve our mixers by incorporating new and improved materials, components and manufacturing methods. Because we're always trying to make things better, we reserve the right to change these specifications at any time, without notice.

Batteries not included.

Your mileage may vary.

Action figures sold separately.

Mackie, the Running Man figure, VLZ, and ULTRA MUTE are trademarks or registered trademarks of Mackie Designs Inc. All other brand names mentioned are trademarks or registered trademarks of their respective holders, and are hereby acknowledged.

© 1997 Mackie Designs Inc.

All rights reserved.

Printed in the U.S.A.

APPENDIX E: Track Sheets

SR56•8 Channels 41-56

41	42	43	44	45	46	47	48	49	50	51	52	53	54	55	56
+48 PH TRIM															
AUX 1															
AUX 2															
AUX 3															
AUX 4															
25 PRE															
AUX 5															
AUX 6															
AUX 7															
AUX 8															
PSE FOR POST EQ															
EQ															
HI MID															
FREQ															
LOW MID															
FREQ															
LOW SHH															
FREQ															
HFF															
EQ IN															
FREQ															
PAN															
MUTE															
SOLO															
ab 10 5 0 5 10															
U 1.2 3.4 5.6 7.8															
CENTER															
LR															
SOLO															

SR40-8/SR56-8 Channels 1-24 and A1-A4

The control panel features 28 vertical channel strips, each with the following controls from top to bottom:

- Channel 1-24:** +48 PH (phantom power), TRIM (gain), AUX (auxiliary input), PRE FDR POST EQ (pre/post EQ), EQ (3-band: HI, MID, LOW), HPF (high pass filter), PAN (panning), MUTE, SOLO, and a vertical fader with CENTER and LR (Left/Right) switch.
- Channel A1-A4:** TRIM (gain), AUX (auxiliary input), PRE FDR POST EQ (pre/post EQ), EQ (3-band: HI, MID, LOW), HPF (high pass filter), PAN (panning), MUTE, SOLO, and a vertical fader with CENTER and LR (Left/Right) switch.

Each channel strip also includes a 'PRE FDR POST EQ' switch and a 'LOW CUT 1800 Hz' indicator.

MACKIE SR40-8
40•8•2 AUDIO MIXING CONSOLE

SECTION 1: DIMMER, METERING, POWER SUPPLY STATUS

- DIMMER: LAMP, METER
- METERING: INPUT SECTION (PFL, AFL), OUTPUT SECTION (PFL, AFL)
- POWER SUPPLY STATUS: V+, V-, 12V, 48V

SECTION 2: AUX SEND MASTERS (Channels 1-8)

- FLIP, MUTE, SOLO

SECTION 3: AUX RETURNS (B1-B4) and TAPE RETURNS (TAPE A, TAPE B)

- LEVEL, MUTE, SOLO
- TAPE RETURNS: TAPE A, TAPE B, MONITOR, SOLO

SECTION 4: TRIM (Channels 25-40)

- TRIM 25-40

SECTION 5: COMMUNICATIONS

- RECEIVE, IGNORE, CALL, LEVEL

SECTION 6: OSCILLATOR

- PHANTOM POWERED

SECTION 7: TALKBACK MIC

- TALKBACK LEVEL

SECTION 8: MATRIX (A-D)

- MATRIX A, B, C, D

SECTION 9: EQ (Channels 25-40)

- EQ (1-2, 3-4, 5-6, 7-8)

SECTION 10: FADER LINK (L & R)

- FADER LINK

SECTION 11: INTERCOM

- INTERCOM

SECTION 12: PHONES

- PHONES

SECTION 13: CHANNEL 25-40 (Channels 25-40)

- AUX, TRIM, EQ, FREQ, LOW, HPF, EQ IN, HPF, PAN, MUTE

SECTION 14: MASTER SECTION (Channels 1-8)

- ASSIGN, AIR, 16kHz, CENTER, L/R, PAN, MUTE

SECTION 15: SOLO (Channels 1-8)

- SOLO

SECTION 16: ULTRA MUTE™

- MODE, SYSTEM BY PASS, MUTE PREVIEW, STORE, CLEAR, GO

SECTION 17: METERING (Channels 1-8)

- db, U, 10, 20, 30, 40, 50, 60, 70, 80, 90, 100

SECTION 18: CENTER and L & R MASTER

- CENTER, L & R MASTER

Addendum/Errata

For the **SR40•8/SR56•8 Owner's Manual**:

Okay kidz! It's time to sharpen up your number 2 pencil and make a few changes in your manual.

1. On page 19:

In the section **Intercom**, the Pin outputs should read:

Pin 1 = ground/0V, Pin 2 = 28–30VDC, Pin 3 = audio + DC signalling.

2. On page 44:

In the section **Globally clearing all Mute Groups from memory**, the last sentence in the first paragraph should read:

“See ‘Using the MIDI Ports’ on [page 50](#) or ‘Using the DATA Port’ on [page 52](#).”

3. On page 45:

In the section **Previewing Mute Groups**, no mention is made of the fact that you can change a Mute Group in Preview mode and save it to memory. The last paragraph in step 3 should read:

“You can manually add a channel to the Preview by pressing its **MUTE** button. Its **MUTE LED** lights, but it's not actually muted yet. You can even save it to the Mute Group by pressing **STORE** and then pressing the number of the Mute Group you're previewing.”

4. On page 47:

In the section **Previewing Snapshots**, no mention is made of the fact that you can change a Snapshot in Preview mode and save it to memory. The last paragraph in step 3 should read:

“You can manually add a channel to the Preview by pressing its **MUTE** button. Its **MUTE LED** lights steadily, though it's not actually muted yet. You can even save it to the Snapshot by pressing **STORE** twice.”

Step 4 should read:

“Once you've decided on a Snapshot or modified Snapshot configuration, press **DO IT** **160** and the new Snapshot, plus any manually muted channels will engage. (Note that any channel mutes manually added to the Snapshot will mute, but their LEDs will not be lit.)”

Add the following to the end of Step 5:

“...Otherwise, press **MUTE PREVIEW** **157** again to exit Preview mode. Press **CLEAR** and the Snapshot number will stop blinking. (The decimal point LED will blink if you have manually added any mutes to the Snapshot.)”

The note following step 6 should read:

“The Numeric Display **153** continues to blink and indicates the last number selected while in Preview mode. If you want the display to return to the Snapshot number currently engaged, press the **CLEAR** button.”

5. On page 50:

In the section **Using the MIDI Ports**, the last sentence in the first paragraph should read:

“The standard MIDI implementation table is located on [page 53](#).”

In the section **System Exclusive Messages (Sysex)**, the note (second paragraph) should read:

“Sysex messages do not change the current state of the console, but only transfer data to and from **ULTRA MUTE's** memory. When a Sysex Request is made, two horizontal bars appear in the Numeric Display while data is being transferred (usually only noticeable during longer data transfers). While the console is receiving a Sysex dump, the Numeric Display flickers. Once the transfer is complete, use MIDI Note Messages or Program Change Messages to implement new Groups or Snapshots.”

6. On page 51:

In the **MIDI SYSEX MESSAGE NUMBERS** chart, message 44h is ignored by the console. System status is a “request-only” message (04h), and cannot be written to the console with a sysex message.

The DATA Structure for Sysex dumps is as follows (this replaces the DATA Structure chart shown on page 51):

³ DATA Structure: SR40•8 = 18 bytes, nibblized low-high.

0 = Mute OFF; 1 = Mute ON.

{[0000 N1] [0000 N2] [0000 N3] ... [0000 N18]}

N1 = Channels 1-4	[4 3 2 1]
N2 = Channels 5-8	[8 7 6 5]
N3 = Channels 9-12	[12 11 10 9]
N4 = Channels 13-16	[16 15 14 13]
N5 = Channels 17-20	[20 19 18 17]
N6 = Channels 21-24	[24 23 22 21]
N7 = AUX RETURN A1-A4	[A4 A3 A2 A1]
N8 = Not Used	[— — — —]
N9 = Channels 25-28	[28 27 26 25]
N10 = Channels 29-32	[32 31 30 29]
N11 = Channels 33-36	[36 35 34 33]
N12 = Channels 37-40	[40 39 38 37]
N13 = AUX SEND 1-4	[4 3 2 1]
N14 = AUX SEND 5-8	[8 7 6 5]
N15 = SUB 1-4	[4 3 2 1]
N16 = SUB 5-8	[8 7 6 5]
N17 = MATRIX A-D	[D C B A]
N18 = Not Used	[— — — —]

³ DATA Structure: SR56•8 = 22 bytes, nibblized low-high.

0 = Mute OFF; 1 = Mute ON.

{[0000 N1] [0000 N2] [0000 N3] ... [0000 N22]}

N1 = Channels 1-4	[4 3 2 1]
N2 = Channels 5-8	[8 7 6 5]
N3 = Channels 9-12	[12 11 10 9]
N4 = Channels 13-16	[16 15 14 13]
N5 = Channels 17-20	[20 19 18 17]
N6 = Channels 21-24	[24 23 22 21]
N7 = Channels 25-28	[28 27 26 25]
N8 = Channels 29-32	[32 31 30 29]
N9 = Channels 33-36	[36 35 34 33]
N10 = Channels 37-40	[40 39 38 37]
N11 = AUX RETURN A1-A4	[A4 A3 A2 A1]
N12 = Not Used	[— — — —]
N13 = Channels 41-44	[44 43 42 41]
N14 = Channels 45-48	[48 47 46 45]
N15 = Channels 49-52	[52 51 50 49]
N16 = Channels 53-56	[56 55 54 53]
N17 = AUX SEND 1-4	[4 3 2 1]
N18 = AUX SEND 5-8	[8 7 6 5]
N19 = SUB 1-4	[4 3 2 1]
N20 = SUB 5-8	[8 7 6 5]
N21 = MATRIX A-D	[D C B A]
N22 = Not Used	[— — — —]

7. On page 53:

In the **MIDI IMPLEMENTATION CHART**, the remark for the Note Number function should read: “See [Table 163 on page 54](#).”

The remark for the Velocity function should read: “See [Table 163 on page 54](#).”

The remark for the System Exclusive function should read: “See [MIDI Sysex Detail on pages 50-51](#).”



8. Regarding altered states (of ULTRA MUTE):

ULTRA MUTE has a built-in method of letting you know when a mute configuration has been altered, either deliberately or accidentally, from its nominal state.

In Preview Mode: When you enter preview mode, then select a different group or snapshot to preview, the LED above the **PREVIEW** button begins to blink, indicating that the mute LEDs on the console represent a different state than what is actually implemented.

In Snapshot Mode: When you recall a snapshot, the decimal point LED in the numeric display lights steadily. If you manually add or subtract a mute from the snapshot, the LED begins to blink, indicating that the snapshot has been altered from its original state. Return the mutes to the snapshot's original state and the LED lights steadily again. You can do this by pressing the **DO IT** button.

In Group Mode: When you recall a group, the decimal point LED in the numeric display lights steadily. If you manually add or subtract a mute from a group, the LED begins to blink, indicating that the group has been altered from its original state. Return the mutes to the group's original state and the LED lights steadily again.

Whenever you turn off the mute groups, ULTRA MUTE views whatever mute configuration that exists on the console as the new nominal state. The decimal point LED lights steadily, indicating a nominal starting point.

Think of mute groups as “layers” of mutes which you can add to or subtract from any existing mute configuration on the board. For example, let's say that you want to have all the channels on the right side of the board muted during a couple of songs while using mute groups.

- You program Snapshot 10 to mute the right side of the board (channels 25-40 on the SR40•8).
- Now you change to Group Mode and recall Group 1 (in Set 1). Group 1 mutes channels 1-8.
- The mutes programmed into Group 1 are layered on top of the channels already muted by Snapshot 10.
- ULTRA MUTE now looks at the muted right side of the board as the nominal state of the console.
- If you accidentally unmute channel 25 on the right side of the board, the decimal point LED in the numeric display begins blinking, even though it's not a part of Group 1.
- If you turn off Group 1, the LED stops blinking, even though channel 25 is still unmuted. When you turn off all the Groups, ULTRA MUTE views the current state of the console as the new nominal state. It's a “soft store,” a temporary nominal mute configuration that you can retain until either a snapshot is recalled or the board is cleared of all mutes.
- Remember, you can turn off all the mutes (“clean the slate”) at any time by pressing the **CLEAR** button for two seconds.



MACKIE®

MACKIE®

Mackie Designs Inc. • 16220 Wood-Red Road N.E.
Woodinville • WA • 98072 • 800/258-6883
Outside the U.S. call 425/487-4333 • FAX 425/487-4337
www.mackie.com

© 2001 Mackie Designs Inc. All rights reserved.
Printed in the USA.
Part No. 820-052-10 Rev. B 1/2001 