

Service Manual

74 CD57/01B/02B/05B
74 CD67/01B/02B/05B/01G/02G
/11B/12B/15B/12G
CD-67/67SE UBL, FB, FN
Compact disc player

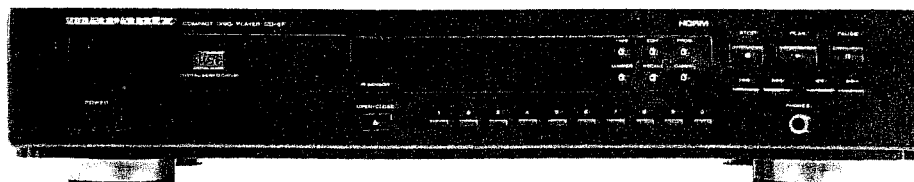

TABLE OF CONTENTS

SECTION	PAGE
1. TECHNICAL SPECIFICATIONS	1
2. SERVICE MODE	2
3. MICROPROCESSOR AND IC DATA	3
4. BLOCK DIAGRAM	6
5. SCHEMATIC DIAGRAMS AND PARTS LOCATIONS (PATTERN SIDE)	7
6. EXPLODED VIEW AND PARTS LIST	17
7. ELECTRICAL PARTS LIST	20

Please use this service manual with referring to the guide (D.F.U.) without fail.
修理の際は、必ず取扱説明書を準備し操作方法を確認の上作業を行ってください。

marantz®

model CD-57 CD-67 CD-67SE

First issue : 1996/10
4822 725 51124
186W855090

MARANTZ DESIGN AND SERVICE

Using superior design and selected high grade components, **MARANTZ** company has created the ultimate in stereo sound. Only original **MARANTZ** parts can insure that your **MARANTZ** product will continue to perform to the specifications for which it is famous.

Parts for your **MARANTZ** equipment are generally available to our National Marantz Subsidiary or Agent.

ORDERING PARTS :

Parts can be ordered either by mail or by Fax. In both cases, the correct part number has to be specified.

The following information must be supplied to eliminate delays in processing your order :

1. Complete address
2. Complete part numbers and quantities required
3. Description of parts
4. Model number for which part is required
5. Way of shipment
6. Signature : any order form or Fax. must be signed, otherwise such part order will be considered as null and void.

<p>USA MARANTZ AMERICA, INC. 440 MEDINAH ROAD ROSELLE, ILLINOIS 60172- 2330 USA PHONE : 708 - 307 - 3100 FAX : 708 - 307 - 2687</p>	<p>CANADA LENBROOK INDUSTRIES LIMITED 633 GRANITE COURT, PICKERING, ONTARIO L1W 3K1 CANADA PHONE : 416-831-6333 FAX : 416-831-6936</p>	<p>EUROPE MARANTZ EUROPE B.V. P.O.BOX 80002 BUILDING SFF2 5600 JB EINDHOVEN THE NETHERLANDS PHONE : +31 - 40 - 2732241 FAX : +31 - 40 - 2735578</p>
<p>PROFESSIONAL USA SUPERSCOPE TECHNOLOGIES, INC. MARANTZ PROFESSIONAL PRODUCTS 1000 CORPORATE BLVD., SUITE D AURORA, ILLINOIS 60504 USA PHONE : 708 - 820 - 4800 FAX : 708 - 820 - 8103</p>	<p>PROFESSIONAL CANADA TC ELECTRONICS CANADA LTD 540 FIRING AVE. BAIE D'URFÉ, QUEBEC H9X 3T2 CANADA PHONE : 514 - 457 - 4044 FAX : 514 - 457 - 5524</p>	<p>TRADING MARANTZ EUROPE B,V, P.O.BOX 80002 BUILDING SFF2 5600 JB EINDHOVEN THE NETHERLANDS PHONE : +31 - 40 - 2732241 FAX : +31 - 40 - 2735578</p>
<p>AUSTRALIA MARANTZ AUSTRALIA 3 Figtree Drive Australia Centre Homebush, NSW2140 AUSTRALIA PHONE : +61 2 742 8311 FAX : +61 2 764 3074</p>	<p>BRAZIL MARANTZ BRAZIL Caixa Postal 21462 CEP 04698-970 Sao Paulo, SP, BRAZIL PHONE : 0800 - 123123 (Discagem Direta Gratuita) FAX : +55 11 534. 8988</p>	<p>HONG KONG FORWARD INTERNATIONAL CORP.LTD. 15 TH FLOOR, REGENT CENTRE, 88 QUEEN'S ROAD, CENTRAL, H. K. PHONE : +852 521 - 0883 FAX : +852 521 - 7835</p>
<p>TAIWAN PAL-YUING CO., LTD. 6 TH FL NO, 148 SUNG KIANG ROAD, TAIPEI, 10429, TAIWAN R.O.C. PHONE : +886 (2) 5221304 - 8 FAX : +886 (2) 5630415</p>	<p>THAILAND MRZ STANDARD CO., LTD. 746 - 750 WANGBURAPA BANGKOK 10200 THAILAND PHONE : +66 2222 9181 FAX : +66 2225 8871</p>	<p>MALAYSIA WO KEE HONG ELECTRONICS SDN. BHD. NO. 102 JALAN SS 21/35, DAMANSARA UTAMA, 47400 PETALING JAYA SELANGOR DARUL EHSAN, MALAYSIA PHONE : +60 3 - 7184666 FAX : +60 3 - 7173828</p>
<p>JAPAN Technical MARANTZ JAPAN INC. 35-1, 7- chome, Sagamiono Sagamihara - shi, Kanagawa Japan PHONE : +81 427 44 7950 FAX : +81 427 48 0889</p>	<p style="text-align: center;">日本マランツ株式会社</p> <p>本社 〒228 神奈川県相模原市相模大野 7-35-1 営業本部 〒150 東京都渋谷区恵比寿南 1-11-9</p>	<p>SINGAPORE FORWARD MARKETING (SINGAPORE) PTE. LTD. 29, LENG KEE ROAD SINGAPORE 159099, PHONE : +65 475 - 4555 FAX : +65 475 - 8623</p>

SHOCK, FIRE HAZARD SERVICE TEST :

CAUTION : After servicing this appliance and prior to returning to customer, measure the resistance between either primary AC cord connector pins (with unit NOT connected to AC mains and its Power switch ON), and the face or Front Panel of product and controls and chassis bottom.

Any resistance measurement less than 1 Megohms should cause unit to be repaired or corrected before AC power is applied, and verified before it is return to the user/customer.

Ref. UL Standard NO.1492.

In case of difficulties, do not hesitate to contact the Technical Department at above mentioned address.

1. TECHNICAL SPECIFICATIONS

	CD-57	CD-67	CD-67SE
Audio Characteristics			
Channels		2 channels	
Sampling frequency		44.1 kHz	
Quantization		16-bit linear/channel	
Error correction		Cross-interleave read solomon code	
D/A conversion		1-bit linear/channel	
Wow & flutter		Precision of quartz	
Optical Readout System			
Laser		GaAIAs semiconductor	
Wavelength		780 nm	
Frequency Characteristics			
Frequency range	5 Hz – 20 kHz	5 Hz – 20 kHz	5 Hz – 20 kHz
Dynamic range	> 96 dB	> 96 dB	> 96 dB
S/N ratio	> 102 dB	> 104 dB	> 104 dB
Channel separation (1 kHz)	> 100 dB	> 102 dB	> 102 dB
THD (1 kHz)	0.0025 %	0.0025 %	0.0025 %
Analog output jack			
Output level	2V RMS	2V RMS	2V RMS
Output impedance	200 ohms	200 ohms	200 ohms
Digital output			
Pin jack	0.5 Vp-p/75 ohms	0.5 Vp-p/75 ohms	0.5 Vp-p/75 ohms
Optical output	—	-19 dBm	-19 dBm
Power Supply			
/01, /11 version		115/230V AC 50/60 Hz	
/02, /05, /12, /15 version		230V AC 50 Hz	
Power consumption	11 W	12 W	12 W
Cabinet, etc.			
Dimensions			
Width	439 mm	439 mm	439 mm
Height	86 mm	86 mm	88 mm
Depth	310 mm	310 mm	310 mm
Net weight	4.3 kg	4.3 kg	5.8 kg
Operating temperatures		+5 °C ~ +35 °C	
Operating humidity		5 % ~ 90 % (without dew)	
Accessories			
Remote control unit (RC-63CD)	1	1	1
AA (R6) batteries	2	2	2
Stereo audio cable with RCA pins	1	1	1

Specifications subject to change without prior notice.



**CAUTION
VARO!
WARNING
ADVERSEL
DANGER
VORSICHT**

INVISIBLE LASER RADIATION WHEN OPEN. AVOID EXPOSURE TO BEAM.
AVATTAESSA OLET ALTTIINA NÄKYMÄTTÖMÄLLE LASER SÄTTEILYLLE ÄLÄ KATSO SÄTEESSEN.
OSYNLIG LASERSTRÅLNING NÄR DENNA DEL ÄR ÖPPNAD BETRAKTA EJ STRÅLEN.
USYNLIG LASERSTRÅLNING VED ÅBNING. UNDGÅ UNSÄTTELSE FOR STRÅLING.
INVISIBLE LASER RADIATION WHEN OPEN. AVOID DIRECT EXPOSURE TO BEAM.
UNSICHTBARE LASERSTRAHLUNG WENN ABDECKUNG GEÖFFNET. NICHT DEM STRAHL AUSSETZEN.

**CLASS 1 LASER PRODUCT
KLASSE 1 LASER PRODUKT
I.H.T. IEC 825**

2. サービスモード

1. サービスモードへの入り方
 - [STOP]、[PLAY]、[NEXT]、[PREV] keyのうち2つ以上を押して電源を入れる。
2. モード0 (表示 P 0 0)

状態: [FOCUS OFF] [SPINDLE OFF] [RADIAL OFF] [MUTE ON]

 - [CUE] keyを押すとスレッドが外周へ移動します。
 - [REVIEW] keyを押すとスレッドが内周へ移動します。
 - [NEXT] keyを押すとモード1へ移行します。
3. モード1 (表示 P 0 1)

状態: [FOCUS ON] [SPINDLE OFF] [RADIAL OFF] [MUTE ON]

 - [NEXT] keyを押すとモード2へ移行します。
 - [PREV] keyを押すとモード0へ移行します。
4. モード2 (表示 P 0 2)

状態: [FOCUS ON] [SPINDLE ON] [RADIAL OFF] [MUTE ON]

 - [NEXT] keyを押すとモード3へ移行します。
 - [PREV] keyを押すとモード0へ移行します。
5. モード3 (表示 P 0 3)

状態: [FOCUS ON] [SPINDLE ON] [RADIAL ON] [MUTE OFF]

 - [PREV] keyを押すとモード2へ移行します。

* サービスモードの全ての状態で以下のキーが有効です。

 - 1) [STOP] keyを押すとFLが全点灯します。
 - 2) [PAUSE] keyを押すとモデル番号とバージョンを表示します。

Cd 67 : 10
|
プロセッサバージョン番号

- 3) [PLAY] keyを押すと通常 (サービスモード以外) と同じ動作となります。
ただし、異常が確認された時にエラー番号が表示されます。(例: Err 10)
右の表を参考にしてください。

6. サービスモードの解除
 - 電源を切るとサービスモードが解除されます。

2. SERVICE MODE

1. How to enter into the Service Mode
 - Turn the power on while pressing at least 2 of [STOP], [PLAY], [NEXT], [PREV] keys.
2. Mode 0 (Display P00)

Condition: [FOCUS OFF] [SPINDLE OFF] [RADIAL OFF] [MUTE ON]

 - The Sled moves outside when pressing [CUE] key.
 - The Sled moves inside when pressing [REVIEW] key.
 - The function moves to Mode 1 when pressing [NEXT] key.
3. Mode 1 (Display P01)

Condition: [FOCUS ON] [SPINDLE OFF] [RADIAL OFF] [MUTE ON]

 - The function moves to Mode 2 when pressing [NEXT] key.
 - The function moves to Mode 0 when pressing [PREV] key.
4. Mode 2 (Display P02)

Condition: [FOCUS ON] [SPINDLE ON] [RADIAL OFF] [MUTE ON]

 - The function moves to Mode 3 when pressing [NEXT] key.
 - The function moves to Mode 0 when pressing [PREV] key.
5. Mode 3 (Display P03)

Condition: [FOCUS ON] [SPINDLE ON] [RADIAL ON] [MUTE OFF]

 - The function moves to Mode 2 when pressing [PREV] key.

* The following key operation can be available at all of the conditions of the service mode.

 - 1) All of FL display light by pressing [STOP] key.
 - 2) Model Number and Version Nbr of the μ -processor are displayed by pressing [PAUSE] key.

Cd 67 : 10
|
 μ -Processor Version Nbr.

- 3) The same as Normal operation (except Service mode) is performed by pressing [PLAY] key.
However if some default is detected, an error code is displayed. (For example: Err 10)
The content for each error code is shown below.

Error Code	Error
Err 02	FOCUS Error
Err 07	SUB CODE Error
Err 08	T. O. C Error
Err 09	DECODER Error
Err 10	RADIAL Error
Err 11, 12	SLED Error
Err 13	SPINDLE Error
Err 16 ~ 20	SEARCH Error
Err 30	DOOR Error
Err 31	TRAY Error
Err 32 ~ 47	KEY INPUT Error

6. Cancelling the Service Mode
 - The Service Mode is cancelled by turning the power off.

3. MICROPROCESSOR AND IC DATA

MN187164 (MICROPROCESSOR)

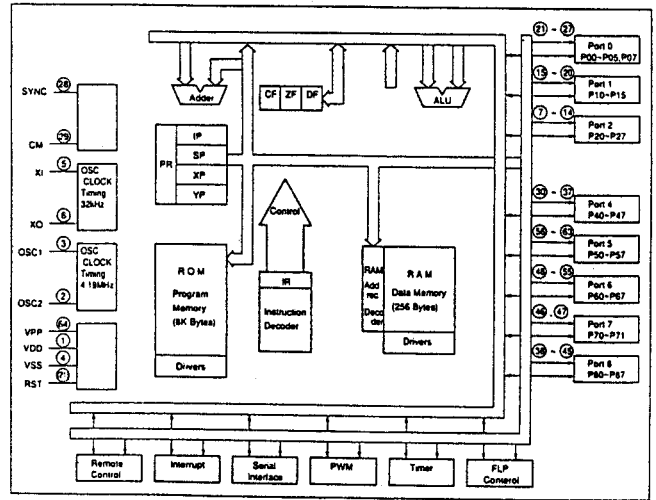
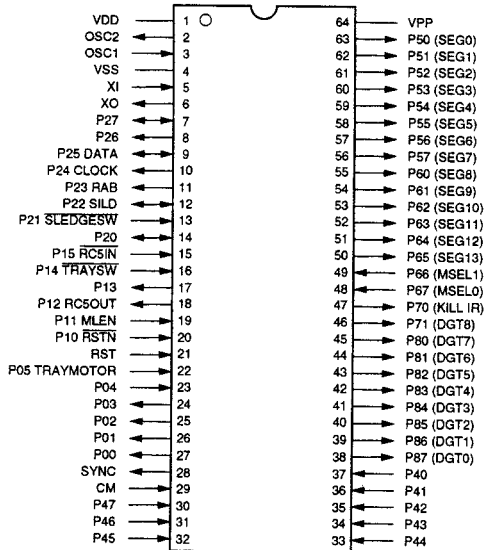

Pin Nbr	Pin Name	I/O	Function	Pin Nbr	Pin Name	I/O	Function
1	Vdd	-	Power Supply +5V	33	P44	I	Key Input, KEY 5
2	OSC2	O	Clock out (8.0MHz)	34	P43	I	Key Input, KEY 4
3	OSC1	I	Clock in (8.0MHz)	35	P42	I	Key Input, KEY 3
4	Vss	-	GND 0V	36	P41	I	Key Input, KEY 2
5	XI	I	0V	37	P40	I	Key Input, KEY 1
6	XO	O	Not Used	38	P87 (DGT0)	O	FL Digit Data, G9
7	P27	O	SAA7372 RESET	39	P86 (DGT1)	O	FL Digit Data, G8
8	P26	O	Not Used	40	P85 (DGT2)	O	FL Digit Data, G7
9	P25 DATA	I/O	Data Bus Data, SIDA	41	P84 (DGT3)	O	FL Digit Data, G6
10	P24 CLOCK	O	Data Bus Clock, SICK	42	P83 (DGT4)	O	FL Digit Data, G5
11	P23 RAB	O	SAA7372 RAB	43	P82 (DGT5)	O	FL Digit Data, G4
12	P22 SILD	I/O	SAA7372 SILD (latch)	44	P81 (DGT6)	O	FL Digit Data, G3
13	P21 SLEDGESW	I	Sledge SW, SLSW	45	P80 (DGT7)	O	FL Digit Data, G2
14	P20	O	Not Used	46	P71 (DGT8)	O	FL Digit Data, G1
15	P15 RC5IN	I	RC-5 code Input	47	P70 KILL IR	O	Kill IR, N.C.
16	P14 TRAYSW	I	Tray In/Out SW, TRSW	48	P67 MSEL0	I	Model Select SW 0
17	P13	O	Not Used	49	P66 MSEL1	I	Model Select SW 1
18	P12 RC5OUT	O	RC-5 code Output	50	P65 (SEG13)	O	FL Segment Data, P1
19	P11 MLEN	O	SM5872 MLEN (latch)	51	P64 (SEG12)	O	FL Segment Data, P2
20	P10 RSTN	O	SM5872 RSTN (reset)	52	P63 (SEG11)	O	FL Segment Data, P3
21	RST	I	RESET	53	P62 (SEG10)	O	FL Segment Data, P4
22	P05 TRAYMOTOR	O	Tray Motor	54	P61 (SEG9)	O	FL Segment Data, P5
23	P04	O	Not Used	55	P60 (SEG8)	O	FL Segment Data, P6
24	P03	O	Not Used	56	P57 (SEG7)	O	FL Segment Data, P7
25	P02	O	Not Used	57	P56 (SEG6)	O	FL Segment Data, P8
26	P01	I	Not Used	58	P55 (SEG5)	O	FL Segment Data, P9
27	P00	I	Not Used	59	P54 (SEG4)	O	FL Segment Data, P10
28	SYNC	O	Not Used	60	P53 (SEG3)	O	FL Segment Data, P11
29	CM	I	0V	61	P52 (SEG2)	O	FL Segment Data, P12
30	P47	I	Key Input, KEY 8	62	P51 (SEG1)	O	FL Segment Data, P13
31	P46	I	Key Input, KEY 7	63	P50 (SEG0)	O	FL Segment Data, P14
32	P45	I	Key Input, KEY 6	64	Vpp	-	Power Supply -25V

SAA7372GP (DIGITAL DECODING IC WITH RAM)

SYMBOL	PIN	DESCRIPTION
V _{SSA1}	1	analogue supply*
V _{DDA1}	2	analogue supply*
D1	3	unipolar current input (central diode signal input)
D2	4	unipolar current input (central diode signal input)
D3	5	unipolar current input (central diode signal input)
V _{RL}	6	reference input for ADC
D4	7	unipolar current input (central diode signal input)
R1	8	unipolar current input (satellite diode signal input)
R2	9	unipolar current input (satellite diode signal input)
IREFT	10	current reference for calibration ADC
V _{RH}	11	reference output from ADC
V _{SSA2}	12	analogue supply*
SELPLL	13	selects whether internal clock multiplier PLL is used
ISLJCE	14	current feedback from data slicer
HFIN	15	comparator signal input
V _{SSA3}	16	analogue supply*
HFREF	17	comparator common mode input
IREF	18	reference current pin (nominally V _{DD} /2)
V _{DDA2}	19	analogue supply*
TEST1	20	test control input; this pin should be tied LOW
CRIN	21	crystal/resonator input
CROUT	22	crystal/resonator output
TEST2	23	test control input; this pin should be tied LOW
CL16	24	16.9344 MHz system clock output
CL11	25	11.2896 MHz clock output
RA	26	radial actuator output
FO	27	focus actuator output
SL	28	sledge control output
TEST3	29	test control input; this pin should be tied LOW
V _{DD1P}	30	digital supply periphery*
DOBM	31	bi-phase mark output (externally buffered) (tri-state)
V _{SS1}	32	digital supply*
MOTO1	33	motor out 1 - versatile (tri-state)
MOTO2	34	motor out 2 - versatile (tri-state)
SBSY	35	subcode byte sync (tri-state)
SFSY	36	subcode frame sync (tri-state)
RCK	37	subcode clock input
SUB	38	P to W subcode bits (tri-state)
V _{SS2}	39	digital supply
V5	40	versatile output pin
V4	41	versatile output pin
V3	42	versatile output pin (open drain)
KILL	43	kill output - programmable (open drain)
MISC	44	general purpose DAC output (tri-state)
DATA	45	serial data output (tri-state)
WCLK	46	word clock output (tri-state)
V _{DD2P}	47	digital supply periphery*
SCLK	48	serial bit clock output (tri-state)
V _{SS3}	49	digital supply*
CL4	50	4.2336 MHz μ P clock output
SDA	51	μ P interface data I/O line (open drain output)
SCL	52	μ P interface clock line
RAB	53	μ P interface R/W and load control line (decoder part)
SILD	54	μ P interface R/W and load control line (servo part)
N/C	55	No connection
V _{SS4}	56	digital supply*
RESET	57	power-on reset input (active low)
STATUS	58	request line/status register output (open drain)
V _{DD3C}	59	digital supply core*
C2FAIL	60	indication of correction failure (open drain)
CFLG	61	correction flag output (open drain)
V1	62	versatile input pin
V2	63	versatile input pin
LDON	64	laser drive on output (open drain)

* Note: All supply pins must be connected to the same external power supply voltage.

SM5872BS (DIGITAL FILTER AND D/A CONVERTER)

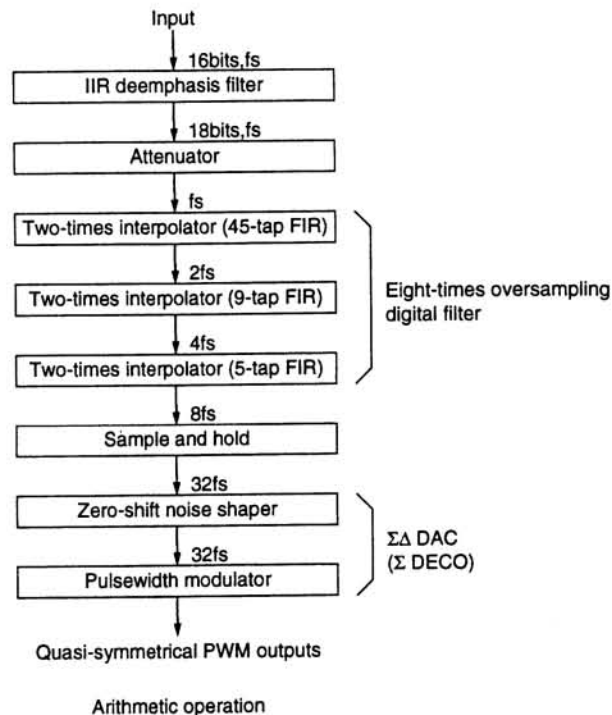
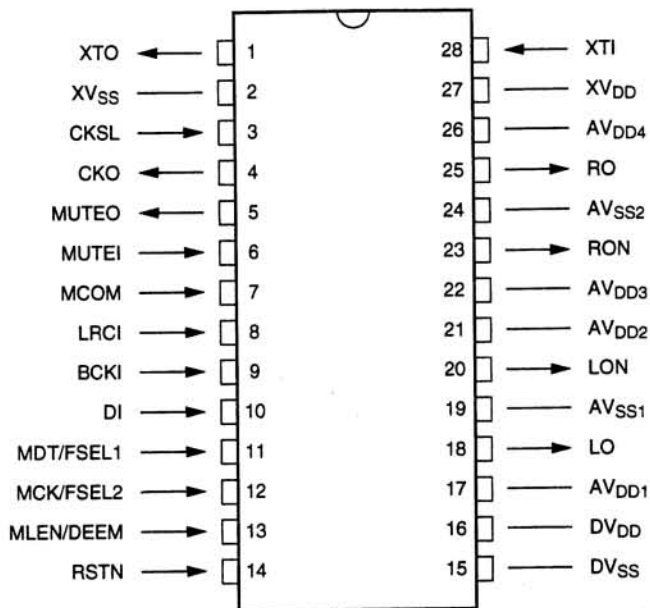

Pin Nbr	Pin Name	I/O	Function
1	XTO	O	Crystal oscillator output
2	XV _{SS}	-	GND (X'TAL)
3	CKSL	I	This pin should be tied HIGH for normal operation. Internal pull-up resistor
4	CKO	O	Clock output (384fs)
5	MUTE0	O	Mute detect output
6	MUTEI	I	Mute input. Internal pull-resistor
7	MCOM	I	Interface mode select input. Internal pull-up resistor : H = Interface mode L = Local
8	LRCI	I	Data sample rate clock input. Internal pull-up resistor : H = L ch L = R ch
9	BCKI	I	Bit clock input. Internal pull-up resistor
10	DI	I	Serial data input. Internal pull-up resistor
11	MDT/FSEL1	I	Microprocessor interface data input (and local mode frequency select input). Internal pull-up resistor
12	MCK/FSEL2	I	Microprocessor interface clock input (and local mode frequency select input). Internal pull-up resistor
13	MLEN/DEEM	I	Microprocessor interface latch enable input (and local mode deemphasis control input). Internal pull-up resistor
14	RSTN	I	Reset input. Internal pull-up resistor
15	DV _{SS}	-	GND (Digital)
16	DV _{DD}	-	Power supply (Digital)
17	AV _{DD1}	-	Power supply 1 (Analogue)
18	LO	O	Left-channel positive PWM output
19	AV _{SS1}	-	GND 1 (Analogue)
20	LON	O	Left-channel negative PWM output
21	AV _{DD2}	-	Power supply 2 (Analogue)
22	AV _{DD3}	-	Power supply 3 (Analogue)
23	RON	O	Right-channel negative PWM output
24	AV _{SS2}	-	GND 2 (Analogue)
25	RO	O	Right-channel positive PWM output
26	AV _{DD4}	-	Power supply 4 (Analogue)
27	XV _{DD}	-	Power supply (X'TAL)
28	XTI	I	Crystal oscillator or external clock input, 384fs (16.9344 MHz)

4. BLOCK DIAGRAM

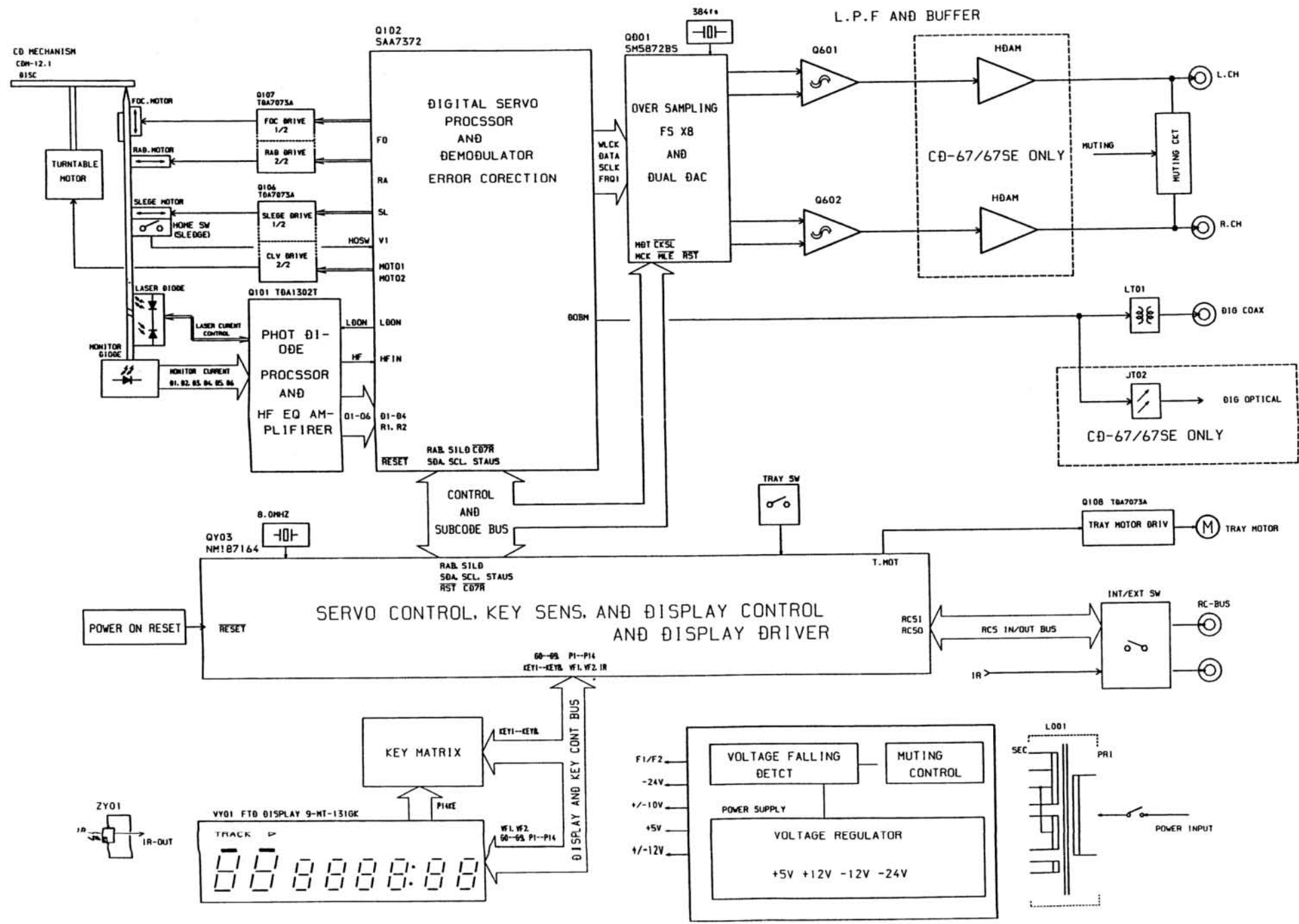

101

5. SCHEMATIC DIAGRAMS AND PARTS LOCATIONS (PATTERN SIDE)

Q10,QH04,QH06,QH52,QN06,QH54,QH08,QH14,QH12,QN08 QN05,QH11,QH13,QH09,QH05,QN07,QH03,QH51,QH53,QH07
 Q606 QD01 Q605 Q811 QN01,QN03,QN04 Q871,Q106 Q854,Q853 Q851,Q108,Q107 Q852
 QN92,QN91 QN25,QN24,QN20,QF02,QF52,QF51,QF61 QF01 Q102

P116 MAIN PCB

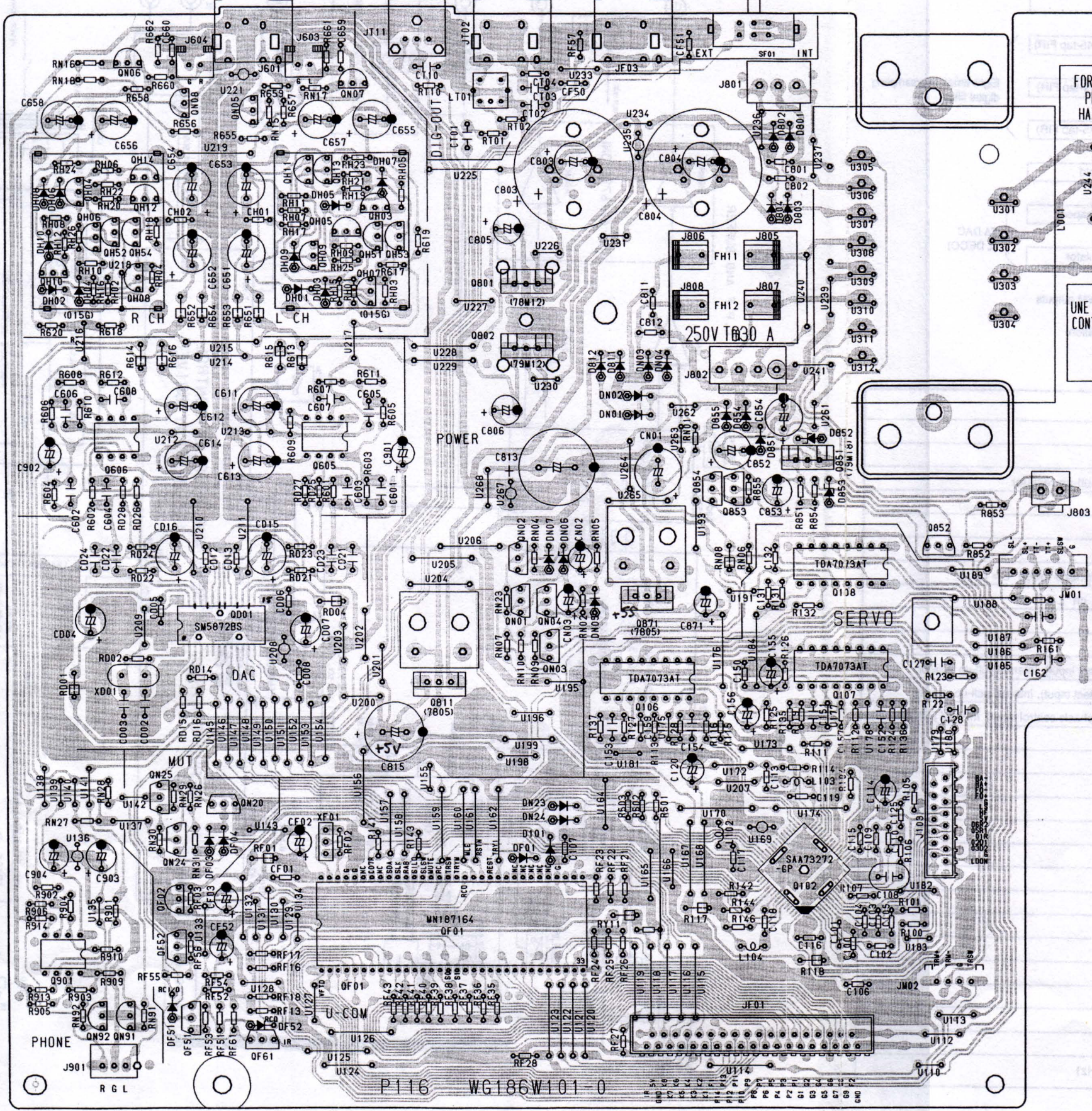

FOR CONTINUED CAUTION:
 PROTECTION AGAINST FIRE
 HAZARD. REPLACE ONLY WITH
 SAME TYPE FUSE.

ATTENTION:
 UNE PROTECTION AFIN D'ASSURER
 CONTRE LES RISQUES PERMANENTE
 D'INCENDIE. REMPLACER
 FUSIBLE UNIQUEMENT PAR UN
 DE MEME TYPE FUSE.

P126 SERVO PCB

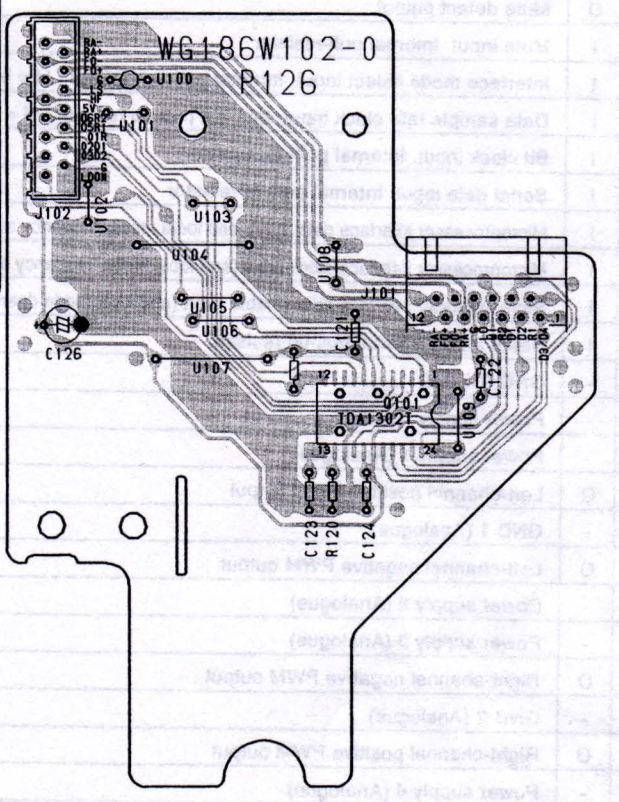

PP16 (1/2) - POWER AUDIO/DIGITAL PCB

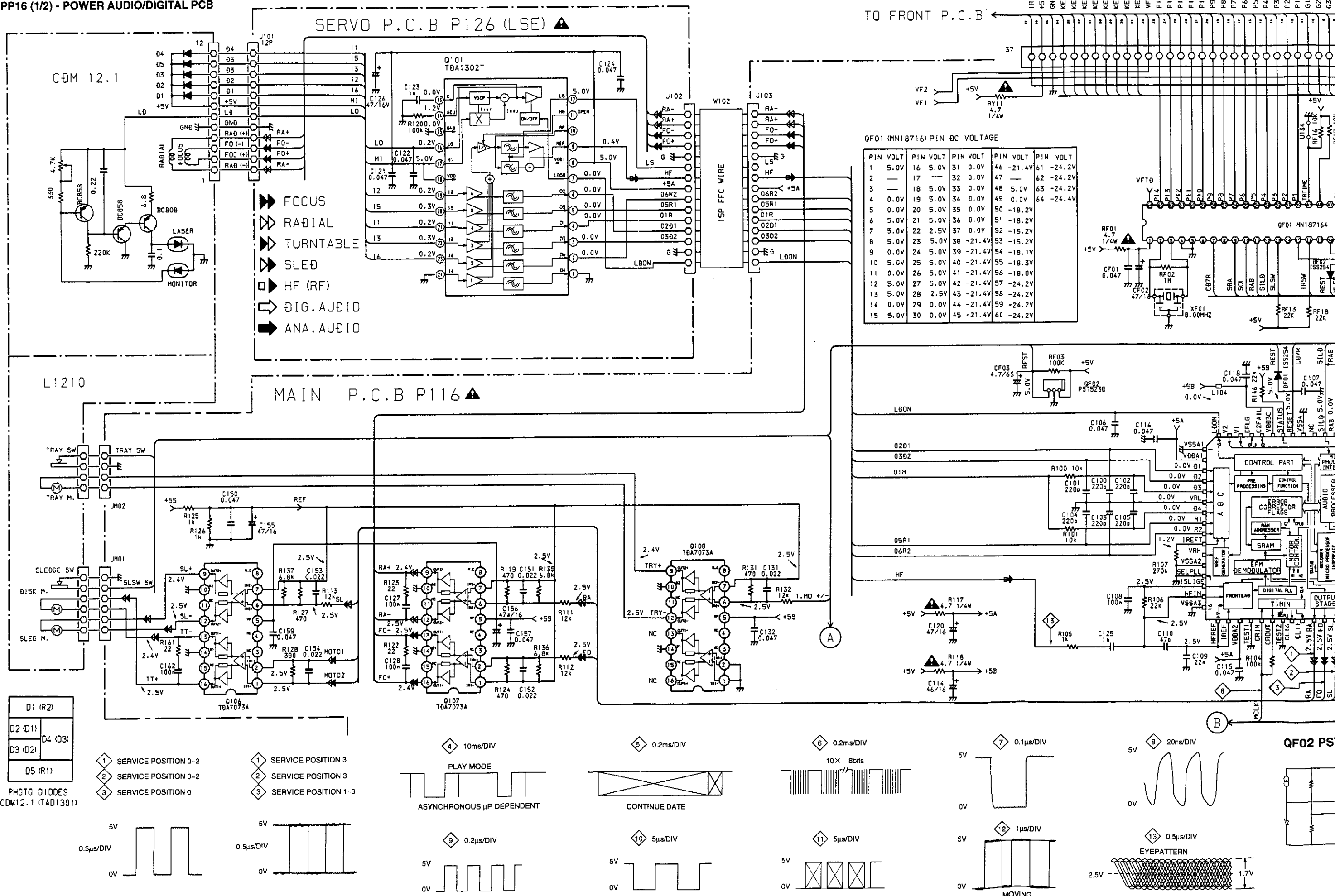

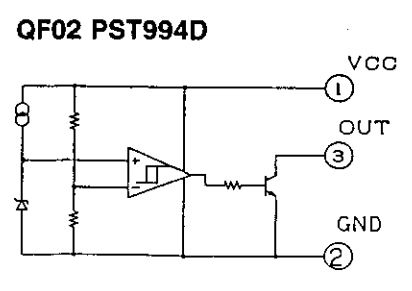
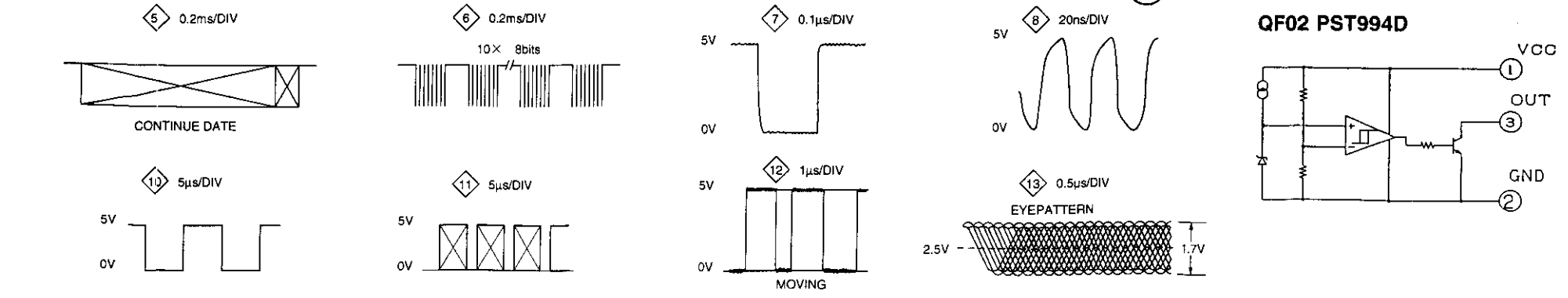
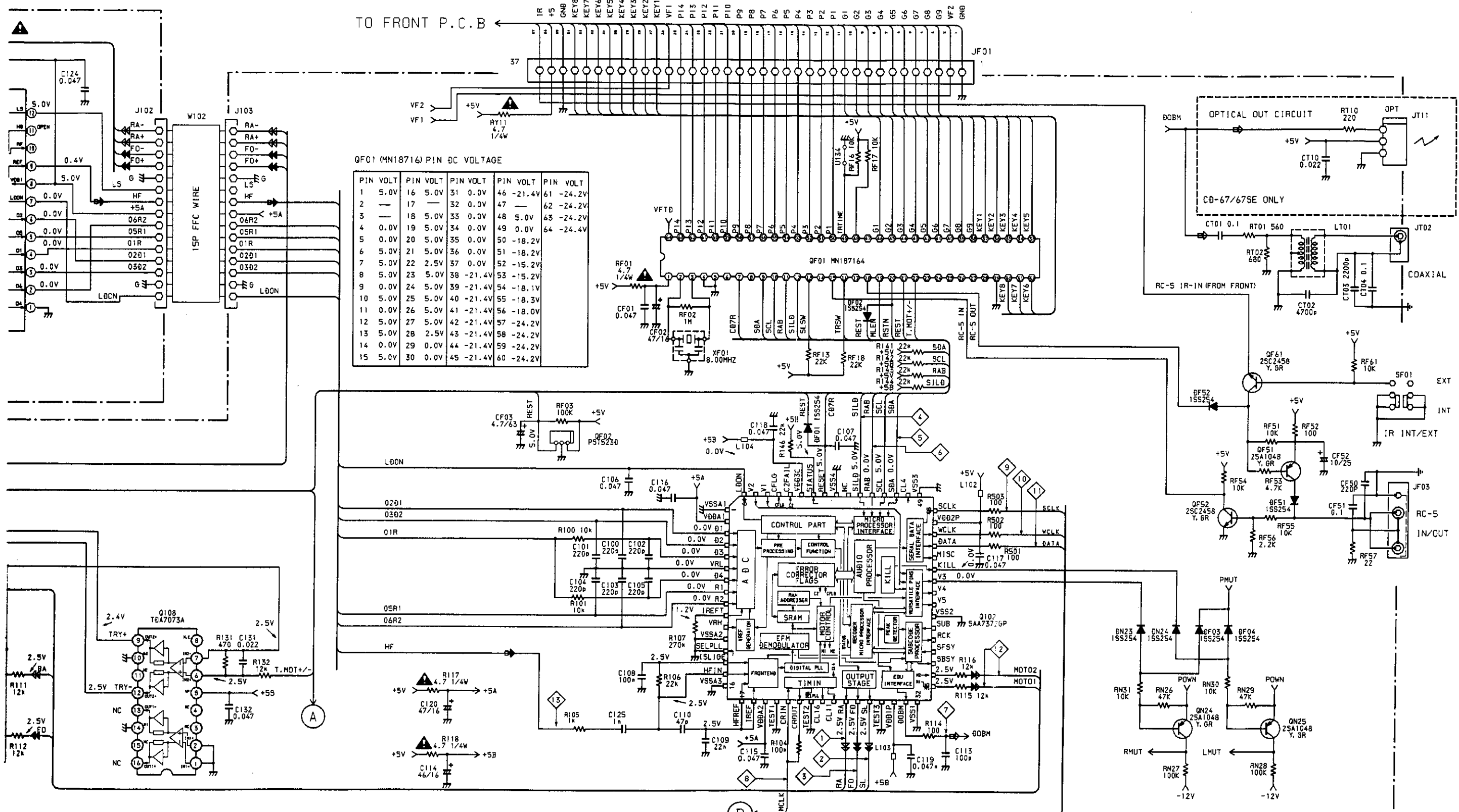

安全上の注意：
 ▲ が付いている部品は、安全上重要な部品です。必ず指定されている部品番号の部品を使用してください。

NOTE ON SAFETY:
 Symbol ▲ Fire or electrical shock hazard. Only original parts should be used to replace any part marked with symbol ▲. Any other component substitution (other than original type), may increase risk of fire or electrical shock hazard.

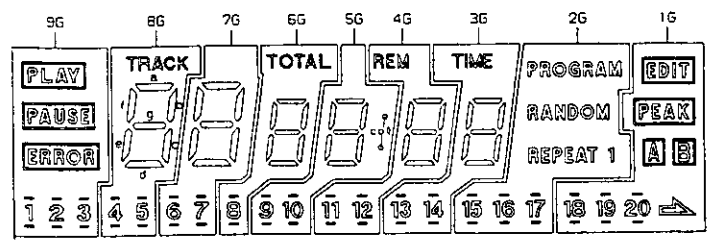
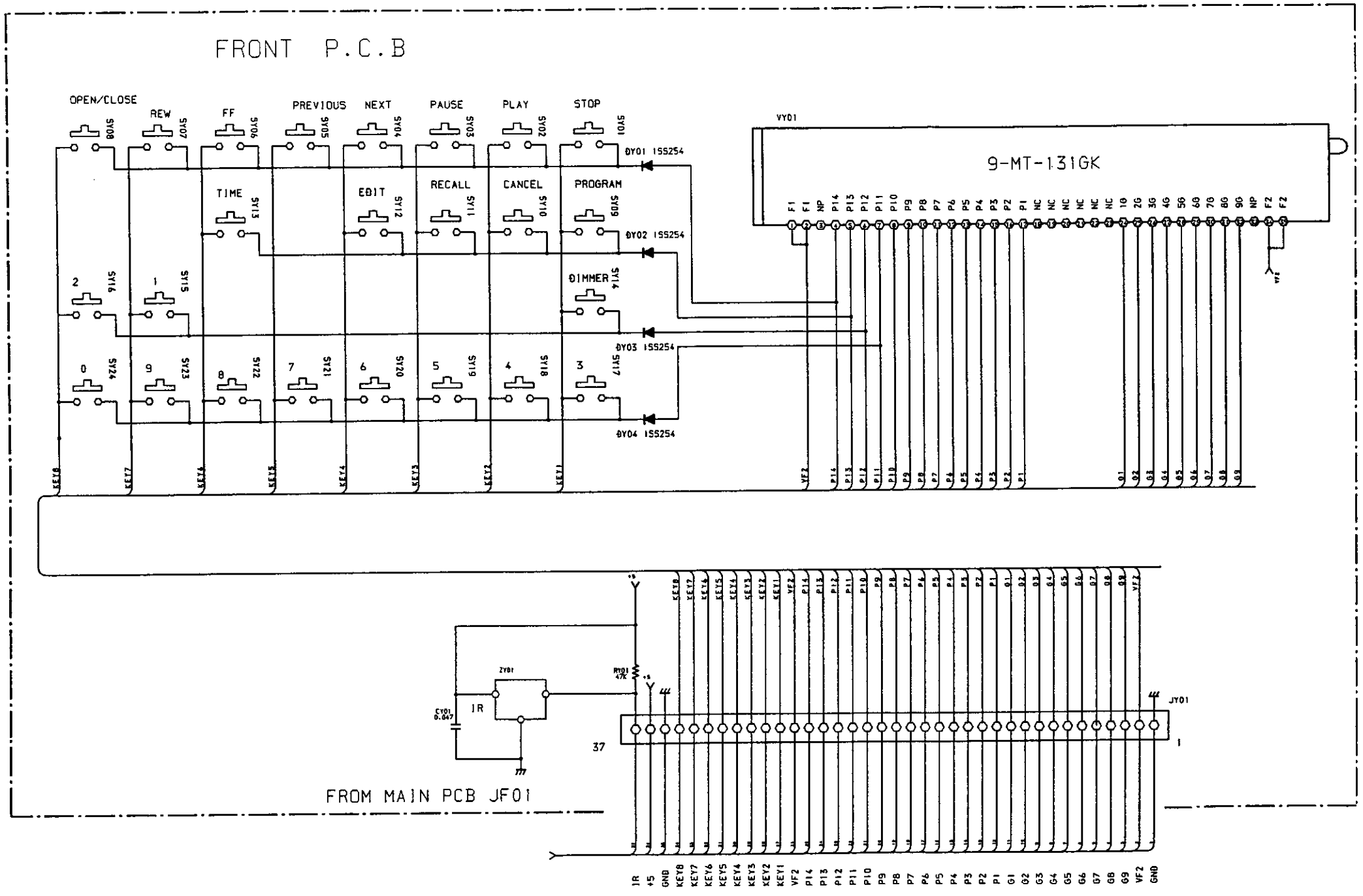

ANODE CONNECTION

	9G	8G	7G	6G	5G	4G	3G	2G	1G
P1	-	a	a	a	a	a	a	PROGRAM	EDIT
P2	(1)	b	b	b	b	b	b	3	3
P3	1	c	c	c	c	c	c	(15)	(18)
P4	(1)	d	d	d	d	d	d	1	1
P5	-	e	e	e	e	e	e	REPEAT	EDIT
P6	ERROR	f	f	f	f	f	f	-	A
P7	(2)	g	g	g	g	g	g	(15)	(18)
P8	2	(4)	-	TOTAL	col	REM	(13)	(16)	(19)
P9	(2)	4	(6)	-	(9)	(11)	13	16	19
P10	(3)	(4)	6	(8)	9	11	(13)	(16)	(19)
P11	3	(5)	(6)	8	(9)	(11)	(14)	(17)	(20)
P12	(3)	5	(7)	(8)	(10)	(12)	14	17	20
P13	PLAY	(5)	7	-	10	12	(14)	(17)	(20)
P14	PAUSE TRACK	(7)	-	(10)	(12)	TIME	RANDOM	EDIT	

9-MT-131GK
ANODE CONNECTION

PY16 FRONT PCB

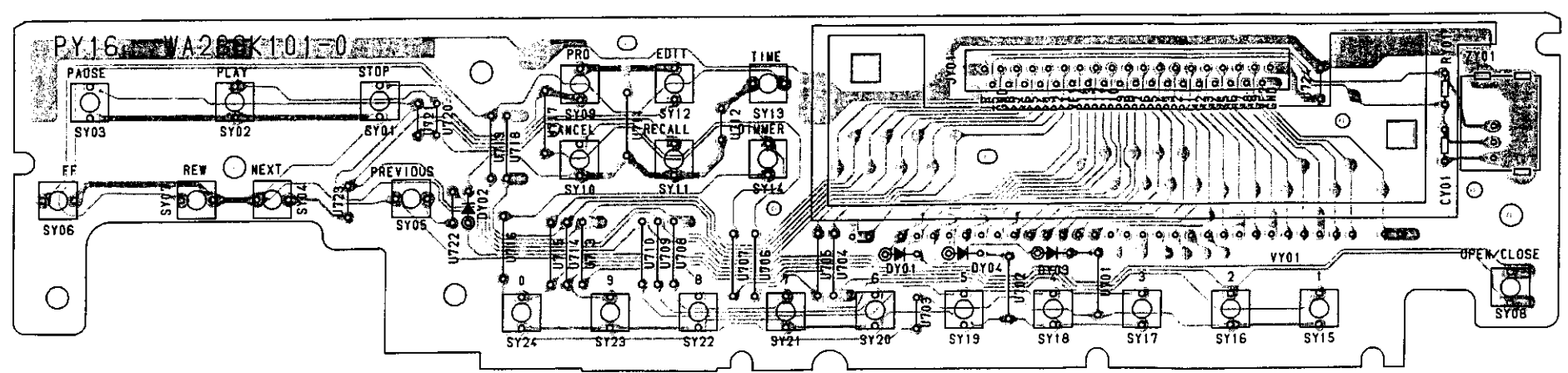

[VERS.:VERSION, U:U.S.A., F:Japan, K:Far East, /XX:Europe]

POS. NO.	VERS. COLOR	PART NO. (For EUROPE)	DESCRIPTION	PART NO. (For U/J/K/F)
002B	BLACK	4822 464 10206	CHASSIS FRONT PL BLK	185W105020
002B	GOLD	4822 464 10207	CHASSIS FRONT PL GLD	185W105120
003B	CD-57 BLACK	4822 459 04341	FRONT PANEL AL CD-57 BLK	185W248010
003B	CD-67 BLACK	4822 459 04342	FRONT PANEL AL CD-67 BLK	186W248010
003B	CD-67 GOLD	4822 459 04343	FRONT PANEL AL CD-67 GLD	186W248020
003B	CD-67SE BLACK	4822 459 04344	FRONT PANEL AL CD-67 SE BLK	187W248010
003B	CD-67SE GOLD	4822 459 04345	FRONT PANEL AL CD-67 SE GLD	187W248020
005B		4822 410 62898	BUTTON D3 GOLD HOT STAMPED	285K270020
006B	BLACK	4822 410 62899	BUTTON OPEN/CLOSE BLK	285K270030
006B	GOLD	4822 410 62931	BUTTON OPEN/CLOSE GLD	285K270130
007B		4822 450 62145	WINDOW CD-57/67 WITH REMOTE	285K158010
008B	BLACK		BADGE MARANTZ BADGE (BL)	185J251010
008B	GOLD		BADGE MARANTZ BADGE (GL)	185J251110
045B	BLACK	4822 410 62744	BUTTON POWER BLACK	285K270010
045B	GOLD	4822 410 62745	BUTTON POWER GOLD	285K270110
050B	BLACK	4822 454 30491	TRAY ESCUTCHEON BLACK	285K063010
050B	GOLD	4822 454 30494	TRAY ESCUTCHEON BLACK	285K063110
001D	BLACK		LID TOP COVER BLACK	185W257010
001D	GOLD		LID TOP COVER GOLD	185W257110
009G		4822 462 42045	LEG, (GOLD HOT STAMP) FRONT	183J057010
010G		4822 462 42048	LEG, (GOLD HOT STAMP) REAR	183J057110
025G		4822 403 70989	LINK, POWER SW.	285K121010
001M			MECHANISM SAM LOADER 1210/11	271K304510
011M		4822 444 50678	CHASSIS 3104 144 01230	271K105030
012M		4822 444 50679	TRAY 3104 144 01420 SLIDE	271K163010
013M		4822 464 50895	CHASSIS 3104 144 00450 SUBCHASSIS	271K105040
015M		4822 402 61412	CLAMPER 3104 147 10030 ASSY	271K005010
016M		4822 325 50215	BUFFER 3104 144 00650 SUSPENSION	271K056010
021M		4822 502 12001	SCREW 2522 201 00002 SCR.TORXM2X4	271K010010
023M		4822 528 81465	PULLEY 3104 144 00400 PULLEY	271K262010
026M		4822 528 81464	GEAR 3104 144 00390 DRIVE PINION	271K058010
027M		4822 358 31168	BELT 3104 144 00900 DRIVE BELT	271K264010
028M		4822 325 80511	BUFFER 3104 144 01390 ORNAMENTAL TU	271K056030
029M		4822 325 60379	BUFFER 3104 144 00810 DAMPING G ROMME	271K056020
030M		4822 276 13222	MINI SWITCH 8204 055 29120 SINMEI QA S1229	*SM000300R
031M		4822 361 21492	D.C MOTOR 3104 148 00270 RF-310T A-1140	*MM000660R
050M		4822 691 30278	MECHANISM 3104 147 00300 CDM12.1 EX WIR	271K304560
▲W001	U		A.C POWER CORD (U) MAYOR UL/CSA	YC01800580
▲W001	/05/15		A.C POWER CORD MAIN BS 250V5A	YC02000700
▲W001	/01/02/11//12		A.C POWER CORD MAIN N	YC01800440
▲W001	F		A.C POWER CORD AC (F/E)	YC02000770
WY01	/01/02/05/11/12/15, F		JUMPER LEAD, SUMI-CARD37P/120MM	YU37120500
WY01	U		JUMPER LEAD, SUMI-CARD37P/120MM	YU37120520
			PACKING	
001T	U		USER MANUAL CD-67/67SE COMB	186W851250
001T	/01/02/05/11/12/15	4822 736 14664	USER MANUAL CD-57/67/67SE COM.	186W851310
001T	F		USER MANUAL CD-67/67SE COMB.	186W851110
B001			BATTERY UM-3NEPH/2S AN D 2P	ZF23302000
J081	CD-57	4822 321 21438	CONNECTIVE CORRCA ST. 1M	ZD01000330
J081	CD-67/67SE	4822 321 62205	CONNECTIVE CORD RCA ST. 1M (GOLD)	ZD01000550
J082	/01/11		JACK AC ADAPTER PLUG 6A 250V	YJ04002310
T100		4822 218 10527	UNIT KIT IR COMANDER (RC-63CD)	ZK286K0010

VOLTAGE CONVERSION (/01B version only)

To convert the unit to a different power source voltage, change the position as illustrated in the drawing below.

VOLTAGE SELECTOR

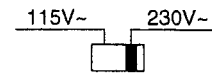

CAUTION

DISCONNECT POWER SUPPLY CORD FROM AC OUTLET BEFORE CONVERTING VOLTAGE.

7. ELECTRICAL PARTS LIST

ASSIGNMENT OF COMMON PARTS CODES.

RESISTOR

- R***** : (1) GD05 x x x 140, Carbon film fixed resistor, ±5% 1/4W
R*** : (2) GD05 x x x 160, Carbon film fixed resistor, ±5% 1/6W

① ——— Resistance value

Examples ;

① Resistance value

0.1 Ω.....001	10 Ω.....100	1 kΩ.....102	100 kΩ.....104
0.5 Ω.....005	18 Ω.....180	2.7 kΩ.....272	680 kΩ.....684
1 Ω.....010	100 Ω.....101	10 kΩ.....103	1 MΩ.....105
6.8 Ω.....068	390 Ω.....391	22 kΩ.....223	4.7 MΩ.....475

(Note) Please distinguish 1/4W from 1/6W by the shape of parts used actually.

C*** : CERAMIC CAP.

- (1) DD1 x x x 370, Ceramic capacitor
 Disc type
 Temp. coeff. P350 ~ N1000, 50V

① ——— Capacity value
 ② ——— Tolerance

Examples ;

- ① Tolerance (Capacity deviation)
- | |
|-----------------|
| ± 0.25pF..... 0 |
| ± 0.5pF..... 1 |
| ± 5%..... 5 |

*Tolerance of COMMON PARTS handled here are as follows :

0.5pF - 5pF..... ±0.25pF
6pF - 10pF..... ±0.5pF
12pF - 560pF..... ±5%

② Capacity value

0.5 pF.....005	3 pF.....030	100 pF.....101
1 pF.....010	10 pF.....100	220 pF.....221
1.5 pF.....015	47 pF.....470	560 pF.....561

C*** : CERAMIC CAP.

- (1) DK16 x x x 300, High dielectric constant ceramic capacitor
 Disc type
 Temp. chara. 2B4, 50V

① ——— Capacity value

Examples ;

① Capacity value

100 pF.....101	1000 pF.....102	10000 pF.....103
470 pF.....471	2200 pF.....222	

C*** : ELECTROLY CAP. (≠), FILM CAP. (≠)

- (1) EA x x x x 10, Electrolytic capacitor
 One-way lead type, Tolerance ± 20%

① ——— Working voltage
 ② ——— Capacity value

Examples ;

① Capacity value

0.1 μF.....104	4.7 μF.....475	100 μF.....107
0.33 μF.....334	10 μF.....106	330 μF.....337
1 μF.....105	22 μF.....226	1100 μF.....118
		2200 μF.....228

② Working voltage

6.3 V.....006	25 V.....025
10 V.....010	35 V.....035
16 V.....016	50 V.....050

- (2) DF15 x x x 350 ——— Plastic film capacitor
 DF15 x x x 310 ——— One-way type, Mylar ± 5% 50V
 DF16 x x x 310 ——— Plastic film capacitor
 One-way type, Mylar ± 10% 50V

① ——— Capacity value

Examples ;

① Capacity value

0.001 μF (1000pF).....102	0.1 μF.....104
0.0018 μF.....182	0.56 μF.....564
0.01 μF.....103	1 μF.....105
0.015 μF.....153	

- NOTE** : 1) The above CODES (**R*****, **R*****, **C*****, **C***** and **C*****) are omitted on the schematic diagram in some case.
 2) On the occasion, be confirmed common parts on the parts list.
 3) Refer to "Common Parts List" for the other common parts (R105, DD4, DK4).

NOTE ON SAFETY FOR FUSIBLE RESISTOR :

The suppliers and their type numbers of fusible resistors are as follows :

1. KOA Corporation

Part No.	Type No.	Description
NH05 x x x 140	RF25S x x x x Ω J	(± 5% 1/4W)
NH05 x x x 120	RF50S x x x x Ω J	(± 5% 1/2W)
NH85 x x x 110	RF73B2A x x x x Ω J	(± 5% 1/10W)
NH85 x x x 140	RF73B2E x x x x Ω J	(± 5% 1/4W)

* Resistance value * Resistance value
 (0.1 - 10kΩ)

2. Matsushita Electronic Components Co., Ltd

Part No.	Type No.	Description
NF05 x x x 140	ERD-2FCJ x x x	(± 5% 1/4W)
RF05 x x x 140		
NF02 x x x 140	ERD-2FCG x x x	(± 2% 1/4W)
RF02 x x x 140		

* Resistance value * Resistance value

Examples :

* Resistance value

0.1 Ω.....001	10 Ω.....100	1 kΩ.....102	100 kΩ.....104
0.5 Ω.....005	18 Ω.....180	2.7 kΩ.....272	680 kΩ.....684
1 Ω.....010	100 Ω.....101	10 kΩ.....103	1 MΩ.....105
6.8 Ω.....068	390 Ω.....391	22 kΩ.....223	4.7 MΩ.....475

ABBREVIATION AND MARKS

1	ANT. : ANTENNA	2	BATT. : BATTERY
3	CAP. : CAPACITOR	4	CER. : CERAMIC
5	CONN. : CONNECTING	6	DIG. : DIGITAL
7	HP : HEADPHONE	8	MIC. : MICROPHONE
9	μ-PRO : MICROPROCESSOR	10	REC. : RECORDING
11	RES. : RESISTOR	12	SPK : SPEAKER
13	SW : SWITCH	14	TRANSF. : TRANSFORMER
15	TRIM. : TRIMMING	16	TRS. : TRANSISTOR
17	VAR. : VARIABLE	18	XTAL : CRYSTAL
19		20	
21		22	
23		24	
25		26	
27		28	
29		30	

NOTE ON SAFETY :

Symbol **▲** Fire or electrical shock hazard. Only original parts should be used to replace any part marked with symbol **▲**. Any other component substitution (other than original type), may increase risk of fire or electrical shock hazard.

安全上の注意 :

▲ がついている部品は、安全上重要な部品です。必ず指定されている部品番号の部品を使用して下さい。

POS. NO.	VERS. COLOR	PART NO. (For EUROPE)	DESCRIPTION	PART NO. (For U/K/F)	POS. NO.	VERS. COLOR	PART NO. (For EUROPE)	DESCRIPTION	PART NO. (For U/K/F)
Q852		4822 130 42298	TRS. 2SC536SP, 2SC2458, 2SC3311, 2SC1740S	HT30001000				P116-MISCELLANEOUS	
Q853		4822 130 42715	TRS. 2SA608SP, 2SA1048, 2SA1309, 2SA933S	HT10001000	▲FH11	CD-57/01/02/05		FUSE T 630MA 250V SL	FS10063210
Q854		4822 130 42715	TRS. 2SA608SP, 2SA1048, 2SA1309, 2SA933S	HT10001000	▲FH11	F, U	4822 253 40196	FUSE 1.6A 125V GGS	FS10160310
Q901		4822 209 82362	IC NJM4556D	HC10016090	▲FH11	CD-67/01/02/05/11/12/15	4822 070 36301	FUSE 630MA 250V BS LISTED	FS10063850
QD01		4822 209 32762	IC SM5872BS DIG.FIL & DAC	HC10010350	▲FH12	CD-57/01/02/05		FUSE T 630MA 250V SL	FS10063210
QF01		4822 209 15166	MAIN CPU MN187164	HU186WA000	▲FH12	F, U	4822 253 40196	FUSE 1.6A 125V GGS	FS10160310
QF02		4822 209 15167	IC RESET IC PST994D	HC10073550	▲FH12	CD-67/01/02/05/11/12/15	4822 070 36301	FUSE 630MA 250V BS LISTED	FS10063850
QF51		4822 130 42715	TRS. 2SA608SP, 2SA1048, 2SA1309, 2SA933S	HT10001000	J103		4822 265 41351	JACK ZC-015 15P-CONNECTER	YJ07007960
QF52		4822 130 42298	TRS. 2SC536SP, 2SC2458, 2SC3311, 2SC1740S	HT30001000	J601	CD-57		TERMINAL 1L2P W/R A OUT	YT02021210
QF61		4822 130 42298	TRS. 2SC536SP, 2SC2458, 2SC3311, 2SC1740S	HT30001000	J601	CD-67/67SE	4822 265 31045	TERMINAL RCA P-JACK W/R GOLD	YT02021080
QH03	CD-67/67SE	4822 130 43233	TRS. 2SC2240 (GR OR BL)	HT322402A0	JF01		4822 265 61251	JACK 37 PIN FFC	YJ06011070
QH04	CD-67/67SE	4822 130 43233	TRS. 2SC2240 (GR OR BL)	HT322402A0	JF03		4822 267 41009	TERMINAL 2P RCA PIN JACK	YT02020890
QH05	CD-67/67SE	4822 130 42949	TRS. 2SA970 (GR OR BL)	HT109702A0	JH01			TERMINAL AC CORD ON PCB	YL01010250
QH08	CD-67/67SE	4822 130 42949	TRS. 2SA970 (GR OR BL)	HT109702A0	JH02			TERMINAL AC CORD ON PCB	YL01010250
QH09	CD-67/67SE	4822 130 43233	TRS. 2SC2240 (GR OR BL)	HT322402A0	JM01		4822 265 30473	PLUG 6P PLUG 86B-XH-A	YP06003420
QH10	CD-67/67SE	4822 130 43233	TRS. 2SC2240 (GR OR BL)	HT322402A0	JM02		4822 265 30482	PLUG 4P PLUG 84B-XH-A	YP06003440
QH11	CD-67/67SE	5322 130 41844	F.E.T. 2SK170 BL	HF201701G0	JT02	CD-57	4822 265 10328	TERMINAL 1L1P BLK	YT02010780
QH12	CD-67/67SE	5322 130 41844	F.E.T. 2SK170 BL	HF201701G0	JT02	CD-67/67SE	4822 290 81638	TERMINAL 14X14 RA 1L1P BLK	YT02010790
QH13	CD-67/67SE	4822 130 62649	F.E.T. 2SJ74 BL	HF100741G0	JT11	CD-67/67SE	4822 267 31369	OPT. CONNECTOR GP1F32T	YJ15000090
QH14	CD-67/67SE	4822 130 62649	F.E.T. 2SJ74 BL	HF100741G0	▲L001	CD-57/02/05	4822 146 10645	POWER TRANSF.	TS15740010
QH51	CD-67/67SE	4822 130 42839	F.E.T. 2SK369BL	HF203691B0	▲L001	CD-57/01	4822 146 10644	POWER TRANSF.	TS15740020
QH54	CD-67/67SE	4822 130 42839	F.E.T. 2SK369BL	HF203691B0	▲L001	CD-67, U		POWER TRANSF.	TS15740030
QN01		4822 130 42298	TRS. 2SC536SP, 2SC2458, 2SC3311, 2SC1740S	HT30001000	▲L001	CD-67/02/05	4822 146 10645	POWER TRANSF.	TS15740010
QN04		4822 130 43818	TRS. 2SC2878 A OR BRANK	HT328782A0	▲L001	CD-67/01	4822 146 10644	POWER TRANSF.	TS15740020
QN05		4822 130 43818	TRS. 2SC2878 A OR BRANK	HT328782A0	▲L001	CD-67, F		POWER TRANSF.	TS15740040
QN08		4822 130 42298	TRS. 2SC536SP, 2SC2458, 2SC3311, 2SC1740S	HT30001000	▲L001	CD-67/12/15	4822 146 10646	POWER TRANSF.	TS15740050
QN20		4822 130 42298	TRS. 2SC536SP, 2SC2458, 2SC3311, 2SC1740S	HT30001000	▲L001	CD-67/11	4822 146 10647	POWER TRANSF.	TS15740060
QN24		4822 130 42715	TRS. 2SA608SP, 2SA1048, 2SA1309, 2SA933S	HT10001000	▲L001	CD-67SE, U		POWER TRANSF.	TS15740070
QN25		4822 130 42715	TRS. 2SA608SP, 2SA1048, 2SA1309, 2SA933S	HT10001000	▲L001	CD-67SE, F		POWER TRANSF.	TS15740080
QN91		4822 130 43818	TRS. 2SC2878 A OR BRANK	HT328782A0	L102		4822 526 10584	FERRITE CORE	FC90090010
QN92		4822 130 43818	TRS. 2SC2878 A OR BRANK	HT328782A0	L103		4822 526 10584	FERRITE CORE	FC90090010
▲R614		4822 116 83036	P116-RESISTORS	RF02270140	L104		4822 526 10584	FERRITE CORE	FC90090010
▲R615		4822 116 83036	27 Ω ±2% 1/4W	RF02270140	LT01		4822 142 60388	PULSE TRANSF.	TP41042010
▲R616		4822 116 83036	27 Ω ±2% 1/4W	RF02270140	▲SF01		4822 277 21824	SLIDE SWITCH	SS02021620
▲R651	CD-67/67SE	4822 116 83036	27 Ω ±2% 1/4W	RF02270140	▲SH02	/01/11	4822 277 21763	SLIDE SWITCH	SS02021240
▲R654	CD-67/67SE	4822 116 83036	27 Ω ±2% 1/4W	RF02270140	▲SH91		4822 276 13364	PUSH SWITCH	SP01011990
▲RD01	CD-67/67SE	4822 052 10478	P116-RESISTORS(COMMON)	RF05047140	XD01		4822 242 72334	CRYSTAL 16.9344MHZ	JX16002260
▲RD04	CD-67/67SE	4822 052 10478	CARBON FILM FIXED RESISTOR, ±5% 1/6W	RF05047140	XF01		4822 242 72066	SERAMIC VIB. CST8.0MHZ (MT) TAPING	FQ08004010
▲RF01		4822 052 10478	R100, R101, R104-R107, R111-R116, R119, R122-R128, R131, R132, R135, R136, R137, R141-R144, R146, R161, R501, R502, R503, R601-R612, R617, R618, R619, R620, R655-R662, R851-R855, R901-R906, R909, R910, R913, R914, RD14, RD15, RD16, RD21-RD28, RF02, RF03, RF13, RF16, RF17, RF18, RF51-RF57, RF61, RH01-RH12, RH15-RH26, RN01, RN02, RN04-RN07, RN09, RN10, RN15-RN18, RN23, RN26-RN31, RN91, RN92, RT01, RT02, RT10	RF05047140					
▲RN08		4822 052 10478		RF05047140					
▲RY11		4822 052 10478		RF05047140					
▲R614		4822 116 83036		RF02270140					
▲R615		4822 116 83036		RF02270140					
▲R616		4822 116 83036		RF02270140					
▲R651	CD-67/67SE	4822 116 83036		RF02270140					
▲R654	CD-67/67SE	4822 116 83036		RF02270140					
▲RD01	CD-67/67SE	4822 052 10478		RF05047140					
▲RD04	CD-67/67SE	4822 052 10478		RF05047140					
▲RF01		4822 052 10478		RF05047140					
▲RN08		4822 052 10478		RF05047140					
▲RY11		4822 052 10478		RF05047140					
▲R614		4822 116 83036		RF02270140					
▲R615		4822 116 83036		RF02270140					
▲R616		4822 116 83036		RF02270140					
▲R651	CD-67/67SE	4822 116 83036		RF02270140					
▲R654	CD-67/67SE	4822 116 83036		RF02270140					
▲RD01	CD-67/67SE	4822 052 10478		RF05047140					
▲RD04	CD-67/67SE	4822 052 10478		RF05047140					
▲RF01		4822 052 10478		RF05047140					
▲RN08		4822 052 10478		RF05047140					
▲RY11		4822 052 10478		RF05047140					
▲R614		4822 116 83036		RF02270140					
▲R615		4822 116 83036		RF02270140					
▲R616		4822 116 83036		RF02270140					
▲R651	CD-67/67SE	4822 116 83036		RF02270140					
▲R654	CD-67/67SE	4822 116 83036		RF02270140					
▲RD01	CD-67/67SE	4822 052 10478		RF05047140					
▲RD04	CD-67/67SE	4822 052 10478		RF05047140					
▲RF01		4822 052 10478		RF05047140					
▲RN08		4822 052 10478		RF05047140					
▲RY11		4822 052 10478		RF05047140					
▲R614		4822 116 83036		RF02270140					
▲R615		4822 116 83036		RF02270140					
▲R616		4822 116 83036		RF02270140					
▲R651	CD-67/67SE	4822 116 83036		RF02270140					
▲R654	CD-67/67SE	4822 116 83036		RF02270140					
▲RD01	CD-67/67SE	4822 052 10478		RF05047140					
▲RD04	CD-67/67SE	4822 052 10478		RF05047140					
▲RF01		4822 052 10478		RF05047140					
▲RN08		4822 052 10478		RF05047140					
▲RY11		4822 052 10478		RF05047140					
▲R614		4822 116 83036		RF02270140					
▲R615		4822 116 83036		RF02270140					
▲R616		4822 116 83036		RF02270140					
▲R651	CD-67/67SE	4822 116 83036		RF02270140					
▲R654	CD-67/67SE	4822 116 83036		RF02270140					
▲RD01	CD-67/67SE	4822 052 10478		RF05047140					
▲RD04	CD-67/67SE	4822 052 10478		RF05047140					
▲RF01		4822 052 10478		RF05047140					
▲RN08		4822 052 10478		RF05047140					
▲RY11		4822 052 10478		RF05047140					
▲R614		4822 116 83036		RF02270140					
▲R615		4822 116 83036		RF02270140					
▲R616		4822 116 83036		RF02270140					
▲R651	CD-67/67SE	4822 116 83036		RF02270140					
▲R654	CD-67/67SE	4822 116 83036		RF02270140					
▲RD01	CD-67/67SE	4822 052 10478		RF05047140					
▲RD04	CD-67/67SE	4822 052 10478		RF05047140					
▲RF01		4822 052 10478		RF05047140					
▲RN08		4822 052 10478		RF05047140					
▲RY11		4822 052 10478		RF05047140					
▲R614		4822 116 83036		RF02270140					
▲R615		4822 116 83036		RF02270140					
▲R616		4822 116 83036		RF02270140					
▲R651	CD-67/67SE	4822 116 83036		RF02270140					
▲R654	CD-67/67SE	4822 116 83036		RF02270140					

POS. NO.	VERS. COLOR	PART NO. (For EUROPE)	DESCRIPTION	PART NO. (For U/K/F)	POS. NO.	VERS. COLOR	PART NO. (For EUROPE)	DESCRIPTION	PART NO. (For U/K/F)
P116-MAIN CIRCUIT BOARD									
P116-CAPACITORS									
C100		4822 126 10408	CER. 220 PF	DA16221110	C902		4822 124 41534	ELECT. 10 µF M 25V	OA10602520
C105					C903		4822 124 41535	ELECT. 100 µF M 25V	OA10702520
C106		4822 122 40589	CER. 0.047 µF +80%-20% 50V	DA17473110	C904		4822 124 41535	ELECT. 100 µF M 25V	OA10702520
C107		4822 122 40589	CER. 0.047 µF +80%-20% 50V	DA17473110	CD01		4822 122 32185	CER. 10 PF 50V BLK	DD11100300
C109		4822 122 40588	CER. 0.022 µF	DA17223110	CD02		4822 122 32185	CER. 10 PF 50V BLK	DD11100300
C110		4822 126 10513	CER. 47 PF	DA15470110	CD03		4822 122 32185	CER. 10 PF 50V BLK	DD11100300
C113		4822 126 10364	CER. 100 PF	DA16101110	CD04		4822 124 90363	ELECT. 220 µF M 10V	OA22701020
C114		4822 124 41539	ELECT. 47 µF M 16V	OA47601620	CD05		4822 122 40589	CER. 0.047 µF +80%-20% 50V	DA17473110
C115					CD06		4822 122 40589	CER. 0.047 µF +80%-20% 50V	DA17473110
C119		4822 122 40589	CER. 0.047 µF +80%-20% 50V	DA17473110	CD07		4822 124 90363	ELECT. 220 µF M 10V	OA22701020
C120		4822 124 41539	ELECT. 47 µF M 16V	OA47601620	CD08		4822 122 40589	CER. 0.047 µF +80%-20% 50V	DA17473110
C125		4822 122 33639	CER. 1000 PF	DA16102110	CD12		4822 122 40589	CER. 0.047 µF +80%-20% 50V	DA17473110
C132		4822 122 40589	CER. 0.047 µF +80%-20% 50V	DA17473110	CD13		4822 122 40589	CER. 0.047 µF +80%-20% 50V	DA17473110
C150		4822 122 40589	CER. 0.047 µF +80%-20% 50V	DA17473110	CD15	CD-57	4822 124 90363	ELECT. 220 µF M 10V	OA22701020
C155		4822 124 41539	ELECT. 47 µF M 16V	OA47601620	CD15	CD-67/67SE	4822 124 90371	ELECT. 470 µF M 10V	OA47701020
C156		4822 124 41539	ELECT. 47 µF M 16V	OA47601620	CD16	CD-57	4822 124 90363	ELECT. 220 µF M 10V	OA22701020
C157		4822 122 40589	CER. 0.047 µF +80%-20% 50V	DA17473110	CD16	CD-67/67SE	4822 124 90371	ELECT. 470 µF M 10V	OA47701020
C159		4822 122 40589	CER. 0.047 µF +80%-20% 50V	DA17473110	CD21	CD-57	4822 126 11559	CER. 120 PF ± 50V BLK	DD15121300
C601	CD-57	4822 126 11559	CER. 120 PF ± 0.5% 50V BLK	DD15121300	CD21	CD-67/67SE	4822 121 70544	FILM 120 PF ± 100V	OF15121540
C601	CD-67/67SE	4822 121 70544	FILM 120 PF ± 0.5% 100V	OF15121540	CD22	CD-57	4822 126 11559	CER. 120 PF ± 50V BLK	DD15121300
C602	CD-57	4822 126 11559	CER. 120 PF ± 0.5% 50V BLK	DD15121300	CD22	CD-67/67SE	4822 121 70544	FILM 120 PF ± 100V	OF15121540
C602	CD-67/67SE	4822 121 70544	FILM 120 PF ± 0.5% 100V	OF15121540	CD23	CD-57	4822 126 11559	CER. 120 PF ± 50V BLK	DD15121300
C603	CD-57	4822 126 11559	CER. 120 PF ± 0.5% 50V BLK	DD15121300	CD23	CD-67/67SE	4822 121 70544	FILM 120 PF ± 100V	OF15121540
C603	CD-67/67SE	4822 121 70544	FILM 120 PF ± 0.5% 100V	OF15121540	CD24	CD-57	4822 126 11559	CER. 120 PF ± 50V BLK	DD15121300
C604	CD-57	4822 126 11559	CER. 120 PF ± 0.5% 50V BLK	DD15121300	CD24	CD-67/67SE	4822 121 70544	FILM 120 PF ± 100V	OF15121540
C604	CD-67/67SE	4822 121 70544	FILM 120 PF ± 0.5% 100V	OF15121540	CF01		4822 122 40589	CER. 0.047 µF +80%-20% 50V	DA17473110
C605	CD-67/67SE	4822 121 70437	FILM 1000 PF ± 0.5% 100V	OF15102540	CF02		4822 124 41539	ELECT. 47 µF M 16V	OA47601620
C606	CD-67/67SE	4822 121 70437	FILM 1000 PF ± 0.5% 100V	OF15102540	CF03		4822 124 40246	ELECT. 4.7 µF M 63V	OA47506320
C607	CD-57	5322 122 32265	CER. 100 PF ± 0.5% 50V BLK	DD15101300	CF50		4822 126 10408	CER. 220 PF	DA16221110
C607	CD-67/67SE	4822 121 70543	FILM 100 PF ± 0.5% 100V	OF15101540	CF51		4822 126 11558	CER. 0.1 µF 80%-20% 50V	DA17104110
C608	CD-57	5322 122 32265	CER. 100 PF ± 0.5% 50V BLK	DD15101300	CF52		4822 124 41534	ELECT. 10 µF M 25V	OA10602520
C608	CD-67/67SE	4822 121 70543	FILM 100 PF ± 0.5% 100V	OF15101540	CH01	CD-67/67SE	4822 126 11069	CER. 150 PF	DA16151110
C611		4822 124 22238	ELECT. 100 µF M 25V	OA10702550	CH02	CD-67/67SE	4822 126 11069	CER. 150 PF	DA16151110
C614					▲CH11		4822 121 43732	FILM 0.01 µF M 250V	DF77103500
C651					CN02		4822 124 41543	ELECT. 1 µF M 50V	OA10505020
C651					CN03		4822 124 90357	ELECT. 2.2 µF M 50V	OA22505020
C654	CD-67/67SE	4822 124 22277	ELECT. 470 µF M 16V	OA47701620	CT01			FILM 0.1 µF J 50V	DF15104310
C655	CD-57	4822 124 90364	ELECT. 220 µF M 16V	OA22701620	CT02		4822 122 31125	CER. 4700 PF Z 50V	DK18472310
C655	CD-67/67SE	4822 124 80123	ELECT. 220 µF M 16V ARS	OA22701640	CT03			CER. 2200 PF K 50V	DK16222300
C656	CD-57	4822 124 90364	ELECT. 220 µF M 16V	OA22701620	CT04		4822 126 11558	CER. 0.1 µF Z 50V	DA17104110
C656	CD-67/67SE	4822 124 80123	ELECT. 220 µF M 16V ARS	OA22701640	CT10	CD-67/67SE	4822 122 30103	CER. 0.022 µF Z 50V	DK18223310
C657	CD-57	4822 124 90364	ELECT. 220 µF M 16V	OA22701620	P116-CAPACITORS (COMMON)				
C657	CD-67/67SE	4822 124 80123	ELECT. 220 µF M 16V ARS	OA22701640	ELECTROLYTIC CAPACITOR				
C658	CD-57	4822 124 90364	ELECT. 220 µF M 16V	OA22701620	ONE-WAY LEAD TYPE,				
C658	CD-67/67SE	4822 124 80123	ELECT. 220 µF M 16V ARS	OA22701640	TOLERANCE ± 20%				
C659	CD-57	5322 122 32265	CER. 100 PF ± 0.5% 50V BLK	DD15101300	C108, C127, C128, C131, C151-C154,				
C659	CD-67/67SE	4822 126 10364	CER. 100 PF	DA16101110	C162, CT01, CT03,				
C660	CD-57	5322 122 32265	CER. 100 PF ± 0.5% 50V BLK	DD15101300	C605, C606				
C660	CD-67/67SE	4822 126 10364	CER. 100 PF	DA16101110	P116-SEMICONDUCTORS				
C801	CD-57	4822 122 30103	CER. 0.022 µF +80%-20% 50V	DK18223310	D853		4822 130 33759	ZENER DIODE, 4.7V RD4.7ES O4A24.7, MTZJ4.7A	HD30471000
C801	CD-67/67SE	4822 122 40589	CER. 0.047 µF +80%-20% 50V	DA17473110	DF01				
C802	CD-57	4822 122 30103	CER. 0.022 µF +80%-20% 50V	DK18223310	DF04		4822 130 32362	DIODE 1SS254 30V 0.1A	HD20022210
C802	CD-67/67SE	4822 122 40589	CER. 0.047 µF +80%-20% 50V	DA17473110	DF51		4822 130 32362	DIODE 1SS254 30V 0.1A	HD20022210
▲C803	CD-57	4822 124 90366	ELECT. 220 µF 50V M	OA22705020	DF52		4822 130 32362	DIODE 1SS254 30V 0.1A	HD20022210
▲C803	CD-67/67SE	4822 124 80823	ELECT. 470 µF 35V M	OA47703540	DH01				
▲C804	CD-57	4822 124 90366	ELECT. 220 µF 50V M	OA22705020	DH10	CD-67/67SE	4822 130 32362	DIODE 1SS254 30V 0.1A	HD20022210
▲C804	CD-67/67SE	4822 124 80823	ELECT. 470 µF 35V M	OA47703540	DN05		4822 130 32362	DIODE 1SS254 30V 0.1A	HD20022210
C805	CD-57	4822 124 90354	ELECT. 100 µF M 16V	OA10701620	DN06		4822 130 33948	ZENER DIODE, 5.6V RD5.6ES O4AZ5.6, MTZJ5.6A	HD30561000
C805	CD-67/67SE	4822 124 22277	ELECT. 470 µF 16V M	OA47701620	DN07		4822 130 32362	DIODE 1SS254 30V 0.1A	HD20022210
C806	CD-57	4822 124 90354	ELECT. 100 µF M 16V	OA10701620	DN23		4822 130 32362	DIODE 1SS254 30V 0.1A	HD20022210
C806	CD-67/67SE	4822 124 22277	ELECT. 470 µF 16V M	OA47701620	DN24		4822 130 32362	DIODE 1SS254 30V 0.1A	HD20022210
C811		4822 122 40589	CER. 0.047 µF +80%-20% 50V	DA17473110	Q102		4822 209 91174	IC CD RECORDER SAA7372GPCD7	HC10132490
C812		4822 122 40589	CER. 0.047 µF +80%-20% 50V	DA17473110	Q106		4822 209 61073	IC TDA7073A DUAL DRIVER	HC10137490
▲C813		4822 124 80582	ELECT. 4700 µF 16V M	OA47801620	Q107		4822 209 61073	IC TDA7073A DUAL DRIVER	HC10137490
C815		4822 124 80773	ELECT. 3300 µF M 6.3V	OA33800620	Q108		4822 209 61073	IC TDA7073A DUAL DRIVER	HC10137490
▲C852		4822 124 90355	ELECT. 100 µF 50V M	OA10705020	Q605		4822 209 31153	IC DUAL LOW NOISE OP-AMP NJM2114D	HC10111090
C853		4822 124 80772	ELECT. 47 µF M 35V	OA47603520	Q606		4822 209 31153	IC DUAL LOW NOISE OP-AMP NJM2114D	HC10111090
▲C854		4822 124 90355	ELECT. 100 µF 50V M	OA10705020					
C871		4822 124 41539	ELECT. 47 µF M 16V	OA47601620					
C901		4822 124 41534	ELECT. 10 µF M 25V	OA10602520					

[VERS.:VERSION, U:U.S.A, F:Japan, K:Far East, /XX:Europe]

POS. NO.	VERS. COLOR	PART NO. (For EUROPE)	DESCRIPTION	PART NO. (For U/K/F)
			PY16-FRONT CIRCUIT BOARD	
			PY16-CAPACITORS	
CY01		4822 122 40589	CER. 0.047 μ F +80%-20% 50V	DA17473110
			PY16-SEMICONDUCTORS	
DY01		4822 130 32362	DIODE 1SS254 30V 0.1A	HD20022210
DY02		4822 130 32362	DIODE 1SS254 30V 0.1A	HD20022210
DY03		4822 130 32362	DIODE 1SS254 30V 0.1A	HD20022210
DY04		4822 130 32362	DIODE 1SS254 30V 0.1A	HD20022210
			PY16-RESISTORS(COMMON)	
			CARBON FILM FIXED RESISTOR, \pm 5% 1/6W: RY01	
			PY16-MISCELLANEOUS	
			R***	
SY01 & SY24		4822 276 20508	PUSH SWITCH	SP01011280
VY01		4822 130 91287	DISPLAY UNIT 9MT131GK FTD	HQ30914410