

marantz[®]

AV Surround Receiver

NR1602

Owner's Manual

SAFETY PRECAUTIONS



CAUTION
RISK OF ELECTRIC SHOCK
DO NOT OPEN



CAUTION:
TO REDUCE THE RISK OF ELECTRIC SHOCK, DO NOT REMOVE COVER (OR BACK). NO USER-SERVICEABLE PARTS INSIDE. REFER SERVICING TO QUALIFIED SERVICE PERSONNEL.

The lightning flash with arrowhead symbol, within an equilateral triangle, is intended to alert the user to the presence of uninsulated "dangerous voltage" within the product's enclosure that may be of sufficient magnitude to constitute a risk of electric shock to persons.

The exclamation point within an equilateral triangle is intended to alert the user to the presence of important operating and maintenance (servicing) instructions in the literature accompanying the appliance.

WARNING:
TO REDUCE THE RISK OF FIRE OR ELECTRIC SHOCK, DO NOT EXPOSE THIS APPLIANCE TO RAIN OR MOISTURE.

IMPORTANT SAFETY INSTRUCTIONS

1. Read these instructions.
2. Keep these instructions.
3. Heed all warnings.
4. Follow all instructions.
5. Do not use this apparatus near water.
6. Clean only with dry cloth.
7. Do not block any ventilation openings. Install in accordance with the manufacturer's instructions.
8. Do not install near any heat sources such as radiators, heat registers, stoves, or other apparatus (including amplifiers) that produce heat.
9. Protect the power cord from being walked on or pinched particularly at plugs, convenience receptacles, and the point where they exit from the apparatus.
10. Only use attachments/accessories specified by the manufacturer.
11. Use only with the cart, stand, tripod, bracket, or table specified by the manufacturer, or sold with the apparatus. When a cart is used, use caution when moving the cart/apparatus combination to avoid injury from tip-over. 
12. Unplug this apparatus during lightning storms or when unused for long periods of time.
13. Refer all servicing to qualified service personnel. Servicing is required when the apparatus has been damaged in any way, such as power-supply cord or plug is damaged, liquid has been spilled or objects have fallen into the apparatus, the apparatus has been exposed to rain or moisture, does not operate normally, or has been dropped.
14. Batteries shall not be exposed to excessive heat such as sunshine, fire or the like.

CAUTION:

To completely disconnect this product from the mains, disconnect the plug from the wall socket outlet.
The mains plug is used to completely interrupt the power supply to the unit and must be within easy access by the user.

DECLARATION OF CONFORMITY

We declare under our sole responsibility that this product, to which this declaration relates, is in conformity with the following standards: EN60065, EN55013, EN55020, EN61000-3-2 and EN61000-3-3. Following the provisions of Low Voltage Directive 2006/95/EC and EMC Directive 2004/108/EC, the EC regulation 1275/2008 and its frame work Directive 2009/125/EC for Energy-related Products (ErP).

marantz Europe
A division of D&M Europe B.V.
Beemdstraat 11, 5653 MA Eindhoven,
The Netherlands

A NOTE ABOUT RECYCLING:

This product's packaging materials are recyclable and can be reused. Please dispose of any materials in accordance with the local recycling regulations.

When discarding the unit, comply with local rules or regulations.

Batteries should never be thrown away or incinerated but disposed of in accordance with the local regulations concerning battery disposal.

This product and the supplied accessories, excluding the batteries, constitute the applicable product according to the WEEE directive.



Pb

❑ NOTES ON USE

WARNINGS

- Avoid high temperatures.
Allow for sufficient heat dispersion when installed in a rack.
- Handle the power cord carefully.
Hold the plug when unplugging the cord.
- Keep the unit free from moisture, water, and dust.
- Unplug the power cord when not using the unit for long periods of time.
- Do not obstruct the ventilation holes.
- Do not let foreign objects into the unit.
- Do not let insecticides, benzene, and thinner come in contact with the unit.
- Never disassemble or modify the unit in any way.
- Ventilation should not be impeded by covering the ventilation openings with items, such as newspapers, tablecloths or curtains.
- Naked flame sources such as lighted candles should not be placed on the unit.
- Observe and follow local regulations regarding battery disposal.
- Do not expose the unit to dripping or splashing fluids.
- Do not place objects filled with liquids, such as vases, on the unit.
- Do not handle the mains cord with wet hands.
- When the switch is in the OFF (STANDBY) position, the equipment is not completely switched off from MAINS.
- The equipment shall be installed near the power supply so that the power supply is easily accessible.

❑ CAUTIONS ON INSTALLATION

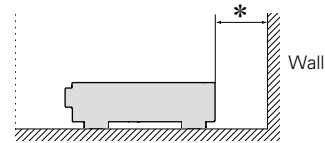
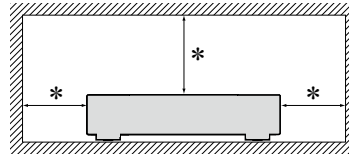

*** For proper heat dispersal, do not install this unit in a confined space, such as a bookcase or similar enclosure.**

- More than 0.3 m is recommended.
- Do not place any other equipment on this unit.

Getting started

Thank you for purchasing this marantz product. To ensure proper operation, please read this owner's manual carefully before using the product. After reading them, be sure to keep them for future reference.

Contents

Getting started	1
Accessories	2
Features	2
Cautions on handling	3

Basic version

Connections	5
Important information	5
Connecting an HDMI-compatible device	7
Connecting a TV	9
Connecting a Blu-ray Disc player	9
Connecting a DVD player	10
Connecting a set-top box (Satellite tuner/Cable TV)	10
Connecting an iPod or USB memory device to the USB port	11
Connecting a CD player	12
Connecting an antenna	12
Connecting a wireless receiver (RX101)	13
Connecting to a home network (LAN)	14
Settings	15
Set up speakers (Audyssey® Auto Setup)	15
Making the network settings (Network Setup)	21
Playback (Basic operation)	22
Important information	22
Playing a Blu-ray Disc player/DVD player	24
Playing a CD player	24
Playing an iPod	25
Playing a USB memory device	27
Tuning in radio stations	29
Playing a network audio	33
Selecting a listening mode (Surround mode)	46
Selecting a listening mode	46

Advanced version

Speaker installation/connection (Advanced)	51
Install	51
Connect	53
Set up speakers	59
Connections (Advanced connection)	61
Connecting the remote control connectors	61
Playback (Advanced operation)	62
Convenient functions	62
Playback in ZONE2 (Separate room)	73
Audio output	73
Playback	73
Sleep timer function	74
How to make detailed settings	75
Menu map	75
Examples of menu screen displays	76
Examples of menu and front display	77
Inputting characters	78
Audio Adjust	80
Information	85
System Setup	86
Input Setup	99
Other settings	105
Remote control settings	105
Operating the connected devices by remote control unit	106
Operating AV devices	106
Registering preset codes	107
Operating devices	109
Operating learn function	111

Information

Part names and functions	114
Front panel	114
Display	115
Rear panel	116
Remote control unit	117
Other information	119
Trademark information	119
Surround	120
Relationship between video signals and monitor output	124
Explanation of terms	125
Troubleshooting	128
Resetting the microprocessor	132
Specifications	133

Accessories

Check that the following parts are supplied with the product.

① Getting Started	1
② CD-ROM (Owner's manual)	1
③ Power cord	1
④ Remote control unit (RC014SR)	1
⑤ R03/AAA batteries	2
⑥ Setup microphone (ACM1H)	1
⑦ AM loop antenna	1
⑧ FM indoor antenna	1

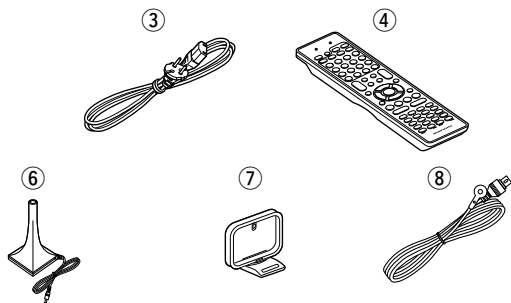

Features

Fully discrete, identical quality and power for all 7 channels (50 W x 7ch, 8 Ω)

The unit is equipped with a power amplifier that reproduces high-fidelity sound in surround mode with equal quality and power for all channels, true to the original sound.

The power amplifier circuit adopts a discrete-circuit configuration that achieves high-quality surround sound reproduction.

Supports internet radio, music, and photograph streaming

Supports AirPlay® (👉 page 65)

When connected to a network, this unit can play audio files and still images such as photographs that are stored on your computer. You can also listen to internet radio and a host of other online music sources that use network technology. This unit also supports AirPlay that lets you stream your music library from an iPhone, iPad, iPod touch or iTunes.

Compatible with "Wizz App" for performing basic operations of the unit with an iPhone or iPod touch*1

"Wizz App" is application software that allows you to perform basic operations with an iPhone or iPod touch such as turning the unit ON/OFF, controlling the volume, and switching the source.

*1 Download "Wizz App" from iTunes® App Store. The unit needs to be connected to a LAN and the iPhone/iPod touch needs to be connected to the same network by Wi-Fi (wireless LAN).

Setup wizard, providing easy-to-follow setup instructions

First select the language when prompted. Then simply follow the instructions displayed on the TV screen to set up the speakers, network, etc.

Easy to use, Graphical User Interface

This unit is equipped with an easy to see "Graphical User Interface" that uses menu displays and levels. The use of level displays increases operability of the this unit.

Direct play for iPod® and iPhone® via USB (👉 page 11)

Music data from an iPod can be played back if you connect the USB cable supplied with the iPod via the USB port of this unit, and also an iPod can be controlled with the remote control unit for this unit. When an iPod is connected, merely pressing  starts playback of music from the iPod.

Supports HDMI 1.4a with 3D, ARC, Deep Color, "x.v.Color", Auto Lip Sync and HDMI control function (👉 page 7)

This unit can output 3D video signals input from a Blu-ray Disc player to a TV that supports a 3D system. This unit also supports the ARC (Audio Return Channel) function, which reproduces TV sound with this unit via an HDMI cable used for connecting the unit and a TV*2.

*2 The TV should support the ARC function.

Important information

4-HDMI inputs and 1-output

The unit is equipped with 4 HDMI input connectors for connecting devices with HDMI connectors, such as a Blu-ray Disc player, game machine, HD video camera, etc.

High definition audio support

The unit is equipped with a decoder which supports high-quality digital audio format for Blu-ray Disc players such as Dolby TrueHD, DTS-HD Master Audio, etc.

M-XPort (marantz-eXtension Port) (👉 [page 13](#))

This unit is equipped with the M-XPort, a marantz original innovation that provides outstanding expandability. You can connect the Wireless Receiver RX101 (sold separately) to this port.

Cautions on handling

• Before turning the power on

Check once again that all connections are correct and that there are no problems with the connection cables.

- Power is supplied to some of the circuitry even when the unit is set to the standby mode. When going on vacation or leaving home for long periods of time, be sure to unplug the power cord from the power outlet.

• About condensation

If there is a major difference in temperature between the inside of the unit and the surroundings, condensation (dew) may form on the operating parts inside the unit, causing the unit not to operate properly.

If this happens, let the unit sit for an hour or two with the power turned off and wait until there is little difference in temperature before using the unit.

• Cautions on using mobile phones

Using a mobile phone near this unit may result in noise. If that occurs, move the mobile phone away from this unit when it is in use.

• Moving the unit





Turn off the power and unplug the power cord from the power outlet. Next, disconnect the connection cables to other system units before moving the unit.

















• About care









- Wipe the cabinet and control panel clean with a soft cloth.
- Follow the instructions when using a chemical cleaner.
- Benzene, paint thinner or other organic solvents as well as insecticide may cause material changes and discoloration if brought into contact with the unit, and should therefore not be used.

Basic version

Here, we explain the connections and basic operation methods for this unit.

- **Connections**  [page 5](#)
- **Settings**  [page 15](#)
- **Playback (Basic operation)**  [page 22](#)
- **Selecting a listening mode (Surround mode)**  [page 46](#)

	Connection	 page 8, 9
	Playback	–
	Connection	 page 8, 10
	Playback	 page 24
	Connection	 page 8, 10
	Playback	–
	Connection	 page 11
	Playback	 page 27
	Connection	 page 12
	Playback	 page 29
	Connection	 page 14
	Playback	 page 33

	Connection	 page 8, 9
	Playback	 page 24
	Connection	 page 12
	Playback	 page 24
	Connection	 page 11
	Playback	 page 25
	Connection	 page 8
	Playback	–
	Connection	 page 13
	Playback	–

For speaker connections, see [page 53](#),  [page 6 "Connecting the speakers"](#).

Connections

Important information

- Make connections as follows before using this unit. Select an appropriate connection type according to the devices to be connected.
- You may need to make some settings on this unit depending on the connection method. Refer to each description for more information.
- Select the cables (sold separately) according to the devices being connected.

NOTE

- Do not plug in the power cord until all connections have been completed. (When the Setup wizard is running, follow the instructions in the Setup wizard screen for making connections.)
- When running the Setup wizard, turn off the power supply of connected devices.
- When making connections, also refer to the operating instructions of the other devices being connected.
- Be sure to connect the left and right channels properly (left with left, right with right).
- Do not bundle power cords together with connection cables. Doing so can result in noise.

Converting input video signals for output (Video conversion function)

This unit is equipped with three types of video input connectors (HDMI, Component video and video) and three types of video output connectors (HDMI, Component video and video).

Use the connectors corresponding to the devices to be connected.

This function automatically converts various formats of video signals input to this unit into the formats used to output the video signals from this unit to a monitor.

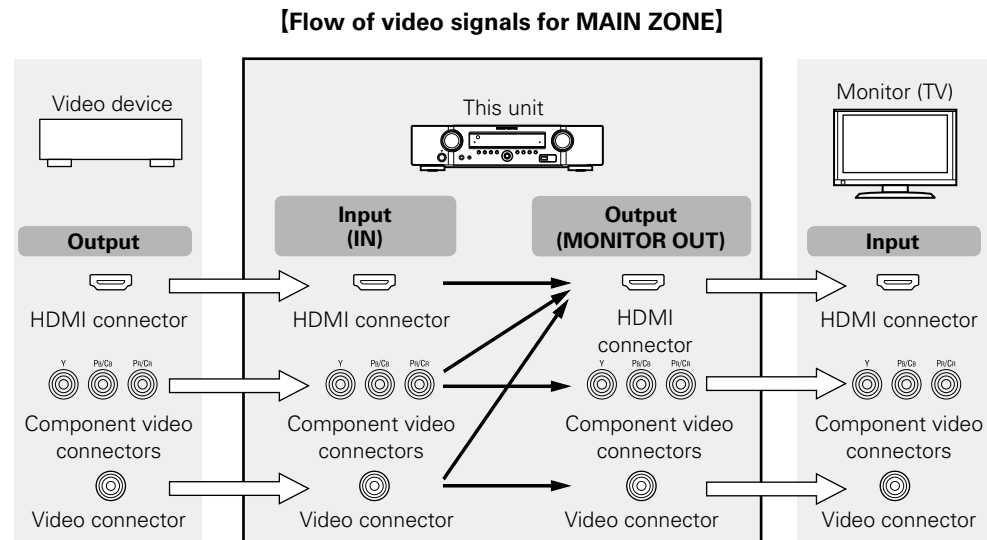

- The video conversion function supports the NTSC, PAL, SECAM, NTSC 4.43, PAL-N, PAL-M and PAL-60 formats.
- Resolutions of HDMI-compatible TVs can be checked at "Monitor Info." ([page 85](#)).

NOTE

- HDMI signals cannot be converted into analog signals.
- Component video input signals cannot be converted into Video format.
- When a non-standard video signal from a game machine or some other source is input, the video conversion function might not operate.

Examples of screen display

- Menu screen

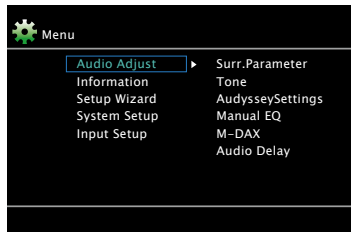

- Status display screen
When the input source is switched.

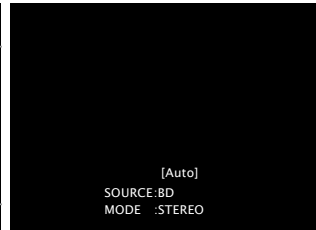

When the volume is adjusted.

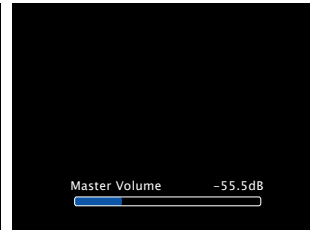

Status display: The operating status appears briefly on the screen when the input source is switched or the volume is changed.

NOTE

- If you operate the menu while playing back 3D video content or computer's resolution (e.g. VGA), the playback video is replaced by the menu screen. The playback video is not displayed behind the menu screen.
- This unit does not show the status display while playing back 3D video content or computer's resolution (e.g. VGA).
- The menu screen and status display are displayed when this unit and a TV are connected by HDMI. Furthermore, the menu screen and status display are not displayed when this unit and a TV are connected by VIDEO and COMPONENT VIDEO.

Connecting an HDMI-compatible device

You can connect up to five HDMI-compatible devices (4-inputs/1-output) to the unit.

HDMI function

This unit supports the following HDMI functions:

- 3D
- Deep Color ([page 125](#))
- Auto Lip Sync ([page 90, 125](#))
- "x.v.Color", sYCC601 color, Adobe RGB color, Adobe YCC601 color ([page 125, 126, 127](#))
- High definition digital audio format
- ARC (Audio Return Channel)
- Content Type
- CEC (HDMI control)

Copyright protection system

In order to play back digital video and audio such as BD-Video or DVD-Video via HDMI connection, both this unit and TV or the player need to support the copyright protection system known as HDCP (High-bandwidth Digital Content Protection System). HDCP is copyright protection technology comprised of data encryption and authentication of the connected AV devices. This unit supports HDCP.

- If a device that does not support HDCP is connected, video and audio are not output correctly. Read the owner's manual of your television or player for more information.

About HDMI cables

- When a device supporting Deep Color is connected, use a cable compatible with "High Speed HDMI cable" or "High Speed HDMI cable with Ethernet".
- When the ARC function is used, connect a device with a "Standard HDMI cable with Ethernet" or "High Speed HDMI cable with Ethernet" for HDMI 1.4a.

HDMI control function ([page 62](#))

This function allows you to operate external devices from the unit and operate the unit from external devices.

NOTE

- The HDMI control function may not work depending on the device it is connected to and its settings.
- You cannot operate a TV or Blu-ray Disc player/DVD player that is not compatible with the HDMI control function.

About 3D function

This unit supports input and output of 3D (3 dimensional) video signals of HDMI 1.4a.

To play back 3D video, you need a TV and player that provide support for the HDMI 1.4a 3D function and a pair of 3D glasses.

NOTE

- When playing back 3D video, refer to the instructions provided in the manual of your playback device together with this manual.
- If you operate the menu while playing back 3D video content, the playback video is replaced by the menu screen. The playback video is not displayed behind the menu screen.
- This unit does not show the status display while playing back 3D video content.
- If 3D video with no 3D information is input, the menu screen and status display on this unit are displayed over the playback video.
- If 2D video is converted to 3D video on the television, the menu screen and status display on this unit are not displayed correctly. To view the menu screen and status display on this unit correctly, turn the television setting that converts 2D video to 3D video off.

About ARC (Audio Return Channel) function

The Audio Return Channel in HDMI 1.4a enables a TV, via a single HDMI cable, to send audio data "upstream" to this unit.

NOTE

- To enable the ARC function, set "HDMI Control" to "ON" ([page 90](#)).
- When connecting a TV that does not support the ARC function, a separate connection using an audio cable is required. In this case, refer to "Connecting a TV" ([page 9](#)) for the connection method.

About Content Type

HDMI 1.4a enables simple, automated picture setting selection with no user intervention.

NOTE

To enable the Content Type, set "Video Mode" to "Auto" ([page 102](#)).

Cables used for connections

Audio and video cable (sold separately)

HDMI cable 

- This interface allows transfer of digital video signals and digital audio signals over a single HDMI cable.

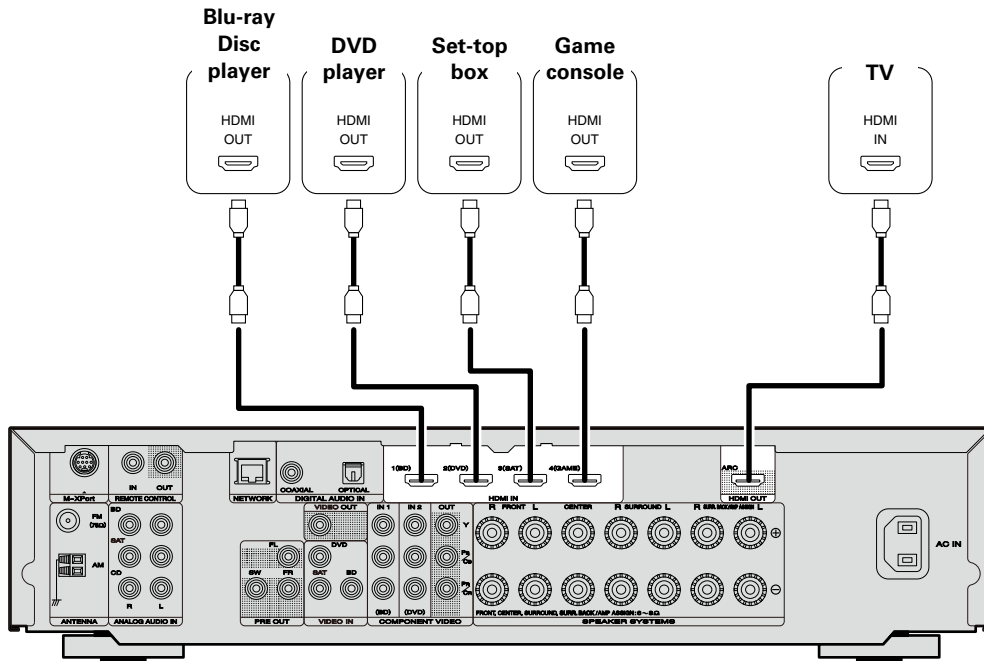

- When this unit is connected to other devices with HDMI cables, connect this unit and TV also with an HDMI cable.
- When connecting a device that supports Deep Color, please use a “High Speed HDMI cable” or “High Speed HDMI cable with Ethernet”.
- Video signals are not output if the input video signals do not match the monitor’s resolution. In this case, switch the Blu-ray Disc/DVD player’s resolution to a resolution with which the monitor is compatible.
- When this unit and monitor are connected with an HDMI cable, if the monitor is not compatible with HDMI audio signal playback, only the video signals are output to the monitor.

NOTE

The audio signal from the HDMI output connector (sampling frequency, number of channels, etc.) may be limited by the HDMI audio specifications of the connected device regarding permissible inputs.

Connecting to a device equipped with a DVI-D connector

When an HDMI/DVI conversion cable (sold separately) is used, the HDMI video signals are converted to DVI signals, allowing connection to a device equipped with a DVI-D connector.

NOTE

- No sound is output when connected to a device equipped with a DVI-D connector. Make separate audio connections.
- Signals cannot be output to DVI-D devices that do not support HDCP.
- Depending on the combination of devices, the video signals may not be output.

Settings related to HDMI connections

Set as necessary. For details, see the respective reference pages.

Input Assign [\(page 101\)](#)

Set this to change the HDMI input connector to which the input source is assigned.

HDMI Setup [\(page 90\)](#)

Make settings for HDMI video/audio output.

- Auto Lip Sync
- HDMI Audio Out
- HDMI Control
- Standby Source
- P.Off Control

NOTE

The audio signal input from the HDMI input connector can be output as an output signal from the HDMI output connector by setting the HDMI audio output destination to TV.

Audio signals input via the Analog/Coaxial/Optical input connectors cannot be output from the HDMI output connector.

Connecting a TV

- Select the connector to use and connect the device.
- For video connections, see “Converting input video signals for output (Video conversion function)” ([page 5](#)).
- For instructions on HDMI connections, see “Connecting an HDMI-compatible device” ([page 7](#)).



To listen to TV audio through this device, use the optical digital connection.

NOTE

The optical connection is not required when a TV compatible with the ARC function (Audio Return Channel HDMI 1.4a standard function) is connected to this unit via an HDMI connection.

For details, see “About ARC (Audio Return Channel) function” ([page 7](#)) or refer to the instruction manual for your TV.

Cables used for connections

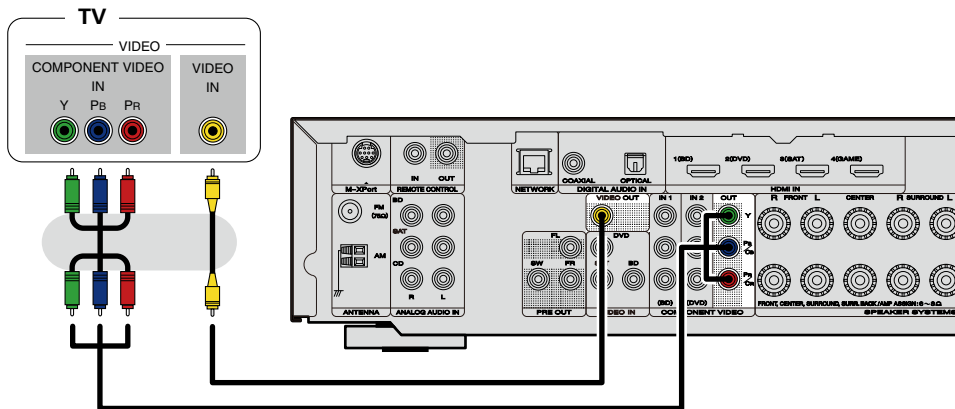
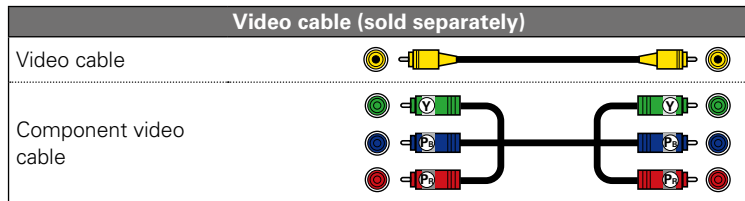

in Set as Necessary

At the time of purchase, the OPTICAL input connector is assigned to “CD”. To use the OPTICAL input connector for the TV audio input, change the settings of “Input Assign” ([page 101](#)) in the menu.

Connecting a Blu-ray Disc player

- You can enjoy video and audio from a Blu-ray Disc.
- Select the connector to use and connect the device.
- For instructions on HDMI connections, see “Connecting an HDMI-compatible device” ([page 7](#)).

Cables used for connections

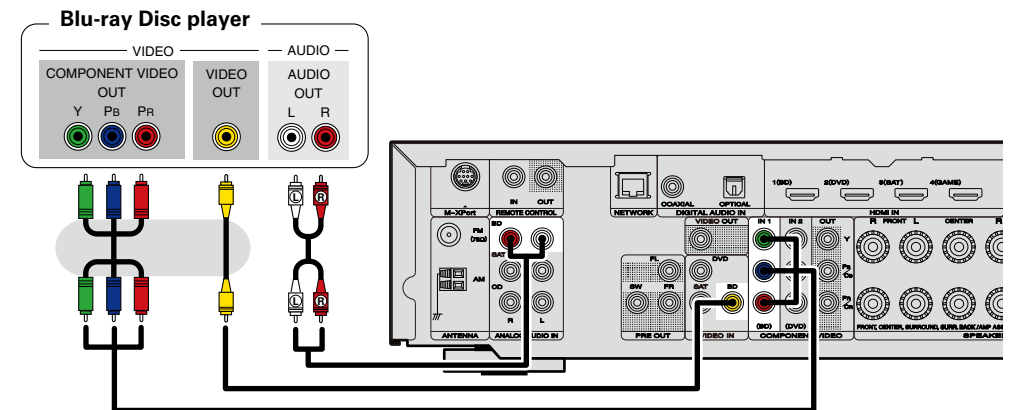
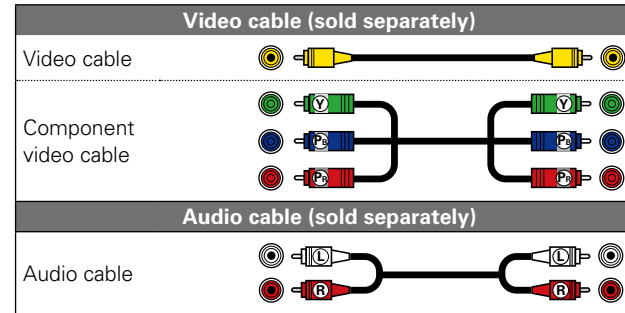

in Set as Necessary

Set this to change the digital input connector or component video input connector to which the input source is assigned.

“Input Assign” ([page 101](#))



When you want to play back HD Audio (Dolby TrueHD, DTS-HD, Dolby Digital Plus, DTS Express) and Multi-channel PCM with this unit, use an HDMI connection ([page 7](#) “Connecting an HDMI-compatible device”).

Connecting a DVD player

- You can enjoy video and audio from a DVD.
- Select the connector to use and connect the device.
- For instructions on HDMI connections, see “Connecting an HDMI-compatible device” ([page 7](#)).

Cables used for connections

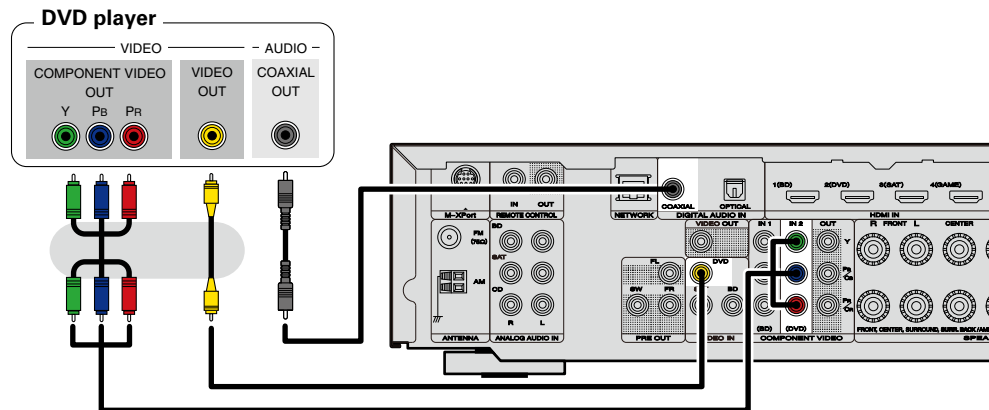
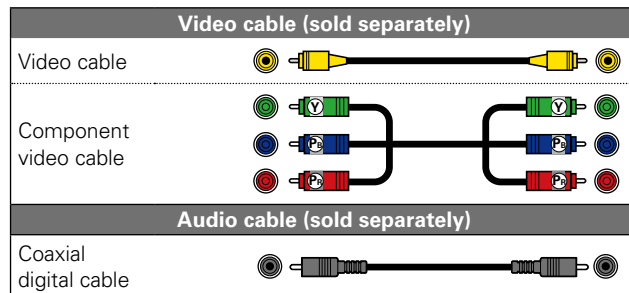

in Set as Necessary

Set this to change the digital input connector or component video input connector to which the input source is assigned.

“Input Assign” ([page 101](#))

Connecting a set-top box (Satellite tuner/Cable TV)

- You can watch satellite or cable TV.
- Select the connector to use and connect the device.
- For instructions on HDMI connections, see “Connecting an HDMI-compatible device” ([page 7](#)).

Cables used for connections

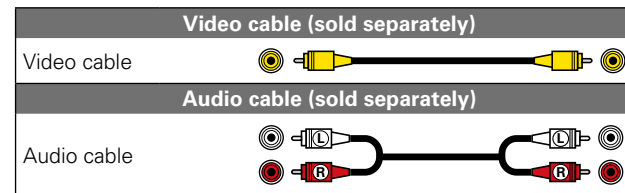

Satellite tuner/ Cable TV

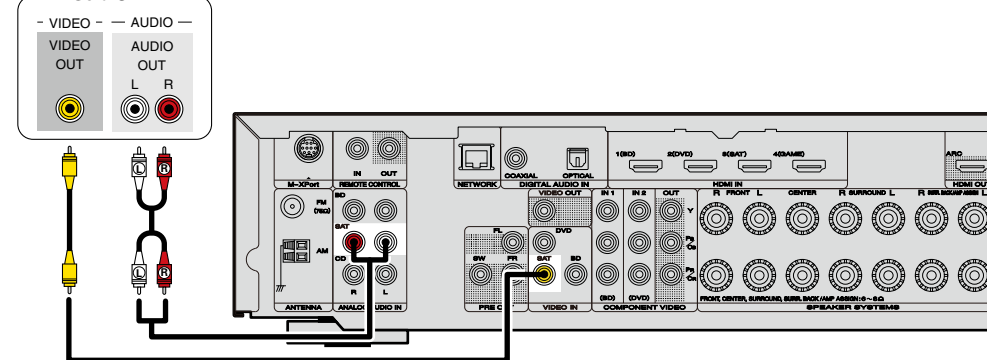

in Set as Necessary

Set this to change the digital input connector or component video input connector to which the input source is assigned.

“Input Assign” ([page 101](#))

Connecting an iPod or USB memory device to the USB port

You can enjoy music stored on an iPod or USB memory device.

Cables used for connections

To connect an iPod to this unit, use the USB cable supplied with the iPod.

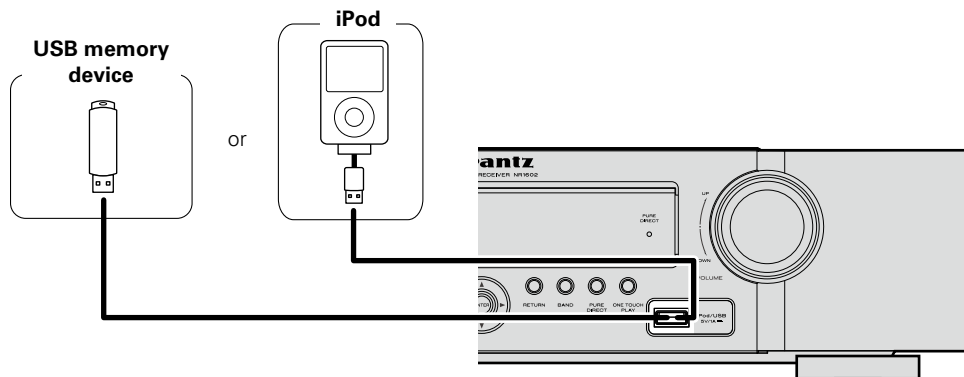

marantz does not guarantee that all USB memory devices will operate or receive power. When using a portable USB connection type HDD of the kind to which an AC adapter can be connected to supply power, use the AC adapter.

NOTE

- USB memory devices will not work via a USB hub.
- Do not use an extension cable when connecting a USB memory device. This may cause radio interference with other devices.
- This unit does not support playback on an iPad. Do not connect an iPad to the unit.
- When connecting an iPhone to this unit, keep the iPhone at least 20 cm away from this unit. If the iPhone is kept closer to this unit and a telephone call is received by the iPhone, noise may be output from this device.

Supported iPod models

• iPod / iPod classic



iPod
5th generation
(video)
60GB 80GB



iPod
5th generation
(video)
30GB



iPod classic
80GB



iPod classic
160GB (2007)



iPod classic
160GB (2009)

• iPod nano



iPod nano
1st generation
1GB 2GB 4GB



iPod nano
2nd generation
(aluminum)
2GB 4GB 8GB



iPod nano
3rd generation
(video)
4GB 8GB



iPod nano
4th generation (video)
8GB 16GB



iPod nano
5th generation (video camera)
8GB 16GB



iPod nano
6th generation
8GB 16GB

• iPod touch



iPod touch
1st generation
8GB 16GB 32GB



iPod touch
2nd generation
8GB 16GB 32GB



iPod touch
3rd generation
32GB 64GB



iPod touch
4th generation
8GB 32GB 64GB

• iPhone



iPhone
4GB 8GB 16GB



iPhone 3G
8GB 16GB



iPhone 3GS
8GB 16GB 32GB



iPhone 4
16GB 32GB

Connecting a CD player

- You can enjoy CD sound.
- Select the connector to use and connect the device.

Cables used for connections

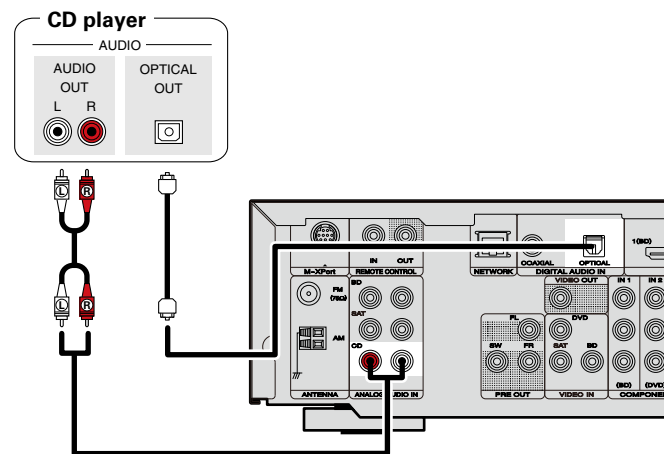
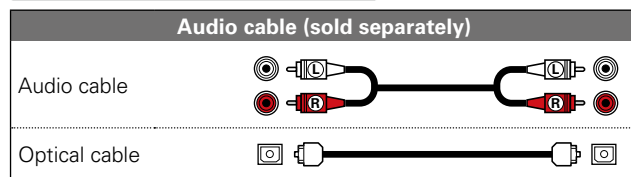

in Set as Necessary

Set this to change the digital input connector to which the input source is assigned.
"Input Assign" (page 101)

Connecting an antenna

- Connect the FM antenna or AM loop antenna supplied with the unit to enjoy listening to radio broadcasts.
- After connecting the antenna and receiving a broadcast signal (page 29 "Listening to FM/AM broadcasts"), fix the antenna with tape in a position where the noise level becomes minimal.

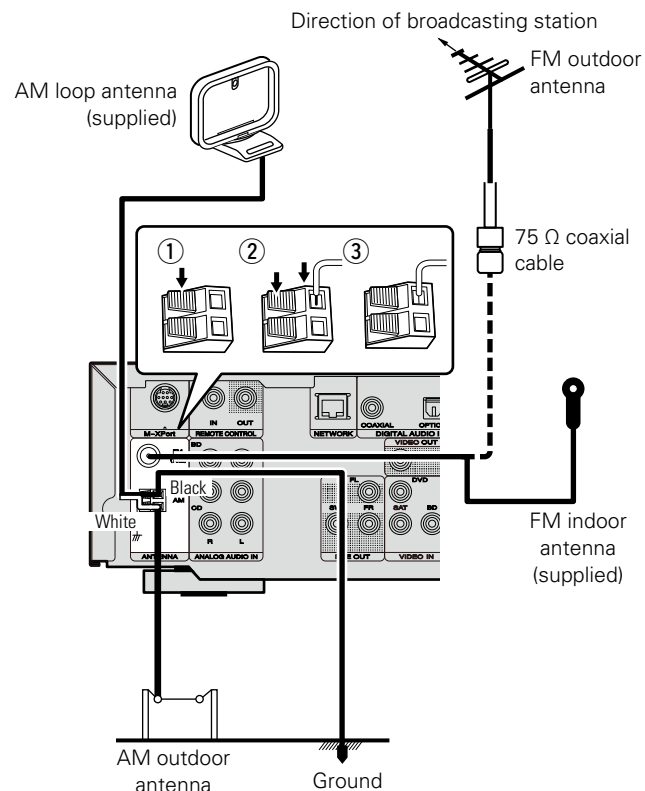

AM loop antenna assembly

- 1 Put the stand section through the bottom of the loop antenna from the rear and bend it forward.
- 2 Insert the projecting part into the square hole in the stand.

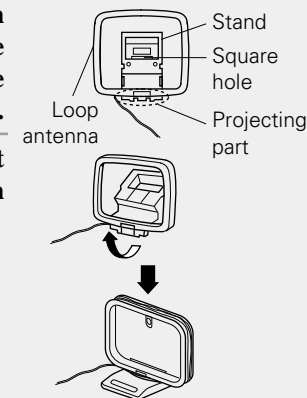

Using the AM loop antenna Suspending on a wall

Suspend directly on a wall without assembling.

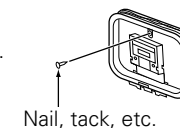

Standing alone

Use the procedure shown above to assemble.

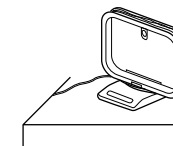

NOTE

- Do not connect two FM antennas simultaneously.
- Even if an external AM antenna is used, do not disconnect the AM loop antenna.
- Make sure the AM loop antenna lead terminals do not touch metal parts of the panel.
- If the signal has noise interference, connect the ground terminal (GND) to reduce noise.
- If you are unable to receive a good broadcast signal, we recommend installing an outdoor antenna. For details, inquire at the retail store where you purchased the unit.

Connecting a wireless receiver (RX101)

By connecting a wireless receiver RX101 (sold separately) to this unit, you can receive and playback audio signals from other devices using the Bluetooth Communication Function.

- Use a Bluetooth device that is A2DP compatible (☞ [page 125](#) "A2DP").
- You can also use wireless receiver RX101 as an external IR receiver.
- For instructions on the wireless receiver settings, refer to the RX101's operating instructions.

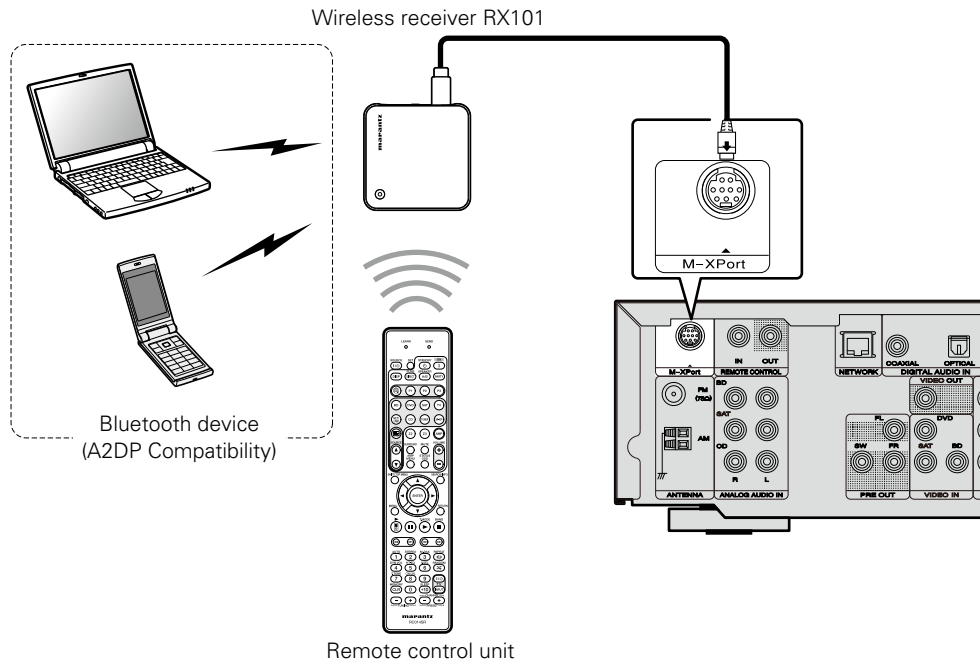

You can enjoy listening to music by connecting a wireless receiver via the M-XPport input connector. In this case, set the input source to "M-XPport".

NOTE

To use wireless receiver RX101 as external IR receiver, set the remote sensor function of this unit to disable (☞ [page 105](#) "Remote control settings").

Connecting to a home network (LAN)

- This unit lets you play via your home network (LAN) music files stored on a computer and music content such as that from Internet radio.
You can also operate this unit from a computer using the Web control function.
- You can update by downloading the latest firmware from the marantz website.
For more information, on the menu, select "Firmware Update" ([page 97](#)).
- See "Network Setup" on the menu ([page 92](#)) for more information on network setting.

Cables used for connections

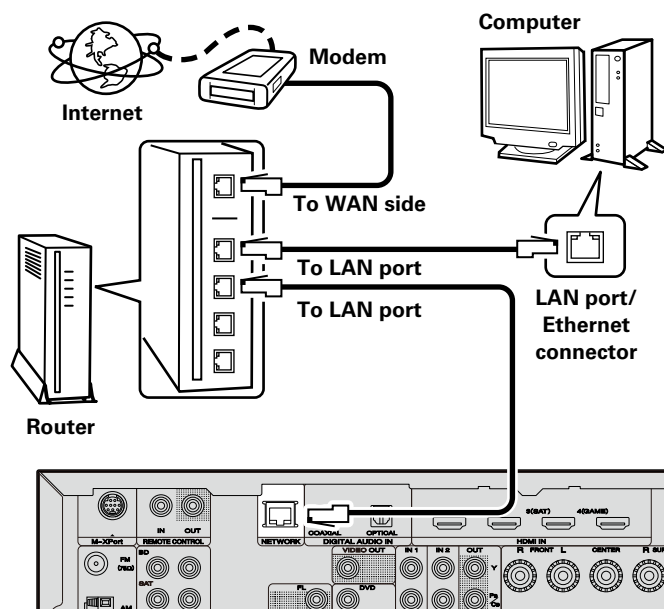
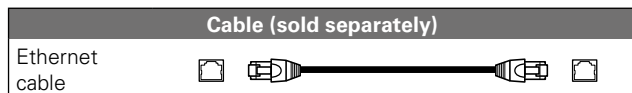

For connections to the Internet, contact an ISP (Internet Service Provider) or a computer shop.

Required system

❑ Broadband internet connection

❑ Modem

Device that connects to the broadband circuit and conducts communications on the Internet.

A type that is integrated with a router is also available.

❑ Router

When using this unit, we recommend you use a router equipped with the following functions:

- Built-in DHCP server
This function automatically assigns IP addresses on the LAN.
- Built-in 100BASE-TX switch

When connecting multiple devices, we recommend a switching hub with a speed of 100 Mbps or greater.

❑ Ethernet cable (CAT-5 or greater recommended)

- Use only a shielded STP or ScTP LAN cable which is available at retailer.
- Some flat type Ethernet cables are easily affected by noise.
We recommend using a normal type cable.



- If you have an Internet provider contract for a line on which network settings are made manually, make the settings at "Network Setup" ([page 92](#)).
- With this unit, it is possible to use the DHCP and Auto IP functions to make the network settings automatically.
- When using this unit with the broadband router's DHCP function enabled, this unit automatically performs the IP address setting and other settings.
When using this unit connected to a network with no DHCP function, make the settings for the IP address, etc., at "Network Setup" ([page 92](#)).
- When setting manually, check the setting contents with the network administrator.

NOTE

- A contract with an ISP is required to connect to the Internet.
No additional contract is needed if you already have a broadband connection to the Internet.
- The types of routers that can be used depend on the ISP. Contact an ISP or a computer shop for details.
- marantz assumes no responsibility whatsoever for any communication errors or troubles resulting from customer's network environment or connected devices.
- This unit is not compatible with PPPoE. A PPPoE-compatible router is required if you have a contract for a type of line set by PPPoE.
- Do not connect an NETWORK connector directly to the LAN port/Ethernet connector on your computer.
- To listen to audio streaming, use a router that supports audio streaming.

Settings

Here, we explain “Audyssey® Auto Setup”, which allows you to automatically make the optimal settings for your speakers, and “Network Setup”, which allows you to connect this unit to a home network (LAN).

This unit lets you play via your home network (LAN) music files stored on a computer and music content such as that from Internet radio.

❑ Set up speakers (Audyssey® Auto Setup)

(👉 [page 15](#))

❑ Making the network settings (Network Setup)

(👉 [page 21](#))

Playback (Basic operation) (👉 [page 22](#))

Selecting a listening mode (Surround mode)

(👉 [page 46](#))

Playback (Advanced operation) (👉 [page 62](#))



Set up speakers (Audyssey® Auto Setup)



The acoustic characteristics of the connected speakers and listening room are measured and the optimum settings are made automatically. This is called “Audyssey® Auto Setup”.

To perform measurement, place the setup microphone in multiple locations all around the listening area. For best results, we recommend you measure in six positions, as shown in the illustration (up to six positions).

- When performing Audyssey® Auto Setup, Audyssey MultEQ®/Audyssey Dynamic EQ®/Audyssey Dynamic Volume® functions become active (👉 [page 82, 83](#)).
- To set up the speakers manually, use “Speaker Setup” (👉 [page 87](#)) on the menu.

NOTE

- Make the room as quiet as possible. Background noise can disrupt the room measurements. Close windows, silence cell phones, televisions, radios, air conditioners, fluorescent lights, home appliances, light dimmers, or other devices as measurements may be affected by these sounds.
- Cell phones should be placed away from all audio electronics during the measurement process as Radio Frequency Interference (RFI) may cause measurement disruptions (even if the cell phone is not in use).
- Do not unplug the setup microphone from the main unit until Audyssey® Auto Setup is completed.
- Do not stand between the speakers and setup microphone or allow obstacles in the path while the measurements are being made. This will cause inaccurate readings.
- Loud test sounds may be played during Audyssey® Auto Setup. This is part of normal operation. If there is background noise in room, these test signals will increase in volume.
- Operating **VOLUME +, -** during the measurements will cancel the measurements.
- Measurement cannot be performed when headphones are connected.

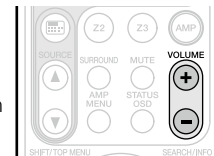

About setup microphone placement

- Measurements are performed by placing the setup microphone successively at multiple positions throughout the entire listening area, as shown in **[Example ①]**. For best results, we recommend you measure in six positions, as shown in the illustration (up to six positions).
- Even if the listening environment is small as shown in **[Example ②]**, measuring at multiple points throughout the listening environment results in more effective correction.

[Example ①]

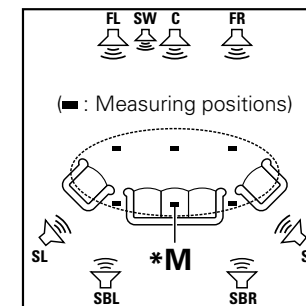

[Example ②]

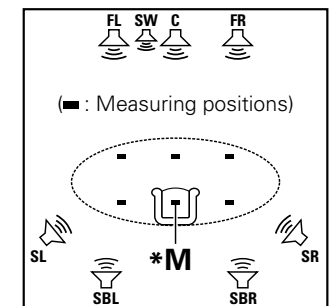

- FL** Front speaker (L)
- FR** Front speaker (R)
- C** Center speaker
- SW** Subwoofer

- SL** Surround speaker (L)
- SR** Surround speaker (R)
- SBL** Surround back speaker (L)
- SBR** Surround back speaker (R)

About the main listening position (*M)

The main listening position is the position where listeners would normally sit or where one would normally sit alone within the listening environment. Before starting Audyssey® Auto Setup, place the setup microphone in the main listening position. Audyssey MultEQ® uses the measurements from this position to calculate speaker distance, level, polarity, and the optimum crossover value for the subwoofer.

1 Set up the microphone

Mount the setup microphone on a tripod or stand and place it in the main listening position.

When placing the setup microphone, adjust the height of the sound receptor to the level of the listener's ear.

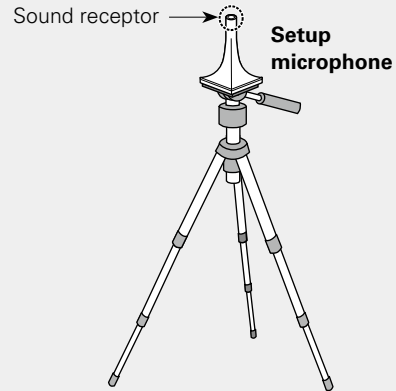

If you do not have a tripod or stand, set up the microphone on, for example, a seat without a back.

NOTE

- Do not hold the setup microphone in your hand during measurements.
- Avoid placing the setup microphone close to a seat back or wall as sound reflections may give inaccurate results.

2 Set up the subwoofer

If using a subwoofer capable of the following adjustments, set up the subwoofer as shown below.

□ When using a subwoofer with a direct mode

Set the direct mode to "On" and disable the volume adjustment and crossover frequency setting.

□ When using a subwoofer without a direct mode

Make the following settings:

- **Volume** : "12 o'clock position"
- **Crossover frequency** : "Maximum/Highest Frequency"
- **Low pass filter** : "Off"
- **Standby mode** : "Off"

3 Set up the remote control unit

□ Set up the operation mode

Press **AMP** to set the remote control unit to AMP-operation mode.

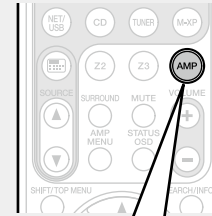

Press AMP

STEP 1 Preparation

4 Connect the setup microphone to the SETUP MIC jack of this unit.

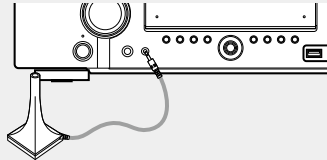

When the setup microphone is connected, the following screen is displayed.

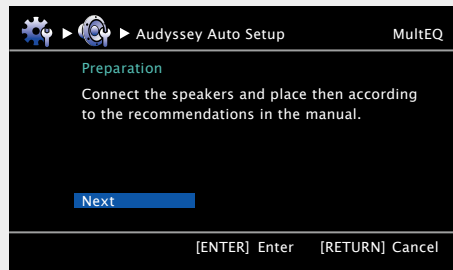

5 Select “Next” and then press ENTER.

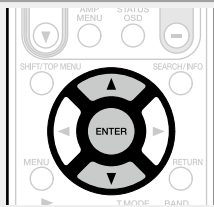

STEP 2 Detect & Measure (Main)

6 Use Δ / ∇ to select “Auto Setup Start” and then press ENTER.

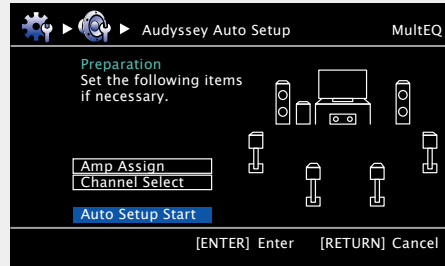

Here, we explain setup using the example of 7.1-channel speaker playback using surround back speakers. For setup of surround speaker systems other than 7.1-channels, follows steps 4 and 5 in “Set up “Amp Assign”” (page 59). . If unused channels are set with “Channel Select”, measuring time can be shortened. For setting, perform steps 7 to 10 of “Set up “Channel Select”” (page 60).

- In STEP 2, you will perform measurements at the main listening position.
- This step automatically checks the speaker configuration and speaker size, and calculates the channel level, distance, and crossover frequency.

It also corrects distortion in the listening area.

7 Select “Measure” and then press ENTER.

When measuring begins, a test tone is output from each speaker.

- Measurement requires several minutes.

8 The detected speakers are displayed.

- The illustration below shows an example of when the front speakers, center speaker, subwoofer, and surround speakers have been detected.

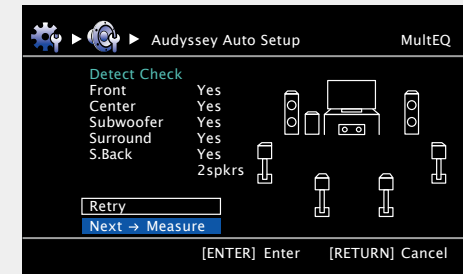

NOTE

If a connected speaker is not displayed, the speaker may not be connected correctly. Check the speaker connection.

9 Use Δ / ∇ to select “Next → Measure” and then press ENTER.

STEP 2 (Continued) Detect & Measure (Main)

NOTE

If "Caution!" is displayed:

Go to "Error messages" (page 20), check any related items, and perform the necessary procedures.

If the problem is resolved, return and restart "Audyssey® Auto Setup".

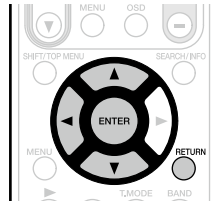

When performing Audyssey® Auto Setup over again

Press Δ / ∇ to select "Retry", and then press **ENTER**.

When measuring has stopped

- ① Press **RETURN**, to the "Cancel Auto Setup?" prompt is displayed.
- ② Press \leftarrow to select "Yes", then press **ENTER**.

Setting up the speakers again

Repeat the operation from step 4 of **STEP 1 Preparation**.

STEP 3 Measure (2nd – 6th)

- In STEP 3, you will perform measurements at multiple positions (two to six positions) other than the main listening position.
- Just one position can be measured but measuring multiple positions increases the accuracy of the correction of acoustic distortion within the listening area.

10 Move the setup microphone to position 2, use Δ / ∇ to select "Measure", and then press **ENTER**.

The measurement of the second position starts. Measurements can be made in up to six positions.

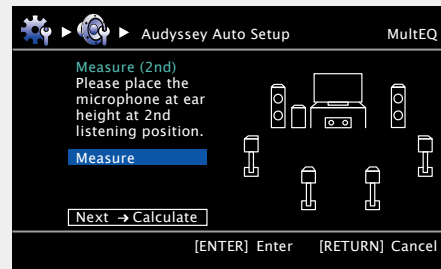

If you want to omit measurements from the next position onward, select "Next \rightarrow Calculate".

(Go to **STEP4 Calculate**)

11 Repeat step 10, measuring positions 3 to 6.

When measurement of position 6 is completed, a "Measurements finished." message is displayed.

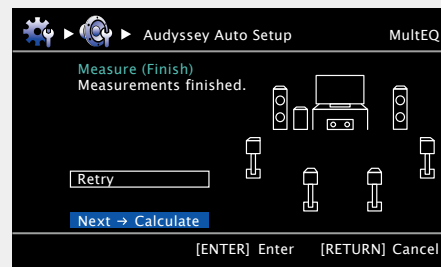

STEP 4 Calculate

12 On the **STEP 3** screen, use Δ / ∇ to select "Next \rightarrow Calculate", and then press **ENTER**.

Measuring results are analyzed, and the frequency response of each speaker in the listening room is determined.

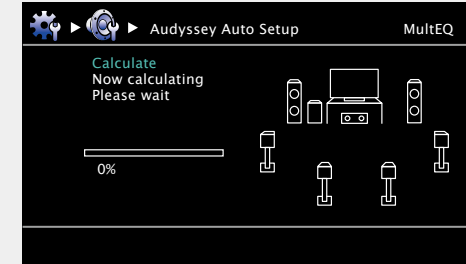

- Analysis takes several minutes to complete. The time required for this analysis depends on the number of speakers connected. The more connected speakers there are, the longer it takes to perform analysis.

STEP 5 Check

- 13** Use Δ / ∇ to select the item you want to check, and then press **ENTER**.

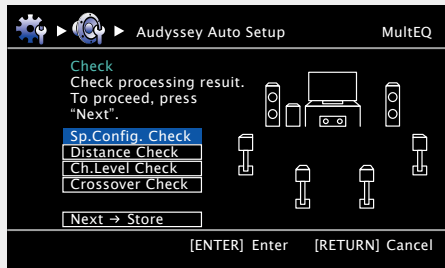
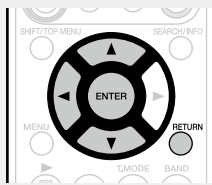

- Subwoofers may measure a greater reported distance than the actual distance due to added electrical delay common in subwoofers.
- If you want to check another item, press **RETURN**.

- 14** Use Δ / ∇ to select “Next → Store” and then press **ENTER**.

NOTE

- If the result differs from the actual connection status, or if “Caution!” is displayed, see “Error messages” ([page 20](#)). Then carry out Audyssey® Auto Setup again.
- If you change speaker positions or orientation, perform Audyssey® Auto Setup again to find the optimal equalizer settings.

STEP 6 Store

- 15** Select “Store” and then press **ENTER**.
Save the measurement results.

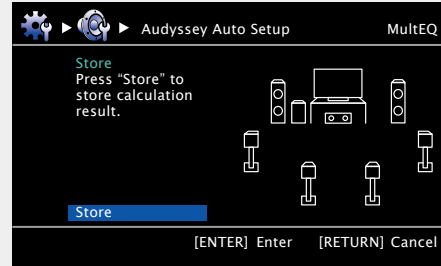

- Saving the results requires about 10 seconds.
- If the measuring results are not to be saved, press **RETURN**. A message “Cancel Auto Setup?” will be displayed. Press \triangleleft then select “Yes”. All the measured Audyssey® Auto Setup data will be erased.
- During saving of measurements results, “Now storing Please wait” is displayed. When saving is completed, “Storing complete. Auto Setup is now finished.” is displayed.

NOTE

During saving of measurement results, be sure not to turn off the power.

Finish

- 16** Unplug the setup microphone from the unit’s **SETUP MIC** jack.

- 17** Set Audyssey Dynamic Volume®.

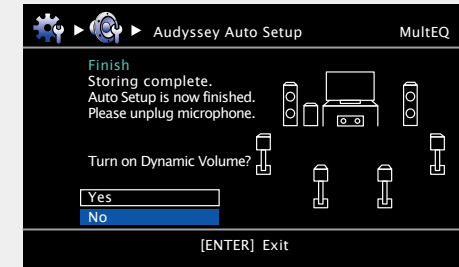

- This feature adjusts the output volume to the optimal level while constantly monitoring the level of the audio input to the unit. Optimal volume control is performed automatically without any loss in the dynamism and clarity of the sound when, for example, the volume suddenly increases for commercials shown during television programs.

When turning Dynamic Volume® on

- Use Δ to select “Yes”, and then press **ENTER**. The unit automatically enters “Medium” mode.

When turning Dynamic Volume® off

- Use ∇ to select “No”, and then press **ENTER**.

NOTE

After performing Audyssey® Auto Setup, do not change the speaker connections or subwoofer volume. In event of a change, perform Audyssey® Auto Setup again.

Error messages

NOTE

- An error message is displayed if Audyssey® Auto Setup could not be completed due to speaker placement, the measurement environment, etc. If this happens, check the relevant items, be sure to take the necessary measures, then perform Audyssey® Auto Setup over again.
- If the result still differs from the actual connection status after remeasurement or the error message still appears, it is possible that the speakers are not connected properly. Turn this unit off, check the speaker connections and repeat the measurement process from the beginning.
- Be sure to turn off the power before checking speaker connections.

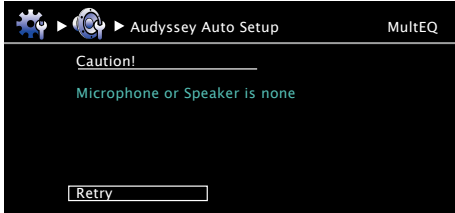
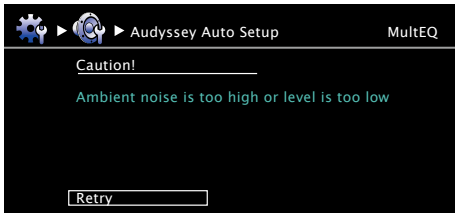
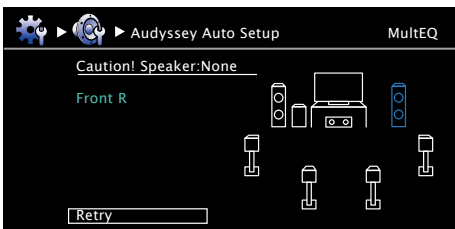
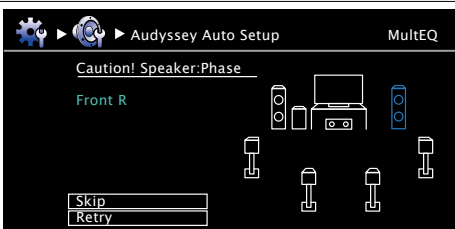
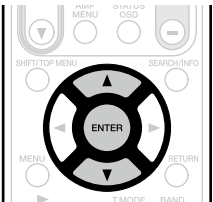
Examples	Error details	Measures
	<ul style="list-style-type: none"> • The connected setup microphone is broken, or a device other than the supplied setup microphone is connected. • Not all speakers could be detected. • The front L speaker was not properly detected. 	<ul style="list-style-type: none"> • Connect the included setup microphone to the SETUP MIC jack of this unit. • Check the speaker connections.
	<ul style="list-style-type: none"> • There is too much noise in the room for accurate measurements to be made. • Speaker or subwoofer sound is too low for accurate measurements to be made. 	<ul style="list-style-type: none"> • Either turn off any device generating noise or move it away. • Perform again when the surroundings are quieter. • Check the speaker installation and the direction in which the speakers are facing. • Adjust the subwoofer's volume.
	<ul style="list-style-type: none"> • The displayed speaker could not be detected. (The screen on the left indicates that the front right speaker cannot be detected.) 	<ul style="list-style-type: none"> • Check the connections of the displayed speaker.
	<ul style="list-style-type: none"> • The displayed speaker is connected with the polarity reversed. (The screen on the left indicates that the polarity phases of the front right speakers are reversed.) 	<ul style="list-style-type: none"> • Check the polarity of the displayed speaker. • For some speakers, this error message may be displayed even if the speaker is properly connected. If you are sure the connection is correct, press $\Delta \nabla$ to select "Skip", then press ENTER. 

Parameter Check

This function enables you to check the measurement results and equalizer characteristics after Audyssey® Auto Setup.

1 Use Δ / ∇ to select “Parameter Check” and then press **ENTER**.

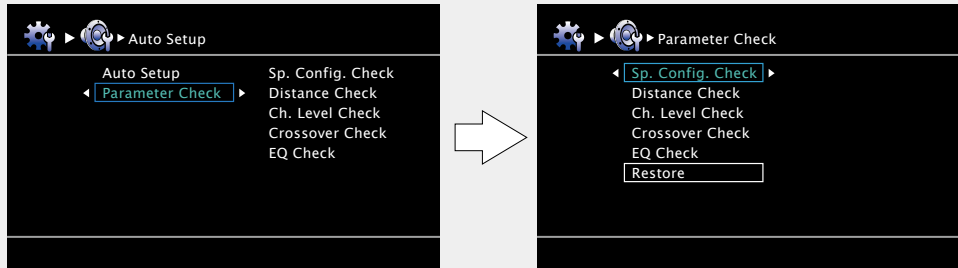

2 Use Δ / ∇ to select the item you want to check, then press **ENTER** or \triangleright .

Measurement results for each speaker are displayed.

Sp. Config. Check	Check the speaker configuration.
Distance Check	Check the distance.
Ch. Level Check	Check the channel level.
Crossover Check	Check the crossover frequency.
EQ Check	Check the equalizer.

- If “EQ Check” is selected, press Δ / ∇ to select equalizing curve (“Audyssey” or “Audyssey Flat”) to be checked.
Use \triangleleft / \triangleright to switch the display between the different speakers.

3 Press **RETURN**.

The confirmation screen reappears. Repeat step 2.

Retrieving Audyssey® Auto Setup settings

If you set “Restore” to “Yes”, you can return to Audyssey® Auto Setup measurement result (value calculated at the start by MultEQ®) even when you have changed each setting manually.



Making the network settings (Network Setup)



This unit can be connected to a home network (LAN) to listen to Internet radio or play back music files and still image (JPEG) files stored on a computer.

1 Connect the Ethernet cable (👉 [page 14](#) “Connecting to a home network (LAN)”).

2 Turn on this unit (📖 [page 5](#) “Getting Started”).

This unit performs automatic network setup due to the DHCP function.

When connecting to a network that has no DHCP function, perform the setting in “Network Connect.” (👉 [page 92](#)).

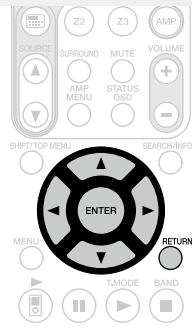

Playback (Basic operation)

Settings (🔗 page 15)

- ❑ **Selecting the input source** (🔗 page 22)
- ❑ **Adjusting the master volume** (🔗 page 23)
- ❑ **Turning off the sound temporarily** (🔗 page 23)

❑ **Playing a Blu-ray Disc player/DVD player**

(🔗 page 24)

- ❑ **Playing a CD player** (🔗 page 24)
- ❑ **Playing an iPod** (🔗 page 25)
- ❑ **Playing a USB memory device** (🔗 page 27)
- ❑ **Tuning in radio stations** (🔗 page 29)
- ❑ **Playing a network audio** (🔗 page 33)

Selecting a listening mode (Surround mode)

(🔗 page 46)

Playback (Advanced operation) (🔗 page 62)

Important information

Before starting playback, make the connections between the different devices and the settings on the unit.

NOTE

Also refer to the operating instructions of the connected devices when playing them.

Selecting the input source

Press the input source select button (**BD, DVD, SAT, TV, NET/USB, CD, TUNER or M-XP**) twice to be played back.

When an input source select button (**BD, DVD, SAT, TV, CD, NET/USB, TUNER or M-XP**) is pressed once, the unit switches to device selected by the operating mode of the remote control. If the input source select button is then pressed again twice, the input source for the unit is switched.

- When  is pressed, the input source of this unit is switched to "NET/USB" and the connected iPod is automatically played (🔗 page 26 "iPod play function").

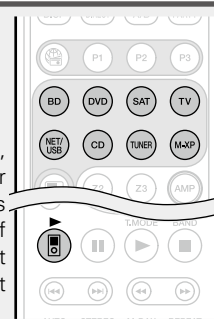

The input source "GAME" is selected to playback from a game device connected to GAME connector of HDMI IN.





Select the input source "GAME" using one of the following methods.

- "Source Select" menu
(Using the "Source Select" menu" provided on the right)
- **SOURCE ▲▼** button on the remote control unit
(Using the **SOURCE ▲▼** button on the remote control unit" (🔗 page 23))
- **INPUT SELECTOR** knob on the main unit
(Using the knob on the main unit" (🔗 page 23))

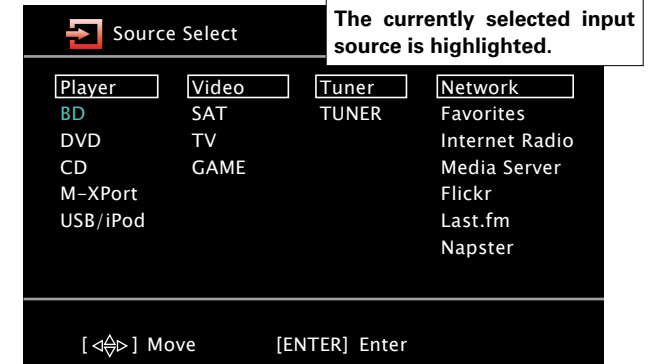

You can also use the following operation to select an input source.

❑ Using the "Source Select" menu

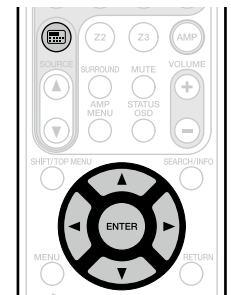

- 1 Press .
Display the "Source Select" menu.
- 2 Use     to select the input source, then press **ENTER**.
The input source is set and the source selection menu is turned off.



- When using with an iPod connected directly to the USB port of this unit, select "USB/iPod" for the input source.
- Input sources that are not going to be used can be set ahead of time. Make this setting at "Source Delete" (🔗 page 96).
- To turn off the source selection menu without selecting an input source, press  again.
- When  is pressed, the AMP-operation mode starts automatically (🔗 page 106).

Using the SOURCE ▲▼ button on the remote control unit

Press **SOURCE ▲** or **SOURCE ▼**.

- Every time you press **SOURCE ▲** or **SOURCE ▼**, the input source switches in the following order.

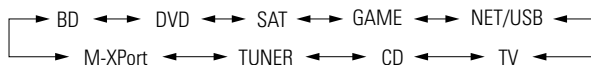
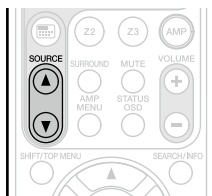

Using the knob on the main unit

Turn **INPUT SELECTOR**.

- Every time you turn **INPUT SELECTOR**, the input source switches in the following order.

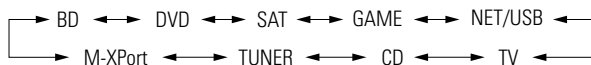

Adjusting the master volume

Use **VOLUME +, -** to adjust the volume.

- When the "Volume Display" setting (☞ [page 96](#)) is "Relative" [Adjustable range]

--- -80.5dB - 18.0dB

- When the "Volume Display" setting (☞ [page 96](#)) is "Absolute"

[Adjustable range] 0.0 - 99.0

- The variable range differs according to the input signal and channel level setting.



You can also operate via the main unit. In this case, perform the following operations.

Turn **VOLUME** to adjust the volume.

Turning off the sound temporarily

Press **MUTE**.

- "MUTE" indicator on the display lights.
-  appears on a TV screen.

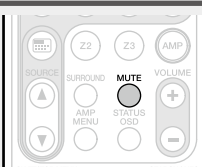

- The sound is reduced to the level set at "Mute Level" (☞ [page 96](#)).
- To cancel, press **MUTE** again. Muting can also be canceled by adjusting the master volume.

Set the front speakers to be used

Press **SPEAKER A/B**.

- Each time you press **SPEAKER A/B**, the front speaker setting will change as follows.

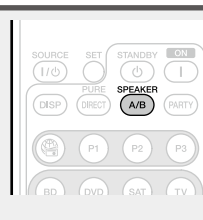
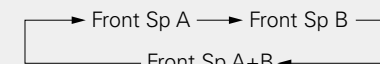

If you use front speakers A and B, set "Amp Assign" to "Front B" (☞ [page 87](#)) in advance.

Playing a Blu-ray Disc player/DVD player

The following describes the procedure for playing Blu-ray Disc player/DVD player.

1 Prepare for playback.

- ① Turn on the power of the TV, subwoofer and player.
- ② Change the TV input to the input of this unit.
- ③ Load the disc in the player.



2 Press ON to turn on power to the unit.

3 Press BD or DVD twice to switch an input source for a player used for playback.

4 Play the device connected to this unit.

Make the necessary settings on the player (language setting, subtitles setting, etc.) beforehand.

Playing a CD player

The following describes the procedure for playing CD player.

1 Prepare for playback.

- ① Turn on the power of the subwoofer and player.
- ② Load the disc in the player.

2 Press ON to turn on power to the unit.

3 Press CD twice to switch the input source to the CD player.

4 Play the device connected to this unit.



Playing an iPod

You can enjoy music stored on an iPod.

1 Connect the iPod to the USB port (see [page 11](#) “Connecting an iPod or USB memory device to the USB port”).

2 Press **ON** to turn on power to the unit.

3 Press **NET/USB** twice to switch the input source to “NET/USB”.

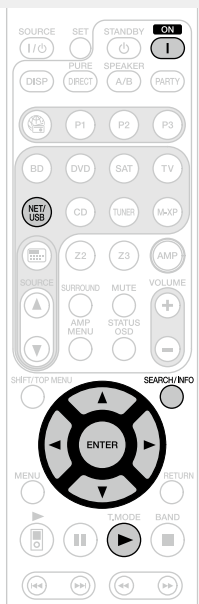
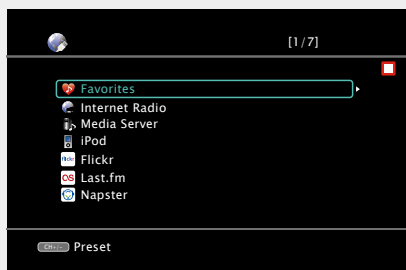

4 Use Δ / ∇ to select “iPod”, then press **ENTER** or \triangleright .

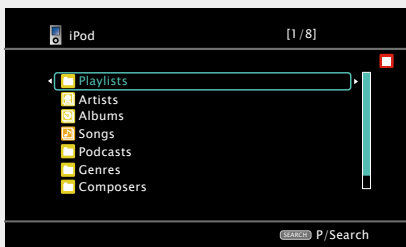

NOTE

If the “iPod” is not displayed, the iPod may not be properly connected. Reconnect it.

5 Press **SEARCH/INFO** and hold it down for 2 seconds or more to select the display mode.

• There are two modes for displaying the contents recorded on the iPod.

Remote mode Display iPod information on the TV screen.

- The unit display shows single-byte alphanumeric characters and some symbols only. “.” is displayed in place of incompatible characters.
- In “Remote mode”, the iPod display is as shown at right.



Direct mode Display iPod information on the iPod screen.

- “Direct iPod” is displayed on the display of this unit.

Display mode		Remote mode	Direct mode
Playable files	Music file	✓	✓
	Video file		*
Active buttons	Remote control unit (This unit)	✓	✓
	iPod		✓

* Only the sound is played.

6 Use Δ / ∇ to select the item, then press **ENTER** or \triangleright to select the file to be played.

7 Press **ENTER**, \triangleright or \blacktriangleright . Playback starts.



- You can specify the duration of the on-screen display to be displayed (default: 30 sec) at menu “iPod” (see [page 97](#)). Press Δ / ∇ / \triangleleft / \triangleright to return to the original screen.
- To play back compressed audio with extended bass or treble reproduction, we recommend playback in M-DAX mode (see [page 84](#)). The default setting is “OFF”.
- In Remote mode, press **STATUS** on the main unit during playback to check the title name, artist name, and album name.

NOTE

- Depending on the type of iPod and the software version, some functions may not operate.
- Note that marantz will accept no responsibility whatsoever for any problems arising with the data on an iPod when using this unit in conjunction with the iPod.

□ iPod operation

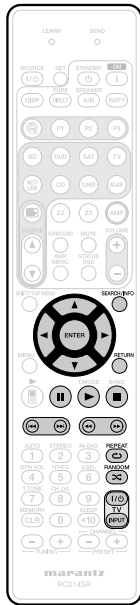

Operation buttons	Function
SEARCH/INFO (Press and release)	Page search*1 / Character sort*2
SEARCH/INFO (Press and hold)	Remote / Direct mode switching
△▽◀▶	Cursor operation / Auto search (cue, △▽) / Manual search (Press and hold, △▽)
ENTER (Press and release)	Enter / Pause
ENTER (Press and hold)	Stop
RETURN	Return
⏸	Pause
▶	Playback / Pause
■	Stop
⏮⏪⏩⏭	Auto search (cue)
⏮⏪⏩⏭ (Press and hold)	Manual search (fast-reverse/fast-forward)
REPEAT ↺	Repeat playback
RANDOM ↻	Random playback
TV I / ⏻	TV power on/standby (Default : marantz)
TV INPUT	Switch TV input (Default : marantz)

- Repeat playback (☞ page 104 "Repeat")
- Random playback (☞ page 104 "Random")

- *1 When the menu screen is displayed, press **SEARCH/INFO**, then press ◀ (previous page) or ▶ (next page).
To cancel, press △▽ or **SEARCH/INFO** twice.
- *2 When the menu screen is displayed, press **SEARCH/INFO** twice, then press ◀▶ to select the first letter you want to search mode.
• If it is not possible to search the list, "unsorted list." is displayed.
To cancel, press △▽ or **SEARCH/INFO**.



If the list is not in alphabetical order, you may not be able to perform a character sort.

iPod play function

If is pressed when an iPod (USB) is connected, the iPod starts playback.

Press ▶.

- This unit's input source switches to "NET/USB".
- iPod playback starts.

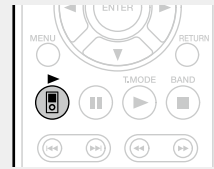

Playing a USB memory device

Playing back music or still picture (JPEG) files recorded on a USB memory device.

Important information

USB memory devices

A USB memory device can be connected to the USB port of this unit to play music and still picture (JPEG) files stored on the USB memory device.

Also, files stored on an iPod can be played when the iPod is connected directly to the USB port of this unit. See "Playing an iPod" (page 25).

- Only USB memory devices conforming to mass storage class and MTP (Media Transfer Protocol) standards can be played on this unit.
- This unit is compatible with USB memory devices in "FAT16" or "FAT32" format.

Album art function

When an MP3 music file includes album art data, the album art can be displayed while playing the file.

Slide show function

Still picture (JPEG) files stored on USB memory devices can be played as slide shows.

Also, you can set the time display that is shown during playback (page 104).



This unit plays back image (JPEG) files in the orientation in which they are stored in the folder.

Function that simultaneously plays back music and image files from the network

You can playback music and image files at the same time by playing back music files, and then playing back image files.

Also, when selecting music files after playing back image files, press **SEARCH/INFO** when the music playback screen is displayed. Music files and image files can be played back simultaneously. At this time, set "Slide Show" (page 104) in the menu to "ON".

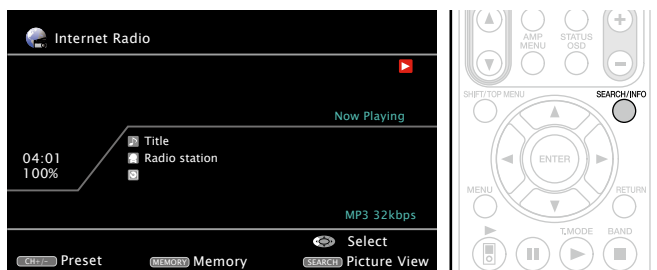

Network contents that can be played back simultaneously are as follows.

- Music files: Favorites, Internet Radio, Media Server, USB, iPod Remote Mode (NET/USB)
- Image files: Media Server, USB, Flickr

[Compatible formats]

	USB memory devices *1
WMA (Windows Media Audio)	✓*2
MP3 (MPEG-1 Audio Layer-3)	✓
WAV	✓
MPEG-4 AAC	✓*3
FLAC (Free Lossless Audio Codec)	✓
JPEG	✓

*1 USB

- This unit is compatible with MP3 ID3-Tag (Ver. 2) standard.
- This unit can show the artwork that was embedded by using MP3 ID3-Tag Ver. 2.3 or 2.4.
- This unit is compatible with WMA META tags.
- WAV format Quantization bit rate: 16 bits
- FLAC format Quantization bit rate: 16 or 24 bits

*2 Copyright-protected files can be played on certain portable players compatible with MTP.

*3 Only files that are not protected by copyright can be played on this unit.

Content downloaded from pay sites on the Internet are copyright protected. Also, files encoded in WMA format when ripped from a CD, etc. on a computer may be copyright protected, depending on the computer's settings.

[Compatible formats]

	Sampling frequency	Bit rate	Extension
WMA (Windows Media Audio)	32/44.1/48 kHz	48 – 192 kbps	.wma
MP3 (MPEG-1 Audio Layer-3)	32/44.1/48 kHz	32 – 320 kbps	.mp3
WAV	32/44.1/48 kHz	–	.wav
MPEG-4 AAC	32/44.1/48 kHz	16 – 320 kbps	.aac/ .m4a/ .mp4
FLAC (Free Lossless Audio Codec)	32/44.1/48/88.2/96 kHz	–	.flac

Playing files stored on USB memory devices

1 Connect the USB memory device to the USB port (page 11 “Connecting an iPod or USB memory device to the USB port”).

2 Press **NET/USB** twice to switch the input source to “NET/USB”.

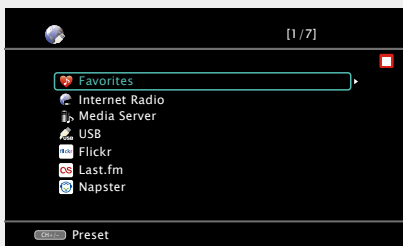

3 Use $\Delta \nabla$ to select “USB”, then press **ENTER** or \triangleright .

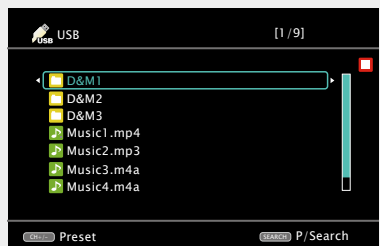

• Selecting “USB/iPod” in the “Source Select” menu, lets you directly select “USB”.

4 Press $\Delta \nabla$ to select the search item or folder, then press **ENTER** or \triangleright .

5 Press $\Delta \nabla$ to select the file, then press **ENTER**, \triangleright or \blacktriangleright . Playback starts.



- You can specify the duration of the on-screen display to be displayed (default: 30 sec) at menu “NET/USB” (page 97). Press $\Delta \nabla \triangleleft$ \triangleright to return to the original screen.
- To play back compressed audio with extended bass or treble reproduction, we recommend playback in M-DAX mode (page 84). The default setting is “OFF”.
- If the USB memory device is divided into multiple partitions, only the top partition can be selected.
- This unit is compatible with MP3 files conforming to “MPEG-1 Audio Layer-3” standards.

NOTE

- Note that marantz will accept no responsibility whatsoever for any problems arising with the data on a USB memory device when using this unit in conjunction with the USB memory device.
- USB memory devices will not work via a USB hub.
- marantz does not guarantee that all USB memory devices will operate or be supplied power. When using a USB portable hard disk that can draw power from an AC adapter, we recommend using the AC adapter.
- It is not possible to connect and use a computer via the USB port of this unit using a USB cable.

One touch play function

You can play back music files and image files stored on a USB memory device at the same time simply by pressing **ONE TOUCH PLAY** on the main unit.

Press ONE TOUCH PLAY.

“ONE TOUCH PLAY” is shown on the display, and the music and image files on the USB memory device are played in list order.



If there are no music files on the USB memory device, only images are played. However, if there are no image files on the USB memory device, only musics are played.

NOTE

Place music and image files that you want to play back directly onto the USB memory device. Files inside folders cannot be played.

USB operation

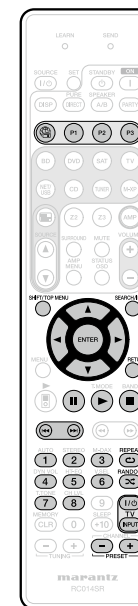

Operation buttons	Function
	Last played internet radio station
P1 – P3	Preset channel (1 – 3) selection
SHIFT/TOP MENU	Preset channel block selection
SEARCH/INFO	Page search*1 / Character sort*2
$\Delta \nabla \triangleleft \triangleright$	Cursor operation / Auto search (cue, $\Delta \nabla$)
ENTER (Press and release)	Enter / Pause
ENTER (Press and hold)	Stop
RETURN	Return
II	Pause
	Playback / Pause
	Stop
	Auto search (cue)
1 – 8	Preset channel selection
REPEAT	Repeat playback
RANDOM	Random playback
TV I/O	TV power on/standby (Default : marantz)
TV INPUT	Switch TV input (Default : marantz)
PRESET +, –	Preset channel (A1 – G8) selection

- Repeat playback (page 104 “Repeat”)
- Random playback (page 104 “Random”)
- Slide show playback (page 104 “Slide Show”)

- *1 When the menu screen is displayed, press **SEARCH/INFO**, then press \triangleleft (previous page) or \triangleright (next page). To cancel, press $\Delta \nabla$ or **SEARCH/INFO** twice.
- *2 When the menu screen is displayed, press **SEARCH/INFO** twice, then press $\triangleleft \triangleright$ to select the first letter you want to search mode.
 - If it is not possible to search the list, “unsorted list.” is displayed. To cancel, press $\Delta \nabla$ or **SEARCH/INFO**.



If the list is not in alphabetical order, you may not be able to perform a character sort.

Tuning in radio stations

Listening to FM/AM broadcasts

1 Press **TUNER** twice to switch the input source to “TUNER”.

2 Press **BAND** to select “FM” or “AM”.

FM When listening to an FM broadcast.

AM When listening to an AM broadcast.

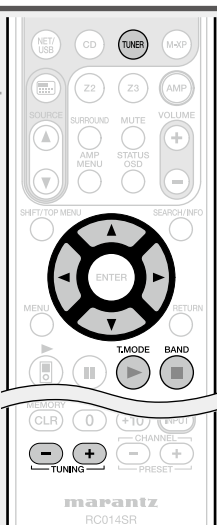
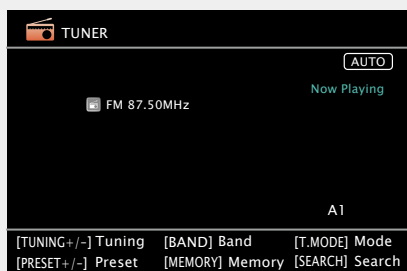

3 Tune in the desired broadcast station.

① To tune in automatically (Auto tuning)

Press **T.MODE** to light the “AUTO” indicator on the display, then use **TUNING +** or **TUNING -** to select the station you want to hear.

② To tune in manually (Manual tuning)

Press **T.MODE** to turn off the display’s “AUTO” indicator, then use **TUNING +** or **TUNING -** to select the station you want to hear.

❑ Presetting radio stations (Manual preset)

Your favorite broadcast stations can be preset so that you can tune them in easily. Up to 56 stations can be preset.

• Stations can be preset automatically at “Auto Preset” (page 100). If “Auto Preset” is performed after performing “Manual preset”, the “Manual preset” settings will be overwritten.

1 Tune in the broadcast station you want to preset.

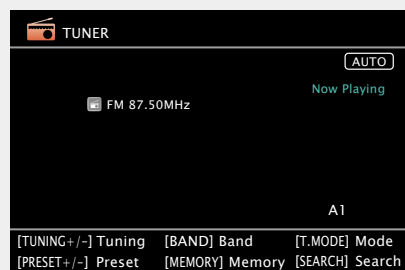

2 Press **MEMORY**.

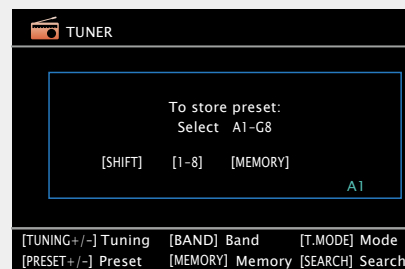

3 Press **SHIFT/TOP MENU** to select the block (A to G) in which the channel (1 to 8 per a block) is to be preset, then press **PRESET +**, **PRESET -** or **1 - 8** to select the preset number.

4 Press **MEMORY** again to complete the setting.

• To preset other stations, repeat steps 1 to 4.

Default settings

Block (A - G) and Channel (1 - 8)	Default Settings
A1 - A8	87.50 / 89.10 / 98.10 / 108.00 / 90.10 / 90.10 / 90.10 / 90.10 MHz
B1 - B8	522 / 603 / 999 / 1404 / 1611 kHz, 90.10 / 90.10 / 90.10 MHz
C1 - C8	90.10 MHz
D1 - D8	90.10 MHz
E1 - E8	90.10 MHz
F1 - F8	90.10 MHz
G1 - G8	90.10 MHz

Specify a name for the preset broadcast station (Preset Name) (page 100)



- You can also operate via the main unit. In this case, perform the following operations. Press **BAND** to select “FM” or “AM”. Press $\Delta \nabla$ to select the station you want to hear.
- If the desired station cannot be tuned in with auto tuning, tune it in manually.
- When tuning in stations manually, press and hold **TUNING +** or **TUNING -** to change frequencies continuously.
- The time (default : 30 sec) for which the menu are displayed can be set at menu “Tuner” (page 97). Press $\Delta \nabla \triangleleft \triangleright$ to return to the original screen.

Listening to preset stations

1 Press **SHIFT/TOP MENU** to select the memory block (A to G).

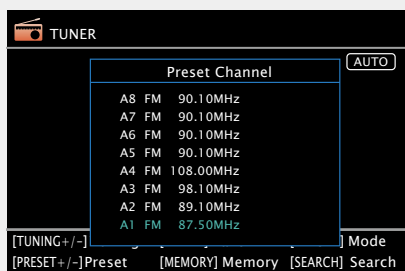

2 Press **PRESET +**, **PRESET -** or **1 - 8** to select the desired preset channel.



Direct frequency tuning

You can enter the receiving frequency directly to tune in.

1 Press **SEARCH/INFO**.

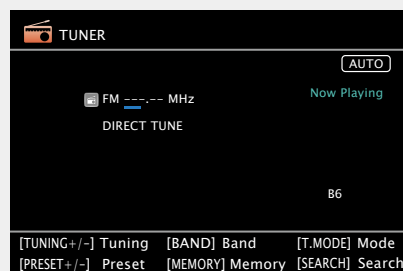

2 Input frequencies using the **0 - 9**.

- If **<** is pressed, the immediately preceding input is cancelled.

3 When setting is completed, press **ENTER**.
The preset frequency is tuned in.



RDS (Radio Data System)

Note that the RDS function only works when receiving RDS compatible stations.

RDS (works only on the FM band) is a broadcasting service which allows a station to send additional information along with the regular radio program signal.

NOTE

The operations described as follows using **SEARCH/INFO** will not function in areas in which there are no RDS broadcasts.

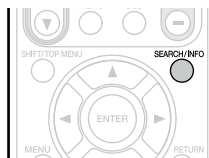

RDS search

Use this function to automatically tune to FM stations that provide the RDS service.

1 Press **TUNER** twice to switch the input source to "TUNER".

2 Press **SEARCH/INFO** to select "RDS".

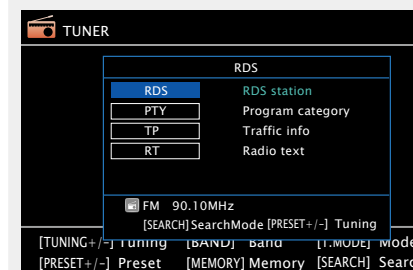

3 Press **PRESET +** or **PRESET -**.
The search for RDS stations begins automatically.

- If no RDS stations are found with the above operation, all the reception bands are searched.
- When a broadcast station is found, that station's name appears on the display.
- If no RDS station is found when all the frequencies have been searched, "NO RDS" is displayed.

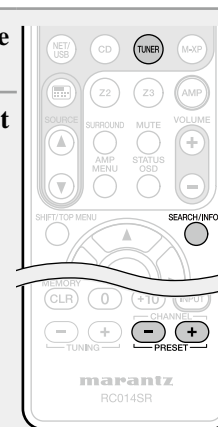

If you press **PRESET +** or **PRESET -** within 5 seconds after the broadcast station name is shown on the display, you can search for a different station.

PTY (Program Type)

PTY identifies the type of RDS program.
The program types and their displays are as follows:

NEWS	News	WEATHER	Weather
AFFAIRS	Current Affairs	FINANCE	Finance
INFO	Information	CHILDREN	Children's program
SPORT	Sports	SOCIAL	Social Affairs
EDUCATE	Education	RELIGION	Religion
DRAMA	Drama	PHONE IN	Phone In
CULTURE	Culture	TRAVEL	Travel
SCIENCE	Science	LEISURE	Leisure
VARIED	Varied	JAZZ	Jazz Music
POP M	Pop Music	COUNTRY	Country Music
ROCK M	Rock Music	NATION M	National Music
EASY M	Easy Listening Music	OLDIES	Oldies Music
LIGHT M	Light Classical	FOLK M	Folk Music
CLASSICS	Serious Classical	DOCUMENT	Documentary
OTHER M	Other Music		

PTY search

Use this function to find RDS stations broadcasting a designated program type (PTY).

- Press **TUNER** twice to switch the input source to "TUNER".
- Press **SEARCH/INFO** to select "PTY".

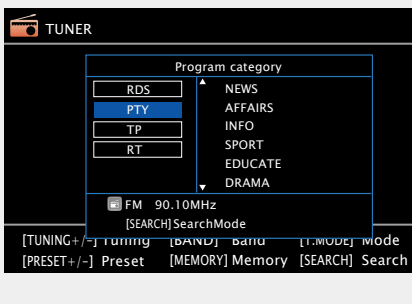
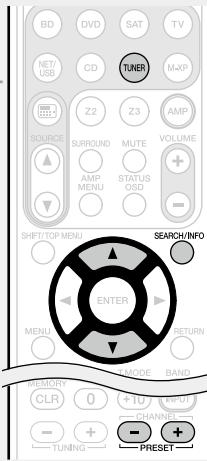
- Watching the display, press Δ / ∇ to call out the desired program type.
- Press **PRESET +** or **PRESET -**.
PTY search begins automatically.

- If there is no station broadcasting the designated program type with the above operation, all the reception bands are searched.
- The station name is displayed on the display after searching stops.
- If no station broadcasting the designated program type is found when all the frequencies have been searched, "NO PROGRAMME" is displayed.



If you press **PRESET +** or **PRESET -** within 5 seconds after the broadcast station name is shown on the display, you can search for a different station.



TP (Traffic Program)

TP identifies programs that carry traffic announcements.
This allows you to easily find out the latest traffic conditions in your area before leaving home.

TP search

Use this function to find RDS stations broadcasting traffic programs (TP stations).

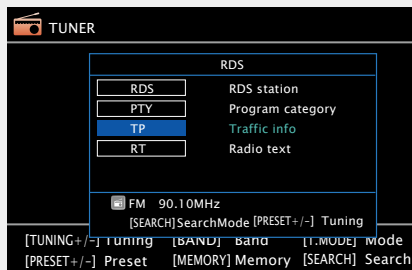
- Press **TUNER** twice to switch the input source to "TUNER".
- Press **SEARCH/INFO** to select "TP".

- Press **PRESET +** or **PRESET -**.
TP search begins automatically.

- If no TP station is found with the above operation, all the reception bands are searched.
- The station name is displayed on the display after searching stops.
- If no other TP station is found when all the frequencies have been searched, "NO PROGRAMME" is displayed.



If you press **PRESET +** or **PRESET -** within 5 seconds after the broadcast station name is shown on the display, you can search for a different station.

RT (Radio Text)

RT allows RDS stations to send text messages that appear on the display.

"RT" appears on the display when radio text data is received.

1 Press **TUNER** twice to switch the input source to "TUNER".

2 Press **SEARCH/INFO** to select "RT".

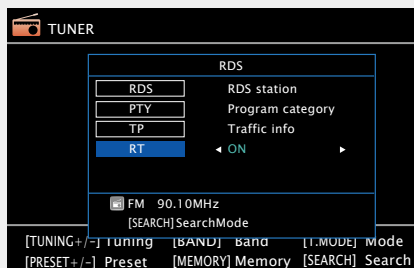

- While receiving an RDS broadcast station, the text data broadcast from the station is displayed.
- To turn the display off, press $\triangleleft \triangleright$.
- If no text data is being broadcast, "NO TEXT DATA" is displayed.



Tuner (FM/AM) operation

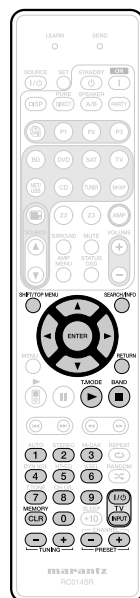

Operation buttons	Function
SHIFT/TOP MENU	Preset channel block selection
SEARCH/INFO	Direct frequency tuning / RDS search
$\triangle \nabla \triangleleft \triangleright$	Cursor operation
ENTER	Enter
RETURN	Return
T.MODE	Switch search modes
BAND	FM/AM switching
0-9	Preset channel selection (1-8) / Direct frequency tuning (0-9)
MEMORY	Preset memory registration
TV I/⏻	TV power on/standby (Default : marantz)
TV INPUT	Switch TV input (Default : marantz)
TUNING +, -	Tuning (up/down)
PRESET +, -	Preset channel selection

Switching the tuning increment

The tuning increment factory settings are 9 kHz for AM, and 0.05 MHz for FM.

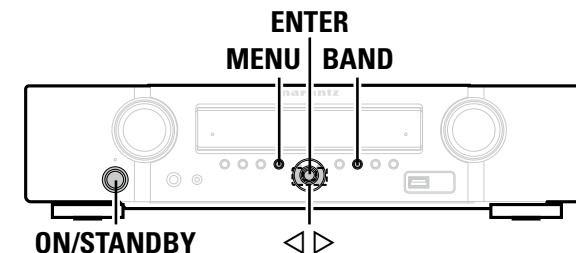

1 While pressing down **MENU** and **BAND**, press **ON/STANDBY** to turn on the power. "AM9/FM50" appears on the display.

2 Press $\triangleleft \triangleright$. "AM10/FM200" appears on the display, and the tuning increment is switched to AM and FM are 10 kHz and 0.2 MHz.

3 Press **ENTER**.

4 Press **ON/STANDBY**.

- The tuner preset memory will be cleared if this operation is performed.
- This setting will not revert to the default values even when the microprocessor is reset.

Playing a network audio

Follow this procedure to play Internet radio stations or music or still picture (JPEG) files stored on a computer.

Important information

□ About the internet radio function

- Internet radio refers to radio broadcasts distributed over the Internet. Internet radio stations from around the world can be received.
- This unit is equipped with the following Internet radio functions:
 - Stations can be selected by genre and location.
 - Up to 56 Internet radio stations can be preset.
 - Internet radio stations in MP3 and WMA (Windows Media Audio) format can be listened to.
 - Your favorite radio stations can be registered by accessing an exclusive marantz Internet radio URL from a Web browser on a computer.
- The function is managed for individual users, so you must provide your MAC or e-mail address. Exclusive URL: <http://www.radiomarantz.com>
- The radio station database service may be suspended without notice.
- This unit's Internet radio station list is created using a radio station database service (vTuner). This database service provides a list edited and created for this unit.

□ Media player

This function lets you play music files and playlists (m3u, wpl) stored on a computer (media server) connected to this unit via a network.

With this unit's network audio playback function, connection to the server is possible using one of the technologies below.

- Windows Media Player Network Sharing Service
- Windows Media DRM10

Album art function

When a WMA (Windows Media Audio), MP3 or MPEG-4 AAC file includes album art data, the album art can be displayed while the music files are playing.



If you use Ver.11 or later of Windows Media Player, the album art for WMA files can be displayed.

Slide show function

You can play back image (JPEG) files that are stored in folders on a media server and photographs on Flickr as a slideshow.

Also, you can set the time display that is shown during playback ([page 104](#)).



This unit plays back image (JPEG) files in the orientation in which they are stored in the folder.

□ Function that simultaneously plays back music and image files from the network

You can playback music and image files at the same time by playing back music files, and then playing back image files.

Also, when selecting music files after playing back image files, press **SEARCH/INFO** when the music playback screen is displayed. Music files and image files can be played back simultaneously. At this time, set "Slide Show" ([page 104](#)) in the menu to "ON".

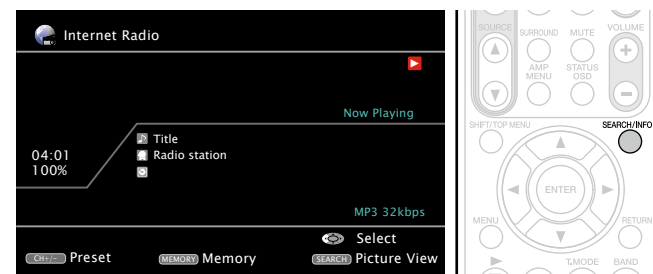

Network contents that can be played back simultaneously are as follows.

- Music files: Favorites, Internet Radio, Media Server, USB, iPod Remote Mode (NET/USB)
- Image files: Media Server, USB, Flickr

[Compatible formats]

	Internet radio	Media server *1
WMA (Windows Media Audio)	✓	✓
MP3 (MPEG-1 Audio Layer-3)	✓	✓
WAV		✓
MPEG-4 AAC		✓*2
FLAC (Free Lossless Audio Codec)		✓
JPEG		✓

A server or server software compatible with distribution in the corresponding formats is required to play music files via a network.

*1 Media server

- This unit is compatible with MP3 ID3-Tag (Ver. 2) standard.
- This unit can show the artwork that was embedded by using MP3 ID3-Tag Ver. 2.3 or 2.4.
- This unit is compatible with WMA META tags.
- WAV format Quantization bit rate: 16 bits
- FLAC format Quantization bit rate: 16 or 24 bits

*2 Only files that are not protected by copyright can be played on this unit.

Content downloaded from pay sites on the Internet are copyright protected. Also, files encoded in WMA format when ripped from a CD, etc. on a computer may be copyright protected, depending on the computer's settings.

[Compatible formats]

	Sampling frequency	Bit rate	Extension
WMA (Windows Media Audio)	32/44.1/48 kHz	48 – 192 kbps	.wma
MP3 (MPEG-1 Audio Layer-3)	32/44.1/48 kHz	32 – 320 kbps	.mp3
WAV	32/44.1/48 kHz	–	.wav
MPEG-4 AAC	32/44.1/48 kHz	16 – 320 kbps	.aac/ .m4a/ .mp4
FLAC (Free Lossless Audio Codec)	32/44.1/48/88.2/96 kHz	–	.flac

□ About Flickr

Flickr is an online photograph sharing service that started in 2004. You can use the this unit to view photographs that have been made public by Flickr users. You do not need an account to use Flickr. To view photographs that you recorded yourself, you need an account in order to upload these photographs to the Flickr server. For details, see the Flickr homepage.

<http://www.flickr.com/>

□ About Last.fm

Last.fm learns what you love... and it's a great way to discover new music.

Your new marantz AV receiver is very clever. You can create a free Last.fm profile when you start using your marantz AV receiver and magically keep track of all the songs you hear.

When you sign in at www.last.fm, you can see your top music charts, view thousands of reviews, biographies and artwork, and get recommendations for local performances you won't want to miss.

With an affordable subscription you can enjoy an endless choice of personalised ad-free radio stations. Check out www.last.fm/subscribe today for more details.

Your subscription also gives you access to Last.fm radio on a great range of music products, including your marantz AV Receiver. This feature is not available in all countries. Visit www.last.fm/hardware to find out more.

□ About Napster

Napster is a monthly subscription music distribution service provided by Napster LLC. This service allows users to download and play pieces of music they want to hear on this unit. Before you can use Napster, you will need to visit the Napster website on your PC to create an account and register as a member. For details, access the following site:

http://www.napster.com/choose/index_default.html

Listening to internet radio

1 Prepare for playback.

- ① Check the network environment, then turn on this unit's power (refer page 14 "Connecting to a home network (LAN)").
- ② If settings are required, make the "Network Connect." (refer page 92).

2 Press NET/USB twice to switch the input source to "NET/USB".

3 Press Δ / ∇ to select "Internet Radio", then press ENTER or \triangleright .

- Selecting "Internet Radio" in the "Source Select" menu, lets you directly select "Internet Radio".

4 Press Δ / ∇ to select the item you want to play, then press ENTER or \triangleright .

5 Repeat step 4 until the station list is displayed.

The station list is displayed.

6 Press Δ / ∇ to select the station, then press ENTER or \triangleright .

Playback starts once buffering reaches "100%".

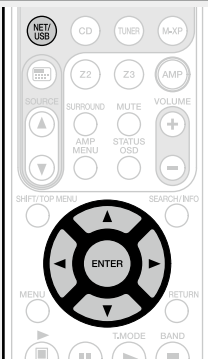

- There are many Internet radio stations on the Internet, and the quality of the programs they broadcast as well as the bit rate of the tracks varies widely. Generally, the higher the bit rate, the higher the sound quality, but depending on the communication lines and server traffic, the music or audio signals being streamed may be interrupted. Inversely, lower bit rates mean a lower sound quality but less tendency for the sound to be interrupted.
- "Server Full" or "Connection Down" is displayed if the station is busy or not broadcasting.
- On this unit, folder and file names can be displayed as titles. Any characters that cannot be displayed are replaced with "." (period).
- To play back compressed audio with extended bass or treble reproduction, we recommend playback in M-DAX mode (refer page 84). The default setting is "OFF".
- You can specify the duration of the on-screen display to be displayed (default: 30 sec) at menu "NET/USB" (refer page 97). Press Δ / ∇ / \triangleright to return to the original screen.
- When **STATUS** on the main unit is pressed, the display can be switched between the title name and radio station name.

□ Playing the last played Internet radio station

Simply press  to switch the input source to "Internet Radio" and play the last played radio station.

Press .

The source switches to "Internet Radio" and the last played radio station plays.

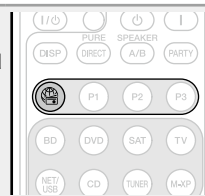

When  is pressed, the NET/USB-operation mode starts automatically (refer page 106).

□ Recently played internet radio stations

Recently played internet radio stations can be selected from "Recently Played".

Up to 20 stations stored in "Recently Played".

1 Press Δ / ∇ to select "Recently Played", then press ENTER or \triangleright .

2 Press Δ / ∇ to select the item you want to play, then press ENTER or \triangleright .

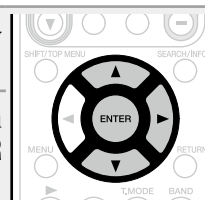

❑ Searching stations by keyword (Alphabetic strings)

1 Press Δ / ∇ to select “Search by Keyword”, then press **ENTER** or \triangleright .



2 Input the characters, then press **OK**.

• For character input, see [page 78](#).

❑ Presetting internet radio stations

Preset Internet radio stations can be selected directly.

1 While the Internet radio station you want to preset is playing, press **MEMORY**.

2 Press Δ / ∇ to select “Preset”, then press **ENTER**.

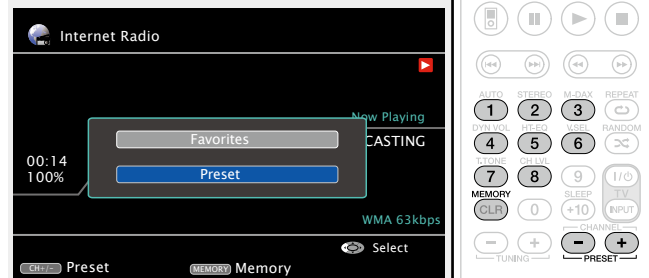

3 Press **SHIFT/TOP MENU**, then press **PRESET +**, **PRESET -** or **1 - 8** to select the desired preset number.



4 Press **MEMORY** again to complete the setting. The Internet radio station is now preset.

❑ Listening to preset internet radio stations

After pressing **SHIFT/TOP MENU**, press **PRESET +**, **PRESET -** or **1 - 8** to select the registered preset number.

This unit automatically connects to the Internet and playback begins.

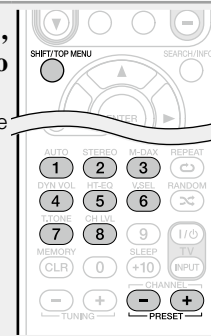

Registering Internet radio stations to preset channel buttons

- Up to three Internet radio stations can be registered to the **P1 - P3** buttons.
- Recommended Internet radio stations have already been registered to the **P1 - P3** buttons.

While the internet radio station you want to preset is playing, press and hold **P1 - P3** for at least 3 seconds.

The internet radio station is now preset.

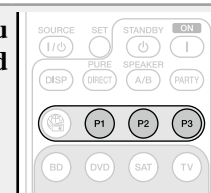

NOTE

If registered at a number that has already been preset, the previously registered setting is cleared.

Listening to an Internet radio station registered to a preset channel button

Press one of the registered P1 – P3.



Registering internet radio stations as your favorites

Favorites are listed at the top of the menu screen, so when a station is registered as a favorite it can be tuned in easily.

1 Press **MEMORY** while the Internet radio station you want to register is playing.

2 Press Δ / ∇ to select “Favorites”, then press **ENTER**.

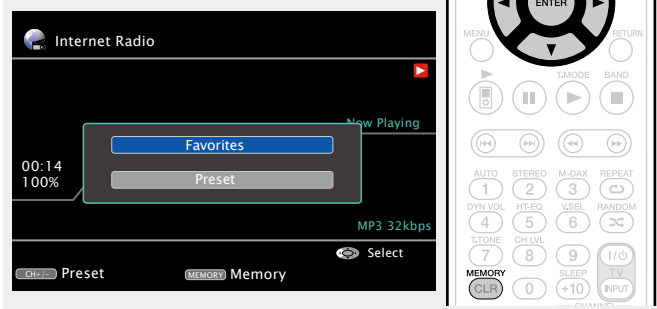

3 Press \triangleleft to select “Add”.
The Internet radio station is registered.

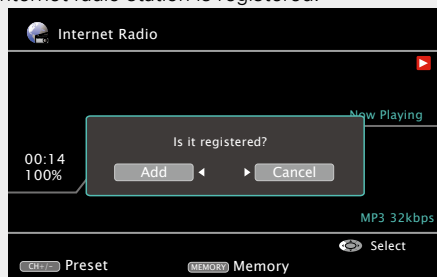

• If you do not want to register the station, press \triangleright .

Listening to internet radio stations registered in your favorites

1 Press \square to display the “Source Select” menu, then select “Favorites” (page 22).

2 Press **NET/USB** to switch the remote control operating mode to “NET/USB”.

3 Press Δ / ∇ to select the Internet radio station, then press **ENTER** or \triangleright .
This unit automatically connects to the Internet and playback begins.

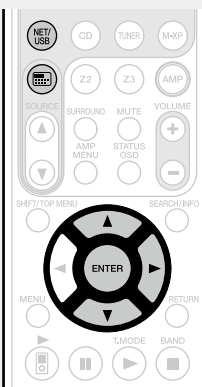

Clearing internet radio stations from your favorites

1 Press \square to display the “Source Select” menu, then select “Favorites” (page 22).

2 Press **NET/USB** to switch the remote control operating mode to “NET/USB”.

3 Press Δ / ∇ to select the Internet radio station you want to clear, then press **MEMORY**.

4 Press \triangleleft to select “Remove”.
The selected Internet radio station is cleared.



• To cancel the operation without clearing the station, press \triangleright .

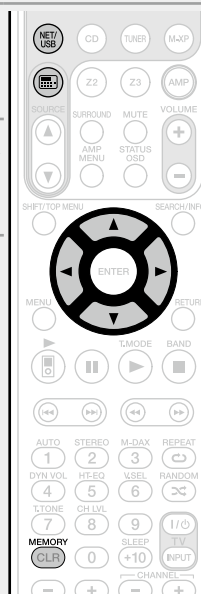

Internet radio operation

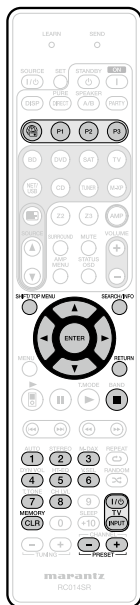

Operation buttons	Function
	Last played internet radio station
P1 – P3	Preset channel (1 – 3) selection
SHIFT/TOP MENU	Preset channel block selection
SEARCH/INFO	Page search*1 / Character sort*2
	Cursor operation
ENTER (Press and release)	Enter
ENTER (Press and hold)	Stop
RETURN	Return
	Stop
1 – 8	Preset channel selection
MEMORY	Favorites / Preset memory registration
TV I / ⏻	TV power on/standby (Default : marantz)
TV INPUT	Switch TV input (Default : marantz)
PRESET +, –	Preset channel (A1 – G8) selection

- *1 When the menu screen is displayed, press **SEARCH/INFO**, then press (previous page) or (next page).
To cancel, press or **SEARCH/INFO** twice.
- *2 When the menu screen is displayed, press **SEARCH/INFO** twice, then press to select the first letter you want to search mode.
- If it is not possible to search the list, "unsorted list." is displayed.
- To cancel, press or **SEARCH/INFO**.



If the list is not in alphabetical order, you may not be able to perform a character sort.

Playing files stored on a computer

Use this procedure to play music files, image files or playlists.

1 Prepare for playback.

- ① Check the network environment, then turn on this unit's power (☞ [page 14](#) "Connecting to a home network (LAN)").
- ② If settings are required, make the "Network Connect." (☞ [page 92](#)).
- ③ Prepare the computer (☞ Computer's operating instructions).

2 Press to display the "Source Select" menu, then select "Media Server" (☞ [page 22](#)).

3 Press NET/USB to switch the remote control operating mode to "NET/USB".

4 Press Δ/∇ to select the server including the file to be played, then press ENTER or \triangleright .

5 Press Δ/∇ to select the search item or folder, then press ENTER or \triangleright .

6 Repeat step 4 until the file is displayed.

7 Press Δ/∇ to select the file, then press ENTER or \triangleright . Playback starts once buffering reaches "100%".

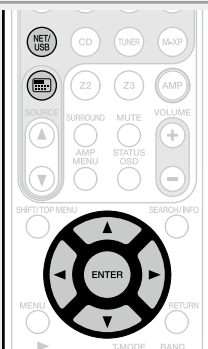

- Connections to the required system and specific settings must be made in order to play music files (☞ [page 14](#)).
- Before starting, you must launch the computer's server software and set the files as server contents. For details, see the operating instructions of your server software.
- Depending on the size of the still picture (JPEG) file, some time may be required for the file to be displayed.
- The order in which the tracks/files are displayed depends on the server specifications. If the tracks/ files are not displayed in alphabetical order due to the server specifications, searching by the first letter may not work properly.
- WMA Lossless files can be played when using a server supporting transcoding, such as Windows Media Player Ver. 11 or later.
- To play back compressed audio with extended bass or treble reproduction, we recommend playback in M-DAX mode (☞ [page 84](#)). The default setting is "OFF".
- You can specify the duration of the on-screen display to be displayed (default: 30 sec) at menu "NET/USB" (☞ [page 97](#)). Press $\Delta/\nabla/\triangleleft/\triangleright$ to return to the original screen.
- Use **STATUS** on the main unit to switch between displaying the title name, artist name or album name.

□ Playing files that have been preset or registered in your favorites

Files can be preset, registered in your favorites and played using the same operations as for Internet radio stations (☞ [page 37](#)).

NOTE

- Presettings are erased by overwriting them.
- When the operations described below is performed, the media server's database is updated and it may no longer be possible to play preset or favorite music files.
- When you quit the media server and then restart it.
- When music files are deleted or added on the media server.

Media server operation

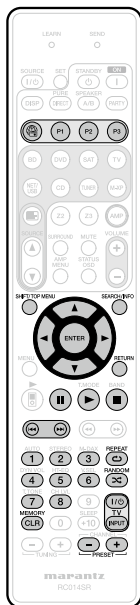

Operation buttons	Function
	Last played internet radio station
P1 – P3	Preset channel (1 – 3) selection
SHIFT/TOP MENU	Preset channel block selection
SEARCH/INFO	Page search*1 / Character sort*2
	Cursor operation / Auto search (cue,)
ENTER (Press and release)	Enter / Pause
ENTER (Press and hold)	Stop
RETURN	Return
	Pause
	Playback / Pause
	Stop
	Auto search (cue)
1 – 8	Preset channel selection
REPEAT	Repeat playback
RANDOM	Random playback
MEMORY	Favorites / Preset memory registration
TV I/⏻	TV power on/standby (Default : marantz)
TV INPUT	Switch TV input (Default : marantz)
PRESET +, –	Preset channel (A1 – G8) selection

- Repeat playback ([page 104](#) "Repeat")
- Random playback ([page 104](#) "Random")
- Slide show playback ([page 104](#) "Slide Show")

- *1 When the menu screen is displayed, press **SEARCH/INFO**, then press (previous page) or (next page).
To cancel, press or or **SEARCH/INFO** twice.
- *2 When the menu screen is displayed, press **SEARCH/INFO** twice, then press to select the first letter you want to search mode.
- If it is not possible to search the list, "unsorted list." is displayed.
- To cancel, press or **SEARCH/INFO**.



If the list is not in alphabetical order, you may not be able to perform a character sort.

Viewing photographs on the Flickr site

You can view photographs shared by particular users, or all of the photographs shared on Flickr.

□ Viewing photographs shared by particular users

1 Prepare for playback.

- ① Check the network environment, then turn on this unit's power (☞ [page 14](#) "Connecting to a home network (LAN)").
- ② If settings are required, make the "Network Connect." (☞ [page 92](#)).

2 Press to display the "Source Select" menu, then select "Flickr" (☞ [page 22](#)).

3 Press NET/USB to switch the remote control operating mode to "NET/USB".

4 Use $\Delta \nabla$ to select "Add Flickr Contact", then press ENTER or \triangleright .



5 Enter "Contact".

• For character input, see [page 78](#).



6 After inputting the "Contact", then press ENTER. The "Contact" entered in step 4 is displayed.

- If the Contact you typed in cannot be found, "The Flickr Contact you entered could not be found" appears. Check and type in the correct Contact.

7 Press $\Delta \nabla$ to select the folder, and then press ENTER or \triangleright .

- Favorites** Displays the favorite photographs of the specified user.
- Photostream** Displays a list of shared photographs.
- PhotoSets** Displays the folder (photograph album) list.
- Contacts** Displays Contacts registered for Flickr Contact by a specified user.
- Remove this Contact** Deletes a user from Flickr Contact.

8 Press $\Delta \nabla$ to select the file, and then press ENTER or \triangleright . The selected file is displayed.

□ Viewing all photographs on Flickr

1 Prepare for playback.

- ① Check the network environment, then turn on this unit's power (☞ [page 14](#) "Connecting to a home network (LAN)").
- ② If settings are required, make the "Network Connect." (☞ [page 92](#)).

2 Press to display the "Source Select" menu, then select "Flickr" (☞ [page 22](#)).

3 Press NET/USB to switch the remote control operating mode to "NET/USB".

4 Use $\Delta \nabla$ to select "All Content", then press ENTER or \triangleright .

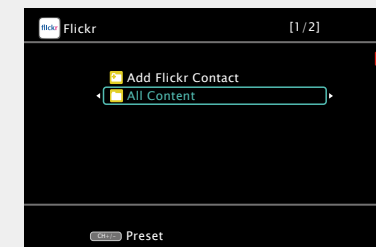

5 Press $\Delta \nabla$ to select the folder, and then press ENTER or \triangleright .

- Interestingness** Displays photographs that are popular from the number of user comments or number of times they are added as favorites.
- Recent** Displays the most recently added photographs.
- Search by text** Search for photographs by keyword.

6 Press $\Delta \nabla$ to select the file, and then press ENTER or \triangleright . The selected file is displayed.

NOTE

Depending on the file format, some photographs cannot be viewed.

□ Flickr operation

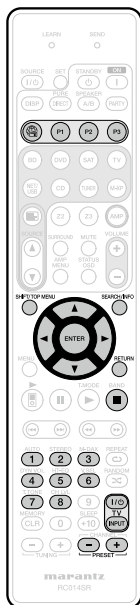

Operation buttons	Function
	Last played internet radio station
P1 – P3	Preset channel (1 – 3) selection
SHIFT/TOP MENU	Preset channel block selection
SEARCH/INFO	Page Search*
△▽◀▶	Cursor operation / Auto search (cue, △▽)
ENTER (Press and release)	Enter
ENTER (Press and hold)	Stop
RETURN	Return
■	Stop
1 – 8	Preset channel selection
TV I/⏻	TV power on/standby (Default : marantz)
TV INPUT	Switch TV input (Default : marantz)
PRESET +, –	Preset channel (A1 – G8) selection

• Slide show playback ([page 104](#) "Slide Show")

* When the menu screen is displayed, press **SEARCH/INFO**, then press ◀ (previous page) or ▶ (next page). To cancel, press △▽ or **SEARCH/INFO**.

How to listen to Last.fm on this unit

Last.fm radio is not available in all countries. Please check www.last.fm/hardware for more information. You'll also need a subscription. Get one today at www.last.fm/subscribe.

1 Prepare for playback.

- Check the network environment, then turn on this unit's power ([page 14](#) "Connecting to a home network (LAN)").
- If settings are required, make the "Network Connect." ([page 92](#)).

2 Press to display the "Source Select" menu, then select "Last.fm" ([page 22](#)).

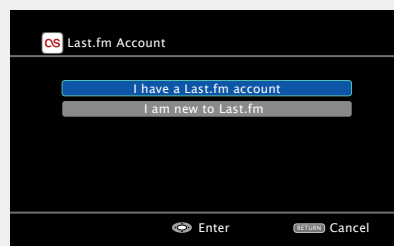

• If you do not have a Last.fm account, press ▽ to select "I am new to Last.fm". Then press **ENTER**. Create an account in accordance with the instructions on the screen.

3 Press **NET/USB** to switch the remote control operating mode to "NET/USB".

4 If you have a Last.fm account, press △▽ to select "I have a Last.fm account". Then press **ENTER** or ▶.

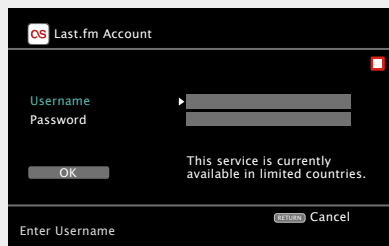

5 Use △▽▶ to enter your username and password.

• For character input, see [page 78](#).

6 After inputting the username and password, select "OK", then press **ENTER**.

If the username and password match, the top menu for Last.fm is displayed.

• The types of characters that can be input are as shown below.

Username:

[Upper case characters]

ABCDEFGHIJKLMNOPQRSTUVWXYZ

[Lower case characters]

abcdefghijklmnopqrstuvwxyz

[Symbols] - _

[Numbers] 0123456789

Password:

[Upper case characters]

ABCDEFGHIJKLMNOPQRSTUVWXYZ

[Lower case characters]

abcdefghijklmnopqrstuvwxyz

[Symbols]

! " # \$ % & ' () * + , . - / : ; < = > ? @ [\] ^ _ ` { | } ~

[Numbers] 0123456789 (Space)

7 Use △▽ to select menu and then press **ENTER**.

Popular Stations Play popular artists and tags in your area.

You Recent Stations Play your recent stations.

Your stations You can play tracks from the following personalised stations ("Your Recommended Radio", "Your Library", "Your Friends' Radio", "Your Top Artists").

Search Stations You can search station by Artist or Tag.

8 Use Δ / ∇ to select a station, and press **ENTER** or \blacktriangleright to start playback.

Playback starts and the following screen appears.

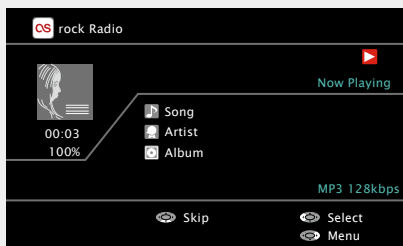

9 Menu items on playback screen.

Love this track Loving tracks improves your Last.fm recommendations, and you can optionally share them on popular social networks.

Ban this track If you ban a track, we won't play it again. You can undo this on the Last.fm website.

Scrobbling Scrobbling sends the tracks you played to your Last.fm account. You can see charts of the music you've been listening to, get recommendations for new music and events in your area and share your listening tastes with your friends. You can turn this service on or off using this option. The more you scrobble, the better your recommendations will become.

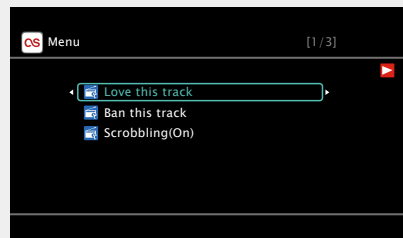

NOTE

- The password should be no longer than 99 characters.
- Press **RETURN** to cancel the input. When "Cancel input?" is displayed, select "Yes", then press **ENTER**.



- To play back compressed audio with extended bass or treble reproduction, we recommend playback in M-DAX mode (page 84). The default setting is "OFF".
- You can specify the duration of the on-screen display to be displayed (default: 30 sec) at menu "NET/USB" (page 97). Press Δ / ∇ / \blacktriangleleft / \blacktriangleright to return to the original screen.
- Use **STATUS** on the main unit to switch between displaying the title name, artist name or album name.

□ Last.fm operation

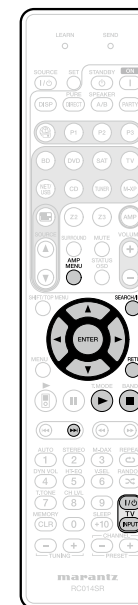

Operation buttons	Function
SEARCH/INFO	Page Search*
Δ / ∇ / \blacktriangleleft / \blacktriangleright	Cursor operation / Auto search (cue, ∇)
ENTER (Press and release)	Enter
ENTER (Press and hold)	Stop
AMP MENU	Amp menu
RETURN	Return
\blacktriangleright	Playback
\blacksquare	Stop
$\blacktriangleright\blacktriangleright$	Auto search (cue)
TV I / ϕ	TV power on/standby (Default : marantz)
TV INPUT	Switch TV input (Default : marantz)

* When the menu screen is displayed, press **SEARCH/INFO**, then press \blacktriangleleft (previous page) or \blacktriangleright (next page).
To cancel, press Δ / ∇ or **SEARCH/INFO**.

Listening to Napster

1 Prepare for playback.

- ① Check the network environment, then turn on this unit's power (☞ [page 14](#) "Connecting to a home network (LAN)").
- ② If settings are required, make the "Network Connect." (☞ [page 92](#)).

2 Press to display the "Source Select" menu, then select "Napster" (☞ [page 22](#)).

3 Press **NET/USB** to switch the remote control operating mode to "NET/USB".

4 Use $\Delta \nabla \triangleright$ to input "Username" and "Password".

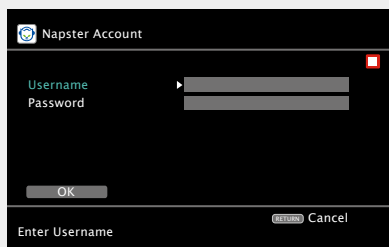

- For character input, see [page 78](#).

5 After inputting the "Username" and "Password", select "OK", then press **ENTER**.

If the "Username" and "Password" match, the top menu for Napster is displayed.

NOTE

- The password should be no longer than 99 characters.
- Press **RETURN** to cancel the input. When "Cancel input?" is displayed, select "Yes", then press **ENTER**.

□ Searching from Napster menu

1 Use $\Delta \nabla$ to select search item or folder, then press **ENTER** or \triangleright .

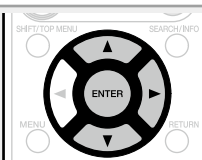

2 Repeat step 1 until the track is displayed.

3 Use $\Delta \nabla$ to select the track item, then press **ENTER** or \triangleright .

□ Entering a character sort for the track you want to listen to

1 Press **SEARCH/INFO**.

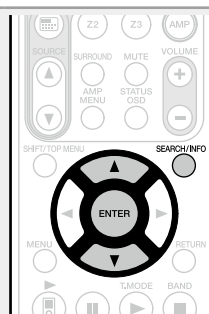
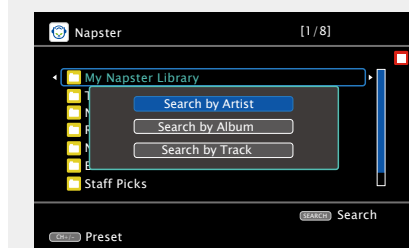

- You can search by artist name, album name or track name.

2 Use $\Delta \nabla$ to select the search item, then press **ENTER**.

3 Input the characters, then press **OK**.

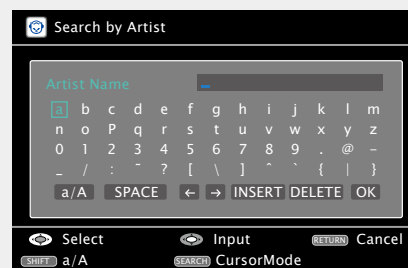

- For character input, see [page 78](#).

□ Registering tracks in my Napster library

1 Press \triangleright while the track you wish to register is playing.

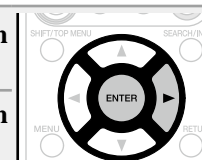

2 Select "Add to my library", then press **ENTER** or \triangleright .
The track is entered in the Library.

Listening to tracks registered in my Napster library

1 Use $\Delta \nabla$ to select "My Napster Library", then press **ENTER** or \triangleright .

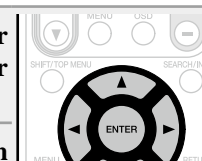

2 Use $\Delta \nabla$ to select the information or track, then press **ENTER**.



- To play back compressed audio with extended bass or treble reproduction, we recommend playback in M-DAX mode (☞ [page 84](#)). The default setting is "OFF".
- You can specify the duration of the on-screen display to be displayed (default: 30 sec) at menu "NET/USB" (☞ [page 97](#)). Press $\Delta \nabla \triangleleft$ to return to the original screen.
- Use **STATUS** on the main unit to switch between displaying the title name, artist name or album name.

□ Napster operation

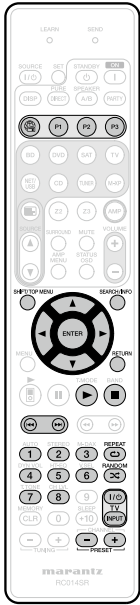

Operation buttons	Function
	Last played internet radio station
P1 – P3	Preset channel (1 – 3) selection
SHIFT/TOP MENU	Preset channel block selection
SEARCH/INFO	Search menu / Page search*
	Cursor operation / Auto search (cue,)
ENTER (Press and release)	Enter
ENTER (Press and hold)	Stop
RETURN	Return
	Playback
	Stop
	Auto search (cue)
1 – 8	Preset channel selection
REPEAT	Repeat playback
RANDOM	Random playback
TV I / ⏻	TV power on/standby (Default : marantz)
TV INPUT	Switch TV input (Default : marantz)
PRESET +, –	Preset channel (A1 – G8) selection

- Repeat playback ([page 104](#) "Repeat")
- Random playback ([page 104](#) "Random")

* When the menu screen is displayed, press **SEARCH/INFO** twice, then press (previous page) or (next page). To cancel, press or **SEARCH/INFO**.

Selecting a listening mode (Surround mode)

This unit can play input audio signals in multi-channel surround mode or in stereo mode.
Select a listening mode suitable for the playback contents (movie, music, etc.) or according to your liking.

Selecting a listening mode

1 Play the selected device (see [page 24 – 27](#)).

2 Press **SURROUND**, **AUTO**, **STEREO** or **PURE DIRECT** to select a listening mode.

- Each time **SURROUND**, **AUTO**, **STEREO** or **PURE DIRECT** is pressed, the listening mode is switched.



SURROUND Various types of surround sound can be selected to match the source being played back. Press **SURROUND** until the desired surround mode is reached.

AUTO This mode detects the type of input digital signal, and automatically selects the corresponding mode for playback.

STEREO Switches the listening mode to Stereo mode.

PURE DIRECT Switches the listening mode to Direct or Pure Direct mode. In DIRECT mode, the audio is played back exactly how it was recorded.

When PURE DIRECT mode is selected, the PURE DIRECT indicator on the unit lights.







The listening mode can also be selected in the same way for the **SURROUND MODE** on the main unit.

AUTO and **STEREO** are effective only when the remote control unit is in AMP-operation mode.

Listening mode

- The following listening modes can be selected using the **SURROUND**, **AUTO**, **STEREO** and **PURE DIRECT** buttons.
- Adjust the sound field effect with the menu "Surr.Parameter" (page 81) to enjoy your favorite sound mode.

Operation button	Input signal	Listening mode
SURROUND 	2-channel *1	AUTO *2
		STEREO
		DOLBY PLIIx Movie *3
		DOLBY PLII Movie *3
		DOLBY PLIIx Music *3
		DOLBY PLII Music *3
		DOLBY PLIIx Game *3
		DOLBY PLII Game *3
		DOLBY Pro Logic *3
		DTS NEO:6 Cinema *3
		DTS NEO:6 Music *3
		DOLBY PLIIz Height *3
		MULTI CH STEREO
		VIRTUAL
	Multi-channel *4	AUTO *2
		STEREO
	Dolby Digital	DOLBY DIGITAL
		DOLBY DIGITAL EX
		DOLBY DIGITAL + PLIIx Movie
		DOLBY DIGITAL + PLIIx Music
	Dolby TrueHD	DOLBY DIGITAL + PLIIz
		DOLBY TrueHD
		DOLBY TrueHD + EX
		DOLBY TrueHD + PLIIx Movie
	Dolby Digital Plus	DOLBY TrueHD + PLIIx Music
		DOLBY TrueHD + PLIIz
		DOLBY DIGITAL Plus
		DOLBY DIGITAL Plus + EX
	DTS	DOLBY DIGITAL Plus + PLIIx Movie
		DOLBY DIGITAL Plus + PLIIx Music
		DOLBY DIGITAL Plus + PLIIz
		DTS SURROUND
		DTS ES DSCRT 6.1
DTS ES MTRX 6.1		
DTS 96/24		
DTS 96 ES MTRX		
DTS ES DSCRT		
DTS + NEO:6		
DTS + PLIIx Movie		
DTS + PLIIx Music		
DTS + PLIIz		

Operation button	Input signal	Listening mode
SURROUND 	DTS-HD / DTS Express	DTS-HD HI RES
		DTS-HD MSTR
		DTS Express
		DTS-HD + NEO:6
		DTS-HD + PLIIx Movie
		DTS-HD + PLIIx Music
	PCM multi-channel	DTS-HD + PLIIz
		MULTI CH IN
		MULTI CH IN 7.1
		MULTI IN + Dolby EX
Multi-channel *4	MULTI IN + PLIIx Movie	
	MULTI IN + PLIIx Music	
	MULTI IN + PLIIz	
	MULTI CH STEREO	
	VIRTUAL	
AUTO 	All	AUTO *2
STEREO 	All	STEREO
PURE DIRECT 	All	DIRECT PURE DIRECT AUTO *2

- *1 2-channel also includes analog input.
- *2 When AUTO mode is selected, the surround mode that is compatible with the input signal is used for playback.
- *3 This mode plays back 2-channel source in 5.1 or 7.1-channel playback. It cannot be selected when headphones are used, or when only front speakers are used.
- *4 Some listening modes cannot be selected, depending on the audio format or number of channels of the input signal. For details, see "Types of input signals, and corresponding surround modes" (page 122).

Views on the TV screen or display

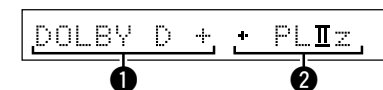

- 1 Shows a decoder to be used.
 - A DOLBY DIGITAL Plus decoder is displayed as "DOLBY D +".
- 2 Shows a decoder that creates sound output from the surround back speakers.
 - "+ PLIIz" indicates the front height sound from front height speakers.

□ Description of listening mode types

Dolby listening mode

Listening mode type	Description
DOLBY PLIIx*1	This mode can be selected when a Dolby Pro Logic IIx decoder is used to play back 2-channel source in 6.1/7.1-channel surround sound including the surround back channel. By adding the surround back channel, a stronger surround feeling is obtained compared to Dolby Pro Logic II. There are three playback modes: "Movie" mode that is optimized for movie playback, "Music" mode that is optimized for music playback, and "Game" mode that is optimized for game play.
DOLBY PLII	This mode can be selected when a Dolby Pro Logic II decoder is used to play back 2-channel source in 5.1-channel surround sound with a natural, realistic feel.
DOLBY Pro Logic	This mode can be selected when a DOLBY Pro Logic decoder is used to play 2-channel source in 4.1-channel surround sound (Left/Center/Right/Surround Mono).
DOLBY PLIIz*2	This mode can be selected when a Dolby Pro Logic IIz decoder is used to play back 2-channel source in 7.1-channel surround sound with added front height channel. By adding a front height channel, the vertical expression is emphasized, improving the three-dimensionality of the sound.
DOLBY DIGITAL	This mode can be selected when playing sources recorded with Dolby Digital.
DOLBY DIGITAL EX*1	This mode improves the depth, dimension, and expressiveness of the sound stage by sound field playback including surround back channels.
DOLBY TrueHD	This mode can be selected when playing sources recorded in Dolby TrueHD.
DOLBY DIGITAL Plus	This mode can be selected when playing sources recorded with Dolby Digital Plus.

*1 This can be selected when "Speaker Config." – "S.Back" is not set to "None".

*2 This can be selected when "Speaker Config." – "F.Height" is not set to "None".

DTS listening mode

Listening mode type	Description
DTS NEO:6	This mode can be selected when a DTS NEO:6 decoder is used to play back 2-channel source in 6.1/7.1-channel surround sound including the surround back channel. There is a "Cinema" mode optimized for movie playback, and a "Music" mode optimized for music playback.
DTS SURROUND	This mode can be selected when playing sources recorded in DTS.
DTS ES DSCRT6.1*	This mode can be selected when playing sources recorded in DTS-ES. Provides optimum playback of DTS-ES Discrete signals using surround back.
DTS ES MTRX6.1*	This mode can be selected when playing sources recorded in DTS-ES. Surround back channel data encoded in DTS-ES Matrix recording software is played from the surround back channel.
DTS 96/24	This mode can be selected when playing sources recorded in DTS 96/24.
DTS-HD	This mode can be selected when playing sources recorded in DTS-HD.
DTS Express	This mode can be selected when playing sources recorded in DTS Express.

* This can be selected when "Speaker Config." – "S.Back" is not set to "None".

PCM multi-channel listening mode

Listening mode type	Description
MULTI CH IN	This mode can be selected when playing multi-channel PCM sources .

marantz original listening mode

Listening mode type	Description
MULTI CH STEREO	This mode is for enjoying stereo sound from all speakers. The same sound as that from the front speakers (L/R) is played back at the same level from the surround speakers (L/R) and surround back speakers (L/R).
VIRTUAL	This mode is for enjoying surround effects using only the front speakers or headphones.
AUTO	In this mode, the type of digital signal input, such as Dolby Digital, Dolby TrueHD, Dolby Digital Plus, Dolby Digital EX, DTS, DTS-HD, DTS-ES, PCM (multi-channel) is detected, and the playback mode switches automatically to the corresponding mode. If the input signal is analog or PCM (2-channel), stereo playback is used.

STEREO listening mode

Listening mode type	Description
STEREO	This is the mode for playing in stereo. The tone can be adjusted. <ul style="list-style-type: none"> • Sound is output from the front left and right speakers and subwoofer. • If multichannel signals are input, they are mixed down to 2-channel audio and are played.

Direct listening mode

Listening mode type	Description
DIRECT	This mode plays back tracks at high sound quality without passing through the sound quality adjustment circuits. <ul style="list-style-type: none"> • Surround back signals or front height signals are not created.
PURE DIRECT	This mode plays back tracks at the closest to the original sound quality. Turn the display of the amplifier off to stop the analogue video circuit. This suppresses the source of noise that affects sound quality. <ul style="list-style-type: none"> • Surround back signals or front height signals are not created.



In Direct listening mode, the following items cannot be adjusted.







- Tone ([page 82](#))
- MultEQ® ([page 82](#))
- Dynamic EQ® ([page 83](#))
- Dynamic Volume® ([page 83](#))
- M-DAX ([page 84](#))

NOTE

- Video signals are only output when HDMI signals are played in the PURE DIRECT mode.
- When in the PURE DIRECT mode, the menu screen is not displayed.

Advanced version

Here, we explain functions and operations that let you make better use of this unit.

- **Speaker installation/connection (Advanced)**  [page 51](#)
- **Connections (Advanced connection)**  [page 61](#)
- **Playback (Advanced operation)**  [page 62](#)
- **Playback in ZONE2 (Separate room)**  [page 73](#)
- **How to make detailed settings**  [page 75](#)
- **Other settings**  [page 105](#)
- **Operating the connected devices by remote control unit**  [page 106](#)

Speaker installation/connection (Advanced)

This section provides the installation, connection, and setup methods of speaker systems other than the 7.1-channel system with surround back speakers. For the speaker installation, connection, and setup methods of the 7.1-channel system with surround back speakers, see [page 4 "Setup Wizard"](#). Use Audyssey® Auto Setup function of this unit to automatically detect the number of connected speakers and perform optimal settings for the speakers to be used.

Procedure for speaker settings

Install

Connect ([page 53](#))

Set up speakers ([page 59](#))

Install

This unit is compatible with Dolby Pro Logic IIz ([page 125](#)), which offers an even wider and deeper surround sensation. When using Dolby Pro Logic IIz, install front height speakers.



Install the surround back speakers in a position 60 to 90 cm higher than ear level.

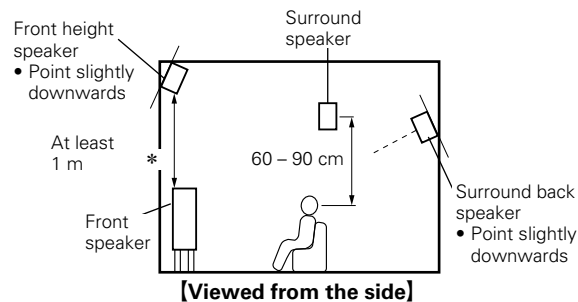

* Recommended for Dolby Pro Logic IIz

NOTE

It is not possible to use the surround back speakers and front height speakers simultaneously.

When 7.1ch (Front height speaker) installed

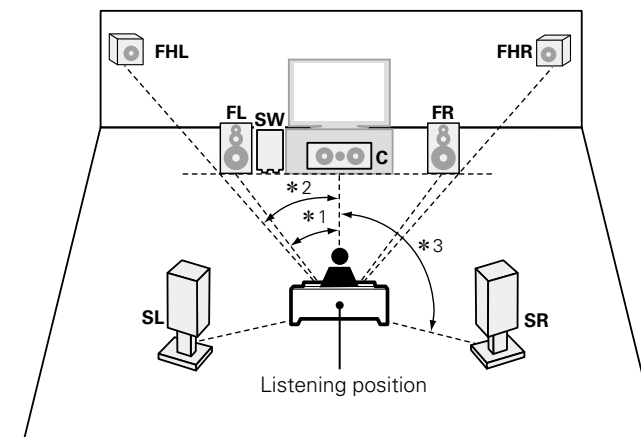

*1 22° - 30° *2 22° - 45° *3 90° - 110°

[Speaker abbreviations]

- | | |
|-----------------------------|-------------------------------------|
| FL Front speaker (L) | SL Surround speaker (L) |
| FR Front speaker (R) | SR Surround speaker (R) |
| C Center speaker | FHL Front height speaker (L) |
| SW Subwoofer | FHR Front height speaker (R) |

When 6.1ch (Surround back speaker) installed

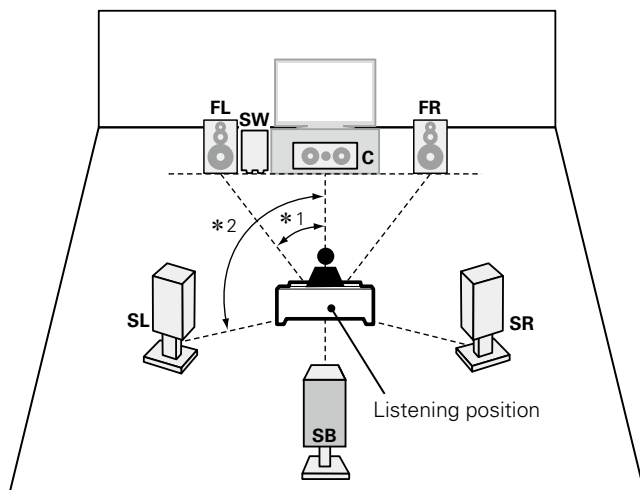

*1 22° - 30° *2 90° - 110°

[Speaker abbreviations]

- | | |
|-----------------------------|---------------------------------|
| FL Front speaker (L) | SL Surround speaker (L) |
| FR Front speaker (R) | SR Surround speaker (R) |
| C Center speaker | SB Surround back speaker |
| SW Subwoofer | |

When 5.1ch installed

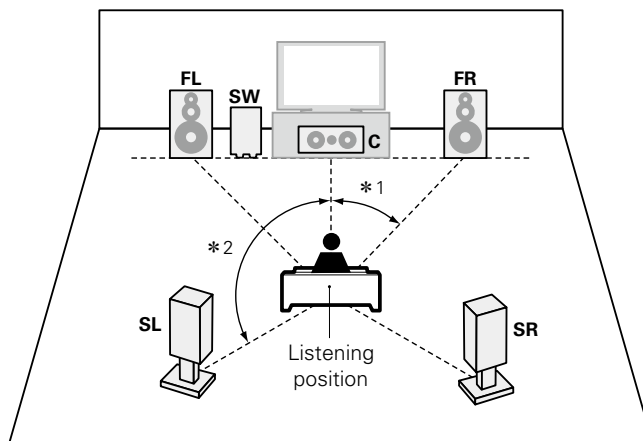

*1 22° - 30° *2 120°

When Front A/B speakers installed

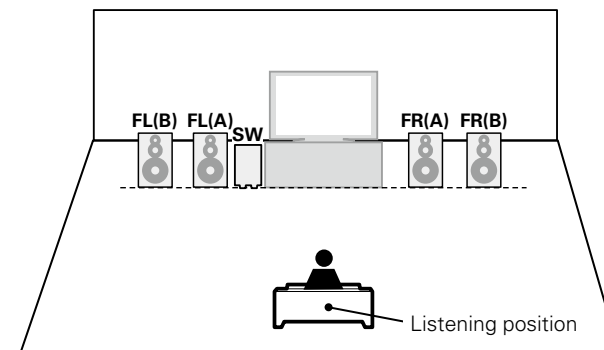

Connect

- For the method of connecting 7.1-channel system with surround back speakers, see [page 6](#) “Connecting the speakers”.
- For the method of connecting the TV, see [page 3](#) “Connect this unit to the television using an HDMI cable (sold separately)”.

7.1-channel (Front height speaker) connection

The illustration on the right shows a connection example for performing 7.1-channel playback using the front height speakers.

If you connect the surround back and front height speakers before you start playback, the audio is played back by automatically switching the speakers in accordance with the surround mode or input signals.

To perform 7.1-channel playback using the front height speaker, set “Amp Assign” to “F.HEIGHT” in steps 3 and 4 for “Set up “Amp Assign”” ([page 59](#)).

NOTE

- For speaker cable connections, see [page 6](#) “Connecting the speakers”.
- Connect so that the speaker cable core wires do not protrude from the speaker terminal. The protection circuit may be activated if the core wires touch the rear panel or if the + and - sides touch each other ([page 126](#) “Protection Circuit”).
- Never touch the speaker terminals while the power supply is connected. Doing so could result in electric shock (When the Setup wizard is running, follow the instructions in the Setup wizard screen for making connections.).
- Use speakers with the speaker impedances shown below.

Speaker terminals	Speaker impedance
FRONT	6 – 8 Ω
CENTER	
SURROUND	
SURR. BACK / AMP ASSIGN	

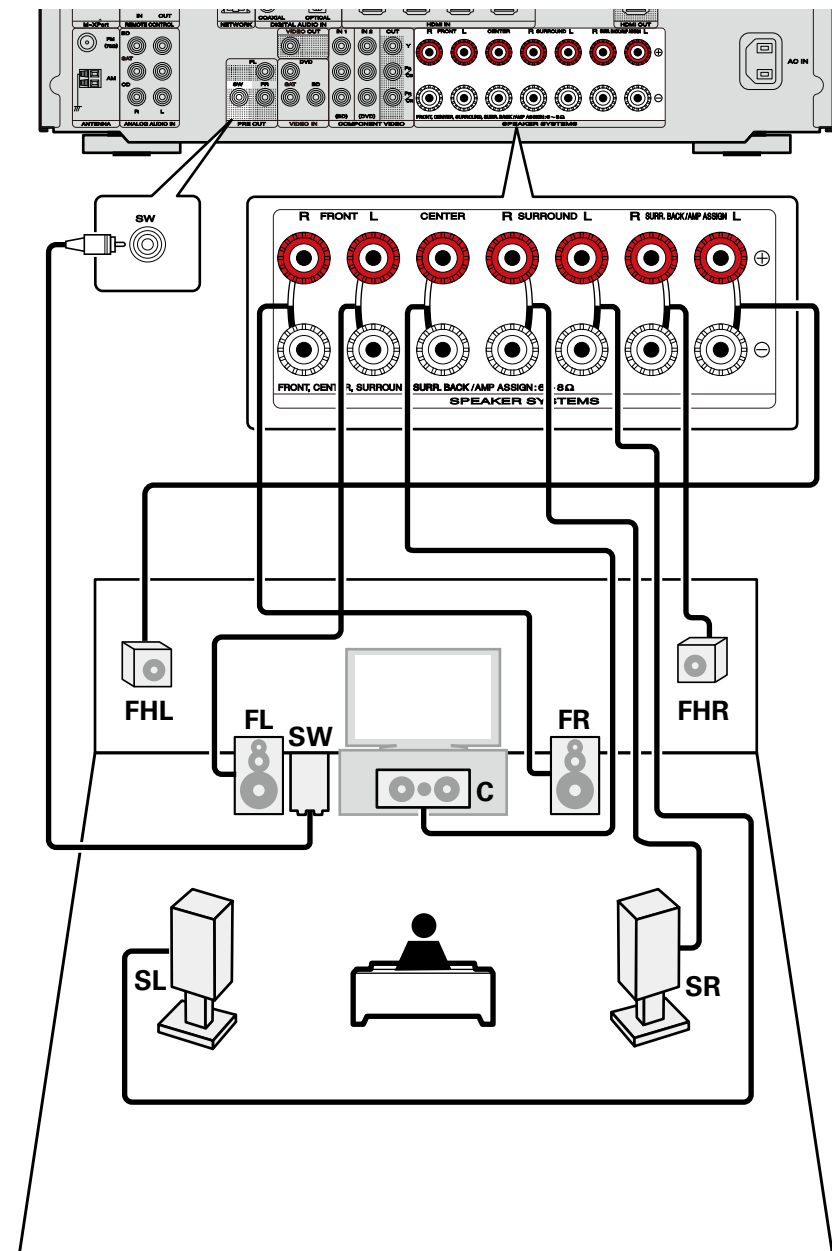

6.1-channel (Surround back speaker) connection

If using only one surround back speaker (with a 6.1-channel connection), connect to the “L” side of the SURR. BACK/AMP ASSIGN terminal.

For speaker settings in this case, see “When 6.1ch (Surround back speaker) installed” ([page 52](#)).

To perform 6.1-channel playback using the surround back speaker, set “Amp Assign” to “NORMAL” in steps 3 and 4 for “Set up “Amp Assign”” ([page 59](#)).

Also use the “Speaker Config.” setting ([page 87](#)) to set “S.Back” to “1spkr”.

NOTE

- For speaker cable connections, see [page 6](#) “Connecting the speakers”.
- For speaker impedance, see [page 53](#).

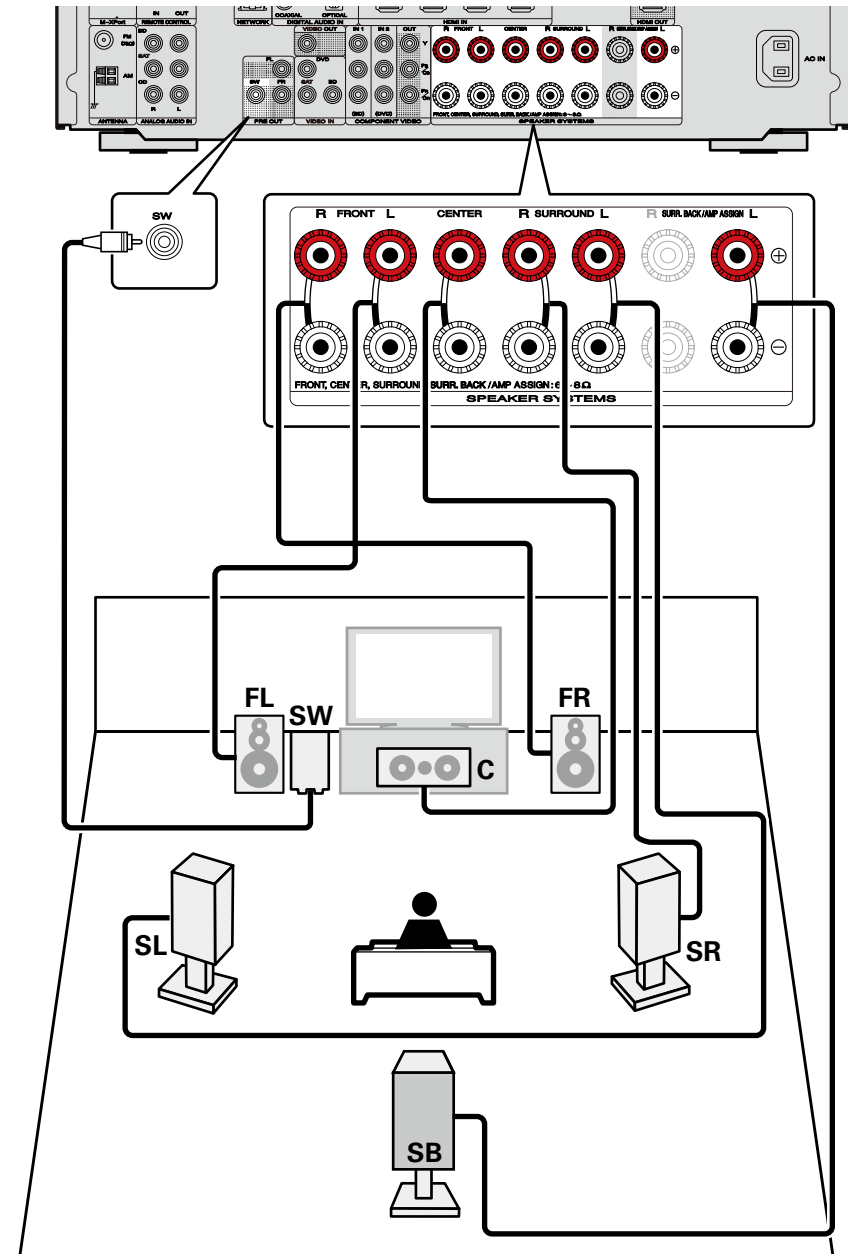

5.1-channel connection

To perform 5.1-channel playback, set "Amp Assign" to "NORMAL" in steps 3 and 4 for "Set up "Amp Assign"" ([page 59](#)).

NOTE

- For speaker cable connections, see [page 6 "Connecting the speakers"](#).
- For speaker impedance, see [page 53](#).

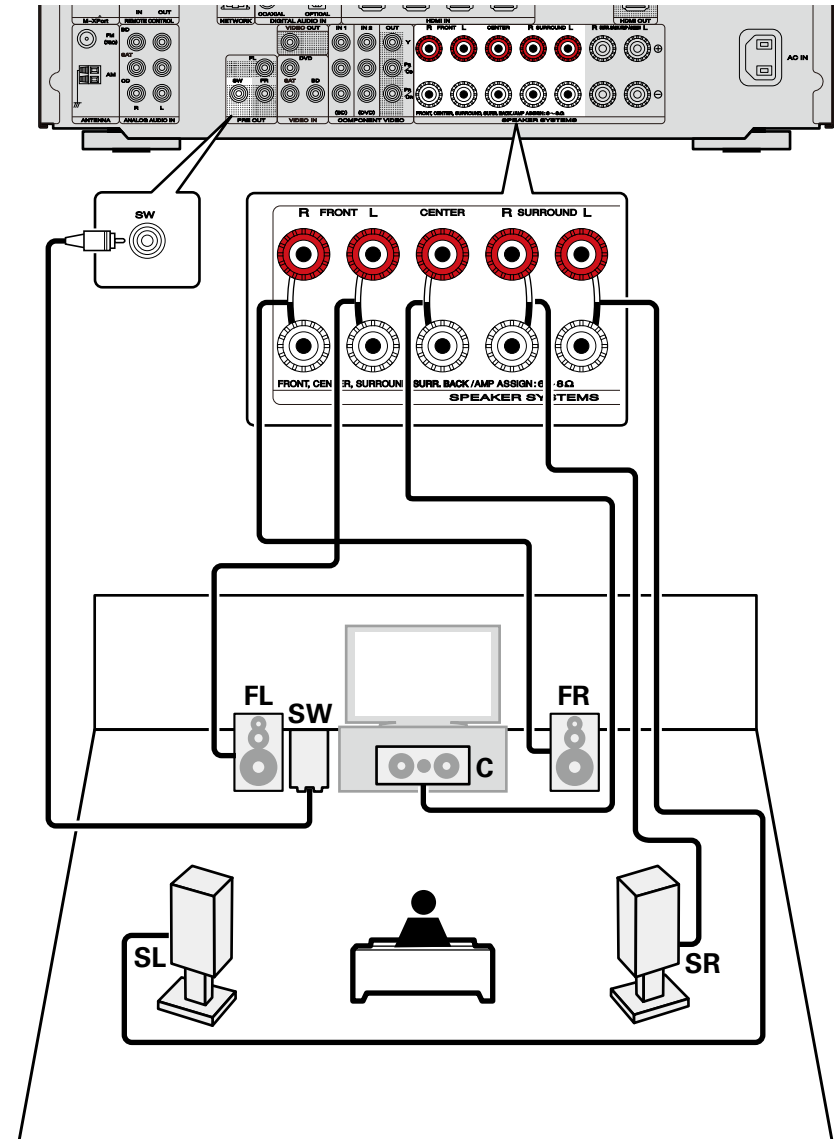

Front A/B connection

You can connect a second set of speakers to this unit and use them for playback. In this case, perform the settings using the **SPEAKER A/B** (🔗 [page 23](#) “Set the front speakers to be used”).

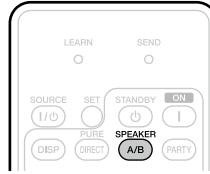

For surround playback of a multichannel source, if you connect the center speaker, surround speakers and subwoofers, 5.1-channel playback is available.

Front speakers can be used separately, depending on the speaker's specifications or playback source such as front speakers (A) for multichannel playback and front speakers (B) for 2-channel playback.

NOTE

- For speaker cable connections, see 📖 [page 6](#) “Connecting the speakers”.
- For speaker impedance, see [page 53](#).
- When using the A front speakers and B front speakers simultaneously, make sure you check the impedance of the connected speakers (🔗 [page 53](#)).

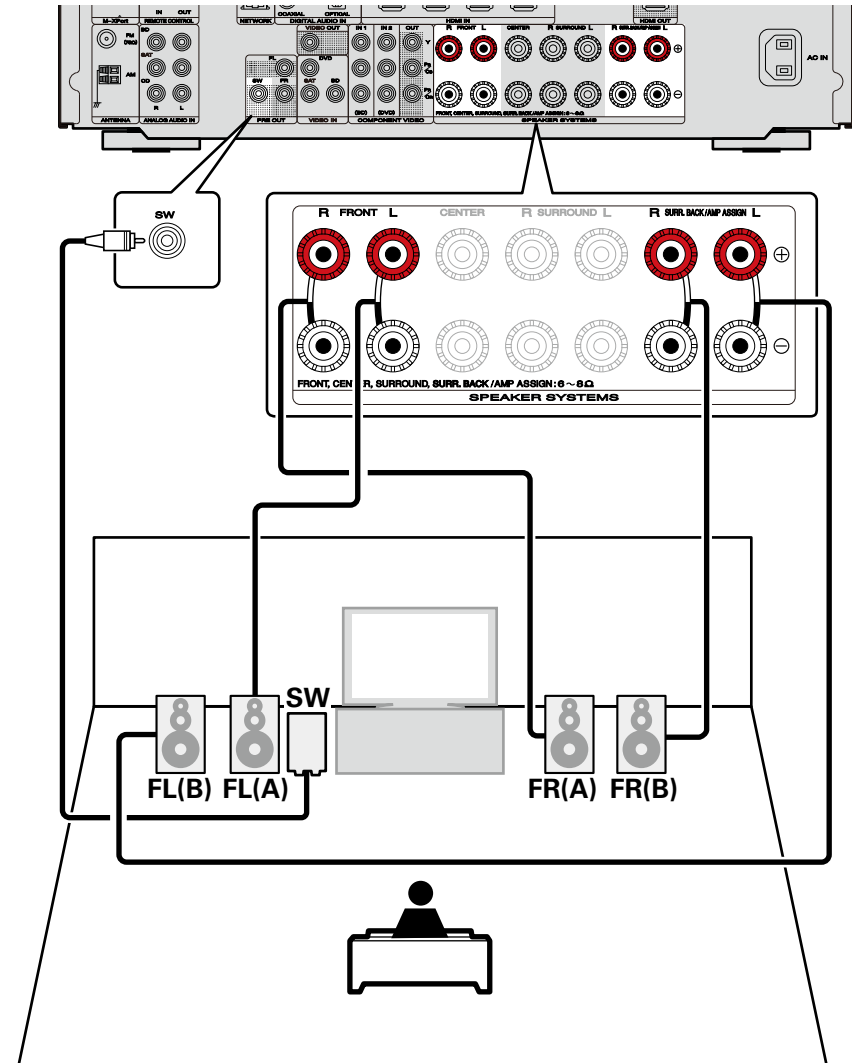

2.1-channel connection

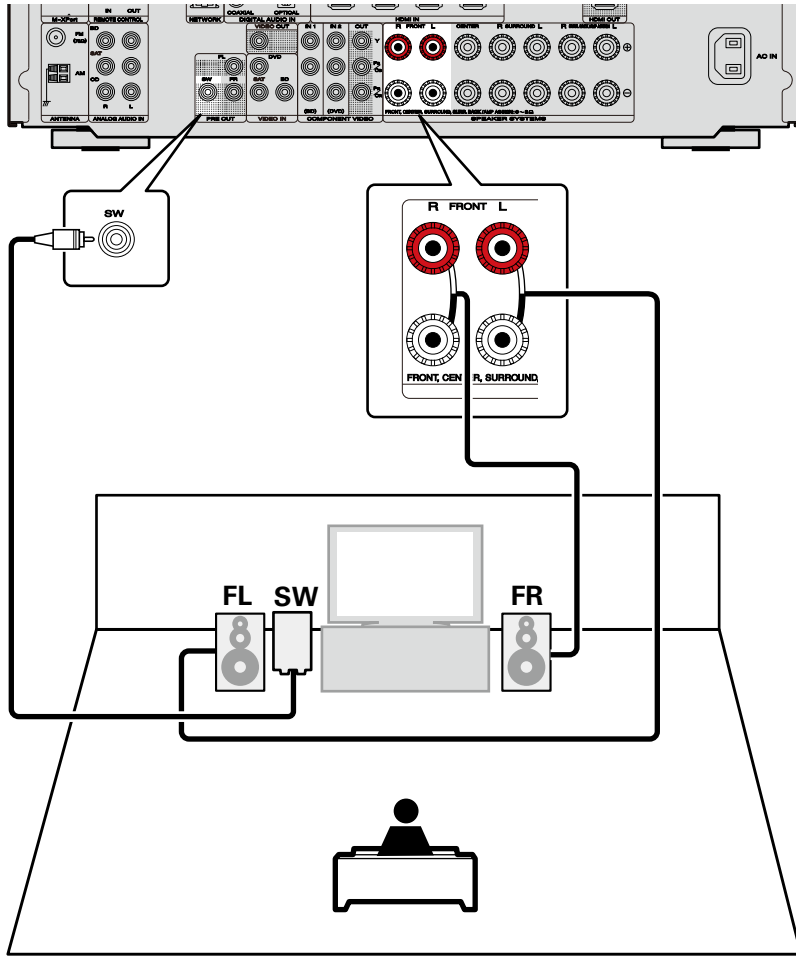

NOTE

- For speaker cable connections, see [page 6](#) "Connecting the speakers".
- For speaker impedance, see [page 53](#).



The PRE OUT connectors can be used to connect front speakers.

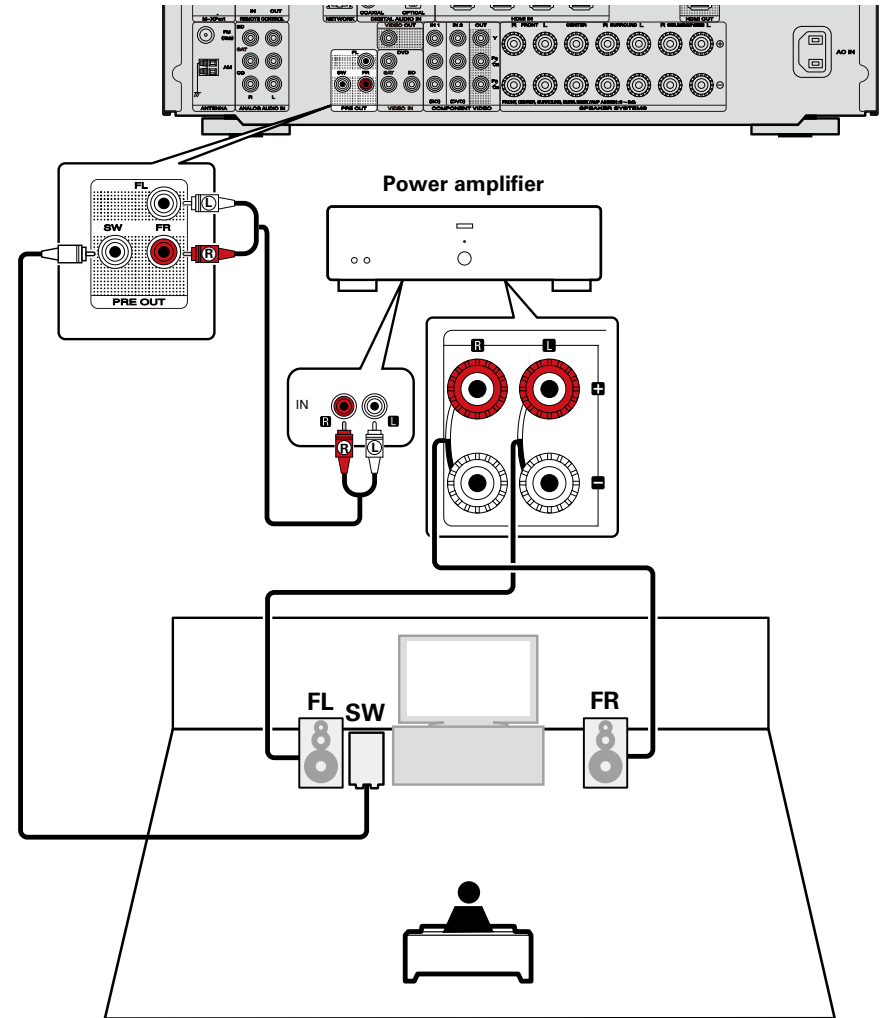

Bi-Amp connection

You can use the front speakers via the bi-amp connection.

A bi-amp connection is to connect separate amplifiers to the tweeter terminals and woofer terminals of speakers compatible with the bi-amp function. This prevents the back electromotive force (returned force without output) of the woofer sent to the tweeter, which affects the sound quality of the tweeter, and you can enjoy playback with higher-quality sound.

In this case, set "Amp Assign" to "SPKR-C" in steps 3 and 4 for "Set up "Amp Assign"" (🔗 [page 59](#)).



For surround playback of a multichannel source, if you connect the center speaker, surround speakers and subwoofers, 5.1-channel playback is available.

NOTE

- For speaker cable connections, see [page 6](#) "Connecting the speakers".
- For speaker impedance, see [page 53](#).
- Use speakers compatible with bi-amp connections.
- When making bi-amp connections, be sure to remove the short-circuiting plate or wire between the speaker's woofer and tweeter terminals.

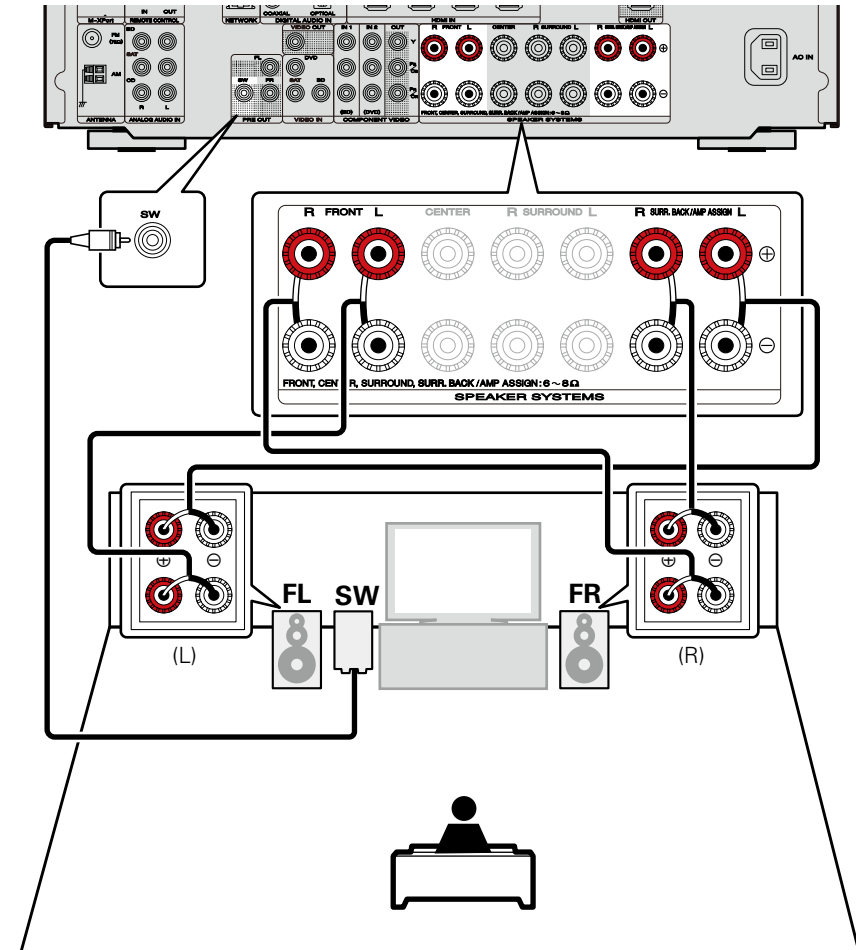

Set up speakers

 around items indicate the settings.

This section provides the setup methods of speaker systems other than the 7.1-channel system (with surround back speakers). For the setup methods of the 7.1-channel system with surround back speakers, see [page 4 "Setup Wizard"](#).

First install and connect the speakers to this unit.

Before Auto Setup measurement, the settings shown below can be made.

- Changing the amplifier assignment (Amp Assign)
The signal output from the SURR.BACK/AMP ASSIGN speaker terminal of this unit can be switched to match your speaker environment ([page 59 "Set up "Amp Assign""](#)).
- Setting the channels to be used (Channel Select)
If channels that are not to be used are set in advance, measurement for the set channels is skipped, and measuring time can be reduced. You can also change the number of surround back speakers ([page 60 "Set up "Channel Select""](#)).

1 Set up the remote control unit

Set up the operation mode
Press **AMP** to set the remote control unit to AMP-operation mode.

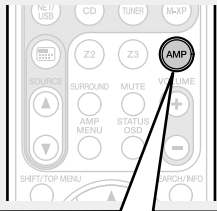

Press AMP

2 Connect the setup microphone.

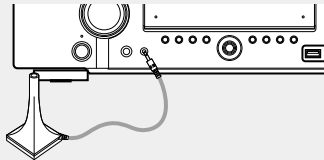

When the setup microphone is connected, the following screen is displayed.

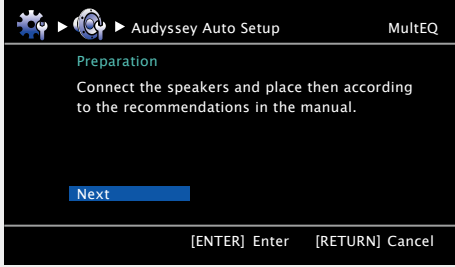

3 Select "Next", and then press ENTER.

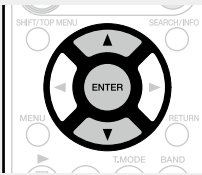

4 Set up "Amp Assign"

Use Δ / ∇ to select "Amp Assign", and then press ENTER.

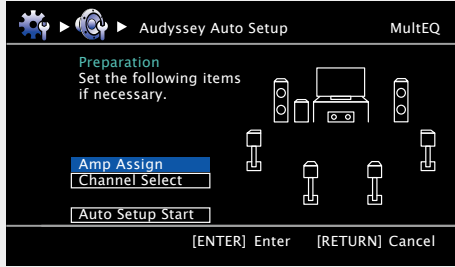

Next

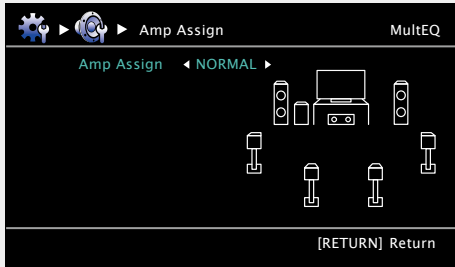

[RETURN] Return

5 Use ◀ ▶ to select the configuration of the connected speakers.

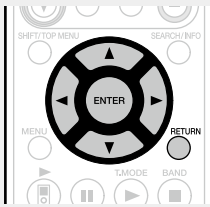

NORMAL Select the "NORMAL" setting to perform 7.1-channel playback using the surround back speakers.

ZONE2 Select the "ZONE2" setting to assign the unit's built-in power amplifier for ZONE2 and output the audio in stereo.

SPKR-C Select the "SPKR-C" setting to connect the front speakers via the bi-amp connection.

Front B Select the "Front B" setting to use the second set of front speakers for playback.

F.HEIGHT Select the "F.HEIGHT" setting to use the front height speaker for playback.

6 Press **RETURN** to exit the "Amp Assign" setting.

7 Set up "Channel Select"

Use ▲▼ to select "Channel Select", and then press **ENTER**.

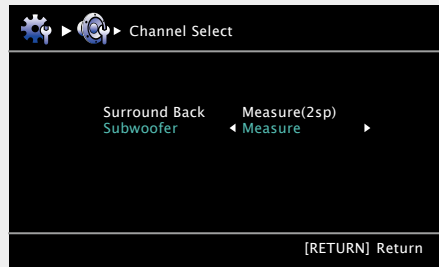
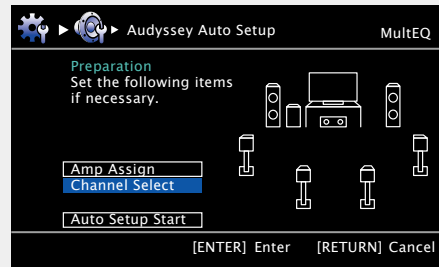

8 Use ▲▼ to select a channel.

Surround Back Select the number of surround back speakers to be used. In this case, go to step 9.

- "Surround Back" can be set when "Amp Assign" is set to "NORMAL".

Subwoofer Select for no subwoofer to be used. In this case, go to step 10.

9 Use ◀ ▶ to set whether or not a surround back channel is measured.

Measure (2 sp) Set for measuring two surround back speakers.

Measure (1 sp) Set for measuring a surround back speaker.

Skip Set for no measuring of a surround back speaker.

10 Use ◀ ▶ to set whether or not a subwoofer channel is measured.

Measure Set for measuring a subwoofer.

Skip Set for no measuring of a subwoofer.

11 Press **RETURN**. Proceed to [page 17](#) **STEP1 Preparation** step 6.

NOTE

After performing Audyssey® Auto Setup, do not change the speaker connections or subwoofer volume. In event of a change, perform Audyssey® Auto Setup again.

Connections (Advanced connection)

Connecting the remote control connectors

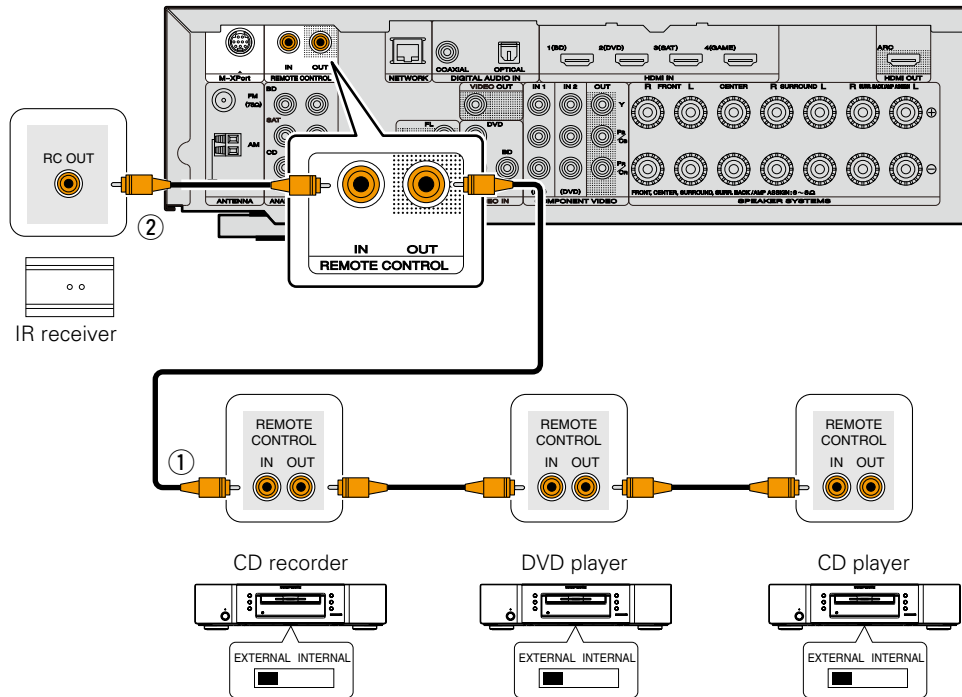

- ① You can control other marantz products through this unit with the remote control unit by connecting the REMOTE CONTROL connectors on each unit.
 - The signal transmitted from the remote control unit is received by the remote sensor on this unit. Then the signal is sent to the connected device through REMOTE CONTROL connector. Therefore you need to aim the remote control only at the this unit.
 - Set the remote control switch located on the rear panel of the connected audio component to "EXTERNAL" or "EXT." to use this feature.
 - If a marantz power amplifier (excluding certain models) is connected to any of these connectors, the power of the power amplifier switches to on/standby in conjunction with the **ON/STANDBY** button of the this unit.
- ② Whenever external infrared sensors or similar devices are connected to REMOTE CONTROL IN connector of the this unit, be sure to always disable operation of the infrared sensor on the this unit ([page 105](#) "Remote control settings").

NOTE

Be sure to set to "enable" when external infrared sensors or similar devices are not connected. Otherwise, the unit will be unable to receive remote control commands.

Playback (Advanced operation)

Settings (🔗 page 15)

Playback (Basic operation) (🔗 page 22)

Selecting a listening mode (Surround mode)
(🔗 page 46)

- ❑ HDMI control function (🔗 page 62)
- ❑ Sleep timer function (🔗 page 63)
- ❑ Adjusting the volume of the speakers
(🔗 page 64)
- ❑ AirPlay (🔗 page 65)
- ❑ Party mode function (🔗 page 66)
- ❑ Zone Management function (🔗 page 67)
- ❑ Operating a media controller to play music and still pictures (🔗 page 68)
- ❑ Web control function (🔗 page 69)
- ❑ Dual backup memory function (🔗 page 71)
- ❑ Panel lock function (🔗 page 71)
- ❑ Various memory functions (🔗 page 72)

Convenient functions

HDMI control function

If you connect the unit and an HDMI control function compatible TV or player with an HDMI cable and then enable the HDMI control function setting on each device, the devices will be able to control each other.

❑ Operations possible by HDMI control

- This unit power off can be linked to the TV power off step.
- You can switch audio output devices with a TV operation.
When you set "Output audio from amp" in the TV audio output setup operation, you can switch the amp power on.
- You can adjust this unit volume in the TV volume adjustment operation.
- You can switch this unit input sources through linkage to TV input switching.
- When playing the player, this unit input source switches to the source for that player.
- If you switch the input source of the unit to "TV", you can play TV audio with this unit (🔗 page 7 "About ARC (Audio Return Channel) function").
- When "HDMI Control" (🔗 page 90) in the menu is set to "ON", signals input to the HDMI input connector are output to the television or other device connected to the HDMI output connector, even if the power of this unit is in standby (pass-through function).



- To play the audio of a TV that does not support the ARC function with the unit, connect the TV with an optical digital connection.
- To use the pass-through function, connect an HDMI connection device that is compatible with HDMI control.

❑ Setting procedure

- 1 Set the HDMI output connector corresponding with the HDMI control function.**
Set "HDMI Control" (🔗 page 90) to "ON".
- 2 Turn the power on for all the devices connected by HDMI cable.**
- 3 Set the HDMI control function for all devices connected by HDMI cable.**
 - Please consult the operating instructions for the connected devices to check the settings.
 - Carry out steps 2 and 3 should any of the devices be unplugged.
- 4 Switch the television input to the HDMI input connected to this unit.**
- 5 Switch this unit input to the HDMI input source and check if the picture from the player is ok.**
- 6 When you turn the TV's power to standby, check that the power of this unit also goes to standby.**



If the HDMI control function does not operate properly, check the following points.

- Is the TV or player compatible with the HDMI control function?
- Is "HDMI Control" (🔗 page 90) set to "ON"?
- Is "P.Off Control" (🔗 page 90) set to "All" or "Video"?
- Are the HDMI control function settings of all devices correct?

NOTE

- When “HDMI Control” is set to “ON”, it consumes more standby power.
- The HDMI control function controls operations of a TV that is compatible with the HDMI control function. Make sure that the TV and HDMI are connected when you perform HDMI control.
- Some functions may not operate depending on the connected TV or player. Check the owner’s manual of each device for details beforehand.
- When “P.Off Control” on the menu is set to “OFF” ([page 90](#)), this unit is not set to standby even if the connected device is in the standby mode.
- When connection changes are implemented, such as adding connections to HDMI devices, linked operations may be initialized. In this case, you will need to reconfigure the settings.
- When “HDMI Control” is set to “ON”, it is not possible to assign an HDMI connector to “TV” at “Input Assign” ([page 101](#)).
- Should any of the operations below be performed, the interlocking function may be reset, in which case, repeat steps 2 and 3.
 - “Input Assign” – “HDMI” ([page 101](#)) setting has changed.
 - There is a change to the connection between the devices and the HDMI, or an increase in devices.

Sleep timer function

The power automatically goes into standby once the set time has elapsed.

This is convenient for playing sources while going to sleep.

1 Press AMP to set the remote control unit to AMP-operation mode.

2 Press SLEEP and display the time you want to set.

The “SLEEP” indicator on the display lights.

- The time switches as shown below each time SLEEP is pressed.

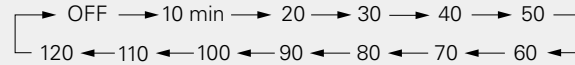

To confirm the countdown time before putting the unit to sleep

Press **SLEEP**.

“Sleep : *min” appears on the display.

* Countdown time

To cancel the sleep timer

Press **SLEEP** to set “OFF”.

The “SLEEP” indicator on the display turns off.



- The sleep timer setting is canceled if this unit’s power is set to standby.
- The sleep timer function can be set separately for the different zones ([page 74](#) “Sleep timer function”).

Adjusting the volume of the speakers

You can adjust the channel level either according to the playback sources or to suit your taste, as described below.

Adjusting the volume of the different speakers

1 Press **AMP** to set the remote control unit to AMP-operation mode.

2 Press **CH LVL**.

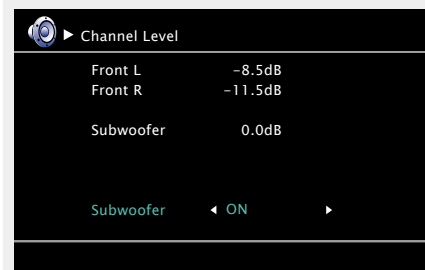

3 Use **△▽** to select the speaker.
The speaker that can be set switches each time one of the buttons is pressed.

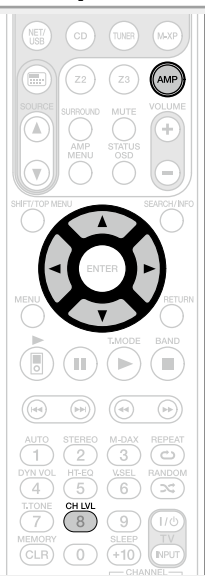

4 Use **◀▶** to adjust the volume.

- You can directly turn "OFF" the subwoofer outputs during 2-channel playback in DIRECT or STEREO mode. Select "Subwoofer" and use **◀▶** to select "ON" or "OFF".

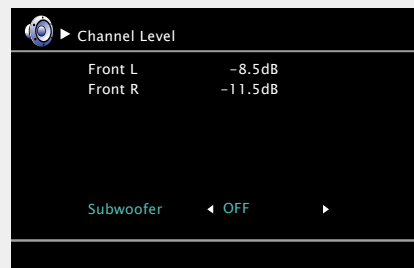

When a headphone jack is inserted, the headphone channel level can be adjusted.

Adjusting the volume of groups of speakers (Fader function)

This function lets you adjust (fade) the sound all at once from the front (front speaker / front height speaker / center speaker) or rear (surround speaker / surround back speaker).

1 Press **AMP** to set the remote control unit to AMP-operation mode.

2 Press **CH LVL**.

3 Press **▽** to select "Fader", then select the item to be adjusting using **◀▶**.

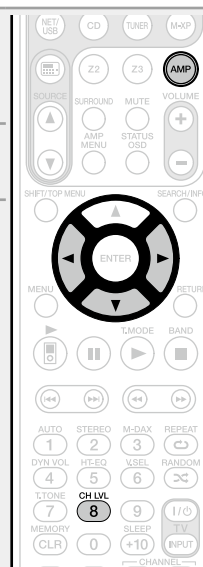
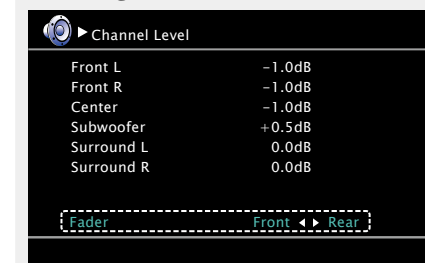

4 Use **◀▶** to adjust the volume of the speakers.
(◀ : front, ▶ : rear)



- The fader function does not affect the subwoofer.
- The fader can be adjusted until the volume of the speaker is adjusted to the lowest value of -12 dB.

AirPlay

Enjoy music from your iTunes library with marantz quality sound anywhere in your home.

Use the Apple Remote app* for iPhone, iPod touch and iPad to control iTunes from any room in your home.

* Available as a free download from the App Store.

Setting procedure

1 Install iTunes 10, or later, on a Mac or Windows PC that is connected to the same network as this unit.

2 Turn this unit ON.
Set "Network Standby" to "ON" for this unit.

NOTE

When "Network Standby" is set to "ON", the unit consumes more standby power.

3 Launch iTunes and click the AirPlay icon  displayed in the lower right of the window and select this unit from the list.

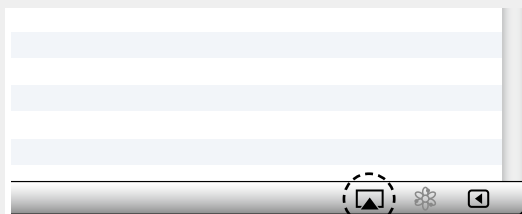

4 Choose a song and click play in iTunes.
The music will stream to this unit.

Multiple Speakers

You can easily stream music from iTunes to multiple speakers in your home.

1 Click the AirPlay icon  and select "Multiple Speakers" from the list.

2 Check the speakers you want to use.

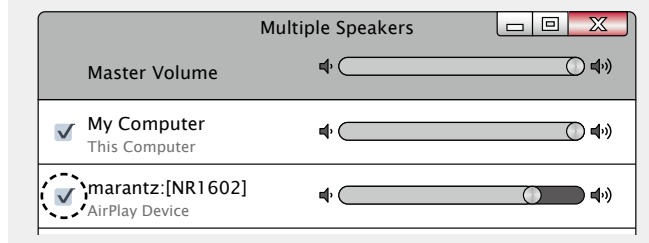

Streaming music stored in iPhone, iPod touch, or iPad directly to the unit

If you update your "iPhone/iPod touch/iPad" to iOS 4.2.1 or later, you can stream music stored in your "iPhone/iPod touch/iPad" directly to this unit.

1 Tap the AirPlay icon .

2 Select the speaker you want to use.

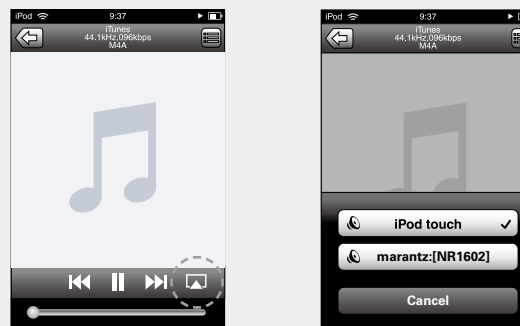



Remote operations

You can use your marantz remote control to play and pause iTunes, as well as skip to next and previous tracks.

1 Open Preferences in iTunes, and click "Devices".

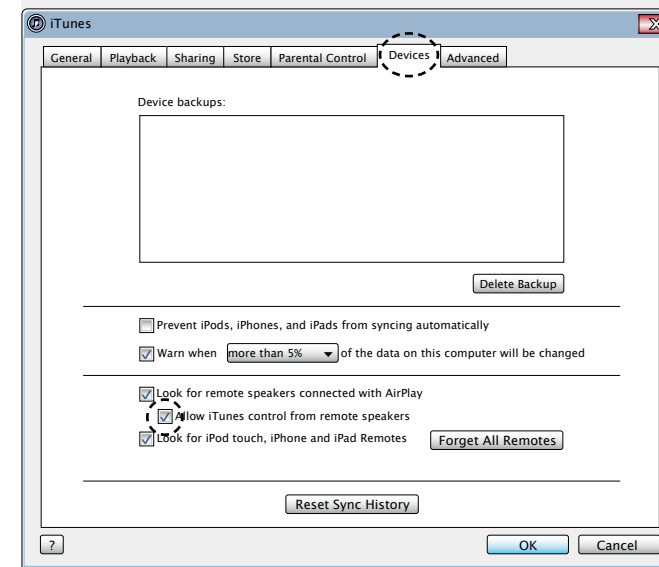
2 Check "Allow iTunes control from remote speakers".



-  is displayed on the menu screen while AirPlay is being operated.
- Source input will be switched to "NET/USB" when AirPlay playback is started.
- You can stop AirPlay playback by pressing the  or choosing other input source.

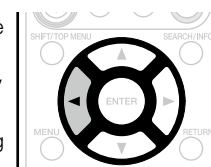

- To see song and artist names together, press **STATUS** on the main unit.
- For information about how to use iTunes, also see the Help for iTunes.
- The screen may differ depending on the OS and software versions.

Party mode function

The same network audio (Internet radio, Media server or iPod DIRECT) can be played on multiple marantz products equipped with the Party Mode function and connected in a network.

The party mode consists of one organizer and up to four attendees. When one unit starts the party mode as the organizer, up to four devices on which the party mode function is activated automatically participate in the party as attendees. "Party Mode" (page 94) must be set to "ON" ahead of time in order to use the party mode function.

Starting the party mode as the organizer

1 Press PARTY to become the organizer.

"Enter Party Mode?" is displayed.

- An error message is displayed when you are not connected to a network.

2 Press ◀▶ to select "Yes", then press ENTER.

The input source automatically switches to "NET/USB" and the attendees are automatically selected.

3 Play the desired track.

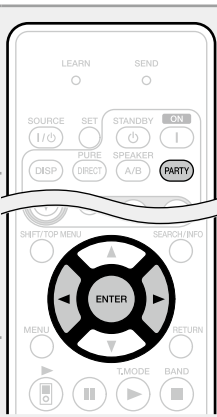

Canceling the party mode

1 While in the party mode, press PARTY.

"Exit Party Mode?" is displayed on the menu screen.

2 Press ◀▶ to select "Yes", then press ENTER.

"Power off attendees component?" is displayed.

3 Press ◀▶ to select "Yes" or "No", then press ENTER.

- | | |
|------------|--|
| Yes | The power of the attendees is turned off and the party mode is canceled. |
| No | The party mode is canceled without turning off the power of the attendees. |

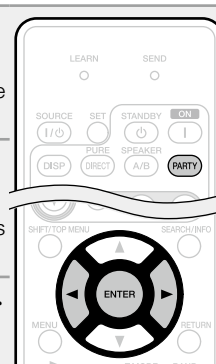

Participating in the party mode as an attendee

- When the organizer starts the party mode, up to four attendees are selected automatically. No operation is required.
- The input source automatically switches to "NET/USB" and the same network audio as on the organizer is played.
- If there are fewer than four attendees, a device can join the party mode after it has started. To participate in the party mode, perform the operation described below.

1 Press PARTY.

"Enter Party Mode?" is displayed.

- An error message is displayed when you are not connected to a network.

2 Press ◀▶ to select "Yes", then press ENTER.

When you start the party mode, the monitor of the attendee (child) displays the network menu screen for the organizer (parent).

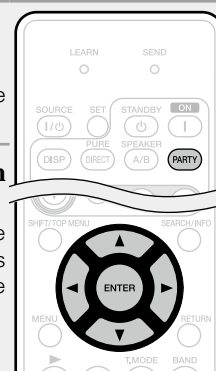

3 Press ▲▼◀▶ and ENTER to select the desired track.



The party mode function can only be used on a combination of marantz devices that are equipped with the party mode function.

Canceling the party mode

1 While in the party mode, press PARTY.

"Exit Party Mode?" is displayed on the menu screen.

2 Press ◀▶ to select "Yes", then press ENTER.

In this case, the other devices remain in the party mode.

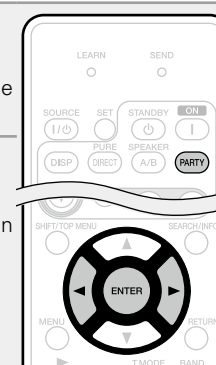

"Flickr", "Last.fm", "Napster" and "USB" are not available in the Party Mode.

There can only be one organizer in the network. To form a new party mode, first cancel the current party mode.

Zone Management function

The status of devices connected to the same network can be displayed. Additionally, network menu browsers and volume controls can be performed via the network for the connected devices.

This is useful when playing back network services of a device located in a separate room.



Only devices compatible with the Zone Management function can be operated.

With the Zone Management function, the network menu screen and playback screen of the target device to be controlled are displayed but playback with this unit is not possible. If you also want to play the same music as the other device, use the Party Mode function.

- 1 Press Δ / ∇ to select “Network Setup” – “Other” – “Zone Management” from the menu, and then press **ENTER** or \triangleright .

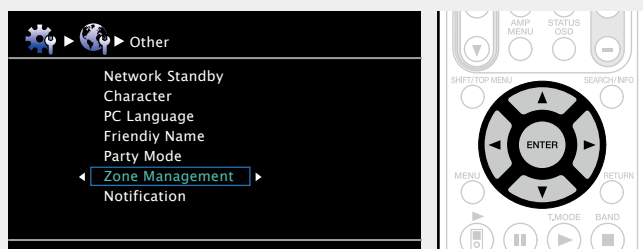

- 2 Press Δ / ∇ to select the Friendly Name of the device, and then press **ENTER** or \triangleright .

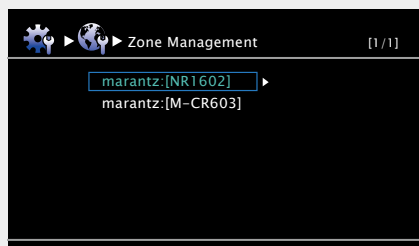

- Displays up to a maximum of 10 marantz products connected on the same network.

- 3 Press Δ / ∇ to select “Device Control”, and then press **ENTER**.

When the device control mode is started, the network menu of the connected device is displayed on this unit’s television screen.

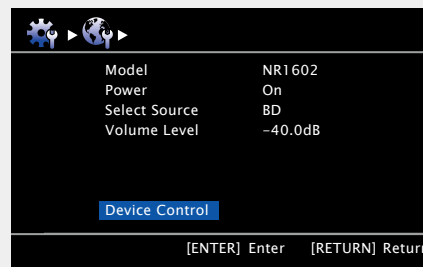

NOTE

- If the selected device is compatible with the Zone Management function, “Device Control” mode starts.
- If the selected device is in Party Mode or being controlled with Zone Management, “Device Control” is not displayed.

- 4 Press Δ / ∇ / \triangleleft / \triangleright and **ENTER** to select the desired track.



- When in device control mode, **REMOTE CONTROL** is displayed on the television screen of the controlling device, and **REMOTE** is displayed on the television screen of the device being controlled.



The zone management function can only be used on a combination of marantz devices that are equipped with the zone management function.

NOTE

- When the input source is switched to NET/USB operation mode by pressing **NET/USB**, the volume of the selected device can be controlled using **CHANNEL +** (volume up) and **CHANNEL -** (volume down). Note that the volume level is not displayed.
- For services that require an account, set the account settings on the target device in advance. Also, some functions of the device may be restricted in “Device Control” mode.

To end “Device Control” mode

- 1 Press **AMP MENU** in “Device Control” mode.

“Exit Device Control Mode?” is displayed on the TV screen.

- 2 Press \triangleleft / \triangleright to select “Yes”, then press **ENTER**.

“Power off Remote component?” is displayed on the TV screen.

- 3 Press \triangleleft / \triangleright to select “Yes” or “No”, then press **ENTER**.

- | | |
|------------|--|
| Yes | Turns off the target device and ends “Device Control” mode. |
| No | Ends “Device Control” mode without turning off the power of the target device. |



“Device Control” mode can also be ended from the controlled device side.

- ① Press **AMP MENU** on the controlled device.
- ② When “Exit Device Control Mode?” is displayed on the TV screen, select “Yes” and then press **ENTER**.

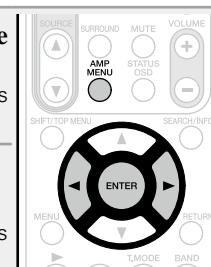

Operating a media controller to play music and still pictures

- Perform this procedure using a media controller conforming to the DLNA (Digital Living Network Alliance) standard.
- This function allows you to play content located on a computer (media server) or connected on a network by operating a media controller on the same network.
- There are two types of operations on the media controller.

□ Playing content on a computer (Media server)

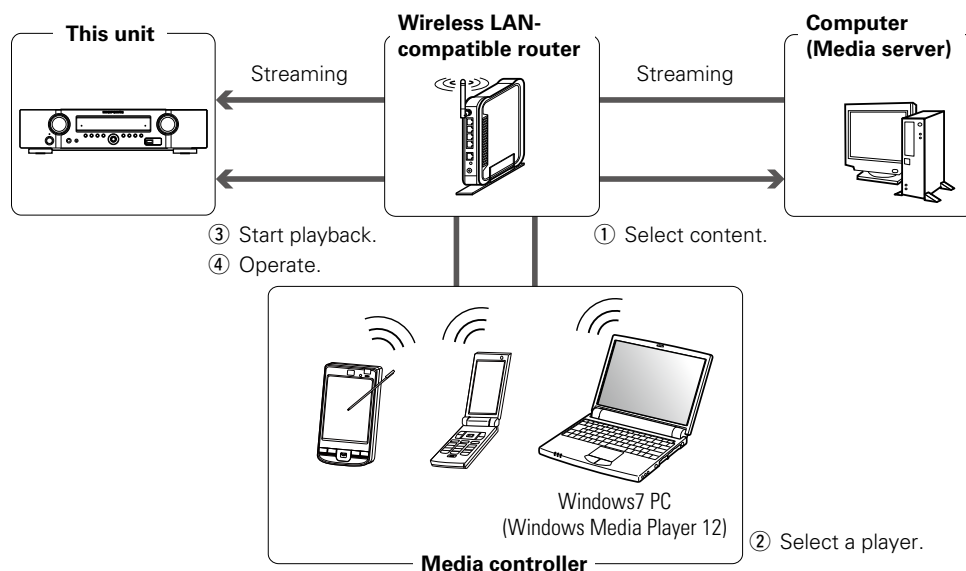

1 From the media controller, browse the media server on the same network and choose the content you want to play.

2 From the media controller, select this unit from among the products on the network. Playback of the content selected in step 1 begins.

- When selecting this unit from the media controller, the name of this unit is displayed at “Friendly Name” (☞ page 94 “Friendly Name”).
- The following operations are possible from the media controller:
 - File operations (play, stop, pause, track search)
 - Play mode settings (repeat/random)
 - Volume adjustment

□ Playing contents on a media controller

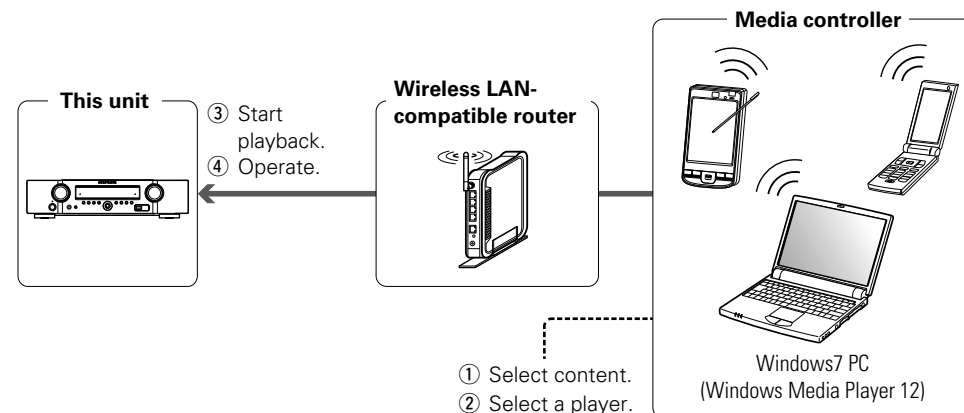

1 Select the content you want to play from among the media controller.

2 From the media controller, select this unit from among the products on the network. Playback of the content selected in step 1 begins.

- When selecting this unit from the media controller, the name of this unit is displayed at “Friendly Name” (☞ page 94 “Friendly Name”).
- The following operations are possible from the media controller:
 - File operations (play, stop, pause, track search)
 - Play mode settings (repeat/random)
 - Volume adjustment



-  is displayed on the menu screen while the media controller is being operated.
- For the various settings and operating procedures, see the operating instructions of the media controller being used.
- When selecting this unit from the media controller, the name of this unit is displayed at “Friendly Name”. “Friendly Name” can be edited at “Friendly Name” (☞ page 94) as desired so that it is easily distinguishable from other devices.
- When playback is started from the media controller, this unit’s input source automatically switches to “NET/USB”. Also, when the “Network Standby” setting (☞ page 94) is set to “ON”, the power automatically turns on.

NOTE

When operations related to browsing or playback (play, stop, pause, track search) are performed on this unit while operating the media controller, the connection to the network is disconnected. The network connection is also disconnected when the party mode is started.

Web control function

You can operate this unit using a browser.

1 Switch the “Network Standby” setting to “ON”. (🔗 [page 94](#)).

2 Check the IP address of this unit with “Network Info.” (🔗 [page 95](#)).

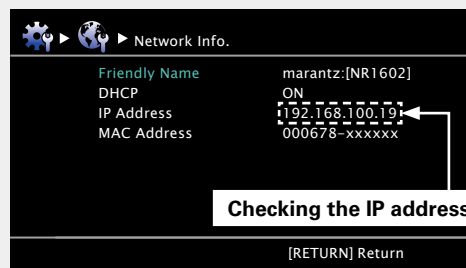

3 Enter the IP address of this unit in browser’s address box.

For example, if the IP address of this unit is “192.168.100.19”, enter “http://192.168.100.19/”.

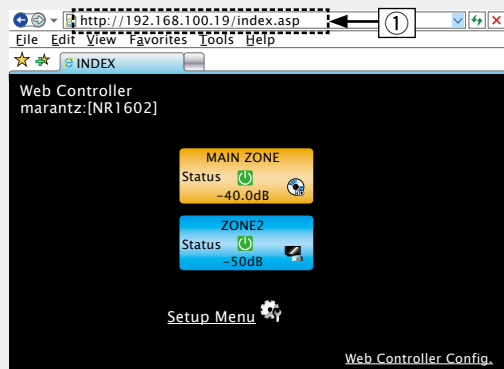

① Entering the IP address.

4 When the top menu is displayed, click on the menu item you want to operate.

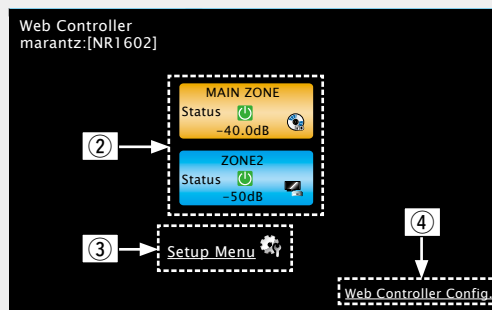

- ② Click when you operate each zone. (🔗 [Example 1](#))
- ③ Click when you operate the setup menu. (🔗 [Example 2](#))
- ④ Click to change the Web control screen setting. (🔗 [Example 3](#))

5 Operate.

[Example 1] Main zone control screen

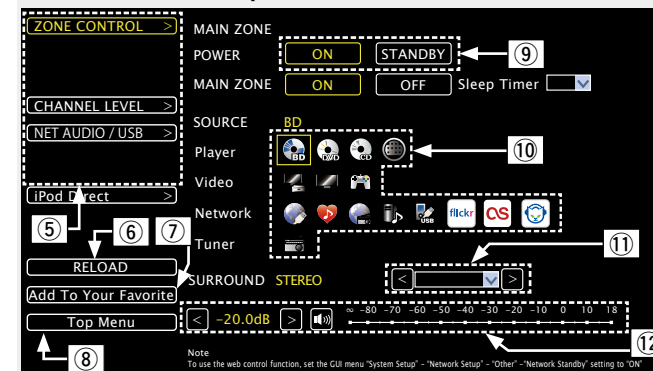

- ⑤ Click to perform individual operations.
 Changes to individual operation screens. (🔗 [Example 4](#))
- ⑥ Click when you update to the latest information.
 Normally, there is a change to the latest information each time you operate. When operating from the main unit, click this or else the screen will not be updated.
- ⑦ Click to add a setting to “Favorites” in your browser.
 We recommend registering the setting screens for the different zones in the browser’s favorites so as not to accidentally perform menu operations for zones you do not intend to operate.
- ⑧ Click to return to the top menu.
 Displayed when setting “Top Menu Link Setup” to “ON” in **[Example 3]**
- ⑨ Click when you perform a power operation of the unit.
- ⑩ Click an icon to change the input source.
- ⑪ Click “v” and then select a surround mode from the displayed items.
- ⑫ To adjust the main volume, click “<”, “>” or the volume display.

[Example 2] Setup menu screen

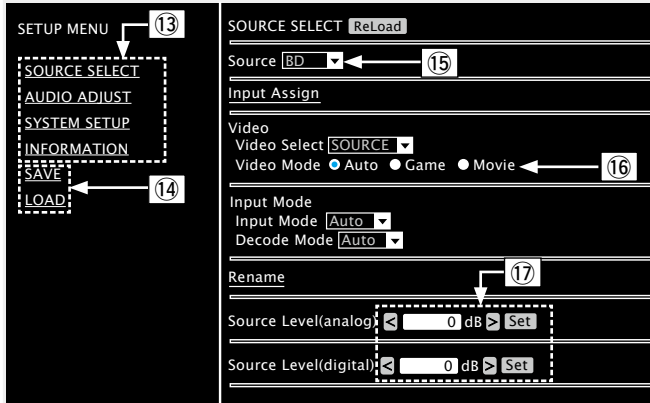

- 13 Click the menu item from which you want to make settings.
The display on the right becomes the individual setting screens.
- 14 Click "SAVE" when you want to save settings, and click "LOAD" when you want to call settings.
- 15 Click "v" and select from the displayed items.
- 16 Click an item to make a setting.
- 17 Enter figures or click "<" or ">" to make the setting, and then click "Set".

[Example 3] Web configuration screen

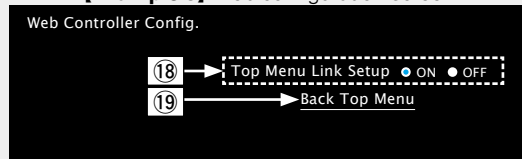

- 18 Click "ON" when performing Top Menu Link Setup.
When set up, return to the top menu from each operation screen.
(Default setting : "OFF")
- 19 Click this item to return to the top menu.

[Example 4] Net Audio operating screen

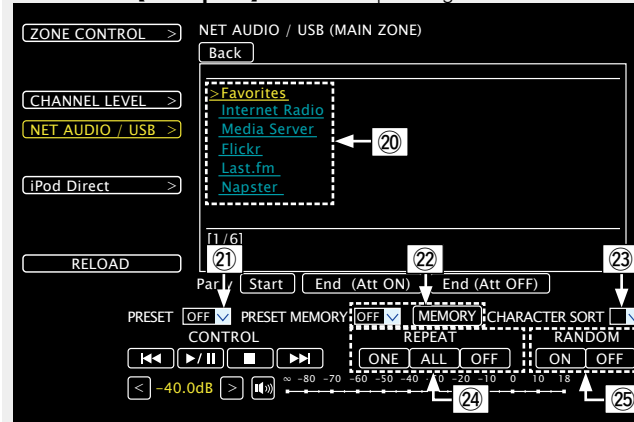

- 20 Click the menu items from which you want to play.
- 21 Click "v" to select the preset channel you want to play.
- 22 When registering presets, click "v" to select the channel you want to register, and then click "MEMORY".
- 23 When searching using an acronym, click "v" and select from the displayed characters.
- 24 Click this item to play back repeatedly.
- 25 Click this item to play back randomly.

Dual backup memory function

The unit stores settings information in nonvolatile memory even when the main power supply is turned off. Using the Dual Backup Memory function, you can write settings information to another memory area to back up saved settings for recovery anytime as needed.

☐ Remembering set details (Backup)

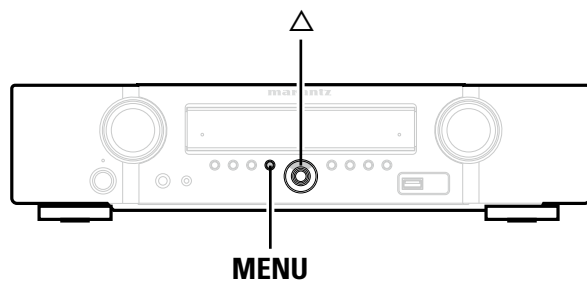

Set the unit in the state you want remembering, and press and hold **Δ** and **MENU** for at least 3 seconds.

"MEMORY SAVING" is shown in the display, and the setting details are remembered.

NOTE

- The volume is not remembered.
- If remembered details are overwritten, the previously remembered contents are deleted.

☐ Recalling remembered details (Recovery)

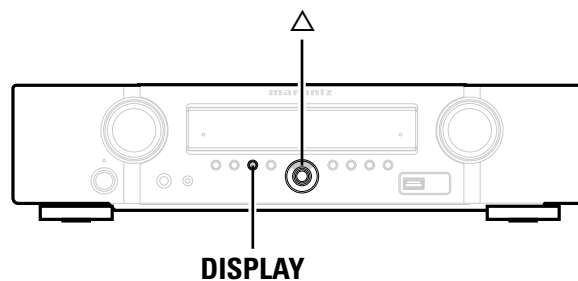

Press and hold **Δ** and **DISPLAY** together for at least 3 seconds.

"MEMORY LOAD" is shown in the display, and the remembered details are recalled.

NOTE

- If there is no remembered data, "NO BACKUP" is shown in the display, and no remembered details are recalled.
- As the volume cannot be recalled, it returns to the factory setting volume.

Panel lock function

To prevent accidental operation of this unit, you can disable operation of the buttons on the front panel.

ON/STANDBY DISPLAY ONE TOUCH PLAY

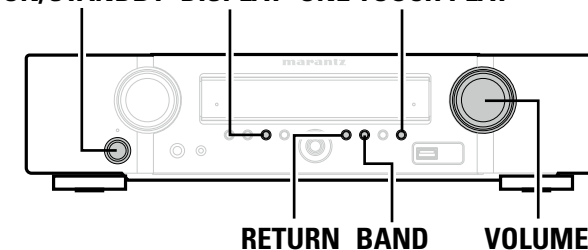

☐ Disabling all key button operations

Press **ON/STANDBY** while you press and hold **ONE TOUCH PLAY** and **BAND** with the unit in standby mode.

"Panel Lock:ON" appears on the display and all button operations except **ON/STANDBY** are disabled.

☐ Disabling all button operations except VOLUME

Press **ON/STANDBY** while you press and hold **ONE TOUCH PLAY** and **DISPLAY** with the unit in standby mode.

"Panel Lock:ON" appears on the display and all button operations except **ON/STANDBY** and **VOLUME** are disabled.

☐ Canceling the Panel lock function

Press **ON/STANDBY** while you press and hold **ONE TOUCH PLAY** and **RETURN** with the unit in standby mode.

The Panel lock function is canceled.



Even when the Panel lock function is set, you can operate the unit using the remote control unit.

Various memory functions

❑ Personal memory plus function

This function sets the settings (input mode, surround mode, HDMI output mode, MultEQ®, Dynamic EQ®, audio delay etc.) last selected for the individual input sources.



The surround parameters, tone settings and the volumes of the different speakers are stored for the individual surround modes.

❑ Last function memory

This function stores the settings which were made before going into the standby mode.

When the power is turned back on, the settings are restored.

Playback in ZONE2 (Separate room)

- You can operate this unit so as to enjoy audio in a room (ZONE2) other than the MAIN ZONE (room where the unit is located).
- You can simultaneously play back the same source in both the MAIN ZONE, ZONE2. You can also play back separate sources in the MAIN ZONE and ZONE2.

Audio output

Zone playback by speaker output

The ZONE2 audio signals are output from this unit's SURR.BACK/AMP ASSIGN speaker terminals using the amplifier assignment function.

Connecting and setting the speakers

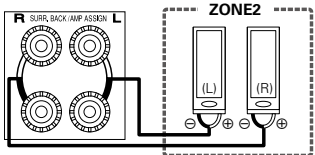
<p>"Amp Assign" setting (page 87) and audio signals output</p>	<p>Connecting the speakers</p>
<p>ZONE2 Output signal : Stereo (L / R)</p>	

NOTE

It is not possible to play the digital audio signals input from the HDMI, COAXIAL or OPTICAL connectors in ZONE2. Play using analog connections (in stereo).

Playback

1 Press Z2 to set the remote control unit to ZONE2-operation mode.

2 Press ON | to turn on the ZONE2 power.
The **Z2** indicator on the display lights.

- When **STANDBY** is pressed, ZONE2 turns off.

3 Press SOURCE ▲ or SOURCE ▼.
The audio signal of the selected source is output to ZONE2.

- Every time you press **SOURCE ▲** or **SOURCE ▼**, the input source switches in the following order.

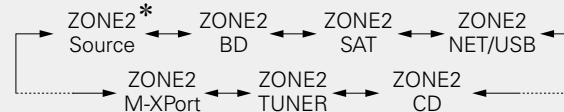

* When "ZONE2 Source" is selected, the input source for MAIN ZONE will be assigned to ZONE2.



Adjusting the volume

Use **VOLUME +, -** to adjust the volume.

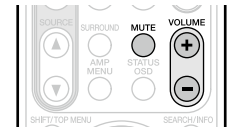

[Adjustable range] --- **-80dB - -40dB - 18dB**

(When the "Volume Display" ([page 96](#)) setting is "Relative")

[Adjustable range] **0 - 41 - 99**

(When the "Volume Display" ([page 96](#)) setting is "Absolute")

- At time of purchase, "Volume Limit" ([page 95](#)) is set to "-10dB (71)".

Turning off the sound temporarily

Press **MUTE**.

The sound is reduced to the level set at "Mute Level" ([page 95](#)) in the menu.

- To cancel, either adjust the volume or press **MUTE** again.
- The setting is canceled when the zone's power is turned off.

Sleep timer function

This is useful when you want to sleep while listening in ZONE2.

- 1 Press Z2 to set the remote control unit to ZONE2-operation mode.**

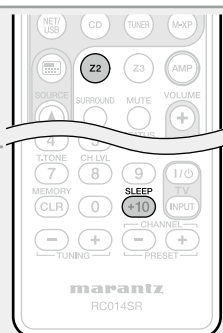

- 2 Press SLEEP and display the time you want to set.**

- The time switches as shown below each time **SLEEP** is pressed.

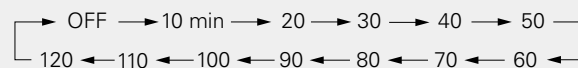

To confirm the countdown time before putting the unit to sleep

Press **SLEEP**.

"Z2 Sleep : *min" appears on the display.

* Countdown time

To cancel the sleep timer

Press **SLEEP** to set "OFF".





The sleep timer is also canceled when the ZONE2 power is turned off.

How to make detailed settings

Menu map

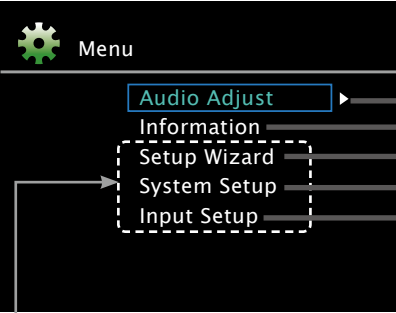
For menu operation, connect a TV to this unit and display the menu on the TV screen. For menu operations, see the following page.

Setting items	Detailed items	Description	Page
	Audio Adjust		
	Surr.Parameter	Adjusts surround sound parameters.	81
	Tone	Adjusts the tonal quality of the sound.	82
	Audyssey Settings	Makes Audyssey MultEQ®, Audyssey Dynamic EQ® and Audyssey Dynamic Volume® settings.	82
	Manual EQ	Uses the graphic equalizer to adjust the tone of each speaker.	84
	M-DAX	Expands the low and high frequency components of compressed audio to enable richer audio playback.	84
	Audio Delay	Compensates for incorrect timing between video and audio.	84
	Information		
	Status	Shows information about current settings.	85
	Audio Signal	Shows information about audio input signals.	85
	HDMI Information	Displays the HDMI input/output signals and HDMI monitor information.	85
	Preset Channel	Shows information about tuner or network preset channels.	85
Setup Wizard		Perform the installation, connection, and setup procedures to prepare the unit for operation following guidance.	4
	System Setup		
	Speaker Setup	Sets the speaker size and distance, the channel level, etc.	87
	HDMI Setup	Makes settings for HDMI video/audio output.	90
	Audio Setup	Makes settings for audio playback.	91
	Network Setup	Makes network settings.	92
	ZONE2 Setup	Makes settings for audio playback in a ZONE2 system.	95
	Option Setup	Makes various other settings.	96
	Language	Sets the language for display the menu on the TV screen.	98
	Input Setup		
	 Auto Preset	Uses the auto preset function to program radio stations.	100
	Preset Skip	Sets the preset memories that you do not want to display when tuning.	100
	Preset Name	Assigns name to a preset memory.	100
	Input Assign	Changes input connector assignment.	101
	Video	Makes the video settings.	102
	Input Mode	Sets the audio input mode and decode mode.	103
	Rename	Changes the display name for this source.	103
	Source Level	Adjusts the playback level of the audio input.	103
	Playback Mode	Makes settings for iPod, USB memory device or network source playback.	104
	Still Picture	Makes settings for still picture playback.	104

Items that only need to be set once

Set these for example upon purchase. Once these items are set, there is no need to set them again unless the speaker layout or the connected speakers have been changed.

 Displayed items of the "Input Setup" menu differs, depending on the selected input source.

Examples of menu screen displays

Typical examples are described below.

[Example 1] Menu selection screen (Top menu)

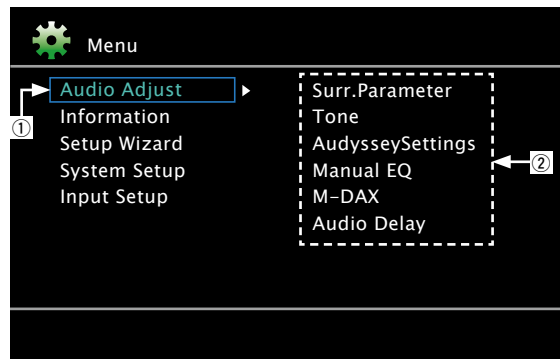

- ① Currently selected setup item
- ② List of currently selected setup subcategory

Press ▾ to select "System Setup" and then press ▷.
(Or press ENTER.)

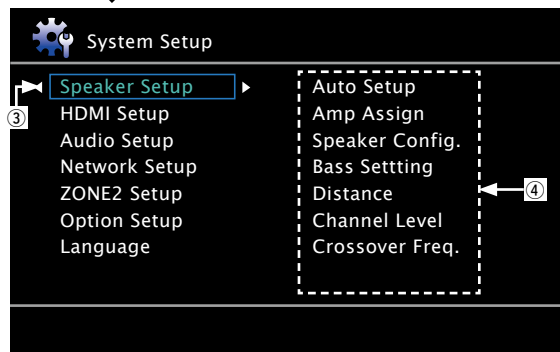

- ③ Selected setup item
- ④ Options of the selected setup item

[Example 2] Audyssey® Auto Setup screen (with illustration)

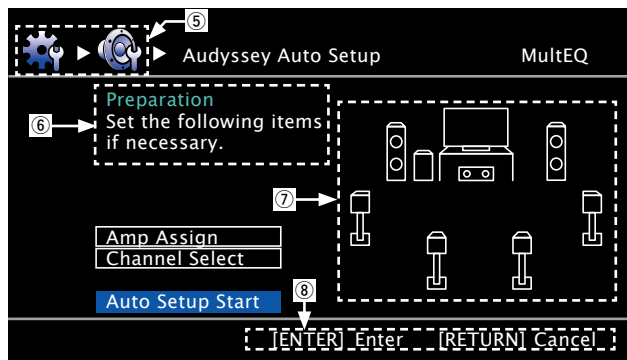

- ⑤ History icon
- ⑥ Operation guidance text
- ⑦ Illustration
- ⑧ Operation button guidance

List

Selected item

- Switch the selected item using △▽.

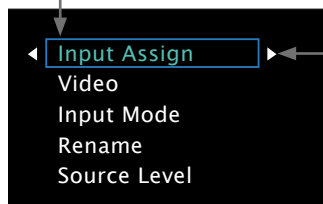

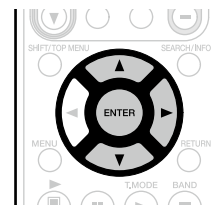

Proceed to the subcategory
(Use ▷ or ENTER to switch.)

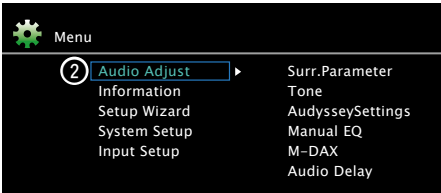
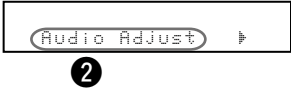
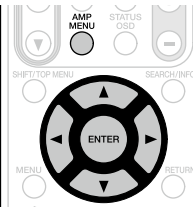
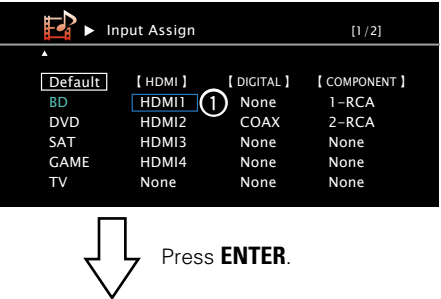
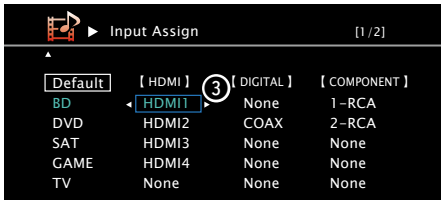

Examples of menu and front display

Below we describe typical examples of displays on the TV screen and on the set's display window.

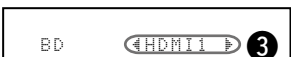
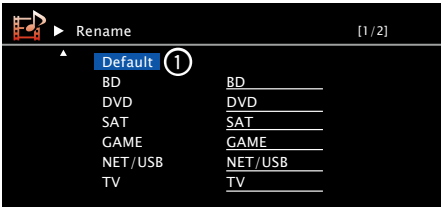
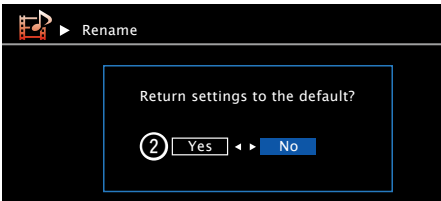
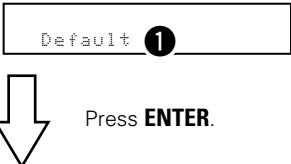
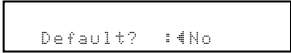
	Menu display	Front display	Description
Top menu display			<ol style="list-style-type: none"> 1 Press AMP MENU to display the menu screen. 2 TV screen: Displays the selected line. Display: Displays the selected item. <ul style="list-style-type: none"> • Use $\Delta \nabla$ to move to the item you want to set. 
Display when changing settings	 	 	<ol style="list-style-type: none"> 1 TV screen: Displays the selected line. Display: Displays the selected item. 2 Press ENTER to set to the mode in which the setting can be made. <p>3 $\leftarrow \rightarrow$ is displayed at the sides of items whose setting can be changed. Use $\leftarrow \rightarrow$ to change to the desired setting.</p>
Display when resetting	 	 	<ol style="list-style-type: none"> 1 Press Δ to select "Default", then press ENTER. 2 Press \leftarrow to select "Yes", then press ENTER.

Inputting characters

You can change the names as desired using the "Preset Name" (page 100), "Rename" (page 103), "Last.fm Account" (page 95), "Napster Account" (page 95), "Zone Rename" (page 97) and character input for the network functions. For inputting characters, there are two methods, as shown below.

Method for inputting characters

Method	Operations
Using the keyboard screen	<ul style="list-style-type: none"> Operating with the remote control unit. Select a character on the TV screen to input characters.
Using the cursor buttons (Cursor mode screen)	<ul style="list-style-type: none"> Operating with the remote control unit. Use $\Delta \nabla \triangleleft \triangleright$ and ENTER to input characters.

Keyboard screen

Display of a keyboard input screen

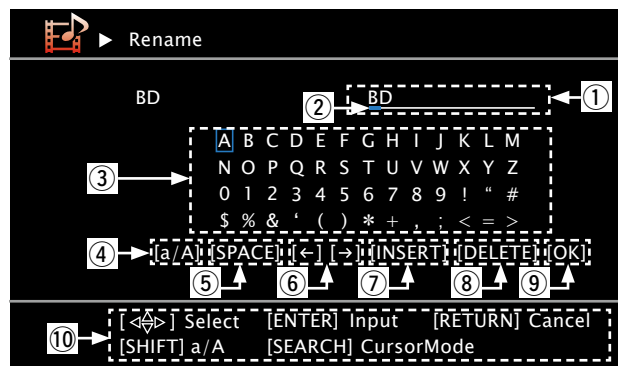

- ① Character input section (Maximum 8 characters)
- ② Cursor
- ③ Keyboard section
- ④ Uppercase and lowercase switch key
- ⑤ Space key
- ⑥ Cursor keys
- ⑦ Insert key
- ⑧ Delete key
- ⑨ OK key
- ⑩ Guide for operation buttons

Using the keyboard screen

1 Display the screen for inputting characters (page 75 "Menu map").

2 Select a character to be changed.
① Press $\Delta \nabla \triangleleft \triangleright$ to select [←] or [→].

② Press **ENTER** to place the cursor at the character to be changed.

Each time **ENTER** is pressed, the cursor moves by one character.

3 Select a character to be input with $\Delta \nabla \triangleleft \triangleright$ then press **ENTER**.

- The types of characters that can be input are as shown below.

[Upper case characters/Numbers/Symbols]

ABCDEFGHIJKLMNOPQRSTUVWXYZ

0123456789

! " # \$ % & ' () * + , ; < = >

[Lower case characters/Numbers/Symbols]

abcdefghijklmnopqrstuvwxyz

0123456789

. @ - _ / : ? [\] ^ ` { | }

- When you press **SHIFT/TOP MENU** while you type in, you can change uppercase characters to lowercase and vice versa.

4 Repeat steps 2 and 3 to change the name.

5 Use $\Delta \nabla \triangleleft \triangleright$ to select [OK], then press **ENTER**.

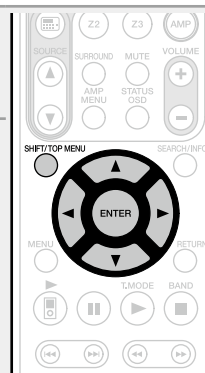

Cursor mode screen

□ Display of a cursor mode screen

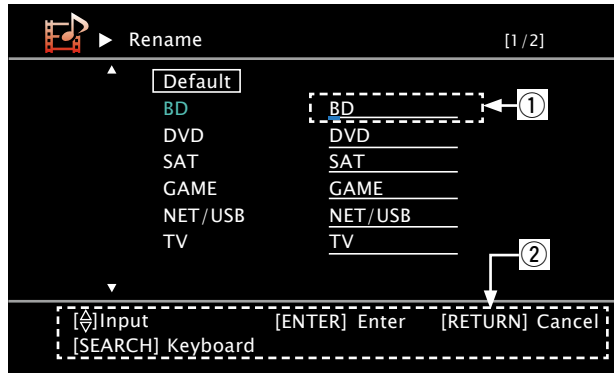

- ① Character input section (Maximum 8 characters)
- ② Guide for operation buttons

Using the cursor buttons

- 1** Display the screen for inputting characters (see [page 75](#) “Menu map”).
- 2** Press **SEARCH/INFO** while a keyboard screen is displayed.
A cursor mode screen is displayed.
- 3** Use **< >** to set the cursor to the character you want to change.
- 4** Use **△ ▽** to change the character, then press **ENTER**.
 - The types of characters that can be input are as shown below.

[Upper case characters]
 ABCDEFGHIJKLMNOPQRSTUVWXYZ
[Lower case characters]
 abcdefghijklmnopqrstuvwxyz
[Symbols] ! " # \$ % & ' () * + , - . / : ; <
 = > ? @ [\] ^ _ ` { | } ~
[Numbers] 0 1 2 3 4 5 6 7 8 9 (Space)

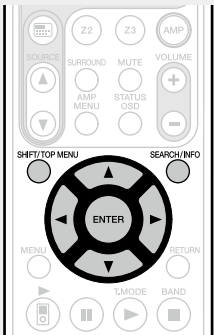
- When you press **SHIFT/TOP MENU** while you type in, you can change uppercase characters to lowercase and vice versa.
- 5** Repeat steps 3 and 4 to change the name then press **ENTER** to register it.



The sound being played in the surround mode can be adjusted to your liking. The items (parameters) that can be adjusted depend on the signal being input and the currently set surround mode. For details on the adjustable parameters, see “Surround modes and surround parameters” ([page 120](#)).

NOTE

Some setting items cannot be set while playback is stopped. Make the settings during playback.

Menu operation

- 1 Press AMP MENU.**
The menu is displayed on the TV screen.
- 2 Use Δ / ∇ to select the menu to be set or operated.**
- 3 Press ENTER or \triangleright to enter the setting.**
 - To return to the previous item, press **RETURN**.
 - Exiting the Menu, press **AMP MENU** while the menu is displayed. The menu display disappears.

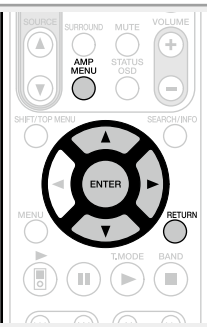

If **MENU** on the main unit is pressed, the same function as with the remote control unit can be obtained.

Items that can be set with the “Audio Adjust” procedure

Surr.Parameter ([page 81](#))

Tone ([page 82](#))

Audyssey Settings ([page 82](#))

Manual EQ ([page 84](#))

M-DAX ([page 84](#))

Audio Delay ([page 84](#))



Surr.Parameter

Default settings are underlined.

Adjust surround sound parameters. It may not be possible to set this item depending on the input signal (refer to [page 120](#) "Surround modes and surround parameters").

NOTE

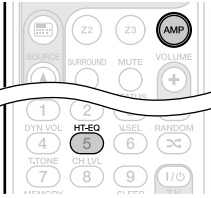

- You cannot set the surround parameters in the PURE DIRECT mode.
- During playback in PURE DIRECT mode, the surround parameters are the same as in DIRECT mode.

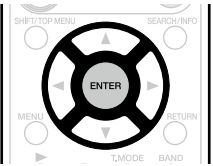
Setting items	Setting details
HT-EQ Soften the treble range of movie soundtracks for better understanding.	<p>ON : "HT-EQ" is used. OFF : "HT-EQ" is not used.</p>  <p>Buttons on the remote control unit can be used for operations.</p> <p>① Press AMP to set the remote control unit to AMP-operation mode. ② Press HT-EQ.</p>
DRC Compress dynamic range (difference between loud and soft sounds).	<p>Auto : Automatic dynamic range compression on/off control according to source. This can be set in the Dolby TrueHD mode. Low / Middle / High : These set the compression level. OFF : Dynamic range compression always off.</p>
D.Comp Compress dynamic range (difference between loud and soft sounds).	<p>OFF : Turn dynamic range compression off. Low / Middle / High : These set the compression level.</p>
LFE Adjust the low-frequency effects level (LFE).	<p>-10dB - 0dB</p> <p> For proper playback of the different sources, we recommend setting to the values below.</p> <ul style="list-style-type: none"> Dolby Digital sources : "0dB" DTS movie sources : "0dB" DTS music sources : "-10dB"
C.Image Assign center channel signal to front left and right channels for wider sound.	<p>0.0 - 1.0 (0.3)</p>

Setting items	Setting details
Panorama Assign front L/R signal also to surround channels for wider sound.	<p>ON : Set. OFF : Do not set.</p>
Dimension Shift sound image center to front or rear to adjust playback balance.	<p>0 - 6 (3)</p>
C.Width Assign center channel signal to front left and right channels for wider sound.	<p>0 - 7 (3)</p>
Height Gain Control the front height channel volume.	<p>Low : Reduce the front height channel volume. Middle : Front height channel sound is output with standard sound volume. High : Increase the front height channel volume.</p> <p>NOTE</p> <p>"Height Gain" is displayed for the following settings.</p> <ul style="list-style-type: none"> When "Amp Assign" (page 87) is set to "F.HEIGHT". When the "Speaker Config." - "F.Height" setting (page 88) is set other than to "None". When surround mode is "PLIIz" or the PLIIz decoder is used.
Default The "Surr.Parameter" settings are returned to the default settings.	<p>Yes : Reset to the defaults. No : Do not reset to the defaults.</p> <p> When you select "Default" and press ENTER, the "Return settings to the default?" prompt is displayed. Select either "Yes" or "No", and press ENTER.</p> 

Tone

Adjust the tonal quality of the sound.

Setting items	Setting details
Tone Control Set the tone control function to "ON" and "OFF".	ON : Allow tone adjustment (bass, treble). OFF : Playback without tone adjustment.  "Tone Control" can be set when "Dynamic EQ®" (page 83) is set to "OFF". <div style="background-color: #f08080; color: white; padding: 2px; display: inline-block; margin-top: 5px;">NOTE</div> <ul style="list-style-type: none"> • "Tone Control" settings are not reflected to ZONE2. • The tone cannot be adjusted in the "DIRECT" mode.
Bass Adjust low frequency range (bass).	-6dB – +6dB  "Bass" can be set when "Tone Control" is set to "ON".
Treble Adjust high frequency range (treble).	-6dB – +6dB  "Treble" can be set when "Tone Control" is set to "ON".



Audyssey Settings

Default settings are underlined.

Set Audyssey MultEQ®, Audyssey Dynamic EQ® and Audyssey Dynamic Volume®. These can be selected after Audyssey® Auto Setup has been performed. For additional information on Audyssey technology, please see [page 125](#).



NOTE



- If you have not performed Auto Setup, or if you change the speaker settings after performing Auto Setup, you may not be able to select Dynamic EQ®/Dynamic Volume®. In this case, either perform Audyssey® Auto Setup over again or perform "Restore" ([page 21](#)) to return to the settings after Audyssey® Auto Setup was run.
- When HD Audio for which the sampling frequency exceeds 96 kHz is played back, the "Audyssey Settings" cannot be set.

Setting items	Setting details
MultEQ® MultEQ® corrects both time and frequency response problems in the listening area based on Audyssey® Auto Setup calibration. We recommend "Audyssey". MultEQ® is the prerequisite function for Dynamic EQ® and Dynamic Volume®.	Audyssey : Optimize the frequency response of all speakers. Audyssey Byp.L/R : Optimize frequency response of speakers except front L and R speakers. Audyssey Flat : Optimize frequency response of all speakers to flat response. Manual : Apply frequency response set with "Manual EQ" (page 84). OFF : Turn "MultEQ®" equalizer off.  <ul style="list-style-type: none"> • "Audyssey", "Audyssey Byp. L/R" and "Audyssey Flat" can be selected after Audyssey® Auto Setup has been performed. "Audyssey" is automatically selected after performing Audyssey® Auto Setup. When "Audyssey", "Audyssey Byp. L/R" or "Audyssey Flat" is selected,  illuminates. • After running Audyssey® Auto Setup, if the Speaker Configuration, Distance, Channel Level, and Crossover Frequency have changed without increasing the number of speakers measured, only  illuminates. <div style="background-color: #f08080; color: white; padding: 2px; display: inline-block; margin-top: 5px;">NOTE</div> <ul style="list-style-type: none"> • "MultEQ®" and "Manual" cannot be selected when "EQ Customize" is set to "Not Used" (page 91). • When using headphones, "MultEQ®" is automatically set to "OFF".



"MultEQ®", "Dynamic EQ®" and "Dynamic Volume®" settings are stored for each input source.

Setting items	Setting details
<p>Dynamic EQ® Solve the problem of deteriorating sound quality as volume is decreased by taking into account human perception and room acoustics. Works with MultEQ®.</p>	<p>ON : Use Dynamic EQ®. OFF : Do not use Dynamic EQ®.</p> <p>  is displayed when set to "ON".</p>
<p>Reference Offset Audyssey Dynamic EQ® is referenced to the standard film mix level. It makes adjustments to maintain the reference response and surround envelopment when the volume is turned down from 0 dB. However, film reference level is not always used in music or other non-film content. Dynamic EQ® Reference Level Offset provides three offsets from the film level reference (5 dB, 10 dB, and 15 dB) that can be selected when the mix level of the content is not within the standard.</p>	<p>0dB (Film Ref) : This is the default setting and should be used when listening to movies. 5dB : Select this setting for content that has a very wide dynamic range, such as classical music. 10dB : Select this setting for jazz or other music that has a wider dynamic range. This setting should also be selected for TV content as that is usually mixed at 10 dB below film reference. 15dB : Select this setting for pop/rock music or other program material that is mixed at very high listening levels and has a compressed dynamic range.</p> <p> Setting is enabled when "Dynamic EQ®" is "ON" (page 83).</p>

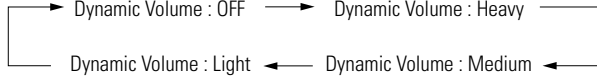

Setting items	Setting details
<p>Dynamic Volume® Solve the problem of large variations in volume level between TV, movies and other content (between quiet passages and loud passages, etc.) by automatically adjusting to the user's preferred volume setting.</p>	<p>Heavy : Most adjustment to softest and loudest sounds. Medium : Medium adjustment to loudest and softest sound. Light : Least adjustment to loudest and softest sounds. OFF : Do not use "Dynamic Volume®".</p> <p>  is displayed when set to "Heavy", "Medium" or "Light".</p> <ul style="list-style-type: none"> If "Dynamic Volume®" is set to "Yes" in Auto Setup (page 19), the setting is automatically changed to "Medium". Buttons on the remote control unit can be used for operations. <ol style="list-style-type: none"> Press AMP to set the remote control unit to AMP-operation mode. Press DYN VOL. Each time DYN VOL is pressed, the setting is changed as shown below. <div style="text-align: center;">  <pre> graph TD OFF[Dynamic Volume : OFF] --> Heavy[Dynamic Volume : Heavy] Heavy --> Medium[Dynamic Volume : Medium] Medium --> Light[Dynamic Volume : Light] Light --> OFF </pre> </div>



Manual EQ

Default settings are underlined.

Use the graphic equalizer to adjust the tone of each speaker.
 "Manual EQ" can be set when "MultEQ®" setting (page 82) is "Manual".

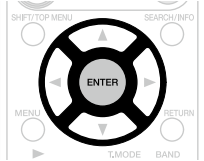
Setting items	Setting details
Adjust Channel Correct the tone of each speaker.	① Select the speaker tone adjustment method. All : Adjust the tone of all speakers together. L/R : Adjust the tone of left and right speakers together. Each : Adjust the tone of each speaker. ② Select the speaker. ③ Select the adjustment frequency band. 63Hz / 125Hz / 250Hz / 500Hz / 1kHz / 2kHz / 4kHz / 8kHz / 16kHz • Select the speakers you want to adjust when "L/R" or "Each" is selected. ④ Adjust the level. -20.0dB – +6.0dB (0.0dB)
Curve Copy Copy "Audyssey Flat" curve from MultEQ®.	Yes : Copy. No : Do not copy.  <ul style="list-style-type: none"> "Curve Copy" is displayed after Audyssey® Auto Setup has been performed. When you select "Curve Copy" and press ENTER, the "Set EQ curve to Audyssey Flat?" prompt is displayed. Select either "Yes" or "No", and press ENTER.
Default The "Manual EQ" settings are returned to the default settings.	Yes : Reset to the defaults. No : Do not reset to the defaults.  When you select "Default" and press ENTER , the "Return settings to the default?" prompt is displayed. Select either "Yes" or "No", and press ENTER . 

M-DAX

Default settings are underlined.

Compressed audio formats such as MP3, WMA (Windows Media Audio) and MPEG-4 AAC reduce the amount of data by eliminating signal components that are hard for the human ear to hear. The M-DAX function generates the signals eliminated upon compression, restoring the sound to conditions near those of the original sound before compression. It also corrects the sense of volume of the bass to obtain richer sound with compressed audio signals.

Setting details

- OFF** : Do not use M-DAX.
- Low** : Optimized mode for compressed sources with very weak highs.
- Middle** : Apply suitable bass and treble boost for all compressed sources.
- High** : Optimized mode for compressed sources with normal highs.



- This item can be set with analog signals or PCM signal (fs = 44.1/48 kHz) is input.
- "M-DAX" settings are stored for each input source.
- When set to "OFF", the M-DAX indicator on the front panel switches off.
- This cannot be set when the surround mode is set to "DIRECT" or "PURE DIRECT".
- This can also be set by pressing **M-DAX**.
- Buttons on the remote control unit can be used for operations.
 - Press **AMP** to set the remote control unit to AMP-operation mode.
 - Press **M-DAX**.

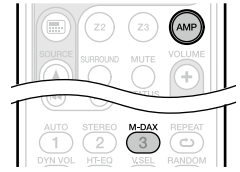

Audio Delay

Default settings are underlined.

While viewing video, manually adjust the time to delay audio output.

Setting details

0ms – 200ms



- This item can be set within the range of 0 to 100 ms when "Auto Lip Sync" (page 90) is set to "ON" and when a TV compatible with Auto Lip Sync is connected.
- Store "Audio Delay" for each input source.
- Audio Delay for game mode can be set when "Video Mode" (page 102) is set to "Auto" or "Game".



Show information about receiver settings, input signals, etc.

Items	Setting details		
Status Show information about current settings.	<input type="checkbox"/> MAIN ZONE This item shows information about settings for MAIN ZONE. The information displayed differs according to the input source. Select Source / Name / Surround Mode / Input Mode / Decode Mode / Assign / Video Select / Video Mode / Content Type etc.		
	<input type="checkbox"/> ZONE2 This item shows information about settings for ZONE2. Power / Select Source / Volume Level <input type="pencil"/> "Volume Level" for ZONE2 is displayed when "Amp Assign" is set to "ZONE2".		
Audio Signal Show information about audio input signals.	Surround Mode : The currently set surround mode. Signal : The input signal type. fs : The input signal's sampling frequency. Format : The number of channels in the input signal (front, surround, LFE). Offset : The dialogue normalization correction value. Flag : This is displayed when inputting signals including a surround back channel. "MATRIX" is displayed with Dolby Digital EX and DTS-ES Matrix signals, "DISCRETE" with DTS-ES Discrete signals.		
	<table border="1" style="width: 100%;"> <thead> <tr> <th style="text-align: center;">Dialogue normalization function</th> </tr> </thead> <tbody> <tr> <td> This function is automatically activated when playing Dolby Digital sources. It automatically corrects the standard signal level for individual program sources. The correction value can be checked using the STATUS on the main unit. </td> </tr> <tr> <td style="text-align: center;"> <div style="border: 1px solid black; padding: 5px; width: fit-content; margin: 0 auto;">Offset - 4dB</div> <p>The figure is the corrected value. This cannot be changed.</p> </td> </tr> </tbody> </table>	Dialogue normalization function	This function is automatically activated when playing Dolby Digital sources. It automatically corrects the standard signal level for individual program sources. The correction value can be checked using the STATUS on the main unit.
Dialogue normalization function			
This function is automatically activated when playing Dolby Digital sources. It automatically corrects the standard signal level for individual program sources. The correction value can be checked using the STATUS on the main unit.			
<div style="border: 1px solid black; padding: 5px; width: fit-content; margin: 0 auto;">Offset - 4dB</div> <p>The figure is the corrected value. This cannot be changed.</p>			

Items	Setting details
HDMI Information Show information about HDMI input/output signals and monitor.	Signal Info. • Resolution / Color Space / Pixel Depth Monitor Info. • Interface / Support Resol.
Preset Channel Show information about preset channels. <div style="border: 1px solid black; padding: 2px; display: inline-block;">TUNER</div> <div style="border: 1px solid black; padding: 2px; display: inline-block;">NET/USB</div>	Preset 1 – 3 A1 – G8 <input type="pencil"/> "Preset 1 – 3" is displayed when the input source is "NET/USB".



Even if **STATUS OSD** is pressed, the Information screen (Status, Audio Signal, HDMI Information) can be displayed.

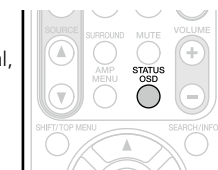



Set when changing Audyssey® Auto Setup settings, or when changing the audio, video, display or other settings.

- If you change the speaker settings after performing Audyssey® Auto Setup, it will not be possible to set Audyssey MultEQ®, Audyssey Dynamic EQ® and Audyssey Dynamic Volume® (page 82, 83).
- Can be used without changing the settings. Please set if necessary.

Menu operation

1 Press AMP MENU.
The menu is displayed on the TV screen.

2 Use Δ / ∇ to select the menu to be set or operated.

3 Press ENTER or \triangleright to enter the setting.

- To return to the previous item, press **RETURN**.
- Exiting the Menu, press **AMP MENU** while the menu is displayed.
The menu display disappears.

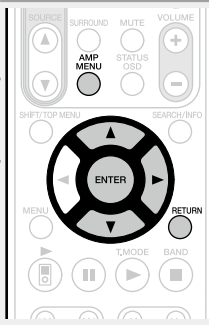

Items that can be set with the "System Setup" procedure

Speaker Setup (page 87)

HDMI Setup (page 90)

Audio Setup (page 91)

Network Setup (page 92)

ZONE2 Setup (page 95)

Option Setup (page 96)

Language (page 98)



Speaker Setup

Default settings are underlined.

Perform when setting the speakers manually or when changing settings made in Audyssey® Auto Setup.

- If you change the speaker settings after performing Audyssey® Auto Setup, it will not be possible to select Audyssey MultEQ®, Audyssey Dynamic EQ® and Audyssey Dynamic Volume® ([page 82, 83](#)).
- "System Setup" can be used without changing the settings. Please set if necessary.



Setting items	Setting details
Amp Assign The signal output from the SURR.BACK/AMP ASSIGN speaker terminal of this unit can be switched to match your speaker environment.	<p>NORMAL : Select the "NORMAL" setting to perform 7.1-channel playback using the surround back.</p> <p>ZONE2 : Select the "ZONE2" setting to assign the unit's built-in power amplifier for ZONE2 and output the audio in stereo.</p> <p>SPKR-C : Select the "SPKR-C" setting to connect the front speakers via the bi-amp connection.</p> <p>Front B : Select the "Front B" setting to use the second set of front speakers for playback. You can switch the front speakers A and B to be used for playback in accordance with the 2-channel playback or multi-channel playback mode.</p> <p>F.HEIGHT : Select the "F.HEIGHT" setting to use the front height speaker for playback.</p>
Speaker Config. Select speaker configuration and size (bass reproduction capability).	<p>Front : Set the front speaker size.</p> <ul style="list-style-type: none"> • Large : Use a large speaker that can adequately play back low frequencies. • Small : Use a small speaker that has inadequate playback capacity for low frequencies. <p> When "Subwoofer" is set to "No", "Front" is automatically set to "Large".</p> <p> When "Front" is set to "Small", "Center", "Surround", "S.Back" and "F.Height" can not be set to "Large".</p> <p>Center : Set the presence and size of the center speaker.</p> <ul style="list-style-type: none"> • Large : Use a large speaker that can adequately play back low frequencies. • Small : Use a small speaker that has inadequate playback capacity for low frequencies. • None : Select when a center speaker is not connected. <p> "Large" is not displayed when "Front" is set to "Small".</p>



NOTE

Do not use the outward shape of the speaker to determine selection of a "Large" or "Small" speaker. Instead, use the frequencies set in "Crossover Freq." ([page 89](#)) as the standard for determining bass reproduction capability.

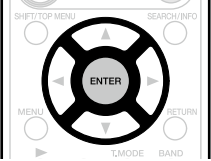
Setting items	Setting details
Speaker Config. (Continued)	<p>Subwoofer : Set the presence of a subwoofer.</p> <ul style="list-style-type: none"> • Yes : Use a subwoofer. • No : Select when a subwoofer is not connected. <p> When "Front" is set to "Small", "Subwoofer" is automatically set to "Yes".</p> <p>Surround : Set the presence and size of the surround speakers.</p> <ul style="list-style-type: none"> • Large : Use a large speaker that can adequately play back low frequencies. • Small : Use a small speaker that has inadequate playback capacity for low frequencies. • None : Select when the surround speakers are not connected. <p> When "Surround" is set to "Large", "S.Back" and "F.Height" can be set to "Large".</p> <p> When "Surround" is set to "None", "S.Back" and "F.Height" are automatically set to "None".</p> <p>S.Back : Set the presence, size and number of surround back speakers.</p> <ul style="list-style-type: none"> • Large : Use a large speaker that can adequately play back low frequencies. • Small : Use a small speaker that has inadequate playback capacity for low frequencies. • None : Select when the surround back speakers are not connected. <ul style="list-style-type: none"> • 2spkr : Use two surround back speakers. • 1spkr : Use only one surround back speaker. When you select this setting, connect the surround back speaker to the left (L) channel. <p>NOTE</p> <p>When "Amp Assign" setting (page 87) is "NORMAL", you can make the "S.Back" setting.</p>

Setting items	Setting details
Speaker Config. (Continued)	<p>F.Height : Set the presence and size of the front height speakers.</p> <ul style="list-style-type: none"> • Large : Use a large speaker that can adequately play back low frequencies. • Small : Use a small speaker that has inadequate playback capacity for low frequencies. • None : Select when the front height speakers are not connected. <p>NOTE</p> <p>When “Amp Assign” setting (page 87) is “F.HEIGHT”, you can make the “F.Height” setting.</p>
Bass Setting Set subwoofer and LFE signal range playback.	<p>Subwoofer Mode : Select low range signals to be reproduced by subwoofer.</p> <ul style="list-style-type: none"> • LFE : The low range signal of the channel set to “Small” speaker size is added to the LFE signal output from the subwoofer. • LFE+Main : The low range signal of all channels is added to the LFE signal output from the subwoofer. <p></p> <ul style="list-style-type: none"> • “Subwoofer Mode” can be set when “Speaker Config.” – “Subwoofer” (page 87) is set to “Yes”. • Play music or a movie source and select the mode offering the strongest bass. • Select “LFE+Main” if you want the bass signals to always be produced from the subwoofer. <p>NOTE</p> <p>If “Front” and “Center” for “Speaker Config.” are set to “Large”, and “Subwoofer Mode” is set to “LFE”, no sound may be output from the subwoofers, depending on the input signal or selected surround mode.</p> <p>LPF for LFE : Set LFE signal playback range. Set this when you want to change the playback frequency of the subwoofer.</p> <p>• 80Hz / 90Hz / 100Hz / 110Hz / 120Hz / 150Hz / 200Hz / 250Hz</p>

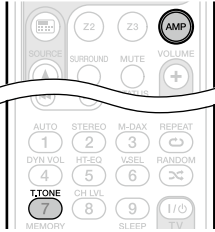
Setting items	Setting details
Distance Set distance from listening position to speakers. Measure beforehand the distance from the listening position to each speaker.	<p>Unit : Set the unit of distance.</p> <ul style="list-style-type: none"> • Meters / Feet <p>Step : Set the minimum variable width of the distance.</p> <ul style="list-style-type: none"> • 0.1m / 0.01m • 1ft / 0.1ft <p>Default : The “Distance” settings are returned to the default settings.</p> <ul style="list-style-type: none"> • Yes : Reset to the defaults. • No : Do not reset to the defaults. <p> When you select “Default” and press ENTER, the “Return settings to the default?” prompt is displayed. Select either “Yes” or “No”, and press ENTER.</p> 
	<p>Front L / Front R / Center / Subwoofer / Surround L / Surround R / S.Back L* / S.Back R* / F.Height L / F.Height R : Select the speaker.</p> <p>* When the “Speaker Config.” – “S.Back” setting (page 87) is set to “1spkr”, “S.Back” is displayed.</p> <ul style="list-style-type: none"> • 0.00m – 18.00m / 0.0ft – 60.0ft : Set the distance. <p></p> <ul style="list-style-type: none"> • The speakers that can be selected differ depending on the “Amp Assign” (page 87) and “Speaker Config.” (page 87) settings. • Default settings : Front L / Front R / Center / Subwoofer / F.Height L / F.Height R : 3.60 m (12.0 ft) Surround L / Surround R / S.Back L / S.Back R : 3.00 m (10.0 ft) • Set the difference in the distance between the speakers to less than 6.00 m (20.0 ft). <p>NOTE</p> <p>Speakers set to “None” in “Speaker Config.” (page 87) are not displayed.</p>

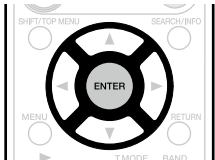

Setting items	Setting details
<p>Channel Level</p> <p>Set the volume of the test tone to be the same when it is output from each speaker.</p>	<p>Test Tone Start : Output test tone.</p> <ul style="list-style-type: none"> • Front L / F.Height L / Center / F.Height R / Front R / Surround R / S.Back R* / S.Back L* / Surround L / Subwoofer : Select the speaker. * When the "Speaker Config." – "S.Back" setting (page 87) is set to "1spkr", "S.Back" is displayed. • -12.0dB – +12.0dB (0.0dB) : Adjust the volume. <p></p> <ul style="list-style-type: none"> • When "Channel Level" is adjusted, the adjusted values are set for all the surround modes. To adjust the channel level separately for the different surround modes, use the operation see page 64. • You can enter this setting item immediately after pressing AMP, then T.TONE. <p>NOTE</p> <ul style="list-style-type: none"> • Speakers set to "None" in the "Speaker Config." (page 87) settings are not displayed. <p></p> <ul style="list-style-type: none"> • When a headphones jack is inserted in the PHONES jack of this unit, the "Channel Level" is not displayed. <p>Default : The "Channel Level" settings are returned to the default settings.</p> <ul style="list-style-type: none"> • Yes : Reset to the defaults. • No : Do not reset to the defaults. <p> When you select "Default" and press ENTER, the "Return settings to the default?" prompt is displayed. Select either "Yes" or "No", and press ENTER.</p> <p></p>



Setting items	Setting details
<p>Crossover Freq.</p> <p>Set the maximum frequency of the bass signal output from each channel to the subwoofer. Set the Crossover Frequency to suit the bass reproduction capability of the speaker being used.</p>	<p>Crossover : Set the crossover frequency.</p> <ul style="list-style-type: none"> • 40Hz / 60Hz / 80Hz / 90Hz / 100Hz / 110Hz / 120Hz / 150Hz / 200Hz / 250Hz <p>Advanced : Specify crossover frequency for each speaker.</p> <ul style="list-style-type: none"> • Front / Center / Surround / S.Back / F.Height : Select the speaker. • 40Hz / 60Hz / 80Hz / 90Hz / 100Hz / 110Hz / 120Hz / 150Hz / 200Hz / 250Hz : Set the crossover frequency. <p></p> <ul style="list-style-type: none"> • "Crossover Freq." can be set when the "Bass Setting" – "Subwoofer Mode" (page 88) setting is "LFE+Main", or when you have a speaker that is set to "Small". • Always set the crossover frequency to "80Hz". When using small speakers, however, we recommend setting the crossover frequency to a higher frequency. • For speakers set to "Small", sound below the crossover frequency is cut from the sound output. The cut bass sound is output from the subwoofer or front speakers. • The speakers that can be set when "Advanced" is selected differ depending on to the "Subwoofer Mode" setting (page 88). • When "LFE" is selected, speakers set to "Small" at "Speaker Config." can be set. If the speakers are set to "Large", "Full Band" is displayed and the setting cannot be made. • If set to "LFE+Main", this setting can be made regardless of the speaker size.

HDMI Setup

Default settings are underlined.

Make settings for HDMI video/audio output.

Setting items	Setting details
Auto Lip Sync Make automatic compensation for timing shift in audio and video output.	ON : Compensated. OFF : Not compensated.
HDMI Audio Out Select HDMI audio output device.	AMP : Play back through speakers connected to the unit. TV : Play back through TV connected to the unit.  <ul style="list-style-type: none"> The audio signal input from the HDMI input connector can be output as an output signal from the HDMI output connector by setting the HDMI audio output destination to TV. Audio signals input via the Analog/Coaxial/Optical input connectors cannot be output from the HDMI output connector. When the HDMI control function is activated, priority is given to the TV audio setting (page 62 "HDMI control function").
HDMI Control You can link operations with devices connected to HDMI and compatible with HDMI Control.	ON : Use HDMI control function. OFF : Do not use HDMI control function.  <ul style="list-style-type: none"> When a device that is not compatible with the HDMI control function is connected, set "HDMI Control" to "OFF". Please consult the operating instructions for each connected device to check the settings. Refer to "HDMI control function" (page 62) for more information about the HDMI control function. <p>NOTE</p> <ul style="list-style-type: none"> When "HDMI Control" is set to "ON", it consumes more standby power. If you are not using this unit for an extended period, it is recommended that you unplug the power cord from the power outlet. "HDMI Control" does not work when the power to the device is off. Either turn power on or set to standby. The HDMI control function controls operations of a TV that is compatible with the HDMI control function. Make sure that the TV and HDMI are connected when you perform HDMI control. If the "HDMI Control" settings have been changed, always reset the power to connected devices after the change.

Setting items	Setting details
Standby Source Sets the HDMI input source to put into standby when the power is on.	Last : This item is set at the last-used input source. HDMI1 / HDMI2 / HDMI3 / HDMI4 : Put the respective input source into standby.  "Standby Source" can be set when "HDMI Control" is set to "ON".
P.Off Control Links the power standby of this unit to external devices.	All : If power to a connected TV is turned off independently of the input source, power to this unit is automatically set to standby. Video : If power to a connected TV is turned off when the input source is BD / DVD / SAT / GAME / TV, power to this unit is automatically set to standby. OFF : This unit does not link with power to a TV.  "P.Off Control" can be set when "HDMI Control" is set to "ON".



Audio Setup

Default settings are underlined.

Make settings for audio playback.

Setting items	Setting details
EQ Customize Set the disengaged equalizers to not display when MultEQ [®] is selected.	Manual : Set when not using the "Manual" equalizer. • Used : Use. • Not Used : Do not use.
	Audyssey Flat : Set when not using "Audyssey Flat" equalizer. • Used : Use. • Not Used : Do not use.
	<input type="checkbox"/> Set so that "Audyssey Flat" settings can be made when Audyssey [®] Auto Setup is performed.
	Audyssey Byp. L/R : Set when not using "Audyssey Byp. L/R" equalizer. • Used : Use. • Not Used : Do not use.
	<input type="checkbox"/> Set so that "Audyssey Byp. L/R" settings can be made when Audyssey [®] Auto Setup is performed.



Network Setup

Default settings are underlined.

Make network settings.

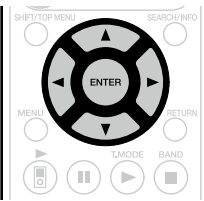

Setting items	Setting details
Network Connect. Make settings for wired LAN.	Only set "Network Connect." when connecting to a network without a DHCP function. ① On the menu, select "Network Connect." – "Detail" and press ENTER . ② Use $\Delta \nabla \triangleleft \triangleright$ to set "DHCP" to "OFF". The DHCP function is disabled.



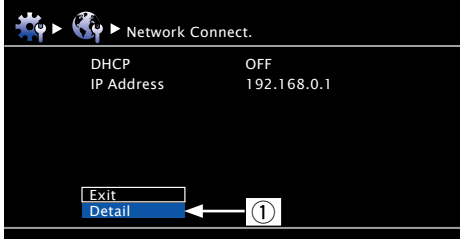
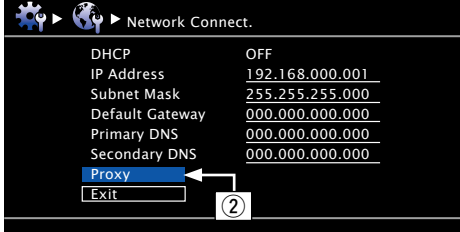
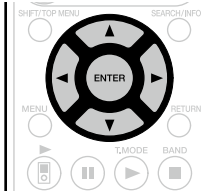

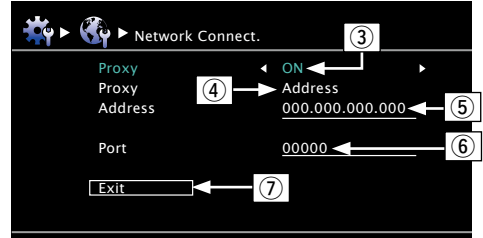
Setting items	Setting details
Network Connect. (Continued)	③ Use $\Delta \nabla \triangleleft \triangleright$ to input the address and press ENTER . <ul style="list-style-type: none"> • IP Address : Set the IP address within the ranges shown below. The Network Audio function cannot be used if other IP addresses are set. CLASS A: 10.0.0.1 – 10.255.255.254 CLASS B: 172.16.0.1 – 172.31.255.254 CLASS C: 192.168.0.1 – 192.168.255.254 • Subnet Mask : When connecting an xDSL modem or terminal adapter directly to this unit, input the subnet mask indicated in the documentation supplied by your provider. Normally input 255.255.255.0. • Default Gateway : When connected to a gateway (router), input its IP address. • Primary DNS, Secondary DNS : If there is only one DNS address indicated in the documentation supplied by your provider, input it at "Primary DNS". If there are two or more DNS addresses, input the first one at "Secondary DNS". ④ Use ∇ to select "Exit" and press ENTER . Setup is complete. <ul style="list-style-type: none"> • When connecting to the network via a Proxy server, select "Proxy" and press ENTER (see page 93 "Proxy settings"). <ul style="list-style-type: none"> • If you are using a broadband router (DHCP function), there is no need to make the settings at "IP Address" and "Proxy", since the DHCP function is set to "ON" in this unit's default settings. • If this unit is being used connected to a network without the DHCP function, the network settings must be made. In this case, some knowledge of networks is required. For details, consult a network administrator. • If you cannot connect to the Internet, recheck the connections and settings (see page 14). • If you do not understand about Internet connection, contact your ISP (Internet Service Provider) or the store from which you purchased your computer. • When you want to cancel the setting during IP address input, press RETURN.

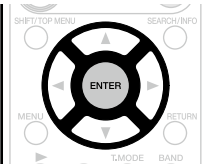

Setting items	Setting details
Network Connect. (Continued)	<p>Proxy settings : Make this setting when connecting to the Internet via a proxy server.</p>   <p>① On the menu, select "Network Connect." – "Detail" and press ENTER.</p> <p>② Use $\Delta \nabla$ to set "Proxy" and press ENTER.</p> 

Setting items	Setting details
Network Connect. (Continued)	 <p>③ Use $\triangleleft \triangleright$ to set "Proxy" to "ON" and press ∇. The proxy server is enabled.</p> <p>④ Use $\triangleleft \triangleright$ to select the proxy server input method, and then press ∇. Address : Select when inputting by address. Name : Select when inputting by domain name.</p> <p>⑤ Use $\Delta \nabla \triangleleft \triangleright$ to input the proxy server address or domain name and press ENTER. When "Address" is selected in step ④ : Input the address When "Name" is selected in step ④ : Input the domain name • For character input, see page 78.</p> <p>⑥ Use $\Delta \nabla \triangleleft \triangleright$ to input the proxy server port number and press ENTER.</p> <p>⑦ Use ∇ to select "Exit" and press ENTER. Setup is complete.</p>

Setting items	Setting details
Other Network function on/off setting during standby, and PC language setting.	<p>Network Standby : Set the network function on/off during standby.</p> <ul style="list-style-type: none"> • ON : Network is on during standby. Main unit operable with a network compatible controller. • OFF : Suspend network function during standby. <p> Set to "ON" when using the web control function.</p> <p>NOTE</p> <p>When "Other" – "Network Standby" is set to "ON", it consumes more standby power.</p> <hr/> <p>Character : When characters are not displayed correctly, set the MP3 ID3-Tag character code type reproduced by the USB memory device.</p> <ul style="list-style-type: none"> • Auto : Auto-select character code. • Latin : Select ISO 8859-1 Latin-1. • Japanese : Select Shift-JIS. <p> If the characters are not properly displayed when set to "Auto", set to "Latin" or "Japanese".</p> <hr/> <p>PC Language : Select computer environment language.</p> <ul style="list-style-type: none"> • Arabic / Chinese(simplified) / Chinese(traditional) / Czech / Danish / Dutch / English / Finnish / French / German / Greek / Hebrew / Hungarian / Italian / Japanese / Korean / Norwegian / Polish / Portuguese / Portuguese(Brazil) / Russian / Spanish / Swedish / Turkish <hr/> <p>Friendly Name : The Friendly Name is the name of this unit displayed on the network. Up to 63 characters can be input. The default Friendly Name on first use is "marantz:[NR1602]".</p> <ul style="list-style-type: none"> • For character input, see page 78. <p>Default : Restores Friendly Name, which you had changed, to the default setting.</p> <ul style="list-style-type: none"> • Yes : Reset to the defaults. • No : Do not reset to the defaults. <p> When you select "Default" and press ENTER, the "Return settings to the default?" prompt is displayed. Select either "Yes" or "No", and press ENTER.</p>



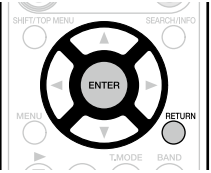

Setting items	Setting details
Other (Continued)	<p>Party Mode : Set the Party Mode.</p> <p>Party Mode : Set the Party Mode function.</p> <ul style="list-style-type: none"> • ON : Enable party mode function. • OFF : Disable party mode function. <p> Refer to page 66, "Party mode function" for more information on the party mode function.</p> <p>Party Start Lev. : Make settings for volume level when the party mode is started.</p> <ul style="list-style-type: none"> • Last : The same volume as set before the party mode was started. • --- (0) : Always use the muting on condition when the party mode is started. • -80dB – 18dB (1 – 99) : Start party mode with your preferred volume. <p> This can be set when "Party Mode" is set to "ON".</p> <p>This is displayed from 0 to 99 when "Volume Display" (page 96) is set to "Absolute".</p> <p>You can set to the upper limit set with "Volume Limit" (page 96).</p> <p>Zone Management : See "Zone Management function" (page 67).</p>

Setting items	Setting details
Other (Continued)	<p>Notification : Sets the display of a notification message when the latest firmware is released.</p> <p>Update : Displays a notification message on this unit's menu screen when the latest firmware is released with "Firmware Update". The notification message is displayed for about 20 seconds when the power is turned on. Connect to broadband Internet (page 14) when using this function.</p> <ul style="list-style-type: none"> • ON : Display update message. • OFF : Do not display update message. <p> When you press ENTER during display of the notification message, the "Check for Update" screen is displayed (Refer to page 97 for more information on "Firmware Update").</p> <p>• Press RETURN to erase the notification message.</p>  <p>Upgrade : Display a notification message on this unit's menu screen when downloadable firmware is released with "Add New Feature". The notification message is displayed for about 20 seconds when the power is turned on. Connect to broadband Internet (page 14) when using this function.</p> <ul style="list-style-type: none"> • ON : Display upgrade message. • OFF : Do not display upgrade message. <p> When you press ENTER during display of the notification message, the "Add New Feature" screen is displayed (Refer to page 98 for more information on "Add New Feature").</p> <ul style="list-style-type: none"> • Press RETURN to erase the notification message.
Napster Account Set or change Username and Password (page 44 "Listening to Napster").	<p>Username / Password / Clear</p> <ul style="list-style-type: none"> • For character input, see page 78.
Last.fm Account Set or change Username and Password (page 42 "How to listen to Last.fm on this unit").	<p>Username / Password / Clear</p> <ul style="list-style-type: none"> • For character input, see page 78.
Last.fm Display Set whether or not to display Last.fm item on the menu.	<p>Display : Display Last.fm item on the menu.</p> <p>Hidden : Do not display Last.fm item on the menu.</p>
Network Info. Display network information.	<p>Friendly Name / DHCP=ON or OFF / IP Address / MAC Address</p>

ZONE2 Setup

Default settings are underlined.

Set the audio to play back with multi-zone (ZONE2).
 "ZONE2 Setup" is displayed when "ZONE2" is selected with "Amp Assign".



Setting items	Setting details
Lch Level Adjust the left channel output level.	<p>-12dB – +12dB (0dB)</p>
Rch Level Adjust the right channel output level.	<p>-12dB – +12dB (0dB)</p>
Volume Limit Make a setting for maximum volume.	<p>OFF : Do not set a maximum volume.</p> <p>-20dB (61) / -10dB (71) / 0dB (81)</p> <p> This is displayed from 0 to 99 when "Volume Display" (page 96) is set to "Absolute".</p>
Power On Level Define the volume setting that is active when the power is turned on.	<p>Last : Use the memorized setting from the last session.</p> <p>--- (0) : Always mute when power is turned on.</p> <p>-80dB – 18dB (1 – 99) : The volume is adjusted to the set level.</p> <p> This is displayed from 0 to 99 when "Volume Display" (page 96) is set to "Absolute".</p>
Mute Level Set the amount of attenuation when muting is on.	<p>Full : The sound is muted entirely.</p> <p>-40dB : The sound is attenuated by 40 dB down.</p> <p>-20dB : The sound is attenuated by 20 dB down.</p>







Option Setup

Default settings are underlined>.

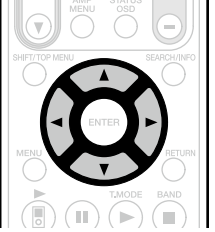
Make various other settings.

Setting items	Setting details
Volume Control Set the MAIN ZONE (room where the unit is located) volume setting.	Volume Display : Set how volume is displayed. <ul style="list-style-type: none"> • Relative : Display --dB (Min), in the range -80.5 dB to 18 dB. • Absolute : Display in the range 0 (Min) to 99.  <ul style="list-style-type: none"> • The "Volume Display" setting is applied also to the "Volume Limit" and "Power On Level" display method. • The "Volume Display" setting applies to all zones. Volume Limit : Make a setting for maximum volume. <ul style="list-style-type: none"> • OFF : Do not set a maximum volume. • -20dB (61) / -10dB (71) / 0dB (81) Power On Level : Define the volume setting that is active when the power is turned on. <ul style="list-style-type: none"> • Last : Use the memorized setting from the last session. • --- (0) : Always use the muting on condition when power is turned on. • -80dB - 18dB (1 - 99) : The volume is adjusted to the set level. Mute Level : Set the amount of attenuation when muting is on. <ul style="list-style-type: none"> • Full : The sound is muted entirely. • -40dB : The sound is attenuated by 40 dB down. • -20dB : The sound is attenuated by 20 dB down.
Source Delete Remove from the display input sources that are not used.	BD / DVD / SAT / GAME / NET/USB / TV / CD / TUNER / M-XPort : Select input source that is not used. <ul style="list-style-type: none"> • ON : Use this source. • Delete : Do not use this source. <div style="border: 1px solid black; padding: 5px; margin: 10px 0;"> <p>NOTE</p> <ul style="list-style-type: none"> • Input sources being used in the various zones cannot be deleted. • Input sources set to "Delete" cannot be selected using the input source select button or SOURCE ▲▼. </div> 

Setting items	Setting details
GUI Make the settings related to displays on the TV screen.	Screensaver : Make screensaver settings. <ul style="list-style-type: none"> • ON : The screensaver is activated during menu display, NET/USB, iPod or Tuner screen display if no operation is performed for an approximately 5-minute continuous period. When you press $\Delta \nabla \triangleleft \triangleright$, the screensaver is cancelled and the screen before that screen saver started is displayed. • OFF : Screensaver is not activated.  Format : Set the video signal format to be output for the TV you are using. <ul style="list-style-type: none"> • NTSC : Select NTSC output. • PAL : Select PAL output.  <p>"Format" can also be set by the following procedure. However, the menu screen is not displayed.</p> <ol style="list-style-type: none"> 1. Press and hold the main unit's MENU and ENTER for at least 3 seconds. "V.Format:<PAL>" appears on the display. 2. Press the main unit's $\triangleleft \triangleright$ and set the video signal format. 3. Press the main unit's ENTER to complete the setting. <div style="border: 1px solid black; padding: 5px; margin: 10px 0;"> <p>NOTE</p> <p>When a format other than the video format of the connected TV is set, the picture will not be displayed properly.</p> </div> Text : Display the details of operation when switching surround mode, input mode, etc. <ul style="list-style-type: none"> • ON : Turn display on. • OFF : Turn display off. Master Volume : Display the master volume during adjustment. <ul style="list-style-type: none"> • Bottom : Display at the bottom. • Top : Display at the top. • OFF : Turn display off.  <p>When the master volume display is hard to see when superimposed on movie subtitles, set to "Top".</p>

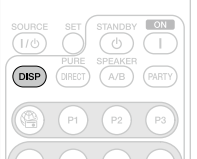
Setting items	Setting details
GUI (Continued)	<p>NET/USB : Set the NET/USB screen display time when the input source is "NET/USB".</p> <ul style="list-style-type: none"> • Always : Show display continuously. • 30s : Show display for 30 seconds after operation. • 10s : Show display for 10 seconds after operation. • OFF : Turn display off. <hr/> <p>iPod : Set the iPod screen display time when the input source is "USB/iPod".</p> <ul style="list-style-type: none"> • Always : Show display continuously. • 30s : Show display for 30 seconds after operation. • 10s : Show display for 10 seconds after operation. • OFF : Turn display off. <hr/> <p>Tuner : Set the tuner screen display time when the input source is "TUNER".</p> <ul style="list-style-type: none"> • Always : Show display continuously. • 30s : Show display for 30 seconds after operation. • 10s : Show display for 10 seconds after operation. • OFF : Turn display off.
Zone Rename Change the display title of each zone to one you prefer.	<ul style="list-style-type: none"> • Up to 10 characters can be input. • For character input, see page 78.
Display Set the display on/off setting.	<p>ON : Display is always on. Auto OFF : Display is off except when showing the status display. OFF : Display is always off.</p> <p></p> <ul style="list-style-type: none"> • This can also be set by pressing DISP. Each time DISP is pressed, the setting is changed as shown below. <div style="display: flex; align-items: center; margin: 10px 0;"> <div style="border: 1px solid black; padding: 5px; margin-right: 10px;"> <p style="text-align: center;">ON → Auto Off</p> <hr/> <p style="text-align: center;">← OFF</p> </div>  </div> <ul style="list-style-type: none"> • If DISPLAY on the main unit is pressed, the same function as with the remote control unit can be obtained.



Setting items	Setting details												
Setup Lock Protect settings from inadvertent change.	<p>ON : Turn protection on. OFF : Turn protection off.</p> <p> When canceling the setting, set "Setup Lock" to "OFF".</p> <p>NOTE</p> <p>When "Setup Lock" is set to "ON", the settings listed below can no longer be changed. Also, "Setup Lock!" is displayed if you attempt to operate related settings.</p> <ul style="list-style-type: none"> • Menu operations • M-DAX • HT-EQ • Channel Level • Dynamic Volume® • Display settings 												
Firmware Update Update the firmware of the receiver.	<p>Check for Update : Check for firmware updates. You can also check approximately how long it will take to complete an update. Start : Execute the update process.</p> <p>When updating starts, the power indicator becomes red and the menu screen is shut down. The amount of update time which has elapsed is displayed.</p> <ul style="list-style-type: none"> • If updating fails, the set automatically retries, but if updating is still not possible, one of the messages shown below is displayed. If the display reads as shown below, check the settings and network environment, then update again. <table border="1" style="width: 100%; border-collapse: collapse;"> <thead> <tr> <th>Display</th> <th>Description</th> </tr> </thead> <tbody> <tr> <td>Updating fail</td> <td>Updating failed.</td> </tr> <tr> <td>Login failed</td> <td>Failure to log into server.</td> </tr> <tr> <td>Server is busy</td> <td>Server is busy. Wait a while then try again.</td> </tr> <tr> <td>Connection fail</td> <td>Failure in connecting to server.</td> </tr> <tr> <td>Download fail</td> <td>Downloading of the firmware has failed.</td> </tr> </tbody> </table>	Display	Description	Updating fail	Updating failed.	Login failed	Failure to log into server.	Server is busy	Server is busy. Wait a while then try again.	Connection fail	Failure in connecting to server.	Download fail	Downloading of the firmware has failed.
Display	Description												
Updating fail	Updating failed.												
Login failed	Failure to log into server.												
Server is busy	Server is busy. Wait a while then try again.												
Connection fail	Failure in connecting to server.												
Download fail	Downloading of the firmware has failed.												

Setting items	Setting details
Add New Feature Display new features that can be downloaded to this unit and perform an update.	<p>Upgrade : Execute the upgrade process. When updating starts, the power indicator becomes red and the menu screen is shut down. The amount of update time which has elapsed is displayed.</p> <ul style="list-style-type: none"> • If the upgrade is not successful, an error message identical to those in "Firmware Update" will appear on the display. Check the settings and network environment, then update again. <p>Upgrade Status : Display a list of the additional functions provided by the upgrade.</p> <p> See the marantz website for details about updates. When the procedure is complete, "Registered" is displayed in this menu and updates can be carried out. If the procedure has not been carried out, "Not Registered" is displayed. The ID number shown on this screen is needed when carrying out the procedure. The ID number can also be displayed by pressing and holding the main unit's ▷ and MENU for at least 3 seconds.</p>

Notes concerning use of "Firmware Update" and "Add New Feature"

- In order to use these functions, you must have the correct system requirements and settings for a broadband Internet connection ( [page 14](#)).
- Do not turn off the power until updating or upgrading is completed.
- Even with a broadband connection to the Internet, approximately 1 hour is required for the updating/upgrading procedure to be completed.
- Once updating/upgrade starts, normal operations on this unit cannot be performed until updating/upgrading is completed.
- Furthermore, updating/upgrading the firmware may reset the backup data for the parameters, etc. set for this unit.
- If the update or upgrade fails, press and hold the **ON/STANDBY** on the main unit for more than 5 seconds, or remove and re-insert the power cord. "Update retry" appears on the display and update restarts from the point at which update failed. If the error continues despite this, check the network environment.



- Information regarding the "Firmware Update" function and "Add New Feature" will be announced on the marantz web site each time related plans are defined.
- When usable new firmware is released with "Firmware Update" or "Add New Feature", a notification message is displayed on the menu screen. When you do not want to be notified, set "Notification" – "Update" ( [page 95](#)) and "Upgrade" ( [page 95](#)) to "OFF".

Language

Default settings are underlined.

Set the language for display on the menu screen.

Setting details

English / Deutsch / Français



"Language" can also be set by the following procedure. However, the menu screen is not displayed.

1. Press and hold the main unit's **MENU** and **ENTER** for at least 3 seconds.
 "V.Format:<PAL>" appears on the display.
2. Press the main unit's **STATUS** and set "Lang:<ENGLISH >".
3. Press the main unit's **◀ ▶** and set the language.
4. Press the main unit's **ENTER** to complete the setting.



Perform settings related to input source playback.

- You do not have to change the settings to use the unit. Make settings when needed.

Menu operation

1 Press AMP MENU.

The menu is displayed on the TV screen.

2 Use Δ / ∇ to select the menu to be set or operated.

3 Press ENTER or \triangleright to enter the setting.

- To return to the previous item, press RETURN.
- Exiting the Menu, press AMP MENU while the menu is displayed. The menu display disappears.

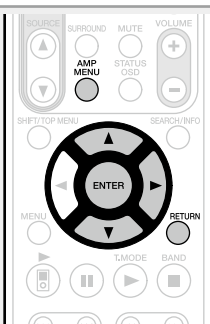

Important information

□ About the display of input sources

In this section, the configurable input sources for each item are shown as follows.

BD	DVD	SAT	GAME	NET/USB	Favorites	Internet Radio	Media Server	USB/iPod	Flickr
Last.fm	Napster	TV	CD	TUNER	M-XPort				

NOTE

Input sources that have been set to "Delete" at "Source Delete" ([page 96](#)) cannot be selected.

Items that can be set with the "Input Setup" procedure

Auto Preset ([page 100](#))

Preset Skip ([page 100](#))

Preset Name ([page 100](#))

Input Assign ([page 101](#))

Video ([page 102](#))

Input Mode (Audio) ([page 103](#))

Rename ([page 103](#))

Source Level (Audio) ([page 103](#))

Playback Mode ([page 104](#))

Still Picture ([page 104](#))

Auto Preset

Use the auto preset function to program radio stations.

Setting items	Setting details
Start Start the auto preset process. TUNER	 If an FM station cannot be preset automatically, select the desired station by tuning it in manually, then preset it manually.

Preset Skip

Default settings are underlined.

Set preset channel to be skipped when selecting.

Setting items	Setting details
Block Select the preset memory block. TUNER	<u>A / B / C / D / E / F / G</u>
Block Presets Skip all channels of the selected preset memory blocks. TUNER	<u>ON</u> : Display the selected preset memory block. <u>Skip</u> : Do not display the selected preset memory block.
A1 – G8 Set by individual preset channels in the currently selected preset memory block. TUNER	<u>ON</u> : Display the selected preset channel. <u>Skip</u> : Do not display the selected preset channel.  If you set “Block Presets” to “Skip”, you can skip by blocks (A – G).

Preset Name

Assign name to a preset memory.

Setting items	Setting details
Block Select the preset memory block. TUNER	<u>A / B / C / D / E / F / G</u>
A1 – G8 Change the display name of the selected channel. TUNER	<ul style="list-style-type: none"> Up to eight characters can be input. For character input, see page 78.
Default The changed preset name is returned to the default setting.	Yes : Reset to the defaults. No : Do not reset to the defaults.  When you select “Default” and press ENTER , the “Return settings to the default?” prompt is displayed. Select either “Yes” or “No”, and press ENTER .

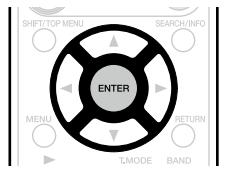

Input Assign

Examples of "Input Assign" menu screen displays

This screen appears when the "Input Setup" – "each input source" – "Input Assign" menu is selected. Use the "Input Assign" menu to change the ② HDMI input connectors, ③ Digital input connectors, and ④ component input connectors that are assigned to the ① input sources in default settings.

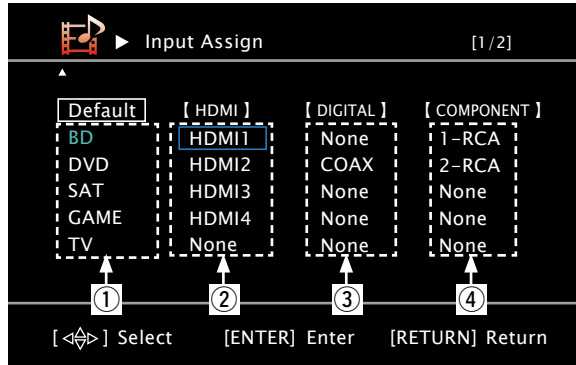

Input assignments menu operations

- 1** Use $\Delta \nabla \triangleleft \triangleright$ to move the highlight to the item you want to set.
- 2** Press **ENTER**, then use $\triangleleft \triangleright$ to select the input connector to be assigned.
- 3** Press **ENTER** to register the setting.

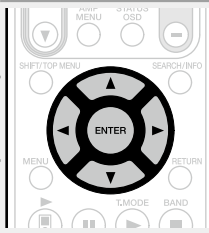

Setting items	Setting details														
HDMI Set this to change the HDMI input connectors assigned to the input sources. <div style="display: flex; flex-wrap: wrap; gap: 5px;"> BD DVD SAT </div> <div style="display: flex; flex-wrap: wrap; gap: 5px;"> GAME TV </div>	HDMI 1 / HDMI 2 / HDMI 3 / HDMI 4 None : Do not assign an HDMI input connector to the selected input source. <ul style="list-style-type: none"> At time of purchase, the settings of the different input sources are as shown below. <table border="1"> <thead> <tr> <th>Input source</th> <th>BD</th> <th>DVD</th> <th>SAT</th> <th>GAME</th> <th>TV</th> </tr> </thead> <tbody> <tr> <td>Default setting</td> <td>HDMI 1</td> <td>HDMI 2</td> <td>HDMI 3</td> <td>HDMI 4</td> <td>None</td> </tr> </tbody> </table> <ul style="list-style-type: none"> An input source to which an HDMI input connector cannot be assigned is displayed as "---". To play the video signal assigned at "HDMI" combined with the audio signal assigned at "Input Assign" – "DIGITAL", select "Digital" at "Input Mode" (page 103). The audio signals input from the analog and digital connectors are not output to the monitor. When "HDMI Control" (page 90) is set to "ON", HDMI input connector cannot be assigned to "TV". 	Input source	BD	DVD	SAT	GAME	TV	Default setting	HDMI 1	HDMI 2	HDMI 3	HDMI 4	None		
Input source	BD	DVD	SAT	GAME	TV										
Default setting	HDMI 1	HDMI 2	HDMI 3	HDMI 4	None										
DIGITAL Set this to change the digital input connectors assigned to the input sources. <div style="display: flex; flex-wrap: wrap; gap: 5px;"> BD DVD SAT </div> <div style="display: flex; flex-wrap: wrap; gap: 5px;"> GAME TV CD </div>	COAX (coaxial) / OPT (optical) None : Do not assign a digital input connector to the selected input source. <ul style="list-style-type: none"> At time of purchase, the settings of the different input sources are as shown below. <table border="1"> <thead> <tr> <th>Input source</th> <th>BD</th> <th>DVD</th> <th>SAT</th> <th>GAME</th> <th>TV</th> <th>CD</th> </tr> </thead> <tbody> <tr> <td>Default setting</td> <td>None</td> <td>COAX</td> <td>None</td> <td>None</td> <td>None</td> <td>OPT</td> </tr> </tbody> </table>	Input source	BD	DVD	SAT	GAME	TV	CD	Default setting	None	COAX	None	None	None	OPT
Input source	BD	DVD	SAT	GAME	TV	CD									
Default setting	None	COAX	None	None	None	OPT									

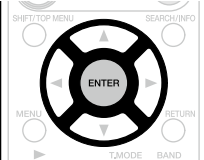
Setting items	Setting details																		
<p>COMPONENT (Component video) Set this to change the component video input connectors assigned to the input sources.</p> <table border="1"> <tr> <td>BD</td> <td>DVD</td> <td>SAT</td> </tr> <tr> <td>GAME</td> <td>TV</td> <td></td> </tr> </table>	BD	DVD	SAT	GAME	TV		<p>1-RCA / 2-RCA None : Do not assign a component video input connector to the selected input source.</p> <ul style="list-style-type: none"> At time of purchase, the settings of the different input sources are as shown below. <table border="1"> <thead> <tr> <th>Input source</th> <th>BD</th> <th>DVD</th> <th>SAT</th> <th>GAME</th> <th>TV</th> </tr> </thead> <tbody> <tr> <td>Default setting</td> <td>1-RCA</td> <td>2-RCA</td> <td>None</td> <td>None</td> <td>None</td> </tr> </tbody> </table> <p> An input source to which an component video input connector cannot be assigned is displayed as "----".</p>	Input source	BD	DVD	SAT	GAME	TV	Default setting	1-RCA	2-RCA	None	None	None
BD	DVD	SAT																	
GAME	TV																		
Input source	BD	DVD	SAT	GAME	TV														
Default setting	1-RCA	2-RCA	None	None	None														
<p>Default The "Input Assign" settings are returned to the default settings.</p>	<p>Yes : Reset to the defaults. No : Do not reset to the defaults.</p> <p> If you select "Default" and press ENTER, the message "Return settings to the default?" is displayed. Select "Yes" or "No", and then press ENTER.</p> 																		

Video

Default settings are underlined.

Set the source video.

* "GAME" or "TV" can be set when "HDMI" ([page 101](#)) or "COMPONENT" ([page 102](#)) has been assigned.

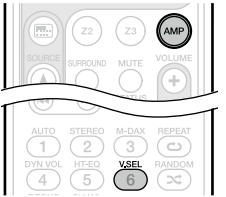
Setting items	Setting details						
<p>Video Select Video of another input source is played back combined with the playing audio.</p>	<p>Source : Play the picture and sound of the input source. BD / DVD / SAT / GAME / TV : Select video input source to view. This can be set for individual input sources.</p> <p></p> <ul style="list-style-type: none"> "GAME" and "TV" can be selected only when a component video is assigned as an input source. Buttons on the remote control unit can be used for operations. <ol style="list-style-type: none"> Press AMP to set the remote control unit to AMP-operation mode. Press V.SEL until the desired picture appears. <ul style="list-style-type: none"> To cancel, press V.SEL to select "Source". 						
<p>Video Mode Make settings for video processing.</p> <table border="1"> <tr> <td>BD</td> <td>DVD</td> <td>SAT</td> </tr> <tr> <td>GAME*</td> <td>TV*</td> <td></td> </tr> </table>	BD	DVD	SAT	GAME*	TV*		<p>Auto : Process video automatically based on the HDMI content information. Game : Always process video appropriate for game content. Movie : Process video normally.</p> <p></p> <ul style="list-style-type: none"> If "Video Mode" is set to "Auto", the mode is switched according to the input contents. If a source is played in both MAIN ZONE (audio and video) and ZONE2 (audio only) modes in the same room, audio in MAIN ZONE and ZONE2 modes may sound out of synchronization, but this is not malfunction. In this case, setting to "Game" mode may improve audio synchronization.
BD	DVD	SAT					
GAME*	TV*						



NOTE

- It is not possible to select HDMI input signals.
- Input sources for which "Delete" is selected at "Source Delete" ([page 96](#)) cannot be selected.

Input Mode (Audio)

Default settings are underlined.

The input modes available for selection may vary depending on the input source.

Setting items	Setting details						
<p>Input Mode Set the audio input modes for the different input sources. It is normally recommended to set the audio input mode to "Auto".</p>	<p>Auto : Automatically detect input signal and perform playback. HDMI : Play only signals from HDMI input. Digital : Play only signals from digital input. Analog : Play only signals from analog input.</p> <p> <ul style="list-style-type: none"> "HDMI" can be set for input sources for which "HDMI" is assigned at "Input Assign" (page 101). "Digital" can be set for input sources for which "DIGITAL" is assigned at "Input Assign" (page 101). If the input source is set to "GAME" or "TV", it cannot be set to "Analog". When digital signals are properly input, the DIG indicator lights on the display. If the DIG indicator does not light, check the digital input connector assignment and the connections. If "HDMI Control" is set to "ON" and a TV compatible with the ARC is connected via the HDMI MONITOR connectors, the input mode whose input source is "TV" is fixed to ARC. </p>						
<p>Decode Mode Set the audio decode mode for input source.</p> <table border="1"> <tr> <td>BD</td> <td>DVD</td> <td>SAT</td> </tr> <tr> <td>GAME</td> <td>TV</td> <td>CD</td> </tr> </table>	BD	DVD	SAT	GAME	TV	CD	<p>Auto : Detect type of digital input signal and decode and play automatically. PCM : Decode and play only PCM input signals. DTS : Decode and play only DTS input signals.</p> <p> <ul style="list-style-type: none"> This item can be set for input sources for which "HDMI" or "DIGITAL" is assigned at "Input Assign" (page 101). Normally set this mode to "Auto". Set "PCM" and "DTS" when inputting the corresponding input signal. </p>
BD	DVD	SAT					
GAME	TV	CD					

Rename

Change the display name of the selected input source.

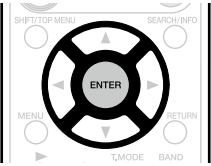
Setting items	Setting details
<p>Rename Change the display name of the selected input source.</p>	<ul style="list-style-type: none"> Up to eight characters can be input. For character input, see page 78.
<p>Default The input source name is returned to the default setting.</p>	<p>Yes : Reset to the defaults. No : Do not reset to the defaults.</p> <p> If you select "Default" and press ENTER, the message "Return settings to the default?" is displayed. Select "Yes" or "No", and then press ENTER.</p> 

Source Level (Audio)

Default settings are underlined.

- This function corrects the playback level of the selected input source's audio input.
- Make this setting if there are differences in the input volume levels between the different sources.

Setting details

-12dB - +12dB (0dB)

-  The analog input level and digital input level can be adjusted independently for input sources for which "HDMI" or "DIGITAL" is assigned at "Input Assign" ([page 101](#)).

Playback Mode

Default settings are underlined.

Input source : "NET/USB"

Setting items	Setting details
Repeat Make settings for repeat mode. <div style="display: flex; justify-content: space-between; margin-top: 5px;"> Media Server Napster </div> <div style="display: flex; justify-content: space-between; margin-top: 5px;"> USB/iPod </div>	All : All files are played repeatedly (All files in a Folder or an album are played repeatedly). One : A file being played is played repeatedly. <u>OFF</u> : Repeat playback mode is canceled.
Random Make random mode settings. <div style="display: flex; justify-content: space-between; margin-top: 5px;"> Media Server Napster </div> <div style="display: flex; justify-content: space-between; margin-top: 5px;"> USB/iPod </div>	ON : Enable random playback. <u>OFF</u> : Disable random playback.

Still Picture

Default settings are underlined.

Make settings for playing back still picture images.

Setting items	Setting details
Slide Show Make slide show settings. <div style="display: flex; justify-content: space-between; margin-top: 5px;"> NET/USB </div>	<u>ON</u> : Display still picture images in a slide show. OFF : The slide show is not played back.
Interval Set the time for displaying a single image when playing back images in the slide show. <div style="display: flex; justify-content: space-between; margin-top: 5px;"> NET/USB </div>	<u>5s – 60s</u>

Other settings

Remote control settings

- When you connect a remote control receiver unit (purchased separately) to the REMOTE CONTROL IN connector of this unit, use the following procedure to disable the remote sensor function of this unit.
- The remote sensor function of remote control signals is enabled by default.

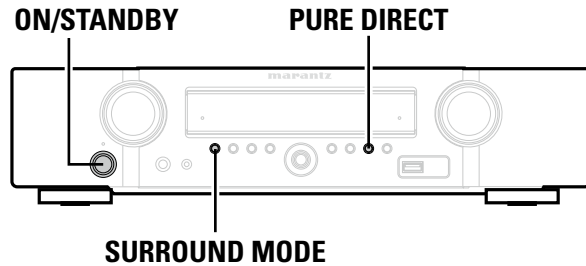

Disabling the sensor function of the remote control unit

When the main unit is in standby mode, press **ON/STANDBY** while holding down **SURROUND MODE** and **PURE DIRECT** on the main unit.

"Remote Lock:ON" is shown on the display, and the infrared light receiving function is disabled.

Enabling the remote sensor function

When the main unit is in standby mode, press **ON/STANDBY** while holding down **SURROUND MODE** and **PURE DIRECT** on the main unit.

The infrared light receiving function on the main unit is enabled.

NOTE

If a remote control receiver unit (purchased separately) is not connected, do not perform this setting. If you do, you will not be able to operate this unit using the remote control unit.

Operating the connected devices by remote control unit

Registering the supplied preset codes in the remote control unit enables you to operate devices made by other manufacturers.

Operating AV devices

1 Press the input source select button (page 22).

The operation mode of the remote control unit is switched as shown in the table.

NOTE

Press the input source select buttons once to switch the operation mode of the remote control unit supplied with this unit.

Press the input source select buttons twice consecutively to switch the operation mode of the remote control unit and input source of this unit.



Input source select button	Input source of this unit	Operation mode
		Devices controllable with the remote control unit
BD *	BD	Device registered on the BD button
DVD *	DVD	Device registered on the DVD button
SAT *	SAT	Device registered on the SAT button
TV *	TV	Device registered on the TV button
NET/USB	NET/USB	<ul style="list-style-type: none"> • Network function • iPod or USB memory device connected to the USB port
CD	CD	marantz CD player
TUNER	TUNER	Radio of this unit
M-XP	M-XP port	Device registered on the M-XP button

* If a preset code is registered for this button, the remote control unit of this unit can control another devices.



When  is pressed, the AMP-operation mode starts automatically.

NOTE

If the mode of the remote control unit is set to other than AMP-operation mode, press **AMP** to switch the remote control unit to the AMP-operation mode to perform the following operations:

- For setting the channel level of the unit by pressing **CH LVL**.
- For performing direct playback.
- For switching Dynamic Volume® settings.
- For using the Video Select function.
- For using the sleep timer function.
- For switching the M-DAX function.
- For directly selecting "AUTO" and "STEREO" of the listening modes.
- For using the test tone function.
- For using the HT-EQ function.

2 Operate this unit or the device whose input source is switched.

For details, refer to the operating instructions for each device. For operations of iPod and TUNER, see the following pages.

- iPod (page 26)
- TUNER (page 32)

Registering preset codes

When preset codes are registered in the included remote control unit, it can then be used to operate any devices you have, such as DVD players or TVs made by different manufacturers.

NOTE

- No preset codes other than **BD**, **DVD**, **SAT** and **TV** can be registered.
- In the factory settings, remote control codes for all marantz products are registered.

□ Buttons used for operating the devices

- ① **SOURCE I/⏻**
For switching power of each device on or off.
- ② **△▽◀▶, ENTER**
For menu operation of each device.
- ③ **MENU, SHIFT/TOP MENU**
For displaying the menu of each device.
- ④ **⏮, ▶, ■, ◀, ⏭, ⏪, ⏩, ▶▶**
- ⑤ Number button (**0 - 9, +10**)
- ⑥ **PRESET +, PRESET -**
- ⑦ **TV I/⏻, TV INPUT**
For operating a TV
This button is enabled in any mode.

For details on operation with the remote control unit, see pages [26](#), [28](#), [32](#), [38](#), [40](#), [42](#), [45](#), [109](#), [110](#).

Registering preset codes

The following two methods can be used for registering the reset code.

- ① Entering a 4-digit code
- ② Scanning the code table

① Entering a 4-digit code

See the preset code list table for the code to be input.

- 1 Press and hold down the input source select buttons for the appliance to control, and press **SET** until the **SEND** indicator blinks.

- 2 Press the 4-digit code for the appliance using **0 - 9** (code table at the end of this manual).

When the procedure is successful, the **LEARN** indicator blinks twice.

NOTE

If the **LEARN** indicator did not blink twice, then repeat steps 1 and 2 and try entering the same code again.

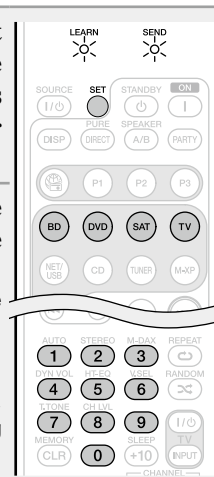

② Scanning the code table

- 1 Switch the power of the appliance to which you want to register the preset code to ON.

- 2 Press and hold down the input source select buttons for the appliance to control, and press **SET** until the **SEND** indicator blinks.

- 3 Aim the remote control at the appliance and slowly alternate between pressing **SOURCE ▲** and **SOURCE I/⏻** for the appliance.

- 4 When the power of the appliance that you want to register has turned off, release the button.

- 5 Press **ENTER**.
When the procedure is successful, the **LEARN** indicator blinks twice.



Check the registered preset code

1 Press and hold down the input source select buttons for the appliance to control, and press **SET** until the **SEND** indicator blinks.

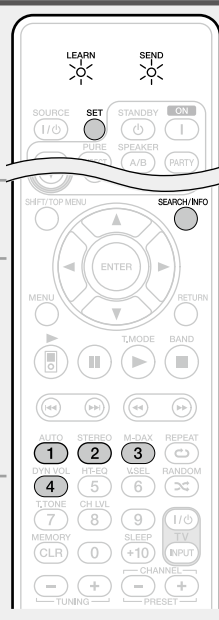

2 Press **SEARCH/INFO**.
The LEARN indicator blinks twice.

3 To view the code for first digit, press **1**.

Count the number of times the LEARN indicator blinks (e.g. 3 blinks = 3) and write down the number.

• If a code digit is "0", the LEARN indicator does not blink.

4 Then press **2** to check the second digit of the code. Now press **3** and **4** to check the third and fourth digits of the code.

Default settings for preset codes

The devices shown below are registered for each input source button as default. Settings can be changed according to the devices to be used.

1 Press and hold down the input source select buttons for the appliance to control, and press **SET** until the **SEND** indicator blinks.

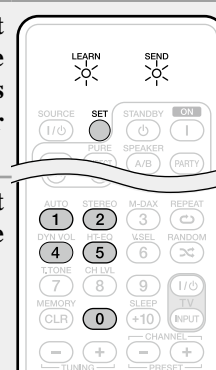

2 Enter the appropriate preset code (4 digits) from the table below.

The LEARN indicator blinks twice.

Input source select buttons	Category	Brand	Preset code
	Blu-ray Disc player	marantz	5000
	DVD player	marantz	2000
	Television	marantz	1000
	Satellite set top box	marantz	4000

NOTE

After this procedure, the selected source reset to its initial code.

Operating devices

The supplied remote control unit can control a device other than this unit.

1 Press the input source select button to which the preset code for the device you want to operate has been registered (page 106).

2 Operate the device.

• For details, refer to the device's operating instructions.



Blu-ray Disc player / HD-DVD player / DVD player / DVD recorder operation

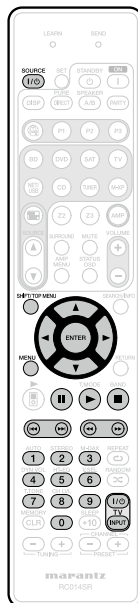

Operation buttons	Function
SOURCE I / ⏻	Power on/standby
SHIFT/TOP MENU	Top menu
△▽◀▶	Cursor operation
ENTER	Enter
MENU	(Popup) Menu
⏸	Pause
▶	Playback
■	Stop
⏮ ▶▶▶	Auto search (cue)
◀▶▶▶	Manual search (fast-reverse/fast-forward)
0 - 9	Select title, chapter or channel selection
TV I / ⏻	TV power on/standby (Default : marantz)
TV INPUT	Switch TV input (Default : marantz)

CD player operation

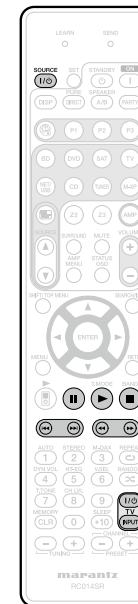

Operation buttons	Function
SOURCE I / ⏻	Power on/off
⏸	Pause
▶	Playback
■	Stop
⏮ ▶▶▶	Auto search (cue)
◀▶▶▶	Manual search (fast-reverse/fast-forward)
TV I / ⏻	TV power on/standby (Default : marantz)
TV INPUT	Switch TV input (Default : marantz)

TV operation

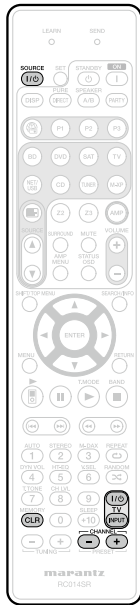

Operation buttons	Function
SOURCE I / ⏻	TV power on/standby (Default : marantz)
CLR	Clear the inputting
TV I / ⏻	TV power on/standby (Default : marantz)
TV INPUT	Switch TV input (Default : marantz)
CHANNEL +, -	Switch channels (up/down)

Set top box for satellite (SAT) operation

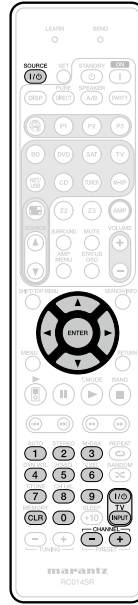

Operation buttons	Function
SOURCE I / ⏻	Power on/standby
△▽◀▶	Cursor operation
ENTER	Enter
0 - 9	Channel selection
CLR	Clear the inputting
TV I / ⏻	TV power on/standby (Default : marantz)
TV INPUT	Switch TV input (Default : marantz)
CHANNEL +, -	Switch channels (up/down)

Operating learn function

- This remote control unit is capable of learning and storing codes used by other remote controls that you already own.
- If the AV device is not a marantz device, or if the device does not operate even when the preset code is registered, use the learning function. Remote codes for different devices can be remembered for use by the marantz remote control included with this device.
- This remote control unit is capable of learning around 60 codes.

Learning procedure

- 1 Place the marantz remote control and remote control from the other device approximately 5 cm apart, with the remote control signal transmission sections facing each other.**

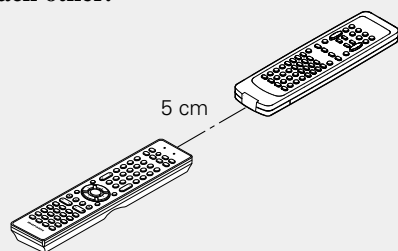

- 2 Press and hold down SET and SURROUND until the LEARN indicator blinks.**

- 3 Press input source select buttons (BD, DVD, SAT, TV, or CD) to select the input source.**

- 4 Select the button to be learned.**
The LEARN indicator lights.

NOTE

- The learning function is unavailable for all **SOURCE I/O** and **DISP** in any mode.
- The learning function is unavailable for all buttons in TUNER mode, NET/USB mode and AMP mode.

- 5 Press and hold the button of the original remote control unit to be learned until the SEND indicator blinks twice.**



- When the SEND indicator blinks once again, the transmitting code is unavailable for remote control unit, or the transmitting signal has been interrupted by noise.
- If the SEND indicator blinks once, repeat this step.
- When the memory of the remote control unit is full, the LEARN and SEND indicators blink once. If you want to learn the code, you need to erase a different learned button.

NOTE

If the LEARN indicator flashes when the SEND indicator is lit, then the button cannot be learned.

- 6 Repeat steps 4 and 5 to learn other buttons for the same input source.**



- 7 Repeat steps 3 to 6 to learn other input sources.**

- 8 When programming of the remote control unit is completed, press SET.**

The LEARN display disappears, and the remote control unit exits learn mode.

NOTE

- The learning function is unavailable for all buttons in TUNER mode, AMP mode, NET/USB mode and M-XP mode.
- The learning procedure does not operate correctly if the batteries have become worn.
- If no buttons are pressed for approximately 1 minutes while in the LEARN mode, the remote control unit automatically exits from the LEARN mode.

Delete saved remote control codes

Codes can be erased in three ways: by buttons, sources, and by all memory contents.

❑ Delete remote control codes for each button

1 Press and hold down **SET** and **SURROUND** until the **LEARN** indicator blinks.

The LEARN indicator blinks.

2 Press input source select buttons (**BD**, **DVD**, **SAT**, **TV** or **CD**) to select the input source you want to delete.

The SEND indicator blinks twice.

3 Press and hold down **DISP** and press the learned button to be erased twice.

The SEND indicator blinks twice and the mode returns to LEARN mode.

4 To return the normal mode, press **SET**.

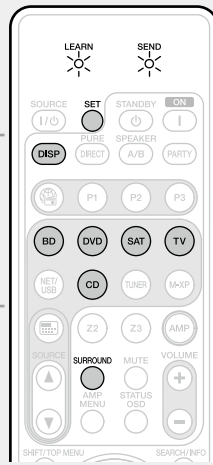

❑ Delete remote control codes for each input source

1 Press and hold down **SET** and **SURROUND** until the **LEARN** indicator blinks.

The LEARN indicator blinks.

2 Press and hold down **DISP** and press the learned input source select buttons (**BD**, **DVD**, **SAT**, **TV**, or **CD**) to be erased twice.

The LEARN indicator lights.

3 Press **ENTER**.

The SEND indicator blinks twice and the mode returns to LEARN mode.

- To cancel the erasing operation, do not press **ENTER**, and simply press any other button.

4 To return the normal mode, press **SET**.



❑ Delete remote control codes for all input sources

1 Press and hold down **SET** and **SURROUND** until the **LEARN** indicator blinks.

The LEARN indicator blinks.

2 Press and hold down **DISP** and press **ON** and **STANDBY**.

The LEARN indicator lights.

3 Press **ENTER**.

The SEND indicator blinks twice and the mode returns to LEARN mode.

- To cancel the erasing operation, do not press **ENTER**, and simply press any other button.

4 To return the normal mode, press **SET**.









NOTE

Erasing codes will return to the factory preset code, or there will leave empty if the button has no factory preset code.

Information

Here, we list various information related to this unit.
Please refer to this information as needed.

- Part names and functions  [page 114](#)
- Other information  [page 119](#)
- Troubleshooting  [page 128](#)
- Specifications  [page 133](#)
- Index  [page 134](#)
- List of preset codes  [page 136](#)

Part names and functions

Front panel

For buttons not explained here, see the page indicated in parentheses ().

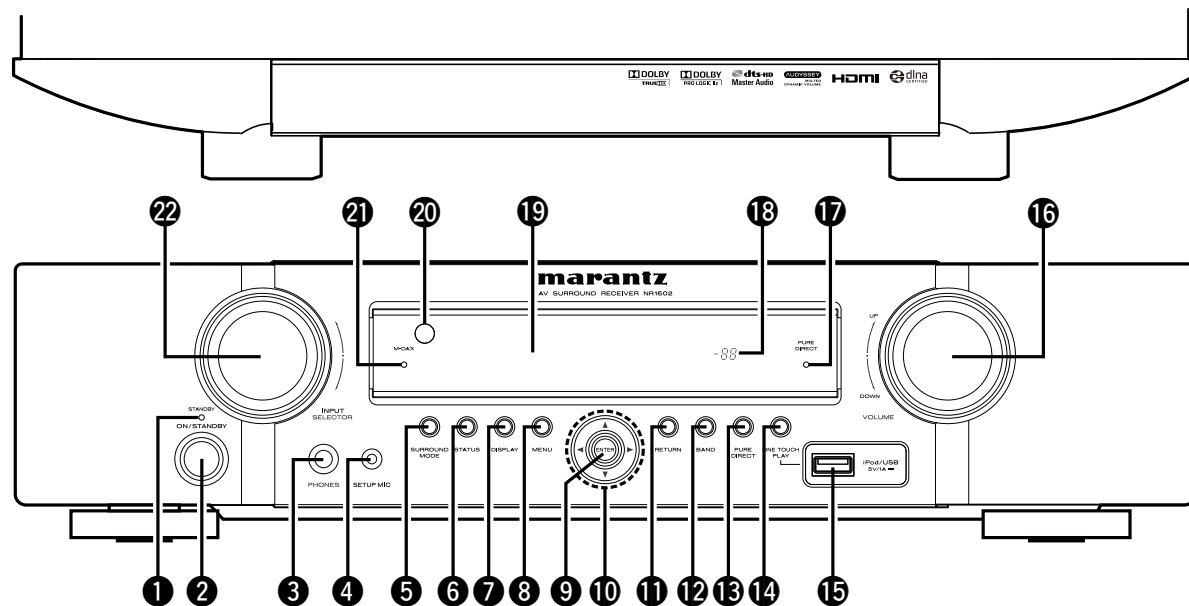

- | | | |
|--|--|---|
| <p>1 Power indicator (STANDBY) (5)</p> <p>2 Power operation button (ON/STANDBY) (5)
Turns power to this unit on and off (standby).</p> <p>3 Headphones jack (PHONES)
When the headphones are plugged into this jack, audio will no longer be output from the connected speakers.</p> <p>NOTE
To prevent hearing loss, do not raise the volume level excessively when using headphones.</p> | <p>4 SETUP MIC jack (17, 59)</p> <p>5 SURROUND MODE button (46, 105)</p> <p>6 STATUS button (25, 65, 98)</p> <p>7 DISPLAY button (71, 97)</p> <p>8 MENU button (71, 96, 98)</p> <p>9 ENTER button (77, 78, 80, 86, 99)</p> <p>10 Cursor buttons (Δ▽◀▶) (71, 77, 78, 80, 86, 99)</p> <p>11 RETURN button (80, 86, 99)</p> <p>12 BAND button (29, 71)</p> | <p>13 PURE DIRECT button (46)</p> <p>14 ONE TOUCH PLAY button (28, 71)</p> <p>15 iPod/USB port (11)</p> <p>16 VOLUME control knob (23)</p> <p>17 PURE DIRECT indicator (46)</p> <p>18 Master volume indicator</p> <p>19 Display (115)</p> <p>20 Remote control sensor (118)</p> <p>21 M-DAX indicator (84)</p> <p>22 INPUT SELECTOR knob (23)</p> |
|--|--|---|

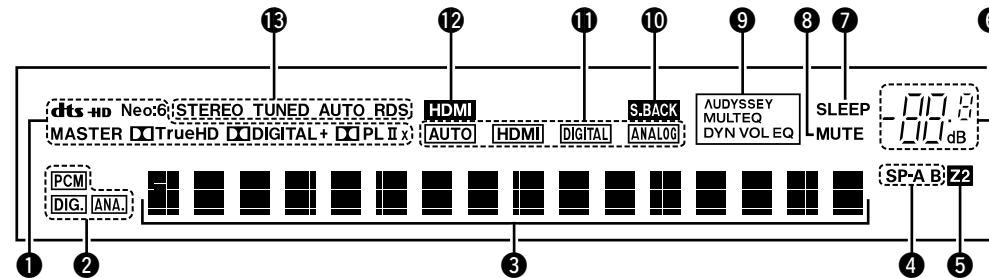

1 Decoder indicators

These light when the respective decoders are operating.

2 Input signal indicators

3 Information display

The input source name, surround mode, setting values and other information are displayed here.

4 Front speaker indicator

This lights according to the setting of the front A and B speakers.

5 Multi-zone indicators

This lights up when ZONE2 (separate room) power is turned on ([page 73](#)).

6 Master volume indicator

7 Sleep timer indicator

This lights when the sleep mode is selected ([page 63, 74](#)).

8 MUTE indicator

This lights when the mute mode is selected ([page 23](#)).

9 Audyssey® indicators

Light up as follows, depending on the setting of "MultEQ®" ([page 82](#)), "Dynamic EQ®" ([page 83](#)) and "Dynamic Volume®" ([page 83](#)).



When "MultEQ®", "Dynamic EQ®" and "Dynamic Volume®" are "ON".



When "MultEQ®" and "Dynamic EQ®" are "ON" and "Dynamic Volume®" is "OFF".



When "MultEQ®" is "ON" and "Dynamic EQ®" and "Dynamic Volume®" are "OFF".

10 Surround back indicator

This lights when audio signals are being output from the surround back speakers ([page 87](#)).

11 Input mode indicators

Set the audio input modes for the different input sources ([page 103](#)).

12 HDMI indicator

This lights when playing using HDMI connections.

13 Tuner reception mode indicators

These light according to the reception conditions when the input source is set to "TUNER".

STEREO : In the FM mode, this lights up when receiving stereo broadcasts.

TUNED : Lights up when the broadcast is properly tuned in.

AUTO : Lights up when in the auto tuning mode.

RDS : Lights up when receiving RDS broadcasts.

Rear panel

See the page indicated in parentheses ().

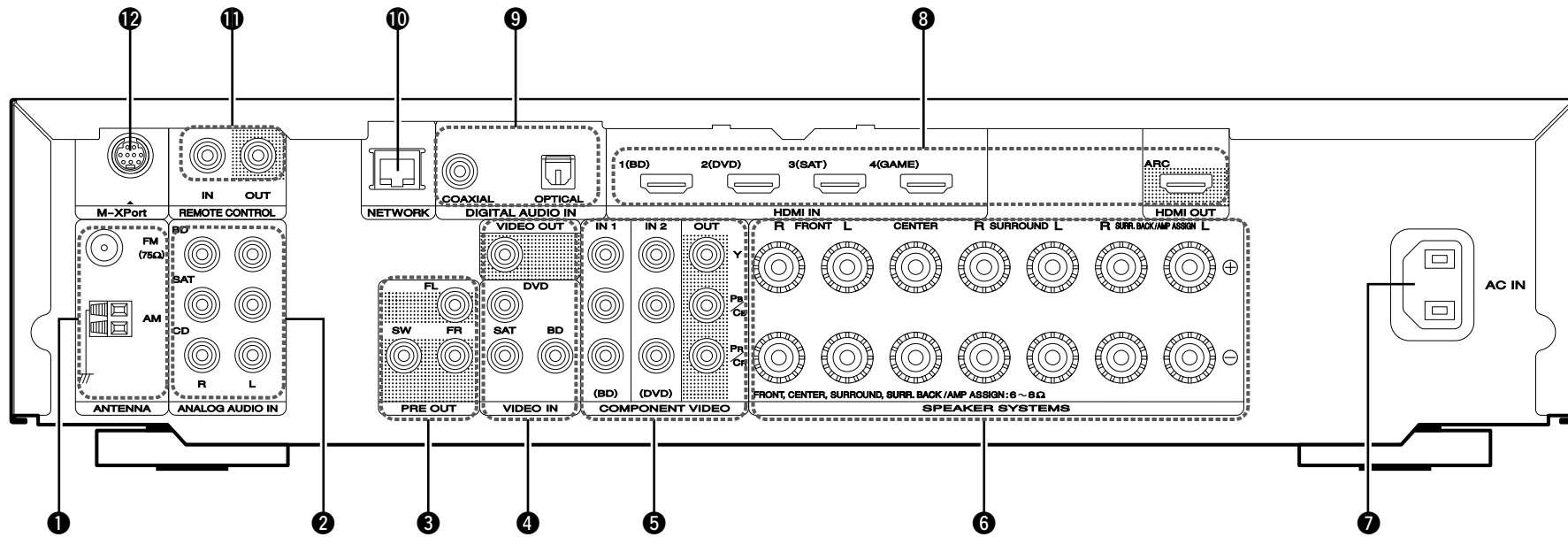

- ① FM/AM antenna terminals (12)
- ② Analog audio connectors (9, 10, 12)
- ③ PRE OUT connectors (6, 53, 54, 55, 56, 57, 58)
- ④ VIDEO connectors (9, 10)
- ⑤ COMPONENT VIDEO connectors (9, 10)
- ⑥ Speaker terminals (6, 53, 54, 55, 56, 57, 58)
- ⑦ AC inlet (AC IN) (5)
- ⑧ HDMI connectors (3, 8)
- ⑨ Digital audio connectors (10, 12)
- ⑩ NETWORK connector (14)
- ⑪ REMOTE CONTROL connectors (61)
- ⑫ M-XPort connector (13)

NOTE

Do not touch the inner pins of the connectors on the rear panel. Electrostatic discharge may cause permanent damage to the unit.

Remote control unit

For buttons not explained here, see the page indicated in parentheses ().

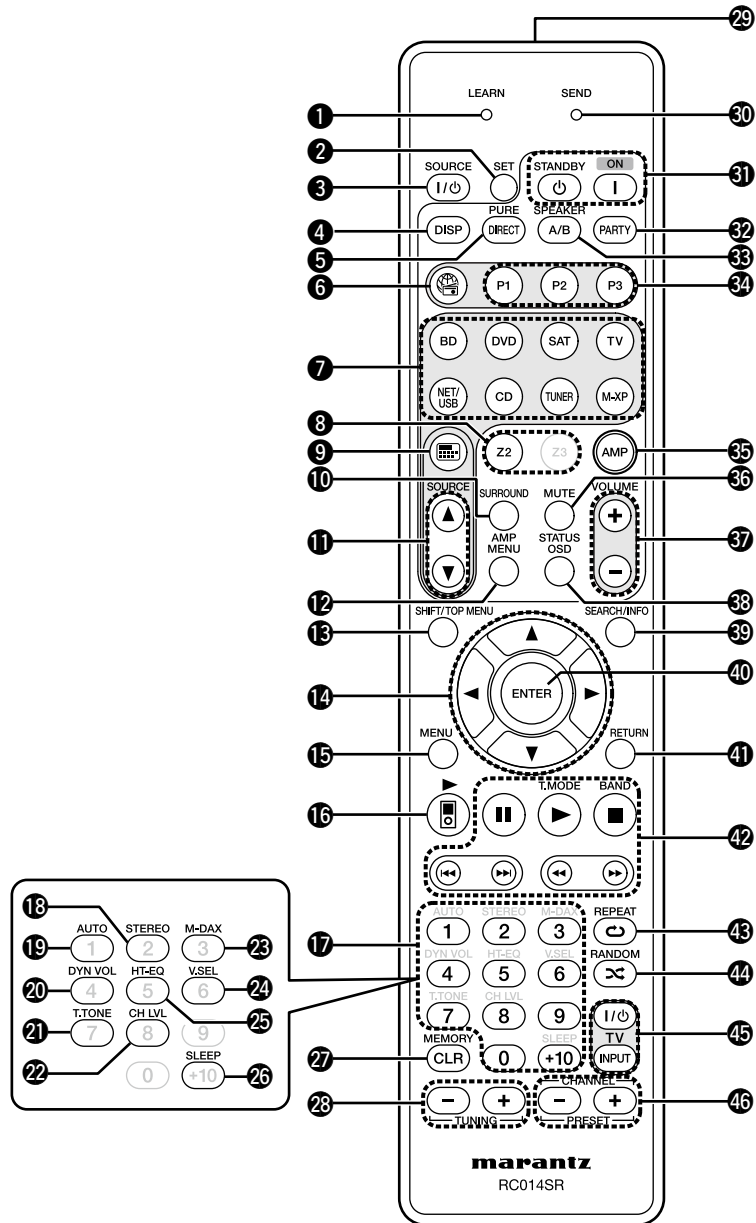

- 1 LEARN indicator (107, 111)
- 2 SET button (107, 111)
- 3 SOURCE power button (I / ⏻) (107, 109, 110)
- 4 Display button (DISP) (97)
- 5 PURE DIRECT button (46)
- 6 Internet radio button (📻) (35)
- 7 Input source select buttons (22, 73)
- 8 Zone mode buttons (Z2, Z3) (73)
- 9 Source select menu button (☰) (22)
- 10 SURROUND button (46, 111)
- 11 Source select buttons (SOURCE ▲ ▼) (23, 107)
- 12 AMP MENU button (80, 86, 99)
- 13 SHIFT/TOP MENU button (29, 36, 78)
- 14 Cursor buttons (△▽◀▶) (77, 78, 80, 86, 99)
- 15 MENU button (109)
- 16 iPod play button (🎵▶) (26)
- 17 Number buttons (29, 36, 107, 109, 110)
- 18 STEREO button (46)
- 19 AUTO buttons (46)
- 20 Audyssey Dynamic Volume® button (DYN VOL) (83)
- 21 Test tone button (T.TONE) (89)
- 22 Channel level button (CH LVL) (64)
- 23 M-DAX button (84)
- 24 Video select button (V.SEL) (102)
- 25 HT-EQ button (81)
- 26 SLEEP button (63, 74)
- 27 Clear (CLR)/MEMORY button (29, 36, 37, 110)
- 28 TUNING buttons (+, -) (29)
- 29 Remote control signal transmitter (118)
- 30 SEND indicator (107, 111)
- 31 Power buttons (ON, STANDBY) (5)
- 32 PARTY button (66)
- 33 SPEAKER A/B button (23)
- 34 Preset channel buttons (P1 – P3) (36, 37)
- 35 AMP button (16, 59, 64, 106)
- 36 Muting button (MUTE) (23, 73)
- 37 Volume control buttons (VOLUME +, -) (23, 73)
- 38 STATUS OSD button (85)
- 39 SEARCH/Information (INFO) button (25, 27, 30, 44, 79)
- 40 ENTER button (77, 78, 80, 86, 99)
- 41 RETURN button (80, 86, 99)
- 42 System buttons (26, 28, 38, 40, 42, 45, 109, 110)
 - Pause button (⏸)
 - Play button (▶)
 - Stop button (■)
 - Skip buttons (⏮, ⏭)
 - Search buttons (🔍, 🔍)
- Tuner system buttons (32)
 - FM/AM band switching button (BAND)
 - Tuning mode button (T.MODE)
- 43 REPEAT button (🔄) (26, 28, 40, 45)
- 44 RANDOM button (🎲) (26, 28, 40, 45)
- 45 TV operation buttons (TV I / ⏻ / INPUT) (109, 110)
- 46 CHANNEL/PRESET buttons (+, -) (29, 30, 36, 67, 110)

NOTE

The Z3 button cannot be used.

Inserting the batteries

- ① Remove the rear lid in the direction of the arrow and remove it.
- ② Load the two batteries properly as indicated by the marks in the battery compartment.

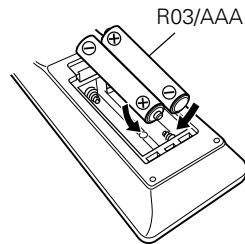
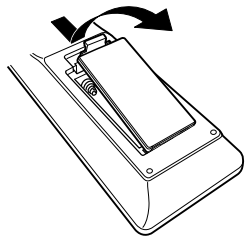

- ③ Put the rear cover back on.

NOTE

- Insert the specified batteries in the remote control unit.
- Replace the batteries with new ones if the set does not operate even when the remote control unit is operated close to the unit. (The supplied batteries are only for verifying operation.)
- When inserting the batteries, be sure to do so in the proper direction, following the ⊕ and ⊖ marks in the battery compartment.
- To prevent damage or leakage of battery fluid:
 - Do not use a new battery together with an old one.
 - Do not use two different types of batteries.
 - Do not attempt to charge dry batteries.
 - Do not short-circuit, disassemble, heat or dispose of batteries in flames.
 - Do not keep the battery in a place exposed to direct sunlight or in places with extremely high temperatures, such as near a heater.
- If the battery fluid should leak, carefully wipe the fluid off the inside of the battery compartment and insert new batteries.
- Remove the batteries from the remote control unit if it will not be in use for long periods.
- Used batteries should be disposed of in accordance with the local regulations regarding battery disposal.
- The remote control unit may function improperly if rechargeable batteries are used.

Operating range of the remote control unit

Point the remote control unit at the remote sensor when operating it.

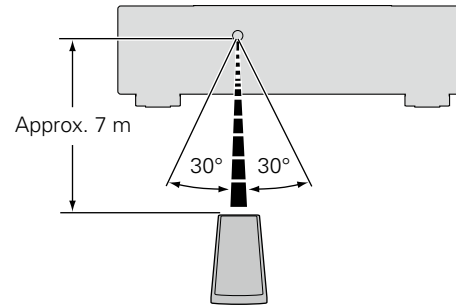

NOTE

- The set may function improperly or the remote control unit may not operate if the remote control sensor is exposed to direct sunlight, strong artificial light from an inverter type fluorescent lamp or infrared light.
- When using 3D video devices that transmit radio communication signals (such as infrared signals etc) between the various units (such as the monitor, 3D glasses, 3D transmitter unit etc), the remote control unit may not operate due to interference from those radio communication signals. If this occurs, adjust the direction and distance of the 3D communication for each unit, and check that the remote control unit operation is not affected by these signals.

Other information

- ❑ **Trademark information** ([page 119](#))
- ❑ **Surround** ([page 120](#))
- ❑ **Relationship between video signals and monitor output** ([page 124](#))
- ❑ **Explanation of terms** ([page 125](#))

Trademark information

This product uses the following technologies:

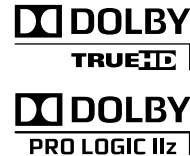

Manufactured under license from Dolby Laboratories. "Dolby", "Pro Logic" and the double-D symbol are trademarks of Dolby Laboratories.



Manufactured under license under U.S. Patent #'s: 5,451,942; 5,956,674; 5,974,380; 5,978,762; 6,226,616; 6,487,535; 7,212,872; 7,333,929; 7,392,195; 7,272,567 & other U.S. and worldwide patents issued & pending. DTS and the Symbol are registered trademarks, & DTS-HD, DTS-HD Master Audio, and the DTS logos are trademarks of DTS, Inc. Product includes software. © DTS, Inc. All Rights Reserved.



HDMI, the HDMI Logo and High-Definition Multimedia Interface are trademarks or registered trademarks of HDMI Licensing LLC in the United States and other countries.



Manufactured under license from Audyssey Laboratories™. U.S. and foreign patents pending. Audyssey MultEQ® is a registered trademark of Audyssey Laboratories. Audyssey Dynamic EQ® is a registered trademark of Audyssey Laboratories. Audyssey Dynamic Volume® is a registered trademark of Audyssey Laboratories.



"Made for iPod" and "Made for iPhone" mean that an electronic accessory has been designed to connect specifically to iPod, or iPhone, respectively, and has been certified by the developer to meet Apple performance standards.

Apple is not responsible for the operation of this device or its compliance with safety and regulatory standards. Please note that the use of this accessory with iPod, or iPhone, may affect wireless performance.

AirPlay, the AirPlay logo, iPhone, iPod, iPod classic, iPod nano, iPod shuffle, and iPod touch are trademarks of Apple Inc., registered in the U.S. and other countries. iPad is a trademark of Apple Inc.

- Individual users are permitted to use iPhone, iPod, iPod classic, iPod nano, iPod shuffle, and iPod touch for private copy and playback of non-copyrighted contents and contents whose copy and playback is permitted by law. Copyright infringement is prohibited by law.



Windows Media and the Windows logo are trademarks or registered trademarks of Microsoft Corporation in the United States and/or other countries.

Surround

This unit is equipped with a digital signal processing circuit that lets you play program sources in the surround mode to achieve the same sense of presence as in a movie theater.

Surround modes and surround parameters

This table shows the speakers that can be used in each surround mode and the surround parameters adjustable in each surround mode.

Symbols in the table

- This indicates the audio output channels or surround parameters that can be set.
- ◎ This indicates the audio output channels. The output channels depend on the settings of "Speaker Config." (page 87).

Surround mode (page 46)	Channel output						Surr.Parameter (page 81)			
	Front L/R	Center	Surround L/R	Surround Back L/R	Front Height L/R	Subwoofer	HT-EQ (page 81)	DRC *4 (page 81)	D. Comp *5 (page 81)	LFE *6 (page 81)
DIRECT/PURE DIRECT (2channel)*1	○					◎*3		○	○	
DIRECT/PURE DIRECT (Multi-channel)*1	○	◎	◎	◎*2	◎*2	◎		○	○	○
STEREO	○					◎		○	○	○
MULTI CH IN	○	◎	◎	◎	◎	◎	○			○
DOLBY PRO LOGIC IIz	○	◎	◎		◎	◎	○	○	○	
DOLBY PRO LOGIC IIx	○	◎	◎	◎		◎	○	○	○	
DOLBY PRO LOGIC II	○	◎	◎			◎	○	○	○	
DTS NEO:6	○	◎	◎	◎		◎	○	○	○	
DOLBY DIGITAL	○	◎	◎	◎	◎	◎	○		○	○
DOLBY DIGITAL Plus	○	◎	◎	◎	◎	◎	○		○	○
DOLBY TrueHD	○	◎	◎	◎	◎	◎	○	○		○
DTS SURROUND	○	◎	◎	◎	◎	◎	○		○	○
DTS 96/24	○	◎	◎	◎	◎	◎	○		○	○
DTS-HD	○	◎	◎	◎	◎	◎	○		○	○
DTS Express	○	◎	◎	◎	◎	◎	○		○	○
MULTI CH STEREO	○	◎	◎	◎	◎	◎	○	○	○	○
VIRTUAL	○					◎		○	○	○

- *1 During playback in PURE DIRECT mode, the surround parameters are the same as in DIRECT mode.
- *2 A signal for each channel contained in an input signal is output as audio.
- *3 Only when "Subwoofer Mode" is set to "LFE+Main" (page 88), sound is output from the subwoofer.
- *4 This item can be selected when a Dolby TrueHD signal is played.
- *5 This item can be selected when a Dolby Digital or DTS signal is played.
- *6 This item can be selected when a Dolby Digital or DTS signal or DVD-Audio is played.

Surround mode (page 46)	Surr.Parameter (page 81)				Tone *8 (page 82)	Audyssey Settings*9 (page 82)			M-DAX *12 (page 84)	
	Height Gain *7 (page 81)	PRO LOGIC II/IIx Music mode only				C.Image (page 81)	MultEQ® (page 82)	Dynamic EQ® *10 (page 83)		Dynamic Volume® *11 (page 83)
		Panorama (page 81)	Dimension (page 81)	C.Width (page 81)						
DIRECT/PURE DIRECT (2channel)*1										
DIRECT/PURE DIRECT (Multi-channel)*1										
STEREO					<input type="radio"/>	<input type="radio"/>	<input type="radio"/>	<input type="radio"/>	<input type="radio"/>	
MULTI CH IN	<input type="radio"/>				<input type="radio"/>	<input type="radio"/>	<input type="radio"/>	<input type="radio"/>	<input type="radio"/>	
DOLBY PRO LOGIC IIz	<input type="radio"/>				<input type="radio"/>	<input type="radio"/>	<input type="radio"/>	<input type="radio"/>	<input type="radio"/>	
DOLBY PRO LOGIC IIx		<input type="radio"/>	<input type="radio"/>	<input type="radio"/>	<input type="radio"/>	<input type="radio"/>	<input type="radio"/>	<input type="radio"/>	<input type="radio"/>	
DOLBY PRO LOGIC II		<input type="radio"/>	<input type="radio"/>	<input type="radio"/>	<input type="radio"/>	<input type="radio"/>	<input type="radio"/>	<input type="radio"/>	<input type="radio"/>	
DTS NEO:6				<input type="radio"/>	<input type="radio"/>	<input type="radio"/>	<input type="radio"/>	<input type="radio"/>	<input type="radio"/>	
DOLBY DIGITAL	<input type="radio"/>				<input type="radio"/>	<input type="radio"/>	<input type="radio"/>	<input type="radio"/>		
DOLBY DIGITAL Plus	<input type="radio"/>				<input type="radio"/>	<input type="radio"/>	<input type="radio"/>	<input type="radio"/>		
DOLBY TrueHD	<input type="radio"/>				<input type="radio"/>	<input type="radio"/>	<input type="radio"/>	<input type="radio"/>		
DTS SURROUND	<input type="radio"/>				<input type="radio"/>	<input type="radio"/>	<input type="radio"/>	<input type="radio"/>		
DTS 96/24	<input type="radio"/>				<input type="radio"/>	<input type="radio"/>	<input type="radio"/>	<input type="radio"/>		
DTS-HD	<input type="radio"/>				<input type="radio"/>	<input type="radio"/>	<input type="radio"/>	<input type="radio"/>		
DTS Express	<input type="radio"/>				<input type="radio"/>	<input type="radio"/>	<input type="radio"/>	<input type="radio"/>		
MULTI CH STEREO					<input type="radio"/>	<input type="radio"/>	<input type="radio"/>	<input type="radio"/>	<input type="radio"/>	
VIRTUAL					<input type="radio"/>	<input type="radio"/>	<input type="radio"/>	<input type="radio"/>	<input type="radio"/>	

- *1 During playback in PURE DIRECT mode, the surround parameters are the same as in DIRECT mode.
- *7 This item can be set when surround mode is "PLIIz" or PLIIz decoder is used.
- *8 This item cannot be set when "Dynamic EQ®" (page 83) is set to "ON".
- *9 For HD Audio whose sampling frequency of an input signal is more than 96 kHz, this sound parameter cannot be set.
- *10 This item cannot be set when "MultEQ®" (page 82) is set to "OFF" or "Manual".
- *11 This item cannot be set when "Dynamic EQ®" (page 83) is set to "OFF".
- *12 This item can be set when the input signal is analog, PCM 48 kHz or 44.1 kHz.

Types of input signals, and corresponding surround modes

This table shows the input signal that can be played in each surround mode. Check the audio signal of the input source then select the surround mode.

Symbols in the table

○ This indicates the selectable surround mode.

Surround mode (page 46)	NOTE	Input signal types and formats														
		ANALOG	PCM		DTS-HD		DTS				DOLBY		DOLBY DIGITAL			
			PCM (multi ch)	PCM (2ch)	DTS-HD Master Audio	DTS-HD High Resolution Audio	DTS EXPRESS	DTS ES DSCRT (With Flag)	DTS ES MTRX (With Flag)	DTS (5.1ch)	DTS 96/24	DOLBY TrueHD	DOLBY DIGITAL Plus	DOLBY DIGITAL EX (With Flag)	DOLBY DIGITAL EX (With no Flag)	DOLBY DIGITAL (5.1/5/4ch/3ch)
DTS SURROUND																
DTS-HD MSTR					○											
DTS-HD HI RES						○										
DTS ES DSCRT6.1	*1*3								○							
DTS ES MTRX6.1	*1*3									○						
DTS SURROUND									○							
DTS 96/24																○
DTS (-HD) + PLIIx MOVIE	*2*3				○	○	○			○	○	○				
DTS (-HD) + PLIIx MUSIC	*1*3				○	○	○			○	○	○				
DTS (-HD) + PLIIz	*4				○	○	○	○		○	○	○				
DTS EXPRESS								○								
DTS (-HD) + NEO:6	*1*3				○	○	○			○	○	○				
DTS NEO:6 CINEMA		○		○												○
DTS NEO:6 MUSIC		○		○												○
DOLBY SURROUND																
DOLBY TrueHD													○			
DOLBY DIGITAL+														○		
DOLBY DIGITAL EX	*1*3												○		○	
DOLBY (D+) (HD) +EX	*1*3												○	○	○	
DOLBY DIGITAL													○	○	○	
DOLBY (D) (D+) (HD) +PLIIx MOVIE	*2*3												○	○	○	
DOLBY (D) (D+) (HD) +PLIIx MUSIC	*1*3												○	○	○	
DOLBY (D) (D+) (HD) +PLIIz	*4												○	○	○	
DOLBY PRO LOGIC IIx MOVIE	*1*3	○		○												○
DOLBY PRO LOGIC IIx MUSIC	*1*3	○		○												○
DOLBY PRO LOGIC IIx GAME	*1*3	○		○												○
DOLBY PRO LOGIC IIz	*4	○		○												○
DOLBY PRO LOGIC II MOVIE		○		○												○
DOLBY PRO LOGIC II MUSIC		○		○												○
DOLBY PRO LOGIC II GAME		○		○												○
DOLBY PRO LOGIC		○		○												○

- *1 If "Speaker Config." - "S.Back" (page 87) is set to "None", this surround mode cannot be selected.
- *2 If "Speaker Config." - "S.Back" (page 87) is set to "1spkr" or "None", this surround mode cannot be selected.
- *3 This surround mode can be selected when "Amp Assign" (page 87) is set to "NORMAL".
- *4 If "Speaker Config." - "F.Height" (page 88) is set to "None", this surround mode cannot be selected.

Surround mode (page 46)	NOTE	Input signal types and formats															
		ANALOG	PCM		DTS-HD		DTS					DOLBY		DOLBY DIGITAL			
			PCM (multi ch)	PCM (2ch)	DTS-HD Master Audio	DTS-HD High Resolution Audio	DTS EXPRESS	DTS ES DSCRT (With Flag)	DTS ES MTRX (With Flag)	DTS (5.1ch)	DTS 96/24	DOLBY TrueHD	DOLBY DIGITAL Plus	DOLBY DIGITAL EX (With Flag)	DOLBY DIGITAL EX (With no Flag)	DOLBY DIGITAL (5.1/5/4ch/3ch)	DOLBY DIGITAL (2ch)
MULTI CH IN																	
MULTI CH IN			<input type="radio"/>														
MULTI CH IN + PLIIx MOVIE	*2*3		<input type="radio"/>														
MULTI CH IN + PLIIx MUSIC	*1*3		<input type="radio"/>														
MULTI CH IN + PLIIz	*4		<input type="radio"/>														
MULTI CH IN + Dolby EX	*1*3		<input type="radio"/>														
MULTI CH IN 7.1	*3		<input type="radio"/>														
DIRECT		<input type="radio"/>	<input type="radio"/>	<input type="radio"/>	<input type="radio"/>	<input type="radio"/>	<input type="radio"/>	<input type="radio"/>	<input type="radio"/>	<input type="radio"/>	<input type="radio"/>	<input type="radio"/>	<input type="radio"/>	<input type="radio"/>	<input type="radio"/>	<input type="radio"/>	<input type="radio"/>
PURE DIRECT		<input type="radio"/>	<input type="radio"/>	<input type="radio"/>	<input type="radio"/>	<input type="radio"/>	<input type="radio"/>	<input type="radio"/>	<input type="radio"/>	<input type="radio"/>	<input type="radio"/>	<input type="radio"/>	<input type="radio"/>	<input type="radio"/>	<input type="radio"/>	<input type="radio"/>	<input type="radio"/>
MULTI CH STEREO		<input type="radio"/>	<input type="radio"/>	<input type="radio"/>	<input type="radio"/>	<input type="radio"/>	<input type="radio"/>	<input type="radio"/>	<input type="radio"/>	<input type="radio"/>	<input type="radio"/>	<input type="radio"/>	<input type="radio"/>	<input type="radio"/>	<input type="radio"/>	<input type="radio"/>	<input type="radio"/>
VIRTUAL		<input type="radio"/>	<input type="radio"/>	<input type="radio"/>	<input type="radio"/>	<input type="radio"/>	<input type="radio"/>	<input type="radio"/>	<input type="radio"/>	<input type="radio"/>	<input type="radio"/>	<input type="radio"/>	<input type="radio"/>	<input type="radio"/>	<input type="radio"/>	<input type="radio"/>	<input type="radio"/>
STEREO		<input type="radio"/>	<input type="radio"/>	<input type="radio"/>	<input type="radio"/>	<input type="radio"/>	<input type="radio"/>	<input type="radio"/>	<input type="radio"/>	<input type="radio"/>	<input type="radio"/>	<input type="radio"/>	<input type="radio"/>	<input type="radio"/>	<input type="radio"/>	<input type="radio"/>	<input type="radio"/>

- *1 If "Speaker Config." - "S.Back" ([page 87](#)) is set to "None", this surround mode cannot be selected.
- *2 If "Speaker Config." - "S.Back" ([page 87](#)) is set to "1spkr" or "None", this surround mode cannot be selected.
- *3 This surround mode can be selected when "Amp Assign" ([page 87](#)) is set to "NORMAL".
- *4 If "Speaker Config." - "F.Height" ([page 88](#)) is set to "None", this surround mode cannot be selected.

Relationship between video signals and monitor output

Input connector			Output connector			Menu displayed		
HDMI	COMPONENT	VIDEO	HDMI	COMPONENT	VIDEO	HDMI	COMPONENT	VIDEO
×	×	×	×	×	×	Only the menu is displayed	×	×
×	×	○	○ <VIDEO>	×	○ <VIDEO>	○ (VIDEO)	×	× (VIDEO)
×	○	×	○ <COMPONENT>	○ <COMPONENT>	×	○ (COMPONENT)	× (COMPONENT)	×
×	○	○	○ <COMPONENT>	○ <COMPONENT>	○ <VIDEO>	○ (COMPONENT)	× (COMPONENT)	× (VIDEO)
○	×	×	○ <HDMI>	×	×	○ (HDMI)	×	×
○	×	○	○ <HDMI>	×	○ <VIDEO>	○ (HDMI)	×	× (VIDEO)
○	○	×	○ <HDMI>	○ <COMPONENT>	×	○ (HDMI)	× (COMPONENT)	×
○	○	○	○ <HDMI>	○ <COMPONENT>	○ <VIDEO>	○ (HDMI)	× (COMPONENT)	× (VIDEO)

○ Video signal input present
 × No video signal input

○ < > The input signal between the < > marks is output.
 × No video signal output

○ () Superimposed on the picture indicated in ().
 × () Only the picture in () is output.



The main zone video conversion function is compatible with the following formats: NTSC, PAL, SECAM, NTSC4.43, PAL-N, PAL-M and PAL-60.

NOTE

- If you operate the menu while playing back 3D video content or computer's resolution (e.g. VGA), the playback video is replaced by the menu screen. The playback video is not displayed behind the menu screen.
- This unit does not show the status display while playing back 3D video content or computer's resolution (e.g. VGA).

Explanation of terms

A

A2DP

A2DP is one profile of Bluetooth defined for in-car devices or AV devices that use wireless communication instead of a cable.

Adobe RGB color, Adobe YCC601 color

Like “x.v.Color”, each of these color spaces defines a palette of available colors that is larger than the traditional RGB color model.

AirPlay

AirPlay sends (plays) contents recorded in iTunes or on an iPhone/iPod touch/iPad to a compatible device via the network.

App Store

App Store is a site that sells application software for such devices as the iPhone or iPod touch, and is operated by Apple Inc.

Audyssey Dynamic EQ®

Dynamic EQ® solves the problem of deteriorating sound quality as volume is decreased by taking into account human perception and room acoustics. Audyssey Dynamic EQ® works in tandem with Audyssey MultEQ® to provide well-balanced sound for every listener at any volume level.

Audyssey Dynamic Volume®

Dynamic Volume® solves the problem of large variations in volume level between television programs, commercials, and between the soft and loud passages of movies. Audyssey Dynamic EQ® is integrated into Dynamic Volume® so that as the playback volume is adjusted automatically, the perceived bass response, tonal balance, surround impression, and dialog clarity remain the same.

Audyssey MultEQ®

MultEQ® is a room equalization solution that calibrates any audio system so that it can achieve optimum performance for every listener in a large listening area. Based on several room measurements, MultEQ® calculates an equalization solution that corrects for both time and frequency response problems in the listening area and also performs a fully automated surround system setup.

Auto Lip Sync

If you connect the unit to a TV that supports the Auto Lip Sync function, it can automatically correct delay between the audio and video.

B

Bluetooth

Bluetooth is a short-distance wireless communication technology used for connecting handheld devices several meters apart. This enables notebook computers, PDA s, mobile phones, etc. to connect without a cable for transmitting audio and data.

D

Deep Color

This technology allows expression of more number of colors than the conventional 8 bits and can reproduce colors close to natural ones without color streak.

DLNA

DLNA and DLNA CERTIFIED are trademarks and/or service marks of Digital Living Network Alliance. Some contents may not be compatible with other DLNA CERTIFIED™ products.

Dolby Digital

Dolby Digital is a multi-channel digital signal format developed by Dolby Laboratories.

A total of 5.1 channels are played: 3 front channels (“FL”, “FR” and “C”), 2 surround channels (“SL” and “SR”) and the “LFE” channel for low frequencies.

Because of this, there is no crosstalk between channels and a realistic sound field with a “three-dimensional” feeling (sense of distance, movement and positioning) is achieved.

A realistic, powerful sense of presence is achieved when playing movie sources in AV rooms as well.

Dolby Digital EX

Dolby Digital EX is a 6.1-channel surround format proposed by Dolby Laboratories that allows users to enjoy in their homes the “DOLBY DIGITAL SURROUND EX” audio format jointly developed by Dolby Laboratories and Lucas Films.

The 6.1 channels of sound, including surround back channels, provide improved sound positioning and expression of space.

Dolby Digital Plus

Dolby Digital Plus is an improved Dolby Digital signal format that is compatible with up to 7.1 channels of discrete digital sound and also improves sound quality thanks to extra data bit rate performance. It is upwardly compatible with conventional Dolby Digital, so it offers greater flexibility in response to the source signal and the conditions of the playback device.

Dolby Pro Logic II

Dolby Pro Logic II is a matrix decoding technology developed by Dolby Laboratories.

Regular music such as that on CDs is encoded into 5 channels to achieve an excellent surround effect. The surround channel signals are converted into stereo and full band signals (with a frequency response of 20 Hz to 20 kHz or greater) to create a “three-dimensional” sound image offering a rich sense of presence for all stereo sources.

Dolby Pro Logic IIx

Dolby Pro Logic IIx is a further improved version of the Dolby Pro Logic II matrix decoding technology. Audio signals recorded in 2 channels are decoded to achieve a natural sound with up to 7.1 channels. There are three modes: “Music” suited for playing music, “Movie” suited for playing movies, and “Game” which is optimized for playing games.

Dolby Pro Logic IIz

Dolby Pro Logic IIz introduces a new dimension to Home Entertainment through the addition of a pair of front height channels. Compatible with stereo, 5.1-channel and 7.1-channel content, Dolby Pro Logic IIz provides enhanced spaciousness, depth and dimension to movies, concert video and video game playback while maintaining the full integrity of the source mix.

Dolby Pro Logic IIz identifies and decodes spatial cues that occur naturally in all content, directing this information to the front height channels, complementing the performance of left and right surround sound speakers. Content that is encoded with Dolby Pro Logic IIz height channel information can be even more revealing, with perceptually discrete height channel information bringing an exciting new dimension to home entertainment.

Dolby Pro Logic IIz, with front height channels is also an ideal alternative for households that cannot support the placement of back surround speakers of a typical 7.1-channel system but may have bookshelf space available to support the addition of height speakers.

Dolby TrueHD

Dolby TrueHD is a high definition audio technology developed by Dolby Laboratories, using lossless coding technology to faithfully reproduce the sound of the studio master.

This format provides the facility to support up to 8 audio channels with a sampling frequency of 96kHz/24bit resolution and up to 6 audio channels with a sampling frequency of 192kHz/24bit resolution. Dolby TrueHD is adopted for applications that put very high importance on sound quality.

Downmix

This function converts the number of channels of surround audio to less number of channels and plays back.

DTS

This is an abbreviation of Digital Theater System, which is a digital audio system developed by DTS. When playing back audio by connecting this system with a device such as DTS amplifier, accurate sound field position and realistic sound effect as if you are in a movie theater can be obtained.

DTS 96/24

DTS 96/24 is a digital audio format enabling high sound quality playback in 5.1 channels with a sampling frequency of 96 kHz and 24 bit quantization on DVD-Video.

DTS Digital Surround

DTS Digital Surround is the standard digital surround format of DTS, Inc., compatible with a sampling frequency of 44.1 or 48 kHz and up to 5.1 channels of digital discrete surround sound.

DTS-ES™ Discrete 6.1

DTS-ES™ Discrete 6.1 is a 6.1-channel discrete digital audio format adding a surround back (SB) channel to the DTS digital surround sound.

Decoding of conventional 5.1-channel audio signals is also possible according to the decoder.

DTS-ES™ Matrix 6.1

DTS-ES™ Matrix 6.1 is a 6.1-channel discrete digital audio format inserting a surround back (SB) channel to the DTS digital surround sound through matrix encoding. Decoding of conventional 5.1-channel audio signals is also possible according to the decoder.

DTS Express

DTS Express is an audio format supporting low bit rates (max. 5.1 channels, 24 to 256 kbps).

DTS-HD

This audio technology provides higher sound quality and enhanced functionality than the conventional DTS and is adopted as an optional audio for Blu-ray Disc. This technology supports multi-channel, high data transfer speed, high sampling frequency, and lossless audio playback. Maximum 7.1-channels are supported in Blu-ray Disc.

DTS-HD High Resolution Audio

DTS-HD High Resolution Audio is an improved version of the conventional DTS, DTS-ES and DTS 96/24 signals formats, compatible with sampling frequencies of 96 or 48 kHz and up to 7.1 channels of discrete digital sound. High data bit rate performance provides high quality sound. This format is fully compatible with conventional products, including conventional DTS digital surround 5.1-channel data.

DTS-HD Master Audio

DTS-HD Master Audio is a lossless audio format created by Digital Theater System (DTS). This format provides the facility to support up to 8 audio channels with a sampling frequency of 96kHz/24bit resolution and up to 6 audio channels with a sampling frequency of 192kHz/24bit resolution. It is fully compatible with conventional products, including conventional DTS digital surround 5.1-channel data.

DTS NEO:6™ Surround

DTS NEO:6™ is a matrix decoding technology for achieving 6.1-channel surround playback with 2-channel sources. It includes “DTS NEO:6 Cinema” suited for playing movies and “DTS NEO:6 Music” suited for playing music.

Dynamic range

The difference between the maximum undistorted sound level and the minimum discernible level above the noise emitted by the device.

F**FLAC**

FLAC stands for Free lossless Audio Codec, and is a lossless free audio file format. Lossless means that the audio is compressed without any loss in quality. The FLAC license is as shown below.

Copyright (C) 2000,2001,2002,2003,2004,2005,2006,2007,2008,2009 Josh Coalson

Redistribution and use in source and binary forms, with or without modification, are permitted provided that the following conditions are met:

- Redistributions of source code must retain the above copyright notice, this list of conditions and the following disclaimer.
- Redistributions in binary form must reproduce the above copyright notice, this list of conditions and the following disclaimer in the documentation and/or other materials provided with the distribution.
- Neither the name of the Xiph.org Foundation nor the names of its contributors may be used to endorse or promote products derived from this software without specific prior written permission.

THIS SOFTWARE IS PROVIDED BY THE COPYRIGHT HOLDERS AND CONTRIBUTORS “AS IS” AND ANY EXPRESSOR IMPLIED WARRANTIES, INCLUDING, BUT NOT LIMITED TO, THE IMPLIED WARRANTIES OF MERCHANTABILITY AND FITNESS FOR A PARTICULAR PURPOSE ARE DISCLAIMED. IN NO EVENT SHALL THE FOUNDATION OR CONTRIBUTORS BE LIABLE FOR ANY DIRECT, INDIRECT, INCIDENTAL, SPECIAL, EXEMPLARY, OR CONSEQUENTIAL DAMAGES (INCLUDING, BUT NOT LIMITED TO, PROCUREMENT OF SUBSTITUTE GOODS OR SERVICES; LOSS OF USE, DATA, OR PROFITS; OR BUSINESS INTERRUPTION) HOWEVER CAUSED AND ON ANY THEORY OF LIABILITY, WHETHER IN CONTRACT, STRICT LIABILITY, OR TORT (INCLUDING NEGLIGENCE OR OTHERWISE) ARISING IN ANY WAY OUT OF THE USE OF THIS SOFTWARE, EVEN IF ADVISED OF THE POSSIBILITY OF SUCH DAMAGE.

H**HDCP**

When transmitting digital signals between devices, this copyright protection technology encrypts the signals to prevent content from being copied without authorization.

HDMI

This is an abbreviation of High-Definition Multimedia Interface, which is an AV digital interface that can be connected to a TV or amplifier. Video signal and audio signal can be connected using 1 cable.

I**iTunes**

iTunes is the name of the multimedia player provided by Apple Inc. It enables management and playback of multimedia contents including music and movies. iTunes supports many main file formats including AAC, WAV, and MP3.

L**LFE**

This is an abbreviation of Low Frequency Effect, which is an output channel that emphasizes low frequency effect sound. Surround audio is intensified by outputting 20 Hz to 120 Hz deep bass.

M**MAIN ZONE**

The room where this unit is placed is called the MAIN ZONE.

MP3 (MPEG Audio Layer-3)

This is an internationally standardized audio data compression scheme, using the “MPEG-1” video compression standard. It compresses the data volume to about one eleventh its original size while maintaining sound quality equivalent to a music CD.

MPEG (Moving Picture Experts Group), MPEG-2, MPEG-4

These are the names for digital compression format standards used for the encoding of video and audio. Video standards include “MPEG-1 Video”, “MPEG-2 Video”, “MPEG-4 Visual”, “MPEG-4 AVC”. Audio standards include “MPEG-1 Audio”, “MPEG-2 Audio”, “MPEG-4 AAC”.

P**Pairing**

Pairing is an operation required for settings to connect two Bluetooth devices. Pairing enables Bluetooth devices to access each other.

Progressive (sequential scanning)

This is a scanning system of video signal that displays 1 frame of video as one image. Compared to the interlace system, this system provides images with less flickering and bleeding.

Protection Circuit

This is a function to prevent damage to devices within the power supply when an abnormality such as an overload, excess voltage occurs or temperature for any reason.

In this unit, the power indicator blinks and the unit enters standby mode when an abnormality occurs.

S**Sampling frequency**

Sampling involves taking a reading of a sound wave (analog signal) at regular intervals and expressing the height of the wave at each reading in digitized format (producing a digital signal).

The number of readings taken in one second is called the “sampling frequency”. The larger the value, the closer the reproduced sound is to the original.

Speaker impedance

This is an AC resistance value, indicated in Ω (ohms). Greater power can be obtained with this value smaller.

sYCC601 color

Like “x.v.Color”, each of these color spaces defines a palette of available colors that is larger than the traditional RGB color model.

V

vTuner

This is a free online content server for Internet radio. Note that usage fees are included in upgrade costs.

For inquiries about this service, visit the vTuner site below.

vTuner website: <http://www.radiomarantz.com>

This product is protected by certain intellectual property rights of Nothing Else Matters Software and BridgeCo. Use or distribution of such technology outside of this product is prohibited without a license from Nothing Else Matters Software and BridgeCo or an authorized subsidiary.

W

WAV (Wave)

WAV is a standard audio format of Windows. The file size tends to increase, but sound near the original sound can be maintained.

Windows Media DRM

This is a copyright protection technology developed by Microsoft.

Content providers are using the digital rights management technology for Windows Media contained in this device (WM-DRM) to protect the integrity of their content (Secure Content) so that their intellectual property, including copyright, in such content is not misappropriated. This device uses WM-DRM software to play Secure Content (WM-DRM Software). If the security of the WM-DRM Software in this device has been compromised, owners of Secure Content (Secure Content Owners) may request that Microsoft revoke the WM-DRM Software's right to acquire new licenses to copy, display and/or play Secure Content. Revocation does not alter the WM-DRM Software's ability to play unprotected content. A list of revoked WM-DRM Software is sent to your device whenever you download a license for Secure Content from the Internet or from a PC. Microsoft may, in conjunction with such license, also download revocation list onto your device on behalf of Secure Content Owners.

Windows Media Player Ver.11 or later

This is a media player distributed free of charge by Microsoft Corporation.

It can play playlists created with Ver.11 or later of Windows Media Player, as well as WMA, DRM WMA, WAV, and other files.

WMA (Windows Media Audio)

This is audio compression technology developed by Microsoft Corporation.

WMA data can be encoded using Windows Media® Player Ver.7, 7.1, Windows Media® Player for Windows® XP and Windows Media® Player 9 Series.

To encode WMA files, only use applications authorized by Microsoft Corporation. If you use an unauthorized application, the file may not work properly.

X

x.v.Color

This function lets HDTVs display colors more accurately. It enables display with natural, vivid colors. "x.v.Color" is a Sony registered trademark.

Z

ZONE2

This unit can operate in a room other than the room where this unit is placed (MAIN ZONE) (ZONE2 playback). The room for ZONE2 playback is called ZONE2.

Troubleshooting

If a problem should arise, first check the following:

1. Are the connections correct?



2. Is the set being operated as described in the owner's manual?

3. Are the other devices operating properly?

If this unit does not operate properly, check the items listed in the table below. Should the problem persist, there may be a malfunction.

In this case, disconnect the power immediately and contact your store of purchase.



[General]

Symptom	Cause/Solution	Page
Power does not turn on.	<ul style="list-style-type: none"> Check whether the power plug is correctly inserted into the power outlet. The protection circuit is active. Disconnect the power plug from the electric outlet, wait 5 to 10 seconds and then insert it back into the outlet. 	 5 126
Display is off.	<ul style="list-style-type: none"> Set "Display" on the menu to something other than "OFF". 	97
The power indicator is blinking red in intervals of approximately 2 seconds.	<ul style="list-style-type: none"> The temperature inside the unit has risen. Please turn off power once, and re-apply the power after the temperature has fallen sufficiently. Please re-install this unit in a place having good ventilation. 	– –
The power indicator is blinking red in intervals of approximately 0.5 seconds.	<ul style="list-style-type: none"> Please use speakers which have the specified impedance. The speaker cable has shorted (is touching). Firmly twist the core wire in the speaker cable, and then re-connect it to the speaker terminal. 	 6 , 53  6
After turning on the power, the power indicator is blinking red in intervals of approximately 0.5 seconds.	<ul style="list-style-type: none"> This unit amplifier circuit has failed. Turn off the power and please contact the marantz service adviser. 	–
Set does not operate properly.	<ul style="list-style-type: none"> Reset the microprocessor. 	132

[HDMI]

Symptom	Cause/Solution	Page
No audio is output with HDMI connection.	<ul style="list-style-type: none"> Check the connection of the HDMI connectors. When outputting HDMI audio from the speakers, set "HDMI Audio Out" on the menu to "AMP". When outputting HDMI audio from a TV, set "HDMI Audio Out" on the menu to "TV". 	8 90 90
No video is output with HDMI connection.	<ul style="list-style-type: none"> Check the connection of the HDMI connectors. Set the input source to match the connected HDMI connector. Check whether the TV is compatible with copyright protection (HDCP). If connected to a device not compatible with HDCP, video will not be output correctly. 	8 8 , 22 7
When the following operations are performed on devices compatible with HDMI control, the same operations occur on this unit. <ul style="list-style-type: none"> Power ON/OFF Switching audio output devices Adjust volume Switch input source 	<ul style="list-style-type: none"> Set "HDMI Control" in the menu to "OFF". Furthermore, if you do not want to link the power off operation with devices compatible with HDMI control, set "P.Off Control" in the menu to "OFF".	62 , 90

[Video]

Symptom	Cause/Solution	Page
No picture appears.	<ul style="list-style-type: none"> Check the TV connection. Set the TV input correctly. 	 3  3

[Audio]

Symptom	Cause/Solution	Page
Audio is not output.	<ul style="list-style-type: none"> • Check the connections for all devices. • Check the speaker connections and configurations. • Check whether the audio device power is turned on. • Adjust the master volume. • Cancel the mute mode. • Select a suitable input source. • Select a suitable input mode. • Disconnect the headphones. No sound is output from the speakers when headphones are connected. 	3 , 8 , 9 , 10 , 11 , 12 , 13 , 14 6 , 87 , 88 – 23 , 73 23 , 73 22 , 73 103 114
No sound is produced from surround speaker.	<ul style="list-style-type: none"> • Check if the surround speakers are connected to the SURROUND terminals. 	–
No sound is produced from surround back speaker.	<ul style="list-style-type: none"> • Check if “Amp Assign” is set appropriately in order to output audio from the surround back speakers. • Set “Speaker Config.” – “S.Back” on the menu to something other than “None”. • Set the surround mode to something other than “STEREO” and “VIRTUAL”. 	87 87 46
No sound is produced from front height speaker.	<ul style="list-style-type: none"> • Check if “Amp Assign” is set appropriately in order to output audio from the front height speakers. • Set “Speaker Config.” – “F.Height” on the menu to something other than “None”. 	87 88
No sound is produced from subwoofer.	<ul style="list-style-type: none"> • Check the subwoofer connections. • Turn on the subwoofer’s power. • Set “Speaker Config.” – “Subwoofer” on the menu to “Yes”. • If “Front” and “Center” for “Speaker Config.” are set to “Large”, and “Subwoofer Mode” is set to “LFE”, no sound may be output from the subwoofers, depending on the input signal or selected surround mode. 	6 , 53 , 54 , 55 , 56 , 57 , 58 – 87 87 , 88
DTS sound is not output.	<ul style="list-style-type: none"> • Set “Decode Mode” on the menu to “Auto” or “DTS”. 	103

Symptom	Cause/Solution	Page
Dolby TrueHD, DTS-HD, Dolby Digital Plus audio is not output.	<ul style="list-style-type: none"> • Make HDMI connections. 	8
Dolby PLII mode or DTS NEO:6 mode cannot be selected.	<ul style="list-style-type: none"> • Check that “Speaker Config.” – “Center” or “Surround” is set to other than “None”. If the speaker system is 2.0/2.1ch, this surround mode cannot be selected. • When headphones are used, Dolby PLII or DTS NEO:6 cannot be selected. 	87 –
Audyssey MultEQ®, Audyssey Dynamic EQ® and Audyssey Dynamic Volume® cannot be selected.	<ul style="list-style-type: none"> • Switch the surround mode to other than “DIRECT” or “PURE DIRECT”. • When headphones are used, MultEQ®, Dynamic EQ® and Dynamic Volume® cannot be selected. 	46 –
Dynamic EQ® and Dynamic Volume® cannot be selected.	<ul style="list-style-type: none"> • Run Audyssey® Auto Setup. 	15 , 59
M-DAX cannot be selected.	<ul style="list-style-type: none"> • Check that an analog signal or PCM signal (fs=44.1/48 kHz) is input. For playback of multichannel signals such as Dolby Digital or DTS surround, M-DAX cannot be used. • Switch the surround mode to other than “DIRECT” or “PURE DIRECT”. 	84 46

[Radio]



Symptom	Cause/Solution	Page
Reception fails, or there is a lot of noise or distortion.	<ul style="list-style-type: none"> • Change the antenna orientation or position. • Separate the AM loop antenna from the unit. • Use an FM outdoor antenna. • Separate the antenna from other connection cables. 	12 12 12 12

[Internet radio / Media server / iPod / USB memory device / Flickr / Last.fm / Napster]

Symptom	Cause/Solution	Page
When a USB memory device is connected, "USB" is not displayed on the menu.	<ul style="list-style-type: none"> The set cannot recognize a USB memory device. Check the connection. A USB memory device not conforming to mass storage class or MTP standards is connected. Connect a USB memory device conforming to mass storage class or MTP standards. A USB memory device that the set cannot recognize is connected. This is not a malfunction. marantz does not guarantee that all USB memory devices will operate or receive power. USB memory device is connected via USB hub. Connect the USB memory device directly to the USB port. 	<p>11</p> <p>–</p> <p>–</p> <p>–</p>
Files on a USB memory device cannot be played.	<ul style="list-style-type: none"> USB memory device is in format other than FAT16 or FAT32. Set the format to FAT16 or FAT32. For details, refer to the USB memory device's operating instructions. USB memory device is divided into multiple partitions. When divided into multiple partitions, only files stored in the top partition can be played. Files are stored in a non-compatible format. Record the files in a compatible format. You are attempting to play a file that is copyright protected. Files that are copyright protected cannot be played on this unit. 	<p>–</p> <p>–</p> <p>27</p> <p>27</p>
The file names are not displayed properly ("...", etc.).	<ul style="list-style-type: none"> Characters that cannot be displayed are used. This is not a malfunction. On this unit, characters that cannot be displayed are replaced with a "." (period). 	–
Internet radio cannot be played.	<ul style="list-style-type: none"> Ethernet cable is not properly connected or network is disconnected. Check the connection status. Program is being broadcast in non-compatible format. Only Internet radio programs in MP3 and WMA can be played on this unit. The router's firewall is activated. Check the router's firewall settings. Radio station is not currently broadcasting. Choose a radio station that is currently broadcasting. IP address is wrong. Check the set's IP address. 	<p>14</p> <p>33</p> <p>–</p> <p>35</p> <p>95</p>
Files stored on a computer cannot be played.	<ul style="list-style-type: none"> Files are stored in a non-compatible format. Record in a compatible format. You are attempting to play a file that is copyright protected. Files that are copyright protected cannot be played on this unit. Set and computer are connected by USB cable. The set's USB port cannot be used for connection to a computer. 	<p>33</p> <p>33</p> <p>–</p>

Symptom	Cause/Solution	Page
Server is not found, or it is not possible to connect to the server.	<ul style="list-style-type: none"> The computer's or router's firewall is activated. Check the computer's or router's firewall settings. Computer's power is not turned on. Turn on the power. Server is not running. Launch the server. Set's IP address is wrong. Check the set's IP address. 	<p>–</p> <p>–</p> <p>–</p> <p>95</p>
iPod cannot be played.	<ul style="list-style-type: none"> Some iPods do not support being used connected directly to the USB port. 	11
Cannot connect to preset or favorite radio stations.	<ul style="list-style-type: none"> Radio station is not currently broadcasting. Wait a while before trying again. Radio station is not currently in service. It is not possible to connect to radio stations that are no longer in service. 	<p>–</p> <p>–</p>
For some radio stations, "Radio station server full" or "Connection down" is displayed and station cannot be connected to.	<ul style="list-style-type: none"> Station is congested or not currently broadcasting. Wait a while before trying again. 	–
Sound is broken during playback.	<ul style="list-style-type: none"> Network's signal transfer speed is slow or communications lines or radio station is congested. This is not a malfunction. When playing broadcast data with a high bit rate, the sound may be broken, depending on the communications conditions. 	–
Sound quality is poor or played sound is noisy.	<ul style="list-style-type: none"> File being played has a low bit rate. This is not a malfunction. 	–
Cannot compile Playlist.	<ul style="list-style-type: none"> This unit does not respond to playlist compilation. When the playlist is compiled in PC Application, it is registered to "My Library". In this way, the playlist can be played in this unit 	–
Cannot delete Tracks, Playlists, Channels registered in "My Library"	<ul style="list-style-type: none"> Cannot be done with this unit. Delete from PC Application. 	–
Cannot login to Napster. ("Incorrect Username or Password" is displayed.)	<ul style="list-style-type: none"> Login information is incorrect. Check if the Username for Napster has been properly entered. Re-enter the Password. (Password is not displayed.) http://www.napster.com/choose/index_default.html 	34 , 44 , 95

[AirPlay]

Symptom	Cause/Solution	Page
The AirPlay icon  is not displayed in iTunes or on the iPhone/iPod touch/iPad.	<ul style="list-style-type: none"> This unit and the computer or iPhone/iPod touch/iPad are not connected to the same network (LAN). Connect the computer or iPhone/iPod touch/iPad to the same network as this unit. iTunes or the iPhone/iPod touch/iPad do not have firmware that supports AirPlay installed. Update to the latest firmware. 	14 97
No sound.	<ul style="list-style-type: none"> The volume in iTunes or on the iPhone/iPod touch/iPad is set to the minimum setting. Adjust the volume to the optimum level. This unit is not selected in the screen that is displayed when iTunes or the iPhone/iPod touch/iPad is started. Start iTunes or switch on the iPhone/iPod touch/iPad, click the AirPlay icon  in the displayed screen, and select this unit. 	<p>–</p> 65

[M-XPort]

Symptom	Cause/Solution	Page
Audio is not output when a wireless receiver (RX101 is connected).	<ul style="list-style-type: none"> Check that the Bluetooth device and Wireless receiver (RX101) are correctly paired. 	13 , 126

[Remote Control Unit]

Symptom	Cause/Solution	Page
The set cannot be operated with the remote control unit.	<ul style="list-style-type: none"> Batteries are worn out. Replace with new batteries. Operate the remote control unit within a distance of about 7 m from this unit and at an angle of within 30°. Remove any obstacle between this unit and the remote control unit. Insert the batteries in the proper direction, checking the ⊕ and ⊖ marks. The set's remote control sensor is exposed to strong light (direct sunlight, inverter type fluorescent bulb light, etc.). Move the set to a place in which the remote control sensor will not be exposed to strong light. The operation mode does not match the settings of the device to operate. Check the operation mode. 	118 118 118 118 106

Resetting the microprocessor

Perform this procedure if the display is abnormal or if operations cannot be performed. When the microprocessor is reset, all the settings are reset to their default values.

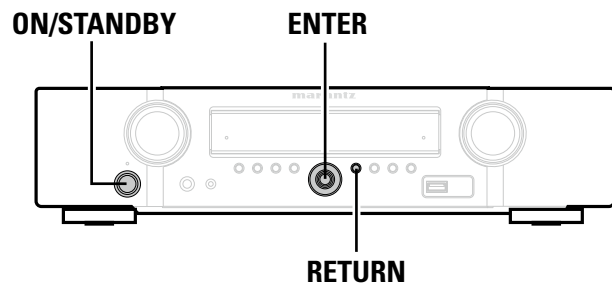

- 1** Turn off the power using **ON/STANDBY**.
- 2** Press **ON/STANDBY** while simultaneously pressing **ENTER** and **RETURN**.
- 3** Once the display starts flashing at intervals of about 1 second, release the two buttons.



If in step 3 the display does not flash at intervals of about 1 second, start over from step 1.

Specifications

□ Audio section

• Power amplifier

Rated output:

Front:
50 W + 50 W (8 Ω, 20 Hz – 20 kHz with 0.08 % T.H.D.)

Center:
50 W (8 Ω, 20 Hz – 20 kHz with 0.08 % T.H.D.)

Surround:
50 W + 50 W (8 Ω, 20 Hz – 20 kHz with 0.08 % T.H.D.)

Surround back:
50 W + 50 W (8 Ω, 20 Hz – 20 kHz with 0.08 % T.H.D.)

Maximum effective output power:

Front:
75 W + 75 W (6 Ω, 1 kHz with 10 % T.H.D.)

Center:
75 W (6 Ω, 1 kHz with 10 % T.H.D.)

Surround:
75 W + 75 W (6 Ω, 1 kHz with 10 % T.H.D.)

Surround back:
75 W + 75 W (6 Ω, 1 kHz with 10 % T.H.D.)

Output connectors:

6 – 8 Ω

• Analog

Input sensitivity/Input impedance: 130 mV/47 kΩ

Frequency response: 10 Hz – 100 kHz — +1, –3 dB (DIRECT mode)

S/N: 98 dB (IHF–A weighted, DIRECT mode)

□ Video section

• Standard video connectors

Input/output level and impedance: 1 Vp-p, 75 Ω

Frequency response: 5 Hz – 10 MHz — 0, –3 dB

• Color component video connector

Input/output level and impedance: Y (brightness) signal — 1 Vp-p, 75 Ω

P_B / C_B signal — 0.7 Vp-p, 75 Ω

P_R / C_R signal — 0.7 Vp-p, 75 Ω

Frequency response: 5 Hz – 60 MHz — 0, –3 dB

□ Tuner section

	[FM]	[AM]
Receiving Range:	87.5 MHz – 108.0 MHz	522 kHz – 1611 kHz
Usable Sensitivity:	1.2 μV (12.8 dBf)	18 μV
50 dB Quieting Sensitivity:	MONO 2.0 μV (17.3 dBf)	
	STEREO 42 μV (34.5 dBf)	
S/N:	MONO 72 dB (IHF–A weighted, DIRECT mode)	
	STEREO 67 dB (IHF–A weighted, DIRECT mode)	
Total harmonic Distortion (at 1 kHz):	MONO 0.3 %	
	STEREO 0.7 %	

(Note: μV at 75 Ω, 0 dBf = 1 x 10⁻¹⁵ W)

□ General

Power supply: AC 230 V, 50/60 Hz

Power consumption: 220 W

0.2 W (Standby)

3 W (CEC standby)

For purposes of improvement, specifications and design are subject to change without notice.

Index

Numerics

2.1-channel	57
3D	7
5.1-channel	52, 55
6.1-channel	52, 54
7.1-channel	51, 53

A

A2DP	13, 125
Accessories	2
Add New Feature	98
Adjust Channel	84
Adjusting the master volume	23
Adobe RGB color / Adobe YCC601 color	125
AirPlay	65, 125
AM loop antenna	12
Amp Assign	87
App Store	125
ARC	7
Audio Adjust	80
Audio Delay	84
Audio Setup	91
Audyssey® Auto Setup	15, 59
Audyssey Dynamic EQ®	83, 125
Audyssey Dynamic Volume®	83, 125
Audyssey MultEQ®	82, 125
Audyssey Settings	82
Auto Lip Sync	90, 125
Auto Preset	100
Auto Setup	15, 59

B

Bass	82
Bass Setting	88
Bi-amp	58
Bluetooth	13, 125

C

Cable	
Audio cable	9, 10, 12
Coaxial digital cable	10
Component video cable	9, 10
Ethernet cable	14
HDMI cable	8
Optical cable	12
Video cable	9, 10
Channel Level	64, 89
Characters	78
C.Image	81
Condensation	3

Connection	
Antenna	12
Blu-ray Disc player	8, 9
Cable TV	10
CD player	12
DVD player	8, 10
Game console	8
HDMI	7
Home network (LAN)	14
iPod (USB)	11
Remote control connectors	61
Satellite tuner	10
Set-top box	8, 10
Speaker	53
TV	8, 9
USB memory device	11
Wireless receiver (RX101)	13
Content Type	7
Crossover Freq.	89
Curve Copy	84
C.Width	81

D

D.Comp	81
Decode Mode	103
Deep Color	7, 125
Dimension	81
Direct mode	25
Display	97, 115
Distance	88
DLNA	125
Dolby	
Dolby Digital	125
Dolby Digital EX	125
Dolby Digital Plus	125
Dolby Pro Logic II	125
Dolby Pro Logic IIx	125
Dolby Pro Logic IIz	51, 125
Dolby TrueHD	125
Downmix	125
DRC	81
DTS	125
DTS 96/24	125
DTS Digital Surround	125
DTS-ES Discrete 6.1	125
DTS-ES Matrix 6.1	126
DTS Express	126
DTS-HD	126
DTS-HD High Resolution Audio	126
DTS-HD Master Audio	126
DTS NEO:6™ Surround	126

Dual backup memory function	71
Dynamic EQ®	83
Dynamic range	126
Dynamic Volume®	83

E

EQ Customize	91
Error messages (Auto Setup)	20

F

Fader function	64
F.Height	88
Firmware Update	97
FLAC	126
Flickr	34, 41
FM/AM	29
FM indoor antenna	12
Front A/B (connection)	52, 56
Front height speaker	51, 53
Front Panel	114

G

GUI	96
-----	----

H

HDCP	7, 126
HDMI	7, 126
HDMI 1.4a	7
HDMI Audio Out	90
HDMI Control	62, 90
HDMI Setup	90
Headphones	114
Height Gain	81
HT-EQ	81

I

Information	85
Audio Signal	85
HDMI Information	85
Preset Channel	85
Status	85
Input Assign	101
Input Mode	103
Input Setup	99
Input signal	122
Inputting characters	78
Interval	104
iPod PLAY	26
iTunes	126

L

Language	98
Last.fm	42
Lch Level	95
Learn function	111
LFE	81, 126
Listening mode	46
Listening position	15

M

MAIN ZONE	126
Manual EQ	84
Master volume	96
M-DAX	84
Media controller	68
Menu map	75
MP3	126
MPEG	126
MultEQ®	82
Mute Level	95, 96
M-XPort	13

N

Napster	34, 44
Network Setup	21, 92
Last.fm Account	95
Last.fm Display	95
Napster Account	95
Network Connect	92
Network Info	95
Other	94

O

One touch play function	28
Option Setup	96
Add New Feature	98
Display	97
Firmware Update	97
GUI	96
Setup Lock	97
Source Delete	96
Volume Control	96
Zone Rename	97

P

Pairing	126
Panel lock function	71
Panorama	81
Parameter Check	21
Party mode	66

Playback	
Blu-ray Disc player	24
CD player	24
Direct	49
DVD player	24
Flickr	41
FM/AM	29
Internet radio	35
iPod (USB)	25
Last.fm	42
Media server	39
MP3	27, 34
MPEG-4 AAC	27, 34
Napster	44
Network audio	33
PTY	31
Pure direct	49
RDS	30
RT	32
Stereo	49
TP	31
USB memory device	27
WMA	27, 34
ZONE2	73
Playback Mode (NET/USB)	104
P.Off Control	90
Power On Level	95, 96
Preset codes	107
Preset Name	100
Preset Skip	100
Presetting radio stations	29
Progressive	126
Protection circuit	126
PTY	31
R	
Random	104
Rich Level	95
RDS	30
Rear panel	116
Reference Offset	83
Remote control settings	105
Remote control unit	106, 117
Inserting the batteries	118
Operating AV devices	106
Operating devices	109
Operating learn function	111
Registering Preset Codes	107
Remote mode	25
Rename	103
Repeat	104
Resetting the microprocessor	132
RT	32

S

Sampling frequency	126
S.Back	87
Screensaver	96
Selecting the input source	22
Setup Lock	97
Sleep timer	63, 74
Slide Show	104
Source Delete	96
Source Level	103
Speaker	
Connect	53
Install	51
Set up	15, 21, 59
Speaker Config.	87
Speaker impedance	126
Speaker Setup	87
Standby Source	90
Still Picture	104
Subwoofer setting	16
Surround back speaker	52, 54
Surround mode	46, 120
Surr.Parameter	81
Switching the front speakers	23
sYCC601 color	126
System Setup	86

T

Tone	82
Tone Control	82
TP	31
Trademark	119
Treble	82
Troubleshooting	128
Turning off the sound temporarily	23

V

Video	102
Video conversion	5
Video Mode	102
Video Select	102
Volume Control	96
Volume Display	96
Volume Limit	95, 96
vTuner	127

W

WAV	127
Web control	69
Windows Media DRM	127
Windows Media Player Ver.11 or later	127
WMA	127

X

x.v.Color	7, 127
-----------	--------

Z

ZONE2	73, 115, 127
ZONE2 Setup	95
Zone Management	67
Zone Rename	97

List of preset codes

Device select : BD

Blu-ray Disc Player

D	Denon	5034, 5035, 5036
H	Hitachi	5031, 5032, 5033
I	Integra	5013
J	JWC	5014, 5015, 5017, 5018, 5019, 5020
L	LG	5010, 5011
M	marantz	5000, 5026, 5027
	Mitsubishi	5024, 5025
O	Onkyo	5013
P	Panasonic	5001, 5002, 5003
	Philips	5004
	Pioneer	5005
R	RCA	5012
S	Samsung	5005
	Sharp	5028, 5029, 5030
	Sony	5007, 5008, 5009, 5016
T	Toshiba	5012
Y	Yamaha	5021, 5022, 5023

Device select : DVD

DVD Player

A	Aiwa	2036, 2037
	Apex	2012, 2017, 2018, 2019, 2021, 2034
B	BOSE	2038, 2039, 2063
D	Denon	2047, 2048
F	Funai	2049
G	GE	2009, 2020, 2029, 2033
H	Harman Kardon	2061
	Hitachi	2008, 2012, 2031
J	JVC	2006, 2010, 2040, 2041, 2042, 2043
K	Kenwood	2053, 2054
	Koss	2058
M	Magnavox	2007, 2011, 2023, 2025
	marantz	2025, 2065
	Mitsubishi	2011, 0215
O	Onkyo	2062
	Oritron	2009, 2030
P	Panasonic	2003, 2015, 2016, 2055
	Philips	2007, 2011, 2058
	Pioneer	2002, 2014, 2056
	Proscan	2009, 2020, 2032
R	RCA	2005, 2009, 2020, 2035, 2057

S	Sampo	2041
	Samsung	2008, 2012, 2022, 2024, 2027
	Sanyo	2050, 2052
	Sharp	2044, 2045
	Sherwood	2051
	Sony	2001, 2013, 2059
T	Toshiba	2004, 2008, 2026, 2028
Y	Yamaha	2046, 2060
Z	Zenith	2010

Device select : SAT

Satellite Receiver

A	Alphastar	4027
	Amstrad	4047, 4050
	Atsky	4048
B	B Sky B	4021, 4045
C	Chaparral	4039
D	DIRECTV	4001, 4016
	DISH Network	4030
	Drake	4026
E	EchoStar	4007, 4017, 4018, 4019, 4020
	Eurosky	4047, 4056
	Express Vu	4017
F	Foxtel	4051
	Fujitsu	4025
G	GE	4002, 4008, 4009
	General Instruments	4036, 4037
	Gradiente	4044, 4057
H	Hitachi	4001, 4015
	Hughes	4001, 4016
	Humax	4049, 4050, 4051
J	Janeil	4025
	JVC	4017
M	Mitsubishi	4001
O	Optima	4048
P	Panasonic	4004, 4010
	Philips	4031, 4035, 4044, 4057
	Proscan	4002, 4008, 4009, 4011
R	Radio Shack	4036, 4037
	RCA	4002, 4008, 4009, 4029
	Realistic	4040
	Rural Cable	4036
S	Samsung	4022, 4027, 4050
	Schneider	4041
	SKY	4044, 4045, 4057
	Skyplus	4048

	Skysat	4041, 4047, 4056
	Sony	4003, 4012, 4014
	Star Choice	4032
	Star Trak	4024
	STS	4038
	SuperDish	4028
T	Teac	4049
	Thomson	4056
	Toshiba	4001, 4034
U	Uniden	4005, 4006, 4013
	Universum	4056
V	Video Pall	4025
Z	Zenith	4023, 4025, 4033

Device select : TV

Television

A	Acer	1141
	Admiral	1002, 1009, 1089
	Aiko	1059
	Aiwa	1117, 1118
	Akai	1001
	Amtron	1023
	Anam	1113
	Anam National	1023, 1069, 1092
	AOC	1003, 1024, 1049, 1127
	Audiovox	1023
B	Bell & Howell	1009, 1025
	Benq	1104, 1142
	Broksonic	1003, 1097, 1098, 1113
C	Celebrity	1001
	Citizen	1003, 1013, 1023, 1026, 1059, 1063
	Colortyme	1003, 1043
	Contec	1113
	Contec/Cony	1023, 1045, 1047
	Craig	1020, 1022, 1023, 1113
	Crown	1023, 1067
	Curtis Mathes	1003, 1013, 1025, 1026, 1062, 1103, 1110
D	Daewoo	1003, 1013, 1024, 1035, 1036, 1059, 1084, 1101
	Daytron	1003, 1013, 1016
	Dimensia	1103, 1110
	Dumont	1003, 1010, 1153
E	Electroband	1001
	Electrohome	1001, 1003, 1069, 1133
	Emerson	1003, 1013, 1015, 1020, 1021, 1022, 1023, 1025, 1038, 1044, 1045, 1048, 1055, 1061, 1094, 1096, 1099, 1101, 1113

	Envision	1003
F	Fisher	1025, 1051, 1091, 1160
	Fujitsu	1038, 1124, 1125, 1155
	Funai	1023, 1038, 1113
G	Gateway	1150
	GE	1003, 1018, 1022, 1046, 1054, 1069, 1085, 1103, 1110, 1113, 1133, 1136, 1153
	Goldstar	1003, 1013, 1024, 1030, 1045, 1080, 1100
		1112, 1154
H	Hallmark	1003
	Hisense	1116
	Hitachi	1003, 1012, 1031, 1032, 1037, 1041, 1045, 1047, 1065, 1068, 1082, 1088, 1094, 1139, 1140, 1145, 1159
I	Infiniti	1067
J	Janeil	1134
	JBL	1067
	JC Penney	1003, 1013, 1018, 1019, 1024, 1026, 1046, 1047, 1054, 1063, 1083, 1085, 1100, 1103, 1110, 1112, 1133, 1154
	Jensen	1003
	JVC	1028, 1029, 1045, 1047, 1050, 1060, 1065
K	Kawasho	1001, 1003
	Kenwood	1003
	Kloss Novabeam	1023, 1056, 1057, 1134
	KTV	1013, 1023, 1033, 1034, 1073, 1099, 1113
L	LG	1024, 1030
M	M.Wards	1002, 1009, 1038
	Magnavox	1003, 1052, 1053, 1056, 1057, 1063, 1067, 1081, 1106
	marantz	1003, 1031, 1067, 1122
	Mitsubishi	1003, 1024, 1051, 1115, 1122, 1133
	Motorola	1014, 1069
N	NEC	1003, 1012, 1024, 1043, 1069
	NET-TV	1137, 1150
O	Orion	1020, 1096
P	Panasonic	1017, 1067, 1069, 1095, 1111
	Philips	1003, 1011, 1045, 1052, 1054, 1056, 1057, 1058, 1063, 1067, 1069, 1106
	Pioneer	1003, 1018, 1037, 1070, 1071, 1094, 1145, 1147, 1149
	Plasmsync	1135
	Portland	1003, 1013, 1024, 1059
	Price Club	1026
	Prism	1018
	Proscan	1004, 1005, 1006, 1007, 1008, 1085, 1103, 1110
	Proton	1003, 1045
Q	Quasar	1010, 1069, 1073, 1111, 1153

R	Radio Shack	1003, 1013, 1015, 1023, 1024, 1025, 1045, 1100, 1103, 1110, 1113
	RCA	1003, 1004, 1005, 1006, 1007, 1008, 1014, 1024, 1049, 1069, 1075, 1079, 1085, 1087, 1088, 1093, 1094, 1101, 1103, 1110, 1113, 1153
	Realistic	1013, 1015, 1023, 1025, 1045, 1100, 1103, 1110
	Runco	1010, 1153
S	Sampo	1150
	Samsung	1003, 1013, 1024, 1026, 1040, 1045, 1062, 1078, 1083, 1090, 1100, 1105, 1114, 1120, 1121, 1146, 1148, 1157
	Sansui	1119
	Sanyo	1003, 1025, 1051, 1072, 1077, 1091, 1156, 1157, 1158
	Sharp	1003, 1013, 1014, 1015, 1045, 1055, 1064, 1066, 1076, 1089, 1123
	Signature	1009
	Sony	1001, 1102, 1108
	Soundesign	1003, 1023, 1038, 1063, 1113
	Starlite	1023
	Supre-Macy	1134
	Sylvania	1003, 1039, 1042, 1052, 1053, 1056, 1057, 1063, 1067, 1089, 1151
	Symphonic	1023, 1039, 1044
T	Tandy	1014
	Tatung	1069
	Technics	1018
	Techwood	1003, 1018
	Teknika	1003, 1009, 1013, 1023, 1024, 1026, 1038, 1045, 1047, 1059, 1063, 1111, 1113
	Telecaption	1074
	Toshiba	1003, 1019, 1025, 1026, 1042, 1074, 1098, 1107, 1111, 1135, 1136
	Totevision	1013
U	Universal	1046, 1054
V	Video Concepts	1113
	Viewsonic	1006, 1022, 1109, 1128, 1129, 1130, 1131, 1138, 1143, 1145, 1150
W	Wards	1003, 1009, 1015, 1024, 1038, 1044, 1046, 1052, 1054, 1056, 1057, 1067, 1086, 1103, 1110
	White Westinghouse	1001, 1101
Y	Yamaha	1003, 1024
Z	Zenith	1003, 1009, 1010, 1132, 1144, 1153

Dimensions

Unit : mm

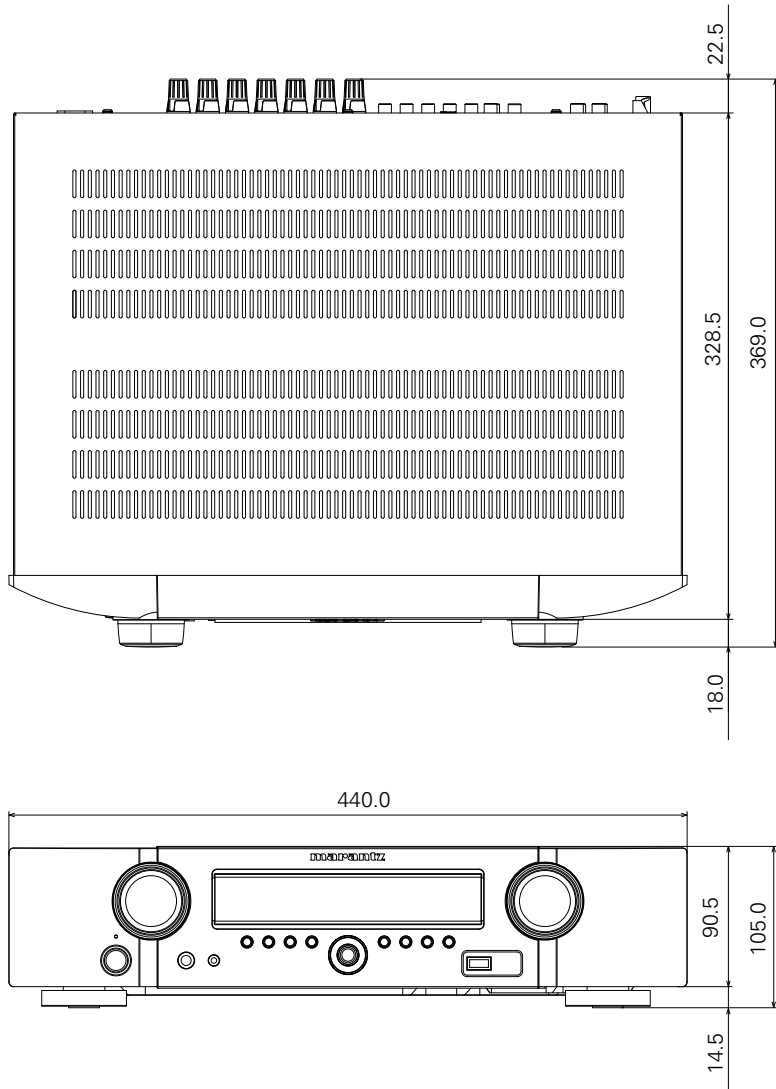

Weight : 8.3 kg

www.marantz.com

You can find your nearest authorized distributor or dealer on our website.

marantz[®] is a registered trademark.