



PROFESSIONAL

Model PMD670 User Guide

Portable Solid State Recorder

marantz®

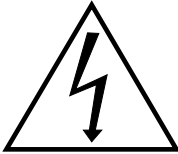
Warnings and Cautions

| | | |
|---|---|---|
|  | CAUTION RISK OF ELECTRIC SHOCK DO NOT OPEN |  |
| CAUTION: TO REDUCE THE RISK OF ELECTRIC SHOCK, DO NOT REMOVE COVER (OR BACK) NO USER-SERVICEABLE PARTS INSIDE REFER SERVICING TO QUALIFIED SERVICE PERSONNEL | | |

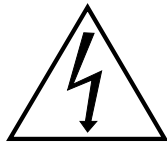

The lightning flash with arrowhead symbol within an equilateral triangle is intended to alert the user to the presence of uninsulated "dangerous voltage" within the product's enclosure that may be of sufficient magnitude to constitute a risk of electric shock to persons.



The exclamation point within an equilateral triangle is intended to alert the user to the presence of important operating and maintenance (servicing) instructions in the literature accompanying the product.

WARNING

**TO REDUCE THE RISK OF FIRE OR ELECTRIC SHOCK,
DO NOT EXPOSE THIS APPLIANCE TO RAIN OR MOISTURE.**

**CAUTION: USE OF CONTROLS OR ADJUSTMENTS OR
PERFORMANCE OF PROCEDURES OTHER
THAN THOSE SPECIFIED HEREIN MAY
RESULT IN HAZARDOUS RADIATION
EXPOSURE.**

Important Safety Instructions

READ BEFORE OPERATING EQUIPMENT

This product was designed and manufactured to meet strict quality and safety standards. There are, however, some installation and operation precautions which you should be particularly aware of.

1. Read Instructions – All the safety and operating instructions should be read before the product is operated.
2. Retain Instructions – The safety and operating instructions should be retained for future reference.
3. Heed Warnings – All warnings on the product and in the operating instructions should be adhered to.
4. Follow Instructions – All operating and use instructions should be followed.
5. Cleaning – Unplug this product from the wall outlet before cleaning. Do not use liquid or aerosol cleaners. Use a damp cloth for cleaning.
6. Attachments – Do not use attachments not recommended by the product manufacturer as they may cause hazards.
7. Water and Moisture – Do not use this product near water—for example, near a bath tub, wash bowl, kitchen sink, laundry tub, swimming pool, in a wet basement, and the like.
8. Accessories – Do not place this product on an unstable cart, stand, tripod, bracket, or table. The product may fall, causing serious injury to a child or adult, and serious damage to the product. Use only with a cart, stand, tripod, bracket or table recommended by the manufacturer, or sold with the product. Any mounting of the product should follow the manufacturer's instructions, and should use a mounting accessory recommended by the manufacturer.
9. A product and cart combination should be moved with care. Quick stops, excessive force, and uneven surfaces may cause the product and cart combination to overturn.
10. Ventilation – Slots and openings in the cabinet are provided for ventilation and to ensure reliable operation of the product and to protect it from overheating. These openings must not be blocked or covered. The openings should never be blocked by placing the product on a bed, sofa, rug, or other similar surface. This product should not be placed in a built-in installation such as a bookcase or rack unless proper ventilation is provided or the manufacturer's instructions have been adhered to.
11. Power Sources – This product should be operated only from the type of power source indicated on the marking label. If you are not sure of the type of power supply to your home, consult your product dealer or local power company. For products intended to operate from battery power or other sources, refer to the operating instructions.
12. Power Cord Protection – Power supply cords should be routed so that they are not likely to be walked on or pinched by items placed upon or against them, paying particular attention to cords at plugs, convenience receptacles, and the point where they exit from the product.
13. Protective Attachment Plug – The product is equipped with an attachment plug having overload protection. This is a safety feature. See Instruction Manual for replacement or resetting of protective device. If replacement of the plug is required, be sure the service technician has used a replacement plug specified by the manufacturer that has the same overload protection as the original plug.
14. Outdoor Antenna Grounding – If an outside antenna or cable system is connected to the product, be sure the antenna or cable system is grounded so as to provide some protection against voltage surges and built-up static charges. Article 810 of the National Electrical Code, ANSI/NFPA 70, provides information with regard to proper grounding of the mast and supporting structure, grounding of the lead-in wire to an antenna discharge unit, size of grounding conductors, location of antenna-discharge unit, connection to grounding electrodes, and requirements for the grounding electrode. See Figure 1.



15. Lightning – Lightning – Unplug the unit from the wall outlet and disconnect the antenna or cable system for added protection during a lightning storm or when it is left unattended and unused for long periods of time. This will prevent damage to the product due to lightning and power line surges.
16. Power Lines – An outside antenna system should not be located in the vicinity of overhead power lines or other electric light or power circuits, or where it can fall into such power lines or circuits. When installing an outside antenna system, extreme care should be taken to keep from touching such power lines or circuits as contact with them might be fatal.
17. Overloading – Do not overload wall outlets, extension cords, or integral convenience receptacles as this can result in a risk of fire or electric shock.
18. Object and Liquid Entry – Never push objects of any kind into this product through openings as they may touch dangerous voltage points or short-out parts that could result in a fire or electric shock. Never spill liquid of any kind on the product.
19. Servicing – Do not attempt to service this product yourself as opening or removing covers may expose you to dangerous voltage or other hazards. Refer all servicing to qualified service personnel.
20. Damage Requiring Service – Unplug this product from the wall outlet and refer servicing to qualified service personnel under the following conditions:
 - a. When the power supply cord or plug is damaged.
 - b. If liquid has been spilled, or objects have fallen into the product.
 - c. If the product has been exposed to rain or water.
 - d. If the product does not operate normally by following the operating instructions. Adjust only those controls that are covered by the operating instructions, as an improper adjustment of other controls may result in damage and will often require extensive work by a qualified technician to restore the product to its normal operation.
 - e. If the product has been dropped or damaged in any way, and
 - f. When the product exhibits a distinct change in performance – this indicates a need for service.
21. Replacement Parts – When replacement parts are required, be sure the service technician has used replacement parts specified by the manufacturer or have the same characteristics as the original part. Unauthorized substitutions may result in fire, electric shock, or other hazards.
22. Safety Check – Upon completion of any service or repairs to this product, ask the service technician to perform safety checks to determine that the product is in proper operating condition.
23. Wall or Ceiling Mounting – The product should be mounted to a wall or ceiling only as recommended by the manufacturer.
24. Heat – The product should be situated away from heat sources such as radiators, heat registers, stoves, or other products (including amplifiers) that produce heat.

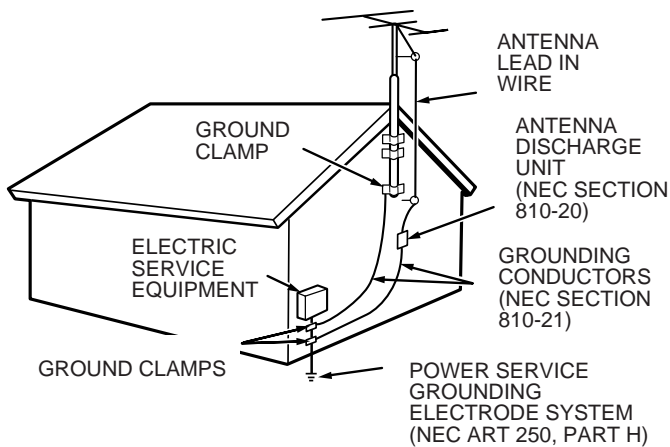

FIGURE 1
EXAMPLE OF ANTENNA GROUNDING AS PER
NATIONAL ELECTRICAL CODE, ANSI/NFPA 70
 NEC - NATIONAL ELECTRICAL CODE

NOTE TO CATV SYSTEM INSTALLER:

This reminder is provided to call the CATV (Cable-TV) system installer's attention to Article 820-40 of the NEC, which provides guidelines for proper grounding and, in particular, specifies that the cable ground shall be connected to the grounding system of the building, as close to the point of cable entry as practical.

NOTE:

This equipment has been tested and found to comply with the limits for a Class B digital device, pursuant to Part 15 of the FCC Rules. These limits are designed to provide reasonable protection against harmful interference in a residential installation. This equipment generates, uses and can radiate radio frequency energy and, if not installed and used in accordance with the instructions, may cause harmful interference to radio communications. However, there is no guarantee that interference will not occur in a particular installation. If this equipment does cause harmful interference to radio or television reception, which can be determined by turning the equipment off and on, the user is encouraged to try to correct the interference by one or more of the following measures:

- Reorient or relocate the receiving antenna.
- Increase the separation between the equipment and receiver.
- Connect the equipment into an outlet on a circuit different from that to which the receiver is connected.
- Consult the dealer or an experienced radio/TV technician for help.

NOTE: Changes or modifications may cause this unit to fail to comply with Part 15 of the FCC Rules and may void the user's authority to operate the equipment.

WARNINGS

Do not expose the equipment to rain or moisture.

Do not remove the cover from the equipment.

Do not insert anything into the equipment through the ventilation holes.

Do not cover the ventilation with any items such as tablecloths, newspapers, curtains, etc.

No naked flame sources, such as lighted candles, should be placed on the equipment.

When disposing of used batteries, please comply with governmental regulations or environmental public instruction's rules that apply in your country or area.

When setting up the recorder ensure that:

- it will not be exposed to interference from external equipment.
- it will not be exposed to electrostatic discharges.
- it will not be exposed to direct sunlight.
- heavy objects are not placed on the recorder.

Copyright

Recording and playback of any material may require consent. For further information refer to the following US ordinances:

- Copyright act of 1956
- Dramatic and Musical Performance Act 1958
- Performers Protection Acts 1963 and 1972
- any subsequent statutory enactments and orders

CE marking (only EU version)

- CE English**
This product is in conformity with the EMC directive and low-voltage directive.
- CE Français**
Cet appareil est conforme á la directive EMC et á la de directive sur les basses tensions.
- CE Deutsch**
Dieses Greät entspricht den EMC-Richtlinien und den Richtlinien für Niederspannungsgeräte.
- CE Nederlands**
Dit apparaat voldoet aan de EMC-richtlijnene en de richtlijnen voor apparatuur met laag voltage.
- CE Italiano**
Quest' unità è conforme alle direttive EMC ed alla direttiva sulle basse tensioni.
- CE Português**
Esta unidade está em conformidade com as directivas EMC e as directivas de baixa voltagem.
- CE Español**
Esta unidad estáde acuerdo con las normas EMC y las relacionadas con baja tensión.

Equipment mains working system

This product complies with household power and safety requirements in your area.

This Class B digital apparatus complies with Canadian ICES-003.

Cet appareil numérique de la Classe B est conforme á la norme NMB-003 du Canada.

SI DICHIARA CHE L'APPARECCHIO SINTO-AMPLIFACATORE SR-39
RISPONDE ALLE PRESCRIZIONI DELL'ART. 2 COMMA 1 DEL D.M. 28
AGOSTO 1995 N° 548.

FATTO A EINDHOVEN, IL 1/1/1997.

MARANTZ EUROPE B.V.
5600 EINDHOVEN
THE NETHERLANDS

"Este aparato lleva elementos antiparasitarios necesarios para cumplir con ls limites que se estableren en el Anexo V del Reglamento sobre Perturbaciones Radioelectricas e Interferencias aprobado en el Real Decreto 138/1989. (B.O.E. de 9 Febrero 1989)."

Quick Start

Follow the instructions on this page to Quick Start your new PMD670 Portable Solid State Recorder and begin recording.

Note: Outside of the USA a CF card is not included. See page 41 for installing a CF card and page 22 to format a CF card.

Quick Start Basic Instructions

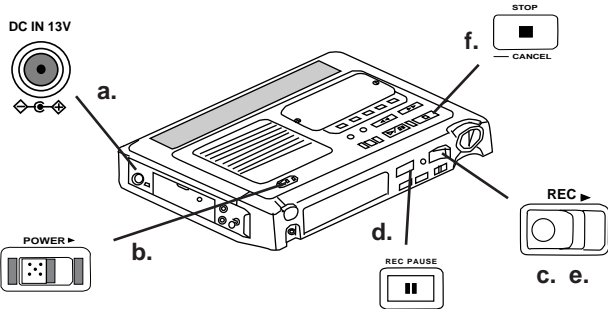

- Plug the AC adapter in.
- Slide the POWER switch to turn on.
- Slide the REC switch to start recording.
- Push and release REC PAUSE when recording is not necessary.
- Slide the REC switch to resume recording.
- Push the STOP button to stop recording.

Quick Start Detailed Instructions

The PMD670 comes factory preset for recording voice using its built-in (internal) microphone. These are settings for recording a meeting, not settings for recording a vocal performance. Quick Start ignores your changing any of these presets, it even ignores installing batteries.

1. Unpack the AC adapter and the PMD670.

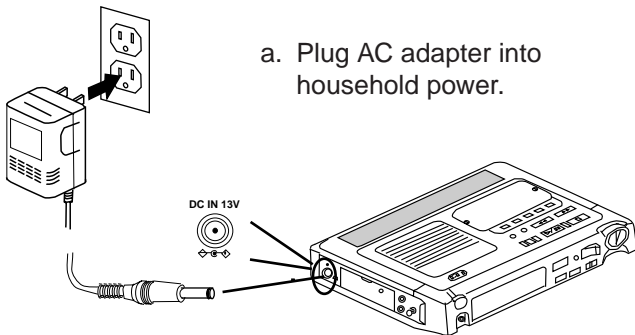

a. Plug AC adapter into household power.

b. Plug the adaptor jack into the PMD670 at DC IN 13V.

2. Slide the POWER switch to the right and release.

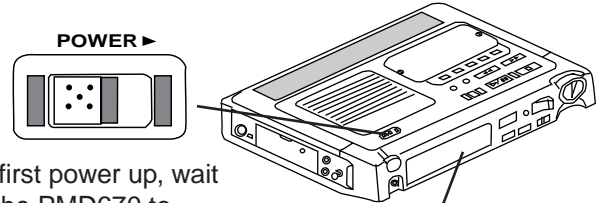

On first power up, wait for the PMD670 to initialize.

A full display will appear momentarily.

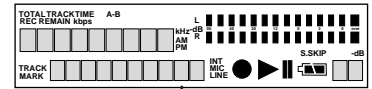

The display will change to Loading then to Reading.

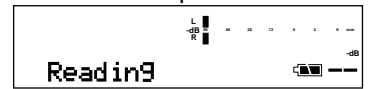

The display will change to this display for a newly formatted CF card.

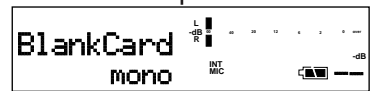

3. Slide the REC button to the right and release. Recording begins.

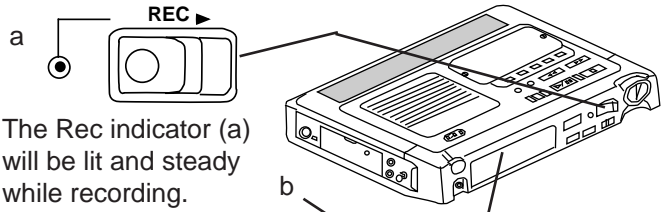

The Rec indicator (a) will be lit and steady while recording.

The display will show the recording time (b) of the current track (c).

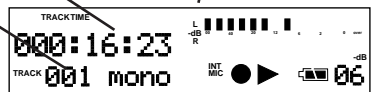

4. Push and release the STOP button to stop recording and end the track (close the audio file).

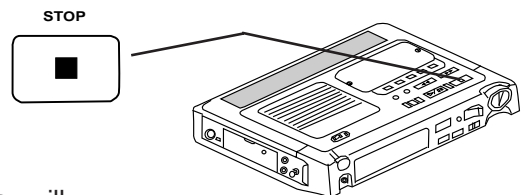



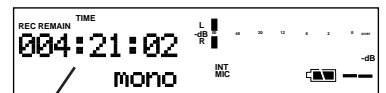







The display will show the remaining recording time at current settings for the CF card.



example shows 4 hours 21 minutes and 02 seconds remaining

To transfer audio files to your computer: transfer the CF card, see page 41, or connect via I/O, see page 43.

Table of Contents

| | | |
|--|----|--|
| Precautions | | |
| Warnings and Cautions | 2 | |
| Important Safety Instructions | 3 | |
| Regulatory Compliance | 4 | |
| Quick Start | 6 | |
| Table of Contents | 7 | |
| US/Europe models | 8 | |
| Package Contents | 8 | |
| Control and Connection Diagrams | | |
| Top | 9 | |
| Front | 10 | |
| Left side | 10 | |
| Right side | 10 | |
| Bottom | 10 | |
| Display | 11 | |
| Introduction | 12 | |
| Features | 13 | |
| Controls and Connections | | |
| Top | 14 | |
| Speaker | 14 | |
| MIC (internal microphone) | 14 | |
| POWER switch | 14 | |
| Security cover | 14 | |
| Recording setup controls | | |
| AUTO MARK switch | 14 | |
| PRE REC switch | 15 | |
| INPUT LOCK switch | 15 | |
| ANALOG OUT switch | 15 | |
| MIC ATTEN switch | 15 | |
| REPEAT switch | 16 | |
| ANC switch | 16 | |
| EDL PLAY switch | 16 | |
| LEVEL CONT. switch | 16 | |
| INPUT button | 17 | |
| What the Input selections do: | 17 | |
| Recording (file) parameters | 17 | |
| Input device(s) and channels | 18 | |
| A-B REPEAT button | 18 | |
| A-B Repeat playback | 18 | |
| MARK/  EDIT buttons | 19 | |
| EDL Marks | 19 | |
| Adding EDL Marks | 19 | |
| Locating EDL Marks | 19 | |
| Custom playback sequences | 19 | |
| Editing EDL Marks | 19 | |
| EDL A-B looping | 20 | |
| Edit mode | 20 | |
| How to renumber tracks | 20 | |
| How to erase tracks | 20 | |
| How to erase all EDL marks within one track | 21 | |
| How to erase all track EDL marks | 21 | |
| How to format a CF card | 22 | |
| TRACK JUMP buttons | 23 | |
| TRACK JUMP reverse button  | 23 | |
| REC UNDO button | 23 | |
| TRACK JUMP forward button  | 23 | |
| -/REW button  | 23 | |
| FWD/+ button  | 23 | |
| MARGIN RESET/ I/O  MENU/STORE button | 24 | |
| MARGIN RESET button | 24 | |
| I/O button | 24 | |
|  MENU/STORE button | 24 | |
| MENU operations | 24 | |
| The Menu choices are: | 25 | |
| How to set or change the Date and time | 25 | |
| Date Format | 27 | |
| Algor/File | 28 | |
| How to set or change the Algor/file parameters | 29 | |
| Other menu choices: | | |
| Manual track incrementing | 31 | |
| Seamless play | 31 | |
| Silent Skip | 32 | |
| Auto Cue | 33 | |
| Single Play | 34 | |
| Beep | 34 | |
| Automatic Power Off | 35 | |
| Battery Type | 35 | |
| Remote Mode | 36 | |
| bwf ID numbers | 36 | |
| Menu Default | 37 | |
| PLAY/PAUSE / | | |
| ENTER button  | 38 | |
| PLAY/PAUSE button  | 38 | |
| ENTER button  | 38 | |
| STOP/CANCEL button  | 38 | |
| Front | | |
| HP/SP VOLUME control | 39 | |
| Display | 39 | |
| REC PAUSE button | 39 | |
| REC indicator | 39 | |
| REC switch | 39 | |
| REC LEVEL controls | 39 | |
| PHONES jack | 40 | |
| DISPLAY button | 40 | |
| LIGHT button | 40 | |
| KEY LOCK switch | 41 | |

Left side

CHARGE indicator 41
 CF card compartment 41
 To eject a CF card 41
 To insert a CF card 41
 DIGITAL IN/OUT jacks 42
 DC IN 13V jack 42
 I/O port 42
 How to connect via I/O port 43

Right side

Remote jack 44
 Remote Mode 44
 LINE OUT/IN jacks 44
 MIC IN jacks 44
 PHANTOM +48V switch 45
 Microphone recommendations 45
 Carry studs 45
 Installing the carry strap 45

Bottom

Battery compartment 46
 Battery power 46
 Installing AA size batteries 46
 Installing an optional Ni-Cd or Ni-MH battery 46

Display 47
 Care and maintenance 48
 Recording time chart 49
 Troubleshooting 50
 Record setting recommendations 50
 Specifications 51
 Optional accessories 51
 Menu defaults 51
 Warranty 52

US/Europe models

The US model, PMD670/UIB distributed in the USA, and European model, PMD670/W1B distributed elsewhere, differ slightly in supplied accessories and default settings. Those differences are noted in this User Guide.

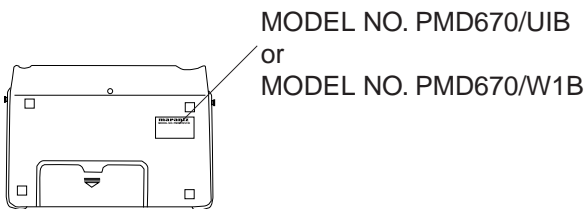

Package contents

- PMD670

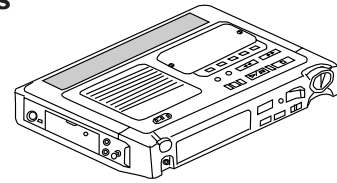

- 64MB CF card (US only) (shipped formatted and installed)



- AC adapter

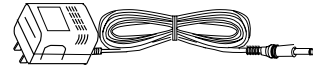

- I/O cable (3 ft)

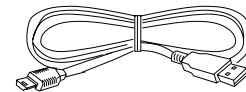

- AA battery holder

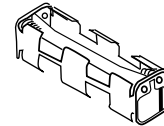

- Carry strap



- Carry strap retainers (2)



- Security screws (3)
 ISO 3x10 (3mm x 10mm long)
 For Memory compartment door (1)
 or Security cover (2 spares).

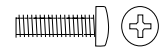

- Plastic pin and retainer (spare - for Memory compartment door)



- CD
 Contents of the CD may vary.
 Contents usually include:
 - PDF format manual(s)
 Several languages may be included.
 - Demonstration copy of PMD Edit software
 - Instructions for obtaining full copy of PMD Edit

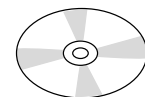

- This User Guide

- Customer Registration Document

Control and Connection Diagrams

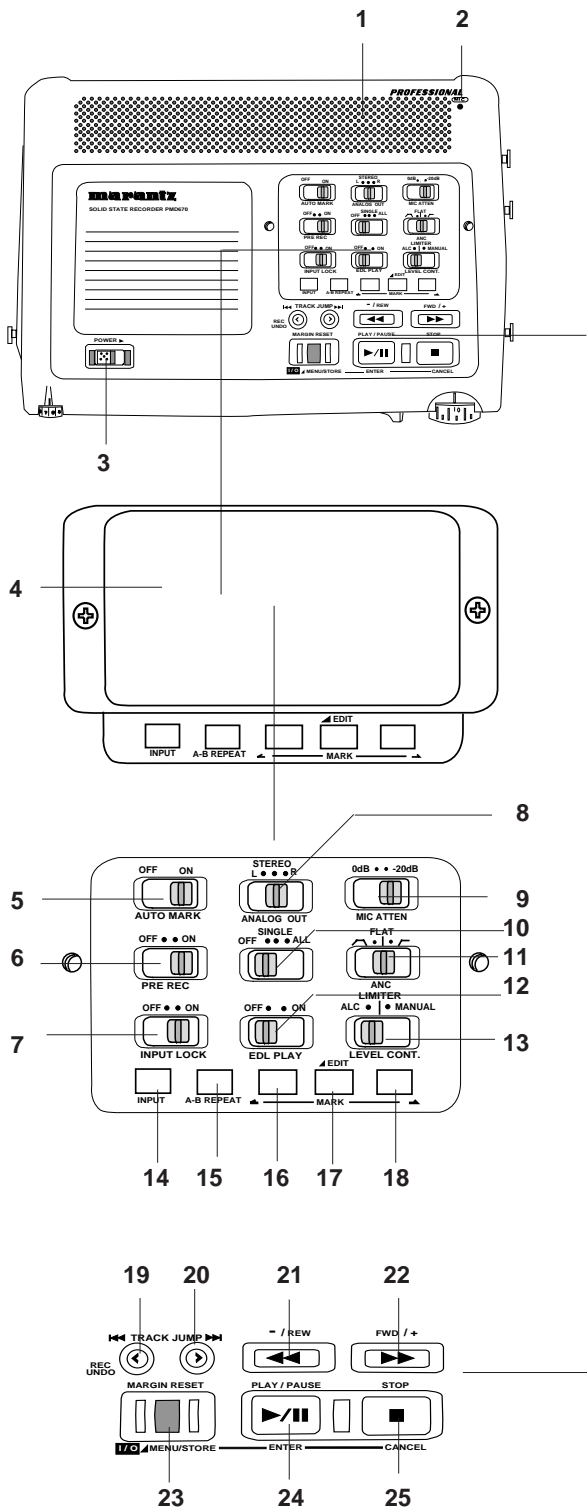

| # | Control | Page |
|---------------------------------|---|------|
| Top | | |
| 1 | Speaker | 14 |
| 2 | MIC (internal microphone) | 14 |
| 3 | POWER switch | 14 |
| 4 | Security cover | 14 |
| Setup controls | | |
| 5 | AUTO MARK switch | 14 |
| 6 | PRE REC switch | 15 |
| 7 | INPUT LOCK switch | 15 |
| 8 | ANALOG OUT switch | 15 |
| 9 | MIC ATTN switch | 15 |
| 10 | REPEAT switch | 16 |
| 11 | ANC switch | 16 |
| 12 | EDL PLAY switch | 16 |
| 13 | LEVEL CONT. | 16 |
| 14 | INPUT button | 17 |
| 15 | A-B REPEAT button | 18 |
| MARK/▲EDIT controls | | |
| 16 | Mark reverse button | 19 |
| 17 | MARK/▲ EDIT button | 19 |
| 18 | Mark forward button | 19 |
| Record/Playback controls | | |
| 19 | TRACK JUMP reverse button ◀◀ (playback) | 23 |
| | REC UNDO button (record) | 23 |
| 20 | TRACK JUMP forward button ▶▶ (playback) | 23 |
| 21 | -/REW button ◀◀ | 23 |
| 22 | FWD/+ button ▶▶ | 23 |
| 23 | MARGIN RESET/ I/O ▲MENU/STORE button MARGIN RESET button (playback) | 24 |
| | I/O button | 24 |
| | ▲MENU/STORE button | 24 |
| 24 | PLAY/PAUSE button ▶/ (playback) | 38 |
| | PAUSE button (record) | 38 |
| | ENTER button ▶/ (menu) | 38 |
| 25 | STOP/CANCEL button ■ | 38 |

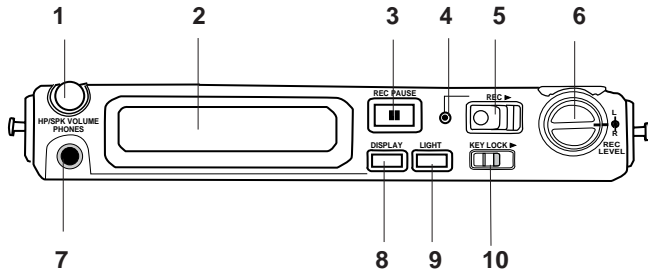

Control Page

Front

1 HP/SPK VOLUME control 39
 2 Display (see next page) 39
 3 REC PAUSE button 39
 4 REC indicator. 39
 5 REC switch ► 39
 6 REC LEVEL controls 39
 7 PHONES jack 40
 8 DISPLAY button 40
 9 LIGHT button 40
 10 KEY LOCK switch 41

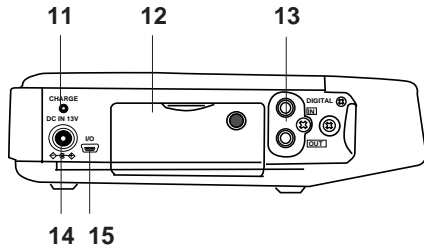

Left side

11 CHARGE indicator 41
 12 CF card compartment 41
 13 DIGITAL IN/OUT jacks 42
 14 DC IN 13V jack 42
 15 I/O port 42

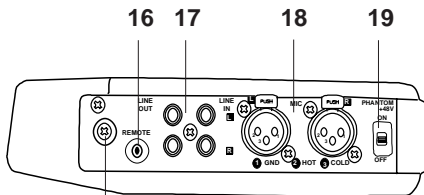

Right side

16 REMOTE jack 44
 17 LINE IN/OUT jacks 44
 18 MIC IN jacks 44
 19 PHANTOM power switch 45
 20 Carry studs 45

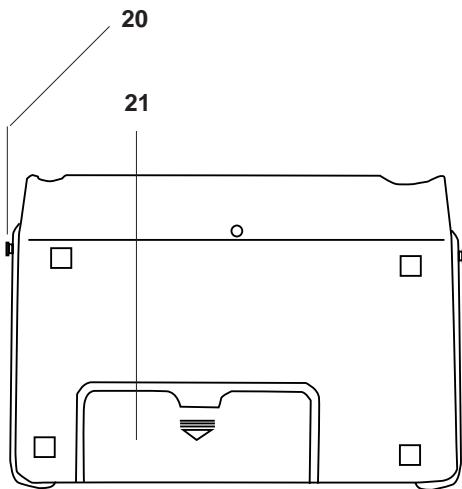

Bottom

21 Battery compartment 46

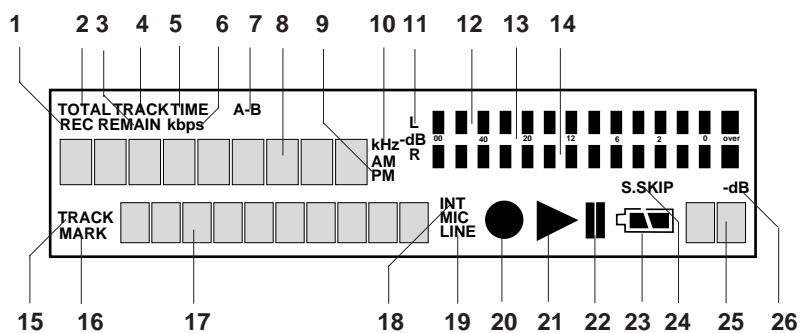

Control Page

Display

| | | |
|----|----------------------------------|----|
| 1 | REC label | 47 |
| 2 | TOTAL label | 47 |
| 3 | REMAIN label | 47 |
| 4 | TRACK label | 47 |
| 5 | TIME label | 47 |
| 6 | kbps label | 47 |
| 7 | A-B label | 47 |
| 8 | Upper alphanumeric display | 47 |
| 9 | AM/PM label | 47 |
| 10 | kHz label | 47 |
| 11 | L -dB R level meter labels | 47 |
| 12 | Left level meter | 47 |
| 13 | -dB over scale | 47 |
| 14 | Right level meter | 47 |
| 15 | TRACK label | 47 |
| 16 | MARK label | 47 |
| 17 | Lower alphanumeric display | 47 |
| 18 | INT MIC label | 48 |
| 19 | LINE label | 48 |
| 20 | Record ● | 48 |
| 21 | Play ► | 48 |
| 22 | Pause | 48 |
| 23 | Battery 🔋 | 48 |
| 24 | S. SKIP label | 48 |
| 25 | Peak level | 48 |
| 26 | -dB label | 48 |

Hint:

When making major changes to your recording setup we suggest the following procedure:

1. Identify the appropriate input device (internal microphone, microphone(s), Line input).
2. Select the input menu choice corresponding to your input device selection. (See page 17.)
3. If necessary, set or change the default Algor/File parameters for your recording situation. (See page 28.)

Introduction

Thank you for selecting the Marantz Professional PMD670 Portable Solid State Recorder. The PMD670 is an audio recorder that records in digital audio formats onto a Compact Flash™ memory card (CF card) or Microdrive™.

Compact flash memory cards, also used in digital cameras, are widely available at consumer electronics retailers and computer resellers.

Audio inputs may be from:

- the built-in microphone,
- condenser or dynamic microphone(s) connected to the XLR jacks,
- line level audio sources connected to the LINE IN jacks, or
- digital audio sources in SP/DIF format connected to the DIGITAL IN jack.

Audio outputs may be from:

- the built-in speaker,
- headphones connected to the PHONES jack,
- analog audio devices such as an amplifier or other device connected to the LINE OUT jacks, and/or
- digital audio devices using SP/DIF format connected to the DIGITAL OUT jack.

Computer compatible

The PMD670 records directly onto CF cards. Recordings can be transferred to your desktop or laptop computer by removing the CF card from the PMD670 or by using the supplied cable to connect the PMD670 to your computer via the I/O port. Audio recorded in the popular MP3 compression format is directly available for intranet or internet file sharing.

- log and archive audio files
- play audio files on your computer
- save audio files to:
 - your hard drive
 - a floppy
 - a CD-R disc
- post streaming audio files on your web site
- use software and your computer to transcribe digital recordings
- An editing program (PMD Edit, available from Marantz Professional for PC users) lets you

convert and edit audio files that were recorded on the PMD670.

Voice recording

The PMD670 has several helpful features for voice recording in situations such as meetings, conferences or other events.

- **Use less memory** (longer recording time)
For voice recording the recording quality level (bit rate recorded and/or sampling frequency) can be set to the lowest levels permitting more time recorded on the CF card.
- **Easy to use for recording**
One control begins recording. Simply slide and release the red REC switch.
- **Security – Input settings**
After you have set up the input settings* for your application the settings can be set to ON with the INPUT LOCK switch.

As an added precaution the input setting switches (including the ability to change input devices) can be protected with the supplied screw-on cover preventing unintentional changes.

*Settings for recording meetings for example, will usually be the same from meeting to meeting.

- **Security – CF cards**
For added security the CF card compartment door can be secured with a screw. This is especially recommended if you transfer audio files via the I/O cable.

Playback aids

A common problem with lengthy voice or other recordings is difficulty in locating one or more specific passages for playback. The PMD670 has several ways to mark or tag specific record starting points.

- **Date and time**
A built-in date and time generator marks the beginning of each track.

- **Tracks**

A new track (file) is automatically started each time recording is stopped using the STOP button.

- **Automatic recording**

The PMD670 can be set to stop recording when there is silence (Silent Skip) and automatically start when sound resumes. The PMD670 can be set to automatically add an EDL mark to the track at each such starting point.

- **EDL marks***

EDL (Edit Decision List) marks can be created during recording manually or automatically. EDL marks help you find those specific points in the recording.

*The EDL marking system is proprietary to Marantz Professional solid state recorders.

- During playback you can search for EDL marks in forward or reverse.
- You can change an EDL mark into a skip mark or an A-B repeating point. That lets you create custom playback sequences which include skipping audio between EDL marks or repeating audio between EDL marks.
- Up to 255 EDL marks can be added to a CF card. EDL marks are numbered consecutively starting at one. During recording you can manually add an EDL mark by pressing MARK. EDL marks can be added automatically, for example at the beginning of each track.
- PMD Edit computer software, is specifically designed for the PMD670. PMD Edit recognizes EDL marks generated by the PMD670. This is especially useful for editing audio files on your PC. For more information visit www.marantzpro.com/Products/PMDEdit.html.

Features

- Stereo (2 channels) and mono (1 channel) audio recording and playback.
- Records onto various types of CF cards. (Please refer to the Marantz Professional web site at www.marantzpro.com for a complete updated list of approved cards.)
- Two different recording formats.
 - Compressed recording using MPEG1 Layer II (MP2) or MPEG1 Layer III (MP3) mono and stereo.
 - Uncompressed recording using 16-bit linear Pulse Code Modulation (PCM).
- MS-DOS™ and Windows compatible file system.
- Selectable file types:
 - Wave (.wav)
 - Broadcast Wave Format (.bwf)
 - RAW MP2 (.mpg)/MP3 (.mp3).
- recording bit rate is selectable
 - .mpg/mp3 compressed at 32kbps (recommended for dictation), 32, 48, or 64kbps (recommended for voice recording), or 128, or 192 kbps (recommended for recording music)
 - PCM (.wav) uncompressed at 768kbps (mono) (very high quality mono audio recording)
 - PCM (.wav) uncompressed at 1536kbps (stereo) (recommended for very high quality audio recording)
- Manual, manual with limiter and automatic record level control (ALC).
- An ANC (Ambient Noise Cancel) switch for reducing unwanted background noise.
- Pre-Recording memory buffer that records 2 seconds of audio before recording is started.
- Portions of multiple recordings can be played back in sequence using EDL marks.
- There are four ways to power the PMD670:
 - Included AC adapter
 - AA Alkaline batteries (~ 6 hours)
 - Optional rechargeable Ni-Cd battery pack RB1100 (~ 5 hours).
 - Optional rechargeable Ni-MH battery RB1650 (~ 7 hours).
- Built-in Time and Date generator marks the beginning of each track.
- REMOTE jack permits a wired remote button for controlling the recording process.

Controls and Connections

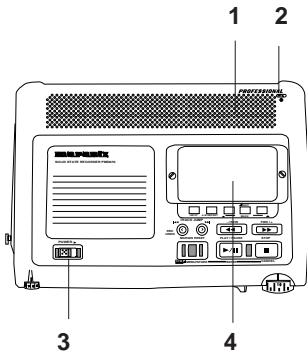

Top

1. Speaker

The played back audio signal is simultaneously output to the built-in speaker, the PHONES jack, LINE OUT jacks and DIGITAL OUT jack. Headphones plugged into the PHONES jack mutes the internal speaker. The HP/SPK VOLUME control controls the built-in Speaker and Headphone volume.



2. MIC (internal microphone)

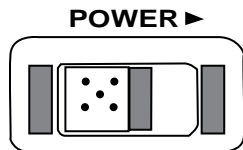

3. POWER switch

Slide to the right and release to turn Power on or off.

If the AC adaptor is connected at DC IN and plugged in, it powers the PMD670.

If power is not detected at DC IN, battery power is automatically used if available.

When first powered up the PMD670 takes some time to initialize.

Loading is displayed, then a blank screen for a while.

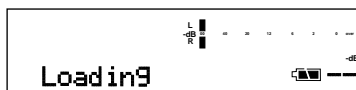

Reading is displayed while the CF card is read.

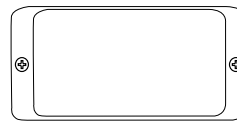
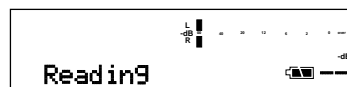

4. Security cover

Use a small Phillips screwdriver to remove or replace the Security cover.

The Security cover makes setup controls relatively unavailable. The setup controls allow you to setup the PMD670 for your unique application. You can then have someone operate the PMD670 without concern that they might change something that could cause failure to record.

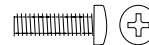

Note: Two 3mm machine screws 10mm long are used for the security cover.

Recording setup controls

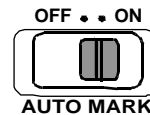
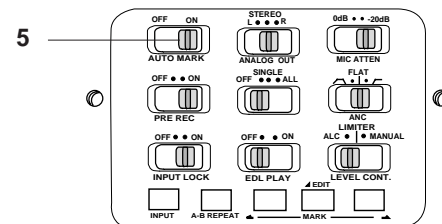

5. AUTO MARK switch

Turns the automatic EDL mark feature on or off.

ON: During record, a pause (pushing the REC PAUSE button) adds an EDL mark to the track. During record an EDL mark is added to the track if a remote device (plugged into the REMOTE jack) is used to pause recording.

OFF: Pausing during record does not add an EDL mark to the track.

Factory default: AUTO MARK switch ON.

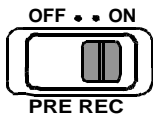
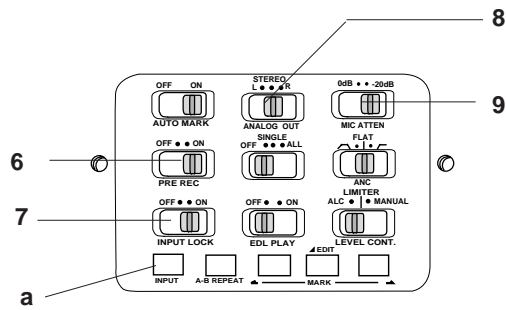

6. PRE REC switch

Lets you turn off pre record cache if it is not desired.

When power is on the PMD670 is constantly saving 2 seconds of audio input. This is called pre record cache. When recording is started by sliding the REC switch, or resumed from REC PAUSE by sliding the REC switch the pre-recorded 2 seconds is recorded.

OFF: Turns the 2 second pre-record cache off.

ON: Leaves the 2 second pre-record cache on.

Factory default: PRE REC switch at ON.

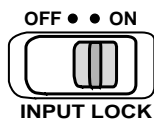

7. INPUT LOCK switch

The INPUT LOCK switch lets you lock your selected input settings with a switch covered by the Security cover.

OFF: When the INPUT LOCK switch is at OFF push and release the INPUT button (a) to tab through the input choices. The selection “times out” to the displayed input choice in 5 seconds.

Example display:

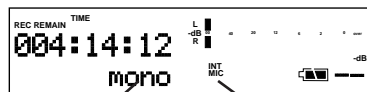

mono with INT MIC

ON: When the INPUT LOCK switch is at ON pushing the INPUT button (a) does nothing (skips the input selection choices).

Factory default: INPUT LOCK switch at OFF.

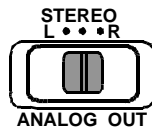

8. ANALOG OUT switch

Selects the audio output channel for playback.

Applies to playback output to LINE OUT, and Internal speaker or headphones.

L: Audio recorded on the Left channel is output to both the left and right output channels.

If the recording is dual level mono (a mono input was recorded onto both the right and left channels) the L setting outputs the left audio at a normal level while the right is reduced -15dB.

STEREO: Audio recorded on the Left channel is output to the left output channel, and audio recorded on the Right channel is output to the right output channel. Both channels are output to the internal speaker.

R: Audio recorded on the Right stereo channel is output to both the left and right output channels.

Factory default: ANALOG OUT switch at STEREO.



9. MIC ATTEN switch

The microphone attenuation switch permits the direct use of microphones that differ in sensitivity.

0dB: No microphone attenuation.

-20dB: Input from a microphone(s) connected to the XLR MIC IN jacks is cut by -20dB.

Factory default: MIC ATTEN switch at 0dB.

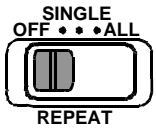
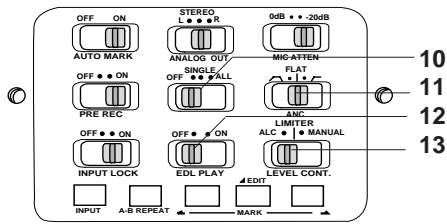

10. REPEAT switch
Lets you endlessly repeat playback of a track or entire memory card.

OFF: No repeat.

SINGLE: During playback the current track is repeated. When playback reaches the end of the track it automatically starts playback from the beginning of that track.

ALL: During playback all tracks are repeated. When playback reaches the end of the last track it automatically starts playback from the beginning of the first track.

Factory default: REPEAT switch at OFF.

Note:
For other methods of repeat playback see the A-B REPEAT button and/or EDL A-B looping.

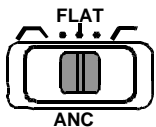

11. ANC switch
The ANC (Ambient Noise Cancel) switch lets you choose to reduce ambient noise before recording on the internal microphone or MIC inputs.

Ambient Noise Cancel positions do not change the memory used in recording. Examples of low ambient noise sources include: traffic, air conditioning hum, and wind noise.

Band pass position reduces the lows and highs and passes (records) the center (voice level) audio frequencies. This reduces the recording of high and low frequency ambient noise.

FLAT: No filtering applied.

High pass position reduces low frequency ambient noise only.

US default: ANC switch at Band pass
Europe default: ANC switch at FLAT.

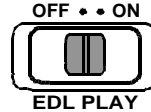

12. EDL PLAY switch
The EDL PLAY switch turns EDL PLAY off or on.

OFF: When the EDL PLAY switch is at OFF PMD670 playback does not respond to EDL mark instructions.

ON: When EDL PLAY is ON PMD670 playback follows EDL mark instructions regarding playback order, skipping sections of recording on the memory card, or repeating a section of recording on the memory card.

Note: If the EDL PLAY switch is at ON and there are no EDL marks on the CF card (recording was done with the AUTO MARK switch at OFF) playback is not available. Switch to OFF for playback.

Factory default: EDL PLAY switch at OFF.



13. LEVEL CONT. switch
The LEVEL CONT(rol) switch lets you select the type of input level control.

MANUAL: At MANUAL you control the input level with the REC LEVEL controls.

LIMITER: At LIMITER peak sound levels that would distort the recording are limited.

ALC: At ALC (Automatic Level Control = Automatic Gain Control) the PMD670 automatically responds to changes in input level. If recording is quiet the input level is increased. If recording is loud the input level is decreased. This is a desirable feature when recording a meeting with several speakers, because a speaker close to the microphone and/or with a loud voice will be automatically recorded at a reduced level and a quiet speaker will be recorded at an increased level and is less likely to have their input missed.

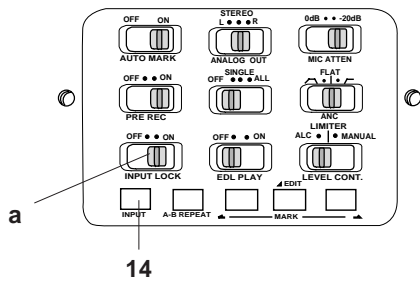

ALC is usually not desired when recording music (voice or instrument) because the transitions in input level may be audible in the recording, and can make the recording 'hissy' by raising the level during quiet passages and recording ambient noise.

The REC LEVEL controls do not work when the LEVEL CONT. switch is set at ALC.

US default: LEVEL CONT. switch at ALC.
 Europe default: LEVEL CONT. switch at MANUAL.



14. INPUT button

The INPUT button lets you select the audio input and audio channels for recording.

When the INPUT LOCK switch (a) is at OFF, press and release the INPUT button to tab through the input choices. When the desired input is displayed switch the INPUT LOCK switch (a) to ON.

Example display:

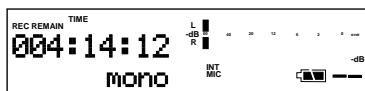

mono with INT MIC

The nine input choices are:

- mono with INT MIC input
- stereo with LINE input
- mono with LINE input (L only)
- LR mono with LINE input (L + R mix)
- Digiln (digital input)
- stereo with MIC input
- DLmono with MIC input (dual level mono, L only)
- mono with MIC input (L only)
- LRmono with MIC input (L + R mix)

Note: The PMD670 'listens' only to the selected input. For example if the input selected is LRmono with LINE input, and no input source is connected to the LINE IN jacks the PMD670 will record silence.

US default: mono with INT MIC input.
 Europe default: stereo with MIC input.

What the input selections do:

Selects the input device(s) and channels

The input selection chooses which input(s) the PMD670 is using for recording and how many channels are recorded.

Selects the recording (file) parameters

The input selection also determines which set of algorithm/file parameters are used (stereo file, mono file, or digital file).

Recording (file) parameters:

stereo (recorded as a stereo file): stereo with LINE input, stereo with MIC input, DLmono with MIC input.

mono (recorded as a mono file): mono with INT MIC input, mono with LINE input, LR mono with LINE input, mono with MIC input, LRmono with MIC input.

digital (recorded as a digital file): DIGITAL IN input.

The default algorithm/file parameters are:

stereo file: MP2, 48kHz sample frequency, 128kbps per channel, and file extension .mpg.

mono file: MP3, 44.1kHz sample frequency, 32kbps, and file extension .mp3.

digital file: MP2, 44.1kHz or 48kHz sample frequency (dependent on input source rather than default or PMD670 menu selection), 128kbps, and file extension .mpg.

Via the Algor/File Menu choice, the algorithm/file parameters for stereo, mono or digital files can be changed. See Algor/File Menu choice on page 29.

Input device(s) and channels:

mono with INT MIC input

Mono audio input from the internal microphone is recorded as a mono file.

stereo with LINE input

Audio input from the L LINE IN jack is recorded on the Left channel.

Audio input from the R LINE IN jack is recorded on the Right channel.

mono with LINE input

Audio input from the L LINE IN jack is recorded as a mono file.

LR mono with LINE input

Audio input from the L LINE IN jack and the R LINE IN jack are combined and recorded as a mono file.

Digiln

Digital audio data at 44.1kHz or 48kHz input through the DIGITAL IN jack can be recorded.

stereo with MIC input

The microphone connected to the L MIC IN XLR jack is recorded on the Left channel and the microphone connected to the R MIC IN XLR jack is recorded on the Right channel.

DLmono with MIC input

In Dual Level mono with MIC input the microphone input from the L MIC IN XLR jack is recorded on both the Left and Right channels. The Right channel is reduced -15dB.

mono with MIC input

In mono with MIC input the microphone input from the L MIC IN XLR jack is recorded as a mono file.

LRmono with MIC input

In LR mono with MIC input the microphone input from the L MIC IN XLR jack and the R MIC IN XLR are combined and recorded as a mono file.

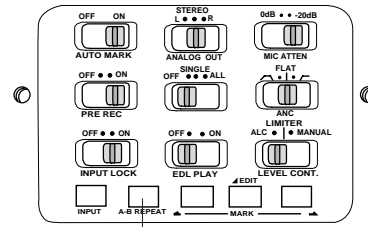

15

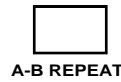

15. A-B REPEAT button

While in playback press and release to start point A to point B repeat playback.

A-B Repeat playback

Point A (starting point) is set when the A-B REPEAT button is pressed and released. The next press and release sets point B (ending point). Playback repeats between A and B.

Note:

You can use the -/REW ◀◀ or FWD/+ ▶▶ buttons between setting the A and B points. You cannot use the TRACK JUMP forward ▶▶ or reverse ◀◀ buttons.

You can pause during A-B repeat playback by pressing and releasing the PLAY/PAUSE button ▶||. Resume A-B playback by pressing the PLAY/PAUSE button ▶|| again.

Exit and cancel A-B repeat by pressing the STOP button ■ or pressing the A-B REPEAT button.

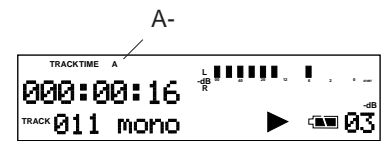

Example display when an A point has been set.

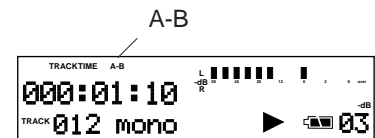

Example display during A-B repeat.

Note:

For other methods of repeat playback see the REPEAT switch and/or EDL A-B looping.

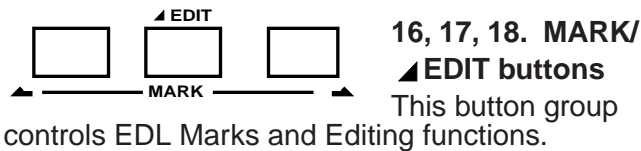
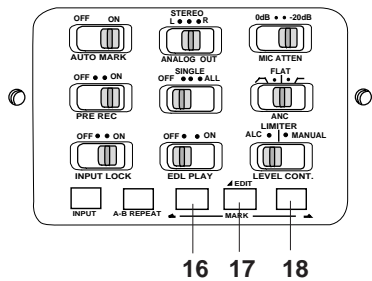

EDL Marks

Mark functions: manually adding Marks, and locating Marks.

Adding EDL Marks

Press and release the MARK/▲EDIT button to manually add an EDL Mark during recording.

Press the MARK/▲EDIT button during pause, recording, or playback to add an EDL Mark. During recording adding an EDL Mark introduces an audible click in the recording when using the internal microphone.

Locating EDL Marks

From Stop press and release the Mark forward button (18) or Mark reverse button (16) to tab through the EDL marks on the CF card.

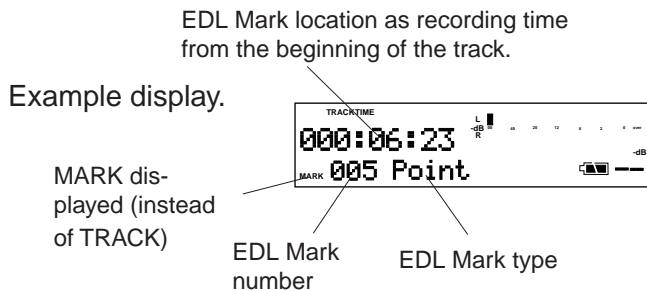

To start playback from the displayed EDL Mark press and release the PLAY/PAUSE button ►||.

Edit functions: editing EDL Marks to create custom playback sequences, erasing and renumbering Tracks, and formatting the CF card.

Custom playback sequences

EDL Marks are numbered consecutively from 001 and automatically renumbered when an EDL Mark is added or erased. Playback is also consecutive from the point that playback begins.

EDL Mark custom playback can:

Skip playback from the beginning of a 'Skip' EDL Mark to the beginning of the next EDL Mark.

A-B loop from a 'Loop_A' EDL Mark to a 'Loop_B' EDL Mark.

Note: EDL Marks are not automatically placed at the beginning of tracks. If you want your custom playback sequence to include track beginning points add EDL Marks to coincide with track beginning points by:

- Start playback by pressing and releasing PLAY/Pause ►|| and then pause playback by pressing and releasing PLAY/Pause ►|| again.
- Press and release TRACK JUMP forward ►► or TRACK JUMP reverse ◀◀ until the desired track number is displayed.
- Press and release the MARK/▲EDIT button.

Editing EDL Marks:

All EDL Marks are initially entered as 'Point' marks.

From Stop display the EDL Mark by pressing and releasing the Mark forward button (18) or Mark reverse button (16) to tab through the EDL marks on the CF card.

When the EDL mark to be edited is displayed press and release the MARK/▲EDIT button. The current EDL Mark type will be flashing.

Example display.

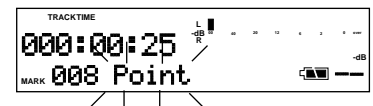

Press and release the MARK/▲EDIT button to tab through the EDL Mark types: Point, Skip, Loop_A, Loop_B, and Erase. When the type you want to change the EDL Mark to is flashing press and release the ENTER button ►||.

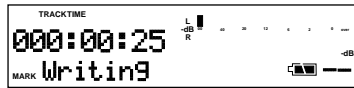

Writing will be displayed briefly and the PMD670 will return to stop mode.

Skip

An EDL Mark changed to 'Skip' will be skipped during EDL playback (playback with EDL PLAY switch at ON). Playback will skip to the beginning of the next EDL Mark.

A skipped EDL recording is not erased. The recording is still on the CF card. The skipped EDL recording will play if the EDL PLAY switch is at OFF. You can change the type later.

EDL A-B looping

To playback an EDL A-B loop press the PLAY/PAUSE button ►|| to begin playback then press and release the A-B REPEAT button.

If there is an error, for example there is an EDL Mark of type Loop_A but no EDL Mark of type Loop_B an error message is displayed.

Example display.

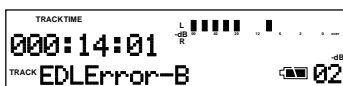

Only one EDL A-B loop can programmed. When a 'Loop_A' or 'Loop_B' exists on a CF card and another is created the old mark automatically changes to a 'Skip'.

Erase

When an EDL mark is erased the remaining EDL marks are automatically renumbered from 1 through the number of EDL marks on the CF card.

Edit mode

Edit mode includes: Renumber (renumber tracks), TrkERASE (erase a track), TrkMkERASE (erase an EDL mark), AllMkERASE (erase all EDL marks), and FORMAT (format the CF card).

How to renumber tracks

If you have erased tracks from the CF card it is easier to locate recordings if the tracks are renumbered.

From stop press and hold the MARK/▲EDIT button for about 2 seconds to enter Edit mode.

Renumber flashing in the display.

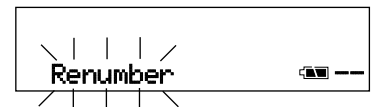

While Renumber is flashing (5 seconds) press and release the ENTER button ►||. (Or press and release the STOP button ■ to cancel.)

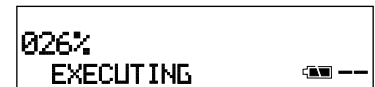

EXECUTING will be displayed and the percentage executing will increase to 100%.



100% done will be displayed momentarily. Then the PMD670 and the display will return to stop mode.

How to erase tracks

From stop press and hold the MARK/▲EDIT button for about 2 seconds to enter Edit mode.

Renumber flashing in the display.

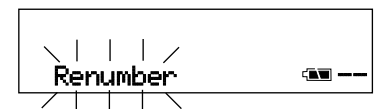

While Renumber is flashing (5 seconds) press and release the MARK/▲EDIT button again.

TrkERASE flashing in the display.



While TrkERASE is flashing (5 seconds) press and release the ENTER button ►||.

Track number flashing in the ERASE display.

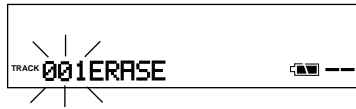

Press and release the FWD/+ button ►► or the -/REW button ◀◀ to select the track number you want to erase.

Example track 34.



While the track to be erased is flashing (5 seconds) press and release the ENTER button ►/||. (Or press and release the STOP button ■ to cancel.)

EXECUTING will be displayed momentarily.



Done will be displayed momentarily.



The PMD670 and the display will return to stop mode.

The recording time (file space on the CF card) used by the erased track is available for recording.

How to erase all EDL marks within one track

From stop press and hold the MARK/▲EDIT button for about 2 seconds to enter Edit mode.

Renumber flashing in the display.

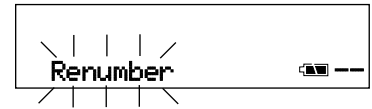

While the display is flashing (5 seconds) press and release the MARK/▲EDIT button two more times.

TrkMkErase flashing in the display.

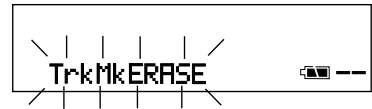

While TrkMkERASE is flashing (5 seconds) press and release the ENTER button ►/||.



Press and release the FWD/+ button ►► or the -/REW button ◀◀ to select the track that contains the EDL Marks you want to erase.

Example Track 12.

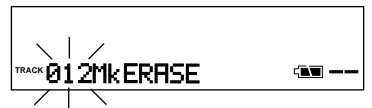

While the track number is flashing (5 seconds) press and release the ENTER button ►/||. (Or press and release the STOP button ■ to cancel.)

EXECUTING will be displayed momentarily.



Done will be displayed momentarily.



The PMD670 and the display will return to stop mode.

How to erase all EDL marks

From stop press and hold the MARK/▲EDIT button for about 2 seconds to enter Edit mode.

Renumber flashing in the display.

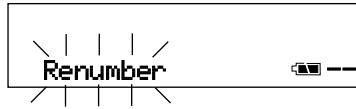

While the display is flashing (5 seconds) press and release the MARK/▲EDIT button three more times.

AllMkERASE flashing in the display.

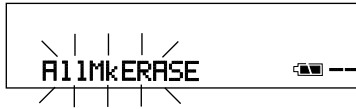

While AllMkERASE is flashing (5 seconds) press and release the ENTER button ►||.

AllMkErOK? flashing in the display.

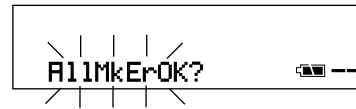

The display asks you to confirm that you want to erase all EDL Marks on the CF card. While AllMkErOK? is flashing press and release the ENTER button ►|| to confirm. (Or press and release the STOP button ■ to cancel.)

EXECUTING will be displayed momentarily.



Done will be displayed momentarily.



The PMD670 and the display will return to stop mode.

How to format a CF card

From stop press and hold the MARK/▲EDIT button for about 2 seconds to enter Edit mode.

Renumber flashing in the display.

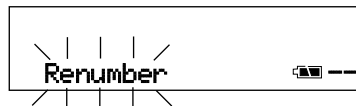

While the display is flashing (5 seconds) press and release the MARK/▲EDIT button four more times.

FORMAT flashing in the display.

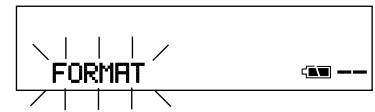

While FORMAT is flashing (5 seconds) press and release the ENTER button ►||.

FORMAT OK? flashing in the display.

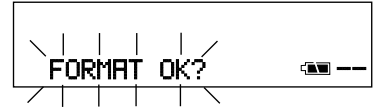

The display asks you to confirm that you want to format the CF card. Formatting the CF card will erase all recordings on the card.

While FORMAT OK? is flashing press and release the ENTER button ►|| to confirm. (Or press and release the STOP button ■ to cancel.)

EXECUTING will be displayed momentarily.



Done will be displayed momentarily.

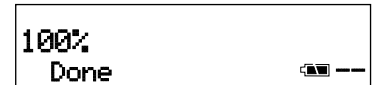

The PMD670 returns to stop mode.

BlankCard will be displayed.

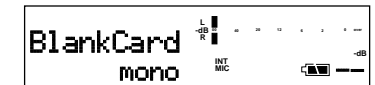

The CF card formats used by the PMD670 are Windows compatible. You can copy audio files using a Windows compatible computer* that can read a CF card or be connected via the I/O port.

*Or a Macintosh computer that can recognize Windows compatible removable drives.

CF cards with less than 2 GB capacity are automatically formatted FAT16 (FAT = File Allocation Table).

CF cards with 2 - 8 GB capacity are automatically formatted FAT32.

The maximum CF card that can be formatted in the PMD670 is 8 GB. If larger cards are used please format in your computer.

Controls and Connections
Top continued

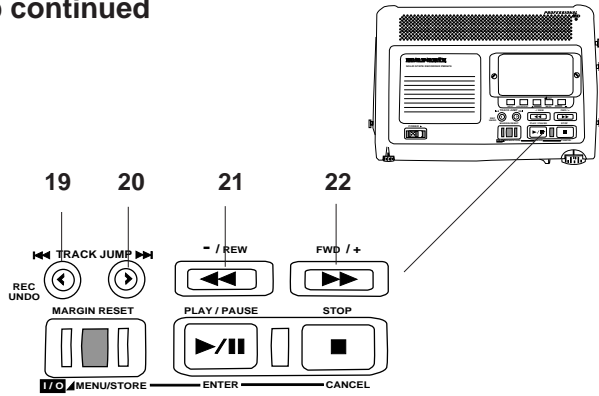

20. TRACK JUMP forward button ▶▶

During playback press and release to jump to the next track. If pressed while playing the last track jumps to the first track on the CF card.

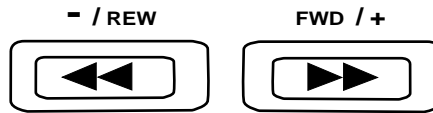

21. -/REW button ◀◀

22. FWD/+ button ▶▶

During playback press and hold the -/REW button ◀◀ to "rewind", do an audible search in the reverse direction. Press and hold the FWD/+ button ▶▶ to "forward", do a 2X speed audible search in the forward direction. Release to return to normal forward playback.

During play pause, press and hold the -/REW button ◀◀ or the FWD/+ button ▶▶ to rewind or fast forward quickly. The rewind or fast forward is at 10X speed for three seconds, then automatically speeds up to 140X speed.

Notes:

If the -/REW button ◀◀ or the FWD/+ button ▶▶ is held past the beginning or end of a track the rewind or fast forward will continue onto the previous or next track.

If REPEAT SINGLE or REPEAT ALL is on, the rewind or fast forward will follow the repeat order. Does not function in EDL playback or EDL A-B repeat.

During Editing and Menu functions press and release the -/REW button ◀◀ to increment a parameter in the - direction and press and release the FWD/+ button ▶▶ to increment a parameter in the + direction.

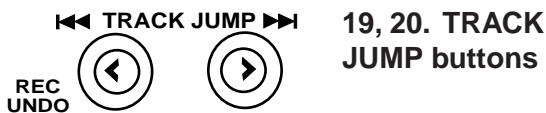

TRACK JUMP reverse button ◀◀
 REC UNDO button
 TRACK JUMP forward button ▶▶

19. TRACK JUMP reverse button ◀◀

During playback press and release to jump to the previous track. If pressed while playing the first track jumps to the last track on the CF card.

19. REC UNDO button

During recording press and release twice to undo (erase) the recording and pause recording at the beginning of the track.

Example display during record.

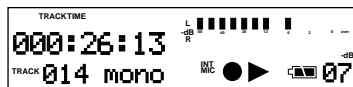

Example display for 3 seconds after REC UNDO button is pressed.

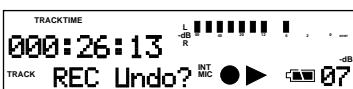

Example if REC UNDO button is pressed again within the 3 seconds.

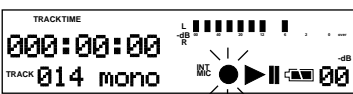

Recording is at REC pause at the beginning of the track.

Controls and Connections Top continued

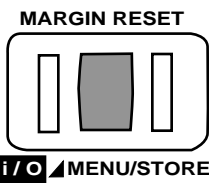
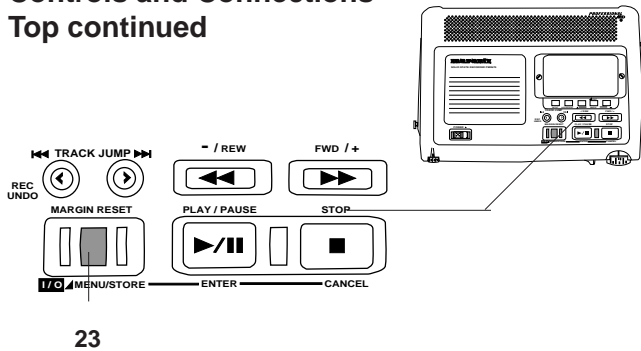

23. MARGIN RESET/ I/O MENU/STORE buttons

Several functions depending on state of the PMD670.

MARGIN RESET button

During record press and release to reset the peak level margin.

Example display with level margin at -02dB before pressing the MARGIN RESET button.

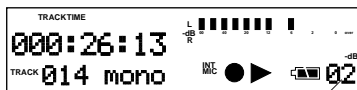

level margin

The level margin displays the highest level achieved since the track began or the MARGIN RESET button was pressed and released. OV indicates a margin over 0dB.

I/O button

Connects the CF card via the I/O port to a connected device (usually a computer).

From power off press and hold the I/O button while you slide the POWER switch on the PMD670 to the right to power on.

This display appears.



The CF card in the PMD670 appears as an external drive on a connected computer.

Power off to disconnect.

See page 43, How to connect via the I/O port.

▲ MENU/STORE button

The PMD670 Menu lets you preset various parameters. To access the Menu with POWER on and the PMD670 in Stop:

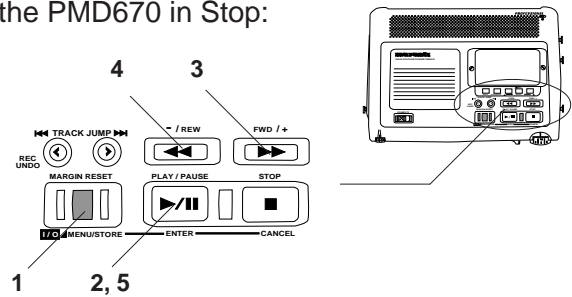

Menu operations

1. Press and hold the ▲ MENU/STORE button for about 2 seconds. MENU will appear (flashing) in the display.

Example display:

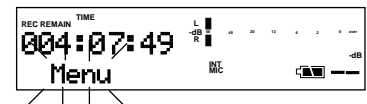

2. While MENU is flashing (for about 3 seconds) press and release the ENTER button ▶/||. The Menu choice will appear. If the flashing MENU times out start over at 1.

The last Menu choice entered appears, the following starts from the Date/Time menu choice.

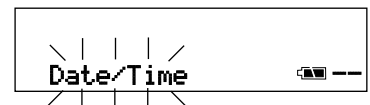

3. Press and release the FWD/+ button ▶▶
4. or the -/REW button ◀◀ to tab through the menu choices.

The rest of the menu setting procedure differs slightly depending on the menu item. In general you:

5. Press and release the ENTER button ▶/|| to select a menu choice.
6. Press and release the FWD/+ button ▶▶ or the -/REW button ◀◀ to change the menu setting.
7. Press and release the ENTER button ▶/|| to confirm the menu setting.

Then either:

- 8a. Press and release the FWD/+ button ►► or the -/REW button ◀◀ to tab to another menu choice, or
- 8b. Press and release the ▲MENU/STORE button to write the menu changes and return to stop mode, or
- 8c. Press and release the CANCEL button ■ to cancel any menu changes and return to stop mode.

The Menu choices are:

Date/Time – For setting or changing the Date and Time associated with when an audio track (file) was created.

DateForm – For selecting the date order.

Algor/File – For setting or changing the recording compression algorithm, associated bit rate, audio file type, and channels recorded.

M. Track – Turn manual track incrementing feature on or off.

SeamIsPly – Turn the Seamless play feature on or off.

S.Skip – Turn Silent Skip feature on or off, set the number of seconds the dB level must meet or exceed the set threshold, and set the dB threshold level.

A.Cue – Turn the Auto Cue feature on or off, set the number of milli-seconds the dB level must meet or exceed the set threshold, and set the dB threshold level.

S.Play – Turn the single track play feature on or off.

Beep – Turn the beep on or off.

A.PowOff – Enable or disable the Automatic Power Off feature.

Batt_Type – Set the battery type.

RemoteMode – Set the effect of the optional wired remote switch.

ID1 – Set the description ID code for broadcast wave file recordings.

ID2 – Set the origin ID code for broadcast wave file recordings.

ID3 – Set the origin reference ID code for broadcast wave file recordings.

Default – Reset all Menu settings to factory default settings.

How to set or change the Date and time

The date and time are written on each audio track (file) when the track is started. When an audio track is viewed on a computer this date and time appears as when the file was 'modified'. (US date format is illustrated.)

1. From stop, press and hold the ▲MENU/STORE button for about 2 seconds. MENU will appear (flashing) in the display.

Example display:

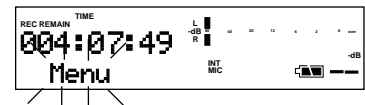

2. While MENU is flashing (for about 3 seconds) press and release the ENTER button ►||.

The Date/Time Menu choice will appear.

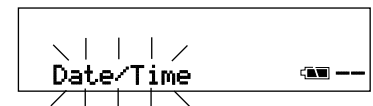

(If the flashing MENU times out start over at 1.)

3. Press and release the ENTER button ►|| again. The current date and time information will be displayed with the month flashing.

Example display:

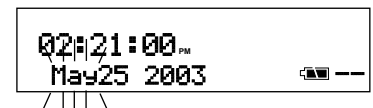

4. With the month flashing press and release the FWD/+ button ►► or the -/REW button ◀◀ to tab through the months. When the month is correct, press and release the ENTER button ►||.

The day will be flashing.

Example display.



The display will return to stop mode.

5. With the day flashing press and release the FWD/+ button ►► or the -/REW button ◄◄ to tab through days. When the day is correct, press and release the ENTER button ►||. The year will be flashing.

Example display

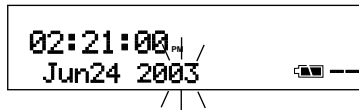

Note:

The date and time settings will remain for about a month if the AC Adapter is not plugged in and no batteries are installed.

6. With the year flashing press and release the FWD/+ button ►► or the -/REW button ◄◄ to tab through years (2003 - 2099). When the year is correct, press and release the ENTER button ►||. The hour will be flashing.

Example display.

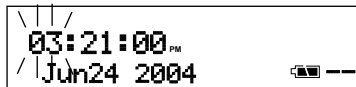

7. With the hour flashing press and release the FWD/+ button ►► or the -/REW button ◄◄ to tab through hours. AM, PM will change when you pass 12, check that it is correct. When the hour and AM/PM is correct, Press and release the ENTER button ►||. The minute will be flashing.

Example display.

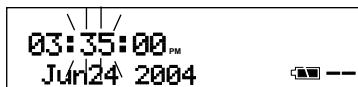

8. With the minute flashing press and release the FWD/+ button ►► or the -/REW button ◄◄ to tab through minutes. When the minute is correct, Press and release the ENTER button ►||.

Date/Time will be flashing.

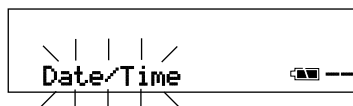

9. Press and release the ▲MENU/STORE button. If you have made changes to the date and/or time Stored will be displayed briefly.

How to set or change the Date Form

The date form is the date order month/day/year or day/month/year.

The US default is M/D/Y (month/day/year).
The Europe default is D/M/Y (day/month/year).

1. From stop, press and hold the ▲MENU/STORE button for about 2 seconds. MENU will appear (flashing) in the display.

Example display:

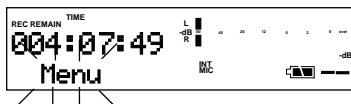

2. While MENU is flashing (for about 3 seconds) press and release the ENTER button ►/||. The Date/Time Menu choice will appear.

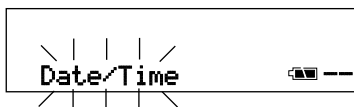

(If the flashing MENU times out start over at 1.)

3. While Date/Time is flashing (for about 3 seconds) press and release the FWD/+ button ►►. The DateForm Menu choice will appear



4. Press and release the ENTER button ►/|| again. The M/D/Y choice will flash.

Example display:



5. Press and release the FWD/+ button ►► or the -/REW button ◀◀ to toggle between M/D/Y and D/M/Y. When the desired form appears press and release the ENTER button ►/||.
6. Press and release the FWD/+ button ►► or the -/REW button ◀◀ to tab to another menu choice, or

7. Press and release the ▲MENU/STORE button to write the menu changes and return to stop mode, or
8. Press and release the CANCEL button ■ to cancel all menu changes and return to stop mode.

Algor/File

The PMD670 can record in a variety of compression algorithm, associated bit rate, file format, and recording type (channels recorded) parameters. See explanations below and chart in right column.

First select your input device (internal microphone, microphone(s), Line in, or digital input).

Second select your input channel choice with the INPUT button, see page 17.

Recording Type

The recording type can be stereo (two channels of recording) mono (one channel of recording) or digital. This is set by your choice of input device and input channel choice.

Algorithm

The PMD670 can record using three methods two of which are compression algorithms: PCM, MP3, and MP2.

PCM (Pulse Code Modulation) is uncompressed. These are high quality audio files used in the recording industry. For example, for recording CD quality music. PMD Edit and other professional level computer applications are available for computer processing of PCM files.

MP3 (MPEG1 Layer III) is highly compressed, and creates relatively small files that are commonly used to transfer files on the internet.

MP2 (MPEG1 Layer II) is a compressed file format that is commonly used in broadcasting. MP2 audio is a higher quality than MP3. This is especially useful when lower bitrates are used. If you are a news reporter you will probably want to record in MP2 format using the .bwf extension.

Sample Frequency

Sample frequency is measured in kHz (kilo Hertz). The sample frequency is the number of samples of the audio wave(s) per second. For example, the PMD670 can record PCM at 48 kHz that is 48,000 samples per second.

Bit Rate

The bit rate for PCM is constant at 768kbps/ch. MP2 and MP3 can be recorded at a number of different bit rates.

File Format

The file format (3 character computer file extension) might be .wav, .bwf, .mpg or .mp3. Broadcast Wave Files (.bwf) include identification codes in the file header.

1 Algor/File default

| 2 | 3 | 4 | 5 | 6 |
|--------|-------|-----------------------|-----------------------|-----------|
| Stereo | PCM | 48 | - - - - - | .wav/.bwf |
| | | 44.1 | | |
| | | 32 | | |
| | | 24 | | |
| | | 22.05 | | |
| | MP2 | 48 | 384,256,192,128,96,64 | .mpg/.bwf |
| | | 44.1 | | |
| | | 32 | | |
| | | 24 | | |
| | | 22.05 | | |
| MP3 | 48 | 320,256,160,128,80,64 | .mp3/.bwf | |
| | 44.1 | | | |
| | 32 | | | |
| | 24 | 160,128,80,64,40,32 | | |
| | 22.05 | | | |
| | 16 | | | |
| Mono | PCM | 48 | - - - - - | .wav/.bwf |
| | | 44.1 | | |
| | | 32 | | |
| | | 24 | | |
| | | 22.05 | | |
| | MP2 | 48 | 192,128,96,64,48,32 | .mpg/.bwf |
| | | 44.1 | | |
| | | 32 | | |
| | | 24 | | |
| | | 22.05 | | |
| MP3 | 48 | 160,128,80,64,40,32 | .mp3/.bwf | |
| | 44.1 | | | |
| | 32 | | | |
| | 24 | | | |
| | 22.05 | | | |
| Dig-In | PCM | - - | - - - - - | .wav/.bwf |
| | MP2 | - - | 384,256,192,128,96,64 | .mpg/.bwf |
| | MP3 | - - | 320,256,160,128,80,64 | .mp3/.bwf |

Chart of Algorithm/File Parameters

- Column
- selected by input device and input channel choice
 - file choice
 - sample frequency
 - bit rate
 - file extension

1 Algor/File

default

| 2 | 3 | 4 | 5 | 6 |
|--------|-------|-----------------------|-----------------------|-----------|
| Stereo | PCM | 48 | - - - - - | .wav/.bwf |
| | | 44.1 | | |
| | | 32 | | |
| | | 24 | | |
| | | 22.05 | | |
| | MP2 | 48 | 384,256,192,128,96,64 | .mpg/.bwf |
| | | 44.1 | | |
| | | 32 | | |
| | | 24 | | |
| | | 22.05 | | |
| MP3 | 48 | 320,256,160,128,80,64 | .mp3/.bwf | |
| | 44.1 | | | |
| | 32 | 160,128,80,64,40,32 | | |
| | 24 | | | |
| | 22.05 | | | |
| Mono | PCM | 48 | - - - - - | .wav/.bwf |
| | | 44.1 | | |
| | | 32 | | |
| | | 24 | | |
| | | 22.05 | | |
| | MP2 | 48 | 192,128,96,64,48,32 | .mpg/.bwf |
| | | 44.1 | | |
| | | 32 | | |
| | | 24 | | |
| | | 22.05 | | |
| MP3 | 48 | 160,128,80,64,40,32 | .mp3/.bwf | |
| | 44.1 | | | |
| | 32 | | | |
| | 24 | | | |
| | 22.05 | | | |
| Dig-In | PCM | - - - - - | .wav/.bwf | |
| | MP2 | 384,256,192,128,96,64 | .mpg/.bwf | |
| | MP3 | 320,256,160,128,80,64 | .mp3/.bwf | |

How to set or change the Algor/File parameter defaults.

The Chart of Algorithm/File Parameters reflects the menu setting procedure of those parameters. The factory defaults are circled.

1. Select the Algor/File menu choice:
 - a. From stop, press and hold the MENU button for about 2 seconds. MENU will appear (flashing) in the display.

Example display:

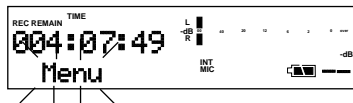

- b. While MENU is flashing (for about 3 seconds) press and release the ENTER button . The Date/Time Menu choice, or the last menu choice, will appear. (If the flashing MENU times out start over at a.)

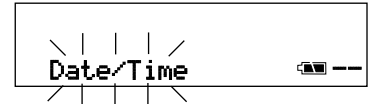

- c. Press and release the FWD/+ button repeatedly until the Algor/File is flashing.

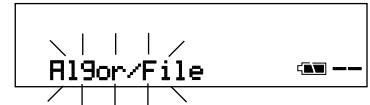

- d. Press and release the ENTER button . You are now at column 2 of the chart of Algorithm File Parameters where you choose between the parameters for Stereo, Mono, or Dig-in input selections.

Mono flashing in display.

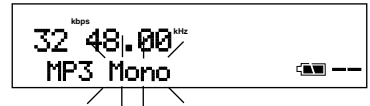

2. Press and release the FWD/+ button or the -/REW button to tab to your recording type choice.

Example display with Stereo chosen.

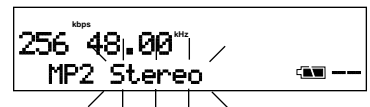

Press and release the ENTER button to accept the Stereo choice and switch to column 3.

3. Press and release the FWD/+ button or the -/REW button to tab to your algorithm choice.

Example display with MP2 chosen.



How to set or change the Algor/File parameters continued

1 Algor/File

default

| 2 | 3 | 4 | 5 | 6 |
|--------|-------|-----------------------|-----------------------|-----------|
| Stereo | PCM | 48 | - - - - - | .wav/.bwf |
| | | 44.1 | | |
| | | 32 | | |
| | | 24 | | |
| | | 22.05 | | |
| | MP2 | 48 | 384,256,192,128,96,64 | .mpg/.bwf |
| | | 44.1 | | |
| | | 32 | | |
| | | 24 | | |
| | | 22.05 | | |
| MP3 | 48 | 320,256,160,128,80,64 | .mp3/.bwf | |
| | 44.1 | | | |
| | 32 | 160,128,80,64,40,32 | | |
| | 24 | | | |
| | 22.05 | | | |
| Mono | PCM | 48 | - - - - - | .wav/.bwf |
| | | 44.1 | | |
| | | 32 | | |
| | | 24 | | |
| | | 22.05 | | |
| | MP2 | 48 | 192,128,96,64,48,32 | .mpg/.bwf |
| | | 44.1 | | |
| | | 32 | | |
| | | 24 | | |
| | | 22.05 | | |
| MP3 | 48 | 160,128,80,64,40,32 | .mp3/.bwf | |
| | 44.1 | | | |
| | 32 | | | |
| | 24 | | | |
| | 22.05 | | | |
| Dig-In | PCM | - - - - - | .wav/.bwf | |
| | MP2 | -- | 384,256,192,128,96,64 | .mpg/.bwf |
| | MP3 | -- | 320,256,160,128,80,64 | .mp3/.bwf |

In our example we press and release the ENTER button ►|| to accept the MP2 choice and switch to column 4.

4. Press and release the FWD/+ button ►► or the -/REW button ◀◀ to tab to your sample frequency choice.

Example display with 44.1 chosen.

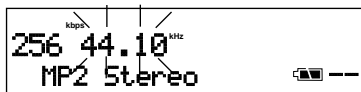

In our example we press and release the ENTER button ►|| to accept the 44.1 choice and switch to column 5.

5. Press and release the FWD/+ button ►► or the -/REW button ◀◀ to tab to your bit rate choice.

Example display with 128 chosen.



In our example we press and release the ENTER button ►|| to accept the 128 choice and switch to column 6.

6. Press and release the FWD/+ button ►► or the -/REW button ◀◀ to tab to your file format choice.

Example display with .bwf chosen.



In our example we press and release the ENTER button ►|| to accept the .bwf choice and switch to Algor/File.

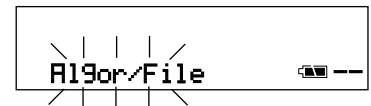

In this example we press and release the MENU/STORE button ▲ to save the change and exit menu. Stored is displayed briefly.



The display returns to stop mode.

Note:

Changes to Algor/File usually also mean hardware and INPUT menu changes. In our example we changed the default MP2 Stereo.mpg with to MP2 Stereo .bwf. We would expect to connect microphones, change the INPUT settings from mono with INT MIC input to stereo with MIC input, and enter ID numbers for the .bwf file header.

Other menu choices:

Manual track incrementing.

When Manual track incrementing is on, during recording slide and release the REC switch ► to increment the track. A new track is created at that point. There is no break in recording. When Manual track incrementing is off, sliding and releasing REC switch ► during recording does nothing.

Default setting is On.

1. Select the M. Track menu choice:
 - a. From stop, press and hold the ▲MENU button for about 2 seconds. MENU will appear (flashing) in the display.
 - b. While MENU is flashing (for about 3 seconds) press and release the ENTER button ►||. The last Menu choice selected will appear. (If the flashing MENU times out start over at a.)
2. Press and release the FWD/+ button ►► repeatedly until M. Track is displayed and flashing.

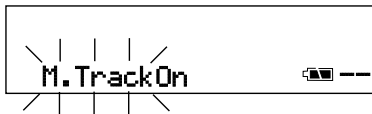

3. Press and release the ENTER button ►|| to accept the M. Track choice and switch to ON or OFF.



4. Press and release the FWD/+ button ►► or the -/REW button ◀◀ to toggle between On and Off.
5. When correct Press and release the ENTER button ►||.
6. Press and release the FWD/+ button ►► to switch to another menu choice, or press and release the ▲MENU/STORE button to write the menu change(s) and return to stop mode.

Seamless Play.

When Seamless Play is On, during playback multiple tracks will be played back in sequence without any break (space) between the tracks. When Seamless Play is Off, during playback multiple tracks will be played back in sequence with breaks (brief periods of silence) between the tracks.

Default setting is Off.

1. Select the Seamless Ply menu choice:
 - a. From stop, press and hold the ▲MENU button for about 2 seconds. MENU will appear (flashing) in the display.
 - b. While MENU is flashing (for about 3 seconds) press and release the ENTER button ►||. The last Menu choice selected will appear. (If the flashing MENU times out start over at a.)
2. Press and release the FWD/+ button ►► repeatedly until Seamless Ply is displayed and flashing.

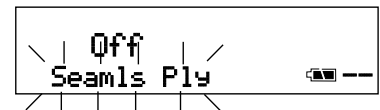

3. Press and release the ENTER button ►|| to accept the SeamlessPly choice and switch to Off or On.

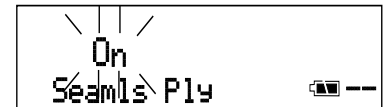

4. Press and release the FWD/+ button ►► or the -/REW button ◀◀ to toggle between Off and On.
5. When correct press and release the ENTER button ►||.
6. Press and release the FWD/+ button ►► to switch to another menu choice, or press and release the ▲MENU/STORE button to write the menu change(s) and return to stop mode.

Silent Skip.

Silent skip automatically pauses recording when there is a period of silence and continues recording when sound resumes. Silent Skip looks for sound below a preset level for a preset period of time. When that occurs the PMD670 switches to record pause. When a signal of about -30 dB is input recording resumes.

For example, if you are both the recorder and master of ceremonies for an event, you can preset the PMD670 for recording and automatically start recording when you start speaking into the microphone.

When the AUTO MARK switch is at ON resumption of recording after a record pause by Silent Skip adds an EDL mark.

Default settings are Off, 03 seconds, and -40 dB.

1. Select the S.Skip menu choice:
 - a. From stop, press and hold the **▲MENU** button for about 2 seconds. MENU will appear (flashing) in the display.
 - b. While MENU is flashing (for about 3 seconds) press and release the ENTER button **▶||**. The last Menu choice selected will appear. (If the flashing MENU times out start over at a.)
2. Press and release the FWD/+ button **▶▶** repeatedly until S.Skip is displayed and flashing.

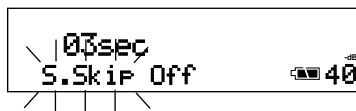

3. Press and release the ENTER button **▶||** to accept the S.Skip choice and switch to On or Off.

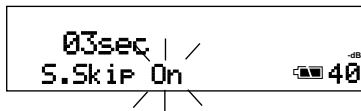

4. Press and release the FWD/+ button **▶▶** or the -/REW button **◀◀** to toggle between ON and OFF.

5. When correct Press and release the ENTER button **▶||** to switch to set or change seconds.

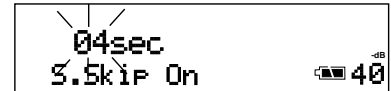

6. Press and release the FWD/+ button **▶▶** or the -/REW button **◀◀** to change the number of seconds of silence. The range is 1 to 5.

7. When correct press and release the ENTER button **▶||** to switch to the decibel threshold level.

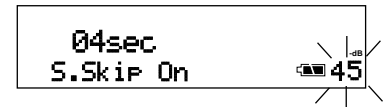

8. Press and release the FWD/+ button **▶▶** or the -/REW button **◀◀** to change the (-dB) decibel threshold level. The range is 20 to 60 in 5 dB increments.

9. When correct press and release the ENTER button **▶||** to switch to S.Skip flashing.

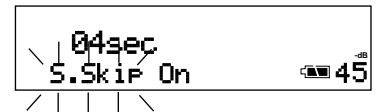

10. Press and release the FWD/+ button **▶▶** to switch to another menu choice, or press and release the **▲MENU/STORE** button to write the menu change(s) and return to stop mode.

Auto Cue

Auto Cue skips the silence at the beginning of an audio track and pauses playback at the point where the sound is loud enough for long enough. You can adjust how loud (how many dB) and how long (milliseconds) the audio has to be before playback is cued.

If S.Play is selected (see next page), when the end of the track is reached Auto Cue pauses playback cued to the sound of the next track.

Default settings are Off, 20 milliseconds, and -40 dB.

1. Select the A.Cue menu choice:
 - a. From stop, press and hold the **▲MENU** button for about 2 seconds. MENU will appear (flashing) in the display.
 - b. While MENU is flashing (for about 3 seconds) press and release the ENTER button **▶||**. The last Menu choice selected will appear. (If the flashing MENU times out start over at a.)
2. Press and release the FWD/+ button **▶▶** repeatedly until A.Cue is displayed and flashing.

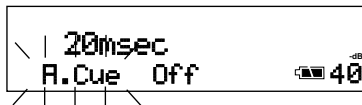

3. Press and release the ENTER button **▶||** to accept the A.Cue choice and switch to On or Off.

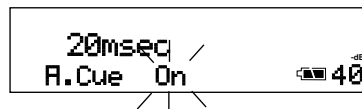

4. Press and release the FWD/+ button **▶▶** or the -/REW button **◀◀** to toggle between On and Off.
5. When correct press and release the ENTER button **▶||** to switch to set or change milliseconds.



6. Press and release the FWD/+ button **▶▶** or the -/REW button **◀◀** to change the number of milliseconds of sound exceeding the threshold. The range is 5 to 60 in five millisecond increments.
7. When correct Press and release the ENTER button **▶||** to switch to the decibel threshold level.



8. Press and release the FWD/+ button **▶▶** or the -/REW button **◀◀** to change the decibel threshold level. The range is -60dB to -20dB in 5dB increments.
9. When correct Press and release the ENTER button **▶||** to switch to A.Cue flashing.

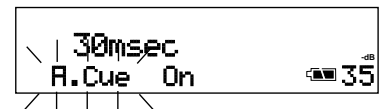

10. Press and release the FWD/+ button **▶▶** to switch to another menu choice, or press and release the **▲MENU/STORE** button to write the menu change(s) and return to stop mode.

Single Play

During playback, when Single Play and Auto Cue are Off, and the end of a track is reached the next track automatically starts playing.

During playback, when Single Play is On, and the end of a track is reached the PMD670 automatically pauses. This differs from Auto Cue in that Single Play does not cue to start of audio.

Default is S.Play Off.

1. Select the S.Play menu choice:
 - a. From stop, press and hold the **MENU** button for about 2 seconds. MENU will appear (flashing) in the display.
 - b. While MENU is flashing (for about 3 seconds) press and release the ENTER button **▶||**. The last Menu choice selected will appear.
(If the flashing MENU times out start over at a.)
2. Press and release the FWD/+ button **▶▶** repeatedly until S.Play is displayed and flashing.

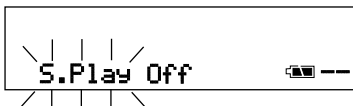

3. Press and release the ENTER button **▶||** to accept the S.Play choice and switch to On or Off.

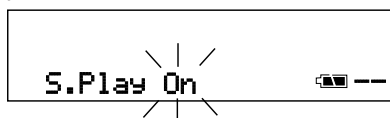

4. Press and release the FWD/+ button **▶▶** or the -/REW button **◀◀** to toggle between ON and OFF.
5. When correct Press and release the ENTER button **▶||** to switch to S.Play flashing.

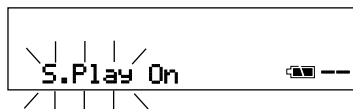

6. Press and release the FWD/+ button **▶▶** to switch to another menu choice, or press and release the **MENU/STORE** button to write the menu change(s) and return to stop mode.

Beep

When battery charge can provide no more than 1-3 minutes of recording or playback and Beep is set to On, the battery indicator will flash, the REC indicator will flash and the PMD670 will beep.

If the PMD670 is not operated for 30 minutes during stop or play pause, power can be automatically shut off to conserve battery life. (See A.PowOFF next page.) If A.PowOFF is set to Y, and Beep is set to ON, the PMD670 will beep to alert you that the power is shutting off.

Default is Beep On.

1. Select the Beep menu choice:
 - a. From stop, press and hold the **MENU** button for about 2 seconds. MENU will appear (flashing) in the display.
 - b. While MENU is flashing (for about 3 seconds) press and release the ENTER button **▶||**. The last Menu choice selected will appear.
(If the flashing MENU times out start over at a.)
2. Press and release the FWD/+ button **▶▶** repeatedly until Beep is displayed and flashing.

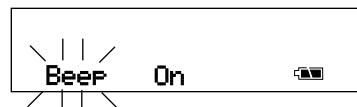

3. Press and release the ENTER button **▶||** to accept the Beep choice and switch to On or Off.

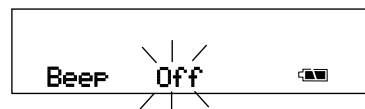

4. Press and release the FWD/+ button **▶▶** or the -/REW button **◀◀** to toggle between ON and OFF.
5. When correct Press and release the ENTER button **▶||** to switch to Beep flashing.

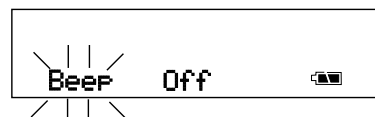

6. Press and release the FWD/+ button ►► to switch to another menu choice, or press and release the ▲MENU/STORE button to write the menu change(s) and return to stop mode.

Automatic Power Off

If the PMD670 is not operated for 30 minutes during stop or play pause, power can be automatically shut off to conserve battery life.

Default is A.PowOFF Y (on).

1. Select the A.PowOFF menu choice:
 - a. From stop, press and hold the ▲MENU button for about 2 seconds. MENU will appear (flashing) in the display.
 - b. While MENU is flashing (for about 3 seconds) press and release the ENTER button ►||. The last Menu choice selected will appear.
(If the flashing MENU times out start over at a.)
2. Press and release the FWD/+ button ►► repeatedly until A.PowOff is displayed and flashing.

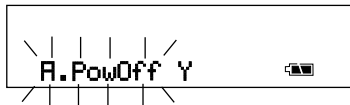

3. Press and release the ENTER button ►|| to accept the A.PowOff choice and switch to Y or N.
4. Press and release the FWD/+ button ►► or the -/REW button ◀◀ to toggle between Y and N.

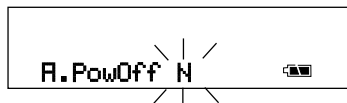

5. When correct Press and release the ENTER button ►|| to switch to A.PowOff flashing.

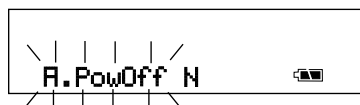

6. Press and release the FWD/+ button ►► to switch to another menu choice, or press and release the ▲MENU/STORE button to write the menu change(s) and return to stop mode.

Battery Type

The PMD670 can operate on 8 store bought AA size Alkaline, Ni-Cd* or Ni-MH* batteries.

*Not charged by the built-in charger.

An optional Ni-Cd battery pack (Model RB1100 available from Marantz Professional) will be charged by the built-in charger when the AC adaptor is plugged in.

An optional Ni-MH battery pack (Model RB1650 available from Marantz Professional) can be used but is not charged by the built in charger and requires Marantz Professional charger model BC600.

Default is Alkaline.

1. Select the Batt_Type menu choice:
 - a. From stop, press and hold the ▲MENU button for about 2 seconds. MENU will appear (flashing) in the display.
 - b. While MENU is flashing (for about 3 seconds) press and release the ENTER button ►||. The last Menu choice selected will appear.
(If the flashing MENU times out start over at a.)
2. Press and release the FWD/+ button ►► repeatedly until Batt_Type is displayed and flashing.
3. Press and release the ENTER button ►|| to accept the Batt_Type choice and switch to the type of battery.
4. Press and release the FWD/+ button ►► or the -/REW button ◀◀ to tab between Alkaline, Ni-Cd, and Ni-MH.

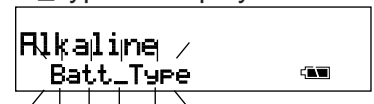

- When correct Press and release the ENTER button ►|| to switch to Batt_Type flashing.



- Press and release the FWD/+ button ►► to switch to another menu choice, or press and release the ▲MENU/STORE button to write the menu change(s) and return to stop mode.

Remote Mode

Use a wired remote, not supplied, to control the PMD670. There are four remote modes:

- StartStop – during recording or playback switch the remote off to pause, on to resume.
- EDL Mark – during recording or playback switch remote to on to add an EDL mark.
- PWR REC – during power off, switch remote to on to turn power on and begin recording. During recording switch remote to off to stop recording and power off.
- M.Track – during recording, switch remote to on to increment the track. A new track is created at that point.

Default is StartStop.

- Select the RemoteMode menu choice:
 - From stop, press and hold the ▲MENU button for about 2 seconds. MENU will appear (flashing) in the display.
 - While MENU is flashing (for about 3 seconds) press and release the ENTER button ►||. The last Menu choice selected will appear. (If the flashing MENU times out start over at a.)
- Press and release the FWD/+ button ►► repeatedly until RemoteMode is displayed and flashing.

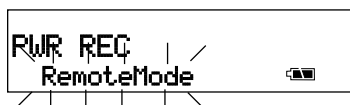

- Press and release the ENTER button ►|| to accept the RemoteMode choice and switch to RemoteMode choices.



- Press and release the FWD/+ button ►► or the -/REW button ◀◀ to tab through the RemoteMode choices: StartStop, EDL Mark, PWR REC, or M.Track



- When correct Press and release the ENTER button ►|| to switch to RemoteMode flashing.
- Press and release the FWD/+ button ►► to switch to another menu choice, or press and release the ▲MENU/STORE button to write the menu change(s) and return to stop mode.

Broadcast Wave ID numbers

Broadcast Wave Format (.bwf) has three identification numbers in the header (Extension Chunk): Description, Originator, and Originator Reference.

For example, if the IDs are used for a broadcast station ID1 could be the identifier of the station, ID2 could be used for the department code, and ID3 for the badge number of the reporter.

Default is all ID number at 000000.

- Select the ID1 menu choice:
 - From stop, press and hold the ▲MENU button for about 2 seconds. MENU will appear (flashing) in the display.
 - While MENU is flashing (for about 3 seconds) press and release the ENTER button ►||. The last Menu choice selected will appear. (If the flashing MENU times out start over at a.)
- Press and release the FWD/+ button ►► repeatedly until ID1 is displayed and flashing.

- Press and release the ENTER button **▶/||** to accept the ID# choice and switch to the highest number position.



- Press and release the FWD/+ button **▶▶** or the -/REW button **◀◀** to tab through the digits 0 through 9.

- When correct Press and release the ENTER button **▶/||** to switch to the next digit.



- Press and release the FWD/+ button **▶▶** or the -/REW button **◀◀** to tab through the digits 0 through 9.



Repeat steps 5 and 6 until all six digits are set.

- Press and release the ENTER button **▶/||** to switch to ID# flashing.

- Press and release the FWD/+ button **▶▶** to switch to the next ID#.

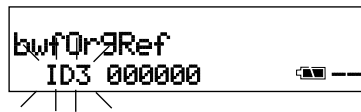

- Repeat 5 - 8 for all three ID numbers. When ID3 is flashing,

- Press and release the FWD/+ button **▶▶** to switch to another menu choice, or press and release the **▲MENU/STORE** button to write the menu change(s) and return to stop mode.

Menu Default

The Default menu choice resets all menu items to their defaults. This is handy if you are setting up a new setting configuration because you don't have to check all the settings, you know they are at the default.

Defaults are listed for each menu item.

Note:

US defaults are used for illustration. See page 51 for a table of menu defaults.

- Select the Default menu choice:
 - From stop, press and hold the **▲MENU** button for about 2 seconds. MENU will appear (flashing) in the display.
 - While MENU is flashing (for about 3 seconds) press and release the ENTER button **▶/||**. The last Menu choice selected will appear. (If the flashing MENU times out start over at a.)
- Press and release the FWD/+ button **▶▶** repeatedly until Default is displayed and flashing.

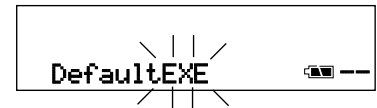

- Press and release the ENTER button **▶/||** to write the defaults. EXECUTING will be displayed,



then Done will be displayed briefly.



- Or, press and release the CANCEL button **■** to exit menu mode without changing menu settings.

Controls and Connections Top continued

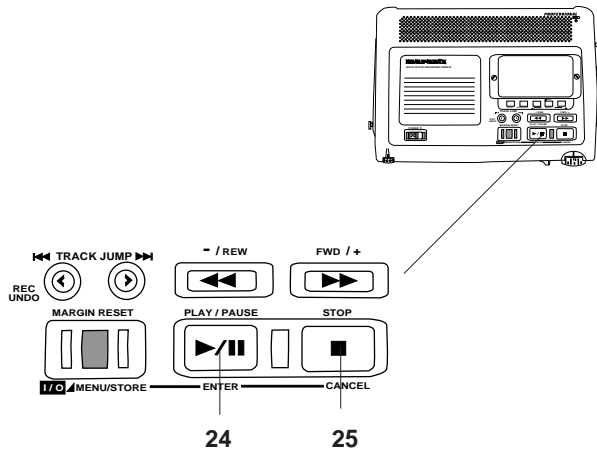

24. PLAY/PAUSE button ▶/|| (playback)
ENTER button ▶/|| (menu)

PLAY/PAUSE button ▶/||

From stop press and release to begin playback.
During playback press and release to pause playback.
During playback pause, press and release to resume playback.



ENTER button ▶/||
During menu functions press and release to accept the current setting and switch to the next menu item to be set.

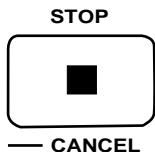

25. STOP/CANCEL button ■
During recording, press and release to stop recording and end the track (file).

During playback, press and release to stop playback and end the playback session. When you resume playback starts at the beginning of the first track.

During menu operations press and release to cancel all entries made and return to stop mode.

Front

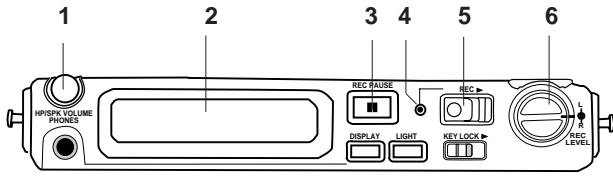

- 1. HP/SPK VOLUME control**
Turn to adjust the volume of headphones plugged into the PHONE jack or the built-in speaker.

Audio on the built-in speaker is automatically interrupted when recording with the internal microphone.

During playback what is heard on the L or R headphone depends on the recording and for a Stereo or Dual Mono recording, the setting of the ANALOG OUT switch.

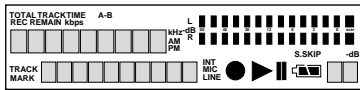

- 2. Display**
See Display on page 47 for details.



- 3. REC PAUSE button**
During recording push and release to pause.

When paused the REC indicator will flash.

Example display.

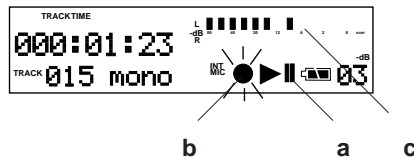

The Pause symbol (a) will be displayed.
The Record symbol (b) will flash in the display
The Level meter (c) will remain active.
To resume recording slide the REC switch to the right and release.

A REC PAUSE does not increment the track.

If the AUTO MARK switch is at ON, a REC PAUSE adds an EDL mark. When recording is resumed the following is displayed for a couple of seconds.

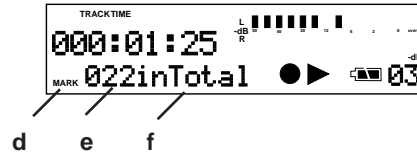

MARK (d) is displayed to indicate that the number (e) indicates the count of EDL marks. "inTotal" (f) reminds you that EDL marks are counted from the beginning the Flash memory card not the beginning of the current track.

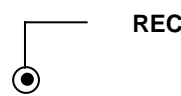

- 4. REC indicator**
Red indicator light is lit and steady during Record, flashing during Record pause.

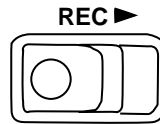

- 5. REC switch**
From Stop slide to the right and release to start recording.

From REC PAUSE slide to the right and release to resume recording.

During recording slide to the right and release to increment the track (start a new audio file).

To stop recording press and release STOP ■.

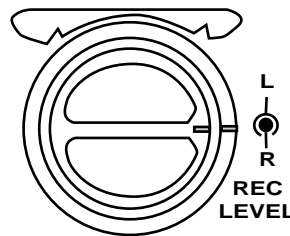

- 6. REC LEVEL controls**
Turn to adjust the record level when the LEVEL CONT. switch is at MANUAL.

The inside control (Right channel) and outside control (Left channel) turn together unless you hold one while turning the other. The optimum record level is when the level meter goes as close to 0dB as possible but does not go OVER.

Front continued

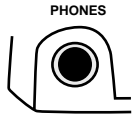
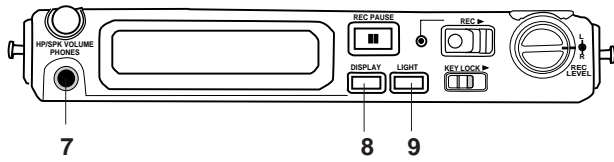

7. PHONES jack
Plug stereo headphones in here.

Adjust headphone volume with the HP/SPK volume control.

Headphones are active during recording and playback.

During playback plugging in headphones mutes the internal speaker.



8. DISPLAY button
Press and release to tab through alternate information displays.

Displays are slightly different in Stop, Record and Play.

During Stop:
Default display is **Remaining record time for the card.**

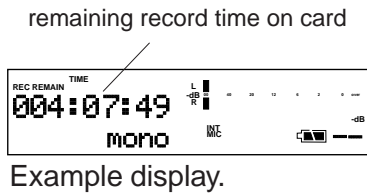

After the first press **track information** is displayed.

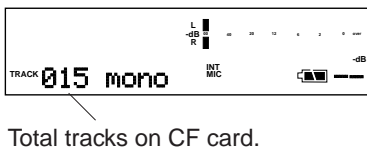

After the second press **EDL mark information** is displayed.

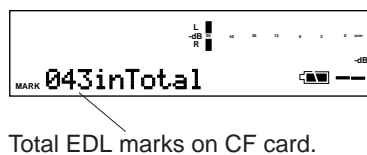

After the third press **file parameters** are displayed.

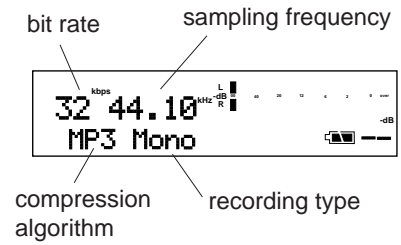

After the fourth press **Date and Time** information is displayed.

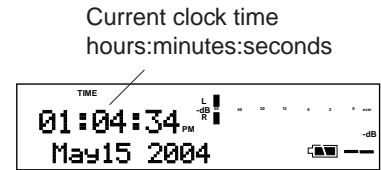

After the fifth press the display returns to the default: remaining record time on the card.

During Record
the default display is **Record time on the current track.**

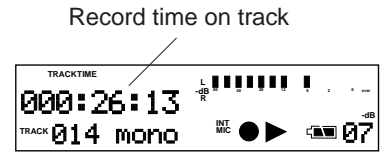

The first press of the DISPLAY button switches to remaining record time for the card.

The second press switches to file parameters.

The third press switches to date and time.

The fourth press returns to the default.

During Playback
the default display is **playing time on the current track.**

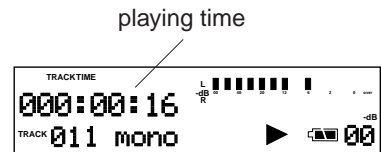

The first press switches to file parameters.

The second press switches to date and time.

The third press returns to the default.

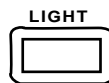

9. LIGHT button
Press and release to momentarily turn the Display light on.

Press and hold for three seconds to switch the Display light on.

Press and release to switch the Display light off.

Front continued

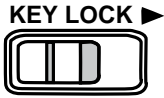
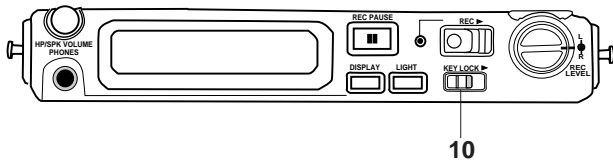

10. KEY LOCK switch
The KEY LOCK switch secures the PMD670 in the state it is in during Record, Playback or Stop.

Slide the switch to the right to turn KEY LOCK on.

Only these controls will work:
Display LIGHT button.
POWER switch - Works during Playback or Stop.
PRE REC switch.

If you try to operate a button or switch that is locked, "HOLD" appears briefly in the display.

Example display:

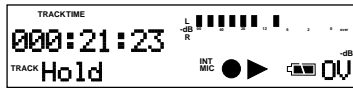

Left side

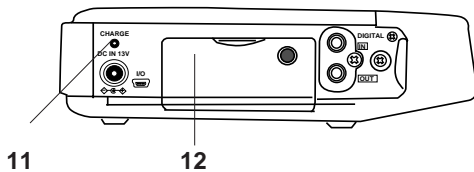

CHARGE



11. CHARGE indicator
Lit when optional Ni-Cd battery is charging.

Flashing when the batteries have about 1 to 2 minutes of record or playback time remaining. Lit and steady after shut down because of low batteries.

12. CF card compartment

Pull to open to access the CF card.

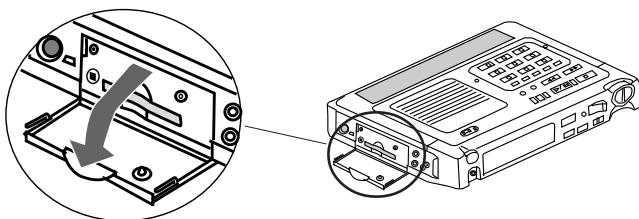

OpenDoor Power Down is displayed for about one second.

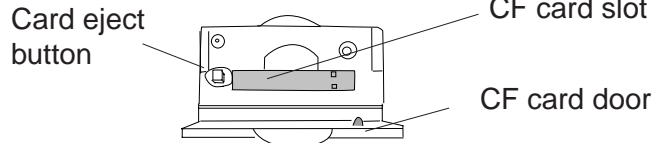

Card eject button

The Card eject button has two positions: click out (a) and click in (b).

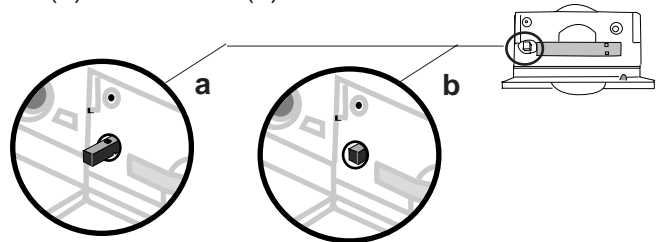

To eject a CF card:

1. If recording or in playback push STOP ■. If other operations are in progress cancel them by pushing STOP ■ or wait for them to complete.
2. Open the CF card door*.
3. Push and release the Card eject button so it is in click out position (a).
4. Push the Card eject button from the click out position to the click in position (b).

*Opening the CF card door turns power off. If recording is in progress, opening the Memory card door automatically stops recording and writes critical track information to properly close the file before powering off.

To insert a CF card:

1. Push and release the Card eject button so it is in the click in position (b above).
2. Fully insert the CF card.
3. Close the CF card door.

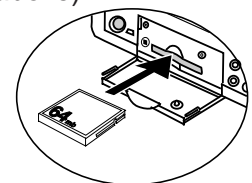

Note: If the CF card door won't latch, check that the Card eject button is in the click in position (b above).

Security

The supplied Memory compartment security screw requires using a small Phillips screwdriver to open the Memory compartment door. That reduces the possibility that the CF card will be misplaced or stolen.

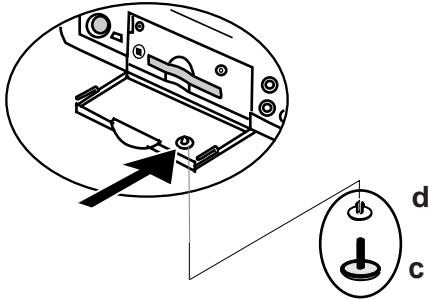
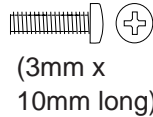

1. Remove the plastic pin (c) and then the retainer (d).
2. Add the screw. Tighten the screw with a small Phillips screwdriver tight enough so the screw cannot be removed with a fingernail.

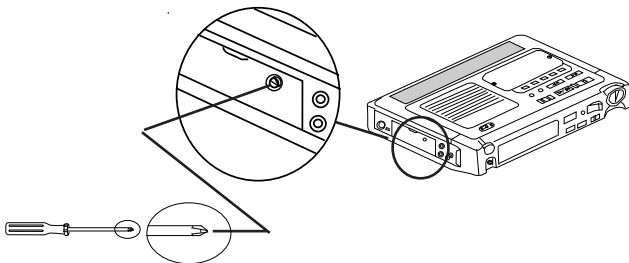

Left side continued

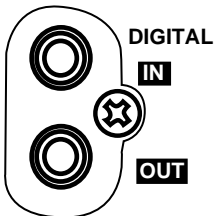
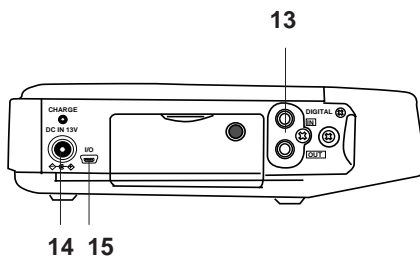

- 13. DIGITAL IN/OUT jacks**
RCA jacks for connecting the PMD670 to an audio component that accepts or outputs digital audio signals.

IN: Connect to the digital out of a digital audio component. PCM audio data input at 44.1 and 48 kHz can be recorded. This input has to be selected in the Input menu for the signal to be recorded. See INPUT button.

OUT: Connect to the digital in of a digital audio component.

- Only files with sample frequencies of 48 or 44.1kHz can be output.
- Digital audio is only output during normal or EDL playback.
- The receiving component must be able to accept audio in SPDIF (IEC-958-II) format.
- The receiving component must be able to accept a sampling frequency of 48 or 44.1kHz.

DC IN 13V

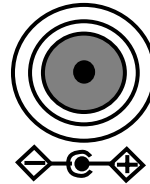

14. DC IN 13V jack

Plug the supplied AC adapter in here. The power supplied is 1.0A at 13V AC. The PMD670 automatically switches to adapter power if

it was running on battery power. If AC power is interrupted by a power outage or unplugging the adapter the PMD670 automatically switches to battery power.

I/O



15. I/O port

Plug the supplied I/O cable in here and connect the other end to your computer (PC or MAC).

The connection makes it easy to copy audio files to your computer's hard drive or a CD. The I/O connection can only be made active when the PMD670 is off (neither recording or during playback).

How to connect via the I/O port

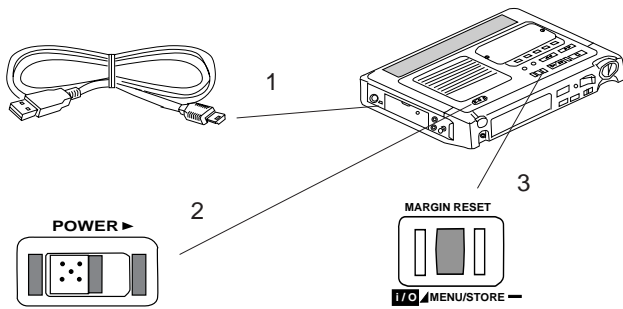

1. Connect the cable to the PMD670 and your computer.
2. Slide the POWER switch on the PMD670 to the right and release to power off.
3. Press and hold the I/O MENU/STORE button while you slide the POWER switch on the PMD670 to the right and release to power on.

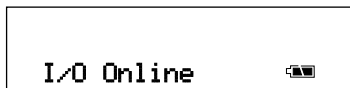

This display appears:

The CF card in the PMD670 appears as a removable device on your computer. The audio files are in a MPGLANG1 folder.

CAUTION: Only copy audio files (tracks) to other volumes. Do not modify or delete the EDL file. If the EDL file is missing or damaged PMD670 will not be able to recognize one or more recorded tracks or all tracks.

See the enclosed CD for demo PMDEdit software for computer audio file manipulation. PMDEdit is a full featured software suite designed for Marantz Professional digital recorders available for purchase at www.marantzpro.com/Products/PMDEdit.html or at (630) 741-0330.

Power off and power the PMD670 back on to resume recording or playback.

What will appear on your computer is a file titled PMD670.EDL and a folder (directory) titled MPGLANG1. Files within the MPGLANG1 folder are numbered from 1001 through the number of tracks recorded to a maximum of 1999. The file extension will be .mp3, .wav, .bwf or .mpg depending on the Algor/File parameters that were set for the recording.

Diagram of file structure (assuming .mp3 files).

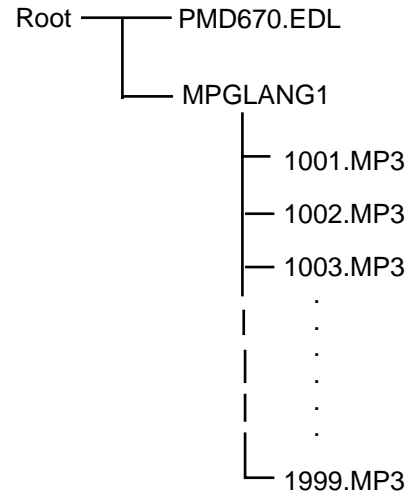

Changes made to file names or file structure made on your computer will prevent file recognition and therefore playback in the PMD670.

However audio files from your computer that are renamed using the file names above and put into the structure above may be playable on the PMD670. For example, if you name an mp3 audio file 1234.MP3 and place it in MPGLANG1 folder the PMD670 may play it.

Right side

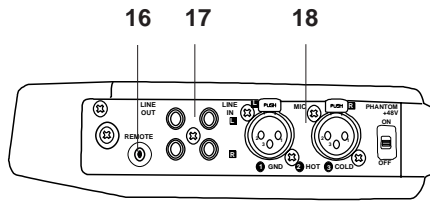

REMOTE



16. Remote jack

Plug a wired remote (not supplied) in here.

Wiring diagram

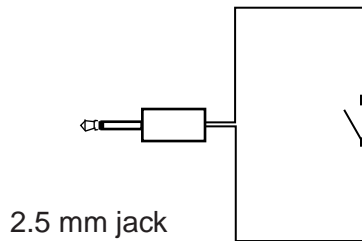

A switch connected to the 2.5mm mini jack off (open) and on (closed) does the following depending on the RemoteMode setting:

RemoteMode:

Start Stop

During record or playback switch remote off to pause, on to resume.

EDL Mark

During record or playback switch remote to on to add an EDL mark.

PWR REC

During POWER off, switch remote to on to turn power on and begin recording.

During recording, switch remote to off to stop recording and power off.

M.Track

During recording, switch remote to on to increment the track. A new track is created at that point. There is no break in recording.

See Remote Mode on page 36 to set or change the Remote Mode.

LINE
OUT

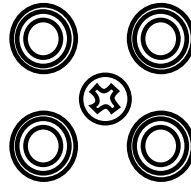

LINE
IN
L

R

17. LINE OUT/IN jacks

Plug external line level audio devices in here.

LINE OUT jacks

Plug Left and Right RCA audio cables in here to connect to the input of an amplifier or other external unit.

During playback what is output on the L or R channel depends on the recording and for a Stereo or Dual Mono recording, the setting of the ANALOG OUT switch.

LINE IN jacks

Plug Left and Right RCA audio cables in here to connect to the output of an external unit.

To record, mono, stereo, or LR mono LINE input must be selected in the input select menu. See INPUT button.

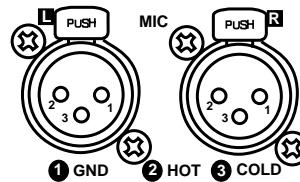

18. MIC IN jacks

Plug external microphones in here.

For mono recording use the Left jack.

To record, stereo with MIC input, DLmono with MIC input, mono with MIC input, or LRmono with MIC input must be selected in the input select menu. See INPUT button.

Notes:

XLR pinout is 1 ground, 2 hot and 3 cold.

Microphones with a PHONE jack can be used with an adapter (not supplied) from PHONE to XLR.

Right side continued

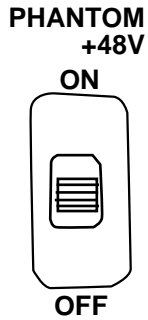
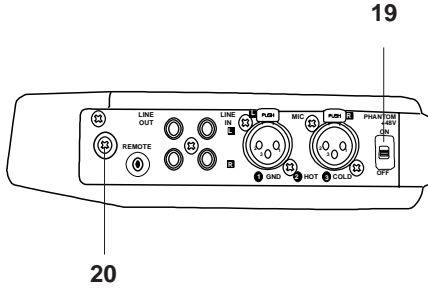

19. PHANTOM +48V switch
Switch to ON to provide 48V of power for a condenser microphone(s).

ON: +48V is supplied to power condenser microphone(s).

OFF: No microphone power is supplied.

Microphone recommendations

Professional condenser microphone(s) (which require additional power either phantom power from the PMD670 or from another source) are recommended because they provide greater sensitivity, and higher quality audio recording.

Dynamic microphone(s) can be used but do not yield optimum audio quality recordings.

Consult with your local dealer to select the appropriate microphone(s) for your specific application. In many cases they can demonstrate the various performances and characteristics of microphones for your use.

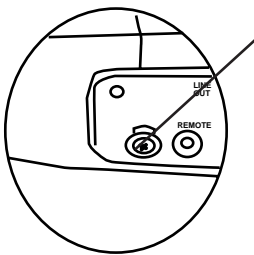

20. Carry studs
Attach the supplied carry strap here.

Installing the carry strap

1. Attach a strap retainer through the round hole.

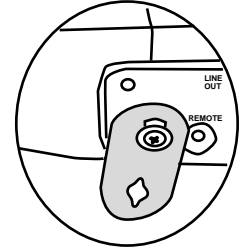

2. Add carry strap.

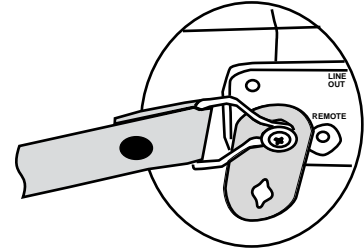

3. Close strap retainer.

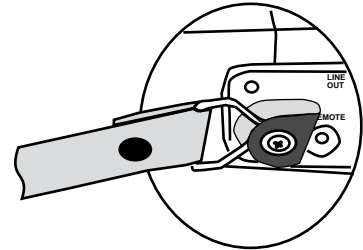

Bottom

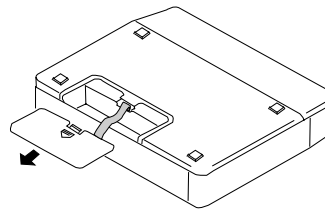
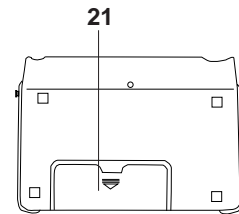

21. Battery compartment
Press and slide at arrow to open the Battery compartment.

Battery power

The PMD670 can operate on several types of battery power.

Hint:

Keep fully charged batteries in the PMD670 when recording using AC power. Otherwise if AC power is interrupted, as much as 30 minutes of your recording could be lost.

Eight AA alkaline batteries and the supplied battery carrier can be used. Alkaline batteries can power recording or playback for about *6 hours.

AA size rechargeable Ni-Cd or Ni-MH batteries can be used in the supplied battery carrier, but those cannot be recharged with the PMD670's built in charger.

An optional Ni-Cd battery model RB1100 can be charged in the PMD670. The RB1100 can also be charged with an optional charger model BC600. Ni-Cd batteries can power recording or playback for about *5 hours.

An optional Ni-MH (Nickel metal hydride) battery model RB1650 can be used, but cannot be recharged with the PMD670's built-in charger. It requires charger model BC600. Ni-MH batteries can power recording or playback for about *7 hours.

*Using compact flash media.

Installing AA size batteries:

Power off, turn the PMD670 over.

Press and push in the direction of the arrow to remove the battery compartment cover.

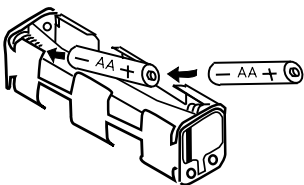
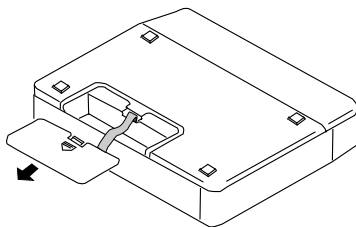

Install 8 AA size batteries to the battery carrier with the - ends towards the springs.

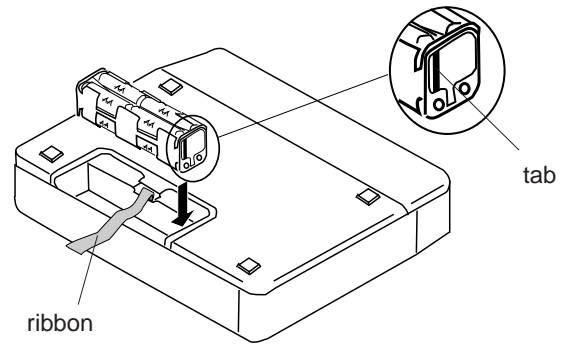

Install the battery carrier with tab as shown and over the ribbon for easy battery carrier removal.

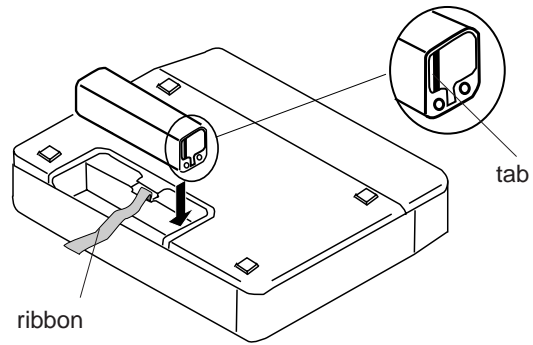

Replace the battery compartment cover**.

Installing an optional Ni-Cd or Ni-MH battery

Install the battery with tab as shown and over the ribbon for easy battery removal**.

The optional Ni-Cd battery is charged only when:

- The AC adaptor is connected.
- The Ni-Cd battery is loaded correctly in the battery compartment.
- The power to the PMD670 is off.

While charging (about 3 hours) the CHARGE indicator will blink.

When the Ni-Cd battery charge cycle is complete the CHARGE indicator will be lit and steady.

**When charging battery type, for optimal battery performance, be sure you change the Batt_Type menu setting.

Display

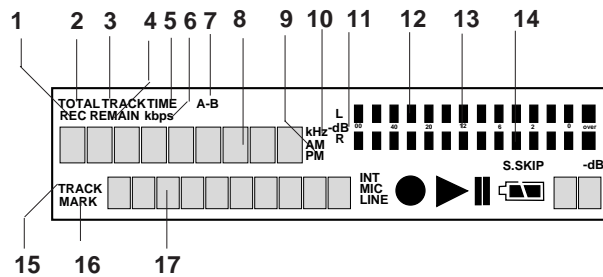

1. REC label

The REC label appears with other labels in this area to indicate TOTAL REC TIME or REC TIME REMAINING displayed on the upper alphanumeric display.

2. TOTAL label

The TOTAL label appears with other labels in this area to indicate TOTAL REC TIME, or TOTAL REC TIME REMAINING displayed on the upper alphanumeric display.

3. TRACK label

The TRACK label appears with other labels in this area to indicate TRACK TIME displayed on the upper alphanumeric display.

4. REMAIN label

The REMAIN label appears with other labels in this area to indicate REC TIME REMAINING, or TOTAL REC TIME REMAINING displayed on the upper alphanumeric display.

5. TIME label

The TIME label appears with other labels in this area to indicate REC TIME REMAINING, TOTAL REC TIME REMAINING, or TRACK TIME displayed on the upper alphanumeric display.

6. kbps label

The kbps label appears to indicate that the first five places in the upper alphanumeric display are kilobytes per second.

7. A-B label

A- indicates that the beginning (A point) of an A-B loop has been set.
A-B indicates that the ending (B point) of an A-B loop has also been set.

8. Upper alphanumeric display

Displays a variety of information including remaining recording time, clock time, menu settings etc. Associated labels are display items 1-7 and 9-10.

9. AM / PM label

Displays AM or PM when clock time is displayed.

10. kHz label

The kHz label appears to indicate that the last five places in the Upper alphanumeric display is frequency in kiloHertz.

11. L -dB R level meter labels

L is the label for the upper (Left) level meter.
-dB is the label for the center level meter scale in decibels.
R is the label for the lower (Right) level meter.

12. Upper level meter

The louder the sound input to the recorder on the Left channel the more bars are displayed.

13. Decibel scale

The scale in dB (decibels) for the upper and lower level meters.

14. Lower level meter

The louder the sound input to the recorder on the Right channel the more bars are displayed.

15. TRACK label

The TRACK label appears to indicate that the number displayed on the left of the lower alphanumeric display is the track number.

16. MARK label

The MARK label appears to indicate that the number displayed on the left of the lower alphanumeric display is the EDL Mark number.

17. Lower alphanumeric display

Displays a variety of information including remaining recording algorithm, date, track number, number of tracks on CF card, EDL

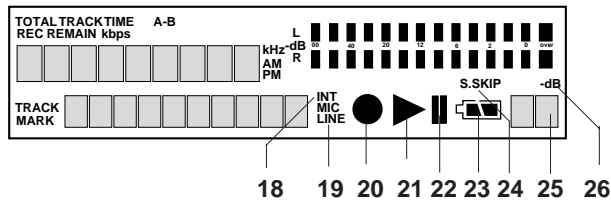

Mark number, number of EDL Marks on CF card etc. Associated labels are display items 15 and 16.

18. MIC/INT MIC label

The MIC label appears when external microphones are selected.
The INT MIC label appears when input selected for recording is the internal microphone.

19. LINE label

The LINE label appears when input(s) selected for recording is (are) the LINE IN jacks.

20. Record ●

The Record symbol appears when the PMD670 is in record mode. Appears with the Play symbol when recording. Appears flashing when in record pause.

21. Play ▶

The Play symbol appears when the PMD670 is in playback, playback pause, recording, record pause.

22. Pause ||

The Pause symbol appears when the PMD670 is in playback pause, or record pause.

23. Battery 

The Battery symbol appears in most displays to indicate battery charge.

 indicates that battery charge is okay.

 indicates that battery charge is getting low and there is approximately 5 to 10 minutes of record or playback time available.

 flashing indicates that battery has approximately 1 to 3 minutes of record or playback time remaining.

The CHARGE indicator light will flash. If BEEP is set to On the PMD670 will also beep.

If the PMD670 continues to operate it will automatically shut down. If recording it will write track information, stop recording and power off. If in playback it will stop playback and power off. The CHARGE indicator will be lit and steady.

 indicates that battery charge is depleted or no battery is installed.

24. S.SKIP label

The Silent Skip label appears when Silent Skip is enabled.

25. Margin level

The Margin level is displayed. The PMD670 holds this display at the highest level achieved during the current recording. If more than 0 dB, OV is displayed. To reset the Margin level press and release the MARGIN RESET button.

26. -dB label

The -dB label applies to the Peak level display.

Care and Maintenance

Use a soft cloth slightly moistened with mild detergent solution.

Recording time chart

Recording time chart

The recording time available on a CF card depends on the size of the card in MB, the recording type (.mp3, .mp2 or PCM), the bitrate of the recording and if recording in mono or stereo.

This Recording time chart lists approximate recording times based on those factors.

| CARD SIZE | bitrate | 32 kbps | | 64 kbps | | 80 kbps | | 128 kbps | | 160 kbps | | 256 kbps | | 320 kbps | |
|-----------|----------------|----------|----------|----------|----------|----------|----------|----------|----------|----------|---------|----------|---------|----------|---------|
| | | mono | stereo | mono | stereo | mono | stereo | mono | stereo | mono | stereo | mono | stereo | mono | stereo |
| | .mp3 | | | | | | | | | | | | | | |
| | 32 MB | 2:13:00 | 1:06:30 | 1:46:24 | 0:53:12 | 1:06:30 | 0:33:15 | 0:33:15 | 0:33:15 | 0:26:36 | 0:16:38 | 0:33:15 | 0:16:38 | 0:26:36 | 0:13:18 |
| | 64 MB | 4:26:00 | 2:13:00 | 3:32:48 | 1:46:24 | 2:13:00 | 1:06:30 | 1:06:30 | 1:06:30 | 0:53:12 | 0:33:15 | 1:06:30 | 0:33:15 | 0:53:12 | 0:26:36 |
| | 128 MB | 8:52:00 | 4:26:00 | 7:05:36 | 3:32:48 | 4:26:00 | 2:13:00 | 2:13:00 | 2:13:00 | 1:46:24 | 1:06:30 | 2:13:00 | 1:06:30 | 1:46:24 | 0:53:12 |
| | 256 MB | 17:44:00 | 8:52:00 | 14:11:12 | 7:05:36 | 8:52:00 | 4:26:00 | 4:26:00 | 4:26:00 | 3:32:48 | 2:13:00 | 4:26:00 | 2:13:00 | 3:32:48 | 1:46:24 |
| | 340 MB | 23:33:08 | 11:46:34 | 18:50:30 | 9:25:15 | 11:46:34 | 5:53:17 | 5:53:17 | 5:53:17 | 4:42:38 | 2:56:38 | 4:42:38 | 2:56:38 | 4:42:38 | 2:21:19 |
| | 512 MB | 35:28:00 | 17:44:00 | 28:22:24 | 14:11:12 | 17:44:00 | 8:52:00 | 8:52:00 | 8:52:00 | 7:05:36 | 4:26:00 | 7:05:36 | 4:26:00 | 7:05:36 | 3:32:48 |
| | (1 GB) 1024 MB | 70:56:00 | 35:28:00 | 56:44:48 | 28:22:24 | 35:28:00 | 17:44:00 | 17:44:00 | 17:44:00 | 14:11:12 | 8:52:00 | 14:11:12 | 8:52:00 | 14:11:12 | 7:05:36 |

| CARD SIZE | bitrate | 32 kbps | | 48 kbps | | 96 kbps | | 128 kbps | | 192 kbps | | 256 kbps | | 384 kbps | |
|-----------|----------------|----------|----------|----------|----------|----------|----------|----------|----------|----------|---------|----------|---------|----------|---------|
| | | mono | stereo | mono | stereo | mono | stereo | mono | stereo | mono | stereo | mono | stereo | mono | stereo |
| | .mp2 | | | | | | | | | | | | | | |
| | 32 MB | 2:13:00 | 1:06:30 | 1:39:45 | 0:49:53 | 0:49:53 | 0:33:15 | 0:33:15 | 0:33:15 | 0:24:56 | 0:16:38 | 0:33:15 | 0:16:38 | 0:24:56 | 0:12:28 |
| | 64 MB | 4:26:00 | 2:13:00 | 3:19:30 | 1:39:45 | 1:39:45 | 1:06:30 | 1:06:30 | 1:06:30 | 0:49:53 | 0:33:15 | 1:06:30 | 0:33:15 | 0:49:53 | 0:24:56 |
| | 128 MB | 8:52:00 | 4:26:00 | 6:39:00 | 3:19:30 | 3:19:30 | 2:13:00 | 2:13:00 | 2:13:00 | 1:39:45 | 1:06:30 | 2:13:00 | 1:06:30 | 1:39:45 | 0:49:53 |
| | 256 MB | 17:44:00 | 8:52:00 | 13:18:00 | 6:39:00 | 6:39:00 | 4:26:00 | 4:26:00 | 4:26:00 | 3:19:30 | 2:13:00 | 4:26:00 | 2:13:00 | 3:19:30 | 1:39:45 |
| | 340 MB | 23:33:08 | 11:46:34 | 17:39:51 | 8:49:55 | 8:49:55 | 5:53:17 | 5:53:17 | 5:53:17 | 4:24:58 | 2:56:38 | 4:24:58 | 2:56:38 | 4:24:58 | 2:12:29 |
| | 512 MB | 35:28:00 | 17:44:00 | 26:36:00 | 13:18:00 | 13:18:00 | 8:52:00 | 8:52:00 | 8:52:00 | 6:39:00 | 4:26:00 | 6:39:00 | 4:26:00 | 6:39:00 | 3:19:30 |
| | (1 GB) 1024 MB | 70:56:00 | 35:28:00 | 53:12:00 | 26:36:00 | 26:36:00 | 17:44:00 | 17:44:00 | 17:44:00 | 13:18:00 | 8:52:00 | 13:18:00 | 8:52:00 | 13:18:00 | 6:39:00 |

| CARD SIZE | fs | 32 kHz | | 44.1 kHz | | 48 kHz | |
|-----------|----------------|---------|---------|----------|---------|---------|---------|
| | | mono | stereo | mono | stereo | mono | stereo |
| | PCM | | | | | | |
| | 32 MB | 0:08:20 | 0:04:10 | 0:06:03 | 0:03:01 | 0:05:33 | 0:02:47 |
| | 64 MB | 0:16:40 | 0:08:20 | 0:12:06 | 0:06:03 | 0:11:07 | 0:05:33 |
| | 128 MB | 0:33:20 | 0:16:40 | 0:24:11 | 0:12:06 | 0:22:13 | 0:11:07 |
| | 256 MB | 1:06:40 | 0:33:20 | 0:48:23 | 0:24:11 | 0:44:27 | 0:22:13 |
| | 340 MB | 1:28:33 | 0:44:16 | 1:04:15 | 0:32:07 | 0:59:02 | 0:29:31 |
| | 512 MB | 2:13:20 | 1:06:40 | 1:36:45 | 0:48:23 | 1:28:54 | 0:44:27 |
| | (1 GB) 1024 MB | 4:26:41 | 2:13:20 | 3:13:30 | 1:36:45 | 2:57:47 | 1:28:54 |

ALL TIMES ARE APPROXIMATE

TROUBLESHOOTING

Should faults occur, it is in many cases not necessary to consult your dealer or technical service department. On the basis of the following checks, you will be able to rectify a number of conditions yourself without difficulty. If the condition cannot be remedied after the following check, please consult your dealer or contact Marantz Professional at 630 741 0330.

The PMD670 does not turn on

- Check power
- install fresh batteries
- check AC adaptor connections

The PMD670 turns on then turns itself off

- install fresh batteries

The PMD670 seems to record but there is no sound on playback

- check input settings (For example, if LINE input is selected and no input is connected to the LINE IN jacks the PMD670 will record silence.)

The PMD670 will not playback

- check EDL switch, if ON switch to OFF

No audio playback through headphones or internal speaker

- check HP/SPK VOLUME control setting
- check a different track or CF card

The PMD670 will not record

- check that the maximum of 999 tracks have not been recorded
- check that the PMD670 acknowledges the CF card

No signal from microphone input

- check input selection
- check REC level control settings
- check if microphone(s) require Phantom power

Excessive noise

- check cable connections

Playback on a PC results in poor sound

- check quality of PC sound card and program
- check frequency conversion program*

*The PMD670 records audio files with a sampling frequency of 48kHz. Some PC programs convert the files to 44.1kHz (using a sample rate converter). Only high quality sample rate converters should be used.

PC cannot read files

- check if the files are MP2 or MP2 with a .wav file extension Some PC's cannot interpret this combination. Try renaming the MP2 file so it has a .mp2 or .mp3 file extension.
- check the capability of the PC program

Some playback and editing programs do not support MP2/MP3 or Broadcast Wave (.bwf) formats. Consult the Marantz Professional website at www.marantzpro.com for links to programs that support MP2/MP3 and Broadcast Wave Format.

The rechargeable battery not recharging

- check that the CHARGE indicator is flashing during charging and lit and steady when charging is complete.
- check AC adaptor connections
- check that Power is turned off on the PMD670

Rechargeable battery life low

- make sure you fully charge and discharge the Ni-Cd battery during each charge cycle
- replace battery

Media cards that are heavily used should be occasionally reformatted to avoid audio problems due to fragmentation.

If the PMD670 exhibits erratic behavior, the microprocessor can be reset by, powering off, disconnecting AC power and removing batteries.

Record setting recommendations

Recording a meeting

LEVEL CONT. switch at ALC.

ANC switch at .

Factory default settings.

Input: INT MIC mono or MIC mono

Menu settings:

Algor/File: mono, MP3, 44.1kHz, 32 kbps, .mp3.

M.Track: On

S.Skip: On

Beep: On

A.PowOff: Yes

Recording music

LEVEL CONT. switch at MANUAL.

ANC switch at FLAT.

Input: MIC stereo

Menu settings:

Algor/File: Stereo, MP3, 44.1kHz, 128kbps, .mp3.

M.Track: Off

S.Skip: Off

Beep: Off

A.PowOff: Yes

Menu settings (highest quality):

Algor/File: Stereo, PCM, 44.1kHz, 128kbps, .wav.

M.Track: Off

S.Skip: Off

Beep: Off

A.PowOff: Yes

SPECIFICATIONS*

Digital audio system

System Solid State Recorder
 Usable Media CF memory cards
 (Microdrive) cards

Recording and media methods

.mp2 MPEG1 Layer II compression
 .mp3 MPEG1 Layer III compression
 .mp3 MPEG2 Layer III compression*
 *for all half sample rates.
 PCM 16 bit linear PCM

Recording bit rate (selectable)

MP2 mono 192, 128, 96, 64, 48, 32 kbps
 MP2 stereo 384, 256, 192, 128, 96, 64 kbps
 MP3 mono 160, 128, 80, 64, 40, 32 kbps
 MP3 stereo 320, 256, 160, 128, 80, 64 kbps

Sampling frequency

Analog 48, 44.1, 32, 24*, 22.05*, 16* kHz
 *except MP2
 Digital 48, 44.1 kHz

Number of channels 2 (stereo), 1 (mono)

Frequency response 20,000 Hz (-0.5dB)

Signal-to-Noise Ratio

IEC-A weighted LINE 86 dB
 MIC 65 dB

Total Harmonic Distortion

at 0 VU (PCM) LINE 0.03%
 MIC 0.08%

Dynamic Range 86 dB

Inputs

MIC IN L/R

Type XLR (1:GND, 2:HOT, 3:COLD)
 Input Sensitivity (MIC) 1.2 mVrms/6.5 kohms

LINE IN L/R

Type RCA jack
 Input Sensitivity 300 mVrms/20 kohms

DIGITAL IN

Type RCA jack
 Input impedance 75 ohms
 Standard input level 0.5 Vp-p
 Sampling frequency 44.1/48 kHz
 Format SPDIF (IEC 958 Typell)

Outputs

LINE OUT L/R

Type RCA jack
 Standard level 2 Vrms max./2 kohms

DIGITAL OUT

Type RCA jack
 Output impedance 75 ohms
 Standard output level 0.5 Vp-p
 Sampling frequency 44.1/48 kHz
 Format SPDIF (IEC-958 Type II)

General

Headphone Output power 20 mW/32 ohms
 Speaker Output power 100 mW/4 ohms
 Phantom power +48V, 10mA

Power consumption

Recording/Playback 5.2 W
 Charging 12 W max
 Standby (battery driven) 2.2 mW
 Battery life (Alkaline) 6 hours (typical)

Dimensions

Width 264 mm (10.4")
 Height 55 mm (2.0")
 Depth 185 mm (7.3")
 Weight 1.3 kg (2 lbs. 14 oz.)

Included accessories

AC adapter 1
 Battery carrier 1
 Carry strap 1
 Carry strap retainers 2
 Screws (ISO 3x10 mm) 3
 Plastic pin and retainer 1
 I/O cable 1
 User Guide 1

Optional accessories**

Ni-Cd battery pack RB1100
 Ni-MH battery pack RB1650
 Battery charger BC600
 Carrying cover (vinyl) CLC670
 Carrying bag PRC300
 Professional reporter's bag PRC600
 Attache carrying case CA200

**See www.marantzpro.com for details.

*Specifications subject to change without notice.

Menu defaults

| Menu | selection | default | |
|------------|------------------|------------|------------|
| | | US | Europe |
| Date/Time | 2003-2099 | 2003 | 2003 |
| | JAN-DEC | JAN | JAN |
| | 1-31 | 1 | 1 |
| | AM/PM 0:00-11:59 | AM 0:00 | AM 0:00 |
| DateForm | | M/D/Y | D/M/Y |
| Algor/File | stereo/mono | Mono | Stereo |
| | PCM/MP2/MP3 | MP3 | MP2 |
| | kHz | 44.1 | 48 |
| | bit rate kbps | 32 | 128 |
| | extension | .mp3 | .mpg |
| M.Track | | On | On |
| SeamlsPly | | Off | Off |
| S.Skip | | Off | Off |
| | seconds | 03 | 03 |
| | dB | -40 | -40 |
| A.Cue | | Off | Off |
| | milliseconds | 20 | 20 |
| | dB | -40 | -40 |
| S.Play | | Off | Off |
| Beep | | On | On |
| A.PowOFF | | Y | Y |
| Batt_Type | | Alkaline | Alkaline |
| RemoteMode | | Start/Stop | Start/Stop |
| ID1 | | 0000000 | 0000000 |
| ID2 | | 0000000 | 0000000 |
| ID3 | | 0000000 | 0000000 |

LIMITED WARRANTY

Your Marantz Professional product is warranted against manufacturer defects in material and workmanship for a period of one year parts and labor.

Except as specified below, this warranty covers defects in material and workmanship. The following are not covered under warranty:

1. Damage, deterioration, malfunction or failure to meet performance specifications resulting from:
 - a) Accidents, acts of nature, misuse, abuse, neglect or unauthorized product modification.
 - b) Improper installation, removal or maintenance, or failure to follow supplied instructions.
 - c) Repair or attempted repair by a non-Marantz authorized agent.
 - d) Any shipment (claims must be presented to the carrier).
 - e) Any cause other than a defect of manufacturing.
2. Cleaning, check-ups with no fault found or changes incurred for installation, removal or reinstallation of the product.
3. Any serialized product on which the serial number has been defaced, modified or removed.
4. Batteries and battery chargers.
5. Accessories, including but not limited to: cables, mounting hardware and brackets, cleaning accessories, power cords and adapters, and carry cases.
6. Products purchased outside of the United States, its possessions or territories.

Non-transferable warranty

This Warranty may be enforced only by the original purchaser.

What We Will Pay For

We will pay for all labor and material expenses for items covered by the warranty.

How You Can Get Service

1. If your unit needs service in the USA, contact our service referral at the appropriate telephone number indicated below. We will advise you of the name and location of one or more authorized service centers from which service may be obtained. Please do not return the unit directly to us.
2. You must pay any shipping charges if it is necessary to ship the product for service. If the necessary repairs are covered by the warranty, we will pay return shipping charges to your location anywhere in the United States or its territories.
3. Whenever warranty service is required, you must present the original dated sales receipt or other proof of date purchased.

Limitation of Implied Warranties

All implied warranties, including warranties of merchantability and fitness for a particular purpose, are limited in duration to the length of this warranty.

Exclusion of Damages

Liability for any defective product is limited to repair or replacement of the product at manufacturer's option. Manufacturer shall not be liable for damage to other products caused by any defects in Marantz products, damages based on inconvenience or loss of use of the product, or any other damages, whether incidental, consequential, or otherwise.

Some States do not allow limitations on how long an implied warranty lasts and/or do not allow the exclusion or limitation of incidental or consequential damages, so the above limitations and exclusions may not apply to you.

How State Law Relates to the Warranty

This warranty gives you specific legal rights, and you may have other rights which may vary from State to State.

Marantz Professional Service Number:

Marantz Professional Factory Service (630) 741-0330

This warranty is enforceable only in the United States and its possessions or territories.

marantz[®]

Marantz is a registered trademark.

