

marantz®

Model SR3001 User Guide

AV Surround Receiver

ENGLISH

WARRANTY

For warranty information, contact your local Marantz distributor.

RETAIN YOUR PURCHASE RECEIPT

Your purchase receipt is your permanent record of a valuable purchase. It should be kept in a safe place to be referred to as necessary for insurance purposes or when corresponding with Marantz.

IMPORTANT

When seeking warranty service, it is the responsibility of the consumer to establish proof and date of purchase. Your purchase receipt or invoice is adequate for such proof.

FOR U.K. ONLY

This undertaking is in addition to a consumer's statutory rights and does not affect those rights in any way.

FRANÇAIS

GARANTIE

Pour des informations sur la garantie, contacter le distributeur local Marantz.

CONSERVER L'ATTESTATION D'ACHAT

L'attestation d'achat est la preuve permanente d'un achat de valeur. La conserver en lieu sûr pour s'y reporter aux fins d'obtention d'une couverture d'assurance ou dans le cadre de correspondances avec Marantz.

IMPORTANT

Pour l'obtention d'un service couvert par la garantie, il incombe au client d'établir la preuve de l'achat et d'en corroborer la date. Le reçu ou la facture constituant des preuves suffisantes.

DEUTSCH

GARANTIE

Bei Garantiefragen wenden Sie sich bitte an Ihren Marantz-Händler.

HEBEN SIE IHRE QUITTING GUT AUF

Die Quittung dient Ihnen als bleibende Unterlage für Ihren wertvollen Einkauf. Das Aufbewahren der Quittung ist wichtig, da die darin enthaltenen Angaben für Versicherungszwecke oder bei Korrespondenz mit Marantz angeführt werden müssen.

WICHTIG!

Bei Garantiefragen muß der Kunde eine Kaufunterlage mit Kaufdatum vorlegen. Ihren Quittung oder Rechnung ist als Unterlage ausreichend.

NEDERLANDS

GARANTIE

Voor inlichtingen omtrent garantie dient u zich tot uw plaatselijke Marantz.

UW KWITANTIE, KASSABON E.D. BEWAREN

Uw kwitantie, kassabon e.d. vormen uw bewijs van aankoop van een waardevol artikel en dienen op een veilige plaats bewaard te worden voor evt. verwijzing bij, in verbind met verzekering of bij correspondentie met Marantz.

BELANGRIJK

Bij een evt. beroep op de garantie is het de verantwoordelijkheid van de consument een gedateerd bewijs van aankoop te tonen. Uw kassabon of factuur zijn voldoende bewijs.

ESPAÑOL

GARANTIA

Para obtener información acerca de la garantía póngase en contacto con su distribuidor Marantz.

GUARDE SU RECIBO DE COMPRA

Su recibo de compra es su prueba permanente de haber adquirido un aparato de valor. Este recibo deberá guardarlo en un lugar seguro y utilizarlo como referencia cuando tenga que hacer uso del seguro o se ponga en contacto con Marantz.

IMPORTANTE

Cuando solicite el servicio otorgado por la garantía el usuario tiene la responsabilidad de demostrar cuándo efectuó la compra. En este caso, su recibo de compra será la prueba apropiada.

ITALIANO

GARANZIA

L'apparecchio è coperto da una garanzia di buon funzionamento della durata di un anno, o del periodo previsto dalla legge, a partire dalla data di acquisto comprovata da un documento attestante il nominativo del Rivenditore e la data di vendita. La garanzia sarà prestata con la sostituzione o la riparazione gratuita delle parti difettose.

Non sono coperti da garanzia difetti derivanti da uso improprio, errata installazione, manutenzione effettuata da personale non autorizzato o, comunque, da circostanze che non possano riferirsi a difetti di funzionamento dell'apparecchio. Sono inoltre esclusi dalla garanzia gli interventi inerenti l'installazione e l'allacciamento agli impianti di alimentazione.

Gli apparecchi verranno riparati presso i nostri Centri di Assistenza Autorizzati. Le spese ed i rischi di trasporto sono a carico del cliente.

La casa costruttrice declina ogni responsabilità per danni diretti o indiretti provocati dalla inosservanza delle prescrizioni di installazione, uso e manutenzione dettagliate nel presente manuale o per guasti dovuti ad uso continuato a fini professionali.

SVENSKA

GARANTI

För information om garantin, kontakta Marantz lokalagent.

SPAR KVITTOT

Kvittot är ett inköpsbevis på en värdefull vara. Det skall förvaras säkert och hänvisas till vid försäkringsfall eller vid korrespondens med Marantz.

VIKTIGT

Fö att garantin skall gälla är det kundens sak att framställa bevis och datum om köpet. Kvitto eller faktura är tillräckligt bevis för detta.

CE MARKING



English

The SR3001 is in conformity with the EMC directive and low-voltage directive.



Français

Le SR3001 est conforme à la directive EMC et à la directive sur les basses tensions.



Deutsch

Das Modell SR3001 entspricht den EMC-Richtlinien und den Richtlinien für Niederspannungsgeräte.



Nederlands

De SR3001 voldoet aan de EMC eisen en de vereisten voor laag-voltage.



Español

El SR3001 está de acuerdo con las normas EMC y las relacionadas con baja tensión.



Italiano

Il SR3001 è conforme alle direttive CEE ed a quelle per i bassi voltaggi.



Svenska

SR3001 är tillverkad i enlighet med EMC direktiven och direktiven för lågvoltstrusning.

English

WARNINGS

- Do not expose the equipment to rain or moisture.
- Do not remove the cover from the equipment.
- Do not insert anything into the equipment through the ventilation holes.
- Do not handle the mains cord with wet hands.
- Do not cover the ventilation with any items such as tablecloths, newspapers, curtains, etc.
- No naked flame sources, such as lighted candles, should be placed on the equipment.
- When disposing of used batteries, please comply with governmental regulations or environmental public instruction's rules that apply in your country or area.
- Make a space of about 0.2 meter around the unit.
- No objects filled with liquids, such as vases, shall be placed on the equipment.
- When the switch is in the OFF position, the equipment is not completely switched off from MAINS.
- The equipment shall be installed near the power supply so that the power supply is easily accessible.
- Do not touch hot spots during and immediately after use.
- During and immediately after use, this product is hot in areas other than the controls and rear panel connection jacks. Do not touch hot spots and especially the top panel. Contact with hot areas can cause burns.

Français

AVERTISSEMENTS

- Ne pas exposer l'appareil à la pluie ni à l'humidité.
- Ne pas essayer de retirer le boîtier de l'appareil.
- Ne rien insérer dans l'appareil par les orifices de ventilation.
- Ne pas manipuler le cordon d'alimentation avec les mains mouillées.
- Ne pas recouvrir les ouïes de ventilation avec un objet quelconque comme une nappe, un journal, un rideau, etc.
- Ne placer aucune source de flamme nue, comme une bougie allumée, sur l'appareil.
- Pour mettre au rebut les piles usées, respecter les lois gouvernementales ou les règlements officiels concernant l'environnement qui s'appliquent à votre pays ou région.
- Veiller à ce qu'aucun objet ne soit à moins de 0,2 mètre des côtés de l'appareil.

- Aucun objet rempli de liquide, un vase par exemple, ne doit être placé sur l'appareil.
- Lorsque l'interrupteur est sur la position OFF, l'appareil n'est pas complètement déconnecté du SECTEUR (MAINS).
- L'appareil sera installé près de la source d'alimentation, de sorte que cette dernière soit facilement accessible.
- Ne pas toucher aux zones chaudes pendant et immédiatement après l'utilisation.
- Pendant l'utilisation et immédiatement après, cet appareil est chaud en dehors des commandes et des prises de raccordement arrière. Ne pas toucher aux zones chaudes, et particulièrement au panneau supérieur, pour éviter tout risque de brûlure.

Deutsch

WARNHINWEISE

- Das Gerät nicht Regen oder Feuchtigkeit aussetzen.
- Die Abdeckung nicht vom Gerät abnehmen.
- Keine Gegenstände durch die Belüftungsschlitze stecken.
- Das Netzkabel nicht mit feuchten oder nassen Händen anfassen.
- Decken Sie die Lüftungsöffnungen nicht mit einem Tischtuch, einer Zeitung, einem Vorhang usw. ab.
- Es dürfen keine Gegenstände mit offener Flamme, wie etwa brennende Kerzen, auf dem Gerät aufgestellt werden.
- Beachten Sie bei der Entsorgung der verbrauchten Batterien alle geltenden lokalen und überregionalen Regelungen.
- Auf allen Geräteseiten muß ein Zwischenraum von ungefähr 0,2 meter vorhanden sein.
- Auf das Gerät dürfen keine mit Flüssigkeiten gefüllte Behälter, wie etwa eine Vase, gestellt werden.
- Wenn der Schalter ausgeschaltet ist (OFF-Position), ist das Gerät nicht vollständig vom Stromnetz (MAINS) abgetrennt.
- Das Gerät sollte in der Nähe einer Netzsteckdose aufgestellt werden, damit es leicht an das Stromnetz angeschlossen werden kann.
- Berühren Sie während oder unmittelbar nach dem Gebrauch keine heißen Stellen des Gerätes.
- Während oder unmittelbar nach dem Gebrauch ist dieses Produkt mit Ausnahme der Bedienelemente und der Anschlussbuchsen auf der Rückseite heiß. Berühren Sie die heißen Stellen und insbesondere die Oberseite nicht. Der Kontakt mit heißen Flächen kann zu Verbrennungen führen.

Nederlands

WAARSCHUWINGEN

- Stel het apparaat niet bloot aan regen of vocht.
- Verwijder de afdekplaat van het apparaat niet.
- Duw niets door de ventilatieopeningen in het apparaat.
- Raak het netsnoer niet met natte handen aan.
- Bedek de ventilatieopeningen niet met enige voorwerpen, zoals tafelkleden, kranten, gordijnen, enz.
- Plaats geen brandende voorwerpen, zoals kaarsen, op het apparaat.
- Volg bij het weggoien van verbruikte batterijen de overheidswetgeving of milieuvoorschriften op die van kracht zijn in het land of de regio waarin u zich bevindt.
- Zorg dat er 0,2 meter vrije ruimte rond het toestel is.
- Plaats geen voorwerpen met een vloeistof erin, zoals een bloemenvaas, op het apparaat.
- Als de schakelaar op OFF staat, is het apparaat niet volledig losgekoppeld van de netspanning (MAINS).
- De apparatuur wordt in de buurt van het stopcontact geïnstalleerd, zodat dit altijd gemakkelijk toegankelijk is.
- Raak hete gedeelten van het apparaat niet aan tijdens en onmiddellijk na het gebruik.
- Tijdens en onmiddellijk na het gebruik is dit product heet, behalve in de omgeving van de bedieningstoetsen en de aansluitingen op het achterpaneel. Raak geen hete plekken aan, vooral niet het bovenpaneel. Contact met hete plekken kan brandwonden veroorzaken.

Español

ADVERTENCIAS

- No exponga el equipo a la lluvia ni a la humedad.
- No extraiga la tapa del equipo.
- No introduzca nada en el interior del equipo a través de los orificios de ventilación.
- No maneje el cable de alimentación con las manos mojadas.
- No cubra la ventilación con objetos como manteles, periódicos, cortinas, etc.
- No deben colocarse sobre el equipo elementos con fuego, por ejemplo velas encendidas.
- Cuando se eliminen baterías usadas, deben cumplirse las reglamentaciones oficiales o las normas de protección medioambiental aplicables en su país o en su zona.
- Deje un espacio de unos 0,2 metro alrededor de la unidad.

- No se deben colocar sobre el aparato recipientes que contengan líquidos, como por ejemplo jarrones.
- Cuando el interruptor está en la posición OFF, el equipo no está completamente desconectado de la alimentación MAINS.
- El equipo se instalará cerca de la fuente de alimentación de manera que resulte fácil acceder a ella.
- No tocar las áreas calientes mientras la unidad está en uso ni inmediatamente después.
- Mientras esta en funcionamiento e inmediatamente después de su uso, este producto presenta zonas calientes en diversas partes, no exclusivamente en el sector de los controles o en las conexiones del panel posterior. No tocar las áreas calientes, especialmente el panel superior dado que pueden producirse quemaduras.

Italiano

AVVERTENZE

- Non esporre l'apparecchio alla pioggia o all'umidità.
- Non rimuovere il coperchio dell'apparecchio.
- Non introdurre oggetti all'interno dell'apparecchio attraverso i fori di ventilazione.
- Non toccare il cavo di alimentazione con le mani bagnate.
- Non coprire le fessure di ventilazione con tovaglie, giornali, tende od oggetti analoghi.
- Non posare sull'apparecchio sorgenti di fiamme scoperte quali candele accese.
- Smaltire le pile usate in conformità alle norme governative o disposizioni ambientali vigenti nel proprio paese o zona.
- Lasciare 0,2 metro liberi tutto intorno l'unità.
- Non mettere sull'apparecchiatura alcun contenitore di liquido, come ad esempio dei vasi.
- Quando l'interruttore è nella posizione OFF, l'apparecchiatura non è completamente scollegata da MAINS.
- L'apparecchio va installato in prossimità della fonte di alimentazione, in modo che quest'ultima sia facilmente accessibile.
- Non toccare i punti caldi né durante, né immediatamente dopo l'uso.
- Durante, e subito dopo l'utilizzo, questo prodotto risulta essere molto caldo in alcune sue parti come ad esempio i connettori del pannello posteriore. Non toccare i punti caldi e specialmente la superficie del pannello. Il contatto con parti calde può provocare ustioni.

Svenska

VARNINGAR

- Utsätt inte utrustningen för regn eller fukt.
- Ta inte bort utrustningens hölje.
- För inte in föremål i utrustningen genom ventilationshålen.
- Hantera inte nätsladden med våta händer.
- Täck inte för ventilationsöppningarna med några föremål som till exempel bordsdukar, dagstidningar, gardiner e.d.
- Inga föremål med öppen låga, som till exempel tända stearinljus, bör placeras på utrustningen.
- Följ de lagar och miljöskyddsråd som gäller i det land eller område där du bor när du gör dig av med batterier.
- Se till att det finns omkring 0,2 meter fri plats runt omkring enheten.
- Inga objekt som är fyllda med någon vätska, till exempel blomstervaser, bör placeras på apparaten.
- Även om strömbrytaren står i det avstängda läget OFF, så är utrustningen inte helt bortkopplad från det elektriska nätet (MAINS).
- Utrustningen ska vara installerad nära strömuttaget så att strömförsörjningen är lätt att tillgå.
- Vidrör inte varma punkter under och omedelbart efter användning.
- Bortsett från kontrollerna och anslutningsuttagen på baksidan är den här produkten varm under och omedelbart efter användning. Vidrör inte varma punkter och särskilt inte ovansidan. Kontakt med varma ytor kan orsaka brännskador.

TABLE OF CONTENTS

FOREWORD..... 1

INTRODUCTION 1

PRECAUTIONS..... 1

A NOTE ABOUT RECYCLING 1

DESCRIPTION 2

FEATURES..... 3

ACCESSORIES..... 3

FRONT PANEL 4

 FL DISPLAY 5

REAR PANEL 6

REMOTE CONTROL OPERATION 7

 FUNCTION AND OPERATION 7

 PROGRAMMING THE REMOTE CONTROLLER 8

 OPERATION OF REMOTE CONTROL UNIT 9

 GENERAL INFORMATION OF RC5500SR TO SR3001 9

CONNECTIONS 11

 SPEAKER PLACEMENT 11

 CONNECTING SPEAKERS..... 11

 CONNECTING AUDIO COMPONENTS..... 12

 CONNECTING VIDEO COMPONENTS..... 13

 ADVANCED CONNECTING 14

 CONNECTING THE REMOTE CONTROL JACKS..... 14

 CONNECTING THE ANTENNA TERMINALS..... 15

SETUP 16

 SETUP MENU SYSTEM 16

 ENTER THE DESIRED MENU ITEM

 OF THE SETUP MENU..... 16

 SIMPLE SETUP..... 17

 1. INPUT SETUP (ASSIGNABLE DIGITAL INPUT) 17

 2. SPEAKER SETUP..... 18

 3. PREFERENCE 21

 4. SURROUND 21

 5. PL II (DOLBY PRO LOGIC II) MUSIC PARAMETER..... 22

 6. CS II (CIRCLE SURROUND II) 22

BASIC OPERATION (PLAY BACK).....23

 SELECTING AN INPUT SOURCE.....23

 SELECTING THE SURROUND MODE.....23

 ADJUSTING THE MAIN VOLUME23

 ADJUSTING THE TONE (BASS & TREBLE) CONTROL23

 TEMPORARILY TURNING OFF THE SOUND23

 USING THE SLEEP TIMER23

 NIGHT MODE23

SURROUND MODE24

OTHER FUNCTION.....27

 ATTENUATION TO ANALOG INPUT SIGNAL27

 LISTENING THROUGH HEADPHONES27

 VIDEO ON/OFF27

 DISPLAY MODE.....27

 SELECTING ANALOG AUDIO INPUT OR DIGITAL AUDIO INPUT27

 RECORDING AN ANALOG SOURCE.....28

 HT-EQ28

 7.1 CH INPUT.....28

 7.1 CH INPUT LEVEL.....29

BASIC OPERATION (TUNER).....30

 LISTENING TO THE TUNER.....30

 PRESET MEMORY30

 RDS OPERATION.....32

SURROUND SPEAKER B SYSTEM.....33

 MULTI ROOM PLAYBACK USING THE S(SURROUND)

 SPEAKER B TERMINALS33

TROUBLESHOOTING34

TECHNICAL SPECIFICATIONS.....35

DIMENSIONS35

FOREWORD

This section must be read before any connection is made to the mains supply.

EQUIPMENT MAINS WORKING SETTING

Your Marantz product has been prepared to comply with the household power and safety requirements that exist in your area.
SR3001 can be powered by 230V AC only.

COPYRIGHT

Recording and playback of any material may require consent. For further information refer to the following:

- Copyright Act 1956
- Dramatic and Musical Performers Act 1958
- Performers Protection Acts 1963 and 1972
- any subsequent statutory enactments and orders

INTRODUCTION

Thank you for purchasing the Marantz SR3001 Surround receiver. This remarkable component has been engineered to provide you with many years of home theater enjoyment. Please take a few minutes to read this manual thoroughly before you connect and operate the SR3001.

As there are a number of connection and configuration options, you are encouraged to discuss your own particular home theater setup with your Marantz A/V specialist dealer.

PRECAUTIONS

CAUTIONS ON INSTALLATION

For heat dispersal, leave at least 0.2 m/8 inch of space between the top, back and sides of this unit and the wall or other components.

- Do not obstruct the ventilation holes.

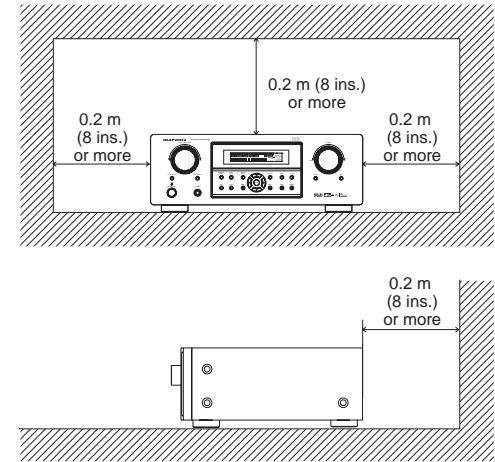

A NOTE ABOUT RECYCLING

This product's packaging materials are recyclable and can be reused. This product and the accessories packed together are the applicable product to the WEEE directive except batteries. Please dispose of any materials in accordance with your local recycling regulations. When discarding the unit, comply with your local rules or regulations. Batteries should never be thrown away or incinerated but disposed of in accordance with your local regulations concerning chemical wastes.

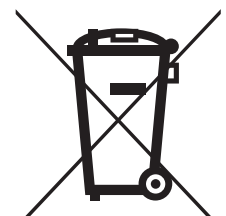

DESCRIPTION



DTS was introduced in 1994 to provide 5.1 channels of discrete digital audio into home theater systems.

DTS brings you premium quality discrete multichannel digital sound to both movies and music.

DTS is a multichannel sound system designed to create full range digital sound reproduction.

The no compromise DTS digital process sets the standard of quality for cinema sound by delivering an exact copy of the studio master recordings to neighborhood and home theaters.

Now, every moviegoer can hear the sound exactly as the moviemaker intended.

DTS can be enjoyed in the home for either movies or music on of DVD's, LD's, and CD's.

"DTS" and "DTS Digital Surround" are registered trademarks of Digital Theater Systems, Inc.



The advantages of discrete multichannel systems over matrix are well known.

But even in homes equipped for discrete multichannel, there remains a need for high-quality matrix decoding. This is because of the large library of matrix surround motion pictures available on disc and on VHS tape; and analog television broadcasts.

The typical matrix decoder of today derives a center channel and a mono surround channel from two-channel matrix stereo material. It is better than a simple matrix in that it includes steering logic to improve separation, but because of its mono, band-limited surround it can be disappointing to users accustomed to discrete multichannel.

Neo:6 offers several important improvements as follow,

- Neo:6 provides up to six full-band channels of matrix decoding from stereo matrix material. Users with 6.1 and 5.1 systems will derive six and five separate channels, respectively, corresponding to the standard home-theater speaker layouts.
- Neo:6 technology allows various sound elements within a channel or channels to be steered separately, and in a way which follows naturally from the original presentation.
- Neo:6 offers a music mode to expand stereo nonmatrix recordings into the five- or six-channel layout, in a way which does not diminish the subtlety and integrity of the original stereo recording.



DTS-ES Extended Surround is a new multichannel digital signal format developed by Digital Theater Systems Inc. While offering high compatibility with the conventional DTS Digital Surround format, DTS-ES Extended Surround greatly improves the 360-degree surround impression and space expression thanks to further expanded surround signals. This format has been used professionally in movie theaters since 1999.

In addition to the 5.1 surround channels (FL, FR, C, SL, SR and LFE), DTS-ES Extended Surround also offers the SB (Surround Back) channel for surround playback with a total of 6.1 channels. DTS-ES Extended Surround includes two signal formats with different surround signal recording methods, as DTS-ES Discrete 6.1 and DTS-ES Matrix 6.1.

"DTS", "DTS-ES" and "Neo:6" are trademarks of Digital Theater Systems, Inc.



The stereo CD is a 16-bit medium with sampling at 44.1 kHz. Professional audio has been 20- or 24-bit for some time, and there is increasing interest in higher sampling rates both for recording and for delivery into the home. Greater bit depths provide extended dynamic range. Higher sampling rates allow wider frequency response and the use of anti-alias and reconstruction filters with more favorable aural characteristics.

DTS 96/24 allows for 5.1 channel sound tracks to be encoded at a rate of 96kHz/24bits on DVD-Video titles.

When DVD-video appeared, it became possible to deliver 24-bit, 96 kHz audio into the home, but only in two channels, and with serious limitations on picture. This capability has had little use.

DVD-audio allows 96/24 in six channels, but a new player is needed, and only analog outputs are provided, necessitating the use of the D/A converters and analog electronics provided in the player.

DTS 96/24 offers the following:

1. Sound quality transparent to the original 96/24 master.
2. Full backward compatibility with all existing decoders. (Existing decoders will output a 48 kHz signal)

3. No new player required: DTS 96/24 can be carried on DVD-video, or in the video zone of DVD-audio, accessible to all DVD players.

4. 96/24 5.1-channel sound with full-quality full-motion video, for music programs and motion picture soundtracks on DVD-video.

"DTS" and "DTS 96/24" are trademarks of Digital Theater Systems, Inc.



Dolby Digital identifies the use of Dolby Digital audio coding for such consumer formats as DVD and DTV. As with film sound, Dolby Digital can provide up to five full-range channels for left, center, and right screen channels, independent left and right surround channels, and a sixth (".1") channel for low-frequency effects.

Dolby Surround Pro Logic II is an improved matrix decoding technology that provides better spatiality and directionality on Dolby Surround program material; provides a convincing three-dimensional soundfield on conventional stereo music recordings; and is ideally suited to bring the surround experience to automotive sound. While conventional surround programming is fully compatible with Dolby Surround Pro Logic II decoders, soundtracks will be able to be encoded specifically to take full advantage of Pro Logic II playback, including separate left and right surround channels. (Such material is also compatible with conventional Pro Logic decoders.)

Dolby Digital EX creates six full-bandwidth output channels from 5.1-channel sources. This is done using a matrix decoder that derives three surround channels from the two in the original recording. For best results, Dolby Digital EX should be used with movies soundtracks recorded with Dolby Digital Surround EX.

About Dolby Pro Logic IIx

Dolby Pro Logic IIx technology delivers a natural and immersing 7.1-channel listening experience to the home theater environment. A product of Dolby's expertise in surround sound and matrix decoding technologies, Dolby Pro Logic IIx is a complete surround sound solution that maximizes the entertainment experience from stereo as well as 5.1-channel encoded sources.

Dolby Pro Logic IIx is fully compatible with Dolby Surround Pro Logic technology and can optimally decode the thousands of commercially available Dolby Surround encoded video cassettes and television programs with enhanced depth and spatiality. It can also process any high-quality stereo or Advanced Resolution 5.1-channel music content into a seamless 6.1- or 7.1-channel listening experience.

Manufactured under license from Dolby Laboratories. "Dolby", "Pro Logic", and the double-D symbol are trademarks of Dolby Laboratories.



Circle Surround II (CS-II) is a powerful and versatile multichannel technology. CS-II is designed to enable up to 6.1 multichannel surround sound playback from mono, stereo, CS encoded sources and other matrix encoded sources. In all cases the decoder extends it into 6 channels of surround audio and a LFE/subwoofer signal. The CS-II decoder creates a listening environment that places the listener "inside" music performances and dramatically improves both hi-fi audio conventional surround-encoded video material. CS-II provides composite stereo rear channels to greatly improve separation and image positioning – adding a heightened sense of realism to both audio and A/V productions.

CS-II is packed with other useful feature like dialog clarity (SRS Dialog) for movies and cinema-like bass enrichment (TruBass). CS-II can enable the dialog to become clearer and more discernable in movies and it enables the bass frequencies contained in the original programming to more closely achieve low frequencies – overcoming the low frequency limitations of the speakers by full octave.

Circle Surround II, Dialog Clarity, TruBass, SRS and  symbol are trademarks of SRS Labs, Inc. Circle Surround II, Dialog Clarity and TruBass technology are incorporated under license from SRS Labs, Inc.



HDCD® (High Definition Compatible Digital®) is a patented process for delivering on Compact Disc the full richness and details of the original microphone feed.

HDCD encoded CDs sound better because they are encoded with 20-bits of real musical information as compared to 16-bits for all other CDs.

HDCD overcomes the limitation of the 16-bit CD format by using a sophisticated system to encode the additional four bits onto the CD while remaining completely compatible with the CD format.

When listening to HDCD recordings, you hear more dynamic range, a focused 3-D sound stage, and extremely natural vocal and musical timbre. With HDCD, you get the body, depth and emotion of the original performance not a flat, digital imitation.

HDCD system manufactured under license from Microsoft. This product is covered by one or more of the following: In the United States 5,479,168 5,638,074 5,640,161 5,808,574 5,838,274 5,854,600 5,864,311 5,872,531 and in Australia 669,114 with other patents pending.

FEATURES

The SR3001 incorporates the latest generation of digital surround sound decoding technology such as Dolby Digital EX, Dolby Digital, DTS ES (Discrete 6.1 and Matrix 6.1), DTS Neo:6 (Cinema, Music), Dolby Pro-Logic IIx (Movie, Music and Game), Circle Surround II (Cinema and Music).

In addition, Marantz has focused on the future. By utilizing pre-out jack, 7.1 direct inputs the SR3001 is tomorrow's technology, today!

The SR3001 features a fully discrete 7 channel amplifier section capable of delivering 60 watts of high-current amplification, for continuously clean and stable power into each of the seven channels. It employs a massive EI power transformer in combination with oversized filter capacitors. This design configuration is capable of a clear and powerful reproduction of the most demanding action movie soundtracks and full range (multichannel) music discs. Through its ability to generate very high output voltages, the SR3001 can easily drive the most demanding speakers with optimum results.

The SR3001 incorporates the most advanced Digital Signal Processing circuitry, along with a Crystal® 192 kHz/24 bit D/A converter in each of the 7 channels. Independent power supply circuits are incorporated for the FL display, audio and video sections for maximum separation, clarity and dynamic range. Together with hand-selected customized components, all elements work in harmony to recreate the emotion, exactly as the artist had intended.

The SR3001 is designed and engineered with extensive feedback from dealers and consumers. It features a heavy duty speaker binding posts and an extensive array of both analog and digital inputs / outputs. With 3 assignable digital inputs, 2 component inputs and SACD Multi Channel (7.1 channel) direct inputs is taken to a stunning new level.

An easy-to-use universal remote control allows full access to all of the operating functions and can be used for system operation as well.

This unit has Simple Setup function for easy setup. You can setup all speaker settings by just selecting your room size and the number of your speakers with Simple Setup function. You can also setup customized settings just like conventional AV amplifiers.

The TruSurround Headphone technology provides a surround sound listening experience over headphones.

When listening to multichannel content such as DVD movies over headphones, the listening experience is fundamentally different than listening to speakers. Since the headphone speaker drivers are covering the pinna of the ear, the listening experience differs greatly from traditional speaker playback. TruSurround utilizes patented headphone perspective curves to solve this problem and provides a non-fatiguing, immersive, home theater listening experience. TruSurround Headphone also delivers exceptional 3D audio from mono and stereo material.

- Dolby Digital EX, Dolby Digital , DTS ES (Discrete 6.1, Matrix 6.1, Neo: 6)
- Dolby Pro Logic IIx (Movie, Music, Game)
- Circle Surround II (Movie, Music, Mono)
- HDCD decoding
- 7 × 60 Watts (8 Ohm), Discrete Amplifiers
- Massive Energy Power Supply, Huge EI Transformer, Large ELCO's.
- 192 kHz/24 bit Crystal® DAC for all 7 Channels
- 32 bit Digital Surround Processing Chipsets
- Video Off Mode
- Large Heavy Duty Speaker Terminals for all Channels
- Auto Input Signal Detection
- Improved Station Name Input Method, 50 Presets
- Auto Adjust Function for Speaker Distance Settings (Delay Time)
- Universal remote control
- Simple Setup Function

ACCESSORIES

Remote Controller RC5500SR

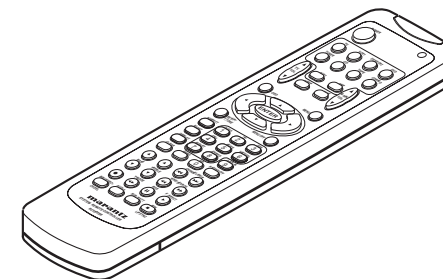

AAA-size batteries × 2

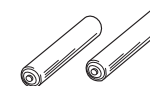

AM Loop Antenna

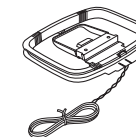

FM Antenna

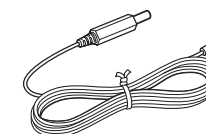

User Guide

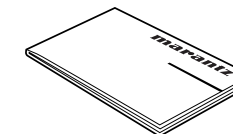

FRONT PANEL

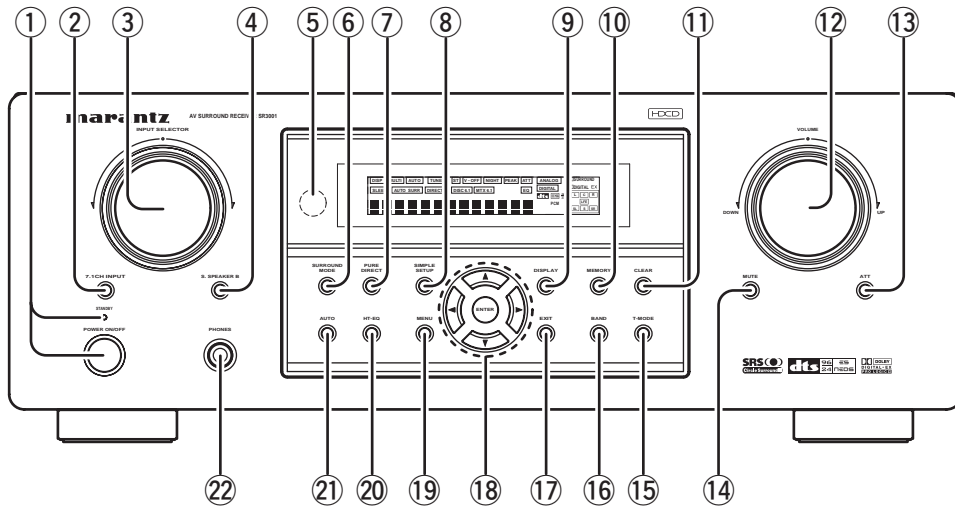

① POWER switch and STANDBY indicator

Press the button to turn the power ON, and press again to turn it OFF. If the **POWER** switch is in the ON position, the power of this unit can be turned ON/OFF by pressing the **POWER** button on the remote control unit. When this unit is in the standby mode with the **POWER** switch set to the ON position, pressing the **ENTER** button also allows to turn the power on. The **STANDBY** indicator lights up when this unit is the standby mode (power OFF) by the remote control unit.

② 7.1CH INPUT button

Press this button to select the output of an external multichannel player.

③ INPUT SELECTOR knob (AUDIO/VIDEO)

This knob is used to select the input sources. The video function selector, such as TV, DVD, VCR1 and DSS, selects video and audio simultaneously. Audio function sources such as CD, TAPE, CDR/MD, and TUNER may be selected in conjunction with a Video source.

This feature (Sound Injection) combines a sound from one source with a picture from another. Choose the video source first, and then choose a different audio source to activate this function.

④ S.(Surround) SPEAKER B button

Press this button to activate the Surround Speaker B system. "SPKR B" indicator will be illuminated in the display. (See page 33)

⑤ INFRARED receiving sensor window

This window receives infrared signals for the remote control.

⑥ SURROUND MODE button

You can select the surround mode by pressing this button.

⑦ PURE DIRECT button

When this button is pressed, the tone control circuitry is bypassed as well as Bass Management. **DIRECT** indicator will be illuminated in the display.

Notes:

- The surround mode is automatically switched to **AUTO** when the pure direct function is turned on.
- Additionally, Speaker Configurations are fixed automatically as follows.
Front SPKR = Large, Center SPKR = Large, Surround SPKR = Large, Sub woofer = On
- This function is unavailable when the surround speaker B system is activated. While this function is activated, this function will be canceled if the **S. SPEAKER B** button is pressed.

⑧ SIMPLE SETUP button

Press this button to enter the simple setup mode. You can setup the speaker conditions (speaker sizes, number of speakers, speaker delay times) quickly by pressing the cursor buttons.

⑨ DISPLAY button

When this button is pressed, the FL display mode is changed as Surround Mode → Auto-display Off → Display Off → Input Function and the display off indicator (**DISP**) lights up in condition of DISPLAY OFF.

⑩ MEMORY button

Press this button to enter the tuner preset memory numbers or station names. (See page 30)

⑪ CLEAR button

Press this button to cancel the station-memory setting mode or preset scan tuning. (See page 31)

⑫ VOLUME control knob

Adjusts the overall sound level. Turning the control clockwise increases the sound level.

⑬ ATT (Attenuate) button

If the selected analog audio input signal is greater than the capable level of internal processing, the **PEAK** indicator will illuminate. If this happens, you should press the **ATT** button. "**ATT**" is displayed when this function is activated.

The signal-input level is reduced by about half. Attenuation will not work with the output signal of "REC OUT" (TAPE, CD-R/MD, VCR1 and VCR2 output). This function is memorized for each input function.

⑭ MUTE button

Press this button to mute the output to the speakers. Press it again to return to the previous volume level.

⑮ T-MODE button

Press this button to select the auto stereo mode or mono mode when the FM band is selected. The "**AUTO**" indicator lights in the auto stereo mode. (See page 30)

⑯ BAND button

Press this button to switch between FM and AM in the TUNER mode.

⑰ EXIT button

This button is used to exit from the SETUP MAIN MENU.

⑱ Cursor (◀, ▶, ▲, ▼) / ENTER button

Use these buttons when operating the SETUP MAIN MENU and TUNER function.

⑲ MENU button

This button is used to enter the SETUP MAIN MANU.

⑳ HT-EQ button

Used to turn on or off HT(Home Theater)-EQ mode. This mode compensates for the audio portion of a movie sounding "bright". When this button is pressed, "EQ" indicator lights up.

㉑ AUTO (Auto surround) button

Press this button to select the **AUTO** mode from the surround modes. When this mode is selected, the receiver determines the surround mode corresponding to a digital input signal automatically.

22 **HEADPHONE jack for stereo headphones**

This jack may be used to listen to the SR3001's output through a pair of headphones. Be certain that the headphones have a standard 1 / 4" stereo phono plug. Note that the main room speakers will automatically be turned off when the headphone jack is in use.

Notes:

- When using headphones, the surround mode will change to STEREO and TruSurround (TS) headphones by SURROUND MODE button.
- The surround mode returns to the previous setting as soon as the headphone plug is removed from the jack.

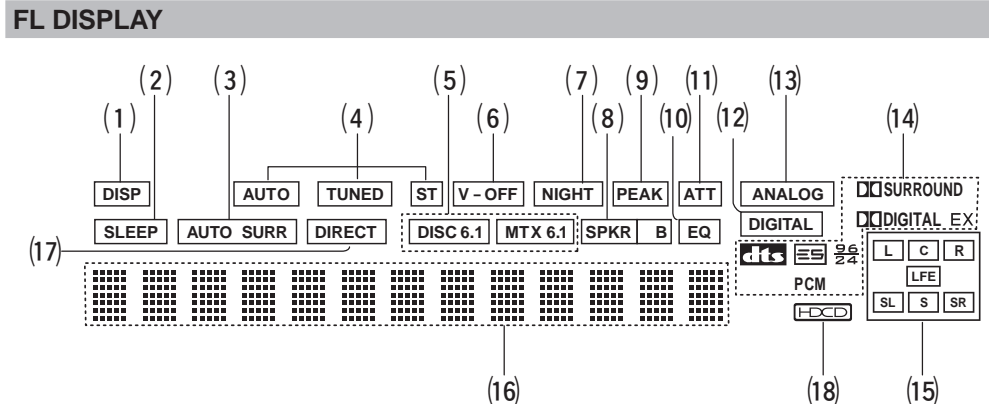

(1) **DISP (Display Off) indicator**

This indicator is illuminated when the SR3001 is in the display off condition.

(2) **SLEEP timer indicator**

This indicator is illuminated when the sleep timer function is active.

(3) **AUTO SURR (Auto Surround mode) indicator**

This indicator is illuminated to show that the AUTO SURROUND mode is in use.

(4) **TUNER's indicators**

AUTO : This indicator illuminates when the tuner's Auto mode is in use.

TUNED : This indicator illuminates when a station is being received with sufficient signal strength to provide acceptable listening quality.

ST(Stereo) : This indicator illuminates when an FM station is being tuned into stereo condition.

(5) **DTS-ES mode indicators (DISC6.1, MTX6.1)**

These indicators will illuminate to show the DTS-ES decoding mode (Discrete 6.1 or Matrix 6.1).

(6) **V (video)-OFF mode indicator**

This indicator is illuminated when the Video-OFF function is active.

(7) **NIGHT mode indicator**

This indicator is illuminated when the SR3001 is in the Night mode, which reduces the dynamic range of digital program material at low volume levels.

(8) **SPKR (Speaker) B indicator**

This indicator is illuminated when the S(Surround) speaker B system is active.

(9) **PEAK indicator**

This indicator is a monitor for an analog audio input signal. If the selected analog audio input signal is greater than the capable level of internal processing, this will illuminate. If this happens, you should press the **ATT** button on the front panel or the remote.

(10) **EQ mode indicator**

This indicator is illuminated when the HT-EQ function is active.

(11) **ATT (Attenuation) indicator**

This indicator is illuminated when the attenuation function is active.

(12) **DIGITAL Input Indicator**

This indicator lights when a digital input has been selected.

(13) **ANALOG input indicator**

This indicator is illuminated when an analog input source has been selected.

(14) **SIGNAL FORMAT indicators**

□□ DIGITAL, EX, □□ SURROUND, dts, ES, 96/24, PCM

When the selected input is a digital source, some of these indicators will be illuminated to display the specific type of signal in use.

(15) **ENCODED CHANNEL STATUS indicators**

These indicators display the channels that are encoded with a digital

input signal. If the selected digital input signal is Dolby Digital 5.1ch or DTS 5.1ch, "L", "C", "R", "SL", "SR" and "LFE" will be illuminated. If the digital input signal is 2 channel PCM-audio, "L" and "R" will be displayed.

If Dolby Digital 5.1ch signal with Surround EX flag or DTS-ES signal comes in, "L", "C", "R", "SL", "S", "SR" and "LFE" will be illuminated.

(16) **Main Information Display**

This display shows messages relating to the status, input source, surround mode, tuner, volume level or other aspects of unit's operation.

(17) **DIRECT (Pure direct) indicator**

This indicator is illuminated when the SR3001 is in the PURE DIRECT mode.

(18) **HDCD indicator**

When HDCD signal is decoded from digital input, this indicator will light up.

REAR PANEL

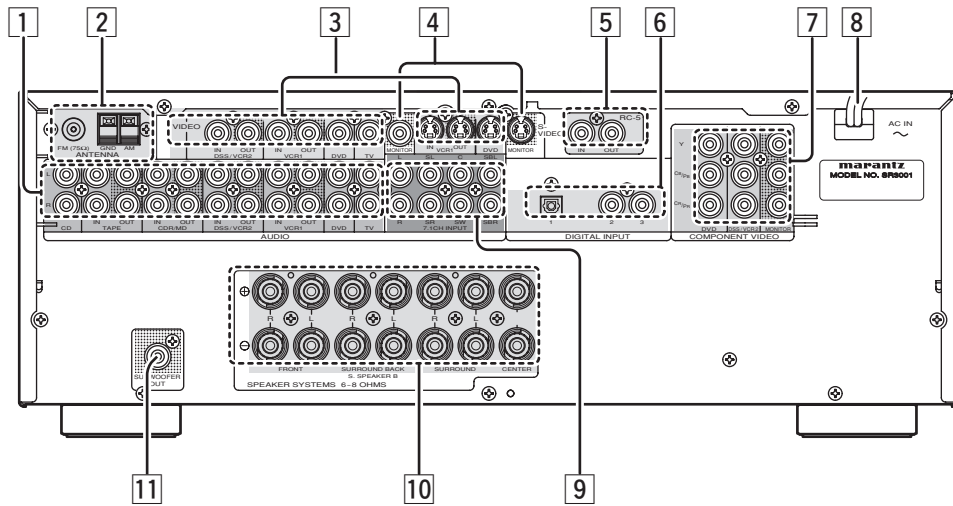

1 AUDIO IN/OUT (CD, TAPE, CD-R/MD, TV, DVD, VCR1, DSS/VCR2)

These are the analog audio inputs and outputs. There are 7 audio inputs (4 of which are linked to video inputs) and 4 audio outputs (2 of which are linked to video outputs). The audio jacks are nominally labeled for cassette tape decks, compact disc players, DVD players and etc.... The audio inputs and outputs require RCA-type connectors.

2 FM antenna terminal (75 ohms)

Connect an external FM antenna with a coaxial cable, or a cable network FM source.

AM antenna and ground terminals

Connect the supplied AM loop antenna. Use the terminals marked "AM" and "GND". The supplied AM loop antenna will provide good AM reception in most areas. Position the loop antenna until you hear the best reception.

3 VIDEO IN/OUT (TV, DVD, VCR1, DSS/VCR2)

These are the video inputs and outputs. There are 4 video inputs and 2 video outputs and each one includes both composite video and S-video configurations. Connect VCRs, DVD players, and other video components to the video inputs. The 2 video output channels can be used to be connected to video tape recorders for making recordings.

4 MONITOR OUT

This is a monitor output and each one includes both composite video and S-video configurations.

5 REMOTE CONT. IN/OUT terminals

Connect to a Marantz component equipped with remote control (RC-5) terminals.

6 DIGITAL INPUT (Dig.1 - 3) (coaxial, optical)

There are 2 digital inputs with coaxial jacks, 1 with optical jack.

The inputs accept digital audio signals from a compact disc, LD, DVD, or other digital source component.

7 COMPONENT VIDEO INPUT/OUTPUT

If your DVD player or other device has component video connectors, be sure to connect them to these component video connectors on the SR3001. The SR3001 has two component video input connectors to obtain the color information (Y, C_B, C_R) directly from the recorded DVD signal or other video component and one component video output connector to output it directly into the matrix decoder of the display device. By sending the pure DVD component video signal directly, the DVD signal forgoes the extra processing that normally would degrade the image. The result is vastly increased image quality, with incredibly life like colors and crisp detail.

8 AC Power Cord

Connect to an AC power outlet. SR3001 has to be powered by 230V AC only.

9 7.1 CHANNEL INPUT

By connecting a DVD Audio player, SACD multichannel player, or other components that has a multichannel port, you can playback the audio with 5.1 channel or 7.1 channel outputs.

10 Speaker outputs terminals

Seven terminals are provided for the front left, front right, front center, surround left, surround right, surround back left and surround back right speakers.

Note:

You can use surround back speaker terminals as S(Surround) SPEAKER B terminals, when you use no surround back speaker.

11 Subwoofer Output

Connect this jack to the line level input of a powered subwoofer. If an external subwoofer amplifier is used, connect this jack to the subwoofer amplifier input. If you are using two subwoofers, either powered or with a 2 channel subwoofer amplifier, connect a "Y" connector to the subwoofer output jack and run one cable from it to each subwoofer amplifier.

REMOTE CONTROL OPERATION

FUNCTION AND OPERATION

The provided remote control unit is a universal remote controller. The **POWER** button, numeric buttons and control buttons are used in common across different input source components.

The input source controlled with the remote control unit changes when one of the input selector buttons is pressed.

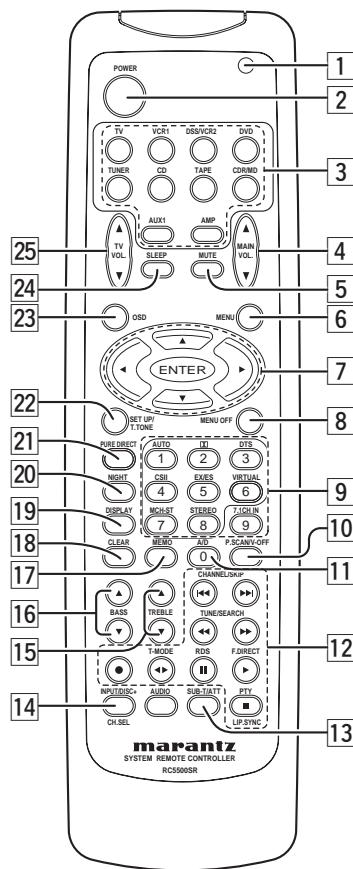

1 Transmitting indicator

Lights up during a button is pressed and an infra-red signal is sending.

2 (Main) POWER buttons

(when AMP mode is selected)

Press to switch the power of the SR3001 ON or OFF after pressing the **AMP** button.

3 Input selector buttons/ FUNCTION SELECTOR buttons (AUDIO/VIDEO INPUT)

These buttons are used to select a Audio or Video source component. Press one of these buttons once to change the function of the remote control. Press same button within 2 seconds, the input function of the SR3001 is changed.

Audio function sources such as CD, TAPE, CDR/MD, and TUNER may be selected in conjunction with a Video source.

This feature (Sound Injection) combines a sound from one source with a picture from another. Choose the video source first, and then choose a different audio source to activate this function.

Notes:

- CDR/MD button is set CDR function at initial. To switch MD function, press and hold down **CDR/MD** button and press **2** button.
- To return CDR function, press and hold down **CDR/MD** button and press **1** button.

4 MAIN VOLUME UP (▲) /DOWN (▼) buttons

Main volume control of the SR3001. The front, surround, center and subwoofer channel volumes controlled by these buttons simultaneously.

5 MUTE button

Muting button of the SR3001. Press this button decrease the sound temporarily. Press this button again to return to the previous sound. When this button is pressed, "MUTE" indicator lights up.

6 MENU button

(when AMP mode is selected)

This button is used to enter the SETUP MAIN MENU.

7 Cursor (◀, ▶, ▲, ▼) / OK buttons

(when AMP mode is selected)

Use these button when operating the SETUP MAIN MENU.

8 MENU OFF button

(when AMP mode is selected)

This button is used to exit from the SETUP MAIN MENU.

9 Numeric buttons 1 to 9 / Surround mode buttons

Numeric buttons

These buttons are used to enter figures in the selection of a tuner preset station and station name preset or to set select a CD track number, etc. The functions of these buttons are dependent on the function button selected.

Surround mode buttons

(when AMP mode is selected)

These buttons are used to select the surround mode.

10 P.SCAN (Preset scan) / V(Video)-OFF button

(when TUNER mode is selected)

This button is used to start preset scan when SR3001 is selected TUNER mode.

(when AMP mode is selected)

This is used when switching the video signals from the various monitor outputs to Video-Off mode.

11 0 / A/D button

0 button

This button is used to enter the number "0"

A/D button (when AMP mode is selected)

This is used to switch between the analog and digital inputs.

12 CONTROL buttons

These buttons are used when operating the CD player, TAPE deck, etc.

The function of these buttons are dependent on the function button selected.

For the controllable functions of each input function, please refer to controllable function table on the page 10.

13 SUB-T (Title) / ATT (attenuator) button

When the input signal is too high and the voice distorts even while adjusting the SR3001 VOLUME control, turn on this function. "ATT" is illuminated when this function is activated.

The input level is reduced. Attenuator is invalid for the output signal of "REC OUT".

Note:

This function is unavailable while the digital input is selected.

14 INPUT/DISC+ / CH.SEL buttons

This button is used to enter the input level setup menu.

15 TREBLE UP (▲) /DOWN (▼) buttons

These buttons are used to adjust the tone control of high frequency sound for left and right speaker.

16 BASS UP (▲) /DOWN (▼) buttons

These buttons are used to adjust the tone control of low frequency sound for left, right and subwoofer speaker.

17 MEMO button

Memory enable button for various preset functions.

18 CLEAR button

This button is used to cancel for certain memory or programming operations.

19 DISPLAY button

Selects the display mode for the front display of the SR3001.

20 NIGHT button

Pressing this button prevents the Dolby Digital signal from playback at a loud voice. This function reduces the voice by 1/3 to 1/4 at maximum. Thus, it eliminates the occurrence of an abruptly loud voice at night. However, the function is valid only in the case when the Dolby Digital signal is entered into OPTICAL or COAXIAL and data to compress the voice exists in the signal to be played back. When this button is pressed, the "NIGHT" indicator is illuminated.

21 PURE DIRECT button

When this button is pressed, the tone control circuit is bypassed.

22 SETUP / T.TONE button

(when AMP mode is selected)
Used to enter the test tone menu.

23 OSD button

Note:

This button is unavailable for SR3001.

24 SLEEP (sleep timer) button

This button is used for setting the sleep timer. It can be operated the same way as the button on the unit.

25 TV VOLUME UP (▲) /DOWN (▼) buttons

These buttons increase or decrease TV's volume.

PROGRAMMING THE REMOTE CONTROLLER

The remote controller RC5500SR must be programmed to use the codes for your appliances of different brands. This is done by keying in a 4-digit code or by scanning the codes until the correct one is found. We recommend to using the 4-digit code. This mode is faster and more reliable. The code scanning method should be used only if you cannot find the code for one of your appliances. The codes are listed at the end of this book.

Important:

- Use the remote control buttons for programming, not the buttons of the receiver or other appliances.
- Some codes may be not match your equipment. In this case, your equipment cannot be controlled with this remote controller.

PROGRAMMING WITH THE 4-DIGIT CODE

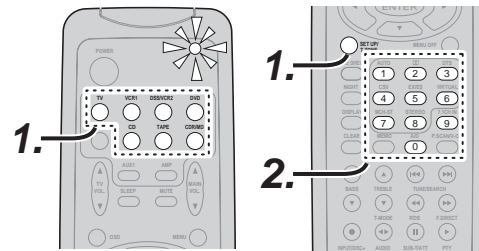

1. Press and hold down the **Function Selector** button for the appliance which should be controlled and press **SETUP** button until the indicator blinks twice.
2. Press the 4-digit code for appliance (code table at the end of this book)
3. When the procedure is successful, the indicator will blink twice.

Note:

If the indicator did not blink twice, then repeat steps 1 through 2 and try entering the same code again.

SCANNING THE CODE TABLE

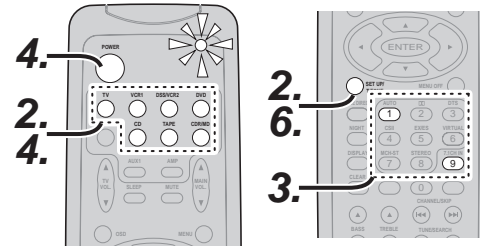

1. Switch on the appliance which should be controlled.
2. Press and hold down the **Function Selector** button for appliance which should be controlled and press **SETUP** button until the indicator blinking twice.
3. Press the code **9 - 9 - 1**.
The indicator will blink twice.
4. Aim the remote control at the appliance and slowly alternate between pressing **POWER** button and the **Function Selector** button for the appliance.
5. Stop when the appliance turns off.
6. Press **SETUP** button once to lock in the code.

CHECKING THE CODE

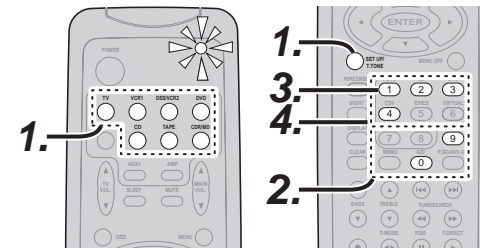

1. Press and hold down the **Function Selector** button for appliance which should be controlled and press **SETUP** button until the indicator blinking twice.
2. Press the code **9 - 9 - 0**.
The indicator will blink twice.
3. To view the code for first digit, press **1** once.
Wait 3 seconds, count the indicator blinks (e.g. 3 blinks = 3) and write down the number.

Note:

If a code digit is "0", the indicator will not blink.

4. Repeat step 3 three more times for remaining digits. Use **2** for the second digit, **3** for the third digit, and **4** for the fourth digit.

RESETTING THE ALL CODE

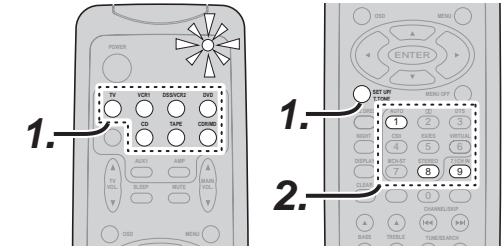

1. Press and hold down the any **Function Selector** button and press **SETUP** button until the indicator blinking twice.
2. Press the code **9 - 8 - 1**.
The indicator will blink twice.
Then, RC5500SR will return to the factory preset code.

Note:

After this procedure, the selected function button is set initial code and other function buttons are set initial code too.

Once you have found and the codes for your various appliances, you may want to write them down here.

- TV _____
- VCR _____
- DSS _____
- DVD _____
- CD _____
- TAPE _____
- CDR _____
- MD _____

OPERATION OF REMOTE CONTROL UNIT

REMOTE CONTROL

The distance between the transmitter of the remote control and the IR SENSOR of the SR3001 should be less than 5 meters. If the remote control is pointed in a direction other than the IR SENSOR or if there is an obstacle between them, use of the remote control may not be possible.

Remote-controllable range

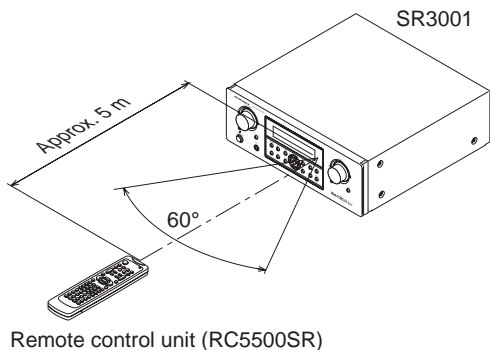

LOADING BATTERIES

The life of the batteries used with the remote control is about 4 months with normal use. Also be sure to replace batteries earlier when you notice that they are getting weak.

1. Remove the back cover.

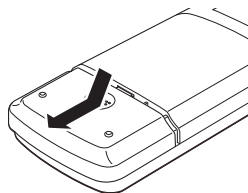

2. Insert the new batteries (AAA type) with correct + and - polarity.

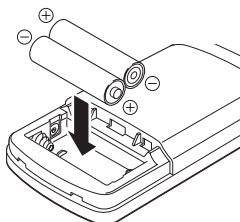

3. Close the cover until it clicks.

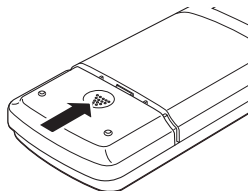

GENERAL INFORMATION OF RC5500SR TO SR3001

To control the SR3001 by your RC5500SR, you have to select the device AMP or TUNER by pressing the function selector button. Please refer below for the details in AMP and TUNER mode.

AMP MODE

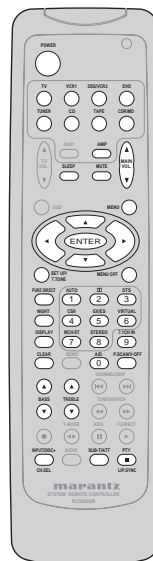

| | |
|---------------------|--|
| POWER | Turns the SR3001 on and off |
| Function selector * | Selects a particular source component |
| SLEEP * | Sets the sleep timer function |
| MUTE * | Decreases the sound temporarily |
| VOL ▲▼ * | Adjusts the over all sound level |
| MENU | Enters the SETUP MENU |
| Cursor | Moves the cursor for settings in the SETUP MENU |
| ENTER | • Enters the SETUP MENU • Confirms the settings in SETUP MENU |
| SETUP/T.TONE | Enters the test tone mode for setting the Speaker Level Setup |
| MENU OFF | Exits from the SETUP MENU |
| PURE DIRECT * | Selects the Pure Direct mode |
| NIGHT * | Turns on or off the NIGHT mode |
| DISPLAY * | Change the front display mode |
| Surround mode (1-8) | Selects the surround mode |
| 7.1CH-IN (9) | Selects the 7.1CH IN |
| A/D (0) | Switches between the analog and digital inputs |
| BASS ▲▼ * | Adjusts the tone control of low frequency sound |
| TREBLE ▲▼ * | Adjusts the tone control of high frequency sound |
| SUB-T/ATT | Reduces the input level |
| P.SCAN/V-OFF | Turns on or off the Video output |
| CH. SEL | Adjusts the input level |
| LIP.SYNC | Selects the LIP. SYNC mode |

* These buttons are used to control SR3001 in any function mode.

TUNER MODE

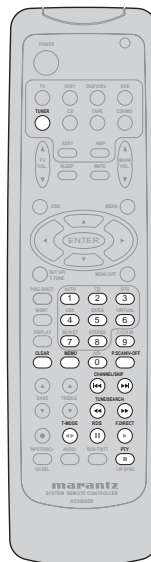

| | |
|--------------|--|
| TUNER | Selects a frequency band |
| 0-9 | Inputs the numeric #s |
| CLEAR | Clears the inputting |
| MEMO | Enters the tuner preset memory numbers |
| P.SCAN/V-OFF | Starts preset scan |
| CHANNEL/SKIP | • Selects a preset station • Changes a PTY type * |
| TUNE/SEARCH | Tunes a station |
| ◀▶ | Selects the auto stereo mode or mono mode |
| RDS ■ | Selects the display mode in RDS * |
| F.DIRECT ▶ | Selects the "Frequency direct input" |
| PTY ■ | Displays the programmed information of the current station * |

* : European model only

THE CONTRABLE FUNCTION TABLE

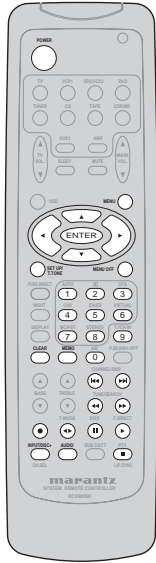

| | TV | VCR | DVD | DSS | CD | TAPE | CDR | MD |
|-----------------|---------------|---------------|---------------|---------------|----------------|----------------|----------------|----------------|
| POWER | POWER | POWER | POWER | POWER | POWER | POWER | POWER | POWER |
| MENU | CALL UP MENU | CALL UP MENU | CALL UP MENU | CALL UP MENU | SWITCH DISPLAY | SWITCH DISPLAY | SWITCH DISPLAY | SWITCH DISPLAY |
| Cursor | Cursor | Cursor | Cursor | Cursor | - | - | - | - |
| ENTER | OK | OK | OK | OK | - | - | - | - |
| SETUP/T.TONE | - | - | SETUP MENU | - | - | - | - | - |
| MENU OFF | - | CANCEL MENU | - | CANCEL MENU | - | - | - | - |
| 0 - 9 | INPUT NUMERIC | INPUT NUMERIC | INPUT NUMERIC | INPUT NUMERIC | INPUT NUMERIC | INPUT NUMERIC | INPUT NUMERIC | INPUT NUMERIC |
| CLEAR | INPUT CLEAR | TAPE SPEED | INPUT CLEAR | INPUT CLEAR | INPUT CLEAR | INPUT CLEAR | INPUT CLEAR | INPUT CLEAR |
| MEMO | - | - | CALL PROGRAM | - | CALL PROGRAM | CALL PROGRAM | CALL PROGRAM | CALL PROGRAM |
| CHANNEL/SKIP ◀◀ | CH- | PREV | PREV | CH- | PREV | PREV | PREV | PREV |
| CHANNEL/SKIP ▶▶ | CH+ | NEXT | NEXT | CH+ | NEXT | NEXT | NEXT | NEXT |
| TUNE/SEARCH ◀◀ | - | REWIND | REWIND | - | REWIND | REWIND | REWIND | REWIND |
| TUNE/SEARCH ▶▶ | - | FF | FF | - | FF | FF | FF | FF |
| ● (REC) | - | REC | - | - | - | REC | REC | REC |
| T-MODE ◀▶ | - | - | - | - | - | DIRECTION | - | - |
| RDS | - | PAUSE | PAUSE | - | PAUSE | PAUSE | PAUSE | PAUSE |
| F.DIRECT ▶ | - | PLAY | PLAY | - | PLAY | PLAY | PLAY | PLAY |
| INPUT/DISC+ | INPUT SEL. | TV/VCR | DISC+ | TV/DSS | DISC+ | - | DISC+ | - |
| AUDIO | - | AUDIO | AUDIO | AUDIO | - | - | - | - |
| PTY ■ | - | STOP | STOP | - | STOP | STOP | STOP | STOP |
| SUB-T/ATT | - | - | SUBTITLE | - | - | - | - | - |

CONNECTIONS

SPEAKER PLACEMENT

The ideal surround speaker system for this unit is 7-speaker systems, using front left and right speakers, a center speaker, surround left and right speakers, surround back left and right speakers, and a subwoofer.

For best results we recommend that all front speakers be of the same type, with identical or similar driver units. This will deliver smooth pans across the front sound stage as the action moves from side to side.

Your center channel speaker is very important as over 80 % of the dialog from a typical motion picture emanates from the center channel.

It should possess similar sonic characteristics to the main speakers. Surround channel speakers need not be identical to the front channel speakers, but they should be of high quality.

The surround center speaker is useful for playback of Dolby Digital Surround EX or DTS-ES. One of the benefits of both Dolby Digital and DTS is that surround channels are discrete full range, while they were frequency limited in earlier "Pro Logic" type systems.

Bass effects are an important part of home theater. For optimal enjoyment a subwoofer should be used as it is optimized for low frequency reproduction. If you have full range front speakers, however, they may be used in place of a subwoofer with proper setting of the switches in the menu system.

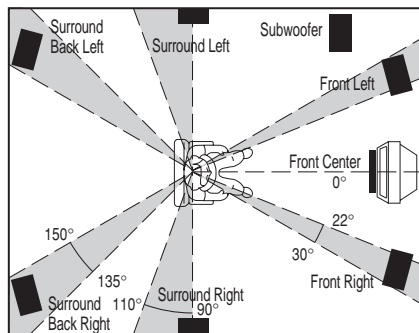

Front left and right speakers

We recommend to set the front L and R speakers with 45-60 degrees from the listening position.

Center speaker

Align the front line of the center speaker with the front L/R speakers. Or place the center speaker a little backward from the line.

Surround left and right speakers

When the SR3001 is used in surround operation, the preferred location for surround speakers is on the side walls of the room, at or slightly behind the listening position.

The center of the speaker should face into the room.

Surround back left and right speakers

Surround back speakers are required when a full 7.1-channel system is installed.

Speakers should be placed on a rear wall, behind the listening position.

The center of the speaker should face into the room.

Subwoofer

We recommend using a subwoofer to have maximum bass effect. Subwoofer bears only low frequency range so you can place it any where in the room.

HEIGHT OF THE SPEAKER UNITS

Front left and right speakers, and a center speaker

Align the tweeters and mid-range drivers on the three front speakers at the same height, as best as possible.

Surround left and right speakers, and surround back speaker

Place the surround left, right and surround back speakers higher than your ears by about 70cm – 1m. Also place the speakers at the same height, as best as possible.

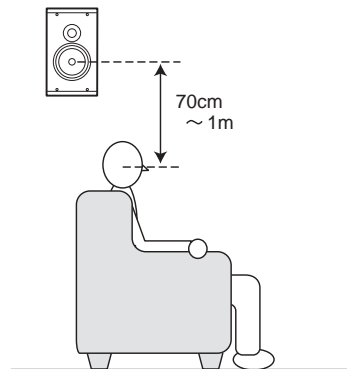

Note:

Use magnetically-shielded speakers for front left, right and the center speakers when the speakers are installed near the TV and the TV is a monitor type.

CONNECTING SPEAKERS

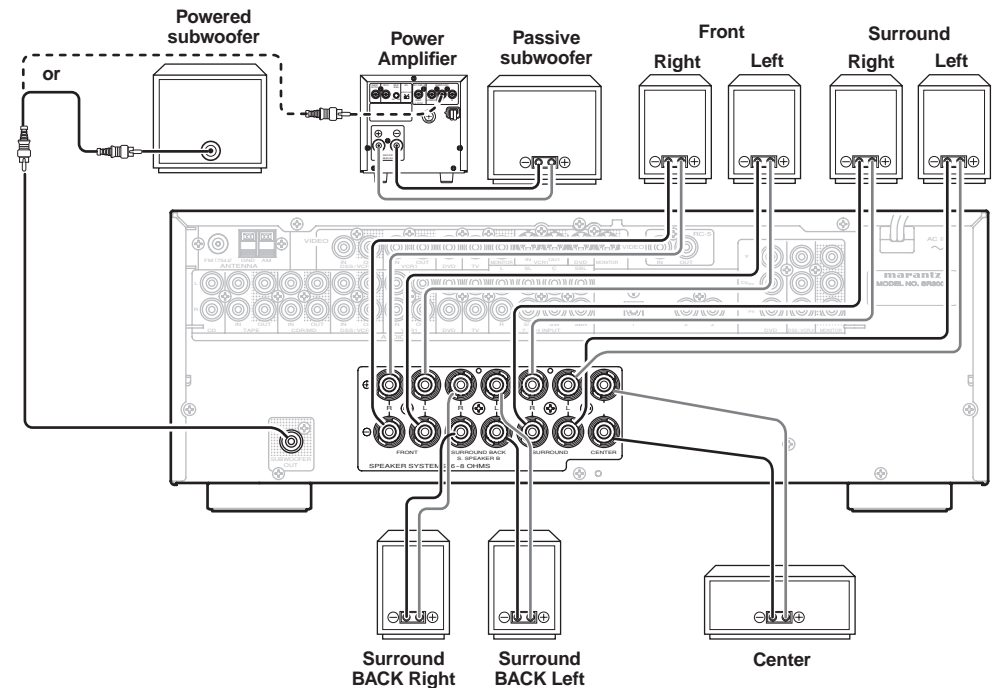

CONNECTING SPEAKER WIRE

1. Strip away approx. 10 mm of wire insulation.
2. Twist the bared wire ends tight, to prevent short circuits.
3. Loosen the knob by turning it counterclockwise.
4. Insert the bare part of the wire into the hole in side of each terminal.
5. Tighten the knob by turning it clockwise to secure the wire.

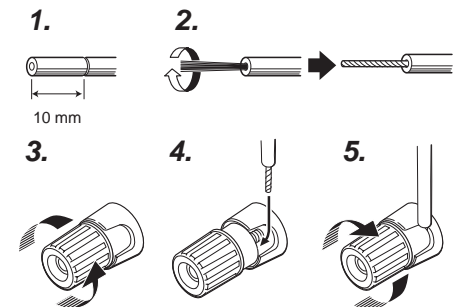

Caution:

- Be sure to use speakers with the specified impedance as shown on the rear panel of this unit.
- To prevent damage to circuitry, do not let the bare speaker wires touch each other and do not let them touch any metal part of this unit.
- Do not touch the speaker terminals when the power is on. It may cause you to receive an electric shocks.
- Do not connect more than one speaker cable to one speaker terminal. Doing so may damage this unit.

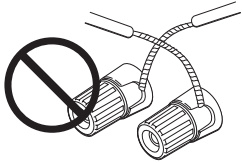
**Note:**

Be sure to connect the positive and negative cables for the speaker properly. If they are miss-connected, the signal phase will be reversed and the signal quality will be corrupted.

CONNECTING A SUBWOOFER

Use the PRE OUT SUBWOOFER jack to connect a powered subwoofer (power amplifier built in). If your subwoofer is a passive type (power amplifier is not built in), connect a monaural power amplifier to the PRE OUT SUBWOOFER jack and connect the subwoofer to the amplifier.

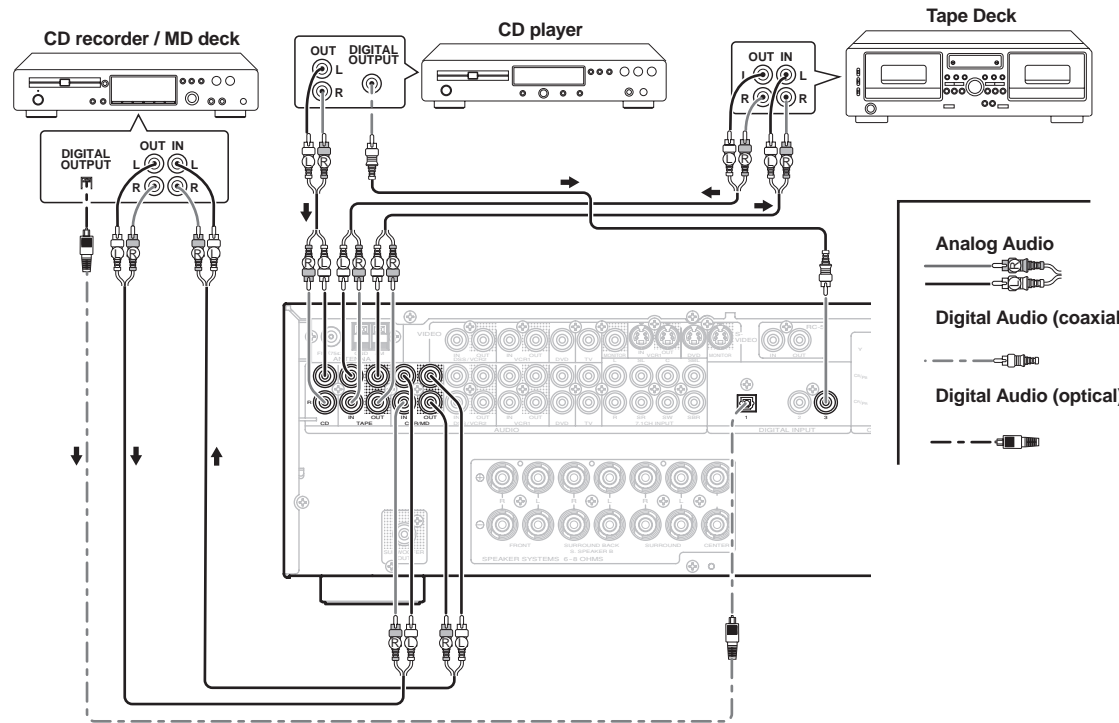
CONNECTING AUDIO COMPONENTS

The output audio signal from the TAPE OUT jack and the CD-R/MD OUT jack is the same signal which is currently selected.

Caution:

Do not connect this unit and other components to mains power until all connections between components have been completed.

Notes:

- Insert all plugs and connectors securely. Incomplete connections may make noise.
- Be sure to connect the left and right channels properly.
Red connectors are for the R (right) channel, and white connectors are for the L (left) channel.
- Be sure to connect input and output properly.
- Refer to the instructions for each component that is connected to this unit.
- Do not bind audio/video connection cables with power cords and speaker cables this will result in generating a hum or other noise.

CONNECTING DIGITAL AUDIO COMPONENTS

- There are 3 digital inputs, 2 coaxial jacks and 1 optical jack, on the rear panel. You can use these jacks to input PCM, Dolby Digital and DTS bitstream signals from a CD, DVD, or other digital source components.
- Refer to the instructions for each component. To setup the digital audio format of DVD player, or other digital source's connected to digital input jacks.
- Use fiber optical cables (optical) for DIG-1 input jacks. Use 75 ohms coaxial cables (for digital audio or video) for DIG-2, 3 input jacks.
- You can designate the input for each digital input jacks according to your component. See page 17.

Notes:

- There is no Dolby Digital RF input jack. Please use an external RF demodulator Dolby Digital decoder when connecting the Dolby Digital RF output jack of the video disc player to the digital input jack.
- The digital signal jacks on this unit conform to the EIA standard. If you use a cable that does not conform to this standard, this unit may not function properly.
- Each type of audio jack works independently. Signals input through the digital and analog jacks are output through the corresponding digital and analog jacks, respectively.

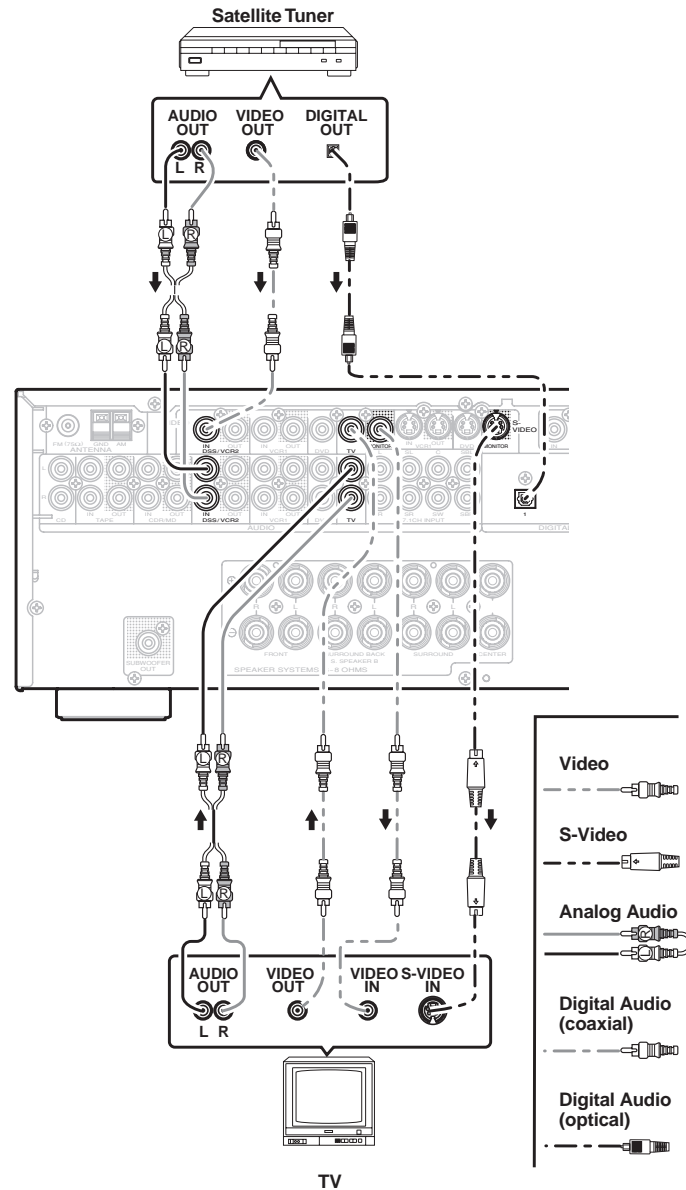
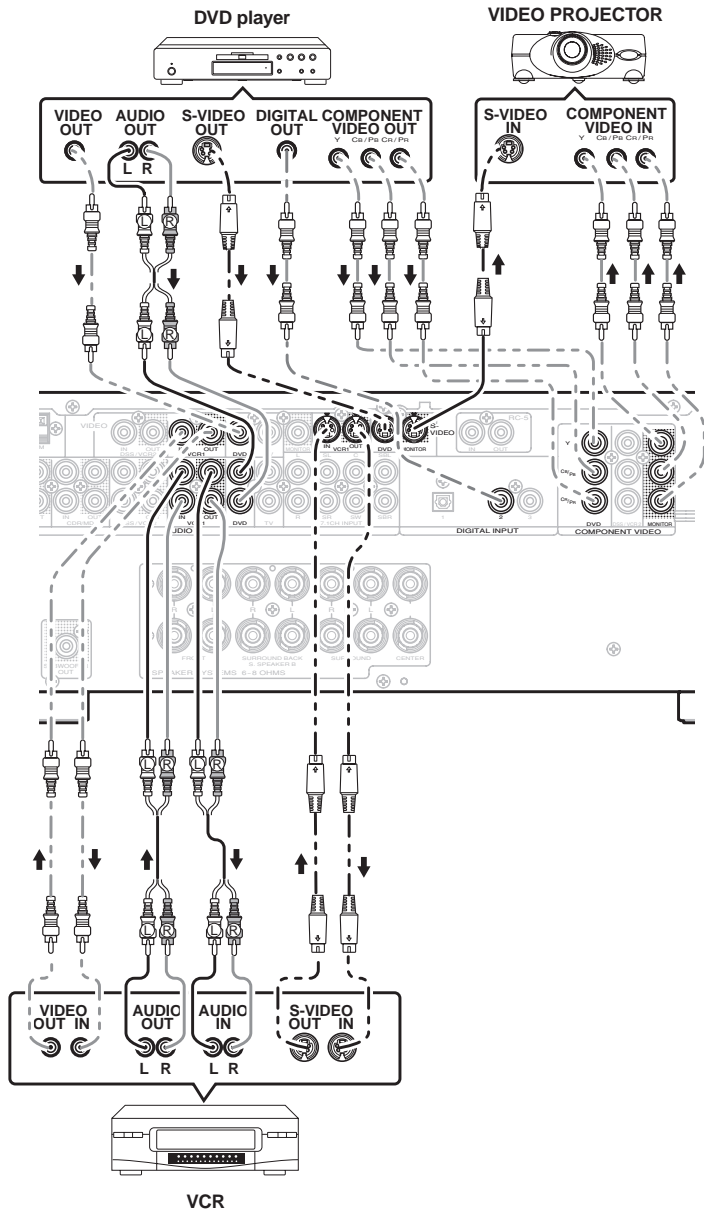

VIDEO, S-VIDEO, COMPONENT JACKS

There are 3 types of video jacks on the rear panel.

VIDEO jack

The video signal for the VIDEO jacks is the conventional composite video signal.

S-VIDEO jack

The video signal is separated into luminance (Y) and color (C) signals for the S-VIDEO jack. The S-VIDEO signals enables high-quality color reproduction. If your video component has an S-VIDEO output, we recommend to use it. Connect the S-VIDEO output jack on your video component to the S-VIDEO input jack on this unit.

Component jack

Make component video connections to a TV or monitor with component inputs to produce higher quality video images. Use a component video cable or 3 video cords to connect the component video out jacks on the SR3001 to the monitor.

Notes:

- Be sure to connect the left and right audio channels properly.
Red connectors are for the R (right) channel, and white connectors are the for L (left) channel.
- Be sure to connect the inputs and outputs of the video signals properly.
- If you connect the S-VIDEO or component signal to the S-VIDEO or component jack on this unit, it is not necessary to connect the conventional video signal to the VIDEO (composite) jack. If you use both video inputs, this unit gives priority to the S-VIDEO signal.
- Each type of video jack works independently. Signals input to the VIDEO (composite) and S-VIDEO jacks or component are output to the corresponding VIDEO (composite) and S-VIDEO or component jacks, respectively.
- You may need to setup the digital audio output format of your DVD player, or other digital source components. Refer to the instructions of the each component connected to the digital input jacks.
- There is no Dolby Digital RF input jack. Please use an external RF demodulator with a Dolby Digital decoder to connect a video disc player which has a Dolby Digital RF output jack to the digital input jack on this unit.

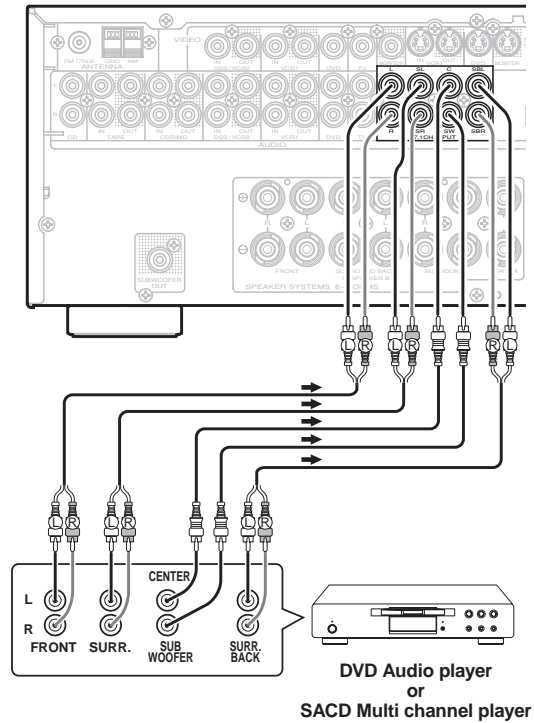

CONNECTING MULTI CHANNEL AUDIO SOURCE

The 7.1CH INPUT jacks are for multichannel audio source such as a SACD multichannel player, DVD audio player or external decoder.

If you use these jacks, switch on the 7.1CH INPUT and set the 7.1CH INPUT level by using the 7.1 channel input level menu. See page 29.

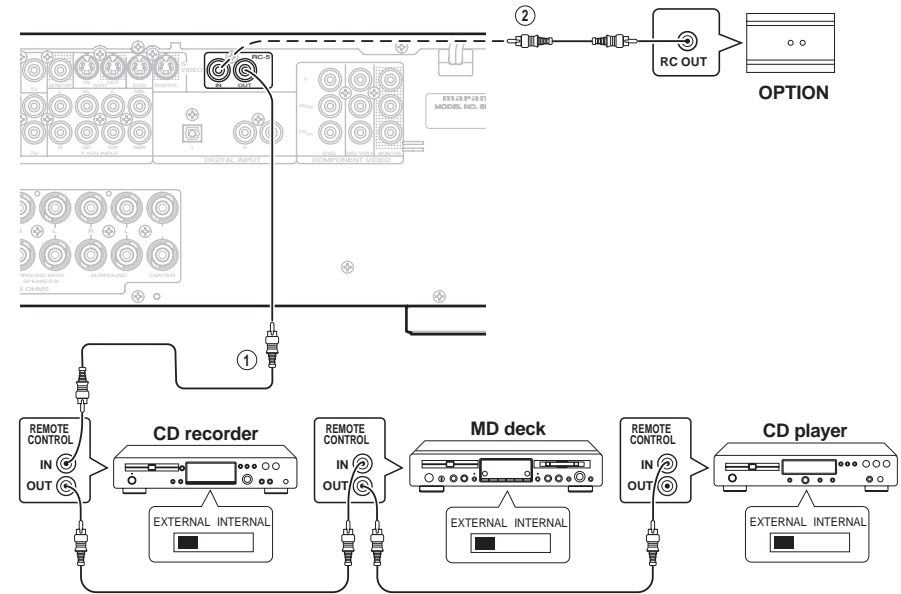

①

You can control other Marantz products through this unit with the remote control by connecting the REMOTE CONTROL terminals on each unit. The signal transmitted from the remote control is received by the remote sensor on this unit. Then the signal is sent to the connected device through this terminal. Therefore you only need to aim the remote at one unit. Also, if a Marantz power amplifier (some models excluded) is connected to one of these terminals, the power amplifier's power switch is synchronized with this unit's power switch.

Set the REMOTE CONTROL SWITCH on the units, other than the main unit to EXT.(EXTERNAL) for this feature.

②

Whenever external infrared sensors or similar devices are connected to RC-5 IN of the SR3001, be sure to always disable operation of the infrared sensor on the main unit by using the following procedure.

1. Hold down the **7.1CH INPUT** button and **MENU** button on the front panel at the same time for five seconds.
2. The setting "IR=ENABLE" is shown on the FL DISPLAY.
3. Press the ◀ or ▶ cursor button to change this to "IR=DISABLE".
4. Press the **ENTER** button. Once this setting is made, the infrared sensor on the main unit is disabled.

Note:

Be sure to set to "IR=ENABLE" when external infrared sensors or similar devices are not connected. Otherwise, the main unit will be unable to receive remote control commands.

5. To restore the original setting, perform steps 1 to 4 to set to "IR=ENABLE".

CONNECTING THE ANTENNA TERMINALS

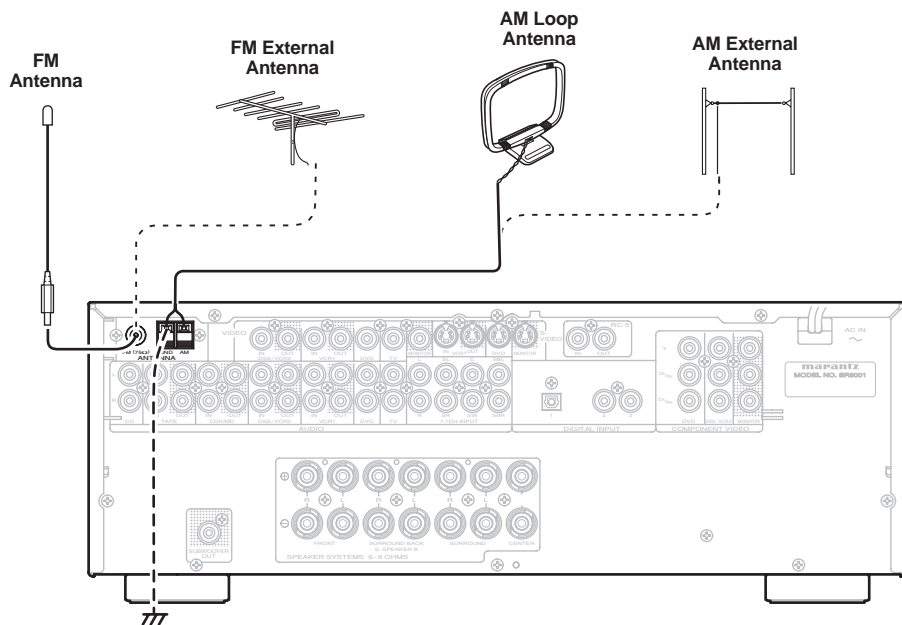

ASSEMBLING THE AM LOOP ANTENNA

1. Release the vinyl tie and take out the connection line.
4. Place the antenna on stable surface.

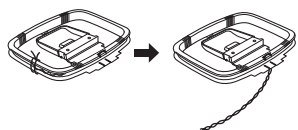

2. Bend the base part in the reverse direction.



3. Insert the hook at the bottom of the loop part into the slot at the base part.



CONNECTING THE SUPPLIED ANTENNAS

Connecting the supplied FM antenna

The supplied FM antenna is for indoor use only. During use, extend the antenna and move it in various directions until the clearest signal is received. Fix it with push pins or similar implements in the position that will cause the least amount of distortion. If you experience poor reception quality, an outdoor antenna may improve the quality.

Connecting the supplied AM loop antenna

The supplied AM loop antenna is for indoor use only. Set it in the direction and position it to where you receive the clearest sound. Put it as far away as possible from the unit, televisions, speaker cables, and power cords. If you experience poor reception quality, an outdoor antenna may improve the quality.

1. Press and hold down the lever of the AM antenna terminal.
2. Insert the bare wire into the antenna terminal.
3. Release the lever.

CONNECTING AN FM OUTDOOR ANTENNA

Notes:

- Keep the antenna away from noise sources (neon signs, busy roads, etc.).
- Do not put the antenna close to power lines. Keep it well away from power lines, transformers, etc.
- To avoid the risk of lightning and electrical shock, grounding is necessary.

CONNECTING AN AM OUTDOOR ANTENNA

An outdoor antenna will be more effective if it is stretched horizontally above a window or outside.

Notes:

- Do not remove the AM loop antenna.
- To avoid the risk of lightning and electrical shock, grounding is necessary.

SETUP

After all components are connected, initial setup must be performed.

SETUP MENU SYSTEM

The SR3001 incorporates an menu on the front display, which makes various operations possible by using the cursor (▲, ▼, ◀, ▶) and ENTER buttons.

ENTER THE DESIRED MENU ITEM OF THE SETUP MENU

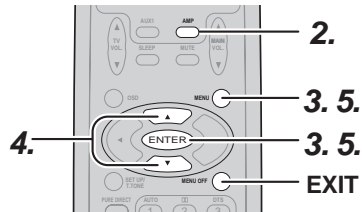
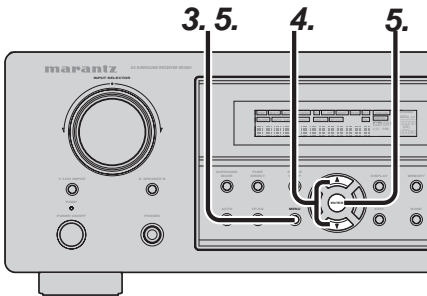

1. Turn on the unit.
2. Press the **AMP** button of the remote control.
3. Press the **MENU** button or the **ENTER** button of the remote control to enter the SETUP MENU.
4. Press the **▲** or **▼** cursor button to select the SETUP MENU item.
5. Press the **ENTER** button or the **MENU** button to enter the desired menu item.

After finishing all setup, press the **MENU OFF** button to exit the SETUP MENU.

MENU STRUCTURE

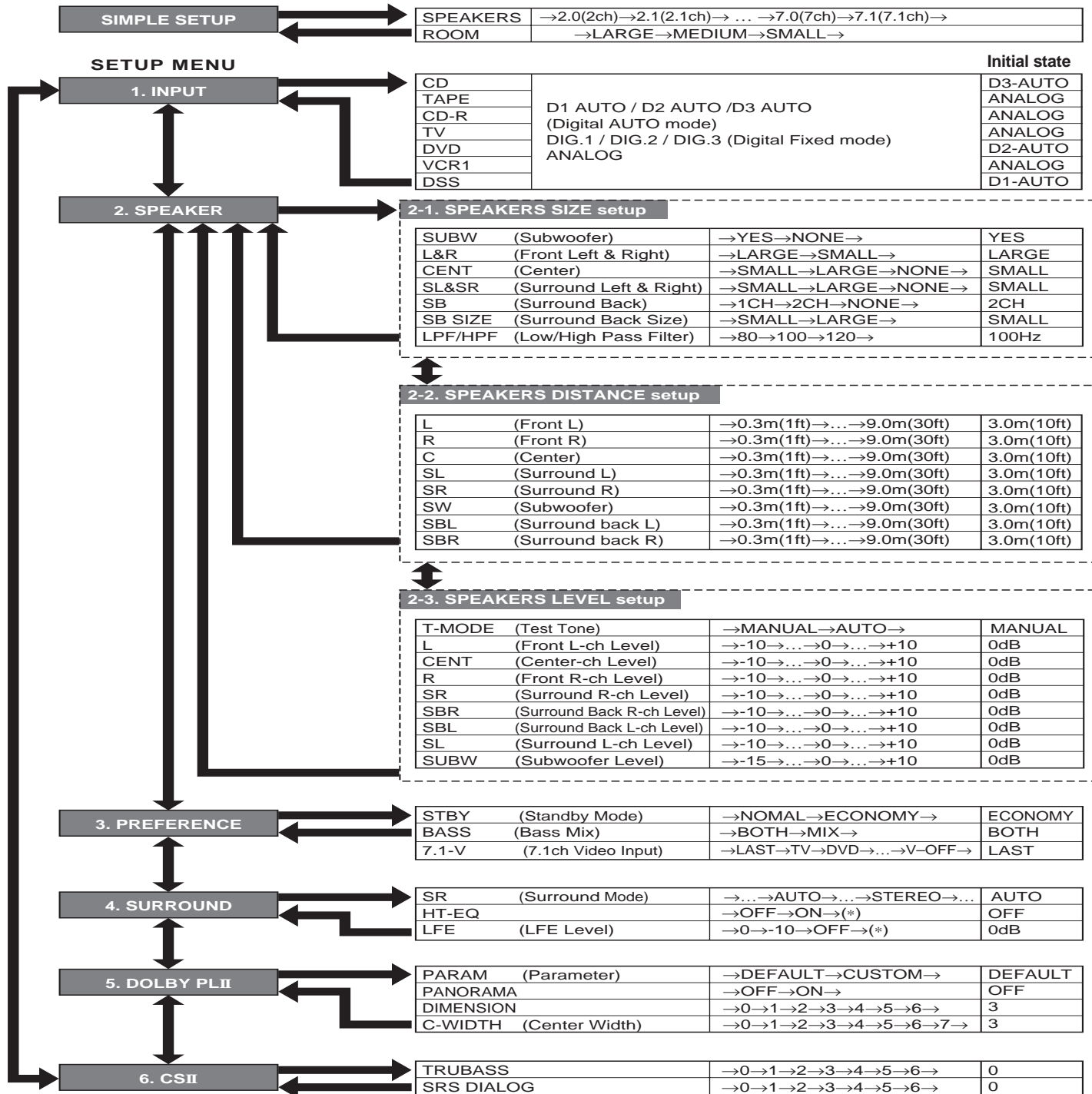

SIMPLE SETUP

You can setup the speaker conditions quickly with SIMPLE SETUP menu. In this menu, the number of speakers and speaker delay time can be set. These settings can be changed more detail in "2. SPEAKER" setup menu.

Press the **SIMPLE SETUP** button on the unit to enter this menu.

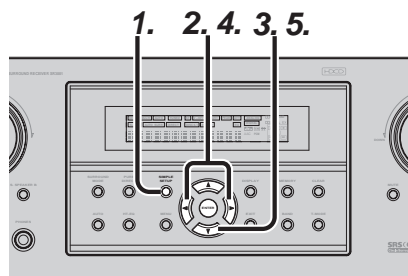

1. Press the **SIMPLE SETUP** button on the unit to enter the "SPEAKERS" menu.
2. Press ◀ or ▶ cursor button to select the speaker number.
3. Press the ▼ cursor button to enter the "ROOM" menu.
4. Press ◀ or ▶ cursor button to select the room size.
5. After finishing all setup, press the ▼ cursor button to exit the SIMPLE SETUP menu.

Note:

All Simple Setup menu is reset when the speaker setting is changed with Speaker Setup menu.

MENU STRUCTURE of Simple Setup

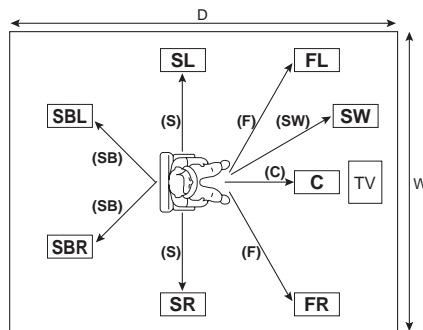
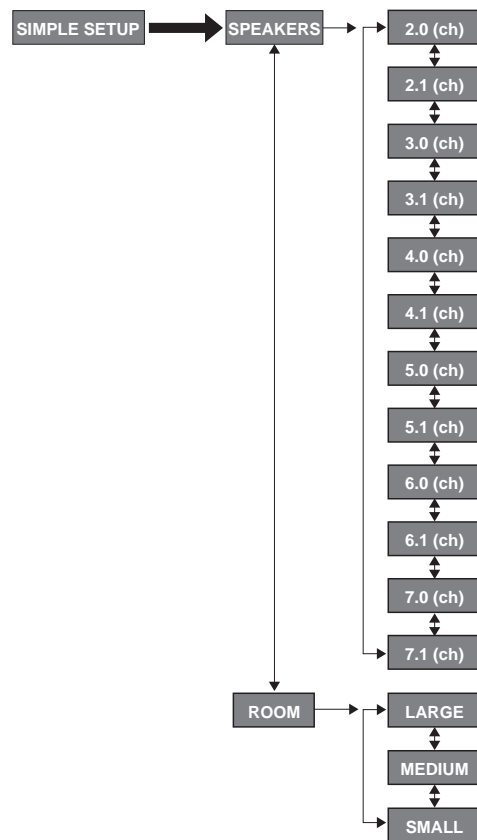

The relation of the speakers number and connected speaker

| CHANNEL | Front L/R (F) | Front Center (C) | Surround L/R (S) | Surround Back L/R (SB) | Sub woofer (SW) |
|---------|---------------|------------------|------------------|------------------------|-----------------|
| 7.1 ch | LARGE | SMALL | SMALL | 2ch | YES |
| 7.0 ch | LARGE | SMALL | SMALL | 2ch | NONE |
| 6.1 ch | LARGE | SMALL | SMALL | 1ch | YES |
| 6.0 ch | LARGE | SMALL | SMALL | 1ch | NONE |
| 5.1 ch | LARGE | SMALL | SMALL | NONE | YES |
| 5.0 ch | LARGE | SMALL | SMALL | NONE | NONE |
| 4.1 ch | LARGE | NONE | SMALL | NONE | YES |
| 4.0 ch | LARGE | NONE | SMALL | NONE | NONE |
| 3.1 ch | LARGE | SMALL | NONE | NONE | YES |
| 3.0 ch | LARGE | SMALL | NONE | NONE | NONE |
| 2.1 ch | LARGE | NONE | NONE | NONE | YES |
| 2.0 ch | LARGE | NONE | NONE | NONE | NONE |

The relation of the room size and floor space

| SIZE | Floor space | Width (W) | Depth (D) | Imaging Distance | |
|--------|-------------------|-----------|-----------|------------------|---------------|
| | | | | Speaker | Distance |
| SMALL | 10 m ² | 2.7 m | 3.6 m | Front (F) | 6 ft. (1.8 m) |
| | | | | Center (C) | 5 ft. (1.5 m) |
| | | | | Surround (S) | 4 ft. (1.2 m) |
| | | | | Surr. Back (SB) | 5 ft. (1.5 m) |
| | | | | Sub Woofer (SW) | 5 ft. (1.5 m) |
| MEDIUM | 16 m ² | 3.6 m | 4.5 m | Front (F) | 7 ft. (2.1 m) |
| | | | | Center (C) | 6 ft. (1.8 m) |
| | | | | Surround (S) | 5 ft. (1.5 m) |
| | | | | Surr. Back (SB) | 7 ft. (2.1 m) |
| | | | | Sub Woofer (SW) | 6 ft. (1.8 m) |
| LARGE | 24 m ² | 4.5 m | 5.4 m | Front (F) | 9 ft. (2.7 m) |
| | | | | Center (C) | 8 ft. (2.4 m) |
| | | | | Surround (S) | 7 ft. (2.1 m) |
| | | | | Surr. Back (SB) | 8 ft. (2.4 m) |
| | | | | Sub Woofer (SW) | 8 ft. (2.4 m) |

The relation of the room size and floor space is a roughly standard.

1. INPUT SETUP (ASSIGNABLE DIGITAL INPUT)

Four digital inputs can be assigned as the desired source.

Use this menu to select the digital input jack to be assigned to the input source.

The Input Setup consists of 6 items, which are as below.

• **D1AUTO to D3AUTO : Digital AUTO mode**

If the input signal from the selected source is digital signal, this unit chooses a digital input automatically.

• **DIG.1 to DIG.3 : Digital FIXED mode**

The SR3001 chooses a digital input regardless of a input signal from the selected source.

• **ANA : Analog mode**

Use this menu to select the digital input jack to be assigned to the input source.

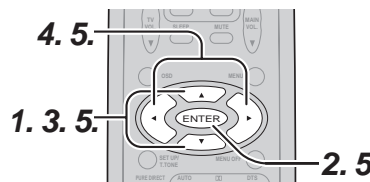
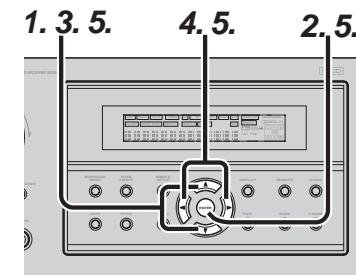

1. Select "1.INPUT" in SETUP MENU with the ▲ or ▼ cursor button.
2. Press the **ENTER** button to enter the menu.
3. Press the ▲ or ▼ cursor button to select the input source.
4. Press ◀ or ▶ cursor button to select the input function.

Select "DxAUTO", "DIG.x" or "ANA" for input sources.

- If you finish these setup, press the ▲ or ▼ cursor button to select "TO MAIN MENU" then press the **ENTER** button to return the SETUP MENU.

Or press the ◀ or ▶ cursor button to select "EXIT" then press the **ENTER** button to exit the SETUP MENU.

Notes:

- When a DTS-LD or DTS-CD is playing, this setup is not available. This is to avoid noise being generated from the analog input.
- If "Dx-AUTO" is selected and a DVD, compact disc or LD is fast forwarded during playback, decoded signals may produce a skipping sound. In such cases, change the setting to DIGITAL.
- Same digital input function cannot be set. In this case, the previous setting is set to ANALOG. Same digital input number cannot be set in Digital AUTO mode and Digital Fixed mode. For example, DIAUTO and DIG.1 are not set at same time.
- The TUNER is fixed to the analog input, and can not be selected for any digital input.

2. SPEAKER SETUP

After you have installed the SR3001, connected all the components, and determined the speaker layout, it is now time to perform the settings in the Speaker Setup menu for the optimum sound acoustics for your environment and speaker layout.

Before you perform the following settings, it is important that you first determine the following characteristics:

2-1. SPEAKERS SIZE

When setting the speaker size in the SPEAKER SIZE sub-menu, use the guidelines given below.

Large:

The complete frequency range for the channel you are setting will be output from the speaker.

Small:

Frequencies of the channel you are setting lower than approx. 100Hz will be output from the subwoofer.

If the Subwoofer is set to "NONE" and the front speakers are set to "Large," then the sound may be output from both the left and right speakers.

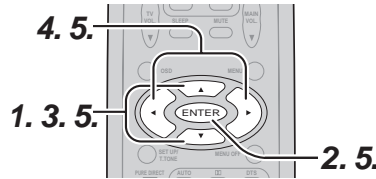
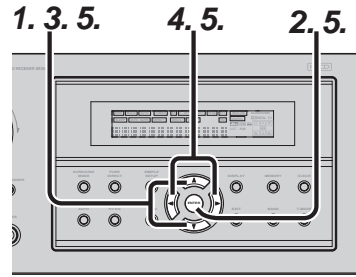

- Select "2.SPEAKER" in SETUP MENU with ▲ or ▼ cursor button,
- Press the **ENTER** button to enter the menu. The first sub-menu item is "2-1.Speakers Size" setup.
- Press ▲ or ▼ cursor button to select the each speaker.
- Press ◀ or ▶ cursor button to select the setting of size to each speaker.
- If you finish these setup, press the ▲ or ▼ cursor button to select "NEXT".
- Press the **ENTER** button to enter the next "2-2. Speakers Distance" setup.

Or press the ◀ or ▶ cursor button to select "EXIT" then press the **ENTER** button to exit the SETUP MENU.

Or press the ◀ or ▶ cursor button to select "TO MAIN MENU" then press the **ENTER** button to return the SETUP MENU.

MENU STRUCTURE of Speakers Size setup

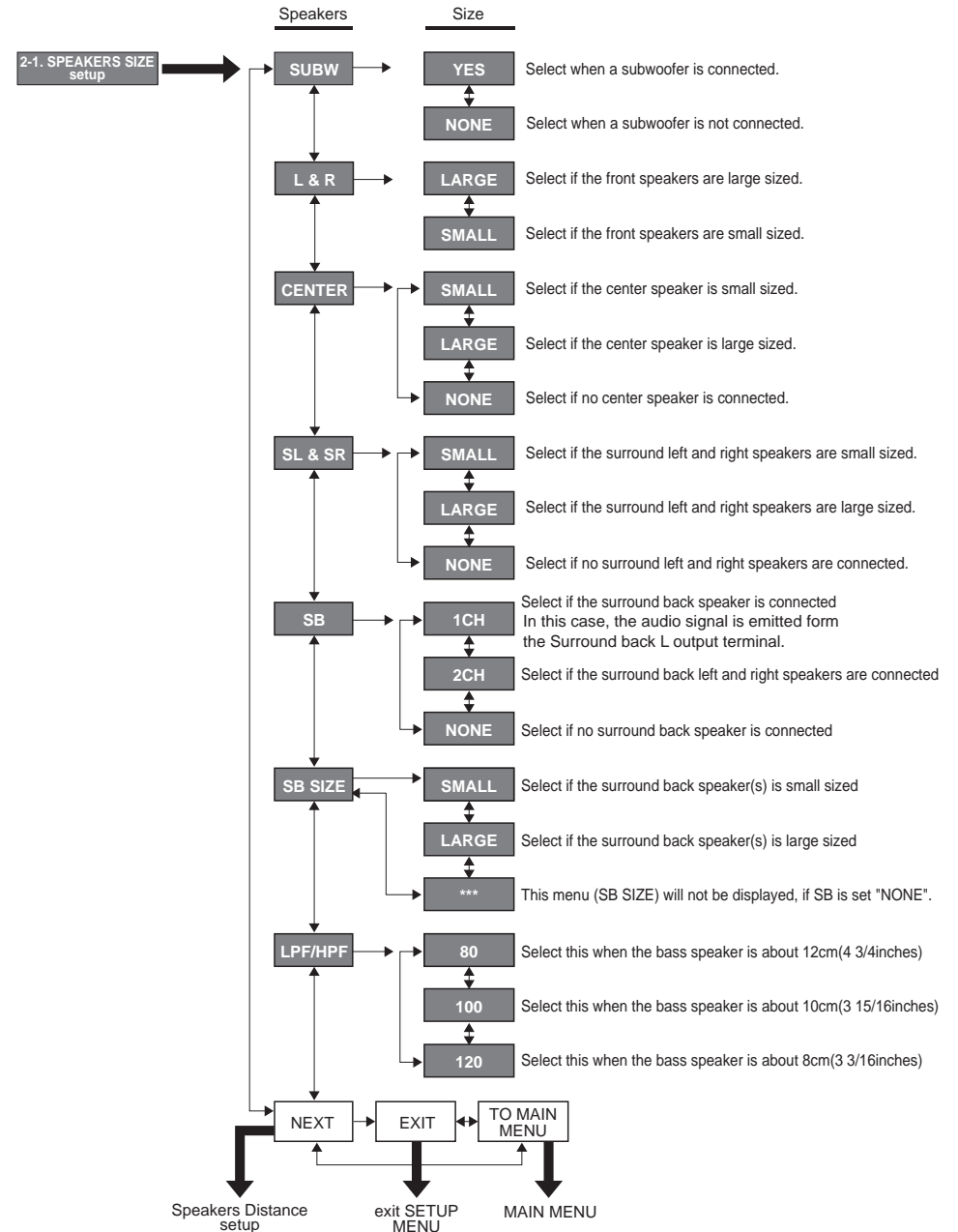

2-2. SPEAKERS DISTANCE

Use this parameter to specify the distance of each speaker's position from the listening position. The delay time is automatically calculated according to these distances.

Begin by determining the ideal or most commonly used seating position in the room.

This is important for the timing of the acoustics to create the proper sound space that the SR3001 and today's sound systems are able to produce.

Note that the speakers that you selected "None" for in the Speaker Config sub-menu will not appear here.

1. 3. 5. 4. 5. 2. 5.

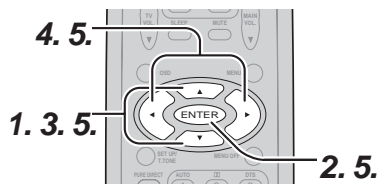
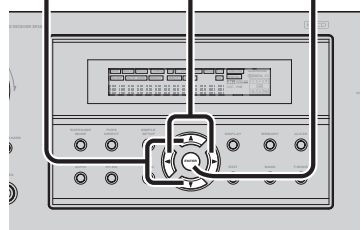

1. Enter to the "2-2. Speakers Distance" from the previous "2-1. Speakers Size".
2. Press ▲ or ▼ cursor button to select the each speaker.
3. Press ◀ or ▶ cursor button to set the distance from your listening position for each speaker.
4. After finishing the Speaker Distance setup, press the ▲ or ▼ cursor button to select "NEXT".
5. Press the **ENTER** button to enter the next "Speaker Level" setup.

Or press the ◀ or ▶ cursor button to select "EXIT" then press the **ENTER** button to exit the SETUP MENU.

Or press the ◀ or ▶ cursor button to select "TO MAIN MENU" then press the **ENTER** button to return the SETUP MENU.

Or press the ◀ or ▶ cursor button to select "RETURN" then press the **ENTER** button to return the previous "2-2. Speakers Distance" setup.

L&R :

Set the distance from the front left and right speakers to your normal listening position between 1 and 30 feet in 1.0 foot interval (0.3 to 9 meters in 0.3-meter intervals).

C :

Set the distance from the center speaker to your normal listening position between 1 and 30 feet in 1.0 foot interval (0.3 to 9 meters in 0.3-meter intervals).

SL&SR:

Set the distance from the surround left and right speaker to your normal listening position between 1 and 30 feet in 1.0 foot interval (0.3 to 9 meters in 0.3-meter intervals).

SW :

Set the distance from the subwoofer to your normal listening position between 1 and 30 feet in 1.0-foot intervals (0.3 to 9 meters in 0.3-meter intervals).

SB:

Set the distance from a surround back speaker to your normal listening position between 1 and 30 feet in 1.0-foot intervals (0.3 to 9 meters in 0.3-meter intervals).

Note:

Speakers that you selected "No" or "None" for in the Speaker Size menu will not appear.

MENU STRUCTURE of Speakers Distance setup

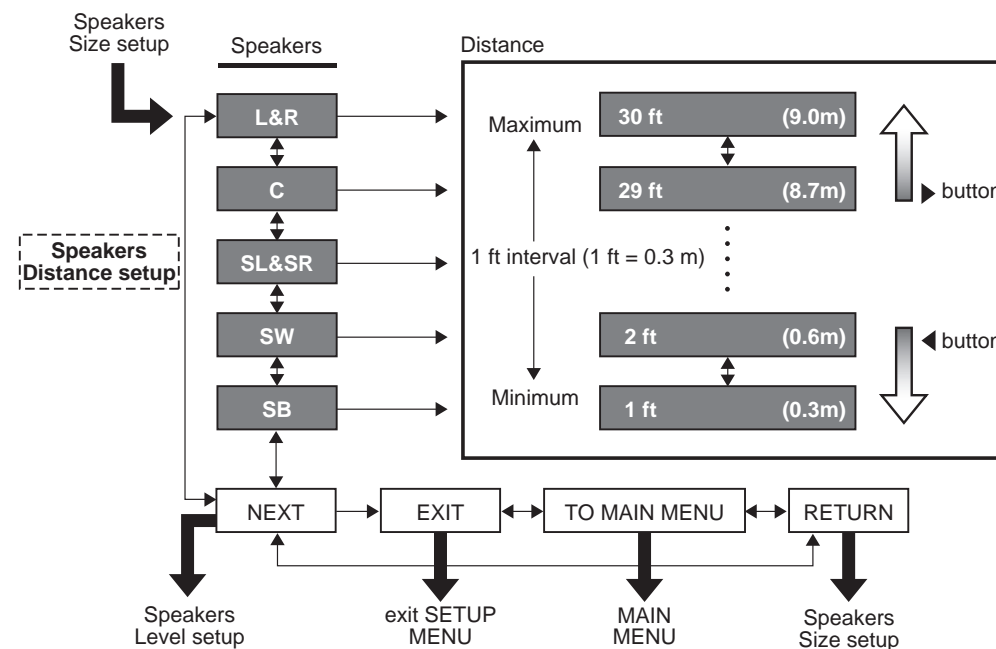

2-3. SPEAKERS LEVEL SETTING WITH TEST TONE

Here you will set the volume for each speaker so that they are all heard by the listener at the same level. Moreover, if the **T.TONE** button is pressed, unit can enter into this menu directly.

Note:

The speaker level settings are not available in 7.1 Channel Input mode, CS mode and Multi Channel Stereo mode.

T(TEST) MODE :

Selects **"MANUAL"** or **"AUTO"** for generating mode of test tone ◀ or ▶ cursor button.

If you select **"AUTO"** by pressing the ▼ button, the test tone will be cycled through in a circular pattern which is L (Left) → C (Center) → R (Right) → SR (Surround Right) → SBR (Surround Back Right) → SBL (Surround Back Left) → SL (Surround Left) → SW (Subwoofer) → L →.. increments of 2 seconds for each channel.

Using the ◀ and ▶ cursor buttons, adjust the volume level of the noise from the speaker so that it is the same level for all speaker.

Press the **ENTER** button, you can stop the test tone mode. Or press the ◀ or ▶ cursor button to select **"EXIT"** then press the **ENTER** button to exit the **SETUP MENU**.

Or press the ◀ or ▶ cursor button to select **"RETURN"** then press the **ENTER** button to return the previous **"2-2. Speakers Distance"** setup.

If you select **"MANUAL"**, adjust the output level of each speaker as follow.

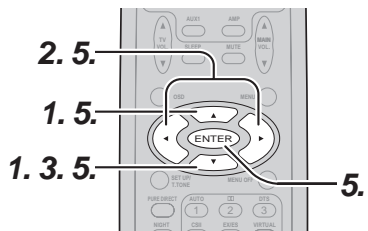
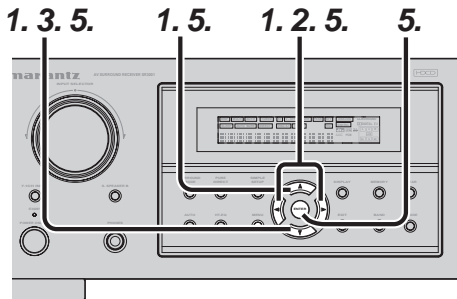

1. When you select **"MANUAL"** in T-MODE menu by pressing the ◀ or ▶ button, this unit will emit a pink noise from the front left speaker. At this time, adjust the desired level of the master volume. Remember the level of this noise and then press the ▼ button. This unit will emit the pink noise from the center speaker.
2. Using the ◀ and ▶ cursor buttons, adjust the volume level of the noise from the center speaker so that it is the same level as the front left speaker (Note that this can be adjusted to any level between -10 and +10 dB in 1dB intervals).

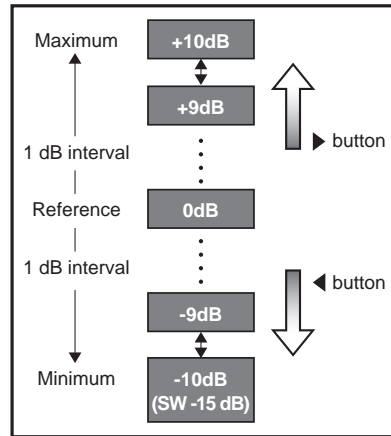

3. Press the ▼ cursor button again. This unit will now emit the pink noise from the front right speaker.
4. Repeat steps 2 and 3 above for the front right and other speakers until all speakers are adjusted to the same volume level.
5. Press the **ENTER** button, you can stop the test tone mode. Or press the ◀ or ▶ cursor button to select **"EXIT"** then press the **ENTER** button to exit the **SETUP MENU**. Or press the ◀ or ▶ button to select **"RETURN"** then press the **ENTER** button to return the previous **"2-2. Speakers Distance"** setup.

Notes:

- Speakers that you selected **"None"** for in the Speaker Size Setup menu will not appear.
- The setup level for each channel is memorized for reproduction in all surround mode by this method exclude CS mode, Multi channel stereo mode and 7.1 ch input mode.
- To adjust the speaker levels for 7.1-channel input sources, you will need to use the 7.1CH Level Input setup menu.

MENU STRUCTURE of Speaker Level setup

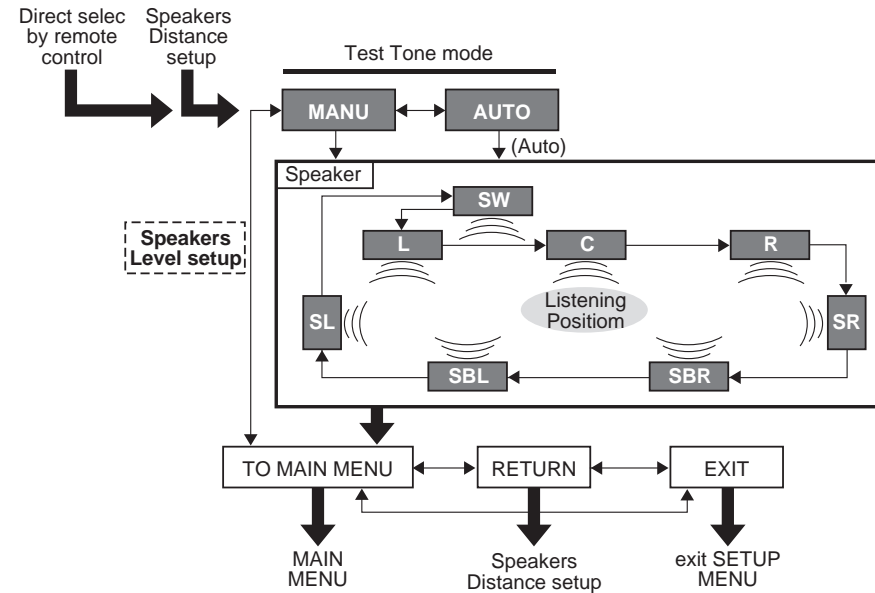

2-4. SPEAKERS LEVEL SETTING WITHOUT TEST TONE

Channel level (speaker level) can be adjusted without using test tone.

Note:

Four channel level settings can be memorized for reproduction: the 7.1 ch input mode, CS mode, Multi channel stereo mode, and all other surround modes, respectively.

1. Set the surround mode or 7.1 ch input mode which you want to adjust the channel level.
2. Press the **CH.SEL** button on the remote.
3. Select the desired channel (speaker) with the ◀ or ▶ cursor buttons.
4. Adjust the level with the ▲ or ▼ cursor buttons.
5. After completing the setup, press the **CH.SEL** button again.

3. PREFERENCE

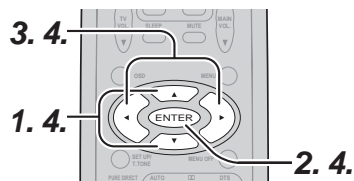
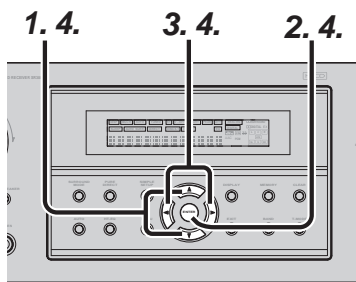

1. Select "3. PREFERENCE" in SETUP MENU with ▲ or ▼ cursor button.
2. Press the **ENTER** button.
3. Press ▲ or ▼ cursor button to select desired item.
4. Press ◀ or ▶ cursor button to set the mode.

MENU STRUCTURE of PREFERENCE setup

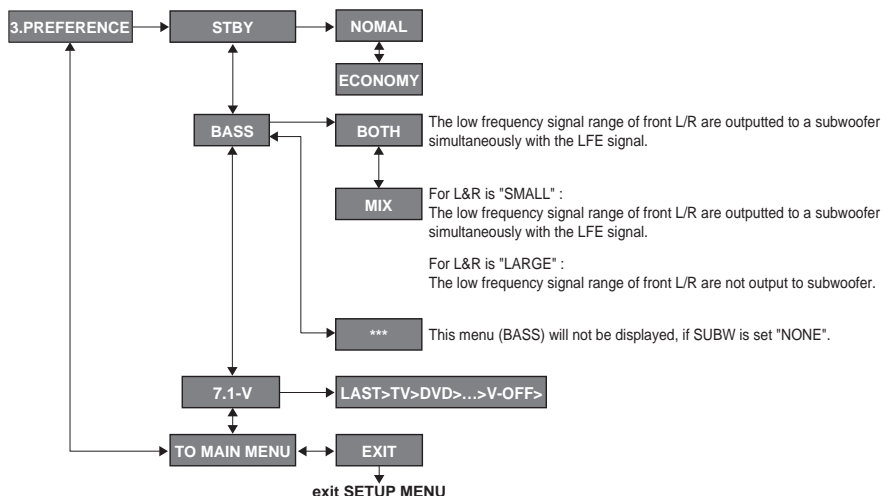

STANDBY MODE:

When this function is set to "ECONOMY", you can reduce the power consumption when the unit is in the standby mode.

5. When you select "TO MAIN MENU" by pressing the ▲ or ▼ button, you can return the SETUP MENU by pressing the **ENTER** button.

Or press the ◀ or ▶ cursor button to select "EXIT" then press the **ENTER** button to exit the SETUP MENU.

BASS MIX

- The bass mix setting is only valid when "LARGE" is set for the front speakers and "YES" is set for the subwoofer at stereo playback.
 - When the "BOTH" is selected, the low frequency signal range of "LARGE" are produced simultaneously from those channels and the subwoofer channel.
- When actual low frequency sound volume is weak depending on room size, use this function to fill low frequency sound equally in the room.
- When "Mix" is selected, subwoofer output is determined depending on the speaker sizes for each channels. If the front speaker size is set to "Large", subwoofer output is only the LFE signal contained in Dolby Digital or DTS processed signals.

Note:

When Front speaker is set "SMALL", then BASS MIX is set "MIX". (The display appears "BASS MIX = ***".)

4. SURROUND

This sub menu is to adjust channel levels for each surround setting groups. There are three surround setting groups shown below. Therefore if settings for a surround mode are changed, settings for all other surround modes in the same group are also changed.

Surround setting group

- 1: AUTO, DOLBY, DTS, EX/ES, VIRTUAL, STEREO
- 2: Multi-ch stereo
- 3: CS II

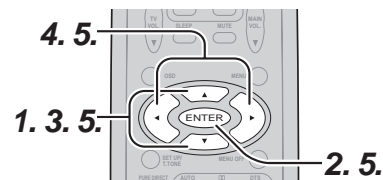
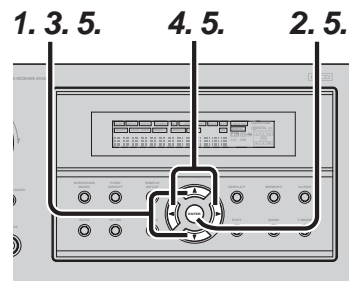

1. Select "4. SURROUND" in SETUP MENU with ▲ or ▼ cursor button.
2. Press the **ENTER** button.
3. To select a desired item, press ▲ or ▼ cursor button.
4. Using the ◀ or ▶ cursor button to select the mode or adjust the volume level of each speaker.
5. When you select "TO MAIN MENU" by pressing the ▲ or ▼ button, you can return the SETUP MENU by pressing the **ENTER** button.
Or press the ◀ or ▶ cursor button to select "EXIT" then press the **ENTER** button to exit the SETUP MENU.

SR(SURR-MODE) :

Select the desired surround mode with ◀ or ▶ cursor button.

- If one of the following modes is selected, all other modes are also set to the same. AUTO, DOLBY, DTS, EX/ES, VIRTUAL, STEREO.

HT-EQ :

Select to active the HT-EQ with the ◀ or ▶ cursor buttons.

The tonal balance of a film soundtrack will be excessively bright and harsh when played back over audio equipment in the home. This is because film soundtracks were designed to be played back in large movie theater environments.

Activating the HT-EQ feature when watching a film made for movie theaters corrects this and restores the correct tonal balance.

The HT-EQ feature can be activated only while in Dolby Pro Logic Mode, or while decoding Dolby Digital or DTS encoded material.

LFE LEVEL :

Select the output level of the LFE signal included in the Dolby Digital signal or the DTS signal.

Select 0 dB, -10 dB or OFF with the ◀ or ▶ cursor buttons.

When you select "TO MAIN MENU" by pressing the ▲ or ▼ button, you can return the SETUP MAIN MENU by pressing the **ENTER** button.

MENU STRUCTURE of SURROUND setup

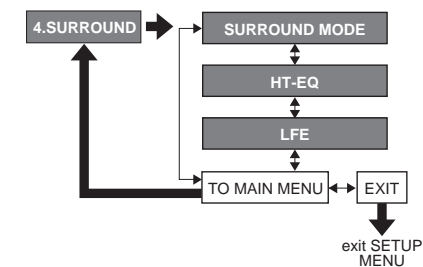

5. PL II (DOLBY PRO LOGIC II) MUSIC PARAMETER

Pro Logic II-Music mode creates a rich and enveloping surround ambience from stereo sources such as CDs. In this mode, SR3001 includes three controls to fine-tune the soundfield as follows.

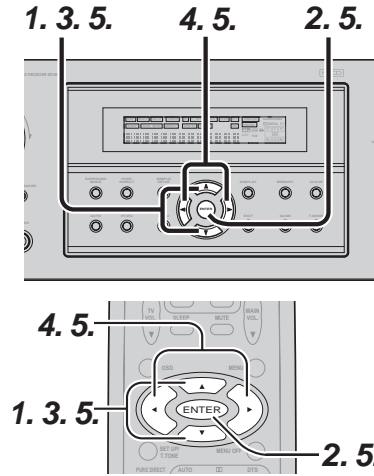

1. Select "5. PL II MUSIC PARAMETER" in SETUP MENU with ▲ or ▼ cursor button.
2. Press the **ENTER** button to enter the menu.
3. Press ▲ or ▼ cursor button to select a desired item.
4. Press ◀ or ▶ cursor button to select the mode or set the level.
5. When you select "TO MAIN MENU" by pressing the ▲ or ▼ button, you can return the SETUP MENU by pressing the **ENTER** button.
Or press the ◀ or ▶ cursor button to select "EXIT" then press the **ENTER** button to exit the SETUP MENU.

PANORAMA:

Select the Panorama mode On or Off with ◀ or ▶ cursor button. Panorama wraps the sound of the front left and right speakers around you for an exciting perspective.

DIMENSION:

Set the Dimension level between 0 and 6 level in 1 level interval with ◀ or ▶ cursor button. Adjust the soundfield either towards the front or towards the rear. This can be useful to help achieve a more suitable balance from all the speakers with certain recordings.

C WIDTH:

Set the Center width level between 0 and 7 level in 1 level interval with ◀ or ▶ cursor button. Center Width allows you to gradually spread the center channel sound into the front left and right speakers. At its widest setting, all the sound from the center is mixed into the left and right. This control may help achieve a more spacious sound or a better blend of the front image. If "NONE" was selected for the Center speaker setting in the Speaker size, then this setting will not appear.

MENU STRUCTURE of PRO LOGIC II setup

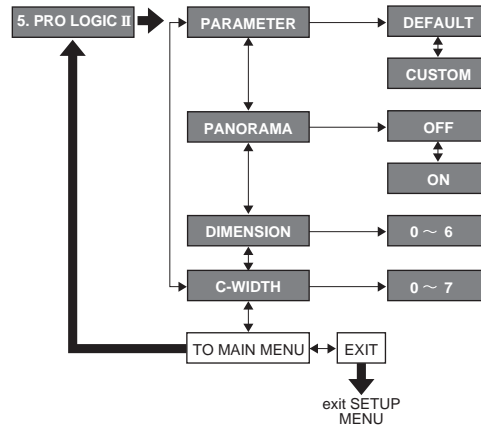

6. CS II (CIRCLE SURROUND II)

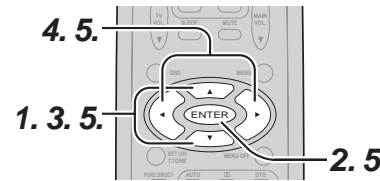
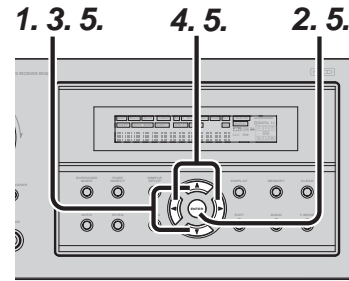

1. Select "6. CS II" in SETUP MENU with ▲ or ▼ cursor button.
2. Press the **ENTER** button to enter this menu.
3. Press ▲ or ▼ cursor button to select desired item.
4. Press ◀ or ▶ cursor button to set the level.
5. When you select "TO MAIN MENU" by pressing the ▲ or ▼ button, you can return the SETUP MENU by pressing the **ENTER** button.
Or press the ◀ or ▶ cursor button to select "EXIT" then press the **ENTER** button to exit the SETUP MENU.

TRUBASS:

Set the TRUBASS level between 0 and 6 level in 1 level interval with ◀ or ▶ cursor button. TRUBASS produced by the speakers to be an octave below the actual physical capabilities of the speakers adding exciting, deeper bass effects.

SRS DIALOG:

Set the SRS DIALOG level between 0 and 6 level in 1 level interval with ◀ or ▶ cursor button. This can be popped out of the surround audio effects allowing the listener to easily discern what the actors say. If "NONE" was selected for the Center speaker setting in the Speaker size, then this setting will not appear.

MENU STRUCTURE of CS II setup

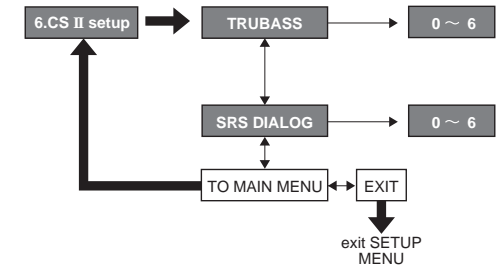

BASIC OPERATION

(PLAY BACK)

SELECTING AN INPUT SOURCE

Before you can listen to any input media, you must first select the input source on the SR3001.

Example : DVD

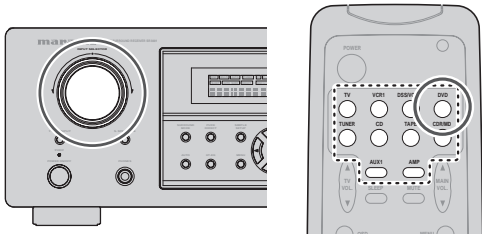

To select DVD, turn the **INPUT FUNCTION SELECTOR** knob on the front panel or simply press the **DVD** button on the remote.

After you have selected DVD, simply turn on the DVD player and play the DVD.

- The input name will appear in the display on the front panel.
- As the input is changed, the SR3001 will automatically switch to the digital input, surround mode, attenuation, and night mode status which were entered during the configuration process for that source.
- When an audio source is selected, the last video input used remains routed to the **VCR1 & DSS/VCR2** Outputs and **Monitor** Outputs. This permits simultaneous viewing and listening to different sources.
- When a Video source is selected, the video signal for that input will be routed to the **Monitor Outputs** jacks and will be viewable on a TV monitor connected to the SR3001.
- When a Video source is selected, the video signal for that input will be routed to the **Monitor Outputs** jacks and will be viewable on a TV monitor connected to the SR3001. If a component video input is connected to the **DVD** or **DSS** component inputs, it will be routed to the **Component Video Output**. Make certain that your TV is set to the proper input to view the signal.

SELECTING THE SURROUND MODE

Example : AUTO SURROUND

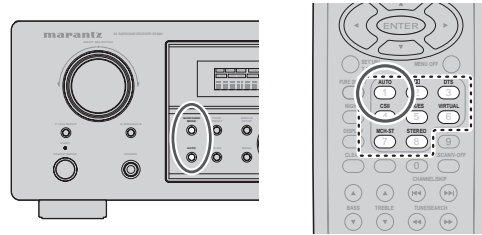

To select the surround mode during playback, press the **SURROUND MODE** button on the front panel or the **Surround mode** buttons on the remote.

ADJUSTING THE MAIN VOLUME

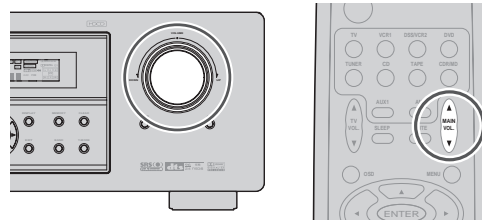

Adjust the volume to a comfortable level using the **VOLUME** control knob on the front panel or **VOL ▲ / ▼** buttons on the remote.

To increase the volume, turn the **VOLUME** knob clockwise or press **VOL ▲** button on the remote, to decrease the volume, turn counterclockwise or press **VOL ▼** button on the remote.

Notes:

- The volume can be adjusted within the range of $-\infty$ to 18 dB, in steps of 1 dB.
- However, when the channel level is set as described on page 20, if the volume for any channel is set at +1 dB or greater, the volume cannot be adjusted up to 18 dB.
(In this case the maximum volume adjustment range is "18 dB - Maximum value of channel level")

ADJUSTING THE TONE (BASS & TREBLE) CONTROL

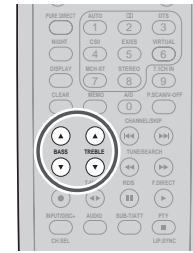

During a listening session you may wish to adjust the Bass and Treble Control to suit your listening tastes or room acoustics.

(Using the remote control unit)

To adjust the bass effect, press **BASS▲** or **BASS▼** on the remote.

To adjust the treble effect, press **TREBLE▲** or **TREBLE▼** on the remote.

Note:

The tone control function can work in the **AUTO Surround, Stereo, Dolby PLIIX, DTS, DTS-ES, and Multi Ch. Stereo** mode.

TEMPORARILY TURNING OFF THE SOUND

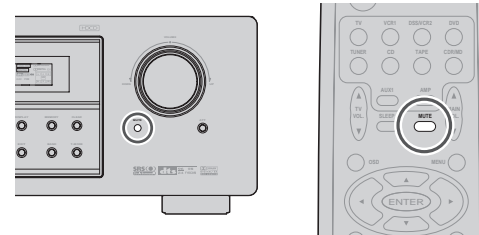

To temporarily silence all speaker outputs such as when interrupted by a phone call, press the **MUTE** button on the front panel or **MUTE** button on the remote.

This will interrupt the output to all speakers and the head-phone jack, but it will not affect any recording or dubbing that may be in progress.

When the system is muted, the display will show **"MUTE"**.

Press the **MUTE** button again to return to normal operation.

USING THE SLEEP TIMER



To program the SR3001 for automatic standby, press the **SLEEP** button on the remote.

Each press of the button will increase the time before shut down in the following sequence.

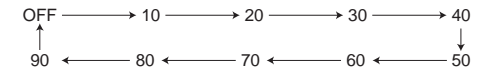

The sleep time will be shown for a few seconds in the display on the front panel, and it will count down until the time has elapsed.

When the programmed sleep time has elapsed, the unit will automatically turn off.

Note that the **SLEEP** indicator on the display will illuminate when the Sleep function is programmed.

To cancel the Sleep function, press the **SLEEP** button until the display shows **"SLEEP OFF"** and the **SLEEP** indicator will disappear.

NIGHT MODE



Press the **NIGHT** button on the remote to turn on the **NIGHT** mode.

Selecting the **Night Mode ON** is effective in **Dolby Digital** only, and it compresses the dynamic range.

This softens loud passages such as sudden explosions, to help prevent disturbing others late at night.

To turn off the **Night mode**, press the **NIGHT** button again.

SURROUND MODE

The SR3001 is equipped with many surround modes. These are provided to reproduce a variety of surround sound effects, according to the content of the source to be played.

The available surround modes may be restricted depending on the input signal and speaker setup.

AUTO

When this mode is selected, the receiver determines whether the digital input signal is Dolby Digital, Dolby Digital Surround EX, DTS, DTS-ES, DTS 96/24 or PCM-audio.

Surround EX & DTS-ES will operate for multichannel source that has a Dolby Digital Surround EX or DTS-ES auto trigger flag in the digital signal.

When a Dolby Digital or DTS signal is input, the number of channels for which the corresponding signal is encoded will be played.

Inputting a Dolby Digital two channel signal with Dolby surround status automatically subjects that signal to Pro Logic IIx movie processing before play.

PCM 96 kHz source material can be played in this mode.

Notes:

- When you use this mode with certain DVD and CD players, performing operations such as “Skip” or “Stop” may momentarily interrupt the output.
- When the signal is not decoded, the mode is changed to AUTO mode automatically. Refer to page 26 to confirm the available decoding mode.

DI MODE

(Dolby Digital, Pro Logic IIx MOVIE, Pro Logic IIx MUSIC, Pro Logic IIx GAME, Pro Logic)

This mode is used with source materials encoded in Dolby Digital and Dolby Surround.

DOLBY DIGITAL

This mode is enabled when playing source materials encoded in Dolby Digital.

Playing multichannel encoded 6.1 or 7.1-channel Dolby Digital sources provides five main audio channels (left, center, right, surround left and surround right) and Low Frequency Effect channel.

Dolby Digital EX decoding is not available in this mode.

Dolby Pro Logic IIx brings the excitement of surround sound to any stereo mix, while making existing Dolby Surround mixes sound more like discrete 6.1 or 7.1-channel Surround sound.

Dolby Pro Logic IIx has 3 modes. Please see below.

Pro Logic IIx MOVIE

This mode provides 6.1 or 7.1 channel surround sound from Dolby Surround encoded stereo movie sound tracks.

Pro Logic IIx MUSIC

This mode provides 6.1 or 7.1 channel surround sound from conventional stereo sources, analog or digital, such as CD, Tape, FM, TV, Stereo VCR, etc.

Pro Logic IIx GAME

Game mode restores the impact low-frequency surround effects by routing them to the system's subwoofer.

Pro Logic

This mode emulated original Dolby Pro Logic decoding (3/1 surround) suit for Dolby Surround encoded stereo movie soundtracks.

Notes:

- Pro Logic IIx mode will decode as Pro Logic II mode when the SURROUND BACK SPEAKER is set NONE in SPEAKER SETUP menu. (See SPEAKER SETUP, page 18)
- Pro Logic IIx mode is available for a 2ch input signal which is encoded in Dolby Digital or PCM format.
- PCM-audio signals can be subjected to Pro Logic processing when the sampling frequency is 32 kHz, 44.1 kHz or 48 kHz.

EX/ES

This mode provides 6.1 channel surround for DOLBY DIGITAL EX, DTS-ES encoded source material such as DVD.

This mode cannot be used when an analog input has been selected.

Dolby Digital EX

In a movie theater, film soundtracks that have been encoded with Dolby Digital surround EX technology are able to reproduce an extra channel which has been added during the mixing of the program.

This channel, called Surround Back, places sounds behind the listener in addition to the currently available front left, front center, front right, surround right, surround left and subwoofer channels.

This additional channel provides the opportunity for more detailed imaging behind the listener and brings more depth, spacious ambience and sound localization than ever before.

Dolby Digital EX is not available in the system without surround back speaker(s).

DTS-ES (Discrete 6.1, Matrix 6.1)

DTS-ES adds the surround center channel audio to the DTS 5.1-channel format to improve the acoustic positioning and makes acoustic image movement more natural with the 6.1-channel reproduction.

This receiver incorporates a DTS-ES decoder, which can handle DTS-ES Discrete-encoded and DTS-ES Matrix-encoded program sources from DVD, etc..

DTS-ES Discrete 6.1 features digital discrete recording of all channels including the surround back channel(s) and higher quality of audio reproduction.

DTS-ES is not available in the system without a surround back speaker.

dts MODE

(dts, Neo:6 Cinema, Neo:6 Music)

This mode is for DTS encoded source materials such as LASER DISC, CD, and DVD. Neo:6 is for some 2 channel sources.

dts : This mode is enabled when playing source materials encoded in dts multichannel.

Playing multichannel encoded 5.1-channel dts sources provides five main audio channels (left, center, right, surround left and surround right) and Low Frequency Effect channel.

dts-ES decoding is not available in this mode.

The DTS mode cannot be used when an analog input has been selected.

Neo:6 Cinema, Neo:6 Music

This mode decodes 2-channel signals into 6-channel signals using high-accuracy digital matrix technology.

The DTS Neo:6 decoder has near-discrete properties in the frequency characteristics of the channels as well as in channel separation.

According to the signals to be played back, DTS Neo:6 uses either the Neo:6 CINEMA mode optimized for movie playback or the Neo:6 MUSIC mode optimized for music playback.

Notes:

- Neo:6 mode is available to 2ch input signals which are encoded in Dolby Digital or PCM format.
- PCM-audio signals can be subjected to Pro Logic processing when the sampling frequency is 32 kHz, 44.1 kHz or 48 kHz.

MULTI CH. ST

This mode is used to create a wider, deeper and more natural soundstage from two channel source material.

This is done by feeding the left channel signal to both left front and left surround speaker and the right channel signal to both right front and right surround speaker. Additionally, the center channel reproduces a mix of the right and left channel.

CIRCLE SURROUND II (CSII-CINEMA, CSII-MUSIC, CSII-MONO)

Circle Surround is designed to enable multichannel surround sound playback of non-encoded and multichannel encoded material.

Backward compatibility provides listeners with up to 6.1 channels of surround performance from entire collection of music and film, including broadcast, videotape and stereo recorded music.

Depending on source material, you can select **CSII-Cinema** mode, **CSII-Music** mode or **CSII-Mono** mode.

Notes:

- CS II mode is available for 2ch input signals which are encoded in Dolby Digital or PCM format.
- PCM-audio signals can be subjected to Pro Logic processing when the sampling frequency is 32 kHz, 44.1 kHz or 48 kHz.

VIRTUAL

This mode creates a virtualized surround sound experience from a two-speaker (front L and R) playback system playing any multichannel audio source (such as found on DVDs and digital broadcasts), including Dolby Digital, Dolby Pro Logic or DTS.

STEREO

This mode bypasses all surround processing. In stereo program sources, the left and right channels play normally when PCM-audio or analog stereo is input. With Dolby Digital and DTS sources, the 5.1 multichannels are converted to two channel stereo. 96 kHz PCM source material can be played back in stereo mode.

PURE - DIRECT

In the Pure Direct mode, the tone control circuit and bass management configuration are bypassed for full range frequency response and the purist audio reproduction. 96 kHz PCM source material can be played back in this mode.

Notes:

- Internal speaker size is setup to front L/R = LARGE, Center = LARGE, Surround L/R = LARGE and Subwoofer = YES automatically. Tone controls and additional processing are also defeated.
- When you use this mode with certain DVD and CD players, performing operations such as "Skip" or "Stop" may momentarily interrupt the output.

CAUTION***NOTE for DTS signal***

- * Connected DVD-player, laser-disc player or CD-player needs to support DTS-digital output. You may not be able to play some DTS source signals from certain CD players and LD players even if you connect the player to the SR3001 digitally. This is because the digital signal has been processed (such as the output level, sampling frequency, or frequency response) and the SR3001 cannot recognize the signal as DTS data.
- * Depending on the player used, DTS play may produce a short noise. This is not a malfunction.
- * While signals from DTS-laser disc or CD are playing in another Surround mode, you cannot switch to digital input or from digital input to analog input by INPUT SETUP in SETUP MAIN MENU or the A/D button.
- * The outputs for the VCR 1 OUT, DSS/VCR 2 OUT, TAPE OUT, and CD-R OUT output analog audio signals. Do not record from CDs or LDs that support DTS using these outputs. If you do, the DTS-encoded signal will be recorded as noise.

NOTE for Dolby Digital Surround EX signal

- * When playing Dolby Digital Surround EX-encoded software in 6.1 channels, it is required to set the EX/ES mode.
- * Note that some of Dolby Digital Surround EX-encoded software does not contain the identification signal. In this case, set the EX/ES mode manually.

NOTE for 96kHz PCM audio

- * AUTO, Pure- DIRECT, and STEREO modes can be used when playing PCM signals with a sampling frequency of 96 kHz (such as from DVD-Video discs that contain 24 bit, 96 kHz audio). If such signals are input during playback in one of the other surround modes, output from SR3001 will be muted.
- * Certain DVD player models inhibit digital output. For details, refer to the player's operation manual.
- * Some DVD formatted discs feature copy protection. When using such disc, 96 kHz PCM signal is not output from the DVD player. For details, refer to the player's operation manual.

NOTE for HDCD signal

- * HDCD is effective only at the time of digital input.
- * AUTO, PURE DIRECT, and STEREO modes can be used when playing HDCD signals (such as from CD discs that contain HDCD).
- * You may not be able to play some HDCD source signals from certain CD players if you connect the player to the SR3001 digitally. This is because the digital signal has been processed (such as the output level, sampling frequency, or frequency response) and the SR3001 cannot recognize the signal as HDCD data.

The relation between the selected surround mode and the input signal

The surround mode is selected with the surround mode selector on SR3001 or the remote control unit. However, the sound you hear is subject to the relationship between the selected surround mode and input signal. That relationship is as follows;

| Surround Mode | Input Signal | Decoding | Output Channel | | | | | Front information display | |
|---|--------------------|----------------------|----------------|---|----------|------------|------|---------------------------|-------------------------|
| | | | L/R | C | SL SR | SBL SBR | SubW | Signal format indicators | Channel status |
| AUTO | Dolby Surr. EX | Dolby Digital EX | ○ | ○ | ○ | ○ | ○ | DD DIGITAL | L, C, R, SL, SR, S, LFE |
| | Dolby D (5.1ch) | Dolby Digital 5.1 | ○ | ○ | ○ | - | ○ | DD DIGITAL | L, C, R, SL, SR, LFE |
| | Dolby D(2ch) | Dolby Digital 2.0 | ○ | - | - | - | - | DD DIGITAL | L, R |
| | Dolby D (2ch Surr) | Pro Logic IIx movie | ○ | ○ | ○ | ○ | - | DD DIGITAL , DD SURROUND | L, R, S |
| | DTS-ES | DTS-ES | ○ | ○ | ○ | ○ | ○ | dts, ES | L, C, R, SL, SR, S, LFE |
| | DTS 96/24 | DTS 96/24 | ○ | ○ | ○ | - | ○ | dts 96/24 | L, C, R, SL, SR, LFE |
| | DTS (5.1ch) | DTS 5.1 | ○ | ○ | ○ | - | ○ | dts | L, C, R, SL, SR, LFE |
| | PCM(Audio) | PCM (Stereo) | ○ | - | - | - | - | PCM | L, R |
| | PCM 96kHz | PCM (96kHz Stereo) | ○ | - | - | - | - | PCM | L, R |
| | HDCD | PCM (Stereo) | ○ | - | - | - | - | PCM HDCD | L, R |
| | Analog | Stereo | ○ | - | - | - | - | ANALOG | - |
| PURE-DIRECT | Dolby D Surr. EX | Dolby Digital EX | ○ | ○ | ○ | ○ | ○ | DD DIGITAL | L, C, R, SL, SR, S, LFE |
| | Dolby D (5.1ch) | Dolby Digital 5.1 | ○ | ○ | ○ | - | ○ | DD DIGITAL | L, C, R, SL, SR, LFE |
| | Dolby D (2ch) | Dolby Digital 2.0 | ○ | - | - | - | - | DD DIGITAL | L, R |
| | Dolby D (2ch Surr) | Pro Logic IIx movie | ○ | ○ | ○ | ○ | - | DD DIGITAL , DD SURROUND | L, R, S |
| | DTS-ES | DTS-ES | ○ | ○ | ○ | ○ | ○ | dts, ES | L, C, R, SL, SR, S, LFE |
| | DTS 96/24 | DTS 96/24 | ○ | ○ | ○ | - | ○ | dts 96/24 | L, C, R, SL, SR, LFE |
| | DTS (5.1ch) | DTS 5.1 | ○ | ○ | ○ | - | ○ | dts | L, C, R, SL, SR, LFE |
| | PCM (Audio) | PCM (Stereo) | ○ | - | - | - | - | PCM | L, R |
| | PCM 96kHz | PCM (96kHz Stereo) | ○ | - | - | - | - | PCM | L, R |
| | HDCD | PCM (Stereo) | ○ | - | - | - | - | PCM HDCD | L, R |
| | Analog | Stereo | ○ | - | - | - | - | ANALOG | - |
| EX/ES | Dolby D Surr. EX | Dolby Digital EX | ○ | ○ | ○ | ○ | ○ | DD DIGITAL | L, C, R, SL, SR, S, LFE |
| | Dolby D (5.1ch) | Dolby Digital EX | ○ | ○ | ○ | ○ | ○ | DD DIGITAL | L, C, R, SL, SR, LFE |
| | DTS-ES | DTS-ES | ○ | ○ | ○ | ○ | ○ | dts , ES | L, C, R, SL, SR, S, LFE |
| | DTS(5.1ch) | DTS-ES | ○ | ○ | ○ | ○ | ○ | dts | L, C, R, SL, SR, LFE |
| DOLBY (PL IIx movie) (PL IIx music) (PL IIx game) (Pro Logic) | Dolby D Surr. EX | Dolby Digital 5.1 | ○ | ○ | ○ | ○ | ○ | DD DIGITAL | L, C, R, SL, SR, S, LFE |
| | Dolby D (5.1ch) | Dolby Digital 5.1 | ○ | ○ | ○ | ○ | ○ | DD DIGITAL | L, C, R, SL, SR, LFE |
| | Dolby D (2ch) | Pro Logic IIx | ○ | ○ | ○ | ○ | - | DD DIGITAL | L, R |
| | Dolby D (2ch Surr) | Pro Logic IIx | ○ | ○ | ○ | ○ | - | DD DIGITAL , DD SURROUND | L, R, S |
| | PCM (Audio) | Pro Logic IIx | ○ | ○ | ○ | ○ | - | PCM | L, R |
| | Analog | Pro Logic IIx | ○ | ○ | ○ | ○ | - | ANALOG | - |
| DTS (Neo:6 Cinema) (Neo:6 Music) | DTS-ES | DTS 5.1 | ○ | ○ | ○ | - | ○ | dts, ES | L, C, R, SL, SR, S, LFE |
| | DTS 96/24 | DTS 96/24 | ○ | ○ | ○ | - | ○ | dts 96/24 | L, C, R, SL, SR, LFE |
| | DTS (5.1ch) | DTS 5.1 | ○ | ○ | ○ | - | ○ | dts | L, C, R, SL, SR, LFE |
| | PCM (Audio) | Neo:6 | ○ | ○ | ○ | ○ | - | PCM | L, R |
| | Analog | Neo:6 | ○ | ○ | ○ | ○ | - | ANALOG | - |
| | Dolby D (2ch) | Neo:6 | ○ | ○ | ○ | ○ | - | DD DIGITAL | L, R |
| | Dolby D (2ch Surr) | Neo:6 | ○ | ○ | ○ | ○ | - | DD DIGITAL , DD SURROUND | L, R, S |
| CS II Cinema CS II Music CS II Mono | PCM (Audio) | CS II | ○ | ○ | ○ | ○ | ○ | PCM | L, R |
| | Analog | CS II | ○ | ○ | ○ | ○ | ○ | ANALOG | - |
| | Dolby D (2ch) | CS II | ○ | ○ | ○ | ○ | ○ | DD DIGITAL | L, R |
| | Dolby D (2ch Surr) | CS II | ○ | ○ | ○ | ○ | ○ | DD DIGITAL , DD SURROUND | L, R, S |
| STEREO | Dolby Surr. EX | Stereo | ○ | - | - | - | ○ | DD DIGITAL | L, C, R, SL, SR, S, LFE |
| | Dolby D (5.1ch) | Stereo | ○ | - | - | - | ○ | DD DIGITAL | L, C, R, SL, SR, LFE |
| | Dolby D (2ch) | Stereo | ○ | - | - | - | - | DD DIGITAL | L, R |
| | Dolby D (2ch Surr) | Stereo | ○ | - | - | - | - | DD DIGITAL , DD SURROUND | L, R, S |
| | DTS-ES | Stereo | ○ | - | - | - | ○ | dts, ES | L, C, R, SL, SR, S, LFE |
| | DTS 96/24 | Stereo | ○ | - | - | - | ○ | dts 96/24 | L, C, R, SL, SR, LFE |
| | DTS (5.1ch) | Stereo | ○ | - | - | - | ○ | dts | L, C, R, SL, SR, LFE |
| | PCM (Audio) | Stereo | ○ | - | - | - | - | PCM | L, R |
| | PCM 96kHz | Stereo | ○ | - | - | - | - | PCM | L, R |
| | HDCD | PCM (Stereo) | ○ | - | - | - | - | PCM HDCD | L, R |
| | Analog | Stereo | ○ | - | - | - | - | ANALOG | - |
| Virtual | Dolby Surr. EX | Virtual | ○ | - | - | - | - | DD DIGITAL | L, C, R, SL, SR, S, LFE |
| | Dolby D (5.1ch) | Virtual | ○ | - | - | - | - | DD DIGITAL | L, C, R, SL, SR, LFE |
| | Dolby D (2ch) | Virtual | ○ | - | - | - | - | DD DIGITAL | L, R |
| | Dolby D (2ch Surr) | Virtual | ○ | - | - | - | - | DD DIGITAL , DD SURROUND | L, R, S |
| | DTS-ES | Virtual | ○ | - | - | - | - | dts, ES | L, C, R, SL, SR, S, LFE |
| | DTS (5.1ch) | Virtual | ○ | - | - | - | - | dts | L, C, R, SL, SR, LFE |
| | PCM (Audio) | Virtual | ○ | - | - | - | - | PCM | L, R |
| | Analog | Virtual | ○ | - | - | - | - | ANALOG | - |
| Multi Ch. Stereo | Dolby Surr. EX | Dolby Digital EX | ○ | ○ | ○ | ○ | ○ | DD DIGITAL | L, C, R, SL, SR, S, LFE |
| | Dolby D (5.1ch) | Dolby Digital 5.1 | ○ | ○ | ○ | - | ○ | DD DIGITAL | L, C, R, SL, SR, LFE |
| | Dolby D (2ch) | Multi Channel Stereo | ○ | ○ | ○ | ○ | - | DD DIGITAL | L, R |
| | Dolby D (2ch Surr) | Multi Channel Stereo | ○ | ○ | ○ | ○ | - | DD DIGITAL , DD SURROUND | L, R, S |
| | DTS-ES | DTS-ES | ○ | ○ | ○ | ○ | ○ | dts, ES | L, C, R, SL, SR, S, LFE |
| | DTS (5.1ch) | DTS 5.1 | ○ | ○ | ○ | - | ○ | dts | L, C, R, SL, SR, LFE |
| | PCM (Audio) | Multi Channel Stereo | ○ | ○ | ○ | ○ | - | PCM | L, R |
| | Analog | Multi Channel Stereo | ○ | ○ | ○ | ○ | - | ANALOG | - |

Notes:

- Dolby Digital (2 ch: Lt/Rt): signal with Dolby Surround flag Speakers are full set.
- No sound outputs from the surround speaker, center speaker and subwoofer if the DVD disc has no surround data.

Abbreviations

- L/R : Front speakers
- C : Center speaker
- SL/SR : Surround speakers
- SBL/SBR : Surround Back speakers
- SubW : Sub woofer speaker

OTHER FUNCTION

ATTENUATION TO ANALOG INPUT SIGNAL

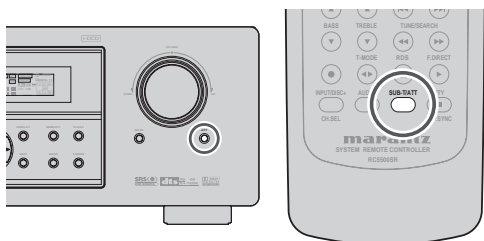

If the selected analog audio input signal is greater than the capable level of internal processing, the "PEAK" indicator will light up on the front display. If this happens, you should press the **ATT** button on the front panel or on the remote.

"ATT" indicator will be illuminated when this function is activated. The signal-input level is reduced by about half. Attenuation will not work with the output signal of TAPE-OUT, CD-R/MD-OUT, VCR1-OUT and DSS/VCR2-OUT.

This function is memorized for each individual input source.

LISTENING THROUGH HEADPHONES

This jack may be used to listen to the SR3001's output through a pair of headphones. Be certain that the headphones have a standard 1/4" stereo phono plug. (Note that the speakers will automatically be turned off when the headphone jack is in use.)

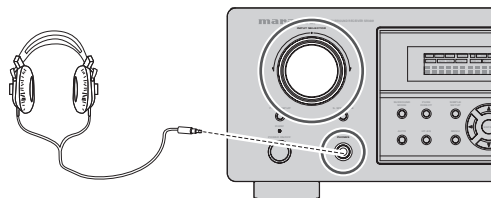

Notes:

- When using headphones, the surround mode will change to STEREO and TruSurround (TS) headphones by SURROUND MODE button.
- The surround mode returns to the previous setting as soon as the plug is removed from the jack.

VIDEO ON/OFF

When no video signal is connected to the SR3001 or a DVD, etc., is connected directly to your TV, the unnecessary video circuit can be turned off by selecting the "VIDEO OFF" setting.

To select video off, press the **V-OFF** button on the remote.



DISPLAY MODE

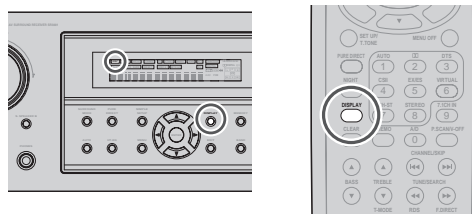

You can select the display mode for the front display of the SR3001.

To select this mode, press the **DISPLAY** on the front panel or on the remote.

When this button is pressed, the display mode is switched in the following sequence.

→ Surround Mode → Auto-display Off → Display Off → Input Function → Surround Mode...

In Auto display off mode, the display is off. But, if you make a change to the unit such as input or surround mode, the display will show that change, then go back to off after about 3 seconds. When changing the volume, it is not displayed.

In Display off mode, the display is off completely.

Note:

Only the DISP indicator will be illuminated on the front display, in display off condition

SELECTING ANALOG AUDIO INPUT OR DIGITAL AUDIO INPUT



If you have already assigned the digital inputs, you can temporarily select the audio input mode for each input source with the **A/D** button on the remote controller.

When this button is pressed, the input mode is switched in the following sequence.

→ Digital Auto → Digital → Analog → Digital Auto...

In Digital Auto mode, the types of signals being input to the digital and analog input jacks for the selected input source are detected automatically.

If no digital signal is being input, the analog input jacks are selected automatically.

In Digital mode, input is fixed to an assigned digital input terminal.

In analog mode, the analog input jacks are selected.

This selecting is temporary, so the result will not be stored in memory.

If you need to change the input mode completely, use INPUT setup in SETUP MENU system. (see page 17)

RECORDING AN ANALOG SOURCE

In normal operation, the audio or video source selected for listening through the SR3001 is sent to the record outputs.

This means that any program you are watching or listening to may be recorded simply by placing machines connected to the outputs for **TAPE OUT**, **CD-R/MD OUT**, **VCR1 OUT**, and **DSS/VCR2 OUT** in the record mode.

To record the input source signal you are currently watching or listening to

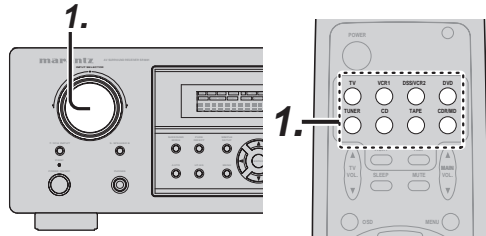

1. Select the input source to record by turning the **INPUT FUNCTION SELECTOR** knob on the front panel or simply press the **input selector** buttons on the remote.

The input source is now selected and you may watch or listen to it as desired.

2. The currently selected input source signal is output to the **TAPE OUT**, **CD-R/MD OUT**, **VCR1 OUT**, and **DSS/VCR2 OUT** outputs for recording.
3. Start recording to the recording component as desired.

Recording the video from one source and the audio from another

You can add the sound from one source to the video of another source to make your own video recordings.

Below is an example of recording the sound from a compact disc player connected to CD IN and the video from a video camera connected to VCR1 to video cassette recorder connected to the DSS/VCR2 OUT jack.

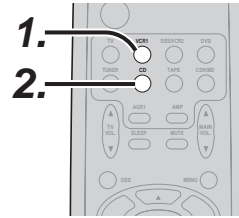

1. Switch the video output source to VCR1 by simply pressing the **input selector** buttons on the remote.
2. Switch the audio input source to CD by simply pressing the **input selector** buttons on the remote.
3. Now "CD" has been selected as the audio input source and "VCR1" as the video input source.

Notes:

- If you change the input source during recording, you will record the signals from the newly selected input source.
- You cannot record the surround effects.
- There is no conversion from digital to analog .

When connecting CD players and other digital components, do not connect only the digital terminals, but the analog ones as well.

HT-EQ

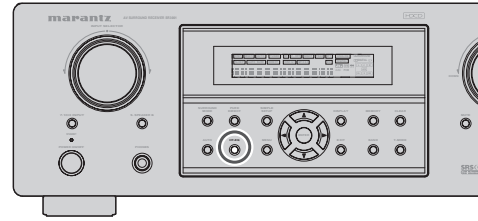

Press the **HT-EQ** button on the front panel to turn on the HT-EQ mode.

The tonal balance of a film soundtrack will be excessively bright and harsh when played back over audio equipment in the home. This is because film soundtracks were designed to be played back in large movie theater environments.

Activating the HT-EQ feature when watching a film made for movie theaters corrects this and restores the correct tonal balance.

The HT-EQ feature can be activated only while in Dolby Pro Logic Mode, or while decoding Dolby Digital or DTS encoded material.

7.1 CH INPUT

The SR3001 is equipped for future expansion through the use of Multi channel SACD multichannel player or DVD-Audio player.

When this is selected, the input signals connected to the L (front left), R (front right), CENTER, SL (surround left), SR (surround right) and SBL (surround back left) and SBR (surround back right) channels of the 7.1 CH. In jacks are output directly to the front (left and right), center, surround (left and right) and surround back speaker systems as well as the pre-out jacks without passing through the surround circuitry.

In addition, the signal input to the SW (subwoofer) jack is output to the PRE OUT SW (subwoofer) jack. When 7.1 CH. INPUT is selected, the last video input used remains routed to the **Monitor Outputs**. This permits simultaneous viewing with video sources

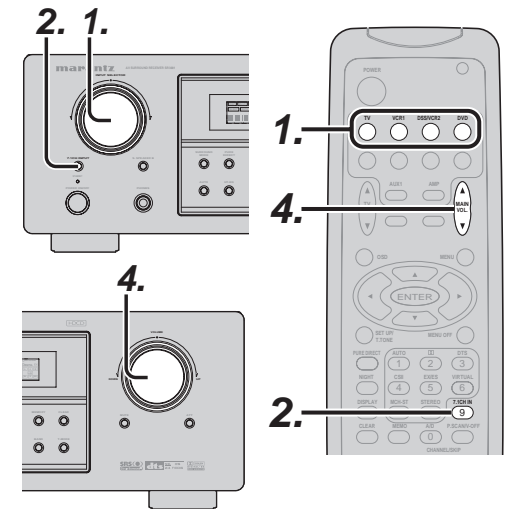

1. Select a desired Video source to decide the routed video signal to the **Monitor Outputs** .
2. Press the **7.1 CH INPUT** button on the front panel or press **7.1 CH IN** on the remote to switch the 7.1 channel input.

- If it is necessary to adjust the output level of each channel, press the **CH.SEL** button on the remote.

Adjust the speaker output levels so that you can hear the same sound level from each speaker at the listening position. For the front left, front right, center, surround left, surround right and surround back speakers, the output levels can be adjusted between -10 to +10 dB.

The subwoofer can be adjusted between -15 and +10 dB.

These adjustments result will be stored to 7.1 CH. INPUT memory.

- Adjust the main volume with the **MAIN VOLUME** knob or the **VOL** buttons on the remote.

To cancel the 7.1 CH. INPUT setting, press the **7.1 CH INPUT** button on the front panel or press **7.1 CH IN** on the remote.

Notes:

- When the 7.1 CH. Input is in use, you may not select a surround mode, as the external decoder determines processing.
- In addition, there is no signal at the record outputs when the 7.1 CH. Input is in use.

7.1 CH INPUT LEVEL

This menu is to adjust the speaker levels for 7.1-channel input sources.

Here you will adjust the volume for each channel so that they are all heard by the listener at the same level.

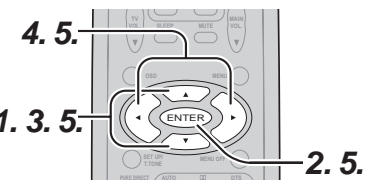
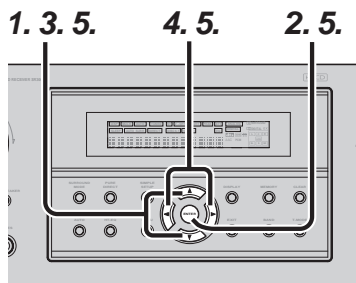

- Press the **CH.SEL** button on the remote to enter this menu.
- Press **▲** or **▼** cursor button to select desired channel.
- Using the **◀** or **▶** cursor button, adjust the volume level of each channel.

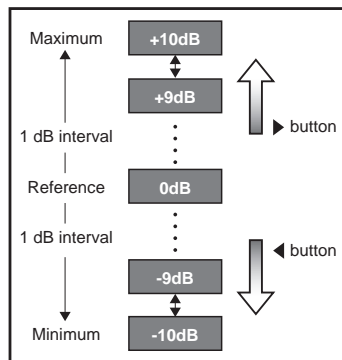

Notes:

- When no operation is taken for 5 seconds, the level setup mode will be cancelled.
- The condition of these setup will be memorized to 7.1CH INPUT source.

MENU STRUCTURE of 7.1CH INPUT LEVEL setup

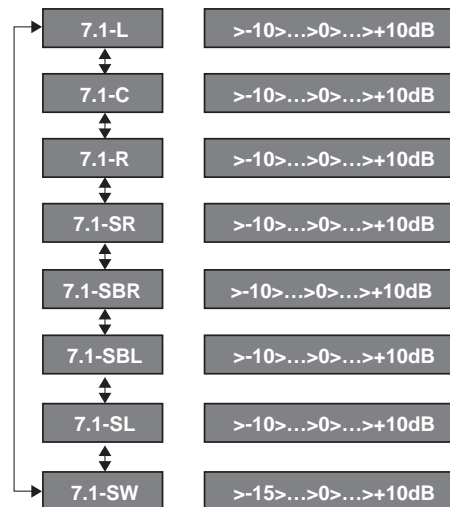

BASIC OPERATION

(TUNER)

LISTENING TO THE TUNER

Frequency scan step for AM is selectable. Default setup is 9 kHz step, if your country's standard is 10 kHz step, Press **TUNER** button on the remote more than 6 seconds. Scan step will change.

Note:

Preset memory for the tuner will clear by changing this setup.

AUTO TUNING

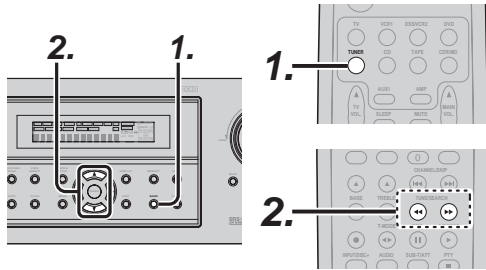

(Using the SR3001)

1. To select tuner and desired band (FM or AM), press the **BAND** button on the front panel.
2. Press the **▲** or **▼** cursor buttons on the front panel for more than 1 second to start the auto tuning function.
3. Automatic searching begins then stops when a station is tuned in.

(Using the remote control unit)

1. To select tuner and desired band (FM or AM), press the **TUNER** button twice within in two seconds on the remote.
2. Press the **◀** or **▶** for more than 1 second on the remote.
3. Automatic searching begins then stops when a station is tuned in.

If tuning does not stop at the desired station, use to the "Manual tuning" operation.

MANUAL TUNING

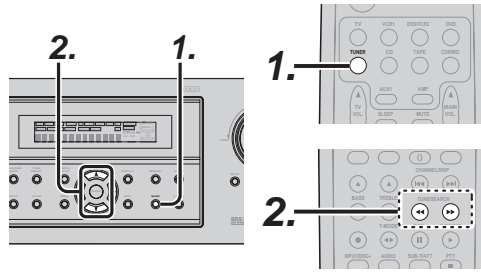

(Using the SR3001)

1. To select tuner and desired band (FM or AM), press the **BAND** button on the front panel
2. Press the **▲** or **▼** cursor buttons on the front panel to select the desired station.

(Using the remote control unit)

1. To select tuner and desired band (FM or AM), press the **TUNER** button twice within in two seconds on the remote.
2. Press the **◀** or **▶** on the remote to tune in the desired station.

DIRECT FREQUENCY CALL

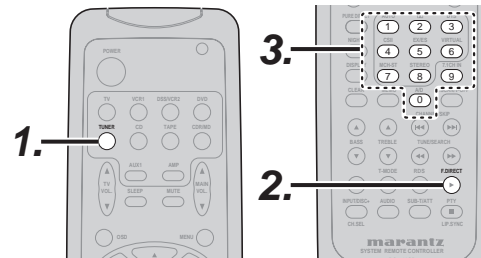

1. To select tuner and desired band (FM or AM), press the **TUNER** button twice within two seconds on the remote.
2. Press the **F.DIRECT** on the remote, display will show "FREQ ----".
3. Input your desired station's frequency with the **numeric** buttons on the remote.
4. The desired station will automatically be tuned.

(FM) TUNING MODE (AUTO STEREO OR MONO)

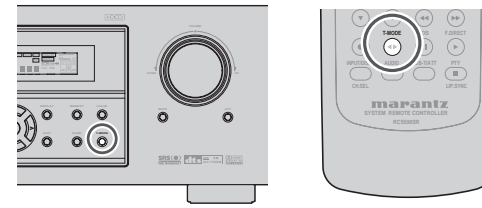

When in the auto stereo mode, **AUTO** indicator will be illuminated on the display. The "ST" indicator is illuminated when a stereo broadcast is tuned in.

At open frequencies, the noise is muted and the "TUNED" and "ST" indicators are not illuminated. If the signal is weak, it may be difficult to tune into the station in stereo. In such a case, press the **T-MODE** button on the front panel or remote.

"AUTO" indicator is not illuminated, if FM stereo broadcasts are received in monaural and the "ST" indicator is not illuminated.

To return to auto stereo mode, press the **T-MODE** button or press **T-MODE** button on the remote again. **AUTO** indicator is illuminated on the display.

PRESET MEMORY

With this unit you can preset up to 50 FM/AM stations in any order.

For each station, you can memorize the frequency and reception mode if desired.

AUTO PRESET MEMORY

This function automatically scans the FM and AM band and enters all stations with proper signal strength into the memory.

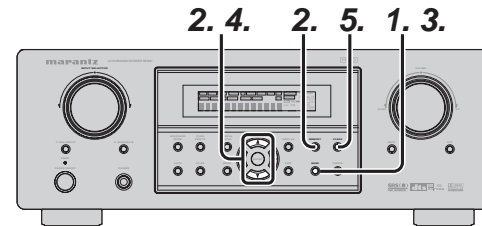

1. To select FM, press the **BAND** button on the front panel.
2. While pressing the **MEMO** button, press the **▶** cursor button.

"AUTO PRESET" will appear on the display, and scanning starts from the lowest frequency.

3. Each time the tuner finds a station, scanning will pause and the station will be played for five seconds.

During this time, the following operations are possible.

The band can be changed by the **BAND** button.

4. If no button is pressed during this period, the current station is memorized in location Preset 02.

If you wish to skip the current station, press the **▲** cursor button during this period, this station is skipped and auto presetting continues.

5. Operation stops automatically when all 50 preset memory positions are filled or when auto scanning attains the highest end of all bands. If you desire to stop the auto preset memory at anytime, press the **CLEAR** button.

MANUAL PRESET MEMORY

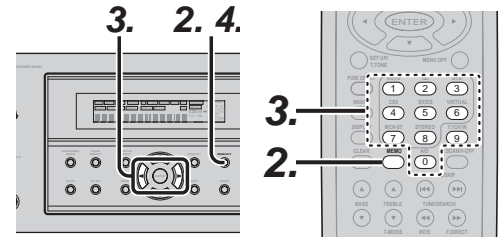

(Using the SR3001)

1. Tune into the radio station you desire (Refer to the "MANUAL TUNING" or "AUTO TUNING" section).
2. Press the **MEMO** button on the front panel. "--" (preset number) starts blinking on the display.
3. Select the preset number by pressing the **▲** or **▼** cursor buttons, while this is still blinking (approx. 5 seconds)
4. Press the **MEMO** button again to enter. The display stops blinking.

The station is now stored in the specified preset memory location.

(Using the remote control unit)

1. Tune into the radio station you desire (Refer to the "MANUAL TUNING" or "AUTO TUNING" section).
2. Press the **MEMO** button on the remote. "--" (preset number) starts blinking on the display.
3. Enter the desired preset number by pressing the **numeric** buttons.

Note:

When entering a single digit number (2 for example), either input "02" or just input "2" and wait for a few seconds.

RECALLING A PRESET STATION

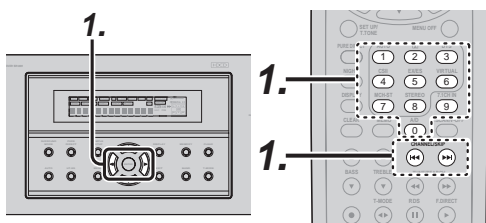

(Using the SR3001)

1. Select the desired preset station by pressing the ◀ or ▶ cursor buttons on the front panel

(Using the remote control unit)

1. Press the ◀◀ or ▶▶ buttons to select the desired preset station, or input your desired preset channel with the **numeric** buttons on the remote.

PRESET SCAN

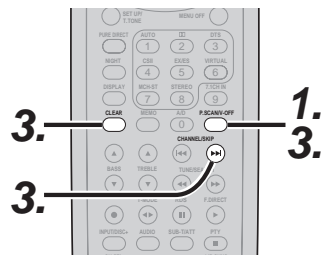

(Using the remote control unit)

1. Press the **P.SCAN** on the remote. "PRESET SCAN" appears on the display and then the preset station with the lowest preset number is recalled first.
2. Preset stations are recalled in sequence (No.1 → No.2 → etc.) for 5 seconds each. No stored preset number will be skipped.
3. You can fast forward the preset stations by pressing the ▶▶ continuously. When the desired preset station is received, cancel the preset scan operation by pressing the **CLEAR** button or **P.SCAN** on the remote.

CLEARING STORED PRESET STATIONS

You can remove preset stations from the memory using the following procedure.

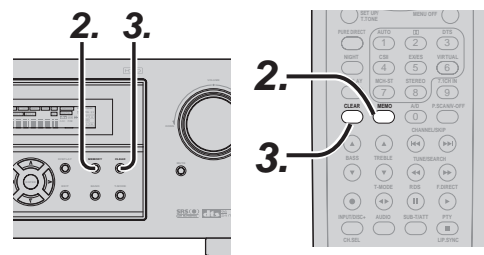

1. Recall the preset number to be cleared with the method described in "Recalling" a preset station.
2. Press the **MEMO** button on the front panel or press the **MEMO** button on the remote.
3. The stored preset number blinks in the display for 5 seconds. While blinking, press the **CLEAR** button on the front panel or the remote.
4. "xx CLEAR" appears on the display to indicate that the specified preset number has been cleared.

Note:

To clear all stored preset stations, press and hold the **CLEAR** and the **ENTER** buttons for two seconds.

SORTING PRESET STATIONS

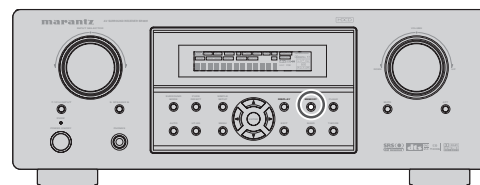

If you have stations memorized, and there is a gap in the sequential order:

i.e. the stations are stored as follows

- 1) 87.1 MHz
- 2) 93.1 MHz
- 3) 94.7 MHz
- 10) 105.9 MHz

(notice there is no stations programmed for pre sets for 4-9), you can have pre set 10 become pre set 5: To sort the numbers, press and hold the **MEMO** and the ▼ cursor buttons.

"PRESET SORT" will appear on the display and sorting will be done.

NAME INPUT OF THE PRESET STATION.

This function allows the name of each preset channel to be entered using alphanumeric characters.

Before name inputting, you need to store preset stations with the preset memory operation.

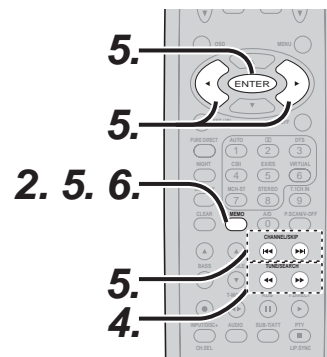
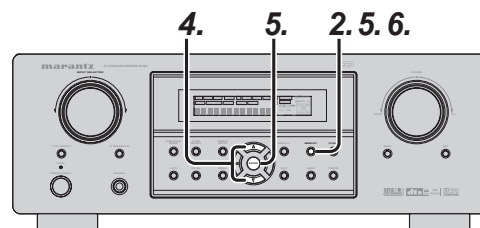

1. Recall the preset number to be inputted name with the method described in "Recalling" a preset station.
2. Press the **MEMO** button on the front panel or press the **MEMO** button on the remote for more than 3 seconds.
3. The left most column of the station name indicator flashes, indicating the character entry ready status.
4. When you press the ▲ or ▼ cursor buttons on the front panel or the ◀◀ / ▶▶ buttons on the remote, alphabetic and numeric characters will be displayed in the following order:
A → B → C ... Z → 1 → 2 → 3 0 → - → + → / → (Blank) → A
UP →
DOWN →
5. After selecting the first character to be entered, press the **MEMO** or **ENTER** buttons, press the **MEMO** button on the remote.

The entry in this column is fixed and the next column starts to flash. Fill the next column the same way.

To move back and forth between the characters, press the ◀/▶ cursor buttons or press ◀◀ or ▶▶ buttons on the remote.

Note:

Unused columns should be filled by entering blanks.

6. To save the name, press the **MEMO** button on the front panel or remote for more than 2 seconds.

| Ten keypad | Press, press again, press again, etc. |
|------------|---------------------------------------|
| 1 | A → B → C → 1 → A |
| 2 | D → E → F → 2 → D |
| 3 | G → H → I → 3 → G |
| 4 | J → K → L → 4 → J |
| 5 | M → N → O → 5 → M |
| 6 | P → Q → R → 6 → P |
| 7 | S → T → U → 7 → S |
| 8 | V → W → X → 8 → V |
| 9 | Y → Z → space → 9 → Y |
| 0 | -- → + → / → 0 |

RDS OPERATION

Now in use in many countries, RDS (Radio Data System) is a description of the station's programming hidden space in the FM signal.

Your new receiver is equipped with RDS to assist in the selection of FM stations using station and network names, rather than broadcast frequencies. Additional RDS functions include the ability to search for programme types.

RADIO TEXT

Some RDS stations broadcast RADIO TEXT, which is additional information on the station and programme being broadcast.

RADIO TEXT information appears as 'running' text in the display. RADIO TEXT is transmitted character by the radio station. As a result of that it may take some time until the entire text has been completely received.

RDS DISPLAY

When a receiver is tuned to an FM station that is transmitting RDS data, the Front Panel Information Display will automatically show the station name or RADIO TEXT in place of the typical display of the station's broadcast frequency.

To change the display, press the **RDS** button on the remote.

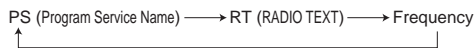

PROGRAMME TYPE (PTY) DISPLAY

The RDS system categorizes programmes according to their genre into different programme type (PTY) groups. To display the programme type information of the current station, press the **PTY** button in the **TUNER MODE** on the remote.



PTY AUTO SEARCH

Your receiver is equipped to automatically search for stations transmitting any of 29 different programme types. To search for a PTY, follow these procedures:

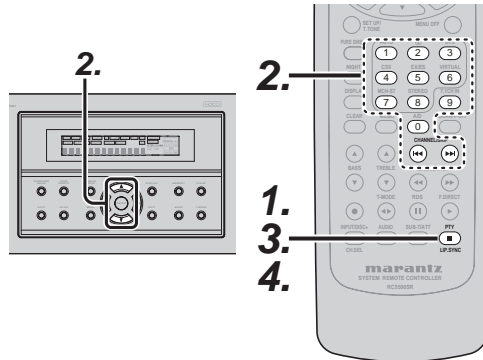

1. Press the **PTY** button in the **TUNER MODE** on the remote controller. The current station's PTY will be displayed, or the currently selected PTY group will be displayed in blinking if no station or RDS data is present.
2. To change to a new PTY type, press the **▲** or **▼** cursor button on the front panel or **numeric** buttons on the remote until the desired PTY is shown in the display.
3. Once the desired PTY group or type has been selected, press the **PTY** button while the display blink (approx. 5 seconds). The PTY Auto search will start, and the tuner will pause at each station broadcasting RDS PTY information corresponding to the selected choice.

4. To advance to the next RDS station with the desired PTY, press the **PTY** button again within 5 seconds.

| NUMBER | DISPLAY | PROGRAMME TYPE |
|--------|----------|-----------------------|
| 1 | POP | Pop Music |
| 2 | ROCK | Rock Music |
| 3 | MOR | M. O. R. Music |
| 4 | LIGHT | Light classical |
| 5 | CLASSIC | Serious classical |
| 6 | NEWS | News |
| 7 | AFFAIR | Current Affairs |
| 8 | INFO | Information |
| 9 | SPORT | Sport |
| 10 | EDUCATE | Education |
| 11 | DRAMA | Drama |
| 12 | CULTURE | Culture |
| 13 | SCIENCE | Science |
| 14 | OTHERS | Varied |
| 15 | OTHER | Other Music |
| 16 | WEATHER | Weather |
| 17 | FINANCE | Finance |
| 18 | CHILDREN | Children's programmes |
| 19 | SOCIAL | Social Affairs |
| 20 | RELIGION | Religion |
| 21 | PHONE IN | Phone In |
| 22 | TRAVEL | Travel |
| 23 | HOBBIES | Hobbies |
| 24 | JAZZ | Jazz Music |
| 25 | COUNTRY | Country Music |
| 26 | NATION | National Music |
| 27 | OLDIES | Oldies Music |
| 28 | FOLK | Folk Music |
| 29 | DOCUMENT | Documentary |

SURROUND SPEAKER B SYSTEM

The Surround Speaker B system is a function which allows you to listen to the same source in a room other than the room in which the SR3001 is located.

The operations possible with the Surround speaker function are explained briefly below.

ANOTHER ROOM PLAYBACK USING THE S(SURROUND) SPEAKER B TERMINALS

The SR3001 allows you to connect another set of speakers and place them in a another room or separated area for listening to music.

The SURROUND SPEAKER B system can not be operated with the supplied remote controller.

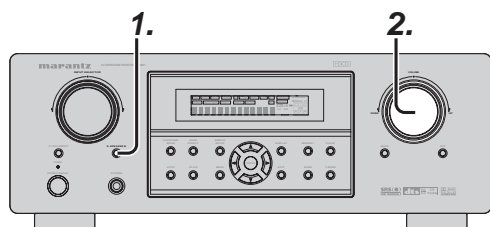

1. Press the **S(Surround) SPEAKER B** button. The unit enters surround speaker B mode and the “**SPKR B**” will appear on the display.
2. The volume of S. SPEAKER B is interlocked with the main volume.

Notes for SURROUND SPEAKER B

- SURROUND SPEAKER B On/ Off is available in main room only.
- SURROUND SPEAKER B output terminals can be used when the SURROUND BACK SPEAKER is set NONE in SPEAKER SETUP menu. (See SPEAKER SETUP, page 18)
- “The Surr. Back Speakers are in use” is displayed by pressing the **S. SPEAKER B** button when the SURROUND BACK SPEAKER is set except NONE in SPEAKER SETUP menu. (See SPEAKER SETUP, page 18)
- Surround Speaker B function is unavailable, while the unit is 7.1 CH input mode.

TROUBLESHOOTING

In case of trouble, check the following before calling for service:

1. Are the connections made properly ?
2. Are you operating the unit properly following the user's guide ?
3. Are the power amplifiers and speaker working properly ?

If the unit does not operate properly, check items shown in the following table.

If your trouble cannot be recovered with the remedy actions listed in the following table, malfunction of the internal circuitry is suspected; immediately unplug the power cable and contact your dealer, nearest Marantz authorized dealer or the Marantz Service Center in your country.

| SYMPTOM | CAUSE | REMEDY |
|--|---|--|
| SR3001 cannot be turned up. | The power plug is not connected. | Connect the power plug to the outlet. |
| No sound and picture are output even when power is on. | Mute is on. | Cancel mute using the remote control unit. |
| | The input cable is not connected correctly. | See the connection diagram and connect the cables correctly. |
| | The master volume control is turned all the way down. | Adjust the master volume. |
| | The function selector position is wrong. | Select correct position. |
| No speaker output. | The headphones are connected to the headphone jack. | Disconnect the headphones. (Speakers will not output sound when headphones are connected.) |
| Incorrect Audio or Video for selected source. | Input cable connected incorrectly. | Connect the cable correctly by referring to the connection diagram. |
| Incorrect Audio from a channel. | Speaker cable connected incorrectly. | Connect the cable correctly by referring to the connection diagram. |
| No Audio output from the center channel speaker. | The center speaker cable connection is incomplete. | Connect the cable correctly. |
| | STEREO has been selected for Surround mode. | When STEREO is selected for Surround mode, no sound will be output from the center speaker. Set another Surround mode. |
| | Center = NONE has been selected in SETUP mode. | Make the correct setting. |
| No Audio output from the surround speakers. | The surround speaker cable connection is incomplete. | Connect the cable correctly. |
| | STEREO has been selected for Surround mode. | When STEREO has been selected for Surround mode, no sound will be output from the surround speaker. Set another Surround mode. |
| | Surround = NONE has been selected in SETUP mode. | Make the correct setting. |
| No Audio output from the surround back speakers. | The surround back speaker cable connection is incomplete. | Connect the cable correctly. |
| | Surround mode is not EX/ES mode. | Set surround mode EX/ES. |
| | Surround back = NONE has been selected in SPEAKERS SIZE SETUP | Make the correct setting. |

| SYMPTOM | CAUSE | REMEDY |
|--|---|---|
| Can not select EX/ES mode. | Surround center= NONE has been selected in SPEAKERS SIZE SETUP | Make the correct setting. |
| | Input signal is incompatible. | Use 5.1 channel source. |
| Can not select Pro Logic IIx mode. | Input signal is incompatible. | Use 2 channel Dolby Digital input signal, PCM input signal or analog input signal. |
| Can not select Neo:6 mode. | Input signal is incompatible. | Use 2 channel Dolby Digital input signal, PCM input signal or analog input signal. |
| Can not select CSII mode. | Input signal is incompatible. | Use 2 channel Dolby Digital input signal, PCM input signal or analog input signal. |
| No output to Sub Woofer Out. | Sub-woofer = NONE has been selected in SETUP mode. | Select Sub-woofer = YES. |
| Noise is produced during DTS-encoded CD or laser disc play. | Analog has been selected for input. | Be sure to perform digital connection, select digital input, then play. |
| A specific channel does not produce output. | Nothing recorded on source. | Check the encoded channel on the source side. |
| FM or AM reception fails. | Antenna connection is incomplete. | Correctly connect the indoor FM and AM antennas to FM and AM antenna outlets. |
| Noise is heard during AM reception. | Reception is affected by other electrical fields. | Try changing location where the AM indoor antenna is set up. |
| Noise is heard during FM reception. | The radio waves from the broadcasting station are weak. | Install an FM outdoor antenna. |
| Cannot get programmed station when the PRESET button is pressed. | Preset data has been erased. | Disconnecting power plug for long periods of time will erase preset data. If that happens, input the preset data again. |
| Control with the remote control unit fails. | Batteries are consumed. | Replace all the batteries with new ones. |
| | Remote controller's function-key setting is wrong. | Select different position from which equipment will be controlled. |
| | The distance between this SR3001 and the remote commander is too far. | Move closer to this SR3001. |
| | Something is blocking SR3001 and the remote commander. | Remove offending object. |

GENERAL MALFUNCTION

If the equipment malfunctions, this may be because an electrostatic discharge or AC line interference has corrupted the information in the equipment memory circuits. Therefore:

- disconnect the plug from the AC line supply
- after waiting at least three minutes, reconnect the plug to the AC line supply
- re-attempt to operate the equipment

Memory backup

- In case a power outage occurs or the power cord is accidentally unplugged, the SR3001 is equipped with a backup function to prevent memory data such as the preset memory from being erased.

HOW TO RESET THE UNIT

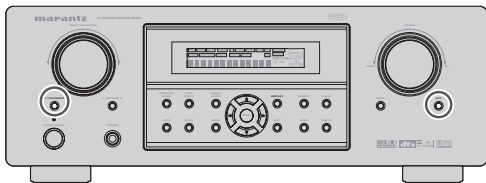

Should the operation or display seem to be abnormal, reset the unit with the following procedure. The SR3001 is turned on, press and hold the **7.1CH INPUT** and **ATT** buttons simultaneously for 3 seconds or more. Remember that the procedure will reset the settings of the function selector, Surround mode, delay time, TUNER PRESET etc., to their initial settings.

TECHNICAL SPECIFICATIONS

FM TUNER SECTION

Frequency Range87.5 - 108.0 MHz
 Usable SensitivityIHF 1.8 μV/16.4 dBf
 Signal to Noise Ratio Mono/Stereo 75/70 dB
 Distortion.....Mono/Stereo 0.2/0.3 %
 Stereo Separation..... 1 kHz 45 dB
 Alternate Channel Selectivity± 300 kHz 60 dB
 Image Rejection.....98 MHz 70 dB
 Tuner Output Level 1 kHz, ± 75 kHz Dev 800 mV

AM TUNER SECTION

Frequency Range 531 - 1602 kHz
 Signal to Noise Ratio 50 dB
 Usable Sensitivity Loop 400mV/m
 Distortion.....400Hz, 30 % Mod. 0.5 %
 Selectivity.....± 18 kHz 70 dB

AUDIO SECTION

Power Output (20 Hz - 20 kHz/THD=0.08%)
 Front L&R8 ohms 60 W / Ch
 Center8 ohms 60 W / Ch
 Surround L&R8 ohms 60 W / Ch
 Surround Back L&R8 ohms 60 W / Ch

Front L&R6 ohms 75 W / Ch
 Center6 ohms 75 W / Ch
 Surround L&R6 ohms 75 W / Ch
 Surround Back L&R6 ohms 75 W / Ch

Input Sensitivity/Impedance..... 168 mV/ 47 Kohms
 Signal to Noise Ratio(Analog Input / Pure Direct) 105 dB
 Frequency Response
 (Analog Input / Pure Direct)
8 Hz - 100 kHz (± 3 dB)
 (Digital Input / 96 kHz PCM)
 8 Hz - 45 kHz (± 3 dB)

VIDEO

Television Format..... PAL
 Input Level/Impedance 1 Vp-p/75 ohms
 Output Level/Impedance..... 1 Vp-p/75 ohms
 Video Frequency Response 5 Hz to 8 MHz (- 1 dB)
 Video Frequency (Component) 5 Hz to 80 MHz (- 1 dB)
 S/N..... 60 dB

GENERAL

Power Requirement.....AC 230 V 50/60 Hz
 Power Consumption 370 W
 Weight 11.1 Kg

ACCESSORIES

Remote Control Unit RC5500SR 1
 AAA-size batteries 2
 FM Antenna 1
 AM Loop Antenna 1

Specifications subject to change without prior notice.

DIMENSIONS

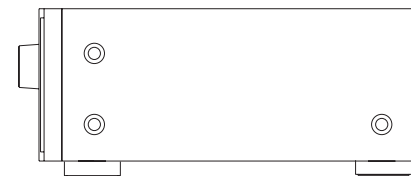
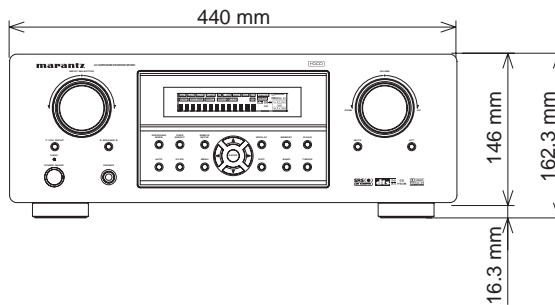
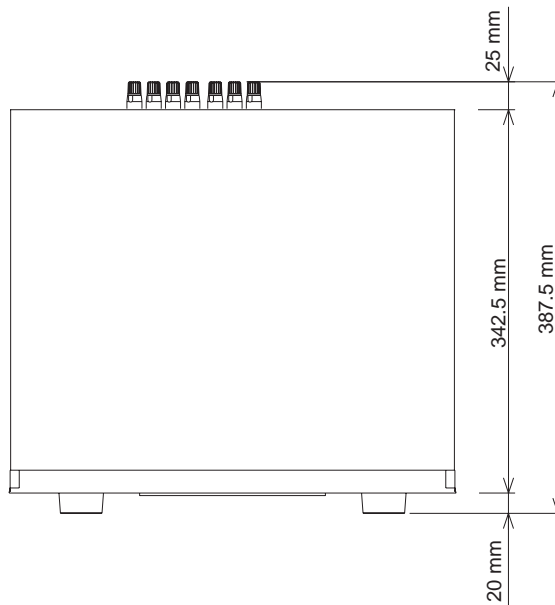

SETUP CODES

CD

| | |
|----------------------------|---|
| Aiwa..... | 0184 |
| Burmester..... | 0447 |
| California Audio Labs..... | 0056 |
| Carver..... | 0184, 0206 |
| Classic..... | 0324 |
| Denon..... | 0030 |
| DKK..... | 0027 |
| DMX Electronics..... | 0184 |
| Emerson..... | 0332 |
| Fisher..... | 0352, 0206 |
| Garrard..... | 0447 |
| Genexxa..... | 0059, 0332 |
| GPX..... | 0323 |
| Harman/Kardon..... | 0184, 0200, 0229 |
| Hitachi..... | 0059 |
| Integra..... | 0128 |
| JVC..... | 0099, 0321 |
| Kenwood..... | 0055, 0064, 0217 |
| KLH..... | 0345 |
| Koss..... | 0344 |
| Krell..... | 0184 |
| Linn..... | 0184 |
| Luxman..... | 0120 |
| LXI..... | 0332 |
| Magnavox..... | 0184, 0332 |
| Marantz..... | 0999, 0056, 0184 |
| MCS..... | 0056 |
| Miro..... | 0027 |
| Mission..... | 0184 |
| MTC..... | 0447 |
| NSM..... | 0184 |
| Onkyo..... | 0128 |
| Optimus..... | 0027, 0059, 0064, 0332, 0206, 0495, 0172, 0447, 0102 |
| Panasonic..... | 0056 |
| Parasound..... | 0447 |
| Philips..... | 0999, 0184 |
| Pioneer..... | 0059, 0332, 0495 |
| Polk Audio..... | 0184 |
| Proton..... | 0184 |
| QED..... | 0184 |
| Quad..... | 0184 |

| | |
|----------------------|---|
| Quasar..... | 0056 |
| RadioShack..... | 0102 |
| RCA..... | 0089, 0059, 0447, 0080, 0332, 0206, 0495 |
| Realistic..... | 0447, 0206 |
| Rotel..... | 0184, 0447 |
| SAE..... | 0184 |
| Sansui..... | 0184, 0332 |
| Sanyo..... | 0206 |
| Scott..... | 0332 |
| Sears..... | 0332 |
| Sharp..... | 0064 |
| Sonic Frontiers..... | 0184 |
| Sony..... | 0027, 0127, 0391 |
| Soundesign..... | 0172 |
| Symphonic..... | 0332 |
| TAG McLaren..... | 0184 |
| Tascam..... | 0447 |
| TDK..... | 0235 |
| Teac..... | 0447 |
| Technics..... | 0056 |
| Victor..... | 0099 |
| Wards..... | 0184, 0080 |
| Yamaha..... | 0063, 0319 |
| Zonda..... | 0184 |

CDR

| | |
|--------------------|------------|
| Classic..... | 0324 |
| Fisher..... | 0352 |
| Harman/Kardon..... | 0229 |
| JVC..... | 0321 |
| Kenwood..... | 0999 |
| Marantz..... | 0999 |
| Philips..... | 0999 |
| Pioneer..... | 0089, 0114 |
| Sony..... | 0391, 0127 |
| TDK..... | 0235 |
| Teac..... | 0447 |
| Yamaha..... | 0319 |

MD PLAYERS

| | |
|--------------|------------|
| Denon..... | 1900 |
| Kenwood..... | 1708, 1853 |
| Marantz..... | 1207 |
| Onkyo..... | 1895 |

| | |
|---------------|------|
| Optimus..... | 1090 |
| Pioneer..... | 1090 |
| Sharp..... | 1888 |
| Sherwood..... | 1094 |
| Sony..... | 1517 |
| Yamaha..... | 1915 |

TAPE

| | |
|--------------------|------------------------|
| Aiwa..... | 0056, 0227, 0224 |
| Akai..... | 0310 |
| Carver..... | 0056 |
| Denon..... | 0103 |
| Fisher..... | 0101 |
| Garrard..... | 0466, 0335 |
| Harman/Kardon..... | 0209, 0056 |
| JVC..... | 0271, 0300 |
| Kenwood..... | 0097 |
| Magnavox..... | 0056 |
| Marantz..... | 0056, 0036 |
| Mitsubishi..... | 0310 |
| NAD..... | 0171 |
| Onkyo..... | 0309, 0163, 0162 |
| Optimus..... | 0054, 0247, 0466, 0364 |
| Panasonic..... | 0256 |
| Philips..... | 0056 |
| Pioneer..... | 0054, 0247, 0126 |
| Polk Audio..... | 0056 |
| RCA..... | 0054, 0247 |
| Revox..... | 0217 |
| Sansui..... | 0056, 0036 |
| Sherwood..... | 0364 |
| Sony..... | 0270, 0197, 0318 |
| Teac..... | 0335 |
| Technics..... | 0256 |
| Victor..... | 0300 |
| Wards..... | 0054 |
| Yamaha..... | 0124, 0121 |

SAT (DSS)

| | |
|-------------------|---|
| AlphaStar..... | 0799 |
| Chaparral..... | 0243 |
| Crossdigital..... | 1136 |
| DirecTV..... | 0419, 0593, 0666, 1666, 1169, 0274, 0776, 1776, 0751, 0846, 1883, 1103, |

| | |
|-----------------------------|---|
| Dish Network System..... | 1032, 0802, 1197 |
| Dishpro..... | 1032, 0802 |
| Echostar..... | 1032, 0802, 1197 |
| Expressvu..... | 0802 |
| GE..... | 0593 |
| General Instrument..... | 0896 |
| GOI..... | 0802 |
| Hitachi..... | 0846 |
| HTS..... | 0802 |
| Hughes Network Systems..... | 1169, 0776, 1776, 1470, 1469 |
| JVC..... | 0802, 1197 |
| Magnavox..... | 0751, 0749 |
| Memorex..... | 0751 |
| Mitsubishi..... | 0776 |
| Motorola..... | 0896 |
| Next Level..... | 0896 |
| Panasonic..... | 0274, 0728 |
| Paysat..... | 0751 |
| Philips..... | 1169, 0776, 1776, 0751, 1103, 0749, 0126, 1469 |
| Proscan..... | 0419, 0593 |
| RadioShack..... | 0896 |
| RCA..... | 0419, 0593, 0882, 0170 |
| Samsung..... | 1303, 1136 |
| SKY..... | 0883 |
| Sony..... | 0666, 1666 |
| Star Choice..... | 0896 |
| Tivo..... | 1169, 1470, 1469 |
| Toshiba..... | 0776, 1776, 0817, 1312 |
| Uniden..... | 0751, 0749 |
| Zenith..... | 0883, 1883 |

TV

| | |
|---------------------|------------------|
| Admiral..... | 0120, 0490 |
| Advent..... | 0788, 0869 |
| Aiko..... | 0119 |
| Akai..... | 0729, 0057, 0699 |
| Albatron..... | 0870 |
| America Action..... | 0207 |
| Anam..... | 0207 |
| AOC..... | 0057 |
| Apex Digital..... | 0775, 0792, 0906 |
| Audiovox..... | 0478, 0207, 0119 |
| Bell & Howell..... | 0181 |
| Bradford..... | 0207 |

| | | | | | | | |
|--------------------|--|-----------------|---|-------------------------|---|-----------------------------|---|
| Broksonic..... | 0263, 0490 | KEC..... | 0207 | Sanyo..... | 0181 | Broksonic..... | 0211, 0148, 0236, 1506 |
| Candle..... | 0057 | Kenwood..... | 0057 | Scotch..... | 0205 | Calix..... | 0064 |
| Carnivale..... | 0057 | KLH..... | 0792 | Scott..... | 0263, 0207, 0205 | Canon..... | 0062 |
| Carver..... | 0081 | KTV..... | 0207, 0057 | Sears..... | 0074, 0081, 0181, 0183, 0205, 0198 | Carver..... | 0108 |
| Celebrity..... | 0027 | LG..... | 1205, 0883, 0469 | Sharp..... | 0120 | Citizen..... | 0064, 1305 |
| Celera..... | 0792 | LXI..... | 0074, 0081, 0181, 0183, 0205 | Sheng Chia..... | 0120 | Craig..... | 0064, 0074, 0267 |
| Changhong..... | 0792 | Magnavox..... | 0081, 0057, 1481, 0733, 1281 | Sony..... | 0027 | Curtis Mathes..... | 0087, 0062, 0189, 1062 |
| Citizen..... | 0087, 0057, 0119 | Marantz..... | 0081, 0057, 1581, 0731 | Soundesign..... | 0207, 0205 | Cybernex..... | 0267 |
| Clarion..... | 0207 | Matsushita..... | 0277, 0677 | Squareview..... | 0198 | Daewoo..... | 0072, 1305 |
| Contec..... | 0207 | Megatron..... | 0205, 0172 | SSS..... | 0207 | Denon..... | 0069 |
| Craig..... | 0207 | Memorex..... | 0181, 0490, 0177, 0205 | Starlite..... | 0207 | Durabrand..... | 0066 |
| Crosley..... | 0081 | MGA..... | 0177, 0057, 0205 | Studio Experience..... | 0870 | Dynatech..... | 0027 |
| Crown..... | 0207 | Midland..... | 0074, 0044, 0078 | Supreme..... | 0027 | Electrohome..... | 0064 |
| Curtis Mathes..... | 0074, 0081, 0181, 0478, 0120, 0087, 0729, 0057, 0172, 0193, 1174, 1374 | Mitsubishi..... | 0120, 0177, 1277, 0205, 0863 | SVA..... | 0775, 0892 | Electrophonic..... | 0064 |
| CXC..... | 0207 | Monivision..... | 0870 | Sylvania..... | 0081, 0057, 0198 | Emerex..... | 0059 |
| Daewoo..... | 0478, 1688, 0119, 0699 | Motorola..... | 0120 | Symphonic..... | 0207, 0198 | Emerson..... | 0064, 0211, 0027, 0148, 0070, 0236, 1305, 1506 |
| Denon..... | 0172 | MTC..... | 0087, 0057 | Tandy..... | 0120 | Fisher..... | 0074, 0131 |
| Dumont..... | 0044 | Multitech..... | 0207 | Tatung..... | 1783 | Fuji..... | 0062, 0060 |
| Durabrand..... | 0207, 0205 | NAD..... | 0183, 0205 | Technics..... | 0277, 0078 | Funai..... | 0027 |
| Electroband..... | 0027 | NEC..... | 0057, 1731 | Techwood..... | 0078 | Garrard..... | 0027 |
| Elektra..... | 0044, 1688 | Nikko..... | 0057, 0205, 0119 | Teknika..... | 0081, 0207, 0177, 0087, 0119 | GE..... | 0087, 0062, 0267, 1087, 1062, 0834 |
| Emerson..... | 0181, 0263, 0490, 0207, 0205, 0198 | Norcent..... | 0775, 0851 | Telefunken..... | 0729 | GoldStar..... | 0064, 1264 |
| Envision..... | 0057 | NTC..... | 0119 | TMK..... | 0205 | Gradiente..... | 0027 |
| Fisher..... | 0181 | Onwa..... | 0207 | TNCi..... | 0044 | Harley Davidson..... | 0027 |
| Fujitsu..... | 0710, 0880, 0836 | Optimus..... | 0181, 0277, 0193, 0677 | Toshiba..... | 0181, 0183, 0087, 1283, 1383, 1183, 1731, 0677 | Harman/Kardon..... | 0108 |
| Funai..... | 0207, 0198 | Optonica..... | 0120 | TVS..... | 0490 | Hi-Q..... | 0074 |
| Futuretech..... | 0207 | Orion..... | 0263, 0490 | Vector Research..... | 0057 | Hitachi..... | 0027, 0069 |
| Gateway..... | 1782, 1783 | Panasonic..... | 0277, 0078, 0677 | Victor..... | 0080 | Hughes Network Systems..... | 0069 |
| GE..... | 0074, 0078, 0478, 0205, 1474, 1374, 1174 | Penney..... | 0074, 0183, 0078, 0087, 0057, 0205, 1374 | Vidikron..... | 0081 | JVC..... | 0094 |
| Gibraltar..... | 0044, 0057 | Philco..... | 0081, 0057 | Vidtech..... | 0205 | KEC..... | 0064 |
| GoldStar..... | 0057, 0205 | Philips..... | 0081, 1481, 0717 | Viewsonic..... | 1782 | Kenwood..... | 0094 |
| Grunpy..... | 0207 | Pilot..... | 0057 | Wards..... | 0081, 0057, 0205, 1183 | Kodak..... | 0062, 0064 |
| Hallmark..... | 0205 | Pioneer..... | 0193, 0706 | Waycon..... | 0183 | Lloyd's..... | 0027 |
| Harman/Kardon..... | 0081 | Portland..... | 0119 | White Westinghouse..... | 0490 | LXI..... | 0064 |
| Harvard..... | 0207 | Prima..... | 0788 | Yamaha..... | 0057 | Magnasonic..... | 1305 |
| Havermy..... | 0120 | Prism..... | 0078 | Zenith..... | 0044, 0490, 0205, 0119 | Magnavox..... | 0062, 0066, 0108, 0027, 1808 |
| Hello Kitty..... | 0478 | Proscan..... | 0074, 1474, 1374 | | | Magnin..... | 0267 |
| Himitsu..... | 0207 | Proton..... | 0205 | | | Marantz..... | 0062, 0108, 1408 |
| Hisense..... | 0775 | Pulsar..... | 0044 | | | Marta..... | 0064 |
| Hitachi..... | 1172, 0172 | Quasar..... | 0277, 0078, 0677 | | | Matsushita..... | 0062, 0189 |
| Infinity..... | 0081 | RadioShack..... | 0074, 0181, 0207, 0057, 0205 | | | MEI..... | 0062 |
| Inteq..... | 0044 | RCA..... | 0074, 1474, 1274, 1574, 0117, 1174, 1074, 1374, 0706 | | | Memorex..... | 0062, 0189, 0064, 0075, 0066, 0074, 0267, 0027, 0131, 0236, 1264 |
| JBL..... | 0081 | Realistic..... | 0181, 0207, 0057, 0205 | | | MGA..... | 0267, 0070 |
| JCB..... | 0027 | Runco..... | 0044, 0057 | | | MGN Technology..... | 0267 |
| Jensen..... | 0788 | Sampo..... | 0057, 1782 | | | Minolta..... | 0069 |
| JVC..... | 0080 | Samsung..... | 0087, 0729, 0057, 0205 | | | Mitsubishi..... | 0094, 0070, 0834 |
| | | Sansui..... | 0490 | | | Motorola..... | 0062, 0075 |

VCR

| | |
|--------------------|------------|
| Admiral..... | 0075, 0236 |
| Adventura..... | 0027 |
| Aiwa..... | 0064, 0027 |
| American High..... | 0062 |
| Asha..... | 0267 |
| Audiovox..... | 0064 |
| Beaumarck..... | 0267 |
| Bell & Howell..... | 0131 |

MTC..... 0267, 0027
Multitech 0027
NAD 0085
NEC 0131, 0094
Nikko..... 0064
Noblex 0267
Olympus 0062
Optimus 1089, 0189, 0064,
0075, 0131, 0085
Orion..... 0211, 0236, 1506
Panasonic..... 1089, 0062, 0189,
0252, 1062, 0643
Penney 0062, 0064, 0267,
0069, 1264, 1062
Pentax 0069
Philco..... 0062
Philips..... 0062, 0108, 0645
Pilot..... 0064
Pioneer 0094, 0085
Polk Audio..... 0108
Profitronic 0267
Proscan 0087, 1087
Pulsar 0066
Quasar..... 0062, 0189, 1062
RadioShack 0027
Radix 0064
Randex 0064
RCA 0087, 0267, 0069, 1062,
0907, 0085, 0834, 1087
Realistic 0062, 0064, 0075,
0074, 0027, 0131
ReplayTV..... 0643
Runco 0066
Samsung 0267, 0072, 1041
Sanky..... 0075, 0066
Sansui..... 0027, 0094, 0236, 1506
Sanyo 0074, 0267, 0131
Scott 0211, 0072, 0148, 0070
Sears 0062, 0064, 0074, 0027,
0069, 0131, 1264
Sharp..... 0075, 0834
Shogun..... 0267
Sonic Blue 0643
Sony 0062, 0059, 0060, 0027, 1259, 0663
STS..... 0069
Sylvania..... 0062, 0108, 0027, 0070, 1808
Symphonic..... 0027
Teac 0027
Technics..... 0062, 0189
Teknika 0062, 0064, 0027
Thomas..... 0027

Tivo..... 1530, 0663, 0645
TMK..... 0267
Toshiba 0072, 0070, 1530, 1172, 0872
Totevision..... 0064, 0267
Unitech 0267
Vector 0072
Video Concepts 0072
Videomagic..... 0064
Videosonic..... 0267
Villain 0027
Wards 0087, 0062, 0075, 0074,
0108, 0267, 0027, 0069
White Westinghouse..... 0236
XR-1000 0062, 0027
Zenith..... 0066, 0060, 0027, 0236, 1506

DVD

Aiwa..... 0668
Allegro 0896
Apex Digital 0699, 0823, 1031, 1127,
0821, 0857, 1088, 0824, 1047
Blue Parade..... 0598
Broksonic..... 0722
CineVision 0903, 0896
Curtis Mathes 1114
CyberHome 1050, 0843, 1051
Daewoo 0896, 0860
Denon..... 0517
DVD2000 0548
Emerson 0618, 0848
Enterprise 0618
GE 0549, 0842
Go Video..... 0860, 0742, 0896
Harman/Kardon 0729, 0609
Hitachi..... 0600
Hiteker 0699
JBL 0729
JVC..... 0585, 0650, 0894
Kenwood..... 0517, 0561
KLH..... 1047
Koss..... 0678
Magnavox 0530, 0848
Marantz..... 0566
Memorex..... 0722
Microsoft..... 0549
Mintek 0866
Mitsubishi..... 1548, 0548
Onkyo 0530
Oritron..... 0678

Panasonic..... 0517, 1789, 1389
Philips 0530, 0566, 0673, 0881
Pioneer 0552, 0598
Polaroid 1088
Polk Audio..... 0566
Proscan 0549
Qwestar 0678
RCA 0549, 0598, 0849, 1049
Rio 0896
Rotel 0650
Sampo 0779
Samsung 0517, 0600, 0847
Sansui..... 0722
Sanyo 0722
Sharp 0657, 0779
Shinsonic..... 0560, 0866
Sonic Blue 0896
Sony 0560, 0891, 1060
Superscan 0848
Sylvania..... 0848
Technics..... 0517
Theta Digital 0598
Toshiba 0530, 1072, 0722
Tredex 0826
Urban Concepts..... 0530
US Logic..... 0866
Xbox 0549
Yamaha 0517, 0566, 0572
Zenith..... 0530, 0618, 0896

www.marantz.com

You can find your nearest authorized distributor or dealer on our website.

marantz[®] is a registered trademark.

