





marantz[®]

AV Surround Receiver

SR6003

User Guide

	CAUTION RISK OF ELECTRIC SHOCK DO NOT OPEN	
CAUTION: TO REDUCE THE RISK OF ELECTRIC SHOCK, DO NOT REMOVE COVER (OR BACK) NO USER-SERVICEABLE PARTS INSIDE REFER SERVICING TO QUALIFIED SERVICE PERSONNEL		



The lightning flash with arrowhead symbol within an equilateral triangle is intended to alert the user to the presence of uninsulated "dangerous voltage" within the product's enclosure that may be of sufficient magnitude to constitute a risk of electric shock to persons.



The exclamation point within an equilateral triangle is intended to alert the user to the presence of important operating and maintenance (servicing) instructions in the literature accompanying the product.

WARNING

TO REDUCE THE RISK OF FIRE OR ELECTRIC SHOCK, DO NOT EXPOSE THIS APPLIANCE TO RAIN OR MOISTURE.

CAUTION: TO PREVENT ELECTRIC SHOCK, MATCH WIDE BLADE OF PLUG TO WIDE SLOT, FULLY INSERT.

ATTENTION: POUR EVITER LES CHOCS ELECTRIQUES, INTRODUIRE LA LAME LA PLUS LARGE DE LA FICHE DANS LA BORNE CORRESPONDANTE DE LA PRISE ET POUSSER JUSQU'AU FOND.

NOTE TO CATV SYSTEM INSTALLER:

This reminder is provided to call the CATV (Cable-TV) system installer's attention to Section 820-40 of the NEC which provides guidelines for proper grounding and, in particular, specifies that the cable ground shall be connected to the grounding system of the building, as close to the point of cable entry as practical.

NOTE:

This equipment has been tested and found to comply with the limits for a Class B digital device, pursuant to Part 15 of the FCC Rules. These limits are designed to provide reasonable protection against harmful interference in a residential installation. This equipment generates, uses and can radiate radio frequency energy and, if not installed and used in accordance with the instructions, may cause harmful interference to radio communications. However, there is no guarantee that interference will not occur in a particular installation. If this equipment does cause harmful interference to radio or television reception, which can be determined by turning the equipment off and on, the user is encouraged to try to correct the interference by one or more of the following measures:

- Reorient or relocate the receiving antenna.
- Increase the separation between the equipment and receiver.
- Connect the equipment into an outlet on a circuit different from that to which the receiver is connected.
- Consult the dealer or an experienced radio/TV technician for help.

NOTE:

Changes or modifications may cause this unit to fail to comply with Part 15 of the FCC Rules and may void the user's authority to operate the equipment.

This Class B digital apparatus complies with Canadian ICES-003.

Cet appareil numerique de la Classe B est conforme a la norme NMB-003 du Canada.

DECLARATION OF CONFORMITY

This device complies with Part 15 of the FCC rules. Operation is subject to the following conditions: (1) This device may not cause harmful interference, and (2) this device must accept any interference received, including interference that may cause undesired operation.

U.S. Responsible Party: Marantz America, Inc.
100 Corporate Drive,
Mahwah, NJ, 07430, U.S.A.
TEL: 201-762-6500

Type of Product: AV Surround Receiver
 Model: SR6003

IMPORTANT SAFETY INSTRUCTIONS

READ BEFORE OPERATING EQUIPMENT

This product was designed and manufactured to meet strict quality and safety standards. There are, however, some installation and operation precautions which you should be particularly aware of.

1. Read these instructions.
2. Keep these instructions.
3. Heed all warnings.
4. Follow all instructions.
5. Do not use this apparatus near water.
6. Clean only with dry cloth.
7. Do not block any ventilation openings. Install in accordance with the manufacture's instructions.
8. Do not install near any heat sources such as radiators, heat registers, stoves, or other apparatus (including amplifiers) that produce heat.
9. Do not defeat the safety purpose of the polarized or grounding-type plug. A polarized plug has two blades with one wider than the other. A grounding type plug has two blades and a third grounding prong. The wide blade or the third prong are provided for your safety. If the provided plug does not fit into your outlet, consult an electrician for replacement of the obsolete outlet.
10. Protect the power cord from being walked on or pinched particularly at plugs, convenience receptacles, and the point where they exit from the apparatus.
11. Only use attachments/accessories specified by the manufacturer.
12. Use only with the cart, stand, tripod, bracket, or table specified by the manufacturer, or sold with the apparatus. When a cart is used, use caution when moving the cart/apparatus combination to avoid injury from tip-over.



13. Unplug this apparatus during lightning storms or when unused for long periods of time.
14. Refer all servicing to qualified service personnel. Servicing is required when the apparatus has been damaged in any way, such as power-supply cord or plug is damaged, liquid has been spilled or objects have fallen into the apparatus, the apparatus has been exposed to rain or moisture, does not operate normally, or has been dropped.

Additional Safety Information!

- This product should not be placed in a built-in installation such as a bookcase or rack unless proper ventilation is provided or the manufacturer's instructions have been adhered to.
- Apparatus shall not be exposed to dripping or splashing and that no objects filled with liquids, such as vases, shall be placed on the apparatus.
- When the switch is in the OFF position, the apparatus isn't completely switched-off from the MAINS.
- The equipment shall be installed near the power supply so that the power supply is easily accessible.
- Do not touch hot areas, especially around the "hot surface mark" during and immediately after use.
- During and immediately after use, this product is hot in areas other than the controls and rear panel connection jacks. Do not touch hot areas, especially around the "hot surface mark" and the top panel. Contact with hot areas can cause burns.



Hot surface mark

- Do not expose the unit and batteries to excessive heat such as direct sunlight, fire or the like.
- Make a space of about 8 inches (0.2 m) around the unit.

INTRODUCTION

Thank you for purchasing the Marantz SR6003 Surround receiver. This remarkable component has been engineered to provide you with many years of home theater enjoyment. Please take a few minutes to read this manual thoroughly before you connect and operate the SR6003. As there are a number of connection and configuration options, you are encouraged to discuss your own particular home theater setup with your Marantz A/V authorized dealer.

ACCESSORIES CHECK

Before use, check the below accessories were included in the package.

Remote Controller

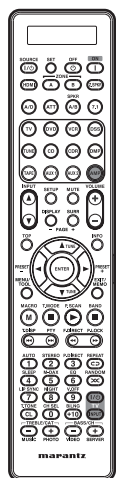

AM Loop Antenna

FM Antenna

AC power cable

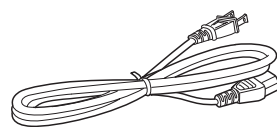

User Guide

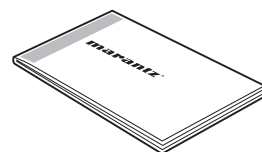

Warranty Card USA × 1 Canada × 1

AAA-size batteries (× 2)

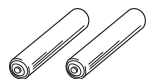

Microphone

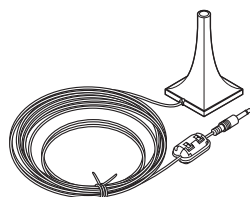

TABLE OF CONTENTS

INTRODUCTION	1	SETUP	24	TROUBLESHOOTING	75
ACCESSORIES CHECK.....	1	GRAPHICAL USER INTERFACE MENU SYSTEM	24	HDMI	76
TABLE OF CONTENTS	2	1 INPUT SETUP	26	USB.....	76
FEATURES	2	2 SPEAKER SETUP.....	29	XM SATELLITE RADIO.....	77
BEFORE USE	3	ERROR MESSAGES	32	SIRIUS SATELLITE RADIO	77
OPERATION OF REMOTE CONTROLLER.....	4	3 SURROUND SETUP	35	OTHERS	78
NAMES AND FUNCTION	5	4 VIDEO SETUP	37	SURROUND MODE.....	78
FRONT PANEL.....	5	5 PREFERENCE	38	DESCRIPTION	81
FL DISPLAY AND INDICATER.....	6	6 ACOUSTIC EQ	40	TECHNICAL SPECIFICATIONS	84
REMOTE CONTROLLER	7	ADVANCED OPERATION	42	CLEANING OF EQUIPMENT EXTERNAL SURFACES	84
REAR PANEL	9	AMP OPERATION	42	REPAIRS.....	84
BASIC CONNECTIONS	10	USB OPERATION	47		
SPEAKER PLACEMENT	10	TUNER OPERATION (PRESET MEMORY).....	51		
CONNECTING SPEAKERS.....	11	XM RADIO OVERVIEW	53		
CONNECTING AUDIO COMPONENTS.....	12	LISTENING TO XM SATELLITE RADIO	53		
CONNECTING VIDEO COMPONENTS.....	13	SEARCH MODE	55		
CONNECTING HDMI COMPONENTS.....	14	PRESET MEMORY	56		
CONNECTING THE ANTENNA TERMINALS.....	15	SIRIUS RADIO OVERVIEW.....	58		
CONNECTING THE AC POWER CABLE	15	LISTENING TO SIRIUS SATELLITE RADIO.....	58		
BASIC OPERATION	16	SEARCH MODE	60		
AMP OPERATION	16	PRESET MEMORY	61		
TUNER OPERATION	16	PARENTAL LOCK.....	62		
REMOTE CONTROLLER OPERATION.....	18	ZONE SYSTEM.....	64		
ADVANCED CONNECTIONS	19	REMOTE CONTROLLER OPERATION.....	66		
CONNECTING MULTI CHANNEL AUDIO COMPONENTS...19		BASIC OPERATION (REMOTE CONTROLLER)	68		
CONNECTING THE USB MEDIA	19	MACRO MODE.....	71		
CONNECTING AN EXTERNAL POWER AMPLIFIER....20					
CONNECTING FOR SPEAKER C USE (BI-AMP CONNECTION) ...20					
CONNECTION FOR ANOTHER ZONE.....	21				
CONNECTING THE REMOTE CONTROL JACKS.....	22				
CONNECTING OTHER EQUIPMENT.....	22				
CONNECTING THE SATELLITE RADIO	23				

FEATURES

This unit incorporates the latest generation of digital surround sound decoding technology such as Dolby Digital EX, Dolby Digital, DTS ES (Discrete 6.1 and Matrix 6.1), DTS Neo:6 (Cinema, Music), Dolby Pro-Logic II (Movie, Music and Game), Dolby Pro-Logic IIx (Movie, Music and Game), Circle Surround II (Cinema, Music and Mono).

Additionally, the unit is compatible with Dolby TrueHD and DTS-HD (as used for Blu-ray and HD DVD discs) as well as Dolby Digital Plus, an expanded and improved version of Dolby Digital positioned as the next-generation delivery format. These audio formats can be sent with video signals via an HDMI cable to HDMI 1.3a-compatible equipment.

In addition, Marantz has focused on the future. By utilizing pre-out jacks, 7.1 direct inputs and a RS-232C communication port, the unit is tomorrow's technology, today!

This unit can play music content that has been recorded on USB media in the following file formats: MP3, WMA, AAC and WAV. This means almost any music content at hand can be played back using the unit.

This unit uses the Graphic User Interface in the setup menu. Setup using eye-pleasing 3D graphics is possible using the speaker setup or acoustic equalizer setup menu.

This unit features a fully discrete 7 channel amplifier section capable of delivering 100 watts of high-current amplification, for continuously clean and stable power into each of the 7 channels. It employs a massive EI power transformer in combination with oversized filter capacitors. This design configuration is capable of a clear and powerful reproduction of the most demanding action movie soundtracks and full range (multichannel) music discs. Through its ability to generate very high output voltages, the unit can easily drive the most demanding speakers with optimum results.

This unit incorporates the most advanced Digital Signal Processing circuitry, along with a 192 kHz/24 bit D/A converter in each of the 7 channels. Independent power supply circuits are incorporated for the FL display, audio and video sections for maximum separation, clarity and dynamic range. Together with hand-selected customized components, all elements work in harmony to recreate the emotion, exactly as the artist had intended.

This unit is designed and engineered with extensive feedback from custom installation experts, dealers and consumers. It features ZONE/multisource, assignable DC trigger, a RS-232C communication port, Flasher input, heavy duty speaker binding posts and an extensive array of both analog and digital inputs / outputs. With 5 assignable digital inputs (6 total), 3 component inputs, Super Audio CD Multi Channel (7.1 channel) direct inputs, video convert system and a speaker-B and OSD output versatility is taken to a stunning new level. Furthermore, the unit can output the OSD information through the Y/C (S-video) and composite video outputs.

An easy-to-use programmable, learning remote controller allows full access to all of the operating functions and can be used for system operation as well.

The new generation of Marantz Receivers is stylish and completely symmetrical. On the front panel of the unit, buttons are kept to a minimum. Source selectors and volume controls are intuitively placed. This unit is here to perform in your unrivaled home entertainment setup.

HDMI (High-Definition Multimedia Interface) is an enhancement to the DVI (Digital Visual Interface) standard. It adds capabilities for digitally transmitting audio signals in addition to video signals. Where multiple cables were previously needed for audio/video, HDMI enables audio/video connection via a single cable.

The HDMI input jacks of this unit support HDMI Ver. 1.3a. and the HDMI output jacks of this transmitter support HDMI Ver. 1.3a.

This unit supports HDCP (High-bandwidth Digital Content Protection). HDCP is copyright protection technology that consists of data encoding and other device authentication. Its purpose is to protect digital video content. Both this unit and the connected component (such as a video player or monitor) must support HDCP. Before connecting a component to this unit, refer to its instruction manual.

- x.v. Color
- Deep Color 36bit
- Dolby True HD, Dolby Digital Plus, dts HD
- Dolby Digital EX, Dolby Digital, DTS ES (Discrete 6.1, Matrix 6.1, Neo:6)
- Dolby Headphone
- Dolby Pro Logic II (Movie, Music, Game)
- Dolby Pro Logic IIx (Movie, Music, Game)
- Circle Surround II (Cinema, Music, Mono)
- HDCD
- Bi-amp drive
- Source/Pure Direct mode
- 9 bands x 7 ch Graphic EQ
- DSD to PCM converter
- Audyssey MultEQ®
- XM Satellite Radio Ready
- XM® HD Surround Powered by Neural Audio
- SIRIUS Satellite Radio Ready
- M-DAX (Marantz Dynamic Audio eXpander)
- Improved Station Name Input Method, 60 Presets
- Auto Adjust Function for Speaker Distance Settings (Delay Time)
- Assignable DC Trigger Output
- Assignable Video Input
- Auto Lipsync (Audio Delay)
- 7 × 100 Watts (8 Ohms), Discrete Amplifiers
- Massive Energy Power Supply, Huge EI Transformer, Large ELCO's.
- Function Rename
- 192 kHz/24 bit DAC for all 8 Channels
- 32 bit Digital Surround Processing Chipsets
- Auto Input Signal Detection
- Front Digital Optical Input
- ZONE B Output (Digital Optical Output)
- Video Off Mode
- Graphical User Interface
- Menu via all Video Output (Composite, S-Video, Component Video and HDMI)
- Video Up/Down Converter (HDMI ← Component Video ↔ S-Video ↔ Composite Video)
- Two HDMI Outputs
- Two Component Monitor Outputs
- Analog Video Up-scaling to HDMI Output (480i→480p→720p→1080i→1080p)
- USB Audio Player (MP3, WMA, AAC, WAV)
- RS-232C Terminal for Future Upgrade or System Control
- Flasher Input
- Full Backlight Learning Remote Controller

BEFORE USE

This section must be read before any connection is made to the mains supply.

EQUIPMENT MAINS WORKING SETTING

Your Marantz product has been prepared to comply with the household power and safety requirements that exist in your area. SR6003 can be powered by 120V AC only.

COPYRIGHT

Recording and playback of any material may require consent. For further information refer to the following:

- Copyright Act 1956
- Dramatic and Musical Performers Act 1958
- Performers Protection Acts 1963 and 1972
- Any subsequent statutory enactments and orders

DO NOT LOCATE IN THE FOLLOWING PLACES

To ensure long-lasting use, do not locate the unit where:

- Exposed to direct sunlight.
- Near to sources of heat such as heaters.
- Highly humid or poorly ventilated.
- Dusty.
- Subjected to mechanical vibrations.
- On wobbly, inclined or otherwise unstable surfaces
- Radiated heat is blocked such as in cramped audio racks.

To ensure proper heat radiation, ensure the below clearance from walls and other equipment.

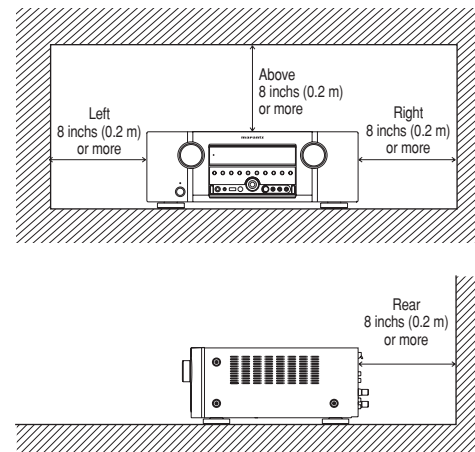

KEEP OBJECTS OFF

Keep objects off the unit. Blocking the vent can result in accident and damage.

DO NOT TOUCH HOT SPOTS DURING AND IMMEDIATELY AFTER USE

During and immediately after use, the unit is hot in areas other than the controls and rear panel connection jacks. Do not touch hot spots and especially the top panel. Contact with hot areas can cause burns.

Opening and closing the front panel door

When you want to use the controls behind the front panel door, open the door by gently pressing on the lower part of the panel. Keep the door closed when not using these controls.

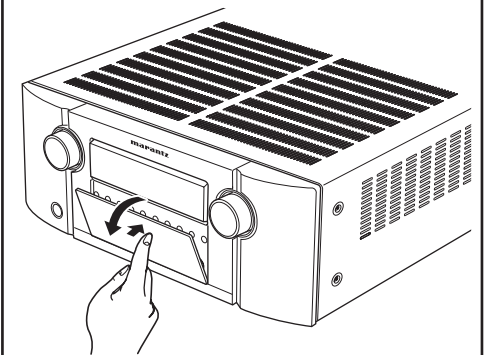

Caution:

- Be careful not to pinch your fingers between the door and the panel.

OPERATION OF REMOTE CONTROLLER

REMOTE CONTROL

Operate the remote controller within a distance of approx. 16.4ft. (5 m) from the infrared receptor window on the front of the unit.

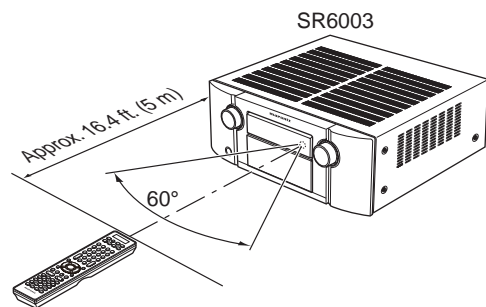
**Caution:**

- Do not allow direct sunlight, an inverter fluorescent light or other strong source of light to shine onto the player's infrared receptor window. Otherwise, the operation of the remote controller may be disabled.
- Bear in mind that operating the remote controller may cause other devices operated by infrared rays to be operated by mistake.
- The remote controller cannot be operated if the space between the controller and the player's infrared receptor window is obstructed.
- Do not place any objects on top of the remote controller. Doing so may cause one or more buttons to be held down which will cause the batteries to run down.

LOADING BATTERIES

Before using the remote controller for the first time, load the batteries in the remote controller. The batteries provided are used to verify the operations of the remote controller only.

1. Remove the battery cover.

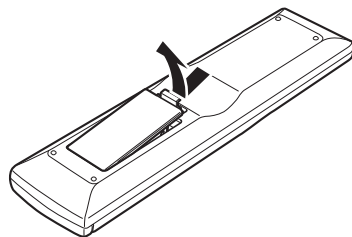

2. Insert the new batteries (AAA type) with correct ⊕ and ⊖ polarity.

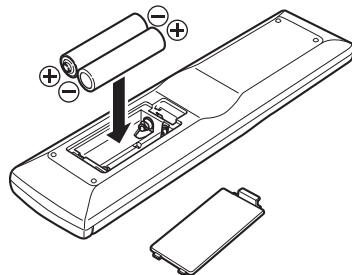

3. Close the battery cover until it clicks shut.

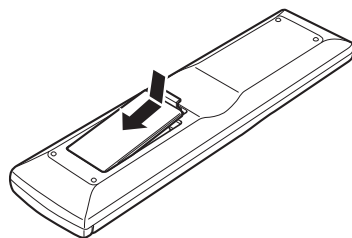

CAUTIONS ON BATTERIES

- Use "AAA" type batteries in this remote controller.
- We recommend that you use alkaline batteries.
- If the remote controller does not operate from close to the unit, replace the batteries with new ones, even if less than a year has passed.
- The included battery is only for verifying operation. Replace it with a new battery as soon as possible.
- When inserting the batteries, be careful to do so in the proper direction, following the + and - marks in the remote controller's battery compartment.
- To prevent damage or battery fluid leakage:
 - Do not use a new battery with an old one.
 - Do not use two different types of batteries.
 - Do not short-circuit, disassemble, heat or dispose of batteries in flames.
- Remove the batteries when not planning to use the remote controller for a long period of time.
- If the batteries should leak, carefully wipe off the fluid from the inside of the battery compartment, then insert new batteries.
- When disposing of used batteries, please comply with governmental regulations or environmental public instruction's rules that apply in your country or area.

NAMES AND FUNCTION

FRONT PANEL

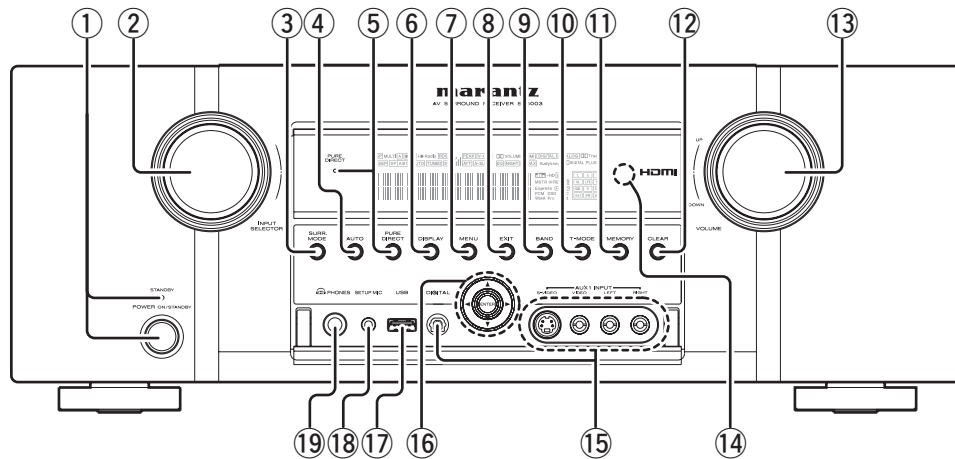

① POWER switch and STANDBY indicator

When this switch is pressed once, the unit turns ON and the display illuminates. When pressed again, the unit turns OFF and the STANDBY indicator will be illuminated.

② INPUT SELECTOR knob (AUDIO/VIDEO)

This knob is used to select the input sources. (See page 16)

③ SURROUND MODE button

Press this button to select the surround mode.

④ AUTO (Auto surround) button

Press this button to select the AUTO mode from the surround modes. When this mode is selected, the unit determines the surround mode corresponding to a digital input signal automatically.

⑤ PURE DIRECT button and indicator

When this button is pressed once, "SOURCE DIRECT" appears on the FL display. If pressed again, "PURE DIRECT" appears. After 2 seconds, the FL display indication goes out. In the source/pure direct mode, the tone control circuitry and bass management are bypassed.

Notes:

- The surround mode is automatically switched to AUTO when the pure direct function is turned on.
- Additionally, speaker configurations are fixed automatically as follows.
Front SPKR = LARGE
Center SPKR = LARGE
Surround SPKR = LARGE
Surround Back SPKR = LARGE
Sub woofer = YES

⑥ DISPLAY button

Press this button to change the FL display mode.

⑦ MENU button

Press this button to enter the SETUP MAIN MENU.

⑧ EXIT button

Press this button to exit from the SETUP MAIN MENU.

⑨ BAND button

Press this button to switch between FM and AM in the TUNER mode.

⑩ T-MODE button

Press this button to select the auto stereo mode or mono mode when the FM band is selected. The "AUTO" indicator lights in the auto stereo mode. (See page 17)

⑪ MEMORY button

Press this button to enter the tuner preset memory numbers or station names. (See page 51)

⑫ CLEAR button

Press this button to cancel the station-memory setting mode or preset scan tuning. (See page 52)

⑬ VOLUME control knob

This knob is used to adjust the overall sound level. Turning the control clockwise increases the sound level.

⑭ INFRARED receiving sensor window

This window receives infrared signals for the remote controller.

⑮ AUX1 INPUT jacks

These auxiliary video/audio input jacks accept the connections of a camcorder, portable DVD, game etc. When not using these jacks, protect by the jack cover.

⑯ Cursor (▲, ▼, ◀, ▶) / ENTER button

Press these buttons to operate the SETUP MAIN MENU and TUNER function.

⑰ USB jack

Connect USB media to this USB jack. (See page 19, 47)

⑱ MIC jack

Automatically measure speaker characteristics using the included microphone. (See page 30)

⑲ HEADPHONE jack for stereo headphones

This jack may be used to listen to the unit's output through a pair of headphones. Be certain that the headphones have a standard 1/4" stereo phono plug.

FL DISPLAY AND INDICATOR

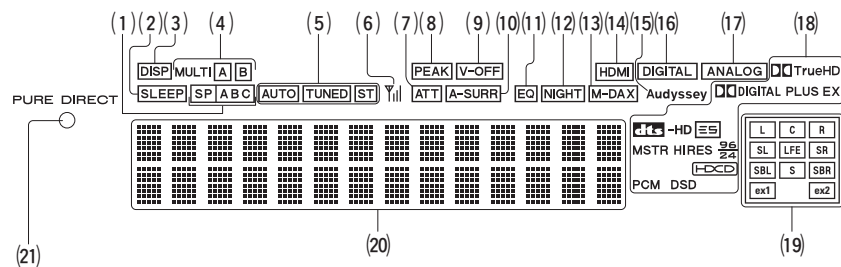
**(1) SP (speaker) ABC indicator**

This indicator is illuminated when the speaker system is active.

(2) SLEEP timer indicator

This indicator is illuminated when the sleep timer function in the main-ZONE is in use.

(3) DISP (Display Off) indicator

This indicator is illuminated when this unit is in the display off mode.

(4) MULTI (ZONE system) AB indicator

This indicator is illuminated when the ZONE system is active.

(5) TUNER's indicators

AUTO: This indicator illuminates when the tuner's Auto mode is in use.

TUNED: This indicator illuminates when the tuner receives a sufficiently strong radio signal.

ST(Stereo): This indicator illuminates when an FM station is being tuned into stereo condition.

(6) ȳil (Signal strength) indicator

This indicator indicates the strength of the XM Satellite Radio or SIRIUS Satellite Radio signal that is received.

(7) ATT (Attenuation) indicator

This indicator is illuminated when the attenuation function is active.

(8) PEAK indicator

This indicator is a monitor for an analog audio input signal. If the selected analog audio input signal is greater than the capable level of internal processing, this will illuminate. If this happens, you should press the **ATT** button. (See page 8)

(9) V-OFF (Video off mode) indicator

This indicator is illuminated when the Video-OFF function is active.

(10) A-SURR (Auto Surround mode) indicator

This indicator is illuminated when the AUTO SURROUND mode is in use.

(11) EQ mode indicator

This indicator is illuminated when the HT-EQ function is active.

(12) NIGHT mode indicator

This indicator is illuminated when this unit is in the Night mode, which reduces the dynamic range of digital program material at low volume levels.

(13) M-DAX indicator

This indicator illuminates when this unit is in the M-DAX mode.

(14) HDMI indicator

This indicator is illuminated when the HDMI device is connected to the unit.

(15) Audyssey indicator

This indicator is illuminated when the EQ MODE is selected to "AUDYSSEY", "AUDYSSEY FRONT" or "AUDYSSEY FLAT".

(16) DIGITAL Input Indicator

This indicator is illuminated when a digital input has been selected.

(17) ANALOG input indicator

This indicator is illuminated when an analog input source has been selected.

(18) SIGNAL FORMAT indicators**TrueHD**

This indicator is illuminated when a Dolby Digital True HD signal is input.

DIGITAL

This indicator is illuminated when a Dolby Digital signal is input.

DIGITAL PLUS

This indicator is illuminated when a Dolby Digital Plus signal is input.

DIGITAL EX

This indicator is illuminated when a Dolby Digital EX signal is input.

dts

This indicator is illuminated when a DTS signal is input.

dts-HD

This indicator is illuminated when a DTS-HD signal is input.

dts ES

This indicator is illuminated when a DTS ES signal is input.

dts MSTR

This indicator is illuminated when a Master Audio signal is input.

dts HIRES

This indicator is illuminated when a High Resolution Audio signal is input.

dts 96/24

This indicator is illuminated when a DTS 96/24 signal is input.

HDCCD

This indicator is illuminated when the HDCCD signal is decoded from digital input signal.

PCM

This indicator is illuminated when the input signal is PCM (pulse code modulation).

DSD

This indicator is illuminated when a DSD signal is input.

AAC

This indicator lights when AAC format files on the USB media are played back.

WMA

This indicator lights when WMA format files on the USB media are played back.

MP3

This indicator lights when MP3 format files on the USB media are played back.

(19) ENCODED CHANNEL STATUS indicators

These indicators display the channels that are encoded with a digital input signal.

If the digital input signal is Dolby Digital 5.1ch or DTS 5.1ch, "L", "C", "R", "SL", "SR" and "LFE" will be illuminated.

If the digital input signal is 2 channel PCM-audio, "L" and "R" will be illuminated.

If the digital input signal is Dolby Digital 5.1ch signal with Surround EX flag or DTS-ES, "L", "C", "R", "SL", "S", "SR" and "LFE" will be illuminated.

If the digital input signal is 7.1 channel PCM-audio, "L", "C", "R", "SL", "SBL", "SR", "SBR", and "LFE" will be illuminated.

If the digital input signal includes a channel other than those above, "ex1" or "ex2" will be illuminated. (See page 78)

Note:

When the unit is decoding Dolby TrueHD, the input signal status displayed depends on the number of channels of the speakers used.

If a 7.1-channel signal is supplied for a 5.1-channel speaker system (L/C/R/SL/SR/SW), the "SBL", "SBR", "S" indicator is not illuminated.

(20) Main Information Display

This display shows messages relating to the status, input source, surround mode, tuner, volume level or other aspects of unit's operation.

(21) PURE DIRECT indicator

This indicator is illuminated when this unit is in the PURE DIRECT mode.

REMOTE CONTROLLER

The provided remote controller is a universal remote controller. The POWER button, numeric buttons and control buttons are used in common across different input source components.

The input source controlled with the remote controller changes when one of the input selector buttons is pressed.

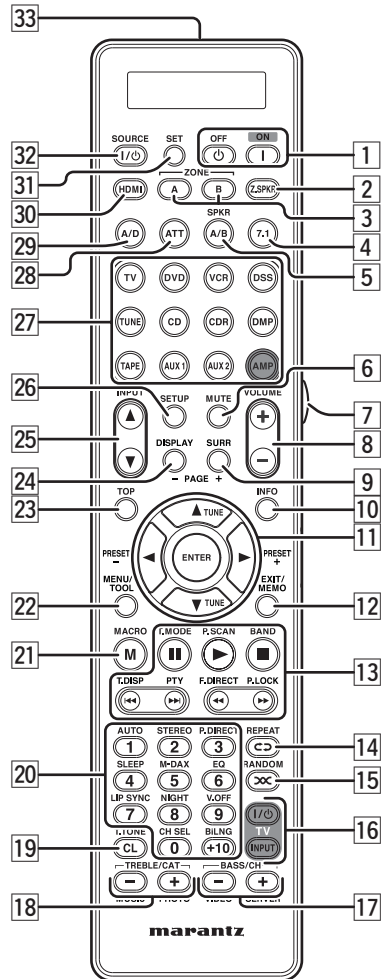

1 | / OFF POWER ON and OFF buttons

(When AMP mode is selected)

These buttons are used to turn the unit on or off.

2 | Z.SPKR button

(When AMP mode is selected)

This button is used to turn on and off ZONE speaker.

3 | ZONE A / B buttons

These buttons are used to turn the ZONE system on or off.

4 | 7.1 (7.1CH IN) button

This button is used to select the output of an external multi channel decoder.

5 | SPKR A/B button

This button is used to select the speaker system. The speaker system is switched in the following sequence.
A → B → A+B → off

6 | MUTE button

This button is used to mute the audio for the amplifier.

7 | LIGHT button

This button is used to turn on the backlight for the buttons.

8 | VOLUME +/- buttons

This button is used to adjust the volume for the amplifier.

9 | SURR (SURROUND) button

(When a mode other than DMP (USB) is selected)

This button is used to select the surround mode.

(When DMP (USB) mode is selected)

This button is used to select the next page.

10 | INFO button

(When AMP mode is selected)

When this button is pressed, the current setting of AV receiver are displayed on the connected TV monitor.

11 | ◀, ▶, ▲, ▼ (CURSOR) / ENTER buttons

These buttons are used when controlling the cursor of the unit, DVD or other AV equipment.

(When Tuner mode mode is selected)

PRESET +/- / PRESET - buttons

Used to select a preset station up and down.

TUNE ▲ / TUNE ▼ buttons

Used to tune a frequency station up and down.

12 | EXIT / MEMO button

(When AMP mode is selected)

This button is used to cancel setting in the setup menu.

(When TUNER mode is selected)

This button is used to store the setting of preset channel and others.

13 | CONTROL buttons

These buttons are used when operating PLAY, STOP, PAUSE and other commands of a source.

(When TUNER mode is selected)

T.MODE button

This button is used to select auto stereo mode or mono mode when the FM band is selected. The "AUTO" indicator lights in the auto stereo mode.

P.SCAN button

This button is used to start preset scan.

BAND button

This button is used to select a radio band.

T.DISP button

This button is used to select the display mode in XM Satellite Radio and SIRIUS Satellite Radio.

PTY button

These button is not used for this unit.

F.DIRECT button

This button is used to select the "Frequency direct input".

P.LOCK button

This button selects the parental lock of SIRIUS Satellite Radio.

(When DMP (USB) mode is selected)

|| button

This pauses playback.

▶ button

This starts playback.

■ button

This stops playback.

◀ / ▶ buttons

Skips forward or previous.

◀◀ / ▶▶ buttons

Search forward or backward.

14 | REPEAT button

This button is used to select the REPEAT mode of a source.

15 | RANDOM button

This button is used to select the RANDOM mode of a source.

16 | TV CONTROL buttons

These buttons are used when operating of TV and Monitor.

17 | BASS / CH +/- buttons

(When AMP mode is selected)

These buttons are used to adjust the tone control of low frequency sound for left, right and subwoofer speaker.

(When TV/DSS mode are selected)

These buttons are used to change channels.

18 | TREBLE / CAT +/- buttons

(When AMP mode is selected)

These buttons are used to adjust the tone control of high frequency sound for left and right speaker.

19 | CL (Clear) / T.TONE button

This button is used to erase the memory or program of a source include the Tuner mode.

(When AMP mode is selected)

This button is used to enter the test tone menu.

[20] Numeric buttons

These buttons are used to switch between 0 to +10 of the source components.
If the source is set to the amplifier, these buttons are used to perform operations.

(When AMP mode is selected)

1/AUTO button

This button is used to select auto surround.

2/STEREO button

This button is used to select STEREO mode.

3/P.DIRECT button

When this button is pressed once, SOURCE DIRECT mode is selected.
If pressed again, PURE DIRECT mode is selected.

4/SLEEP button

This button is used for setting the sleep timer.

5/M-DAX button

This button is used to select M-DAX mode.

6/EQ button

This button is used to select Audyssey mode.

7/LIP SYNC button

This button is used to select LIP SYNC mode.

8/NIGHT button

Pressing this button prevents the Dolby Digital signal from playback at a loud voice.
When this button is pressed, the "NIGHT" indicator is illuminated.

9/V.OFF button

This button is used to turn off the video signal.

0/CH SEL button

This button is used to call up CH LEVEL ADJUST and adjust speaker levels or 7.1 ch input level.

[21] M (MACRO) button

This button is used to program Macros. Pressing this button switches between Normal mode and Macro mode.

[22] MENU button

(When AMP mode is selected)

This button is used to call up the SETUP MAIN MENU of the unit.

[23] TOP button

Pressing this button during setup returns you to the top screen of the setup main menu.

[24] DISPLAY button

(When a mode other than DMP (USB) is selected)
This button is used to select the display mode for the front display of the unit.

(When DMP mode (USB) is selected)

This button is used to select the previous page.

[25] INPUT ▲ button

This button is for forward-feeding the input source to select a desired source.

INPUT ▼ button

This button is for backward-feeding the input source to select a desired source.

[26] SETUP button

This button is used to setup for DVD and other device.

[27] SOURCE button

These buttons are used to switch the source of your A/V Receiver. Each time a source button is pressed, the remote controller changes to the source which was pressed.

This remote controller can control 12 types of equipment. To change the A/V Receiver source, press this button twice within two seconds. The signal is sent when it is pressed the second time.

Notes:

- Select the AMP as the source to use this remote controller with the unit.
- In the case of the unit, the DMP button cannot be used.

[28] ATT. button

When the input signal is too high and the voice distorts even by throttling the unit VOLUME control, turn on this function.

"ATT" is indicated when this function is activated.

The input level reduced. Attenuator is invalid for the output signal of "REC OUT".

Note:

- This function is unavailable while the digital input is selected.

[29] A/D button

This button is used to switch between the analog and digital inputs.

[30] HDMI button

This button is used to select HDMI OUTPUT 1 or 2.

[31] SET button

This button is used to enter learn mode and preset mode.

[32] | / ⏻ SOURCE ON/OFF button

This button is used to turn a specific source (such as a DVD player) on or off independently from the rest of the system.

[33] Infrared Transmitter and Learning Sensor

This transmitter emits infrared light. Press the buttons while pointing the transmitter towards the infrared receiver window of the unit or other AV equipment. Be sure to also point towards other remote controllers when using the learning function.

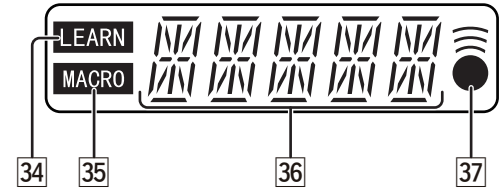
**[34] LEARN indicator**

This indicator is displayed when the remote controller is in the LEARN mode.

[35] MACRO indicator

This is displayed when a macro program is selected by the remote controller.

[36] Information indicator

Information about the sources and modes are shown on the LCD.

[37] ̸ indicator

This indicator is displayed when the remote controller is transmitting a signal.

REAR PANEL

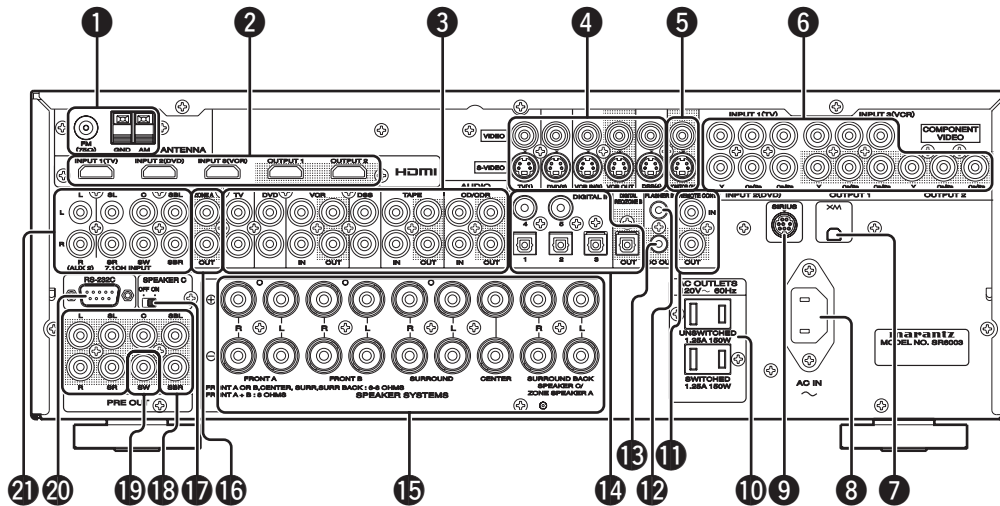
**1 FM antenna terminal (75 ohms)**

Connect an external FM antenna with a coaxial cable, or a cable network FM source.

AM antenna and ground terminals

Connect the supplied AM loop antenna. Use the terminals marked "AM" and "GND". The supplied AM loop antenna will provide good AM reception in most areas. Position the loop antenna until you hear the best reception.

2 HDMI INPUT/OUTPUT

The unit has 3 HDMI inputs and 2 HDMI outputs. The input function can be selected from the GUI menu system. (See page 26)

3 AUDIO IN/OUT (TAPE, CD/CDR, TV, DVD, VCR, DSS)

These are the analog audio inputs and outputs. There are 6 audio inputs (4 of which are linked to video inputs) and 3 audio outputs (1 of which are linked to video outputs). The audio jacks are nominally labeled for cassette tape decks, compact disc players, DVD players and etc.... The audio inputs and outputs require RCA-type connectors.

4 VIDEO IN/OUT (TV, DVD, VCR, DSS)

These are the video inputs and outputs. There are 4 video inputs and 1 video output and each one includes both composite video and S-video configurations. Connect VCRs, DVD players, and other video components to the video inputs. The video output channel can be used to be connected to video tape recorders for making recordings.

5 MONITOR OUT

This is a monitor output and each one includes both composite video and S-video configurations. When connecting two video monitors or televisions, be aware that the OSD interface can be used with both MONITOR OUT connections.

6 COMPONENT VIDEO INPUT/OUTPUT

If your DVD player or other device has component video connectors, be sure to connect them to these component video connectors on the unit. This unit has two component video input connectors to obtain the color information (Y, C_B, C_R) directly from the recorded DVD signal or other video component and one component video output connector to output it directly into the matrix decoder of the display device. By sending the pure DVD component video signal directly, the DVD signal forgoes the extra processing that normally would degrade the image. The result is vastly increased image quality, with incredibly life like colors and crisp detail.

When the video convert function is enabled, video and S-video images can be output to the COMPONENT VIDEO OUTPUT jacks.

7 XM terminal

Connect to the XM Mini-Tuner and Home Dock. (See page 23)

8 AC INLET

Plug the supplied power cable into this AC INLET and then into the power outlet on the wall. This unit can be powered by 120V AC only.

9 SIRIUS terminal

Connect to the SiriusConnect™ Home Tuner. (See page 23)

10 AC OUTLETS

Connect the AC power cables of components such as a DVD and CD player to these outlets. SWITCHED and UNSWITCHED outlets are provided.

The one marked SWITCHED provides power only when the unit is turned on and is useful for components which you use every time you play your system.

The one marked UNSWITCHED is always live as long as the unit is plugged into a live outlet.

A component connected here may be left on permanently, or may be switched off with via its own power switch.

Caution:

- In order to avoid potential turn-off thumps, anything plugged into these outlets should be powered up before the unit is turned on.
- The capacity of this AC outlet is 150W. Do not connect devices that consume electricity more than the capacity of these AC outlets. If the total power consumption of the connected devices exceeds the capacity, the protection circuit shuts down the power supply.

11 REMOTE CONT. IN/OUT terminals

Connect to a Marantz component equipped with remote control (RC-5) terminals.

12 FLASHER IN (Flasher input terminal)

These terminals are to control the unit from each ZONE. Connect the control signal from a Keypad, etc.

13 DC TRIGGER output terminal

Connect a device that needs to be triggered by DC under certain conditions (screen, power strip, etc...) Use the system OSD setup menu to determine the conditions by which these jack will be active.

Note:

This output voltage is for (status) control only. It is not sufficient for drive capability.

14 DIGITAL INPUT (DIGITAL IN 1-5) / OUTPUT (optical)

These are the digital audio inputs and output.

The unit has 2 digital inputs with coaxial jacks, 3 with optical jacks.

The inputs accept digital audio signals from a CD, DVD, or other digital source component.

For digital output, this is 1 optical output.

The digital outputs can be connected to MD recorders, CD recorders, or other similar components.

In addition, this digital output can be used as ZONE B output.

15 Speaker outputs terminals

Seven terminals are provided for the front left, front right, front center, surround left, surround right, surround back left and surround back right speakers.

Note:

You can use surround back speaker terminals as ZONE SPEAKER A terminals, when you use no surround back speaker.

16 ZONE A Outputs

These are the audio output jacks for the ZONE A.

Connect these jacks to optional audio power amplifiers to listen the source selected by the ZONE system in a remote room.

17 SPEAKER C SELECTOR SWITCH

The terminals can be used to connect a third set of speakers by setting the SPEAKER C selector switch to ON. For connection and use, see page 20.

18 Preamp Outputs (L, R, SL, SR, SBL, SBR, C)

Jacks for L (front left), R (front right), C (Center), SL (surround left), SR (surround right), SBL (surround back left) and SBR (surround back right).

Use these jacks for connection to external power amplifiers.

19 Subwoofer Output

Connect this jack to the line level input of a powered subwoofer. If an external subwoofer amplifier is used, connect this jack to the subwoofer amplifier input. If you are using two subwoofers, either powered or with a 2 channel subwoofer amplifier, connect a "Y" connector to the subwoofer output jack and run one cable from it to each subwoofer amplifier.

20 RS-232C

The RS-232C port is to be used in conjunction with an external controller to control the operation of the unit by using an external device.

21 7.1 CHANNEL or AUX2 INPUT

By connecting a DVD Audio player, Super Audio CD multichannel player, or other components that has a multichannel port, you can playback the audio with 5.1 channel or 7.1 channel outputs.

BASIC CONNECTIONS

SPEAKER PLACEMENT

The ideal surround speaker system for this unit is 7-speaker systems, using front left and right speakers, a center speaker, surround left and right speakers, a surround back left and right speakers, and a subwoofer.

For best results we recommend that all front speakers be of the same type, with identical or similar driver units. This will deliver smooth pans across the front sound stage as the action moves from side to side.

Your center channel speaker is very important as over 80 % of the dialog from a typical motion picture emanates from the center channel.

It should possess similar sonic characteristics to the main speakers. Surround channel speakers need not be identical to the front channel speakers, but they should be of high quality.

The surround center speaker is useful for playback of Dolby Digital Surround EX or DTS-ES. One of the benefits of both Dolby Digital and DTS is that surround channels are discrete full range, while they were frequency limited in earlier "Pro Logic" type systems.

Bass effects are an important part of home theater. For optimal enjoyment a subwoofer should be used as it is optimized for low frequency reproduction. If you have full range front speakers, however, they may be used in place of a subwoofer with proper setting of the switches in the menu system.

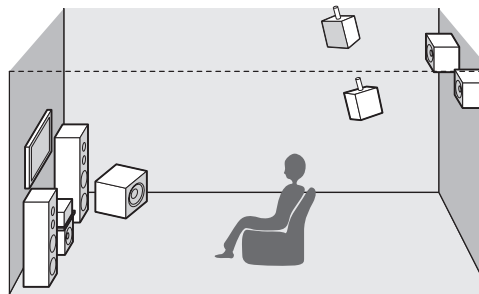
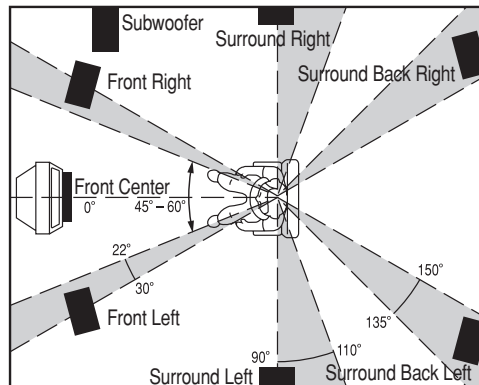

Front left and right speakers

We recommend to set the front L and R speakers with 45-60 degrees from the listening position.

Center speaker

Align the front line of the center speaker with the front L/R speakers. Or place the center speaker a little backward from the line.

Surround left and right speakers

When this unit is used in surround operation, the preferred location for surround speakers is on the side walls of the room, at or slightly behind the listening position.

The center of the speaker should face into the room.

Surround back left and right speakers

Surround back speakers are required when a full 7.1-channel system is installed.

Speakers should be placed on a rear wall, behind the listening position.

The center of the speaker should face into the room.

Subwoofer

We recommend using a sub-woofer to have maximum bass effect. As the subwoofer only handle low frequency. You can place it any where in the room.

HEIGHT OF THE SPEAKER UNITS

Front left and right speakers, and a center speaker

Align the tweeters and mid-range drivers on the three front speakers at the same height, as best as possible.

Surround left and right speakers, and surround back speaker

Place the surround left, right and surround back speakers higher than your ears by about 27-9/16 – 39-3/8 inches (70cm–1m). Also place the speakers at the same height, as best as possible.

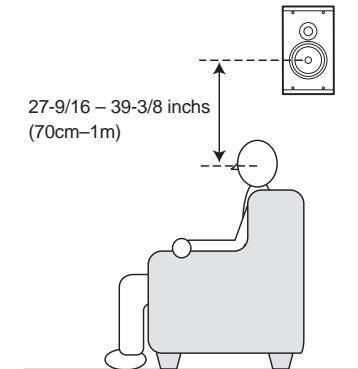

Note:

- Use magnetically-shielded speakers for front left, right and the center speakers when the speakers are installed near the TV.

CONNECTING SPEAKERS

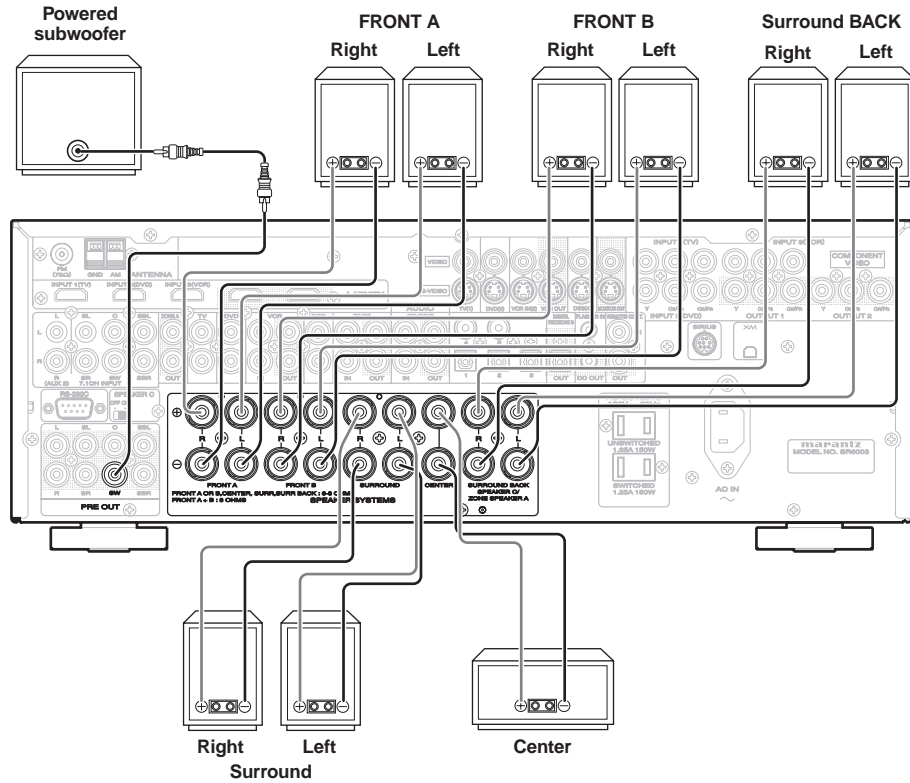

CONNECTING SPEAKER WIRE

1. Strip away approx. 3/8 inch (10 mm) of wire insulation.
2. Twist the bared wire ends tight, to prevent short circuits.
3. Loosen the knob by turning it counterclockwise.
4. Insert the bare part of the wire into the hole in side of each terminal.
5. Tighten the knob by turning it clockwise to secure the wire.

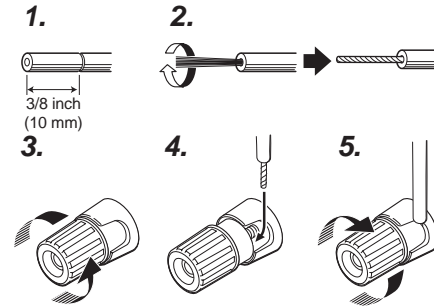

Caution:

- Be sure to use speakers with the specified impedance as shown on the rear panel of this unit.
- To prevent damage to circuitry, do not let the bare speaker wires touch each other and do not let them touch any metal part of this unit.

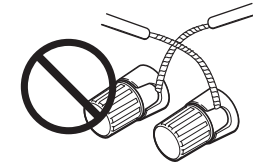

- Do not touch the speaker terminals when the power is on. It may cause you to receive an electric shocks.
- Do not connect more than one speaker cable to one speaker terminal. Doing so may damage this unit.

Note:

- Be sure to connect the positive and negative cables for the speaker properly. If they are miss-connected, the signal phase will be reversed and the signal quality will be corrupted.

CONNECTING A SUBWOOFER

Use the PRE OUT SUBWOOFER jack to connect a powered subwoofer (power amplifier built in).

CONNECTING AUDIO COMPONENTS

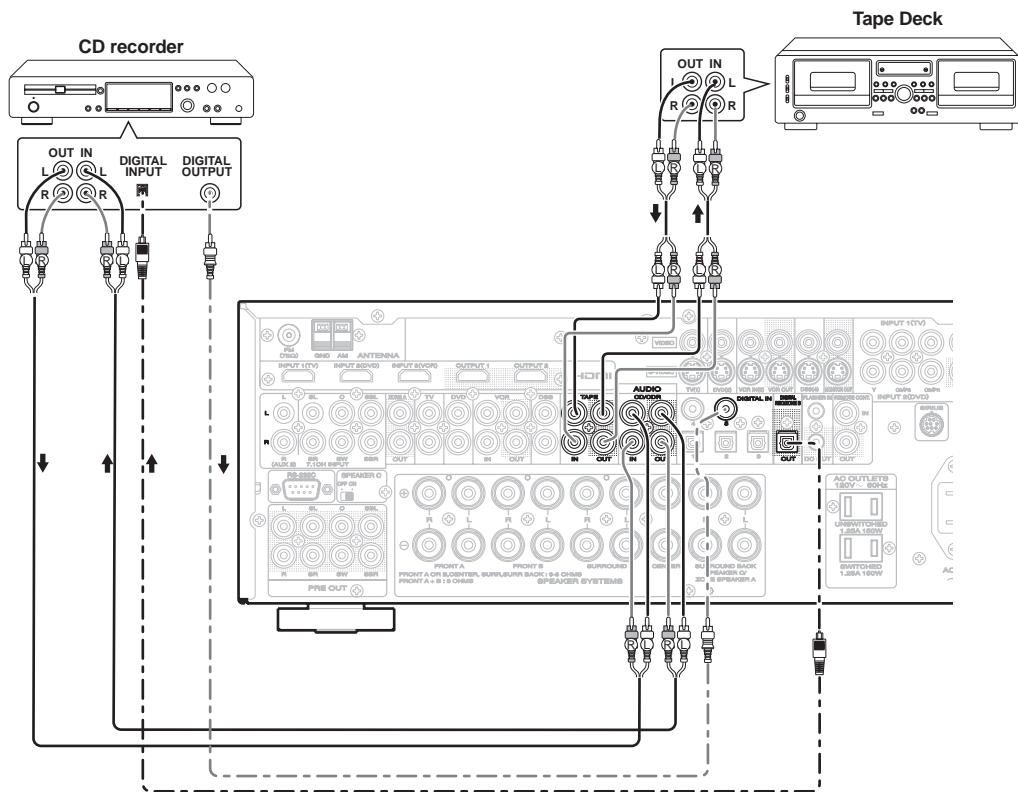

Analog Audio



Digital Audio (coaxial)



Digital Audio (optical)



The output audio signal from the TAPE OUT jack and the CD/CD RECORDER OUT jack is the same signal which is currently selected.

Caution:

- Do not connect this unit and other components to mains power until all connections between components have been completed.

Notes:

- Insert all plugs and connectors securely. Incomplete connections may make noise.
- Be sure to connect the left and right channels properly. Red connectors are for the R (right) channel, and white connectors are for the L (left) channel.
- Be sure to connect input and output properly.
- Refer to the instructions for each component that is connected to this unit.
- Do not bind audio/video connection cables with power cables and speaker cables this will result in generating a hum or other noise.

CONNECTING DIGITAL AUDIO COMPONENTS

- There are 5 digital inputs, 2 coaxial jacks and 3 optical jacks, on the rear panel. You can use these jacks to input PCM, Dolby Digital and DTS bitstream signals from a CD, DVD, or other digital source components.
- There is one optical output jack on the rear panel. This jack can be connected to a CD recorder or a MD recorder input. When you use this jack as ZONE B, you cannot use it as recording output. (See page 9, 38)
- Refer to the instructions for each component. To setup the digital audio format of DVD player, or other digital source's connected to digital input jacks.
- Use fiber optical cables (optical) for DIG-1,2,3 input jacks and REC/ZONE B output jack. Use 75 ohms coaxial cables (for digital audio or video) for DIG-4, 5 input jacks.
- You can designate the input for each digital input/output jacks according to your component. (See page 27)

Notes:

- The digital signal jacks on this unit conform to the EIA standard. If you use a cable that does not conform to this standard, this unit may not function properly.
- Each type of audio jack works independently. Signals input through the digital and analog jacks are output through the corresponding digital and analog jacks, respectively.

NAMES AND FUNCTION
BASIC CONNECTIONS
BASIC OPERATION
ADVANCED CONNECTIONS
SETUP
ADVANCED OPERATION
TROUBLESHOOTING
OTHERS

CONNECTING VIDEO COMPONENTS

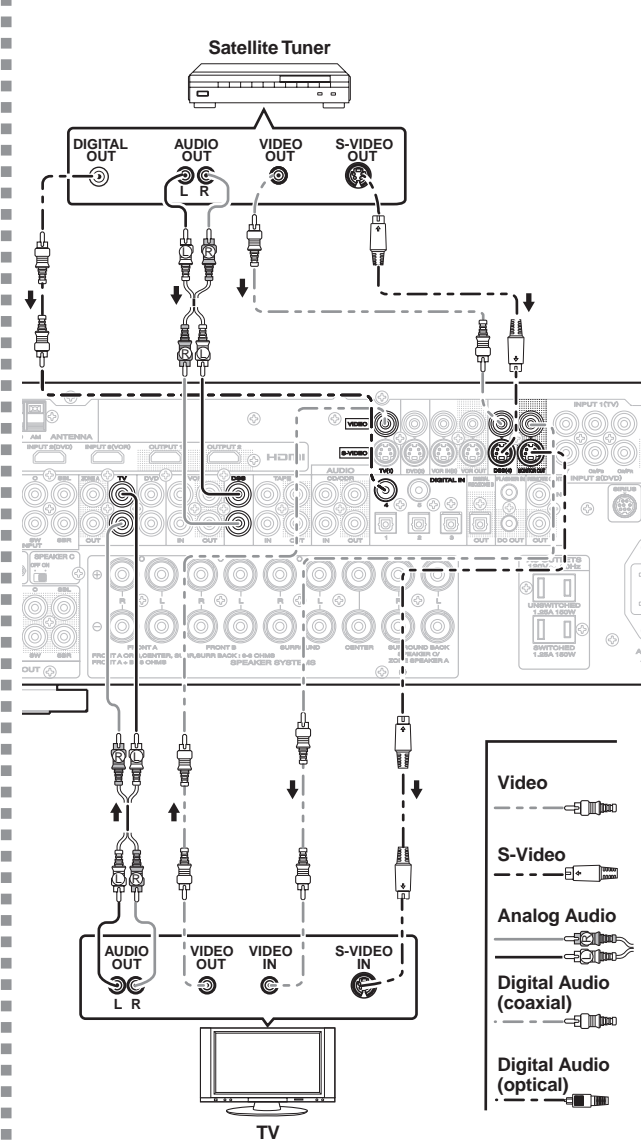
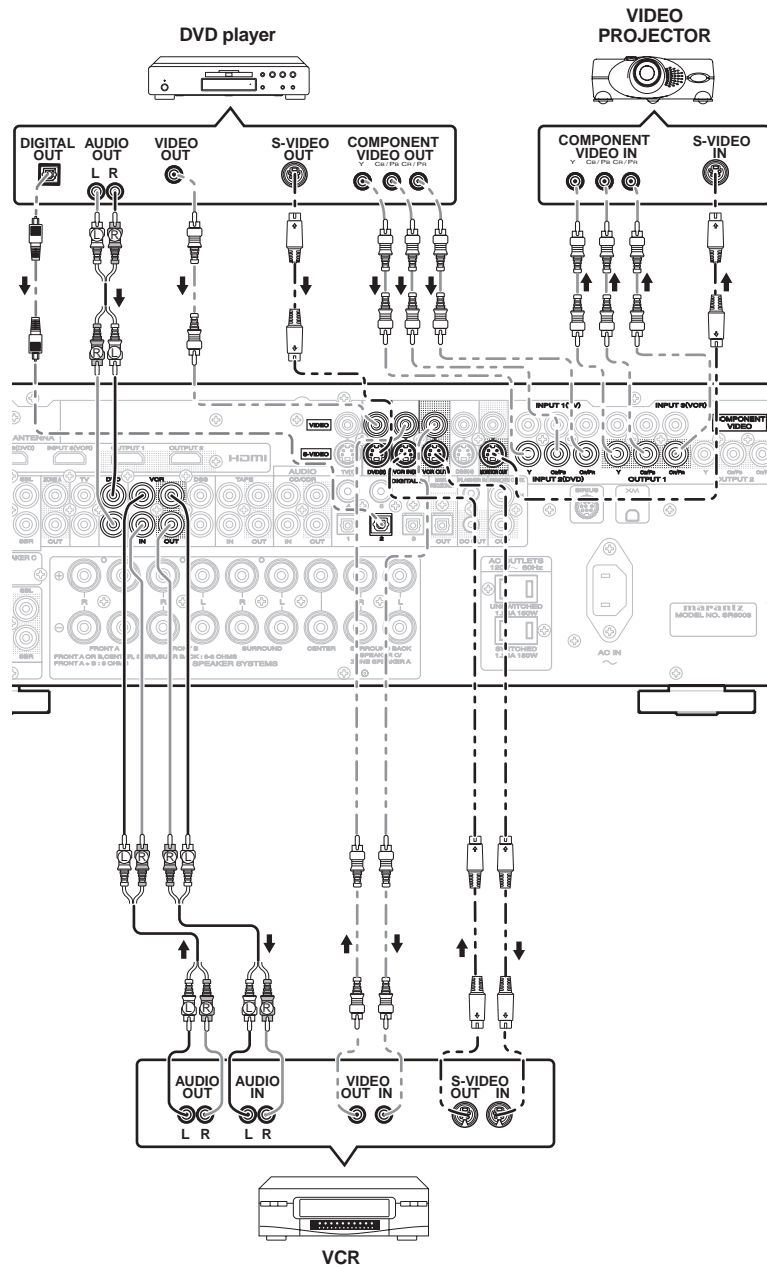

VIDEO, S-VIDEO, COMPONENT JACKS

There are 3 types of video jacks on the rear panel.

VIDEO jack

The video signal for the VIDEO jacks is the conventional composite video signal.

S-VIDEO jack

The video signal is separated into luminance (Y) and color (C) signals for the S-VIDEO jack. The S-VIDEO signals enables high-quality color reproduction. If your video component has an S-VIDEO output, we recommend to use it. Connect the S-VIDEO output jack on your video component to the S-VIDEO input jack on this unit.

COMPONENT jack

Make component video connections to a TV or monitor with component inputs to produce higher quality video images. Use a component video cable or 3 video cords to connect the component video out jacks on the unit to the monitor.

Notes:

- Be sure to connect the left and right audio channels properly. Red connectors are for the R (right) channel, and white connectors are for the L (left) channel.
- Be sure to connect the inputs and outputs of the video signals properly.
- If you connect the S-VIDEO or component signal to the S-VIDEO or component jack on this unit, it is not necessary to connect the conventional video signal to the VIDEO (composite) jack. If you use both video inputs, this unit gives priority to the S-VIDEO signal.
- Each type of video jack works independently. Signals input to the VIDEO (composite) and S-VIDEO jacks or component are output to the corresponding VIDEO (composite) and S-VIDEO or component jacks, respectively.
- This unit has the "TV-AUTO ON/OFF" function to turn the TV ON or OFF automatically, by sensing the incoming video signal from the VIDEO jacks.
- You may need to setup the digital audio output format of your DVD player, or other digital source components. Refer to the instructions of the each component connected to the digital input jacks.
- The COMPONENT OUTPUT 1 and 2 terminals of this unit can output the same video signal. (See page 37)

NAMES AND FUNCTION

BASIC CONNECTIONS

BASIC OPERATION

ADVANCED CONNECTIONS

SETUP

ADVANCED OPERATION

TROUBLESHOOTING

OTHERS

CONNECTING HDMI COMPONENTS

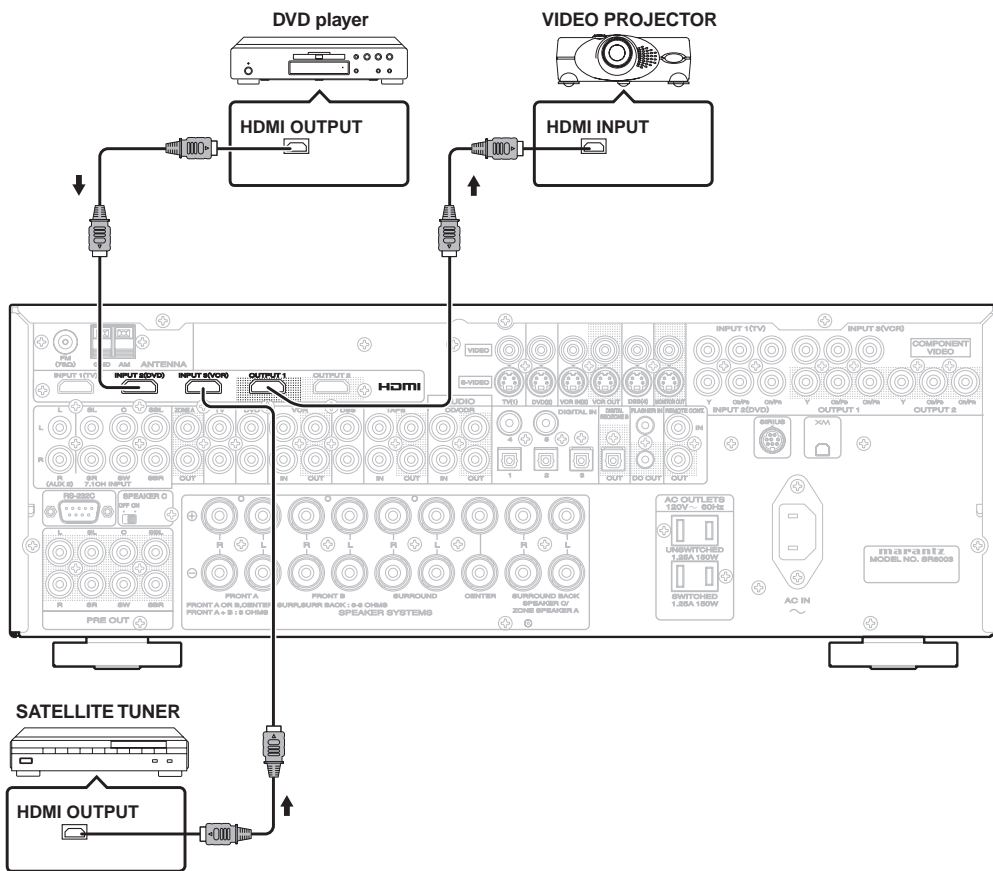

HDMI JACKS

This unit has three HDMI inputs and two HDMI outputs. It can send digital video and audio signals from DVDs and other sources directly to a display. It minimizes signal degradation caused by analog conversion so that high quality images can be enjoyed.

This unit is also capable of converting analog video signals (Composite Video, S-Video, Component Video) for HDMI output.

Select an input source from the GUI menu system. (See page 27)

Notes:

- When the HDMI output is connected to a display monitor that does not support HDCP*, signals are not output. To view images in HDMI, it is necessary to connect to a display that supports HDCP.
- There may be no image output if connected to a TV or display that is not compatible with the above format.
- Refer to the instruction manual of the TV or display to be connected to the unit for detailed information regarding the HDMI terminal.

* **HDCP: High-bandwidth Digital Content Protection**

CONNECTING HDMI COMPONENTS

An HDMI cable (sold separately) is used to connect the HDMI jack on the unit with the HDMI jack on the DVD player, TV, projector or other component. To transmit multichannel audio via HDMI, the connected player must support multichannel audio transmission through its HDMI jack.

Notes:

- Some HDMI components can be controlled over the HDMI cable, but this unit cannot control other components this way.
- When connected to a monitor (i.e., TV, projector, etc.) that does not support HDCP, video and audio are not output.

- Some source devices such as DVD players or set top box do not support HDMI repeater operations like those of the unit. In such case, pictures are not properly projected on monitors such as TVs and projectors.

- When multiple components are connected to this unit, turn power to unused components off to prevent interference between them.

- Disconnecting or connecting cables with the power on can damage the equipment. Turn the power off before disconnecting or connecting cables.

- If the DVD player that does not support HDMI 1.1 or later is connected to the unit, multi channel PCM playback is not possible even with DVD-Audio disks.

- If the Super Audio CD player that does not support HDMI 1.2 or later is connected to the unit, DSD* playback is not possible even with Super Audio CD.

(*DSD: Direct Stream Digital)

- The following functions are not available when the unit is connected to equipment that does not support HDMI 1.3a.

- Deep Color

- x.v. Color

- Bitstream audio signal decoding, as for Dolby Digital Plus, Dolby TrueHD, DTS-HD, and so on

For details, refer to the user's manuals of connected equipment.

- Multi channel PCM signals and audio signals of 64 kHz or higher that are input from the HDMI jack are not output from the DIGITAL OUT jack.

- Depending on the quality of the cable used, the HDMI signal may be affected by noise.

CONNECTING THE ANTENNA TERMINALS

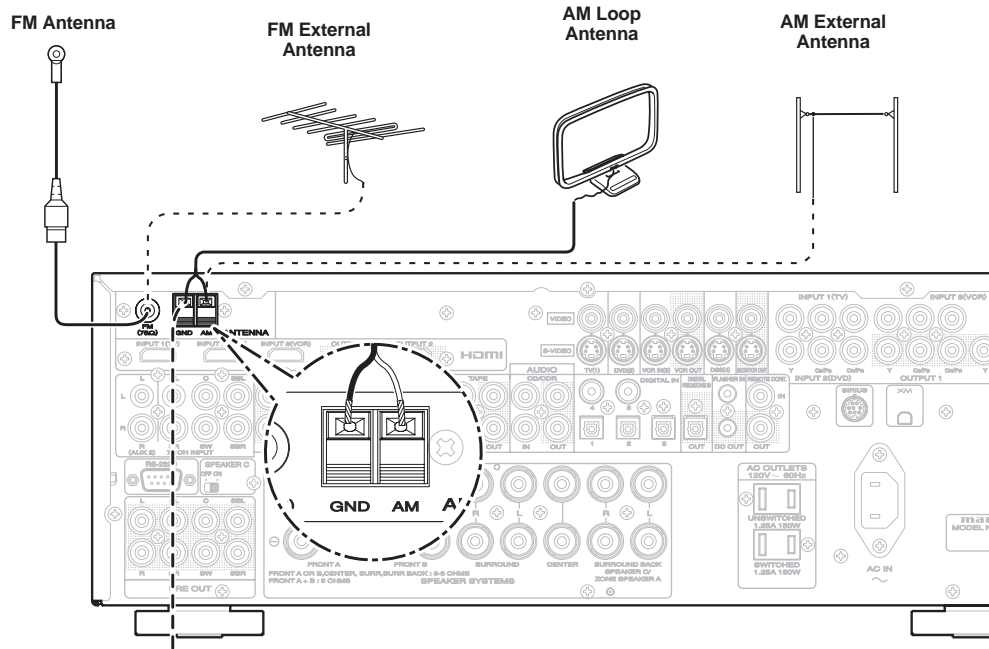

ASSEMBLING THE AM LOOP ANTENNA

1. Release the vinyl tie and take out the connection line.
4. Place the antenna on stable surface.

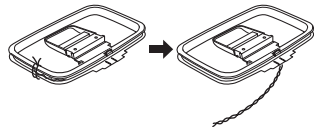

2. Bend the base part in the reverse direction.

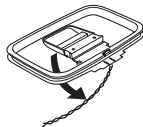

3. Insert the hook at the bottom of the loop part into the slot at the base part.

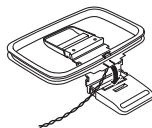

CONNECTING THE SUPPLIED ANTENNAS

Connecting the supplied FM antenna

The supplied FM antenna is for indoor use only. During use, extend the antenna and move it in various directions until the clearest signal is received. Fix it with push pins or similar implements in the position that will cause the least amount of distortion. If you experience poor reception quality, an outdoor antenna may improve the quality.

Connecting the supplied AM loop antenna

The supplied AM loop antenna is for indoor use only. Set it in the direction and position it to where you receive the clearest sound. Put it as far away as possible from the unit, televisions, speaker cables, and power cords. If you experience poor reception quality, an outdoor antenna may improve the quality.

1. Press and hold down the lever of the AM antenna terminal.
2. Insert the bare wire into the antenna terminal.
3. Release the lever.

Note:

- Connect the shielded grounding wire (black) to the AM antenna GND terminal.

CONNECTING THE FM OUTDOOR ANTENNA

Notes:

- Keep the antenna away from noise sources (neon signs, busy roads, etc.).
- Do not put the antenna close to power lines. Keep it well away from power lines, transformers, etc.
- To avoid the risk of lightning and electrical shock, grounding is necessary.

CONNECTING THE AM OUTDOOR ANTENNA

The outdoor antenna will be more effective if it is stretched horizontally above a window or outside.

Notes:

- Do not remove the AM loop antenna.
- To avoid the risk of lightning and electrical shock, grounding is necessary.

CONNECTING THE AC POWER CABLE

1. Plug the supplied AC power cable to the AC IN socket on the rear panel of the unit.

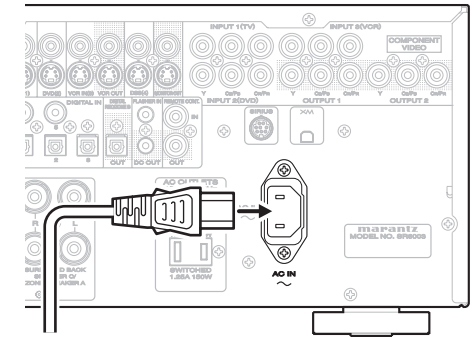

2. Plug the power cable into an AC outlet.

BASIC OPERATION

AMP OPERATION

TURNING ON THE UNIT

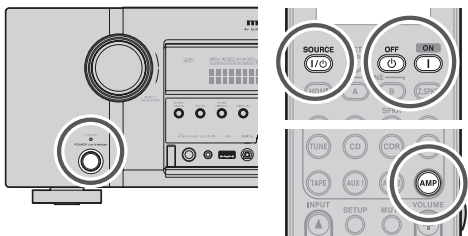

1. Connect the AC power cable to the wall outlet.
2. Turn the power of the equipment connected to this unit on.
3. Press the **POWER ON/STANDBY** button of this unit. Every time the button is pressed, the power to this unit toggles between on and standby.

To activate power using the remote controller, press the **AMP** button, followed by the **ON** button and **SOURCE ON/OFF** button of the remote controller.

SELECTING AN INPUT SOURCE

Before you can listen to any input media, you must first select the input source on the unit.

Example : DVD

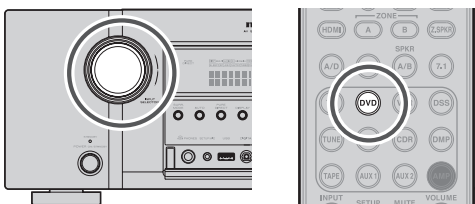

To select DVD, turn the **INPUT SELECTOR** knob on the front panel or press the **DVD** button on the remote controller two times in a row. After you have selected DVD, simply turn on the DVD player and play the DVD.

- As the input source is changed, the new input name will appear momentarily as OSD information on the video display. The input name will also appear in the display, on the front-panel.
- If you use the **FUNCTION RENAME** feature (see page 28), the renamed name appears on the display.
- As the input is changed, this unit will automatically switch to the digital input, surround mode, attenuation, and night mode status which were entered during the configuration process for that source.
- When a video source is selected, the selected video signal is output from the **MONITOR OUT** terminal.

ADJUSTING THE MAIN VOLUME

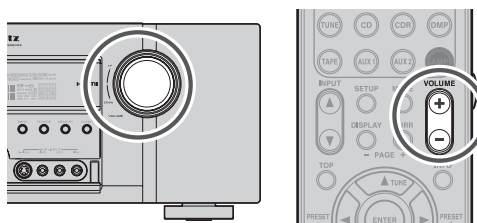

Adjust the volume to a comfortable level using the **VOLUME** control knob on the front panel or **VOLUME +/-** buttons on the remote controller. To increase the volume, turn the **VOLUME** knob clockwise or press **VOLUME +** button on the remote controller, to decrease the volume, turn counterclockwise or press **VOLUME -** button on the remote controller.

Notes:

- The volume can be adjusted within the range of $-\infty$ and -71 to 18 dB, in steps of 1 dB.
- However, when the channel level is set as described on page 34, if the volume for any channel is set at $+1$ dB or greater, the volume cannot be adjusted up to 18 dB. (In this case the maximum volume adjustment range is "18 dB - Maximum value of channel level")

ADJUSTING THE TONE (BASS & TREBLE) CONTROL



During a listening session you may wish to adjust the Bass and Treble Control to suit your listening tastes or room acoustics.

(Using the remote controller)

To adjust the tone, press the **AMP** button.

To adjust the bass effect, press **BASS +** or **BASS -** button.

To adjust the treble effect, **TREBLE +** or **TREBLE -** button.

Notes:

- The tone control function is unavailable for the Source Direct, Pure Direct, Headphone, Dolby Virtual Speaker mode, and 176.4/192kHz PCM.
- The Tone control function is not available when M-DAX is being used.
- The tone control function is not available when ACOUSTIC EQ is being used.
- Additionally, tone control is not available during Dolby TrueHD, Dolby Digital Plus, or DTS-HD playback.

TEMPORARILY TURNING OFF THE SOUND



To temporarily silence all speaker outputs such as when interrupted by a phone call, press the **MUTE** button on the remote controller. This will interrupt the output to all speakers and the head-phone jack, but it will not affect any recording or dubbing that may be in progress. When the system is muted, the display will show "MUTE". Press the **MUTE** button again to return to normal operation.

TUNER OPERATION

To operate the unit from the remote controller, press the **TUNE** button on the remote controller so that the tuner mode is engaged.

LISTENING TO THE TUNER

Frequency scan step for AM is selectable.

Default setup is 10 kHz step, if your country's standard is 9 kHz step, Press **BAND** button on the front panel or **BAND** button on the remote controller more than 5 seconds. Scan step will change.

Note:

- Preset memory for the tuner will clear by changing this setup.

AUTO TUNING

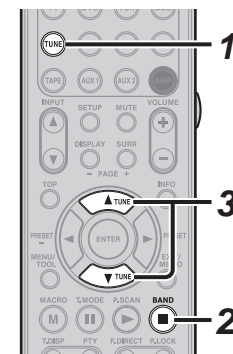
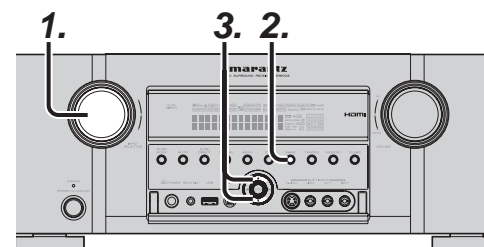

(Using the unit)

1. Turn the **INPUT SELECTOR** knob to select "TUNER".
2. Press the **BAND** button to select either FM or AM.
3. Press the **▲** or **▼** cursor buttons on the front Panel for more than 1 second to start the auto tuning function.
4. Automatic searching begins then stops when a station is tuned in.

(Using the remote controller)

1. To select tuner, Press the **TUNE** button twice within two second on the remote controller.
2. Press the **BAND** button to select either FM or AM.
3. Press and hold the **TUNE ▲** or **▼** button for 1 second or more.
4. Automatic searching begins then stops when a station is tuned in.

If tuning does not stop at the desired station, use to the "Manual tuning" operation.

MANUAL TUNING

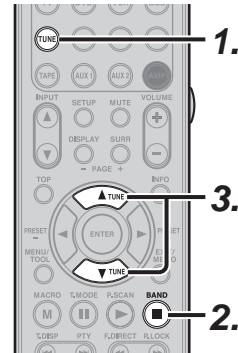
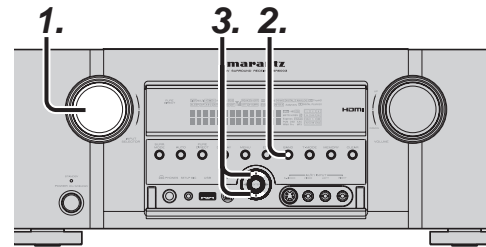

(Using the unit)

1. Turn the INPUT SELECTOR knob to select "TUNER".
2. Press the **BAND** button to select either FM or AM.
3. Press the **▲** or **▼** cursor buttons on the front Panel to select the desired station.

(Using the remote controller)

1. To select tuner, press the **TUNE** button twice within two seconds on the remote controller.
2. Press the **BAND** button to select either FM or AM.
3. Press the **TUNE ▲** or **▼** button to tune in the deseired station.

DIRECT FREQUENCY CALL

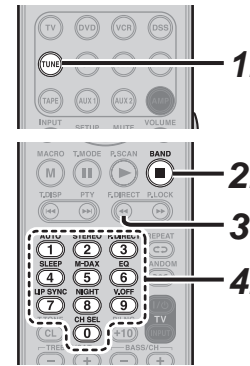

1. To select tuner, Press the **TUNE** button twice within two seconds on the remote controller.
2. Press the **BAND** button to select either FM or AM.
3. Press the **F.DIRECT** on the remote controller, display will show "FREQ----".
4. Input your desired station's, frequency with the ten numbered keypad on the remote controller.
5. The desired station will automatically be tuned.

(FM) TUNING MODE (AUTO STEREO OR MONO)

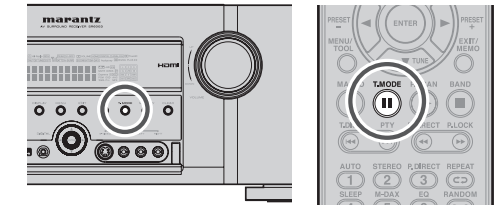

When in the auto stereo mode, "AUTO" indicator will be illuminated on the display.

The "ST" indicator is illuminated when a stereo broadcast is tuned in.

At open frequencies, the noise is muted and the "TUNED" and "ST" indicators are not illuminated.

If the signal is weak, it may be difficult to tune into the station in stereo. In such a case, Press the **T-MODE** button on the front panel or **T.MODE** button on the remote controller.

"AUTO" indicator is not illuminated, if FM stereo broadcasts are received in monaural and the "ST" indicator is not illuminated.

To return to auto stereo mode, Press the **T-MODE** button on the front panel or **T.MODE** button on the remote controller again. "AUTO" indicator is illuminated the display.

REMOTE CONTROLLER OPERATION

To control the unit by your remote controller, you have to select the device AMP, TUNER or DMP (USB) by pressing the **SOURCE** button. Please refer below for the details in AMP, TUNER or DMP (USB) mode.

AMP MODE

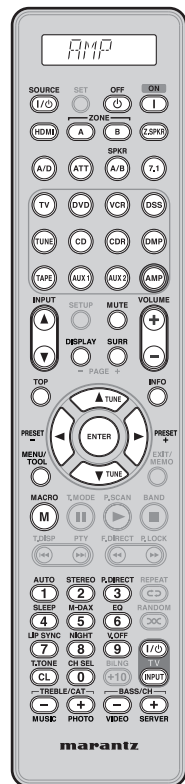

SOURCE ON/OFF	Turns the SR6003 on and off
POWER OFF	Turns the SR6003 off
POWER ON	Turns the SR6003 on
HDMI	Selects the HDMI output
ZONE A/B	Turns on or off ZONE A or ZONE B
Z.SPKR	Turns on or off ZONE Speaker A
A/D	Switches between the analog or digital inputs
ATT	Reduces the input level
SPKR A/B	Selects the speaker system
7.1	Selects the 7.1CH IN
SOURCE	Selects a particular source component
AMP	Select AMP mode of remote unit
INPUT ▲ / ▼	Change the input selector of SR6003
DISPLAY	Changes the front display mode
MUTE	Decreases the sound temporarily
SURR	Selects the surround mode
VOLUME+/-	Adjusts the over all sound level
TOP	Back to the TOP of SETUP MENU
INFO	Displays the current setting on the monitor
Cursor	Moves the cursor for setting in "SETUP MENU" mode
ENTER	Confirms the setting in "SETUP MENU" mode
MENU	Enters the "SETUP MENU"
EXIT	Exits from SETUP MENU
MACRO(M)	Selects the MACRO mode.
AUTO(1)	Selects auto surround
STEREO(2)	Selects STEREO mode
P.DIRECT(3)	Selects the pure direct mode
SLEEP(4)	Sets the sleep timer function
M-DAX(5)	Selects the M-DAX mode
EQ(6)	Selects the EQ mode
LIP SYNC(7)	Selects the LIP SYNC mode
NIGHT(8)	Turns on or off NIGHT mode
V-OFF(9)	Turns on or off video output
T.TONE(CL)	Enters the test tone menu
CH SEL(0)	Calls up CH LEVEL ADJUST and adjusts speaker levels or 7.1ch input level
TV POWER	Turns the TV on and off
TV INPUT	Select the TV video input
TREBLE-/+	Adjusts the tone control of high frequency sound
BASS-/+	Adjusts the tone control of low frequency sound

TUNER MODE

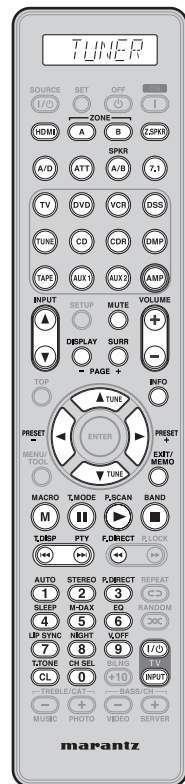

HDMI	AMP function enabled
ZONE A/B	AMP function enabled
Z.SPKR	AMP function enabled
A/D	AMP function enabled
ATT	AMP function enabled
SPKR A/B	AMP function enabled
7.1 IN	AMP function enabled
SOURCE	AMP function enabled
AMP	AMP function enabled
INPUT ▲ / ▼	AMP function enabled
DISPLAY	AMP function enabled
MUTE	AMP function enabled
SURR	AMP function enabled
VOLUME+/-	AMP function enabled
INFO	Shows preset information
TUNE ▲ / ▼	Tunes a frequency station up and down
PRESET + ► / - ◄	Selects a preset station up and down
EXIT/MEMO	Enters the tuner preset memory numbers
T.TONE	AMP function enabled
T.MODE	Selects the auto stereo mode or mono mode
P.SCAN	Starts preset scan
BAND	Selects a radio band
T.DISP	Selects the display mode in XM Satellite Radio and SIRIUS Satellite Radio
F.DIRECT	Selects the "Frequency direct input"
P.LOCK	Select the parental lock mode
0-9	Inputs the numeric
CL	Clears the inputting
TV POWER	Turns the TV on and off
TV INPUT	Select the TV video input

• The remote controller dose not have the PRESET code library for this device.

DMP (USB) MODE

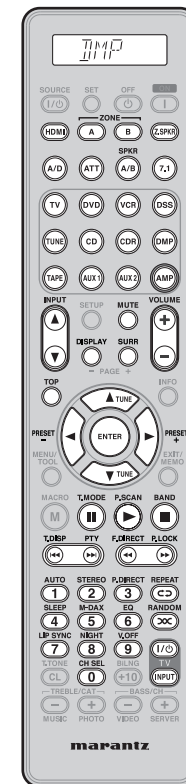

HDMI	AMP function enabled
ZONE A/B	AMP function enabled
Z.SPKR	AMP function enabled
A/D	AMP function enabled
ATT	AMP function enabled
SPK A/B	AMP function enabled
7.1 IN	AMP function enabled
SOURCE	AMP function enabled
AMP	AMP function enabled
INPUT ▲ / ▼	AMP function enabled
DISPLAY (PAGE-)	Moves to the previous page
MUTE	AMP function enabled
SURR (PAGE+)	Moves to the next page
VOLUME+/-	AMP function enabled
TOP	Moves to the highest folder
Cursor	Cursor movement/folder movement
ENTER	Moves to folders/plays files
PAUSE	PAUSE
PLAY	PLAY
STOP	STOP
Previous/Next	Skips forward or previous file
Rewind/Forward	Searchs forward or backward
REPEAT	Select REPEAT PLAY
RANDOM	Select RANDOM PLAY
TV POWER	Turns the TV on and off
TV INPUT	Select the TV video input

NAMES AND FUNCTION
 BASIC CONNECTIONS
 BASIC OPERATION
 ADVANCED CONNECTIONS
 SETUP
 ADVANCED OPERATION
 TROUBLESHOOTING
 OTHERS

ADVANCED CONNECTIONS

CONNECTING THE USB MEDIA

Connect the USB media to the unit.

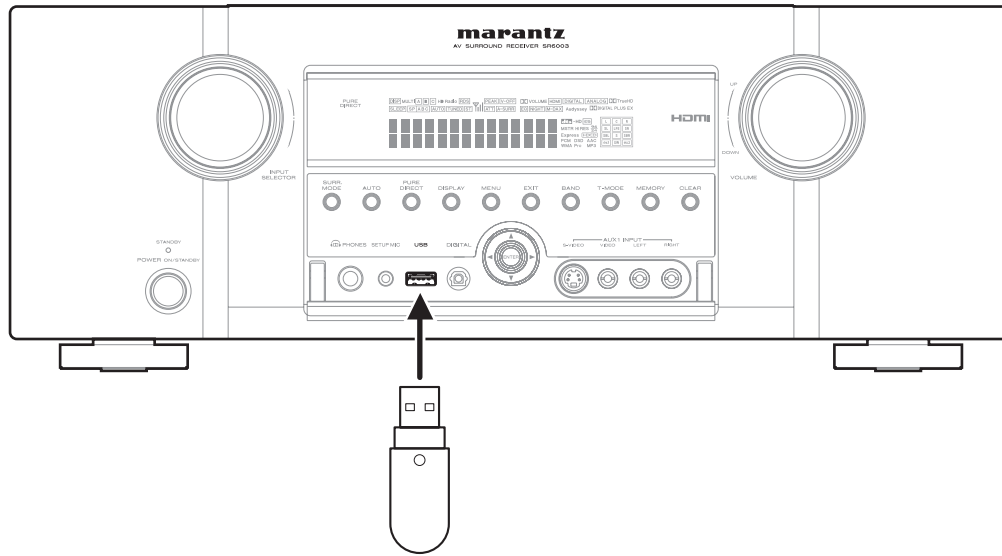

Note:
Remove the USB media after turning off the power. If it is removed while the power is still supplied, its data may be lost and/or the USB media itself may be damaged.

Caution:
When the USB devices are used, do not use the USB extension cable.

CONNECTING MULTI CHANNEL AUDIO COMPONENTS

The 7.1CH INPUT jacks are for multichannel audio source such as the Super Audio CD multichannel player, DVD audio player or external decoder.
If you use these jacks, switch on the 7.1CH INPUT and set the 7.1CH INPUT level by using the SETUP MAIN MENU. See page 27.

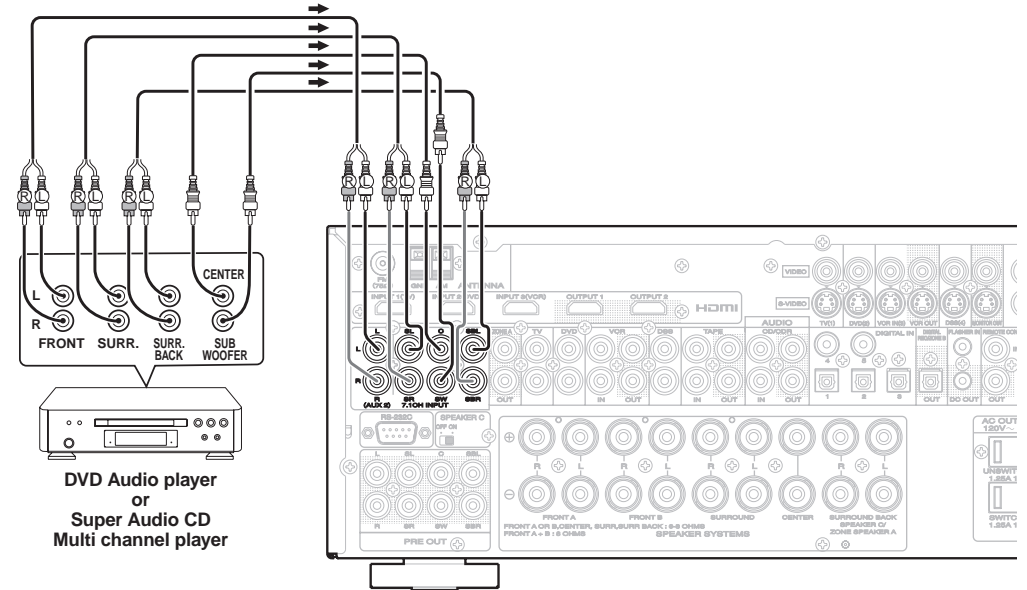

CONNECTING AN EXTERNAL POWER AMPLIFIER

The PREOUT jacks are for connecting external power amplifier.
Be sure to connect each speaker to the corresponding external power amplifier.

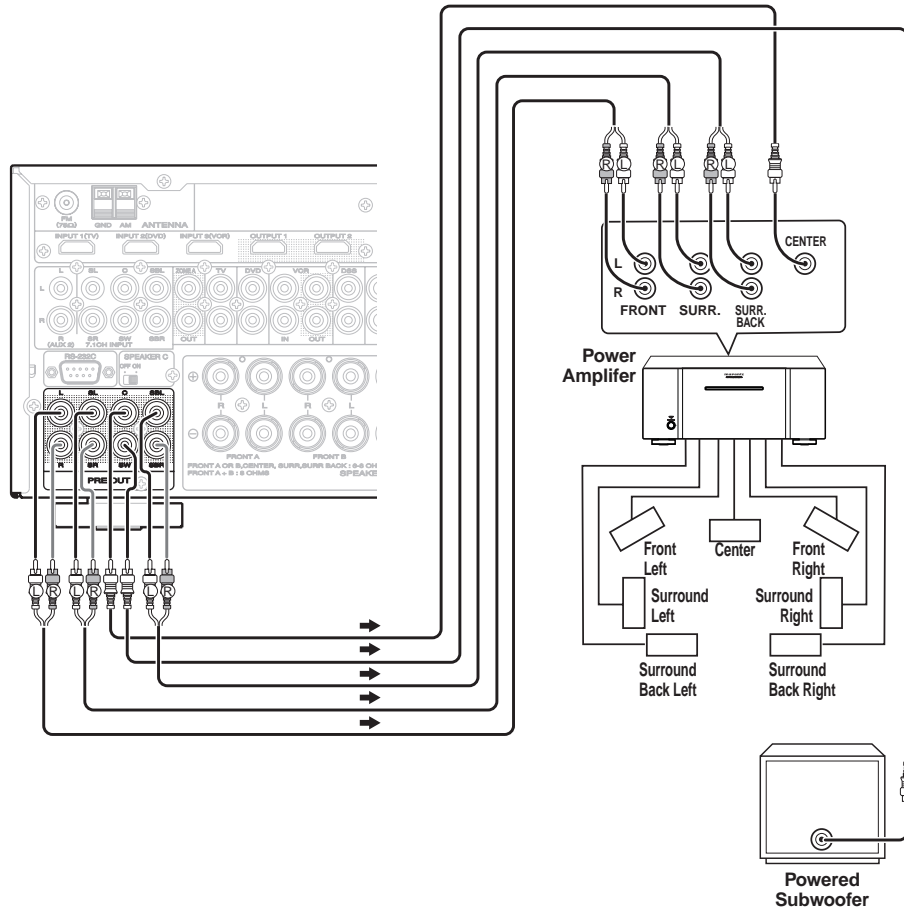

CONNECTING FOR SPEAKER C USE (BI-AMP CONNECTION)

A bi-amp connection is possible with speakers that have two sets of inputs (for treble and bass). This allows you to drive the treble and bass units with separate channel amps, which enables better sound quality. Connect the speakers as shown in the figure. Set the SPEAKER C selector switch on the rear panel to ON.

Notes:

- If incorrectly connected, a protective circuit in the unit will trip and set the unit to standby. (The STANDBY indicator will flash.) In such case, recheck the connections between the speakers and the unit.
- Turn power to the unit off before changing the setting of the SPEAKER C selector switch.

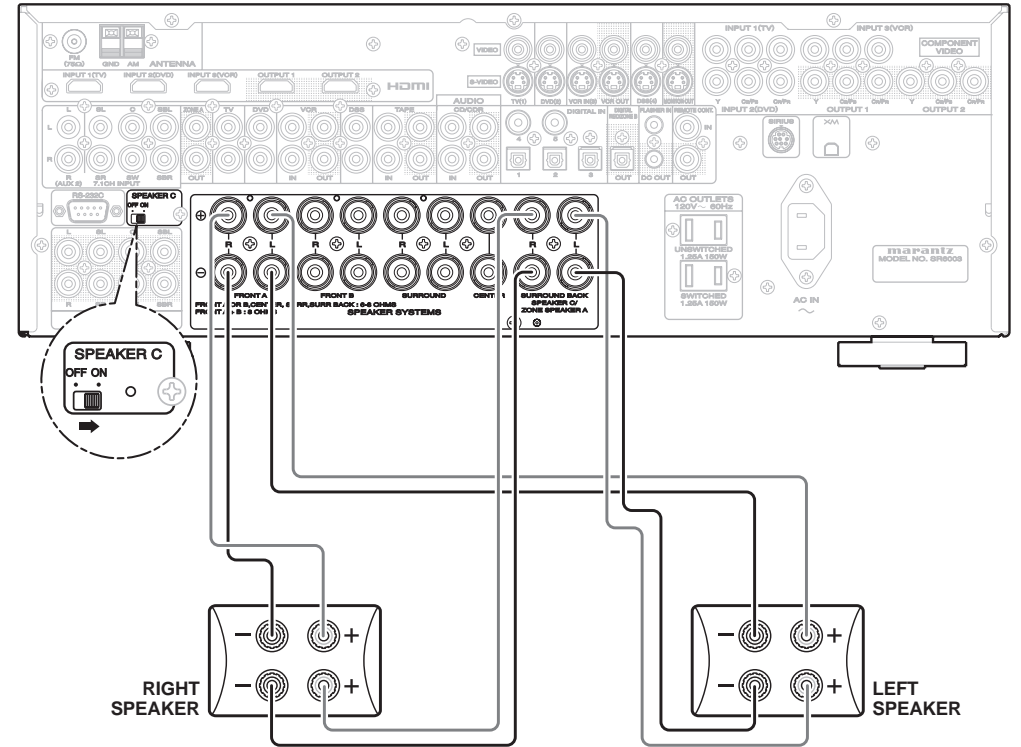

Note:

- You can use surround back speaker terminals as ZONE SPEAKER A. terminals or SPEAKER C terminal when you are not using surround back speakers.

CONNECTION FOR ANOTHER ZONE

As shown in the diagram, a player connected to this unit in another ZONE can be used to play music and movies when used in combination with an amp from Marantz or other manufacturer.

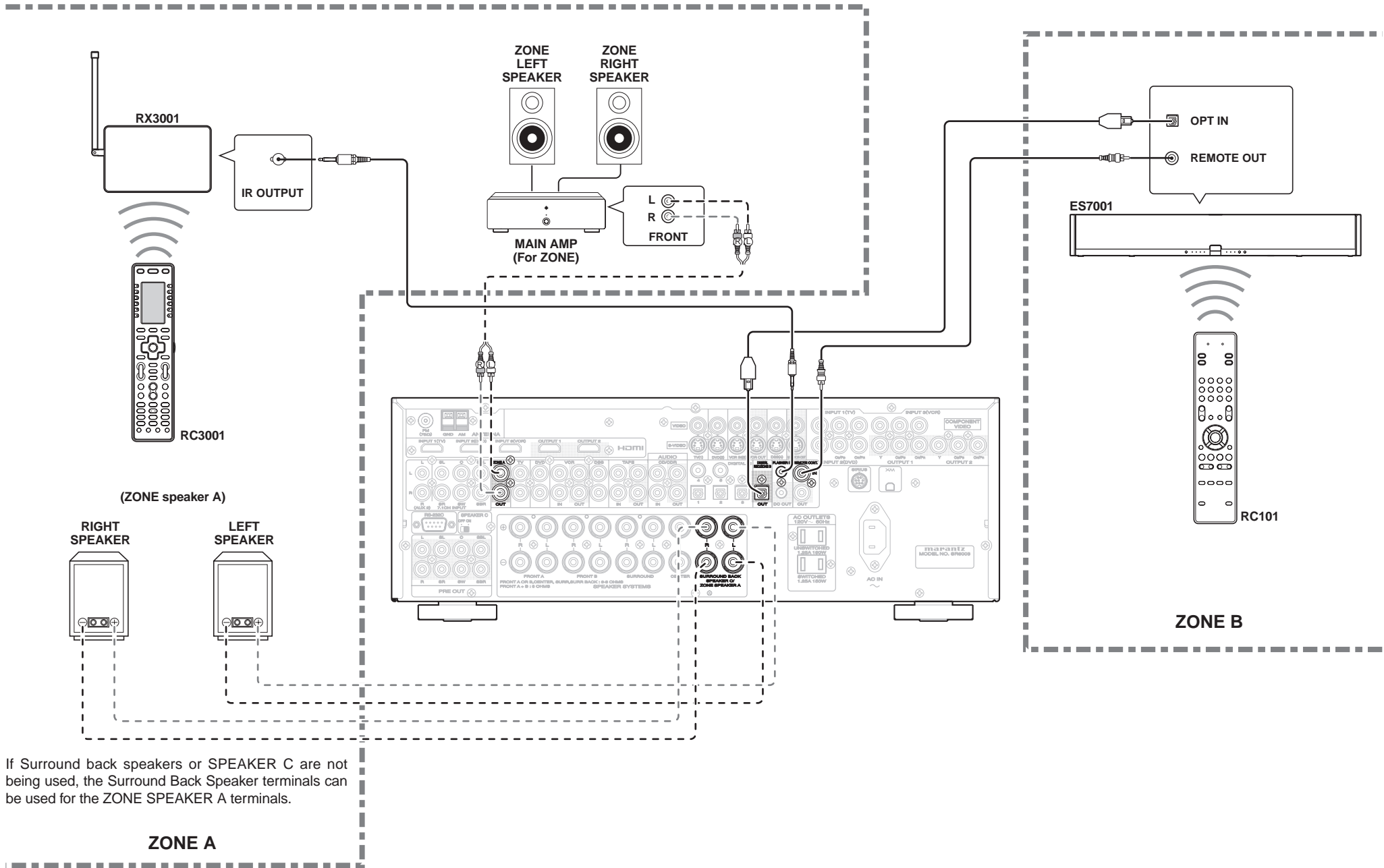

NAMES AND FUNCTION
BASIC CONNECTIONS
BASIC OPERATION
ADVANCED CONNECTIONS
SETUP
ADVANCED OPERATION
TROUBLESHOOTING
OTHERS

CONNECTING THE REMOTE CONTROL JACKS

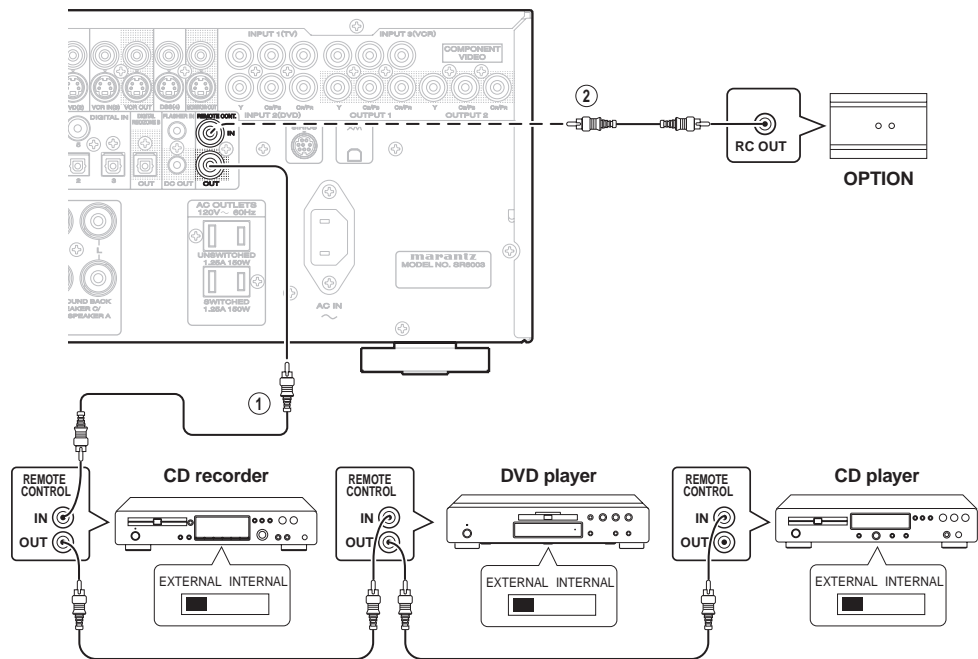

① You can control other Marantz products through this unit with the remote controller by connecting the REMOTE CONTROL terminals on each unit. The signal transmitted from the remote controller is received by the remote sensor on this unit. Then the signal is sent to the connected device through this terminal. Therefore you need to aim the remote control only at the unit. Also, if a Marantz power amplifier (some models excluded) is connected to one of these terminals, the power amplifier's, power switch is synchronized with this unit's power switch.

Set the REMOTE CONTROL SWITCH on the back of other units (not the SR6003) to "EXT." (EXTERNAL) to use this feature.

② Whenever external infrared sensors or similar devices are connected to RC-5 IN of the unit, be sure to always disable operation of the infrared sensor on the unit by using the following procedure.

1. Hold down the **SURROUND MODE** button and the **MENU** button on the front panel at the same time for five seconds.
2. The setting "IR=ENABLE" is shown on the FL DISPLAY.
3. Press the **CURSOR** buttons (◀, ▶) to change this to "IR=DISABLE".
4. Press the **ENTER** button. Once this setting is made, the infrared sensor on the unit is disabled.

Note:

- Be sure to set to "IR=ENABLE" when external infrared sensors or similar devices are not connected. Otherwise, the unit will be unable to receive remote control commands.
5. To restore the original setting, perform steps 1 to 4 to set to "IR=ENABLE".

CONNECTING OTHER EQUIPMENT

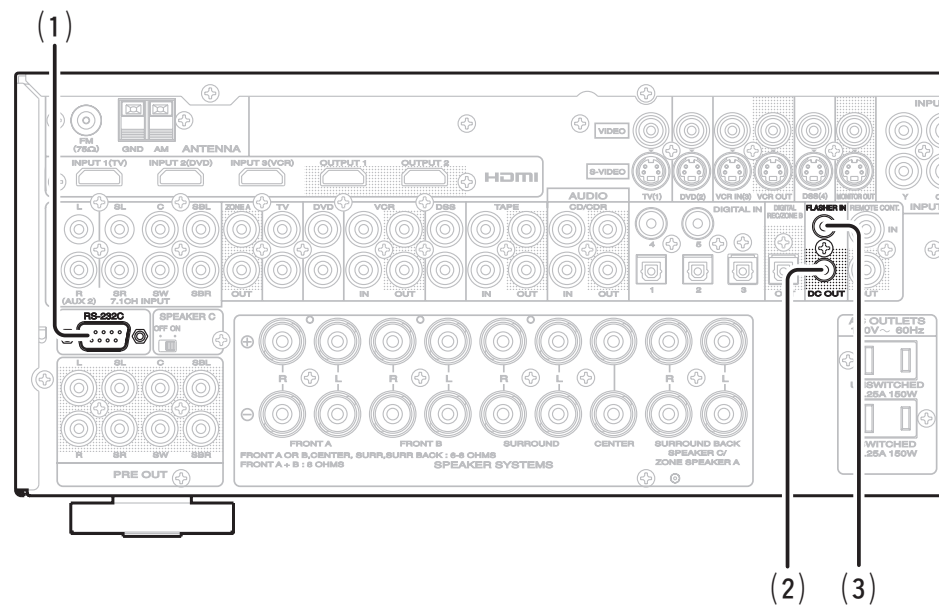

(1) RS-232C

Connect an external control device or other device for servicing. (Use a straight cable for the connection.)

(2) DC OUT (DC TRIGGER)

External devices can be controlled from the unit by connecting them to the DC OUT terminal (12 V 44mA max).

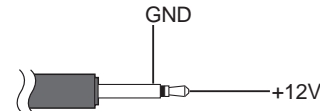

(3) FLASHER IN

This unit can be controlled by connecting a control box or other control device to this unit.

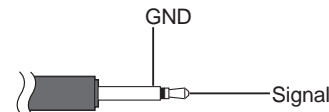

NAMES AND FUNCTION
 BASIC CONNECTIONS
 BASIC OPERATION
 ADVANCED CONNECTIONS
 SETUP
 ADVANCED OPERATION
 TROUBLESHOOTING
 OTHERS

CONNECTING THE SATELLITE RADIO

Subscriptions are required in order to listen to both XM Satellite Radio and SIRIUS Satellite Radio. For details on XM Satellite Radio, see page 53. For details on SIRIUS Satellite Radio, see page 58.

XM SATELLITE RADIO

- Plug the XM Mini-Tuner and Home Dock into XM terminal on the rear panel.
 - Position the XM antenna near a south-facing window to receive the best signal.
- When making connections, also refer to the operating instructions of the XM Mini-Tuner and Home Dock.

Note:

This unit does not support the XM CNP-1000. See page 77.

SIRIUS SATELLITE RADIO

- Plug the SiriusConnect™ Home Tuner, Antenna and AC adapter into SIRIUS terminal on the rear panel.
- Position the SIRIUS antenna for a consistent satellite signal, the antenna must be positioned correctly. Use the following map to determine which area you are in and position the antenna accordingly.

(US)

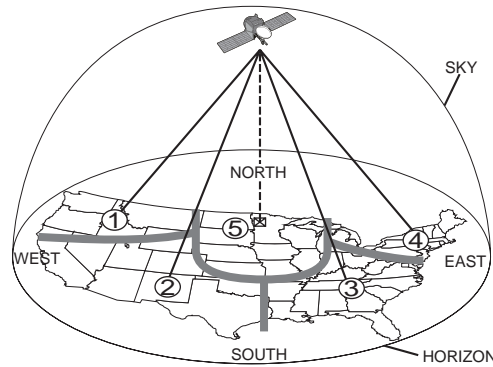

AREA	ANTENNA AIMING DIRECTION
AREA 1	Aim the antenna EAST or NORTHEAST
AREA 2	Aim the antenna NORTH or NORTHEAST
AREA 3	Aim the antenna NORTH or NORTHWEST
AREA 4	Aim the antenna WEST or NORTHWEST
AREA 5	Aim the antenna STRAIGHT UP at the sky (may require outdoor placement)

(Canada)

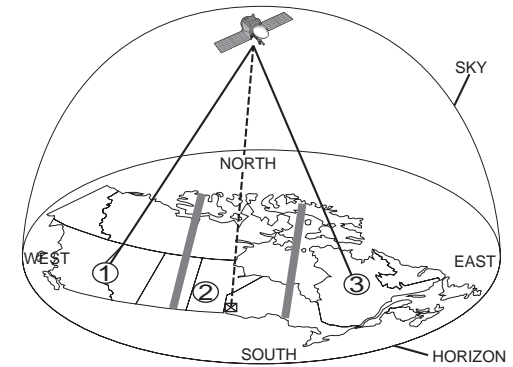

AREA	ANTENNA AIMING DIRECTION
AREA 1	Aim the antenna EAST or SOUTHEAST
AREA 2	Aim the antenna SOUTH or STRAIGHT UP at the sky (may require outdoor placement)
AREA 3	Aim the antenna WEST or SOUTHWEST

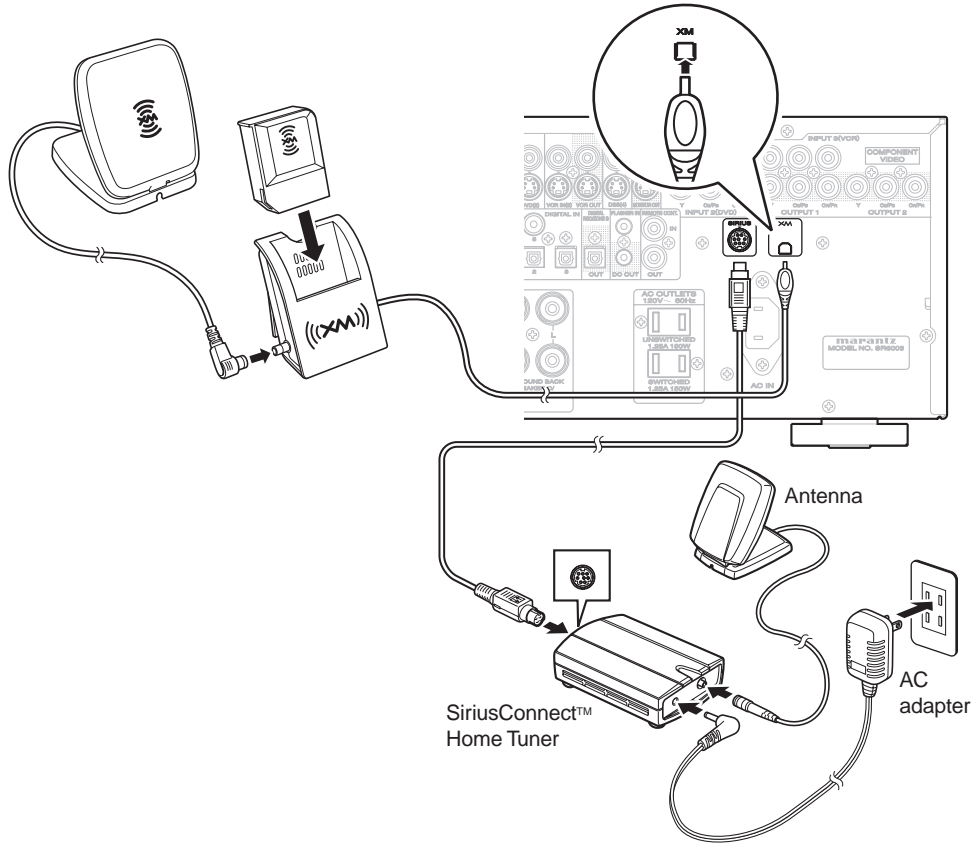

NAMES AND FUNCTION
BASIC CONNECTIONS
BASIC OPERATION
ADVANCED CONNECTIONS
SETUP
ADVANCED OPERATION
TROUBLESHOOTING
OTHERS

SETUP

After all components are connected, initial setup must be performed.

GRAPHICAL USER INTERFACE MENU SYSTEM

This unit incorporates the graphical user interface menu system, which makes various operations possible by using the cursor (▲, ▼, ◀, ▶) and **ENTER** buttons on the remote controller or on the front panel.

Note:

- To view the graphical user interface displays, make certain you have connected the MONITOR OUT jack on the rear panel to the composite, S-Video, component video or HDMI input of your TV or projector. (See page 13, 14)

- Press the **AMP** button on the remote controller. (This step is not needed when operating the setup menus from the unit.)
- Press the **MENU** button on the remote controller or press the **MENU** button on the front panel. The **"Main Menu"** of the GUI menu system is displayed. There are 6 items in the "Main Menu".
- Select the desired sub-menu with the ▲ or ▼ cursor buttons and press the **ENTER** button. The display will change to the selected sub-menu.

<LOCKING SUBMENUS>

- Move the cursor to "Input Setup" in the Main Menu.
- When the ◀ or ▶ cursor button is pressed to display the  (key) icon on an item, the item concerned is locked.
- To exit from the GUI menu system, press the **EXIT** button, or move the cursor to **EXIT** and press the **ENTER** button.

RC003SR BUTTON CONTROL

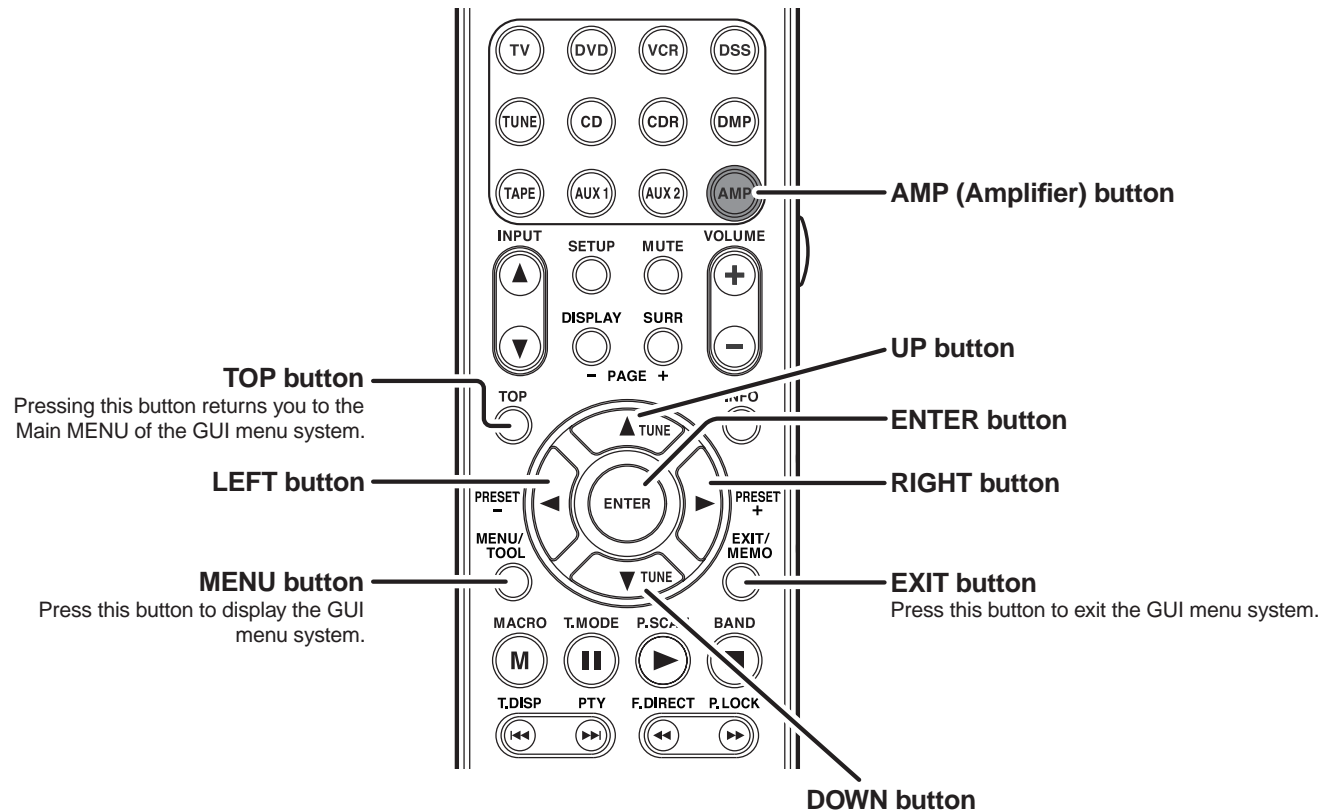

SR6003 FRONT BUTTON CONTROL

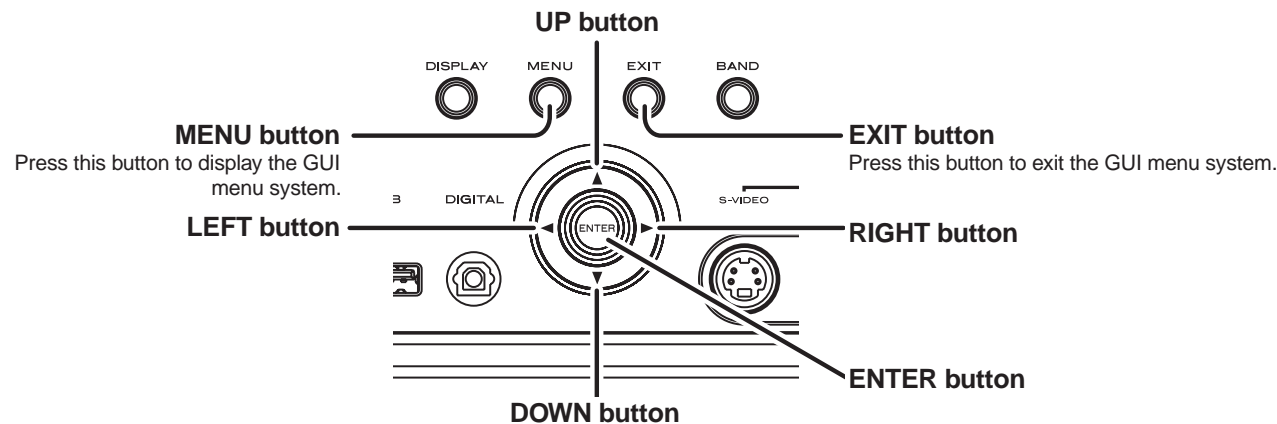

NAMES AND FUNCTION
 BASIC CONNECTIONS
 BASIC OPERATION
 ADVANCED CONNECTIONS
 SETUP
 ADVANCED OPERATION
 TROUBLESHOOTING
 OTHERS

Note:

- After you complete this portion of the setup, move cursor to **Return** with the ▲ and ▼ cursor buttons and press the **ENTER** button.

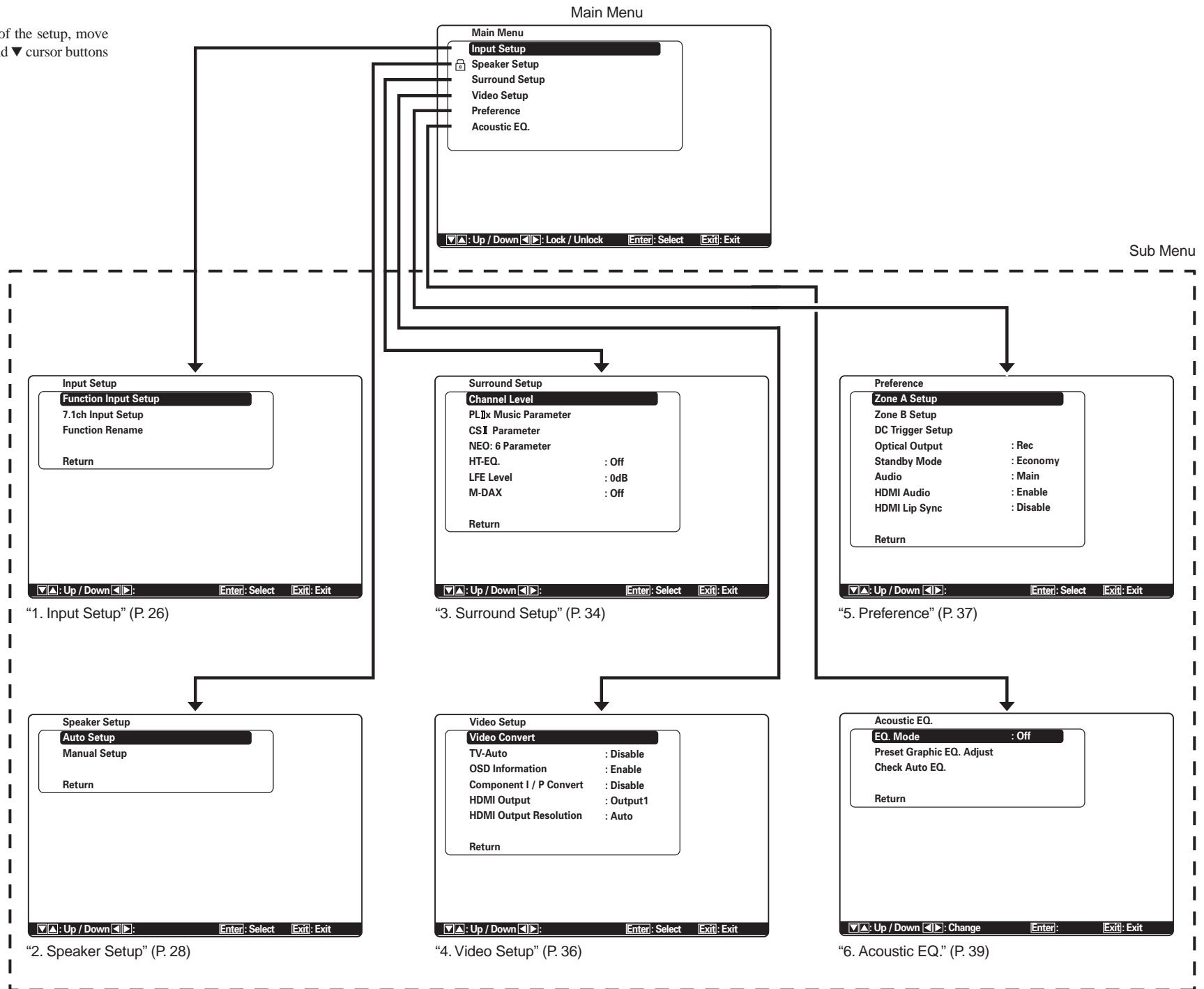

1 INPUT SETUP

This menu is for setting the matching the output of connected audio devices and the input jacks of this unit.

- **Function Input Setup :**
“1-1 FUNCTION INPUT SETUP” (see page 27)
- **7.1 ch Input Setup :**
“1-2 7.1 CH INPUT SETUP” (see page 27)
- **Function Rename :**
“1-3 FUNCTION RENAME” (see page 28)

1. Select “Input Setup” from the Main Menu with ▲ or ▼ cursor button, and press the ENTER button.

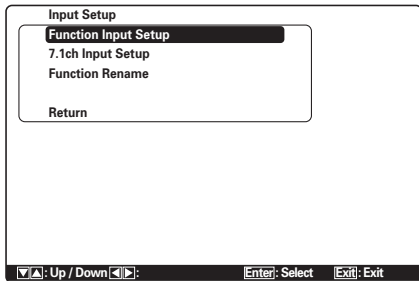

2. Select the desired sub-menu with the ▲ or ▼ cursor buttons, and press the ENTER button.

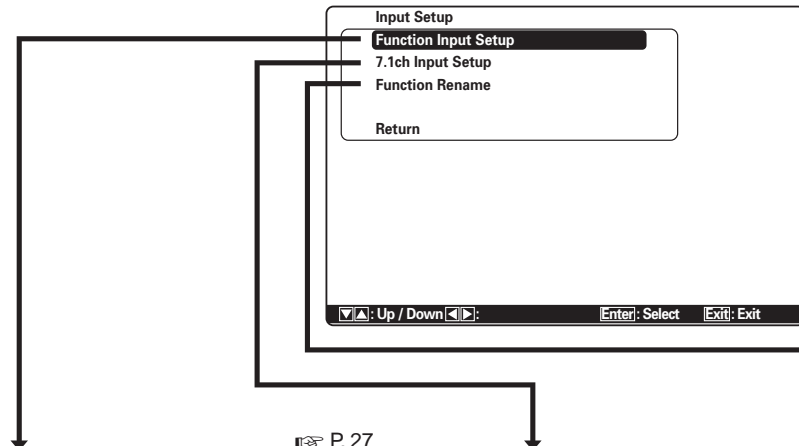
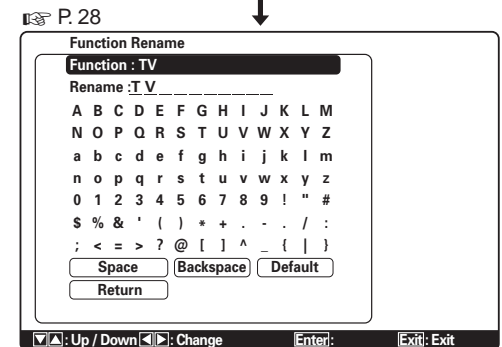
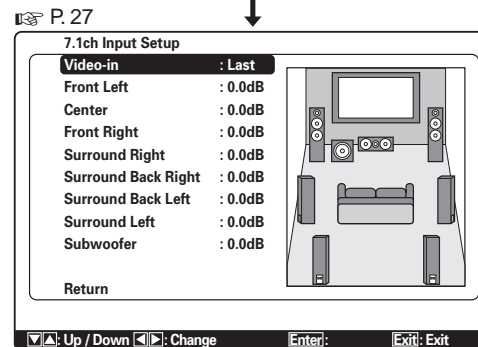
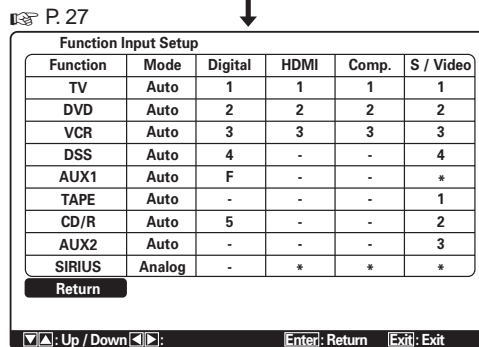

1-1 FUNCTION INPUT SETUP (ASSIGNABLE DIGITAL INPUT)

The 5 and F (Front) digital inputs can be assigned to a desired source.

HDMI and COMPONENT inputs can be assigned to the preferred source.

Use this menu to select which digital input jacks are to be assigned to which input source.

1. Select **"Function Input Setup"** from the Input Setup menu with the **▲** or **▼** cursor buttons and press the **ENTER** button.

Function Input Setup					
Function	Mode	Digital	HDMI	Comp.	S / Video
TV	Auto	1	1	1	1
DVD	Auto	2	2	2	2
VCR	Auto	3	3	3	3
DSS	Auto	4	-	-	4
AUX1	Auto	F	-	-	*
TAPE	Auto	-	-	-	1
CD/R	Auto	5	-	-	2
AUX2	Auto	-	-	-	3
SIRIUS	Analog	-	*	*	*

Return

▲/▼: Up / Down ◀▶: Enter: Return Exit: Exit

2. Select a setting with the **▲**, **▼**, **◀**, and **▶** cursor buttons, and assign a mode and input jack (Digital, HDMI, Comp, S/Video).

MODE

Auto:

Select **"Auto"**, for automatic detection of the digital input signal condition.

If there is no digital signal, but there is an analog signal present, the analog signal will be played. **"Auto"** is the initial setting of all input sources.

HDMI:

Select **"HDMI"**, when only a HDMI signal will be used.

Digital:

Select **"Digital"**, when only a digital signal will be used.

Analog:

Select **"Analog"** for input sources for which no digital input jacks are used.

Digital

5 and F(Front) digital inputs can be assigned to a desired source.

Assign the number of a digital input jack to the device.

HDMI

Assign the number of an HDMI input jack to the device.

Note:

- When FUNCTION MODE is set to HDMI and HDMI AUDIO of "5. PREFERENCE" is set to Through, audio is not output from the unit. (See page 38)

Comp

Assign the number of a component video input jack to the device.

S/Video

Assign the number of a composite video and S-video input jack to the device.

Note:

- Video and S-video can use the same numbers when assigning to input functions.
- The * mark in AUX1 indicates that other inputs cannot be assigned.

3. Press the **ENTER** button.
4. Select each mode setting and input terminal with the **◀** or **▶** cursor buttons.
5. Press the **ENTER** button.
6. Repeat steps 2-5 until all items are set.

Note:

- Assignments cannot be made in sections with a * mark.

1-2 7.1 CH INPUT SETUP

This menu is for adjusting the speaker levels for 7.1-channel input sources.

Here you will adjust the volume for each channel so that they are all heard by the listener at the same level.

1. Select **"7.1 ch Input Setup"** from the Input Setup menu with the **▲** or **▼** cursor buttons and press the **ENTER** button.

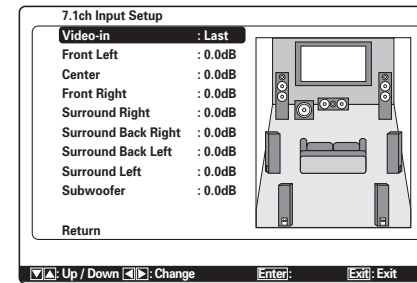

2. Select **"Video-in"** with the **▲** or **▼** cursor buttons.
3. Using the **◀** or **▶** cursor buttons, select the video input source to be played through the MONITOR OUT jack.

The input source is switched by pressing the **◀** or **▶** cursor buttons as follows;

Last ↔ **TV** ↔ **DVD** ↔ **VCR** ↔ **DSS** ↔ **AUX1**
↔ **TAPE** ↔ **CD/R** ↔ **AUX2** ↔ **Video-off** ↔ **Last** ↔...

Notes:

- When **"Last"** is selected, the source is set to the source selected before the 7.1 ch input menu was activated.
- When **"Video-off"** is selected, no signal is emitted from MONITOR OUT jack.

4. Select desired channel with the **▲** or **▼** cursor buttons.
5. Using the **◀** or **▶** cursor buttons, adjust the volume level of each channel.

Move the cursor to **"Return"** with the **▲**, **▼**, **◀**, and **▶** cursor buttons, and press the **ENTER** button to go to the Input Setup menu.

Note:

- The volume level can be set between -12 dB and +12 dB in 1 dB increments on all channels except the subwoofer (SUB W), which can be set from -18dB to +12 dB in 1 dB increments.

1-3 FUNCTION RENAME

Input sources can be registered under any name. This menu is for renaming input source.

This menu is for renaming function name. Names can be up to 10 characters long, including spaces. (Characters are selected from those appearing on the display.) This name appears on the unit's FL display and the GUI, but it does not appear in the GUI Setup menu.

1. Select "**Function Rename**" from the Input Setup menu with the ▲ or ▼ cursor buttons and press the **ENTER** button.

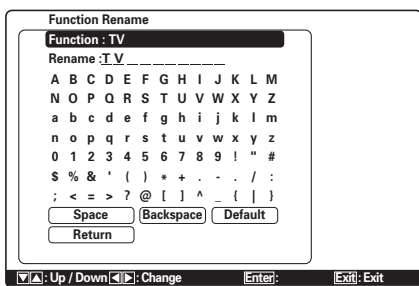

2. Select "**Function**" with the ▲ or ▼ cursor buttons.
3. Select an input source with the ◀ or ▶ cursor buttons.
4. Select "**Rename**" with the ▲ or ▼ cursor buttons.
5. Move the cursor to the character (1st to 10th) to change with the ◀ or ▶ cursor buttons.
6. Move the cursor to the character list with the ▼ cursor button. (Move the cursor to the letter "A" to begin with.)
7. Select a character with the ▲, ▼, ◀, and ▶ cursor buttons.
8. Press the **ENTER** button to enter the selected letter.

9. Repeat steps 5-8 until the new name is input.

Space:

Inserts a space at the cursor point of the "**Rename**" area.

Backspace:

Deletes the character left of the cursor in the "**Rename**" area one character at a time.

Default:

Restores the name in the "**Rename**" area to the name in the "**Function**" area.

Note:

- Rename cannot be left blank.

Move the cursor to "**Return**" with the ▲, ▼, ◀, and ▶ cursor buttons and press the **ENTER** button to go to the Input Setup menu.

2 SPEAKER SETUP

After you have installed the unit connected all the components and determined the speaker layout, it is now time to perform the settings in the Speaker Setup menu for the optimum sound acoustics for your environment and speaker layout. Before you perform the following settings, it is important that you first determine the following characteristics:

- **Auto Setup:**
"2-1 AUTO SETUP (Audyssey MultEQ®)"
(see page 30)
- **Manual Setup:**
"2-2 MANUAL SETUP" (see page 33)

1. Select "Speaker Setup" from the Main Menu with **▲** or **▼** cursor buttons and press the **ENTER** button.

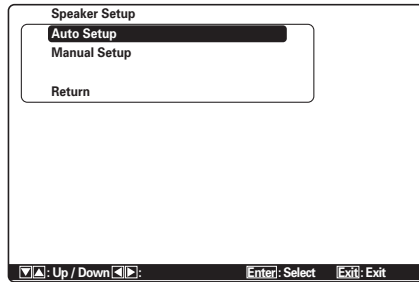

2. Select the desired menu with the **▲** or **▼** cursor buttons, and press the **ENTER** button.

Note:

- After you complete this the portion of the setup, press the **▲**, **▼**, **◀**, and **▶** cursor button. The cursor will move to "Return" and press the **ENTER** button to go to the Sub-menu.

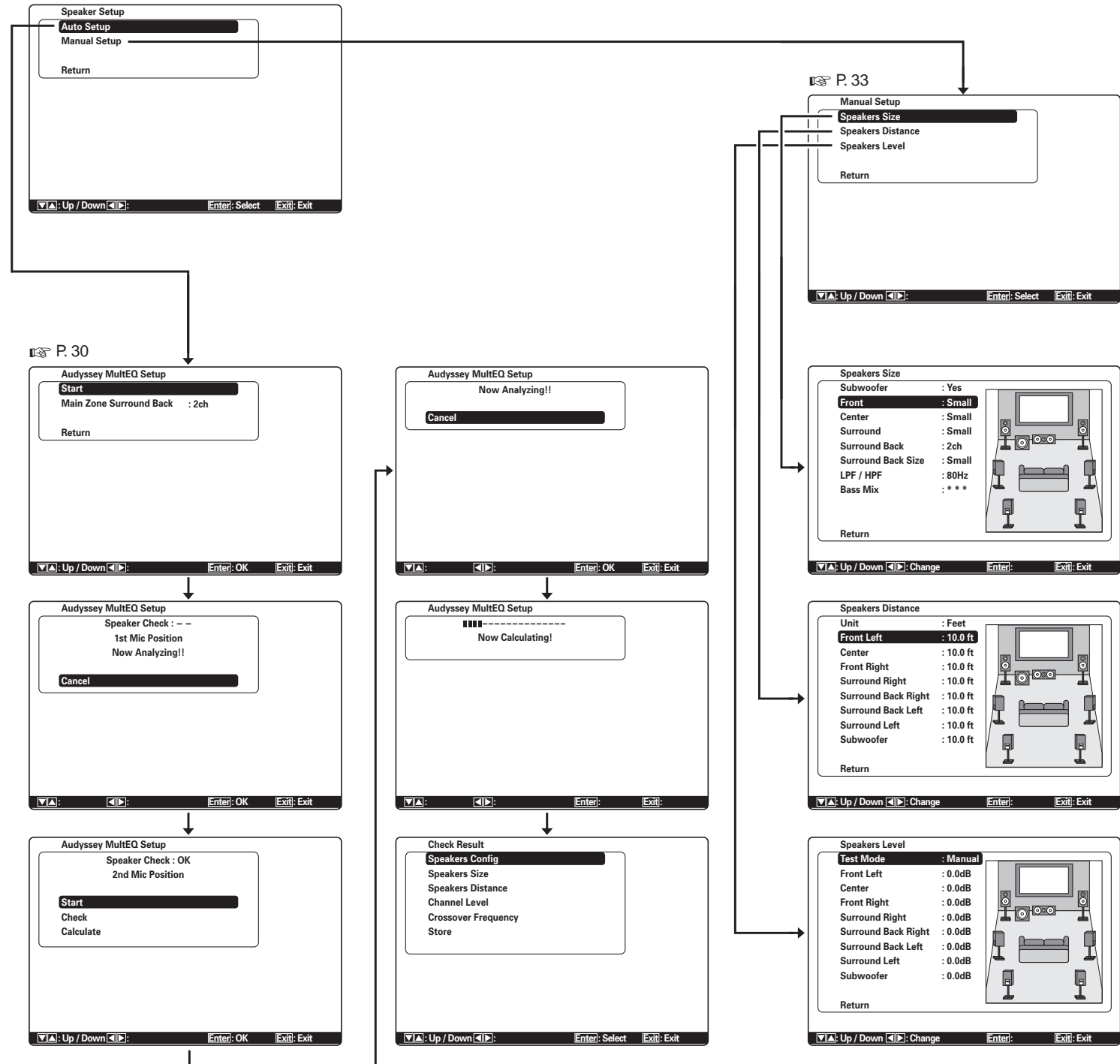

2-1 AUTO SETUP (Audyssey MultEQ®)

AUTO SETUP (performed by Audyssey MultEQ) automatically measures the acoustical problems in the listening environment and optimizes settings to create the best audio experience for your listening environment.

Audyssey MultEQ removes frequency response anomalies caused by the interaction of sound from loudspeakers within the room. This results in the playback of sound as it was intended, without coloration, not just in one seat, but over a large listening area.

Audyssey MultEQ measures up to 6 listening positions in the room and detects the presence of each speaker and automatically calculates the speaker size, channel level, distance, and optimal crossover frequency settings.

To set up the speaker system (i.e., adjusting speaker distance, etc.) without using the AUTO SETUP feature, see "MANUAL SETUP" on page 33 of the manual.

HOW TO PERFORM AUTO SETUP

During measurement, the GUI menu displays the condition, therefore turn power to the monitor on.

1. Connect the supplied microphone to the SETUP MIC jack on the unit.

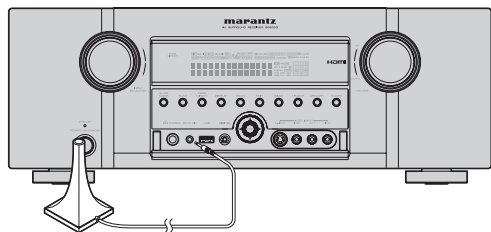

2. Set the microphone in the main listening position.

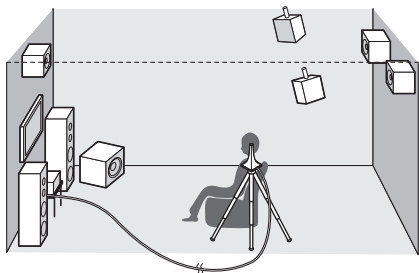

Notes:

- Up to 6 positions around the main listening position can be measured.
For the first measurement, set the microphone in the main listening position.
- Use a stand or tripod to position the microphone at ear height for all listening positions measured with the microphone tip pointing directly up to the ceiling.
- Remove any obstructions between the speakers and microphone.
- When using a powered subwoofer, set the level knob to the middle or 12 o'clock position. Set the crossover to off, or to its highest value.
If the subwoofer has a standby, or sleep mode, disable it. Not doing so could affect the test signal which may result in inaccurate subwoofer measurements.
- During measurements, do not stand between the microphone and the speakers. Make the room as quiet as possible. Background noise can disrupt the room measurements. Close windows, silence cell phones, televisions, radios, air conditioners, fluorescent lights, home appliances, light dimmers, or other devices.
Cell phones should be placed away from all audio electronics during the measurement process as Radio Frequency Interference (RFI) may cause measurement disruptions (even if the cell phone is not in use).

It is suggested to operate the AUTO SETUP via the remote controller rather than by front panel.

- The test tones played through each channel increase level as needed in order to overcome ambient noise present in the listening environment and obtain the best signal to noise ratio.
3. Select "Speaker Setup" from the Main Menu, select "Auto Setup" with the ▲/▼ cursor buttons, and press the ENTER button to display the start screen.
 4. Select the number of channels for the surround back speaker you are using.
For a 5.1 channel speaker system, select "No" (Surround Back speaker off). (To use speaker C or Zone speaker, select "No". See page 20, 38.)
Select "Start" with the ▲/▼ cursor buttons and press the ENTER button to start measurement.

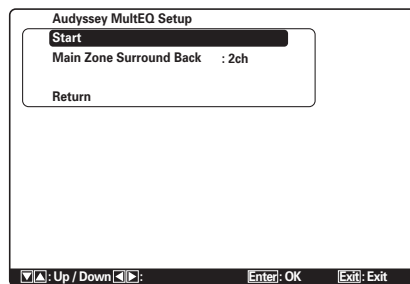

5. "1st Mic Position Check"

The main listening position refers to the most central position where one would normally sit within the listening environment. MultEQ uses the measurements from this position to calculate speaker distance, level, polarity, and the optimum crossover value for the subwoofer.

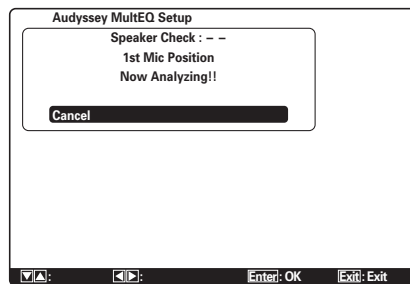

Note:

- The Speakers Check detects the presence of connected speakers. If a channel is not used, the SPEAKERS CHECK will try to detect it, then continue to the next channel.

6. When the 1st Mic Position Check ends, the following GUI appears on the display.

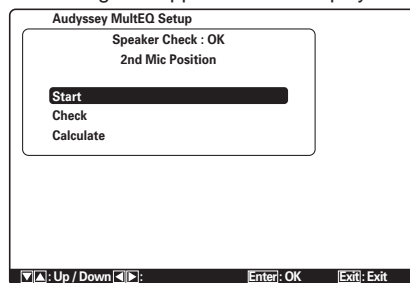

Here, to view the results of the detection check, select "Check" with the ▲/▼ cursor buttons and press the ENTER button. The results will be displayed.

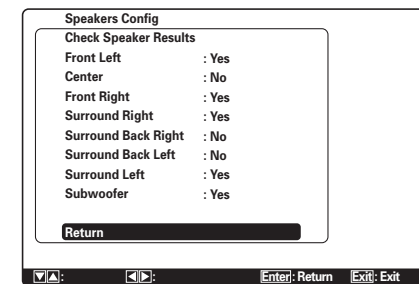

If the check results indicate an error, take suitable action with that item and remeasure. (For error messages, see "ERROR MESSAGES" on page 32.)

After confirming the check results, select "Return" with the ▲/▼ cursor buttons and press the ENTER button to return to the GUI menu.

At this point, you can select "Exit" to end Auto Setup and return to "Speaker Setup".

Note:

- Auto Setup is not available in Pure Direct, Source Direct, or 7.1 Channel Input modes.

7. Move the microphone to the 2nd listening position, select "Start" with the ▲/▼ cursor buttons and press the ENTER button to measure the 2nd point. At this point, you can cancel second point measurement and calculate measurement results by selecting "Calculate" and pressing the ENTER button.

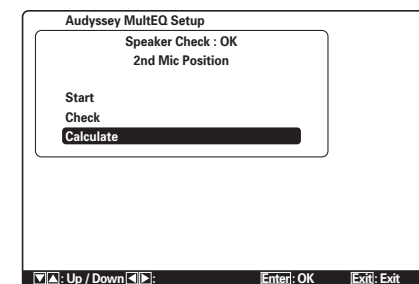

8. Repeat steps 7 until measuring 6 points between the main listening position and surrounding positions.

When all measurements end, the following GUI appears on the display.

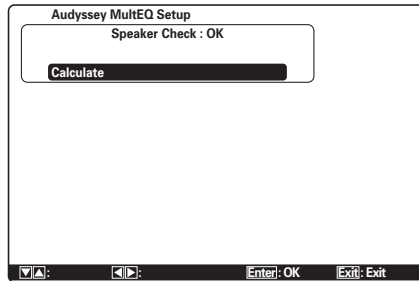

Select "Calculate" with the ▲/▼ cursor buttons and press the ENTER button to calculate measurement results. During calculations, the following GUI appears on the display.

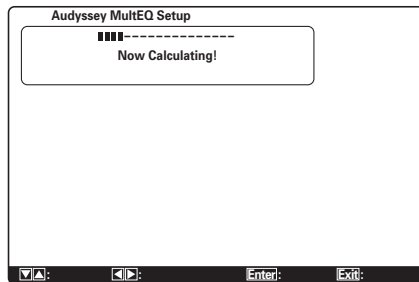

Note:

- Fewer than 6 positions may be measured, but it is recommended to measure in all 6 positions for best results. Measuring in just one position is not recommended as it does not provide enough acoustical information to the MultEQ algorithm.
- The time needed to complete calculations depends on the number of connected speakers and measured listening positions. The more speakers and listening positions, the more time is needed.

9. Checking Measurement Results

When calculations for the measurement results end, a screen appears for confirming the calculation results.

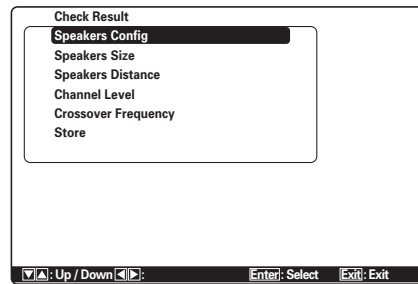

Select items to check with the ▲/▼ cursor buttons and press the ENTER button to enter them.

Note:

To check equalizer (MultEQ) parameters, see page 40.

[Example] Confirmation screen for speaker detection

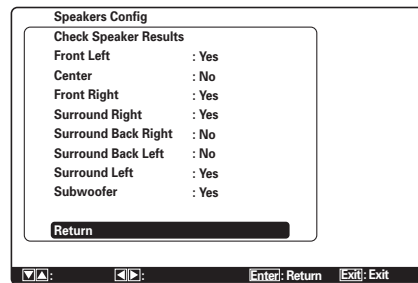

[Example] Confirmation screen for speaker size.

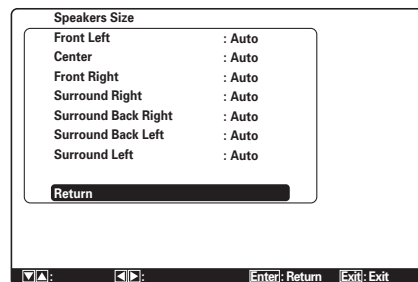

[Example] Confirmation screen for the distance from speakers to the listening position

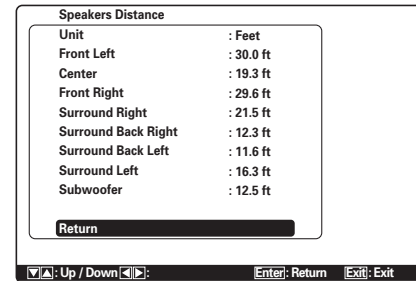

- * The units can be changed by moving the cursor to Meters of Unit and pressing ◀ / ▶ the cursor buttons. Each time a ◀ / ▶ cursor button is pressed, the units alternate between Feet and Meters.

Note:

This system cannot measure a distance of 9.15 m (30.0 ft) or higher. In this case, >9.15 m (>30.0 ft) is displayed.

[Example] Confirmation screen for channel level.

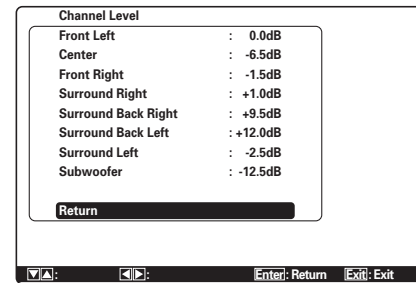

[Example] Confirmation screen for crossover frequency.

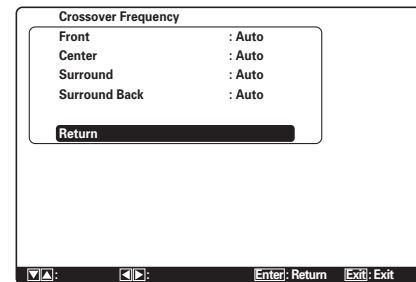

- * Auto is displayed to indicate that the speaker size and crossover frequency results were automatically measured.

10. Storing Measurement Results in Memory

Once finished confirming the measurement results, select "Return" with the ▲/▼ cursor buttons and press the ENTER button to display the Check Result screen.

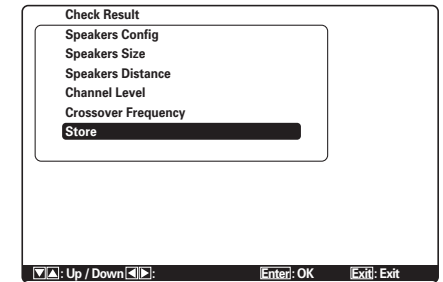

Place the cursor on "Store" and press the ENTER button to store all parameters including the equalizer parameters in memory. If not wanting to store the calculation results in memory, press the Exit button.

Note:

Pressing "Exit" prior to pressing "Store" erases all measurement results and calculation results, therefore operate the remote controller with care.

When storing operations end, the following GUI appears on the display.

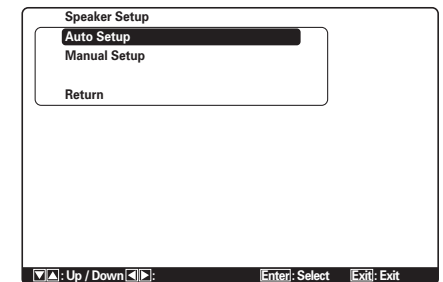

Notes:

- Do not turn the power to the unit off while storing parameters in memory. This may erase all data in the unit's memory and may damage the unit.

ERROR MESSAGES

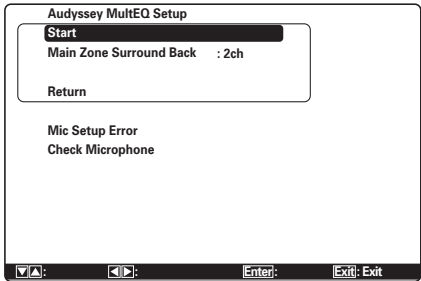
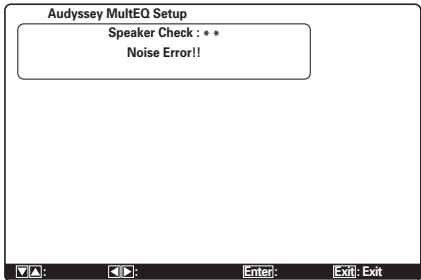
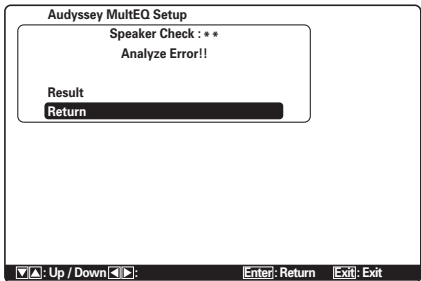
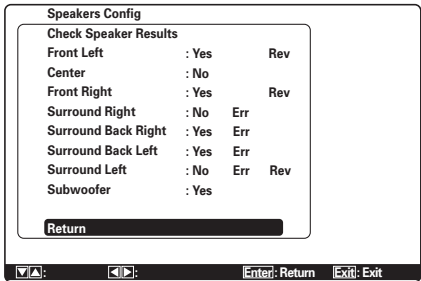
Displayed Error	Cause	How to Remedy
<p>Mic Setup Error!!</p> 	<ul style="list-style-type: none"> The microphone is not properly connected. 	<ul style="list-style-type: none"> Connect the included microphone. Check the microphone connection.
<p>Noise Error!!</p> 	<ul style="list-style-type: none"> There is too much noise in the listening room to measure properly. Volume from the speakers is low. 	<ul style="list-style-type: none"> During measurement, turn off devices that make noise such as air conditioners. Measure at a time when the surrounding area is quiet.
<p>Analyze Error!!</p>  <p>* Under Analyze Error, select "Result" with the ▲/▼ cursor buttons and press the ENTER button. A detail screen like the following appears on the display.</p> 	<ul style="list-style-type: none"> The speakers required for suitable playback were not detected. Speaker polarity is connected backwards. <p>In the examples at left, the following trouble is detected.</p> <ul style="list-style-type: none"> The polarity of the left and right channels of the front speakers is backwards ([Rev] appears on the display.) The surround speaker is not connected ([No] is displayed), but the surround back speaker is connected (In this kind of situation, [Err] is displayed for all surround and surround back speakers.) <p>An error is indicated in addition to the above if the speakers are connected as follows.</p> <ul style="list-style-type: none"> When using just one surround back speaker, but it is connected to the surround back R-channel (To use just one surround back speaker, connect it to the L-channel.) 	<ul style="list-style-type: none"> Check the speaker that is indicated as having reversed polarity ([Rev] can appear with some speakers even when properly connected. In such case, ignore the error indication.) Check speaker direction and layout

2-2 MANUAL SETUP

1. Select **"Speaker Setup"** from the Main Menu.
2. Select **"Manual Setup"** with the ▲ or ▼ cursor buttons.
3. Press the **ENTER** button to enter the selection.

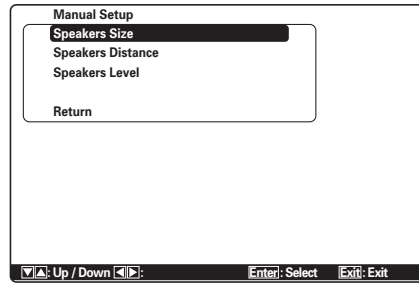

4. Select the sub-menu with the ▲ or ▼ cursor button, and press the **ENTER** button.

<SPEAKER SIZE>

5. Select Speaker Size with the ▲ or ▼ cursor button from the Manual Setup menu, and press the **ENTER** button.

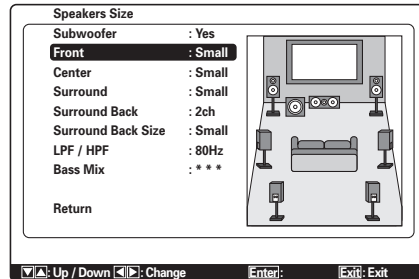

When setting the speaker size in the Speaker Size menu, use the guidelines below.

Large:

The complete frequency range for the channel you are setting will be output from the speaker.

Small:

Frequencies of the channel you are setting that are lower than approx. 80 Hz will be output from the subwoofer.

If the Subwoofer is set to **"No"** and the front speakers are set to **"Large,"** then the sound will be output from both the left and right speakers.

6. Select each speaker with the ▲ or ▼ cursor buttons.
7. Set the size of each speaker with the ◀ or ▶ cursor buttons.

Subwoofer

Yes:

Select when a subwoofer is connected.

No:

Select when a subwoofer is not connected.

Front

Large:

Select if the front speakers are large.

Small:

Select if the front speakers are small.

- If **"No"** is selected for the subwoofer setting, then this setting is fixed at **"Large"**.

Center

None:

Select if no center speaker is connected.

Large:

Select if the center speaker is large.

Small:

Select if the center speaker is small.

Surround

None:

Select if no surround left and right speakers are connected.

Large:

Select if the surround left and right speakers are large.

Small:

Select if the surround left and right speakers are small.

Surround Back

None:

Select if no surround back left and right speakers are connected.

1ch:

Select if one surround back speaker is connected. In this case, the audio signal is emitted from the SURR BACK LEFT SPEAKER terminal.

2ch:

Select if the surround back left and right speakers are connected.

Zone SPKR:

Select if using the SURROUND BACK SPEAKER terminal as ZONE SPEAKER A.

Notes:

- If **"No"** is selected for the Surround setting, then this setting is fixed to **"No."**

Surround Back Size

Large:

Select if the surround back speakers are large.

Small:

Select if the surround back speakers are small.

Note:

- If **"None"** is selected for the Surround setting, then this setting is not available.

LPF/HPF

When you use a subwoofer, you can select the cutoff frequency for the small speakers used. Select one of the crossover frequency levels according to the size of the small speakers connected.

60Hz → 80Hz → 100Hz → 120Hz → 140Hz → 160Hz → 180Hz

Note:

- If using small front speakers, set a slightly higher frequency. If using large front speakers, set a slightly lower frequency.

Bass Mix

- The bass mix setting is only valid when **"Large"** is set for the front speakers and **"Yes"** is set for the subwoofer during stereo playback.

This setting has effect only during playback of PCM or analog stereo sources.

- When **"Both"** is selected, the low frequencies will be played through the main L&R speakers and the subwoofer.

In this playback mode, the low frequency range expands more uniformly throughout the room, but depending on the size and shape of the room, interference may result in a decrease of the actual volume of the low frequency range.

- By selecting **"Mix"**, the low frequencies will play through the main L&R only.

Note:

- LFE signals during playback of Dolby Digital or DTS will be played through the subwoofer.

8. After you complete this portion of the setup, move the cursor to **"Return"** with the ▲ or ▼ cursor buttons and press the **ENTER** button to display the Manual Setup screen.

<SPEAKER DISTANCE>

9. Select Speaker Distance with the ▲ or ▼ cursor button from the Manual Setup menu, and press the **ENTER** button.

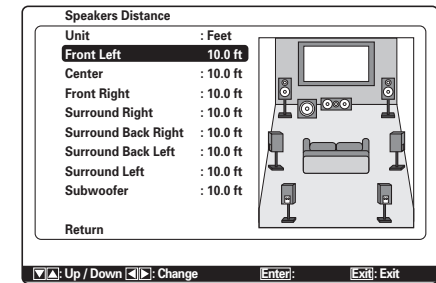

Use this menu to specify the distance of each speaker's position from the listening position. The delay time is automatically calculated according to these distances.

Begin by determining the ideal or most commonly used seating position in the room.

This is important for the timing of the acoustics to create the proper sound space that the unit and today's sound systems are able to produce.

Note:

- For speakers for which you have selected **"None"**, the speaker configuration sub-menu will not appear here.

10. Select either **Meters** or **Feet** for Unit with the ◀ or ▶ cursor buttons.

11. Select each speaker with the ▲ or ▼ cursor buttons.

12. Set the distance for each speaker, press the ◀ or ▶ cursor buttons.

Front Left:

Set the distance from the front left speaker to your normal listening position.

Center:

Set the distance from the center speaker to your normal listening position.

Front Right:

Set the distance from the front right speaker to your normal listening position.

Surround Left:

Set the distance from the surround left speaker to your normal listening position.

Surround Right:

Set the distance from the surround right speaker to your normal listening position.

Subwoofer:

Set the distance from the subwoofer to your normal listening position.

Surround Back Left:

Set the distance from the surround back left speaker to your normal listening position.

Surround Back Right:

Set the distance from the surround back right speaker to your normal listening position.

Notes:

- Set the distance to each speaker in meters (m) or feet (ft) as follows.
m: 0.03 - 9.15 m in 0.03 m steps
ft: 0.1 - 30.0 ft in 0.1 ft steps
(The values appearing on the FL display are approximate.)
- For the speakers that you have selected “No” the speaker size menu will not appear.
- The setting for Surround Back Left and Surround Back Right appears if it is set, two surround back speakers in the Speaker Size menu.
- The setting of Surround Back appears if it is set for one surround back speaker in the Speaker Size menu.

13. After you complete this portion of the setup, move the cursor to “Return” with the ▲ or ▼ cursor buttons and press the ENTER button to display the Manual Setup screen.

<SPEAKERS LEVEL>

14. Select Speakers Level with the ▲ or ▼ cursor button from the Manual Setup menu, and press the ENTER button.

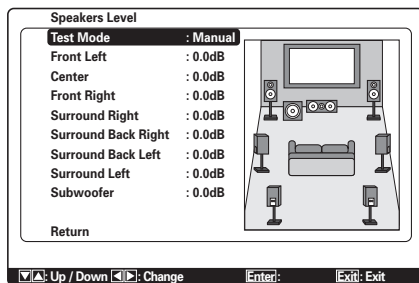

Here you can set the volume for each speaker so that they are all heard by the listener at the same level. We recommend holding a dB SPL (Sound Pressure Level) meter at the listening position, at arms length, and pointing straight up at the ceiling, adjust the level of each speaker in turn unit it reads 75dB SPL when the meter is set to “C” weighting and Slow response.

Note:

- The speaker level settings are not available in 7.1 Channel Input mode, Pure Direct mode and Source Direct mode.

Test tone:

Select “Manual” or “Auto” generation of the test tone with the ◀ or ▶ cursor buttons.

If you select “Auto”, the test tone will be cycled through in a circular pattern beginning at **Front Left** → **Center** → **Front Right** → **Surround Right** → **Surround Back Right** → **Surround Back Left** → **Surround Left** → **Subwoofer** → **Front Left**, in 2 seconds increments for each channel.

Using the ◀ or ▶ cursor buttons, adjust the volume level of the noise from the speaker so that it is the same level for all the speakers.

If you select “Manual”, adjust the output level of each speaker as listed below.

15. Move the cursor to Front Left by pressing the ▼ cursor button. This unit will emit a pink noise from the front left speaker.

Remember the level of this noise and then press the ▼ cursor button.

(Note that this can be adjusted to any level between -12 and +12 dB in 0.5 dB increments.)

This unit will now emit the pink noise from the center speaker.

16. Using the ◀ and ▶ cursor buttons, adjust the volume level of the noise from the center speaker so that it is the same level as the front left speaker.

17. Press the ▼ cursor button again. This unit will now emit the pink noise from the front right speaker.

18. Repeat steps 17 and 18 for the front right and other speakers until all speakers are adjusted to the same volume level.

After you complete this portion of the setup, press the ENTER button to move the cursor to “Return”. Press the ENTER button to go to “Manual Setup”.

Notes:

- Speakers for which you selected “None” in the Speaker Size menu will not appear.
- Surround Back Left and Surround Back Right appear if it is set for two surround back speakers in the Speaker Size menu.
- Surround Back appears if it is set for one surround back speaker in the Speaker Size menu.
- To adjust the speaker levels for 7.1 channel input sources, you will need to use the 7.1 ch Input sub menu. (See page 27)
- Subwoofer can be set from -18dB to +12dB.

3 SURROUND SETUP

This menu is for setting surround effect parameters for the various surround input signals so as to bring out the live audio effect of your speaker system.

- **Channel Level:**
"3-1 CHANNEL LEVEL" (see page 35)
- **PLIIX Music Parameter:**
"3-2 PLIIX MUSIC PARAMETER" (see page 36)
- **CSII Parameter:**
"3-3 CSII PARAMETER" (see page 36)
- **NEO:6 Parameter:**
"3-4 NEO:6 PARAMETER" (see page 36)

1. Select "**Surround Setup**" from the Main Menu with the ▲ or ▼ cursor buttons and press the **ENTER** button.
2. Select the desired menu with the ▲ or ▼ cursor buttons and press the **ENTER** button.

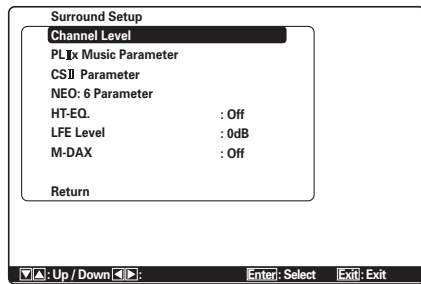

HT-EQ.:

Select to activate the HT-EQ with the ◀ or ▶ cursor buttons.

The total balance of a film soundtrack will be excessively bright and harsh when played back over audio equipment in the home. This is because film soundtracks were designed to be played back in large movie theater environments.

Activating the HT-EQ feature when watching a film made for movie theaters corrects this and restores the correct tonal balance.

The HT-EQ feature is available except in the following modes.

- 7.1 CH INPUT
- PURE DIRECT
- SOURCE DIRECT
- Dolby Head Phone
- When VIRTUAL is set for the surround mode

LFE Level:

Select the output level of the LFE signal included in the Dolby Digital signal or the DTS signal.

Select "**0dB**", "**-10 dB**" or "**OFF**" with the ◀ or ▶ cursor button.

M-DAX:

Select the desired M-DAX mode.

Select "**High**", "**Low**" or "**Off**" with the ◀ or ▶ cursor button. (See page 44)

After you complete this portion of the setup, move the cursor to "**Return**" with the ▲, ▼ cursor buttons and press the **ENTER** button.

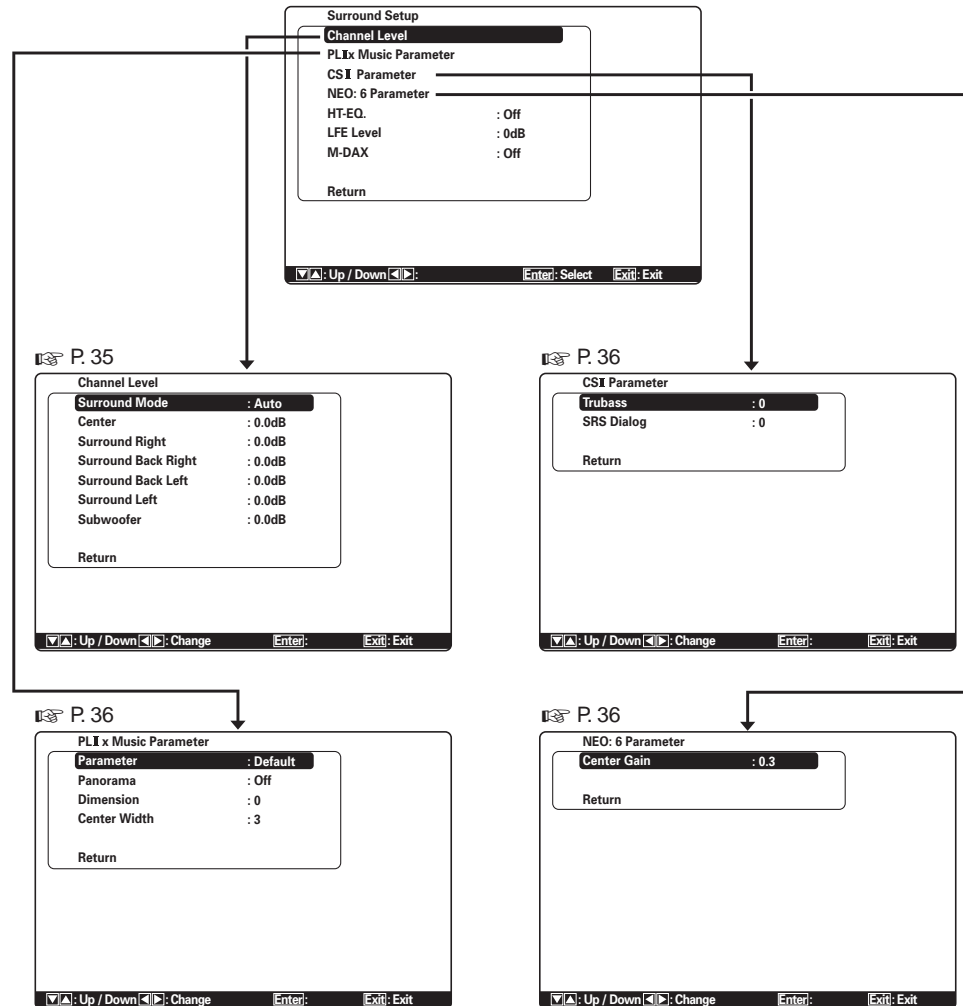

3-1 CHANNEL LEVEL

1. Select "**Surround Setup**" from Main Menu with ▲ or ▼ cursor buttons and press the **ENTER** button.
2. Select "**Channel Level**" with the ▲ or ▼ cursor buttons and press the **ENTER** button.
3. Set the Surround Mode with the ◀ or ▶ cursor buttons.

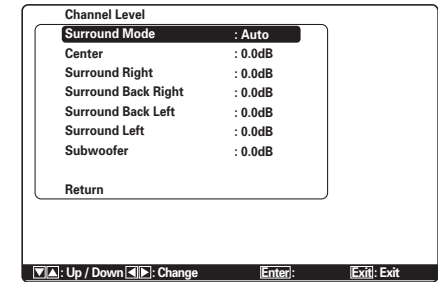

4. Select the desired menu item with the ▲ or ▼ cursor buttons, set the desired level with the ◀ or ▶ cursor buttons, and press the **ENTER** button.

Surround Mode:

The surround mode can be independently set for 3 modes.

1. Multi Ch STEREO
2. CSII
3. Others

CHANNEL LEVEL

Center:

Set the effect level of the center speaker between **-12** and **+12** level in 0.5 level interval .

- If "**None**" was selected for the center speaker setting in the Speaker Size, then this setting will not appear.

Surround Left or Right:

Set the effect level of the Surround speaker between **-12** and **+12** level in 0.5 level interval .

- If "**None**" was selected for the surround speakers setting in the Speaker Size, then this setting will not appear.

Surround Back Left or Right:

Set the effect level of the Surround Back speaker between **-12** and **+12** level in 0.5 level interval .

- If "**None**" was selected for the surround back speakers setting in the Speaker Size, then this setting will not appear.

Subwoofer:

Set the effect level of the subwoofer speaker between **-18** and **+12** level in 0.5 level interval .

- If **"No"** was selected for the subwoofer speaker setting in the Speaker Size, then this setting will not appear.

Note:

- Setting to a mode other than multichannel stereo or CSII will affect the speaker level as explained in "2-2 MANUAL SETUP".

After you complete this portion of the setup, move the cursor to **"Return"** with the **▲** or **▼** cursor buttons and press the **ENTER** button to go to the Surround Setup menu.

3-2 PLIIx (PRO LOGIC IIx) MUSIC PARAMETER

Pro LogicIIx-Music mode creates a rich and enveloping surround ambience from stereo sources such as CDs.

In this mode, this unit includes three controls to fine-tune the sound field as follows.

1. Select **"Surround Setup"** in Main Menu with **▲** or **▼** cursor buttons and press the **ENTER** button.
2. Select **"PLIIx Music Parameter"** with the **▲** or **▼** cursor buttons.
3. Press the **ENTER** button to enter the selection.

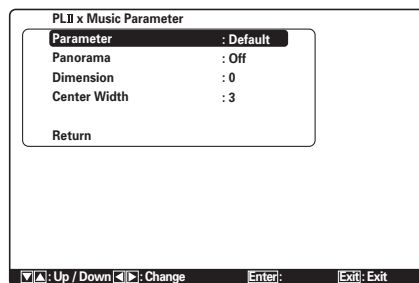

Parameter:

Select **"Default"** or **"Custom"** with the **◀** or **▶** cursor buttons.

If you select **"Custom"**, you can adjust three parameters as listed below.

Panorama:

Select the Panorama mode **"On"** or **"Off"** with the **◀** or **▶** cursor buttons.

Panorama wraps the sound of the front left and right speakers around you, for an exciting perspective.

Dimension:

Set the Dimension level between **-3** and **+3** level in 1 level intervals with the **◀** or **▶** cursor buttons.

Adjust the sound field either towards the front or towards the rear.

This can be useful to help achieve a more suitable balance from all the speakers with certain recordings.

Center Width:

Set the Center Width level between **0** and **7** in 1 level intervals with the **◀** or **▶** cursor buttons.

Center width allows you to gradually spread the center channel sound into the front left and right speakers.

At its widest setting, all the sound from the center is mixed into the left and right speakers.

This control may help achieve a more spacious sound or a better blend for the front image.

If **"None"** was selected for the center speaker setting in the Speaker Size menu, this setting cannot be selected.

After you complete this portion of the setup, move cursor to **"Return"** with the **▲** or **▼** cursor buttons and press the **ENTER** button.

3-3 CSII PARAMETER

1. Select **"Surround Setup"** from Main Menu with the **▲** or **▼** cursor buttons and press the **ENTER** button.
2. Select **"CS II Parameter"** with the **▲** or **▼** cursor buttons.
3. Press the **ENTER** button to enter the selection.

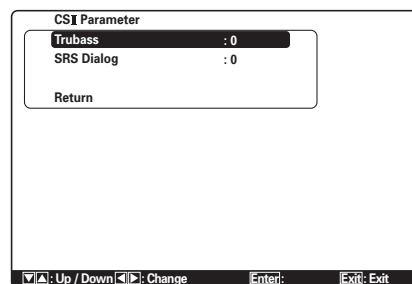

Trubass:

Set the Trubass level between **0** and **6** in 1- level increments with the **◀** or **▶** cursor buttons.

Trubass produced by the speakers are an octave below the actual physical capabilities of the speakers adding exciting, deeper bass effects.

SRS Dialog:

Set the SRS Dialog level between **0** and **6** in 1-increments with the **◀** or **▶** cursor buttons.

This can be popped out of the surround audio effects, allowing the listener to easily discern what the actors say.

If **"None"** was selected for the center speaker setting in the Speaker Size menu, this setting cannot be selected.

After you complete this portion of the setup, move cursor to **"Return"** with the **▲** or **▼** cursor buttons and press the **ENTER** button.

Note:

- This parameter can only be set in the CSII mode.

3-4 NEO:6 PARAMETER

The DTS NEO:6 mode enables a maximum 6.1 channel output with just 2 channel input. (It also supports 5.1 channel input.)

This mode expands the sound image from the center channel.

1. Select **"Surround Setup"** from Main Menu with the **▲** or **▼** cursor buttons and press the **ENTER** button.
2. Select **"NEO:6 Parameter"** with the **▲** or **▼** cursor buttons.
3. Press the **ENTER** button to enter the selection.

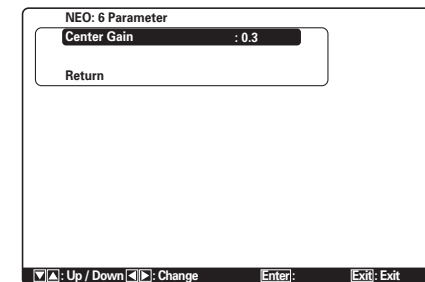

4. Set the Center Gain level between 0.0 and 1.0 in 0.1 level increments with the **◀** or **▶** cursor buttons.

After you complete this portion of the setup, move cursor to **"Return"** with the **▲** or **▼** cursor buttons and press the **ENTER** button.

Notes:

- This parameter can only be set in the NEO:6-Music mode.
- If **"None"** was selected for the center speaker setting in the Speaker Size menu, this setting is disabled.

4 VIDEO SETUP

Video settings are made as follows.

1. Select "Video Setup" from the Main Menu with the ▲ or ▼ cursor buttons and press the ENTER button.

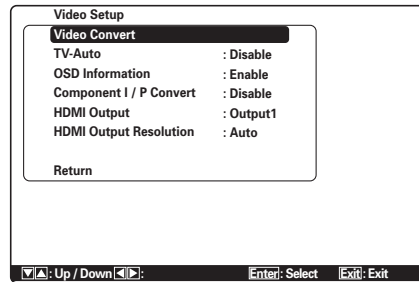

2. Select the desired menu with the ▲ or ▼ cursor buttons and press the ENTER button.

• Video Convert

This unit is equipped to convert video signals for monitor output.

This section explains how to set up conversion for each type of video input.

1. Select "Video Setup" from the Main Menu with the ▲ or ▼ cursor buttons and press the ENTER button.
2. Select "Video Convert" with the ▲ or ▼ cursor buttons and press the ENTER button.

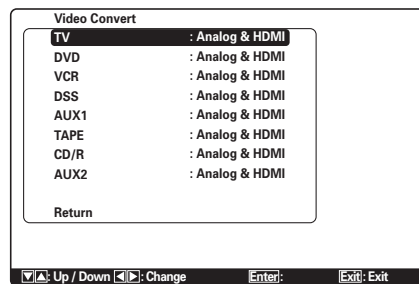

3. Select "Function" with the ▲ or ▼ cursor buttons and set the video conversion mode with the ◀ or ▶ cursor buttons

Analog&HDMI:

This mode both up-converts and down-converts analog video signals (Composite Video, S-Video, Component Video). Furthermore, it up-converts from analog video signal to HDMI. (It cannot down-convert from HDMI digital video signals to analog video signals.)

Analog Only:

This mode both up-converts and down-converts analog video signals (Composite Video, S-Video, Component Video). It does not up-convert to HDMI.

Off:

This mode turns off all conversion features.

Note:

- For details on video convert feature, see page 46.

• TV-Auto

Select the TV-Auto On/Off function to enable or disable with the ◀ or ▶ cursor buttons. (refer to page 45)

• OSD Information

Select the OSD information function to "Enable" or "Disable" with the ◀ or ▶ cursor buttons.

If you select "Enable", this unit will display the status of the feature (Volume up/down, input select, etc.) on the monitor. If you do not desire this information, select "Disable".

Note:

- OSD information is not output to Monitor Output of HDMI and Component Video. However, OSD information is output if the Video Convert function is used to output Video or S-Video video signals to Monitor Out of HDMI and Component Video.

For details, refer to "Video Convert" on page 46.

• Component I/P Convert

Set whether or not to convert 480i signals to 480p signals when outputting the analog video input signal from the VIDEO terminals, S-VIDEO terminals, or COMPONENT terminals.

Select "Enable" or "Disable."

Disable: Do not convert

Enable: Convert

Note:

This setting is enabled only when Video Convert is set to other than Off.

• HDMI Output

This setting is for selecting which output terminal, HDMI 1 or HDMI 2, to output the signal to. Select the output destination with the ◀ / ▶ cursor buttons.

• HDMI Output Resolution

Selects the resolution of the video signal output from the HDMI terminal of this unit.

Select from the following using the ◀ or ▶ cursor buttons.

Auto ↔ Through ↔ 480/576p ↔ 720p ↔ 1080i ↔ 1080p ↔ Auto

5 PREFERENCE

- **Zone A Setup :**
- **Zone B Setup :**
"5-1 ZONE SETUP" (see page 39)
- **DC Trigger Setup :**
"5-2 DC TRIGGER SETUP" (see page 39)

1. Select "Preference" from Main Menu with the ▲ or ▼ cursor buttons and press the ENTER button.

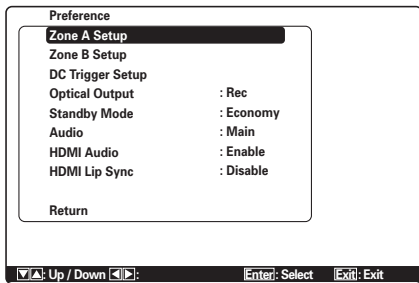

2. Select the desired menu with the ▲ or ▼ cursor buttons and press the ENTER button.

Optical:

Select when using equipment with optical digital output.

Rec: Select when recording to a CD recorder or MD recorder. (See page 12)

Zone B: Select when using ZONE B. (See pages 21, 39, 64)

Standby:

When this is set to "Economy", you can reduce the power consumption when the unit is in the Standby mode. When "Economy" is selected, "TV Auto" and "RS-232C" are disabled when the unit is in the Standby mode.

Audio:

In the Audio mode, Dolby Digital and DTS output is set to either "Main" or "Sub". Select "Audio" with the ◀ or ▶ cursor buttons, then select Main ↔ Sub ↔ Main+Sub with the ◀ or ▶ cursor buttons.

HDMI Audio:

This setting determines whether to play back audio input to the HDMI jacks through the unit or output it through the unit to a TV or projector.

Enable: The audio input to the HDMI jacks can be played back by this unit. In such case, audio signals are not output to the TV or projector.

Through: The audio input to the HDMI jacks is not output from the speaker terminals of the unit. Audio data is output directly to the TV or projector. This setting is used to listen to audio on a multi channel TV, etc.

HDMI Lipsync:

Video signals may take longer to process than audio signals depending on the connected video equipment.

When the unit is connected to TV or Projector supporting Auto Lipsync Correction in HDMI 1.3a, audio and video can be automatically synchronized using this function.

Use the ◀ or ▶ cursor buttons to switch between Enable and Disable.

Enable: Auto Lipsync Correction is used to synchronize audio and video.

Disable: Deactivates this function.

Note:

- This function is not available when the unit is connected to equipment that does not support HDMI 1.3a or Auto Lipsync Correction. For details, check the user's manual of the connected equipment.
- If this function is unavailable, you can use the regular Lipsync function to synchronize audio and video. (See page 45)

After you complete this portion of the setup, move the cursor to "Return" with the ▲ or ▼ cursor buttons and press the ENTER button.

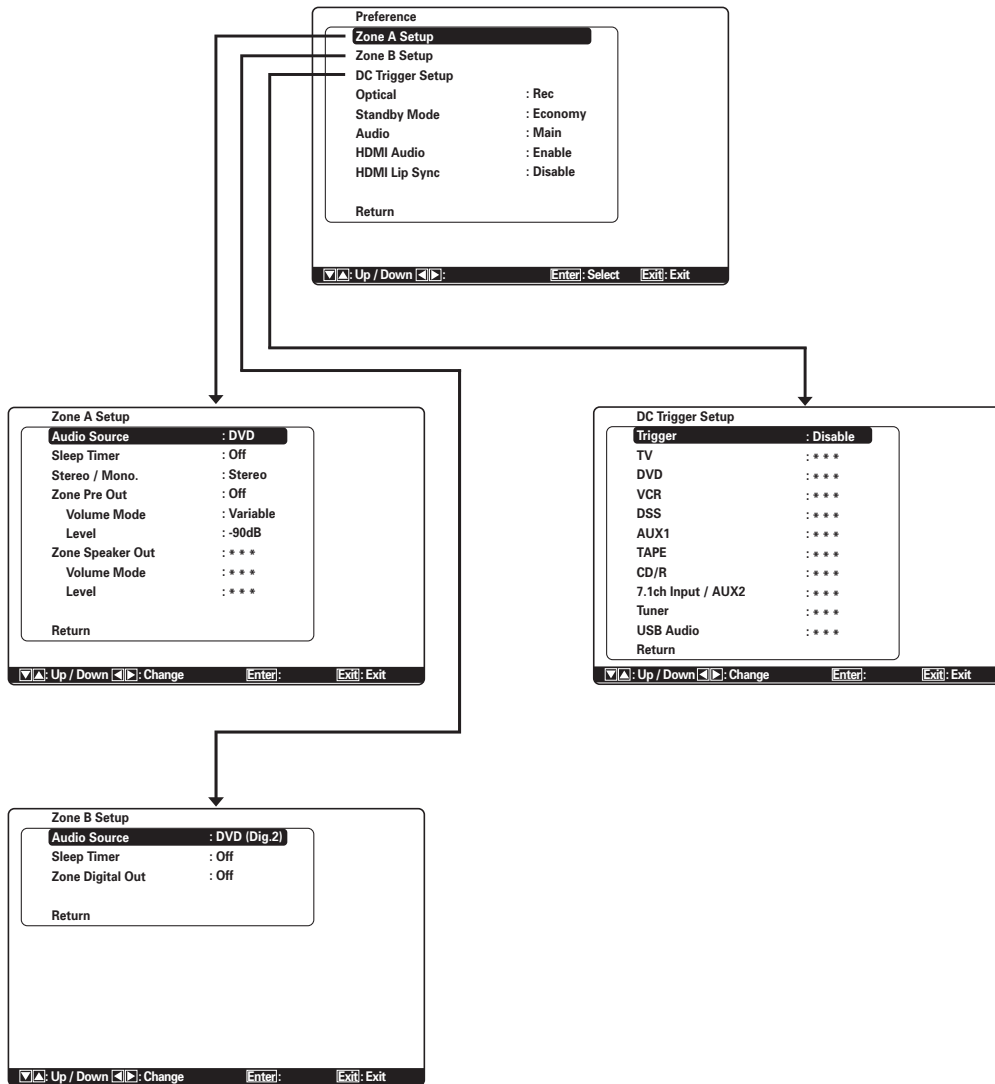

5-1 ZONE SETUP

The SR6003 has source selectors, sleep timers, zonespeaker output, and remote controller for the two other ZONES in the ZONE system. These features can be set from this menu.

1. Select "**Preference**" from the Main Menu with the ▲ or ▼ cursor buttons and press the **ENTER** button.
2. Select "**Zone A Setup**" or "**Zone B Setup**" with the ▲ or ▼ cursor buttons.
3. Press the **ENTER** button to enter the setting.

The following explanation shows how to operate ZONE A of the ZONE system.

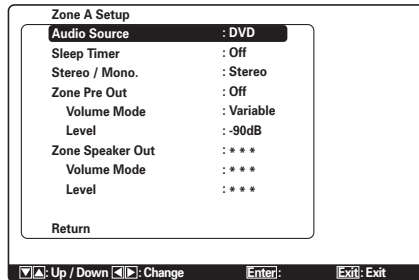

The following explanation shows how to operate ZONE B of the ZONE system.

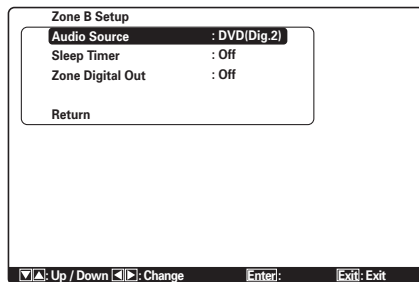

4. Select the desired item with the ▲ or ▼ cursor button.

Audio Source:

Select the audio source of the ZONE output with the ◀ or ▶ cursor buttons.

Sleep Timer:

The sleep mode is available when the ZONE is active, set the time with ◀ or ▶ cursor buttons. The sleep timer can be set to a maximum 120 minutes in 10 minute increments.

Stereo / Mono: (Zone A only)

This mode switches audio output to the ZONE system between Monaural and Stereo, using the ◀ and ▶ cursor buttons.

Zone Pre Out: (Zone A only)

Switch the zone pre out "On" or "Off" with the ◀ or ▶ cursor buttons.

Volume Mode: (Zone A only)

Select whether the zone pre out level is Variable or Fixed with the ◀ or ▶ cursor buttons.

Level (Volume Level): (Zone A only)

Adjust the zone pre out level with the ◀ or ▶ cursor buttons. The volume can be set between -90 dB and 0 dB in 1 dB increments.

Zone Speaker Out: (Zone A only)

Switch the zone speaker out "On" or "Off" with the ◀ or ▶ cursor buttons.

Volume Mode: (Zone A only)

Select whether the zone speaker out level is Variable or Fixed with the ◀ or ▶ cursor buttons.

Level (Volume Level): (Zone A only)

Adjust the zone speaker out level with the ◀ or ▶ cursor buttons. The volume can be set between -90 dB and 0 dB in 1 dB increments.

Zone Digital Out: (Zone B only)

Switch the zone digital out "On" or "Off" with the ◀ or ▶ cursor buttons.

Note:

- Zone Speaker Out setting can be changed when the Surround Back is set to "None" in the Speaker Size menu and "SPEAKER C" is in the OFF position on the rear panel. When this setting is unavailable, "****" is displayed.
- If "Volume" is set to "Fixed", the ZONE output level cannot be adjusted from the ZONE A.
- Zone Speaker Out cannot be on the ZONE B.
- Functions other than ones that are set to either DIGITAL IN 1-5 or F cannot be selected in ZONE B. There are no MONO/ST, VOL, LEV or SPKR settings for ZONE B.
- If Optical Output is set to Rec (See page 38), Zone B functions cannot be used.

5-2 DC TRIGGER SETUP

This unit has a DC trigger control jack, which can be used to link with input functions for the main ZONE or ZONE A or ZONE B.

1. Select "**Preference**" from Main Menu with the ▲ or ▼ cursor buttons and press the **ENTER** button.
2. Select "**DC Trigger Setup**" with the ▲ or ▼ cursor buttons.
3. Press the **ENTER** button to enter the selection.

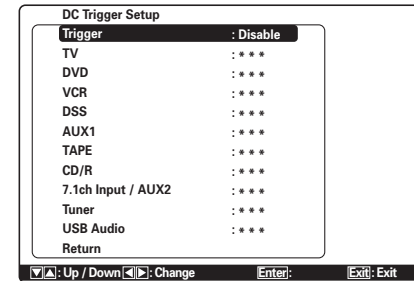

4. You can select "**Main Zone**", "**Zone A**", "**Zone B**", "**Remote**" or "**Disable**" with the ◀ or ▶ cursor buttons.

Note:

- Remote is available for the external control. The RC003SR cannot operate the function.

5. Select desired input source with the ▲ or ▼ cursor buttons.
6. Set to "On" or "Off" with the ◀ or ▶ cursor buttons.
7. After you complete this portion of the setup, move the cursor to "**Return**" with the ▲ or ▼ cursor button and press the **ENTER** button.

Note:

- When an input source that is on in the set ZONE is selected, voltage is output to the DC TRIGGER output terminal.

6 ACOUSTIC EQ

This display is for setting up the equalizer and changing the Equalizer mode.

- **Preset Graphic EQ Adjust :**
"6-1 PRESET G. EQ ADJ" (see page 41)
- **Check Auto EQ :**
"6-2 CHECK AUTO" (see page 41)

EQ Mode:

There are 4 equalizer modes to choose from: Preset Graphic EQ that allows the user to manually adjust the equalizer, and Audyssey, Audyssey Front and Audyssey Flat that automatically adjust the equalizer from the measurement results of the Auto Setup feature (see page 30).

Audyssey Front:

This mode matches the characteristics of each speaker to those of the front speakers.

Audyssey Flat:

This mode flattens the frequency characteristics of all speakers. It is suited for playback of multichannel music such as Dolby Digital and DTS.

Audyssey:

This mode adjusts the frequency characteristics of all speakers so as to create the best listening environment for the sound characteristics of the listening room.

Preset:

This mode adjusts the graphic equalizer that was set in Preset Graphic EQ Adjust to adjust the characteristics of each speaker (see page 41).

Off:

The graphic equalizer is not used.

1. Select "**Acoustic EQ**" from Main Menu with the ▲ or ▼ cursor buttons and press the **ENTER** button.
2. Select "**EQ. Mode**" with the ▲ or ▼ cursor buttons.
3. Select "**Audyssey Front**", "**Audyssey Flat**", "**Audyssey**", "**Preset**" or "**Off**" with the ◀ or ▶ cursor buttons.

After you complete this portion of the setup, move the cursor to "**RETURN**" with the ▲ or ▼ cursor buttons and press the **ENTER** button.

To use the remote controller (RC003SR) to change the EQ Mode, press the AMP button and press the **EQ** button.

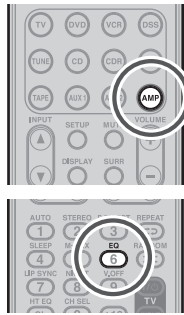

Each time this button is pressed, the EQ Mode changes as follows.



Notes:

- "Audyssey Front", "Audyssey Flat" and "Audyssey" can be selected after executing the Auto Setup feature.
 - If a speaker that was determined "No" in Auto Setup is manually turned on, the "Audyssey", "Audyssey Front" and "Audyssey Flat" modes cannot be selected.
 - The equalizer turns off when the Pure Direct mode, Source Direct mode, Dolby Headphone or Virtual mode is set.
 - Acoustic EQ Modes are not used during playback of Dolby TrueHD, Dolby Digital Plus, or DTS-HD signals.
- Even in this case, settings made using Speaker Auto Setup (speaker yes/no, distance, size, channel level, crossover) are enabled.
- Tone Control is disabled when an EQ Mode is in use.

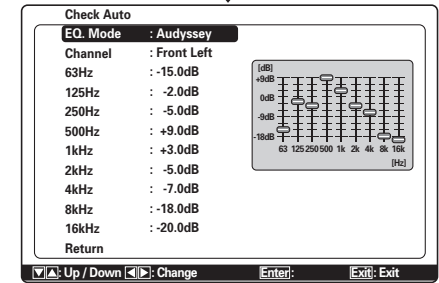
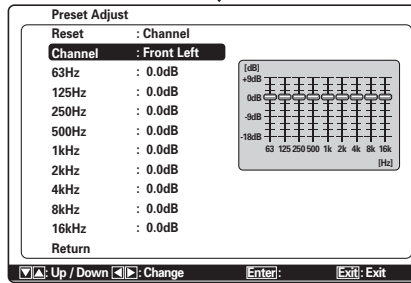
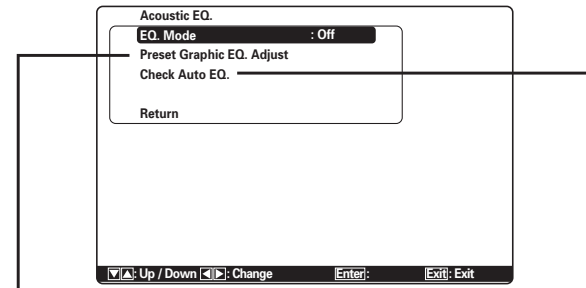

6-1 PRESET G. EQ ADJ

These modes allow you to set a 9-band graphic equalizer for each of the 7 channels.

1. Select "**Acoustic EQ**" from Main Menu with the ▲ or ▼ cursor buttons and press the **ENTER** button.
2. Select "**Preset Graphic EQ Adjust**" with the ▲ or ▼ cursor buttons.
3. Press the **ENTER** button to enter the selection.

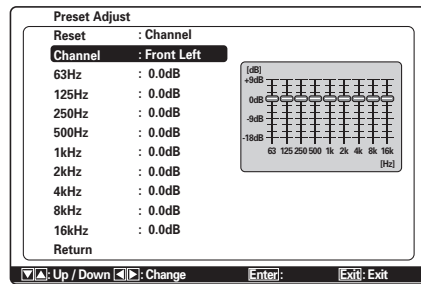

Reset:

Using the ◀ or ▶ cursor buttons, select the channel(s) to be reset to either the currently displayed channel ("Channel") or all channels ("All-Channel"), and press the **ENTER** button to enter the setting.

"All-Channel" : Resets all channels.

"Channel" : Resets only the currently displayed channel.

Channel:

Select the channel ("**Front Left**", "**Center**", "**Front Right**", "**Surround Right**", "**Surround Back Right**", "**Surround Back Left**" or "**Surround Left**") to adjust with the ◀ or ▶ cursor buttons, and switch to the adjustment mode with the ▼ cursor button.

Frequency:

Select the target frequency on the graph with the ▲ or ▼ cursor buttons. Adjust the level with the ◀ or ▶ cursor buttons. (Note that this can be adjusted to any level between **-20** and **+9** dB in 0.5 dB increments.)

Move to the next frequency with the ▲ or ▼ cursor buttons, and adjust the level.

After you complete this portion of the setup move cursor to "**Return**" with the ▲ or ▼ cursor buttons and press the **ENTER** button.

6-2 CHECK AUTO

These menus are for confirming the results of Auto Setup function equalizer measurement (Audyssey Front, Audyssey Flat, Audyssey).

1. Select "**Acoustic EQ**" from Main Menu with the ▲ or ▼ cursor buttons and press the **ENTER** button.
2. Select "**Check Auto EQ**" with the ▲ or ▼ cursor buttons.
3. Press the **ENTER** button to enter the selection.

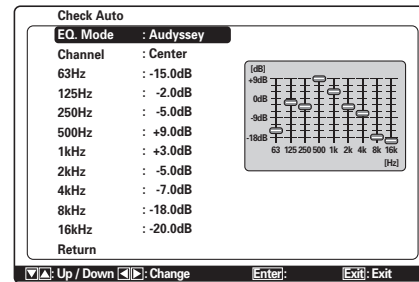

EQ. Mode:

Select EQ (mode) with the ◀ or ▶ cursor buttons followed by the desired equalizer ("Audyssey", "Audyssey Front", "Audyssey Flat").

Channel:

Select the channel to check with the ◀ or ▶ cursor buttons.

Notes:

- The frequency will not be exactly the same as in the Preset Graphic EQ modes.
- Front Left and Front Right are not indicated on the Audyssey Front mode.

4. Once finished checking, select "**Return**" with the ▲ or ▼ cursor buttons and press the **ENTER** button to return to the "Acoustic EQ" menu.

ADVANCED OPERATION

AMP OPERATION

USING THE SLEEP TIMER



To program this unit for automatic standby, press the **SLEEP** button on the remote controller.

Each press of the button will increase the time before shut down in the following sequence.

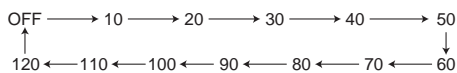

The sleep time will be shown for a few seconds in the display on the front panel, and it will count down until the time has elapsed.

When the programmed sleep time has elapsed, the unit will automatically turn off.

Note that the SLEEP indicator on the display will illuminate when the Sleep function is programmed.

To cancel the Sleep function, press the **SLEEP** button until the display shows "SLEEP OFF" and the SLEEP indicator will disappear.

DISPLAY MODE

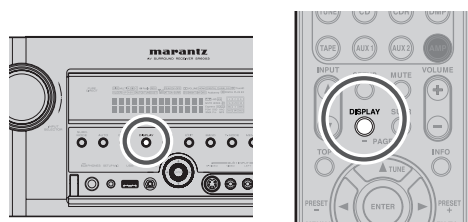

You can select the display mode for the front display of the unit.

To select this mode, press the **DISPLAY** on the remote controller or the front panel.

When this button is pressed, the display mode is switched in the following sequence.

Normal → Volume → Auto display OFF → Display OFF → Normal Mode

Normal mode:

- The following three mode types are displayed.
- Displays the selected input function. If the function has been renamed using the Function Rename feature (see page 28), the renamed name appears on the display.
 - Displays the input mode set via the Function Input Setup feature. (See page 27)
 - Displays the status of the selected surround mode.

Volume mode:

The input function and input mode are displayed in the upper part, and the current volume level is displayed in the lower part.

Auto Display Off mode:

The display is off. But, if you make a change to the unit such as the input or surround mode, the display will show that change, then go back to off after about 3 seconds. When changing the volume, it is not displayed.

Display Off mode:

The display is off completely.

Note:

- Only the "DISP" indicator will be illuminated on the front display in display off condition.

RECORDING AN ANALOG SOURCE

In normal operation, the audio or video source selected for listening through this unit is sent to the record outputs.

This means that any program you are watching or listening to may be recorded simply by placing machines connected to the outputs for **TAPE OUT**, **CD/CDR OUT** and **VCR OUT** in the record mode.

To record the input source signal you are currently watching or listening to

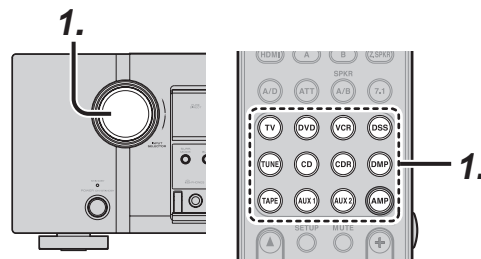

1. Select the input source to record by turning the **INPUT SELECTOR** knob on the front panel or simply press the input selector buttons on the remote controller.
The input source is now selected and you may watch or listen to it as desired.
2. The currently selected input source signal is output to the **TAPE OUT**, **CD/CDR OUT** and **VCR OUT** outputs for recording.
3. Start recording to the recording component as desired.

Notes:

- When connecting only digital signal input, output cannot be made to the TAPEOUT, CD/CDR OUT or VCR OUT terminals. When using recording functions, be sure to also make connections for analog signal input.
- No conversion is made from Video signal input to S-Video signal output or from S-Video signal input to Video signal output. Always use the same signal type for both input and output.
- Video or audio signals input to HDMI input terminals cannot be recorded.

SELECTING ANALOG AUDIO INPUT OR DIGITAL AUDIO INPUT



If you have already assigned the digital inputs, you can temporarily select the audio input mode for each input source as following procedures.

Press the **AMP** button and press the **A/D** button.

When this button is pressed, the input mode is switched in the following sequence.

Auto → HDMI → Digital → Analog → Auto

Auto mode:

The types of signals being input to the digital and analog input jacks for the selected input source are detected automatically.

If no digital signal is being input, the analog input jacks are selected automatically.

HDMI mode:

HDMI mode can be selected only when an HDMI input has been assigned as an input source.

When "HDMI Audio" under Preference of the Setup Menu is set to "Through", the HDMI mode cannot be selected.

Digital mode:

The input signal is fixed to an assigned digital input terminal.

Analog mode:

The analog input jacks are selected.

This selection is temporary and will not be stored in memory.

To store changes to the input mode, select "**Input Setup**" from the Main Menu. (See page 27)

SELECTING THE SURROUND MODE

Example: AUTO SURROUND

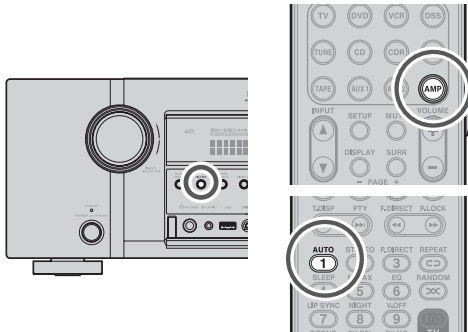

(Using the unit)

To select the Auto surround mode during playback, press the **AUTO** button on the front panel.

(Using the remote controller)

To select the Auto surround mode, press the **AMP** button and press the **AUTO** button.

- For surround modes, see "Surround Mode" on page 78.

DIALOGUE NORMALIZATION MESSAGE

Dialogue Normalization (Dial Norm) is a feature of Dolby Digital.

When playing back software which has been encoded in Dolby Digital, sometimes you may see a brief message on the FL display which will read "D-NORM X dB" (X being a numeric value).

Dialogue Normalization serves to let you know if the source material has been recorded at a higher or lower level than usual. For example, if you see the following message: "D-NORM + 4 dB" on the FL display, to keep the overall output level constant just turn down the volume control by 4 dB. In other words, the source material that you are listening to has been recorded 4 dB louder than usual.

If you do not see a message on the FL display, then no adjustment of the volume control is necessary.

NIGHT MODE

Useful at night or when loud noise is undesirable, this mode compresses the dynamic range, making it easier to hear quieter audio content without increasing the overall volume.

Note that the effect of night mode is determined by the Dolby Digital content. Night mode may have no effect with content that does not support this function.



1. To select this mode, press the **AMP** button on the remote controller.
2. Each time the **NIGHT** button is pressed, the mode changes according to the following options indicated on the front of the unit.

- AUTO Mode

N I G H T A U T O

AUTO mode is available when decoding Dolby TrueHD signals.

When night mode is activated, "NIGHT" is illuminated on the front of the unit. (See page 6)

- NIGHT Mode ON

N I G H T O N

Setting the Night mode to "ON" compresses the dynamic range in Dolby Digital only.

- NIGHT Mode OFF

N I G H T O F F

Turn off the Night mode.

LISTENING THROUGH HEADPHONES

This jack may be used to listen to the unit's output through a pair of headphones. Be certain that the headphones have a standard 1/4" stereo phone plug.

Note that the speakers will automatically be turned off when the headphone jack is in use.

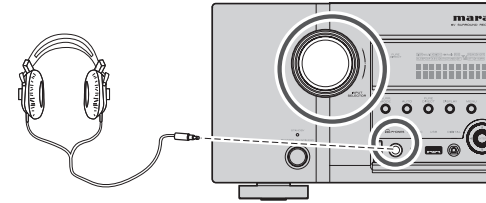

Note:

- When using headphones, the surround mode will change to STEREO and Dolby Headphone by MENU and Cursor button.
- The surround mode returns to the previous setting as soon as the headphone plug is removed from the jack.

DOLBY HEADPHONE MODE

This feature simulates the waveforms of the actual sounds heard from the speakers.

When headphones are used, the **MENU** button automatically switches to the Dolby headphone mode.

The OSD that appears when the **MENU** button is pressed is shown below.

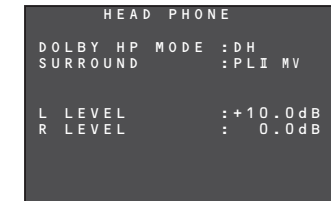

DOLBY HP (Headphone) MODE can be selected with the left and right cursor buttons.

BYPASS → DH (DOLBY Headphone) → BYPASS

BYPASS: Bypasses the Dolby headphone mode and delivers ordinary 2-channel stereo.

DH: Dolby Headphone is a signal processing system that delivers a sound similar to room speakers.

It makes it possible to experience the volume and space of a 5-channel surround system using ordinary stereo headphones.

When the PURE DIRECT mode is selected, Dolby surround processing is bypassed and "***" is displayed as the mode indication.

The surround mode can be selected when the modes in DH is selected.

L/R LEVEL can be set in the ±12 dB range.

Notes:

- The surround mode returns to the previous setting as soon as the plug is removed from the jack.
- In headphone mode, Tone Control and ACOUSTIC EQ are not available.

M-DAX (Marantz Dynamic Audio eXpander)



This function makes up for lost audio content in MP3 or AAC sources (from lossy compression) during playback. Choose one of the following levels for this effect as desired.

- “HIGH”: Stronger effect
- “LOW”: Weaker effect
- “OFF”: Deactivated.

(Using the remote controller)

When switching to M-DAX mode, press the **AMP** button.

Press the **M-DAX** button.

Each time this button is pressed, M-DAX changes as follows.

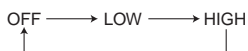

The “M-DAX” indicator on the front display lights when M-DAX mode is LOW or HIGH. (See page 6)

Notes:

- M-DAX is compatible with PCM (48 kHz or lower) and two-channel analog sources.
- The M-DAX is not available when Dolby Virtual Speaker mode is being used.

ATTENUATION TO ANALOG INPUT SIGNAL



If the selected analog audio input signal is greater than the capable level of internal processing, the “**PEAK**” indicator will light up on the front display. If this happens, you should press the **ATT** button on the remote controller.

“**ATT**” indicator will be illuminated when this function is activated. The signal-input level is reduced by about half. Attenuation will not work with the output signal of TAPE-OUT, CD/CD-R and VCR-OUT.

This function is memorized for each individual input source.

SPEAKER A/B



This unit has speaker system-A and speaker system-B for front L/R channels. You can select these systems by pressing **SPKR A/B** on the remote controller.

Press the **SPKR A/B** button.

Each time this button is pressed, Speaker system A and B changes as follows.

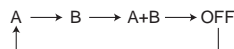

7.1 CH INPUT

This unit is equipped for future expansion through the use of Multi channel Super Audio CD multichannel player or DVD-Audio player.

When this is selected, the input signals connected to the L(front left), R (front right), CENTER, SL (surround left), SR (surround right) and SBL (surround back left) and SBR (surround back right) channels of the 7.1 CH. In jacks are output directly to the front (left and right), center, surround (left and right) and surround back speaker systems as well as the pre-out jacks without passing through the surround circuitry.

In addition, the signal input to the SW (subwoofer) jack is output to the PRE OUT SW (subwoofer) jack. When 7.1 CH. INPUT is selected, the last video input used remains routed to the **Monitor Outputs**.

This permits simultaneous viewing with video sources

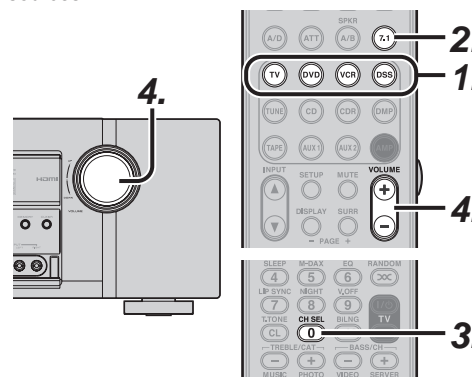

1. Select a desired Video source to decide the routed video signal to the **Monitor Outputs**.
2. Press the **7.1** button on the remote controller to switch the 7.1 channel input.
3. If it is necessary to adjust the output level of each channel, press the **CH.SEL** button on the remote controller.

Adjust the speaker output levels so that you can hear the same sound level from each speaker at the listening position. For the front left, front right, center, surround left, surround right and surround back speakers, the output levels can be adjusted between -12 to +12 dB.

The subwoofer can be adjusted between -18 and +12 dB.

These adjustments result will be stored to 7.1 CH. INPUT memory.

4. Adjust the main volume with the **MAIN VOLUME** knob or the **VOL** buttons on the remote controller.

To cancel the 7.1 CH. INPUT setting, press the **7.1** button on the remote controller.

Notes:

- When the 7.1 CH. Input is in use, you may not select a surround mode, as the external decoder determines processing.
- In addition, there is no signal at the record outputs when the 7.1 CH. Input is in use.
- Furthermore, the following functions are not available during 7.1 CH Input use.
Test Tone, NIGHT MODE, Source Direct, Pure Direct, HT-EQ, Tone Control, Acoustic EQ.

AUX2 INPUT

If you don't need to connect 7.1 Ch. input terminals with multi channel decoder, L(front left) and R (front right) inputs terminals are available as AUX2 input.

In this case, You can connect additional audio source to AUX2 as other audio input terminals.

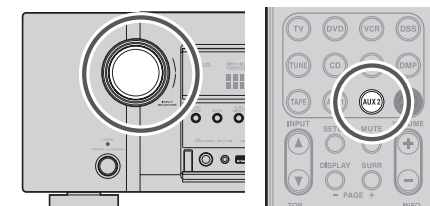

VIDEO ON/OFF

When no video signal is connected to the unit or a DVD, etc., is connected directly to your TV, the unnecessary video circuit can be turned off by selecting the “**VIDEO OFF**” setting.

To select video off, press the **AMP** button and press the **V.OFF** button.

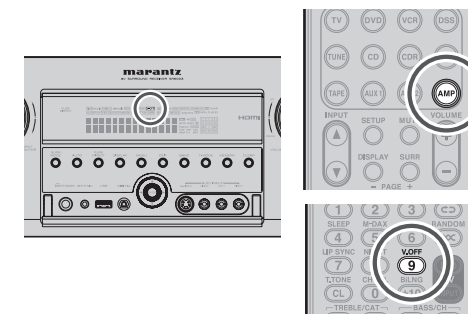

The “**V-OFF**” indicator on the front display panel will light.

TV AUTO ON/OFF FUNCTION

This function allows the component connected to the TV-VIDEO in jack to control the power (ON/OFF) to the unit.

AUTO POWER ON

1. Be sure the TV auto mode is Enabled. (Refer to page 37:)
2. Connect your TV TUNER (etc) to the TV-VIDEO in terminal. Be sure to connect the VIDEO input.
3. Turn OFF the power to the TV TUNER and turn standby to the unit.
4. Turn ON the TV TUNER and tune in a receivable station.
5. When the station is received, this unit turns ON and TV is selected automatically.

AUTO POWER OFF

1. In the above situation, turn the TV TUNER OFF or select a channel that does not contain any broadcast.
2. The power to the unit switches to STANDBY after approx. 5 minutes.

Notes:

- AUTO POWER OFF is canceled if this unit is set to a source other than TV.
The function reactivates when TV is selected again.
- Some TV broadcasts may cause the TV AUTO FUNCTION to turn ON.
- The S-Video, component and HDMI terminal does not support "TV AUTO ON/OFF" function.
- This function is inactive when STANDBY MODE is set to ECONOMY. To use this function, set STANDBY MODE to NORMAL.

LIP.SYNC

Depending on the image device (TV, monitor, projector, etc.) connected to the unit a time lag can occur between image signal processing and audio signal processing. Though minor, this time lag can interfere with movie and music enjoyment. The LIP.SYNC feature delays the audio signal with respect to the image signal output from the unit to correct the time lag between the sound and image. It can be operated with the "LIP SYNC" and ◀ and ▶ cursor buttons of the remote controller. Set the remote controller to the AMP mode before operating the LIP.SYNC feature. The initial setting is OFF (0 ms). The time lag can be adjusted in 10 ms steps up to 200 ms.

Watch the picture on the image device (i.e., TV, monitor, projector, etc.) as you adjust the time lag.



Note:

- The LIP.SYNC feature turns OFF (0 ms) in the SOURCE/PURE DIRECT mode. When the SOURCE/PURE DIRECT mode is deactivated, the set value of the LIP.SYNC feature is automatically restored.
- Even if you do not correct the time lag manually this way, audio and video are automatically synchronized when the unit is connected to TV or Projector supporting Auto Lipsync Correction in HDMI 1.3a. For instructions on Auto Lipsync Correction, see page 38.

DUAL BACKUP MEMORY

The unit stores settings information in nonvolatile memory even when the main power supply is turned off. Using the Dual Backup Memory function, you can write settings information to another memory area to back up saved settings for recovery anytime as needed.

BACKUP

Set up the unit in the state for which you want to store the settings. Hold the **MEMORY** and **ENTER** buttons on the front panel simultaneously for at least 3 seconds.

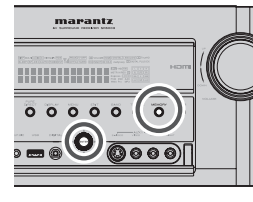

"MEMORY SAVING" is displayed and the unit's settings are saved. The stored settings information is retained until Dual Backup Memory is used again and the information is overwritten.

M E M O R Y S A V I N G

Note:

- The following settings values cannot be backed up.
 - Main ZONE Volume
 - ZONE A Volume
 - ZONE Speaker A Volume

RECOVERY OF MEMORY

Recover backed up settings as follows. Hold the **MEMORY** and **MENU** buttons on the front panel simultaneously for at least 3 seconds.

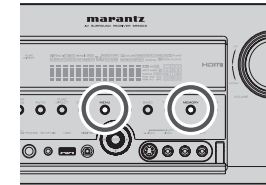

"MEMORY LOAD" is displayed and the unit's stored settings are reapplied.

The unit temporarily enters standby mode. If there is no backup data, "NO BACKUP" is displayed and no data is recovered.

M E M O R Y L O A D

N O B A C K U P

Note:

- Because the following settings values are not backed up, each Volume value is set to Minimum.
 - Main ZONE Volume
 - ZONE A Volume
 - ZONE Speaker A Volume

VIDEO CONVERT

ANALOG VIDEO CONVERSION

This unit is equipped to convert video signals for monitor output. Because of this, indifferent of the connection (VIDEO, S-VIDEO, COMPONENT VIDEO) between the playback device and this unit, listening and viewing are possible with a single higher grade cable between the MONITOR OUT terminal of the unit and the monitor.

UP-CONVERSION FROM ANALOG VIDEO SIGNALS TO HDMI

The up-conversion feature of this unit can output the input analog video signals (for component video signals of 480i, 480p, 1080i and 720p resolution, and S-Video and Video (composite) of 480i resolution) to the HDMI MONITOR terminal.

Notes:

- HDMI video input is only output to the HDMI MONITOR OUT terminal of the unit. If connecting a playback device such as a DVD player to the HDMI input jack, connect the HDMI MONITOR OUT terminal of the unit to a TV monitor.
- This mode is unavailable for the REC out terminal.
- This mode is unavailable for still picture, fast forward and reverse play on video component.
- If, while attempting to use the video convert feature, the unit cannot synchronize with the display device, "NO SIGNAL" appears on the monitor or noise is generated, this feature cannot be used. All of these signs are caused by equipment incompatibility; there is nothing wrong with the unit.

If this occurs, set "VIDEO CONVERT" in the "VIDEO SETUP" menu to "DISABLE". Next, connect the video input signal to the display component via the MONITOR OUT terminal under VIDEO and the S-video input signal to the display component via the MONITOR OUT terminal under S-VIDEO.

- The video convert feature constantly monitors input video signals and determines whether to convert the input signals or not. However, some input video signals cannot be detected correctly. If this occurs, set "VIDEO CONVERT" in the "VIDEO SETUP" menu to "DISABLE".

CONNECTION EXAMPLE

- When a monitor is connected to the HDMI MONITOR OUT terminal of the unit

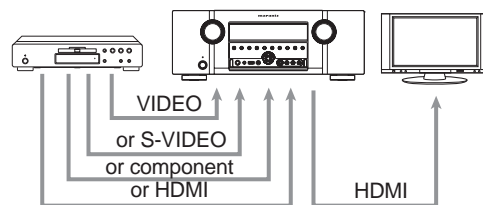

Notes:

- If the resolution of the component video signal input from the playback device is other than 480i, 480p, 1080i or 720p, images are not output from the HDMI MONITOR OUT terminal of the unit.
- If the resolution of the S-Video or Video signal input from the playback device is other than 480i, images are not output from the HDMI MONITOR OUT terminal of the unit.

- When a monitor is connected to the VIDEO or S-VIDEO MONITOR OUT terminals of the unit

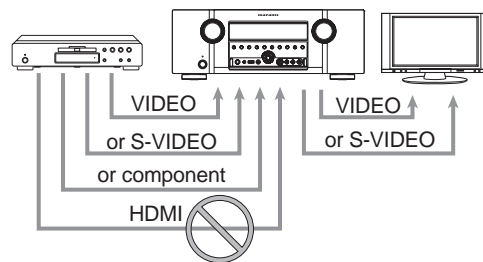

Notes:

- The HDMI video signal input from the playback device is not output from the VIDEO or S-VIDEO MONITOR OUT terminals of the unit.
- If the resolution of the component video signal input from the playback device is other than 480i, it is not output from the VIDEO or S-VIDEO MONITOR OUT terminals of the unit.

- When a monitor is connected to the COMPONENT VIDEO MONITOR OUT terminal of the unit

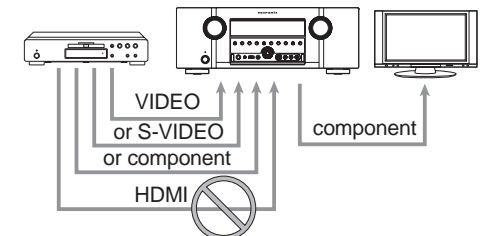

Notes:

- The HDMI video signal input from the playback device is not output from the COMPONENT VIDEO MONITOR OUT terminal of the unit.

Notes of OSD menu system:

- The setup menu can be displayed through all video out terminals ("HDMI", "COMPONENT", "SVIDEO" and "VIDEO").
- OSD information is output only to the VIDEO and S-VIDEO MONITOR OUT terminals.

OSD information is also output when the video conversion feature is on and the video signal input to the VIDEO or S-VIDEO input jack of the unit is converted and output from the COMPONENT VIDEO or HDMI MONITOR OUT terminals.

I/P CONVERT

The video circuit of the unit is equipped with an I/P conversion feature.

When this feature is on, 480i analog video signals (VIDEO, S-VIDEO or COMPONENT VIDEO) input from a playback device can be converted to 480p and progressively output to the COMPONENT VIDEO or HDMI MONITOR OUT terminals of the unit. (For setting instructions, see page 37)

Note:

When a monitor is connected to the HDMI MONITOR OUT terminal, and HDMI RESOLUTION is set to 720p, 1080i, 1080p, or AUTO, the I/P CONVERT for COMPONENT VIDEO OUTPUT does not function.

HDMI OUT



HDMI OUTPUT 1 or 2 can be selected and used with this unit.

Each time the **HDMI** button on the remote controller is pressed, OUTPUT 1 is switched to OUTPUT 2 or vice versa.

HDMI OUT 1 and HDMI OUT 2 cannot be output simultaneously.

HDMI - 0 = OUT 1

HDMI RESOLUTION

This function is used to output the analog video signal to HDMI as follows.

- 480i signals can be converted to 480p, 1080i, 720p or 1080p signals, while 480p signals can be converted to 1080i, 720p or 1080p signals.
- 720p signals can be converted to 1080i or 1080p.
- 1080i signals can be converted to 1080p.
- The output resolution can be set for HDMI OUT 1 and HDMI OUT 2.

Notes:

- Do not set to 1080i, 720p or 1080p when connected to a monitor that does not support 1080i, 720p or 1080p signals. The SETUP MENU will not be displayed. If the SETUP MENU is not displayed, change settings while viewing the main unit display panel.
- The resolution of analog component output cannot be changed.
- HDMI OUT 1 and HDMI OUT 2 cannot be output simultaneously.

USB OPERATION

Any USB media that complies with the USB Mass Storage Class standard can be used with this unit. The USB media file systems support FAT16 and FAT32.

MP3, WMA, AAC and WAV music files can be played back by the unit. (See page 50)

To operate the unit from the remote controller, press the **DMP** button on the remote controller so that the USB mode is engaged.

PREPARATIONS FOR USB OPERATION

Note:

Before proceeding with USB operation, check that the unit and monitor screen are connected properly.

(Using the unit)

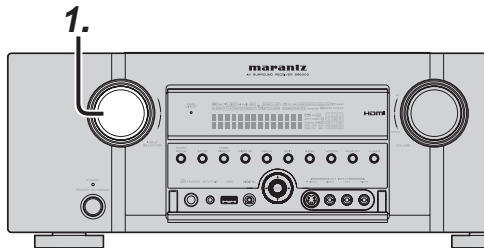

1. To select USB, turn the **INPUT SELECTOR** knob on the front panel.

(Using the remote controller)

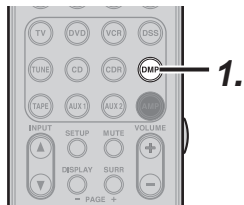

1. Press the **DMP** button two times in a row.
2. The top menu screen is displayed.

What appears on the FL display



- ① Function display:
Displays the names of the functions.
- ② Status display:
Displays the statuses of the USB function. Error messages are also displayed. (See page 76)

What appears on the monitor screen (top menu)

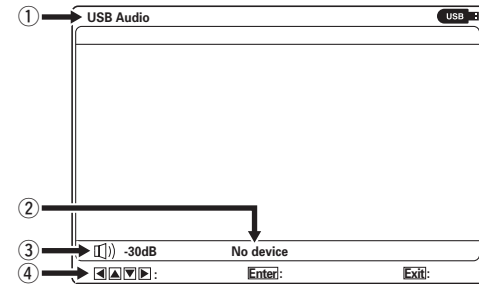

- ① Function display:
Displays the names of the functions.
- ② Status display:
Displays the statuses of the USB function. (See page 50)
- ③ Volume display:
Displays the volume level.
- ④ Guidance display:
Displays descriptions of the function keys.

3. Connect the USB media containing the music files to the USB connector on the unit's front panel.

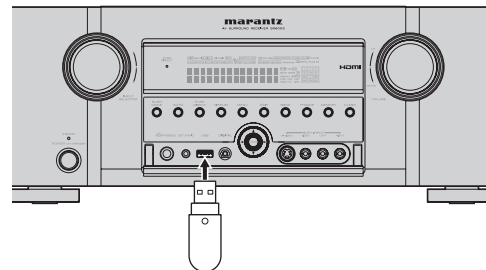

4. The folders and music files contained on the USB media are displayed as a list.

What appears on the FL display



- ① Function display/main folder name:
Displays the names of the functions and main folders.
- ② Cursor information:
Displays the currently selected file and folder.

What appears on the monitor screen (File list)

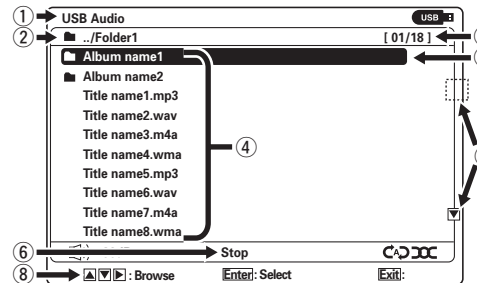

- ① Function display:
Displays the names of the functions.
- ② Name of main folder:
Displays the name of the main folder currently listed and displayed.
- ③ List number/total number:
Displays the list number at the cursor position and the total number of files and subfolders.
- ④ Subfolders, file list:
Displays the subfolders and files in the order in which they were stored on the storage media. When files and folders are mixed, the folders are displayed first.
- ⑤ Selection cursor:
Selects files and folders.
- ⑥ Play status:
Displays the play status of the file being played.
- ⑦ Page indicator:
Appears when the list pages can be scrolled up or down.

- ⑧ Guidance display:
Displays descriptions of the function buttons.

Icon displays

- 📁 : Folders (main folders, subfolders)
- 🎵 : Files being played

Notes:

- Only ASCII characters can be displayed on the unit's monitor screen and FL display. All other characters are converted into asterisks (*) and displayed.
- If no operation is performed for 10 minutes or longer, the screen saver display appears on the monitor screen.
- The screen saver can be enabled or disabled by holding down ENTER (either on the unit or remote controller) for 3 seconds on the top menu screen.

REMOTE CONTROLLER



▲/▼ (Remote controller, unit)	Cursor movement
▶ (Remote controller, unit)	Moves to the selected folder when the cursor is positioned at a folder.
◀ (Remote controller, unit)	Moves to the higher folder.
ENTER (Remote controller, unit)	Moves to the selected folder when the cursor is positioned at a folder. Plays the selected file when the cursor is positioned at a file.
EXIT (Unit)	
■ (STOP) (Remote controller)	Pause
TOP (Remote controller)	Moves to the highest folder.
PAGE + / - (Remote controller)	(+) next page (-) previous page
▶ (PLAY) (Remote controller)	Playback
(PAUSE) (Remote controller)	Pause/release
⏩ / ⏪ (SKIP) (Remote controller)	(⏩) Plays the next file. (⏪) Plays the previous file. (Cues when there is less than 1 second from the start of the file.)
⏪ / ⏩ (SEARCH) (Remote controller)	(⏩) Search + (⏪) Search -
↺ REPEAT (Remote controller)	Repeat play setting
⏮ RANDOM (Remote controller)	Random play setting

THE UNIT

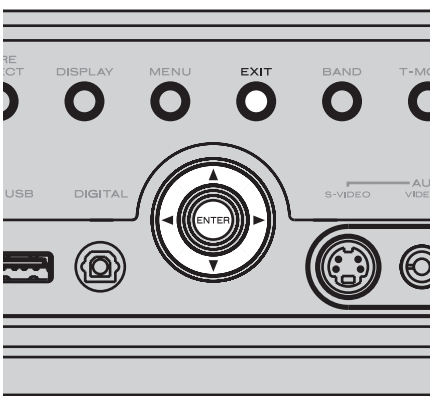

PLAYING FILES ON THE USB MEDIA

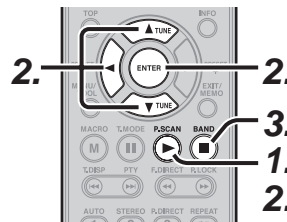

1. Select the tracks to be played, and press the **ENTER** or **▶** button.
The status display screen appears, and the tracks are played in file list order.

What appears on the FL display



- ① Function display/name of artist:
Displays the names of the function and artist. "Unknown" appears if there is no artist name.
- ② Playback status/title:
Displays the playback status and title. If the title is unknown, the filename minus its extension is displayed.

What appears on the monitor screen (statuses)

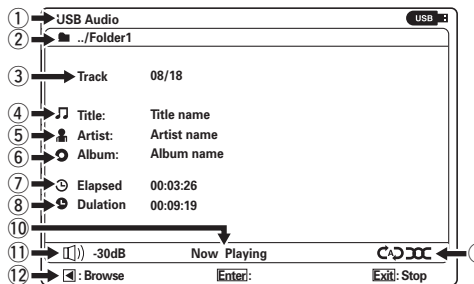

- ① Function display:
Displays the names of the functions.
- ② Status display:
Displays the statuses of the USB function. Error messages are also displayed.
- ③ Current file number/total number of files:
Displays the number of the file currently playing and the total number of files contained in the main folder.

- ④ Title display:
Displays the title of the file being played. The filename is displayed if there is no tag information.
- ⑤ Artist name display:
Displays the name of the play file artist. "UNKNOWN" appears if there is no artist name.
- ⑥ Album name display:
Displays the name of the play file album. "UNKNOWN" appears if there is no album name.
- ⑦ Elapsed time:
Displays the elapsed play time of the file.
- ⑧ Content time:
Displays the total play time of the file.
- ⑨ Repeat/random statuses:
Displays the repeat and random statuses. They are not displayed when the settings are OFF.
- ⑩ Play status:
Displays the play status of the currently selected file.
- ⑪ Volume display:
Displays the volume level.
- ⑫ Guidance display:
Displays descriptions of the function buttons.

Icon displays

The following icons are displayed on the screen.

- 📁 : Folder (main folder)
- 🎵 : File
- 👤 : Artist
- 📀 : Album
- 🕒 : Elapsed time
- 🕒 : Content time

2. To play another file while a file is playing, press the **◀** button, and display the file list. Use the **▲/▼** buttons to move the icon to the desired track, and press the **ENTER** or **▶** (PLAY) button.
3. To stop playback, press the **■** button.

NAMES AND FUNCTION | BASIC CONNECTIONS | BASIC OPERATION | ADVANCED CONNECTIONS | SETUP | ADVANCED OPERATION | TROUBLESHOOTING | OTHERS

LISTENING TO FILES REPEATEDLY (REPEAT PLAY)

The tracks on the USB media can be played in 1 track (1 file) repeat mode, folder file repeat mode or all tracks (all files) repeat mode.



Each time the remote controller's **REPEAT** button is pressed, the modes are selected in the following order.

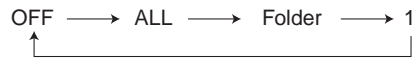

: All files repeat

: Folder file repeat

: 1 file repeat

Note:

When playing files in folder file repeat mode, the files in the selected main folder will be played repeatedly. (Play does not include files in the subfolders.)

PLAYING TRACKS AT RANDOM (RANDOM PLAY)

The files contained on the USB media can be played at random.



Each time the remote controller's **RANDOM** button is pressed, random play is changed from ON to OFF or vice versa.

The range of random play differs depending on the repeat play setting.

Repeat off : All audio files on the USB device are played at random.

Repeat on : The files in the play range of the repeat settings are played repeatedly at random.

Random play is started when the **▶** button is pressed while ON is selected.

PLAYING SPECIFIC PARTS (SEARCH)

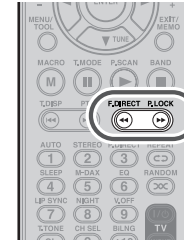

Search is started when the remote controller's **◀◀** or **▶▶** button is pressed during play. The search speed can then be changed by pressing the remote controller's **◀◀** or **▶▶** button.

- Search + / Search -

Each time the **▶▶** (Search +) or **◀◀** (Search -) button is pressed, the speed is changed by one setting in the following sequence.

SEARCH 1 + → SEARCH 2 + → SEARCH 3 + → PLAY → SEARCH 1 + →
 SEARCH 1 - → SEARCH 2 - → SEARCH 3 - → PLAY → SEARCH 1 + →

Search mode	What appears on the monitor display	Operations that appear on the FL display	Movement
SEARCH 1 +/-	(+) 1 Search +	(+) 1 ▶▶	Rapid advance at 2x normal speed
	(-) 1 Search -	(-) 1 ◀◀	Rapid reverse at 2x normal speed
SEARCH 2 +/-	(+) 2 Search +	(+) 2 ▶▶	Rapid advance at 4x normal speed
	(-) 2 Search -	(-) 2 ◀◀	Rapid reverse at 4x normal speed
SEARCH 3 +/-	(+) 3 Search +	(+) 3 ▶▶	Rapid advance at 10x normal speed
	(-) 3 Search -	(-) 3 ◀◀	Rapid reverse at 10x normal speed

OTHER

Status displays

When any of the displays listed in the table below have appeared on the FL display, it means that the unit is one of the statuses listed below.

What appears on the FL display	What appears on the monitor display	Status
N O D E V I C E	No device	No USB storage device is connected.
U N K N O W N D E V I C E	Unknown device	An unrecognizable device has been connected.
U N K N O W N F S	Unknown FS	USB media with an unsupported file system has been connected.
O V E R C U R R E N T	Over current	The overcurrent protection function of the unit's USB connector has been triggered.
N O A U D I O F I L E	No audio file	USB media with no playback files recorded on it has been connected.
C A N ' T P L A Y	Can't play	The unit has attempted to play a non-playable file.

Supported media

- Do not connect a personal computer to the unit's USB connector. Music cannot be imported to the unit's USB connector from a personal computer.
- It may not be possible to use a media device that has been plugged into a USB card reader.
- Depending on the USB media being used, it may take some time to read the data.
- Depending on the USB media being used, it may not be possible to read the data correctly or the power may not be supplied correctly.
- Users should bear in mind that we will not be liable in any way for any losses of or changes to data or for any media malfunctions which occur while the USB media device is being used. We recommend that you make a backup of any data stored on USB media before using the media in this unit.

Specifications	Compliance with USB 2.0 full speed
Connections supported	Devices in compliance with the USB Mass Storage Class standard – USB flash memory devices (sizes of 256MB and up supported) – HDDs supporting USB connections – When a portable audio player is used as a USB memory devices
Sub class	SCSI

File systems supported

- When USB media is partitioned, the unit can read only the first partition. Furthermore, depending on the partition configuration, it may not be possible to read the partition correctly.

Formats	FAT16 / FAT32
Hierarchy	Hierarchical levels of folders whose files can be played hierarchically: Max. 8 levels excluding the root
Partition	First only
Maximum number of folders	700
Maximum number of files	65535
Maximum number of folder characters	64 Byte (VFAT long names supported)
Maximum number of file characters	640Byte (VFAT long names supported) Extensions (.xxx) included

Playable file formats

- Copyright-protected audio files cannot be played using the unit.
- Playlists are not supported.
- Even if the selected music files were recorded in a format supported by the unit, it may not be possible to play them or noise may be heard.

Standards supported	Extension	Character information supported	Standard	Range supported	
MP3	mp3	ID3V1/ID3V2	MPEG-1 Layer-III	Sampling frequency	32kHz – 48kHz
				Bit rate	32kbps – 320kbps (CBR/VBR)
	mp3	ID3V1/ID3V2	MPEG-2 LSF Layer-III	Sampling frequency	16kHz – 24kHz
				Bit rate	8kbps – 160kbps (CBR/VBR)
WMA	wma	WMA Tag	Microsoft Windows Media Audio 9.2 supported	Sampling frequency	32kHz – 48kHz
				Bit rate	8kbps – 160kbps (CBR) Peak 384kbps (VBR)
AAC	m4a	AAC header (iTunes content information)	MPEG-2/4 AAC LC	Sampling frequency	8kHz – 48kHz
				Bit rate	8kbps – 320kbps (CBR/VBR)
WAV	wav	None	RIFF Wave form Audio Format	Sampling frequency	32kHz – 48kHz
				Bit number	16bit

TUNER OPERATION (PRESET MEMORY)

PRESET MEMORY

With this unit you can preset up to 60 FM/AM stations in any order.

For each station, you can memorize the frequency and reception mode if desired.

AUTO PRESET MEMORY

This function automatically scans the FM and AM band and enters all stations with proper signal strength into the memory.

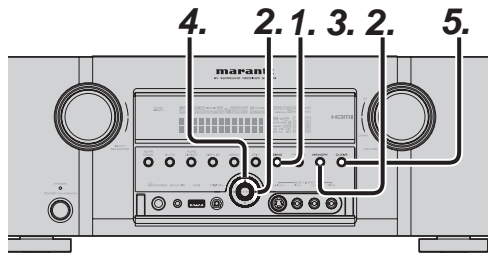

1. To select FM, press the **BAND** button on the front panel.
2. While pressing the **MEMORY** button, press the **▶** cursor button.

"**AUTO PRESET**" will appear on the display, and scanning starts from the lowest frequency.

3. Each time the tuner finds a station, scanning will pause and the station will be played for five seconds.

During this time, the following operations are possible.

The band can be changed by the **BAND** button.

4. If no button is pressed during this period, the current station is memorized in location Preset 01.

If you wish to skip the current station, press the **▲** cursor button during this period, this station is skipped and auto presetting continues.

5. Operation stops automatically when all 60 preset memory positions are filled or when auto scanning attains the highest end of all bands. If you desire to stop the auto preset memory at anytime, press the **CLEAR** button.

MANUAL PRESET MEMORY

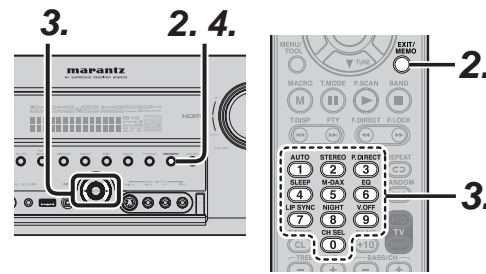

(Using the unit)

1. Tune into the radio station you desire (Refer to the "**MANUAL TUNING**" or "**AUTO TUNING**" section).
2. Press the **MEMORY** button on the front panel. "—" (preset number) starts blinking on the display.
3. Select the preset number by pressing the **◀** or **▶** cursor buttons, while this is still blinking (approx. 5 seconds)
4. Press the **MEMORY** button again to enter. The display stops blinking.
The station is now stored in the specified preset memory location.

(Using the remote controller)

1. Tune into the radio station you desire (Refer to the "**MANUAL TUNING**" or "**AUTO TUNING**" section).
2. Press the **MEMO** button on the remote controller. "—" (preset number) starts blinking on the display.
3. Enter the desired preset number by pressing the **numeric** buttons.

Note:

- When entering a single digit number (2 for example), either input "02" or just input "2" and wait for a few seconds.

RECALLING A PRESET STATION

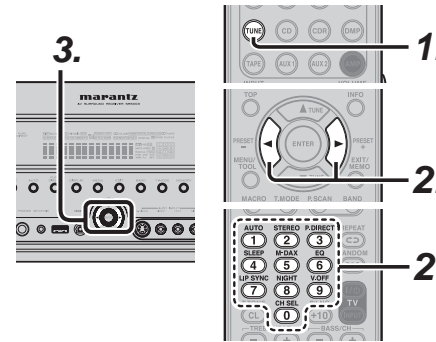

(Using the unit)

1. Select the desired preset station by pressing the **◀** or **▶** cursor buttons on the front panel.

(Using the remote controller)

1. Press the **TUNE** button twice within two seconds on the remote controller.
2. Press the **◀** or **▶** button to tune in the desired preset station.
Or enter the preset station number with the numeric buttons.

PRESET SCAN

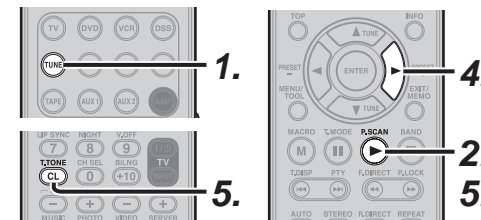

(Using the remote controller)

1. Press the **TUNE** button twice within two seconds on the remote controller.
2. Press the **P.SCAN** button on the remote controller.
"**PRESET SCAN**" appears on the front display and then the preset station with the lowest preset number is recalled first.
3. Preset stations are recalled in sequence (No.1 → No.2 → etc.) for 10 seconds each.
No stored preset number will be skipped.

4. You can fast forward the preset stations, press the **▶** continuously.
5. When the desired preset station is received, cancel the preset scan operation by pressing the **CL** button or **P.SCAN** button on the remote controller.

PRESET CHANNEL LIST DISPLAY

A complete list of the broadcast channels stored in this unit can be displayed.

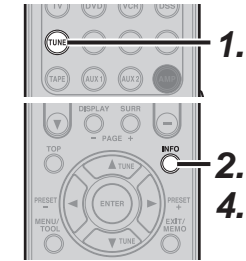

1. Press the **TUNE** button on the remote controller twice within two seconds to switch to the TUNER function.
2. Press **INFO** button on the remote controller.
3. The list of preset channels will be displayed on the screen of the TV monitor connected to this unit.

PRESET LIST			
NO. 1	FM	87.10	MHz
NO. 2	FM	93.10	MHz
NO. 3	FM	94.70	MHz
NO. 10	FM	105.70	MHz

4. Up to 10 channels can be displayed at a time. If there are more than 10 channels, press **INFO** on the remote controller once more to display the next page.
The list display will disappear automatically in 5 seconds.

NAMES AND FUNCTION

BASIC CONNECTIONS

BASIC OPERATION

ADVANCED CONNECTIONS

SETUP

ADVANCED OPERATION

TROUBLESHOOTING

OTHERS

CLEARING STORED PRESET STATIONS

You can remove preset stations from the memory using the following procedure.

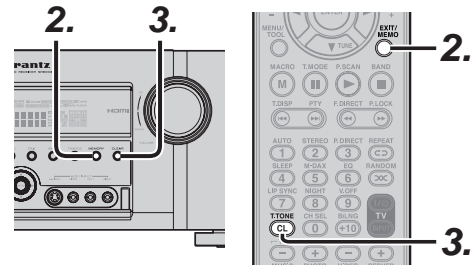

1. Recall the preset number to be cleared with the method described in "Recalling" a preset station.
2. Press the **MEMORY** button on the front panel or press the **MEMO** button on the remote controller.
3. The stored preset number blinks in the display for 5 seconds. While blinking, press the **CLEAR** button on the front panel or the **CL** button on the remote controller.
4. "xx CLEAR" appears on the display to indicate that the specified preset number has been cleared.

Note:

- To clear all stored preset stations, press and hold the **T-MODE** and the **ENTER** buttons for two seconds.

SORTING PRESET STATIONS

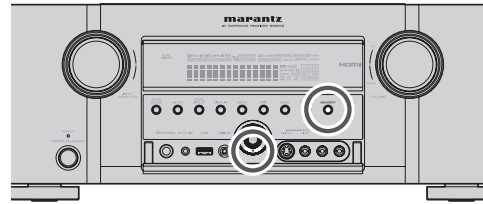

If you have stations memorized, and there is a gap in the sequential order:

I.e. the stations are stored as follows

- 1) 87.1 MHz
- 2) 93.1 MHz
- 3) 94.7 MHz
- 10) 105.9 MHz

(notice there is no stations programmed for presets for 4-9), you can have preset 10 become preset 4: To sort the numbers, press and hold the **MEMORY** and the **▼** cursor buttons.

"PRESET SORT" will appear on the display and sorting will be done.

NAME INPUT OF THE PRESET STATION.

This function allows the name of each preset channel to be entered using alphanumeric characters.

Before name inputting, you need to store preset stations with the preset memory operation.

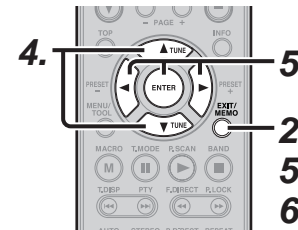
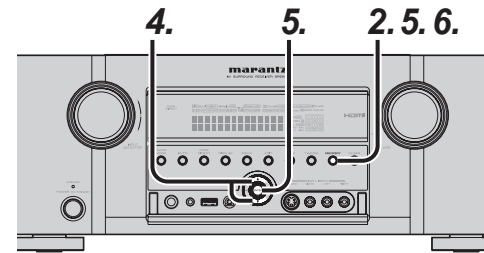

1. Recall the preset number to be inputted name with the method described in "Recalling" a preset station.
2. Press the **MEMORY** button on the front panel or press the **MEMO** button on the remote controller for more than 3 seconds.
3. The left most column of the station name indicator flashes, indicating the character entry ready status.
4. When you press the **▲** or **▼** cursor buttons on the front panel or the remote controller, alphabetic and numeric characters will be displayed in the following order:

A ↔ B ↔ C ... Z ↔ 1 ↔ 2 ↔ 3 0 ↔ - ↔ + ↔ / ↔ (Blank) ↔ A

UP →

← DOWN

5. After selecting the first character to be entered, press the **MEMORY** or **ENTER** button, or press the **MEMO** button on the remote controller.

The entry in this column is fixed and the next column starts to flash. Fill the next column the same way.

To move back and forth between the characters, press the **◀/▶** cursor buttons.

Note:

- Unused columns should be filled by entering blanks.

6. To save the name, press the **MEMORY** or **ENTER** button on the front panel, or press the **MEMO** button on the remote controller for more than 2 seconds.

Instead of using the **▲** and **▼** cursor buttons to select characters, characters can be input from the numeric keys of the remote controller. See the below table for a correspondence between characters and numeric keys.

Ten keypad	Press, press again, press again, etc.
1	A → B → C → 1 → A
2	D → E → F → 2 → D
3	G → H → I → 3 → G
4	J → K → L → 4 → J
5	M → N → O → 5 → M
6	P → Q → R → 6 → P
7	S → T → U → 7 → S
8	V → W → X → 8 → V
9	Y → Z → space → 9 → Y
0	- → + → / → 0 → -

XM RADIO OVERVIEW

This unit is the XM Ready® receiver. You can receive XM Satellite Radio by connecting to the XM Mini-Tuner and Home Dock (each sold separately) and subscribing to XM service.

About XM Radio

XM is North America's number one satellite radio company, offering an extraordinary variety of commercial-free music, plus the best in premier sports, news, talk radio, comedy, children's and entertainment programming, broadcast in superior digital audio quality coast to coast. For more information, or to subscribe, U.S. customers visit xmradio.com or call XM Listener Care at 1-800- XMRADIO (1-800-967-2346); Canadian customers visit xmradio.ca or call XM Listener Care at 1-877-GETXMSR (1-877-438-9677).

XM Ready® Legal

XM monthly service subscription sold separately. XM Mini-Tuner and Home Dock required (each sold separately) to receive XM service. It is prohibited to copy, decompile, disassemble, reverse engineer, hack, manipulate or otherwise make available any technology or software incorporated in receivers compatible with the XM satellite Radio System. Installation costs and other fees and taxes, including a one-time activation fee may apply. All fees and programming subject to change. Channels with frequent explicit language are indicated with an XL. Channel blocking is available for XM radio receivers by calling 1-800-XMRADIO (U.S. residents) and 1-877-GETXMSR (Canadian residents). Subscriptions subject to Customer Agreement available at xmradio.com and xmradio.ca. Only available in the 48 contiguous United States and Canada. ©2008 XM Satellite Radio Inc. All rights reserved.

XM Ready® Subscription

Once you have installed the XM Mini-Tuner Home Dock, inserted the XM Mini-Tuner, connected the XM Mini-Tuner Home Dock to your XM Ready® audio system, and installed the antenna, you are ready to subscribe and begin receiving XM programming. There are three places to find your eight character XM Radio ID: On the XM Mini-Tuner, on the XM Mini-Tuner package, and on XM Channel 0. Record the Radio ID below for reference.

--	--	--	--	--	--	--	--

Note:

The XM Radio ID does not use the letters "I", "O", "S" or "F".

Activate your XM Satellite Radio service in the U.S. online at <http://activate.xmradio.com> or call 1-800-XMRADIO (1-800-967-2346). Activate your XM Satellite Radio service in Canada online at <https://activate.xmradio.ca> or call 1-877-GET-XMSR (1-877-438-9677). You will need a major credit card. XM will send a signal from the satellites to activate the full channel lineup. Activation normally takes 10-15 minutes, but during peak busy periods you may need to keep your XM Ready audio system on for up to an hour. When you can access the full lineup on your XM Ready audio system you are done.

LISTENING TO XM SATELLITE RADIO

SELECTING AN INPUT SOURCE

Before you can listen to XM Satellite Radio, you must first select the input source on the unit.

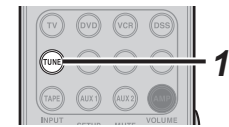
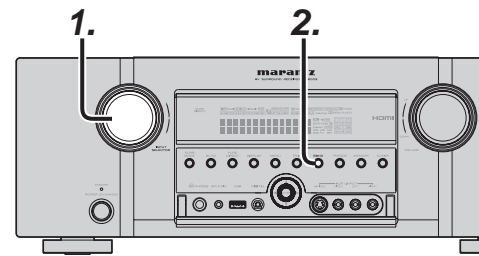

(Using the unit)

1. Turn the **INPUT SELECTOR** knob to select "TUNER".
2. Press the **BAND** button to select XM band.

(Using the remote controller)

1. To select tuner, press the **TUNE** button twice within two seconds on the remote controller.
2. Press the **BAND** button to select XM band.

CHECKING THE XM SIGNAL STRENGTH AND RADIO ID



1. Press the **T.DISP** button 2 times to display the signal status.



- The top line of the display shows the strength of the signal received from satellite, while the bottom line displays the strength of the terrestrial signal received.
- An **||||** mark indicates the strength of the stronger of the satellite and terrestrial signals.
- The display changes as shown below according to the receiving condition.

SIGNAL: STRONG
(Signal strength is strong)



SIGNAL: GOOD
(Signal strength is good)



SIGNAL: MARGINAL
(Signal strength is marginal)



SIGNAL: WEAK
(Signal strength is poor)



SIGNAL: NON
(Loss of the signal)



- Adjust the antenna location until signal strength is good or strong.
- Select channel 0 (XM000) with the ▲ or ▼ cursor buttons on the unit or the remote controller.

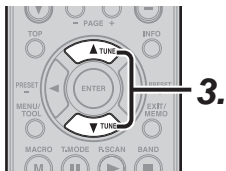
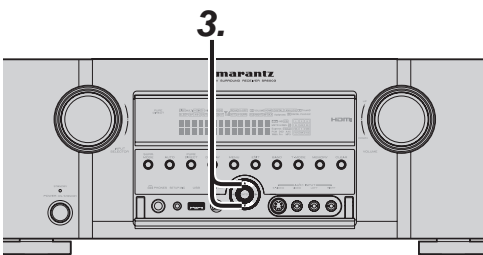

- The Radio ID is displayed.



Notes:

- If “ANTENNA” “TUNER” or “UPGRADE TUNER” appears in the front panel display, see Troubleshooting (page 77).
- To change the display content from XM information to the unit functions, do so with the **DISPLAY** button.

SWITCHING XM INFORMATION IN THE FRONT PANEL DISPLAY

You can display XM information (such as artist name/song title, category or signal status) for the channel currently selected in the front panel display.

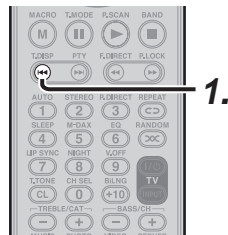

- Press the **T.DISP** button to displayed INFORMATION.

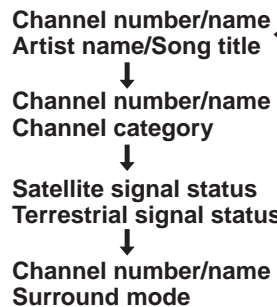

When the channel number/name is displayed:

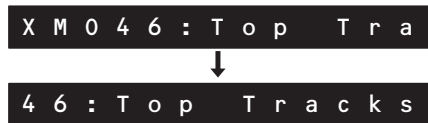

(If text is more than 14 characters long, the text is scrolled.)

Note:

The front Panel display can indicate up to 14 alphanumeric characters at once. If the information contains more than 14 characters, the information scrolls from right to left.

When the channel Artist name/Song title is displayed:

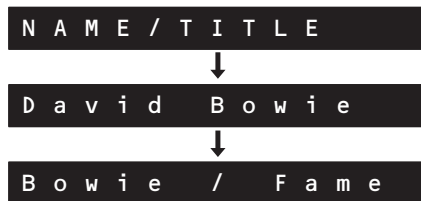

The “NAME/TITLE” is displayed for 2 seconds, followed by the artist’s name and song title. (If artist’s name or song title is more than 14 characters long, the text is scrolled.)

Note:

The front Panel display can indicate up to 14 alphanumeric characters at once. If the information contains more than 14 characters, the information scrolls from right to left.

When the channel category is displayed:



This XM information can also be displayed on a TV monitor connected to the unit.

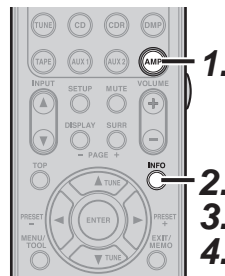

- Press the **AMP** button on the remote controller.
- Press the **INFO** button. The following information will be displayed.

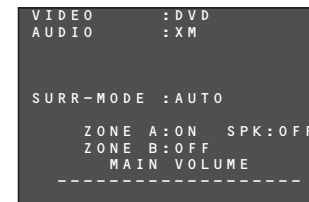

- When this display appears, press the **INFO** button again. XM information like the following will appear.

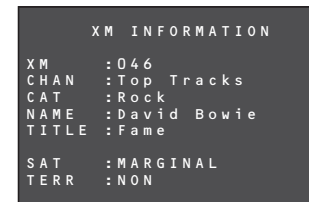

- Press the **INFO** button again. The information display will go out.

Note:

If the information contains a character that cannot be recognized by that unit, the character will be displayed with “ ”(space).

SEARCH MODE

You can search for the channel you want to listen to using one of three search modes. You can also enter the number directly to select the desired channel.

ALL CHANNEL SEARCH MODE

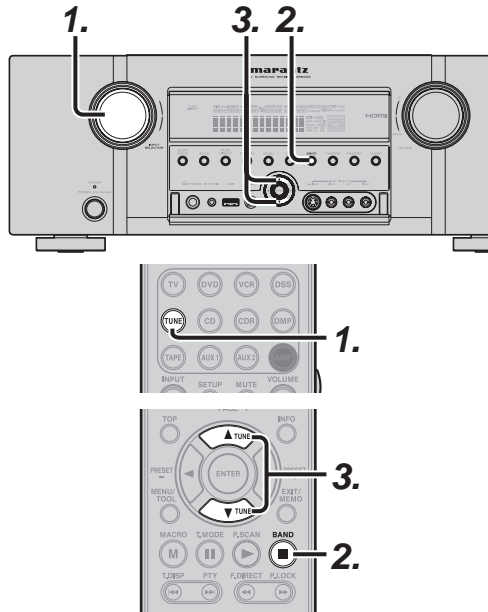

(Using the unit)

1. Turn the **INPUT SELECTOR** knob to select "TUNER".
2. Press the **BAND** button to select XM band.
3. Press the **▲** or **▼** cursor button on the front panel to select the desired channel.

(Using the remote controller)

1. To select tuner, press the **TUNE** button twice within two seconds on the remote controller.
2. Press the **BAND** button to select XM band.
3. Press and hold the **▲ TUNE** or **▼ TUNE** button.

PRESET SEARCH MODE

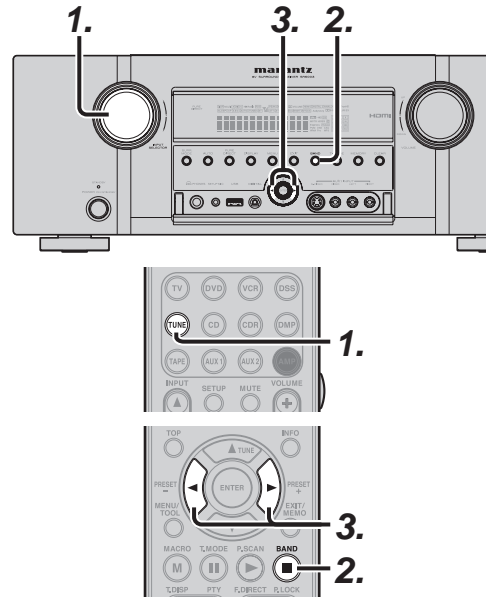

(Using the unit)

1. Turn the **INPUT SELECTOR** knob to select "TUNER".
2. Press the **BAND** button to select XM band.
3. Press the **◀** or **▶** cursor button on the front panel to select the desired preset channel.

(Using the remote controller)

1. To select tuner, press the **TUNE** button twice within two seconds on the remote controller.
2. Press the **BAND** button to select XM band.
3. **◀** or **▶** button to tune in the desired preset channel.

Or enter the preset channel number with the numeric buttons.

CATEGORY SEARCH MODE

You can select the desired channel from the category allocated to each channel. Category being aired can be only selected.

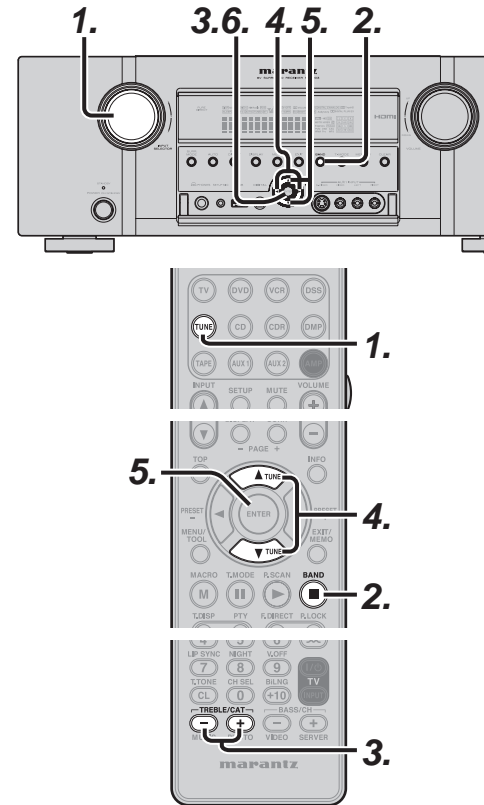

(Using the unit)

1. Turn the **INPUT SELECTOR** knob to select "TUNER".
2. Press the **BAND** button to select XM band.
3. Press the **ENTER** button on the front panel.
4. Press the **◀** or **▶** button on the front panel to select the desired category.
5. After selecting the category, Press the **▲** or **▼** cursor button to select the desired channel of the category.
6. You can return to the normal mode by press the **ENTER** button during Category Search Mode.

(Using the remote controller)

1. To select tuner, press the **TUNE** button twice within two seconds on the remote controller.
2. Press the **BAND** button to select XM band.
3. Press the **CAT +** or **CAT -** button.
4. After selecting the category, Press the **▲** or **▼** button to select the desired channel of the category.
5. You can return to the normal mode by press the **ENTER** button during Category Search Mode.

Note:

Category search automatically ends 10 seconds after the last operation.

CHANNEL DIRECT CALL

You can select the desired channel by directly tapping the numeric keypads on the remote controller.

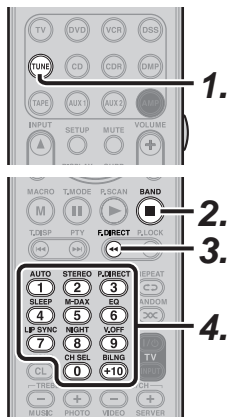

1. To select tuner, press the **TUNE** button twice within two seconds on the remote controller.
2. Press the **BAND** button to select XM band.
3. Press the **F.DIRECT** button.
"XM - -" will appear on the display.
4. Input the three digit number for your desired channel with the numeric keypad on the remote controller.
5. The desired channel will automatically be tuned.

Note:

If there is no input on the keypad for 5 sec., the input is cancelled to return to the original display.

Notes:

- "LOADING" is displayed while receiving the channel or information.
- "CH UNAUTH" is displayed while updating encryption code.
- When the selected channel is not available, "CH UNAVL" is displayed.
- "OFF AIR" is displayed while air is suspended (e.g. midnight).

PRESET MEMORY

You can store the desired channel in the Preset Memory. In addition to AM and FM, it is possible to preset 50 XM Satellite Radio channels.

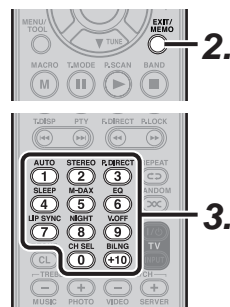
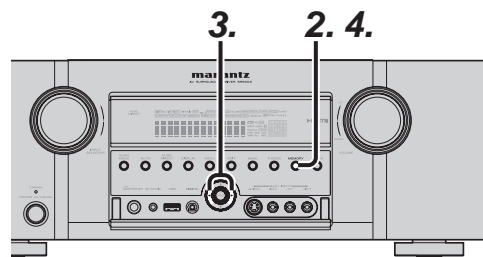

(Using the unit)

1. Tune into the desired channel.
2. Press the **MEMORY** button on the front panel.
"- -" (preset number) starts blinking on the display.
-- XM 0 4 0
3. Select the preset number by pressing the ◀ or ▶ cursor buttons, While this is still blinking (approx. 5 seconds)
0 1 XM 0 4 0
4. Press the **MEMORY** button again to enter.
The display stops blinking.
The channel is now stored in the specified preset memory location.

(Using the remote controller)

1. Tune into the desired channel.
2. Press the **MEMO** button on the remote controller. "- -" (preset number) starts blinking on the display.
3. Enter the desired preset number by pressing the **numeric** buttons.

Note:

When entering a single digit number (2 for example), either input "02" or just input "2" and wait for a few seconds.

CHECKING THE XM PRESET CHANNEL

The preset channel can be checked on the on screen display.

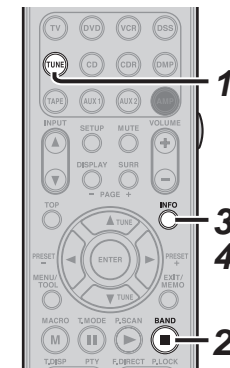

(Using the remote controller)

1. To select tuner, press the **TUNE** button twice within two seconds on the remote controller.
2. Press the **BAND** button to select XM band.
3. Press the **INFO** button, to view a list of tuner preset channel on the on screen display.
4. If there are 10 or more preset channel, press the **INFO** button again.

XM PRESET LIST			
NO. 1	XM010	XXXXXXXXXX	
NO. 2	XM011	XXXXXXXXXX	
NO. 3	XM015	XXXXXXXXXX	
NO. 4	XM022	XXXXXXXXXX	
NO. 5	XM125	XXXXXXXXXX	
NO. 6	XM001	Preview	
NO. 7	XM001	Preview	
NO. 8	XM001	Preview	
NO. 9	XM001	Preview	
NO. 10	XM001	Preview	

Note:

The preset channel indication disappears in about 5 sec.

PRESET SCAN

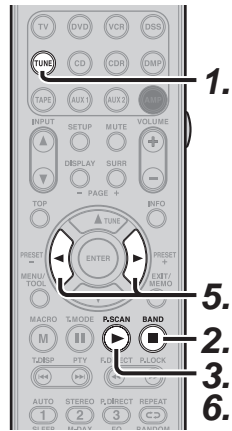

1. Press the **TUNE** button twice within two seconds on the remote controller.
2. Press the **BAND** button to select XM band.
3. Press the **P.SCAN** button on the remote controller.
4. Preset channels are recalled in sequence (No.1 → No.2 → etc.) for about 10 seconds each. The time changes by the received condition. No stored preset number will be skipped.
5. Pressing the **▶** button during prescanning speeds up scanning.
Also, pressing the **◀** button returns to the previous preset channel.
6. When the desired preset channel is received, cancel the preset scan operation by press the **P. SCAN** button.

CLEARING STORED PRESET CHANNELS

You can remove preset channels from the memory using the following procedure.

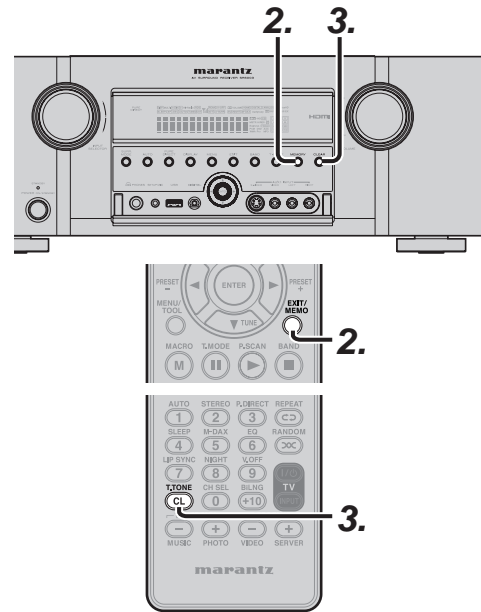

1. Recall the preset number to be cleared with the method described in "PRESET SEARCH MODE".
2. Press the **MEMORY** button on the front panel or press the **MEMO** button on the remote controller.
3. The stored preset number blinks in the display for 5 seconds. While blinking, press the **CLEAR** button on the front panel or **CL** button on the remote controller.
4. "xx CLEAR" appears on the display to indicate that the specified preset number has been cleared.

Notes:

- To clear all stored preset channel, press and hold the **T-MODE** and the **ENTER** buttons on the unit for two seconds.
- There are 50 preset channels prepared at the factory default. The 50 channels are all set to "CHANNEL 001". Each channel can be stored in the preset memory. You can search for only the preset channels.

SIRIUS RADIO OVERVIEW

This unit is the Sirius-Ready receiver. You can receive SIRIUS Satellite Radio by connecting to the SiriusConnect™ Home Tuner, Antenna and AC adapter and subscribing the SIRIUS service.

INTRODUCING SIRIUS SATELLITE RADIO

Simply The Best Radio on Radio™ with all your favorite entertainment including

MUSIC YOU LOVE Incredible variety, original channels, legendary DJs, the latest bands, exclusive live performances, and more – it's all 100% commercial-free

LIVE SPORTS & EXPERT TALK Complete coverage of the NFL, NASCAR® and NBA, plus College Sports, Soccer and more. All the action, all the talk – 24/7

EXCLUSIVE ENTERTAINMENT & TALK From Howard Stern to Martha Stewart, Blue Collar Comedy to political and religious talk, Maxim Radio to COSMO Radio, there's something for everyone.

WORLD CLASS NEWS The local and international news you trust from Fox, CNN, NPR®, CNBC, BBC plus local weather and traffic every four minutes or less.

FAMILY & KIDS It's G-rated fun for everyone with Radio Disney, Kid's Stuff and laugh break comedy – plus you can always block channels with mature programming.

FREE ONLINE LISTENING Subscribers can hear all 69 music channels, Howard Stern, Martha Stewart and much more, for free on sirius.com.

Questions? Visit sirius.com or siriuscanada.ca

HOW TO SUBSCRIBE

Listeners can subscribe by visiting SIRIUS on the web at <https://activate.siriusradio.com> or by calling toll-free at 1-888-539-SIRIUS (1-888-539-7474). Customers should have their Radio ID and credit card ready. The Radio ID can be found by selecting channel 0 on the radio. (See the "CHECKING THE SIRIUS SIGNAL STRENGTH AND RADIO ID" p.58)

A WARNING AGAINST REVERSE ENGINEERING:

It is prohibited to copy, decompile, disassemble, reverse engineer, or manipulate any technology incorporated in receivers compatible with the SIRIUS Satellite Radio system.

SIRIUS Satellite Radio is available in the US for subscribers with addresses in the continental US and is available in Canada for subscribers with a Canadian address. Required subscription plus compatible SIRIUS tuner and antenna are required and sold separately. SIRIUS Programming is subject to change. Visit sirius.com for the most complete and up-to-date channel lineup and product information. "SIRIUS" and the SIRIUS dog logo and related marks are trademarks of SIRIUS Satellite Radio Inc. All rights reserved.

LISTENING TO SIRIUS SATELLITE RADIO

SELECTING AN INPUT SOURCE

Before you can listen to SIRIUS Satellite Radio, you must first select the input source on the unit.

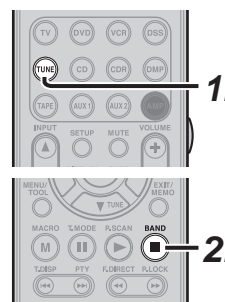
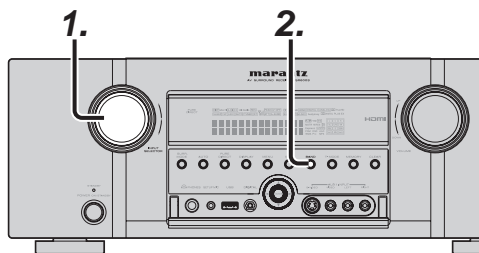

(Using the unit)

1. Turn the **INPUT SELECTOR** knob to select "TUNER".
2. Press the **BAND** button to select SIRIUS.

(Using the remote controller)

1. To select tuner, press the **TUNE** button twice within two seconds on the remote controller.
2. Press the **BAND** button to select SIRIUS.

CHECKING THE SIRIUS SIGNAL STRENGTH AND RADIO ID

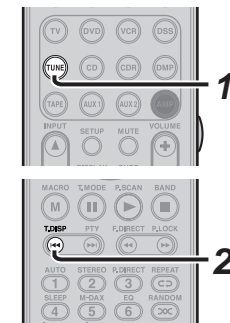

1. Press the **TUNE** button on the remote controller.
2. Press the **T.DISP** button 3 times to display the signal status on the front display of the unit.



- The top line of the display shows the strength of the signal received from satellite, while the bottom line displays the strength of the terrestrial signal received.
- An **Y**il mark indicates the strength of the stronger of the satellite and terrestrial signals.
- The display changes as shown below according to the receiving condition.



- Adjust the antenna location until signal strength is good or excellent.
- Select channel 0 (SR000) with the ▲ or ▼ cursor button of the unit or the remote controller.

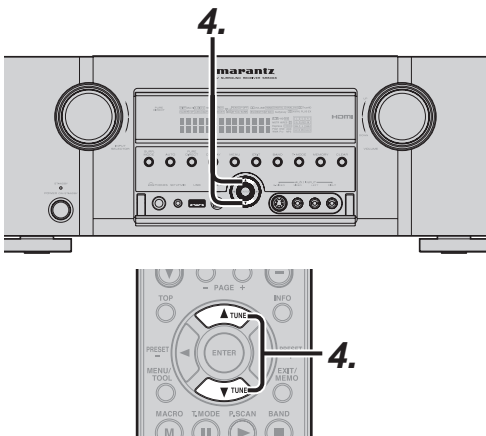

- The Radio ID is displayed.



Notes:

- If “ANTENNA”, “TUNER ERR” or “ACQUIRING” appears in the front panel display, see Troubleshooting (page 77).
- To change the display content from SIRIUS information to unit functions, do so from the display mode. (See “DISPLAY MODE” on page 42)

SWITCHING SIRIUS INFORMATION IN THE FRONT PANEL DISPLAY

You can display SIRIUS information (such as artist name, song title, composer name, category or signal status) for the channel currently selected in the front panel display.

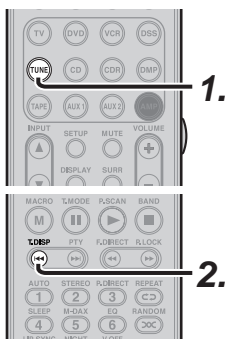

- Press the **TUNE** button on the remote controller.
- Select the information with the **T.DISP** button.

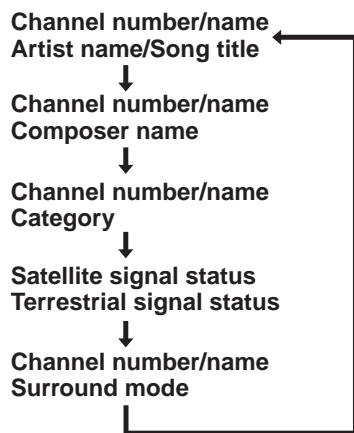

When the Channel number/name mode is displayed:



(If text is more than 14 characters long, the text is scrolled.)

When the Artist name/Song title is displayed:

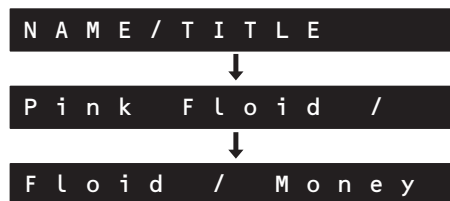

When the Composer name is displayed:



The “NAME / TITLE” or “COMPOSER” is displayed for 2 seconds, followed by the artist name / Song title or Composer name.
(If artist name / song title or composer name is more than 14 characters long, the text is scrolled.)

When the channel category is displayed:



This SIRIUS information can also be displayed on a TV monitor connected to the unit.

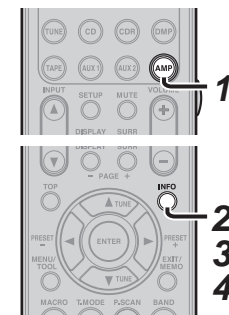

- Press the **AMP** button on the remote controller.
- Press the **INFO** button. The following information will be displayed.

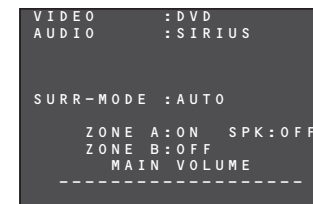

- When this display appears, press the **INFO** button again. SIRIUS information like the following will appear.

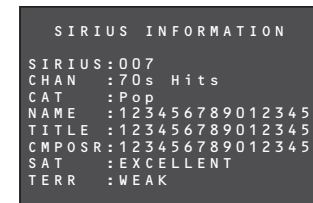

- Press the **INFO** button again. The information display will go out.

Note:

- If the information contains a character that cannot be recognized by that unit, the character will be displayed with “ ”(space).

SEARCH MODE

You can search for the channel you want to listen to using one of three search modes. You can also enter the number directly to select the desired channel.

ALL CHANNEL SEARCH MODE

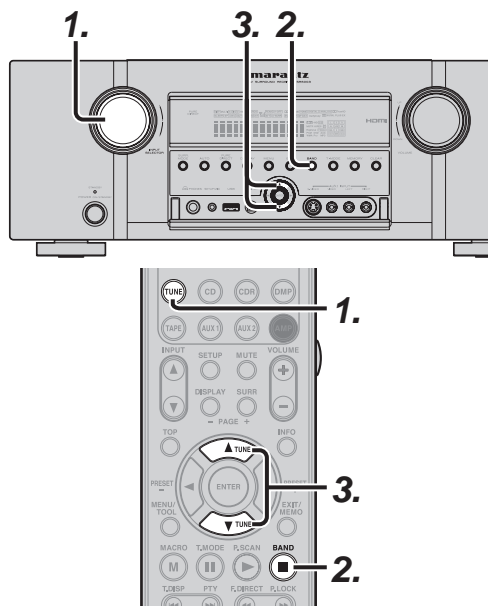

(Using the unit)

1. Turn the **INPUT SELECTOR** knob to select "TUNER".
2. Press the **BAND** button to select SIRIUS band.
3. Press the **▲** or **▼** cursor button on the front panel to select the desired channel.

(Using the remote controller)

1. To select tuner, press the **TUNE** button twice within two seconds on the remote controller.
2. Press the **BAND** button to select SIRIUS band.
3. Press and hold the **▲** or **▼** cursor button.

PRESET SEARCH MODE

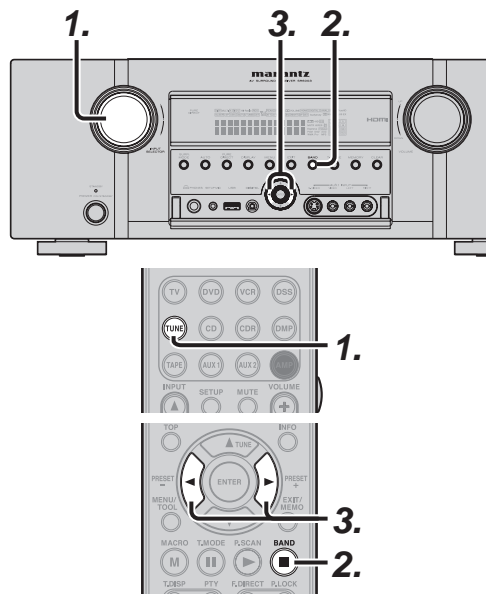

(Using the unit)

1. Turn the **INPUT SELECTOR** knob to select "TUNER".
2. Press the **BAND** button to select SIRIUS band.
3. Press the **◀** or **▶** cursor button on the front panel to select the desired preset channel.

(Using the remote controller)

1. To select tuner, press the **TUNE** button twice within two seconds on the remote controller.
2. Press the **BAND** button to select SIRIUS band.
3. **◀** or **▶** cursor button to tune in the desired preset channel.
Or enter the preset channel number with the numeric buttons.

CATEGORY SEARCH MODE

You can select the desired channel from the category allocated to each channel.
Category being aired can be only selected.

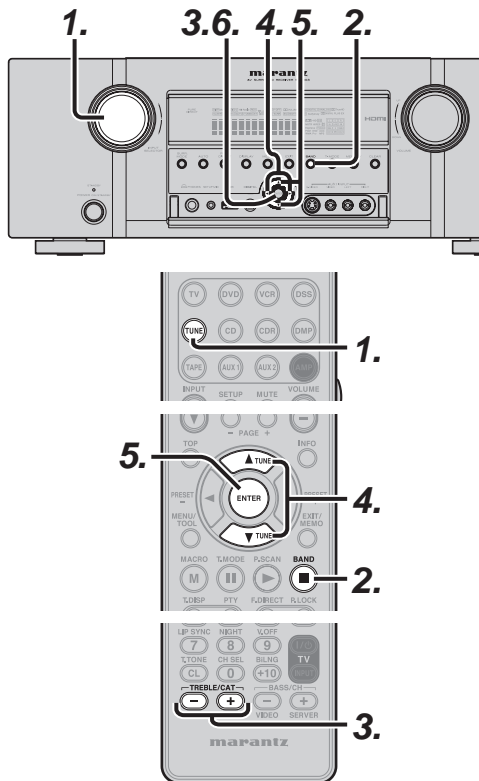

(Using the unit)

1. Turn the **INPUT SELECTOR** knob to select "TUNER".
2. Press the **BAND** button to select SIRIUS band.
3. Press the **ENTER** button on the front panel.
4. Press the **◀** or **▶** button on the front panel to select the desired category.
5. After selecting the category, Press the **▲** or **▼** cursor button to select the desired channel of the category.
6. You can return to the normal mode by press the **ENTER** button during Category Search Mode.

(Using the remote controller)

1. To select tuner, press the **TUNE** button twice within two seconds on the remote controller.
2. Press the **BAND** button to select SIRIUS band.
3. Press the **CAT +** or **-** button.
4. After selecting the category, press the **▲** or **▼** cursor button to select the desired channel of the category.
5. You can return to the normal mode by press the **ENTER** button during Category Search Mode.

Note:

- Category search ends automatically about 10 seconds after the last operation.

CHANNEL DIRECT CALL

You can select the desired channel by directly tapping the numeric keypads on the remote controller.

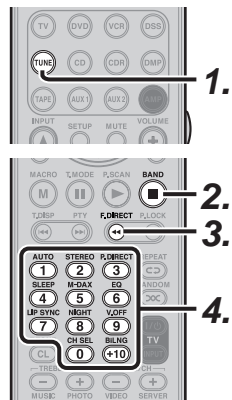

1. To select tuner, press the **TUNE** button twice within two seconds on the remote controller.
2. Press the **BAND** button to select SIRIUS band.
3. Press the **F.DIRECT** button. "SR - - -" will appear on the display.
4. Input the three digit number for your desired channel with the **numeric** keypad on the remote controller.
5. The desired channel will automatically be tuned.

Note:

- If there is no input on the keypad for 5 sec., the input is cancelled to return to the original display.

Notes:

- "UPDATING" is displayed while updating channel map.
- "SUB UPDT" is displayed while updating subscription.
- When the selected channel is not available, "INVALID" is displayed.

PRESET MEMORY

You can store the desired channel in the Preset Memory.

(You can preset 50 SIRIUS Satellite Radio channels in addition to FM/AM stations.)

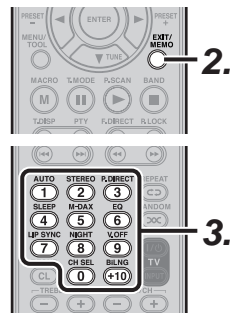
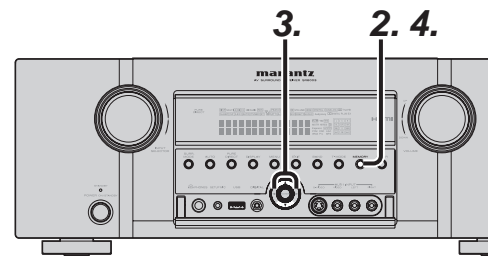

(Using the unit)

1. Tune into the desired channel.
2. Press the **MEMORY** button on the front panel. "- -" (preset number) starts blinking on the display.



3. Select the preset number by pressing the ◀ or ▶ cursor buttons, While this is still blinking (approx. 5 seconds)



4. Press the **MEMORY** button again to enter.

The display stops blinking.

The channel is now stored in the specified preset memory location.

(Using the remote controller)

1. Tune into the desired channel.
2. Press the **MEMO** button on the remote controller. "- -" (preset number) starts blinking on the display.
3. Enter the desired preset number by pressing the **numeric** buttons.

Note:

- When entering a single digit number (2 for example), either input "02" or just input "2" and wait for a few seconds.

CHECKING THE SIRIUS PRESET CHANNEL

The preset channel can be checked on the on screen display.

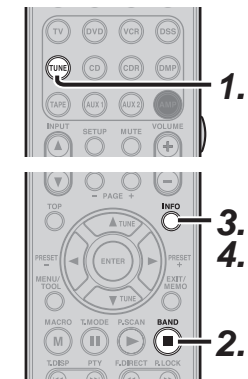

(Using the remote controller)

1. To select tuner, press the **TUNE** button twice within two seconds on the remote controller.
2. Press the **BAND** button to select SIRIUS band.
3. Press the **INFO** button. to view a list of tuner preset channel on the on screen display.
4. If there are 10 or more preset channel, press the **INFO** button again.

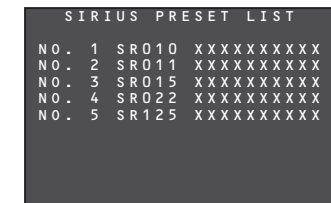

Note:

- The preset channel indication disappears in about 5 sec.

PRESET SCAN

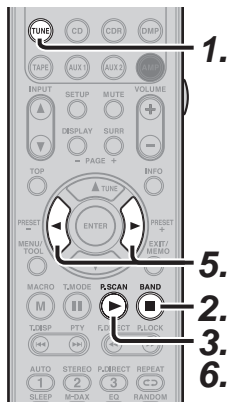

1. Press the **TUNE** button twice within two seconds on the remote controller.
2. Press the **BAND** button to select SIRIUS band.
3. Press the **P.SCAN** button on the remote controller.
4. Preset channels are recalled in sequence (No.1 → No.2 → etc.) for about 10 seconds each. The time changes by the received condition. No stored preset number will be skipped.
5. Pressing the **▶** cursor button during prescanning speeds up scanning. Also, pressing the **◀** cursor button returns to the previous preset channel.
6. When the desired preset channel is received, cancel the preset scan operation by press the **P.SCAN** button.

CLEARING STORED PRESET CHANNELS

You can remove preset channels from the memory using the following procedure.

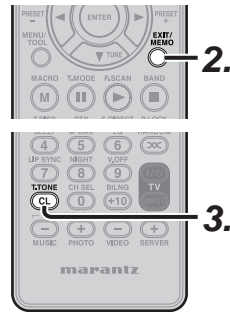
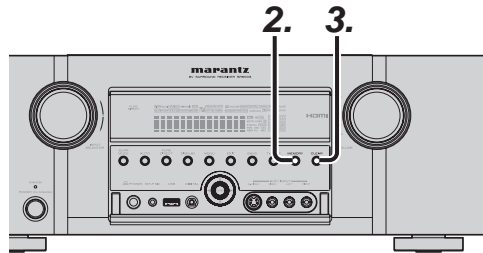

1. Recall the preset number to be cleared with the method described in "PRESET SEARCH MODE".
2. Press the **MEMORY** button on the front panel or the **MEMO** button on the remote controller.
3. The stored preset number blinks in the display for 5 seconds. While blinking, press the **CLEAR** button on the front panel or **CL** button on the remote controller.
4. "xx CLEAR" appears on the display to indicate that the specified preset number has been cleared.

Note:

- To clear all stored preset channels, press and hold the **T-MODE** and the **ENTER** buttons on the unit for two seconds.

PARENTAL LOCK

This function is used to lock channels you do not want to receive.

SETTING/RELEASING PARENTAL LOCK

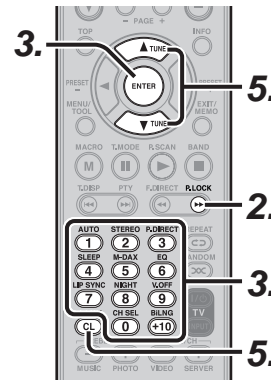
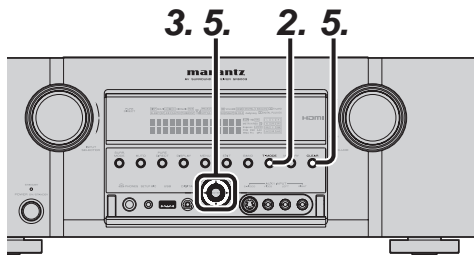

1. Tune to the channel that you want to set parental lock.
2. Press the **T-MODE** button on the main unit or the **P.LOCK** button on the remote controller.

P A S S W O R D * * * *

3. When [PASSWORD ****] appears, use the cursor buttons on the main unit or remote controller, or the numeric buttons on the remote controller, to enter a password (4 digits), then press the **ENTER** button on the main unit or the remote controller.

Note:

The password is set to 9999 when shipped from the factory.

P A S W O R D O K !

S R 0 0 1 ✓ a b c d e f g

4. When the correct password is entered, [PASSWORD OK!] is displayed and the display flashes "✓" or ".".
5. Set parental lock on/off using the **▲ / ▼** cursor buttons on the main unit or remote controller, then confirm the setting using the **ENTER** button on the main unit or remote controller.

"✓" Lock status

":" Unlock status

You can unlock all locked channels at this time by pressing the **CLEAR** button on the main unit or **CL** button on the remote controller for 5 seconds. When "ALL UNLOCK?" is displayed, press the **ENTER** button on the main unit or remote controller. "UNLOCKING.." is displayed and all locked channels are unlocked.

Notes:

- If you mistakenly enter the wrong password, you will be asked to reenter the password.
- You can exit parental lock mode using the **EXIT** button on the main unit or **CLEAR** button on the remote controller.
- No sound will be output when you tune to a locked channel.
- Although parental lock can be set for more than one channel, all channels will share the same password.
- You cannot set Parental Lock for Channel 0.

TEMPORARILY LISTENING TO A LOCKED CHANNEL

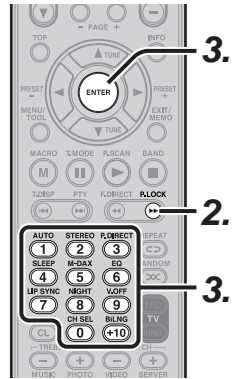
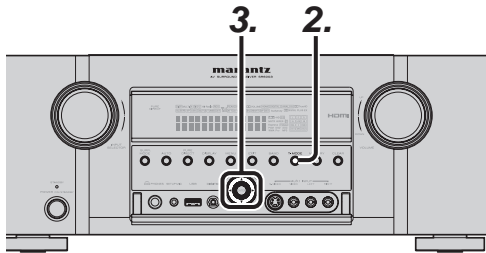

1. Tune to the locked channel you want to listen to.
2. Press the **T-MODE** button on the main unit or the **P.LOCK** button on the remote controller.
3. When [PASSWORD ****] appears, use the cursor buttons on the main unit or remote controller, or the numeric buttons on the remote controller, to enter a password (4 digits), then press the **ENTER** button on the main unit or remote controller.
4. When the correct password is entered, [PASSWORD OK!] is displayed and you can temporarily listen to the channel.

Note:

- You can cancel temporary listening by pressing the **EXIT** button on the main unit or **CL** button on the remote controller.
- Since the purpose is to listen temporarily to a locked channel, lock status is restored if the channel is changed, the function is changed, the power is turned on/off, or any other such operation is performed. If you want to release lock status, see “Setting/Releasing Parental Lock.”

CHANGING THE PASSWORD

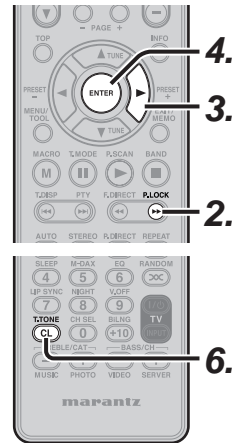
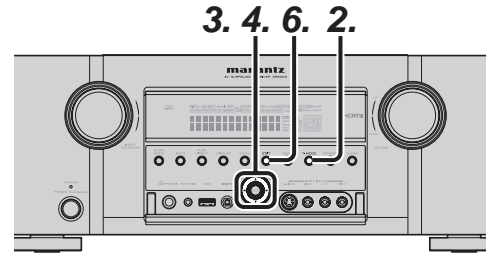

1. Set to receive SIRIUS Satellite Radio.
2. Press the **T-MODE** button on the main unit or the **P.LOCK** button on the remote controller.
3. When [PASSWORD ****] appears, use the cursor buttons on the main unit or remote controller, or the numeric button on the remote controller, to enter a password (4 digits), then, with the cursor located at the far right, press the **▶** cursor button on the main unit or remote controller.



4. When [NEW WORD _ _ _ _] is displayed, enter a new password, then press the **ENTER** button on the main unit or remote controller.



5. When [WORD CHANGED] is displayed, the password has been changed.
6. Press the **EXIT** button on the main unit or **CL** button on the remote controller.

Note:

If the unit is reset the password will be reset to 9999. (See page 77)

ZONE SYSTEM

The ZONE System mode allows the same source or different sources to be heard in two ZONES other than where this unit is installed.

To use the ZONE system, connect the audio from the ZONE OUT A and B AUDIO output terminals to the ZONE A and B amps.

If a surround back channel speaker or speaker C (see page 20) are not used in the ZONE where this unit is installed, the ZONE speaker system can be used with the amp for the surround back channel.

This unit supports ZONE system functions such as source selectors, ZONE speaker output, sleep timers and remote control.

ZONE PLAYBACK USING THE ZONE OUT TERMINALS

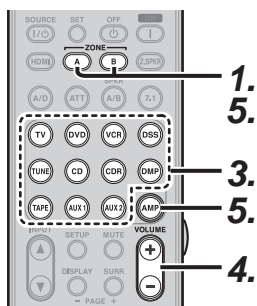
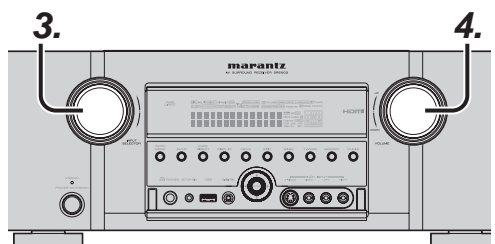

1. Press the **ZONE A** or **B** button on the remote controller.

2. When the ZONE setting mode is engaged, one of the following screens appears on the display for 10 seconds.

* Display when ZONE A is selected

Z A D V D - 1 8 d B

* Display when ZONE B is selected

Z B D V D (D 2)

3. Select the input source using the **INPUT SELECTOR** knob on the main unit or the function button on the remote controller.
4. Set the ZONE volume to be used by the ZONE system to taste either by turning the **VOLUME** knob on the main unit or by pressing the **VOLUME +/-** buttons on the remote controller.

Note:

- The sleep timer, monaural output and other features can also be set using the MAIN MENU. (See page 39)
 - The volume for ZONE B cannot be set on the main unit. Control the volume by adjusting it on the amp connected to ZONE B OUT.
5. To cancel this function, press the **ZONE A** or **B** button on the remote controller (after pressing the AMP button on the remote controller). "MULTI" indicator on the front panel will be turned off.

ZONE PLAYBACK USING THE ZONE SPEAKER A TERMINALS

This unit allows you to connect another set of speakers amp and place them in a different ZONE or separated area for listening to music.

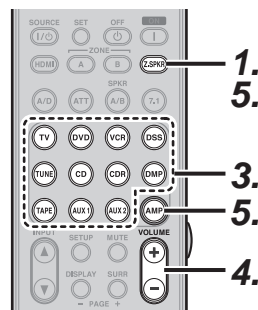
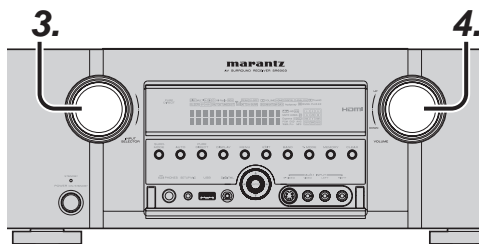

1. Press the **ZONE SPEAKER (Z.SPKR)** button on the remote controller.
2. When the ZONE SPEAKER setting mode is engaged, one of the following screens appears on the display for 10 seconds.

* Display when ZONE SPEAKER A is selected

Z S A D V D - 1 8 d B

3. Select the input source using the **INPUT SELECTOR** knob on the main unit or the function button on the remote controller.
4. Set the ZONE volume to be used by the ZONE system to your own preference, either by turning the **VOLUME** knob on the main unit or by pressing the **VOLUME +/-** buttons on the remote controller.
5. To cancel this function, press the **Z.SPKR** button on the remote controller (after pressing the AMP button on the remote controller). "MULTI" indicator on the front panel will be turned off.

Note:

- The sleep timer, monaural output and other features can also be set using the MAIN MENU. (See page 39.)

Notes for ZONE Speaker

- The ZONE Speaker mode can be set for only one of the ZONE A.
- The ZONE SPEAKER output can be used when Surround Back Speaker = "NONE, Z-SPK" in the SPEAKER SETUP menu. (See SPEAKER SETUP, page 33)
- "The Surr. Back Speakers are in use" is displayed when the **ZONE SPEAKER** button is pressed when the Surround Back Speaker is not set to "NONE, Z-SPK" in the SPEAKER SETUP menu. (See SPEAKER SETUP, page 33)
- The ZONE speaker mode cannot be used at the same time as the speaker C. When connecting for ZONE use, set the **SPEAKER C** selector switch on the rear panel to OFF.
- When the unit is put in ZONE SPEAKER mode and ZSP A has been set as the Surround Back Speaker (page 21), the ZONE SPEAKER function can be turned on automatically simply by pressing the SOURCE button.

OPERATION OF THE MULTI ZONE OUTPUTS WITH THE REMOTE CONTROL FROM ZONE A

The following operations can be performed when using an RC101 remote controller (sold separately).

CHANGE THE ZONE CONTROL COMMANDS (RC101) FOR ZONE A

ZONE A output can be operated from a room where the unit is not installed. This requires a separately sold IR receiver. (For connections, see page 21.)

(When operating the unit by Multi ZONE connected)

- ZONE A: ZONE A Control (Default)
- ZONE B: ZONE B Control

Change the control commands for each ZONE.

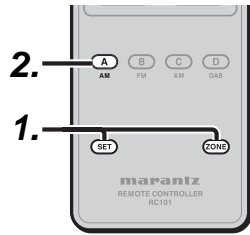

1. Press **SET** button and **ZONE** button until the SEND indicator blinks twice. Then backlight flashes.
2. Press **A** ZONE button. When the procedure is successful, the SEND indicator will blink twice.

These buttons change a special code of each ZONE.

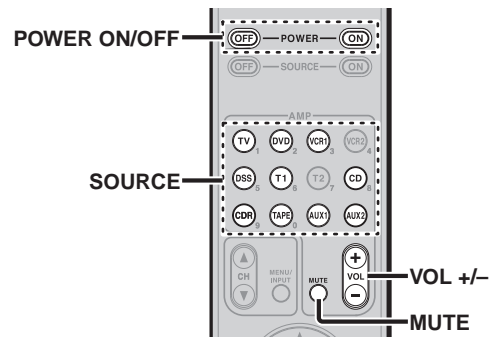

Notes for the Multi ZONE System

- If the Tuner (FM or AM) is active in the main ZONE, you can not control any function of the tuner. In this case, You must listen to the same station as the main ZONE.
- DMP (USB) operations cannot be performed using RC101 (sold separately).

OPERATION OF THE MULTI ZONE OUTPUTS WITH THE REMOTE CONTROL FROM ZONE B

The following operations can be performed when using an RC101 remote controller (sold separately).

CHANGE THE ZONE CONTROL COMMANDS (RC101) FOR ZONE B

ZONE B output can be operated from a room where the unit is not installed. This requires a separately sold IR receiver. (For connections, see page 21.)

Change the control commands for each ZONE.

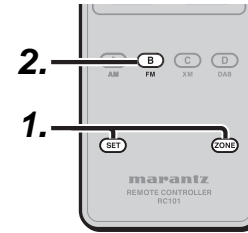

1. Press **SET** button and **ZONE** button until the SEND indicator blinks twice. Then backlight flashes.
2. Press **B** ZONE button. When the procedure is successful, the SEND indicator will blink twice.

These buttons change a special code of each ZONE.

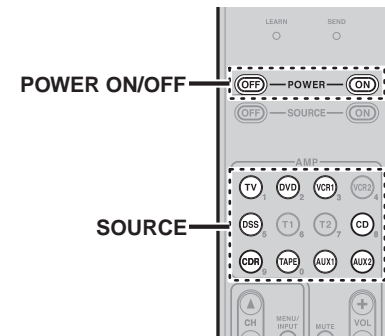

OPERATION OF THE ZONE SPEAKER OUTPUTS WITH THE REMOTE CONTROL

To switch to ZONE SPEAKER SYSTEM A control, perform the following operations with the RC101 set to ZONE A.

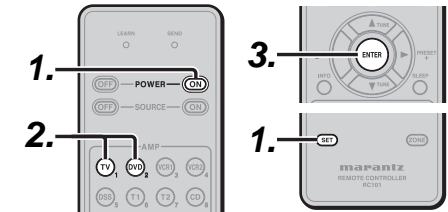

1. Press **SET** button and **POWER ON** button until the SEND indicator blinks twice. Then backlight flashes.
2. Press the **DVD** button.

Note

Press the TV button at this time to return to the ZONE settings.

3. Press **ENTER** button once to lock in the code. When the procedure is successful, the SEND indicator will blink twice.

REMOTE CONTROLLER OPERATION

CONTROLLING MARANTZ COMPONENTS

1. Press the desired **SOURCE** button.
2. Press the desired operation buttons to play the selected component.
 - For details, refer to the component's user guide.
 - It may not be possible to operate some models.

CONTROLLING A MARANTZ TV (TV MODE)

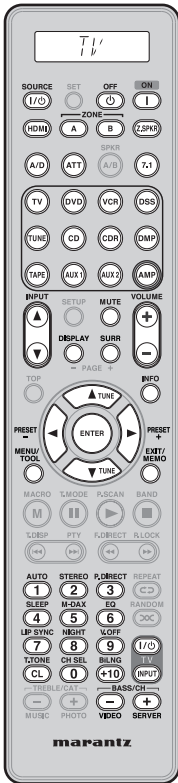

SOURCE ON/OFF	Turns the TV on and off
POWER OFF	Turns the TV off(*)
POWER ON	Turns the TV on(*)
HDMI	AMP function enabled
Z.SPKR	AMP function enabled
ZONE A/B	AMP function enabled
A/D	AMP function enabled
ATT	AMP function enabled
SPKR A/B	AMP function enabled
7.1 IN	AMP function enabled
SOURCE	AMP function enabled
AMP	AMP function enabled
INPUT ▲ / ▼	AMP function enabled
DISPLAY	AMP function enabled
MUTE	AMP function enabled
SURR	AMP function enabled
VOLUME+/-	AMP function enabled
INFO	Display the information of TV(*)
Cursor	Moves the cursor for setting (*)
ENTER	Enters the setting(*)
MENU	Calls up the menu(*)
EXIT	Exits from MENU(*)
0-9,+10	Inputs the numeric(*)
T.TONE(CL)	Clears the inputting(*)
TV POWER	Turns the TV on and off
TV INPUT	Select the TV video input
BASS/CH	Selects TV channel up or down

(*) RC003SR dose not have the PRESET code library for this key

CONTROLLING A MARANTZ DVD (DVD MODE)

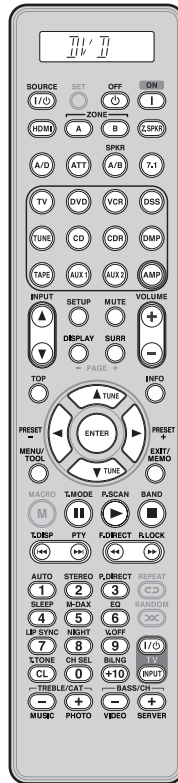

SOURCE ON/OFF	Turns the DVD player on and off
POWER OFF	Turns the DVD player off(*)
POWER ON	Turns the DVD player on(*)
HDMI	AMP function enabled
Z.SPKR	AMP function enabled
ZONE A/B	AMP function enabled
A/D	AMP function enabled
ATT	AMP function enabled
7.1 IN	AMP function enabled
SPKR A/B	AMP function enabled
SOURCE	AMP function enabled
AMP	AMP function enabled
INPUT ▲ / ▼	AMP function enabled
SETUP	Calls up the setup menu of the DVD player(*)
DISPLAY	AMP function enabled
MUTE	AMP function enabled
SURR	AMP function enabled
VOLUME+/-	AMP function enabled
TOP	Calls up the top menu of DVD disc(*)
INFO	Displays the disc information(*)
Cursor	"Moves the cursor for setting in "On Screen Display" mode
ENTER	Enters the setting
MENU	Calls up the menu of DVD disc
EXIT	Exits from SETUP MENU(*)
PAUSE	PAUSE
PLAY	PLAY
STOP	STOP
Previous/Next	Skips forward or previous chapter/track
Rewind/Forward	Searchs forward or backward
0-9,+10	Inputs the numeric(*)
T.TONE(CL)	Clears the inputting(*)
REPEAT	Select REPEAT PLAY(*)
RANDOM	Select RANDOM PLAY(*)
TV POWER	Turns the TV on and off
TV INPUT	Select the TV video input
TREBLE-/+	AMP function enabled
BASS-/+	AMP function enabled

(*) RC003SR dose not have the PRESET code library for this key

CONTROLLING A MARANTZ DSS (DSS MODE)

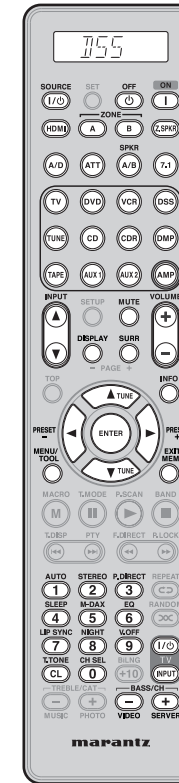

SOURCE ON/OFF	Turns the satellite broadcasting tuner on and off
HDMI	AMP function enabled
Z.SPKR	AMP function enabled
ZONE A/B	AMP function enabled
A/D	AMP function enabled
ATT	AMP function enabled
7.1 IN	AMP function enabled
SPKR A/B	AMP function enabled
SOURCE	AMP function enabled
AMP	AMP function enabled
INPUT ▲ / ▼	AMP function enabled
DISPLAY	AMP function enabled
MUTE	AMP function enabled
SURR	AMP function enabled
VOLUME+/-	AMP function enabled
INFO	Display the information of the satellite broadcasting tuner(*)
Cursor	Moves the cursor for setting
ENTER	Enters the setting
MENU	Calls up the menu
EXIT	Exits from MENU(*)
0-9	Inputs the numeric
T.TONE(CL)	Clears the inputting(*)
TV POWER	Turns the TV on and off
TV INPUT	Select the TV video input
BASS/CH	Selects the satellite broadcasting tuner channel up or down

(*) RC003SR dose not have the PRESET code library for this key

CONTROLLING A MARANTZ CD (CD MODE)

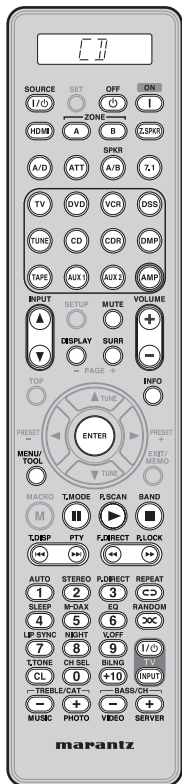

SOURCE ON/OFF	Turns the CD player on and off
POWER OFF	Turns the CD player off(*)
POWER ON	Turns the CD player on(*)
HDMI	AMP function enabled
Z.SPKR	AMP function enabled
ZONE A/B	AMP function enabled
A/D	AMP function enabled
ATT	AMP function enabled
SPKR A/B	AMP function enabled
7.1 IN	AMP function enabled
SOURCE	AMP function enabled
AMP	AMP function enabled
INPUT ▲ / ▼	AMP function enabled
DISPLAY	AMP function enabled
MUTE	AMP function enabled
SURR	AMP function enabled
VOLUME+/-	AMP function enabled
INFO	AMP function enabled
ENTER	Enters the setting(*)
MENU	Calls up the menu(*)
PAUSE	PAUSE
PLAY	PLAY
STOP	STOP
Previous/Next	Skips forward or previous chapter/track
Rewind/Forward	Searchs forward or backward
0-9,+10	Inputs the numeric(*)
T.TONE(CL)	Clears the inputting(*)
REPEAT	Select REPEAT PLAY(*)
RANDOM	Select RANDOM PLAY(*)
TV POWER	Turns the TV on and off
TV INPUT	Select the TV video input
TREBLE-/+	AMP function enabled
BASS-/+	AMP function enabled

(*) RC003SR dose not have the PRESET code library for this key

CONTROLLING A MARANTZ TAPE DECK (TAPE MODE)

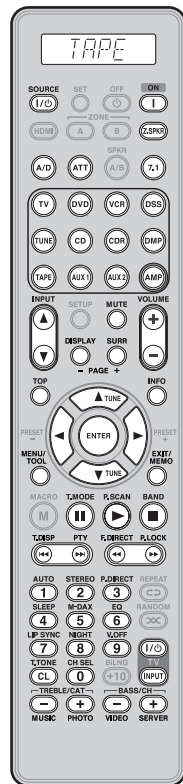

SOURCE ON/OFF	Turns the TAPE deck on and off
POWER OFF	Turns the TAPE deck off
POWER ON	Turns the TAPE deck on
HDMI	AMP function enabled
Z.SPKR	AMP function enabled
ZONE A/B	AMP function enabled
A/D	AMP function enabled
ATT	AMP function enabled
7.1 IN	AMP function enabled
SPKR A/B	AMP function enabled
SOURCE	AMP function enabled
AMP	AMP function enabled
INPUT ▲ / ▼	AMP function enabled
DISPLAY	AMP function enabled
MUTE	AMP function enabled
SURR	AMP function enabled
VOLUME+/-	AMP function enabled
TOP	AMP function enabled
INFO	AMP function enabled
Cursor	AMP function enabled
ENTER	AMP function enabled
MENU	AMP function enabled
EXIT	AMP function enabled
PAUSE	PAUSE
PLAY	PLAY
STOP	STOP
Previous/Next	Skips forward or previous chapter/track
Rewind/Forward	Searchs forward or backward
0-9	Inputs the numeric
T.TONE(CL)	Clears the inputting
TV POWER	Turns the TV on and off
TV INPUT	Select the TV video input
TREBLE-/+	AMP function enabled
BASS-/+	AMP function enabled

RC003SR dose not have the PRESET code library for this device

CONTROLLING A MARANTZ UNIVERSAL DOCK (AUX MODE)

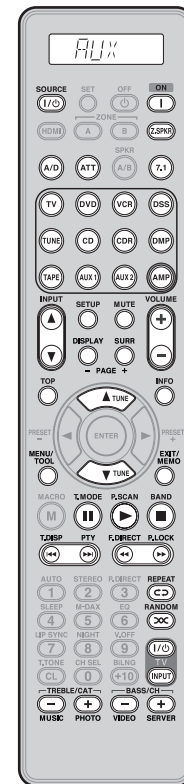

SOURCE ON/OFF	Turns the UNIVERSAL DOCK (Dock connector) ON and OFF
POWER OFF	Turns the UNIVERSAL DOCK (Dock connector) OFF
POWER ON	Turns the UNIVERSAL DOCK (Dock connector) ON
HDMI	AMP function enabled
Z.SPKR	AMP function enabled
ZONE A/B	AMP function enabled
A/D	AMP function enabled
ATT	AMP function enabled
7.1 IN	AMP function enabled
SPKR A/B	AMP function enabled
SOURCE	AMP function enabled
AMP	AMP function enabled
INPUT ▲ / ▼	AMP function enabled
SETUP	MODE
DISPLAY	AMP function enabled
MUTE	AMP function enabled
SURR	AMP function enabled
VOLUME+/-	AMP function enabled
INFO	AMP function enabled
Cursor Up	Select contents Up
ENTER	Enter the setting
Cursor Down	Select contents Down
MENU	Call up the menu
PAUSE	PAUSE
PLAY	PLAY
STOP	STOP
Previous/Next	Skips forward or previous chapter/track
Rewind/Forward	Searchs forward or backward
REPEAT	Select REPEAT PLAY
RANDOM	Select RANDOM PLAY
TV POWER	Turns the TV on and off
TV INPUT	Select the TV video input
TREBLE-/+	AMP function enabled
BASS-/+	AMP function enabled

RC003SR dose not have the PRESET code library for this device

BASIC OPERATION (REMOTE CONTROLLER)

NORMAL MODE

(When operating Marantz AV equipment products)

This remote controller is preset with a total of 12 types of remote codes, including Marantz TV (television), DVD, VCR (VCR deck), DSS (satellite broadcasting tuner), TUNER, CD, CD-R, DMP, TAPE (tape deck), AUX1, AUX2, and AMP (amplifier).

Learning is not necessary for Marantz products. You can use these products without setting any codes.

1. Press the **SOURCE** button.
For this example, press DVD.
Pressing the **SOURCE** button once changes the remote control to the settings for the source that was pressed.
To change the amplifier on other source, press the **SOURCE** button twice (double-click). The code is sent, and then the amplifier source changes to DVD.

SETTING THE BACK LIGHT

Pressing the Light button located on the side of the remote controller lights the remote controller's backlight. Pressing the button again while the backlight is lit lights the backlight for another 2 seconds.
To turn off back light, press and hold down the **SET** and **OFF** button until indicator blinks twice.
To turn on it again, press and hold down the **SET** and **ON** button until indicator blinks twice.
Initial is back light ON.

PRESET MODE

(When operating non-Marantz AV equipment products)

This remote controller is preset with remote control codes from AV equipment by other manufacturers. The preset codes are TV, CD, DVD and DSS. Settings can be made in one of two ways.

When the preset codes are set, the following codes are contained in the source button of the remote controller.

See the attached manufacturer number list for the preset manufacturers, devices, preset numbers, and other settings.

Remote controller source name	Corresponding preset code	Device name
TV	TV	Television
DVD	DVD	DVD player
CD	CD	CD player
DSS	SATELLITE	Satellite broadcasting tuner equipment

Importants:

- Some codes may be not match your equipment. In this case, you can use LEARN mode to store these codes.
- The preset codes do not cover full functions. If you need extra function, use LEARN mode to store extra function.
- When the batteries are getting weak, the preset procedure is not successful.

PROGRAMMING WITH THE 4-DIGIT CODE

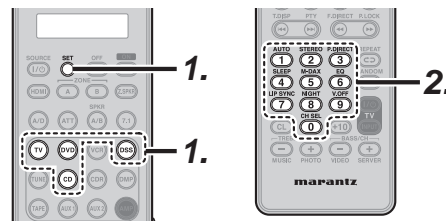

1. Press and hold down the **SOURCE** button for the appliance which should be controlled and press **SET** button until the indicator blinks twice. Then back light flashes.
2. Press the 4-digit code by **numeric** buttons for appliance (code table at the end of this book) Display 4-digit code on the LCD.



When the procedure is successful, "OK" is displayed on the LCD.



Note:

If "NG" is displayed on the LCD, then repeat steps 1 through 2 and try entering the same code again.



SCANNING THE CODE TABLE

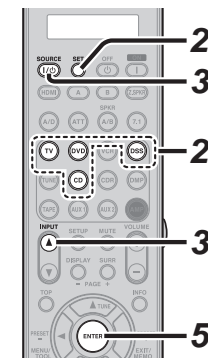

1. Switch on the appliance which should be controlled.
2. Press and hold down the **SOURCE** button for appliance which should be controlled and press **SET** button until the indicator blinks twice. Then back light flashes.
3. Aim the remote control at the appliance and slowly alternate between pressing **INPUT** button and the **SOURCE ON/OFF** button for the appliance.
Display the setup number on the LCD.
4. Stop when the appliance turns off.
5. Press **ENTER** button once to lock in the code.



CHECKING THE CODE

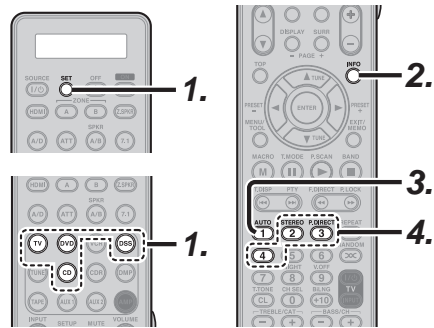

1. Press and hold down the **SOURCE** button for appliance which should be controlled and press **SET** button until the indicator blinking twice then back light flashes.
2. Press the **INFO** button.
The indicator will blink twice.
3. To setup code for all digits is displayed on the LCD in 3 seconds.

RESETTING THE CODE

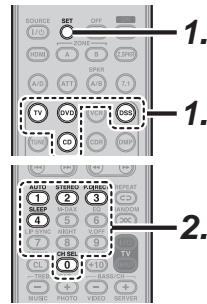

1. Press and hold down the **SOURCE** button for appliance which should be controlled and press **SET** button until the indicator blinking twice.
Then back light flashes.
2. Press the below codes to reset.
TV : 1000
DVD : 2000
CD : 3000
DSS : 4000



Note:
After this procedure, the selected **SOURCE** button is set initial code.

LEARN MODE

This remote controller is capable of learning and storing codes used by other remote controls that you already own.

For codes which are not learned, the remote controller will transmit either the Marantz preset codes from the initial settings, or remote codes from another manufacturer's AV equipment which is set by the customer.

The receiver sensor for the remote controller signals is located at the top of the remote controller.

- Notes:**
- This remote controller is capable to learn around 120 codes.
 - When the batteries are getting weak, the learning procedure is not successful.

LEARNING PROCEDURE

1. Place the remote controller so that its infrared signal transmitter is facing the infrared signal receiver on the Marantz remote controller at a distance of about 0.05 m (2 inches).

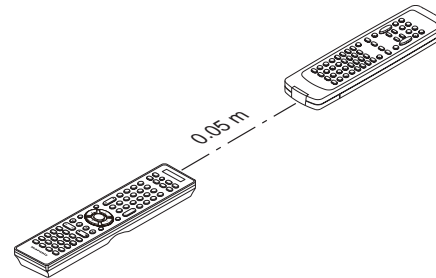

2. Press and hold down the **SET** and **SETUP** buttons until LEARN indicator blinks.

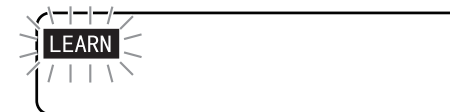

3. Select the **SOURCE** button to select the SOURCE, the SOURCE name is displayed on the LCD.

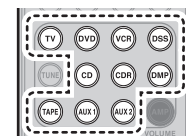

4. Select the button to be learned.
 - LEARN indicator stop to blink.

- Notes:**
- The learning function is unavailable for all SOURCE buttons and HDMI button in any mode.
 - The learning function is unavailable for all buttons in TUNER mode and AMP mode.

5. Press and hold the button of the original remote controller to learn until "OK" is displayed on the LCD.



- When "NG" is displayed on the LCD, repeat this step.



- When the memory of the remote controller is full, "FULL" is displayed on the LCD. If you want to learn the code, you should erase other learned button.



6. Repeat steps 4 and 5 to learn other buttons in same SOURCE.
7. Repeat steps 3 to 6 to learn other SOURCE.
8. When you have finished programming the remote controller, press the **SET** button, then LEARN indicator stops blinking and exits from the LEARN mode.



- Notes:**
- When "NG" is displayed on the LCD once again, the transmitting code is unavailable for remote controller, or the transmitting signal is intercepted by noise.
 - If no buttons are pressed for approximately 1 minute while in the LEARN mode, the remote controller automatically exits from the LEARN mode.

**ERASING PROGRAMMED CODES
(RETURNING TO INITIAL SETTINGS)**

Codes can be erased in three ways: by buttons, sources, and by all memory contents.

Erasing the code by buttons

1. Press and hold down the **SET** and **SETUP** buttons until LEARN indicator blinks.

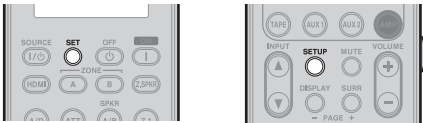

2. Select the **SOURCE** button to select the button to be erased.

The source name is displayed on the LCD.

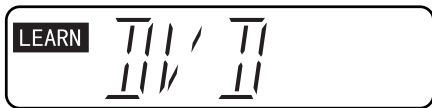
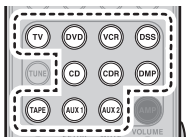

3. Press and hold down the **HDMI** button and press the learned button twice to be erased.
 - "ERASE" is displayed on the LCD and the mode returns to LEARN mode.



4. To return the NORMAL mode, press the **SET** button.

Erasing the code by SOURCE

1. Press and hold down the **SET** and **SETUP** buttons until LEARN indicator blinks.

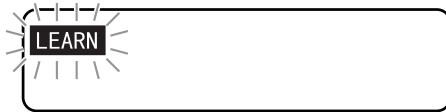
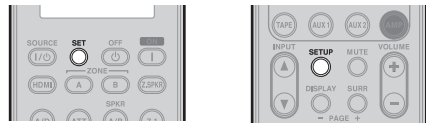

2. Press and hold down the **HDMI** button and press the learned **SOURCE** button twice to be erased.
 - "ERASE" is displayed on the LCD.

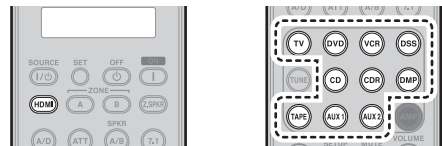

3. Press **ENTER** button to continue erasing.
 - The indicator blinks twice and the mode returns to LEARN mode.
 - To cancel the erasing operation, do not press **ENTER** button and simply touch any other button.

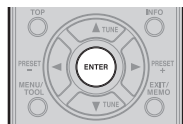

4. To return the NORMAL mode, press the **SET** button.

Erasing the all SOURCES

1. Press and hold down the **SET** and **SETUP** buttons until LEARN indicator blinks.

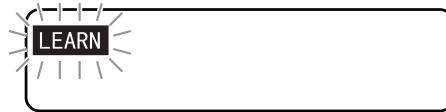

2. Press and hold down the **HDMI** button and press **POWER ON** and **POWER OFF** button.
 - LEARN indicator lights.



3. Press **ENTER** button to continue erasing.
 - "ERASE" is displayed on the LCD and the mode returns to LEARN mode.



- To cancel the erasing operation, do not press **ENTER** button and simply touch any other button.

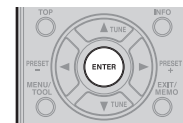

4. To return the NORMAL mode, press the **SET** button.

Note:

Erasing codes will return to the factory preset code, or there will leave empty if the button has no factory preset code.

MACRO MODE

PROGRAMMING MACROS

Macros make it possible to use a single function button to perform more complex series of operations that would normally require pressing several buttons. A single MACRO can be programmed to perform up to 10 steps in sequence. A typical example of such a series might be as follows:

- Turn this unit's power on
 - Switch this unit's input source to DVD
 - Turn the TV's power on
 - Set the DVD player to play.
 - No signals may be transmitted during macro programming.
 - The various steps that make up a macro are set initially to be sent one after another in 1 second intervals, however these intervals may be shortened to as little as 0.5 seconds or lengthened to as much as 5 seconds using the setup mode.
 - In the macro mode, the number of steps the macro is displayed with Macro list number.
 - Macros may be programmed 6 list.
- MACRO** button + numeric button (Example : Macro list No.1 → **MACRO** button + "1")

● **Program method of MACRO**

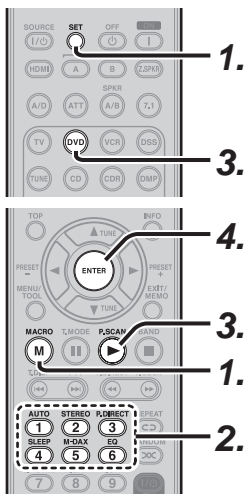

1. Press and hold the **SET** and **MACRO** button until the **LEARN**, **MACRO** indicators and **MACRO** are displayed blinking on the LCD.



2. Press the **numeric** button for which you wish to program a series of operations. Press the 1 button.
 - "M1-01" is displayed on the LCD.



3. Press the function buttons and command button for the operations you wish to program as a macro in the sequence. For example, press **DVD** button and **PLAY** button. Press **DVD** Button (DVD Function)



Press **PLAY** Button (Fixed 1st step)



- The number of steps in the macro is displayed on LCD and this number increases by 1 with each button pressed.
- Each macro number can be programmed to perform up to 10 steps in sequence.

Note:

When programming the amplifier's input source in the macro program, first press the **AMP** button, and press the source button. (In the case of DVD input: **AMP** → **DVD**)

4. When you are finished programming macros, press and hold the **ENTER** button until the display returns to normal mode (Turn off the **LEARN** and **MACRO** indicators) .

- In the macro mode, it is possible to program the memory to perform macros containing up to 10 steps.
- Macros cannot be programmed for the **MEMO**, **cursor**, **ENTER**, **VOLUME+/-** and **CL** buttons.

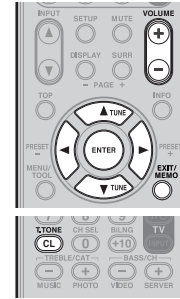

Note:

If, while programming, no buttons are pressed for approximately 1 minute, the remote controller will automatically return to normal mode, and no macro will be programmed in the memory.

CONFIRMING MACROS

Macros may be confirmed using following procedure.

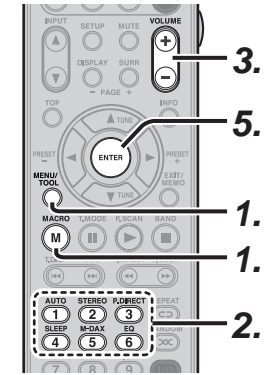

1. Press and hold the **MACRO** and **MENU** buttons until the **LEARN**, **MACRO** indicators and **MACRO** are displayed blinking on the LCD.



2. Press the **numeric** button to be confirmed. Let's use the example of macro number 1, by pressing "1" button.
 - **LEARN**, **MACRO** indicators and **M1-01** are displayed blinking.

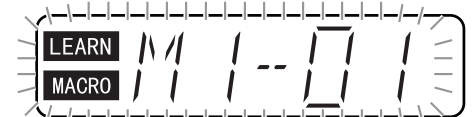

3. Press the **VOLUME** button.
 - **M1-01** is displayed and **LEARN** is disappeared.



- The programmed operation is transmitting.

- Repeat step 3. until the last number of the macro is displayed.
 - The display will return to step 1.
 - The each programmed operation is transmitting when the number of the macro is displayed.
- To return the normal mode, press and hold down the **ENTER** button until MACRO is disappeared on the LCD.

EDITING MACROS

Macros may be edited using following procedure.

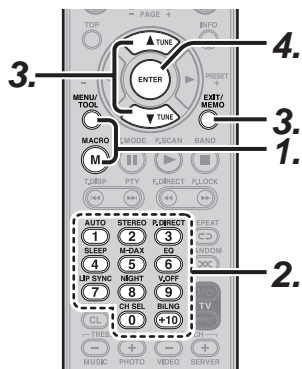

- Press and hold the **MACRO** and **MENU** button until the LEARN, MACRO indicators and MACRO are displayed blinking on the LCD.



- Press the **numeric** button to be changed. Let's use the example of programmed MACRO 1, by pressing "1" button.
 - LEARN, MACRO indicators and M1-01 is displayed blinking.

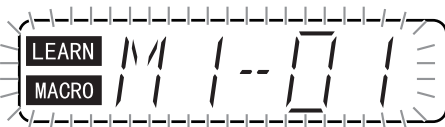

- Press the cursor button (**▲** or **▼**) to select the number of macro to be edited.
 - The programmed operation is displayed after the number of macro is displayed.
 - The number of macro can be changed with the cursor button.
 - To rewrite an existing macro step, simply press function button and programmed for the new step. The old step will be erased and rewritten with the new step.
 - To insert a new step in between existing steps in a macro, after step 3. press the **MEMO** button, then press the button for the new step. The numbers of the other steps will be adjusted accordingly to accommodate the new step. Since only 10 steps may be stored in any macro, the tenth step will be erased if an step is inserted when the total number of steps is already 10.
 - To erase a step in a macro, after step 3. call up the number of the step to be erased and press the **CL** button.

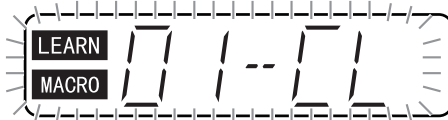

- Press the **ENTER** button to return step 1.
- To return the normal mode, press and hold down the **ENTER** button until MACRO is disappeared on the LCD.

USING MACROS

The following procedure will show how to use macro buttons for which you have programmed macros.

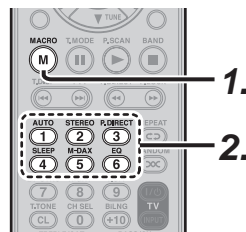

- Press the **MACRO** button
 - MACRO indicator and MACRO is displayed on the LCD.
- Press the **numeric** button for programmed number and send the programmed code step by step.

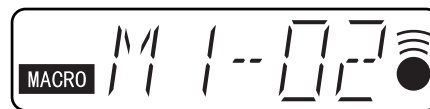
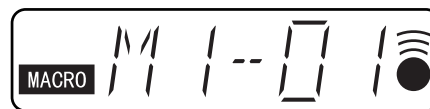

- The remote controller will do nothing if no macros are programmed. The macro steps are executed in order. Also, the step numbers displayed on LCD disappear as each step is executed.
- After all macro commands have been transmitted, the remote controller returns to AMP in normal mode.

EXAMPLES OF MACRO PROGRAMS

Example 1

Change the input source for the unit to CD and play the 3rd track on a CD in the CD player.

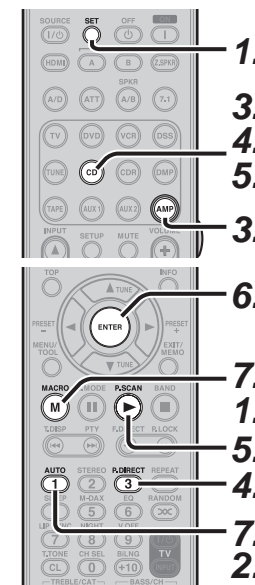

- Press and hold the **MACRO** and **SET** button until the LEARN, MACRO indicators and MACRO are displayed blinking on the LCD.



- Press the "1" button. M1-01 is displayed on the LCD.



3. Press the **AMP** button and **CD** button. M1-02 is displayed on the LCD.

Press the **AMP**.



Press the **CD**.

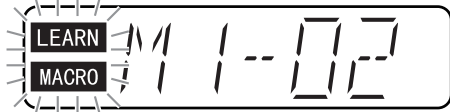

4. Press the **CD** button and "3" button. M1-03 is displayed on the LCD.

Press the **CD**.



Press the "3".

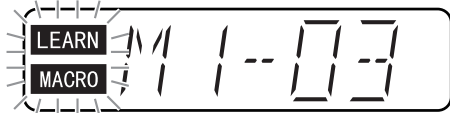

5. Press the **CD** button and **▶** button.

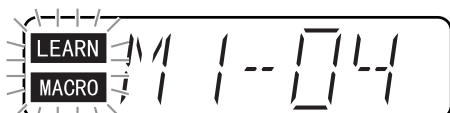

6. When you are finished programming the macro, press the **ENTER** button until the **MACRO** indicator is disappeared and returns to normal mode.

Now, execute the macro you just programmed.

7. Press the **MACRO** button and "1" button.
- The macro commands are transmitted to the components in order, and the steps of the operations are displayed on the LCD in order.

Note:

When programming the amplifier's input source in the macro program, first press the **AMP** button, and press the source button.

(In the case of DVD input: AMP → CD)

Example 2

Turn this unit's power on

Turn the DVD player's power on

Change this unit's input source to DVD

Set the DVD player to play

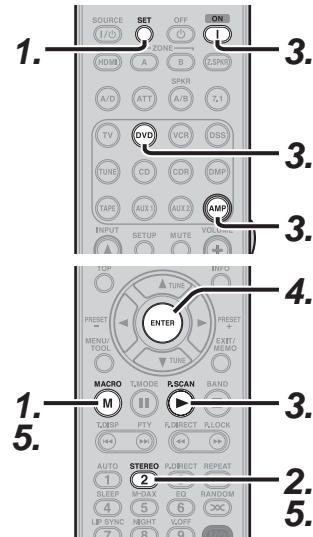

1. Press and hold the **MACRO** and **SET** buttons until the **LEARN**, **MACRO** indicators and **MACRO** are displayed blinking on the LCD.



2. Press the "2" button. M2-01 is displayed on the LCD.

3. To set the various steps of the macro, press the following buttons in order:

(1) **AMP** → **POWER ON**.

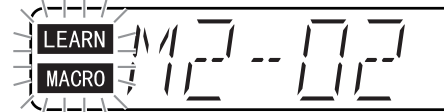

(2) **DVD** → **POWER ON**.



(3) **AMP** → **DVD**.

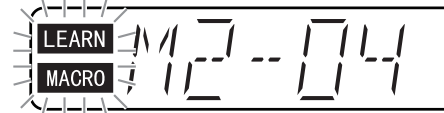

(4) **DVD** → **PLAY**.

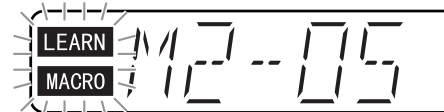

4. When you are finished programming the macro, press the **ENTER** button until **MACRO** indicator is disappeared on the LCD and returns to normal mode.

Now, execute the macro you just programmed.

5. Press the **MACRO** button and "2" button.

- The macro commands are transmitted to the components in order, and the steps of the operations are displayed on the LCD in order.

CLEARING MACRO PROGRAMS

The following procedure is used to erase macros you have programmed into the remote controller's memory.

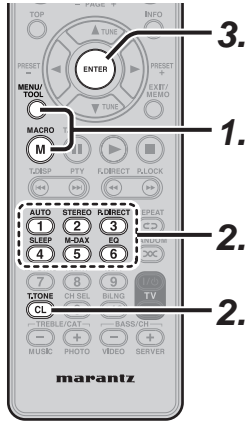

1. Press and hold the **MACRO** and **MENU** button until the LEARN, MACRO indicators and MACRO are displayed blinking on the LCD.



2. Press and hold the **CL** button, then press the button for the **numeric** button to be cleared for 3 seconds. (in this case "2")
 - M2-CL will be displayed blinking on the LCD.

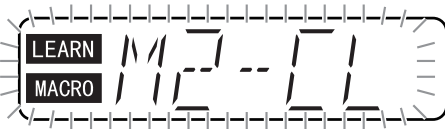

3. Press the **ENTER** button to clear and return step 1.
 - To cancel the memory clearing operation, do not press **ENTER** button and simply touch any other button.

4. To return the normal mode, press and hold down the **ENTER** button until MACRO indicator is disappeared on the LCD and returns to normal mode.

ADJUSTING THE INTERVAL TIME OF MACRO OPERATIONS TRANSMITTING

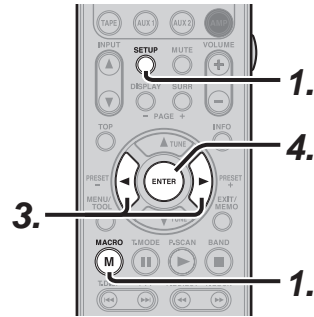

1. Press and hold the **MACRO** and **SETUP** button until the SETUP is displayed on the LCD.
 - SETUP is displayed for 3 seconds.



2. Confirm the display changes from SETUP to MCRxx. ("xx" means the interval time of macro operations transmitting)



3. Press the cursor button (◀ or ▶) to change the interval time.
 - The interval time can be changed from 0.5 to 5 seconds by 0.5 seconds step.
4. Press and hold down the **ENTER** button until MACRO indicator is disappeared on the LCD and returns to normal mode.

TROUBLESHOOTING

In case of trouble, check the following before calling for service:

1. Are the connections made properly ?
2. Are you operating the unit properly following the user's guide ?
3. Are the power amplifiers and speaker working properly ?

If the unit does not operate properly, check items shown in the following table.

If your trouble cannot be recovered with the remedy actions listed in the following table, malfunction of the internal circuitry is suspected; immediately unplug the power cable and contact your dealer, nearest Marantz authorized dealer or the Marantz Service Center in your country.

SYMPTOM	CAUSE	REMEDY
This unit cannot be turned up.	The power plug is not connected.	Connect the power plug to the outlet.
No sound and picture are output even when power is on.	Mute is on.	Cancel mute using the remote controller.
	The input cable is not connected correctly.	See the connection diagram and connect the cables correctly.
	The master volume control is turned all the way down.	Adjust the master volume.
	The function selector position is wrong.	Select correct position.
No speaker output.	The headphones are connected to the headphone jack.	Disconnect the headphones. (Speakers will not output sound when headphones are connected.)
Incorrect Audio or Video for selected source.	Input cable connected incorrectly.	Connect the cable correctly by referring to the connection diagram.
Incorrect Audio from a channel.	Speaker cable connected incorrectly.	Connect the cable correctly by referring to the connection diagram.
No Audio output from the center channel speaker.	The center speaker cable connection is incomplete.	Connect the cable correctly.
	STEREO has been selected for Surround mode.	When STEREO is selected for Surround mode, no sound will be output from the center speaker. Set another Surround mode.
	Center = None has been selected in SETUP mode.	Make the correct setting.
No Audio output from the surround speakers.	The surround speaker cable connection is incomplete.	Connect the cable correctly.
	STEREO has been selected for Surround mode.	When STEREO has been selected for Surround mode, no sound will be output from the surround speaker. Set another Surround mode.
	Surround = None has been selected in SETUP mode.	Make the correct setting.
No Audio output from the surround back speakers.	The surround back speaker cable connection is incomplete.	Connect the cable correctly.
	Surround mode is not EX/ES mode.	Set surround mode EX/ES.
	Surround back = None has been selected in SPEAKERS SIZE SETUP	Make the correct setting.

SYMPTOM	CAUSE	REMEDY
Can not select EX/ES mode.	Surround center= None has been selected in SPEAKERS SIZE SETUP	Make the correct setting.
	Input signal is incompatible.	Use 5.1channel source.
Can not select Pro Logic IIx mode.	Input signal is incompatible.	Use 2 channel Dolby Digital input signal, PCM input signal or analog input signal.
Can not select Neo:6 mode.	Input signal is incompatible.	Use 2 channel DTS input signal, PCM input signal or analog input signal.
Can not select CSII mode.	Input signal is incompatible.	Use 2 channel Dolby Digital input signal, PCM input signal or analog input signal.
No output to Subwoofer Out.	Subwoofer = None has been selected in SETUP mode.	Select Subwoofer = YES.
Noise is produced during DTS-encoded CD or laser disc play.	Analog has been selected for input.	Be sure to perform digital connection, select digital input, then play.
A specific channel does not produce output.	Nothing recorded on source.	Check the encoded channel on the source side.
FM or AM reception fails.	Antenna connection is incomplete.	Correctly connect the indoor FM and AM antennas to FM and AM antenna outlets.
Noise is heard during AM reception.	Reception is affected by other electrical fields.	Try changing location where the AM indoor antenna is set up.
Noise is heard during FM reception.	The radio waves from the broadcasting station are weak.	Install an FM outdoor antenna.
Cannot get programmed station when the PRESET button is pressed.	Preset data has been erased.	Disconnecting power plug for long periods of time will erase preset data. If that happens, input the preset data again.
Control with the remote controller fails.	Batteries are consumed.	Replace all the batteries with new ones.
	Remote controller's function-key setting is wrong.	Select different position from which equipment will be controlled.
	The distance between this unit and the remote commander is too far.	Move closer to this unit.
	Something is blocking the unit and the remote commander.	Remove offending object.
Auto Setup (SPEAKER SETUP) is not working.	Headphones are connected.	Disconnect the headphones.

HDMI

SYMPTOM	CAUSE	REMEDY
The display does not appear over an HDMI connection.	The connected monitor or projector does not support HDCP.	Be sure to use an HDCP-compatible monitor or projector.
	The HDMI input of on the TV is not on.	Set HDMI input so that it turns on, as explained in the TV's instruction manual.
	The HDMI output on the source component (DVD, Set Top Box, etc.) is not on.	Set HDMI output so that it turns on, as explained in the source component's instruction manual.
	The HDMI mode is not correctly set on the unit.	Set HDMI input on the FUNC INPUT SETUP menu as explained on page 27.
	The HDMI output video resolution of the source component (DVD, Set Top Box, etc.) does not match the TV specifications.	Set the resolution so that it matches, as explained in the instruction manuals of both components.
	The device is connected with a non-standard HDMI cable.	A 5 m or shorter cable is recommended to ensure stable operation and prevent image quality deterioration.
	Power to the unit is off. (When the unit is on standby, HDMI connections cannot be turned on.)	Turn on the power to the unit.
	The connection between HDMI components was not authenticated.	Shut off and then turn the power back on to the unit, TV and source component.
Time is needed for the display of an HDMI connection to appear.	The HDMI OUT RES setting does not match that of the connected TV.	Set the HDMI OUT RES setting to AUTO. (See page 37)
	The connection is being authenticated between the HDMI devices.	There is nothing wrong with the system. Some HDMI devices require time for authentication.
Audio is not played back over an HDMI connection.	The HDMI audio output of the source component (DVD, Set Top Box, etc.) is not on.	Set the HDMI audio output so that it turns on, as explained in the source component's instruction manual.
	The signal format of the source component (DVD, Set Top Box, etc.) is not supported by the unit.	Set the HDMI audio output so that it can connect to the unit, as explained in the source component's instruction manual.
	This unit is set to the HDMI audio "THROUGH" mode.	In the "THROUGH" mode, sound is not produced from the unit. Set it to "ENABLE". (see page 38)
DVD-Audio is not played back over an HDMI connection.	The DVD player does not support CPPM, therefore it cannot output HDMI audio.	<ul style="list-style-type: none"> • Use a DVD-Audio player that supports CPPM. • Turn on PCM downsampling on the DVD player. • Use an analog connection.

USB

SYMPTOM	CAUSE	REMEDY
Even when the USB storage device is connected, "NO DEVICE" remains on the status display, and the device is not recognized.	<ul style="list-style-type: none"> • The unit cannot recognize the USB storage device because of connection trouble or some other issue. 	<ul style="list-style-type: none"> • Check whether the USB storage device and USB cable are firmly plugged into the unit's USB connector. • Try removing the USB storage device from the unit, and re-connecting it. • Try turning the unit's power off and back on, and re-connecting the device.
"UNKNOWN DEVICE" appears on the status display when the USB storage device is connected.	<ul style="list-style-type: none"> • A device that cannot be recognized by the unit has been connected. • The device has been connected through a USB hub. 	<ul style="list-style-type: none"> • Even when a USB storage device complies with the USB Mass Storage Class standard, it may not be possible to play its files using the unit. (This does not mean that something is wrong with the unit itself.) • USB storage devices cannot be connected through a USB hub.
"UNKNOWN FILE SYSTEM" appears on the status display when a USB storage device is connected.	<ul style="list-style-type: none"> • A format other than FAT16 or FAT32 is used as the USB storage device's format. 	<ul style="list-style-type: none"> • Set the format to FAT16 or FAT32, and record the files.
"OVER CURRENT" appears on the status display when a USB storage device is connected.	<ul style="list-style-type: none"> • The overcurrent protection function of the unit's USB connector has been triggered. 	<ul style="list-style-type: none"> • No guarantees are made for the operation of a hard disk drive that is powered from the unit's USB connector. Remove the connected USB storage device, and turn the unit's power off and back on.
"NO AUDIO FILE" appears on the status display when a USB storage device is connected.	<ul style="list-style-type: none"> • No playable files have been recorded on a USB storage device. 	<ul style="list-style-type: none"> • Record the supported file on a USB storage device.
"CAN'T PLAY" appears on the status display when a USB storage device is connected.	<ul style="list-style-type: none"> • An attempt has been made to play a copyright-protected file. • The file is damaged. Alternatively, its extension and file structure are incompatible. 	<ul style="list-style-type: none"> • The unit cannot play copyright-protected files. • Check the file.
The files recorded on the USB storage device are not displayed.	<ul style="list-style-type: none"> • The USB storage device is partitioned into a number of partitions. • The number of folders exceeds 700 or the number of files exceeds 65535. 	<ul style="list-style-type: none"> • If the device is partitioned into a number of partitions, displays only for the first partition will appear. • No displays appear for folders after folder no.700 or for files after file no.65535.

XM SATELLITE RADIO

If a problem should arise, first check the following.

1. Are the connections correct?
2. Have you operated the receiver according to the operating instructions?
3. Are the speakers and other components operating properly?

If this unit is not operating properly, Check the items listed in the table below. Should the problem persist, there may be a malfunction. Disconnect the power immediately and contact your store of purchase.

SYMPTOM	CAUSE	REMEDY
"TUNER" is displayed.	The XM Mini-Tuner and this unit are not properly connected.	Check that the units are properly connected.
"ANTENNA" is displayed.	The XM antenna is not properly connected to the Mini-Tuner Dock.	Check that the antenna is properly connected. Also, check the antenna cable for damage.
"NO SIGNAL" is displayed.	The Signal cannot be received.	Reposition your XM antenna.
Receiving only channels 0 and 1.	The XM Mini-Tuner is not activated.	Contact XM Satellite Radio. (See page 53)
"UPGRADE TUNER" is displayed.	The connected XM CNP-1000 is incompatible.	Upgrade the XM CNP-1000 to the XM Mini-Tuner. Report the model of the AV receiver and the ID number of the CNP-1000 to XM Listener Care. (See page 53)

SIRIUS SATELLITE RADIO

SYMPTOM	CAUSE	REMEDY
"TUNER ERR" is displayed.	SiriusConnect™ tuner is not properly connected.	Check the 8pin mini DIN cable and AC adapter connection are correct.
"ANTENNA" is displayed	Antenna is not properly connected.	Check the antenna cable connection is correct.
"ACQUIRING" is displayed.	The signal cannot be received.	Reposition your SiriusConnect™ tuner and antenna.
"CALL SIRIUS" is displayed	You have not subscribed for the selected channel.	Call SIRIUS if you want to subscribe. (See page 58)
"FIRM UPDT" is displayed	SiriusConnect™ is updating software.	Wait until the updating is complete.

PROTECTIVE FEATURE

In some cases, the STANDBY indicator may blink slowly, twice per second. In this case, turn off the unit, unplug the power cord, and check the following points.

- Make sure the speaker cables are not reversed and connected to the wrong sides (+ and -) on the unit.
- Make sure the speaker cables connected to the unit are not shorted. (Check both the unit end and the speaker end.)
- Make sure the volume does not exceed the level that the unit is capable of producing.
- When using the unit in a rack or other enclosed space, heat may build up inside the unit and cause a fire. When installing the unit, be sure to leave sufficient space between the top, back and both sides of the unit and walls or other AV components to prevent the internal temperature from rising.

After checking these points, plug in the power cord and use the remote controller to turn on the unit. Turn down the volume before resuming playback. Confirm that there are no problems with the speaker connections and playback performance.

If this symptom recurs, request service at your nearest service center.

In rare instances, the unit may enter standby mode and the STANDBY indicator may blink rapidly, 8 times per second. In this case, unplug the power cord and request service at your nearest service center.

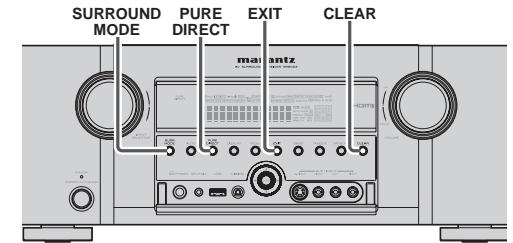

FRONT KEY (BUTTON) LOCK OF THE UNIT

To lock all front panel buttons (except the POWER ON/OFF button) and the INPUT SELECTER and VOLUME knobs, hold the **PURE DIRECT** and **EXIT** buttons on the front panel simultaneously for at least 3 seconds. At this time, "F-KEY LOCK!" is displayed. To unlock the controls, press the same buttons again simultaneously for at least 3 seconds. At this time, "F-KEY UNLOCK" is displayed, and the buttons are released.

GENERAL MALFUNCTION

If the equipment malfunctions, this may be because an electrostatic discharge or AC line interference has corrupted the information in the equipment memory circuits. Therefore:

- disconnect the plug from the AC line supply
- after waiting at least three minutes, reconnect the plug to the AC line supply
- re-attempt to operate the equipment

Memory backup

- In case a power outage occurs or the power cord is accidentally unplugged, this unit is equipped with a backup function to prevent memory data such as the preset memory from being erased.

HOW TO RESET THE UNIT

Should the operation or display seem to be abnormal, reset the unit with the following procedure.

This unit is turned on, press and hold the **SURROUND MODE + CLEAR** buttons simultaneously for 3 seconds or more.

Remember that the procedure will reset the settings of the function selector, Surround mode, delay time, TUNER PRESET etc., to their initial settings.

Surround Mode	Input Signal	Decoding	Output Channel				Front information display		
			L/R	C	SL SR	SBL SBR	SubW	Signal format indicators	Channel status
STEREO	Multi Ch-PCM	Stereo	○	-	-	-	○	PCM	L, C, R, SL, SR, LFE
	Multi Ch-PCM 96kHz	Stereo	○	-	-	-	○	PCM	L, C, R, SL, SR, LFE
	SA-CD (5.1ch)	Stereo	○	-	-	-	○	DSD	L, C, R, SL, SR, LFE
	SA-CD (2ch)	Stereo	○	-	-	-	○	DSD	L, R
	PCM (Audio)	Stereo	○	-	-	-	○	PCM	L, R
	PCM 96kHz	Stereo	○	-	-	-	○	PCM	L, R
	HDCD	Stereo	○	-	-	-	○	PCM, HDCD	L, R
	Analog	Stereo	○	-	-	-	○	ANALOG	-
Dolby Virtual Speaker	Dolby Surr.EX	Dolby Virtual Speaker	○	-	-	-	-	DD DIGITAL EX	L, C, R, SL, SR, S, LFE
	Dolby D (5.1ch)	Dolby Virtual Speaker	○	-	-	-	-	DD DIGITAL	L, C, R, SL, SR, LFE
	Dolby D (2ch)	PLII+ Dolby Virtual Speaker	○	-	-	-	-	DD DIGITAL	L, R
	Dolby D (2ch Surr)	PLII+ Dolby Virtual Speaker	○	-	-	-	-	DD DIGITAL	L, R, S
	DTS-ES	Dolby Virtual Speaker	○	-	-	-	-	dtc, ES	L, C, R, SL, SR, S, LFE
	DTS 96/24	Dolby Virtual Speaker	○	-	-	-	-	dtc 96/24	L, C, R, SL, SR, LFE
	DTS (5.1ch)	Dolby Virtual Speaker	○	-	-	-	-	dtc	L, C, R, SL, SR, LFE
	Multi Ch-PCM	Dolby Virtual Speaker	○	-	-	-	-	PCM	L, C, R, SL, SR, LFE
	SA-CD (5.1ch)	Dolby Virtual Speaker	○	-	-	-	-	DSD	L, C, R, SL, SR, LFE
	SA-CD (2ch)	PLII+ Dolby Virtual Speaker	○	-	-	-	-	DSD	L, R
	PCM (Audio)	PLII+ Dolby Virtual Speaker	○	-	-	-	-	PCM	L, R
	HDCD	PLII+ Dolby Virtual Speaker	○	-	-	-	-	PCM, HDCD	L, R
	Analog	PLII+ Dolby Virtual Speaker	○	-	-	-	-	ANALOG	-
	Multi Ch. Movie Music	Dolby Surr.EX	Dolby Digital EX	○	(○)	○	○	○	DD DIGITAL EX
Dolby D (5.1ch)		Dolby Digital 5.1	○	(○)	○	-	○	DD DIGITAL	L, C, R, SL, SR, LFE
Dolby D (2ch)		Multi Channel	○	(○)	○	○	○	DD DIGITAL	L, R
Dolby D (2ch Surr)		Multi Channel	○	(○)	○	○	○	DD DIGITAL	L, R, S
DTS-ES		DTS-ES	○	(○)	○	○	○	dtc, ES	L, C, R, SL, SR, S, LFE
DTS 96/24		DTS-96/24	○	(○)	○	○	○	dtc 96/24	L, C, R, SL, SR, LFE
DTS (5.1ch)		DTS 5.1	○	(○)	○	○	○	dtc	L, C, R, SL, SR, LFE
Multi Ch-PCM		Multi Ch-PCM	○	(○)	○	-	○	PCM	L, C, R, SL, SR, LFE
Multi Ch-PCM 96kHz		Multi Ch-PCM 96kHz	○	(○)	○	-	○	PCM	L, C, R, SL, SR, LFE
SA-CD (5.1ch)		SA-CD (5.1ch)	○	(○)	○	-	○	DSD	L, C, R, SL, SR, LFE
SA-CD (2ch)		Multi Channel	○	(○)	○	○	○	DSD	L, R
PCM (Audio)		Multi Channel	○	(○)	○	○	○	PCM	L, R
HDCD		Multi Channel	○	(○)	○	○	○	PCM, HDCD	L, R
Analog		Multi Channel	○	(○)	○	○	○	ANALOG	-
(○): Movie mode only.									
Dolby H.P	Dolby Surr.EX	Dolby H.P	○	-	-	-	-	DD DIGITAL EX	L, C, R, SL, SR, S, LFE
	Dolby D (5.1ch)	Dolby H.P	○	-	-	-	-	DD DIGITAL	L, C, R, SL, SR, LFE
	Dolby D (2ch)	Dolby H.P	○	-	-	-	-	DD DIGITAL	L, R
	Dolby D (2ch Surr)	Dolby H.P	○	-	-	-	-	DD DIGITAL	L, R, S
	Dolby Digital Plus (5.1ch)	Stereo	○	-	-	-	-	DD DIGITAL PLUS	L, C, R, SL, SR, LFE
	Dolby Digital Plus (6.1ch)	Stereo	○	-	-	-	-	DD DIGITAL PLUS	L, C, R, SL, SR, S, LFE (ex1)
	Dolby Digital Plus (7.1ch)	Stereo	○	-	-	-	-	DD DIGITAL PLUS	L, C, R, SL, SR, SBL, SBR, LFE
	Dolby TrueHD (5.1ch)	Stereo	○	-	-	-	-	DD TrueHD	L, R
	Dolby TrueHD (6.1ch)	Stereo	○	-	-	-	-	DD TrueHD	L, R
	Dolby TrueHD (7.1ch)	Stereo	○	-	-	-	-	DD TrueHD	L, R
	DTS-ES	Dolby H.P	○	-	-	-	-	dtc, ES	L, C, R, SL, SR, S, LFE
	DTS 96/24	Dolby H.P	○	-	-	-	-	dtc 96/24	L, C, R, SL, SR, LFE
	DTS (5.1ch)	Dolby H.P	○	-	-	-	-	dtc	L, C, R, SL, SR, LFE
	DTS-HD (5.1ch)	Stereo	○	-	-	-	-	dtc-HD MSTR/HIRES	L, C, R, SL, SR, LFE (ex1,ex2)
	DTS-HD (6.1ch)	Stereo	○	-	-	-	-	dtc-HD MSTR/HIRES	L, C, R, SL, SR, S, LFE (ex1,ex2)
	DTS-HD (7.1ch)	Stereo	○	-	-	-	-	dtc-HD MSTR/HIRES	L, C, R, SL, SR, SBL, SBR, LFE (ex1,ex2)
	Multi Ch-PCM	Dolby H.P	○	-	-	-	-	PCM	L, C, R, SL, SR, LFE
PCM	Dolby H.P	○	-	-	-	-	PCM	L, R	
HDCD	Dolby H.P	○	-	-	-	-	PCM, HDCD	L, R	
ANALOG	Dolby H.P	○	-	-	-	-	ANALOG	L, R	

Notes:

- Dolby Digital (2 channel L/R): Speakers for signal with Dolby Surround are fully equipped.
- No sound is outputs from the surround speaker, center speaker and subwoofer if the DVD disc has no surround data.
- Surround modes other than Stereo are not available during Dolby TrueHD, Dolby Digital Plus, or DTS-HD playback.

If surround modes other than Stereo are selected and Dolby TrueHD, Dolby Digital Plus, or DTS-HD content is played, the surround mode setting is disabled.

Abbreviations

- L/R : Front speakers
- C : Center speaker
- SL/SR : Surround speakers
- SBL/SBR : Surround back speakers
- SubW : Subwoofer
- LFE : Low frequency effects
- ex : Extension

AUTO

When this mode is selected, the unit determines whether the digital input signal is Dolby Digital, Dolby Digital Surround EX, Dolby Digital Plus, Dolby TrueHD, DTS-HD, DTS, DTS-ES, DTS 96/24 or PCM audio.

Surround EX & DTS-ES will operate for multichannel sources that have a Dolby Digital Surround EX or DTS-ES auto trigger flag in the digital signal.

When a Dolby Digital or DTS signal is input, the number of channels for which the corresponding signal is encoded will be played.

Inputting a Dolby Digital two channel signal with Dolby surround status automatically subjects that signal to Pro Logic IIx movie processing before play. PCM 96 kHz source material can be played in this mode.

Notes:

- When you use this mode with certain DVD and CD players, performing operations such as skip or stop may momentarily interrupt the output.
- When the signal is not decoded, the mode is changed to AUTO mode automatically. See page 78 to confirm the available decoding modes.

SOURCE DIRECT

In the Source Direct mode, the tone control circuit Acoustic EQ. and bass management configuration are bypassed for full-range frequency response and the purist audio reproduction.

Notes:

- Speaker size is set to Front L/R = LARGE, Center = LARGE, Surround L/R = LARGE and Subwoofer = YES automatically. Tone controls, equalizer and additional processing are deactivated.
- When you use this mode with certain DVD and CD players, performing operations such as skip or stop may momentarily interrupt the output.
- In SOURCE DIRECT mode, ACOUSTIC EQ and M-DAX are not available.

PURE DIRECT

The Pure Direct mode further reduces sources of noise in addition to effect of the Source Direct mode, by blocking output from the video jacks (VIDEO, S-VIDEO, COMPONENT VIDEO and HDMI) and turning the FL display off.

Note:

- In PURE DIRECT mode, ACOUSTIC EQ and M-DAX are not available.

EX/ES

This mode provides 6.1 channel surround for Dolby Digital EX, and DTS-ES-encoded source material such as DVD.

This mode cannot be used when an analog input has been selected.

Dolby Digital EX

In a movie theater, film soundtracks that have been encoded with Dolby Digital Surround EX technology are able to reproduce an extra channel which has been added during the mixing of the program.

This channel, called surround back, places sounds behind the listener in addition to the currently available front left, front center, front right, surround right, surround left and subwoofer channels.

This additional channel provides the opportunity for more detailed imaging behind the listener and brings more depth, spacious ambience and sound localization than ever before.

Dolby Digital EX is not available in systems that do not have without surround back speaker(s).

DTS-ES (Discrete 6.1, Matrix 6.1)

DTS-ES adds the surround center channel audio to the DTS 5.1 channel format to improve the acoustic positioning, and makes acoustic image movement more natural with the 6.1 channel reproduction.

This unit incorporates a DTS-ES-decoder, which can handle DTS-ES Discrete-encoded and DTS-ES Matrix-encoded program sources from DVD, etc.

DTS-ES Discrete 6.1 features digital discrete recording of all channels, including the surround back channel(s), and higher quality audio reproduction. DTS-ES is not available in systems that do not have surround back speakers.

NAMES AND FUNCTION
 BASIC CONNECTIONS
 BASIC OPERATION
 ADVANCED CONNECTIONS
 SETUP
 ADVANCED OPERATION
 TROUBLESHOOTING
 OTHERS

MODE**(Dolby Digital, Pro Logic IIx MOVIE, Pro Logic IIx MUSIC, Pro Logic IIx GAME)**

This mode is used with source materials encoded in Dolby Digital and Dolby Surround.

DOLBY DIGITAL

This mode is enabled when playing source materials encoded in Dolby Digital.

Playing multichannel-encoded 5.1 channel Dolby Digital sources provides 5 main audio channels (left, center, right, surround left and surround right) and a Low Frequency Effect channel.

Dolby Digital EX decoding is not available in this mode.

Dolby Pro Logic IIx has 5 modes:

Pro Logic IIx MOVIE

This mode provides 6.1 or 7.1 channel surround sound from Dolby Surround, encoded stereo movie soundtracks.

Pro Logic IIx MUSIC

This mode provides 6.1 or 7.1 channel surround sound from conventional stereo sources (analog or digital), such as CD, tape, FM, TV, stereo VCR, etc.

Pro Logic IIx GAME

This mode restores the impact low-frequency surround effects by routing them to the system's subwoofer.

5.1ch + Pro Logic IIx Movie

This mode provides 7.1 channel surround sound from 5.1 channel sources movie soundtracks.

5.1ch + Pro Logic IIx Music

This mode provides 6.1 or 7.1 channel surround sound from 5.1 channel sources music soundtracks.

Notes:

- Pro Logic IIx mode will decode as Pro Logic II mode when the SURR. B is set to "None" from SPEAKER SETUP menu. (See page 33)
- Pro Logic IIx mode is available for a 2 channel input signal which is encoded in Dolby Digital, HDCD or PCM format.

dts

dts, Neo:6 Cinema, Neo:6 Music

This mode is for DTS-encoded source materials such as laserdisc, CD and DVD. Neo:6 is for some 2 channel sources.

dts

This mode is enabled when playing source materials encoded in dts multichannel.

Playing multichannel encoded-5.1 channel dts sources provides five main audio channels (left, center, right, surround left and surround right) and a Low Frequency Effects channel.

dts-ES decoding is not available in this mode.

The DTS mode cannot be used when an analog input has been selected.

Neo:6 Cinema, Neo:6 Music

This mode decodes 2 channel signals into 6 channel signals using high-accuracy digital matrix technology. The DTS Neo:6 decoder has near-discrete properties in the frequency characteristics of the channels as well as in channel separation.

According to the signals to be played back, DTS Neo:6 uses either the Neo:6 Cinema mode optimized for movie playback or the Neo:6 Music mode optimized for music playback.

Note:

- The Neo:6 mode is available for 2 channel input signals which are encoded in Dolby Digital, HDCD or PCM format.

CIRCLE SURROUND II (CSII-CINEMA, CSII-MUSIC, CSII-MONO)

Circle Surround is designed to enable multichannel surround sound playback of non-encoded and multichannel encoded material.

Backward compatibility provides listeners with up to 6.1 channels of surround performance from an entire collection of music and film, including broadcast, videotape and stereo recorded music.

Depending on source material, you can select CSII-Cinema mode, CSII-Music mode or CSII-Mono mode.

Note:

- The CS II mode is available for 2 channel input signals which are encoded in Dolby Digital, HDCD or PCM format.

STEREO

This mode bypasses all surround processing.

In stereo program sources, the left and right channels play normally when PCM audio or analog stereo is input.

With Dolby Digital and DTS sources, the 5.1 channels are converted to two channel stereo. 96 kHz PCM source material can be played back in stereo mode.

Dolby Virtual Speaker

Dolby Virtual Speaker technology uses proprietary technology of Dolby Laboratories to create a virtual surround sound field using only two speakers for the front channels, allowing the user to experience sound as if surround speakers were actually being used.

MULTI CH. (MOVIE, MUSIC)

This mode is used to create a wider, deeper and more natural soundstage from two channel source material.

This is done by feeding the left channel signal to both the left front and left surround speakers and the right channel signal to both the right front and right surround speakers. Additionally, the center channel reproduces a mix of the right and left channels.

Note:

- Audio is not output from the CENTER channel when using MULTI CH. MUSIC mode.

Neural Surround

Neural Surround™ represents the latest advancement in surround technology developed for music.

Neural Surround™ employs psychoacoustic frequency domain processing which allows delivery of a more detailed sound stage with superior channel separation and localization of audio elements. System playback is scalable from 5.1 to 7.1 multichannel surround playback.

CAUTION**Note for DTS**

• To connected DVD player, laserdisc player or CD player needs to support DTS digital output. You may not be able to play some DTS source signals from certain CD players and LD players even if you connect the player to the unit digitally. This is because the digital signal has been processed (such as the output level, sampling frequency or frequency response), and the unit cannot recognize the signal as DTS data.

• Depending on the player used, DTS play may produce a short noise. This is not a malfunction.

• While signals from a DTS laserdisc or CD are playing in another surround mode, you cannot switch to digital input or from digital input to analog input from the INPUT SETUP in the MAIN MENU or by pressing the A/D button.

• You can not listen to DTS-encoded software in a multiroom.

• The outputs for VCR OUT, TAPE OUT and CD/CD-R OUT output analog audio signals only. Do not record from CDs or LDs that support DTS using these outputs. If you do, the DTS-encoded signal will be recorded as noise.

Note or Dolby Digital Surround EX

• When playing Dolby Digital Surround EX-encoded software in 6.1 channels, it is required to set the EX/ES mode.

• Note that some Dolby Digital Surround EX-encoded software does not contain the identification signal. In this case, set the EX/ES mode manually.

Note for 96 kHz/192 kHz PCM audio

• The AUTO, Pure Direct, and Stereo modes can be used when playing PCM signals with a sampling frequency of 96/192 kHz (such as from DVD-Video/Audio discs).

• Certain DVD player models inhibit digital output. For details, refer to the player's operation manual.

• Some DVD discs feature copy protection. When using such disc, 96 kHz PCM signal are not output from the DVD player. For details, refer to the player's operation manual.

Note for HDCD

• HDCD is effective only through digital input.

• You may not be able to play some HDCD source signals from certain CD players if you connect the player to the unit digitally. This is because the digital signal has been processed (such as the output level, sampling frequency or frequency response) and the unit cannot recognize the signal as HDCD data.

DESCRIPTION



Neural-THX® Surround has been chosen as the official surround sound broadcast format for leading FM/HD and satellite radio and television stations worldwide. Neural-THX Surround delivers the rich envelopment and discrete image detail of surround sound in a format 100% compatible with stereo.

Neural-THX Surround draws the brain's attention to sonic details in musical instruments, vocals and ambience that are typically masked by other playback systems. This allows the listener to fully experience the richness and subtleties in recorded performance as never before for both surround encoded material and regular stereo material such as CDs or digital media players.

Neural-THX Surround: Taking Surround to the Next Level.

This product is manufactured under license from Neural Audio Corporation and THX Ltd. Marantz hereby grants the user a non-exclusive, non-transferable, limited right of use to this product under USA and foreign patent, patent pending and other technology or trademarks owned by Neural Audio Corporation and THX Ltd. "Neural Surround", "Neural Audio", "Neural" and "NRL" are trademarks and logos owned by Neural Audio Corporation, THX is a trademark of THX Ltd., which may be registered in some jurisdictions. All rights reserved.



Manufactured under license under U.S. Patent #'s: 5,451,942; 5,956,674; 5,974,380; 5,978,762; 6,226,616; 6,487,535; 7,003,467 & other U.S. and worldwide patents issued & pending. DTS, DTS Digital Surround, ES, and Neo:6 are registered trademarks and the DTS logos, Symbol and DTS 96/24 are trademarks of DTS, Inc. © 1996-2007 DTS, Inc. All Rights Reserved.

• dts Digital Surround

DTS was introduced in 1994 to provide 5.1 channels of discrete digital audio into home theater systems. DTS brings you premium quality discrete multichannel digital sound to both movies and music.

DTS is a multichannel sound system designed to create full range digital sound reproduction.

The no compromise DTS digital process sets the standard of quality for cinema sound by delivering an exact copy of the studio master recordings to neighborhood and home theaters.

Now, every moviegoer can hear the sound exactly as the moviemaker intended.

DTS can be enjoyed in the home for either movies or music on of DVD's, LD's, and CD's.

• dts Neo:6®

The advantages of discrete multichannel systems over matrix are well known.

But even in homes equipped for discrete multichannel, there remains a need for high-quality matrix decoding. This is because of the large library of matrix surround motion pictures available on disc and on VHS tape; and analog television broadcasts.

The typical matrix decoder of today derives a center channel and a mono surround channel from two-channel matrix stereo material. It is better than a simple matrix in that it includes steering logic to improve separation, but because of its mono, band-limited surround it can be disappointing to users accustomed to discrete multichannel.

Neo:6 offers several important improvements as follow,

- Neo:6 provides up to six full-band channels of matrix decoding from stereo matrix material. Users with 6.1 and 5.1 systems will derive six and five separate channels, respectively, corresponding to the standard home-theater speaker layouts.
- Neo:6 technology allows various sound elements within a channel or channels to be steered separately, and in a way which follows naturally from the original presentation.
- Neo:6 offers a music mode to expand stereo nonmatrix recordings into the five- or six-channel layout, in a way which does not diminish the subtlety and integrity of the original stereo recording.

• dts Digital Surround ES®

DTS-ES Extended Surround is a new multichannel digital signal format developed by Digital Theater Systems Inc. While offering high compatibility with the conventional DTS Digital Surround format, DTS-ES Extended Surround greatly improves the 360-degree surround impression and space expression thanks to further expanded surround signals. This format has been used professionally in movie theaters since 1999.

In addition to the 5.1 surround channels (FL, FR, C, SL, SR and LFE), DTS-ES Extended Surround also offers the SB (Surround Back) channel for surround playback with a total of 6.1 channels. DTS-ES Extended Surround includes two signal formats with different surround signal recording methods, as DTS-ES Discrete 6.1 and DTS-ES Matrix 6.1.

• dts Digital Surround 96/24

The stereo CD is a 16-bit medium with sampling at 44.1 kHz. Professional audio has been 20- or 24-bit for some time, and there is increasing interest in higher sampling rates both for recording and for delivery into the home. Greater bit depths provide extended dynamic range. Higher sampling rates allow wider frequency response and the use of anti-alias and reconstruction filters with more favorable aural characteristics.

DTS 96/24 allows for 5.1 channel sound tracks to be encoded at a rate of 96kHz/24bits on DVD-Video titles.

When DVD-video appeared, it became possible to deliver 24-bit, 96 kHz audio into the home, but only in two channels, and with serious limitations on picture. This capability has had little use.

DVD-audio allows 96/24 in six channels, but a new player is needed, and only analog outputs are provided, necessitating the use of the D/A converters and analog electronics provided in the player.

DTS 96/24 offers the following:

1. Sound quality transparent to the original 96/24 master.
2. Full backward compatibility with all existing decoders. (Existing decoders will output a 48 kHz signal)
3. No new player required: DTS 96/24 can be carried on DVD-video, or in the video zone of DVD-audio, accessible to all DVD players.
4. 96/24 5.1-channel sound with full-quality full-motion video, for music programs and motion picture soundtracks on DVD-video.



DTS-HD Master Audio is capable of delivering audio that is a bit-for-bit identical to the studio master. DTS-HD Master Audio delivers audio at super high variable bit rates -24.5 mega-bits per second (Mbps) on Blu-ray discs and 18.0 Mbps on HD-DVD - that are significantly higher than standard DVDs. This bit stream is so "fast" and the transfer rate is so "high" that it can deliver the Holy Grail of audio: 7.1 audio channels at 96k sampling frequency/24 bit depths that are identical to the original. With DTS-HD Master Audio, you will be able to experience movies and music, exactly as the artist intended: clear, pure, and uncompromised.

Manufactured under license under U.S. Patent #'s: 5,451,942; 5,956,674; 5,974,380; 5,978,762; 6,226,616; 6,487,535 & other U.S. and worldwide patents issued & pending.

DTS is a registered trademark and the DTS logos, Symbol, DTS-HD and DTS-HD Master Audio are trademarks of DTS, Inc. © 1996-2007 DTS, Inc. All Rights Reserved.



DTS-HD High Resolution Audio can deliver up to 7.1 channels of sound that is virtually indistinguishable from the original. DTS-HD High Resolution Audio delivers audio at high constant bit rates superior to standard DVDs---6.0 Mbps on Blu-ray discs and 3.0 Mbps on HD-DVD to produce outstanding sound quality. It is capable of delivering up to 7.1 channels at 96k sampling frequency/24 bit depth resolution. It allows content creators to deliver rich, high definition audio on movies where disc space may not allow for DTS-HD Master Audio.

Manufactured under license under U.S. Patent #'s: 5,451,942; 5,956,674; 5,974,380; 5,978,762; 6,226,616; 6,487,535 & other U.S. and worldwide patents issued & pending. DTS is a registered trademark and the DTS logos, Symbol, DTS-HD, DTS-HD High Resolution Audio and DTS-HD High Res Audio are trademarks of DTS, Inc. © 1996-2007 DTS, Inc. All Rights Reserved.

DOLBY

DIGITAL EX

PRO LOGIC IIX

Dolby Digital identifies the use of Dolby Digital audio coding for such consumer formats as DVD and DTV. As with film sound, Dolby Digital can provide up to five full-range channels for left, center, and right screen channels, independent left and right surround channels, and a sixth (“1”) channel for low-frequency effects.

Dolby Surround Pro Logic II is an improved matrix decoding technology that provides better spatiality and directionality on Dolby Surround program material; provides a convincing three-dimensional soundfield on conventional stereo music recordings; and is ideally suited to bring the surround experience to automotive sound. While conventional surround programming is fully compatible with Dolby Surround Pro Logic II decoders, soundtracks will be able to be encoded specifically to take full advantage of Pro Logic II playback, including separate left and right surround channels. (Such material is also compatible with conventional Pro Logic decoders.)

Dolby Digital EX creates six full-bandwidth output channels from 5.1-channel sources. This is done using a matrix decoder that derives three surround channels from the two in the original recording. For best results, Dolby Digital EX should be used with movies soundtracks recorded with Dolby Digital Surround EX.

About Dolby Pro Logic IIX

Dolby Pro Logic IIX technology delivers a natural and immersing 7.1-channel listening experience to the home theater environment. A product of Dolby's expertise in surround sound and matrix decoding technologies, Dolby Pro Logic IIX is a complete surround sound solution that maximizes the entertainment experience from stereo as well as 5.1-channel encoded sources.

Dolby Pro Logic IIX is fully compatible with Dolby Surround Pro Logic technology and can optimally decode the thousands of commercially available Dolby Surround encoded video cassettes and television programs with enhanced depth and spatiality. It can also process any high-quality stereo or Advanced Resolution 5.1-channel music content into a seamless 6.1- or 7.1-channel listening experience.



The Dolby Headphone technology provides a surround sound listening experience over headphones.

When listening to multichannel content such as DVD movies over headphones, the listening experience is fundamentally different than listening to speakers. Since the headphone speaker drivers are covering the pinna of the ear, the listening experience differs greatly from traditional speaker playback. Dolby utilizes patented headphone perspective curves to solve this problem and provides a non-fatiguing, immersive, home theater listening experience. Dolby Headphone also delivers exceptional 3D audio from stereo material.

DOLBY

VIRTUAL SPEAKER

Dolby Virtual Speaker is a technology certified by Dolby Laboratories that creates a virtualized surround sound experience from two speakers using a multichannel Dolby Digital source. Additionally, Dolby Virtual Speaker can simulate the surround sound effect produced by Dolby Pro Logic or Dolby Pro Logic II.

Dolby Virtual Speaker retains all the original Multichannel audio information and provides the listener with the sensation of being surrounded by additional speakers.

DOLBY

TRUEHD

Dolby® TrueHD is Dolby's next-generation lossless technology developed for high-definition disc-based media. Dolby TrueHD delivers tantalizing sound that is bit-for-bit identical to the studio master, unlocking the true high-definition entertainment experience on next-generation discs. When coupled with high-definition video, Dolby TrueHD offers an unprecedented home theater experience that lets you enjoy sound as stunning as the high-definition picture.

DOLBY

DIGITAL PLUS

Dolby Digital Plus is a highly sophisticated and versatile audio codec based on Dolby Digital and designed specifically to adapt to the changing demands of future audio, video delivery, and audio storage systems while simultaneously retaining backwards compatibility with the existing Dolby Digital 5.1-channel home theater systems in use today.

Manufactured under license from Dolby Laboratories. “Dolby”, “Pro Logic”, “Surround EX”, and the double-D symbol are trademarks of Dolby Laboratories.

SRS

Circle Surround II

Circle Surround II (CS-II) is a powerful and versatile multichannel technology. CS-II is designed to enable up to 6.1 multichannel surround sound playback from mono, stereo, CS encoded sources and other matrix encoded sources. In all cases the decoder extends it into 6 channels of surround audio and a LFE/subwoofer signal. The CS-II decoder creates a listening environment that places the listener “inside” music performances and dramatically improves both hi-fi audio conventional surround-encoded video material. CS-II provides composite stereo rear channels to greatly improve separation and image positioning—adding a heightened sense of realism to both audio and A/V productions.

CS-II is packed with other useful feature like dialog clarity (SRS Dialog) for movies and cinema-like bass enrichment (TruBass). CS-II can enable the dialog to become clearer and more discernable in movies and it enables the bass frequencies contained in the original programming to more closely achieve low frequencies—overcoming the low frequency limitations of the speakers by full octave.

Circle Surround II, SRS and  symbol are trademarks of SRS Labs, Inc. Circle Surround II technology is incorporated under license from SRS Labs, Inc.

Microsoft®



HD CD® (High Definition Compatible Digital ®) is a patented process for delivering on Compact Disc the full richness and details of the original microphone feed.

HD CD encoded CDs sound better because they are encoded with 20-bits of real musical information as compared to 16-bits for all other CDs.

HD CD overcomes the limitation of the 16-bit CD format by using a sophisticated system to encode the additional four bits onto the CD while remaining completely compatible with the CD format.

When listening to HD CD recordings, you hear more dynamic range, a focused 3-D sound stage, and extremely natural vocal and musical timbre. With HD CD, you get the body, depth and emotion of the original performance not a flat, digital imitation.

HD CD system manufactured under license from Microsoft. This product is covered by one or more of the following: In the United States 5,479,168 5,638,074 5,640,161 5,808,574 5,838,274 5,854,600 5,864,311 5,872,531 and in Australia 669,114 with other patents pending.

HDMI

HDMI, the **HDMI** and High-Definition Multimedia Interface are trademarks or registered trademarks of HDMI Licensing LLC.

AUDYSSEY MULTEQ

Several factors can degrade the sound from even the best loudspeakers in a listening room. One of the most important is the interaction of sound from the loudspeakers with large surfaces such as walls, the floor and the ceiling in the room. Even with careful loudspeaker placement and acoustical treatments, there are significant problems that are caused by room acoustics. These include reflections from nearby surfaces and standing waves created between large parallel surfaces in the room. In a home theater, the situation is further complicated because there are several listening locations. The effects of room acoustics on the sound arriving at each person's ears are very different and the result is a listening experience that is degraded in a different way for each person in the room.

It is not uncommon to have variations in two adjacent seats as large as 10 dB, particularly in the frequency range below 250 Hz. The solution to this problem is to apply room correction after measuring precisely how each loudspeaker interacts with the room. Because the room causes variations in the frequency response of the loudspeakers that are so large from seat to seat, it is important to sample the sound from several locations in the listening room. This should be done even if there is only one listener. Measurement at a single location is not representative of the acoustical problems in the room and will, in most cases, degrade overall performance. Audyssey MultEQ is the only technology able to achieve room correction for multiple listeners in a large listening area. It does so by combining the data collected at several points in the room from each loudspeaker and then applying correction to minimize the acoustical effects of the room and match the frequency resolution of human perception (known as psychoacoustics).

Further, MultEQ correction is applied in frequency and time domains and removes artifacts, such as smearing or modal ringing, sometimes associated with traditional methods of room equalization.

In addition to correcting frequency response problems over a wide listening area, Audyssey MultEQ provides a completely automated sound system set-up process. It identifies the number of loudspeakers connected to the amplifiers and whether they are satellites or subwoofers. If there is a least one subwoofer connected, Audyssey MultEQ determines the optimum crossover frequency between each satellite and the subwoofer(s). It automatically checks the polarity of each loudspeaker and alerts the user to the ones wired out-of-phase relative to the others.

It measures the distance to each loudspeaker from the main listening position and adjusts the delays so the sound from each loudspeaker arrives at the same time. Finally, Audyssey MultEQ determines the playback level of each loudspeaker and adjusts the volume trims so all levels are equal.

AUDYSSEY MULTEQ

Manufactured under license from Audyssey Laboratories. U.S. and foreign patents pending. MultEQ is a registered trademark of Audyssey Laboratories.

x.v.Color

"x.v.Color" and "x.v.Color" logo are trademarks of Sony Corporation.

Windows and Windows Media Audio are registered trademarks or trademarks of Microsoft Corporation of the United States in the United States and other countries.

iTunes is a registered trademark or trademark of Apple Inc. of the United States in the United States and other countries.

XM Satellite Radio Ready



The XM name and related logos are registered trademarks of XM Satellite Radio Inc.

XM HD Surround uses Neural Surround™ technology to achieve optimal surround sound from XM radio.



© 2008 SIRIUS Satellite Radio Inc. "SIRIUS" and the SIRIUS dog logo are registered trademarks of SIRIUS Satellite Radio Inc.

TECHNICAL SPECIFICATIONS

FM TUNER SECTION

Frequency Range	87.5 – 108.0 MHz
Usable Sensitivity	IHF 1.8 µV/16.4 dB
Signal to Noise Ratio	Mono/Stereo 75/70 dB
Distortion.....	Mono/Stereo 0.2/0.3 %
Stereo Separation.....	1 kHz 45 dB
Alternate Channel Selectivity.....	± 400 kHz 60 dB
Image Rejection.....	98.1 MHz 70 dB
Tuner Output Level	1 kHz, ± 75 kHz Dev 800 mV

AM TUNER SECTION

Frequency Range	520 – 1710 kHz
Signal to Noise Ratio	50 dB
Usable Sensitivity	Loop 400µV/m
Distortion.....	400Hz, 30 % Mod. 0.5 %
Selectivity.....	± 20 kHz 70 dB

AUDIO SECTION

Power Output (20 Hz – 20 kHz/THD=0.08%)	
Front L&R	8 ohms 100 W / Ch
Center	8 ohms 100 W / Ch
Surround L&R.....	8 ohms 100 W / Ch
Surround Back L&R.....	8 ohms 100 W / Ch
Front L&R	6 ohms 125 W / Ch
Center.....	6 ohms 125 W / Ch
Surround L&R.....	6 ohms 125 W / Ch
Surround Back L&R.....	6 ohms 125 W / Ch
Input Sensitivity/Impedance.....	180 mV/ 47 Kohms
Signal to Noise Ratio(Analog Input / Pure Direct)	105 dB
Frequency Response	
(Analog Input / Pure Direct)	8 Hz – 100 kHz (± 3 dB)
(Digital Input / 96 kHz PCM)	8 Hz – 45 kHz (± 3 dB)

VIDEO

Television Format.....	NTSC
Input Level/Impedance	1 Vp-p/75 ohms
Output Level/Impedance.....	1 Vp-p/75 ohms
Video Frequency Response	5 Hz to 8 MHz (– 1 dB)
Video Frequency (Component)	5 Hz to 80 MHz (– 1 dB)
S/N.....	60 dB

HDMI

Version.....	1.3a [INPUT]
.....	1.3a [OUTPUT]

GENERAL

Power Requirement.....	AC 120 V 60 Hz
Power Consumption	600 W
Standby Power Consumption	(Normal) 0.7 W
.....	(Economy) 0.4 W
Weight.....	13.2 kg

ACCESSORIES

Remote Controller RC003SR	1
Microphone.....	1
AAA-size batteries	2
FM Antenna	1
AM Loop Antenna	1
AC cable	1
User Guide.....	1
Warranty Card (USA x 1, Canada x 1)	

DIMENSIONS

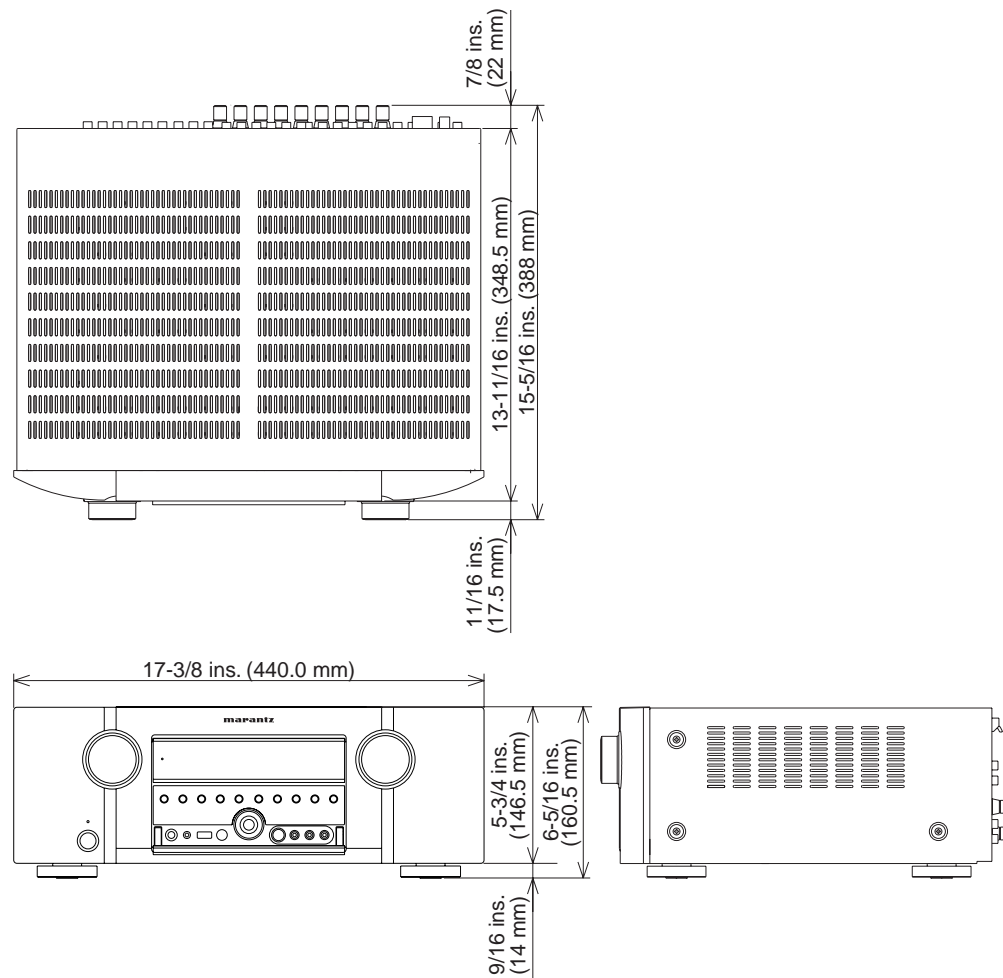

Specifications subject to change without prior notice.

CLEANING OF EQUIPMENT EXTERNAL SURFACES

The exterior finish of your unit will last indefinitely with proper care and cleaning. Never use scouring pads, steel wool, scouring powders or harsh chemical agents (e.g., lye solution), alcohol, thinner, benzene, insecticide or other volatile substances as these will mar the finish of the equipment. Likewise, never use cloths containing chemical substances. If the equipment get dirty, wipe the external surfaces with a soft, lint-free cloth.

If the equipment becomes heavily soiled:

- dilute some washing up liquid in water, in a ratio of one part detergent to six parts water.
- dip a soft, lint free in the solution and wring the it is damp.
- wipe the equipment with the damp cloth.
- dry the equipment by wiping it with a dry cloth.



REPAIRS

Only the most competent and qualified service technicians should be allowed to service the factory-trained warranty station personnel have the knowledge and special facilities needed for repair and calibration of this precision equipment. After the warranty period has expired, repairs will be performed for a charge if the equipment can be returned to normal operation.

In the event of difficulty, refer to your dealer or write directly to the nearest location to you that is listed on the Marantz Authorized Service Station list. If writing, please include the model and serial number of the equipment together with a full description of what you think is abnormal about the equipment's behaviour.

SETUP CODES

TV

Acer	1141
Admiral	1002, 1009, 1089
Aiko	1059
Aiwa	1117, 1118
Akai	1001
Amtron	1023
Anam	1113
Anam National	1023, 1069, 1092
AOC	1003, 1024, 1049, 1127
Audiovox	1023
Bell & Howell	1009, 1025
Benq	1104, 1142
Broksonic	1003, 1097, 1098, 1113
Celebrity	1001
Citizen	1003, 1013, 1023 1026, 1059, 1063
Colortyme	1003, 1043
Contec	1113
Contec/Cony	1023, 1045, 1047
Craig	1020, 1022, 1023, 1113
Crown	1023, 1067
Curtis Mathes	1003, 1013, 1025 1026, 1062, 1103, 1110
Daewoo	1003, 1013, 1024, 1035 1036, 1059, 1084, 1101
Daytron	1003, 1013, 1016
Dimensia	1103, 1110
Dumont	1003, 1010, 1153
Electroband	1001
Electrohome	1001, 1003, 1069, 1133
Emerson	1003, 1013, 1015 1020, 1021, 1022, 1023 1025, 1038, 1044, 1045 1048, 1055, 1061, 1094 1096, 1099, 1101, 1113
Envision	1003
Fisher	1025, 1051, 1091, 1160
Fujitsu	1038, 1124, 1125, 1155
Funai	1023, 1038, 1113
Gateway	1150
GE	1003, 1018, 1022, 1046 1054, 1069, 1085, 1103 1110, 1113, 1133, 1136, 1153
Goldstar	1003, 1013, 1024 1030, 1045, 1080 1100, 1112, 1154
Hallmark	1003
Hisense	1116

Hitachi	1003, 1012, 1031, 1032 1037, 1041, 1045, 1047 1065, 1068, 1082, 1088 1094, 1139, 1140, 1145, 1159
Infinity	1067
Janeil	1134
JBL	1067
JC Penney	1003, 1013, 1018 1019, 1024, 1026 1046, 1047, 1054 1063, 1083, 1085 1100, 1103, 1110 1112, 1133, 1154
Jensen	1003
JVC	1028, 1029, 1045 1047, 1050, 1060, 1065
Kawasho	1001, 1003
Kenwood	1003
Kloss Novabeam	1023, 1056, 1057, 1134
KTV	1013, 1023, 1033 1034, 1073, 1099, 1113
LG	1024, 1030
M.Wards	1002, 1009, 1038
Magnavox	1003, 1052, 1053 1056, 1057, 1063 1067, 1081, 1106
Marantz	1003, 1031, 1067, 1122
Mitsubishi	1003, 1024, 1051 1115, 1122, 1133
Motorola	1014, 1069
NEC	1003, 1012, 1024, 1043, 1069
NET-TV	1137, 1150
Orion	1020, 1096
Panasonic	1017, 1067, 1069, 1095, 1111
Philips	1003, 1011, 1045, 1052 1054, 1056, 1057, 1058 1063, 1067, 1069, 1106
Pioneer	1003, 1018, 1037 1070, 1071, 1094 1145, 1147, 1149
Plasmasync	1135
Portland	1003, 1013, 1024, 1059
Price Club	1026
Prism	1018
Proscan	1004, 1005, 1006, 1007 1008, 1085, 1103, 1110
Proton	1003, 1045
Quasar	1010, 1069, 1073, 1111, 1153
Radio Shack	1003, 1013, 1015 1023, 1024, 1025, 1045 1100, 1103, 1110, 1113

RCA	1003, 1004, 1005 1006, 1007, 1008 1014, 1024, 1049, 1069 1075, 1079, 1085, 1087 1088, 1093, 1094, 1101 1103, 1110, 1113, 1153
Realistic	1013, 1015, 1023, 1025 1045, 1100, 1103, 1110
Runco	1010, 1153
Sampo	1150
Samsung	1003, 1013, 1024, 1026 1040, 1045, 1062, 1078 1083, 1090, 1100, 1105, 1114 1120, 1121, 1146, 1148, 1157
Sansui	1119
Sanyo	1003, 1025, 1051, 1072 1077, 1091, 1156, 1157, 1158
Sharp	1003, 1013, 1014 1015, 1045, 1055, 1064 1066, 1076, 1089, 1123
Signature	1009
Sony	1001, 1102, 1108
Soundesign	1003, 1023, 1038, 1063, 1113
Starlite	1023
Supre-Macy	1134
Sylvania	1003, 1039, 1042 1052, 1053, 1056, 1057 1063, 1067, 1089, 1151
Symphonic	1023, 1039, 1044
Tandy	1014
Tatung	1069
Technics	1018
Techwood	1003, 1018
Teknika	1003, 1009, 1013, 1023 1024, 1026, 1038, 1045 1047, 1059, 1063, 1111, 1113
Telecaption	1074
Toshiba	1003, 1019, 1025 1026, 1042, 1074, 1098 1107, 1111, 1135, 1136
Totevision	1013
Universal	1046, 1054
Video Concepts	1113
Viewsonic	1006, 1022, 1109 1128, 1129, 1130, 1131 1138, 1143, 1145, 1150
Wards	1003, 1009, 1015 1024, 1038, 1044, 1046 1052, 1054, 1056, 1057 1067, 1086, 1103, 1110
White Westinghouse	1001, 1101

Yamaha	1003, 1024
Zenith	1003, 1009, 1010 1132, 1144, 1153

CD

AIWA	3001, 3002, 3003
AKAI	3004, 3005, 3006
AUDIO	3007
AUDIO LABS	3008
CALIFORNIA	3008
CARVER	3010, 3011, 3009
CASIO	3012, 3020
CURTIS	3020, 3012
DENON	3013
EMERSON	3014
FISHER	3011, 3015, 3016, 3017, 3018
GE	3019
GENEXXA	3014, 3021, 3020
HARMON	3022, 3023, 3051
HITACHI	3020
INKEL	3024
JC PENNEY	3012, 3020, 3025
JVC	3026, 3027
KARDON	3022, 3051, 3023
KENWOOD	3028, 3029, 3030, 3031 3032, 3033
KRELL	3010
LUXMAN	3035, 3036, 3037, 3038
LX I	3012, 3020, 3014
MAGNAVOX	3010, 3039, 3040
MARANTZ	3010, 3041, 3042, 3043
MATHES	3012, 3020
MCS	3012, 3020
MGA	3023
MISSION	3010
MINISUBISHI	3023, 3044
NAD	3034, 3045
NAKAMICHI	3046, 3047, 3048
NEC MCS	3025
NIKKO	3007, 3016
ONKYO	3049, 3050, 3051, 3052 3055, 3102, 3103
OPTIMUS	3011, 3014, 3020, 3028, 3053 3054, 3056, 3057, 3058, 3059
PANASONIC	3008, 3060, 3061
PHILIPS	3009, 3010, 3010, 3040
PIONEER	3020, 3021, 3062, 3063, 3064
QUASAR	3008
RCA	3011, 3014, 3065, 3066, 3067 3068, 3069

REALISTIC	3011, 3014, 3020, 3042 3054, 3057
ROTEL	3010
RS ORIGINAL	3070
SAE	3010, 3083
SAMSUNG	3071
SANSUI	3014, 3068, 3072, 3073
SANYO	3011, 3018, 3074, 3075, 3076
SCOTT	3014
SEARS	3012, 3014, 3020, 3028, 3042
SHARP	3028, 3042, 3077
SHERWOOD	3042, 3056, 3070, 3078, 3024
SHURE	3025
SONY	3039, 3079, 3080, 3081, 3082, 3097 3098, 3099, 3100, 3101
SYLVANIA	3010
SYMPHONIC	3083
TEAC	3016, 3042, 3057, 3083, 3084 3085, 3086
TECHNICA	3007, 3008, 3061, 3087, 3088
THETA DIGITAL	3040
TOSHIBA	3045
VICTOR	3026
YAMAHA	3007, 3089, 3090, 3091, 3092
ZENITH	3016, 3093, 3094, 3095, 3096

DVD

Aiwa	2036, 2037
Apex	2012, 2017, 2018, 2019, 2021, 2034
BOSE	2038, 2039, 2063
Denon	2047, 2048
Funai	2049
GE	2009, 2020, 2029, 2033
Harman Kardon	2061
Hitachi	2008, 2012, 2031
JVC	2006, 2010, 2040 2041, 2042, 2043
Kenwood	2053, 2054
Koss	2058
Magnavox	2007, 2011, 2023, 2025
Marantz	2025
Marantz (Blu-ray)	2064
Mitsubishi	2011, 2015
Onkyo	2062
Oritron	2009, 2030
Panasonic	2003, 2015, 2016, 2055
Philips	2007, 2011, 2058
Pioneer	2002, 2014, 2056
Proscan	2009, 2020, 2032
RCA	2005, 2009, 2020, 2035, 2057
Sampo	2041
Samsung	2008, 2012, 2022, 2024, 2027
Sanyo	2050, 2052
Sharp	2044, 2045
Sherwood	2051
Sony	2001, 2013, 2059
Toshiba	2004, 2008, 2026, 2028
Yamaha	2046, 2060
Zenith	2010

DSS

Alphastar	4027
Amstrad	4046, 4047, 4050
Atsky	4048
B Sky B	4021, 4045, 4046
Chaparral	4039
DIRECTV	4001, 4016, 4044
DISH Network	4030
Drake	4026
Echostar	4007, 4017, 4018, 4019, 4020 4062, 4063, 4064
Eurosky	4047, 4056
Express Vu	4017
Foxtel	4051
Freesat	4056
Fujitsu	4025
GE	4002, 4008, 4009
General Instruments	4036, 4037
Gradiente	4044, 4057
Hitachi	4001, 4015
Hughes	4001, 4016
Humax	4049, 4050, 4051, 4052, 4053
Janeil	4025
JVC	4017
Mitsubishi	4001
Nokia	4058, 4059, 4060, 4061
Optima	4048
Panasonic	4004, 4010
Philips	4031, 4035, 4044, 4057
Proscan	4002, 4008, 4009, 4011
Radio Shack	4036, 4037
RCA	4002, 4008, 4009, 4029
Realistic	4040
Rural Cable	4036
Samsung	4022, 4027, 4042, 4043, 4050, 4054, 4055
Schneider	4041, 4043
SKY	4044, 4045, 4057
Skyplus	4048
Skysat	4041, 4047, 4056
Sony	4003, 4012, 4014, 4065, 4066, 4067
Star Choice	4032
Star Trak	4024
STS	4038
SuperDish	4028
Teac	4049
Thomson	4046, 4056
Toshiba	4001, 4034
Uniden	4005, 4006, 4013
Universum	4056
Video Pall	4025
Zenith	4023, 4025, 4033

www.marantz.com

You can find your nearest authorized distributor or dealer on our website.

marantz[®] is a registered trademark.

