

marantz®

Model SR7500/SR8500 User Guide

AV Surround Receiver

ENGLISH

WARRANTY

For warranty information, contact your local Marantz distributor.

RETAIN YOUR PURCHASE RECEIPT

Your purchase receipt is your permanent record of a valuable purchase. It should be kept in a safe place to be referred to as necessary for insurance purposes or when corresponding with Marantz.

IMPORTANT

When seeking warranty service, it is the responsibility of the consumer to establish proof and date of purchase. Your purchase receipt or invoice is adequate for such proof.

FOR U.K. ONLY

This undertaking is in addition to a consumer's statutory rights and does not affect those rights in any way.

FRANÇAIS

GARANTIE

Pour des informations sur la garantie, contacter le distributeur local Marantz.

CONSERVER L'ATTESTATION D'ACHAT

L'attestation d'achat est la preuve permanente d'un achat de valeur. La conserver en lieu sûr pour s'y reporter aux fins d'obtention d'une couverture d'assurance ou dans le cadre de correspondances avec Marantz.

IMPORTANT

Pour l'obtention d'un service couvert par la garantie, il incombe au client d'établir la preuve de l'achat et d'en corroborer la date. Le reçu ou la facture constituent des preuves suffisantes.

DEUTSCH

GARANTIE

Bei Garantiefragen wenden Sie sich bitte an Ihren Marantz-Händler.

HEBEN SIE IHRE QUITTING GUT AUF

Die Quittung dient Ihnen als bleibende Unterlage für Ihren wertvollen Einkauf. Das Aufbewahren der Quittung ist wichtig, da die darin enthaltenen Angaben für Versicherungszwecke oder bei Korrespondenz mit Marantz angeführt werden müssen.

WICHTIG!

Bei Garantiefragen muß der Kunde eine Kaufunterlage mit Kaufdatum vorlegen. Ihre Quittung oder Rechnung ist als Unterlage ausreichend.

NEDERLANDS

GARANTIE

Voor inlichtingen omtrent garantie dient u zich tot uw plaatselijke Marantz.

UW KWITANTIE, KASSABON E.D. BEWAREN

Uw kwitantie, kassabon e.d. vormen uw bewijs van aankoop van een waardevol artikel en dienen op een veilige plaats bewaard te worden voor evt. verwijzing bijv. in verband met verzekering of bij correspondentie met Marantz.

BELANGRIJK

Bij een evt. beroep op de garantie is het de verantwoordelijkheid van de consument een gedateerd bewijs van aankoop te tonen. Uw kassabon of factuur zijn voldoende bewijs.

ESPAÑOL

GARANTIA

Para obtener información acerca de la garantía póngase en contacto con su distribuidor Marantz.

GUARDE SU RECIBO DE COMPRA

Su recibo de compra es su prueba permanente de haber adquirido un aparato de valor. Este recibo deberá guardarlo en un lugar seguro y utilizarlo como referencia cuando tenga que hacer uso del seguro o se ponga en contacto con Marantz.

IMPORTANTE

Cuando solicite el servicio otorgado por la garantía el usuario tiene la responsabilidad de demostrar cuándo efectuó la compra. En este caso, su recibo de compra será la prueba apropiada.

ITALIANO

GARANZIA

L'apparecchio è coperto da una garanzia di buon funzionamento della durata di un anno, o del periodo previsto dalla legge, a partire dalla data di acquisto comprovata da un documento attestante il nominativo del Rivenditore e la data di vendita. La garanzia sarà prestata con la sostituzione o la riparazione gratuita delle parti difettose.

Non sono coperti da garanzia difetti derivanti da uso improprio, errata installazione, manutenzione effettuata da personale non autorizzato o, comunque, da circostanze che non possano riferirsi a difetti di funzionamento dell'apparecchio. Sono inoltre esclusi dalla garanzia gli interventi inerenti l'installazione e l'allacciamento agli impianti di alimentazione.

Gli apparecchi verranno riparati presso i nostri Centri di Assistenza Autorizzati. Le spese ed i rischi di trasporto sono a carico del cliente.

La casa costruttrice declina ogni responsabilità per danni diretti o indiretti provocati dalla inosservanza delle prescrizioni di installazione, uso e manutenzione dettagliate nel presente manuale o per guasti dovuti ad uso continuato a fini professionali.

PORTUGUÊS

GARANTIA

Para informações sobre a garantia, contactar o distribuidor Marantz local.

GUARDAR O RECIBO DE COMPRA

O recibo é o registo permanente da compra que fez. Deve ser guardado num local seguro, para ser apresentado em questões relacionadas com o seguro ou para quando tiver de contactar a Marantz.

IMPORTANTE

Quando procurar assistência técnica ao abrigo da garantia, é da responsabilidade do consumidor estabelecer a prova e data de compra. O recibo é prova adequada.

SVENSKA

GARANTI

För information om garantin, kontakta Marantz lokalt.

SPAR KVITTOT

Kvittot är ett inköpsbevis på en värdefull vara. Det skall förvaras säkert och hänvisas till vid försäkringsfall eller vid korrespondens med Marantz.

VIKTIGT

Fö att garantin skall gälla är det kundens sak att framställa bevis och datum om köpet. Kvitto eller faktura är tillräckligt bevis för detta.

DANSK

GARANTI

Henvend dem til Deres MARANTZ-forhandler angående information om garantien.

GEM DERES KVITTERING

Deres købskvittering er Deres varige bevis på et dyrt køb. Den bør gemmes godt og anvendes som bevis, hvis De vil tegne en forsikring, eller hvis De kommunikerer med Marantz.

VIGTIGT

Det påhviler forbrugeren at skaffe bevis for købet og købsdatoen, hvis han eller hun ønsker garantiservice. Deres købskvittering eller faktura er et fuldgyldigt bevis herpå.

CE MARKING

- English**
The SR7500/SR8500 is in conformity with the EMC directive and low-voltage directive.
- Français**
Le SR7500/SR8500 est conforme à la directive EMC et à la directive sur les basses tensions.
- Deutsch**
Das Modell SR7500/SR8500 entspricht den EMC-Richtlinien und den Richtlinien für Niederspannungsgeräte.
- Nederlands**
De SR7500/SR8500 voldoet aan de EMC eisen en de vereisten voor laag-voltage.
- Español**
El SR7500/SR8500 está de acuerdo con las normas EMC y las relacionadas con baja tensión.
- Italiano**
Il SR7500/SR8500 è conforme alle direttive CEE ed a quelle per i bassi voltaggi.
- Português**
O SR7500/SR8500 conforma com as diretrizes EMC e de baixa voltagem.
- Svenska**
SR7500/SR8500 är tillverkad i enlighet med EMC direktiven och direktiven för lågvoltstrusning.
- Dansk**
Model SR7500/SR8500 er i overensstemmelse med EMC-direktivet og direktivet om lavspænding.

English

WARNINGS

- Do not expose the equipment to rain or moisture.
- Do not remove the cover from the equipment.
- Do not insert anything into the equipment through the ventilation holes.
- Do not handle the mains lead with wet hands.
- Do not cover the ventilation with any items such as tablecloths, newspapers, curtains, etc.
- No naked flame sources, such as lighted candles, should be placed on the equipment.
- When disposing of used batteries, please comply with governmental regulations or environmental public instruction's rules that apply in your country or area.
- Do not place anything about 0.2 meter above the top panel.
- Make a space of about 0.2 meter around the unit.

Français

AVERTISSEMENTS

- Ne pas exposer l'appareil à la pluie ni à l'humidité.
- Ne pas essayer de retirer le boîtier de l'appareil.
- Ne rien insérer dans l'appareil par les orifices de ventilation.
- Ne pas manipuler le cordon d'alimentation avec les mains mouillées.
- Ne pas recouvrir les ouïes de ventilation avec un objet quelconque comme une nappe, un journal, un rideau, etc.
- Ne placer aucune source de flamme nue, comme une bougie allumée, sur l'appareil.
- Pour mettre au rebut les piles usées, respecter les lois gouvernementales ou les règlements officiels concernant l'environnement qui s'appliquent à votre pays ou région.
- Ne placez aucun objet à moins de 0,2 mètre environ du panneau supérieur.
- Veiller à ce qu'aucun objet ne soit à moins de 0,2 mètre des côtés de l'appareil.

Deutsch

WARNHINWEISE

- Das Gerät nicht Regen oder Feuchtigkeit aussetzen.
- Die Abdeckung nicht vom Gerät abnehmen.
- Keine Gegenstände durch die Belüftungsschlitze stecken.
- Das Netzkabel nicht mit feuchten oder nassen Händen anfassen.
- Decken Sie die Lüftungsöffnungen nicht mit einem Tischtuch, einer Zeitung, einem Vorhang usw. ab.
- Es dürfen keine Gegenstände mit offener Flamme, wie etwa brennende Kerzen, auf dem Gerät aufgestellt werden.
- Beachten Sie bei der Entsorgung der verbrauchten Batterien alle geltenden lokalen und überregionalen Regelungen.
- Darauf achten, daß über dem Gerät ein Freiraum von mindestens 0.2 meter vorhanden ist.
- Auf allen Geräteseiten muß ein Zwischenraum von ungefähr 0,2 meter vorhanden sein.

Nederlands

WAARSCHUWINGEN

- Stel het apparaat niet bloot aan regen of vocht.
- Verwijder de afdekplaat van het apparaat niet.
- Duw niets door de ventilatieopeningen in het apparaat.
- Raak het netsnoer niet met natte handen aan.
- Bedek de ventilatieopeningen niet met enige voorwerpen, zoals tafelkleden, kranten, gordijnen, enz.
- Plaats geen brandende voorwerpen, zoals kaarsen, op het apparaat.
- Volg bij het weggooien van verbruikte batterijen de overheidswetgeving of milieuvorschriften op die van kracht zijn in het land of de regio waarin u zich bevindt.
- Zorg dat er tenminste 0.2 meter vrije ruimte boven het toestel is.
- Zorg dat er 0,2 meter vrije ruimte rond het toestel is.

Español

ADVERTENCIAS

- No exponga el equipo a la lluvia ni a la humedad.
- No extraiga la tapa del equipo.
- No introduzca nada en el interior del equipo a través de los orificios de ventilación.
- No maneje el cable de alimentación con las manos mojadas.
- No cubra la ventilación con objetos como manteles, periódicos, cortinas, etc.
- No deben colocarse sobre el equipo elementos con fuego, por ejemplo velas encendidas.
- Cuando se eliminan baterías usadas, deben cumplirse las reglamentaciones oficiales o las normas de protección medioambiental aplicables en su país o en su zona.
- No ponga nada a menos de 0.2 metro por encima del panel superior.
- Deje un espacio de unos 0,2 metro alrededor de la unidad.

Italiano

AVVERTENZE

- Non esporre l'apparecchio alla pioggia o all'umidità.
- Non rimuovere il coperchio dell'apparecchio.
- Non introdurre oggetti all'interno dell'apparecchio attraverso i fori di ventilazione.
- Non toccare il cavo di alimentazione con le mani bagnate.
- Non coprire le fessure di ventilazione con tovaglie, giornali, tende od oggetti analoghi.
- Non posare sull'apparecchio sorgenti di fiamme scoperte quali candele accese.
- Smaltire le pile usate in conformità alle norme governative o disposizioni ambientali vigenti nel proprio paese o zona.
- Non posare alcun oggetto sopra il pannello superiore, lasciando libero uno spazio di circa 0,2 m.
- Lasciare 0,2 metro liberi tutto intorno l'unità.

Português

ADVERTÊNCIAS

- Não exponha o equipamento à chuva nem à humidade.
- Não retire a tampa do equipamento.
- Não atire nada para dentro do equipamento através dos orifícios de ventilação.
- Não manuseie o cabo de alimentação com as mãos molhadas.
- Não cobrir os orifícios de ventilação com objectos tais como toalhas de mesa, jornais, cortinas, etc.
- Não colocar chamas abertas tais como velas acesas, sobre o aparelho.
- Ao deitar foras as pilhas usadas, favor observar os regulamentos governamentais ou as regras com respeito ao meio ambiente que se aplicam no seu país ou área de residência.
- Deixar um espaço completamente livre de cerca de 0.2 metro acima do painel superior.
- Deixar um espaço de cerca de 0,2 metro ao redor do aparelho.

Svenska

VARNINGAR

- Utsätt inte utrustningen för regn eller fukt.
- Ta inte bort utrustningens hölje.
- För inte in föremål i utrustningen genom ventilationshålen.
- Hantera inte nätsladden med våta händer.
- Täck inte för ventilationsöppningarna med några föremål som till exempel bordsdukar, dagstidningar, gardiner e.d.
- Inga föremål med öppen låga, som till exempel tända stearinljus, bör placeras på utrustningen.
- Följ de lagar och miljöskyddsråd som gäller i det land eller område där du bor när du gör dig av med batterier.
- Placera inte någonting närmare än 0.2 meter ovanför apparaten eller enheten.
- Se till att det finns omkring 0,2 meter fri plats runt omkring enheten.

Dansk

ADVARSLER

- Udsæt ikke udstyret for regn eller fugt.
- Fjern ikke dækslet fra udstyret.
- Stik ikke noget ind i udstyret gennem ventilationshullerne.
- Rør ikke ved netledningen med våde hænder.
- Tildæk ikke ventilationsåbningerne med ting som duge, aviser, gardiner og lignende.
- Kilder til åben ild, som for eksempel tændte stearinlys, må ikke anbringes på apparatet.
- Når du skiller dig af med gamle batterier, bedes du gøre dette i overensstemmelse med de love, regler og miljømæssige forskrifter, som er gældende i dit land eller område.
- Anbring ikke noget nærmere end 0.2 m over apparatets overside,
- Sørg for, at der er et frit område på omkring 0,2 m omkring apparatet.

TABLE OF CONTENTS

FOREWORD 1
 EQUIPMENT MAINS WORKING SETTING 1
 COPYRIGHT 1

INTRODUCTION..... 1

DESCRIPTION..... 2

FEATURES 4

ACCESSORIES 4

FRONT PANEL 5
 FL DISPLAY AND INDICATOR 6

REAR PANEL 7

REMOTE CONTROLLER RC8500SR .. 8
 NAMES AND FUNCTIONS 8
 LCD INDICATORS 9
 REMOTE CONTROL RANGE 10
 LOADING BATTERIES 10
 BATTERY REPLACEMENT INTERVAL 10
 SETTING THE TIME 10
 GENERAL INFORMATION OF RC8500SR
 TO SR7500 11

CONNECTIONS..... 12
 SPEAKER PLACEMENT 12
 CONNECTING SPEAKERS 12
 CONNECTING AUDIO COMPONENTS 13
 CONNECTING VIDEO COMPONENTS 14
 ADVANCED CONNECTING 15
 CONNECTING THE REMOTE CONTROL JACKS 15
 CONNECTING THE ANTENNA TERMINALS 16
 CONNECTING FOR THE MULTI ROOM 17

SETUP 18
 ON SCREEN DISPLAY MENU SYSTEM 18
 1 INPUT SETUP
 (ASSIGNABLE DIGITAL INPUT) 19
 2 SPEAKER SETUP 19
 3 PREFERENCE 22
 4 PL II (PRO LOGIC II) MUSIC PARAMETER 22
 5 CS II (CIRCLE SURROUND II) PARAMETER 22
 6 MULTI ROOM 23
 7 7.1 CH INPUT LEVEL 23
 8 DC TRIGGER SETUP 23

BASIC OPERATION (PLAY BACK) .. 24
 SELECTING AN INPUT SOURCE 24
 VIDEO CONVERT 24
 SELECTING THE SURROUND MODE 24
 ADJUSTING THE MAIN VOLUME 24

ADJUSTING THE TONE
 (BASS & TREBLE) CONTROL 24
 TEMPORARILY TURNING OFF THE SOUND 25
 USING THE SLEEP TIMER 25
 NIGHT MODE 25

SURROUND MODE 25

OTHER FUNCTION 29
 TV AUTO ON/OFF FUNCTION 29
 ATTENUATION TO ANALOG INPUT SIGNAL 29
 LISTENING THROUGH HEADPHONES 29
 DOLBY HEADPHONE MODE 29
 VIDEO ON/OFF 29
 DISPLAY MODE 29
 SELECTING ANALOG AUDIO INPUT
 OR DIGITAL AUDIO INPUT 30
 RECORDING AN ANALOG SOURCE 30
 SPEAKER A/B 30
 7.1 CH INPUT 30
 AUX2 INPUT 31
 LIP.SYNC 31

BASIC OPERATION (TUNER) 32
 LISTENING TO THE TUNER 32
 PRESET MEMORY 33
 RDS OPERATION 35

MULTI ROOM SYSTEM..... 36
 MULTI ROOM PLAYBACK
 USING THE MULTI ROOM OUT TERMINALS 36
 MULTI ROOM PLAYBACK
 USING THE MULTI SPEAKER TERMINALS 36
 OPERATION OF THE MULTI ROOM OUTPUTS
 WITH THE REMOTE CONTROL
 FROM A SECOND ROOM 36

REMOTE CONTROLLER OPERATION .. 37
 CONTROLLING MARANTZ COMPONENTS 37
 BASIC OPERATION 39
 PROGRAMMING MACROS 42
 CLONE MODE 44
 SETUP 45

TROUBLESHOOTING 46

TECHNICAL SPECIFICATIONS 47

DIMENSIONS 47

FOREWORD

This section must be read before any connection is made to the mains supply.

This user guide covers the SR7500 and SR8500, though the SR7500 is given for the title. Explanations of features belonging only to the SR8500 are indicated as "SR8500 only".

EQUIPMENT MAINS WORKING SETTING

Your Marantz product has been prepared to comply with the household power and safety requirements that exist in your area. SR7500 can be powered by 230V AC only.

COPYRIGHT

Recording and playback of any material may require consent. For further information refer to the following:

- Copyright Act 1956
- Dramatic and Musical Performers Act 1958
- Performers Protection Acts 1963 and 1972
- Any subsequent statutory enactments and orders

CAUTIONS ON INSTALLATION

For heat dispersal, leave at least 20 cm/8 inch of space between the top, back and sides of this unit and the wall or other components.

- Do not obstruct the ventilation holes.

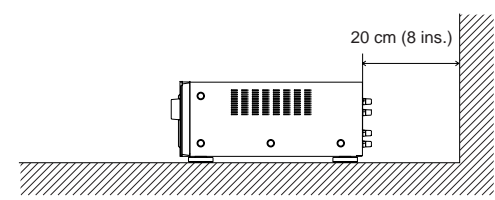
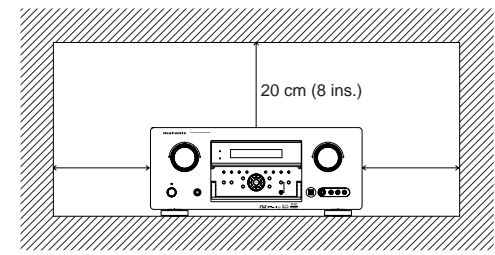

INTRODUCTION

Thank you for purchasing the Marantz SR7500 Surround receiver. This remarkable component has been engineered to provide you with many years of home theater enjoyment. Please take a few minutes to read this manual thoroughly before you connect and operate the SR7500. As there are a number of connection and configuration options, you are encouraged to discuss your own particular home theater setup with your Marantz A/V specialist dealer.

DESCRIPTION



THX® is an exclusive set of standards and technologies established by the world-renowned film production company, Lucasfilm Ltd. THX resulted from George Lucas' desire to reproduce the movie soundtrack as faithfully as possible both in the movie theater and in the home theater.

THX engineers developed patented technologies to accurately translate the sound from a movie theater environment into the home, correcting the tonal and spatial errors that occur.

When the THX mode of the SR7500 is on, three distinct THX technologies are automatically added:

Re-Equalization-restores the correct tonal balance for watching a movie in a home environment.

These sounds are otherwise mixed to be brighter for a large movie theater. Re-EQ compensates for this and prevents the soundtracks from being overly bright and harsh when played in a home theater.

Timbre Matching-filters the information going to the surround speakers so they more closely match the tonal characteristics of the sound coming from the front speakers.

This ensures seamless panning between the front and surround speakers.

Adaptive Decorrelation-slightly changes one surround channel's time and phase relationship with respect to the other surround channel.

This expands the listening position and creates with only two surround speakers the same spacious surround experience as in a movie theater with multiple surround speakers.

The Marantz SR7500 was required to pass a rigorous series of quality and performance tests, in addition to incorporating the technologies explained above, in order to be THX certified by Lucasfilm Ltd.

THX requirements cover every aspect of performance including pre-amplifier and power amplifier performance and operation, and hundreds of other parameters in both the digital and analog domain.

Movies which have been encoded in Dolby Digital, DTS, Dolby Pro Logic, stereo and Mono will all benefit from the THX mode when being viewed.

The THX mode should only be activated when watching movies which were originally produced for a movie theater environment.

THX need not be activated for music, movies made especially for TV, or shows such as sports programming, talk shows, etc.

This is because they were originally mixed for a small room environment.

THX is a trademark or registered trademark of THX Ltd. Surround EX is a jointly developed technology of THX and Dolby Laboratories, Inc. and is a trademark of Dolby Laboratories, Inc. Used under authorization. All rights reserved.

THX SURROUND EX

THX Surround EX—Dolby Digital Surround EX is a joint development of Dolby Laboratories and THX Ltd.

In a movie theater, film soundtracks that have been encoded with Dolby Digital Surround EX technology are able to reproduce an extra channel which has been added during the mixing of the program. This channel, called Surround Back, places sounds behind the listener in addition to the currently available front left, front center, front right, surround right, surround left and subwoofer channels. This additional channel provides the opportunity for more detailed imaging behind the listener and brings more depth, spacious ambience and sound localization than ever before. Movies that were created using the Dolby Digital Surround EX technology, when released into the home consumer market may exhibit wording to that effect on the packaging. A list of movies created using this technology can be found on the Dolby web site at www.dolby.com. A list of available DVD software titles encoded with this technology can be found at www.thx.com.

Only receiver and controller products bearing the THX Surround EX logo, when in the THX Surround EX mode, faithfully reproduce this new technology in the home. This product may also engage the THX Surround EX mode during the playback of 5.1 channel material that is not Dolby Digital Surround EX encoded. In such case, the information delivered to the Surround Back channel will be program dependent and may or may not be very pleasing depending on the particular soundtrack and the tastes of the individual listener.

"SURROUND EX™" is a trademark of Dolby Laboratories. Used under authorization.



DTS was introduced in 1994 to provide 5.1 channels of discrete digital audio into home theater systems.

DTS brings you premium quality discrete multichannel digital sound to both movies and music.

DTS is a multichannel sound system designed to create full range digital sound reproduction.

The no compromise DTS digital process sets the standard of quality for cinema sound by delivering an exact copy of the studio master recordings to neighborhood and home theaters.

Now, every moviegoer can hear the sound exactly as the moviemaker intended.

DTS can be enjoyed in the home for either movies or music on of DVD's, LD's, and CD's.

"DTS" and "DTS Digital Surround" are registered trademarks of Digital Theater Systems, Inc.



The advantages of discrete multichannel systems over matrix are well known.

But even in homes equipped for discrete multichannel, there remains a need for high-quality matrix decoding. This is because of the large library of matrix surround motion pictures available on disc and on VHS tape; and analog television broadcasts.

The typical matrix decoder of today derives a center channel and a mono surround channel from two-channel matrix stereo material. It is better than a simple matrix in that it includes steering logic to improve separation, but because of its mono, band-limited surround it can be disappointing to users accustomed to discrete multichannel.

Neo:6 offers several important improvements as follows,

- Neo:6 provides up to six full-band channels of matrix decoding from stereo matrix material. Users with 6.1 and 5.1 systems will derive six and five separate channels, respectively, corresponding to the standard home-theater speaker layouts.
- Neo:6 technology allows various sound elements within a channel or channels to be steered separately, and in a way which follows naturally from the original presentation.

- Neo:6 offers a music mode to expand stereo nonmatrix recordings into the five- or six-channel layout, in a way which does not diminish the subtlety and integrity of the original stereo recording.



DTS-ES Extended Surround is a new multichannel digital signal format developed by Digital Theater Systems Inc. While offering high compatibility with the conventional DTS Digital Surround format, DTS-ES Extended Surround greatly improves the 360-degree surround impression and space expression thanks to further expanded surround signals. This format has been used professionally in movie theaters since 1999.

In addition to the 5.1 surround channels (FL, FR, C, SL, SR and LFE), DTS-ES Extended Surround also offers the SB (Surround Back) channel for surround playback with a total of 6.1 channels. DTS-ES Extended Surround includes two signal formats with different surround signal recording methods, as DTS-ES Discrete 6.1 and DTS-ES Matrix 6.1.

"DTS", "DTS-ES" and "Neo:6" are trademarks of Digital Theater Systems, Inc.



The stereo CD is a 16-bit medium with sampling at 44.1 kHz. Professional audio has been 20- or 24-bit for some time, and there is increasing interest in higher sampling rates both for recording and for delivery into the home. Greater bit depths provide extended dynamic range. Higher sampling rates allow wider frequency response and the use of anti-alias and reconstruction filters with more favorable aural characteristics.

DTS 96/24 allows for 5.1 channel sound tracks to be encoded at a rate of 96kHz/24bits on DVD-Video titles.

When DVD-video appeared, it became possible to deliver 24-bit, 96 kHz audio into the home, but only in two channels, and with serious limitations on picture. This capability has had little use.

DVD-audio allows 96/24 in six channels, but a new player is needed, and only analog outputs are provided, necessitating the use of the D/A converters and analog electronics provided in the player.

DTS 96/24 offers the following:

1. Sound quality transparent to the original 96/24 master.
2. Full backward compatibility with all existing decoders. (Existing decoders will output a 48 kHz signal)
3. No new player required: DTS 96/24 can be carried on DVD-video, or in the video zone of DVD-audio, accessible to all DVD players.
4. 96/24 5.1-channel sound with full-quality full-motion video, for music programs and motion picture soundtracks on DVD-video.

“DTS” and “DTS 96/24” are trademarks of Digital Theater Systems, Inc.



Dolby Digital identifies the use of Dolby Digital audio coding for such consumer formats as DVD and DTV. As with film sound, Dolby Digital can provide up to five full-range channels for left, center, and right screen channels, independent left and right surround channels, and a sixth (“.1”) channel for low-frequency effects.

Dolby Surround Pro Logic II is an improved matrix decoding technology that provides better spatiality and directionality on Dolby Surround program material; provides a convincing three-dimensional soundfield on conventional stereo music recordings; and is ideally suited to bring the surround experience to automotive sound. While conventional surround programming is fully compatible with Dolby Surround Pro Logic II decoders, soundtracks will be able to be encoded specifically to take full advantage of Pro Logic II playback, including separate left and right surround channels. (Such material is also compatible with conventional Pro Logic decoders.)

Dolby Digital EX creates six full-bandwidth output channels from 5.1-channel sources. This is done using a matrix decoder that derives three surround channels from the two in the original recording. For best results, Dolby Digital EX should be used with movies soundtracks recorded with Dolby Digital Surround EX.

About Dolby Pro Logic IIx

Dolby Pro Logic IIx technology delivers a natural and immersing 7.1-channel listening experience to the home theater environment. A product of Dolby's expertise in surround sound and matrix decoding technologies, Dolby Pro Logic IIx is a complete surround sound solution that maximizes the entertainment experience from stereo as well as 5.1-channel encoded sources.

Dolby Pro Logic IIx is fully compatible with Dolby Surround Pro Logic technology and can optimally decode the thousands of commercially available Dolby Surround encoded video cassettes and television programs with enhanced depth and spatiality. It can also process any high-quality stereo or Advanced Resolution 5.1-channel music content into a seamless 6.1- or 7.1-channel listening experience.



The Dolby Headphone technology provides a surround sound listening experience over headphones. When listening to multichannel content such as DVD movies over headphones, the listening experience is fundamentally different than listening to speakers. Since the headphone speaker drivers are covering the pinna of the ear, the listening experience differs greatly from traditional speaker playback. Dolby utilizes patented headphone perspective curves to solve this problem and provides a non-fatiguing, immersive, home theater listening experience. Dolby Headphone also delivers exceptional 3D audio from stereo material.

Manufactured under license from Dolby Laboratories. “Dolby”, “Pro Logic”, and the double-D symbol are trademarks of Dolby Laboratories.



Circle Surround II (CS-II) is a powerful and versatile multichannel technology. CS-II is designed to enable up to 6.1 multichannel surround sound playback from mono, stereo, CS encoded sources and other matrix encoded sources. In all cases the decoder extends it into 6 channels of surround audio and a LFE/subwoofer signal. The CS-II decoder creates a listening environment that places the listener “inside” music performances and dramatically improves both hi-fi audio conventional surround-encoded video material. CS-II provides composite stereo rear channels to greatly improve separation and image positioning—adding a heightened sense of realism to both audio and A/V productions.

CS-II is packed with other useful feature like dialog clarity (SRS Dialog) for movies and cinema-like bass enrichment (TruBass). CS-II can enable the dialog to become clearer and more discernable in movies and it enables the bass frequencies contained in the original programming to more closely achieve low frequencies—overcoming the low frequency limitations of the speakers by full octave.

Circle Surround II, Dialog Clarity, TruBass, SRS and  symbol are trademarks of SRS Labs, Inc. Circle Surround II, Dialog Clarity and TruBass technology are incorporated under license from SRS Labs, Inc.

Microsoft®



HDCD® (High Definition Compatible Digital®) is a patented process for delivering on Compact Disc the full richness and details of the original microphone feed.

HDCD encoded CDs sound better because they are encoded with 20-bits of real musical information as compared to 16-bits for all other CDs.

HDCD overcomes the limitation of the 16-bit CD format by using a sophisticated system to encode the additional four bits onto the CD while remaining completely compatible with the CD format.

When listening to HDCD recordings, you hear more dynamic range, a focused 3-D sound stage, and extremely natural vocal and musical timbre. With HDCD, you get the body, depth and emotion of the original performance not a flat, digital imitation.

HDCD system manufactured under license from Microsoft. This product is covered by one or more of the following: In the United States 5,479,168 5,638,074 5,640,161 5,808,574 5,838,274 5,854,600 5,864,311 5,872,531 and in Australia 669,114 with other patents pending.

FEATURES

The SR7500 incorporates the latest generation of digital surround sound decoding technology such as Dolby Digital EX, Dolby Digital, DTS ES (Discrete 6.1 and Matrix 6.1), DTS Neo:6 (Cinema, Music), Dolby Pro-Logic II (Movie, Music and Game), Dolby Pro-Logic IIx (Movie, Music and Game), Circle Surround II (Cinema, Music and Mono).

In addition, Marantz has focused on the future. By utilizing pre-out jacks, 7.1 direct inputs and a RS-232C communication port, the SR7500 is tomorrow's technology, today!

• THX Select certified

7ch amplifiers have enough power for even the most difficult conditions found in large rooms. Enormous power reserves endow the system with substantial dynamic ability at high sound levels. 105 watts (SR7500) / 110 watts (SR8500) to each of the 7 main channels the power amp section features an advanced, premium high-storage power supply capacitors, and fully discrete output stages housed in cast aluminum heat sinks.

The SR7500 incorporates the most advanced Digital Signal Processing circuitry, along with a Crystal[®] 192 kHz/24 bit D/A converter in each of the 7 channels. Independent power supply circuits are incorporated for the FL display, audio and video sections for maximum separation, clarity and dynamic range. Together with hand-selected customized components, all elements work in harmony to recreate the emotion, exactly as the artist had intended.

The SR7500 is designed and engineered with extensive feedback from custom installation experts, dealers and consumers. It features multi-room/multisource, assignable DC trigger, a RS-232C communication port, Flasher input, heavy duty speaker binding posts and an extensive array of both analog and digital inputs / outputs. With 6 assignable digital inputs (7 total), 4 component inputs, SACD Multi Channel (7.1 channel) direct inputs video convert system and a speaker-B and OSD output versatility is taken to a stunning new level. Furthermore, the SR7500 can output the OSD information through the Y/C (S-video) and composite video outputs.

An easy-to-use programmable, learning remote control allows full access to all of the operating functions and can be used for system operation as well.

The new generation of Marantz Receivers is stylish and completely symmetrical. On the front panel of the SR7500, buttons are kept to a minimum. Source selectors and volume controls are intuitively placed. The SR7500 is here to perform in your unrivaled home entertainment setup.

- THX / THX Surround EX
- Dolby Digital EX, Dolby Digital, DTS ES (Discrete 6.1, Matrix 6.1, Neo:6)
- Dolby Pro Logic II (Movie, Music, Game)
- Dolby Pro Logic IIx (Movie, Music, Game)
- Circle Surround II (Cinema, Music, Mono)
- MRAC (Marantz Room Acoustic Calibration)
- 7 × 105 Watts (8 Ohms), Discrete Amplifiers (SR8500: 7 × 110 Watts)
- High Power Current Feedback Circuitry
- Massive Energy Power Supply, Huge EI Transformer, Large ELCO's.
- 192 kHz/24 bit Crystal[®] DAC for all 8 Channels
- 32 bit Digital Surround Processing Chipsets
- Video Off Mode
- Large Heavy Duty Speaker Terminals for all Channels
- RS-232C Terminal for Future Upgrade or System Control
- Set Up Menu via all Video Output (Composite, S-Video and Component video)
- Auto Input Signal Detection
- Improved Station Name Input Method, 50 Presets
- Auto Adjust Function for Speaker Distance Settings (Delay Time)
- Front Optical AUX Input (Digital Camera, Portable DVD)
- Assignable DC Trigger Output
- Programmable, learning remote control
- Flasher Input
- Video convert system (Composite Video ↔ S Video → Component Video)
- Assignable DVI-D INPUT (SR8500 only)
- HDCD (SR8500 only)
- Copper Plate Chassis (SR8500 only)
- Troidal Core Transformer (SR8500 only)

ACCESSORIES

Remote Controller RC8500SR

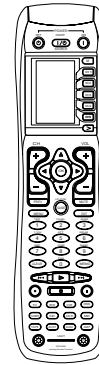

Microphone MC-10

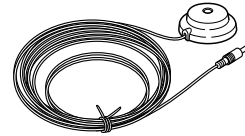

AC cable

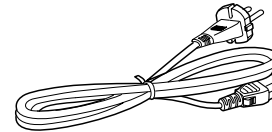

AAA-size batteries × 3

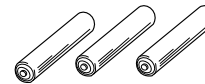

AM Loop Antenna

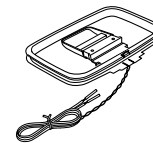

FM Antenna

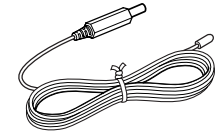

Front AUX Jack Cover

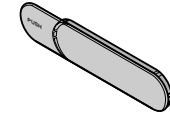

User Guide

FRONT PANEL

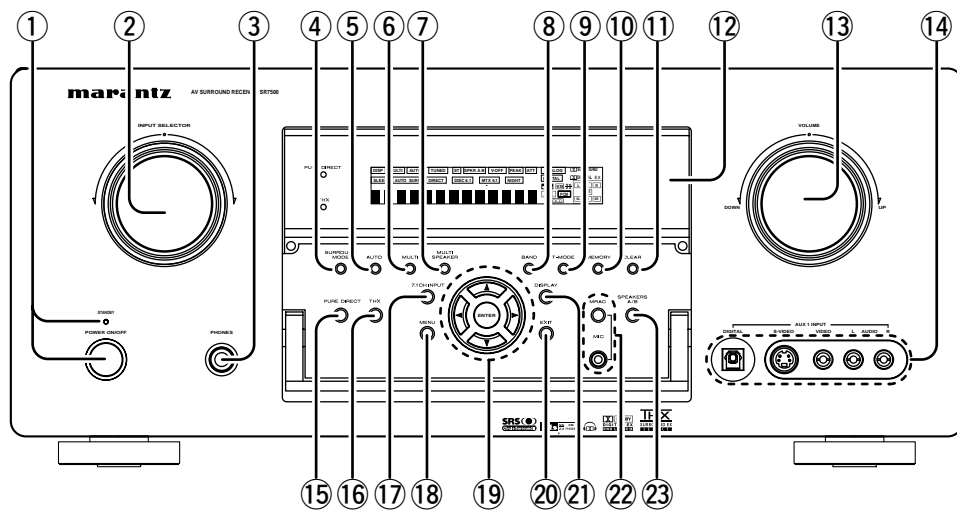

① POWER switch and STANDBY indicator

Press the button to turn the power ON, and press again to turn it OFF. If the **POWER** switch is in the ON position, the power of this unit can be turned ON/OFF by pressing the **POWER** button on the remote control unit.

When this unit is in the standby mode with the **POWER** switch set to the ON position, pressing the **ENTER** button also allows to turn the power on. The **STANDBY** indicator lights up when this unit is the standby mode (power OFF) by the remote control unit.

② INPUT SELECTOR knob (AUDIO/ VIDEO)

This knob is used to select the input sources. The video function selectors, such as TV, DVD, VCR1, DSS and AUX1 select video and audio simultaneously.

Audio function sources such as CD, TAPE, CD-R/MD, TUNER and AUX2 may be selected in conjunction with a Video source.

This feature (Sound Injection) combines a sound from one source with a picture from another. Choose the video source first, and then choose a different audio source to activate this function.

③ HEADPHONE jack for stereo headphones

This jack may be used to listen to the SR7500's output through a pair of headphones. Be certain that the headphones have a standard 1/4" stereo phono plug. Note that the main room speakers will automatically be turned off when the headphone jack is in use.

Notes:

- When using headphones, the surround mode will change to STEREO and Dolby Headphone by MENU and Cursor button.
- The surround mode returns to the previous setting as soon as the headphone plug is removed from the jack.

④ SURROUND MODE button

You can select the surround mode by pressing this button.

⑤ AUTO (Auto surround) button

Press this button to select the AUTO mode from the surround modes. When this mode is selected, the receiver determines the surround mode corresponding to a digital input signal automatically.

⑥ MULTI (Multi Room) button

Press this button to activate the Multiroom system. "MULTI" indicator will be illuminated in the display.

⑦ MULTI SPEAKER button

Press this button to activate the Multiroom Speaker system. "MULTI" indicator will be illuminated in the display. (See page 36)

⑧ BAND button

Press this button to switch between FM and AM in the TUNER mode.

⑨ T-MODE button

Press this button to select the auto stereo mode or mono mode when the FM band is selected. The "AUTO" indicator lights in the auto stereo mode. (See page 32)

⑩ MEMORY button

Press this button to enter the tuner preset memory numbers or station names. (See page 33)

⑪ CLEAR button

Press this button to cancel the station-memory setting mode or preset scan tuning. (See page 33)

⑫ INFRARED receiving sensor window

This window receives infrared signals for the remote control.

⑬ VOLUME control knob

Adjusts the overall sound level. Turning the control clockwise increases the sound level.

⑭ AUX1 INPUT jacks

These auxiliary video/audio input jacks accept the connections of a camcorder, portable DVD, game etc. When not using these jacks, protect with the included jack covers.

How to Attach the Front AUX Jack Cover

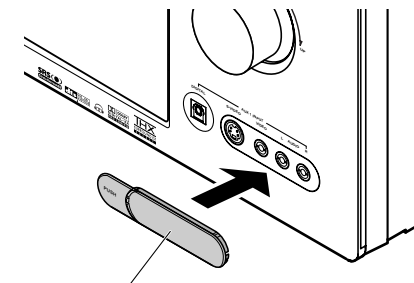

Front AUX Jack Cover

⑮ PURE DIRECT button

When this button is pressed, the tone control circuitry is bypassed as well as Bass Management. "PURE DIRECT" indicator will be illuminated in the display.

Notes:

- The surround mode is automatically switched to AUTO when the pure direct function is turned on.
- Additionally, Speaker Configurations are fixed automatically as follows.
Front SPKR = Large, Center SPKR = Large, Surround SPKR = Large, Sub woofer = On

⑯ THX button

Press this button to select THX processing for input source.

⑰ 7.1CH INPUT button

Press this button to select the output of an external multichannel player.

⑱ MENU button

This button is used to enter the SETUP MAIN MENU.

⑲ Cursor (◀, ▶, ▲, ▼) / ENTER button

Use these buttons when operating the SETUP MAIN MENU and TUNER function.

20 EXIT button

This button is used to exit from the SETUP MAIN MENU.

21 DISPLAY button

When this button is pressed, the FL display mode is changed as Surround Mode → Auto-display Off → Display Off → Input Function and the display off indicator (DISP) lights up in condition of DISPLAY OFF.

22 MRAC button / MIC jack

Press to automatically measure speaker characteristics using the included microphone (MC-10). (See page 21)

23 SPEAKER A/B button

Press this button to select speaker systems A and/or B.

Opening and closing the front panel door

When you want to use the controls behind the front panel door, open the door by gently pressing on the lower part of the panel. Keep the door closed when not using these controls.

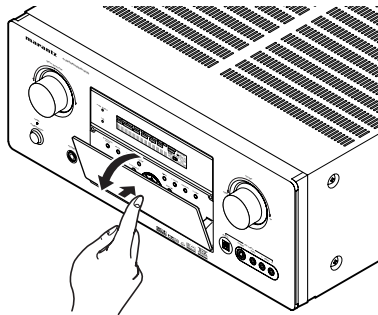

Notes:

- Be careful not to pinch your fingers between the door and the panel.

FL DISPLAY AND INDICATER

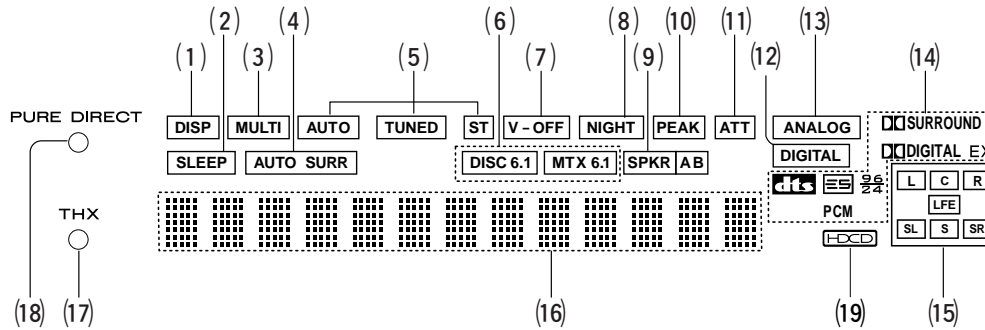

(1) DISP (Display Off) indicator

This indicator is illuminated when the SR7500 is in the display off condition.

(2) SLEEP timer indicator

This indicator is illuminated when the sleep timer function in the main-room is in use.

(3) Multi-room system indicator

This indicator is illuminated when the multi-room system is active.

(4) AUTO SURR (Auto Surround mode) indicator

This indicator is illuminated to show that the AUTO SURROUND mode is in use.

(5) TUNER's indicators

AUTO : This indicator illuminates when the tuner's Auto mode is in use.

TUNED : This indicator illuminates when a station is being received with sufficient signal strength to provide acceptable listening quality.

ST(Stereo) : This indicator illuminates when an FM station is being tuned into stereo condition.

(6) DTS-ES mode indicators (DISC6.1, MTX6.1)

These indicators will illuminate to show the DTS-ES decoding mode (Discrete 6.1 or Matrix 6.1).

(7) V (video)-OFF mode indicator

This indicator is illuminated when the Video-OFF function is active.

(8) NIGHT mode indicator

This indicator is illuminated when the SR7500 is in the Night mode, which reduces the dynamic range of digital program material at low volume levels.

(9) SPKR (speaker) AB indicator

Active speaker system will be illuminated by this indicator.

(10) PEAK indicator

This indicator is a monitor for an analog audio input signal. If the selected analog audio input signal is greater than the capable level of internal processing, this will illuminate. If this happens, you should press the ATT button on the remote.

(11) ATT (Attenuation) indicator

This indicator is illuminated when the attenuation function is active.

(12) DIGITAL Input Indicator

This indicator lights when a digital input has been selected.

(13) ANALOG input indicator

This indicator is illuminated when an analog input source has been selected.

(14) SIGNAL FORMAT indicators

DIGITAL, EX, SURROUND, dts, ES, 96/24, PCM

When the selected input is a digital source, some of these indicators will be illuminated to display the specific type of signal in use.

(15) ENCODED CHANNEL STATUS indicators

These indicators display the channels that are encoded with a digital

input signal. If the selected digital input signal is Dolby Digital 5.1ch or DTS 5.1ch, "L", "C", "R", "SL", "SR" and "LFE" will be illuminated. If the digital input signal is 2 channel PCM-audio, "L" and "R" will be displayed.

If Dolby Digital 5.1ch signal with Surround EX flag or DTS-ES signal comes in, "L", "C", "R", "SL", "S", "SR" and "LFE" will be illuminated.

(16) Main Information Display

This display shows messages relating to the status, input source, surround mode, tuner, volume level or other aspects of unit's operation.

(17) THX indicator

This indicator illuminated when the SR7500 is in the THX mode.

(18) PURE DIRECT indicator

This indicator is illuminated when the SR7500 is in the PURE DIRECT mode.

(19) HDCD indicator (SR8500 only)

When HDCD signal is decoded, this indicator will light up.

REAR PANEL

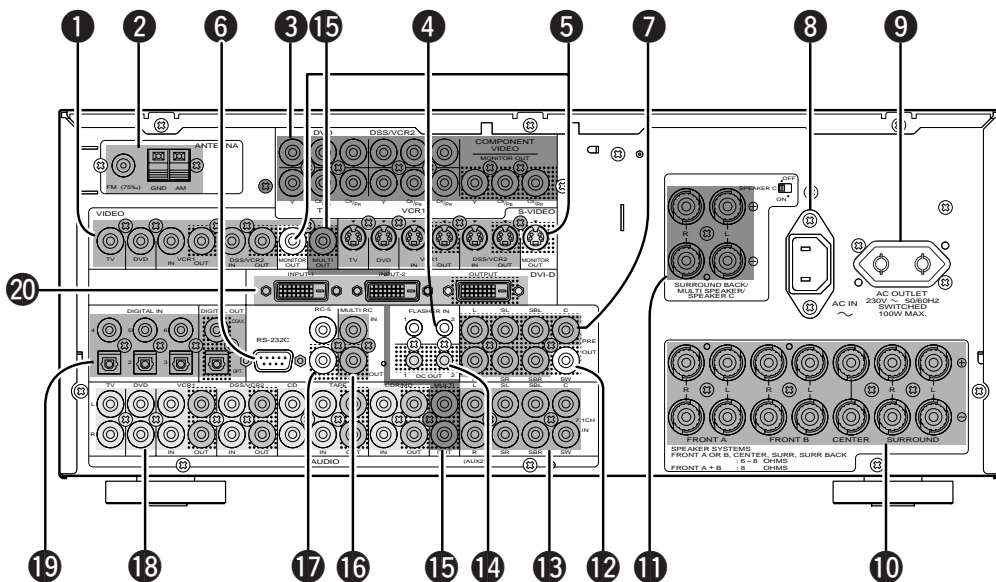

1 VIDEO IN/OUT (TV, DVD, VCR1, DSS/VCR2)

These are the video inputs and outputs. There are 4 video inputs and 2 video outputs and each one includes both composite video and S-video configurations. Connect VCRs, DVD players, and other video components to the video inputs. The 2 video output channels can be used to be connected to video tape recorders for making recordings.

2 FM antenna terminal (75 ohms)

Connect an external FM antenna with a coaxial cable, or a cable network FM source.

AM antenna and ground terminals

Connect the supplied AM loop antenna. Use the terminals marked "AM" and "GND". The supplied AM loop antenna will provide good AM reception in most areas. Position the loop antenna until you hear the best reception.

3 COMPONENT VIDEO INPUT/OUTPUT

If your DVD player or other device has component video connectors, be sure to connect them to these component video connectors on the SR7500. The SR7500 has 4 component video input connectors to obtain the color information (Y, C_B, C_R) directly from the recorded DVD signal or other video component and one component video output connector to output it directly into the matrix decoder of the display device.

By sending the pure DVD component video signal directly, the DVD signal forgoes the extra processing that normally would degrade the image. The result is vastly increased image quality, with incredibly life like colors and crisp detail.

4 FLASHER IN (Flasher input terminal)

These terminals are to control the unit from each zone. Connect the control signal from a Keypad, etc.

5 MONITOR OUT

These are monitor outputs and each one includes both composite video and S-video configurations. When connecting two video monitors or televisions, be aware that the OSD interface can be used with both MONITOR OUT connections.

6 RS-232C

The RS-232C port is to be used in conjunction with an external controller to control the operation of the SR7500 by using an external device. The RS-232C port may also be used in the future to update the operating software of the SR7500 so that it will be able to support new digital audio formats and the like as they are introduced.

7 Preamp Outputs (L, R, SL, SR, SBL, SBR, C)

Jacks for L (front left), R (front right), C (Center), SL (surround left), SR (surround right), SBL (surround back left) and SBR (surround back right). Use these jacks for connection to external power amplifiers.

8 AC INLET

Plug the supplied power cord into this AC INLET and then into the power outlet on the wall. SR7500 can be powered by 230V AC only.

9 AC OUTLETS

Connect the AC power cable of component such as a DVD or CD player to this outlet.

The marked SWITCHED provides power only when the SR7500 is turned on and is useful for components which you use every time you play your system.

Caution:

- In order to avoid potential turn-off thumps, anything plugged into these outlets should be powered up before the SR7500 is turned on.
- The capacity of this AC outlet is 100W. Do not connect devices that consume electricity more than the capacity of these AC outlet. If the total power consumption of the connected devices exceeds the capacity, the protection circuit shuts down the power supply.

10 Speaker outputs terminals

Seven terminals are provided for the front (A) left, front (A) right, front (B) left, front (B) right, front center, surround left and surround right speakers.

11 Speaker outputs terminals (SURROUND BACK / MULTI SPEAKER / SPEAKER C)

Two terminals are provided for the front left, and right speakers for multi room (2nd zone) or surround back.

The terminals can be used to connect a third set of speakers by setting the SPEAKER C selector switch to ON. For connection and use, see page 17.

12 Subwoofer Output

Connect this jack to the line level input of a powered subwoofer. If an external subwoofer amplifier is used, connect this jack to the subwoofer amplifier input. If you are using two subwoofers, either powered or with a 2 channel subwoofer amplifier, connect a "Y" connector to the subwoofer output jack and run one cable from it to each subwoofer amplifier.

13 7.1 CHANNEL or AUX2 INPUT

By connecting a DVD Audio player, SACD multichannel player, or other components that has a multichannel port, you can playback the audio with 5.1 channel or 7.1 channel outputs.

14 DC TRIGGER output terminal

Connect a device that needs to be triggered by DC under certain conditions (screen, power strip, etc...)

Use the system OSD setup menu to determine the conditions by which these jack will be active.

Note:

- This output voltage is for (status) control only, It is not sufficient for drive capability.

15 Multiroom Outputs (Audio L&R, Video)

These are the audio and video output jacks for the Multi zone (Multi room).

Connect these jacks to optional audio power amplifiers or video display devices to listen and view the source selected by the multiroom system in a remote room.

16 MULTI ROOM REMOTE IN/OUT terminals

IN: Connect to a multi-room remote control device, available from your Marantz dealer.

OUT: Connect to the Marantz component equipped with remote control (RC-5) terminals in Multi zone (Multi room).

17 REMOTE CONT. IN/OUT terminals

Connect to a Marantz component equipped with remote control (RC-5) terminals.

18 AUDIO IN/OUT (CD, TAPE, CD-R, TV, DVD, VCR1, DSS/VCR2)

These are the analog audio inputs and outputs. There are 7 audio inputs (4 of which are linked to video inputs) and 4 audio outputs (2 of which are linked to video outputs). The audio jacks are nominally labeled for cassette tape decks, compact disc players, DVD players and etc.... The audio inputs and outputs require RCA-type connectors.

19 DIGITAL INPUT (Dig.1 - 6) / OUTPUT (coaxial, optical)

These are the digital audio inputs and outputs. There are 3 digital inputs with coaxial jacks, 3 with optical jacks.

The inputs accept digital audio signals from a compact disc, LD, DVD, or other digital source component.

For digital output, there is 1 coaxial output and 1 optical output.

The digital outputs can be connected to MD recorders, CD recorders, DAT decks, or other similar components.

20 DVI-D INPUT / OUTPUT (SR8500 only)

This unit has two DVI-D inputs and one DVI-D output. The input function can be selected from the SETUP MAIN MENU.

REMOTE CONTROLLER RC8500SR

NAMES AND FUNCTIONS

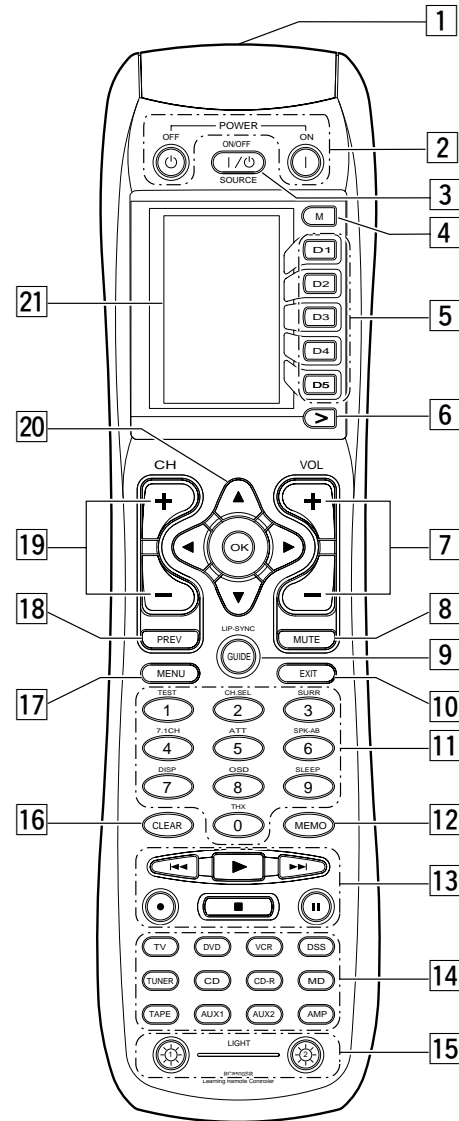

1 Infrared Transmitter and Learning Sensor

This transmitter emits infrared light. Press the buttons while pointing the transmitter towards the infrared receiver window of the SR7500 or other AV equipment. Be sure to also point towards other remote controls when using the learning function.

2 POWER ON and OFF buttons

(When AMP mode is selected)

These buttons are used to turn the SR7500 on or off.

3 SOURCE ON/OFF button

This button is used to turn a specific source (such as a DVD player) on or off independently from the rest of the system.

4 M (Mode) button

This button is used to program Macros. Pressing this button switches between Normal mode and Macro mode.

The > button is used to move to the next page. Up to 20 programs (4 pages) can be made. Holding down the M button for three seconds or more switches to the Setup mode, where the Setup menu is shown on the LCD. The Setup menu has four pages, and the > button is used to move to the next page. Pressing the > button from page 4 returns you to page 1.

5 D1 to D5 (Direct) buttons

Five types of direct operations can be performed for each of the 12 source buttons such as the DVD, television, amplifier, and other AV equipment. The pages can be switched, so 4 pages × 5 types = 20 operations can be performed for a single source. The text display can also be changed.

6 > (Page) button

This button is used to switch pages for the Direct button. The current page is shown on the LCD.

7 VOL (Volume) button

This button is used to adjust the volume for the amplifier and television.

Note:

- Set the AMP mode to use this button with the SR7500.

8 MUTE button

This button is used to mute the audio for the SR7500 and television.

Note:

- Set the AMP mode to use this button with the SR7500.

9 GUIDE button

This button is used to display the menus for the DVD player, DSS (satellite broadcasting tuner), or other AV equipment.

(when AMP mode is selected)

This button is used to select the LIP.SYNC mode.

10 EXIT button

(when AMP mode is selected)

This button is used to cancel settings in the setup menu.

11 Numeric buttons

These buttons are used to switch between 0 to 9 of the source components. If the source is set to the amplifier, these buttons are used to perform operations.

(when AMP mode is selected)

(1) TEST button

Used to enter the test tone menu.

(2) CH SEL. (channel select) button

Used to call up SETUP MAIN MENU and adjust speaker levels or 7.1 ch input level.

(3) SURR (surround) button

Used to select the surround mode.

(4) 7.1CH button

Press this button to select the output of an external multi channel decoder.

(5) ATT button

When the input signal is too high and the voice distorts even by throttling the SR7500 VOLUME control, turn on this function. "ATT" is indicated when this function is activated.

The input level is reduced. Attenuator is invalid for use with the output signal of "REC OUT".

Note:

- This function is unavailable during the digital input is selected.

(6) SPK-AB button

Speaker mode is switched in the following sequence.

A → B → A+B → off

(7) DISP. button

Selects the display mode for the front display of the SR7500.

(8) OSD button

When this button is pressed, the current setting are displayed on the TV monitor.

(9) SLEEP (sleep timer) button

This button is used for setting the sleep timer. It can be operated the same way as the button in unit.

(0) THX button

Use this button to select the THX mode.

12 MEMO button

This button is used to store settings to memory or program a source.

13 CONTROL button

Thses buttons are used when operating the PLAY, STOP, PAUSE, and other commands of a source.

Note:

- This button is unavailable for the SR7500.

14 SOURCE button

Thses buttons are used to switch the source of your A/V Receiver / amplifier. Each time a source button is pressed, the remote control changes to the source which was pressed.

This remote control can control 12 types of equipment. To change the A/V Receiver / amplifier source, press this button twice within two seconds. The signal is sent when it is pressed the second time.

Note:

- Select the AMP as the source to use this remote controll with the SR7500.

15 LIGHT 1 and 2 buttons

Pressing these buttons will light up the LCD and its buttons. This lighting time can be set. If the lighting time is set to 0 seconds, the backlight turns on only while this button is pressed. The operations for LIGHT 1 and 2 are identical.

16 CLEAR button

This button is used to erase the memory or program of a source.

17 MENU button**(when AMP mode is selected)**

This button is used to call up the SETUP MAIN MENU of the SR7500.

18 PREV (Previous) button

This button is used to return to the previous channel on the television or other device.

Note:

- This button is unavailable for SR7500.

19 CH (Channel) button

This is used to change channels.

20 CURSOR buttons

These buttons are used when controlling the cursor of the SR7500, DVD, or other AV equipment.

21 LCD

Information about the sources and modes are shown on the LCD.

LCD INDICATORS

Information about currently selected source and direct code names are displayed on the LCD.

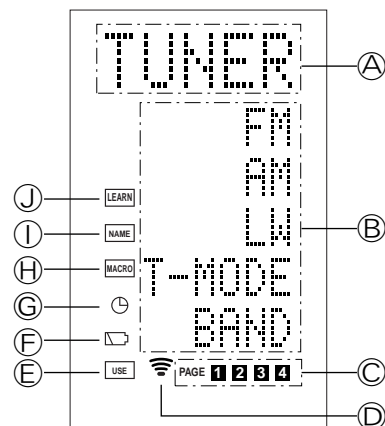
**A Source Name indicator**

This displays the name of the selected source, such as DVD, television, or other AV equipment (up to five characters).

B Direct Button Name indicator

This displays up to 20 types of button names for each source. (up to six characters)

C Page indicator

This displays the current page position.

D Transmission indicator

This lights up when the remote control is sending a signal.

E USE indicator

This is displayed under normal operation.

F Battery Level indicator

This is displayed when the battery level is low.

G TIMER indicator

This is displayed when the macro timer is set.

H MACRO indicator

This is displayed when the remote control is in macro programming mode.

I NAME indicator

This is displayed when the remote control is in renaming mode.

J LEARN indicator

This is displayed when the remote control is in learning mode.

REMOTE CONTROL RANGE

The distance between the transmitter of the remote control and the IR SENSOR of the SR7500 should be less than 5 meters. If the remote control is pointed in a direction other than the IR SENSOR or if there is an obstacle between them, use of the remote control may not be possible.

Remote-controllable range

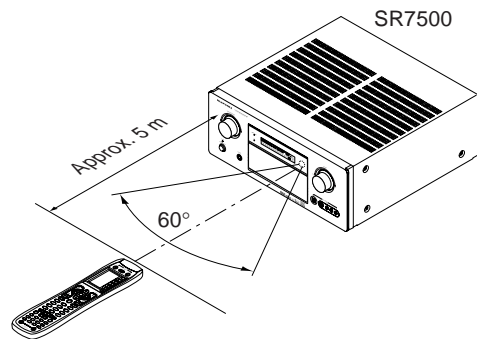

Remote control unit (RC8500SR)

LOADING BATTERIES

The life of the batteries used with the remote control is about 4 months with normal use. Also be sure to replace batteries earlier when you notice that they are getting weak.

1. Remove the back cover.

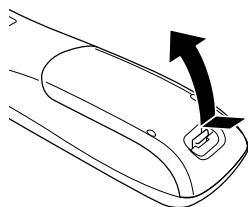

2. Insert the new batteries (AAA type) with correct ⊕ and ⊖ polarity.

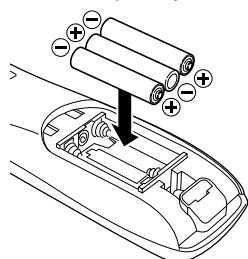

3. Close the cover until it clicks.

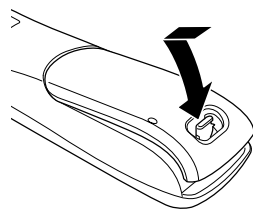

CAUTIONS ON BATTERIES

- Use “AAA” type batteries in this remote control unit.
- If the remote control unit does not operate from close to the main unit, replace the batteries with new ones, even if less than a year has passed.
- The included battery is only for verifying operation. Replace it with a new battery as soon as possible.
- When inserting the batteries, be careful to do so in the proper direction, following the + and - marks in the remote control unit’s battery compartment.
- To prevent damage or battery fluid leakage:
 - Do not use a new battery with an old one.
 - Do not use two different types of batteries.
 - Do not short-circuit, disassemble, heat or dispose of batteries in flames.
- Remove the batteries when not planning to use the remote control unit for a long period of time.
- If the batteries should leak, carefully wipe off the fluid from the inside of the battery compartment, then insert new batteries.
- When disposing of used batteries, please comply with governmental regulations or environmental public instruction’s rules that apply in your country or area.

BATTERY REPLACEMENT INTERVAL

Under normal usage, alkaline batteries last approximately four months. When the batteries wear out, a battery mark is displayed on the LCD. Although the remote control can still be used when the battery mark is displayed, the batteries should be replaced as soon as possible. The LCD eventually starts to flash when buttons are pressed, the remote control will be unable to transmit signals or learn codes.

- This remote control uses non-volatile memory so that the learned codes and macro programs are retained even if the batteries are removed.

Reset the clock after replacing the batteries.

Safety Precautions for Batteries

- Be sure to always observe the following precautions to prevent fluid leakage, overheating, fire, breakage, accidental ingestion, and other accidents.
- If the batteries are left unused for a long period of time, the battery fluid may leak or the batteries may corrode.
 - Do not use the batteries in the remote control with the plus and minus polarity reversed.
 - Do not attempt to recharge, heat, or disassemble the batteries. Do not put the batteries in a fire.
 - Do not use the remote control with old batteries or worn-out batteries inserted.
 - Do not use different types of batteries or mix old and new batteries in the remote control.
 - If the remote control is not operating properly, replace the batteries with new ones.
 - If any of the batteries are leaking, completely wipe up all leaked battery fluid, and then replace the batteries with new ones.

SETTING THE TIME

Example: Setting to 6:20PM (18:20)

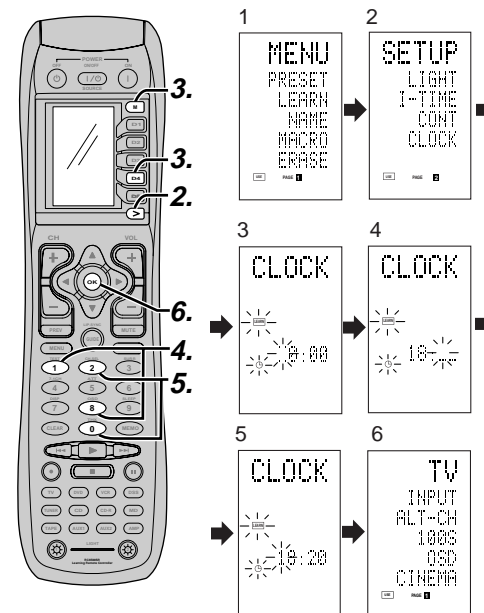

When you bought this remote control and insert the batteries to the remote control at first, the steps 1 to 3 are skipped. Starts from step 4 to set the time.

1. Hold down the **M** button for three seconds or more.
The menu is displayed.
2. Press the **>** button once.
This displays second page (SETUP).
3. Press the **D4** (CLOCK) direct button.
The “:” indicator blinks and the clock indicator displays “0:00”.
4. Press the **1** and **8** numeric button to set the hour indicator.
The hour indicator displays “18”.
The minute indicator blinks “_”.
5. Press the **2** and **0** numeric button to set the minute indicator.
The minute indicator displays “20”.
The hour indicator blinks.
6. Press the **OK** cursor button to start the clock.
The clock starts from 0 second at the time that was set and return to normal (USE) mode.

Whenever the batteries are replaced, the clock shows 00:00. Please reset the clock. (The time setting is not backed up.)

CHECKING THE TIME

To check the time, hold down the > button for three seconds or more. The current time is displayed for five seconds.

Note:

- Although the remote control uses a quartz clock, the time may become out of sync over the course of operation. Be sure to correct the clock from time to time.

GENERAL INFORMATION OF RC8500SR TO SR7500

To control the SR7500 by your RC8500SR, you have to select the device AMP or TUNER by pressing the function selector button. Please refer below for the details in AMP and TUNER mode.

AMP MODE

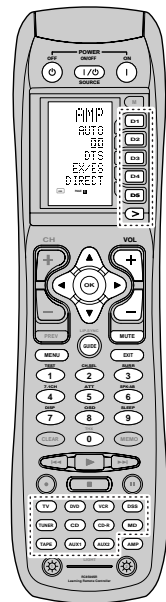

SOURCE ON/OFF	Turns the SR7500 on and off
POWER ON	Turns the SR7500 on
POWER OFF	Turns the SR7500 off
D1 - D5 / >(Page)	(Refer to page vi)
VOL +/-	Adjust the over all sound level
MUTE	Decreases the sound temporarily
Cursor	Move the cursor for setting in "On screen display" mode
OK	Enter the "On screen display" Confirms the setting in "On screen display" mode
MENU	Displays the current setting on the monitor
EXIT	Exits from SETUP MENU
TEST (1)	Enter the test tone menu
CH.SEL (2)	Call up SETUP MENU and adjusts speaker levels or 7.1ch input level
SURR (3)	Selects the surround mode
7.1CH (4)	Selects the 7.1CH IN
ATT (5)	Reduces the input level
SPK-AB (6)	Selects the speaker system
DISP (7)	Changes the front display mode
OSD (8)	Selects the "On screen display" on and off
SLEEP (9)	Sets the sleep timer function
THX (0)	Selects the THX mode
Function selector	Selects a particular source component
GUIDE / LIP.SYNC	Selects the LIP.SYNC mode

TUNER MODE

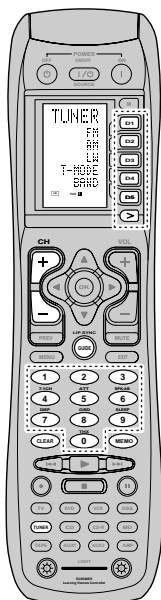

D1 - D5 / >(Page)	(Refer to page vi)
CH +/-	Selects a preset station up and down
GUIDE	Selects the "Frequency direct input"
0-9	Input the numeric
MEMO	Enter the tuner preset memory numbers
CLEAR	Clears the inputting
TUNER	Selects a frequency band

CONNECTIONS

SPEAKER PLACEMENT

The ideal surround speaker system for this unit is 7-speaker systems, using front left and right speakers, a center speaker, surround left and right speakers, a surround back left and right speakers, and a subwoofer.

For best results we recommend that all front speakers be of the same type, with identical or similar driver units. This will deliver smooth pans across the front sound stage as the action moves from side to side.

Your center channel speaker is very important as over 80 % of the dialog from a typical motion picture emanates from the center channel.

It should possess similar sonic characteristics to the main speakers. Surround channel speakers need not be identical to the front channel speakers, but they should be of high quality.

The surround center speaker is useful for playback of Dolby Digital Surround EX or DTS-ES. One of the benefits of both Dolby Digital and DTS is that surround channels are discrete full range, while they were frequency limited in earlier "Pro Logic" type systems.

Bass effects are an important part of home theater. For optimal enjoyment a subwoofer should be used as it is optimized for low frequency reproduction. If you have full range front speakers, however, they may be used in place of a subwoofer with proper setting of the switches in the menu system.

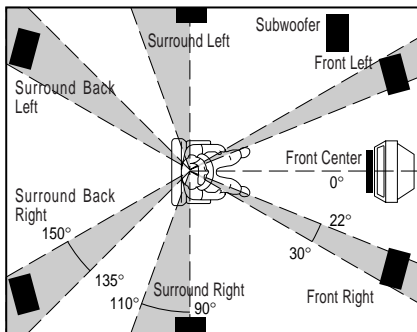

Front left and right speakers

We recommend to set the front L and R speakers with 45-60 degrees from the listening position.

Center speaker

Align the front line of the center speaker with the front L/R speakers. Or place the center speaker a little backward from the line.

Surround left and right speakers

When the SR7500 is used in surround operation, the preferred location for surround speakers is on the side walls of the room, at or slightly behind the listening position.

The center of the speaker should face into the room.

Surround back left and right speakers

Surround back speakers are required when a full 7.1-channel system is installed.

Speakers should be placed on a rear wall, behind the listening position.

The center of the speaker should face into the room.

Subwoofer

We recommend using a sub-woofer to have maximum bass effect. Sub-woofer bears only low frequency range so you can place it any where in the room.

HEIGHT OF THE SPEAKER UNITS

Front left and right speakers, and a center speaker

Align the tweeters and mid-range drivers on the three front speakers at the same height, as best as possible.

Surround left and right speakers, and surround back speaker

Place the surround left, right and surround back speakers higher than your ears by about 70cm-1m. Also place the speakers at the same height, as best as possible.

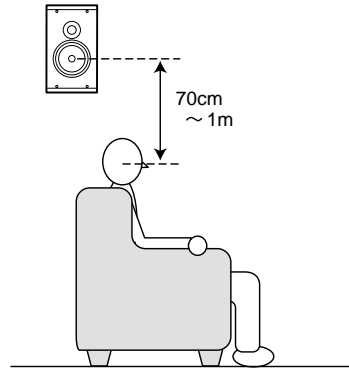

Note:

- Use magnetically-shielded speakers for front left, right and the center speakers when the speakers are installed near the TV and the TV is a monitor type.

CONNECTING SPEAKERS

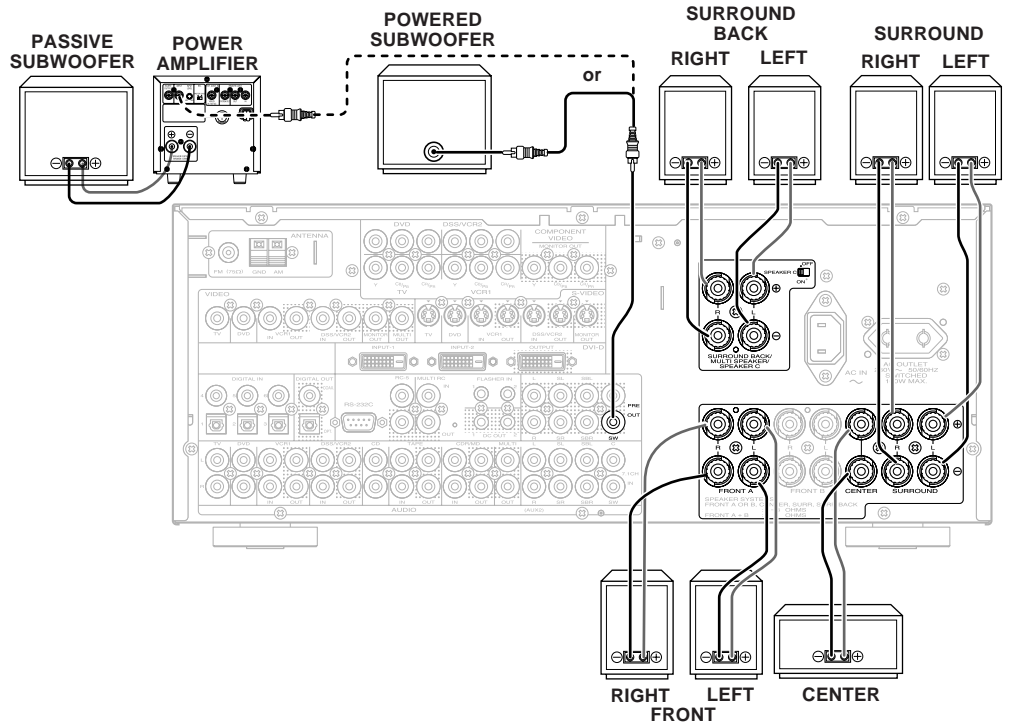

CONNECTING SPEAKER WIRE

1. Strip away approx. 3/8 inch (10 mm) of wire insulation.
2. Twist the bared wire ends tight, to prevent short circuits.
3. Loosen the knob by turning it counterclockwise.
4. Insert the bare part of the wire into the hole in side of each terminal.
5. Tighten the knob by turning it clockwise to secure the wire.

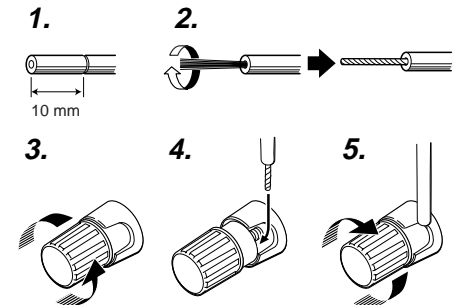

Caution:

- Be sure to use speakers with the specified impedance as shown on the rear panel of this unit.
- To prevent damage to circuitry, do not let the bare speaker wires touch each other and do not let them touch any metal part of this unit.
- Do not touch the speaker terminals when the power is on. It may cause you to receive an electric shocks.
- Do not connect more than one speaker cable to one speaker terminal. Doing so may damage this unit.

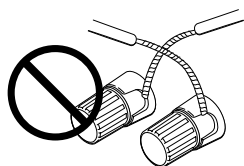

Note:

- Be sure to connect the positive and negative cables for the speaker properly. If they are miss-connected, the signal phase will be reversed and the signal quality will be corrupted.

CONNECTING A SUBWOOFER

Use the PRE OUT SUBWOOFER jack to connect a powered subwoofer (power amplifier built in). If your subwoofer is a passive type (power amplifier is not built in), connect a monaural power amplifier to the PRE OUT SUBWOOFER jack and connect the subwoofer to the amplifier.

CONNECTING AUDIO COMPONENTS

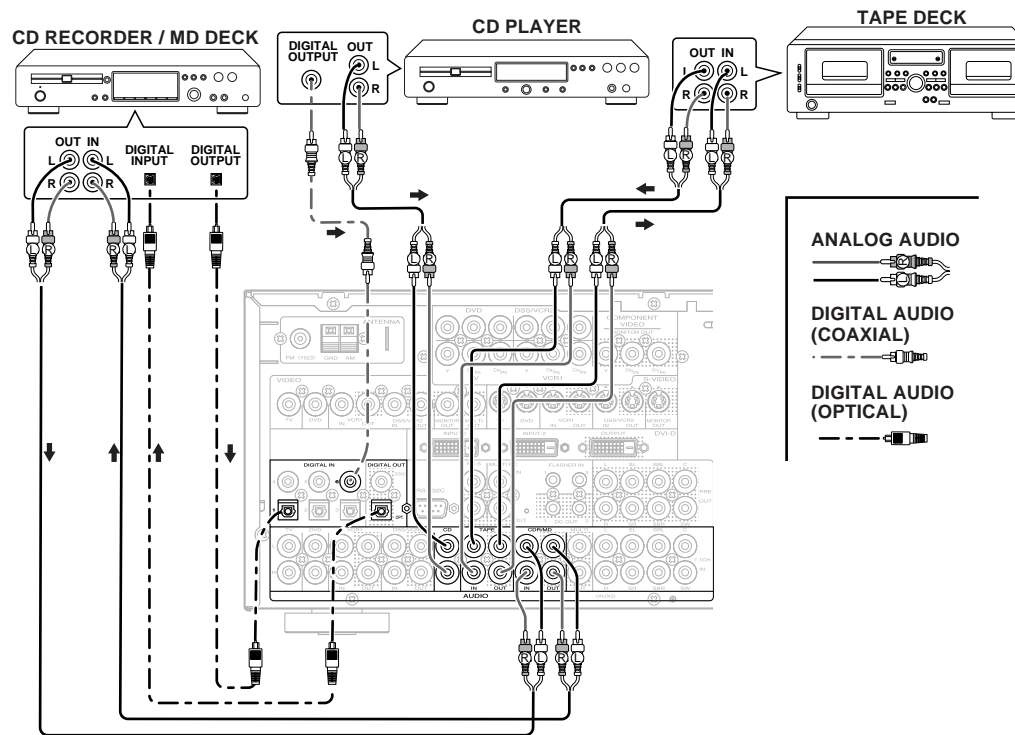

The output audio signal from the TAPE OUT jack and the CD-R/MD OUT jack is the same signal which is currently selected.

Caution:

- Do not connect this unit and other components to mains power until all connections between components have been completed.

Notes:

- Insert all plugs and connectors securely. Incomplete connections may make noise.
- Be sure to connect the left and right channels properly.
Red connectors are for the R (right) channel, and white connectors are for the L (left) channel.
- Be sure to connect input and output properly.
- Refer to the instructions for each component that is connected to this unit.
- Do not bind audio/video connection cables with power cords and speaker cables this will result in generating a hum or other noise.

CONNECTING DIGITAL AUDIO COMPONENTS

- There are 6 digital inputs, 3 coaxial jacks and 3 optical jacks, on the rear panel. You can use these jacks to input PCM, Dolby Digital and DTS bitstream signals from a CD, DVD, or other digital source components.
- There is one digital output coaxial jack and one optical output jack on the rear panel. These jacks can be connected to a CD recorder-, or a MD deck inputs, respectively.
- Refer to the instructions for each component. To setup the digital audio format of DVD player, or other digital source's connected to digital input jacks.
- Use fiber optical cables (optical) for DIG-1,2,3 input jacks. Use 75 ohms coaxial cables (for digital audio or video) for DIG-4, 5, 6 input jacks.
- You can designate the input for each digital input/output jacks according to your component. See page 19.

Notes:

- There is no Dolby Digital RF input jack. Please use an external RF demodulator Dolby Digital decoder when connecting the Dolby Digital RF output jack of the video disc player to the digital input jack.
- The digital signal jacks on this unit conform to the EIA standard. If you use a cable that does not conform to this standard, this unit may not function properly.
- Each type of audio jack works independently. Signals input through the digital and analog jacks are output through the corresponding digital and analog jacks, respectively.

CONNECTING VIDEO COMPONENTS

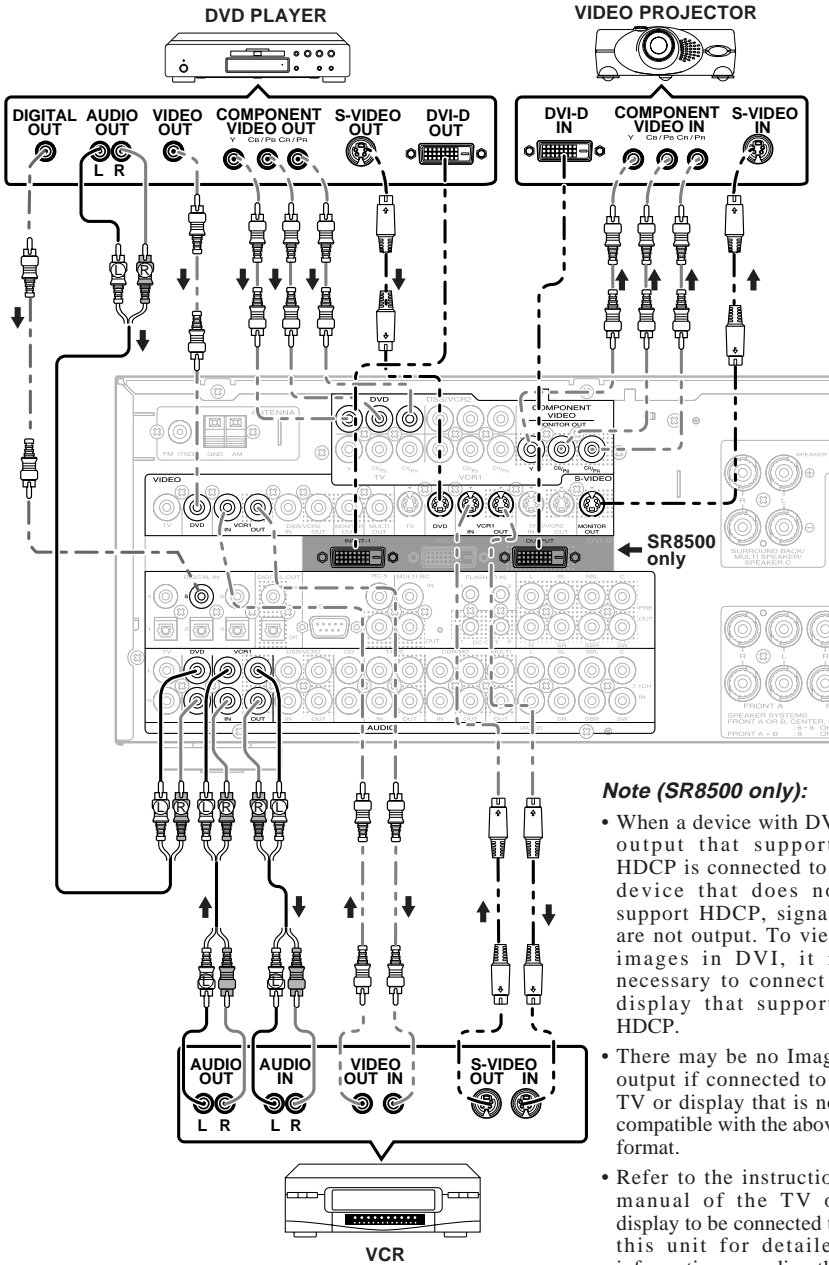

*HDCP: High-bandwidth Digital Content Protection

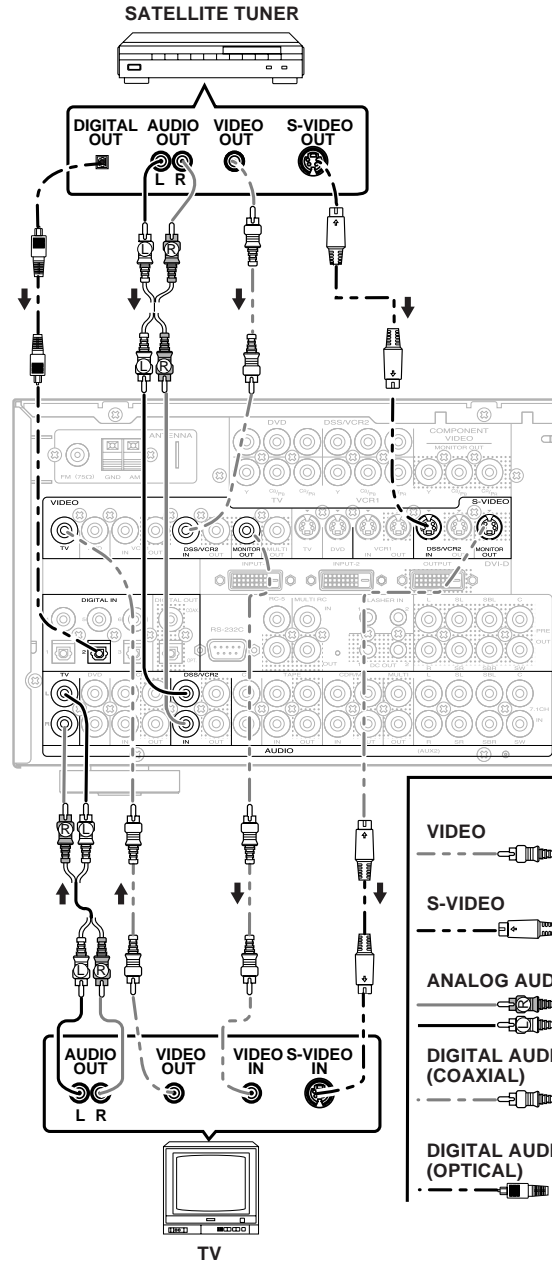

VIDEO, S-VIDEO, COMPONENT JACKS

There are 3 types of video jacks on the rear panel.

VIDEO jack

The video signal for the VIDEO jacks is the conventional composite video signal.

S-VIDEO jack

The video signal is separated into luminance (Y) and color (C) signals for the S-VIDEO jack. The S-VIDEO signals enables high-quality color reproduction. If your video component has an S-VIDEO output, we recommend to use it. Connect the S-VIDEO output jack on your video component to the S-VIDEO input jack on this unit.

Component jack

Make component video connections to a TV or monitor with component inputs to produce higher quality video images. Use a component video cable or 3 video cords to connect the component video out jacks on the SR7500 to the monitor.

DVI-D jack (SR8500 only)

This unit has two DVI-D inputs and one DVI-D output. It can send digital signals from DVDs and other sources directly to a display. It minimizes signal degradation caused by analog conversion so that high quality images can be enjoyed. Select an input source from the SETUP MAIN MENU. (See page 19.)

Notes:

- Be sure to connect the left and right audio channels properly.
Red connectors are for the R (right) channel, and white connectors are for L (left) channel.
- Be sure to connect the inputs and outputs of the video signals properly.
- If you connect the S-VIDEO or component signal to the S-VIDEO or component jack on this unit, it is not necessary to connect the conventional video signal to the VIDEO (composite) jack. If you use both video inputs, this unit gives priority to the S-VIDEO signal.
- Each type of video jack works independently. Signals input to the VIDEO (composite) and S-VIDEO jacks or component are output to the corresponding VIDEO (composite) and S-VIDEO or component jacks, respectively.
- This unit has the "TV-AUTO ON/OFF" function to turn the TV ON or OFF automatically, by sensing the incoming video signal from the VIDEO jacks.
- You may need to setup the digital audio output format of your DVD player, or other digital source components. Refer to the instructions of the each component connected to the digital input jacks.
- There is no Dolby Digital RF input jack. Please use an external RF demodulator with a Dolby Digital decoder to connect a video disc player which has a Dolby Digital RF output jack to the digital input jack on this unit.

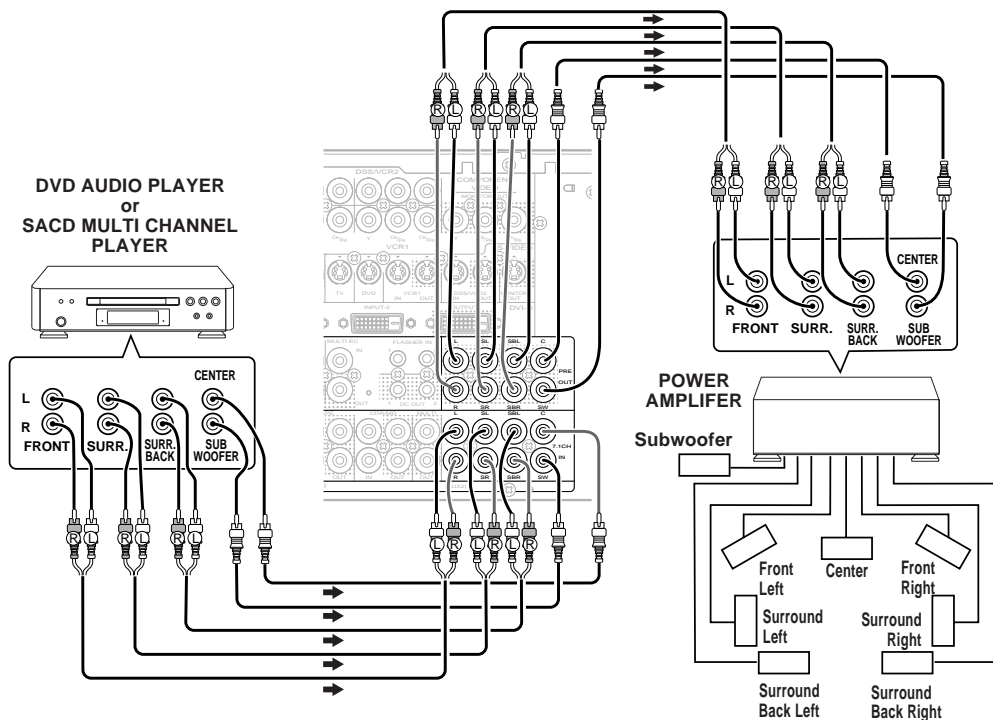

CONNECTING MULTI CHANNEL AUDIO SOURCE

The 7.1CH INPUT jacks are for multichannel audio source such as a SACD multichannel player, DVD audio player or external decoder. If you use these jacks, switch on the 7.1CH INPUT and set the 7.1CH INPUT level by using the SETUP MAIN MENU. See page 23.

CONNECTING AN EXTERNAL POWER AMPLIFIER

The PREOUT jacks are for connecting external power amplifiers. Be sure to connect each speaker to the corresponding external power amplifier.

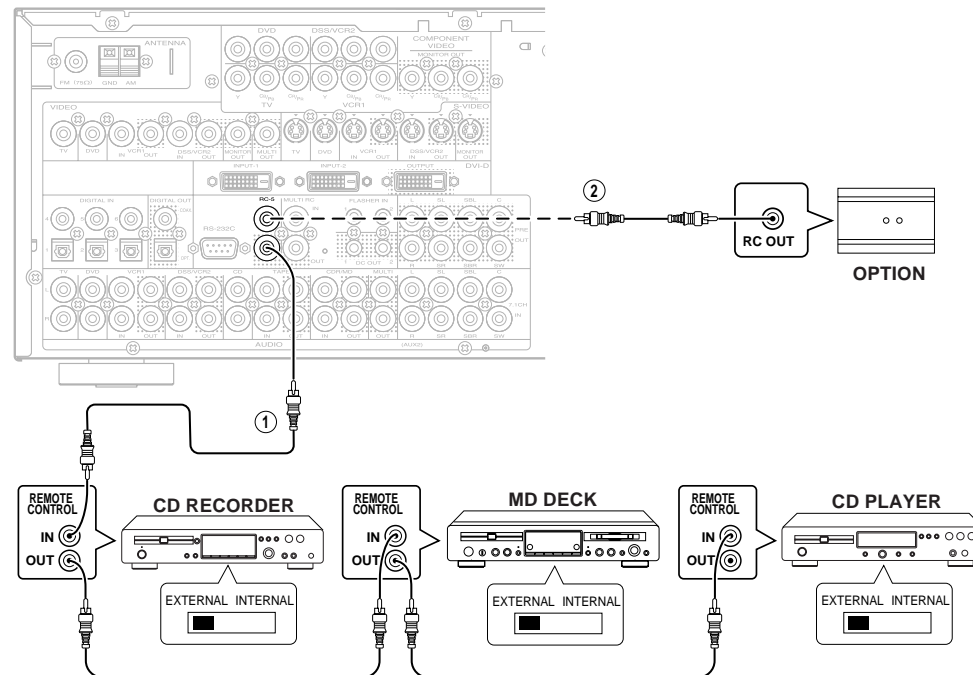

①

You can control other Marantz products through this unit with the remote control by connecting the REMOTE CONTROL terminals on each unit. The signal transmitted from the remote control is received by the remote sensor on this unit. Then the signal is sent to the connected device through this terminal. Therefore you need to aim the remote signal only to the unit. Also, if a Marantz power amplifier (some models excluded) is connected to one of these terminals, the power amplifier's, power switch is synchronized with this unit's power switch.

Set the REMOTE CONTROL SWITCH on the units, other than the main unit to EXT.(EXTERNAL) for this feature.

②

Whenever external infrared sensors or similar devices are connected to RC-5 IN of the SR7500, be sure to always disable operation of the infrared sensor on the main unit by using the following procedure.

1. Hold down the **MULTI** button and the **MENU** button on the front panel at the same time for five seconds.
2. The setting "IR=ENABLE" is shown on the FL DISPLAY.
3. Press the **CURSOR** buttons (◀, ▶) to change this to "IR=DISABLE".
4. Press the **ENTER** button. Once this setting is made, the infrared sensor on the main unit is disabled.

Note:

- Be sure to set to "IR=ENABLE" when external infrared sensors or similar devices are not connected. Otherwise, the main unit will be unable to receive remote control commands.
5. To restore the original setting, perform steps 1 to 4 to set to "IR=ENABLE".

CONNECTING THE ANTENNA TERMINALS

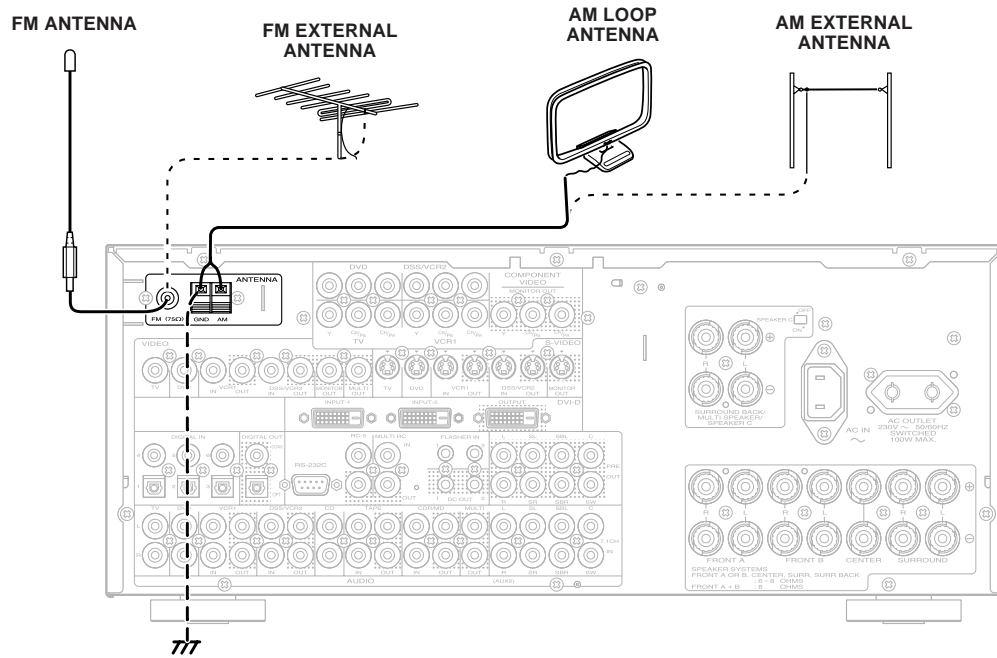

ASSEMBLING THE AM LOOP ANTENNA

1. Release the vinyl tie and take out the connection line.

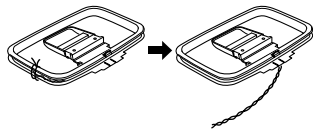

2. Bend the base part in the reverse direction.

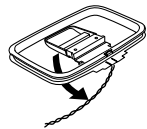

3. Insert the hook at the bottom of the loop part into the slot at the base part.

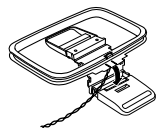

4. Place the antenna on stable surface.

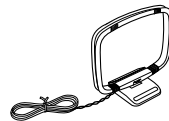

CONNECTING THE SUPPLIED ANTENNAS

Connecting the supplied FM antenna

The supplied FM antenna is for indoor use only. During use, extend the antenna and move it in various directions until the clearest signal is received.

Fix it with push pins or similar implements in the position that will cause the least amount of distortion.

If you experience poor reception quality, an outdoor antenna may improve the quality.

Connecting the supplied AM loop antenna

The supplied AM loop antenna is for indoor use only.

Set it in the direction and position it to where you receive the clearest sound. Put it as far away as possible from the unit, televisions, speaker cables, and power cords.

If you experience poor reception quality, an outdoor antenna may improve the quality.

1. Press and hold down the lever of the AM antenna terminal.
2. Insert the bare wire into the antenna terminal.
3. Release the lever.

CONNECTING AN FM OUTDOOR ANTENNA

Notes:

- Keep the antenna away from noise sources (neon signs, busy roads, etc.).
- Do not put the antenna close to power lines. Keep it well away from power lines, transformers, etc.
- To avoid the risk of lightning and electrical shock, grounding is necessary.

CONNECTING AN AM OUTDOOR ANTENNA

An outdoor antenna will be more effective if it is stretched horizontally above a window or outside.

Notes:

- Do not remove the AM loop antenna.
- To avoid the risk of lightning and electrical shock, grounding is necessary.

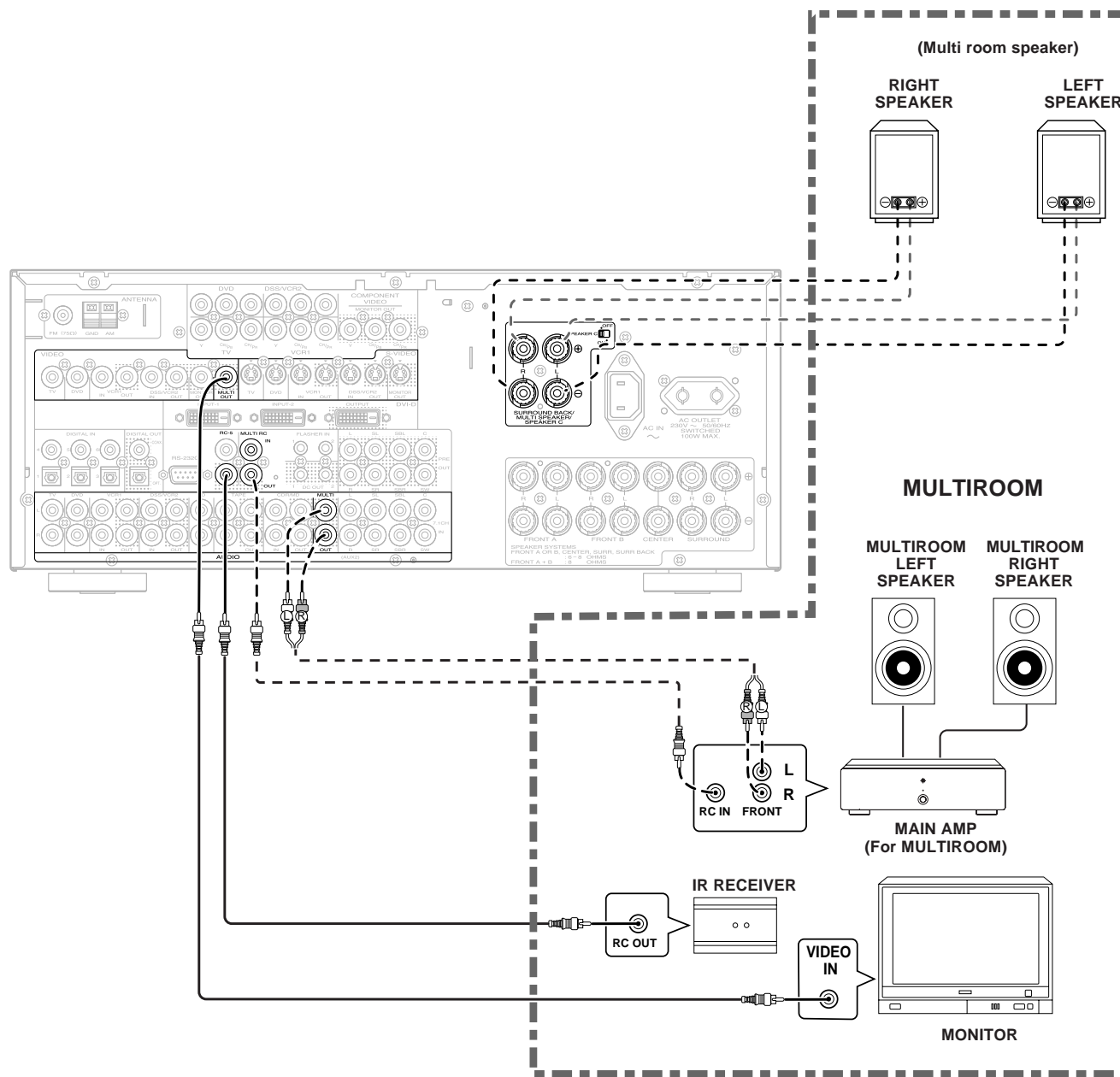

Bi-wire Connection

A bi-wire connection is possible with speakers that have two sets of inputs (for treble and bass). This allows you to drive the treble and bass units with separate channel amps, which enables better sound quality. Connect the speakers as shown in the figure. Set the SPEAKER C selector switch on the rear panel to ON.

Notes:

- If incorrectly connected, a protective circuit in the receiver will trip and set the receiver to standby. (The STANDBY indicator will flash.) In such case, recheck the connections between the speakers and the receiver.
- Turn power to the receiver off before changing the setting of the SPEAKER C selector switch.

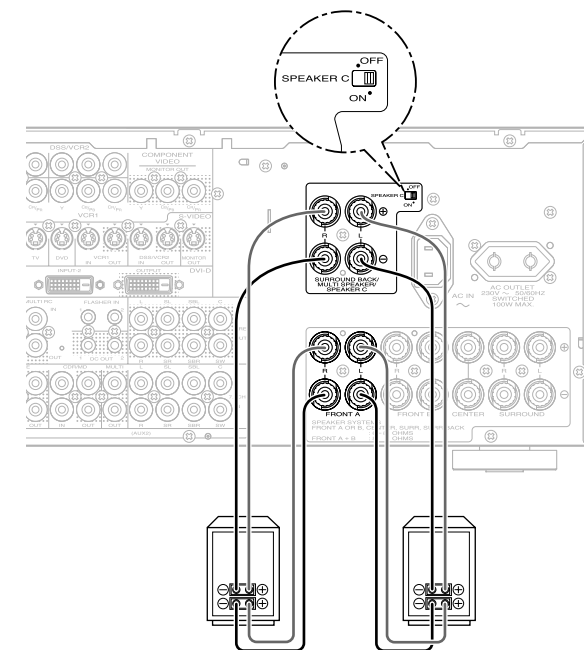

Note:

- You can use surround back speaker terminals as multi room speaker terminals or speaker C terminal when you use no surround back speaker.

SETUP

After all components are connected, initial setup must be performed.

ON SCREEN DISPLAY MENU SYSTEM

The SR7500 incorporates an on-screen menu system, which makes various operations possible by using the cursor (▲, ▼, ◀, ▶) and **ENTER** buttons on the remote control or on the front panel.

Note:

- To view the on-screen displays, make certain you have made a connection from the Monitor Out jack on the rear panel to the composite, S-Video, component video input of your TV or projector. (see page 14)

- Press the **AMP** button of the remote control. (This step is not needed when operating the setup menus from the receiver itself.)
- Press the **MENU** button on the remote control or set to display the "SETUP MAIN MENU" of the OSD menu system.
- Select a desired sub-menu with the ▲ or ▼ cursor buttons, and press the **ENTER** button to enter. The display will change to the selected sub-menu. You can lock the condition of setup to each sub-menu with the ◀ or ▶ cursor buttons.

Note:

- If you desire to adjust any sub-menu, you need to set it to UNLOCKED.

- If you desire to exit from this menu system, press the **EXIT** button, or move the cursor to **EXIT** and press the **ENTER** button.

Note:

- Settings are entered with the **ENTER** button on the unit or the **OK** button on the remote controller. When using the remote control, use the **OK** button as if it were the **ENTER** button.

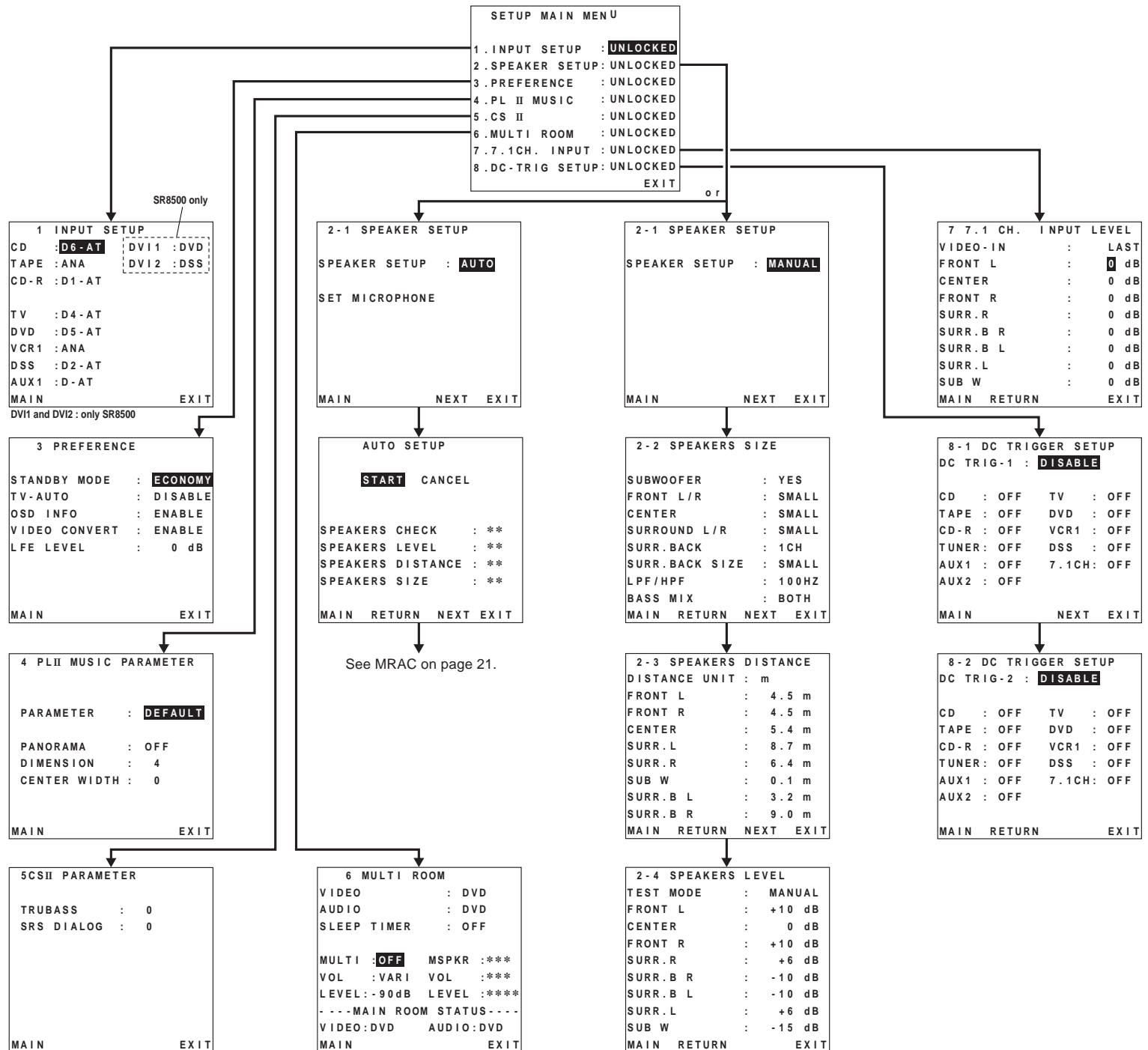

1 INPUT SETUP (ASSIGNABLE DIGITAL INPUT)

6 digital inputs can be assigned to a desired source.
With the SR8500, DVI-D input can be assigned to a preferred source.
Use this menu to select the digital input jack to be assigned to the input source.

1. Select "INPUT SETUP" in SETUP MAIN MENU with ▲ or ▼ cursor button, and press the ENTER button.

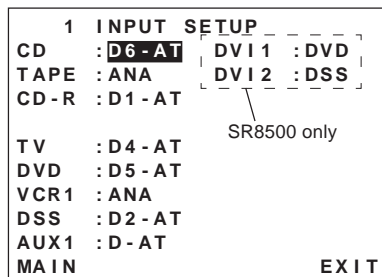

2. To select the input source, press the ▲ or ▼ cursor buttons.
3. To select the digital input jack, press the ◀ or ▶ cursor buttons.
Select "Dx-AT" for input sources, for automatic detection of the digital input signal condition.
If there is not a digital signal present, but there is an analog signal present, the analog signal will be played.
Select "Dig x", when only a digital signal will be used. Select "ANA" for input sources for which no digital input jacks are used.
4. To select the video source, select "DVI1" or "DVI2" by pressing the ▲ or ▼ cursor buttons, and press the ◀ or ▶ cursor buttons to select the video source to be assigned. (SR8500 only)
5. After you complete this portion of the set up, move the cursor to MAIN with the ▲ or ▼ cursor buttons and press the ENTER button.

Notes:

- The TUNER and AUX2 are fixed to the analog input, and cannot be selected for any digital input.
- When a DTS-LD or DTS-CD is playing, this setup is not available. This is to avoid noise being generated from the analog input.
- If "Dx-AT" is selected and a DVD, compact disc or LD is fast-forwarded during playback, decoded signals may produce a skipping sound. In such cases, change the setting to DIGITAL.

2 SPEAKER SETUP

After you have installed the SR7500, connected all the components, and determined the speaker layout, it is now time to perform the settings in the Speaker Setup menu for the optimum sound acoustics for your environment and speaker layout.
Before you perform the following settings, it is important that you first determine the following characteristics:

2-1 SPEAKER SETUP

Speakers are set up by selecting either MANUAL or AUTO using the ◀ and ▶ cursor buttons. For operation when AUTO has been selected, see MRAC on page 21.

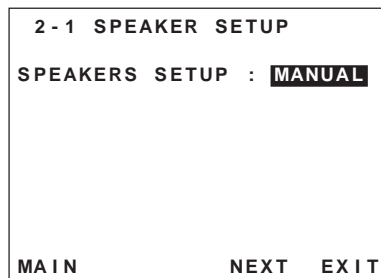

2-2 SPEAKERS SIZE

When setting the speaker size in the SPEAKER SIZE sub-menu, use the guidelines given below.

LARGE:

The complete frequency range for the channel you are setting will be output from the speaker.

SMALL:

Frequencies of the channel you are setting lower than approx. 100 Hz will be output from the subwoofer.

If the Subwoofer is set to "NONE" and the front speakers are set to "LARGE," then the sound will be output from both the left and right speakers.

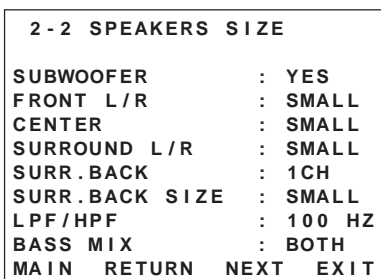

1. Select 2. SPEAKER SETUP on the SETUP MAIN MENU, then select MANUAL for 2-1 SPEAKER SETUP.
2. To select the each speaker, press the ▲ or ▼ cursor buttons.
3. To select the setting of each speaker size, press the ◀ or ▶ cursor buttons.
4. After you complete this portion of the set up, move the cursor to "NEXT" with the ▲ or ▼ cursor buttons and then press the ENTER button to go to the next page.

THX SPEAKER SYSTEM

If you use full THX speaker systems which are approved by THX Ltd. the front, the center and surround speaker size should be "Small" and the subwoofer should be "Yes".

You need to set number of surround back speaker only.

SUBWOOFER

YES:

Select when a subwoofer is connected.

NONE:

Select when a subwoofer is not connected.

FRONT L/R

LARGE:

Select if the front speakers are large.

SMALL:

Select if the front speakers are small.

- If "NONE" is selected for the Subwoofer setting, then this setting is fixed to "LARGE."

CENTER

NONE:

Select if no center speaker is connected.

LARGE:

Select if the center speaker is large.

SMALL:

Select if the center speaker is small.

SURROUND L/R

NONE:

Select if no surround left and right speakers are connected.

LARGE:

Select if the surround left and right speakers are large.

SMALL:

Select if the surround left and right speakers are small.

SURR. BACK

NONE:

Select if no surround back left and right speakers are connected.

2CH:

Select if the surround back left and right speakers are connected.

1CH:

Select if the one surround back speaker is connected.

In this case, the audio signal is emitted from the Surround L output terminal.

Notes:

- If "NONE" is selected for the Surround L/R setting, then this setting is fixed to "NONE."
- You can use surround back speaker terminals as multi room speaker terminals when you use no surround back speaker. (See page 17)

SURR. BACK SIZE

LARGE:

Select if the surround back speaker is large.

SMALL:

Select if the surround back speaker is small.

Note:

- If "NONE" is selected for the Surround L/R setting, then this setting is not available.

LPF/HPF

When you use a subwoofer, you can select the cutoff frequency for the small speakers used. Select one of the crossover frequency levels according to the size of the small speaker connected.

80Hz:

Select this when the bass speaker is about 12 cm (4 3/4 inches).

100Hz:

Select this when the bass speaker is about 10 cm (3 15/16 inches).

120Hz:

Select this when the bass speaker is about 8 cm (3 3/16 inches).

Notes:

- Use the above comments as reference when adjusting.
- If Pure-Direct mode, 7.1CH Input is in use, this function does not take effect.

BASS MIX

• The bass mix setting is only valid when "LARGE" is set for the front speakers and "YES" is set for the subwoofer during stereo playback . This setting has effect only during playback of PCM or analog stereo sources.

• When "BOTH" is selected, the low frequencies will be played through the main L&R, as well as the subwoofer.

In this playback mode, the low frequency range expand more uniformly through the room, but depending on the size and shape of the room, interference may result in a decrease of the actual volume of the low frequency range.

• By selecting "MIX", the low frequencies will play through the main L&R ONLY.

Note:

- LFE signals during playback of Dolby Digital or DTS, will be played through the subwoofer.

2-3 SPEAKERS DISTANCE

Use this parameter to specify the distance of each speaker's position from the listening position. The delay time is automatically calculated according to these distances.

Begin by determining the ideal or most commonly used seating position in the room.

This is important for the timing of the acoustics to create the proper sound space that the SR7500 and today's sound systems are able to produce.

Note:

- For speakers that you have selected "NONE" the Speaker Configuration sub-menu will not appear here. (There are several useful books and special DVD and LD's available to guide you through proper home theater configuration. If you are unsure, have your Marantz dealer perform the installation for you. They are trained professionals familiar with even the most sophisticated custom installations. Marantz recommends the WWW.CEDIA.ORG website for further information about this).

2 - 3 SPEAKERS DISTANCE	
DISTANCE UNIT :	m
FRONT L :	4.5 m
FRONT R :	4.5 m
CENTER :	5.4 m
SURR. L :	8.7 m
SURR. R :	6.4 m
SUB W :	0.1 m
SURR. B L :	3.2 m
SURR. B R :	9.0 m
MAIN RETURN	NEXT EXIT

1. Select either m (meters) or ft (feet) for DISTANCE UNIT.
2. To select each speaker, press the ▲ or ▼ cursor buttons.
3. To set the distance for each speaker, press the ◀ or ▶ cursor buttons.
4. After you complete this portion of the set up, move the cursor to "NEXT" with the ▲ or ▼ cursor buttons and then press the ENTER button to go to the next page.

FRONT L:

Set the distance from the front left speaker to your normal listening position.

FRONT R:

Set the distance from the front right speaker to your normal listening position.

CENTER:

Set the distance from the center speaker to your normal listening position.

SURR. L:

Set the distance from the surround left speaker to your normal listening position.

SURR. R:

Set the distance from the surround right speaker to your normal listening position.

SUB W:

Set the distance from the subwoofer to your normal listening position.

SURR. B L:

Set the distance from the surround back left speaker to your normal listening position.

SURR. B R:

Set the distance from the surround back right speaker to your normal listening position.

Notes:

- Set the distance to each speaker in meters (m) or feet (ft) as follows.
m: 0.1 - 9.0 m in .01 m steps
ft: 0.3 - 30.0 ft in 0.3 ft steps
- For the speakers that you have selected "NONE" the Speaker Size menu will not appear.
- The setting for Surr.Back L and Surr.Back R appears if you set for it to, two surround back speakers in the Speaker Size menu.
- The setting of Surr.Back appears if it is set for one surround back speaker in the Speaker Size menu.

2-4 SPEAKERS LEVEL

Here you will set the volume for each speaker so that they are all heard by the listener at the same level. We recommend using a SPL (Sound Pressure Level) meter, when available.

Note:

- The speaker level settings are not available in 7.1 channel input mode and Pure-Direct mode.

2 - 4 SPEAKERS LEVEL		
TEST MODE :	MANUAL	
FRONT L :	+10 dB	
CENTER :	0 dB	
FRONT R :	+10 dB	
SURR. R :	+6 dB	
SURR. B R :	-10 dB	
SURR. B L :	-10 dB	
SURR. L :	+6 dB	
SUB W :	-15 dB	
MAIN RETURN		EXIT

TEST MODE:

Selects "MANUAL" or "AUTO" for generating the mode of the test tone with the ◀ or ▶ cursor buttons.

If you select "AUTO", the test tone will be cycled through in a circular pattern which is Left → Center → Right → Surround Right → Surround Back Right → Surround Back Left → Surround Left → Subwoofer → Left →.. increments of 3 seconds for each channel.

Using the ◀ or ▶ cursor buttons, adjust the volume level of the noise from the speaker so that it is the same level for all the speakers.

If you select "MANUAL", adjust the output level of each speaker as listed below.

1. When you move the cursor to FRONT L by pressing the ▼ cursor button, the SR7500 will emit a pink noise from the front left speaker. Remember the level of this noise and then press the ▼ cursor button. (Note that this can be adjusted to any level between -10 and +10 dB in 1 dB intervals except the subwoofer setting. The subwoofer can be adjusted to any level between -15 and +10 dB in 1 dB intervals.) The SR7500 will now emit the pink noise from the center speaker.
2. Using the ◀ and ▶ cursor buttons, adjust the volume level of the noise from the center speaker so that it is the same level as the front left speaker.

3. Press the ▼ cursor button again. The SR7500 will now emit the pink noise from the front right speaker.
4. Repeat steps 2 and 3 above for the front right and other speakers until all speakers are adjusted to the same volume level.

After you complete this portion of the set up, press the ENTER button, the cursor will move to "MAIN" and then press the ENTER button to go to SETUP MAIN MENU.

Notes:

- Speakers that you selected "NONE" for in the Speaker Size menu will not appear.
- The setting of Surr.Back L and Surr.Back R appears if you have set it for two surround back speakers in the Speaker Size menu.
- The setting of Surr.Back appears if you have set it for one surround back speaker in the Speaker Size menu.
- To adjust the speaker levels for 7.1-channel input sources, you will need to use the 7.1CH-INPUT sub menu. (See page 23).

MRAC (Marantz Room Acoustic Calibration)

Speaker settings that were difficult by MANUAL setup can now be made by automatically measuring speaker characteristics using the included microphone.

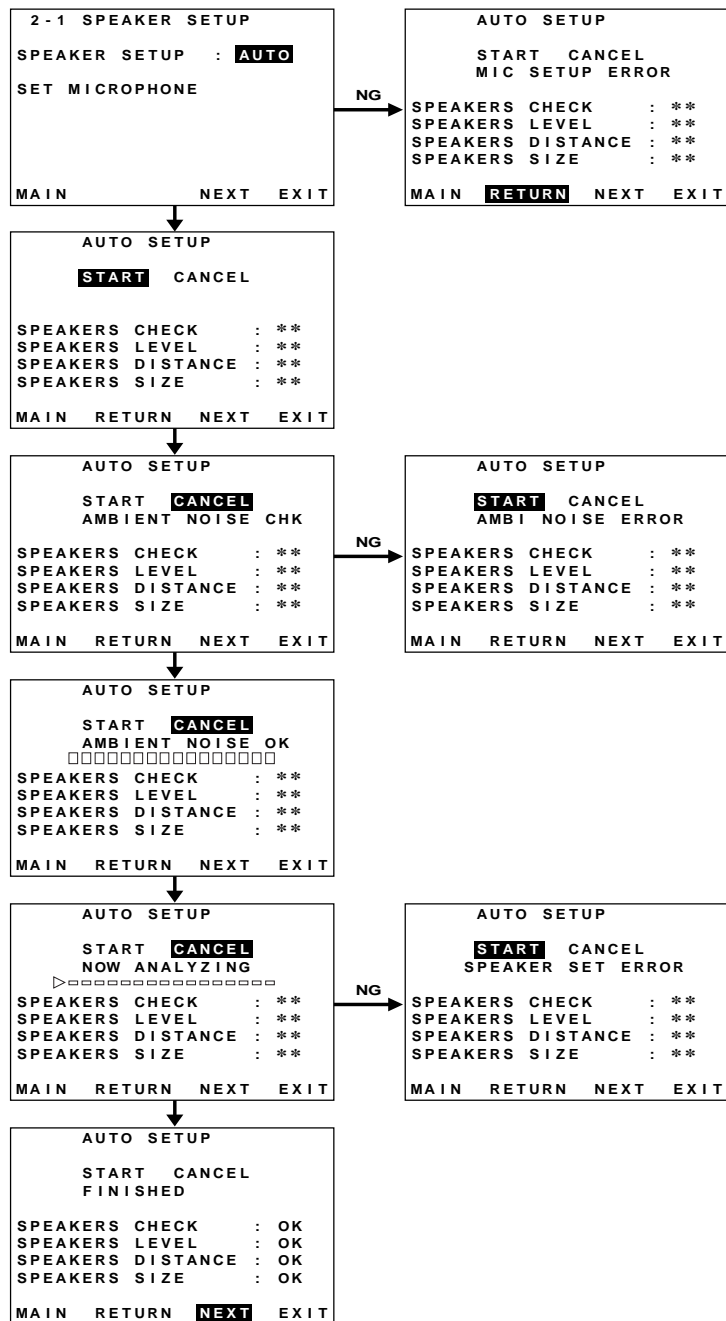

Measurement

During measurement, a test tone is output from the speakers, which is then measured and analyzed through the microphone. The measurement flow and items are as follows.

Microphone connection check: MIC CHECK
 Ambient noise measurement: AMBIENT NOISE
 Speaker connected/not connected check: SPEAKER CHECK
 Speaker output level check: SPEAKER LEVEL
 Distance from speaker (delay time) check: SPEAKER DISTANCE
 Speaker characteristics check: SPEAKER SIZE

How to Operate

Settings are displayed on the monitor during setup, therefore turn the monitor on.

1. Connect the included microphone to the MRAC jack of the unit.

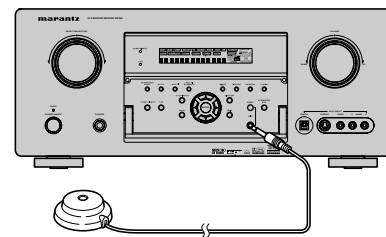

2. Set the microphone at ear height as in the actual listening position. Use a stand or tripod to position the microphone.

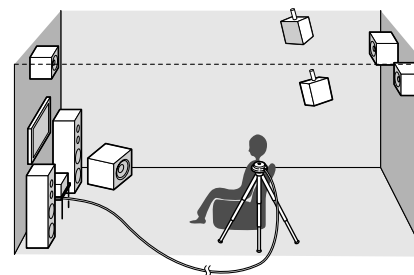

Notes:

- Remove any obstructions between the speakers and the microphone.
- Keep the room quiet during measurement.
- The test tone emitted during measurement is loud. Take considerations for neighboring homes and children.
- Step away from the listening position during measurement and operate the unit with the remote controller from outside the speaker path.

- About surround back speakers :
 When the surround back speaker is set to NONE in the SPEAKER SETUP, it is skipped in the AUTO setup. To use the surround back speaker, set it to YES by MANUAL setup before using the MRAC feature.
- The MRAC feature is available except in the following modes.
 - 7.1 CH INPUT
 - PURE-DIRECT

3. Either press the MRAC button on the front panel of the unit or select "2. SPEAKER SETUP" on the SETUP MAIN MENU, then select AUTO for "2-1 SPEAKER SETUP". Move the cursor to "NEXT" with the ▲ or ▼ cursor buttons and then press the ENTER button.

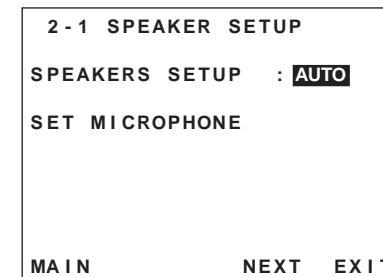

4. Select START on the AUTO SETUP display and press the ENTER button to start measurements.

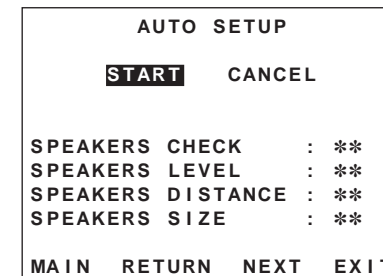

5. For measurement items, see "Measurement".
6. When measurements are completed, "FINISHED" appears on the monitor.
7. Once finished, disconnect the microphone from the unit.
8. Measurement results can be seen by selecting "NEXT" and press the ENTER button or selecting "2. SPEAKER SETUP" on the SETUP MAIN MENU. Then select MANUAL for "2-1 SPEAKER SETUP".

Notes:

- The measured speaker distance may differ from the actual distance from speakers. Nevertheless, the measured value is suitable for the speakers.
- To make changes to individual speakers, select 2. SPEAKER SETUP on the SETUP MAIN MENU, then select MANUAL for 2-1 SPEAKER SETUP.
- The included microphone is designed specifically for this receiver. Other microphones do not guarantee suitable measurement results. Use the included microphone to conduct measurements.
- During measurement, press the **ENTER** or **EXIT** button to cancel measurement.
- In some rooms, an error may occur during auto speaker setup or it may not be possible to set Speaker distance correctly because of room acoustics. In such case, set the speaker distance by MANUAL setup.

Error Indications During Measurement

If trouble occurs during measurement, an error message is displayed on the monitor screen and FL display. Those errors and their remedies are described below. The message appearing on the FL display is given in ().

MIC SETUP ERROR (MIC SET ERROR)
The microphone (MC-10) is not properly connected. → Check the microphone connection.
AMBI NOISE ERROR (AMBI NOISE ER)
Measurement cannot be done correctly because of excessive ambient noise. → Either temporarily turn off power to noisy devices such as air conditioning or move them out of the room. → Retry measurement when the room is quiet.
SPEAKER SET ERROR (SPK SET ERROR)
The speakers are not properly connected. → Recheck speaker layout and connections.

3 PREFERENCE

3 PREFERENCE	
STANDBY MODE	: ECONOMY
TV - AUTO	: DISABLE
OSD INFO	: ENABLE
VIDEO CONVERT	: ENABLE
LFE LEVEL	: 0 dB
MAIN	EXIT

- Select "**PREFERENCE**" in the SETUP MAIN MENU with the ▲ or ▼ cursor buttons, and press the **ENTER** button.
- To select a desired content, press the ▲ or ▼ cursor buttons.

STANDBY MODE:

When this function is set to "**ECONOMY**", you can reduce the power consumption when the unit is in the standby mode.

Note:

- TV-AUTO and RS-232C are disabled in the "**ECONOMY**" setting.

TV AUTO:

Select the TV AUTO ON/OFF function to enable or disable with the ◀ or ▶ cursor buttons. (refer to page 29)

OSD Info:

Select the OSD information function to enable or disable with the ◀ or ▶ cursor buttons. If you select "**ENABLE**", the SR7500 will display the status of the feature (Volume up/down, input select, etc.) on the TV monitor. But if you do not desire this information, select "**DISABLE**".

VIDEO CONVERT:

Select the VIDEO CONVERT function to enable or disable with the ◀ or ▶ cursor buttons. (Video cable connection: Refer to page 24)

LFE LEVEL:

Select the output level of the LFE signal included in the Dolby Digital signal or the DTS signal. Select 0 dB, -10 dB or OFF with the ◀ or ▶ cursor buttons.

After you complete this portion of the set up, move the cursor to "**MAIN**" with the ▲ or ▼ cursor buttons and press the **ENTER** button.

4 PL II (PRO LOGIC II) MUSIC PARAMETER

Pro Logic II-Music mode creates a rich and enveloping surround ambience from stereo sources such as CDs.

In this mode, SR7500 includes three controls to fine-tune the soundfield as follows.

4 PL II MUSIC PARAMETER	
PARAMETER	: DEFAULT
PANORAMA	: OFF
DIMENSION	: 4
CENTER WIDTH	: 0
MAIN	EXIT

Select "**PL II MUSIC**" in the SETUP MAIN MENU with the ▲ or ▼ cursor buttons, and press the **ENTER** button.

PARAMETER:

Select "**DEFAULT**" or "**CUSTOM**" with the ◀ or ▶ cursor buttons.

If you select "**CUSTOM**", you can adjust three parameters as listed below.

PANORAMA:

Select the Panorama mode On or Off with the ◀ or ▶ cursor buttons.

Panorama wraps the sound of the front left and right speakers around you, for an exciting perspective.

DIMENSION:

Set the Dimension level between 0 and 6 level in 1 level intervals with the ◀ or ▶ cursor buttons. Adjust the soundfield either towards the front or towards the rear.

This can be useful to help achieve a more suitable balance from all the speakers with certain recordings.

CENTER WIDTH:

Set the Center width level between 0 and 7 in 1 level intervals with the ◀ or ▶ cursor buttons. Center Width allows you to gradually spread the center channel sound into the front left and right speakers.

At its widest setting, all the sound from the center is mixed into the left and right.

This control may help achieve a more spacious sound or a better blend for the front image.

If "**NONE**" was selected for the Center speaker setting, in the Speaker size set up menu, then this setting will not appear.

After you complete this portion of the set up, move cursor to "**MAIN**" with the ▲ or ▼ cursor buttons and press the **ENTER** button.

5 CS II (CIRCLE SURROUND II) PARAMETER

5 CS II PARAMETER	
TRUBASS	: 0
SRS DIALOG	: 0
MAIN	EXIT

- Select "**CS II**" in the SETUP MAIN MENU with the ▲ or ▼ cursor buttons, and press the **ENTER** button.
- To Select desired contents as below, press the ▲ or ▼ cursor buttons.

TRUBASS:

Set the TRUBASS level between 0 and 6 level in 1 level interval with the ◀ or ▶ cursor buttons.

TRUBASS produced by the speakers are an octave below the actual physical capabilities of the speakers adding exciting, deeper bass effects.

SRS DIALOG:

Set the SRS DIALOG level between 0 and 6 in 1 level intervals with the ◀ or ▶ cursor buttons.

This can be popped out of the surround audio effects, allowing the listener to easily discern what the actors say.

If "**NONE**" was selected for the Center speaker setting, in the Speaker size set up menu, then this setting will not appear.

After you complete this portion of the set up, move cursor to "**MAIN**" with the ▲ or ▼ cursor buttons and press the **ENTER** button.

6 MULTI ROOM

SR7500 has features in MULTI ROOM SYSTEM such as source selector, sleep timer, Multi Room Speaker output and remote control.

You can set these feature in this sub-menu.

6 MULTI ROOM	
VIDEO :	DVD
AUDIO :	DVD
SLEEP TIMER :	OFF
MULTI :	OFF MSPKR : ***
VOL : VARI	VOL : ***
LEVEL : -90dB	LEVEL : ***
- - - MAIN-ROOM STATUS - - -	
VIDEO : DVD	AUDIO : DVD
MAIN	EXIT

1. Select "MULTI ROOM" in the SETUP MAIN MENU with ▲ or ▼ cursor button, and press the ENTER button.

2. To Select desired contents, press ▲ or ▼ cursor button

VIDEO:

Select the video source of the Multi-room output with ◀ or ▶ cursor buttons.

AUDIO:

Select the audio source of the Multi-room output with ◀ or ▶ cursor buttons.

SLEEP TIMER:

SLEEP timer function is available during the multiroom is active, set the time with ◀ or ▶ cursor buttons.

MULTI (MULTI ROOM):

To switch on the Multi-room output ON or OFF, press ◀ or ▶ cursor button.

VOL (VOLUME SETUP):

Select whether the Multi-room output level is variable or fixed with a ◀ or ▶ cursor buttons.

LEVEL (VOLUME LEVEL):

Adjust the Multi-room output level with ◀ or ▶ cursor buttons.

MSPKR (MULTI SPEAKER):

To switch on the Multi-speaker output ON or OFF, press ◀ or ▶ cursor buttons.

Note:

- This setting can be changed when the Surr Back is set "NONE" in 2-1 SPEAKER SIZE menu and select "SPEAKER C" switch OFF position in REAR PANEL. When this setting is unavailable, "***" is displayed.

VOL (VOLUME SETUP):

Select whether the Multi-speaker output level is variable or fixed with ◀ or ▶ cursor buttons.

Note:

- This setting can be changed when the Surr Back is set "NONE" in 2-1 SPEAKER SIZE menu. When this setting is unavailable, "***" is displayed

LEVEL (VOLUME LEVEL):

Adjust the Multi-speaker output level with ◀ or ▶ cursor button.

Note:

- This setting can be changed when the Surr Back is set "NONE" in 2-1 SPEAKER SIZE menu. When this setting is unavailable, "***" is displayed

MAIN ROOM STATUS:

Selected input source in the main room will be displayed.

Note:

- If "VOLUME" is set to "FIXED", the multi-room output level cannot be adjusted from the second zone.

After you complete this portion of the set up, move the cursor to "MAIN" with ▲ or ▼ cursor buttons and press ENTER button.

7 7.1 CH INPUT LEVEL

This sub-menu is to adjust the speaker levels for 7.1-channel input sources.

Here you will adjust the volume for each channel so that they are all heard by the listener at the same level.

7 7.1 CH INPUT LEVEL	
VIDEO IN :	LAST
FRONT L :	0 dB
CENTER :	0 dB
FRONT R :	0 dB
SURR . R :	0 dB
SURR . B R :	0 dB
SURR . B L :	0 dB
SURR . L :	0 dB
SUB W :	0 dB
MAIN	EXIT

1. Select "7.1CH INPUT" in the SETUP MAIN MENU with the ▲ or ▼ cursor buttons, and press the ENTER button.

2. To select "VIDEO IN", press ◀ or ▶ cursor button.

3. Using the ◀ or ▶ cursor buttons, select the video input source which is emitted from Monitor out in the 7.1 CH INPUT function.

The input source is switched by pressing the ◀ or ▶ cursor buttons as follows;

LAST ↔ TV ↔ DVD ↔ VCR1 ↔ DSS ↔ AUX1 ↔ V-OFF ↔ LAST ↔

Notes:

- When select LAST, the source is set previous source before 7.1 CH INPUT function is activated.
 - When select V-OFF, no signal is emitted from monitor out terminal.
4. To Select desired channel , press the ▲ or ▼ cursor buttons.
 5. Using the ◀ or ▶ cursor buttons, adjust the volume level of each channel.
 6. After you complete this portion of the set up, move the cursor to "MAIN" with the ▲ or ▼ cursor buttons and press the ENTER button.

Notes:

- These settings will be memorized to 7.1CH INPUT source.
- This feature can be directly selected with the CH.SEL button of the remote controller.

8 DC TRIGGER SETUP

This unit has 2 DC trigger control jacks, these are selectable to link with input functions for the main room or multi room.

Each trigger can be set up separately.

1. Select "DC-TRIG SETUP" in the SETUP MAIN MENU with ▲ or ▼ cursor button, and press the ENTER button.

8-1 DC-TRIGGER SETUP	
DC TRIG-1 :	DISABLE
CD :	***
TAPE :	***
CD-R :	***
TUNER :	***
AUX1 :	***
AUX2 :	***
TV :	***
DVD :	***
VCR1 :	***
DSS :	***
7.1CH :	***
MAIN	EXIT

2. You can select MAIN ROOM, MULTI ROOM, REMOTE or DISABLE by pressing ◀ or ▶ cursor buttons.

Note:

- REMOTE is available for the external control. The RC8500SR cannot operate this function.

3. To select desired input source , press ▲ or ▼ cursor button.

4. To set ON or OFF, press ◀ or ▶ cursor button.

5. After you complete this portion of the set up, move the cursor to "MAIN" with the ▲ or ▼ cursor buttons and press the ENTER button.

BASIC OPERATION (PLAY BACK)

SELECTING AN INPUT SOURCE

Before you can listen to any input media, you must first select the input source on the SR7500.

Example : DVD



To select DVD, turn the **INPUT FUNCTION SELECTOR** knob on the front panel or simply press the **DVD** button on the remote. After you have selected DVD, simply turn on the DVD player and play the DVD.

- As the input source is changed, the new input name will appear momentarily on an OSD information on the video display. The input name will also appear in the display, on the front-panel.
- As the input is changed, the SR7500 will automatically switch to the digital input, surround mode, attenuation, and night mode status which were entered during the configuration process for that source.
- When an audio source is selected, the last video input used remains routed to the **VCR1 & DSS/ VCR2** Outputs and **Monitor** Output. This permits simultaneous viewing and listening to different sources.
- When a Video source is selected, the video signal for that input will be routed to the **Monitor Output** jacks and will be viewable on a TV monitor connected to the SR7500. If a component video input is connected to the **DVD** or **DSS** component inputs, it will be routed to the **Component Video Output**. Make certain that your TV is set to the proper input to view the signal.

DVI-D INPUT (SR8500 only)

When DVI-D is set as the input source, monitor output is DVI-D as well.

VIDEO CONVERT

When this function is activated, the video or S-video signal can be emitted from the video, S-video or component video output terminal. To activate this function, select VIDEO CONVERT in PREFERENCE menu and set ENABLE.

Notes:

- The component video signal is emitted only from component video output terminal. When the video equipment is connected by component terminal, connect the monitor and SR7500 by the component terminal.
- This function is unavailable for the REC out terminal.
- This function is unavailable for the still picture, fast forward and reverse playing of the video component.
- If, while attempting to use the video convert feature, the SR7500 cannot synchronize with the display device, "NO SIGNAL" appears on the monitor, or noise is generated, this feature cannot be used. All of these signs are caused by equipment incompatibility; there is nothing wrong with the SR7500.

In such case, set VIDEO CONVERT in the PREFERENCE menu to DISABLE. Also, connect the video input signal to the display device via the MONITOR OUT terminal under VIDEO and the S-video input signal to the display device via the MONITOR OUT terminal under S-VIDEO.

Example:

Monitor is connected with the component.

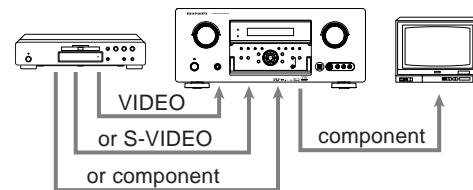

Monitor is connected with the video or S-video.

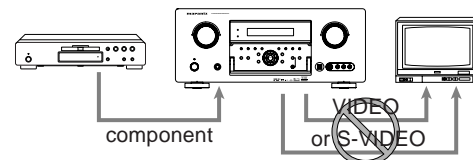
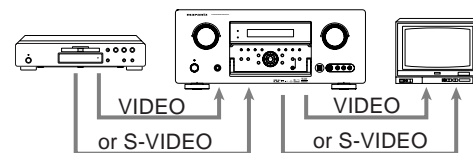

The signal cannot be converted from the component to the video or S-video.

Notes of OSD menu:

- The setup menu can be displayed through all video out (COMPONENT, S-VIDEO, VIDEO).
- The setting informations (e.g. volume setting) are displayed through all video out when the VIDEO CONVERT function are set ENABLE.

Note:

- No setting information is displayed when the signal is emitted from the COMPONENT IN to COMPONENT OUT.
- The setting informations (e.g. volume setting) are displayed through the S-VIDEO or VIDEO out when the VIDEO CONVERT function are set DISABLE. When the S-VIDEO and VIDEO outputs are used simultaneously, the setting informations are displayed through the S-VIDEO out only.

SELECTING THE SURROUND MODE

Example: AUTO SURROUND

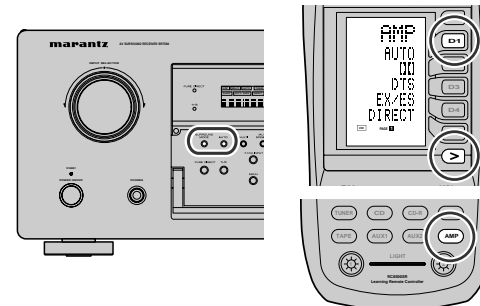

(Using the SR7500)

To select the surround mode during playback, press the **AUTO** button on the front panel.

(Using the remote control unit)

To select the surround mode, press the **AMP** button and press the **>** button until PAGE1 is displayed. Press the **AUTO (D1)** button.

ADJUSTING THE MAIN VOLUME

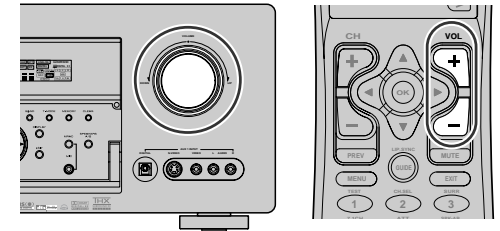

Adjust the volume to a comfortable level using the **VOLUME** control knob on the front panel or **VOL ▲ / ▼** buttons on the remote.

To increase the volume, turn the **VOLUME** knob clockwise or press **VOL ▲** button on the remote, to decrease the volume, turn counterclockwise or press **VOL ▼** button on the remote.

Notes:

- The volume can be adjusted within the range of $-\infty$ to 18 dB, in steps of 1 dB.
- However, when the channel level is set as described on page 20, if the volume for any channel is set at +1 dB or greater, the volume cannot be adjusted up to 18 dB. (In this case the maximum volume adjustment range is "18 dB - Maximum value of channel level")

ADJUSTING THE TONE (BASS & TREBLE) CONTROL

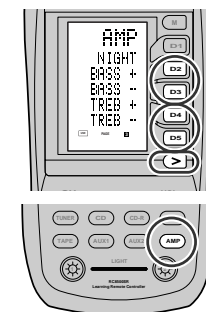

During a listening session you may wish to adjust the Bass and Treble Control to suit your listening tastes or room acoustics.

(Using the remote control unit)

To adjust the tone, press the **AMP** button and press the > button PAGE3 is displayed.

To adjust the bass effect, press **BASS+ (D2)** or **BASS- (D3)**.

To adjust the treble effect, **TREB+ (D4)** or **TREB- (D5)**.

Note:

- The tone control function can work in the AUTO Surround, Stereo, Dolby Pro Logic IIX, DTS, DTS-ES, and Multi Ch. Stereo mode.

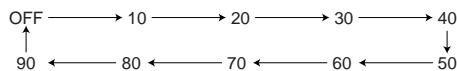

The sleep time will be shown for a few seconds in the display on the front panel, and it will count down until the time has elapsed.

When the programmed sleep time has elapsed, the unit will automatically turn off.

Note that the SLEEP indicator on the display will illuminate when the Sleep function is programmed. To cancel the Sleep function, press the **SLEEP** button until the display shows "SLEEP OFF" and the SLEEP indicator will disappear.

TEMPORARILY TURNING OFF THE SOUND



To temporarily silence all speaker outputs such as when interrupted by a phone call, press the **MUTE** button on the remote.

This will interrupt the output to all speakers and the head-phone jack, but it will not affect any recording or dubbing that may be in progress.

When the system is muted, the display will show "**MUTE**".

Press the **MUTE** button again to return to normal operation.

NIGHT MODE

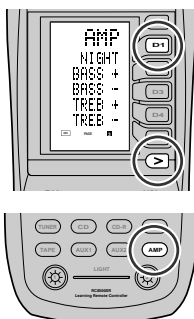

To select the NIGHT mode, press the **AMP** button and press the > button until PAGE3 is displayed. Press the **NIGHT (D1)** button.

Selecting the Night Mode ON is effective in Dolby Digital only, and it compresses the dynamic range. This softens loud passages such as sudden explosions, to help prevent disturbing others late at night.

To turn off the Night mode, press the **NIGHT** button again.

USING THE SLEEP TIMER

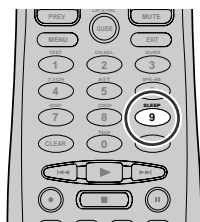

To program the SR7500 for automatic standby, press the **SLEEP** button on the remote. Each press of the button will increase the time before shut down in the following sequence.

SURROUND MODE

The SR7500 is equipped with many surround modes. These are provided to reproduce a variety of surround sound effects, according to the content of the source to be played.

The available surround modes may be restricted depending on the input signal and speaker setup.

AUTO

When this mode is selected, the receiver determines whether the digital input signal is Dolby Digital, Dolby Digital Surround EX, DTS, DTS-ES, DTS 96/24 or PCM-audio.

Surround EX & DTS-ES will operate for multichannel source that has a Dolby Digital Surround EX or DTS-ES auto trigger flag in the digital signal.

When a Dolby Digital or DTS signal is input, the number of channels for which the corresponding signal is encoded will be played.

Inputting a Dolby Digital two channel signal with Dolby surround status automatically subjects that signal to Pro Logic IIX movie processing before play.

PCM 96 kHz source material can be played in this mode.

Notes:

- When you use this mode with certain DVD and CD players, performing operations such as "Skip" or "Stop" may momentarily interrupt the output.
- When the signal is not decoded, the mode is changed to AUTO mode automatically. Refer to page 24 to confirm the available decoding mode.

THX

THX mode applies additional processing to Dolby Digital, DTS, and Dolby Pro Logic multi-channel, surround sources. The THX processing was developed by Lucasfilm Ltd. to recreated the sound of top-quality theater.

Use the THX mode for all movies on disc, tape or broadcast. In this mode, THX Surround EX will not operate in this mode.

THX SURROUND EX

In a movie theater, film soundtracks that have been encoded with Dolby Digital surround EX technology are able to reproduce an extra channel which has been added during the mixing of the program.

This channel, called Surround Back, places sounds behind the listener in addition to the currently available front left, front center, front right, surround right, surround left and subwoofer channels.

This additional channel provides the opportunity for more detailed imaging behind the listener and brings more depth, spacious ambience and sound localization than ever before.

THX Surround EX will operate for any 5.1 channel source whenever THX is active.

THX Surround EX is not available in the system without surround back speaker(s).

Note:

- When playing Dolby Digital Surround EX-encoded software in 6.1 channels, it is required to set the THX Surround EX mode.

DOLBY DIGITAL

(Dolby Digital, Pro Logic IIX MOVIE, Pro Logic IIX MUSIC, Pro Logic IIX GAME)

This mode is used with source materials encoded in Dolby Digital and Dolby Surround.

DOLBY DIGITAL

This mode is enabled when playing source materials encoded in Dolby Digital.

Playing multichannel encoded 6.1 or 7.1-channel Dolby Digital sources provides five main audio channels (left, center, right, surround left and surround right) and Low Frequency Effect channel.

Dolby Digital EX decoding is not available in this mode.

Dolby Pro Logic IIX brings the excitement of surround sound to any stereo mix, while making existing Dolby Surround mixes sound more like discrete 5.1 channels Surround sound.

Dolby Pro Logic IIX has 3 modes. Please see below.

Pro Logic IIX MOVIE

This mode provides 6.1 or 7.1 channel surround sound from Dolby Surround encoded stereo movie sound tracks.

Pro Logic IIX MUSIC

This mode provides 6.1 or 7.1 channel surround sound from conventional stereo sources, analog or digital, such as CD, Tape, FM, TV, Stereo VCR, etc.

Pro Logic IIX GAME

Game mode restores the impact low-frequency surround effects by routing them to the system's subwoofer.

Notes:

- Pro Logic IIx mode will decode as Pro Logic II mode when the SURROUND BACK SPEAKER is set NONE in SPEAKER SETUP menu. (See SPEAKER SETUP, page 19)
- Pro Logic IIx mode is available for a 2ch input signal which is encoded in Dolby Digital or PCM format.
- PCM-audio signals can be subjected to Pro Logic processing when the sampling frequency is 32 kHz, 44.1 kHz or 48 kHz.

EX/ES

This mode provides 6.1 channel surround for DOLBY DIGITAL EX, DTS-ES encoded source material such as DVD.

This mode cannot be used when an analog input has been selected.

Dolby Digital EX

In a movie theater, film soundtracks that have been encoded with Dolby Digital surround EX technology are able to reproduce an extra channel which has been added during the mixing of the program.

This channel, called Surround Back, places sounds behind the listener in addition to the currently available front left, front center, front right, surround right, surround left and subwoofer channels.

This additional channel provides the opportunity for more detailed imaging behind the listener and brings more depth, spacious ambience and sound localization than ever before.

Dolby Digital EX is not available in the system without surround back speaker(s).

DTS-ES (Discrete 6.1, Matrix 6.1)

DTS-ES adds the surround center channel audio to the DTS 5.1-channel format to improve the acoustic positioning and makes acoustic image movement more natural with the 6.1-channel reproduction.

This receiver incorporates a DTS-ES decoder, which can handle DTS-ES Discrete-encoded and DTS-ES Matrix-encoded program sources from DVD, etc..

DTS-ES Discrete 6.1 features digital discrete recording of all channels including the surround back channel(s) and higher quality of audio reproduction.

DTS-ES is not available in the system without a surround back speaker.

dts MODE**(dts, Neo:6 Cinema, Neo:6 Music)**

This mode is for DTS encoded source materials such as LASER DISC, CD, and DVD. Neo:6 is for some 2 channel sources.

dts : This mode is enabled when playing source materials encoded in dts multichannel.

Playing multichannel encoded 5.1-channel dts sources provides five main audio channels (left, center, right, surround left and surround right) and Low Frequency Effect channel.

dts-ES decoding is not available in this mode.

The DTS mode cannot be used when an analog input has been selected.

Neo:6 Cinema, Neo:6 Music

This mode decodes 2-channel signals into 6-channel signals using high-accuracy digital matrix technology.

The DTS NEO:6 decoder has near-discrete properties in the frequency characteristics of the channels as well as in channel separation.

According to the signals to be played back, DTS NEO:6 uses either the NEO:6 CINEMA mode optimized for movie playback or the NEO:6 MUSIC mode optimized for music playback.

Notes:

- Neo:6 mode is available to 2ch input signals which are encoded in Dolby Digital or PCM format.
- PCM-audio signals can be subjected to Pro Logic processing when the sampling frequency is 32 kHz, 44.1 kHz or 48 kHz.

MULTI CH. ST

This mode is used to create a wider, deeper and more natural soundstage from two channel source material. This is done by feeding the left channel signal to both left front and left surround speaker and the right channel signal to both right front and right surround speaker. Additionally, the center channel reproduces a mix of the right and left channel.

**CIRCLE SURROUND II
(CSII-CINEMA, CSII-MUSIC, CSII-MONO)**

Circle Surround is designed to enable multichannel surround sound playback of non-encoded and multichannel encoded material.

Backward compatibility provides listeners with up to 6.1 channels of surround performance from entire collection of music and film, including broadcast, videotape and stereo recorded music. Depending on source material, you can select **CSII-Cinema** mode, **CSII-Music** mode or **CSII-Mono** mode.

Notes:

- CS II mode is available for 2ch input signals which are encoded in Dolby Digital or PCM format.
- PCM-audio signals can be subjected to Pro Logic processing when the sampling frequency is 32 kHz, 44.1 kHz or 48 kHz.

VIRTUAL

This mode creates a virtualized surround sound experience from a two-speaker (front L and R) playback system playing any multichannel audio source (such as found on DVDs and digital broadcasts), including Dolby Digital, Dolby Pro Logic or DTS.

STEREO

This mode bypasses all surround processing. In stereo program sources, the left and right channels play normally when PCM-audio or analog stereo is input.

With Dolby Digital and DTS sources, the 5.1 multichannels are converted to two channel stereo. 96 kHz PCM source material can be played back in stereo mode.

PURE DIRECT

In the pure direct mode, the tone control circuit and bass management configuration are bypassed for full range frequency response and the purist audio reproduction.

96 kHz PCM source material can be played back in this mode.

Notes:

- Internal speaker size is setup to front L/R = LARGE, Center = LARGE, Surround L/R = LARGE and Subwoofer = YES automatically. Tone controls and additional processing are also defeated.
- When you use this mode with certain DVD and CD players, performing operations such as "Skip" or "Stop" may momentarily interrupt the output.

CAUTION**NOTE for DTS signal**

- * Connected DVD-player, laser-disc player or CD-player needs to support DTS-digital output. You may not be able to play some DTS source signals from certain CD players and LD players even if you connect the player to the SR7500 digitally. This is because the digital signal has been processed (such as the output level, sampling frequency, or frequency response) and the SR7500 cannot recognize the signal as DTS data.

- * Depending on the player used, DTS play may produce a short noise. This is not a malfunction.
- * While signals from DTS-laser disc or CD are playing in another Surround mode, you cannot switch to digital input or from digital input to analog input by INPUT SETUP in SETUP MAIN MENU or the A/D button.
- * You can not listen to DTS-encoded course in Multi room.
- * The outputs for the VCR 1 OUT, DSS/VCR 2 OUT, TAPE OUT, and CD-R OUT output analog audio signals. Do not record from CDs or LDs that support DTS using these outputs. If you do, the DTS-encoded signal will be recorded as noise.

NOTE for Dolby Digital Surround EX signal

- * When playing Dolby Digital Surround EX-encoded software in 6.1 channels, it is required to set the EX/ES mode.
- * Note that some of Dolby Digital Surround EX-encoded software does not contain the identification signal. In this case, set the EX/ES mode manually.

NOTE for 96kHz PCM audio

- * AUTO, PURE DIRECT, and STEREO modes can be used when playing PCM signals with a sampling frequency of 96 kHz (such as from DVD-Video discs that contain 24 bit, 96 kHz audio). If such signals are input during playback in one of the other surround modes, output from SR7500 will be muted.
- * Certain DVD player models inhibit digital output. For details, refer to the player's operation manual.
- * Some DVD formatted discs feature copy protection. When using such disc, 96 kHz PCM signal is not output from the DVD player. For details, refer to the player's operation manual.

NOTE for HDCD signal (SR8500 only)

- * HDCD is effective only at the time of digital input.
- * AUTO, PURE DIRECT, and STEREO modes can be used when playing HDCD signals (such as from CD discs that contain HDCD).
- * You may not be able to play some HDCD source signals from certain CD players if you connect the player to the SR8500 digitally. This is because the digital signal has been processed (such as the output level, sampling frequency, or frequency response) and the SR8500 cannot recognize the signal as HDCD data.

The relation between the selected surround mode and the input signal

The surround mode is selected with the surround mode selector on SR7500 or the remote control unit. However, the sound you hear is subject to the relationship between the selected surround mode and input signal. That relationship is as follows;

Surround Mode	Input Signal	Decoding	Output Channel					Front information display	
			L/R	C	SL SR	SBL SBR	SubW	Signal format indicators	Channel status
AUTO	Dolby Surr. EX	Dolby Digital EX	○	○	○	○	○	□□ DIGITAL EX	L, C, R, SL, SR, S, LFE
	Dolby D (5.1ch)	Dolby Digital 5.1	○	○	○	-	○	□□ DIGITAL	L, C, R, SL, SR, LFE
	Dolby D(2ch)	Dolby Digital 2.0	○	-	-	-	-	□□ DIGITAL	L, R
	Dolby D (2ch Surr)	Pro Logic IIx movie	○	○	○	○	-	□□ DIGITAL , □□ SURROUND	L, R, S
	DTS-ES	DTS-ES	○	○	○	○	○	dts, ES	L, C, R, SL, SR, S, LFE
	DTS 96/24	DTS 96/24	○	○	○	-	○	dts 96/24	L, C, R, SL, SR, LFE
	DTS (5.1ch)	DTS 5.1	○	○	○	-	○	dts	L, C, R, SL, SR, LFE
	PCM(Audio)	PCM (Stereo)	○	-	-	-	-	PCM	L, R
	PCM 96kHz	PCM (96kHz Stereo)	○	-	-	-	-	PCM	L, R
	HDCD *	Stereo	○	-	-	-	-	PCM, HDCD	L, R
Analog	Stereo	○	-	-	-	-	ANALOG	-	
PURE DIRECT	Dolby D Surr. EX	Dolby Digital EX	○	○	○	○	○	□□ DIGITAL EX	L, C, R, SL, SR, S, LFE
	Dolby D (5.1ch)	Dolby Digital 5.1	○	○	○	-	○	□□ DIGITAL	L, C, R, SL, SR, LFE
	Dolby D (2ch)	Dolby Digital 2.0	○	-	-	-	-	□□ DIGITAL	L, R
	Dolby D (2ch Surr)	Pro Logic IIx movie	○	○	○	○	-	□□ DIGITAL , □□ SURROUND	L, R, S
	DTS-ES	DTS-ES	○	○	○	○	○	dts, ES	L, C, R, SL, SR, S, LFE
	DTS 96/24	DTS 96/24	○	○	○	-	○	dts 96/24	L, C, R, SL, SR, LFE
	DTS (5.1ch)	DTS 5.1	○	○	○	-	○	dts	L, C, R, SL, SR, LFE
	PCM (Audio)	PCM (Stereo)	○	-	-	-	-	PCM	L, R
	PCM 96kHz	PCM (96kHz Stereo)	○	-	-	-	-	PCM	L, R
	HDCD *	Stereo	○	-	-	-	-	PCM, HDCD	L, R
Analog	Stereo	○	-	-	-	-	ANALOG	-	
EX/ES	Dolby D Surr. EX	Dolby Digital EX	○	○	○	○	○	□□ DIGITAL EX	L, C, R, SL, SR, S, LFE
	Dolby D (5.1ch)	Dolby Digital EX	○	○	○	○	○	□□ DIGITAL	L, C, R, SL, SR, LFE
	DTS-ES	DTS-ES	○	○	○	○	○	dts , ES	L, C, R, SL, SR, S, LFE
	DTS 96/24	DTS-ES	○	○	○	○	○	dts 96/24	L, C, R, SL, SR, LFE
	DTS(5.1ch)	DTS-ES	○	○	○	○	○	dts	L, C, R, SL, SR, LFE
DOLBY (PL IIx movie) (PL IIx music) (PL IIx game)	Dolby D Surr. EX	Dolby Digital 5.1	○	○	○	○	○	□□ DIGITAL EX	L, C, R, SL, SR, S, LFE
	Dolby D (5.1ch)	Dolby Digital 5.1	○	○	○	○	○	□□ DIGITAL	L, C, R, SL, SR, LFE
	Dolby D (2ch)	Pro Logic IIx	○	○	○	○	-	□□ DIGITAL	L, R
	Dolby D (2ch Surr)	Pro Logic IIx	○	○	○	○	-	□□ DIGITAL , □□ SURROUND	L, R, S
	PCM (Audio)	Pro Logic IIx	○	○	○	○	-	PCM	L, R
	HDCD *	Pro Logic IIx	○	○	○	○	-	PCM, HDCD	L, R
	Analog	Pro Logic IIx	○	○	○	○	-	ANALOG	-
DTS (Neo:6 Cinema) (Neo:6 Music)	DTS-ES	DTS 5.1	○	○	○	-	○	dts, ES	L, C, R, SL, SR, S, LFE
	DTS 96/24	DTS 96/24	○	○	○	-	○	dts 96/24	L, C, R, SL, SR, LFE
	DTS (5.1ch)	DTS 5.1	○	○	○	-	○	dts	L, C, R, SL, SR, LFE
	PCM (Audio)	Neo:6	○	○	○	○	-	PCM	L, R
	Analog	Neo:6	○	○	○	○	-	ANALOG	-
	Dolby D (2ch)	Neo:6	○	○	○	○	-	□□ DIGITAL	L, R
Dolby D (2ch Surr)	Neo:6	○	○	○	○	-	□□ DIGITAL , □□ SURROUND	L, R, S	
CS II Cinema CS II Music CS II Mono	PCM (Audio)	CS II	○	○	○	○	○	PCM	L, R
	HDCD *	CS II	○	○	○	○	○	PCM, HDCD	L, R
	Analog	CS II	○	○	○	○	○	ANALOG	-
	Dolby D (2ch)	CS II	○	○	○	○	○	□□ DIGITAL	L, R
	Dolby D (2ch Surr)	CS II	○	○	○	○	○	□□ DIGITAL , □□ SURROUND	L, R, S
STEREO	Dolby Surr. EX	Stereo	○	-	-	-	○	□□ DIGITAL EX	L, C, R, SL, SR, S, LFE
	Dolby D (5.1ch)	Stereo	○	-	-	-	○	□□ DIGITAL	L, C, R, SL, SR, LFE
	Dolby D (2ch)	Stereo	○	-	-	-	-	□□ DIGITAL	L, R
	Dolby D (2ch Surr)	Stereo	○	-	-	-	○	□□ DIGITAL , □□ SURROUND	L, R, S
	DTS-ES	Stereo	○	-	-	-	○	dts, ES	L, C, R, SL, SR, S, LFE
	DTS 96/24	Stereo	○	-	-	-	○	dts 96/24	L, C, R, SL, SR, LFE
	DTS (5.1ch)	Stereo	○	-	-	-	○	dts	L, C, R, SL, SR, LFE
	PCM (Audio)	Stereo	○	-	-	-	-	PCM	L, R
	PCM 96kHz	Stereo	○	-	-	-	-	PCM	L, R
	HDCD *	Stereo	○	-	-	-	-	PCM, HDCD	L, R
Analog	Stereo	○	-	-	-	-	ANALOG	-	

*: SR8500 only

Surround Mode	Input Signal	Decoding	Output Channel					Front information display	
			L/R	C	SL SR	SBL SBR	SubW	Signal format indicators	Channel status
Virtual	Dolby Surr. EX	Virtual	○	-	-	-	-	□□ DIGITAL EX	L, C, R, SL, SR, S, LFE
	Dolby D (5.1ch)	Virtual	○	-	-	-	-	□□ DIGITAL	L, C, R, SL, SR, LFE
	Dolby D (2ch)	Virtual	○	-	-	-	-	□□ DIGITAL	L, R
	Dolby D (2ch Surr)	Virtual	○	-	-	-	-	□□ DIGITAL , □□ SURROUND	L, R, S
	DTS-ES	Virtual	○	-	-	-	-	dots, ES	L, C, R, SL, SR, LFE
	DTS (5.1ch)	Virtual	○	-	-	-	-	dots	L, C, R, SL, SR, LFE
	PCM (Audio)	Virtual	○	-	-	-	-	PCM	L, R
	HDCD*	Virtual	○	-	-	-	-	PCM, HDCD	L, R
Analog	Virtual	○	-	-	-	-	ANALOG	-	
Multi Ch. Stereo	Dolby Surr. EX	Multi Channel Stereo	○	○	○	○	○	□□ DIGITAL EX	L, C, R, SL, SR, S, LFE
	Dolby D (5.1ch)	Multi Channel Stereo	○	○	○	-	○	□□ DIGITAL	L, C, R, SL, SR, LFE
	Dolby D (2ch)	Multi Channel Stereo	○	○	○	○	-	□□ DIGITAL	L, R
	Dolby D (2ch Surr)	Multi Channel Stereo	○	○	○	○	-	□□ DIGITAL , □□ SURROUND	L, R, S
	DTS-ES	DTS-ES	○	○	○	○	○	dots, ES	L, C, R, SL, SR, S, LFE
	DTS (5.1ch)	DTS 5.1	○	○	○	○	-	dots	L, C, R, SL, SR, LFE
	PCM (Audio)	Multi Channel Stereo	○	○	○	○	-	PCM	L, R
	HDCD*	Multi Channel Stereo	○	○	○	○	-	PCM, HDCD	L, R
Analog	Multi Channel Stereo	○	○	○	○	-	ANALOG	-	
THX	Dolby Surr. EX	THX Surround EX + Dolby Digital	○	○	○	○	○	□□ DIGITAL EX	L, C, R, SL, SR, S, LFE
	Dolby D (5.1ch)	THX + Dolby Digital	○	○	○	-	○	□□ DIGITAL	L, C, R, SL, SR, LFE
	Dolby D (2ch)	THX + Pro Logic IIx	○	○	○	○	-	□□ DIGITAL	L, R
	Dolby D (2ch Surr)	THX + Pro Logic IIx	○	○	○	○	-	□□ DIGITAL , □□ SURROUND	L, R, S
	DTS-ES	THX + DTS-ES	○	○	○	○	○	dots, ES	L, C, R, SL, SR, S, LFE
	DTS 96/24	THX + DTS	○	○	○	-	○	dots 96/24	L, C, R, SL, SR, LFE
	DTS (5.1ch)	THX + DTS	○	○	○	-	○	dots	L, C, R, SL, SR, LFE
	PCM (Audio)	THX + Pro Logic IIx	○	○	○	○	-	PCM	L, R
HDCD*	THX + Pro Logic IIx	○	○	○	○	-	PCM, HDCD	L, R	
Analog	THX + Pro Logic IIx	○	○	○	○	-	ANALOG	-	

*: SR8500 only

Notes:

- Dolby Digital (2 ch: Lt/Rt): signal with Dolby Surround flag Speakers are full set.
- No sound outputs from the surround speaker, center speaker and subwoofer if the DVD disc has no surround data.

Abbreviations

- L/R : Front speakers
- C : Center speaker
- SL/SR : Surround speakers
- SBL/SBR : Surround Back speakers
- SubW : Sub woofer speaker

OTHER FUNCTION

TV AUTO ON/OFF FUNCTION

This function allows the component connected to the TV-VIDEO in jack to control the power (ON/OFF) to the SR7500.

AUTO POWER ON

1. Be sure the TV auto mode is ENABLED. (Refer to page 22: PREFERENCE)
2. Connect your TV TUNER (etc) to the TV-VIDEO in terminal. Be sure to connect the VIDEO input.
3. Turn OFF the power to the TV TUNER and the SR7500.
4. Turn ON the TV TUNER and tune in a receivable station.
5. When the station is received, the SR7500 turns ON and TV is selected automatically.

AUTO POWER OFF

1. In the above situation, turn the TV TUNER OFF or select a channel that does not contain any broadcast.
2. The power to the SR7500 switches to STANDBY after approx. 5 minutes.

Notes:

- AUTO POWER OFF is canceled if the SR7500 is set to a source other than TV. The function reactivates when TV is selected again.
- Some TV broadcasts may cause the TV AUTO FUNCTION to turn ON.
- The S-Video terminal does not support "TV AUTO ON/OFF" function.

ATTENUATION TO ANALOG INPUT SIGNAL



If the selected analog audio input signal is greater than the capable level of internal processing, the "PEAK" indicator will light up on the front display. If this happens, you should press the **ATT** button on the remote. "ATT" indicator will be illuminated when this function is activated. The signal-input level is reduced by about half. Attenuation will not work with the output signal of TAPE-OUT, CD-R/MD-OUT, VCR1-OUT and DSS/VCR2-OUT. This function is memorized for each individual input source.

LISTENING THROUGH HEADPHONES

This jack may be used to listen to the SR7500's output through a pair of headphones. Be certain that the headphones have a standard 1/4" stereo phono plug. (Note that the speakers will automatically be turned off when the headphone jack is in use.)

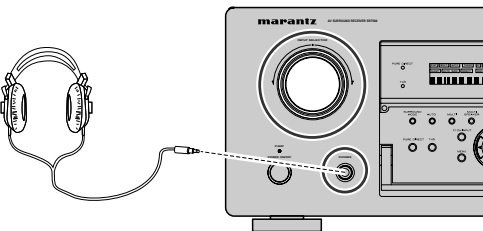

Note:

- The surround mode returns to the previous setting as soon as the plug is removed from the jack.

DOLBY HEADPHONE MODE

This feature simulates the waveforms of the actual sounds heard from the speakers. When headphones are used, the **MENU** button automatically switches to the Dolby headphone mode. The OSD that appears when the **MENU** button is pressed is shown below.

HEAD PHONE	
DOLBY HP MODE	: BYPASS
SURROUND	: ***
L LEVEL	: 0dB
R LEVEL	: 0dB

DOLBY HP (Headphone) MODE can be selected with the left and right cursor buttons. BYPASS → DH1 → DH2 → DH3 → BYPASS

BYPASS: Bypasses the Dolby headphone mode and delivers ordinary 2-channel stereo.

DH1: The size of a typical living room space is simulated.

DH2: The expansiveness of a structure as large as a music hall is simulated.

DH3: A large space such as that found in a movie theater is simulated.

When the PURE DIRECT mode is selected, Dolby surround processing is bypassed and "***" is displayed as the mode indication.

The surround mode can be selected when any of the modes in DH1, DH2, or DH3 is selected.

L/R LEVEL can be set in the ±10 dB range.

Notes:

- The surround mode returns to the previous setting as soon as the plug is removed from the jack.
- TONE cannot be set when any of the modes in DH1, DH2, or DH3 is selected.
- The Dolby Headphone function will not work when 32 or 96 kHz PCM digital signals are input.

VIDEO ON/OFF

When no video signal is connected to the SR7500 or a DVD, etc., is connected directly to your TV, the unnecessary video circuit can be turned off by selecting the "VIDEO OFF" setting. To select video off, press the **AMP** button and press the **>** button until PAGE 4 is displayed. Press the **V-OFF** button.

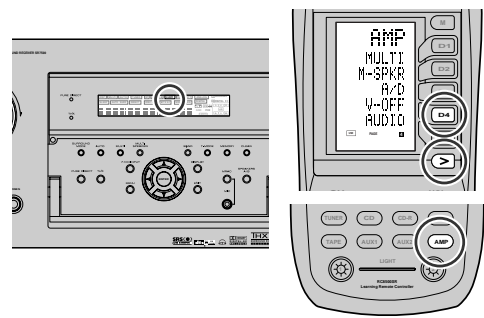

DISPLAY MODE

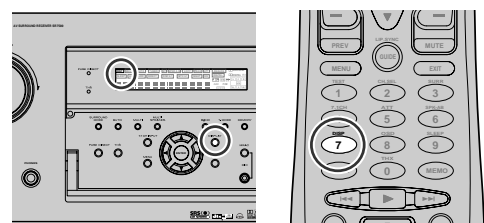

You can select the display mode for the front display of the SR7500.

To select this mode, press the **DISPLAY** on the remote control or the front panel.

When this button is pressed, the display mode is switched in the following sequence.

→ Surround Mode → Auto-display Off → Display Off → Input Function → Surround Mode....

In Auto display off mode, the display is off. But, if you make a change to the unit such as input or surround mode, the display will show that change, then go back to off after about 3 seconds.

When changing the volume, it is not displayed. In Display off mode, the display is off completely.

Note:

- Only the DISP indicator will be illuminated on the front display in display off condition.

SELECTING ANALOG AUDIO INPUT OR DIGITAL AUDIO INPUT

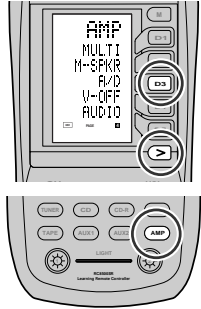

If you have already assigned the digital inputs, you can temporarily select the audio input mode for each input source as following procedures. Press the **AMP** button and press the **>** button until PAGE4 is displayed. Press the **A/D (D3)** button. When this button is pressed, the input mode is switched in the following sequence.
→ Digital Auto → Digital → Analog → Digital Auto....

In Digital Auto mode, the types of signals being input to the digital and analog input jacks for the selected input source are detected automatically. If no digital signal is being input, the analog input jacks are selected automatically.

In Digital mode, input is fixed to an assigned digital input terminal.

In analog mode, the analog input jacks are selected. This selecting is temporary, so the result will not be stored in memory.

If you need to change the input mode completely, use INPUT SETUP in OSD menu system. (see page 19)

RECORDING AN ANALOG SOURCE

In normal operation, the audio or video source selected for listening through the SR7500 is sent to the record outputs.

This means that any program you are watching or listening to may be recorded simply by placing machines connected to the outputs for **TAPE OUT**, **CD-R/MD OUT**, **VCR1 OUT**, and **DSS/VCR2 OUT** in the record mode.

To record the input source signal you are currently watching or listening to

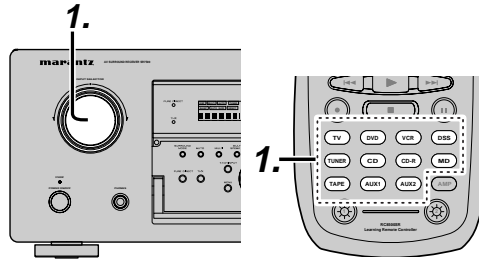

1. Select the input source to record by turning the **INPUT FUNCTION SELECTOR** knob on the front panel or simply press the **input selector** buttons on the remote.
The input source is now selected and you may watch or listen to it as desired.
2. The currently selected input source signal is output to the **TAPE OUT**, **CD-R/MD OUT**, **VCR1 OUT**, and **DSS/VCR2 OUT** outputs for recording.
3. Start recording to the recording component as desired.

Recording the video from one source and the audio from another

You can add the sound from one source to the video of another source to make your own video recordings.

Below is an example of recording the sound from a compact disc player connected to CD IN and the video from a video camera connected to VCR1 to video cassette recorder connected to the DSS/VCR2 OUT jack.

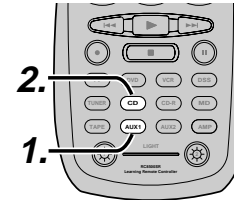

1. Switch the video output source to VCR1 by simply pressing the **input selector** buttons on the remote.
2. Switch the audio input source to CD by simply pressing the **input selector** buttons on the remote.
3. Now "CD" has been selected as the audio input source and "VCR1" as the video input source.

Notes:

- If you change the input source during recording, you will record the signals from the newly selected input source.
- You cannot record the surround effects.
- Digital input signals are only output to the digital outputs. There is no conversion from digital to analog.

When connecting CD players and other digital components, do not connect only the digital terminals, but the analog ones as well.

SPEAKER A/B

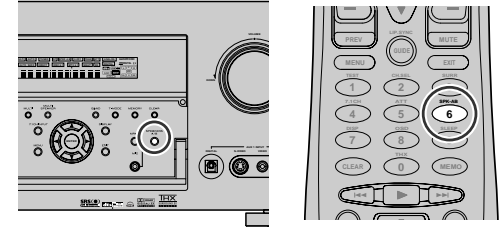

SR7500 has speaker system - A and speaker system- B for front L/R channels. You can select these systems by pressing **SPEAKERS A/B** button on the front panel or **SPK-AB** on the remote.

7.1 CH INPUT

The SR7500 is equipped for future expansion through the use of Multi channel SACD multichannel player or DVD-Audio player.

When this is selected, the input signals connected to the L(front left), R (front right), CENTER, SL (surround left), SR (surround right) and SBL (surround back left) and SBR (surround back right) channels of the 7.1 CH. In jacks are output directly to the front (left and right), center, surround (left and right) and surround back speaker systems as well as the pre-out jacks without passing through the surround circuitry.

In addition, the signal input to the SW (subwoofer) jack is output to the PRE OUT SW (subwoofer) jack.

When 7.1 CH. INPUT is selected, the last video input used remains routed to the **Monitor Outputs**. This permits simultaneous viewing with video sources

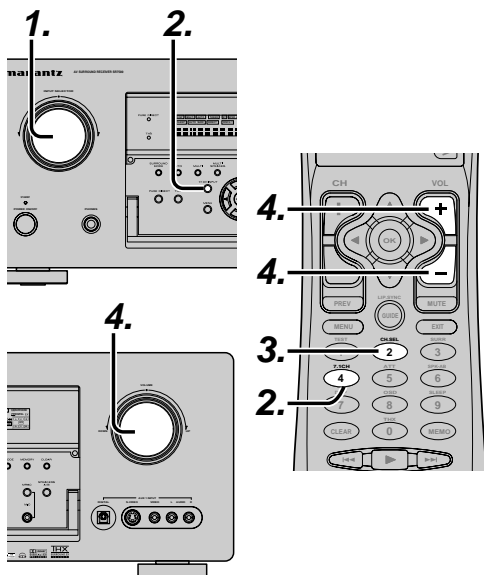

1. Select a desired Video source to decide the routed video signal to the **Monitor Outputs**.
2. Press the **7.1 CH INPUT** button on the front panel or press **7.1 CH** on the remote to switch the 7.1 channel input.
3. If it is necessary to adjust the output level of each channel, press the **CH.SEL** button on the remote.
Adjust the speaker output levels so that you can hear the same sound level from each speaker at the listening position. For the front left, front right, center, surround left, surround right and surround back speakers, the output levels can be adjusted between -10 to $+10$ dB. The subwoofer can be adjusted between -15 and $+10$ dB. These adjustments result will be stored to 7.1 CH. INPUT memory.
4. Adjust the main volume with the **MAIN VOLUME** knob or the **VOL** buttons on the remote.

To cancel the 7.1 CH. INPUT setting, press the **7.1 CH INPUT** button on the front panel or press **7.1 CH** on the remote.

Notes:

- When the 7.1 CH. Input is in use, you may not select a surround mode, as the external decoder determines processing.
- In addition, there is no signal at the record outputs when the 7.1 CH. Input is in use.

AUX2 INPUT

If you don't need to connect 7.1 Ch. input terminals with multi channel decoder, L(front left) and R (front right) inputs terminals are available as AUX2 input. In this case, You can connect additional audio source to AUX2 as other audio input terminals.

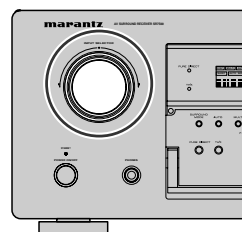

LIP.SYNC

Depending on the image device (TV, monitor, projector, etc.) connected to the SR7500, a time lag can occur between image signal processing and audio signal processing. Though minor, this time lag can interfere with movie and music enjoyment. The LIP.SYNC feature delays the audio signal with respect to the image signal output from the SR7500 to correct the time lag between the sound and image. It can be operated with the "LIP.SYNC" and ◀ and ▶ cursor buttons of the remote controller. Set the remote controller to the AMP mode before operating the LIP.SYNC feature. The initial setting is OFF (0 ms). The time lag can be adjusted in 10 ms steps up to 200 ms. Watch the picture on the image device (i.e., TV, monitor, projector, etc.) as you adjust the time lag.

Note:

- The LIP.SYSNC feature turns OFF (0 ms) in the PURE DIRECT mode. When the PURE DIRECT mode is deactivated, the set value of the LIP.SYSNC feature is automatically restored.

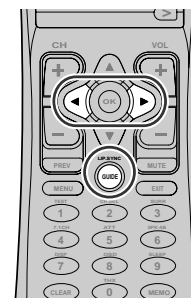

BASIC OPERATION

(TUNER)

To operate the unit from the remote control, press the **TUNER** button on the remote control so that the tuner mode is engaged.

LISTENING TO THE TUNER

Frequency scan step for AM is selectable. Default setup is 9 kHz step, if your country's standard is 10 kHz step, Press **TUNER** button on the remote more than 6 seconds. Scan step will change.

Note:

- Preset memory for the tuner will clear by changing this setup.

AUTO TUNING

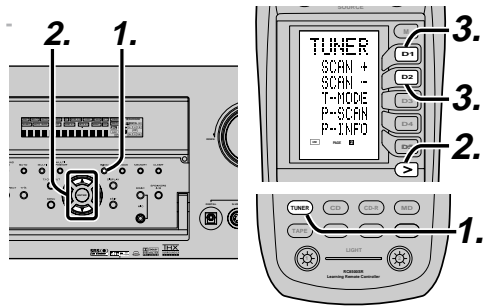

(Using the SR7500)

1. To select tuner and desired band (FM or AM), press the **BAND** button on the front panel.
2. Press the **▲** or **▼** cursor buttons on the front panel for more than 1 second to start the auto tuning function.
3. Automatic searching begins then stops when a station is tuned in.

(Using the remote control unit)

1. To select tuner and desired band (FM or AM), press the **TUNER** button twice within two seconds on the remote.
2. Press the **>** button until PAGE2 is displayed.
3. Press and hold the **SCAN+ (D1)** or **SCAN- (D2)** button for 1 second or more.
4. Automatic searching begins then stops when a station is tuned in.

If tuning does not stop at the desired station, use to the "Manual tuning" operation.

MANUAL TUNING

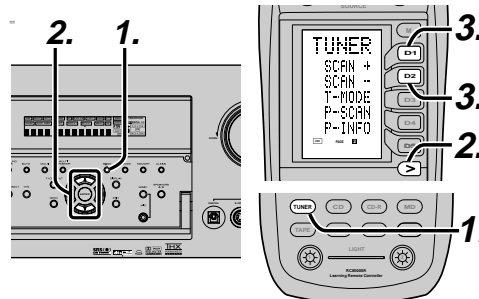

(Using the SR7500)

1. To select tuner and desired band (FM or AM), press the **BAND** button on the front panel
2. Press the **▲** or **▼** cursor buttons on the front panel to select the desired station.

(Using the remote control unit)

1. To select tuner and desired band (FM or AM), press the **TUNER** button twice within two seconds on the remote.
2. Press the **>** button until PAGE2 is displayed
3. Press the **SCAN+ (D1)** or **SCAN- (D2)** button to tune in the deseired station.

DIRECT FREQUENCY CALL

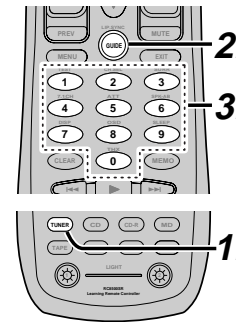

1. To select tuner and desired band (FM or AM), press the **TUNER** button twice within two seconds on the remote.
2. Press the **GUIDE** on the remote, display will show "FREQ - - -".
3. Input your desired station's frequency with the ten numbered keypad on the remote.
4. The desired station will automatically be tuned.

(FM) TUNING MODE (AUTO STEREO OR MONO)

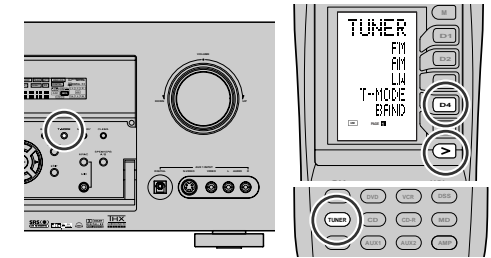

When in the auto stereo mode, **AUTO** indicator will be illuminated on the display.

The "**ST**" indicator is illuminated when a stereo broadcast is tuned in.

At open frequencies, the noise is muted and the "**TUNED**" and "**ST**" indicators are not illuminated.

If the signal is weak, it may be difficult to tune into the station in stereo. In such a case, press the **MODE** button on the front panel. Or press the **TUNER** button and press the **>** button until PAGE1 is displayed. Press the **T-MODE (D4)** button.

"**AUTO**" indicator is not illuminated, if FM stereo broadcasts are received in monaural and the "**ST**" indicator is not illuminated.

To return to auto stereo mode, press the **MODE** button or press **T-MODE** button on the remote again. **AUTO** indicator is illuminated the display.

PRESET MEMORY

With this unit you can preset up to 50 FM/AM stations in any order.

For each station, you can memorize the frequency and reception mode if desired.

AUTO PRESET MEMORY

This function automatically scans the FM and AM band and enters all stations with proper signal strength into the memory.

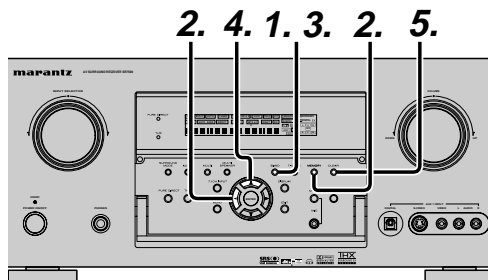

1. To select FM, press the **BAND** button on the front panel.
2. While pressing the **MEMORY** button, press the ◀ cursor button.
“**AUTO PRESET**” will appear on the display, and scanning starts from the lowest frequency.
3. Each time the tuner finds a station, scanning will pause and the station will be played for five seconds.
During this time, the following operations are possible.
The band can be changed by the **BAND** button.
4. If no button is pressed during this period, the current station is memorized in location Preset 02.
If you wish to skip the current station, press the ▲ cursor button during this period, this station is skipped and auto presetting continues.
5. Operation stops automatically when all 50 preset memory positions are filled or when auto scanning attains the highest end of all bands. If you desire to stop the auto preset memory at anytime, press the **CLEAR** button.

MANUAL PRESET MEMORY

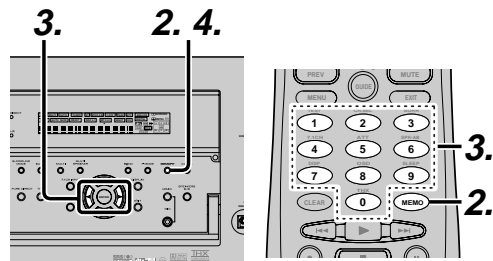

(Using the SR7500)

1. Tune into the radio station you desire (Refer to the “**MANUAL TUNING**” or “**AUTO TUNING**” section).
2. Press the **MEMORY** button on the front panel. “- -” (preset number) starts blinking on the display.
3. Select the preset number by pressing the ◀ or ▶ cursor buttons, while this is still blinking (approx. 5 seconds)
4. Press the **MEMORY** button again to enter. The display stops blinking. The station is now stored in the specified preset memory location.

(Using the remote control unit)

1. Tune into the radio station you desire (Refer to the “**MANUAL TUNING**” or “**AUTO TUNING**” section).
2. Press the **MEMO** button on the remote. “- -” (preset number) starts blinking on the display.
3. Enter the desired preset number by pressing the **numeric** buttons.

Note:

- When entering a single digit number (2 for example), either input “02” or just input “2” and wait for a few seconds.

RECALLING A PRESET STATION

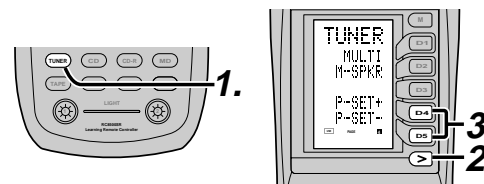

(Using the SR7500)

1. Select the desired preset station by pressing the ◀ or ▶ cursor buttons on the front panel

(Using the remote control unit)

1. Press the **TUNER** button twice within two seconds on the remote.
2. Press the > button until PAGE4 is displayed
3. Press the **P-SET+ (D4)** or **P-SET- (D5)** button to tune in the deseired preset station.
Or enter the preset station number with the numeric buttons.

PRESET SCAN

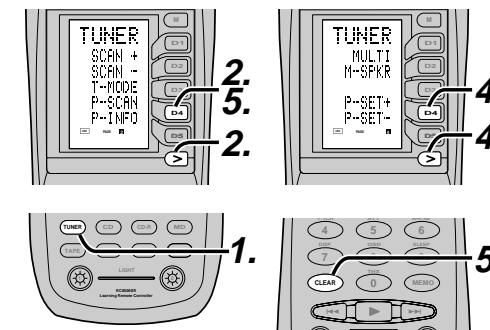

(Using the remote control unit)

1. Press the **TUNER** button twice within two seconds on the remote.
2. Press the > button until PAGE2 is displayed and press the **P-SCAN (D4)** on the remote. “**PRESET SCAN**” appears on the front display and then the preset station with the lowest preset number is recalled first.
3. Preset stations are recalled in sequence (No.1 → No.2 → etc.) for 5 seconds each. No stored preset number will be skipped.
4. You can fast forward the preset stations, press the > button until PAGE4 is displayed and press the **P-SET+ (D4)** continuously.
5. When the desired preset station is received, cancel the preset scan operation by pressing the **CLEAR** button or **P-SCAN (D4)** on the remote.

CLEARING STORED PRESET STATIONS

You can remove preset stations from the memory using the following procedure.

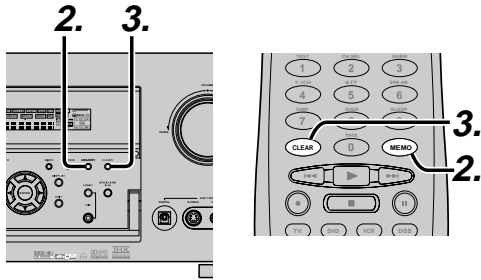

1. Recall the preset number to be cleared with the method described in "Recalling" a preset station.
2. Press the **MEMORY** button on the front panel or press the **MEMO** button on the remote.
3. The stored preset number blinks in the display for 5 seconds. While blinking, press the **CLEAR** button on the front panel or the remote.
4. "xx CLEAR" appears on the display to indicate that the specified preset number has been cleared.

Note:

- To clear all stored preset stations, press and hold the **CLEAR** and the **ENTER** buttons for two seconds.

SORTING PRESET STATIONS

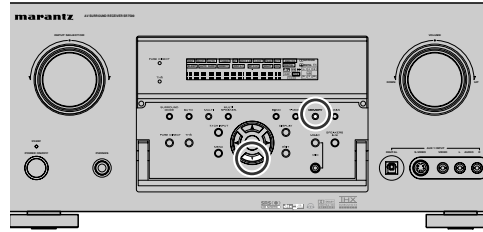

If you have stations memorized, and there is a gap in the sequential order:

I.e. the stations are stored as follows

- 1) 87.1 MHz
- 2) 93.1 MHz
- 3) 94.7 MHz
- 10) 105.9 MHz

(notice there is no stations programmed for pre sets for 4-9), you can have pre set 10 become pre set 5:

To sort the numbers, press and hold the **MEMORY** and the **▼** cursor buttons.

"PRESET SORT" will appear on the display and sorting will be done.

NAME INPUT OF THE PRESET STATION

This function allows the name of each preset channel to be entered using alphanumeric characters.

Before name inputting, you need to store preset stations with the preset memory operation.

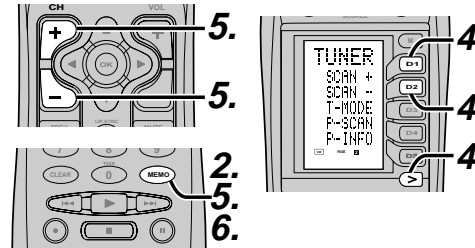
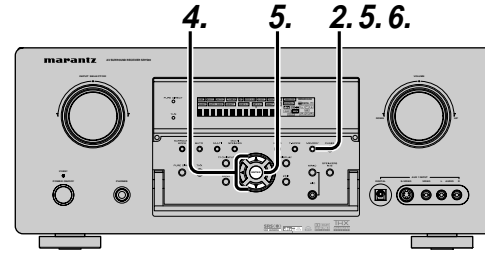

1. Recall the preset number to be inputted name with the method described in "Recalling" a preset station.
2. Press the **MEMORY** button on the front panel or press the **MEMO** button on the remote for more than 3 seconds.
3. The left most column of the station name indicator flashes, indicating the character entry ready status.
4. When you press the **▲** or **▼** cursor buttons on the front panel or the **▲** or **▼** buttons on the remote, alphabetic and numeric characters will be displayed in the following order:
A → B → C ... Z → 1 → 2 → 3 0 → - → + → / → (Blank) → A
 UP →
 ← DOWN

5. After selecting the first character to be entered, press the **MEMORY** or **ENTER** button, or press the **MEMO** button on the remote.

The entry in this column is fixed and the next column starts to flash. Fill the next column the same way.

To move back and forth between the characters, press the **◀/▶** cursor buttons or press **CH+** or **CH-** button on the remote.

Note:

- Unused columns should be filled by entering blanks.

6. To save the name, press the **MEMORY** or **ENTER** button on the front panel, or press the **MEMO** button on the remote for more than 2 seconds.

Ten keypad	Press, press again, press again, etc.
1	A → B → C → 1 → A
2	D → E → F → 2 → D
3	G → H → I → 3 → G
4	J → K → L → 4 → J
5	M → N → O → 5 → M
6	P → Q → R → 6 → P
7	S → T → U → 7 → S
8	V → W → X → 8 → V
9	Y → Z → space → 9 → Y
0	- → + → / → 0

RDS OPERATION

Now in use in many countries, RDS (Radio Data System) is a description of the station's programming hidden space in the FM signal. Your new receiver is equipped with RDS to assist in the selection of FM stations using station and network names, rather than broadcast frequencies. Additional RDS functions include the ability to search for programme types.

RADIO TEXT

Some RDS stations broadcast RADIO TEXT, which is additional information on the station and programme being broadcast.

RADIO TEXT information appears as 'running' text in the display. RADIO TEXT is transmitted character by the radio station. As a result of that it may take some time until the entire text has been completely received.

RDS DISPLAY

When a receiver is tuned to an FM station that is transmitting RDS data, the Front Panel Information Display will automatically show the station name or RDS TEXT in place of the typical display of the station's broadcast frequency.

To change the display, press the **TUNER** button and press the **>** button until PAGE3 is displayed. Press the **DISP (D1)** button.

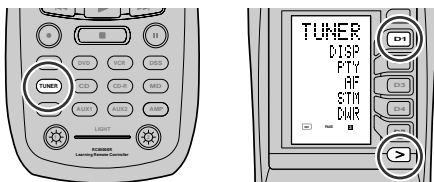

PROGRAMME TYPE (PTY) DISPLAY

The RDS system categorizes programmes according to their genre into different programme type (PTY) groups. To display the programme type information of the current station, press the **TUNER** button and press the **>** button until PAGE3 is displayed. Press the **PTY (D2)** button.

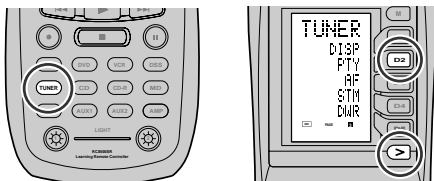

PS (Program Service Name) → RT (RADIO TEXT) → Frequency

PTY AUTO SEARCH

Your receiver is equipped to automatically search for stations transmitting any of 29 different programme types. To search for a PTY, follow these procedures:

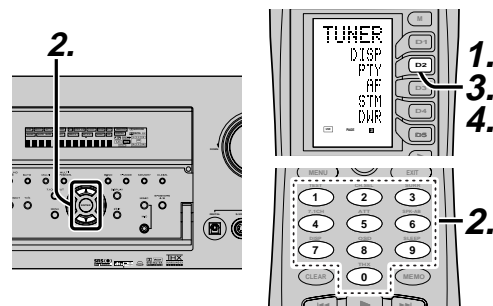

1. Press the **PTY** button in the TUNER MODE on the remote controller. The current station's PTY will be displayed, or the currently selected PTY group will be displayed in blinking if no station or RDS data is present.
2. To change to a new PTY type, press the **TUNING ▲** or **▼** button on the front panel or **numeric** buttons on the remote until the desired PTY is shown in the display.
3. Once the desired PTY group or type has been selected, press the **PTY** button while the display blink (approx. 5 seconds). The PTY Auto search will start, and the tuner will pause at each station broadcasting RDS PTY information corresponding to the selected choice.
4. To advance to the next RDS station with the desired PTY, press the **PTY** button again within 5 seconds.

NUMBER	DISPLAY	PROGRAMME TYPE
1	POP	Pop Music
2	ROCK	Rock Music
3	MOR	M. O. R. Music
4	LIGHT	Light classical
5	CLASSIC	Serious classical
6	NEWS	News
7	AFFAIR	Current Affairs
8	INFO	Information
9	SPORT	Sport
10	EDUCATE	Education
11	DRAMA	Drama
12	CULTURE	Culture
13	SCIENCE	Science
14	OTHERS	Varied
15	OTHER	Other Music
16	WEATHER	Weather
17	FINANCE	Finance
18	CHILDREN	Children's programmes
19	SOCIAL	Social Affairs
20	RELIGION	Religion
21	PHONE IN	Phone In
22	TRAVEL	Travel
23	HOBBIES	Hobbies
24	JAZZ	Jazz Music
25	COUNTRY	Country Music
26	NATION	National Music
27	OLDIES	Oldies Music
28	FOLK	Folk Music
29	DOCUMENT	Documentary

MULTI ROOM SYSTEM

The Multi Room system is a function which allows you to listen to the same or a different source in a room other than the room in which the SR7500 is located.

To use this function, a multi room remote unit and remote control signal receiver available from your Marantz dealer are necessary.

The operations possible with the multi room function are explained briefly below.

For details, refer to the instruction manual supplied with the multi room remote control unit and receiver.

When the outputs of the MULTI OUT terminals are wired and connected to amplifiers installed in other rooms or MULTI SPEAKER OUT terminals are wired and connected to L&R speakers in other room, different sources can be played in rooms other than the main room in which this unit and the playback devices are installed.

SR7500 has some feature to MULTI ROOM SYSTEM as source selector, OSD information, sleep timer, Multi Room Speaker output and remote control.

MULTI ROOM PLAYBACK USING THE MULTI ROOM OUT TERMINALS

The SR7500 is equipped with audio pre-output terminals for which the volume is adjustable and composite video output terminals as the MULTI ROOM output terminals.

A separately sold stereo power amplifier can be connected to enjoy multi room playback.

Operation to MULTI ROOM OUT without the remote controller.

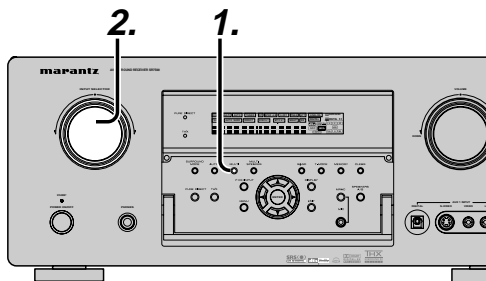

1. Press the **MULTI** button. The unit enters multi room mode and the display indicates "SELECT SOURCE" and flashes the "MULTI" indicator for approx. 10 seconds.

2. In this time, you can select the input source by turning the input selector knob. Then, the display indicates "MULTI VOLUME" "MULTI VOL. xx" for approx. 5 seconds.
3. During this time, you can set the volume level in the multi room as desired. This will only set the volume in the second room.

MULTI ROOM PLAYBACK USING THE MULTI SPEAKER TERMINALS

The SR7500 allows you to connect another set of speakers and place them in a different room or separated area for listening to music.

Operation to MULTI ROOM SPEAKER without the remote controller.

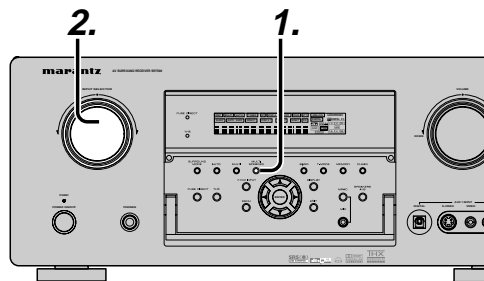

1. Press the **MULTI SPEAKER** button. The unit enters multi room mode and the display indicates "SELECT SOURCE" and flashes the "MULTI" indicators for approx. 10 seconds.
2. In this time, you can select the input source by tuning the input selector knob.
3. Then, the display indicates "MSPKR VOLUME" "MSPKR VOL.-xx" for approx. 5 seconds. During this time, you can set the volume level in the multi room as desired. This will only set the volume in the multi room.

Notes for Multi Room Speaker

- MULTI ROOM SPEAKER On/ Off is available in main room only.
- MULTI ROOM SPEAKER output terminals can be used when the SURROUND BACK SPEAKER is set NONE in SPEAKER SETUP menu. (See SPEAKER SETUP, page 19)
- "The Surr. Back Speakers are in use" is displayed by pressing the **MULTI SPEAKER** button when the SURROUND BACK SPEAKER is set except NONE in SPEAKER SETUP menu. (See SPEAKER SETUP, page 19)
- The multi speaker feature cannot be used at the same time as the SPEAKER C feature. When connecting for multi room use, set the SPEAKER C selector switch on the rear panel to OFF.
- The multi speaker system cannot be used in the 7.1 input channel mode.

OPERATION OF THE MULTI ROOM OUTPUTS WITH THE REMOTE CONTROL FROM A SECOND ROOM

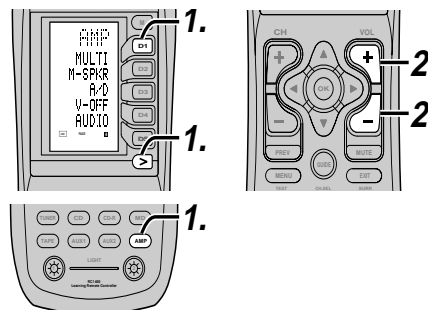

1. Press **MULTI** on the multi room remote control from the MULTI ROOM. (Press the **AMP** button and press the > button until PAGE4 is displayed. Press the **MULTI (D1)** button.) This operations will put the SR7500 into multi room mode and "MULTI" will be illuminated on the display. MULTI ROOM Video output will show OSD information for the MULTI ROOM setup.

MULTI ROOM	
VIDEO	: VCR1
AUDIO	: FM 102.00
SLEEP TIMER	: 90 min
MULTI : OFF MSPKR : OFF	
VOL : VARI	VOL : VARI
LEVEL : -90dB	LEVEL : -90dB
- - - MAIN-ROOM STATUS - - -	
VIDEO : DVD	AUDIO : DVD
MAIN	EXIT

2. Press the **VOL +** or **VOL -** button on the multi room remote control to set the desired volume.
3. In multi room mode, the multi room remote control can be used in the multiroom to operate the following functions.

General:

Controlling volume level, sleep timer, and muting. Selecting input audio and video source

Tuner:

Selecting band, controlling preset channel up and down, tuning up and down, direct frequency call.

Notes for the Multi Room System

- The MULTI ROOM OUT (MULTI OUT/MULTI SPEAKER) has analog outputs. This does not support digital input signals.
- If the Tuner (FM or AM) is active in the main room, you can not control any function of the tuner. In this case, You must listen to the same station as the main room.

REMOTE CONTROLLER OPERATION

CONTROLLING MARANTZ COMPONENTS

1. Press the desired function button.
 - The selected function name and USE are displayed in the LCD.
2. Press the desired operation buttons to play the selected component.
 - For details, refer to the component's user guide.
 - It may not be possible to operate some models.

CONTROLLING A MARANTZ DVD PLAYER (DVD MODE)

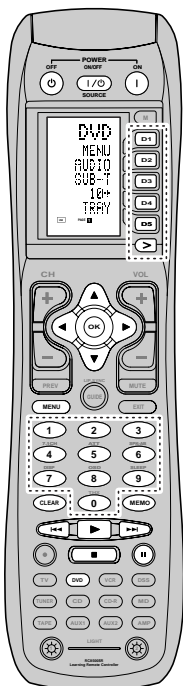

SOURCE ON/OFF	Turns the DVD player on and off
POWER ON	Turns the DVD player on
POWER OFF	Turns the DVD player off
D1 - D5 / >(Page)	(Refer to page vi)
Cursor/OK	Move the cursor, enters the setting
MENU	Calls up the menu of DVD disc
0-9	Input the numeric
MEMO	Call up the programming menu
CLEAR	Clears the inputting
▶	Play
◀▶	Skip forward or previous chapter/track
■	Stop
⏸	Pause

CONTROLLING A MARANTZ CD PLAYER (CD MODE)

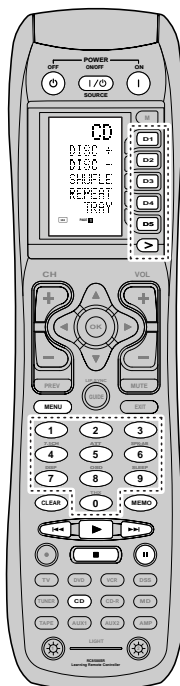

SOURCE ON/OFF	Turns the CD player on and off
POWER ON	Turns the CD player on
POWER OFF	Turns the CD player off
D1 - D5 / >(Page)	(Refer to page vi)
MENU	Switches the display information
0-9	Input the numeric
MEMO	Programs
CLEAR	Clears the inputting
▶	Play
◀▶	Skip forward or previous track
■	Stop
⏸	Pause

CONTROLLING A MARANTZ VCR (VCR MODE)

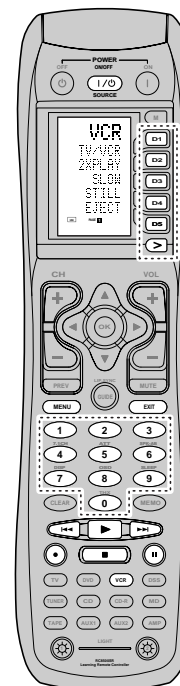

SOURCE ON/OFF	Turns the VCR on and off
D1 - D5 / >(Page)	(Refer to page vi)
MENU	Call up the menu
EXIT	Exits the programming menu
0-9	Input the numeric
▶	Play
◀▶	Skip forward or previous track
■	Stop
⏸	Pause
●	Record

CONTROLLING A MARANTZ CD RECORDER (CDR MODE)

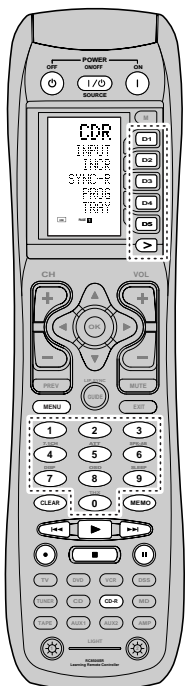

SOURCE ON/OFF	Turns the CD recorder on and off
POWER ON	Turns the CD recorder on
POWER OFF	Turns the CD recorder off
D1 - D5 / >(Page)	(Refer to page vi)
MENU	Switches the display information
0-9	Input the numeric
MEMO	Programs
CLEAR	Clears the inputting
▶	Play
⏮ / ⏭	Skip forward or previous track
■	Stop
⏸	Pause
●	Record

CONTROLLING A MARANTZ MD DECK (MD MODE)

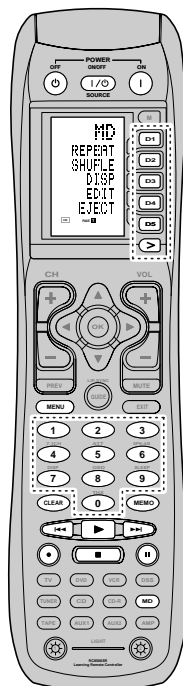

SOURCE ON/OFF	Turns the MD deck on and off
POWER ON	Turns the MD deck on
POWER OFF	Turns the MD deck off
D1 - D5 / >(Page)	(Refer to page vi)
MENU	Switches the display information
0-9	Input the numeric
MEMO	Programs
CLEAR	Clears the inputting
▶	Play
⏮ / ⏭	Skip forward or previous track
■	Stop
⏸	Pause
●	Record

CONTROLLING A MARANTZ TAPE DECK (TAPE MODE)

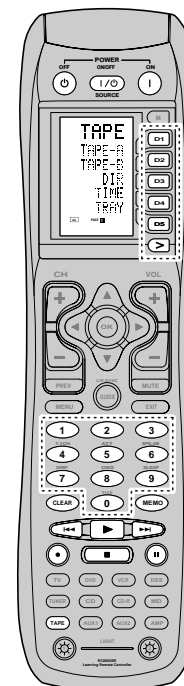

SOURCE ON/OFF	Turns the TAPE deck on and off
POWER ON	Turns the TAPE deck on
POWER OFF	Turns the TAPE deck off
D1 - D5 / >(Page)	(Refer to page vi)
0-9	Input the numeric
MEMO	Programs
CLEAR	Clears the inputting
▶	Play
⏮ / ⏭	Skip forward or previous track
■	Stop
⏸	Pause
●	Record

BASIC OPERATION

USE MODE

(Normal operation status)

This remote control is preset with a total of 12 types of remote codes, including Marantz TV (television), DVD, VCR (VCR deck), DSS (satellite broadcasting tuner), TUNER, CD, CD-R, MD, TAPE (tape deck), AUX1, AUX2, and AMP (amplifier).

Learning is not necessary for Marantz products. You can use these products without setting any codes.

1. Press the **SOURCE** button.

For this example, press DVD.

DVD is shown on the LCD, and the remote control is set for DVD.

Pressing the source button once changes the remote control to the settings for the source that was pressed.

To change the amplifier or other source, press the SOURCE button twice (double-click). The code is sent, and then the amplifier source changes to DVD.

2. Press the buttons to operate the DVD.

The  indicator is shown on the LCD while the remote control codes are being transmitted. It is not displayed when buttons without stored code are pressed.

3. The direct buttons can be used to perform up to 20 operations for each of the 12 sources, including DVD, TV, AMP, and other AV equipment.

The buttons consist of the D1 to D5 buttons, and the equipment is operated by pressing the buttons corresponding to the indicators on the LCD.

Four pages are available, and press the > button to select a page. The current page position is displayed on the LCD.

PRESET MODE

(When operating non-Marantz AV equipment products)

This remote control is preset with remote control codes from AV equipment by other manufacturers. The preset codes are TV, VCR, LD, CABLE, DSS, DVD, TAPE, TUNER, CD, CD-R, MD and AMP. Settings can be made in one of two ways.

When the preset codes are set, the following codes are contained in the source button of the remote control.

See the attached manufacturer number list for the preset manufacturers, devices, preset numbers, and other settings.

Remote control source name	Corresponding preset code	Device name
TV	TV	Television
DVD	DVD	DVD player
VCR	VCR	Video deck
DSS	SATELLITE	Satellite broadcasting tuner equipment
TUNER	RECEIVER/TUNER	AM FM TUNER
CD	CD/CD-R PLAYER	CD player
CD-R	CD/CD-R PLAYER	CD recorder
MD	CD/CD-R PLAYER	MD deck
TAPE	TAPE	Cassette deck
AUX1	CABLE	Cable television
AUX2	LASER DISC	Laser disc player
AMP	AMPLIFIER	Amplifier or receiver
	RECEIVER/TUNER	

- When using Marantz products, TV and DVD can be set to TV1 (TV/VDP: Projector) and TV2 (PDP: Plasma display), and DVD1 (first DVD player) and DVD2 (second DVD player), respectively, to match the customer's operating environment. These settings are made in PRESET mode.

In the factory default state, the remote control is set to TV1 and DVD1. To make the presets, enter the numbers below while referring to the section "Entering and Setting the Manufacturer Number Directly".

TV1: 0001, TV2: 0002

DVD1: 0001, DVD2: 0002

Entering and Setting the Manufacturer Number Directly

Refer to the manufacturer number list.

This example shows how to set a SAMSUNG DVD player.

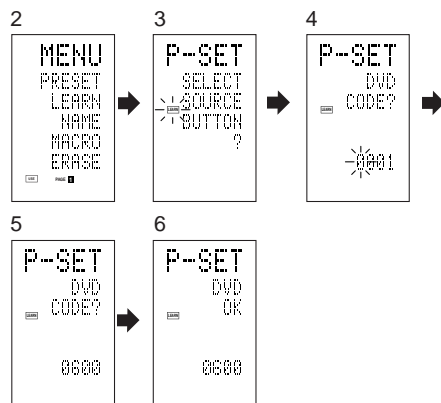

- View the supplied manufacturer number list, and find the number of the manufacturer for the device that you are using.
- Hold down the **M** button for three seconds or more.

The menu is displayed.

- Press the **D1** (PRESET) direct button. The Preset setting (P-SET) is displayed.
- Press the **DVD** source button.
- Press the numeric buttons to enter the four-digit manufacturer number.

Example: To enter "0600" from the manufacturer number list.

To correct the entered number, use the ◀ or ▶ cursor button to enter the correct number.

- If no button is pressed for over one minute during the setting process, any settings that were made are cancelled.

- Press the **OK** cursor button.
- Confirm the OK is displayed and then the display returns to the Preset Setting (P-SET). When the manufacturer number is entered correctly, OK is displayed momentarily on the screen.

- If you enter a number not in the manufacturer number list, WRONG CODE is displayed, and then you return to the preset setting again

Check the manufacturer number list, and either set a different number or use the sequence function to set.

- To set the manufacturer number for another source device, repeat the procedure in steps 4 to 6.
- After the settings are completed, press the **M** button.
- Press the buttons on the remote control to check that the DVD can be operated correctly.

Setting Equipment Not Appearing in Manufacturer Number List

Use the sequence function to set equipment not appearing in the manufacturer number list. You may still be unable to set some equipment even when using the sequence function. In this case, the remote control can be programmed with codes individually.

In the sequence function, the power ON/OFF codes are transmitted by pressing the remote control buttons in order.

If the power for the equipment is left on, hold down the button until the equipment is turned off, and then release. This completes the setting.

This example shows how to set a DVD player.

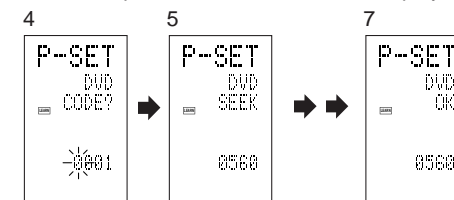

- Turn on the power of the DVD player.
- Hold down the **M** button for three seconds or more. The menu is displayed.
- Press the **D1** (PRESET) direct button. The Preset setting (P-SET) is displayed.
- Press the **DVD** source button.
- Hold down the **CH+** or **CH-** button for one second or more.
- Press the **CH+** button repeatedly in the interval for one second. The signal is transmitted, and the display cycles through the code number. Press the **CH-** button to go back to a number screen.
- Release the button once the DVD player turns off.
- Press the **OK** cursor button.
- Confirm the OK is displayed and then the display returns to the Preset Setting (P-SET).
- To set the manufacturer number for another source device, repeat the procedure in steps 4 to 8.
- After the settings are completed, press the **M** button.
- Press the buttons on the remote control to check that the DVD can be operated correctly.

Check the following points if the equipment which was set does not operate properly.

- If there is more than one number in the manufacturer number list, try setting a different number.
- There may be some buttons which cannot be used. Program the codes to the required buttons.

LEARN MODE

Programming the ► (PLAY) and Other Control Buttons and Numeric Buttons

This remote control is capable of learning and storing codes used by other remote controls that you already own.

For codes which are not learned, the remote control will transmit either the Marantz preset codes from the initial settings, or remote codes from another manufacturer's AV equipment which is set by the customer.

The receiver sensor for the remote control signals is located at the top of the remote control.

This example shows how to learn the codes from the remote control of a DVD player.

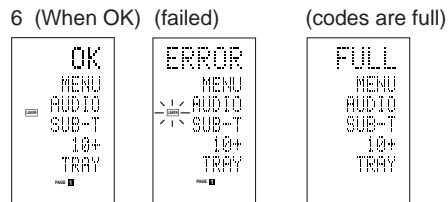
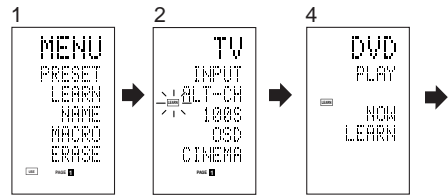

1. Hold down the **M** button for three seconds or more.
The menu is displayed.
2. Press the **D2** (LEARN) direct button.
The LEARN setting (LEARN) is displayed. The **LEARN** indicator then blinks.
3. Press the **DVD** source button.
4. Press the ► (PLAY) button.
The **LEARN** indicator blinks, and then displays to indicate that learning is ready.
5. Place the receiver sensor of the remote control (top) so that it is facing the transmitter of the DVD remote control (top) at a distance of about 5 cm (2 inches).

6. Press and hold down the ► (PLAY) button of the transmitting DVD remote control, and check that OK is displayed on the LCD.

The remote control has finished learning when OK is displayed on the LCD.

If ERROR is displayed on the LCD, some error has prevented the command from being learned. If this happens, repeat the procedure for steps 4 and 5.

In some rare cases, ERROR may be displayed repeatedly during the learning operation. In this case, the transmitting remote control may have special signal codes. These codes cannot be learned by this remote control.

7. Follow the same procedure to make the remote control learn the other buttons.
8. Repeat the procedure in steps 3 to 6 to have the remote control learn the signal codes from a TV, CD player, or other AV equipment.

- When no buttons are pressed for approximately one minute during the learning operation, the remote control automatically returns to USE mode.

- When programming the source buttons, switch to the source in step 3, and then press the source button again.

9. When you have finished programming the codes for each button, press the **M** button.
The **USE** indicator is displayed on the LCD, and the newly stored codes can be used.

- If FULL is displayed on the LCD, the memory cannot hold any more learned codes in LEARN mode.

If FULL is displayed no matter how many times you try the learning operation, the remote control cannot accept any more new codes until some of the previously learned codes are deleted from the memory. Delete some of the learned buttons from the sources.

The **M** button and > button cannot be taught. Only each one code can be learned for the **LIGHT** buttons 1 and 2, regardless of the source.

Programming the Direct Buttons and Rewriting Names

This example shows how to program codes from other manufacturer products to the DVD MENU button (D1) and change the display to OSD.

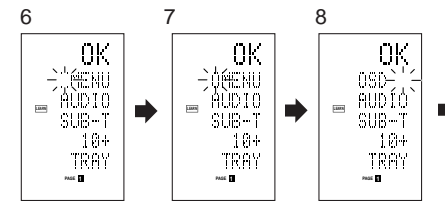

1. Hold down the **M** button for three seconds or more.
The menu is displayed.
2. Press the **D2** (LEARN) direct button.
The **LEARN** setting (LEARN) indicator is displayed. The **LEARN** indicator then blinks.
3. Press the **DVD** source button.
The first page of the direct button screen is displayed. There are four available pages. Pressing the > buttons cycles through the pages in this order 1 → 2 → 3 → 4 → 1.
4. Press the **D1** (MENU) direct button.
The **LEARN** indicator blinks, and then displays to indicate that learning is ready.
5. Place the receiver sensor of the remote control (top) so that it is facing the transmitter of the DVD remote control (top) at a distance of about 5 cm (2 inches).
6. Press and hold down the OSD button of the transmitting DVD remote control, and check that OK is displayed on the LCD.
The remote control has finished learning when OK is displayed on the LCD.
If ERROR is displayed on the LCD, some error has prevented the command from being learned. If this happens, repeat the procedure for steps 4 and 5.
 - After learning is completed, the remote control automatically switches to name rewriting mode. The left end “:” indicator on the MENU blinks to indicate that the blinking part can be rewritten.
 - If no names will be rewritten, press the OK cursor button. The display returns to learning standby mode by pressing the OK cursor button.

7. To change the name, press the numeric buttons to enter the text.

- Use the cursor buttons ◀▶ to move to the sections to be rewritten on the LCD.
- To change MENU to OSD, press the 5 numeric button.

Each time the button is pressed, the display cycles through M → N → O → 5 → M.

8. After rewriting of the text is completed, press the **OK** cursor button.

To delete text that is already entered, press the 0 button to insert a space.

- In this example, MENU is changed to “OSD (space) (space)” in this step, and then OSD is displayed in the right side by pressing the OK button.

For details, refer to the section “Rewriting Names”.

9. In the same way, use the > button to select the page, and then press the direct button to program the codes.

10. After programming the codes for each of the buttons, press the **M** button.

The **USE** indicator displays on the LCD, and the newly stored codes can be transmitted.

REWRITING NAMES

This remote control allows the rewriting of names for the sources and direct buttons. This operation is performed for each individual source.

This example shows how to change the source name from DVD to AVD and AUDIO to SOUND.

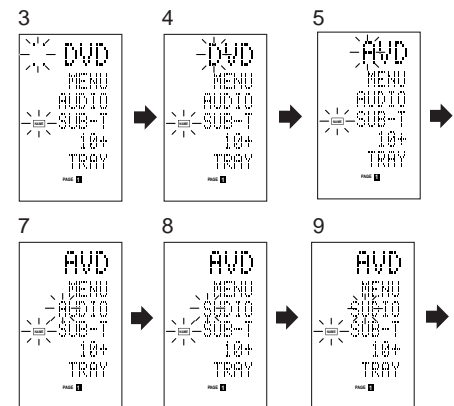

1. Hold down the **M** button for three seconds or more.
The menu is displayed.
2. Press the **D3** (NAME) direct button.

- Press the **DVD** source button .
The **[NAME]** indicator blinks.
The ":" blinks to indicate that the letter can be changed.
- Press the **▶** cursor button twice.
The D in DVD blinks to indicate that the letter can be changed.
- Press the **1** numeric button to select A.
Each time the numeric buttons are pressed, the button cycles through the alphanumeric characters shown below.
1: A → B → C → 1 → A
2: D → E → F → 2 → D
3: G → H → I → 3 → G
4: J → K → L → 4 → J
5: M → N → O → 5 → M
6: P → Q → R → 6 → P
7: S → T → U → 7 → S
8: V → W → X → 8 → V
9: Y → Z → / → 9 → Y
0: SPACE (:) → + → - → , → ' → < → > → ? → 0 → SPACE (:)
 - Press the **◀** or **▶** cursor button .
The letter is changed to "A".
 - The **▲** and **▼** cursor buttons can be used to move the blinking indicator of the section to be rewritten.
 - Press the **▲** or **▼** cursor buttons to select **AUDIO** on the direct button indicator. The A flashes to indicate that the name can be changed.
 - Press the **7** numeric button to select S.
Each time the button is pressed, the button cycles through S → T → U → 7 → S.
 - Press the **▶** cursor button to move the flashing section.
 - Press the **5** numeric button to select O.
 - Follow the same procedure to enter U, N, and D.
 - When finished entering the text, press the **OK** cursor button .
 - Press the **M** button .
The **[USE]** indicator displays on the LCD, and the newly stored codes can be used.
The input is overwritten, and so the currently displayed text is erased.
Up to six characters can be entered for the direct button indicator.

ERASING PROGRAMMED CODES (RETURNING TO INITIAL SETTINGS)

Codes can be erased in five ways: by buttons, direct buttons, direct button pages, sources, and by all memory contents.

Erasing Buttons and Erasing Direct Buttons

This example shows how to erase the code learned from the **PLAY** button of the DVD player and the **AUTO** code of the **AMP** direct button.

Erasing buttons

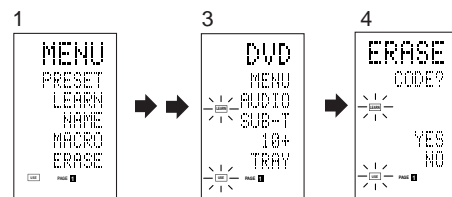

- Hold down the **M** button for three seconds or more.
The menu is displayed.
- Press the **D5 (ERASE)** direct button .
- Press the **DVD** source button .
The **[USE]** and **[LEARN]** indicators blink.
- Press the button **▶** (**PLAY**) that you want to erase while holding down the **CLEAR** button .
A message is displayed on the LCD.
- Press the **D4 (YES)** direct button to erase.
The code programmed to the **▶** (**PLAY**) button is erased.
When the code is cleared, the code for this button resets to the factory default code or becomes blank.

- To cancel the erasing operation, press the **D5 (NO)** button to return to the previous display.

To erase codes programmed for the **CLEAR** button, simply press the **CLEAR** button twice.

To erase codes programmed for the **SOURCE** button, simply press the **SOURCE** button twice.

Erasing direct buttons

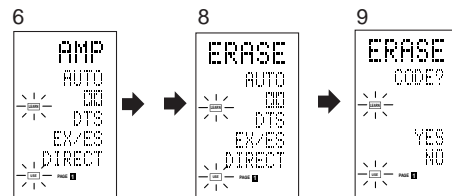

- Press the **AMP** source button .
- Press the **>** button to display the first page for **AMP**.
- Press the **D1 (AUTO)** direct button to be erased while holding down the **CLEAR** button .
- Press the **D4 (YES)** direct button to erase.
The code programmed to the **AUTO** button is erased.
When the code is cleared, the code for this button resets to the factory default code or becomes blank. The rewritten name returns to the original name.
- To cancel the erasing operation, press the **D5 (NO)** button to return to the previous screen.
- When the erasing operation is finished, press the **M** button .
The **[USE]** indicator displays to indicate that the remote control can now be operated.

Erasing Direct Button Pages

This example shows how to erase the entire direct button second page learned from the DVD player.

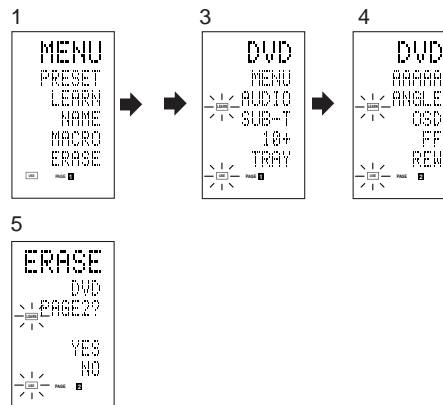

- Hold down the **M** button for three seconds or more.
The menu is displayed.
- Press the **D5 (ERASE)** direct button .
- Press the **DVD** source button .
The **[USE]** and **[LEARN]** indicators blink.
- Press the **>** button to display the second page.
- Press the **>** button while holding down the **CLEAR** button .

- Press the **D4 (YES)** direct button to erase.
All codes and names programmed to page 2 are erased. When the codes are cleared, the codes for this button reset to the factory default code or become blank. Any rewritten names return to the original name.
 - To cancel the erasing operation, press the **D5 (NO)** button to return to the previous screen.
- When the erasing operation is finished, press the **M** button .
The **[USE]** indicator lights up to indicate that the remote control can now be operated.

Erasing Sources

This procedure clears all codes and names programmed to the DVD, TV, or other sources. All codes and names in the four direct button pages are also erased.

This example shows how to erase the names and codes learned from the DVD player.

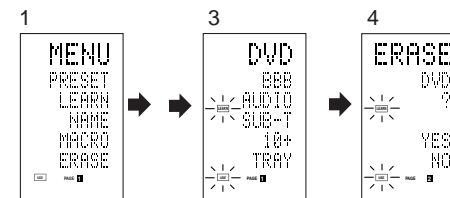

- Hold down the **M** button for three seconds or more.
The menu is displayed.
- Press the **D5 (ERASE)** direct button .
- Press the **DVD** source button .
The **[USE]** and **[LEARN]** indicators blink.
- Press the **DVD** source button while holding down the **CLEAR** button .
- Press the **D4 (YES)** direct button to erase.
All codes and names programmed to the DVD source are erased. When the codes are cleared, the codes for this button reset to the factory default code or become blank. Any rewritten names return to the original name.
 - To cancel the erasing operation, press the **D5 (NO)** button to return to the previous display.
- When the erasing operation is finished, press the **M** button .
The **[USE]** indicator displays to indicate that the remote control can now be operated.

Erasing All

This procedure clears (resets) all programmed codes and names. Once all the data is cleared, the memory is returned to the factory default status. The programmed macros are also erased.

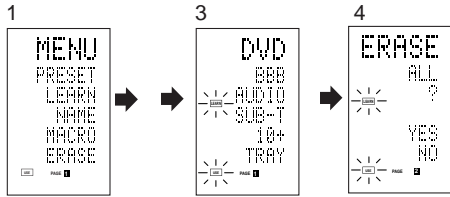

1. Hold down the **M** button for three seconds or more.
The menu is displayed.
2. Press the **D5** (ERASE) direct button .
The **USE** and **LEARN** indicators blink.
3. Press the **CLEAR** button while holding down the **POWER ON** and **OFF** buttons at the same time.
4. Press the **D4** (YES) direct button to erase.

All programmed codes and names are erased and reset to the factory default settings.

- To cancel the erasing operation, press the **D5** (NO) button to return to the previous screen.
- To erase all operation takes a few seconds after the **D4** (YES) button is pressed.

PROGRAMMING MACROS

This remote control can program a series of button operations in sequence.

Macros are a function that makes it possible to use a single button operation to perform a complex series of button operations any number of times. A single button can be programmed to perform up to 20 steps in sequence. A total of 20 buttons can be programmed with macros.

- For example, the following sequence of operations can be programmed to a macro.

Switch amplifier to DVD source → Set amplifier mode to AUTO → Play DVD player → Switch TV to video input

The factory default for the transmission interval (time) between macro operations is one second, but these signal transmission intervals can be set between approximately 0.5 seconds and 5 seconds in the Setup mode. Each transmission interval can be adjusted independently when programming or revising a macro.

Note:

- If the signal transmission interval (interval time) is changed using the Setup mode (described later), this transmission interval is applied to all macro programs. To change individual signal transmission intervals, use the procedures in this section for programming macros and revising macros.
- No signals are transmitted while programming a macro.
- The **M** button, **>** button, cursor buttons, **MEMO** button, **CLEAR** button, and **VOL** buttons cannot be programmed.
- If no button is pressed for approximately one minute during programming, the remote control returns to the state before macro mode.
In this case, the macro program is not stored.
- When executing macro mode, performing the source switching operation two or more times only changes the remote control mode and does not transmit any signals. (Switching of the source selector of the amplifier is valid only once.)

PROGRAMMING MACROS

This example shows how to program a macro to the M-01 button.

(The screens shown in the example are the default factory states. If the names of direct buttons were rewritten, these modified names would be displayed.)

Switch amplifier to DVD source → Play DVD player → Set the interval to 2 seconds until the next signal is sent → Switch TV to video input → Set the amplifier mode to AUTO

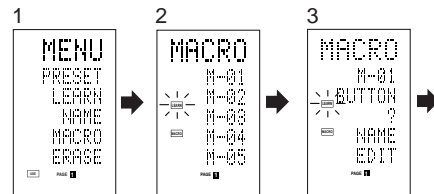

1. Hold down the **M** button for three seconds or more.
The menu is displayed.
2. Press the **D4** (MACRO) direct button .
The macro menu is displayed.
The **MACRO** indicator displays and **LEARN** blinks.
3. Press the **D1** (M-01) direct button .
The menu has four pages, and so use the **>** button to select the page when programming other buttons.

4. Press the buttons in the sequence that you want the operations performed.
The actual program starts here.
Each time a button is pressed, the name of the button is displayed on the LCD.

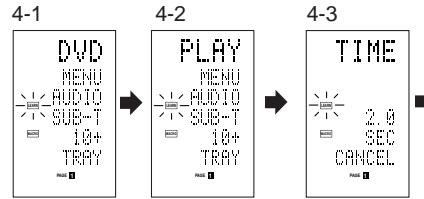

- 4.1. Press the **DVD** source button .
- 4.2. Press the **▶** (PLAY) button .
- 4.3. Press the **▲** or **▼** cursor buttons .
The interval time is displayed on the LCD.
- 4.4. Press the **▲** or **▼** cursor buttons and set to 2.0 (seconds).
 - Use the **▲** cursor button to increase the time and the **▼** button to decrease the time. The interval time can be set from 0.5 seconds to 5 seconds.
 - To stop the time adjustment, press the **D5** (CANCEL) direct button.
- 4.5. Press the **OK** cursor button .
- 4.6. Press the **TV** source button .
- 4.7. Press the **>** button to display the first page.
- 4.8. Press the **D1** (INPUT) direct button .
- 4.9. Press the **AMP** source button .
- 4.10. Press the **>** button to display the first page.
- 4.11. Press the **D1** (AUTO) direct button .
- 4.12. Press the **OK** cursor button .

The LCD displays END to indicate that programming is completed.

5. To program another macro, repeat the procedure in steps 3 to 4-12.
6. To exit macro programming, press the **M** button .
The **USE** indicator displays to indicate that the remote control can now be operated.
When the macro are programmed 20 operations or more, the display returns macro menu.
Edit the macro so that it has 20 operations or less.

EXECUTING MACRO PROGRAMS

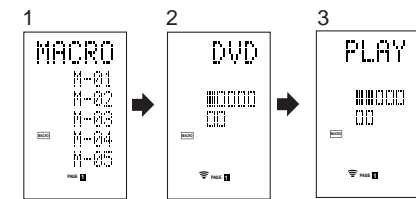

1. Press the **M** button shortly.
The macro menu is displayed.
 2. Press the **D1** (M-01) direct button .
 3. Check that the operations of the program are executed step by step.
The name of the operation button is displayed on the LCD.
 - The programmed section is indicated by **□**.
The bar indicator moves to indicate the progress of the program.
- Select DVD source → PLAY transmit → Interval time: 2 seconds → Select TV → TV INPUT transmit → Select AMP → AUTO transmit → End
- To cancel transmission of the program while it is in progress, press any button.

CHANGING NAMES OF MACRO PROGRAMS

Under the factory default settings, the names of the macro programs are set from M-01 to M-20, but you can change them to any desired name.

The text can have up to six characters, and it is entered using the numeric buttons.

This example shows how to change the M-01 name to MOVIE.

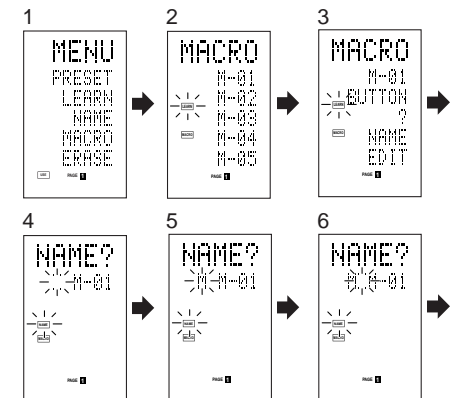

1. Hold down the **M** button for three seconds or more.
The menu is displayed.

2. Press the **D4** (MACRO) direct button.
The macro menu is displayed.
The **[MACRO]** indicator displays and **[LEARN]** blinks.
3. Press the **D1** (M-01) direct button .
The NAME is displayed.
4. Press the **D3** (NAME) direct button .
The "..." blinks to indicate that rewriting is possible.
5. Press the **5** numeric button to select M.
6. Press the **▶** cursor button to next.
The "..." blinks to indicate that rewriting is possible.
7. Press the **5** numeric button to select O.
8. Repeat steps 6 and 7, and then enter V, I, E and "... (space)".
 - To make changes in the text while entering it, use the **◀** or **▶** cursor buttons to move to the blinking section.
9. After making the changes, press the **OK** cursor button.
 - To change the names of other macro programs, repeat the procedure in steps 3 to 9.
10. To exit, press the **M** button.

ERASING STEPS OF MACRO PROGRAMS

This example shows how to delete the TV and INPUT steps from the following macro programmed to M-01.

The program is changed from
DVD → PLAY → TIME → TV → INPUT → AMP → AUTO

to
DVD → PLAY → TIME → AMP → AUTO.

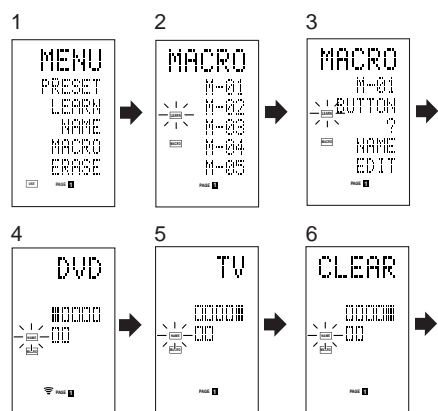

1. Hold down the **M** button for three seconds or more.
The menu is displayed.

2. Press the **D4** (MACRO) direct button.
The macro menu is displayed.
The **[MACRO]** indicator displays and **[LEARN]** blinks.
3. Press the **D1** (M-01) direct button.
4. Press the **D5** (EDIT) direct button.
The LCD displays DVD, and the step position is indicated by ■.
5. Press the **▶** cursor button to display TV.
The programmed section is indicated by □.
6. Press the **CLEAR** button .
The LCD displays CLEAR, and TV and INPUT are deleted.
When deleting steps from a macro program, the operations performed for a source after switching to the source are also deleted.
If the CLEAR button is pressed at the INPUT position, only the INPUT step is deleted.
The □ indicator for the step is also changed.
 - To check the modified steps, press the **◀** or **▶** cursor button.
7. To exit, press the **M** button.
When finished, to change another macro program, press the OK cursor button to return to the menu, and then repeat the procedure for steps 3 to 6.

OVERWRITING STEPS IN MACRO PROGRAMS

This example shows how to change the macro programmed to M-01 from
DVD → PLAY → AMP → AUTO
to
DVD → PLAY → TV → INPUT.

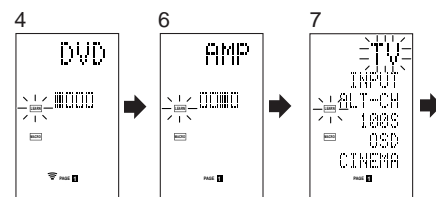

1. Hold down the **M** button for three seconds or more.
The menu is displayed.
2. Press the **D4** (MACRO) direct button.
The macro menu is displayed.
The **[MACRO]** indicator displays and **[LEARN]** blinks.
3. Press the **D1** (M-01) direct button.
4. Press the **D5** (EDIT) direct button.
The LCD displays DVD, and the step position is indicated by ■.
The programmed section is indicated by □.
5. Press the **▶** cursor button so that AMP is displayed.
6. Press the **TV** source button.
TV blinks for 0.5 seconds.

7. Press the **D1** (INPUT) direct button.
INPUT blinks for 0.5 seconds.
TV and INPUT are overwritten.
 - To check the modified steps, press the **◀** or **▶** cursor button.
8. To exit, press the **M** button.
When finished, to change another macro program, press the OK cursor button to return to the menu, and then repeat the procedure for steps 3 to 6.

INSERTING STEPS IN MACRO PROGRAMS

This example shows how to change the macro programmed to M-01 from
DVD → PLAY → AMP → AUTO
to
DVD → PLAY → TV → INPUT → AMP → AUTO

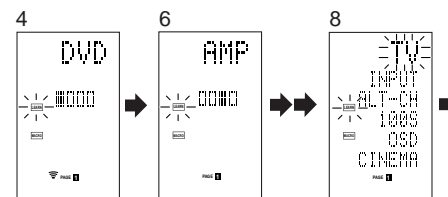

1. Hold down the **M** button for three seconds or more.
The menu is displayed.
2. Press the **D4** (MACRO) direct button.
The macro menu is displayed.
The **[MACRO]** indicator displays and **[LEARN]** blinks.
3. Press the **D1** (M-01) direct button .
4. Press the **D5** (EDIT) direct button .
The LCD displays DVD, and the step position is indicated by ■.
The programmed section is indicated by □.
6. Press the **▶** cursor button so that AMP is displayed.
6. Press the **MEMO** button.
7. Press the **TV** source button.
TV blinks for 0.5 seconds
8. Press the **D1** (INPUT) direct button.
INPUT blinks for 0.5 seconds.
TV and INPUT are inserted.
9. Press the **OK** cursor button.
 - To check the modified steps, press the **◀** or **▶** cursor button.
10. To exit, press the **M** button.
When finished, to change another macro program, press the OK cursor button to return to the menu, and then repeat the procedure for steps 3 to 9.

CLEARING MACRO PROGRAMS

When clearing macros, the macros programmed to the button are erased. Modified macro names are also returned to the factory default settings. This example shows how to clear a macro with the name MOVIE programmed to M-02.

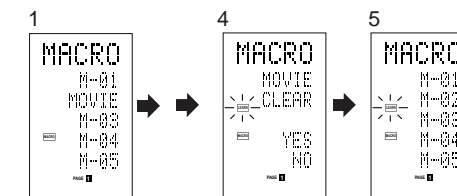

1. Press the **M** button for three second or more.
The macro menu is displayed.
2. Press the **D4** (MACRO) direct button .
The macro menu is displayed.
3. Press the **D2** (MOVIE) direct button while holding down the **CLEAR** button.
4. Press the **D4** (YES) direct button to clear the macro.
To cancel the clearing operation, press the NO (D5 button).
5. To exit, press the **M** button.
When finished, to change another macro program, press the OK cursor button to return to the menu, and then repeat the procedure for steps 2 to 4.

SETTING THE MACRO TIMER

Setting the macro timer enables the macro program to automatically turn the power for a device on or off or perform other operations.

In the settings, you can select to execute the macro timer everyday or only once.

Be sure to set the clock to the correct time before using the timer. The macro timer can only be set for one program a day.

This example shows how to use the timer only once at 20:35 to execute a macro programmed to M-01.

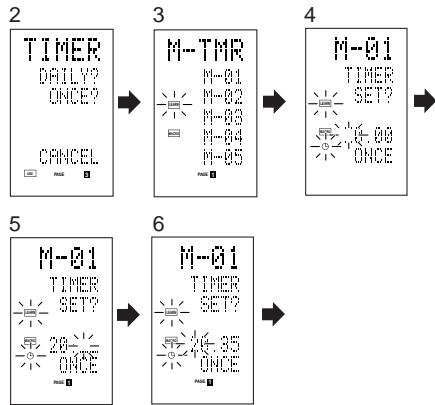

1. Hold down the **M** button for three seconds or more.
The menu is displayed.
2. Press the **>** button to display the third page TIMER menu.
3. Press the **D2** (ONCE?) direct button.
The M-TMR menu is displayed on the LCD.
 - To cancel timer operation, press CANCEL.
4. Press the **D1** (M-01) direct button .
The time which is set previously is displayed.
5. Press the **2** and **0** numeric button to set the hour indicator to 20.
6. Press the **3** and **5** numeric button to set the minute indicator to 35.
7. Press the **OK** cursor button.
This finalizes the time.
8. To exit, press the **M** button.
To cancel the macro timer, return to the TIMER menu and press the D5 (CANCEL) and then press D1 (M-01).

EXECUTING THE MACRO TIMER

The macro program starts when the time that was set is reached. The TIMER \ominus indicator lights up whenever the macro timer is activated.

Note:

- To execute the macro timer, place the remote control facing the infrared sensor of the device to be operated. If the remote control is not in a suitable position, it may not operate the device properly.

CLONE MODE

CREATING COPIES USING CLONE MODE

All of the codes programmed to the RC8500SR remote control can be copied to another RC8500SR using a few simple operations.

- The remote control can copy the entire contents or the contents for specific source buttons.
- When copying the entire contents, all programmed codes, modified names, programmed macros, and signal transmission intervals are copied.

When copying the contents for source buttons, the programmed codes and modified names are copied.

Note:

- The clone function can only be used for copying when using the same model (RC8500SR) for both the transmitting and receiving remote control.

COPYING ENTIRE CONTENTS

<Transmitting remote control>

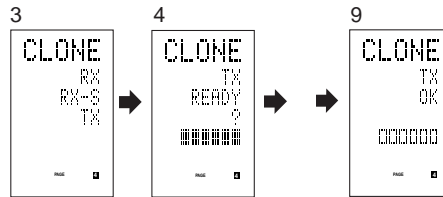

<Receiving remote control>

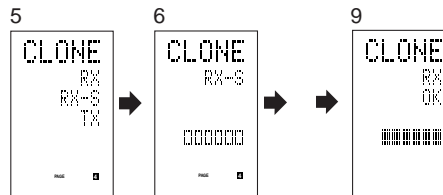

1. Place the receiver sensor of the receiving remote control (top) so that it is facing the transmitter of the transmitting remote control (top) at a distance of about 5 cm (2 inches).
2. Hold down the **M** button of the transmitting remote control for three seconds or more.
The menu is displayed.
3. Press the **>** button to display the fourth page CLONE menu.
4. Press the **D3** (TX) direct button.
The transmitting side is now ready.
5. Hold down the **M** button of the receiving remote control for three seconds or more.
The menu is displayed.
6. Press the **>** button to display the fourth page CLONE menu.
7. Press the **D1** (RX) direct button.
The receiving side is now ready.
8. Press the **OK** cursor button on the receiving remote control.
9. Press the **OK** cursor button on the transmitting remote control.
When copying is started, the bar indicators on both LCDs start to move from the left to the right.
 - When the copying operation is completed, TX OK is displayed on the LCD of the transmitting remote control, and RX OK is displayed on the LCD of the receiving remote control.
 - Do not touch either of the remote controls during the copying operation. Doing so could cause copying to fail.
 - If the copying fails in the middle of the copying process, RX ERROR is displayed on the receiving remote control. Check and perform steps 1 to 7 again.
 - Copying takes about three minutes to complete when the transmitting remote control has been programmed to 100% capacity.
10. Once copying is completed, press the **M** button on both remote controls.

COPYING BY SOURCE

The 12 sources can be copied on a source by source basis. You can select from up to 12 source types.

<Receiving remote control>

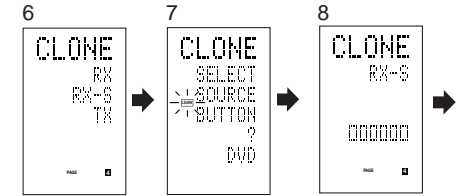

1. Place the receiver sensor of the receiving remote control (top) so that it is facing the transmitter of the transmitting remote control (top) at a distance of about 5 cm (2 inches).
2. Hold down the **M** button of the transmitting remote control for three seconds or more.
The menu is displayed.
3. Press the **>** button to display the fourth page CLONE menu.
4. Press the **D3** (TX) direct button.
The transmitting side is now ready.
5. Hold down the **M** button of the receiving remote control for three seconds or more.
6. Press the **>** button to display the fourth page CLONE menu.
7. Press the **D2** (RX-S) direct button.
8. Press the source button to be copied.
The receiving side is now ready.
The name of the source which was pressed is displayed on the LCD.
 - Each time the source button is pressed, the name is displayed on the LCD.
9. Press the **OK** cursor button on the receiving remote control.
10. Press the **OK** cursor button on the transmitting remote control.
When copying is started, the bar indicators on both LCDs start to move from the left to the right.
 - When the copying operation is completed, TX OK is displayed on the LCD of the transmitting remote control, and RX OK is displayed on the LCD of the receiving remote control.
 - Do not touch either of the remote controls during the copying operation. Doing so could cause copying to fail.

- If the copying fails in the middle of the copying process, ERROR is displayed on the remote control.

Check and perform steps 1 to 7 again.

11. Once copying is completed, press the **M** button on both remote controls.

SETUP

SETTING THE LIGHTING TIME

- The LCD lights up when the **LIGHT** buttons are pressed. The LCD remains lit while the pressed button is held down, and it goes off when the button is released.
- The LCD continues to light up if another button is pressed while it is lit or if pressed within two seconds after the light goes off.
- The lighting time can be set in one-second units from 0 to 60 seconds.

The **LIGHT** buttons have light-absorbing properties that enable them to store light. If the buttons are no longer illuminated in a dimly lit environment, bring the buttons near a fluorescent lamp or other light source for a sufficient amount of time. This should illuminate the buttons again.

- The **LIGHT** buttons consist of a **LIGHT1** and **LIGHT2** button, and they both perform the same operation.

The factory default lighting time is set to 15 seconds.

This example shows how to set the lighting time to 20 seconds.

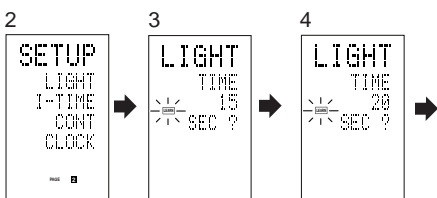

1. Hold down the **M** button for three seconds or more.
The menu is displayed.
2. Press the **>** button to display the second page SETUP menu.
3. Press the **D1** (**LIGHT**) direct button .
The **LIGHT** is displayed on the LCD
4. Press the **▲** or **▼** cursor button to set the lighting time.

5. Press the **OK** cursor button to enter the lighting time.
6. Once the setting is finished, press the **M** button .

SETTING THE MACRO INTERVAL TIME

When a macro program is executed, control signals are transmitted in sequence. This transmission interval (interval time) can be set in 0.5-second units from 0.5 to 5 seconds.

If the interval time is set in this Setup mode, the interval times for all programmed macros are changed. If necessary, use **EDIT** (see page 43) in the macro program to change the individual transmission times.

The factory default setting for the transmission interval is 1 second.

This example shows how to set the interval time to 5 seconds.

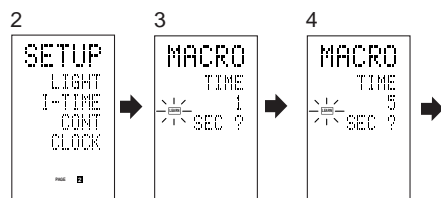

1. Hold down the **M** button for three seconds or more.
The menu is displayed.
2. Press the **>** button to display the second page SETUP menu.
3. Press the **D2** (**I-TIME**) direct button.
4. Press the **▲** or **▼** cursor button to set the interval time.
Holding down the cursor button fast-forwards the time indicator.
5. Press the **OK** cursor button to enter the interval time.
6. Once the setting is finished, press the **M** button.

ADJUSTING THE DISPLAY CONTRAST

The contrast of the LCD can be adjusted. Adjust for maximum visibility according to your viewing environment.

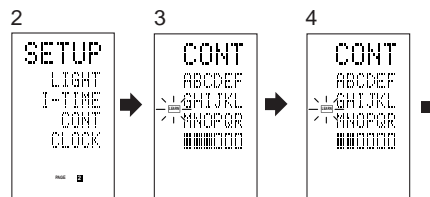

1. Hold down the **M** button for three seconds or more.
The menu is displayed.
2. Press the **>** button to display the second page SETUP menu.
3. Press the **D3** (**CONT**) direct button .
4. Press the **▲** or **▼** cursor button and set the display contrast for maximum visibility.
The adjustment has 10 levels.
The factory default setting for the contrast is the fifth level.
5. Press the **OK** cursor button to enter the display contrast.
6. Once the setting is finished, press the **M** button.

TROUBLESHOOTING

In case of trouble, check the following before calling for service:

1. Are the connections made properly ?
2. Are you operating the unit properly following the user's guide ?
3. Are the power amplifiers and speaker working properly ?

If the unit does not operate properly, check items shown in the following table.

If your trouble cannot be recovered with the remedy actions listed in the following table, malfunction of the internal circuitry is suspected; immediately unplug the power cable and contact your dealer, nearest Marantz authorized dealer or the Marantz Service Center in your country.

SYMPTOM	CAUSE	REMEDY
SR7500 cannot be turned up.	The power plug is not connected.	Connect the power plug to the outlet.
No sound and picture are output even when power is on.	Mute is on.	Cancel mute using the remote control unit.
	The input cable is not connected correctly.	See the connection diagram and connect the cables correctly.
	The master volume control is turned all the way down.	Adjust the master volume.
	The function selector position is wrong.	Select correct position.
No speaker output.	The headphones are connected to the headphone jack.	Disconnect the headphones. (Speakers will not output sound when headphones are connected.)
Incorrect Audio or Video for selected source.	Input cable connected incorrectly.	Connect the cable correctly by referring to the connection diagram.
Incorrect Audio from a channel.	Speaker cable connected incorrectly.	Connect the cable correctly by referring to the connection diagram.
No Audio output from the center channel speaker.	The center speaker cable connection is incomplete.	Connect the cable correctly.
	STEREO has been selected for Surround mode.	When STEREO is selected for Surround mode, no sound will be output from the center speaker. Set another Surround mode.
	Center = NONE has been selected in SETUP mode.	Make the correct setting.
No Audio output from the surround speakers.	The surround speaker cable connection is incomplete.	Connect the cable correctly.
	STEREO has been selected for Surround mode.	When STEREO has been selected for Surround mode, no sound will be output from the surround speaker. Set another Surround mode.
	Surround = NONE has been selected in SETUP mode.	Make the correct setting.
No Audio output from the surround back speakers.	The surround back speaker cable connection is incomplete.	Connect the cable correctly.
	Surround mode is not EX/ES mode.	Set surround mode EX/ES.
	Surround back = NONE has been selected in SPEAKERS SIZE SETUP	Make the correct setting.

SYMPTOM	CAUSE	REMEDY
Can not select EX/ES mode.	Surround center= NONE has been selected in SPEAKERS SIZE SETUP	Make the correct setting.
	Input signal is incompatible.	Use 5.1channel source.
Can not select Pro Logic IIx mode.	Input signal is incompatible.	Use 2 channel Dolby Digital input signal, PCM input signal or analog input signal.
Can not select Neo:6 mode.	Input signal is incompatible.	Use 2 channel Dolby Digital input signal, PCM input signal or analog input signal.
Can not select CSII mode.	Input signal is incompatible.	Use 2 channel Dolby Digital input signal, PCM input signal or analog input signal.
No output to Subwoofer Out.	Subwoofer = NONE has been selected in SETUP mode.	Select Subwoofer = YES.
Noise is produced during DTS-encoded CD or laser disc play.	Analog has been selected for input.	Be sure to perform digital connection, select digital input, then play.
A specific channel does not produce output.	Nothing recorded on source.	Check the encoded channel on the source side.
FM or AM reception fails.	Antenna connection is incomplete.	Correctly connect the indoor FM and AM antennas to FM and AM antenna outlets.
Noise is heard during AM reception.	Reception is affected by other electrical fields.	Try changing location where the AM indoor antenna is set up.
Noise is heard during FM reception.	The radio waves from the broadcasting station are weak.	Install an FM outdoor antenna.
Cannot get programmed station when the PRESET button is pressed.	Preset data has been erased.	Disconnecting power plug for long periods of time will erase preset data. If that happens, input the preset data again.
Control with the remote control unit fails.	Batteries are consumed.	Replace all the batteries with new ones.
	Remote controller's function-key setting is wrong.	Select different position from which equipment will be controlled.
	The distance between this SR7500 and the remote commander is too far.	Move closer to this SR7500.
	Something is blocking SR7500 and the remote commander.	Remove offending object.
MRAC is not working.	Headphones are connected.	Disconnect the headphones.

Note:

- After "PROTECT" appears on the unit's display, the standby indicator may start flashing. If it does, there is a problem in the unit or the connection. If this problem reoccurs even when power is activated from the remote control unit, call for servicing.

GENERAL MALFUNCTION

If the equipment malfunctions, this may be because an electrostatic discharge or AC line interference has corrupted the information in the equipment memory circuits. Therefore:

- disconnect the plug from the AC line supply
- after waiting at least three minutes, reconnect the plug to the AC line supply
- re-attempt to operate the equipment

Memory backup

- In case a power outage occurs or the power cord is accidentally unplugged, the SR7500 is equipped with a backup function to prevent memory data such as the preset memory from being erased.

HOW TO RESET THE UNIT

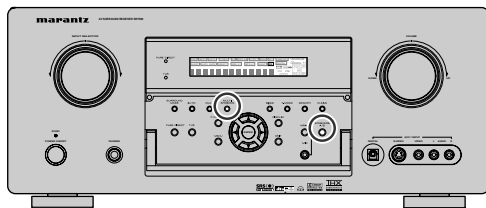

Should the operation or display seem to be abnormal, reset the unit with the following procedure. The SR7500 is turned on, press and hold the **MULTI + SPEAKERS A/B** buttons simultaneously for 3 seconds or more. Remember that the procedure will reset the settings of the function selector, Surround mode, delay time, TUNER PRESET etc., to their initial settings.

TECHNICAL SPECIFICATIONS

FM TUNER SECTION

Frequency Range	87.5 - 108.0 MHz
Usable Sensitivity	IHF 1.8 μV/16.4 dBf
Signal to Noise Ratio	Mono/Stereo 75/70 dB
Distortion	Mono/Stereo 0.2/0.3 %
Stereo Separation	1 kHz 45 dB
Alternate Channel Selectivity	± 300 kHz 60 dB
Image Rejection	98 MHz 70 dB
Tuner Output Level	1 kHz, ± 75 kHz Dev 800 mV

AM TUNER SECTION

Frequency Range	531 - 1602 kHz
Signal to Noise Ratio	50 dB
Usable Sensitivity	Loop 400 μV
Distortion	400Hz, 30 % Mod. 0.5 %
Selectivity	± 20 kHz 70 dB

AUDIO SECTION

SR7500	
Power Output (20 Hz - 20 kHz/THD=0.08%)	
Front L&R	8 ohms 105 W / Ch
Center	8 ohms 105 W / Ch
Surround L&R	8 ohms 105 W / Ch
Surround Back L&R	8 ohms 105 W / Ch
Front L&R	6 ohms 135 W / Ch
Center	6 ohms 135 W / Ch
Surround L&R	6 ohms 135 W / Ch
Surround Back L&R	6 ohms 135 W / Ch
SR8500	
Power Output (20 Hz - 20 kHz/THD=0.08%)	
Front L&R	8 ohms 125 W / Ch
Center	8 ohms 125 W / Ch
Surround L&R	8 ohms 125 W / Ch
Surround Back L&R	8 ohms 125 W / Ch
Front L&R	6 ohms 160 W / Ch
Center	6 ohms 160 W / Ch
Surround L&R	6 ohms 160 W / Ch
Surround Back L&R	6 ohms 160 W / Ch

Input Sensitivity/Impedance	168 mV / 47 Kohms
Signal to Noise Ratio(Analog Input / Pure Direct)	105 dB
Frequency Response	
(Analog Input / Pure Direct)	8 Hz - 100 kHz (± 3 dB)
(Digital Input / 96 kHz PCM)	8 Hz - 45 kHz (± 3 dB)

VIDEO

Television Format	NTSC/PAL
Input Level/Impedance	1 Vp-p/75 ohms
Output Level/Impedance	1 Vp-p/75 ohms
Video Frequency Response	5 Hz to 8 MHz (- 1 dB)
Video Frequency (Component) ...	5 Hz to 80 MHz (- 1 dB)
S/N	60 dB

GENERAL

Power Requirement	AC 230 V 50 Hz
Power Consumption	600 W(SR7500)
.....	620 W(SR8500)
Weight	14.8 Kg (SR7500)
.....	15.0 kg (SR8500)

ACCESSORIES

Remote Control Unit RC8500SR	1
Microphone MC-10	1
AAA-size batteries	3
FM Antenna	1
AM Loop Antenna	1
Front AUX Jack Cover	1
AC cable	1

Specifications subject to change without prior notice.

DIMENSIONS

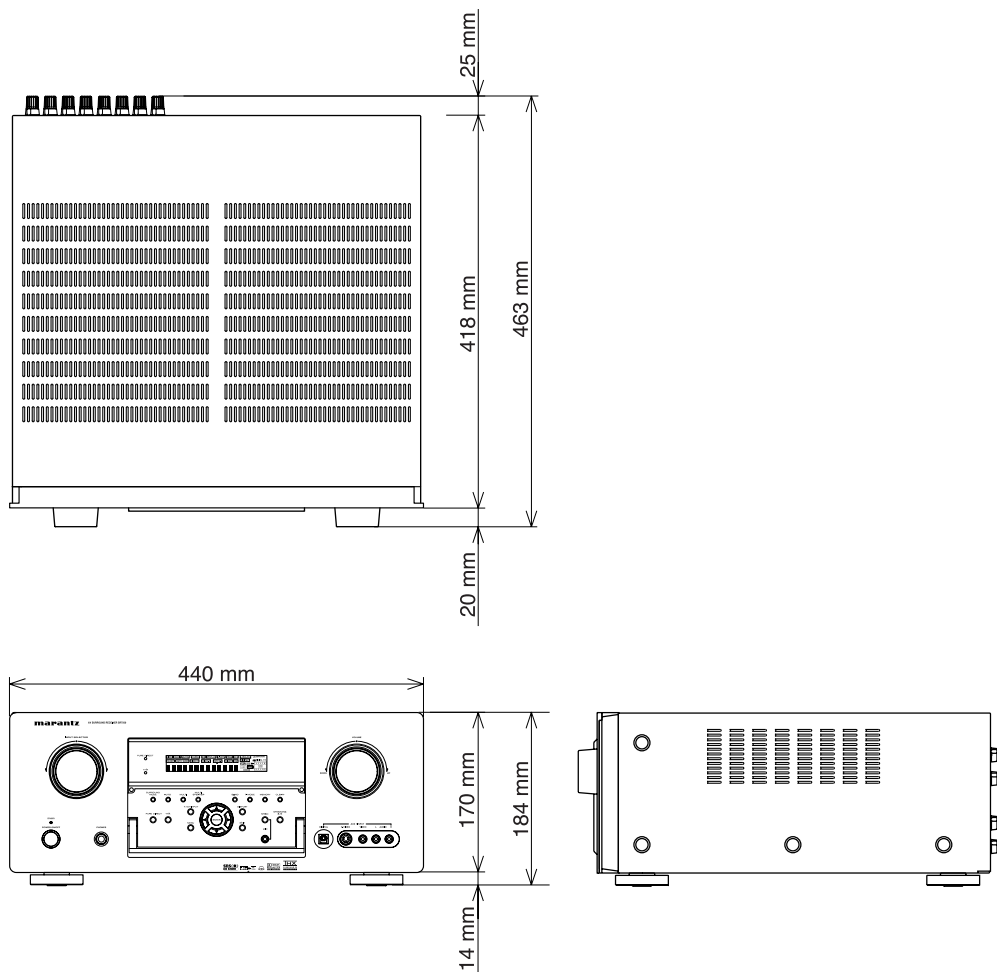

SETUP CODES

AMPLIFIER

Source button name : AMP

Brand name	Setup code
Amstrad	0105
Arcam	0296
Audiolab	0296
Carver	0296
GE	0105
Genexxa	0422
Grundig	0296
Harman/Kardon	0919
JVC	0358
Left Coast	0919
Linn	0296
Magnavox	0296
Marantz	0919, 0296
Micromega	0296
Myryad	0296
Optimus	0422
Panasonic	0335
Philips	0919, 0296
Pioneer	0040
Polk Audio	0919, 0296
Realistic	0422
Revox	0296
Sony	0247
Soundesign	0105
Technics	0335
Thorens	0296
Victor	0358
Wards	0105, 0040
Yamaha	0381

RECEIVER/TUNER

Source button name : AMP, TUNER

Brand name	Setup code
ADC	0558
Aiwa	1432, 0185, 1116, 1415, 1668
Alco	1417
Anam	1636
Apex Digital	1284
Audiolab	1216
Audiotronic	1216
Audiovox	1417
Bose	1256
Cambridge	1397
Soundworks	
Capetronic	0558
Carver	1216, 1116
Centrex	1284
Denon	1387
Ferguson	0558
Fine Arts	1216
Grundig	1216

RECEIVER/TUNER

Source button name : AMP, TUNER

Brand name	Setup code
Harman/ Kardon	0137, 1331
Integra	0162, 1325
JBL	0137, 1333
JVC	0101, 0558, 1401, 1522
KLH	1417, 1439
Kenwood	1340, 1054
MCS	0066
Magnavox	1216, 1296, 0558, 1116
Marantz	1216, 0066, 1116, 1316
Micromega	1216
Musicismagic	1116
Myryad	1216
NAD	0347
Norcent	1416
Onkyo	0162, 0869, 1325
Optimus	1050, 0558
Panasonic	1545, 0066, 1315, 1790
Philips	1216, 1296, 1116, 1293, 1295, 1310, 1316
Pioneer	1050, 0041, 0558, 1411
Polk Audio	1316
Proscan	1281
Quasar	0066
RCA	1050, 1636, 1281, 0558, 1417
Saba	0558
Sansui	1116
Schneider	0558
Sony	1085, 0185, 1185, 1685, 1785
Stereophonics	1050
Sunfire	1340
Teac	1417
Technics	1335, 1545, 0066, 1336
Telefunken	0558
Thomson	1281
Thorens	1216
Uher	0558
Venturer	1417
Victor	0101
Wards	0185, 0041
Yamaha	0203, 1203, 1358

CABLE

Source button name : AUX1

Brand name	Setup code
ABC	0030, 0035
Americast	0926
Bell South	0926
Birmingham Cable	0303
Communications	
British Telecom	0030
Cable & Wireless	1095
Daeryung	0904, 1904, 0504, 0035
Director	0503
Filmnet	0470
General	0503, 0837, 0303,

CABLE

Source button name : AUX1

Brand name	Setup code
GoldStar	0171
Hamlin	0036, 0300
Instrument	0030
Jerrold	0503, 0837, 0303, 0030
LG	0171
MNet	0470
Memorex	0027
Motorola	0503, 0837, 0303, 1133
NTL	1095
Noos	0844
Ono	1095
PVP Stereo	0030
Visual Matrix	
Pace	0264, 1087, 1095
Panasonic	0027, 0035, 0134
Paragon	0027
Philips	0332, 0344
Pioneer	0904, 1904, 0171, 0560
Pulsar	0027
Quasar	0027
Regal	0306, 0300
Runco	0027
Sagem	0844
Samsung	0027, 0171
Scientific Atlanta	0904, 1904, 0504, 0035
Sony	1033
Starcom	0030
Supercable	0303
TS	0030
Tele+1	0470
Telewest	1095
Torx	0030
Toshiba	0027
Trans PX	0303
United Cable	0030
Zenith	0027, 0552, 0926

SATELLITE

Source button name : DSS

Brand name	Setup code
@sat	1327
ABsat	0150
Alba	0482
AlphaStar	0799
Amstrad	0874
Aston	0169, 1156
Astro	0200
Atsat	1327
Avalon	0423
Blaupunkt	0200
British Sky	0874, 1202
Broadcasting	
Canal Digital	0880
Canal Satellite	0880

SATELLITE

Source button name : DSS

Brand name	Setup code
Canal+	0880
Chaparral	0243
Citycom	1203
Connexions	0423
Crossdigital	1136
Cyrus	0227
D-box	0750, 1154
DMT	1102
DNT	0227, 0423
Daeryung	0423
Daewoo	1323
Digenius	0326
DirectTV	0419, 0593, 0666, 1169, 0274, 0776, 1776, 0751, 0846, 1883, 1103, 1136
Dish Network System	1032, 0802
DishPro	1032, 0802
Distratel	0111
Dream Multimedia	1264
Echostar	1032, 0802, 0194, 0423, 0637, 0880, 0898, 1113
Engel	1044
Expressvu	0802
FTE	0890
Finlux	0482
Fracarro	0898
Fuba	0423
GE	0593
GOI	0802
Galaxis	0890, 1138
General Instrument	0896
Gold Box	0880
Grundig	0200, 0874
HTS	0802
Hirschmann	0200, 0423
Hitachi	0846, 0482
Hughes	1169, 0776, 1776
Network Systems	
Humax	0890, 1203
InVideo	0898
JVC	0802
Kathrein	0150, 0200, 0227, 0276, 0685, 1248
Kreiselmeier	0200
Labgear	1323
Logix	1044
Lorenzen	0326
Magnavox	0751, 0749
Manhattan	0482, 1044, 1110
Marantz	0227
MediaSat	0880
Memorex	0751
Metronic	0111
Mitsubishi	0776
Motorola	0896
Myryad	0227
Next Level	0896

SATELLITE**Source button name : DSS**

Brand name	Setup code
Nokia	0482, 0750, 0778, 1154, 1250, 1750
OctalTV	1032
Orbitech	1127
Pace	0482, 0874, 1202, 1350
Panasonic	0274, 0728, 0874, 1347
Panda	0482
Paysat	0751
Philips	1169, 0776, 1776, 0751, 1103, 0749, 0160, 0227, 0482, 0880
Pioneer	0880
Promax	0482
Proscan	0419, 0593
RCA	0419, 0593, 0882, 0170
RFT	0227
RadioShack	0896
Radiola	0227
Radix	0423
SKY	0883, 0874, 1202
SM Electronic	1227
Sabre	0482
Sagem	0847, 1141, 1280
Samsung	1303, 1136, 1044, 1319
Sat Control	1327
Satstation	1110
Schwaiger	1138
Seemann	0423
Siemens	0200
Sony	0666, 1666, 0874
Star Choice	0896
Strong	1327
TPS	0847, 1280
Tantec	0482
TechniSat	1126, 1127
Telestari	1127
Thomson	0482, 0880, 1073, 1318
Topfield	1233
Toshiba	0776, 1776, 0817
UltimateTV	0419, 0666
Uniden	0751, 0749
Universum	0200
Ventana	0227
Wisi	0200, 0423, 0482
XSat	0150
Zehnder	1102
Zenith	0883, 1883

TAPE DECK**Source button name : TAPE**

Brand name	Setup code
Aiwa	0056
Carver	0056
Grundig	0056
Harman/Kardon	0056
Magnavox	0056
Marantz	0056
Myryad	0056
Optimus	0054
Philips	0056
Pioneer	0054
Polk Audio	0056
RCA	0054
Revox	0056
Sansui	0056
Sony	0270
Thorens	0056
Wards	0054

LASER DISK**Source button name : AUX2**

Brand name	Setup code
Carver	0091
Denon	0086
Marantz	0091
Mitsubishi	0086
NAD	0086
Nagsmi	0086
Optimus	0086
Philips	0091
Pioneer	0086
Salora	0091
Sony	0228
Telefunken	0086

CD/CD-R PLAYER**Source button name : CD, CDR, MD**

Brand name	Setup code
Aiwa	0184
Arcam	0184
Audio Research	0184
AudioTon	0184
Audiolab	0184
Audiomeca	0184
Cairn	0184
California Audio Labs	0056
Carver	0184, 0206
Cyrus	0184
DKK	0027
DMX Electronics	0184
Denon	0900
Dynamic Bass	0206
Emerson	0332
Fisher	0206

CD/CD-R PLAYER**Source button name : CD, CDR, MD**

Brand name	Setup code
Genexxa	0059, 0332
Goodmans	0332
Grundig	0184
Harman/ Kardon	0184, 0200
Hitachi	0059
JVC	0099
Kenwood	0708, 0653, 0055, 0064
Krell	0184
LXI	0332
Linn	0184
MCS	0056
Magnavox	0184, 0332
Marantz	0653, 0056, 0184
Matsui	0184
Memorex	0332
Meridian	0184
Micromega	0184
Miro	0027
Mission	0184
Myryad	0184
NAD	0027
NSM	0184
Naim	0184
Onkyo	0895
Optimus	0027, 0059, 0064, 0206, 0332
Panasonic	0056
Philips	0653, 0184
Pioneer	0059, 0332
Polk Audio	0184
Proton	0184
QED	0184
Quad	0184
Quasar	0056
RCA	0059, 0206, 0332
Realistic	0206
Revox	0184
Rotel	0184
SAE	0184
Sansui	0184, 0332
Sanyo	0206
Scott	0332
Sears	0332
Sharp	0888, 0064
Simaudio	0184
Sonic Frontiers	0184
Sony	0517, 0027
Symphonic	0332
TAG McLaren	0184
Tandy	0059
Technics	0056
Thorens	0184
Thule	0184
Universum	0184
Victor	0099
Wards	0184

TV**Source button name : TV**

Brand name	Setup code
MARANTZ	0001
TV1 (TV, VDP)	
MARANTZ	0002
TV2 (Plasma)	
AGB	0543
AOC	0478, 0120, 0207, 0087, 0057, 0205, 0036, 0119, 0135
ASA	0131
AWA	0036
Acura	0036
Addison	0119, 0135, 0680
Admiral	0120, 0490, 0190
Advent	0788
Aiko	0119
Akai	0839, 0729, 0057, 0036, 0235, 0388, 0543
Akura	0291
Alba	0036, 0064, 0398, 0695
America Action	0207
Ampro	0778
Amstrad	0198, 0036, 0064, 0398, 0439, 0460, 0543
Anam	0277, 0207, 0036
Anam National	0277, 0677
Anitech	0036
Apex Digital	0775, 0792, 0794
Audiosonic	0064, 0136
Audiovox	0478, 0207, 0119, 0650
Bang & Olufsen	0592
Basic Line	0036
Baur	0064, 0388, 0539
Baysonic	0207
Beaumarck	0205
Beko	0397, 0513, 0741, 0742
Bell & Howell	0181
Beon	0064
Blaupunkt	0222
Blue Sky	0695, 1064
Bondstec	0274
Bradford	0207
Brandt	0136, 0362
Broksonic	0263, 0490
Bush	0036, 0064, 0398, 0401, 0695, 1064
CCE	0064
CGE	0274
CTC	0274
CXC	0207
Candle	0057
Carnivale	0057
Carver	0081, 0197
Cascade	0036
Cathay	0064
Celebrity	0027
Celera	0792
Centurion	0064
Changhong	0792
Ching Tai	0036, 0119

TV

Source button name : TV

Brand name	Setup code
Chun Yun	0027, 0207, 0036, 0119
Chung Hsin	0207, 0080, 0135
Cimline	0036
Cineral	0478, 0119
Citizen	0087, 0057, 0119
Clarion	0207
Clarivox	0064
Clatronic	0274, 0397
Condor	0347, 0397
Conrac	0835
Contec	0207, 0036
Craig	0207
Crosley	0081
Crown	0207, 0036, 0064, 0397, 0445
Curtis Mathes	0074, 0081, 0181, 0478, 0120, 0087, 0729, 0057, 0172, 0193, 1174, 1374
Daewoo	0181, 0478, 0207, 0057, 0205, 1688, 0036, 0064, 0119, 0135, 0197, 0401, 0650, 0661
Dansai	0064
Dayton	0036
De Graaf	0235, 0575
Decca	0064, 0543
Denon	0172
Digatron	0064
Dixi	0036, 0064
Dumont	0044
Dwin	0747, 0801
ECE	0064
Elbe	0286
Electroband	0027
Elin	0064, 0575
Elite	0347
Elta	0036
Emerson	0181, 0263, 0490, 0207, 0205, 0388, 0650
Envision	0057, 0840
Epson	0860
Erres	0064
Ether	0057, 0036
Etron	0036
Europhon	0543
Ferguson	0064, 0100, 0136, 0265, 0314, 0362, 0587
Fidelity	0388
Finlandia	0235, 0373
Finlux	0064, 0131, 0132, 0373, 0543
Firstar	0263, 0036
Firstline	0036, 0274, 0695
Fisher	0181, 0131, 0235, 0397
Flint	0482
Formenti	0064, 0347
Fortress	0120
Frontech	0190, 0274, 0291
Fujitsu	0710, 0836
Funai	0207, 0198, 0291
Futuretech	0207

TV

Source button name : TV

Brand name	Setup code
GE	0074, 0078, 0478, 0207, 0057, 0205, 1481, 0119, 0587, 1174, 1374
GEC	0064, 0543
Gateway	1782, 1783
Geloso	0036
Genexxa	0190
Gibraltar	0044, 0057
GoldStar	0181, 0057, 0205, 0064, 0136, 0404
Goodmans	0064, 0398, 0401, 0661
Gorenje	0397
Gradiente	0080, 0197
Graetz	0190, 0388
Granada	0064, 0235, 0366, 0543
Grandin	0637
Grundig	0064, 0222, 0514, 0583, 0614
Grunpy	0207
HCM	0036, 0439
Hallmark	0205
Hankook	0207, 0057, 0205
Hanseatic	0064, 0347, 0388, 0455, 0583
Hantarex	0543
Harman/Kardon	0081
Harvard	0207
Havermy	0120
Hello Kitty	0478
Hinari	0036, 0064
Hisawa	0482
Hitachi	0057, 0205, 1172, 0172, 1283, 0036, 0119, 0132, 0136, 0190, 0252, 0383, 0508, 0575, 0605
Hua Tun	0036
Huanyu	0401
Hypson	0064, 0291
ICE	0291, 0398
ITS	0398
ITT	0190, 0388, 0575
Imperial	0274, 0397, 0445
Indiana	0064
Infinity	0081
Ingelen	0190
Inno Hit	0543
Innova	0064
Inteq	0044
Interfunk	0064, 0190, 0274, 0388, 0539
Intervision	0064, 0291, 0404
JBL	0081
JCB	0027
JVC	0490, 0080, 0398, 0680, 0710
Jean	0183, 0078, 0263, 0036, 0119
Jensen	0788
KEC	0207
KTV	0207, 0057
Kaisui	0036
Kapsch	0190
Karcher	0637

TV

Source button name : TV

Brand name	Setup code
Kathrein	0583
Kendo	0064
Kenwood	0057
Kneissel	0286, 0462
Koloin	0207, 0080, 0135
Korpel	0064
Koyoda	0036
L&S Electronic	0835
LG	0087, 0057, 0205, 0064, 0135, 0741
LXI	0074, 0081, 0181, 0183, 0205
Leyco	0064, 0291
Liesenk & Tter	0064
Loewe	0539
Luxor	0383, 0388
M Electronic	0036, 0064, 0131, 0132, 0136, 0190, 0314, 0373, 0401, 0507
MGA	0177, 0057, 0205
MTC	0087, 0057, 0539
Magnadyne	0274, 0543
Magnaфон	0543
Magnavox	0081, 0057, 1481, 1281
Manesth	0291, 0347
Mark	0064
Matsui	0036, 0064, 0235, 0398, 0514, 0543
Matsushita	0277, 0677
Mediator	0064
Medion	0695, 0835, 1064
Megatron	0205, 0172
Memorex	0181, 0277, 0490, 0177, 0205, 0036, 1064
Metz	0474
Micromaxx	0835
Microstar	0835
Midland	0074, 0044, 0078
Minerva	0514
Minoka	0439
Mitsubishi	0181, 0277, 0120, 0263, 0207, 0177, 1277, 0057, 0205, 0135, 0539, 0863
Mivar	0318, 0319, 0543, 0636
Motorola	0120
Multitech	0207, 0036
Myryad	0583
NAD	0183, 0205, 0388, 0893
NEC	0181, 0183, 0078, 0057, 0205, 0036, 0197, 0482, 0524, 1731
NEI	0064
NTC	0119
Neckermann	0064, 0583
Netsat	0064
Newave	0120, 0205, 0036, 0119
Nikkai	0064, 0291
Nikko	0057, 0205, 0119
Nokia	0388, 0500, 0507, 0575, 0658
Norcent	0775, 0851
Nordmende	0136, 0314, 0587
Oceanic	0190, 0388

TV

Source button name : TV

Brand name	Setup code
Onwa	0207, 0460
Optimus	0181, 0277, 0193, 0677
Optonica	0120
Orion	0263, 0490, 0064, 0347, 0543
Osaki	0291, 0439
Otto Versand	0064, 0347, 0539, 0583
Palladium	0397, 0445
Panama	0291
Panasonic	0081, 0277, 0078, 0064, 0190, 0677, 1437
Pathe Cinema	0265, 0347
Pausa	0036
Penney	0074, 0183, 0078, 0087, 0057, 0205, 1374
Perdio	0347
Philco	0081, 0490, 0207, 0057, 0205, 0172, 1688, 0064, 0274
Philips	0081, 0027, 0078, 0057, 0205, 1481, 0064, 0119, 0135, 0401, 0583, 0717
Phonola	0064
Pilot	0057
Pioneer	0193, 0136, 0190, 0314, 0706, 0787, 0893
Portland	0119
Prandoni-Prince	0543
Prima	0788
Prism	0078
Profex	0036, 0388
Proscan	0074
Protech	0036, 0064, 0274, 0291, 0445, 0695
Proton	0057, 0205, 0036
Pulsar	0044
Quasar	0277, 0078, 0677
Quelle	0064, 0131, 0388, 0539
R-Line	0064
RCA	0074, 0027, 0057, 0205, 1474, 1481, 0117, 0119, 0706, 1074, 1174, 1274, 1374, 1574
RFT	0455
RadioShack	0074, 0181, 0207, 0057, 0205
Radiola	0064
Radiomarelli	0543
Realistic	0181, 0207, 0057, 0205
Rediffusion	0388
Reoc	0741
Revovox	0064
Rex	0190, 0286, 0291
Roadstar	0036, 0291, 0445
Runco	0044, 0057, 0524, 0630
SBR	0064
SEG	0291, 0695
SEI	0543
SKY	0064
SSS	0207
Saba	0136, 0190, 0314, 0362
Saccs	0265
Sagem	0637
Saisho	0036, 0291, 0543
Salora	0190, 0383, 0388, 0575

TV

Source button name : TV

Brand name	Setup code
Sambers	0543
Sampo	0181, 0120, 0057, 0205, 0198, 0036, 0119, 0677, 1782
Samsung	0181, 0087, 0839, 0729, 0057, 0205, 0036, 0064, 0117, 0119, 0291, 0397, 0583, 0614, 0645, 0793, 0841
Sansei	0478
Sansui	0490
Sanyo	0181, 0207, 0131, 0235, 0366, 0826
Schaub Lorenz	0388
Schneider	0064, 0274, 0398, 0695
Scotch	0205
Scott	0263, 0207, 0205
Sears	0074, 0081, 0181, 0183, 0205, 0198
Seleco	0190, 0286
Semivox	0207
Semp	0183
Sharp	0120, 0057, 0677
Shen Ying	0036, 0119
Sheng Chia	0120, 0263, 0036
Siamem	0543
Siemens	0064, 0222
Sinudyne	0543
Skantic	0383
Skygiant	0207
Skyworth	0064
Solavox	0190
Sonitron	0235
Sonoko	0036, 0064
Sonolor	0190, 0235
Sontec	0064
Sony	1127, 0027, 0677, 0861, 1532, 1678
Soundesign	0207, 0205
Soundwave	0064, 0445
Sowa	0183, 0078, 0087, 0205, 0119
Squareview	0198
Standard	0036
Starlite	0207
Stern	0190, 0286
Supreme	0027
Sylvania	0081, 0057, 0198
Symphonic	0207, 0198
Synco	0027, 0478, 0120, 0087, 0205, 0119
Sysline	0064
T + A	0474
TCM	0835
TMK	0205
TNCi	0044
TVS	0490
Tacico	0205, 0036, 0119
Tai Yi	0036
Tandy	0120, 0190
Tashiko	0119, 0677
Tatung	0081, 0181, 0183, 0078, 0087, 0036, 0064, 0543

TV

Source button name : TV

Brand name	Setup code
Teac	0036, 0064, 0291, 0439, 0445, 0482, 0695, 1064
Tec	0274
Technema	0347
Technics	0277, 0078, 0677
Techwood	0078
Teco	0078, 0120, 0205, 0036, 0119, 0291, 0680
Teknika	0081, 0207, 0177, 0087, 0119
Telefunken	0729, 0136, 0289, 0362, 0652
Telemeister	0347
Teletech	0036
Tensai	0347
Tera	0057
Thomson	1474, 0136, 0314, 0587, 0652
Thorn	0064, 0131, 0388, 0539
Toshiba	0181, 0183, 0087, 1283, 0535, 0645, 0677, 0859, 1383, 1683, 1731
Triumph	0543
Tuntex	0057, 0036, 0119
Uher	0347
Universum	0064, 0131, 0132, 0291, 0373, 0397, 0519
Vector Research	0057
Vestel	0064
Victor	0277, 0080, 0677, 0680
Videosat	0274
Vidikron	0081
Vidtech	0205
ViewSonic	1782
Vision	0347
Voxson	0190
Waltham	0383
Wards	0081, 0057, 0205, 0893
Watson	0064, 0347
Waycon	0183
White Westinghouse	0490, 0064, 0347, 0650
Yamaha	0057, 0796, 0860
Yapshe	0277
Yoko	0064, 0291
Zenith	0044, 0490, 0205, 0119

VCR

Source button name : VCR

Brand name	Setup code
ASA	0064, 0108
Admiral	0075
Adventura	0027
Aiko	0305
Aiwa	0064, 0027, 0334, 0375, 0379
Akai	0068, 0342
Akiba	0099
Alba	0099, 0305, 0342, 0379
America Action	0305
American High	0062
Amstrad	0027

VCR

Source button name : VCR

Brand name	Setup code
Anam	0064, 0267, 0305, 0253, 0507
Anam National	0253, 1589
Anitech	0099
Asha	0267
Asuka	0064
Audiovox	0064, 0305
Baird	0027, 0131, 0068
Basic Line	0099, 0305
Beaumarck	0267
Bell & Howell	0131
Blaupunkt	0253
Brandt	0347
Brandt Electronic	0068
Broksonic	0211, 0375, 1506
Bush	0099, 0305, 0379
CCE	0099, 0305
CGE	0027
Calix	0064
Canon	0062
Carver	0108
Cimline	0099
Cineral	0305
Citizen	0064, 0305, 1305
Colt	0099
Combitech	0379
Craig	0064, 0074, 0267, 0099
Crown	0099, 0305
Curtis Mathes	0087, 0062, 0068, 1062
Cybernex	0267
Cyrus	0108
Daewoo	0072, 0131, 0305, 0669, 1305
Dansai	0099
De Graaf	0069
Decca	0108, 0027
Denon	0069
Dual	0068
Dumont	0108, 0027, 0131
Dynatech	0027
ESC	0267, 0305
Elcotech	0099
Electrohome	0064
Electrophonic	0064
Emerex	0059
Emerson	0062, 0064, 0211, 0267, 0072, 0027, 0070, 0305, 1305, 1506
Ferguson	0068, 0347
Fidelity	0027
Finlandia	0108, 0131
Finlux	0108, 0027, 0069, 0131
Firstline	0064, 0072, 0070, 0099
Fisher	0074, 0131
Fuji	0062, 0060
Fujitsu	0072, 0027
Funai	0027
GE	0087, 0062, 0267, 0834, 1062, 1087

VCR

Source button name : VCR

Brand name	Setup code
GEC	0108
Garrard	0027
General	0072
Go Video	0459
GoldHand	0099
GoldStar	0064, 0252, 0507, 1264
Goodmans	0064, 0027, 0099, 0305
Gradiente	0027
Graetz	0267, 0131, 0068
Granada	0108, 0131
Grandin	0064, 0027, 0099
Grundig	0108, 0099, 0253, 0374
HCM	0099
HI-Q	0074
Hanseatic	0064
Harley Davidson	0027
Harman/Kardon	0108
Harwood	0099
Hinari	0267, 0099, 0379
Hitachi	0064, 0267, 0027, 0069, 0068
Hughes	0069
Network Systems	
Hypson	0099
ITT	0267, 0131, 0068
ITV	0064, 0305
Imperial	0027
Interfunk	0108
JVC	0072, 0094, 0068
Jensen	0068
KEC	0064, 0305
KLH	0099
Kaisui	0099
Kenwood	0094, 0068
Kodak	0062, 0064
Kolin	0070, 0068
Korpel	0099
LG	0064, 0072, 0069, 0507
LXI	0064
Lenco	0305
Leyco	0099
Lloyd's	0027
Loewe	0064, 0108, 1589
Logik	0267, 0099
Luxor	0075, 0131, 0070
M Electronic	0027
MEI	0062
MGA	0267, 0070
MGN Technology	0267
MTC	0267, 0027
Magnasonic	1305
Magnavox	0062, 0066, 0108, 0027, 1808
Magnin	0267
Manesth	0072, 0099
Marantz	0062, 0108
Marta	0064

VCR**Source button name : VCR**

Brand name	Setup code
Matsui	0375, 0379
Matsushita	0062
Medion	0375
Memorex	0062, 0064, 0075, 0066, 0074, 0267, 0027, 0131, 0334, 0375, 1264
Memphis	0099
Metz	0064, 0374, 1589
Minolta	0069
Mitsubishi	0108, 0094, 0070, 0068, 0834
Motorola	0062, 0075
Multitech	0027, 0099
Murphy	0027
Myryad	0108
NAD	0131
NEC	0062, 0064, 0075, 0131, 0094, 0068
National	0253
Neckermann	0108
Nesco	0099
Newave	0064
Nikko	0064
Noblex	0267
Nokia	0267, 0131, 0068
Nordmende	0068, 0347
Oceanic	0027, 0068
Okano	0342, 0375
Olympus	0062, 0253
Optimus	0064, 0075, 0131, 0459
Orion	0211, 0375, 0379, 1506
Osaki	0064, 0027, 0099
Otto Versand	0108
Palladium	0064, 0068, 0099
Panasonic	0062, 0252, 0253, 0643, 1062, 1589
Pathe Marconi	0068
Penney	0062, 0064, 0267, 0069, 1062, 1264
Pentax	0069
Perdio	0027
Philco	0062
Philips	0062, 0108, 0645, 1108, 1208
Phonola	0108
Pilot	0064
Pioneer	0108, 0069, 0094
Polk Audio	0108
Profitronic	0267
Proline	0027
Proscan	0087, 1087
Protec	0099
Pulsar	0066
Pye	0108
Quasar	0062, 1062
Quelle	0108
RCA	0087, 0062, 0267, 0069, 0834, 1062, 1087
RadioShack	0027
Radiola	0108
Radix	0064
Randex	0064

VCR**Source button name : VCR**

Brand name	Setup code
Realistic	0062, 0064, 0075, 0074, 0027, 0131
Reoc	0375
ReplayTV	0641, 0643
Rex	0068
Roadstar	0064, 0267, 0099, 0305
Runco	0066
SBR	0108
SEG	0267
SEI	0108
STS	0069
Saba	0068, 0347
Salora	0070
Sampo	0064, 0075
Samsung	0267, 0072, 0459
Sanky	0075, 0066
Sansui	0027, 0094, 0068, 1506
Sanyo	0074, 0267, 0131
Saville	0379
Schaub Lorenz	0027, 0131, 0068
Schneider	0108, 0027, 0099
Scott	0211, 0072, 0070
Sears	0062, 0064, 0074, 0027, 0069, 0131, 1264
Seleco	0068
Semp	0072
Sharp	0075, 0834
Shintom	0131, 0099
Shogun	0267
Siemens	0064, 0108, 0131
Silva	0064
Singer	0072, 0099
Sinudyne	0108
Sonic Blue	0641, 0643
Sontec	0064
Sony	0062, 0059, 0060, 0027, 0663, 1259
Sunkai	0375
Sunstar	0027
Suntronic	0027
Sylvania	0062, 0108, 0027, 0070, 1808
Symphonic	0027
TMK	0267
Tandy	0027, 0131
Tashiko	0064, 0027
Diamond	0795
Digitrex	0699
Emerson	0618
Tatung	0108, 0072, 0027, 0094, 0068
Teac	0027, 0068, 0305, 0334, 0669
Technics	0062, 0253
Teco	0062, 0064, 0075, 0068
Teknika	0062, 0064, 0027
Teleavia	0068
Telefunken	0068, 0347
Tenosal	0099
Tensai	0027
Thomas	0027

VCR**Source button name : VCR**

Brand name	Setup code
Thomson	0087, 0094, 0068, 0347
Thorn	0131, 0068
Tivo	0645, 0663
Toshiba	0108, 0072, 0094, 0070, 0068, 0872
Totevision	0064, 0267
Uher	0267
Unitech	0267
Universum	0064, 0108, 0267, 0027
Vector	0072
Victor	0094, 0068
Video Concepts	0072
Videomagic	0064
Videosonic	0267
Villain	0027
Wards	0087, 0062, 0075, 0074, 0108, 0267, 0027, 0069, 0099
White Westinghouse	0099
XR-1000	0062, 0027, 0099
Yamaha	0068
Yamishi	0099
Yokan	0099
Yoko	0267
Zenith	0066, 0060, 0027, 1506

DVD**Source button name : DVD**

Brand name	Setup code
MARANTZ DVD1	0001
MARANTZ DVD2	0002
Acoustic Solutions	0757
Alba	0744
Amstrad	0740
Apex Digital	0699, 0744, 0782, 0821, 0823, 0857, 1127
Blaupunkt	0744
Blue Parade	0598
Bush	0740
Centrex	0699
Clatronic	0815
CyberHome	0741
DVD2000	0548
Daewoo	0811, 0797
Dansai	0797
Decca	0797
Denon	0517
Enterprise	0618
Fisher	0697
GE	0549, 0744
Go Video	0742
GoldStar	0768
Gradiente	0678
Greenhill	0744
Grundig	0566
Hitachi	0600, 0691
Hiteker	0699

DVD**Source button name : DVD**

Brand name	Setup code
JVC	0585, 0650
KLH	0744
Kenwood	0517, 0561
Koss	0678
LG	0768
Limit	0795
Magnavox	0530, 0702
Memorex	0858
MiCO	0750
Microsoft	0549
Mintek	0744
Mitsubishi	0548
Mustek	0757
Nesa	0744
Onkyo	0530
Oritron	0678
Palsonic	0699
Panasonic	0517, 0659, 1389
Philips	0530, 0566, 0673, 0881
Pioneer	0552, 0598, 0658, 0659
Polk Audio	0566
Proscan	0549
Qwestar	0678
RCA	0549, 0598, 0744
Rotel	0650
SM Electronic	0757
Samsung	0600
Sanyo	0697
Sharp	0657
Sherwood	0797
Shinsonic	0560
Slim Art	0811
Sony	0560, 0891
Sylvania	0702
Tatung	0797
Teac	0598, 0744
Technics	0517
Theta Digital	0598
Thomson	0549
Toshiba	0530
Urban Concepts	0530
XBox	0549
Yamaha	0517, 0566, 0572
Zenith	0530, 0618, 0768
Zeus	0811

DIRECT BUTTON FUNCTIONS

Source button name : AMP

PAGE	Command	Note
PAGE 1	1 AUTO	SELECT AUTO SURROUND
	2 DD	SELECT DOLBY MODE
	3 DTS	SELECT DTS MODE
	4 EX/ES	SELECT EX/ES
	5 DIRECT	SELECT PURE DIRECT
PAGE 2	1 MCH-ST	SELECT MULTI CHANNEL STEREO
	2 STEREO	SELECT STEREO MODE
	3 VIRTUA	SELECT VIRTUAL MODE
	4 CS-II	SELECT CS-II MODE
	5 HT-EQ	-
PAGE 3	1 NIGHT	NIGHT MODE ON/OFF
	2 BASS +	BASS +
	3 BASS -	BASS -
	4 TREB +	TREBLE +
	5 TREB -	TREBLE -
PAGE 4	1 MULTI	MULTI ROOM ON/OFF
	2 M-SPKR	MULTI SPEAKER ON/OFF
	3 A/D	SELECT ANALOG/DIGITAL
	4 V-OFF	VIDEO OFF
	5 AUDIO	-

Source button name : TUNER

PAGE	Command	Note
PAGE 1	1 FM	SELECT FM
	2 AM	SELECT AM
	3 LW	SELECT LW
	4 T-MODE	SELECT MONO/STEREO
	5 BAND	SELECT RADIO BAND
PAGE 2	1 SCAN +	FREQUENCY SCAN UP
	2 SCAN -	FREQUENCY SCAN DOWN
	3 T-MODE	SELECT MONO/STEREO
	4 P-SCAN	SELECT PRESET SCAN
	5 P-INFO	SHOW PRESET INFORMATION
PAGE 3	1 DISP	RDS DISPLAY
	2 PTY	RDS PTY
	3 AF	RDS ALTERNATE FREQUENCY
	4 STM	RDS STATION MODE
	5 DWR	RDS DSR WAVE LANGUAGE
PAGE 4	1 MULTI	MULTI ROOM ON/OFF
	2 M-SPKR	MULTI SPEAKER ON/OFF
	3	
	4 P-SET +	PRESET UP
	5 P-SET -	PRESET DOWN

Source button name : DVD

PAGE	Command	Note
PAGE 1	1 MENU	SELECTS MAIN MENU
	2 AUDIO	SELECT LANGUAGES
	3 SUB-T	SELECT SUB TITLE
	4 10+	DIGIT ENTRY +10
	5 TRAY	TRAY OPEN/CLOSE
PAGE 2	1 SETUP	SELECTS SETUP MENU
	2 ANGLE	SELECTS ANGLE
	3 OSD	ACTIVATES ON SCREEN DISPLAY
	4 FF	FAST FORWARD
	5 REW	REWIND
PAGE 3	1 SLOW	SLOW FORWARD
	2 L-PLAY	LAST PLAY
	3 SHUFLE	SHUFFLE PLAY
	4 REPEAT	REPEAT MODE
	5 A/B	REPEAT A TO B
PAGE 4	1 RETURN	RETURN TO MENU
	2 T/C	TITLE AND CHAPTER
	3 3-D	SURROUND ON/OFF
	4 TITLE	SELECTS TITLE MENU
	5 ZOOM	ZOOM MODE ON/OFF

Source button name : CD

PAGE	Command	Note
PAGE 1	1 DISC +	CD CHANGER NEXT DISC
	2 DISC -	CD CHANGER PREVIOUS DISC
	3 SHUFLE	SHUFFLE PLAY
	4 REPEAT	REPEAT
	5 TRAY	TRAY OPEN/CLOSE
PAGE 2	1 TEXT	ACTIVATE TEXT FUNCTION
	2 AMS	AUTO MUSIC SCAN
	3 SCROLL	SCROLL/RECALL
	4 FF	FAST FORWARD
	5 REW	REWIND
PAGE 3	1 DISC 1	CD CHANGER DISC 1
	2 DISC 2	CD CHANGER DISC 2
	3 DISC 3	CD CHANGER DISC 3
	4 DISC 4	CD CHANGER DISC 4
	5 DISC 5	CD CHANGER DISC 5
PAGE 4	1 UNIT	SELECT UNIT No.
	2 TITL-S	SELECT TITLE SEARCH
	3 TRACK	SELECT TRACK No.
	4 CATGRY	SELECT CATEGORY
	5 P-MODE	SELECT PLAY MODE

Source button name : VCR

PAGE	Command	Note
PAGE 1	1 TV/VCR	SELECT TV/VCR
	2 2XPLAY	TWICE NORMAL PLAYBACK SPEED
	3 SLOW	SLOW PLAYBACK SPEED
	4 STILL	STILL FRAME
	5 EJECT	EJECT
PAGE 2	1 OTR	ONE TOUCH RECORDING
	2 AUDIO	SELECT AUDIO MODE
	3 SKIP	SKIP TO NEXT PROG.MARKER
	4 FF	FAST FORWARD
	5 REW	REWIND
PAGE 3	1 VIS +	VHS INDEX SERCH NEXT
	2 VIS-	VHS INDEX SERCH PREVIOUS
	3	
	4	
	5	

Source button name : CDR

PAGE	Command	Note
PAGE 1	1 INPUT	SELECT INPUT SOURCE
	2 INCR	INCREMENTS TRACK No.
	3 SYNC-R	ACTIVATE SYNCRO RECORDING
	4 PROG	ACTIVATE PROGRAM MODE
	5 TRAY	TRAY OPEN/CLOSE
PAGE 2	1 SCROLL	SCROLL/RECALL
	2 FINAL	FINALIZES(WRITES TOC)
	3 BLANK	RECORDS BLANK
	4 FF	FAST FORWARD
	5 REW	REWIND
PAGE 3	1 BLANK	RECORDS BLANK
	2 REPEAT	ACTIVATE REPEAT MODE
	3	
	4	
	5	

Source button name : TAPE

PAGE	Command	Note
PAGE 1	1 TAPE-A	SELECT TAPE DECK A
	2 TAPE-B	SELECT TAPE DECK B
	3 DIR	AUTO REVERSE DIRECTION
	4 TIME	TIME DISPLAY
	5 TRAY	TRAY OPEN/CLOSE
PAGE 2	1 AMS	AUTO MUSIC SCAN
	2	
	3	
	4 FF	FAST FORWARD
	5 REW	REWIND

Source button name : MD

PAGE	Command	Note
PAGE 1	1 REPEAT	SELECTS REPEAT MODE
	2 SHUFLE	SELECTS SHUFFLE PLAY
	3 DISP	SELECTS DISPLAY MODE
	4 EDIT	SELECT EDIT MODE
	5 EJECT	EJECT
PAGE 2	1 SP/LP	SELECTS SP/LP MODE
	2 DELETE	SELECTS DELETE
	3 ENTER	SELECTS ENTER
	4 FF	FAST FORWARD
	5 REW	REWIND
PAGE 3	1 MARKER	SELECTS AUTO MARKER
	2 PROG	SELECTS PROGRAM MODE
	3 SYNC-R	SYNCRO REC
	4 CHAR	SELECTS CHARACTER MODE
	5	

www.marantz.com

You can find your nearest authorized distributor or dealer on our website.

JAPAN	Marantz Japan, Inc.	35-1 Sagami Ohno 7-Chome, Sagamihara-shi, Kanagawa 228-8505, Japan
U.S.A.	Marantz America, Inc.	1100 Maplewood Drive, Itasca, IL 60143, U.S.A.
EUROPE	Marantz Europe B.V.	P.O. Box 8744, 5605 LS Eindhoven, The Netherlands

Manufactured under license from Dolby Laboratories. "Dolby", "Pro Logic" and the double-D symbol are trademarks of Dolby Laboratories.
Confidential Unpublished Works. © 1992-1997 Dolby Laboratories, Inc. All rights reserved.

marantz[®] is a registered trademark.

