



Installation Guide

Motorola SURFboard[®]

SB6121 DOCSIS 3.0[®] Cable Modem



© 2010 Motorola, Inc. All rights reserved. No part of this publication may be reproduced in any form or by any means or used to make any derivative work (such as translation, transformation, or adaptation) without written permission from Motorola, Inc. Motorola and the Stylized M logo are registered trademarks of Motorola, Inc. All other product or service names are the property of their respective owners.

Motorola reserves the right to revise this publication and to make changes in content from time to time without obligation on the part of Motorola to provide notification of such revision or change. Motorola provides this guide without warranty of any kind, implied or expressed, including, but not limited to, the implied warranties of merchantability and fitness for a particular purpose. Motorola may make improvements or changes in the product(s) described in this manual at any time.



Contents

Safety and Regulatory Information

Introduction

| | |
|---------------------------|---|
| In the Box | 1 |
| Contact Information | 1 |
| System Requirements | 1 |

Product Overview

| | |
|-------------------|---|
| Front Panel | 3 |
| Rear Panel | 4 |
| MAC Label | 5 |

Installing the Modem

| | |
|--|---|
| Connecting the SB6121 | 6 |
| Using the Energy Conservation Switch | 7 |
| Wall Mounting the Modem | 7 |
| Wall Mounting Template | 8 |

Connecting to the Internet

| | |
|---|----|
| Checking for an Internet Connection | 10 |
| Configuring TCP/IP for Windows 7 | 10 |
| Configuring TCP/IP for Windows Vista | 11 |
| Configuring TCP/IP for Windows XP | 11 |
| Verifying the IP Address for Windows 7 | 12 |
| Verifying the IP Address for Windows Vista | 12 |
| Verifying the IP Address for Windows XP | 12 |
| Renewing the IP Address for Windows 7, Vista, or XP | 13 |

Monitoring Your Modem

| | |
|--|----|
| Starting the Modem Configuration Manager | 14 |
| Restoring Your Modem Settings | 15 |

Troubleshooting

| | |
|--|----|
| Solutions | 16 |
| Front Panel Icons and Error Conditions | 17 |

Software License & Warranty

| | |
|----------------------------|----|
| Software License | 18 |
| Warranty Information | 19 |



Safety and Regulatory Information

IMPORTANT SAFETY INSTRUCTIONS

Read This Before You Begin

When using your equipment, basic safety precautions should always be followed to reduce the risk of fire, electric shock, and injury to persons, including the following:

- Read all of the instructions listed here and/or in the user manual before you operate this device. Give particular attention to all safety precautions. Retain the instructions for future reference.
- This device must be installed and used in strict accordance with manufacturer's instructions, as described in the user documentation that is included with the device.
- Comply with all warning and caution statements in the instructions. Observe all warning and caution symbols that are affixed to this device.
- To prevent fire or shock hazard, do not expose this device to rain or moisture. The device must not be exposed to dripping or splashing. Do not place objects filled with liquids, such as vases, on the device.
- This device was qualified under test conditions that included the use of the supplied cables between system components. To ensure regulatory and safety compliance, use only the provided power and interface cables and install them properly.
- Different types of cord sets may be used for connections to the main power supply circuit. Use only a main line cord that complies with all applicable device safety requirements of the country of use.
- Installation of this device must be in accordance with national wiring codes and conform to local regulations.
- Operate this device only from the type of power source indicated on the device's marking label. If you are not sure of the type of power supplied to your home, consult your dealer or local power company.
- Do not overload outlets or extension cords, as this can result in a risk of fire or electric shock. Overloaded AC outlets, extension cords, frayed power cords, damaged or cracked wire insulation, and broken plugs are dangerous. They may result in a shock or fire hazard.
- Route power supply cords so that they are not likely to be walked on or pinched by items placed upon or against them. Pay particular attention to cords where they are attached to plugs and convenience receptacles, and examine the point where they exit from the device.
- Place this device in a location that is close enough to an electrical outlet to accommodate the length of the power cord.
- Place the device to allow for easy access when disconnecting the power cord of the device from the AC wall outlet.
- Do not connect the plug into an extension cord, receptacle, or other outlet unless the plug can be fully inserted with no part of the blades exposed.
- Place this device on a stable surface.
- Avoid damaging the cable modem with static by touching the coaxial cable when it is attached to the earth-grounded coaxial cable-TV wall outlet.
- Always first touch the coaxial cable connector on the cable modem when disconnecting or reconnecting the Ethernet cable from the cable modem or user's PC.
- It is recommended that the customer install an AC surge protector in the AC outlet to which this device is connected. This is to avoid damaging the device by local lightning strikes and other electrical surges.
- Do not use this product near water: for example, near a bathtub, washbowl, kitchen sink or laundry tub, in a wet basement, or near a swimming pool.
- Postpone installation until there is no risk of thunderstorm or lightning activity in the area.



- Do not cover the device or block the airflow to the device with any other objects. Keep the device away from excessive heat and humidity and keep the device free from vibration and dust.
- Wipe the device with a clean, dry cloth. Never use cleaning fluid or similar chemicals. Do not spray cleaners directly on the device or use forced air to remove dust.
- For added protection, unplug the device from the wall outlet and disconnect the cables to avoid damage to this device due to lightning and power surges.
- Upon completion of any service or repairs to this device, ask the service technician to perform safety checks to determine that the device is in safe operating condition.
- Do not open the device. Do not perform any servicing other than that contained in the installation and troubleshooting instructions. Refer all servicing to qualified service personnel.
- This device should not be used in an environment that exceeds 40° C.

SAVE THESE INSTRUCTIONS

Note to CATV System Installer: This reminder is provided to call the CATV system installer's attention to Section 820.93 of the National Electric Code, which provides guidelines for proper grounding and, in particular, specifies that the coaxial cable shield shall be connected to the grounding system of the building, as close to the point of cable entry as practical.

Caring for the Environment by Recycling



When you see this symbol on a Motorola product, do not dispose of the product with residential or commercial waste.

Recycling your Motorola Equipment

Please do not dispose of this product with your residential or commercial waste. Some countries or regions, such as the European Union, have set up systems to collect and recycle electrical and electronic waste items. Contact your local authorities for information about practices established for your region. If collection systems are not available, call Motorola Customer Service for assistance. Please visit www.motorola.com/recycle for instructions on recycling.

FCC STATEMENTS

FCC Interference Statement

This equipment has been tested and found to comply with the limits for a Class B digital device, pursuant to part 15 of the FCC Rules. These limits are designed to provide reasonable protection against harmful interference in a residential environment. This equipment generates, uses, and can radiate radio frequency energy and, if not installed and used in accordance with the instructions, may cause harmful interference to radio communications. However, there is no guarantee that interference will not occur in a particular installation. If this equipment does cause harmful interference to radio or television reception, which can be determined by turning the device off and on, the user is encouraged to try to correct the interference by one or more of the following measures:

- Reorient or relocate the receiving antenna.
- Increase the separation between the device and receiver.
- Connect the equipment into an outlet on a circuit different from that to which the receiver is connected.
- Consult the dealer or an experienced radio/TV technician for help.

This device complies with part 15 of the FCC Rules. Operation is subject to the following two conditions: (1) This device may not cause harmful interference, and (2) This device must accept any interference received, including interference that may cause undesired operation.

FCC CAUTION: Any changes or modifications not expressly approved by Motorola for compliance could void the user's authority to operate the equipment.

Use of the 5150-5250 MHz frequency band is restricted to indoor use only.



FCC Radiation Exposure Statement

This equipment complies with FCC radiation exposure limits set forth for an uncontrolled environment. To comply with the FCC RF exposure compliance requirements, the separation distance between the antenna and any person's body (including hands, wrists, feet, and ankles) must be at least 20 cm (8 inches).

This transmitter must not be co-located or operating in conjunction with any other antenna or transmitter except those already approved in this filing.

The availability of some specific channels and/or operational frequency bands are country dependent and are firmware programmed at the factory to match the intended destinations. The firmware setting is not accessible by the end user.

INDUSTRY CANADA (IC) STATEMENT

This device complies with RSS-210 of the Industry Canada Rules. Operation is subject to the following two conditions:

- This device may not cause interference, and
- This device must accept any interference, including interference that may cause undesired operation of the device.

This Class B digital apparatus complies with Canadian ICES-003.

Cet appareil numérique de la classe B est conforme à la norme NMB-003 du Canada.

In Canada, RLAN devices are restricted from using the 5600-5650 MHz frequency band.

CAUTION: To reduce the potential for harmful interference to co-channel mobile satellite systems, use of the 5150-5250 MHz frequency band is restricted to indoor use only.

High power radars are allocated as primary users (meaning they have priority) of 5250-5350 MHz and 5650-5850 MHz frequency bands. These radars could cause interference and/or damage to LE-LAN devices.

IC Radiation Exposure Statement

IMPORTANT NOTE: This equipment complies with IC radiation exposure limits set forth for an uncontrolled environment. This equipment should be installed and operated with a minimum distance of 20 cm (8 inches) between the radiator and your body.



1

Introduction





The Motorola® SURFboard® SB6121 DOCSIS® 3.0 Cable Modem provides high-speed Internet access to the Internet and other online services.

You can use your high-speed cable modem to directly connect one computer in your home or business to the Internet.

This guide provides product overview and setup information for the SB6121. It also provides instructions for installing the cable modem and configuring the Ethernet, router, DHCP, and security settings.

In the Box

Before installing the SB6121 cable modem, make sure the following items are included in the box with the modem. If you obtained the modem from your service provider, some of the included items may be different.

| ITEM | | DESCRIPTION |
|---|---|--|
| Power Supply |  | Provides power via an AC electrical outlet |
| Ethernet Cable |  | Standard Category 5 or higher, cable for connecting to the network |
| Software License & Regulatory Card |  | Contains software license, warranty, and safety information for the SB6121 |
| SB6121 Install Sheet |  | Provides basic information for connecting the SB6121 |

Contact Information

For more information on Motorola consumer cable products, education, and support:

- Visit the Motorola support website:

<http://broadband.motorola.com/consumers/support>

System Requirements

The SB6121 is compatible with the following operating systems:



-
- Windows® 7
 - Windows Vista™, Service Pack 1 or later
 - Windows XP, Service Pack 2 or later
 - Mac® 10.4 or later (Ethernet connection only)
 - UNIX® (Ethernet connection only)
 - Linux® (Ethernet connection only)







2

Product Overview



Front Panel



The SB6121 front panel icons provide the following modem status information for power, communications, and errors:

| ICON | FLASHING | ON |
|---|--|--|
| 1  POWER | Not applicable — icon does not flash | Green: Power is properly connected |
| 2  RECEIVE | Scanning for a downstream (receive) channel connection | Green: Non-bonded downstream channel is connected Blue*: High-speed Internet connection with bonded downstream channels |
| 3  SEND | Scanning for an upstream (send) channel connection | Green: Non-bonded upstream channel is connected Blue*: High-speed Internet connection with bonded upstream channels |
| 4  ONLINE | Scanning for an Internet connection | Green: Startup process completed |



| ICON | FLASHING | ON |
|--|--|--|
| 5  LINK | Transmitting or receiving data on Ethernet port | Amber: A device, computer, or hub is connected to the Ethernet (10Base-T) or Fast Ethernet (100Base-T) port Blue*: High-speed Gigabit Ethernet (1000Base-T) connection from the SB6121 to your PC |
| 6  ENERGY CONSERVATION SWITCH | Powers on and off the cable modem Note: The Energy Conservation switch may be an option that is not provided by your service provider. | |

**Blue icon operation is not available in all locations. Your service provider may implement bonded channels for high-speed Internet and Ethernet connections.*

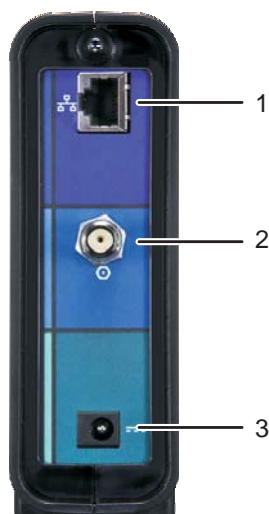

Note: To increase the bandwidth available for receiving and transmitting data, your service provider may also implement bonded channels for RECEIVE and SEND channel connections. The LINK icon turns blue when a high-speed Gigabit Ethernet (GigE) connection is made.

Rear Panel





The SB6121 rear panel contains the following cabling port and connectors:

| ITEM | DESCRIPTION |
|---|---|
| 1  ETHERNET | Ethernet port for connecting an Ethernet-equipped computer, hub, bridge, or switch using an RJ-45 cable |
| 2  CABLE | Coaxial cable connector |
| 3  POWER | +12VDC Power connector |

MAC Label

The SB6121 Media Access Control (MAC) label is located on the bottom of the modem. It contains a MAC address which is a unique, 48-bit value that identifies each Ethernet network device.

To receive data service, you must provide the MAC address marked **HFC MAC ID** to your Internet Service provider.



3

Installing the Modem

Connecting the SB6121



This product is for indoor use only. Do not route the Ethernet cable outside of the building. Exposure of the cables to lightning could create a safety hazard and damage the product.

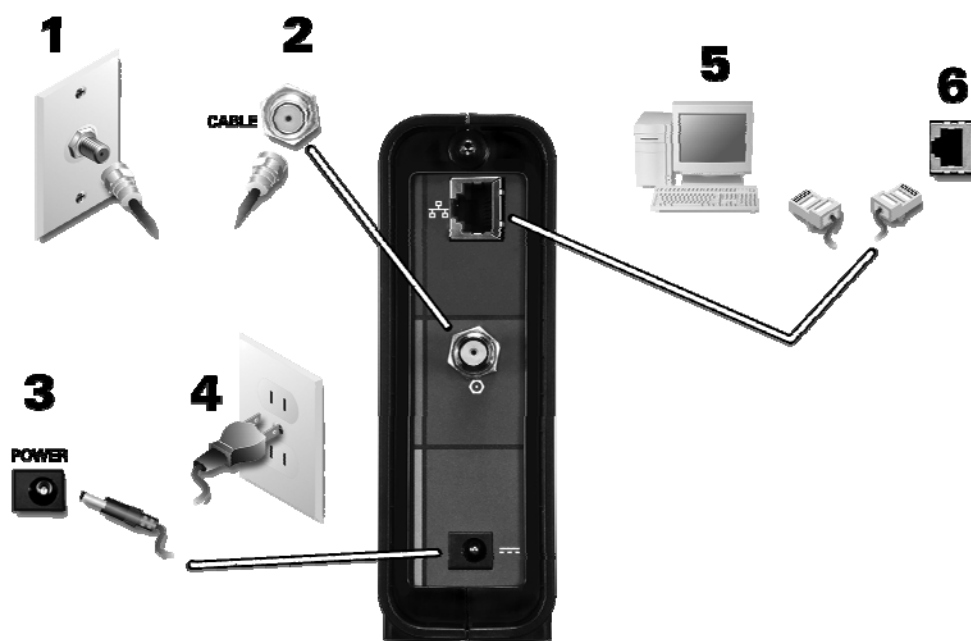



1. Make sure the coaxial cable is connected to a cable outlet or splitter.
2. Connect the other end of the coaxial cable to the Cable connector on the modem.
Hand-tighten the connectors to avoid damaging them.
3. Plug the power cord into the Power port on the modem.
4. Plug the other end of the power cord into an electrical wall outlet.
5. Connect the Ethernet cable to the Ethernet port on your computer.
6. Connect the other end of the Ethernet cable to the Ethernet port on the modem.



Using the Energy Conservation Switch

The Energy Conservation switch is a Power on/off button used to shut off power to the SB6121 when high-speed data services are not being used.



- Push  button in the ON position (pushed in) to power on the cable modem
- Push  button in the OFF position (pushed out) to power off the cable modem

Wall Mounting the Modem

If you choose to mount the cable modem on a wall, do the following before starting:

- Locate the unit as specified by the local or national codes governing residential or business cable TV and communications services.
- Follow all local standards for installing a network interface unit/network interface device (NIU/NID).
- Make sure the power cord is disconnected from the wall outlet and all cables are removed from the back of the cable modem before starting the installation.
- Decide if you are mounting the modem horizontally or vertically.
- Make sure you have the following items:
 - [Wall-mounting template](#)
 - Applicable screwdriver: Phillips or flathead
 - Two M3.5 (#6) screws with a flat underside and maximum screw head diameter of 9.0 mm to mount the cable modem.

Note: *If possible, mount the modem to concrete, masonry, a wooden stud, or some other solid wall material. Use anchor bolts if necessary (for example, if you mount the unit on drywall).*



Before drilling holes in the wall, check the structure for potential damage to water, gas, or electrical lines.

1. Position and secure the wall mounting template on the wall to mark the holes.
2. Select an appropriate depth and diameter to drill the holes to a depth of at least 1½ inches (3.8 cm).

Note: The hole depth will be determined by the installer and by the type of hardware selected.

See the dimension diagram below for the spacing needed between the wall and underside of the screw head:

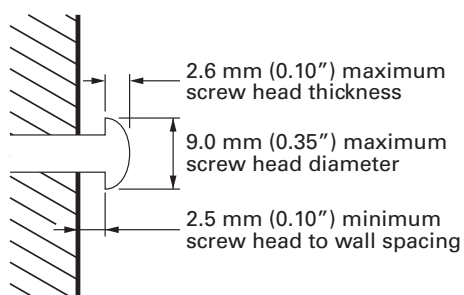

3. After mounting the cable modem, reconnect the coaxial and Ethernet cable.
4. Re-plug the power cord into the +12VDC Power connector on the cable modem and the electrical outlet.
5. Properly arrange the cables to prevent any safety hazards.
6. Verify that the cable modem is still securely attached to the wall.

Wall Mounting Template

Print the wall mounting template on the following page.

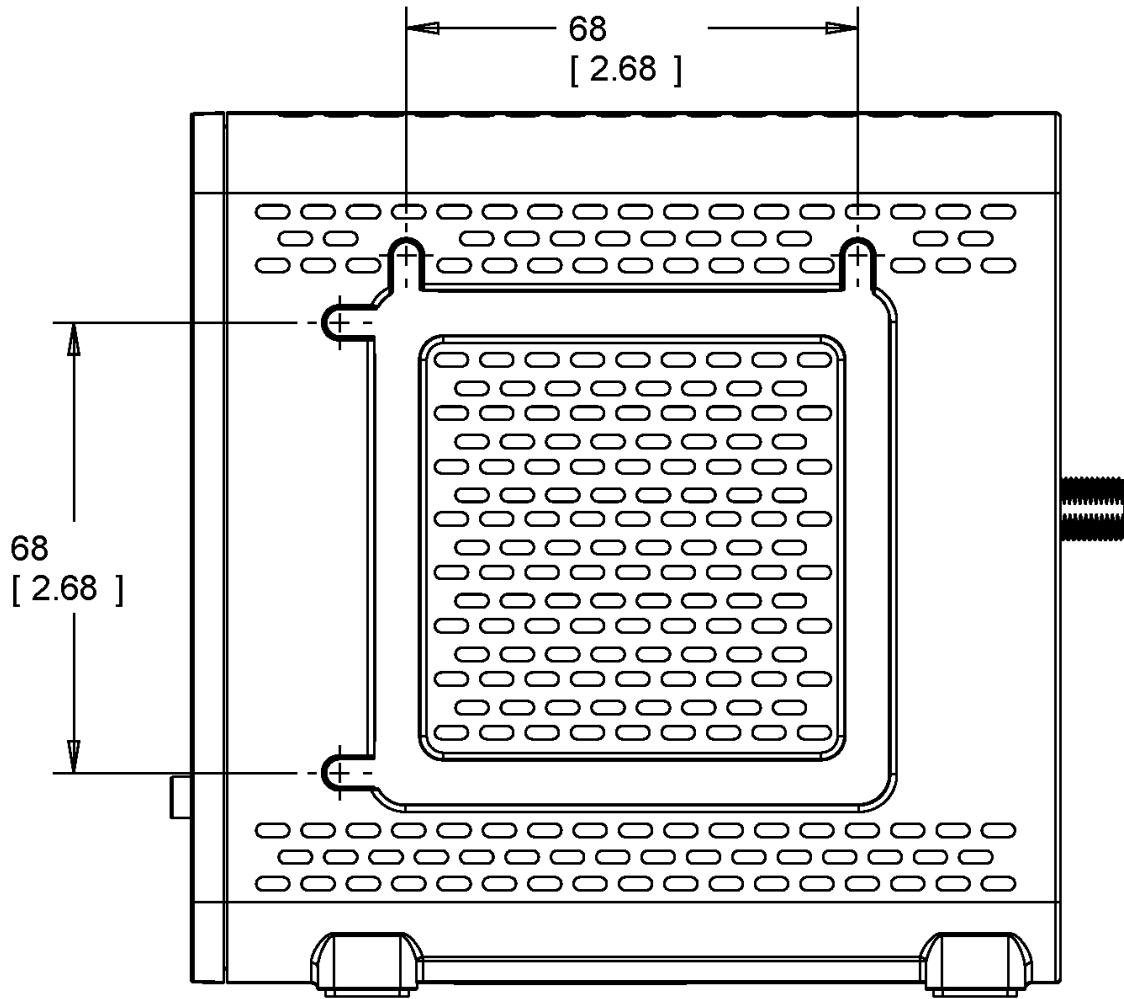



4

Connecting to the Internet

Checking for an Internet Connection

After installing your cable modem, you are now ready to connect your computer and other network devices to the Internet.

1. Open a web browser window on your computer.
2. Type **www.motorola.com** in the Address bar.

If the Motorola website appears, you have successfully connected to the Internet. If you do not see the Motorola website, you may need to configure your cable modem to retrieve an IP address. For more information, see the Configuring TCP/IP section for your operating system.

Configuring TCP/IP for Windows 7

1. Click **Start** and then click **Control Panel**.
2. Click **Network and Internet** to display the Network and Internet window.
3. Click **Network and Sharing Center** to display the Network and Sharing Center window.
4. Click **Change adapter settings** to display the LAN or High-Speed Internet connections window.
5. Right-click the network connection for your network interface.
6. Select *Properties* to display the Local Area Connection Properties window.
7. Select *Internet Protocol Version 4 or 6 (TCP/IPv4 or v6)* and click **Properties** to display the Internet Protocol Properties window.
8. Select *Obtain an IP address automatically* and *Obtain DNS server address automatically*.
9. Click **OK** to save the TCP/IP settings and close the Internet Protocol Version 4 (TCP/IPv4) Properties window.
10. Click **Close** to close the Local Area Connection Properties window.
11. Close the remaining windows and exit the Control Panel.

When you complete the TCP/IP configuration, go to [Verifying the IP Address for Windows 7](#).



Configuring TCP/IP for Windows Vista

1. Click **Start** and then click **Settings**.
2. Open the **Control Panel**.
3. Double-click **Network and Internet** to display the Network and Internet window.
4. Double-click **Network and Sharing Center** to display the Network and Sharing Center window.
5. Click **Manage network connections** to display the LAN or High-Speed Internet connections window.
6. Right-click the network connection for your network interface.
7. Select *Properties* to display the Local Area Connection Properties window.
Vista may prompt you to allow access to the Network Properties Options. If you see the prompt, *User Account Control -- Windows needs your permission to continue*, click **Continue**.
8. Select *Internet Protocol Version 4 or 6 (TCP/IPv4 or v6)* and click **Properties** to display the Internet Protocol Properties window.
9. Select *Obtain an IP address automatically* and *Obtain DNS server address automatically*.
10. Click **OK** to save the TCP/IP settings and close the Internet Protocol Version 4 (TCP/IPv4) Properties window.
11. Click **OK** to close the Local Area Connection Properties window.
12. Close the remaining windows and exit the Control Panel.

When you complete the TCP/IP configuration, go to [Verifying the IP Address for Windows Vista](#).

Configuring TCP/IP for Windows XP

1. Click **Start** and then click **Settings**.
2. Click **Control Panel**.
3. Double-click **Network Connections** to list the Dial-up and LAN or High-Speed Internet connections.
4. Right-click the network connection for your network interface.
5. Select *Properties* from the drop-down menu to display the Local Area Connection Properties window. Be sure Internet Protocol (TCP/IP) is checked.
6. Select *Internet Protocol (TCP/IP)* and click **Properties** to display the Internet Protocol (TCP/IP) Properties window.
7. Select *Obtain an IP address automatically* and *Obtain DNS server address automatically*.
8. Click **OK** to save the TCP/IP settings and exit the TCP/IP Properties window.
9. Close the Local Area Connection Properties window and then exit the Control Panel.

When you complete the TCP/IP configuration, go to [Verifying the IP Address for Windows XP](#).



Verifying the IP Address for Windows 7

1. On the Windows taskbar, click **Start**.
2. Click **All Programs**.
3. Click **Accessories**.
4. Click **Run** to open the Run window.
5. Type **cmd** and click **OK** to open a command prompt window.
6. Type **ipconfig** and press **Enter** to display the IP Configuration.

If an Auto-configuration IP address is displayed, that indicates possible broadband network problems or an improper connection between your computer and the SB6121. The Auto-configuration IP address, ranging from **169.254.0.0** to **169.254.255.255**, is reserved for Automatic Private IP Addressing (APIPA).

Verifying the IP Address for Windows Vista

1. On the Windows taskbar, click **Start**.
2. Click **All Programs**.
3. Click **Accessories**.
4. Click **Run** to open the Run window.
5. Type **cmd** and click **OK** to open a command prompt window.
6. Type **ipconfig** and press **Enter** to display the IP Configuration.

If an Auto-configuration IP address is displayed, that indicates possible broadband network problems or an improper connection between your computer and the SB6121. The Auto-configuration IP address, ranging from **169.254.0.0** to **169.254.255.255**, is reserved for Automatic Private IP Addressing (APIPA).

Verifying the IP Address for Windows XP

1. On the Windows taskbar, click **Start**.
2. Select *Run* to open the Run window.
3. Type **cmd** and click **OK**.
4. Type **ipconfig** and press **Enter** to display your IP configuration.

If an Auto-configuration IP address is displayed, that indicates possible broadband network problems or an improper connection between your computer and the SB6121. The Auto-configuration IP address, ranging from **169.254.0.0** to **169.254.255.255**, is reserved for Automatic Private IP Addressing (APIPA).

This can occur if the modem is configured to automatically obtain an IP address from a Dynamic Host Configuration Protocol (DHCP) server. When Auto-configuration is enabled, Windows will automatically assign an IP address if the cable Modem is unable to obtain one. Because this automatically assigned IP address is not valid, you will not be able to access the Internet using the cable modem. Check the following:

- Your cable connections
- Whether you can see cable-TV channels on your television



After successfully verifying your cable connections and proper cable-TV operation, you can renew your IP address. See [Renewing the IP Address](#) for more information.

Renewing the IP Address for Windows 7, Vista, or XP

1. Open a command prompt window.
 - A. From the Windows taskbar, click **Start**.
 - B. Select *Run* to open the Run window.
 - C. Type **cmd** and click **OK** to open a command prompt window.
 2. Type **ipconfig /renew** and press **Enter**. A valid IP address should appear indicating that Internet access is available.
 3. Type **exit** and press **Enter** to close the command prompt window.
- If, after performing this procedure, your computer still cannot access the Internet, call your service provider.



5

Monitoring Your Modem

Use the SB6121 Modem Configuration Manager to monitor the various configuration settings and operational status of your cable modem. You can also reset the modem configuration back to the original factory settings.

Starting the Modem Configuration Manager

1. Open any web browser on a computer connected to your cable modem.
2. Type **http://192.168.100.1** in the Address bar.
3. Press **Enter**.

The following Modem Configuration Manager Status page appears when you first log on.

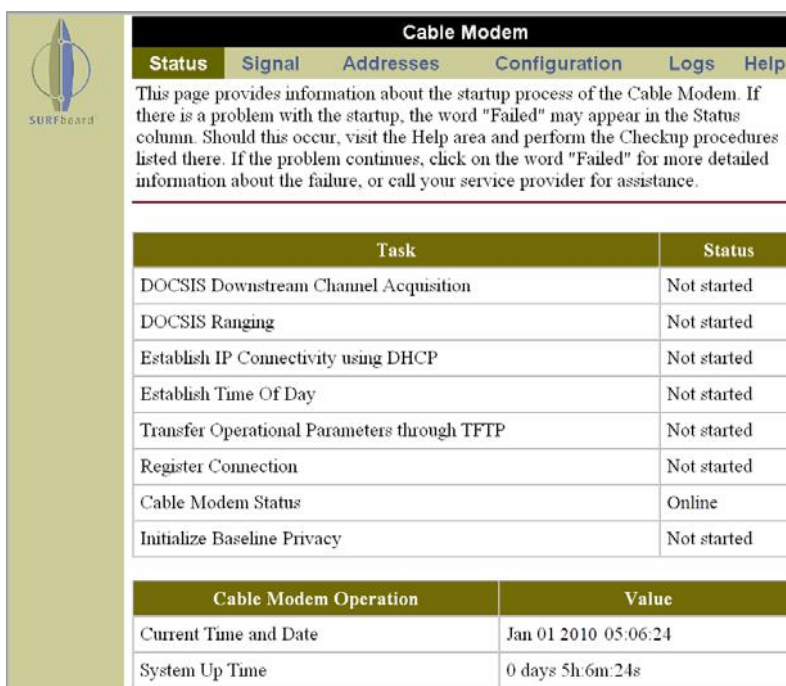

| Cable Modem | | | | | |
|---|--------|----------------------|---------------|------|------|
| Status | Signal | Addresses | Configuration | Logs | Help |
| This page provides information about the startup process of the Cable Modem. If there is a problem with the startup, the word "Failed" may appear in the Status column. Should this occur, visit the Help area and perform the Checkup procedures listed there. If the problem continues, click on the word "Failed" for more detailed information about the failure, or call your service provider for assistance. | | | | | |
| Task | | Status | | | |
| DOCSIS Downstream Channel Acquisition | | Not started | | | |
| DOCSIS Ranging | | Not started | | | |
| Establish IP Connectivity using DHCP | | Not started | | | |
| Establish Time Of Day | | Not started | | | |
| Transfer Operational Parameters through TFTP | | Not started | | | |
| Register Connection | | Not started | | | |
| Cable Modem Status | | Online | | | |
| Initialize Baseline Privacy | | Not started | | | |
| Cable Modem Operation | | Value | | | |
| Current Time and Date | | Jan 01 2010 05:06:24 | | | |
| System Up Time | | 0 days 5h:6m:24s | | | |

Note: If you cannot access the HTML pages in the Modem Configuration Manager, please contact your service provider for more information.



Restoring Your Modem Settings

You can reset your SB6121 modem configuration to the factory default settings.

1. Select *Configuration* from the menu bar.

Cable Modem

Status Signal Addresses **Configuration** Logs Help

This page provides information about the manually configurable settings of the Cable Modem.

| Configuration | |
|-----------------------------|---------------------------------|
| Frequency Plan: | North American Standard/HRC/IRC |
| Upstream Channel ID: | 1 |
| Favorite Frequency (Hz) | 105000000 |
| MDD IP Mode Override (MIMO) | Inactive |
| Modem's IP Mode | IPv4 Only |

DHCP Server Enabled

The SURFboard cable modem can be used as a gateway to the Internet by a maximum of 32 users on a Local Area Network (LAN). When the Cable Modem is disconnected from the Internet, users on the LAN can be dynamically assigned IP Addresses by the Cable Modem DHCP Server. These addresses are assigned from an address pool which begins with 192.168.100.11 and ends with 192.168.100.42. Statically assigned IP addresses for other devices on the LAN should be chosen from outside of this range

Reset All Defaults

Note:

Resetting the cable modem to its factory default configuration will remove all stored parameters learned by the cable modem during prior initializations. The process to get back online from a factory default condition could take from 5 to 30 minutes. Please reference the cable modem User Guide for details on the power up sequence.

Restart Cable Modem

2. Click **Reset All Defaults**.

WARNING: This will delete your existing modem configuration settings.



A

Troubleshooting

If the solutions listed here do not solve your problem, contact your service provider.

You may have to reset the SB6121 modem configuration to its original factory settings if the cable modem is not functioning properly.

Your service provider may ask for the status of the icon lights as described in [Front Panel Icons and Error Conditions](#).

Solutions

Table 1 – Troubleshooting Solutions





| MODEM PROBLEM | POSSIBLE SOLUTION |
|------------------------------------|---|
| Power Icon is OFF | <ul style="list-style-type: none">• Check that the SB6121 is properly plugged into the electrical wall outlet.• Check that the electrical outlet is working.• Check that the Energy Conservation switch  is ON (pushed in). |
| Cannot Send or Receive Data | <ul style="list-style-type: none">• On the front panel, note the status of the icons and refer to Front Panel Icons and Error Conditions to identify the error.• If you have cable television, check your television to ensure your cable service is operating properly.• Check the coaxial cable connection at the SB6121 and cable wall outlet. Hand-tighten if necessary.• Check the IP address. Follow the steps for verifying the IP address for your system described in Configuring TCP/IP. Call your service provider if you need an IP address.• Check that the Ethernet cable is properly connected to the SB6121 and the computer.• If a device is connected via the Ethernet port, check that the ONLINE icon is ON to verify connectivity.• Call your service provider for further assistance. |



Front Panel Icons and Error Conditions

The SB6121 front panel icons provide status information for the following error conditions:

Table 2 – Front Panel Icons and Error Conditions

| ICON | STATUS | IF, DURING STARTUP: | IF, DURING NORMAL OPERATION: |
|---|----------|--|--|
|  POWER | OFF | SB6121 is not properly plugged into the power outlet | SB6121 is unplugged or the Energy Conservation switch is OFF |
|  RECEIVE | FLASHING | Downstream receive channel cannot be acquired | Downstream channel is lost |
|  SEND | FLASHING | Upstream send channel cannot be acquired | Upstream channel is lost |
|  ONLINE | FLASHING | IP registration is unsuccessful | IP registration is lost |
|  LINK | OFF | No connected device is detected | Device is disconnected |



B

Software License & Warranty

SURFboard SB6121 DOCSIS 3.0 Cable Modem

Motorola, Inc.

Home & Networks Mobility Solutions Business ("Motorola")

101 Tournament Drive

Horsham, PA 19044

Software License

IMPORTANT: PLEASE READ THIS SOFTWARE LICENSE ("LICENSE") CAREFULLY BEFORE YOU INSTALL, DOWNLOAD OR USE ANY APPLICATION SOFTWARE, USB DRIVER SOFTWARE, FIRMWARE AND RELATED DOCUMENTATION ("SOFTWARE") PROVIDED WITH MOTOROLA'S CABLE DATA PRODUCT (THE "CABLE DATA PRODUCT"). BY USING THE CABLE DATA PRODUCT AND/OR INSTALLING, DOWNLOADING OR USING ANY OF THE SOFTWARE, YOU INDICATE YOUR ACCEPTANCE OF EACH OF THE TERMS OF THIS LICENSE. UPON ACCEPTANCE, THIS LICENSE WILL BE A LEGALLY BINDING AGREEMENT BETWEEN YOU AND MOTOROLA. THE TERMS OF THIS LICENSE APPLY TO YOU AND TO ANY SUBSEQUENT USER OF THIS SOFTWARE.

IF YOU DO NOT AGREE TO ALL OF THE TERMS OF THIS LICENSE (I) DO NOT INSTALL OR USE THE SOFTWARE AND (II) RETURN THE CABLE DATA PRODUCT AND THE SOFTWARE (COLLECTIVELY, "PRODUCT"), INCLUDING ALL COMPONENTS, DOCUMENTATION AND ANY OTHER MATERIALS PROVIDED WITH THE PRODUCT, TO YOUR POINT OF PURCHASE OR SERVICE PROVIDER, AS THE CASE MAY BE, FOR A FULL REFUND. BY INSTALLING OR USING THE SOFTWARE, YOU AGREE TO BE BOUND BY THE PROVISIONS OF THIS LICENSE AGREEMENT.

The Software includes associated media, any printed materials, and any "on-line" or electronic documentation. Software provided by third parties may be subject to separate end-user license agreements from the manufacturers of such Software.

The Software is never sold. Motorola licenses the Software to the original customer and to any subsequent licensee for personal use only on the terms of this License. Motorola and its 3rd party licensors retain the ownership of the Software.

You may:

USE the Software only in connection with the operation of the Product.

TRANSFER the Software (including all component parts and printed materials) permanently to another person, but only if the person agrees to accept all of the terms of this License. If you transfer the Software, you must at the same time transfer the Product and all copies of the Software (if applicable) to the same person or destroy any copies not transferred.

TERMINATE this License by destroying the original and all copies of the Software (if applicable) in whatever form.

You may not:

(1) Loan, distribute, rent, lease, give, sublicense or otherwise transfer the Software, in whole or in part, to any other person, except as permitted under the TRANSFER paragraph above. (2) Copy or translate the User Guide included with the Software, other than for personal use. (3) Copy, alter, translate, decompile, disassemble or reverse engineer the Software, including but not limited to, modifying the Software to make it operate on non-compatible hardware. (4) Remove, alter or cause not to be displayed, any copyright notices or startup message contained in the Software programs or documentation. (5) Export the Software or the Product components in violation of any United States export laws.



The Product is not designed or intended for use in on-line control of aircraft, air traffic, aircraft navigation or aircraft communications; or in design, construction, operation or maintenance of any nuclear facility. MOTOROLA AND ITS 3RD PARTY LICENSORS DISCLAIM ANY EXPRESS OR IMPLIED WARRANTY OF FITNESS FOR SUCH USES. YOU REPRESENT AND WARRANT THAT YOU SHALL NOT USE THE PRODUCT FOR SUCH PURPOSES.

Title to this Software, including the ownership of all copyrights, mask work rights, patents, trademarks and all other intellectual property rights subsisting in the foregoing, and all adaptations to and modifications of the foregoing shall at all times remain with Motorola and its 3rd party licensors. Motorola retains all rights not expressly licensed under this License. The Software, including any images, graphics, photographs, animation, video, audio, music and text incorporated therein is owned by Motorola or its 3rd party licensors and is protected by United States copyright laws and international treaty provisions. Except as otherwise expressly provided in this License, the copying, reproduction, distribution or preparation of derivative works of the Software, any portion of the Product or the documentation is strictly prohibited by such laws and treaty provisions. Nothing in this License constitutes a waiver of Motorola's rights under United States copyright law.

This License and your rights regarding any matter it addresses are governed by the laws of the Commonwealth of Pennsylvania, without reference to conflict of laws principles. THIS LICENSE SHALL TERMINATE AUTOMATICALLY if you fail to comply with the terms of this License.

Motorola is not responsible for any third party software provided as a bundled application, or otherwise, with the Software.

U.S. GOVERNMENT RESTRICTED RIGHTS

The Product and documentation is provided with RESTRICTED RIGHTS. The use, duplication or disclosure by the Government is subject to restrictions as set forth in subdivision (c)(1)(ii) of The Rights in Technical Data and Computer Software clause at 52.227-7013. The contractor/manufacturer is Motorola, Inc., Home & Networks Mobility Solutions Business, 101 Tournament Drive, Horsham, PA 19044.

Warranty Information

SURFboard SB6121 DOCSIS 3.0 Cable Modem

Home & Networks Mobility ("Motorola")

What is my limited warranty? A limited warranty for this Product (including Software) is provided by Motorola to your distributor, cable operator, or Internet service provider, as applicable. Please contact your cable operator or Internet service provider ("Service Provider") for details. Motorola does not warrant that any Software will perform error-free or without bugs. Motorola's warranty shall not apply: (i) to any Product subjected to accident, misuse, neglect, alteration, Acts of God, improper handling, improper transport, improper storage, improper use or application, improper installation, improper testing, or unauthorized repair; or (ii) to cosmetic problems or defects which result from normal wear and tear under ordinary use, and do not affect the performance or use of the Product. Motorola's warranty applies only to a Product that is manufactured by Motorola and identified by Motorola-owned trademarks, trade names, or product identification logos affixed to the Product. MOTOROLA DOES NOT WARRANT THIS PRODUCT DIRECTLY TO YOU, THE END USER. EXCEPT AS DESCRIBED IN THIS SECTION "WARRANTY INFORMATION," THERE ARE NO WARRANTIES OR REPRESENTATIONS OF ANY KIND RELATING TO THE PRODUCT, EXPRESS, IMPLIED, OR STATUTORY, INCLUDING BUT NOT LIMITED TO IMPLIED WARRANTIES OF MERCHANTABILITY, FITNESS FOR A PARTICULAR PURPOSE, OR WARRANTY AGAINST INFRINGEMENT. MOTOROLA IS NOT RESPONSIBLE FOR, AND PROVIDES "AS IS," ANY SOFTWARE SUPPLIED BY 3RD PARTIES.

What additional provisions should I be aware of? Because it is impossible for Motorola to know the purposes for which you acquired this Product or the uses to which you will put this Product, you assume full responsibility for the selection of the Product for its installation and use. While every reasonable effort has been made to insure that you will receive a Product that you can use and enjoy, Motorola does not warrant that the functions of the Product will meet your requirements or that the operation of the Product will be uninterrupted or error-free. MOTOROLA IS NOT RESPONSIBLE FOR PROBLEMS OR DAMAGE CAUSED BY THE INTERACTION OF THE PRODUCT WITH ANY OTHER SOFTWARE OR HARDWARE.



How long does this Limited Warranty last? Contact your Service Provider for details.

What you must do to obtain warranty service. For Product customer service, technical support, warranty claims, questions about your Internet service or connection, contact your Service Provider. ALL WARRANTIES ARE VOID IF THE PRODUCT IS OPENED, ALTERED, AND/OR DAMAGED.

THESE ARE YOUR SOLE AND EXCLUSIVE REMEDIES for any and all claims that you may have arising out of or in connection with this Product, whether made or suffered by you or another person and whether based in contract or tort. IN NO EVENT SHALL MOTOROLA BE LIABLE TO YOU OR ANY OTHER PARTY FOR ANY DIRECT, INDIRECT, GENERAL, SPECIAL, INCIDENTAL, CONSEQUENTIAL, EXEMPLARY OR OTHER DAMAGES ARISING OUT OF THE USE OR INABILITY TO USE THE PRODUCT (INCLUDING, WITHOUT LIMITATION, DAMAGES FOR LOSS OF BUSINESS PROFITS, BUSINESS INTERRUPTION, LOSS OF INFORMATION OR ANY OTHER PECUNIARY LOSS), OR FROM ANY BREACH OF WARRANTY, EVEN IF MOTOROLA HAS BEEN ADVISED OF THE POSSIBILITY OF SUCH DAMAGES. IN NO CASE SHALL MOTOROLA'S LIABILITY EXCEED THE AMOUNT YOU PAID FOR THE PRODUCT.

Motorola's warranty is governed by the laws of the Commonwealth of Pennsylvania, excluding its conflict of laws principles and excluding the provisions of the United Nations.



Motorola, Inc.
101 Tournament Drive
Horsham, PA 19044 U.S.A.

<http://www.motorola.com>

MOTOROLA and the Stylized M logo are registered in the US Patent and Trademark Office. All other product or service names are the property of their respective owners. ©2010 Motorola, Inc. All rights reserved.
577212-001-a 05/2010