

Nikon

DIGITAL CAMERA

1 AW1

Reference Manual



En

Thank you for your purchase of a Nikon digital camera. To get the most from your camera, please be sure to read all instructions thoroughly and keep them where they will be read by all who use the product.

Camera Settings

The explanations in this manual assume that default settings are used.

Symbols and Conventions

To make it easier to find the information you need, the following symbols and conventions are used:



This icon marks cautions; information that should be read before use to prevent damage to the camera.



This icon marks notes; information that should be read before using the camera.



This icon marks references to other pages in this manual.

The ▲, ▼, ◀, and ▶ symbols represent up, down, left, and right on the multi selector.

For Your Safety

Before using the camera for the first time, read the safety instructions and other precautions on pages xi to xxiii.

1 AW1

 Getting the Most from Your Camera	 ii
Table of Contents	 iv
 Introduction	 1
 Taking and Viewing Photographs	 28
 Underwater Photography	 50
 Recording and Viewing Movies	 66
 Other Shooting Modes	 76
 More on Photography	 87
 Location Data and Other Indicators	 101
 More on Playback	 115
 Connections	 126
 The Playback Menu	 143
 The Shooting Menu	 153
 The Movie Menu	 174
 The Image Processing Menu	 177
 The Setup Menu	 191
 Technical Notes	 201

Getting the Most from Your Camera

Take photos with the shutter-release button.

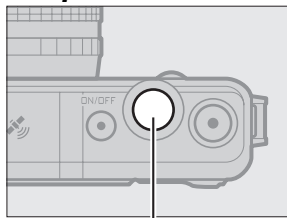

Shutter-release button

Photos can be taken in any mode by pressing the shutter-release button. See page 10 for more information.

Shoot movies with the movie-record button.

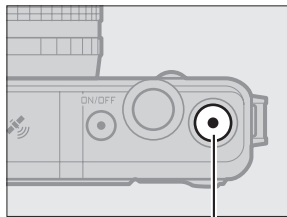

Movie-record button

Movies can be recorded by pressing the movie-record button in auto (📖 28), creative (📖 37), and advanced movie (📖 66) modes.

Shoot **underwater**.

Attach a special-purpose waterproof lens to take pictures at depths of up to 15 m (49 ft) for as long as 60 minutes at a time. See page 50 for more information. The camera offers the following features that may come in handy during underwater photography:



- Compensate for the blue cast in pictures taken under water (📖 54).
- Distortion control for underwater photographs and movies (📖 56).
- A built-in flash that can be used for additional lighting under water (📖 56).

Access altitude, depth, heading, virtual horizon, location data (GPS/GLONASS), and log options.

When shooting in locations with a clear view of the sky, you can:

- Access a variety of information, including a virtual horizon and your heading and altitude or depth (📖 101).
- Record location data (📖 104).
- Log your location or depth (📖 110).

Table of Contents

Getting the Most from Your Camera	ii
For Your Safety.....	xi
Shock-, Water-, and Dust-Proofing	xiv
Shock-Proofing	xiv
Water- and Dust-Proofing	xiv
<i>Important: Waterproof Lenses</i>	xv
Precautions: Shock-Proofing.....	xv
Precautions: Water- and Dust-Proofing	xv
Operating Environment.....	xvii
<i>Important: Location Data (GPS/GLONASS)</i>	xviii
Notices	xix
Introduction	1
Before You Begin	1
Parts of the Camera	2
First Steps.....	14
Taking and Viewing Photographs	28
Point-and-Shoot Photography (Auto Mode)	28
Viewing Photographs	31
Deleting Pictures	32
Live Image Control.....	35
Choosing a Creative Mode.....	37
Choosing a Mode That Matches the Subject or Situation.....	38
Underwater (🏊 (📷, 📷)).....	38
Night landscape (🌃)	38
Night portrait (👤).....	39
Backlighting (📷)	39
Easy panorama (📷).....	39
Soft (📷)	39
Miniature effect (📷)	39
Selective color (📷).....	39

Taking Photos in P, S, A, and M Modes.....	40
Backlighting.....	46
Easy Panorama.....	47
Underwater Photography	50
<hr/>	
<i>Important: Precautions</i>	50
Before Using the Camera Underwater	51
The Final Check	53
Taking Pictures Underwater	54
Tips and Tricks for Underwater Photography	56
Auto Distortion Control.....	56
The Built-in Flash.....	56
The Depth Gauge	57
After Using the Camera Underwater	60
The O-Ring	62
Recording and Viewing Movies	66
<hr/>	
Recording HD Movies	67
Taking Photographs During HD Movie Recording.....	69
Viewing Movies	70
Deleting Movies	71
Recording Slow-Motion Movies	72
Other Shooting Modes	76
<hr/>	
☒ Choosing the Moment (Best Moment Capture)	76
Choosing Your Moment (Slow View).....	76
Letting the Camera Choose the Moment (Smart Photo Selector).....	78
☑ Combining Photos with Brief Movie Vignettes (Motion Snapshot Mode)	83
Viewing Motion Snapshots	86
Deleting Motion Snapshots	86

More on Photography **87**

Continuous Mode	87
Self-Timer Modes.....	89
Exposure Compensation.....	90
The Built-in Flash	92
The  (Action) Button.....	96
Shooting: Choosing a Shooting Mode	96
Playback: Scrolling Through Pictures.....	97
Menus: Outdoor Display	98
The WU-1b Wireless Mobile Adapter.....	99

Location Data and Other Indicators **101**

Altitude and Depth	103
Location Data	104
Location Data Options	107
Track Logs	110
Deleting Logs.....	113
Calibrating the Electronic Compass.....	114

More on Playback **115**

Photo Information.....	115
Thumbnail Playback	118
Calendar Playback.....	119
Playback Zoom.....	120
Deleting Pictures	121
Deleting the Current Picture	121
The Playback Menu	121
Rating Pictures	122
Slide Shows.....	123

Connections	126
Installing the Supplied Software	126
System Requirements	128
Viewing and Editing Pictures on a Computer	130
Transferring Pictures	130
Viewing Pictures.....	132
Creating Short Movies	134
Viewing Pictures on TV	136
High-Definition Devices	136
Printing Photographs	138
Connecting the Printer	138
Printing Pictures One at a Time	139
Printing Multiple Pictures	140
Creating a DPOF Print Order: Print Set.....	142
The Playback Menu	143
Selecting Multiple Images	145
Image Review	146
Rotate Tall	146
Protect	146
Rating	146
D-Lighting	147
Resize	148
Crop	149
Face-Priority Zoom	150
Edit Movie	150
Change Theme	152

The Shooting Menu **153**

Reset Shooting Options	155
Exposure Mode	155
Image Quality	156
Image Size	156
Number of Shots Saved	159
Movie Before/After	159
File Format	160
Metering	160
Auto Distortion Control	161
Color Space	162
Active D-Lighting	163
Long Exposure NR	164
Optical VR	164
Electronic VR	165
Focus Mode	165
Manual Focus	168
AF-Area Mode	170
Focus Lock	171
Face-Priority	172
Built-in AF Assist	172
Flash Control	173
Flash Compensation	173

The Movie Menu **174**

Reset Movie Options	175
Frame Rate	175
Movie Settings	175
Movie Sound Options	176

The Image Processing Menu	177
Reset Processing Options	178
White Balance	178
Fine-Tuning White Balance	179
Preset Manual	180
ISO Sensitivity	183
Picture Control.....	184
Modifying Picture Controls	184
Custom Picture Control.....	188
Edit/Save	188
Load from/Save to Card	189
High ISO Noise Reduction	190
The Setup Menu	191
Reset Setup Options	193
Format Memory Card	193
Slot Empty Release Lock	193
Display.....	194
Display Brightness.....	194
High Contrast Display	194
Grid Display.....	194
Sound Settings	194
Auto Power Off	195
Shutter Button AE Lock.....	195
Control Lock	195
Altitude/Depth Options	196
Altimeter/Depth Gauge	196
Altitude/Depth Correction	196
Altitude/Depth Units.....	196
Flicker Reduction.....	197
Reset File Numbering	197
Time Zone and Date	198

Language	198
Auto Image Rotation.....	199
Pixel Mapping	200
Firmware Version	200
Technical Notes	201
Optional Accessories	201
Non-Waterproof 1 NIKKOR Lenses.....	203
Approved Memory Cards	206
Approved Eye-Fi Cards.....	207
Attaching a Power Connector and AC Adapter	208
Storage and Cleaning	210
Underwater Use	210
Storage.....	210
Cleaning.....	210
Caring for the Camera and Battery: Cautions	211
Available Settings	215
Defaults	219
Memory Card Capacity	220
Troubleshooting	223
Battery/Display.....	223
Shooting (All Modes)	223
Shooting (P, S, A, and M Modes)	225
Movies	225
Playback.....	225
Location Data	226
Miscellaneous	227
Error Messages	228
Specifications	232
Nikon 1 AW1 Digital Camera.....	232
Battery Life.....	249
Index	250

For Your Safety

To prevent damage to your Nikon product or injury to yourself or to others, read the following safety precautions in their entirety before using this equipment. Keep these safety instructions where all those who use the product will read them.

The consequences that could result from failure to observe the precautions listed in this section are indicated by the following symbol:



This icon marks warnings. To prevent possible injury, read all warnings before using this Nikon product.

■ WARNINGS

- ⚠ **Keep the sun out of the frame.** Keep the sun well out of the frame when shooting backlit subjects. Sunlight focused into the camera when the sun is in or close to the frame could cause a fire.
- ⚠ **Observe caution in the presence of water or rain or when using the camera with wet hands.** The camera can be used underwater and safely handled with wet hands only when the special-purpose waterproof lens is attached and the battery-chamber/memory card slot and connector covers are closed. Do not immerse in or expose to water or handle with wet hands unless these conditions are met. Failure to observe these precautions could result in damage to the product, fire, or electric shock.
- ⚠ **Turn off immediately in the event of malfunction.** Should you notice smoke or an unusual smell coming from the equipment or AC adapter (available separately), unplug the AC adapter and remove the battery immediately, taking care to avoid burns. Continued operation could result in injury. After removing the battery, take the equipment to a Nikon-authorized service center for inspection.
- ⚠ **Do not disassemble.** Touching the product's internal parts could result in injury. In the event of malfunction, the product should be repaired only by a qualified technician. Should the product break open as the result of a fall or other accident, remove the battery and/or AC adapter and then take the product to a Nikon-authorized service center for inspection.
- ⚠ **Do not use in the presence of flammable gas.** Do not use electronic equipment in the presence of flammable gas, as this could result in explosion or fire.

- ⚠ **Keep out of reach of children.** Failure to observe this precaution could result in injury. In addition, note that small parts constitute a choking hazard. Should a child swallow any part of this equipment, consult a physician immediately.
- ⚠ **Before using the camera underwater, remove straps intended exclusively for use on land.** The strap could become wrapped around your throat, causing suffocation or drowning.
- ⚠ **Do not place the strap around the neck of an infant or child.** Placing the camera strap around the neck of an infant or child could result in strangulation.
- ⚠ **Follow the instructions of airline and hospital personnel.** This camera transmits radio frequencies that could interfere with medical equipment or aircraft navigation. Disable the location data and all track log functions and disconnect any wireless devices from the camera before boarding an aircraft, and turn the camera off during take off and landing. In medical facilities, follow staff instructions regarding the use of wireless devices and satellite navigation systems.
- ⚠ **Do not remain in contact with the camera, battery, or charger for extended periods while the devices are on or in use.** Parts of the device become hot. Leaving the device in direct contact with the skin for extended periods may result in low-temperature burns.
- ⚠ **Do not leave the product where it will be exposed to extremely high temperatures, such as in an enclosed automobile or in direct sunlight.** Failure to observe this precaution could cause damage or fire.
- ⚠ **Do not aim the flash at the operator of a motor vehicle.** Failure to observe this precaution could result in accidents.
- ⚠ **Observe caution when using a flash.**
- Using the camera with the flash in close contact with the skin or other objects could cause burns.
 - Using a flash close to the subject's eyes could cause temporary visual impairment. The flash should be no less than one meter (3 ft 4 in.) from the subject. Particular care should be observed when photographing infants.
- ⚠ **Avoid contact with liquid crystal.** Should the display break, care should be taken to avoid injury due to broken glass and to prevent the liquid crystal from the display touching the skin or entering the eyes or mouth.
- ⚠ **Do not carry tripods with a lens or camera attached.** You could trip or accidentally strike others, resulting in injury.

⚠ Observe proper precautions when handling batteries. Batteries may leak or explode if improperly handled. Observe the following precautions when handling batteries for use in this product:

- Use only batteries approved for use in this equipment.
- Do not short or disassemble the battery.
- Be sure the product is off before replacing the battery. If you are using an AC adapter, be sure it is unplugged.
- Do not attempt to insert the battery upside down or backwards.
- Do not expose the battery to flame or to excessive heat.
- Do not immerse in or expose to water.
- Replace the terminal cover when transporting the battery. Do not transport or store the battery with metal objects such as necklaces or hairpins.
- Batteries are prone to leakage when fully discharged. To avoid damage to the product, be sure to remove the battery when no charge remains.
- When the battery is not in use, attach the terminal cover and store in a cool, dry place.
- The battery may be hot immediately after use or when the product has been used on battery power for an extended period. Before removing the battery turn the camera off and allow the battery to cool.
- Discontinue use immediately should you notice any changes in the battery, such as discoloration or deformation.

⚠ Observe proper precautions when handling the charger:

- Keep dry. Failure to observe this precaution could result in fire or electric shock.
- Do not short the charger terminals. Failure to observe this precaution could result in overheating and damage to the charger.
- Dust on or near the metal parts of the plug should be removed with a dry cloth. Continued use could result in fire.
- Do not go near the charger during thunderstorms. Failure to observe this precaution could result in electric shock.
- Do not handle the plug or charger with wet hands. Failure to observe this precaution could result in electric shock.
- Do not use with travel converters or adapters designed to convert from one voltage to another or with DC-to-AC inverters. Failure to observe this precaution could damage the product or cause overheating or fire.

⚠ Use appropriate cables. When connecting cables to the input and output jacks, use only the cables provided or sold by Nikon for the purpose to maintain compliance with product regulations.

⚠ CD-ROMs: CD-ROMs containing software or manuals should not be played back on audio CD equipment. Playing CD-ROMs on an audio CD player could cause hearing loss or damage the equipment.

Shock-, Water-, and Dust-Proofing

The product conforms to the following standards:

Shock-Proofing

The camera, with the special-purpose waterproof lens attached, has passed drop tests compliant ¹ with MIL-STD-810F Method 516.5: Shock. ² *These in-house tests do not constitute a blanket guarantee of invulnerability to damage or destruction.*

Water- and Dust-Proofing

With the special-purpose waterproof lens attached, the camera complies with the JIS IP68 waterproofing standard, allowing it to be used at depths of up to 15 m (49 ft) for as long as 60 minutes at a time. ³ *This is not a blanket guarantee that the product will be water- or dust-proof in all circumstances or invulnerable to damage or destruction.*

- 1 Using a test method derived from MIL-STD-810F Method 516.5: Shock, the product is dropped from a height of 200 cm (6.6 ft) onto a plywood surface 5 cm (2 in.) thick. Exterior deformation and surface damage are not tested.
- 2 An American military test standard that involves dropping 5 samples at a time from a height of 122 cm (4 ft) to test the effect of impact on a total of 26 surfaces (12 edges, 8 corners, and 6 faces), with the requirement that the test be passed within a total of 5 samples (if a problem occurs during the test, the test is repeated with 5 new samples, with the requirement that the test be passed within a total of 5 samples).
- 3 This signifies that according to tests performed using Nikon methods, the product can be used at the specified water pressure for the specified period of time.

Important: Waterproof Lenses

The product is not guaranteed shock-, water-, or dust-proof if the special-purpose waterproof lens is not attached. Before using this product, be sure to read the following sections, together with the instructions in “For Your Safety” (□ xi–xiii) and in “Caring for the Camera and Battery: Cautions” (□ 211–214). Before using the product underwater, read the cautions in “Underwater Photography” (□ 50–65).

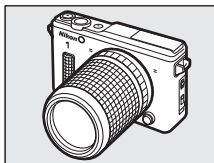

Precautions: Shock-Proofing

Observe the following precautions when using the camera with special-purpose waterproof lenses:

- The product is not guaranteed shockproof if the flash is raised.
- Do not intentionally subject the product to violent physical shocks, place it under heavy objects, or attempt to force it into bags or other spaces too small to contain it.
- Do not expose the product to depths greater than 15 m (49 ft) or to rapids, waterfalls, or other water under high pressure.
- Damage due to user error is not covered under warranty.



Precautions: Water- and Dust-Proofing

Observe the following precautions when using the camera with special-purpose waterproof lenses:

- Apart from the special-purpose waterproof lens, the accessories supplied with the camera are not waterproof. Special-purpose waterproof lenses are themselves waterproof only when attached to the camera.
- The product is proof only against fresh water (such as pools, rivers, and lakes) and seawater. Do not take into hot springs or baths.
- Do not expose to depths greater than 15 m (49 ft) or to rapids, waterfalls, water flowing at full force from a tap, or other water under high pressure. Failure to observe these precautions could expose the product to pressures high enough to cause water entry.
- Do not leave immersed for more than 60 minutes at a time.



- Internal parts will be damaged by water and dust. To prevent water entry, do not remove the lens, open the connector or battery-chamber/memory card slot cover, or operate the lens release button or the latches or security locks on the connector and battery-chamber/memory card slot covers with wet hands, when the camera is wet, or in locations exposed to spray, wind, sand or dust. Ensure that memory cards and batteries are dry before insertion. Should the product leak, cease use immediately, dry the camera and lens, and consult a Nikon-authorized service representative.

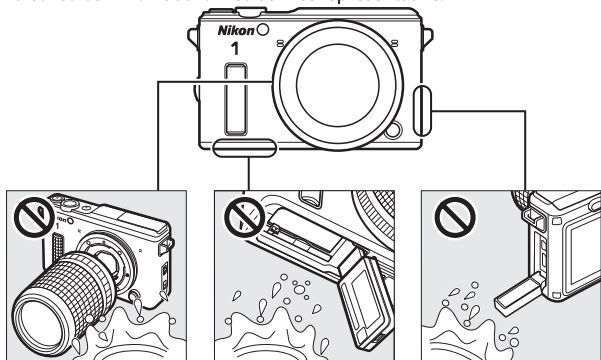

- Water and other liquids on the lens O-ring seal or inside the connector and battery-chamber/memory card slot covers should be removed immediately with a soft, dry cloth. Other foreign matter should be removed from these surfaces with a blower, taking care to remove any small particles from the sides and corners of the watertight channels. Foreign matter on the camera body can be removed with a soft, dry cloth. Do not use soap, cleansers, or other chemicals, and be sure to remove suntan oil, sunblock, bath salts, detergent, soap, organic solvents, oil, alcohol, and the like immediately.
- Do not leave the product for extended periods in locations that are exposed to freezing temperatures or temperatures over 50 °C (122 °F), such as in enclosed vehicles, on board boats, on the beach, in direct sunlight, or near heating equipment. Failure to observe this precaution may make the product vulnerable to water entry.



- The product is not guaranteed waterproof if struck, dropped, or otherwise subjected to strong pressure or violent physical shocks or vibration. If the product does suffer a fall or other physical shock, take it to Nikon-authorized service personnel and have it tested to make sure that it is still waterproof. Note that a fee will be charged for this service.
- Damage due to user error is not covered under warranty.

Operating Environment

The camera and special-purpose waterproof lenses have been tested and approved for use at temperatures between $-10\text{ }^{\circ}\text{C}$ and $+40\text{ }^{\circ}\text{C}$ ($+14\text{ }^{\circ}\text{F}$ to $104\text{ }^{\circ}\text{F}$) on land and $0\text{ }^{\circ}\text{C}$ and $+40\text{ }^{\circ}\text{C}$ ($+32\text{ }^{\circ}\text{F}$ to $104\text{ }^{\circ}\text{F}$) in water. Note the following precautions:

- Battery performance drops at low temperatures. Keep the camera warm, or ready a spare battery and keep it in a warm location.
- At low temperatures, the monitor may not perform as expected immediately after the camera is turned on: for example, after-images may appear or the monitor may seem darker than normal.
- In cold environments, remove any snow or rain immediately. Buttons, switches, and other camera controls may become difficult to operate if allowed to freeze, while sound quality may be affected if water is allowed to accumulate in the holes in the microphone and speaker covers.
- Prolonged contact with cold metal can damage exposed skin. Wear gloves when handling the camera for extended periods at low temperatures.
- Select a dry location when attaching or removing special-purpose waterproof lenses, and avoid leaving the camera with the body cap removed or the battery-chamber/memory slot or connector cover open or the lens with the rear cap removed in humid locations. Failure to observe these precautions could result in condensation forming inside the lens when the product is taken into the water. Condensation may also form inside the lens, monitor, or watertight channel if the product is exposed to rapid changes in temperature, such as occur when the product is taken into cold water from a hot shore location, into a warm room from a cold exterior, or the battery-chamber/memory card slot cover is opened or closed or lenses are attached or removed in a humid location. Such condensation will not cause malfunction or other damage, and should dissipate if the product is first taken to a location with a stable temperature—free from heat, humidity, sand, and dust—and then turned off and left with the battery and memory card removed and the battery-chamber/memory card slot and connector covers open until it has reached the ambient temperature. Consult Nikon-authorized service personnel should the condensation fail to dissipate.

Important: Location Data (GPS/GLONASS)

Observe the following precautions when using the location data and track log features:

- **Track logs:** While **Yes** is selected for **Location data > Record location data** in the setup menu (□ 104), location data will be recorded with all pictures taken and the camera will continue to monitor location data even while off. Radio waves produced by the device may affect medical equipment and aircraft navigation systems; in situations in which the use of satellite navigation devices is restricted or prohibited, such as in hospitals or aircraft, end the current track log, select **No** for **Record location data**, and turn the camera off.
- **Sharing location data:** Note that addresses and other personal information may be inferred from the location data stored in track logs or embedded in images. Exercise caution when sharing images and track logs or when posting them to the Internet or other locations where they can be viewed by third parties. See “Disposing of Data Storage Devices” (□ xxii) for information on erasing location data before disposing of the camera or memory cards.
- **Navigation:** The position, altitude, depth, and other location data reported by the device are approximations only and are not intended for surveying or navigation. Be sure to take appropriate maps or other navigational devices with you when using the product during such outdoor activities as boating, diving, mountain climbing, or hiking.
- **Restrictions on use:** The location data function may not perform as expected in some countries or regions, including (as of October, 2013) China and in the vicinity of the Chinese border. Some countries prohibit unauthorized use of satellite navigation and other location data devices; before travelling, check with your travel agent or the embassy or tourism board of the countries you will be visiting. Where use is prohibited, select **No** for **Location data > Record location data**.

Notices

- No part of the manuals included with this product may be reproduced, transmitted, transcribed, stored in a retrieval system, or translated into any language in any form, by any means, without Nikon's prior written permission.
- Nikon reserves the right to change the specifications of the hardware and software described in these manuals at any time and without prior notice.
- Nikon will not be held liable for any damages resulting from the use of this product.
- While every effort has been made to ensure that the information in these manuals is accurate and complete, we would appreciate it were you to bring any errors or omissions to the attention of the Nikon representative in your area (address provided separately).

Notice for Customers in Canada

CAN ICES-3 B / NMB-3 B

Notice for Customers in Europe

CAUTION: RISK OF EXPLOSION IF BATTERY IS REPLACED BY AN INCORRECT TYPE. DISPOSE OF USED BATTERIES ACCORDING TO THE INSTRUCTIONS.

This symbol indicates that electrical and electronic equipment is to be collected separately.



The following apply only to users in European countries:

- This product is designated for separate collection at an appropriate collection point. Do not dispose of as household waste.
- Separate collection and recycling helps conserve natural resources and prevent negative consequences for human health and the environment that might result from incorrect disposal.
- For more information, contact the retailer or the local authorities in charge of waste management.

This symbol on the battery indicates that the battery is to be collected separately.



The following apply only to users in European countries:

- All batteries, whether marked with this symbol or not, are designated for separate collection at an appropriate collection point. Do not dispose of as household waste.
- For more information, contact the retailer or the local authorities in charge of waste management.

Notice for Customers in the U.S.A.

The Battery Charger

IMPORTANT SAFETY INSTRUCTIONS—SAVE THESE INSTRUCTIONS

DANGER—TO REDUCE THE RISK OF FIRE OR ELECTRIC SHOCK, CAREFULLY FOLLOW THESE INSTRUCTIONS

For connection to a supply not in the U.S.A., use an attachment plug adapter of the proper configuration for the power outlet if needed. This power unit is intended to be correctly oriented in a vertical or floor mount position.

Federal Communications Commission (FCC) Radio Frequency Interference Statement

This equipment has been tested and found to comply with the limits for a Class B digital device, pursuant to Part 15 of the FCC rules. These limits are designed to provide reasonable protection against harmful interference in a residential installation. This equipment generates, uses, and can radiate radio frequency energy and, if not installed and used in accordance with the instructions, may cause harmful interference to radio communications. However, there is no guarantee that interference will not occur in a particular installation. If this equipment does cause harmful interference to radio or television reception, which can be determined by turning the equipment off and on, the user is encouraged to try to correct the interference by one or more of the following measures:

- Reorient or relocate the receiving antenna.
- Increase the separation between the equipment and receiver.
- Connect the equipment into an outlet on a circuit different from that to which the receiver is connected.
- Consult the dealer or an experienced radio/television technician for help.



Nikon
1 AW1

CAUTIONS

Modifications

The FCC requires the user be notified that any changes or modifications made to this device that are not expressly approved by Nikon Corporation may void the user's authority to operate the equipment.

Interface Cables

Use the interface cables sold or provided by Nikon for your equipment. Using other interface cables may exceed the limits of Class B Part 15 of the FCC rules.

Notice for Customers in the State of California

WARNING: Handling the cord on this product may expose you to lead, a chemical known to the State of California to cause birth defects or other reproductive harm. *Wash hands after handling.*

Nikon Inc., 1300 Walt Whitman Road,
Melville, New York 11747-3064, U.S.A.
Tel.: 631-547-4200

Notice Concerning Prohibition of Copying or Reproduction

Note that simply being in possession of material that has been digitally copied or reproduced by means of a scanner, digital camera, or other device may be punishable by law.

• Items prohibited by law from being copied or reproduced

Do not copy or reproduce paper money, coins, securities, government bonds, or local government bonds, even if such copies or reproductions are stamped "Sample."

The copying or reproduction of paper money, coins, or securities which are circulated in a foreign country is prohibited.

Unless the prior permission of the government has been obtained, the copying or reproduction of unused postage stamps or post cards issued by the government is prohibited.

The copying or reproduction of stamps issued by the government and of certified documents stipulated by law is prohibited.

• Cautions on certain copies and reproductions

The government has issued cautions on copies or reproductions of securities issued by private companies (shares, bills, checks, gift certificates, etc.), commuter passes, or coupon tickets, except when a minimum of necessary copies are to be provided for business use by a company. Also, do not copy or reproduce passports issued by the government, licenses issued by public agencies and private groups, ID cards, and tickets, such as passes and meal coupons.

• Comply with copyright notices

The copying or reproduction of copyrighted creative works such as books, music, paintings, woodcuts, prints, maps, drawings, movies, and photographs is governed by national and international copyright laws. Do not use this product for the purpose of making illegal copies or to infringe copyright laws.

Disposing of Data Storage Devices

Please note that deleting images or formatting memory cards or other data storage devices does not completely erase the original image data. Deleted files can sometimes be recovered from discarded storage devices using commercially available software, potentially resulting in the malicious use of personal image data. Ensuring the privacy of such data is the user's responsibility.

Before discarding a data storage device or transferring ownership to another person, select **No** for **Location data** > **Record location data** (□ 104) and erase all data using commercial deletion software, or format the device and then completely refill it with images containing no private information (for example, pictures of empty sky). To remove track log data from the memory card, select **Delete log** and delete all logs (□ 113). Care should be taken to avoid injury when physically destroying data storage devices.

AVC Patent Portfolio License

THIS PRODUCT IS LICENSED UNDER THE AVC PATENT PORTFOLIO LICENSE FOR THE PERSONAL AND NON-COMMERCIAL USE OF A CONSUMER TO (I) ENCODE VIDEO IN COMPLIANCE WITH THE AVC STANDARD ("AVC VIDEO") AND/OR (II) DECODE AVC VIDEO THAT WAS ENCODED BY A CONSUMER ENGAGED IN A PERSONAL AND NON-COMMERCIAL ACTIVITY AND/OR WAS OBTAINED FROM A VIDEO PROVIDER LICENSED TO PROVIDE AVC VIDEO. NO LICENSE IS GRANTED OR SHALL BE IMPLIED FOR ANY OTHER USE. ADDITIONAL INFORMATION MAY BE OBTAINED FROM MPEG LA, L.L.C. SEE <http://www.mpegla.com>

Temperature Warnings

The camera may become warm to the touch during use; this is normal and does not indicate a malfunction. At high ambient temperatures, after extended periods of continuous use, or after several photographs have been taken in quick succession, a temperature warning may be displayed, following which the camera will turn off automatically to minimize damage to its internal circuits. Wait for the camera to cool before resuming use.

Use Only Nikon Brand Electronic Accessories

Nikon cameras are designed to the highest standards and include complex electronic circuitry. Only Nikon brand electronic accessories (including chargers, batteries, AC adapters, and lens accessories) certified by Nikon specifically for use with this Nikon digital camera are engineered and proven to operate within the operational and safety requirements of this electronic circuitry.

The use of non-Nikon electronic accessories could damage the camera and may void your Nikon warranty. The use of third-party rechargeable Li-ion batteries not bearing the Nikon holographic seal shown at right could interfere with normal operation of the camera or result in the batteries overheating, igniting, rupturing, or leaking.



For more information about Nikon brand accessories, contact a local authorized Nikon dealer.

Use Only Nikon Brand Accessories

Only Nikon brand accessories certified by Nikon specifically for use with your Nikon digital camera are engineered and proven to operate within its operational and safety requirements. THE USE OF NON-NIKON ACCESSORIES COULD DAMAGE YOUR CAMERA AND MAY VOID YOUR NIKON WARRANTY.

Servicing the Camera and Accessories

The camera is a precision device and requires regular servicing. Nikon recommends that the camera be inspected by the original retailer or a Nikon-authorized service representative once a year, and that it be serviced once every three to five years (note that fees apply to these services). Frequent inspection and servicing are particularly recommended if the camera is used professionally. Any accessories regularly used with the camera, such as lenses, should be included when the camera is inspected or serviced.

Before Taking Important Pictures

Before taking pictures on important occasions (such as at weddings or before taking the camera on a trip), take a test shot to ensure that the camera is functioning normally. Nikon will not be held liable for damages or lost profits that may result from product malfunction.

Life-Long Learning

As part of Nikon's "Life-Long Learning" commitment to ongoing product support and education, continually-updated information is available on-line at the following sites:

- **For users in the U.S.A.:** <http://www.nikonusa.com/>
- **For users in Europe and Africa:** <http://www.europe-nikon.com/support/>
- **For users in Asia, Oceania, and the Middle East:** <http://www.nikon-asia.com/>

Visit these sites to keep up-to-date with the latest product information, tips, answers to frequently-asked questions (FAQs), and general advice on digital imaging and photography. Additional information may be available from the Nikon representative in your area. For contact information, visit <http://imaging.nikon.com/>

Introduction

Before You Begin

Before using your camera for the first time, confirm that the package contains the items listed in the *User's Manual*.



Parts of the Camera

Take a few moments to familiarize yourself with camera controls and displays. You may find it helpful to bookmark this section and refer to it as you read through the rest of the manual.

The Camera Body

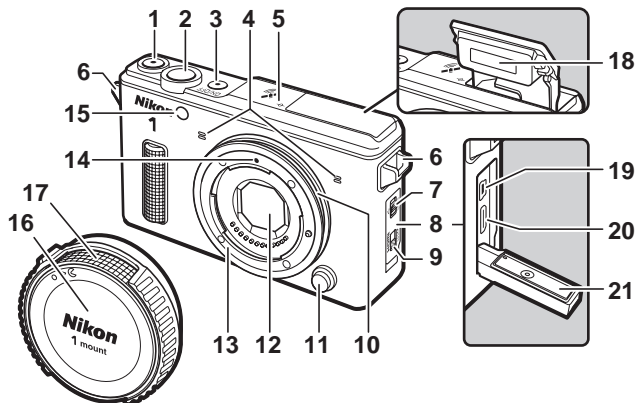

1 Movie-record button66, 68, 73	11 Lens release button.....21
2 Shutter-release button29, 33, 69, 77, 79, 84	12 Dust shield210, 211
3 Power switch.....22	13 Lens mount20, 169
Power lamp22	14 Mounting mark20
4 Microphone.....176	15 AF-assist illuminator172
5 Focal plane mark (☉).....169	Self-timer lamp89
6 Eyelet for camera strap.....14	Red-eye reduction lamp93
7 Connector cover latch99, 130, 136, 138	16 Body cap202
8 Connector cover.....99, 130, 136, 138	17 O-ring protector.....203
9 Connector cover security lock99, 130, 136, 138	18 Built-in flash.....92
10 O-ring19, 62, 201	19 USB connector.....99, 130, 138
	20 HDMI mini-pin connector.....136
	21 Watertight channel51



The Camera Body (Continued)

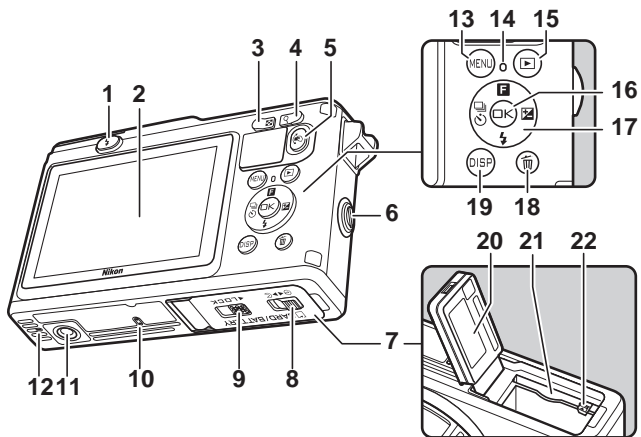

1 Flash pop-up button.....	92	13 MENU (menu) button	9
2 Monitor	5, 115, 194	14 Memory card access lamp.....	18, 30
3 (playback zoom out/thumbnail) button	118	15 (playback) button	31, 81, 86
4 (playback zoom in) button.....	120	16 (OK) button	8
5 (action) button	96	17 Multi selector.....	8
6 Grip attachment screw		F (feature)	12
7 Battery-chamber/ memory card slot cover ...	16, 18, 208	(exposure compensation)	90
8 Battery-chamber/memory card slot cover latch.....	16, 18, 208	(flash mode).....	92, 93
9 Battery-chamber/memory card slot cover security lock.....	16, 18, 208	(continuous shooting/ self-timer).....	87, 89
10 Speaker		18 (delete) button.....	32, 121
11 Tripod socket *		19 DISP (display) button	7
12 Pressure equalization vent		20 Watertight channel	51
		21 Memory card slot.....	16
		22 Battery latch.....	16, 18, 208

* Camera does not support TA-N100 tripod mounting spacer.

Holding the Camera

When framing photographs, hold the camera as shown below.

*Hold the camera in
your right hand.*

*Keep your elbows
propped lightly
against your torso.*

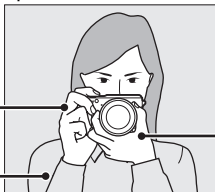

*Cradle the lens with
your left hand.*



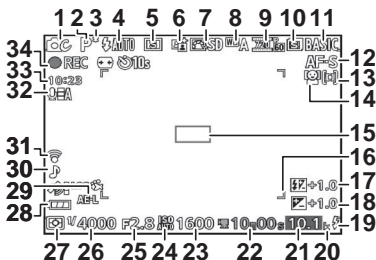

1 Shooting mode 10	19 Flash-ready indicator 92
2 Live image control 35	20 "K" (appears when memory remains for over 1000 exposures) 27
Creative mode 37	21 Number of exposures remaining 27
Best moment capture selection 76, 78	Number of shots remaining before memory buffer fills 88
Advanced movie selection 66, 72	White balance recording indicator 181
Exposure mode 155	Card warning indicator 193, 228
3 Flexible program indicator 40	22 Time available 68, 73
4 Flash mode 92, 93	23 ISO sensitivity 183
5 Continuous mode ¹ 87	24 ISO sensitivity indicator 183
6 Active D-Lighting ¹ 163	Auto ISO sensitivity indicator 183
7 Picture Control ¹ 184	25 Aperture 42, 43
8 White balance ¹ 178	26 Shutter speed 41, 43
9 Movie settings (HD movies) ¹ 175	27 Metering 160
Frame rate (slow-motion movies) ¹ 175	28 Battery indicator ^{1, 2} 27
10 Image size ¹ 156	29 Autoexposure (AE) lock indicator 195
11 Image quality ¹ 156	30 Sound settings ¹ 194
12 Focus mode ¹ 165	31 Eye-Fi connection indicator ¹ 207
13 AF-area mode ¹ 170	32 Microphone sensitivity ¹ 176
14 Face-priority ¹ 34, 172	33 Time elapsed 68, 73
15 Focus area 29, 170	34 Recording indicator 68, 73
16 AF-area brackets ¹ 165	
17 Flash compensation 173	
18 Exposure compensation 90	

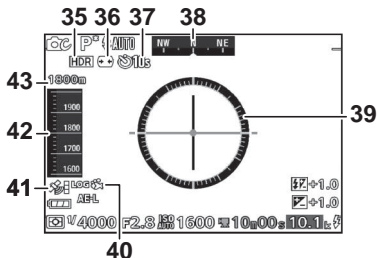

35 HDR	46	40 Track log indicator ^{1,2}	111
36 Auto distortion control.....	161	41 Satellite signal indicator ^{1,2}	105
37 Self-timer	89	42 Altimeter/depth gauge ²	101
38 Heading ²	102	43 Altitude/depth ²	101
39 Virtual horizon ²	102		

1 Shown in detailed display (□ 7).

2 Shown in altimeter, depth gauge, heading, and virtual horizon display (□ 7).

See Also

For information on adjusting monitor brightness, see page 194.

The DISP (Display) Button

Press DISP to cycle through shooting (📖 5) and playback (📖 115) indicators as shown below.

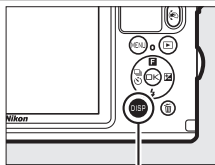

DISP button

Shooting (📖 5)

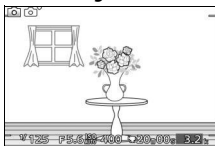

Simplified display

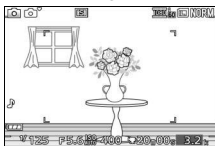

Detailed display

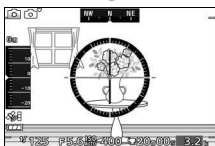

*Altimeter/depth gauge,
heading, and virtual
horizon display (📖 101)*

Playback (📖 115)

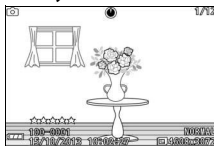

Simple photo info

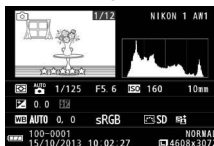

Detailed photo info

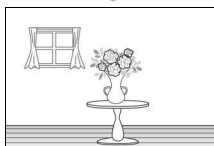

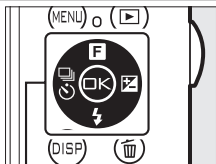

Image only

The Multi Selector

The multi selector and  button are used to adjust settings and navigate the camera menus.



Multi selector



Settings:

See page 12.

Menu navigation:

Move cursor up.

Settings:

View continuous shooting/self-timer menu ( 87, 89).

Menu navigation:

Return to previous menu.

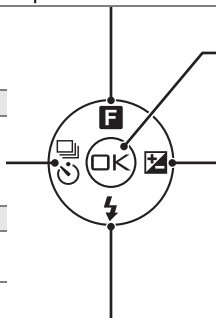

Select highlighted item.

Settings:

View exposure compensation menu ( 90).

Menu navigation:

Select highlighted item or display sub-menu.

Settings:

View flash mode menu ( 92, 93).

Menu navigation:

Move cursor down.

The MENU Button

The shooting mode and most shooting, playback, and setup options can be accessed from the camera menus. Press the MENU button to display the menu selection dialog shown below, then use the multi selector to highlight the icon for the desired menu and press **OK**.

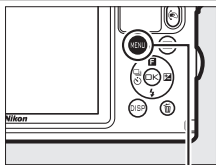

MENU button

Playback menu (☞ 143):

Adjust playback settings.

Shooting menu (☞ 153):

Adjust settings for still photography.

Shooting mode

menu (☞ 10):

Choose a shooting mode.

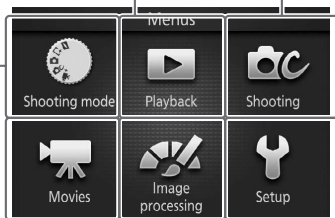

Movie menu (☞ 174):

Adjust movie-recording options.

Setup menu (☞ 191):

Adjust basic camera settings.

Image processing menu (☞ 177):

Adjust white balance, ISO sensitivity, Picture Controls, and other image processing settings for photographs and movies.

■ Choosing a Shooting Mode

To display the shooting mode menu, press the MENU button, highlight **Shooting mode**, and press \odot . Use the multi-selector to highlight a shooting mode and press \odot to select the highlighted option.

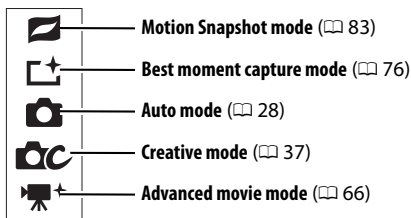
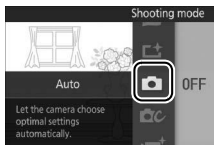

Options for each mode can be displayed by highlighting the mode and pressing \blacktriangleright . Press \blacktriangleleft to return to the shooting mode menu.



■ **Motion Snapshot mode:** Choose a theme (85).

- **Beauty (1)**
- **Waves (2)**
- **Relaxation (3)**
- **Tenderness (4)**

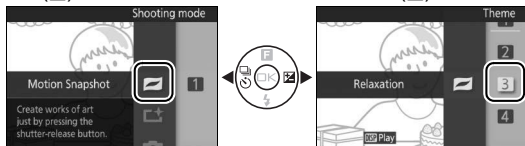

■ The \odot Button

When the view through the lens is displayed in the monitor, you can also select the shooting mode by holding the \odot button, tilting the camera left or right to highlight the desired option, and then releasing the button (96).



Best moment capture mode: Choose between slow view and Smart Photo Selector modes (📖 76).

- **Slow view** ()
- **Smart Photo Selector** ()

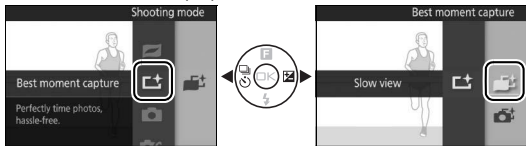





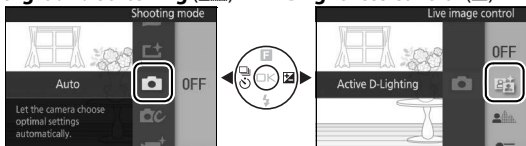





Auto mode: Take photographs using live controls (📖 35).

- **Active D-Lighting** ()
- **Motion control** ()
- **Background softening** ()
- **Brightness control** ()



Creative mode: Choose a scene (📖 37).

- **Programmed auto (P)**
- **Shutter-priority auto (S)**
- **Aperture-priority auto (A)**
- **Manual (M)**
- **Underwater** (, , )
- **Night landscape** ()
- **Night portrait** ()
- **Backlighting** ()
- **Easy panorama** ()
- **Soft** ()
- **Miniature effect** ()
- **Selective color** ()



🎬+ Advanced movie mode: Choose between HD (📖 67) and slow-motion movies (📖 72).

- **Programmed auto (P)**
- **Shutter-priority auto (S)**
- **Aperture-priority auto (A)**
- **Manual (M)**
- **Slow motion (🎬)**

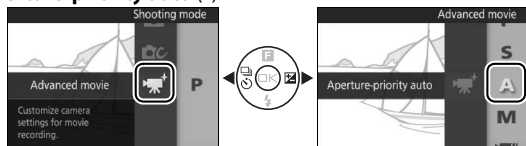

🔍 F (Feature)

The options for each mode can also be displayed by pressing **▲ (F)** on the multi selector after selecting the shooting mode.

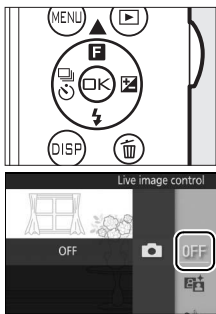

In playback mode, this feature can be used to rate pictures (📖 122).

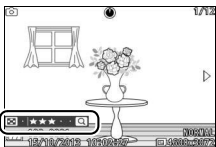

■ Using the Menus

Use the multi selector (📖 8) to navigate the playback, shooting, movie, image processing, and setup menus.

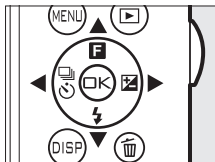

Multi selector

1 Select an item.

Press ▲ or ▼ to highlight menu items and press ► to view options for the highlighted item.

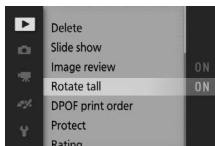

2 Select an option.

Press ▲ or ▼ to highlight the desired option and press  to select.

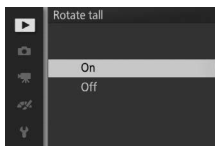

Using the Menus

The items listed may vary with camera settings. Items displayed in gray are not currently available (📖 215). To exit the menus and return to shooting mode, press the shutter-release button halfway (📖 33).

Choosing a Menu

To display another menu, press ◀ in Step 1 and then press ▲ or ▼ to highlight the desired icon. Press ► to position the cursor in the highlighted menu.

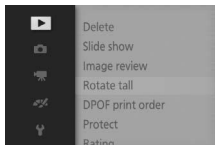

First Steps

1 Attach the strap.

The AN-N1000 strap supplied with the camera is exclusively for use on land. Attach the strap securely to the two camera eyelets.

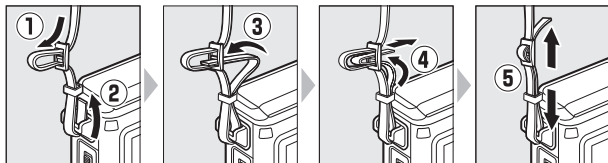

Remove the AN-N1000 before using the camera underwater. A hand strap (available separately from third-party suppliers) is recommended to prevent loss when the camera is used underwater.

2 Charge the battery.

Insert the battery into the charger ① and plug the charger in ②. An exhausted battery fully charges in about two hours. Unplug the charger and remove the battery when charging is complete.

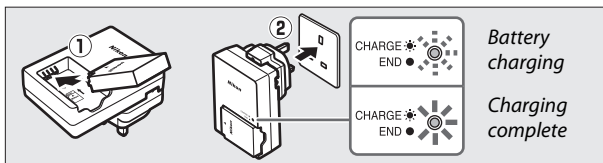

The Plug Adapter

Depending on the country or region of purchase, a plug adapter may be supplied with the charger. The shape of the adapter varies with the country or region of purchase. If a plug adapter is supplied, raise the wall plug and connect the plug adapter as shown at right, making sure the plug is fully inserted. Attempting to forcibly remove the plug adapter could damage the product.

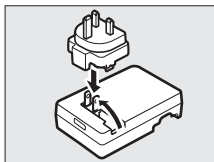



✔ The Battery and Charger

Read and follow the warnings and cautions on pages xi–xiii and 211–214 of this manual. Do not use the battery at ambient temperatures below 0°C (32°F) or above 40°C (104°F); failure to observe this precaution could damage the battery or impair its performance. Capacity may be reduced and charging times may increase at battery temperatures from 0°C (32°F) to 10°C (50°F) and from 45°C (113°F) to 60°C (140°F); the battery will not charge if its temperature is below 0°C (32°F) or above 60°C (140°F).

Charge the battery at ambient temperatures between 5°C (41°F) and 35°C (95°F). If the **CHARGE** lamp flashes quickly during charging, cease use immediately and take battery and charger to your retailer or a Nikon-authorized service representative.

Do not move the charger or touch the battery during charging. Failure to observe this precaution could in very rare instances result in the charger showing that charging is complete when the battery is only partially charged. Remove and reinsert the battery to begin charging again.

Use the charger with compatible batteries only. Unplug when not in use.

3 Insert the battery and a memory card.

Undo the battery-chamber/memory card slot cover security lock (1) and unlatch (2) and slowly open the cover (3). After checking that they are in the correct orientation, insert the battery and memory card as follows: using the battery to keep the orange battery latch pressed to one side, slide the battery in until it latches (4), and then slide in the memory card until it clicks into place (5). Close (6), latch (7), and lock (8) the cover, and confirm that the latch and security lock are in the positions shown (A).

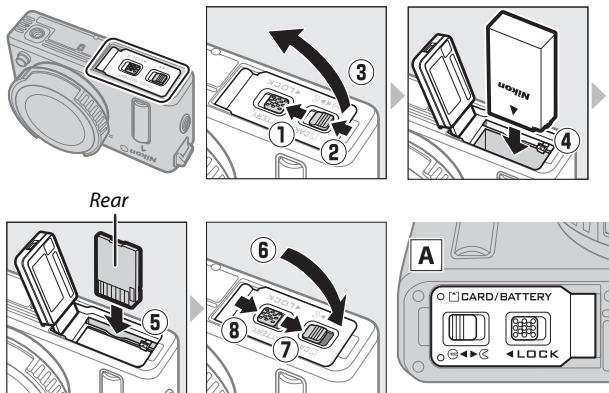

✓ Inserting and Removing Batteries and Memory Cards

Always turn the camera off before inserting or removing batteries or memory cards. Note that the battery and memory cards may be hot after use; observe due caution when removing the battery and memory cards.

✍ Formatting Memory Cards

If this is the first time the memory card will be used in the camera or if the card has been formatted in another device, select **Format memory card** in the setup menu and follow the on-screen instructions to format the card (📖 193). *Note that this permanently deletes any data the card may contain.* Be sure to copy any photographs and other data you wish to keep to a computer before proceeding.

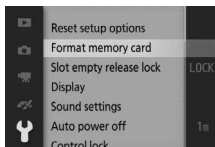

✍ The Write Protect Switch

Memory cards are equipped with a write protect switch to prevent accidental loss of data. When this switch is in the “lock” position, the memory card can not be formatted and photos can not be deleted or recorded. To unlock the memory card, slide the switch to the “write” position.

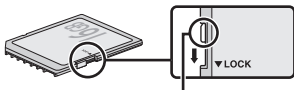

Write-protect switch

Removing Batteries and Memory Cards

After turning the camera off, confirm that the memory card access lamp (☐ 3) is off and open the battery-chamber/memory card slot cover. To remove the battery, first release it by pressing the orange battery latch in the direction shown by the arrow and then remove the battery by hand.

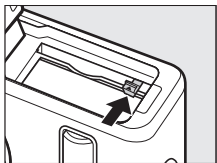

To remove a memory card, first press the card in to eject it (①); the card can then be removed by hand (②).

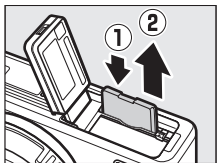

Memory Cards

- The camera stores pictures on SD, SDHC, and SDXC memory cards (available separately; ☐ 206).
- Do not remove memory cards from the camera, turn the camera off, or remove or disconnect the power source during formatting or while data are being recorded, deleted, or copied to a computer. Failure to observe these precautions could result in loss of data or in damage to the camera or card.
- Do not touch the card terminals with your fingers or metal objects.
- Do not bend, drop, or subject to strong physical shocks.
- Do not apply force to the card casing. Failure to observe this precaution could damage the card.
- Do not expose to water, heat, high levels of humidity, or direct sunlight.
- Do not format memory cards in a computer.



4 Attach the special-purpose waterproof lens.

The camera is used with special-purpose waterproof lenses that attach as shown below (for information on attaching non-waterproof 1 NIKKOR lenses, see page 203). The lens generally used in this manual for illustrative purposes is a 1 NIKKOR AW 11–27.5mm f/3.5–5.6. When attaching the lens, care should be taken to avoid damage to the camera and lens and to ensure that dust and other foreign matter does not enter the camera or adhere to the O-ring or surrounding area.

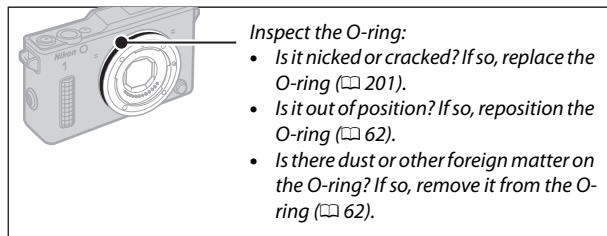
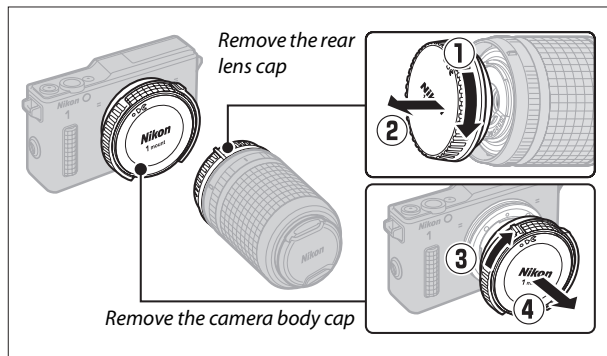

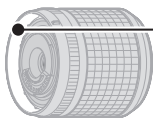

Check the lens: Remove any dust or other foreign matter from the lens O-ring seal (p. 62).

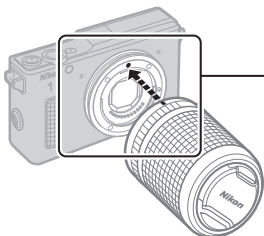

Align the mounting marks

Mounting mark (camera)

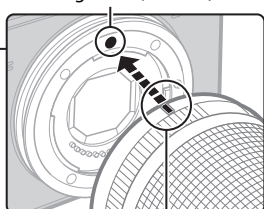

Mounting mark (lens)

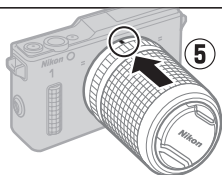

Place the lens over the O-ring and press it into position

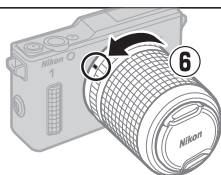

Rotate the lens as shown until it stops

When placing the lens over the O-ring, be careful not to damage the camera or lens; do not use excessive force.



Detaching the Waterproof Lenses

Be sure the camera is off when removing or exchanging lenses. To remove the lens, press and hold the lens release button (1) while rotating the lens as shown (2) and then detach the lens from the camera. After removing the lens, replace the lens caps and camera body cap.

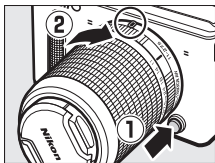

Attaching and Removing Waterproof Lenses

Before attaching or removing a waterproof lens, be sure the lens and camera are completely dry, that the O-ring is not cracked, damaged, twisted, or out of position, and that the camera O-ring and lens O-ring seal (240) are free of hair, dust, sand, and other foreign objects. Do not exchange lenses when your hands are wet or have salt on them or in areas exposed to wind, spray, dust, or sand, and be careful that water does not drop into the interior of the camera or lens.

Silicon Grease

The O-ring can be lubricated with the supplied silicon grease or with optional WP-G1000 silicon grease, preventing wear and making waterproof lenses easier to attach and remove (201). To apply, place a bead of grease in a plastic bag and use your fingers to spread the grease throughout the bag (1), then insert the O-ring and massage the bag to coat the ring (2). *Use only silicon grease designated for use with this product.* Failure to observe this precaution could result in O-ring becoming stretched or otherwise deformed.

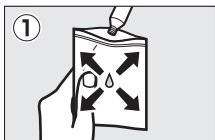

5 Turn the camera on.

Press the power switch to turn the camera on. The power lamp will briefly light green and the monitor will turn on. Be sure to remove the lens cap before shooting.

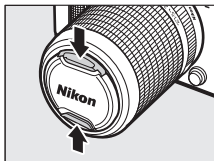
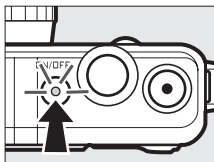

Turning the Camera Off

To turn the camera off, press the power switch again. The monitor will turn off.



Auto Power Off

If no operations are performed for about a minute, the display will turn off and the power lamp start to flash (if desired, the delay before the display turns off automatically can be changed using the **Auto power off** option in the setup menu; □ 195). The camera can be reactivated by operating the shutter-release button. If no operations are performed for about three minutes after the display has turned off, the camera will turn off automatically.

Attaching and Removing Lenses

Turn the camera off before attaching or removing lenses. Note that when the camera is turned off, the sensor protection barrier in the lens will close, protecting the camera image sensor.

6 Choose a language.

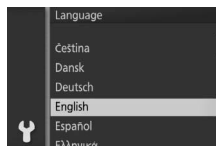

A language-selection dialog will be displayed the first time the camera is turned on. Use the multi selector and  button ( 8) to choose a language.





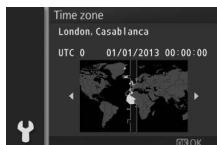

7 Set the clock.

Use the multi selector and  button (book 8) to set the time and date. *Note that the camera uses a 24-hour clock.*

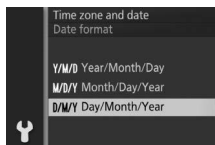



Press  or  to highlight time zone and press .



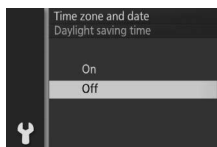



Press  or  to highlight date format and press .

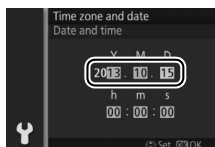





Press  or  to highlight daylight saving time option and press .

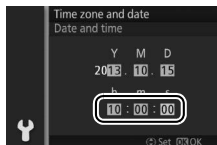

Press  or  to select year, month, or date and press  or  to change. Press  to proceed.



Press  or  to select hour, minute, or second and press  or  to change. Press  when finished.

Note: Language and clock can be changed at any time using **Language** (book 198) and **Time zone and date** (book 198) options in setup menu.



 **The Camera Clock**

The camera clock is less accurate than most watches and household clocks. Check the clock regularly against more accurate time pieces and reset as necessary.

The camera clock is powered by an independent, rechargeable power source, which is charged as necessary when the main battery is installed or the camera is powered by an optional EP-5C power connector and EH-5b AC adapter (📖 208). Three days of charging will power the clock for about a month. If a message warning that the clock is not set is displayed when the camera is turned on, the clock battery is exhausted and the clock has been reset. Set the clock to the correct time and date.



8 Read the instructions on keeping your camera watertight.

Once the clock is set, the camera will display a series of messages on maintaining a watertight seal, which you are encouraged to read before using the camera for the first time. Press ◀ or ▶ to scroll through the messages. To exit, press  when the last message is displayed.

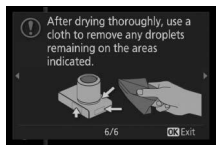
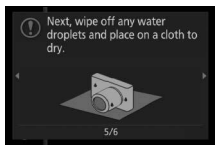
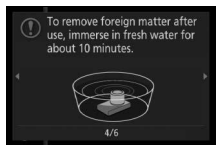
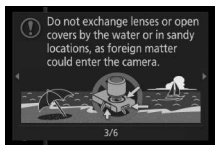
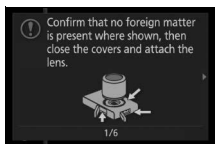

Note

If you remove and reinsert the battery, the first of these messages may be displayed again for a few seconds. To view all messages, press DISP while the first message is displayed and then press ◀ or ▶ to scroll through the remaining messages. To exit, press .

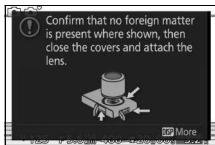

9 Check the battery level and memory card capacity.

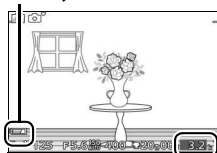

Check the battery level and number of exposures remaining in the monitor.

Battery level



Exposures remaining

■ ■ Battery Level

Display	Description
NO ICON	Battery fully charged or partially discharged; level shown by  or  icon in detailed display (□ 7).
	Low battery. Ready fully-charged battery or prepare to charge battery.
Cannot take pictures. Insert fully-charged battery.	Battery exhausted; shutter-release disabled. Insert charged battery.

■ ■ Number of Exposures Remaining

The monitor shows the number of pictures that can be stored on the memory card at current settings (values over 1000 are rounded down to the nearest hundred; e.g., values between 1200 and 1299 are shown as 1.2 k). If a warning is displayed stating that there is not enough memory for additional images, insert another memory card (□ 16) or delete some photos (□ 121).

Taking and Viewing Photographs

The camera gives you a choice of auto mode for “point-and-shoot” photography that leaves the camera in charge of choosing settings, creative mode, which lets you adjust settings according to your subject or creative intent, and a variety of other modes for hard-to-time shots or to capture the emotion surrounding special moments.

Point-and-Shoot Photography (Auto Mode)



Follow the steps below to take photographs in auto mode, a “point-and-shoot” mode in which the camera automatically detects the subject type and adjusts settings according to the subject and situation.

1 Turn the camera on.

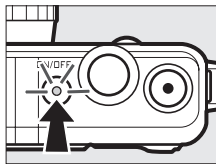
Press the power switch to turn the camera on.



2 Select mode.

Press the MENU button to display the menus. Select **Shooting mode**, then highlight  (auto) and press  (10).

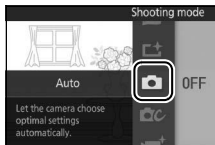

3 Ready the camera.

Hold the camera securely with both hands, being careful not to obstruct the lens, AF-assist illuminator, or microphone. Rotate the camera as shown at lower right when taking pictures in “tall” (portrait) orientation.

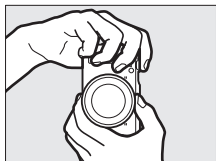
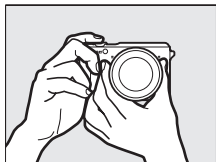

4 Frame the photograph.

Position your subject in the center of the frame.

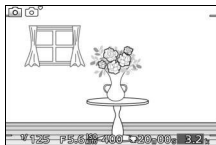

5 Focus.

Press the shutter-release button halfway to focus. If the subject is poorly lit, the AF-assist illuminator (📖 172) may light to assist the focus operation.



If the camera is able to focus, the selected focus area will be highlighted in green and a beep will sound (a beep may not sound if the subject is moving).

If the camera is unable to focus, the focus area will be displayed in red (📖 167).

Focus area

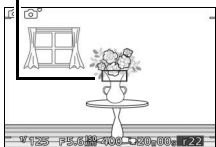

6 Shoot.

Smoothly press the shutter-release button the rest of the way down to release the shutter and record the photograph. The memory card access lamp will light and the photograph will be displayed in the monitor for a few seconds (the photo will automatically clear from the display when the shutter-release button is pressed halfway). *Do not eject the memory card or remove the battery until the lamp has gone out and recording is complete.*

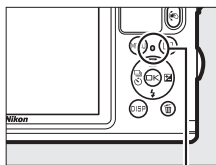

Memory card access lamp

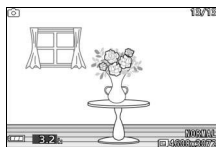

The Framing Grid

A framing grid can be displayed by selecting **On** for **Display > Grid display** in the setup menu (□ 194).

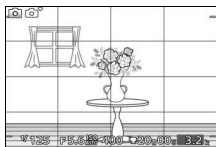

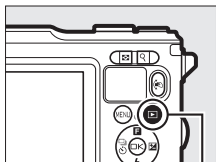

Viewing Photographs

Press  to display your most recent photograph full frame in the monitor (full-frame playback).

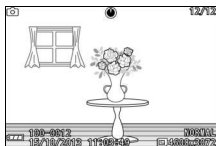

 button





Press  or  to view additional pictures.



To end playback and return to shooting mode, press the shutter-release button halfway.

The Button

During playback, you can also select pictures for display by holding the  button, tilting the camera left or right to highlight the desired image, and then releasing the button to display the highlighted picture full frame ( 97).

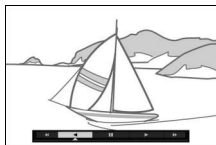

Deleting Pictures

To delete the current picture, press . Note that once deleted, pictures can not be recovered.

1 Display the photograph.

Display the photograph you wish to delete as described on the preceding page.

2 Press .

A confirmation dialog will be displayed.

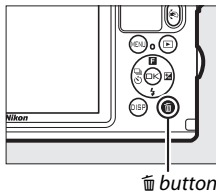

3 Delete the photograph.

Press again to delete the picture and return to playback, or press to exit without deleting the picture.

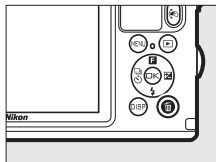

The Shutter-Release Button

The camera has a two-stage shutter-release button. The camera focuses when the shutter-release button is pressed halfway. To take the photograph, press the shutter-release button the rest of the way down.



Focus: Press halfway



Shoot: Press the rest of the way down

Taking Several Photographs in Succession

If **Off** is selected for **Image review** in the playback menu (📖 146), you can take additional photographs without refocusing by keeping the shutter-release button pressed halfway between shots.

Automatic Scene Selection

In auto mode, the camera automatically analyzes the subject and selects the appropriate scene. The selected scene is shown in the monitor.

Scene icon

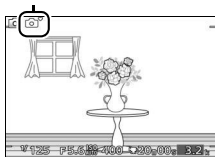

 **Portrait:** Human portrait subjects.

 **Landscape:** Landscapes and cityscapes.

 **Night portrait:** Portrait subjects framed against dark backgrounds.

 **Close up:** Subjects close to the camera.

 **Night landscape:** Poorly-lit landscapes and cityscapes.

 **Auto:** Subjects that do not fall into the categories listed above.

Using a Zoom Lens

Use the zoom ring to zoom in on the subject so that it fills a larger area of the frame, or zoom out to increase the area visible in the final photograph (select longer focal lengths on the lens focal length scale to zoom in, shorter focal lengths to zoom out).

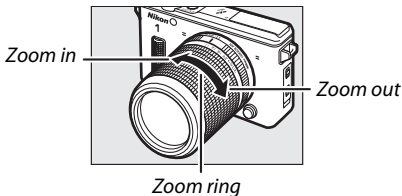

Face Priority

The camera detects and focuses on portrait subjects (face priority). A double yellow border will be displayed if a portrait subject is detected facing the camera (if multiple faces, up to a maximum of five, are detected, the camera will select the closest subject). Press the shutter-release button halfway to focus on the subject in the double yellow border. The border will clear from the display if the camera can no longer detect the subject (because, for example, the subject has looked away).



Available Settings

For information on the options available in auto mode, see page 215.

Deleting Multiple Pictures

The **Delete** option in the playback menu (📖 121) can be used to delete all or selected pictures.

See Also

See page 194 for information on silencing the beep that sounds when the camera focuses or the shutter is released. For information on viewing photo info, see page 7. See page 118 for information on viewing multiple images. For information on zooming in on the center of the current image, see page 120. See page 123 for information on slide shows.



Live Image Control

Live image controls let you adjust settings without leaving the shooting display, allowing you to preview how the changes will affect your photographs. To view the live image controls available in auto mode, press ▲ (F). Highlight a control and press OK to select, then press ▲ or ▼ to adjust the control and press OK to return to shooting mode. To cancel the control, press ▲ (F) again.

Active D-Lighting: Preserve details in highlights and shadows for natural contrast.



Active D-Lighting: High



Active D-Lighting: Low

Background softening: Soften background details to make your subject stand out, or bring both background and foreground into focus.



Background sharp



Background softened



Increase effect

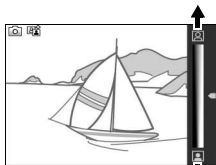

Reduce effect

Sharpen background

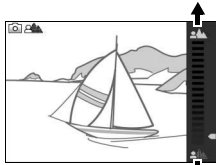

Soften background

Motion control: Suggest motion by blurring moving objects, or “freeze” motion to capture moving objects clearly.



Freeze motion

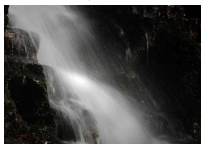

Blur motion

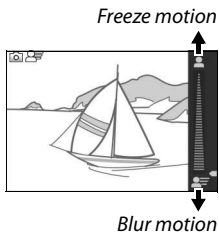

Brightness control: Make pictures brighter or darker.



Brighter



Darker

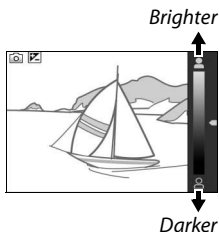



Live Image Control

Continuous shooting is not available (☞ 87) and the built-in flash can not be used when live image control is in effect. Pressing the movie-record button cancels live image control.

Choosing a Creative Mode



Choose creative mode to match settings to the subject or situation, take photos using special effects, or control shutter speed and aperture.

1 Select mode.

Press the MENU button to display the menus. Select **Shooting mode**, then highlight  (creative mode) and press  (10).



2 Choose a scene.

Press  (**F**) and highlight a scene using the multi selector ( 38).

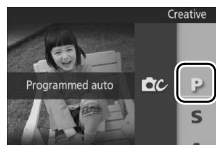

Press  to select the highlighted scene. Your selection is indicated by an icon in the display.

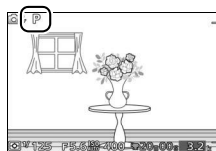

Choosing a Mode That Matches the Subject or Situation

Choose a creative mode according to the subject or situation:

Option	Description
Programmed auto (P)	The camera sets shutter speed and aperture for optimal exposure (□ 40). Recommended for snapshots and in other situations in which there is little time to adjust camera settings.
Shutter-priority auto (S)	You choose the shutter speed; the camera selects an aperture for best results (□ 41). Use to freeze or blur motion.
Aperture-priority auto (A)	You choose the aperture; the camera selects a shutter speed for best results (□ 42). Use to blur the background or bring both foreground and background into focus.
Manual (M)	You control both shutter speed and aperture (□ 43). Choose a shutter speed of “Bulb” for long time-exposures (□ 44).
Underwater (📷, 📷)	Take pictures under water (□ 54, 55).
Night landscape (📷)	Capture low lighting in night scenes. Each time the shutter-release button is fully pressed, the camera takes a series of shots and combines them; during processing, a message is displayed and no pictures can be taken. The flash does not fire and the edges of photos are cropped out. Note that the desired results may not be obtained if the camera or subject moves during shooting; if the camera is unable to combine the images, a warning will be displayed and only one picture will be taken.



Option	Description
Night portrait (📷)	Capture background lighting in portraits taken at night or under low light. Each time the shutter-release button is fully pressed, the camera takes a series of shots, some with the flash and some without, and combines them; during processing, a message is displayed and no pictures can be taken. Raise the built-in flash before shooting; no photograph will be taken if the flash is not raised. Note that the edges of photos are cropped out and that the desired results may not be obtained if the camera or subject moves during shooting; if the camera is unable to combine the images, a warning will be displayed and the camera will take a single picture using the flash.
Backlighting (📷)	Photograph backlit subjects (📖 46).
Easy panorama (📷)	Shoot panoramas for later viewing on the camera (📖 47).
Soft (📷)	Shoot photographs with a soft filter effect. To choose the amount of softening, press OK when the view through the lens is displayed, highlight an option using the multi selector, and press OK to select.
Miniature effect (📷)	The top and bottom of each photo is blurred so that the subject appears to have been a diorama photographed at short range. Works best when shooting from a high vantage point.
Selective color (📷)	Take photos in which only a selected hue appears in color. To choose the hue, press OK when the view through the lens is displayed and use the multi selector and OK button.

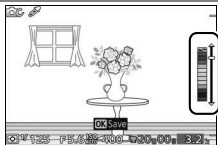
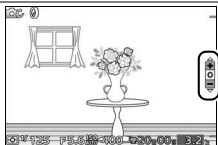

Available Settings

For information on the options available in creative mode, see page 217.

Taking Photos in P, S, A, and M Modes

P, S, A, and M modes offer varying degrees of control over shutter speed and aperture. Choose a mode and adjust settings according to your creative intent.

■ P Programmed Auto

In this mode, the camera automatically adjusts shutter speed and aperture for optimal exposure in most situations. This mode is recommended for snapshots and other situations in which you want to leave the camera in charge of shutter speed and aperture.



Choosing a Combination of Shutter Speed and Aperture

Although the shutter speed and aperture chosen by the camera will produce optimal results, you can also choose from other combinations that will produce the same exposure ("flexible program"). Press **Q** for large apertures (low f-numbers) that blur background details or fast shutter speeds that "freeze" motion, for small apertures (high f-numbers) that increase depth of field or slow shutter speeds that blur motion. ***** is displayed while flexible program is in effect.

button

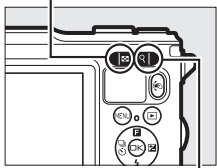

Q button

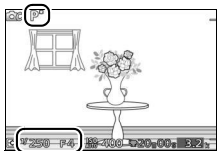

Restoring Default Shutter Speed and Aperture Settings

To restore default shutter speed and aperture settings, press **Q** or until ***** is no longer displayed or turn the camera off. The default shutter speed and aperture is automatically restored when the camera enters standby mode.

■ S Shutter-Priority Auto

In shutter-priority auto, you choose the shutter speed while the camera automatically selects the aperture that will produce the optimal exposure. Use slow shutter speeds to suggest motion by blurring moving subjects, fast shutter speeds to “freeze” motion.



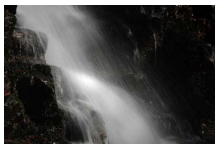

Fast shutter speed ($1/1600$ s)



Slow shutter speed (1 s)

Choosing a Shutter Speed

Use the **Q** and  buttons to choose from shutter speeds between 30 s and $1/16,000$ s. Press **Q** for faster shutter speeds,  for slower shutter speeds.

Continuous Shooting

The selected shutter speed may change if the frame rate for continuous shooting (87) is 15 fps or more.

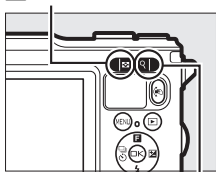

Q button

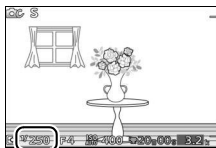

■ ■ A Aperture-Priority Auto

In aperture-priority auto, you choose the aperture while the camera automatically selects the shutter speed that will produce the optimal exposure. Large apertures (low f-numbers) reduce depth of field, blurring objects behind and in front of the main subject. Small apertures (high f-numbers) increase depth of field, bringing out details in the background and foreground. Short field depths are generally used in portraits to blur background details, long field depths in landscape photographs to bring the foreground and background into focus.





Large aperture (f/5.6)



Small aperture (f/16)

Choosing an Aperture

Press  for larger apertures (lower f-numbers),  for smaller apertures (higher f-numbers).

 button

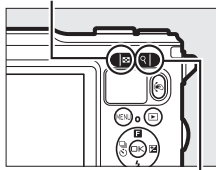

 button

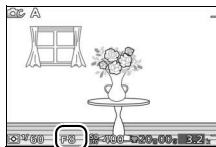

■ M Manual

In manual mode, you control both shutter speed and aperture.

Choosing Shutter Speed and Aperture

Adjust shutter speed and aperture with reference to the exposure indicator (see below). Press **▶** to highlight shutter speed or aperture and use the **Q** and **☒** buttons to choose a value, then repeat for the remaining item. Press **Q** for faster shutter speeds or smaller apertures (higher f-numbers), **☒** for slower shutter speeds and larger apertures (lower f-numbers). Shutter speeds can be set to values as fast as $\frac{1}{16,000}$ s or as slow as 30 s, or to “Bulb” to hold the shutter open indefinitely for a long time-exposure (☐ 44).



☒ button

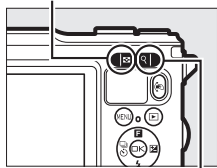

Q button

Shutter speed

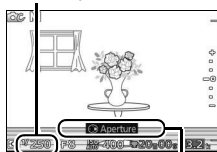

Press **▶** to highlight aperture.

Aperture



Press **▶** to highlight shutter speed.

☒ Continuous Shooting

The selected shutter speed may change if the frame rate for continuous shooting (☐ 87) is 15 fps or more.

The Exposure Indicator

When shutter speeds other than “Bulb” are selected, the exposure indicator shows whether the photograph would be under- or over-exposed at current settings.

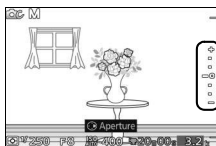

Optimal exposure	Underexposed by $\frac{1}{3}$ EV	Overexposed by over 2 EV
+ . . -0 . . -	+ . . =0 . . -	+ . . . -0 . . . -



Long Time-Exposures (M Mode Only)

Select a shutter speed of “Bulb” for long time-exposures of moving lights, the stars, night scenery, or fireworks. The shutter remains open while the shutter-release button is held down. To prevent blur, use a tripod.



1 Ready the camera.

Mount the camera on a tripod or place it on a stable, level surface. To prevent loss of power before the exposure is complete, use a fully charged EN-EL20 battery or an optional EH-5b AC adapter and EP-5C power connector. Note that noise (bright spots, randomly-spaced bright pixels, or fog) may be present in long exposures; before shooting, choose **On** for **Long exposure NR** in the shooting menu (164).

2 Choose a shutter speed of "Bulb".

Press ► to highlight shutter speed and press the  button to select "Bulb".



 button

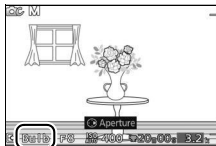
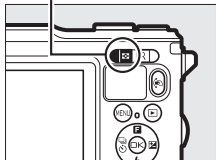

3 Open the shutter.

After focusing, press the shutter-release button all the way down. Keep the shutter-release button pressed until the exposure is complete.

4 Close the shutter.

Take your finger off the shutter-release button.

Shooting ends automatically after about two minutes. Note that some time may be required to record long exposures.

Backlighting

The method used to capture details in shaded areas of back-lit subjects depends on the option selected for **HDR** in the shooting menu (📖 153).

On	<p>Details in highlights and shadows are preserved using HDR (high dynamic range); HDR appears in the display. Each time the shutter-release button is fully pressed, the camera takes two shots in quick succession and combines them to preserve details in highlights and shadows in high-contrast scenes; the built-in flash does not fire. While the shots are combined, a message will be displayed and the shutter release will be disabled. The final photograph will be displayed when processing is complete.</p> <div data-bbox="170 502 937 728"><p><i>First exposure (darker)</i> <i>Second exposure (brighter)</i> <i>Combined HDR image</i></p></div>
Off	<p>The flash fires to “fill in” (illuminate) shadows in back-lit subjects. Only one shot is taken when the shutter-release button is fully pressed, and the flash fires with each shot. No pictures will be taken if the built-in flash is not raised; raise the flash before shooting.</p>

Framing HDR Photographs

The edges of the image will be cropped out. The desired results may not be achieved if the camera or subject moves during shooting. Depending on the scene, shading may be uneven and shadows may appear around bright objects or halos around dark objects. If the camera is unable to successfully combine the two images, a single image will be recorded at normal exposure and Active D-Lighting (📖 163) will be applied.



Easy Panorama

Follow the steps below to shoot panoramas. During shooting, the camera focuses using auto-area AF (📖 170); face detection (📖 34) is not available. Exposure compensation (📖 90) can be used, but the built-in flash will not fire.

1 Set focus and exposure.

Frame the start of the panorama and press the shutter-release button halfway. Guides will appear in the display.

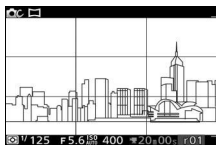

2 Start shooting.

Press the shutter-release button the rest of the way down and then lift your finger from the button. \triangle , ∇ , \triangleleft , and \triangleright icons will appear in the display to indicate the possible pan directions.





3 Pan the camera.

Slowly pan the camera up, down, left, or right as shown below. Shooting will start when the camera detects the pan direction and a progress indicator will appear in the display. Shooting ends automatically when the end of the panorama is reached.

Progress indicator



An example of how to pan the camera is shown below. Without changing your position, pan the camera in a steady curve either horizontally or vertically. Time the pan according to the option selected for **Image size** in the shooting menu: about 15 seconds are needed to complete the pan when  **Normal panorama** is selected, about 30 seconds when  **Wide panorama** is selected.

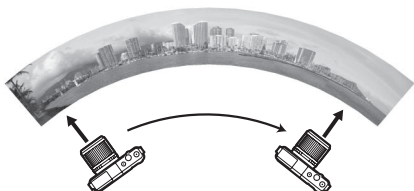



Panoramas

High-distortion wide-angle lenses may fail to produce the desired results. An error message will be displayed if the camera is panned too quickly or unsteadily.

The completed panorama will be slightly smaller than the area visible in the display during shooting. No panorama will be recorded if shooting ends before the halfway point; if shooting ends after the halfway point but before the panorama is complete, the unrecorded portion will be shown in gray.





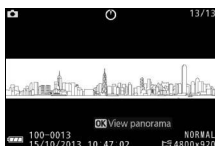



■ Viewing Panoramas

Panoramas can be viewed by pressing  when a panorama is displayed full frame ( 31). The start of the panorama will be displayed with the smallest dimension filling the display and the camera will then scroll through the picture in the original pan direction.



Navigation Guide window

The following operations can be performed:

To	Use	Description
Pause		Pause playback.
Play		Resume playback when the panorama is paused or during rewind/advance.
Advance/ rewind		Press  to rewind,  to advance. If playback is paused, the panorama rewinds or advances a segment at a time; keep the button pressed for continuous rewind or advance.
Return to full-frame playback		Press  or  to exit to full-frame playback.

Underwater Photography

With a special-purpose waterproof lens attached, the camera can be used at depths of up to 15 m (49 ft) for as long as 60 minutes at a time. Before using the camera under water, be sure that you have read and understood the instructions in this section and have removed straps intended exclusively for use on land (hand straps, available separately from third-party suppliers, are recommended to prevent loss during underwater use).

Important: Precautions

To prevent water entry or other damage, observe the following precautions when using the camera underwater:

- Be sure a special-purpose waterproof lens is attached. The camera is not waterproof when a waterproof lens is not attached, while waterproof lenses are only waterproof when attached to the camera. Do not expose the camera to water when a waterproof lens is not attached nor waterproof lens to water when not attached to the camera.
- The sudden change in temperature caused by taking the camera into the water after it has been left on the beach, in direct sunlight, or in other locations exposed to high temperatures could result in water droplets forming inside the camera or lens, potentially damaging the products.
- Do not remove the lens under water, open the connector or battery-chamber/memory card slot cover, or operate the lens release button or the latches or security locks on the connector and battery-chamber/memory card slot covers while the camera is immersed.
- Do not leave the product immersed for more than 60 minutes at a time or expose it to depths greater than 15 m (49 ft) or to rapids, waterfalls, water flowing at full force from a tap, or other water under high pressure. Failure to observe these precautions could expose the product to pressures high enough to cause water entry.





- Do not expose the camera to water colder than 0 °C (32 °F) or warmer than 40 °C (104 °F). Do not take into hot springs or baths.
- Do not dive into the water with the camera, drop it, place it under heavy objects, or otherwise subject it to violent shocks or excessive physical pressure or force. The camera may deform and become vulnerable to leaks under excessive external pressure.
- Failure to follow correct procedures before or during use could result in irreparable damage to the product due to water entry. Should the product leak, cease use immediately, dry the camera and lens, and consult a Nikon-authorized service representative.
- The camera does not float. Be careful not to drop the camera while in or on the water.
- Condensation may form inside the lens or monitor if the product is exposed to rapid changes in temperature, such as occur when the product is taken into cold water from a hot shore location, into a warm room from a cold exterior, or the battery-chamber/memory card slot cover is opened or closed or lenses are attached or removed in a humid location. Such condensation will not cause malfunction or other damage.

Before Using the Camera Underwater

Before using the camera underwater, complete the following checklist.

- Have you removed the strap intended exclusively for use on land? We recommend that you attach a hand strap (available separately from third-party suppliers) before taking the camera into the water.*

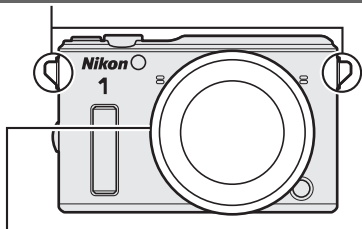

- Have you attached the special-purpose waterproof lens (□ 19)?*

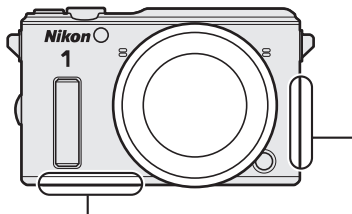

- Have you inserted the battery and memory card (16)?
- To prevent water entry and other damage, remove any sand, dust, hair, and foreign objects from under the connector and battery-chamber/memory card slot covers, and use a blower or cotton swab to remove foreign objects from inside the camera (when using a cotton swab, be sure not to leave any threads behind). If the watertight channel is cracked, deformed, or damaged, consult a Nikon-authorized service representative.

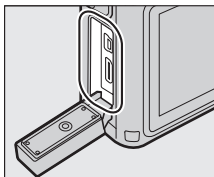
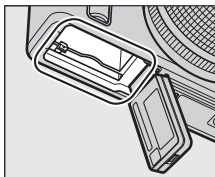

- Be sure that the connector and battery-chamber/memory card slot covers are fully closed, that the hand strap is not caught in either cover, and that the latches and security locks are in the positions shown.

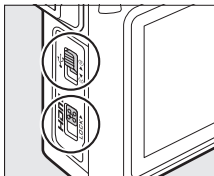
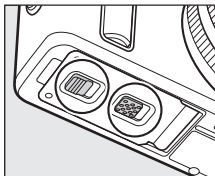

The Final Check

After going through the pre-shooting checklist on page 51 and confirming that the special-purpose waterproof lens is attached and the connector and battery-chamber/memory card slot covers are closed and secure, immerse the camera in fresh water, turn it on, and test the

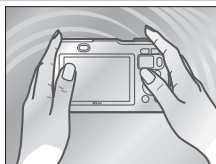

zoom ring and camera controls to ensure that they operate normally and that the camera does not leak. To prevent water entry and other damage, do not operate the lens release button or the latches or security locks on the connector and battery-chamber/memory card slot covers.



Should you notice air escaping from around the lens mount or the connector and battery-chamber/memory card slot covers, end the test and remove the camera from the water immediately (air escaping from the pressure-equalization vent and microphone and speaker covers is normal and does not indicate a malfunction). Dry the camera and lens thoroughly and check the O-ring and connector and battery-chamber/memory card slot covers are properly sealed. Consult a Nikon-authorized service representative if you find that the camera leaks in normal use.

Taking Pictures Underwater



Follow steps below to take pictures in “Underwater” mode (📖 55).

1 Turn the camera on.

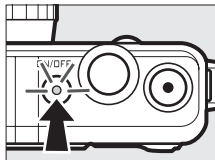
Press the power switch to turn the camera on.





2 Select mode.

Press the MENU button to display the menus, then select **Shooting mode**, highlight  (creative mode), and press  (📖 10).



3 Select **Underwater**.

Press  () to display the creative menu. Highlight **Underwater** and press  to display underwater processing options.

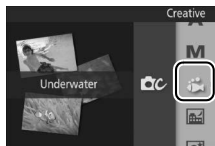

4 Choose an option.

Highlight one of the following options and press **OK** to select the highlighted option and return to the shooting display.

- **Standard**: Standard processing for balanced results when shooting along the shore or in shallow water.
- **Scuba**: Vivid colors for deeper waters.
- **Close up**: Enhanced contrast for underwater close-ups.

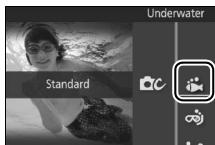

5 Take pictures.

To take photographs, press the shutter-release button halfway to focus and the rest of the way down to shoot. The shutter will be released whether or not the camera is in focus. Movies can be recorded using the movie-record button.

Shutter-release button

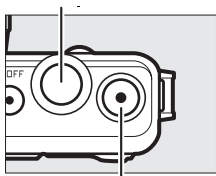

Movie-record button

Underwater Mode

The creative mode **Underwater** option automatically compensates for the blue cast in underwater lighting. Colors can be previewed in the monitor and adjusted manually or using preset options; the results apply to both photographs and movies. To adjust the blue-green balance manually, press **OK** in the shooting display and then press **▲** or **▼**. Press **OK** to exit when colors are adjusted to your satisfaction.

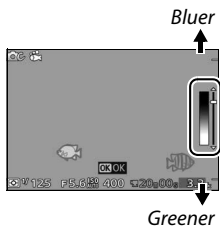

Tips and Tricks for Underwater Photography

The following features may come in handy when you are taking pictures underwater.

Auto Distortion Control

To control distortion when shooting underwater, select **On (underwater)** for **Auto distortion control** in the shooting menu (📖 161). This option is only available when a special-purpose underwater lens is attached.

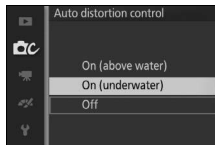

The Built-in Flash

To raise the flash for use underwater, press the flash pop-up button (📖 92). Note that manual color adjustment is not available when the flash is used with the creative mode **Underwater** option (📖 55). Water currents can push the flash part way down, causing vignetting (📖 95).

See Also

The **Underwater** white balance option can be used to correct for the blue cast in underwater lighting (📖 178).

The Depth Gauge

Using the depth gauge, you can view your depth during shooting or include the depth in the photo info recorded when a picture is taken. Set the gauge to zero before entering the water (📖 59).



■ Viewing Depth

1 Select Record location data.

In the setup menu, select **Location data**, then highlight **Record location data** and press ►.

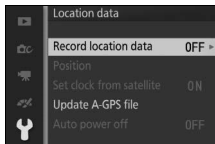

2 Select Yes.

Highlight **Yes** and press Ⓞ.

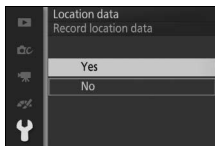

3 Select Altimeter/depth gauge.

In the setup menu, select **Altitude/depth options**, then highlight **Altimeter/depth gauge** and press ►.

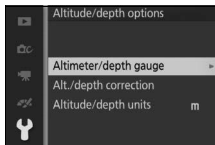

4 Select Depth gauge.

Highlight **Depth gauge** and press .

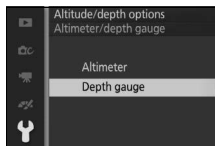

5 Exit the menus.

Press the shutter-release button half-way to exit the menus.



6 Display the depth gauge.

Press the DISP button to display the depth gauge ( 7).



The Depth Gauge

The camera depth gauge is not intended as a replacement for specialized diving gauges; the depths shown are approximations only. The display will not show depths over 20 m (65.6 ft); depths over 15 m (49 ft) are shown in red.



■ Setting the Depth Gauge to Zero

Follow the steps below to set the depth gauge to zero.

1 Select **Alt./depth correction**.

In the setup menu, select **Altitude/depth options**, then highlight **Alt./depth correction** and press ►.

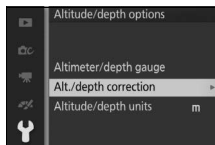

2 Select **Correct manually**.

Highlight **Correct manually** and press ►.

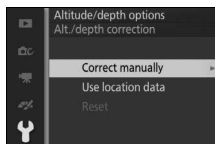

3 Set the depth gauge to zero.

Press ◀ or ▶ to highlight digits and press ▲ or ▼ to change. Press ⊞ when changes are complete.

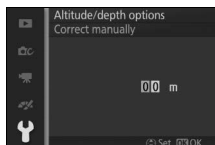

See Also

For information on altitude and depth options, see page 196.

After Using the Camera Underwater

The camera and lens should be cleaned within 60 minutes of underwater use. Leaving the lens attached, immerse the camera in fresh water to remove salt and other foreign matter. Failure to observe this precaution could result in damage, discoloration, corrosion, offensive odors, or vulnerability to leaks.

✓ Before Cleaning the Camera and Lens

Clean the product indoors in areas not exposed to sand or spray and be sure to remove the front cap from the lens and any water, salt, sand, or other foreign matter from your hands or hair before proceeding. Do not open the connector or battery-chamber/memory card slot cover until all foreign matter has been washed away and the camera is dry.

1 Ready the camera.

Be sure that the special-purpose waterproof lens is attached and that connector and battery-chamber/memory card slot covers are closed with the latches and security locks in the positions shown.

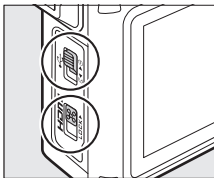
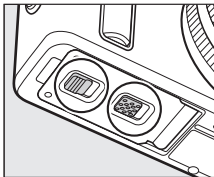

2 Immerse the camera and lens.

Leaving the lens attached, immerse the camera in a basin of fresh water for about 10 minutes. To prevent water entry and other damage, do not open the camera connector or battery-chamber/memory card slot cover while the camera is immersed.

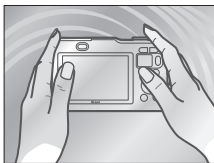

3 Clean the zoom ring and camera controls.

Being careful not to touch the lens release button or the latches or security locks on the connector and battery-chamber/memory card slot covers, press the flash pop-up button to raise the built-in flash and gently move the camera side to side, then operate the lens zoom ring and each of the remaining camera controls a few times to remove salt and other foreign objects.

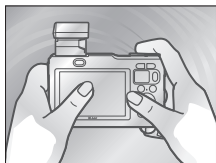

4 Wipe dry.

Dry the camera and lens barrel with a soft, dry cloth. Water, fingerprints, and other foreign matter on the front lens element should be removed immediately by gently wiping the glass with a soft, dry cloth. Do not use force.

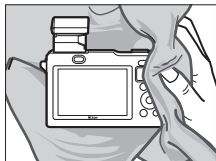

5 Leave in the shade.

Without removing the lens, place the camera on a dry cloth as shown and leave it to dry in a shady, well-ventilated area. Water will drain from the zoom ring, pressure-equalization vent, and the holes in the microphone and speaker covers.

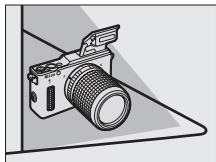

6 Clean inside the covers.

After confirming that no water or other foreign matter remains on the camera, slowly open the connector and battery-chamber/memory card slot covers and remove any water droplets, sand, or other foreign matter from the interior with a soft, dry cloth.

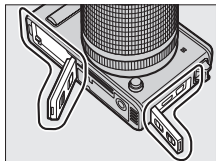

To prevent water falling into the camera when the covers are opened, hold the camera so that the covers open downwards.

7 Remove the lens.

After confirming that the lens and camera are dry, detach the lens and gently wipe the lens O-ring seal with a soft, dry cloth to remove any foreign objects. Note that there may still be water between the camera and the lens; to prevent water falling onto the dust shield or lens when the lens is detached, keep the camera flat and remove the lens slowly.

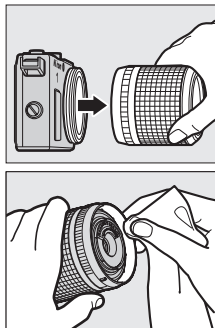

The O-Ring

The camera uses an O-ring to form a watertight seal. Improper handling of the O-ring can produce leaks. *Check the condition of the O-ring as described below whenever the camera has been used under water or whenever foreign matter is found on the O-ring when the lens is removed.*

1 Remove the O-ring.

Lightly stretch the O-ring by sliding your fingers along either side and remove it from the camera (you can also use an optional O-ring remover; □ 201). Do not apply excessive force or use your fingernails, metal objects, or edged or pointed tools.

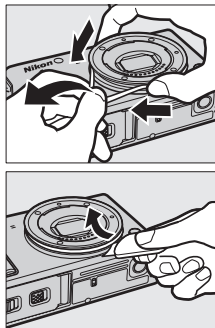

2 Wash the O-ring.

Wash the O-ring thoroughly in fresh water and dry thoroughly. Do not use benzene, thinner, alcohol, soap, neutral detergents, or other cleaning products, as these could damage or weaken the O-ring.

3 Inspect the O-ring.

Remove any foreign matter with a soft, dry cloth, taking care not to leave tissue or threads on the O-ring. Gently bend the O-ring to check for cracking or other damage.

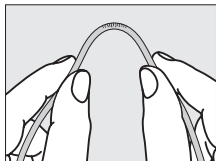

4 Inspect the O-ring guide.

Use a blower or cotton swab to remove any foreign objects from the O-ring guide. Be sure to remove any threads left behind by the swab.

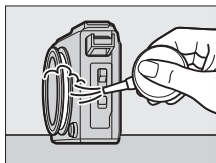

5 Grease the O-ring.

Place a bead of silicon grease in a plastic bag and use your fingers to spread the grease throughout the bag (①), then insert the O-ring and massage the bag to coat the ring (②).

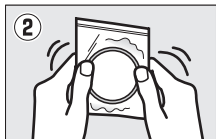
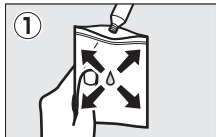

6 Re-insert the O-ring.

After making sure that O-ring and guide are free of foreign objects, place the O-ring so that it runs evenly at the same level all the way round the O-ring guide, without undue stretching and without protruding from the guide.

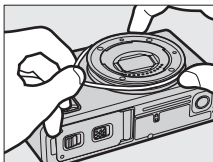

O-Rings

The O-ring requires periodic replacement. Replace the O-ring immediately if it is damaged, cracked, warped, or has lost its elasticity. O-rings should be replaced at least once a year even if the product has not been used; use only O-rings designated for use in this product. O-rings must be greased before use and whenever the surface appears dry; failure to observe this precaution could result in the O-ring cracking and water entering the camera.

Silicon Grease

Coating the O-ring with the supplied silicon grease prevents wear and ensures that the lens rotates smoothly. Use only the supplied silicon grease or optional WP-G1000 silicon grease (□ 201); failure to observe this precaution could result in O-ring becoming stretched or otherwise deformed. Replacement O-rings and silicon grease can be purchased from a Nikon camera retailer or Nikon-authorized service representative. Do not use grease in excessive amounts or apply using paper or cloth, as this may cause dust or fibers to adhere to the O-ring, making the product vulnerable to leaks.



Maintenance

Observe the following precautions when cleaning the camera and lens after underwater use.

- Never remove the lens or open the connector or battery-chamber/memory card slot cover under water. Before exchanging lenses or opening or closing the covers, wipe off water with a soft, dry cloth and be sure the product is completely dry, as otherwise water from the lens or covers may fall into the battery chamber or memory card slot or onto the battery, memory card, watertight channel, hinges, or connectors. Choose shaded locations free from spray, wind, dust, and sand, and check for water on the inside of the covers before closing them. Water on the inside of the covers could result in condensation or other damage.
- Air may escape from the pressure-equalization vent or microphone and speaker covers when the camera is immersed. This is normal and does not indicate a malfunction. Note that water in the holes of the microphone and speaker covers may interfere with sound quality; dry the covers with a soft, dry cloth, but do not insert sharp objects into the holes, as this could damage the camera or make it vulnerable to leaks.
- Do not dry the camera or lens by leaving it in direct sunlight or dry using hair dryers or other powered devices. Failure to observe this precaution could damage the camera, lens, or O-ring, resulting in leaks.
- Benzene, thinner, alcohol, soap, neutral detergents, and other cleaning products may deform the watertight channel or camera body, making the product vulnerable to leaks.
- To ensure that the product remains waterproof, have the watertight channel inspected once a year, and serviced once every 3 to 5 years, by a Nikon-authorized service representative. Fees are charged for these services.

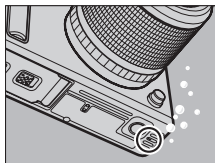





Foreign Matter on the Camera and Lens

Liquid on the lens O-ring seal or inside the connector or battery-chamber/memory card slot cover should be removed immediately with a soft, dry cloth; other foreign matter should be removed with a blower, taking care to remove any small particles from the sides and corners of the watertight channels. Foreign matter on the camera body can be removed with a soft, dry cloth.

Recording and Viewing Movies

The camera can record high-definition (HD) movies with an aspect ratio of 16 : 9 and slow-motion movies with an aspect ratio of 8 : 3. Movie recording is available in the shooting modes listed below (movie recording is not available in best moment capture and Motion Snapshot modes; [□ 76, 83](#)).

Mode	Movie type	Description	
 Auto mode (□ 28)	HD (16 : 9)	The camera automatically optimizes settings for the current subject or scene.	
 Creative mode (□ 37)		Shoot movies. Regardless of the scene selected with the camera, movies are recorded in mode P ; shutter speed and aperture are controlled by the camera.	
 Advanced movie mode (□ 67, 72)		Programmed auto (P)	Shutter speed and aperture are controlled by the camera.
		Shutter-priority auto (S)	You choose the shutter speed; the camera automatically adjusts aperture for optimal exposure (□ 41).
		Aperture-priority auto (A)	You choose the aperture; the camera automatically adjusts shutter speed for optimal exposure (□ 42).
	Manual (M)	You choose the shutter speed and aperture (□ 43).	
Slow motion ()	Slow motion (8 : 3)	Record silent slow-motion movies. Movies are recorded at 400 fps and play back at about 30 fps (□ 72).	

Available Settings

For information on the options available in advanced movie mode, see page 215.

Recording HD Movies

Record movies with sound at an aspect ratio of 16 : 9.

1 Turn the camera on.

Press the power switch to turn the camera on.

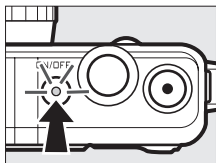

2 Frame the opening shot.

Frame the opening shot with your subject in the center of the display.

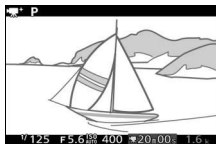

The icon

A  icon indicates that movies can not be recorded.

3 Start recording.

Press the movie-record button to begin recording. A recording indicator, the time elapsed, and the time available are displayed while recording is in progress.

Audio Recording

Be careful not to cover the microphone and note that the built-in microphone may record sounds made by the camera or lens; these noises may sound louder under water. By default, the camera focuses continuously; to avoid recording focus noise, select **Single AF** for **Focus mode** in the movie menu (□ 165). The **Movie sound options** item in the movie menu offers microphone sensitivity and wind noise options (□ 176).

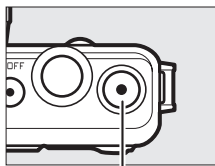

Movie-record button

*Recording indicator/
Time elapsed*



Time available

4 End recording.

Press the movie-record button again to end recording. Recording will end automatically when the maximum length is reached (□ 175), the memory card is full, the lens is removed, or the camera becomes hot (□ xxii).

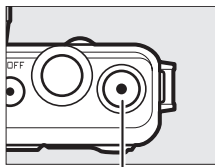

Movie-record button

Maximum Length

At default settings, HD movies can be up to 4 GB in size and 20 minutes in length (for more information, see page 175); note that depending on memory card write speed, shooting may end before this length is reached (□ 206).



Taking Photographs During HD Movie Recording

Press the shutter-release button all the way down to take a photograph without interrupting HD movie recording. Photographs taken during movie recording have an aspect ratio of 3 : 2.

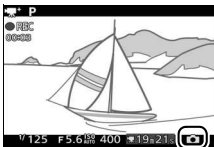



Taking Photographs During Movie Recording

Up to 20 photographs can be taken with each movie shot. Please note that photographs can not be taken with slow-motion movies.

Focus Lock

If **Single AF** is selected for **Focus mode** in the movie menu for advanced movie mode, focus will lock while the shutter-release button is pressed halfway (□ 171).

Viewing Movies

Movies are indicated by a  icon in full-frame playback (31). Press  to start playback.

 icon/Length

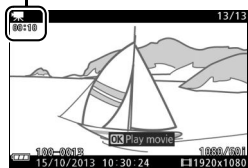



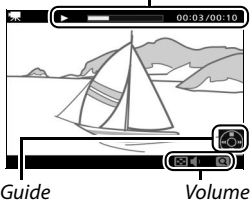









Movie playback indicator/
Current position/total length





The following operations can be performed:





To	Use	Description
Pause		Pause playback.
Play		Resume playback when the movie is paused or during rewind/advance.
Advance/ rewind		Press  to rewind,  to advance. Speed increases with each press, from 2x to 4x to 8x to 16x. If playback is paused, the movie rewinds or advances one frame at a time; keep the button pressed for continuous rewind or advance.
Adjust volume		Press  to increase volume,  to decrease.
Return to full-frame playback	 / 	Press  or  to exit to full-frame playback.

The Button

During movie playback and when playback is paused, you can advance and rewind by holding the  button and tilting the camera left or right ( 97).



Deleting Movies

To delete the current movie, press . A confirmation dialog will be displayed; press  again to delete the movie and return to playback, or press  to exit without deleting the movie. *Note that once deleted, movies can not be recovered.*

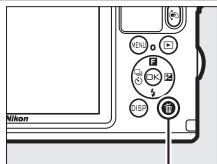

 button

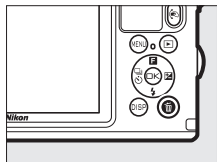

See Also

See page 150 for information on trimming unwanted footage from movies.

Frame size and frame rate options are described on page 175.

Recording Slow-Motion Movies

Silent slow-motion movies with an aspect ratio of 8 : 3 can be recorded by pressing **▲ (F)** in advanced movie mode and selecting **🎥+ Slow motion**. Slow-motion movies are recorded at 400 fps and play back at about 30 fps.

1 Select **🎥+** mode.

Press the MENU button to display the menus, then select **Shooting mode**, highlight **🎥+** (Advanced movie), and press **OK** (📖 10).

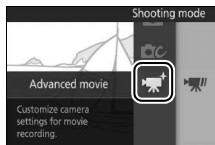

2 Select **Slow motion**.

Press **▲ (F)**, then highlight **Slow motion** and press **OK**.

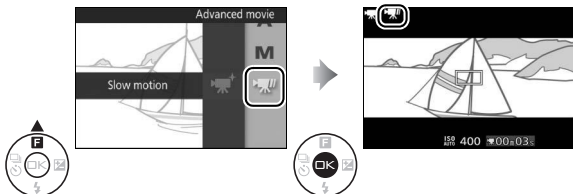

3 Frame the opening shot.

Frame the opening shot with your subject in the center of the display.

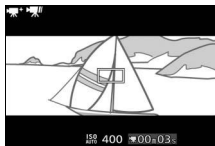

4 Focus.



Focus area

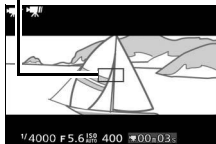

5 Start recording.

Press the movie-record button to begin recording. A recording indicator, the time elapsed, and the time available are displayed while recording is in progress. The camera focuses on the subject at the center of the display; face detection (34) is not available and focus and exposure can not be adjusted.

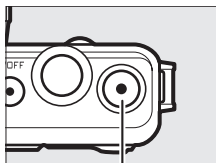

Movie-record button

*Recording indicator/
Time elapsed*

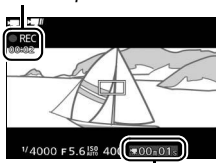

Time available

6 End recording.

Press the movie-record button again to end recording. Recording will end automatically when the maximum length is reached, the memory card is full, the lens is removed, or the camera becomes hot (☞ xxii).

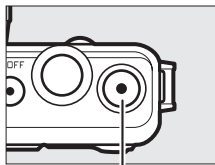

Movie-record button

Maximum Length

Up to 3 seconds of footage can be recorded; note that depending on memory card write speed, shooting may end before this length is reached (☞ 206).



Recording Movies

Flicker, banding, or distortion may be visible in the display and in the final movie under fluorescent, mercury vapor, or sodium lamps or if the camera is panned horizontally or an object moves at high speed through frame (flicker and banding can be reduced in HD movies by choosing a **Flicker reduction** option that matches the frequency of the local AC power supply as described on page 197, but note that the slowest shutter speed available is $\frac{1}{100}$ s at **50 Hz**, $\frac{1}{60}$ s at **60 Hz**; flicker reduction is not available with slow-motion movies). Bright light sources may leave after-images when the camera is panned. Jagged edges, color fringing, moiré, and bright spots may also appear. When recording movies, avoid pointing the camera at the sun or other strong light sources. Failure to observe this precaution could result in damage to the camera's internal circuitry.



The Movie Crop

The movie crop is shown in the monitor.

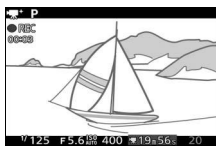

HD crop (16 : 9)

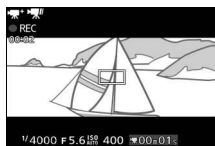



*Slow-motion movie crop
(8 : 3)*

See Also

Frame rate options are described on page 175.

Other Shooting Modes

In addition to the modes described above, the camera offers  (best moment capture) mode to help with hard-to-time shots and a  (Motion Snapshot) mode that combines photographs with brief movie vignettes (📖 83).



Choosing the Moment (Best Moment Capture)

View scenes in slow motion and choose the moment you want to keep (slow view) or let the camera choose the best shot (Smart Photo Selector).

Choosing Your Moment (Slow View)

When slow view is selected in  (best moment capture) mode, the camera captures a short sequence of still images and plays them back in slow motion so that you can choose the precise moment for a photograph.

1 Select mode.

Press the MENU button to display the menus, then select **Shooting mode**, highlight  (Best moment capture), and press  (📖 10).

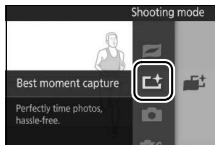

2 Select **Slow view**.

Press  (**F**), then highlight **Slow view** and press .

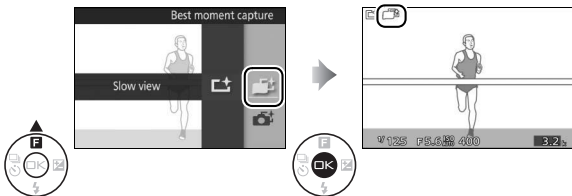

3 Frame the photograph.

Compose the photograph with your subject in the center of the frame.

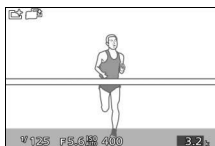

4 Press the shutter-release button halfway.

The camera will focus and then, over a span of about 1.3 s, record 20 frames to a temporary memory buffer, and then slowly play them back in a continuous loop while the shutter-release button is kept pressed halfway. A  icon is displayed in the monitor.



Progress indicator

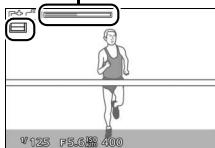

When the desired frame is displayed, press the shutter-release button the rest of the way down to record the current frame and discard the remaining images. The selected frame will be displayed for a few seconds when recording is complete. To delete the buffer contents and exit without recording a photograph, release the button without pressing it the rest of the way down.



Viewing and Deleting Photos Taken in Slow View

Photos taken in slow view can be viewed as described on page 31 or deleted as described on page 32.

Letting the Camera Choose the Moment (Smart Photo Selector)

Choose Smart Photo Selector mode to let the camera help you take photos that capture a fleeting expression on the face of a portrait subject or other hard-to-time shots such as group photos in party scenes. Each time the shutter is released, the camera automatically selects the best shot and a number of best shot candidates based on composition and motion. To use the Smart Photo Selector, press **▲ (F)** in best moment capture mode and select **Smart Photo Selector**.

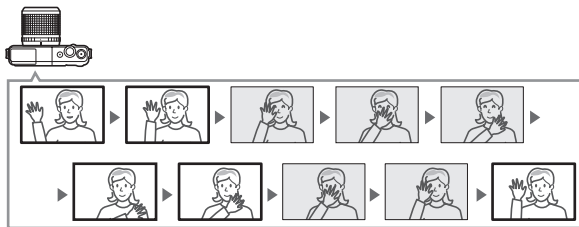

1 Select **☒** mode.

Press the MENU button to display the menus, then select **Shooting mode**, highlight **☒** (Best moment capture), and press **OK** (10).

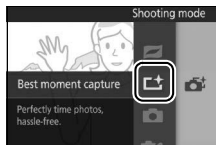

2 Select **Smart Photo Selector**.

Press **▲ (F)**, then highlight **Smart photo selector** and press **OK**.

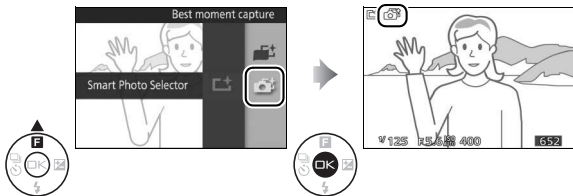

3 Frame the photograph.

Compose the photograph with your subject in the center of the frame.



4 Begin buffering photographs.

Press the shutter-release button half-way to focus (29). A  icon will be displayed as the camera begins recording images to the memory buffer. The camera continuously adjusts focus to account for changes in the distance to the subject while the shutter-release button is pressed halfway.



5 Shoot.

Smoothly press the shutter-release button the rest of the way down. The camera will compare shots recorded to the buffer both before and after the shutter-release button was pressed all the way down, and select five to copy to the memory card. Note that some time may be required. The best picture is displayed in the monitor when recording is complete.



Buffering

Buffering begins when the shutter-release button is pressed halfway and ends after about 90 seconds or when the shutter-release button is pressed all the way down.

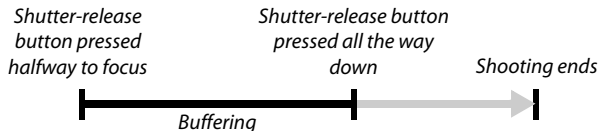

Smart Photo Selector Files

Do not delete the "NCSPSLST.LST" file from the "NCFL" folder on the memory card or change the file names of images taken with the Smart Photo Selector. The camera will no longer recognize the affected files as Smart Photo Selector images and will instead handle them as independent photographs.

Available Settings

For information on the options available in best moment capture mode, see page 215.

Best Moment Capture Mode



The camera automatically chooses a scene mode appropriate to the subject. Movies can not be recorded, and pressing the movie-record button has no effect. The flash can not be used.

See Also

Use the **Number of shots saved** option in the shooting menu to choose the number of shots selected by the Smart Photo Selector (📖 159).



■ Viewing Photos Taken with the Smart Photo Selector



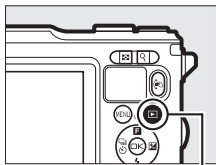

Press  and use the multi selector to display photographs taken with the Smart Photo Selector (see 31; pictures taken with the Smart Photo Selector are indicated by a  icon). Of the photographs recorded by the Smart Photo Selector, only the best shot will be displayed (when you press the multi selector right to view the next picture, the camera will skip over the best shot candidates, with the result that the next picture displayed will not have a file number that immediately follows that of the current picture). To end playback and return to shooting mode, press the shutter-release button halfway.



 button



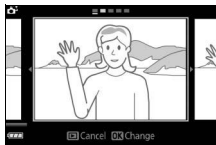

Choosing the Best Shot

When a photograph taken with the Smart Photo Selector is displayed, you can choose the best shot by pressing . Press  or  to view the other pictures in the sequence and press  to select the current picture as the best shot. To return to normal playback, press .



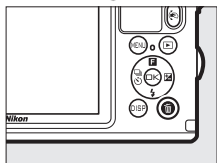
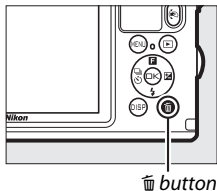

■ Deleting Pictures

Pressing  when a picture taken with the Smart Photo Selector is selected displays a confirmation dialog; press  again to delete the best shot and the best shot candidates, or press  to exit without deleting the pictures. *Note that once deleted, pictures can not be recovered.*



Deleting Individual Photographs

Pressing the  button in the best shot selection dialog displays the following options; highlight an option using the multi selector and press  to select.

- **This image:** Delete the current photo (note that the picture currently selected as the best shot can not be deleted).
- **All except best shot:** Delete the best shot candidates, but not picture currently selected as the best shot.

A confirmation dialog will be displayed; to delete the selected image or images, highlight **Yes** and press .

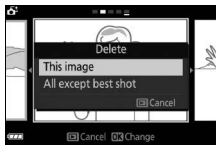

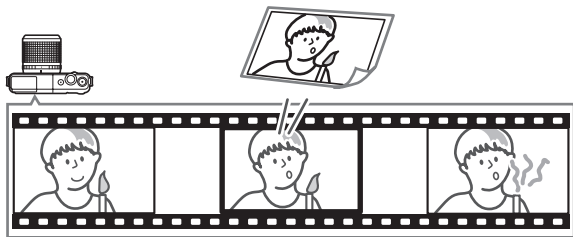

Combining Photos with Brief Movie Vignettes (Motion Snapshot Mode)

Record brief movie vignettes with your photographs. Each time the shutter is released, the camera records a still image and about 1.6 s of movie footage. When the resulting “Motion Snapshot” is viewed on the camera, the movie will play back in slow motion over approximately 4 s, followed by the still image; playback is accompanied by a background track about 10 s long.



1 Select mode.

Press the MENU button to display the menus, then select **Shooting mode**, highlight  (Motion Snapshot), and press  (10).

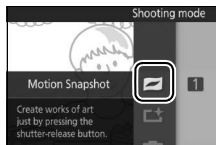

2 Frame the picture.

Compose the photograph with your subject in the center of the frame.



Available Settings

For information on the options available in Motion Snapshot mode, see page 215.

3 Begin buffering.

Press the shutter-release button half-way to focus (📖 29). A  icon will be displayed as the camera begins recording footage to the memory buffer.



4 Shoot.

Smoothly press the shutter-release button the rest of the way down. The camera will record a photograph, together with about 1.6 s of movie footage beginning before and ending after the time the shutter-release button was pressed all the way down. Note that some time may be required. When recording is complete, the photograph will be displayed for a few seconds.



Buffering

Buffering begins when the shutter-release button is pressed halfway and ends after about 90 seconds or when the shutter-release button is pressed all the way down.

*Shutter-release
button pressed
halfway to focus*

*Shutter-release button
pressed all the way
down*

Shooting ends



■ Choosing a Theme

To choose the background music for the movie, press ▲ (F) and use the multi-selector and (OK) button to select from **Beauty, Waves, Relaxation, and Tenderness.**

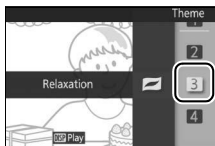

To play the background music for the highlighted theme, press DISP and use the Q and  buttons to raise and lower volume.

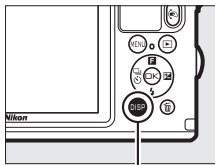

DISP button







Motion Snapshot Mode

Live audio is not recorded. Movies can not be recorded using the movie-record button and the flash can not be used.

See Also



See page 159 for information on choosing what portions of the buffer are included in the movie footage. For information on saving Motion Snapshots in a format that can be viewed in most movie playback software, see page 160.

Viewing Motion Snapshots

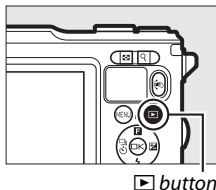
Press  and use the multi selector to display a Motion Snapshot ( 31; Motion Snapshots are indicated by a  icon). Pressing  when a Motion Snapshot is displayed plays back the movie portion in slow motion over a period of about 4 s, followed by the photo; the background track plays for about 10 s (to choose a new background track, use the **Change theme** option in the playback menu;  152). To view the movie portions of all Motion Snapshots, press  ( 123). To end playback and return to shooting mode, press the shutter-release button halfway.



Deleting Motion Snapshots

To delete the current Motion Snapshot, press . A confirmation dialog will be displayed; press  again to delete the photo and movie and return to playback, or press  to exit without deleting the file. *Note that once deleted, Motion Snapshots can not be recovered.*

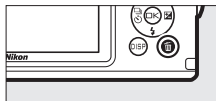
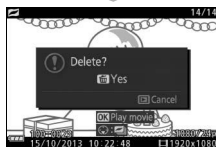
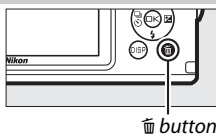

More on Photography

This section describes other features you can use when taking pictures.

Continuous Mode

In continuous (burst) mode, the camera takes pictures while the shutter-release button is pressed all the way down.

1 Display release mode options.

Press ◀ (📷) to display release mode options.



2 Select a frame rate.

Highlight the desired frame rate and press (OK). Frame rate is expressed in terms of the number of frames recorded per second (fps); choose from frame rates of approximately 5, 15, 30, and 60 fps (**5 fps**, **15 fps**, **30 fps**, and **60 fps**, respectively).

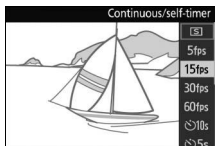

3 Compose the shot and start shooting.

The camera takes pictures while the shutter-release button is pressed all the way down.





✔ Continuous Mode

The maximum number of shots that can be taken in a single burst varies with the release mode. At frame rates of 30 and 60 fps, the maximum number of shots that can be taken in a single burst is 20.

The built-in flash can be used when **5 fps** is selected, but only one picture will be taken each time the shutter-release button is pressed; at settings of 15, 30, and 60 fps, the built-in flash will not fire.

While photographs are being recorded to the memory card, the memory card access lamp will light. Depending on shooting conditions and memory card write speed, recording may take some time. If the battery is exhausted before all photographs are recorded, the shutter release will be disabled and the remaining images transferred to the memory card.

Continuous shooting is not available in creative modes other than **P, S, A, M**, or  (underwater; , ) in best moment capture, advanced movie, or Motion Snapshot mode, or when live image control is used in auto mode (□ 35).

✎ Buffer Size

The camera is equipped with a memory buffer for temporary storage, allowing shooting to continue while photographs are being saved to the memory card. The approximate number of images that can be stored in the memory buffer at current settings is displayed while the shutter-release

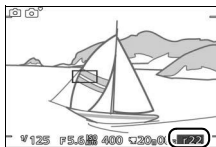

button is pressed halfway (this number is an approximation only and varies with shooting conditions; □ 220). The illustration shows the display when space remains in the buffer for about 22 pictures.

✎ Single Frame

To take only one picture each time the shutter-release button is pressed all the way down, select  (single frame, the default option) for **Continuous/self-timer**.



Self-Timer Modes

The self-timer is used to delay shutter release until 10, 5, or 2 seconds after the shutter-release button is pressed all the way down.

1 Display release mode options.

Press ◀ (📷) to display release mode options.



2 Select the desired self-timer option.

Use the multi selector to highlight ⌚ 10 s, ⌚ 5 s, or ⌚ 2 s and press (OK).

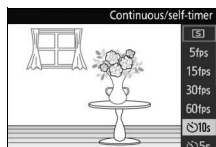

3 Mount the camera on a tripod.

Mount the camera on a tripod or place the camera on a stable, level surface.

4 Frame the photograph and shoot.

Press the shutter-release button half-way to focus, and then press the button the rest of the way down. The self-timer lamp will start to flash and a beep will begin to sound. Two seconds before the photo is taken, the lamp will stop flashing and the beeping will become more rapid.



Note that the timer may not start or a photograph may not be taken if the camera is unable to focus or in other situations in which the shutter can not be released. Turning the camera off cancels the self-timer.

Movie Mode

In self-timer mode, start and stop the timer by pressing the movie-record button instead of the shutter-release button.

Raising the Flash

If additional lighting is required, press the flash pop-up button to raise the flash before shooting. Shooting will be interrupted if the flash is raised while the timer is counting down.

See Also

For information on controlling the beeps that sound when the self-timer is used, see page 194.

Exposure Compensation

Exposure compensation is used to alter exposure from the value suggested by the camera, making pictures brighter or darker.



-1 EV



No compensation



+1 EV

1 Display exposure compensation options.

Press **▶** (**☒**) to display exposure compensation options.



2 Choose a value.

Use the multi selector to choose from values between -3 EV (underexposure) and $+3$ EV (overexposure) in increments of $\frac{1}{3}$ EV. In general, positive values make the image brighter while negative values make it darker.

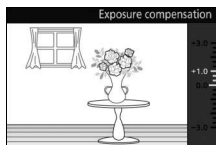

Normal exposure can be restored by setting exposure compensation to ± 0 . If **P**, **S**, **A**, or **☒** (underwater; **∞**, **☒**) is selected in creative mode, exposure compensation will not be reset when the camera is turned off.



✍ Exposure Compensation

Exposure compensation is most effective when used with center-weighted or spot metering (☒ 160).

✍ The Built-in Flash

When used with the built-in flash, exposure compensation affects both background exposure and flash level.

The Built-in Flash

Use the built-in flash for additional lighting when the subject is poorly lit or to “fill-in” (illuminate) back-lit subjects.

1 Raise the flash.

Press the flash pop-up button to raise the flash.

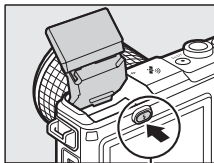

Flash pop-up button

2 Choose a flash mode (☰ 93).

Press ▼ (⚡) on the multi selector to display a list of flash modes, then use the multi selector to highlight the desired mode and press OK to select.

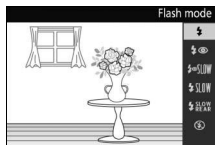





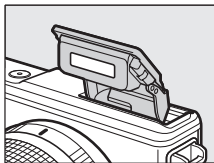









3 Take pictures.

Charging begins when the flash is raised; once charging is complete, a flash-ready indicator (⚡) will be displayed when the shutter-release button is pressed halfway.



Flash Modes

The options available vary with the shooting mode.



-  (fill flash): The flash fires with every shot.
-  (red-eye reduction): Use for portraits. The flash fires with every shot, but before it fires, the red-eye reduction lamp lights to help reduce “red-eye.” Not available in  (underwater; , ) mode.
-  SLOW (red-eye reduction + slow sync): As for “red-eye reduction”, above, except that shutter speed slows automatically to capture background lighting at night or under low light. Use when you want to include background lighting in portraits. Available only in modes **P** and **A**.
-  SLOW (fill flash + slow sync): As for “fill flash”, above, except that shutter speed slows automatically to capture background lighting at night or under low light. Use when you want to capture both subject and background. Available only in modes **P**, **A**, and  (underwater; , ) .
-  SLOW REAR (rear curtain + slow sync): As for “rear-curtain sync”, below, except that shutter speed slows automatically to capture background lighting at night or under low light. Use when you want to capture both subject and background. Available only in modes **P**, **A**, and  (underwater; , ) .
-  REAR (rear-curtain sync): The flash fires just before the shutter closes, creating a stream of light behind moving light sources as shown below at right. Available only in modes **S** and **M**.



Front-curtain sync



Rear-curtain sync

-  (off): The flash does not fire. Available only when built-in flash is raised; not available in  (night portrait) mode or when HDR is disabled in  (backlighting) mode.

✓ Raising the Flash

When using the flash, be sure it is fully raised as shown at right. Do not touch the flash during shooting.

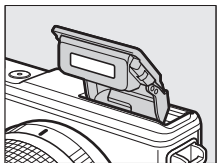



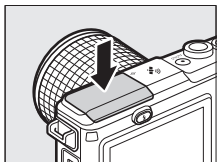

✎ Lowering the Built-in Flash

To save power when the flash is not in use, press it gently downward until the latch clicks into place. *Do not use force.* Failure to observe this precaution could result in product malfunction.



✎ Preventing the Built-in Flash from Firing

Lowering the flash prevents it firing. Except in  (night portrait) mode or when HDR is disabled in  (backlighting) mode ( 46), the flash can also be turned off by selecting a flash mode of .



Using the Built-in Flash

The built-in flash can not be used with live image control (□ 35) and will not fire during continuous shooting at frame advance rates faster than 5 fps (□ 87) or when **On** is selected for **HDR** in the shooting menu (□ 46). If the flash is fired multiple times in quick succession, the flash and shutter may be temporarily disabled to protect the flash. Shooting can be resumed after a brief pause.

Objects close to the camera may be overexposed in photographs taken with the flash at high ISO sensitivities. Note that the product is not shockproof (□ xiv) when the flash is raised.

To avoid vignetting, remove lens hoods. Even without a lens hood, some lenses may cause vignetting or obstruct the red-eye reduction lamp, interfering with red-eye reduction. The following illustrations show the effect of vignetting caused by shadows cast by the lens when the built-in flash is used.

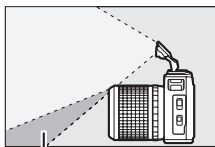

Shadow

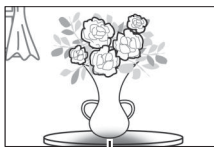

Shadow

After using the built-in flash in dusty or sandy locations, remove any foreign matter from inside the flash compartment using a blower (or, if this fails, using the technique described on page 60) before lowering the flash. Failure to observe this precaution could damage the flash.

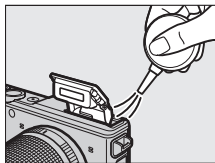

See Also

See page 173 for information on adjusting flash level.

Aperture, Sensitivity, and Flash Range

Flash range varies with sensitivity (ISO equivalency) and aperture. With the standard zoom lens at maximum aperture and ISO sensitivity set to ISO 160 to 6400, the range is approximately 0.6 m–7.0 m (2 ft–23 ft) when the lens is zoomed all the way out, 0.6 m–4.2 m (2 ft–13.8 ft) at maximum zoom.

The (Action) Button

Some operations can be performed by keeping the  button pressed and tilting the camera left or right.

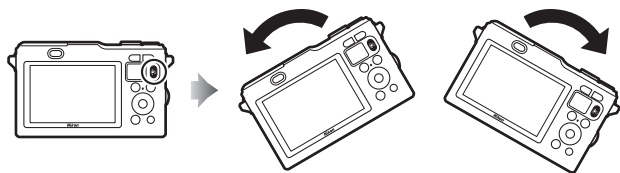

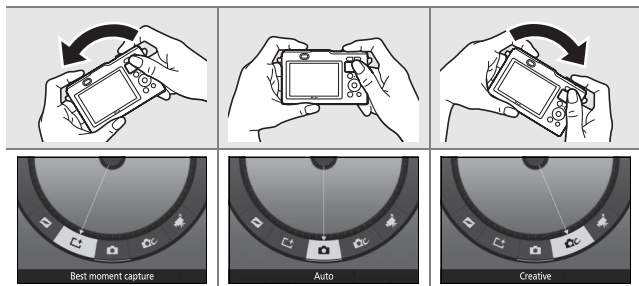

Shooting: Choosing a Shooting Mode

While the view through the lens is displayed, you can choose the shooting mode by pressing the  button, tilting the camera left or right to highlight the desired mode, and releasing the button to select the highlighted option.





To exit without changing settings, tilt the camera forward or back so that no option is highlighted when the  button is released.

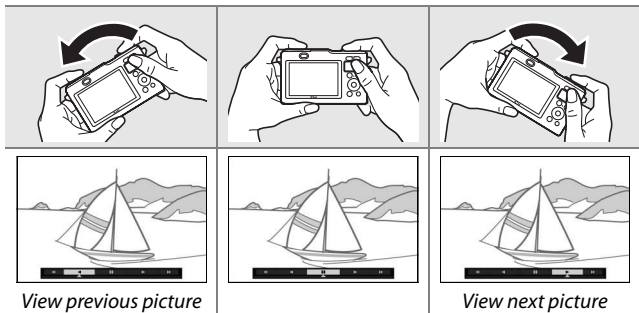

Playback: Scrolling Through Pictures

During playback, you can choose the picture displayed by pressing the  button, tilting the camera left or right, and releasing the button to display the selected picture full frame (in thumbnail playback, the camera will display and scroll through pictures full frame while the  button is pressed, and then when the button is released return to thumbnail playback with the selected picture highlighted).



Tilt the camera sharply to jump ahead or back 10 pictures. During movie playback, you can press the  button and tilt the camera to advance or rewind ( 71; speed increases the more you tilt the camera). When movie playback is paused, you can press the  button and tilt the camera to advance or rewind a frame at a time; playback pauses again when the button is released.



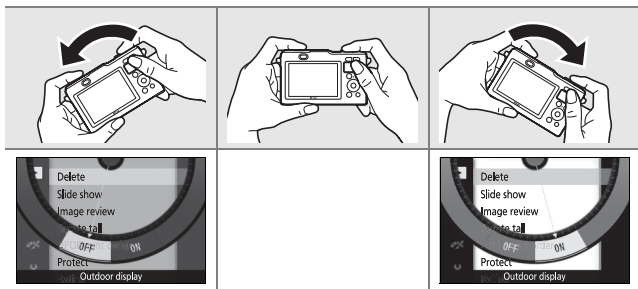

Menus: Outdoor Display

When menus are displayed, you can toggle the outdoor display on or off by pressing the  button, tilting the camera left or right, and releasing the button to select the current mode. Enabling the outdoor display makes the display easier to read outdoors or wherever ambient lighting is bright by setting the **Display brightness** and **High contrast display** options in the **Display** menu to **Hi** and **On**, respectively ( 194), but also increases the drain on the battery.



To exit without changing settings, tilt the camera forward or back so that no option is highlighted when the  button is released.

The Button

Hold the camera securely when using the  button. Controls other than the shutter-release and  buttons and the power switch can not be used while the  button is pressed. The  button can not be used to view NMS format Motion Snapshots or for playback zoom, calendar or panorama playback, or Smart Photo Selector shot selection.

The WU-1b Wireless Mobile Adapter

Attach an optional WU-1b wireless mobile adapter to the camera USB connector to copy images to, or control the camera from, smartphone or tablet devices running the Wireless Mobile Utility app.

1 Connect the WU-1b.

After removing the rubber cap from the WU-1b USB connector, turn the camera off, then unlock (1), unlatch (2), and open (3) the connector cover and attach the adapter to the camera USB connector.

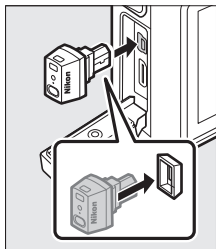
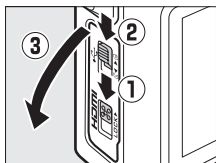

2 Activate the adapter.

Select **Wireless mobile adapter** in the setup menu. A confirmation dialog will be displayed; select **Yes** to activate the WU-1b, allowing wireless connection to smart devices, or **No** to deactivate the WU-1b and prevent wireless connection.

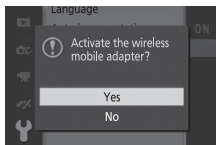

Using the WU-1b for the First Time

After connecting the WU-1b, you will need to adjust smart device wireless settings. See the WU-1b manual for more information.

3 Launch the Wireless Mobile Utility.

Launch the Wireless Mobile Utility on the smart device.

4 Take pictures remotely.

Once a wireless connection is established, the smart device will display the view through the camera lens; the camera will display a message stating that a wireless connection is active.

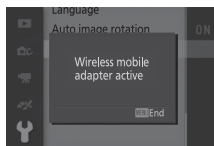

Wireless Networks

Camera settings can not be adjusted while the camera is connected to a wireless network. To end the connection, press the MENU button.

The Wireless Mobile Utility

The Wireless Mobile Utility is available from Google Play and the App Store. System requirements and Information on installation, wireless connections and use may be found in the Wireless Mobile Utility manual available in pdf format from the following URL:

<http://nikonimglib.com/ManDL/WMAU/>



Location Data and Other Indicators

The camera is equipped with a built-in virtual horizon display and altimeter/depth gauge, electronic compass, and location data (GPS/GLONASS) functions that can be used to create logs tracking depth or position. The information shown below can be displayed by pressing the DISP button in the detailed shooting info display (□ 7).

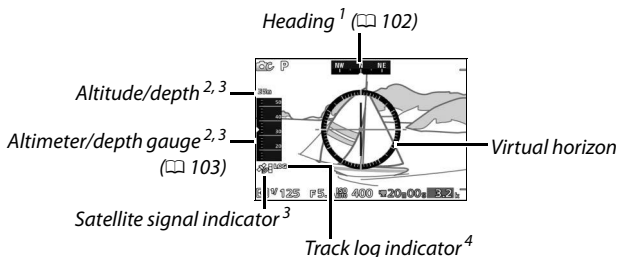

- 1 The heading display changes to a compass circle when the lens is pointed down. 
- 2 Information displayed varies with option selected for **Altitude/depth options** > **Altimeter/depth gauge** (□ 196).
- 3 Displayed if **Yes** is selected for **Location data** > **Record location data** (□ 104).
- 4 Displayed while track log is active (□ 110).

Heading

Except when the camera is oriented with the lens pointing directly upward, the heading provided by the built-in electronic compass is recorded with all pictures taken with 1 NIKKOR AW 11–27.5mm f/3.5–5.6 and 1 NIKKOR AW 10mm f/2.8 lenses. Headings are approximations only and are not intended for navigation: accuracy drops with other lenses and may be affected by the presence of magnets, metal objects, electronic equipment, and power lines. The camera may also be unable to provide accurate headings underground or inside a vehicle or building. The compass can be calibrated as described on page 114.

The Virtual Horizon

The camera uses a built-in accelerometer to show the amount the camera is tilted left or right (roll), in increments of 5°. The reference line turns green when the camera is level.

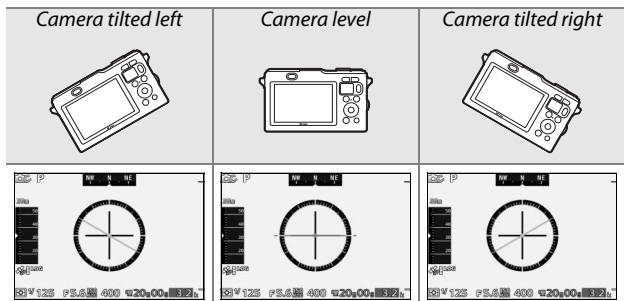

The accuracy of the display drops when the camera is angled sharply forward or back. If the angle is so sharp that the camera is unable to measure tilt, tilt increments will not be displayed.



Altitude and Depth

Depending on the option selected for **Altitude/depth options** > **Altimeter/depth gauge** in the setup menu (☰ 196), the camera displays and records either altitude or depth when **Yes** is selected for **Location data** > **Record location data** (☰ 104).

Altitude

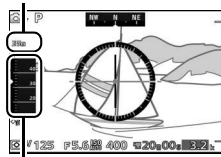

Altimeter

Depth

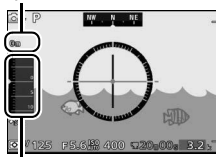

Depth gauge

The altimeter can show altitudes from 500 m (1640 ft) below sea level to 4500 m (14,760 ft) above, the depth gauge depths up to 20 m (65.6 ft).



The Altimeter/Depth Gauge

The altimeter and depth gauge report approximate values only and are not intended as replacements for specialized altimeters and diving gauges. Altitude in particular is measured using air pressure and may vary with atmospheric conditions.

Depths over 15 m (49 ft) are shown in red.



Location Data

The photo information embedded in pictures taken while the location data function is enabled will contain a record of the camera's current position (latitude, longitude, and altitude or depth) and the current time (UTC), obtained from satellite navigation systems (GPS/GLONASS) by the built-in location data unit and altimeter/depth gauge. The location data function works best in locations that offer an unobstructed view of the sky; before using the location data function, be sure the camera clock is set to the correct time and date (📖 198).

1 Select Location data.

Press the MENU button to display the menus, then highlight **Location data** in the setup menu and press ►.

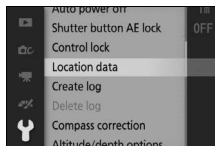

2 Select Record location data.

Highlight **Record location data** and press ►.

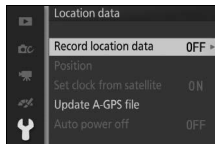

3 Select Yes.

Highlight **Yes** and press  to enable the camera's built-in location data unit. The camera will begin receiving location data from navigation satellites.

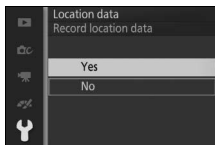

4 Check satellite signal strength.

Press the shutter-release button half-way to exit the menus and check satellite signal status in the shooting info display. Location will only be recorded if the camera is receiving signals from at least three satellites.







5 Take pictures.

The current heading and location will be recorded with each picture taken. See page 115 for information on viewing location data.



The Satellite Signal Indicator

Signal strength is shown in the information display as follows:

- : Location recorded based on data from four or more satellites.
- : Location recorded based on data from three satellites.
- : One or two satellites detected; location not recorded.
- : No satellites detected.

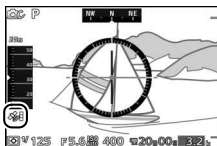

Location Data



Before using the location data function, read the warnings on page xviii.

Local geographic and atmospheric conditions may prevent or delay the acquisition of location data. The camera may be unable to receive location data or may report its location incorrectly indoors, underground, under water, or in metal containers or the vicinity of high-voltage transmission lines, large structures, trees, or other objects that block or reflect satellite signals. Pay attention to your footing and surroundings when looking for locations with good reception. The positions of navigation satellites are continuously changing, preventing or delaying the acquisition of location data at certain hours of the day. The presence of cellular telephones or other devices that produce magnetic fields or that cause radio noise or transmit on frequencies close to those of navigation satellites may also interfere with the acquisition of location data.

Note that the camera may take some time to acquire a signal immediately after the battery is inserted or when the location data function is enabled for the first time, after an extended period of disuse, or after the camera has been moved a great distance from the position in which location data were last received. Location data for photographs recorded in continuous release modes are for the first frame in each sequence. Note that when the location data function is enabled, the camera will continue to receive location data for a limited time even when off, increasing the drain on the battery. To prevent the camera turning off unexpectedly, make sure the battery is charged.

Location data provided by satellite navigation systems are accurate to within a few hundred meters. Depending on the accuracy of the data acquired from the satellite system and the effects of local topography on satellite reception, the location data recorded with pictures may differ from the actual location.

Viewing Location Data

During playback, pictures taken with the location data function enabled are indicated by a  icon. The data can be viewed in the playback photo info display ( 115) or plotted on a map using the supplied ViewNX 2 software ( 133). Note that the playback photo info display shows the time and date of recording as reported by the camera clock; the camera can not be used to view the time and date at which the location data were acquired.



Location Data Options

The **Location data** item in the setup menu provides access to the following options:

- **Record location data:** Select **Yes** to record the current position when a picture is taken (☞ 104). Latitude and longitude are provided by the camera's location data function, and altitude or depth by the altimeter/depth gauge.
- **Position:** View the current latitude, longitude, altitude, and time reported by the built-in location data unit and altimeter, the expiry date for the current assisted GPS (A-GPS or aGPS) file, and the current heading reported by the electronic compass. The location data unit reports the current UTC standard time independent of the time given by the camera clock.
- **Set clock from satellite:** Select **Yes** to synchronize the camera clock with the time reported by the location data unit.
- **Update A-GPS file:** Load an updated A-GPS file from the memory card (☞ 108).
- **Auto power off:** Select **Disable** to prevent the camera powering off automatically while the location data function is on. If **Enable** is selected, the monitor will turn off automatically if no operations are performed for the time selected for **Auto power off** in the setup menu (☞ 22), reducing the drain on the battery.



■ ■ Updating the A-GPS File

Using assisted GPS (A-GPS or aGPS) files reduces the time needed for the built-in location data unit to determine the current position. Assisted GPS files can be updated as described below.

1 Download the latest assisted GPS file.

Download the current assisted GPS file from the following URL:

<http://nikonimglib.com/agps3/>

2 Copy the file to the memory card.

Insert the memory card in a card reader or card slot and copy the file to the "NCFL" folder in the root directory of the memory card (if the folder does not already exist, create a new folder and name it "NCFL").

3 Insert the memory card in the camera.

4 Turn the camera on.

5 Select Update A-GPS file.

In the camera setup menu, select **Location data**, then highlight **Update A-GPS file** and press ►.

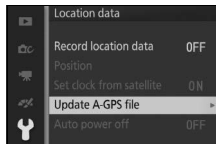

6 Update the data.

Highlight **Yes** and press  to update the assisted GPS file. The update takes about two minutes.

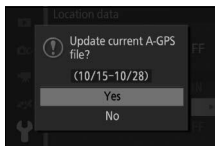

Expiry Date

Assisted GPS files remain valid for about two weeks after download and can not be used after their expiry date (an error message will be displayed if you attempt to use an out-of-date file). To view the expiry date for the current assisted GPS file, select **Location data** > **Position** ( 107). Update assisted GPS files before using the location data function; expired files can not be used to assist the acquisition of location data. Assisted GPS files do not assist the acquisition of location data from GLONASS satellites.



Track Logs

The camera can create logs tracking either position or depth. Data are recorded automatically at preset intervals and saved to track log files stored separately from the pictures taken with the camera. The supplied ViewNX 2 software can then be used to view the track on a map (📖 133).

Before starting a log, select **Yes** for **Location data** > **Record location data** in the setup menu (📖 104) and choose the appropriate option for **Altitude/depth options** > **Altimeter/depth gauge** (📖 57): choose **Altimeter** to track position, **Depth gauge** to track depth.

1 Select Create log.

In the setup menu, highlight **Create log** and press ►.

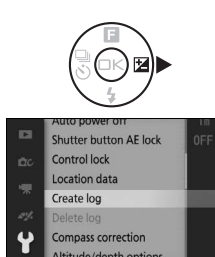

2 Choose the log type.

Highlight one of the following options and press \odot :

- **Start location data log:** Track your position (latitude, longitude, and UTC; altitude is not tracked).
- **Start depth log:** Track your depth (latitude, longitude, and UTC are not tracked).

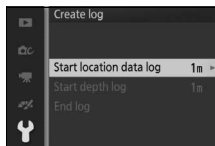

3 Choose how often data are recorded.

Highlight the desired log interval and press **OK**.

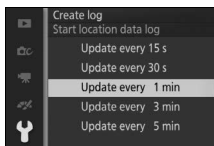

4 Choose the log length.

To choose the length of time over which data will be logged, highlight the desired option and press **OK** to start the log (note that the options available for position and depth logs differ). The camera will continue to log the position or depth at the selected interval even when off; when the camera is on, a **LOG** (**LOG**) icon appears in the display.

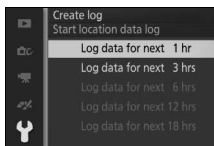

5 End the log.

The camera will automatically end the log when the selected length is reached. To end the log earlier, highlight **Create log** in the setup menu and press **▶**, then highlight **End log** and press **▶**.

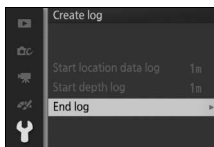

6 Save the log.

Highlight **Save log** and press **OK** to save the log to the memory card (to exit without saving it to the memory card, select **Erase log**).

Logs

Logs can only be created if the camera clock is set. When tracking is active, the camera continues to monitor its position or depth even when off; tracking only ends when the specified log length is reached, the battery is exhausted or removed, **End log > Erase log** is selected for **Create log** in the setup menu, or **No** is selected for **Location data > Record location data** in the setup menu (note that no data will be added to location data logs while the camera is unable to receive location data). To prevent logs ending prematurely, be sure the camera battery is fully charged before starting.

Data logged while tracking is active are temporarily recorded to camera memory; new logs can not be created until the current log has been saved to the memory card or erased. After recording a log, be sure to save it to the memory card.

Copying Logs to a Computer

Logs are stored in the NCFL folder on the memory card and have names consisting of "N" followed by the log date (expressed as a six-digit number in the form yymmdd), a single-character identifier from 0 to Z assigned in ascending order by the camera, and the extension ".log" (location data logs) or ".lgb" (depth logs); thus the first location data log recorded on October 15 2013 will be named "N1310150.log". To copy the files to a computer, insert the memory card in a card reader or card slot and transfer the files using Nikon Transfer 2. Note that although the log files produced by the camera conform to the NMEA standard, they may not display correctly in some applications or on some devices.

See Also

Logs can be deleted from the memory card using the **Delete log** option in the setup menu (☐ 113).



Deleting Logs

Follow the steps below to delete logs from the memory card when they are no longer needed.

1 Select Delete log.

In the setup menu, highlight **Delete** and press **▶**.

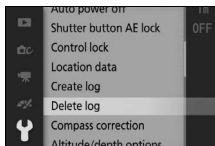

2 Select a log type.

Highlight one of the following options and press **⊙**.

- **Select location data log:** Delete a selected location data log.
- **Select depth log:** Delete a selected depth log.
- **All logs:** Delete all location data and depth logs (proceed to Step 4).

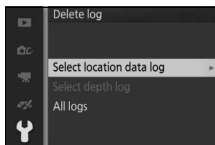

3 Select a log.

Highlight a log and press **⊙**.

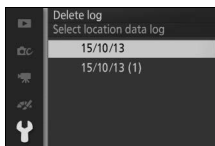

4 Delete the log.

Highlight **Yes** and press **⊙** to delete the log.

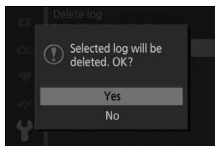

Calibrating the Electronic Compass

If the electronic compass does not give the correct heading, calibrate it as described below. The lens must be attached when the compass is calibrated.

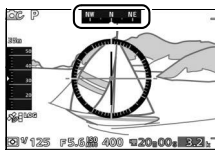

1 Select Compass correction.

In the setup menu, highlight **Compass correction** and press ►.

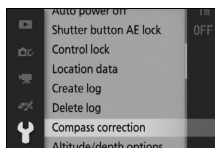

2 Calibrate the compass.

Move the camera in a figure eight while rotating it as shown below.

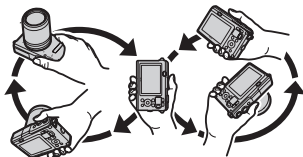

The setup menu will be displayed when calibration is complete. If calibration fails, the message shown at right will be displayed. Try calibrating the compass outdoors.

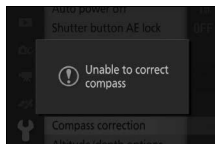

More on Playback

Photo Information

Photo information is superimposed on images displayed in full-frame playback (31). The information displayed can be selected by pressing the DISP button to cycle through the simple photo info, detailed photo info, and image only displays as described on page 7.

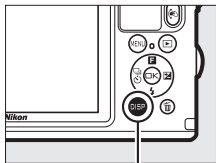

DISP button

■ Simple Photo Info

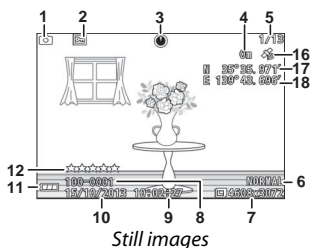

Still images

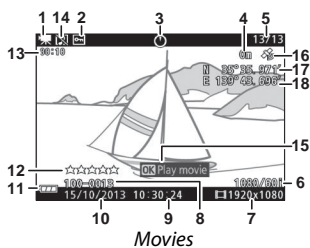

Movies

1 Shooting mode	8 Folder number-file number	117
2 Protect status.....	9 Time of recording	146
3 Heading.....	10 Date of recording.....	24, 198
4 Altitude	11 Battery indicator	103, 196
Depth.....	12 Rating	57, 103, 196
5 Frame number/total number of images	13 Movie length.....	122
6 Image quality.....	14 Audio recording indicator	70
Frame rate	15 On-screen guide (for movies)	196
7 Image size.....	16 Location data icon.....	104
Frame size.....	17 Latitude.....	104
	18 Longitude	104

■ Detailed Photo Info

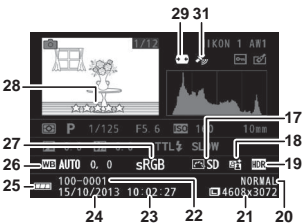
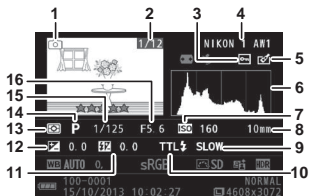

Still images

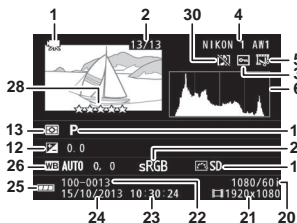

Movies

1 Shooting mode	15 Shutter speed	41, 43
2 Frame number/total number of images	16 Aperture.....	42, 43
3 Protect status.....	17 Picture Control	184
4 Camera name	18 Active D-Lighting indicator.....	163
5 Retouch indicator	19 HDR indicator	46
Movie edit indicator	20 Image quality.....	156
6 Histogram showing distribution of tones in image	Frame rate	175
7 ISO sensitivity	21 Image size.....	156
8 Focal length	Frame size.....	175
9 Flash mode	22 Folder number-file number	117
10 Flash control.....	23 Time of recording	24, 198
11 Flash compensation.....	24 Date of recording.....	24, 198
12 Exposure compensation	25 Battery indicator	27
13 Metering	26 White balance.....	178
14 Creative mode	White balance fine-tuning	179
Best moment capture selection....	27 Color space.....	162
Advanced movie selection	28 Rating	122
Exposure mode	29 Auto distortion control.....	161
	30 Audio recording indicator	176
	31 Location data indicator	104

Folder and File Numbers

Photographs are stored as files with names containing a four-digit number between 0001 and 9999 assigned automatically in ascending order by the camera. These in turn are stored in folders containing up to 999 images. A new folder is created automatically file numbering reaches 9999 or the number of images in the current folder reaches 999.

Folder number 100-0001 File number

Histograms (📖 116)

Camera histograms are intended only as a guide and may differ from those in imaging applications. Sample histograms are shown below:

- **If brightness varies evenly across the image**, the distribution of tones will be relatively even.



- **If the image is dark**, tone distribution will be shifted to the left.



- **If the image is bright**, tone distribution will be shifted to the right.

















Exposure compensation shifts the distribution of tones to the right when raised, to the left when lowered. Histograms can give you a rough idea of overall exposure when bright ambient lighting makes it difficult to see the display in the monitor.

Thumbnail Playback



To view pictures in “contact sheets” of 4, 9, or 72 images, press the  button when a picture is displayed full frame.

The following operations can be performed:











To	Use	Description
Display more images		Press the  button to increase the number of images displayed from 1 to 4, from 4 to 9, or from 9 to 72. To view images taken on selected dates ( 119), press the  button when 72 images are displayed. 
Display fewer images		Press the  button to reduce the number of images displayed from 72 to 9 or 9 to 4. To view the highlighted image full frame, press the  button when 4 images are displayed. 
Highlight images		Use the multi selector to highlight images. You can delete ( 121) the highlighted image or zoom in for a closer look ( 120).
View highlighted image		Press  to view the highlighted image full frame.
Delete highlighted image		See page 121.

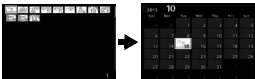

Calendar Playback

To view pictures taken on a selected date, press the  button when 72 pictures are displayed ( 118).







The following operations can be performed:

To	Use	Description
Display calendar		To view the calendar, press the  button when 72 images are displayed ( 118). 
Exit to thumbnail playback		To return to the 72-image display, press the  button when the calendar is displayed. 
Highlight date		Use multi selector to highlight date in calendar display.
View pictures taken on highlighted date		Press  to view the first picture taken on the highlighted date.
Delete pictures taken on highlighted date		Press  to delete all pictures taken on the highlighted date.

Playback Zoom

To zoom in on a photograph, display it full frame and press the **Q** button. Playback zoom is not available with movies or Motion Snapshots.

The following operations can be performed:

To	Use	Description
Zoom in		Press Q to zoom in,  to zoom out. Whenever you zoom in or out, a navigation window will appear with the area currently visible in the display indicated by a yellow border. Press ▲ , ▼ , ◀ , or ▶ to scroll the image.
Zoom out		
View other areas of image		
View faces		Faces (up to five) detected during face priority are indicated by white borders in the navigation window. Press ◀ or ▶ to view other faces.
Exit zoom		Return to full-frame playback.

See Also



The **Face-priority zoom** option in the playback menu (📖 150) is used to choose whether the multi selector to be used to scroll from face to face during face-priority zoom.



Deleting Pictures

Pictures can be deleted from the memory card as described below. *Note that once deleted, pictures can not be recovered; protected images, however, will not be deleted.*

Deleting the Current Picture

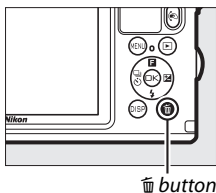

To delete the picture currently displayed in full-frame playback or selected in the thumbnail list, press . A confirmation dialog will be displayed; press  again to delete the picture and return to playback, or press  to exit without deleting the picture.



The Playback Menu

To delete multiple images, press the MENU button, select **Delete** in the playback menu, and choose from the options below. A confirmation dialog will be displayed; select **Yes** to delete the images (note that some time may be required if a large number of images is selected).



Delete selected images	Highlight images and press  or  to select or deselect (145). Press  to exit when the selection is complete.
Delete all images	Delete all pictures on the memory card.

Rating Pictures

Rate pictures or mark them as candidates for later deletion. Rating is not available with protected images.

1 Select a picture.

Display a picture in full-frame playback.

2 Rate the picture.

Press ▲ (F) to view the rating display and then press Q or [] to choose a rating. Choose from ratings of zero to five stars, or select [] to mark the picture as a candidate for later deletion.

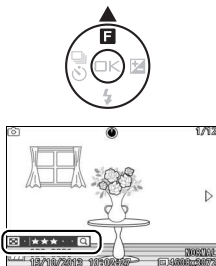

Slide Shows

To view a slide show of the pictures on the memory card, press the **MENU** button, select **Slide show** in the playback menu, and follow the steps below.

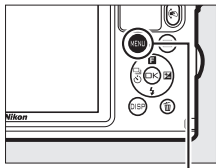

MENU button

1 Select the type of image used in the show.

Highlight the desired option and press **OK**.

All images	Display all the images on the memory card.
Still images	Display still images only. Images taken using Easy panorama will be displayed in panorama mode (□ 49).
Movies	Display movies and Motion Snapshots recorded with MOV file selected for File format (□ 160).
Motion Snapshot	Display Motion Snapshots recorded with NMS files selected for File format (□ 160). Only the movie portion will be played; the associated photographs are not displayed.
Select images by date	Display only images recorded on a selected date. A calendar will be displayed; use the multi-selector to highlight a date. 
Selected scene	Display only photos belonging to a specific scene. Choose from Auto , Portrait , Landscape , Underwater , Night landscape , Night portrait , Backlighting , Close-up , Easy panorama , Soft , Miniature effect , and Selective color .
Face priority	Display only images in which the camera has detected a face (□ 34).

2 Adjust display times and choose a background track.

Adjust the following options:

Frame interval	Choose how long each still image is displayed.
Movie playback time	Choose how much of each movie is played back before the next slide is displayed. Choose Same as frame interval to display the next slide after the time selected for Frame interval , No limit to play back the entire movie before displaying the next slide.
Audio	<p>Mute audio playback or choose a slide show background track (to play the highlighted background track prior to selection, press DISP and use the Q and OK buttons to raise or lower volume; to end playback, press DISP again).</p> <p>Select Movie sound tracks to play only audio recorded with movies; in this case, no sound is played for still images or Motion Snapshots.</p>

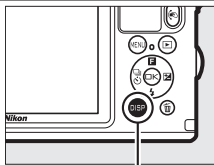

DISP button







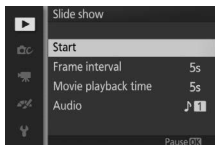



3 Select Start.

Highlight **Start** and press  to start the slide show.



The following operations can be performed while a slide show is in progress:

To	Use	Description
Skip back/skip ahead		Press  to return to the previous frame,  to skip to the next frame.
Pause/resume		Pause the show. To resume, highlight Resume and press  .
Adjust volume		Press  to increase volume,  to decrease.
Exit to playback mode		End the show and return to playback mode.

The options shown at right are displayed when the show ends. Select **Resume** to restart or **Exit** to exit to the playback menu.

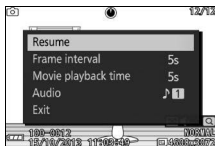

Connections

Installing the Supplied Software

Install the supplied software to copy pictures to your computer for viewing and editing pictures and creating short movies. Before installing the software, confirm that your system meets the requirements on page 128.

1 Launch the installer.

Start the computer, insert **1** *Select region (if required)*

the ViewNX 2/Short Movie Creator installer CD, and launch the installer. A language-selection dialog will be displayed; if the desired language is not available, click **Region Selection** to choose a different region and then choose the desired language (region selection is not available in the European release).



2 Start the installer.

Click **Install** and follow the on-screen instructions.



3 Exit the installer.

Click **Yes** (Windows) or **OK** (Mac OS) when installation is complete.



*Click **Yes***



*Click **OK***

The following software is installed:

- ViewNX 2
- Short Movie Creator

4 Remove the installer CD from the CD-ROM drive.

Supplied Software

Be sure to update to the latest versions of the supplied software. Nikon Message Center 2 will periodically check for updates while the computer is connected to the Internet.



System Requirements

The system requirements for ViewNX 2 are:

Windows	
CPU	<ul style="list-style-type: none">• Photos: Intel Celeron, Pentium 4, Core Series; 1.6 GHz or better• Movies (playback): Pentium D 3.0 GHz or better; Intel Core i5 or better recommended when viewing movies with a frame size of 1280 × 720 or more at a frame rate of 30 fps or above or movies with a frame size of 1920 × 1080 or more• Movies (editing): Intel Core i5 or better
OS	Pre-installed versions of Windows 8, Windows 7, Windows Vista, or Windows XP; note that 64-bit versions of Windows XP are not supported
Memory (RAM)	<ul style="list-style-type: none">• 32-bit Windows 8, Windows 7, or Windows Vista: 1 GB or more (2 GB or more recommended)• 64-bit Windows 8, Windows 7, or Windows Vista: 2 GB or more (4 GB or more recommended)• Windows XP: 512 MB or more (2 GB or more recommended)
Hard disk space	A minimum of 1 GB available on the startup disk (3 GB or more recommended)
Graphics	<ul style="list-style-type: none">• Resolution: 1024 × 768 pixels (XGA) or more (1280 × 1024 pixels or more recommended)• Color: 24-bit color (True Color) or more

Mac OS	
CPU	<ul style="list-style-type: none">• Photos: Intel Core or Xeon series• Movies (playback): Core Duo 2 GHz or better; Intel Core i5 or better recommended when viewing movies with a frame size of 1280 × 720 or more at a frame rate of 30 fps or above or movies with a frame size of 1920 × 1080 or more• Movies (editing): Intel Core i5 or better
OS	OS X 10.8 or 10.7; Mac OS X 10.6
Memory (RAM)	<ul style="list-style-type: none">• OS X 10.8 or 10.7: 2 GB or more (4 GB or more recommended)• Mac OS X 10.6: 1 GB or more (4 GB or more recommended)
Hard disk space	A minimum of 1 GB available on the startup disk (3 GB or more recommended)
Graphics	<ul style="list-style-type: none">• Resolution: 1024 × 768 pixels (XGA) or more (1280 × 1024 pixels or more recommended)• Color: 24-bit color (millions of colors) or more



The system requirements for Short Movie Creator are:

Windows	
CPU	2 GHz intel Core 2 Duo or better
OS	Pre-installed versions of Windows 8, Windows 7, Windows Vista, and Windows XP; note that 64-bit versions of Windows XP are not supported
RAM	1.5 GB or more with at least 128 MB of video RAM (2 GB or more with at least 256 MB of video RAM recommended for creating HD movies)
Hard-disk space	A minimum of 500 MB available on the startup disk (1 GB or more recommended)
Graphics	<ul style="list-style-type: none">• Resolution: 1024 × 768 pixels (XGA) or more• Color: 32-bit color (True Color) or more
Other	DirectX 9 or later and OpenGL 1.4 or later

Mac OS	
CPU	2 GHz intel Core 2 Duo or better
OS	OS X 10.8 or 10.7; Mac OS X 10.6
RAM	1 GB or more
Hard-disk space	A minimum of 500 MB available on the startup disk (1 GB or more recommended)
Graphics	<ul style="list-style-type: none">• Resolution: 1024 × 768 pixels (XGA) or more• Color: 24-bit color (millions of colors) or more

If your system does not meet the above requirements, only ViewNX 2 will be installed (☞ 128).

Motion Snapshots

ViewNX 2 is required to view Motion Snapshots saved using the **File format > NMS files** option in the shooting menu (☞ 160).

Supported Operating Systems

See the websites listed on page xxiii for the latest information on supported operating systems.

Viewing and Editing Pictures on a Computer

Transferring Pictures

1 Choose how pictures will be copied to the computer.

Choose one of the following methods:

- **Direct USB connection:** Turn the camera off and ensure that the memory card is inserted in the camera. Unlock (1), unlatch (2), and open (3) the connector cover and then connect the camera to the computer using the supplied USB cable (do not use force or insert the connectors at an angle) and then turn the camera on.

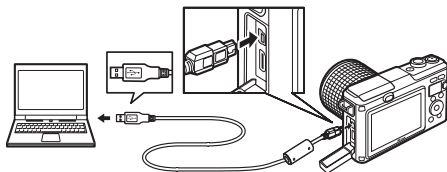
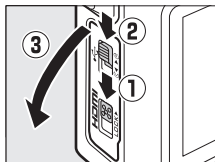

- **SD card slot:** If your computer is equipped with an SD card slot, the card can be inserted directly in the slot.
- **SD card reader:** Connect a card reader (available separately from third-party suppliers) to the computer and insert the memory card.



2 Start the Nikon Transfer 2 component of ViewNX 2.

If a message is displayed prompting you to choose a program, select Nikon Transfer 2.

Windows 7

If the following dialog is displayed, select Nikon Transfer 2 as described below.

- 1 Under **Import pictures and videos**, click **Change program**. A program selection dialog will be displayed; select **Import File using Nikon Transfer 2** and click **OK**.

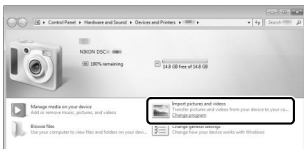

- 2 Double-click **Import file**.

3 Click Start Transfer.

At default settings, all the pictures on the memory card will be copied to the computer.



Click **Start Transfer**

4 Terminate the connection.

If the camera is connected to the computer, turn the camera off and disconnect the USB cable. If you are using a card reader or card slot, choose the appropriate option in the computer operating system to eject the removable disk corresponding to the memory card and then remove the card from the card reader or card slot.

Viewing Pictures

Pictures are displayed in ViewNX 2 when transfer is complete.

Starting ViewNX 2 Manually

- **Windows:** Double-click the ViewNX 2 shortcut on the desktop.
- **Mac OS:** Click the ViewNX 2 icon in the Dock.

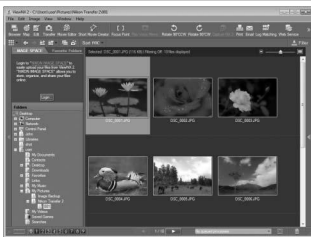

Retouching Photographs

To crop pictures and perform such tasks as adjusting sharpness and tone levels, click the **Edit** button in the toolbar.



Creating Short Movies

Use the Short Movie Creator to create short movies combining photos, music, Motion Snapshots, and movie footage (134).

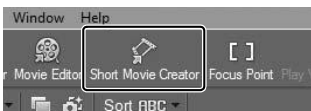

Printing Pictures

Click the **Print** button in the toolbar. A dialog will be displayed, allowing you to print pictures on a printer connected to the computer.

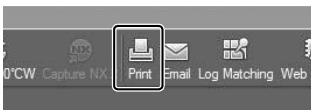

■ Viewing Location Data

To view the locations where pictures were taken (📖 104) or map track logs (📖 110), click the **Map** button in the ViewNX 2 toolbar.



For More Information

Consult online help for more information on using ViewNX 2.

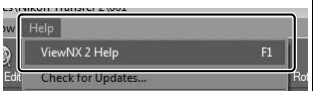

Creating Short Movies

Use the supplied Short Movie Creator software to create movies combining photographs with Motion Snapshots, movies, and music.

1 Transfer pictures.

Transfer pictures as described on page 130.

2 Select components.

Select pictures in ViewNX 2.

3 Start Short Movie Creator.

Click the **Short Movie Creator** button in ViewNX 2.



The images selected in Step 2 will be displayed in the Short Movie Creator “Components” panel; if desired, additional pictures can be dragged into the “Components” panel from ViewNX 2 and re-ordered using drag and drop. In the case of photos taken with the Smart Photo Selector, only the best shot will be displayed. The photo and movie components of Motion Snapshots appear as separate files.

“Components” panel



4 Select a style and background track.

Select a style in the “Styles” panel and a background track in the “Music” panel. To preview the movie, click  .

5 Save the movie.

Click **Create Movie**. The dialog shown at right will be displayed; select one of the following options and click **Create**.

- **Save file:** Save the movie to a folder on the computer.
- **Save to Camera (memory card):** Save the movie to a memory card so that it can later be played back on the camera. To use this option, you will first need to insert a memory card that has been formatted in the camera (📖 193) into a card reader or card slot.

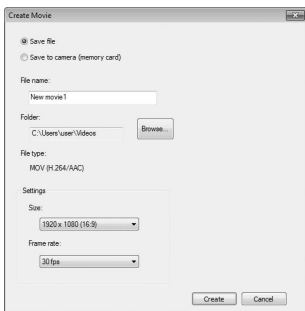

Starting Short Movie Creator

If ViewNX 2 is not running, you can start Short Movie Creator by double-clicking the **Short Movie Creator** icon on the desktop (Windows) or clicking the **Short Movie Creator** icon in the Dock (Mac OS).

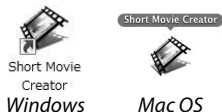

Viewing Short Movies on Other Devices

Movies saved to a memory card using the **Save to Camera (memory card)** option in Short Movie Creator can be viewed on the camera, or displayed on a television monitor when the camera is connected to a TV (📖 136). Movies created in other applications or using the **Save file** option in Short Movie Creator can not be viewed on the camera.

For More Information

Consult online help for more information on using Short Movie Creator.

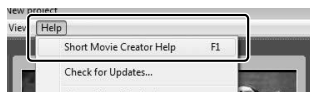

Viewing Pictures on TV

Connect the camera to a television for playback.

Connecting an HDMI Cable

Always turn the camera off before connecting or disconnecting HDMI cables. When connecting cables, do not use force or attempt to insert the connectors at an angle.

High-Definition Devices

A type C mini-pin High-Definition Multimedia Interface (HDMI) cable (available separately from third-party suppliers) can be used to connect the camera to high-definition video devices.

1 Turn the camera off and open the connector cover.

Turn the camera off and unlock (1), unlatch (2), and open (3) the connector cover.

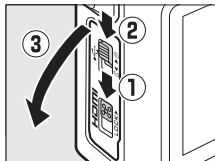

2 Connect the HDMI cable.

Connect the cable as shown.

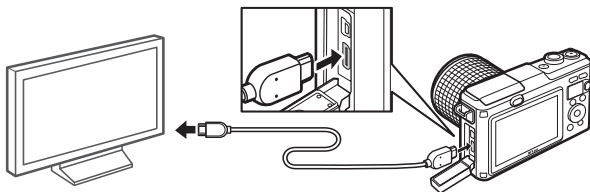

Connect to HD device
(choose cable with
appropriate connector)

Connect to camera

3 Tune the device to the HDMI channel.



4 Turn the camera on.

Turn the camera on; the camera monitor will remain off and the camera shooting mode display will appear on the HD device. Pictures can be played back using camera controls as described elsewhere in this manual; note that the edges of images may not be visible in the display.

Close the Connector Cover



Close the connector cover when the connectors are not in use. Foreign matter in the connectors can interfere with data transfer.

Television Playback

Volume can be adjusted using the controls on the television; adjusting volume on the camera has no effect. Use of an EH-5b AC adapter and EP-5C power connector (available separately) is recommended for extended playback.

■ HDMI Device Control

To control the camera remotely from a device that supports HDMI-CEC (High-Definition Multimedia Interface–Consumer Electronics Control), select **On** for **HDMI device control** in the camera setup menu. The HDMI-CEC device will display a remote control guide and the remote control can be used in place of the following camera controls:

Camera	Remote control
	Up, down, left, and right buttons
	Center button
	Blue button
MENU	Red button
Slide show menu	Green button

The remote control guide can be hidden or displayed at any time by pressing the yellow button on the remote control. See the television manual for details.

Printing Photographs

Selected JPEG images can be printed on a PictBridge printer connected directly to the camera.

Connecting the Printer

Connect the camera using the supplied USB cable.

1 Turn the camera off and open the connector cover.

Turn the camera off and unlock (1), unlatch (2), and open (3) the connector cover.

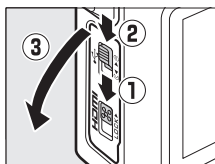

2 Connect the USB cable.

Turn the printer on and connect the USB cable as shown. Do not use force or attempt to insert the connectors at an angle.

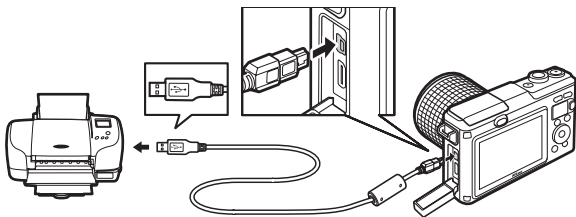

USB Hubs

Connect the camera directly to the printer; do not connect the cable via a USB hub.

3 Turn the camera on.

A welcome screen will be displayed in the monitor, followed by a PictBridge playback display.



Printing Via Direct USB Connection

Be sure the EN-EL20 battery is fully charged or use an optional EH-5b AC adapter and EP-5C power connector.



Printing Pictures One at a Time



1 Select a picture.

Press ◀ or ▶ to view additional pictures. Press the Q button to zoom in on the current frame (□ 120; press the  button to exit zoom). To view nine pictures at a time, press the  button when a picture is displayed full frame. Press ▲, ▼, ◀, or ▶ to highlight pictures, or press the Q button to display the highlighted picture full frame.

2 Adjust print options.

Press  to display PictBridge print options (□ 141). Press ▲ or ▼ to highlight options and press ▶ to select.

3 Start printing.

Highlight **Start printing** and press  to start printing. To cancel before all copies have been printed, press  again.



Selecting Photographs for Printing

Movies and NEF (RAW) photographs (□ 156) can not be selected for printing. If Motion Snapshots are selected, only the photographs will be printed; the movie portion will not be printed. If photographs taken with the Smart Photo Selector are selected, only the best shot will be printed.

Panoramas

Some printers may not print panoramas, while at some settings others may not print entire panoramas. See the printer manual or consult the manufacturer for details.

Printing Multiple Pictures

1 Display the PictBridge menu.

Press the MENU button in the PictBridge playback display (see Step 3 on page 138).

2 Choose an option.

Highlight one of the following options and press ►.

- **Select images for printing:** Select pictures for printing.
 - **Print DPOF print order:** Print an existing print order created with the **DPOF print order** option in the playback menu (□ 142). The current print order will be displayed in Step 3.
 - **Index print:** To create an index print of all JPEG pictures on the memory card, proceed to Step 4. Note that if the memory card contains more than 256 pictures, a warning will be displayed and only the first 256 images will be printed.
-

3 Select pictures.



Press ◀ or ▶ to highlight pictures. To select the current picture for printing, press ▲. The number of prints will be set to 1; press ▲ or ▼ to specify the number of prints (up to 99; to deselect the picture, press ▼ when the number of prints is 1). Continue until all the desired pictures have been selected.

4 Adjust print options.

Press  to display PictBridge print options. Press ▲ or ▼ to highlight page size, border, or time stamp items and press ► to display the options described on page 141; note that a warning will be displayed if the selected page size is too small for an index print.



5 Start printing.















Highlight **Start printing** and press  to start printing. To cancel before all copies have been printed, press  again.



Errors

See page 228 for information on what to do if an error occurs during printing.

PictBridge Print Options

Page size	Highlight a page size (only sizes supported by the current printer are listed) and press  to select and exit to the previous menu (to print at the default page size for the current printer, select Use printer settings).
Number of copies	This option is listed only when pictures are printed one at a time. Press  or  to choose number of copies (maximum 99), then press  to select and return to the previous menu.
Print border	This option is listed only if supported by the printer. Highlight Use printer settings (use current printer settings), Yes (print white borders), or No (no borders) and press  to select and exit to the previous menu.
Print time stamp	Highlight Use printer settings (use current printer settings), Yes (print times and dates of recording on photos), or No (no time stamp) and press  to select and exit to the previous menu.
Crop	This option is listed only when pictures are printed one at a time on a printer that supports cropping. To exit without cropping, highlight No and press  . To crop the current picture, highlight Yes and press  . A crop selection dialog will be displayed; press  to increase the size of the crop,  to decrease. Press  ,  ,  , or  to position the crop and press  . Note that print quality may drop if small crops are printed at large sizes.

Creating a DPOF Print Order: Print Set

The **DPOF print order** option is used to create digital “print orders” for PictBridge-compatible printers and devices that support DPOF. Press the MENU button, select **DPOF print order** in the playback menu, and choose from the following options:

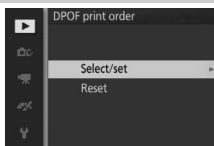

Select/
set

Press ◀ or ▶ to highlight pictures (📄 145). To select the current picture for printing, press ▲. The picture will be marked with a 📄 icon and the number of prints will be set to 1; press ▲ or ▼ to specify the number of prints (up to 99; to deselect the picture, press ▼ when the number of prints is 1). When the selection is complete, press Ⓞ to display printing options. Highlight **Print shooting info** (print the shutter speed and aperture on all pictures in the print order) or **Print date** (print the date of recording on all pictures in the print order) and press ▶ to select or deselect, and then press Ⓞ to complete the print order.

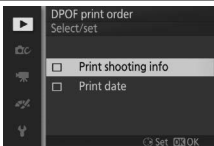

Reset

Remove all pictures from the print order.

☑ DPOF Print Order

DPOF date and shooting info options are not supported when printing via direct USB connection; to print the date of recording on photographs in the current print order, use the PictBridge **Print time stamp** option (📄 141).

The **DPOF print order** option can not be used if there is not enough space on the memory card to store the print order. For restrictions on the types of images that can be selected for printing, see page 139.

Print orders may not print correctly if images are deleted using a computer or other device after the print order is created.



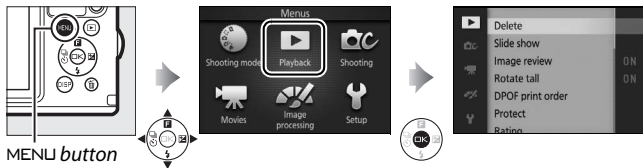

The Playback Menu

To display the playback menu, press MENU and select **Playback**.



The playback menu contains the following options:

Option	Description	Default	
Delete	Delete multiple images.	—	121
Slide show	View movies and photos in a slide show.	Image type: All images Selected scene: Auto Frame interval: 5 s Movie playback time: Same as frame interval Audio: Background track 1	123
Image review	Choose whether pictures are displayed after shooting.	On	146
Rotate tall	Rotate “tall” (portrait-orientation) pictures for display during playback.	On	146
DPOF print order	Create digital “print orders”.	—	142
Protect	Protect pictures from accidental deletion.	—	146
Rating	Rate pictures.	—	146
D-Lighting	Brighten shadows in dark or back-lit photos, creating a retouched copy that is saved separately from the unmodified original.	—	147
Resize	Create small copies of selected pictures.	Choose size: 1280×856; 1.1 M	148

Option	Description	Default	
Crop	Create cropped copies of selected pictures.	Aspect ratio: 3 : 2	149
Face-priority zoom	Choose whether ◀ and ▶ can be used during playback zoom ( 120) to select faces detected with face priority.	On	150
Edit movie	Create copies of movies from which unwanted footage has been trimmed.	—	150
Change theme	Change the themes for existing Motion Snapshots.	—	152

Playback

The camera may be unable to display or retouch images that were created or have been edited with other devices.

Image Quality

Copies created from JPEG photos are the same quality as the original, while copies created from NEF (RAW) photos are saved as fine-quality JPEG images ( 156).



Selecting Multiple Images

Choosing the options listed below displays an image selection dialog. Press ◀ or ▶ to highlight pictures (only pictures to which the operation applies are available for selection).

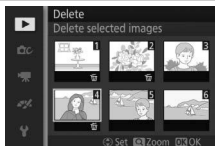

- **Delete > Delete selected images** (📖 121)
- **DPOF print order > Select/set** (📖 142)
- **Protect > Select/set** (📖 146)
- **D-Lighting** (📖 147)
- **Crop > Select images** (📖 149)
- **Change theme** (📖 152)
- **Rating** (📖 146)
- **Resize > Select images** (📖 148)
- **Edit movie** (📖 150)

🔍 Inspecting Pictures

The picture currently highlighted in the thumbnail display can be inspected by pressing the Q button; except in the cases of **DPOF print order**, **Rating**, and **Change theme**, the picture will be displayed full screen while the button is pressed.



Image Review

If **On** is selected, pictures will be displayed immediately after shooting. To view pictures when **Off** is selected, press the  button.



Rotate Tall

Choose whether to rotate “tall” (portrait-orientation) pictures for display during playback. Note that because the camera itself is already in the appropriate orientation during shooting, images are not rotated automatically during image review.

On	“Tall” (portrait-orientation) pictures are automatically rotated for display in the camera monitor. Pictures taken with Off selected for Auto image rotation ( 199) will be displayed in “wide” (landscape) orientation.
Off	“Tall” (portrait-orientation) pictures are displayed in “wide” (landscape) orientation.







Protect

Protect selected images from accidental deletion. Note that this option does NOT protect files from deletion when the memory card is formatted ( 193).

Select/set	Press  or  to highlight pictures ( 145) and press  or  to select or deselect. Press  to exit when the operation is complete.
Reset	Remove protection from all pictures.



Rating

Press  or  to highlight pictures ( 145) and press  or  to choose a rating ( 122). Press  to exit when the operation is complete.

D-Lighting

Applied to selected images, D-Lighting creates copies that have been processed to brighten shadows. Use to retouch dark or backlit photographs.



Before



After

Press ◀ or ▶ to highlight an image (📖 145) and press Ⓞ to display the options shown at right. Press ▲ or ▼ to choose the amount of correction performed (the effect can be previewed in the display) and press Ⓞ to create a retouched copy.

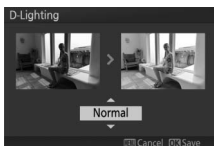

D-Lighting

Noise (randomly-spaced bright pixels, fog, or lines) may appear in copies created with **D-Lighting**. Uneven shading may be visible with some subjects.

Image Size

Copies created from JPEG photos are the same size as the original, while copies created from NEF (RAW) photos are saved as JPEG images with a size of 4608 × 3072.



Resize

Create small copies of selected photographs. Select **Choose size** and choose a size from **1280×856; 1.1M** (1280 × 856 pixels), **960×640; 0.6 M** (960 × 640 pixels), and **640×424; 0.3M** (640 × 424 pixels), and then choose **Select images**. Press ◀ or ▶ to highlight pictures (📖 145) and press ▲ or ▼ to select or deselect. When the selection is complete, press ⏹ to display a confirmation dialog and select **Yes** to save the resized copies.

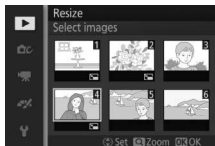

Resized Copies

Playback zoom may not be available with resized copies.



Crop

Create a cropped copy of selected photographs.

Select images To select an image for trimming, choose **Select images**, highlight a picture (□ 145), and press **OK**.

Aspect ratio Choose from aspect ratios of 3 : 2, 4 : 3, 1 : 1, and 16 : 9.

The selected image will be displayed with a default crop of the selected aspect ratio shown in yellow. Use the controls below to size and position the crop and save the copy.

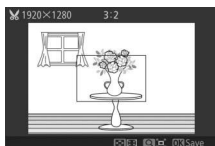

To	Use	Description
Decrease crop size		Press the button to decrease the size of the crop.
Increase crop size		Press the button to increase the size of the crop.
Position crop		Press , , , or to position the crop.
Create copy		Save the current crop as a separate file.



Cropped Copies

Playback zoom may not be available with cropped copies. The size of the copy varies with crop size and aspect ratio and appears at upper left in the crop display.

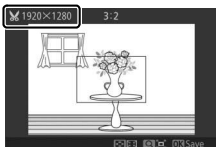

Face-Priority Zoom

If **On** is selected, ◀ and ▶ can be used during playback zoom to select faces detected with face priority. If **Off** is selected, ◀ and ▶ can be used with ▲ and ▼ to scroll the display.

Edit Movie

Trim footage from movies to create edited copies.

1 Choose an edit option.

Highlight one of the following options and press ▶:

- **Choose start point:** Remove all frames before a chosen starting frame.

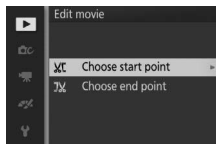
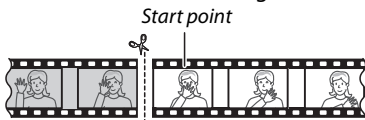

- **Choose end point:** Remove all frames after a chosen closing frame.

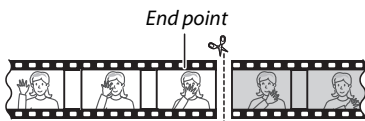







2 Select a movie.

Press ◀ or ▶ to highlight a movie (📖 145) and press Ⓞ to select.



3 Pause the movie on opening or closing frame.

Play the movie back, pressing  to begin and resume playback and  to pause (see 70; the first frame is indicated by a  icon in the display, the last frame by ). While playback is paused, press  or  to rewind or advance one frame at a time. Pause playback when you reach the frame that will become the new opening or closing frame.

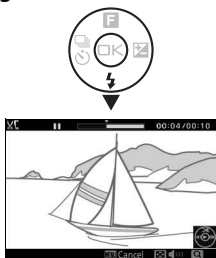

4 Delete the unwanted frames.

Press  to delete all frames before (**Choose start point**) or after (**Choose end point**) the current frame.



5 Save the copy.

Highlight **Yes** and press  to save the edited copy. If necessary, the copy can be trimmed as described above to remove additional footage.





Trimming Movies

Movies must be at least two seconds long. If a copy can not be created at the current playback position, the current position will be displayed in red in Step 4 and no copy will be created. The copy will not be saved if there is insufficient space available on the memory card.

To prevent the camera from turning off unexpectedly, use a fully-charged battery when editing movies.

Change Theme

Assign existing Motion Snapshots new themes (NMS-format files only; Motion Snapshots created with **MOV file** selected for **File format** in the shooting menu can not be assigned new themes). Choose from **Beauty**, **Waves**, **Relaxation**, **Tenderness**, and **None**. Highlight a Motion Snapshot and press  to display a list of themes (to play a theme, highlight it and press the DISP button; volume can be raised or lowered by pressing the Q or  button). Highlight the new theme and press . A confirmation dialog will be displayed; select **Yes** to save the selected Motion Snapshot with the new theme.

See Also

See page 160 for information on Motion Snapshot file formats.



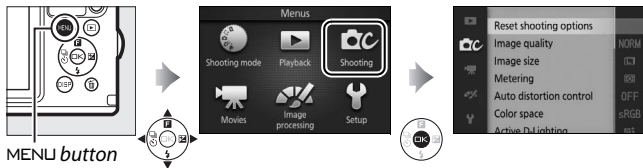

The Shooting Menu

To display the shooting menu, press **MENU** and select **Shooting**.



The shooting menu contains the following options:

Option	Description	Default	
Reset shooting options	Reset shooting options to default values.	—	155
Exposure mode	Choose how the camera sets shutter speed and aperture in Motion Snapshot mode (☐ 83).	Scene auto selector	155
Image quality	Choose a file format and compression ratio.	JPEG normal	156
Image size	Choose a size for new photos.	4608 × 3072; 14.2 M (standard photos)/ Normal panorama (panoramas)	156
Number of shots saved	Choose the number of shots selected by the Smart Photo Selector (☐ 78).	5	159
Movie before/after	Choose when the movie portion of Motion Snapshots is recorded (☐ 83).	1.0 s : 0.6 s	159
File format	Choose a file format for new Motion Snapshots (☐ 83).	NMS files	160
Metering	Choose how the camera meters exposure.	Matrix	160

Option	Description	Default	
Autodistortion control	Choose whether the camera corrects barrel and pin-cushion distortion (also applies during underwater shooting with special-purpose waterproof lenses;  56).	Off	161
Color space	Choose a color space for new pictures.	sRGB	162
Active D-Lighting	Avoid loss of detail in highlights and shadows.	On	163
HDR	Enhance detail in highlights and shadows when photographing high-contrast scenes with Backlighting selected in creative mode.	On	46
Long exposure NR	Reduce noise in long time-exposures.	Off	164
Optical VR	Adjust settings for 1 NIKKOR lenses with vibration reduction.	Active/On*	164
Electronic VR	Choose whether to use vibration reduction in Motion Snapshot mode ( 83). This feature is available even if vibration reduction is not offered by the attached 1 NIKKOR lens.	On	165
Focus mode	Choose how the camera focuses.	See page 166	165
AF-area mode	Choose how the focus area is selected.	Auto-area	170
Face-priority	Turn face priority on or off.	On	172
Built-in AF assist	Control the built-in AF-assist illuminator.	On	172
Flash control	Choose a flash mode for the built-in flash.	TTL (Manual : Full)	173
Flash compensation	Control flash output.	0.0	173

* Varies with lens ( 164).



Reset Shooting Options

Select **Yes** to reset the options in the shooting menu and other shooting settings to default values (☐ 153, 219).

Exposure Mode

The options in the exposure mode menu offer varying degrees of control over shutter speed and aperture in Motion Snapshot mode (☐ 83).

 Scene auto selector	An automatic, “point-and-shoot” mode in which the camera not only chooses shutter speed and aperture but adjusts other settings to suit the subject (automatic scene selection; ☐ 33).
P Programmed auto	The camera sets shutter speed and aperture for optimal exposure (☐ 40). Recommended for snapshots and in other situations in which there is little time to adjust camera settings.
S Shutter-priority auto	You choose the shutter speed; the camera selects an aperture for best results (☐ 41). Use to freeze or blur motion.
A Aperture-priority auto	You choose the aperture; the camera selects a shutter speed for best results (☐ 42). Use to blur the background or bring both foreground and background into focus.
M Manual	You control both shutter speed and aperture (☐ 43). Set shutter speed to “Bulb” for long time-exposures.

ISO Sensitivity (P, S, A, and M Modes)

When an “auto” option is selected for **ISO sensitivity** (☐ 183), the camera will automatically adjust sensitivity within the selected range if optimal exposure can not be achieved at the selected shutter speed or aperture.

Image Quality

Choose a file format and compression ratio for photographs.



Option	File type	Description
NEF (RAW)	NEF	Compressed 12-bit raw data from the image sensor are saved directly to the memory card. White balance, contrast, and other settings can be adjusted on a computer after shooting.
JPEG fine	JPEG	Record JPEG images at a compression ratio of roughly 1 : 4 (fine quality).
JPEG normal		Record JPEG images at a compression ratio of roughly 1 : 8 (normal quality).
JPEG basic		Record JPEG images at a compression ratio of roughly 1 : 16 (basic quality).
NEF (RAW) + JPEG fine	NEF/ JPEG	Two images are recorded: one NEF (RAW) image and one fine-quality JPEG image.

Image Size

Choose the size of photographs.

Standard Photographs

The following options are available in still image and Smart Photo Selector modes and when an option other than **Easy panorama** is selected in creative mode.



Option	Size (pixels)	Approximate print size at 300 dpi (cm/in.)*
 4608×3072; 14.2 M	4608 × 3072	39.0 × 26.0/15.4 × 10.2
 3456×2304; 8.0 M	3456 × 2304	29.3 × 19.5/11.5 × 7.7
 2304×1536; 3.5 M	2304 × 1536	19.5 × 13.0/ 7.7 × 5.1

* Print size in inches equals image size in pixels divided by printer resolution in dots per inch (dpi; 1 inch=approximately 2.54 cm).



■ Panoramas

The following options are available when **Easy panorama** is selected in creative mode.

Option	Size (pixels) ¹	Approximate print size at 300 dpi (cm/in.) ²
 Normal panorama	Camera panned horizontally: 4800 × 920	40.6 × 7.8/16.0 × 3.0
	Camera panned vertically: 1536 × 4800	13.0 × 40.6/5.1 × 16.0
 Wide panorama	Camera panned horizontally: 9600 × 920	81.3 × 7.8/32.0 × 3.1
	Camera panned vertically: 1536 × 9600	13.0 × 81.3/5.1 × 32.0

1 Figures for horizontal and vertical panorama are reversed if camera is rotated 90 degrees.

2 Print size in inches equals image size in pixels divided by printer resolution in dots per inch (dpi; 1 inch=approximately 2.54 cm).





NEF (RAW)/NEF (RAW) + JPEG

The option selected for image size does not affect the size of NEF (RAW) images. NEF (RAW) images can be viewed on the camera or using software such as Capture NX 2 (available separately;  202) or ViewNX 2 (supplied).

When photographs taken at NEF (RAW) + JPEG are viewed on the camera, only the JPEG image will be displayed. When photographs taken at these settings are deleted, both NEF and JPEG images will be deleted.

File Names

Photos and movies are stored as image files with names of the form “xxx_nnnn.yyy,” where:

- xxx is either NMS (Motion Snapshots recorded with **NMS files** selected for **File format**;  160) or DSC (photos, MOV-format Motion Snapshots, and movies, including copies created with **Edit movie**;  150),
- nnnn a four-digit number between 0001 and 9999 assigned automatically in ascending order by the camera, and
- yyy one of the following three letter extensions: “NEF” for NEF (RAW) images, “JPG” for JPEG images, or “MOV” for movies.



The NEF and JPEG files recorded at settings of NEF (RAW)+JPEG have the same file names but different extensions. Trimmed copies created with **Edit movie** ( 150) have file names beginning with “DSC”; copies created with the other retouch options in the playback menu have file names beginning with “CSC” (e.g., “CSC_0001.JPG”). Images recorded with **Adobe RGB** selected for **Color space** ( 162) have names that begin with an underscore (e.g., “_DSC0001.JPG”).

Image Quality and Size

Together, image quality and size determine how much space each photograph occupies on the memory card. Larger, higher quality images can be printed at larger sizes but also require more memory, meaning that fewer such images can be stored on the memory card ( 220).



Number of Shots Saved

Choose the number of shots selected by the Smart Photo Selector. If **5** is selected, the camera will save the best shot and 4 best shot candidates. If **1** is selected, the camera will save only the best shot.

Movie Before/After

Choose whether the movie portions of Motion Snapshots end when the shutter-release button is pressed all the way or about 0.6 s after (📖 83). If **1.6 s : 0 s** is selected, the photograph used for the Motion Snapshot will feature the last frame of the movie.

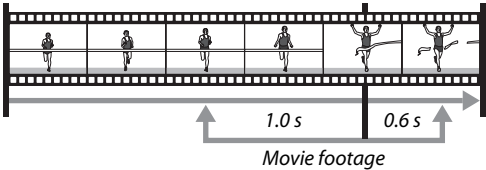
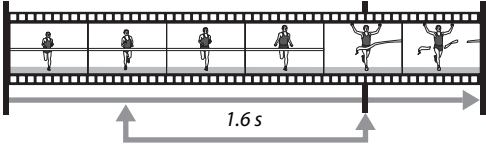
1.0 s : 0.6 s	<p>Movie footage starts about a second before the shutter-release button is pressed all the way down and ends about 0.6 s after.</p> <p><i>Shutter-release button pressed halfway</i> <i>Shutter-release button pressed all the way down</i></p> 
1.6 s : 0 s	<p>The camera records about 1.6 s of movie footage, ending when the shutter-release button is pressed all the way down.</p> <p><i>Shutter-release button pressed halfway</i> <i>Shutter-release button pressed all the way down</i></p> 

File Format

Choose the file format for Motion Snapshots (📖 83).

NMS files	Motion Snapshots are recorded as a 4 s MOV file and a JPEG image. Motion Snapshots can only be viewed on the camera or using ViewNX 2 (📖 128).
MOV file	Motion Snapshots are recorded as a 10 s MOV file that can be viewed in a variety of computer applications. The Motion Snapshot is not displayed automatically when shooting ends (📖 84); for information on viewing Motion Snapshot movies, see page 70.

Metering

Choose how the camera sets exposure.

<input checked="" type="checkbox"/> Matrix	The camera meters a wide area of the frame and adjusts for contrast (tone distribution), color, composition, and subject distance, producing natural results in most situations.
<input checked="" type="checkbox"/> Center-weighted	The camera meters the entire frame but assigns the greatest weight to the center area. This is the classic meter for portraits and is recommended if you are using filters with an exposure factor (filter factor) over 1×.
<input type="checkbox"/> Spot	The camera meters the current focus area; use to meter off-center subjects (if Auto-area is selected for AF-area mode as described on page 170, the camera will meter the center focus area, while during face priority the camera will meter the focus area closest to the center of the selected face; 📖 34). Spot metering ensures that the subject will be correctly exposed, even when framed against a background that is much brighter or darker.



Auto Distortion Control

Reduce distortion caused by the optical characteristics of the lens. The options available depend on the type of lens attached. The following options are available with special-purpose waterproof lenses:

On (above water)	Reduce barrel distortion in pictures taken with wide-angle lenses and pin-cushion distortion in pictures taken with long lenses.
On (underwater)	Reduce pin-cushion distortion in pictures taken underwater (📖 56).
Off	Auto distortion control off.

The following options are available with other 1 NIKKOR lenses:

On	Reduce barrel distortion in pictures taken with wide-angle lenses and pin-cushion distortion in pictures taken with long lenses.
Off	Auto distortion control off.

Auto distortion control is available only with 1 NIKKOR lenses and not with NIKKOR lenses attached using the FT1 mount adapter (📖 201, 243). Results are not guaranteed with third-party lenses. Note that when auto distortion control is enabled, the edges of photographs may be cropped out and there may be an increase in the time needed to process images before they are saved.



Color Space

The color space determines the gamut of colors available for color reproduction. Choose **sRGB** for general-purpose printing and display; **Adobe RGB**, with its broader gamut of colors, is more suited to shots destined for professional publication and commercial printing.

Adobe RGB

For accurate color reproduction, Adobe RGB images require applications, displays, and printers that support color management.

Color Space

ViewNX 2 (supplied) and Capture NX 2 (available separately) automatically select the correct color space when opening photographs created with this camera. Results can not be guaranteed with third-party software.



Active D-Lighting

Active D-Lighting preserves details in highlights and shadows for natural contrast. Use with high contrast scenes such as a brightly lit outdoor view framed in a door or window or a subjects in the shade on a sunny day. It is most effective when used with **Matrix** metering (☐ 160).



Active D-Lighting: **Off**



Active D-Lighting: ☑ **On**

☑ Active D-Lighting

Noise (randomly-spaced bright pixels, fog, or lines) may appear in photographs taken with Active D-Lighting. Uneven shading may be visible with some subjects.

✍ “Active D-Lighting” Versus “D-Lighting”

The **Active D-Lighting** option in the shooting menu adjusts exposure before shooting to optimize the dynamic range, while the **D-Lighting** option in the playback menu (☐ 147) brightens shadows in images after shooting.



Long Exposure NR

Photographs taken at slow shutter speeds are automatically processed to reduce “noise” (bright spots, randomly-spaced bright pixels, or fog), slightly increasing recording times. Selecting **On** increases the amount of noise reduction performed at shutter speeds slower than 1 s and increases the time required to record images by roughly 1.5 to 2 times. During processing, a warning will be displayed and pictures can not be taken (if the camera is turned off before processing is complete, the picture will be saved but noise reduction will not be performed). In continuous release mode, frame rates will slow and while photographs are being processed, the capacity of the memory buffer will drop.

Optical VR

This option is available with 1 NIKKOR lenses that support vibration reduction (VR). The options available vary with the type of lens: **Normal/Active/Off** for lenses that support active vibration reduction and **On/Off** for other VR lenses. Choose **Active, Normal**, or **On** to reduce the effects of vibration; choose **Active** when shooting from a moving vehicle or while walking or for other forms of strong camera shake, **Normal** for the relatively mild camera shake that occurs while standing still.

Vibration Reduction

When the camera is panned, vibration reduction applies only to motion that is not part of the pan (if the camera is panned horizontally, for example, vibration reduction will be applied only to vertical shake), making it much easier to pan the camera smoothly in a wide arc. The composition may appear to change after the shutter is released, but this does not indicate a malfunction.



Electronic VR

Select **On** to enable electronic vibration reduction while recording Motion Snapshots. This feature is available even if the attached 1 NIKKOR lens does not support vibration reduction. Note that there will be a slight delay before recording begins and that the edges of the image will be cropped out when **On** is selected.

Focus Mode

Choose how the camera focuses.

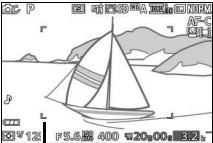
AF-A	Auto-select AF: The camera automatically selects AF-S if the subject is stationary, AF-C if it is moving.
AF-S	Single AF: For stationary subjects. Focus locks when the shutter-release button is pressed halfway.*
AF-C	Continuous AF: For subjects in motion. The camera focuses continuously on the subject in the AF-area brackets while the shutter-release button is pressed halfway (note that the AF-area brackets appear only in the detailed display; □ 7). Photos can be taken whether or not the camera is in focus. 
AF-F	Full-time AF: For subjects in motion. The camera focuses continuously; photos can be taken whether or not the camera is in focus.
MF	Manual focus: Focus manually (□ 168). Photos can be taken whether or not the camera is in focus.

* Shutter can only be released if camera is able to focus.



Focus Mode

The options available vary as shown below.

Menu		Focus mode
Shooting		AF-A (default), AF-S, AF-C, MF
Movies	P Programmed auto, S Shutter-priority auto, A Aperture-priority auto, M Manual	AF-F (default), AF-S, MF
	 Slow motion	AF-S (default), MF

See Also

See page 194 for information on controlling the beep that sounds when the camera focuses.



Getting Good Results with Autofocus

Autofocus does not perform well under the conditions listed below. The shutter release may be disabled if the camera is unable to focus under these conditions, or the focus area may be displayed in green and the camera may sound a beep, allowing the shutter to be released even when the subject is not in focus. In these cases, focus manually (☐ 168) or use focus lock (☐ 171) to focus on another subject at the same distance, and then recompose the photograph.

There is little or no contrast between the subject and the background.

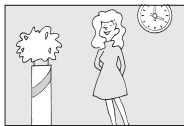

Example: The subject is the same color as the background.

The subject contains areas of sharply contrasting brightness.

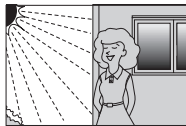

Examples: The subject is half in the shade; a night scene with point illumination.

The subject contains objects at different distances from the camera.



Example: The subject is inside a cage.

Background objects appear larger than the subject.



Example: A building is in the frame behind the subject.

The subject is dominated by regular geometric patterns.

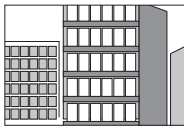

Example: Blinds or a row of windows in a skyscraper.

The subject contains many fine details or is made up of objects that are small or lack variation in brightness.

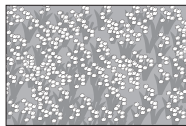

Example: A field of flowers.

The subject is partially obscured by floating particles.

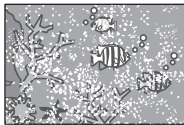

Example: Underwater photography.



Manual Focus

Manual focus can be used when autofocus does not produce the desired results.

1 Select manual focus.

Highlight **Manual focus** in the focus mode menu (📖 165) and press ►.

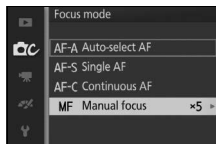

2 Choose a magnification.

Highlight an option and press . Choose from **10x zoom**, **5x zoom**, **2x zoom**, and **1x zoom** (zoom off).

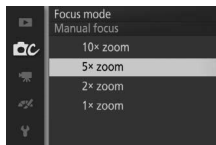

3 Display the manual focus guides.

In the shooting display, press to magnify the view at the center of the frame by the amount selected in Step 2 (this feature is not available during movie recording or in slow-motion movie mode). Manual focus guides are also displayed.



4 Focus.

Use the **Q** and **☒** buttons to focus. **☒** button
Press **Q** to increase the focus distance, **☒** to decrease. The focus indicator shows the approximate focus distance. Press **OK** when the subject is in focus.

Press **▲**, **▼**, **◀**, or **▶** to view areas of the frame not currently visible in the display; the visible portion is shown by the navigation window.

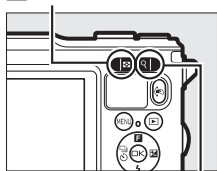

Q button

Focus indicator

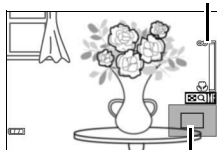

Navigation window

☒ Focal Plane Position

To determine the distance between your subject and the camera, measure from the focal plane mark on the camera body. The distance between the lens mounting flange and the focal plane is approximately 17 mm (0.7 in.).

Approx. 17 mm

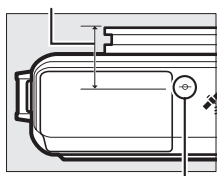

Focal plane mark



AF-Area Mode

Choose how the focus area for autofocus is selected.

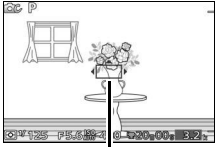
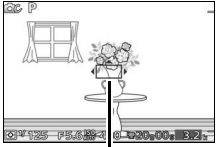
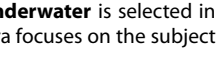
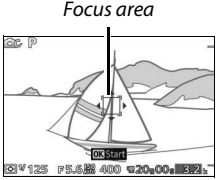
[] Auto-area	The camera automatically detects the subject and selects the focus area.	 <p>The image shows a camera's viewfinder with a focus area selection display. A vertical line with a small square at the top indicates the selected focus area, which is centered on a subject (a person holding a basket) in the center of the frame. The background includes a window and some foliage. Below the viewfinder, the text "Focus area" is written.</p>
[r1] Single-point *	Press OK to view the focus area selection display, then use the multi selector to position the focus area over your subject and press OK ; the camera focuses on the subject in the selected focus area only. Use with stationary subjects.	 <p>The image shows a camera's viewfinder with a focus area selection display. A vertical line with a small square at the top indicates the selected focus area, which is centered on a subject (a person holding a basket) in the center of the frame. The background includes a window and some foliage. Below the viewfinder, the text "Focus area" is written.</p>
[r1] Single-point (center)	This option is available when Underwater is selected in creative mode (p 55). The camera focuses on the subject in the center focus area.	 <p>The image shows a camera's viewfinder with a focus area selection display. A vertical line with a small square at the top indicates the selected focus area, which is centered on a subject (a sailboat) in the center of the frame. The background includes a body of water and mountains. Below the viewfinder, the text "Focus area" is written.</p>
[] Subject tracking *	Press OK to view the focus area selection display, then use the multi selector to position the focus area over your subject and press OK . The focus area will track the subject as it moves through the frame. The camera will focus on the selected subject when the shutter-release button is pressed halfway. To end focus tracking when shooting is complete, press OK .	 <p>The image shows a camera's viewfinder with a focus area selection display. A vertical line with a small square at the top indicates the selected focus area, which is centered on a subject (a sailboat) in the center of the frame. The background includes a body of water and mountains. Below the viewfinder, the text "Focus area" is written.</p>

* Not available when **Underwater** is selected in creative mode.

Subject Tracking

The camera may be unable to track subjects if they move quickly, leave the frame or are obscured by other objects, change visibly in size, color, or brightness, or are too small, too large, too bright, too dark, or similar in color or brightness to the background.



Focus Lock

When **Single AF** is selected for **Focus mode** (📖 165), focus lock can be used to change the composition after focusing on the subject in the center of the frame, allowing you to focus on a subject that will not be in the center of the final composition. If the camera is unable to focus using autofocus (📖 167), you can also focus on another subject at the same distance and then use focus lock to recompose the photograph. Focus lock is most effective when an option other than **Auto-area** is selected for **AF-area mode** (📖 170).

1 Lock focus.

Position the subject in the center of the frame and press the shutter-release button halfway to initiate focus. Check that the focus area is displayed in green. Focus will remain locked while the shutter-release button is pressed halfway.

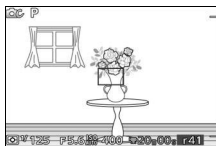

2 Recompose the photograph and shoot.

Focus will remain locked between shots.

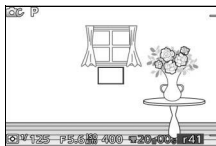

Do not change the distance between the camera and the subject while focus lock is in effect. If the subject moves, lift your finger from the shutter-release button to end focus lock and then focus again at the new distance.

Face-Priority

Choose **On** to enable face priority (📖 34).

Built-in AF Assist

When **On** is selected, the built-in AF-assist illuminator will light to illuminate poorly-lit subjects if:

- **AF-S** is selected for focus mode (📖 165) or single AF is selected in **AF-A**, and
- **Auto-area**, **Single-point**, or **Single-point (center)** is selected for **AF-area mode** (📖 170).

AF-assist illuminator



The AF-assist illuminator will not light to assist the focus operation in advanced movie mode, during movie recording, or when **Off** is selected. If the AF-assist illuminator does not light, autofocus may not produce the desired results when lighting is poor.



The AF-Assist Illuminator

Larger lenses may prevent the illuminator lighting all or part of the subject. Remove lens hoods when using the illuminator. Information on the modes in which AF-assist is available may be found on page 215.



Flash Control

Choose a flash control mode for the built-in and optional flash units.

TTL 	Flash output is adjusted automatically in response to shooting conditions (TTL flash control).
M  Manual	<p>Choose a flash level between Full and 1/32 (1/32 of full power). At full power, the built-in flash has a guide number of about 5/16 (m/ft, ISO 100, 20 °C/68 °F; at ISO 160, the guide number is about 6.3/20.7).</p> <p>A  icon flashes in the display during flash photography when this option is selected.</p>

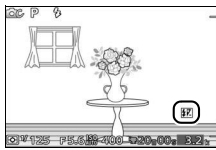
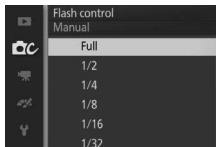

Flash Compensation

Flash compensation alters flash output from the level suggested by the camera, changing the brightness of the main subject relative to the background. Choose from values between -3 EV (darker) and $+1$ EV (brighter) in increments of $\frac{1}{3}$ EV; in general, positive values make the subject brighter while negative values make it darker.

A  icon is displayed when flash compensation is in effect. Normal flash output can be restored by setting flash compensation to ± 0 . Flash compensation is not reset when the camera is turned off.

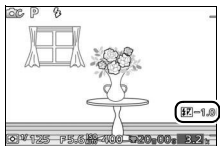
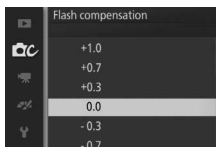

The Movie Menu

To display the movie menu, press MENU and select **Movies**.



The movie menu contains the following options:

Option	Description	Default	
Reset movie options	Reset movie menu options to their default values.	—	175
Frame rate	Choose a frame rate for slow-motion movies (72).	400 fps	175
Movie settings	Choose HD movie frame size and frame rate (67).	1080/60i	175
Metering	Choose how the camera meters exposure.	Matrix	160
Movie sound options	Choose sound recording options.	Microphone: Auto sensitivity (A) Wind noise reduction: On	176
Optical VR	Adjust settings for 1 NIKKOR lenses with vibration reduction.	Active/On ¹	164
Focus mode	Choose how the camera focuses.	See page 166	165
AF-area mode	Choose how the focus area is selected.	Auto-area ²	170
Face-priority	Turn face priority on or off.	On ³	172

1 Varies with lens (164).

2 The camera focuses on the subject in the center of the frame when **Slow motion** is selected in advanced movie mode.

3 Face detection is not available when **Slow motion** is selected in advanced movie mode.



Reset Movie Options

Select **Yes** to reset the options in the movie menu to default values (📖 174).

Frame Rate

Choose a frame rate for slow-motion movies (📖 72). The faster the frame rate, the smaller the frame size.

Option	Frame size (pixels)	Bit rate (approx.)	Maximum length (shooting)	Maximum length (playback)*
400 fps	640 × 240	2 Mbps	3 seconds	40 seconds
1200 fps	320 × 120	1 Mbps	3 seconds	2 minutes





* All figures are approximate. Slow-motion movies will play back over a period of about 13.2 (400 fps) or 40 (1200 fps) times the recording time.

See Also

For information on the total length of movies that can be stored on the memory card, see page 222.

Movie Settings

Choose a frame size and frame rate for HD movies (📖 67).

Option	Frame size (pixels)	Recording rate	Bit rate (approx.)	Maximum length
 1080/60i	1920 × 1080	59.94 fields/s*	24 Mbps	20 minutes
 1080/30p		29.97 fps	24 Mbps	
 720/60p	1280 × 720	59.94 fps	16 Mbps	29 minutes
 720/30p		29.97 fps	12 Mbps	

* Sensor output is about 60 fps.



Photo Frame Size

Photographs recorded by pressing the shutter-release button all the way down during movie recording have an aspect ratio of 3 : 2. The frame size varies with the option selected for **Movie settings**:

- **1080/60i and 1080/30p**: 4608 × 3072 pixels
- **720/60p and 720/30p**: 1280 × 856 pixels

See Also

For information on the total length of movies that can be stored on the memory card, see page 222.

Movie Sound Options

Adjust movie sound recording settings for the built-in microphone.

Microphone

Select **Microphone off** to disable sound recording. Selecting any other option enables recording and sets the microphone to the selected sensitivity.

The Icon

Movies recorded with the microphone off are indicated by a  icon in full-frame and movie playback.

Wind Noise Reduction

Select **On** to enable the low-cut filter, reducing noise produced by wind blowing over the microphone (note that other sounds may also be affected).



The Image Processing Menu

To display the image processing menu, press MENU and select **Image processing**.

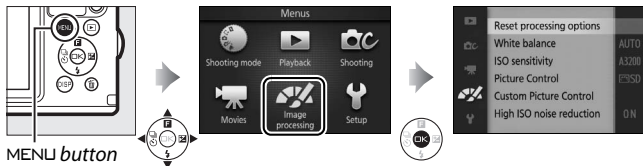

The image processing menu contains the following options:

Option	Description	Default	
Reset processing options	Reset image processing options to their default values.	—	178
White balance	Adjust settings for different types of lighting.	Auto	178
ISO sensitivity	Control the camera's sensitivity to light.	Auto (160–3200)	183
Picture Control	Choose how the camera processes pictures.	Standard	184
Custom Picture Control	Create custom Picture Controls.	—	188
High ISO noise reduction	Reduce noise at high ISO sensitivities.	On	190









Reset Processing Options

Select **Yes** to reset the options in the image processing menu to default values (☐ 177).

White Balance

White balance ensures that colors are unaffected by the color of the light source. Auto white balance is recommended for most light sources, but other values can be selected if necessary according to the type of source.

AUTO Auto	Automatic white balance adjustment. Recommended in most situations.
 Underwater	For underwater photography. The camera automatically corrects for the blue cast produced by underwater lighting.
 Incandescent	Use under incandescent lighting.
 Fluorescent	Use with cool-white fluorescent lighting.
 Direct sunlight	Use with subjects lit by direct sunlight.
 Flash	Use with built-in flash.
 Cloudy	Use in daylight under overcast skies.
 Shade	Use in daylight with subjects in the shade.
PRE Preset manual	Measure white balance (☐ 180).

White Balance and Shooting Mode

In auto and best moment capture modes and creative modes other than P, S, A, and M, and when  **Scene auto selector** (☐ 155) is chosen in Motion Snapshot mode, white balance is adjusted automatically according to the scene.



Fine-Tuning White Balance

Options other than **Preset manual** can be fine-tuned as follows:

1 Display fine-tuning options.

Highlight an option other than **Preset manual** and press **▶** to display the fine-tuning options shown at right.



Coordinates

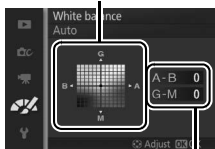

Adjustment

2 Fine-tune white balance.

Use the multi selector to fine-tune white balance.

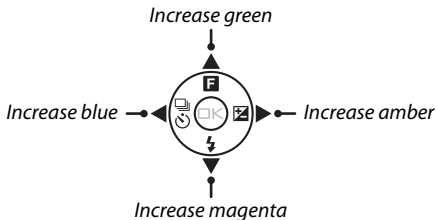

White Balance Fine Tuning

The colors on the fine-tuning axes are relative, not absolute. For example, moving the cursor to **B** (blue) when a “warm” setting such as  (incandescent) is selected will make photographs slightly “colder” but will not actually make them blue.

3 Save changes and exit.

Press **OK**. An asterisk will appear next to the white balance icon (📖 5) in the detailed display (📖 7) to show that white balance has been altered from default values.

Preset Manual

Preset manual is used to record and recall custom white balance settings for shooting under mixed lighting or to compensate for light sources with a strong color cast.

1 Light a reference object.

Place a neutral gray or white object under the lighting that will be used in the final photograph. A standard gray panel can be used for increased precision.

2 Select Preset manual.

Highlight **Preset manual** in the white balance menu and press ►. The dialog shown at right will be displayed; highlight **Yes** and press (OK) to overwrite the existing value for preset manual white balance.

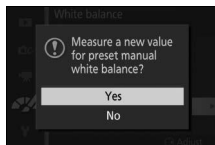

The message shown at right will be displayed.

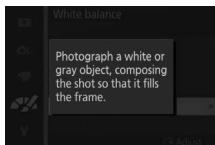

3 Measure white balance.

When the camera is ready to measure white balance, a flashing PRE will be displayed. Before the indicator stops flashing, frame the reference object so that it fills the display and press the shutter-release button all the way down. No photograph will be recorded; white balance can be measured accurately even when the camera is not in focus.

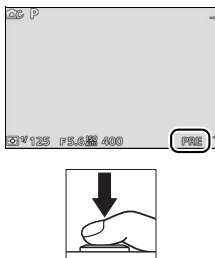

4 Check the results.

If the camera was able to measure a value for white balance, the message shown at right will be displayed. To return to shooting mode immediately, press the shutter-release button half-way.



If lighting is too dark or too bright, the camera may be unable to measure white balance. The message at right will be displayed. Return to Step 3 and measure white balance again.



☑ Auto Power Off

White balance measurement will end without a new value being acquired if no operations are performed for the time selected for **Auto power off** in the setup menu (☞ 195; the default is 1 minute).

☑ Preset White Balance

The camera can store only one value for preset white balance at a time; the existing value will be replaced when a new value is measured. Note that exposure is automatically increased by 1 EV when measuring white balance; in mode **M**, adjust exposure so that the exposure indicator shows ± 0 (☞ 43).

☑ Color Temperature

The perceived color of a light source varies with the viewer and other conditions. Color temperature is an objective measure of the color of a light source, defined with reference to the temperature to which an object would have to be heated to radiate light in the same wavelengths. While light sources with a color temperature in the neighborhood of 5000–5500 K appear white, light sources with a lower color temperature, such as incandescent light bulbs, appear slightly yellow or red. Light sources with a higher color temperature appear tinged with blue. The camera white balance options are adapted to the following color temperatures (all figures are approximate):

- | | |
|--|---------------------------------------|
| • Sodium-vapor lamps: 2700 K | • ☀ (direct sunlight): 5200 K |
| • ⚡ (incandescent)/
Warm-white fluorescent: 3000 K | • ⚡ (flash): 5400 K |
| • White fluorescent: 3700 K | • ☁ (cloudy): 6000 K |
| • ☀ (cool-white fluorescent): 4200 K | • Daylight fluorescent: 6500 K |
| • Day white fluorescent: 5000 K | • Mercury-vapor lamps: 7200 K |
| | • 🏠 (shade): 8000 K |



ISO Sensitivity

The camera's sensitivity to light can be adjusted according to the amount of light available. The higher the ISO sensitivity, the less light needed to make an exposure, allowing faster shutter speeds or smaller apertures.

A6400 Auto (160–6400) A3200 Auto (160–3200) A800 Auto (160–800)	The camera adjusts ISO sensitivity in response to lighting conditions. ISO sensitivity is adjusted in the range given in brackets; choose larger ranges for increased sensitivity when lighting is poor, smaller ranges to reduce noise (randomly-spaced bright pixels, fog, or lines).
160, 200, 400, 800, 1600, 3200, 6400	ISO sensitivity is fixed at the selected value.





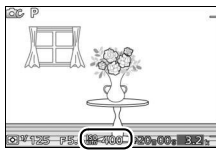

"Auto" ISO Sensitivity Options

When auto ISO sensitivity control is in effect, the display shows an **ISO AUTO** icon and the current ISO sensitivity.



Picture Control

Choose how the camera processes photographs.

 SD Standard	Standard processing for balanced results. Recommended in most situations.
 NL Neutral	Minimal processing for natural results. Choose for photographs that will later be extensively processed or retouched.
 VI Vivid	Pictures are enhanced for a vivid, photoprint effect. Choose for photographs that emphasize primary colors.
 MC Monochrome	Take monochrome photographs.
 PT Portrait	Process portraits for natural texture and a rounded feel.
 LS Landscape	Take vibrant photographs of landscapes and cityscapes.

Modifying Picture Controls

Existing preset and custom Picture Controls (📖 188) can be modified to suit the scene or your creative intent.

1 Display options.

Highlight an item in the Picture Control menu and press ► to display Picture Control settings (📖 186; the settings available with custom Picture Controls are the same as the preset controls on which they are based). To use an unmodified Picture Control, highlight it and press Ⓞ.

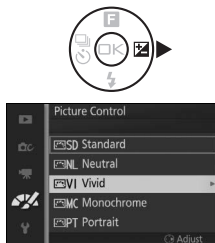

2 Adjust settings.

Press ▲ or ▼ to highlight the desired setting and press ◀ or ▶ to choose a value. Repeat this step until all settings have been adjusted, or select **Quick adjust** to choose a preset combination of settings. Default settings can be restored by pressing the  button.



3 Save changes and exit.

Press .

Preset Picture Controls Versus Custom Picture Controls

The Picture Controls supplied with the camera are referred to as *preset Picture Controls*. *Custom Picture Controls* are created through modifications to existing Picture Controls using the **Custom Picture Control** option in the image processing menu (□ 188). If desired, custom Picture Controls can be saved to a memory card and copied to other Nikon 1 AW1 cameras or loaded into compatible software (□ 189).

Modified Picture Controls

Picture Controls that have been modified from default settings are indicated by an asterisk ("*") in the Picture Control menu (□ 184) and in the detailed display (□ 7).



Picture Control and Shooting Mode

In auto and best moment capture modes and creative modes other than **P**, **S**, **A**, and **M**, and when  **Scene auto selector** (□ 155) is chosen in Motion Snapshot mode, the camera automatically chooses a Picture Control according to the scene.



Picture Control Settings

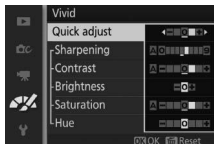

Quick adjust		Mute or exaggerate the effect of the selected Picture Control (note that this resets all manual adjustments). Not available with Neutral , Monochrome , or custom Picture Controls.
Manual adjustments (all Picture Controls)	Sharpening	Manually adjust the sharpness of outlines, or select A to adjust sharpness automatically.
	Contrast	Adjust contrast manually, or select A for automatic contrast adjustment.
	Brightness	Adjust brightness without affecting exposure.
Manual adjustments (non-monochrome only)	Saturation	Control the vividness of colors. Select A to adjust saturation automatically.
	Hue	Adjust hue.
Manual adjustments (monochrome only)	Filter effects	Simulate the effect of color filters on monochrome photographs.
	Toning	Choose the tint used in monochrome photographs.

"A" (Auto)

Results for auto sharpening, contrast, and saturation vary with exposure and the position of the subject in the frame.



Previous Settings

The line under the value displayed in the Picture Control setting menu indicates the previous value for the setting. Use this as a reference when adjusting settings.



Filter Effects (Monochrome Only)

The options in this menu simulate the effect of color filters on monochrome photographs. The following filter effects are available:

Y (yellow)	Enhance contrast. Can be used to reduce the brightness of the sky in landscape photographs. Orange produces more contrast than yellow, red more contrast than orange.
O (orange)	
R (red)	
G (green)	Softens skin tones. Can be used for portraits.

Note that the effects achieved with **Filter effects** are more pronounced than those produced by physical glass filters.

Toning (Monochrome Only)

Choose from **B&W** (black-and-white), **Sepia**, **Cyanotype** (blue-tinted monochrome), **Red**, **Yellow**, **Green**, **Blue Green**, **Blue**, **Purple**, **Blue**, **Red Purple**. Pressing ▼ when **Toning** is highlighted displays saturation options. Press ◀ or ▶ to adjust saturation. Saturation control is not available when **B&W** (black-and-white) is selected.

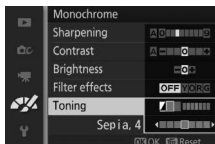

Custom Picture Control

The Picture Controls supplied with the camera can be modified and saved as custom Picture Controls.

Edit/Save

To create a custom Picture Control, select **Edit/save** and follow the steps below.

1 Select a Picture Control.

Highlight an existing Picture Control and press **▶**, or press **OK** to proceed to Step 3 to save a copy of the highlighted Picture Control without further modification.

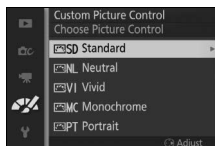

2 Edit the selected Picture Control.

See page 186 for more information. To abandon any changes and start over from default settings, press the **Reset** button. Press **OK** when settings are complete.

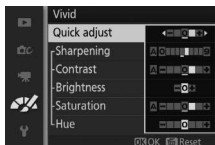

3 Save the Picture Control.

Highlight a destination (C-1 through C-9) and press  to save the custom Picture Control and return to the image processing menu.

The new Picture Control will be listed in the **Picture Control** menu.

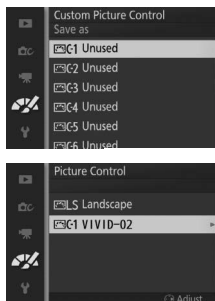

Load from/Save to Card

Custom Picture Controls created using the Picture Control Utility available with ViewNX 2 or optional software such as Capture NX 2 can be copied to a memory card and loaded into the camera, or custom Picture Controls created with the camera can be copied to the memory card to be used in other Nikon 1 AW1 cameras and compatible software and then deleted when no longer needed.



To copy custom Picture Controls to or from the memory card, or to delete custom Picture Controls from the memory card, select **Load from/save to card** in the **Custom Picture Control** menu. The following options will be displayed:

Copy to camera	Copy custom Picture Controls from the memory card to custom Picture Controls C-1 through C-9.
Delete from card	Delete selected custom Picture Controls from the memory card. The confirmation dialog shown at right will be displayed before a Picture Control is deleted; to delete the selected Picture Control, highlight Yes and press [OK] .
Copy to card	Copy a custom Picture Control (C-1 through C-9) to a selected destination (1 through 99) on the memory card.

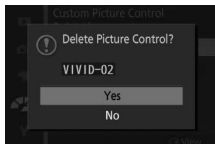

Copy to Card

Up to 99 custom Picture Controls can be stored on the memory card at any one time. The memory card can only be used to store user-created custom Picture Controls. The preset Picture Controls supplied with the camera can not be copied to the memory card or deleted.

Custom Picture Control > Delete

The **Delete** option in the **Custom Picture Control** menu can be used to delete selected custom Picture Controls from the camera when they are no longer needed.

High ISO Noise Reduction

Select **On** to reduce “noise” (randomly-spaced bright pixels, lines, or fog). If **Off** is selected, noise reduction will only be performed at high ISO sensitivities; the amount of noise reduction is less than that performed when **On** is selected.



The Setup Menu

To display the setup menu, press **MENU** and select **Setup**.

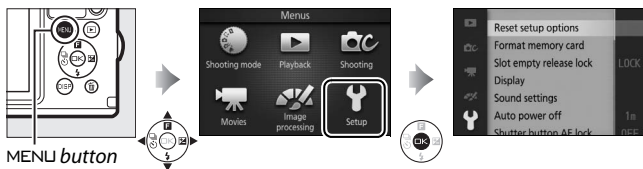

The setup menu contains the following options:

Option	Description	Default	
Reset setup options	Reset setup menu options to default values.	—	193
Format memory card	Format the memory card.	—	193
Slot empty release lock	Allow the shutter to be released when no memory card is inserted in the camera.	Release locked	193
Display	Adjust display brightness and contrast or view or hide a framing grid.	Display brightness: 0 High contrast display: Off Grid display: Off	194
Sound settings	Choose the sounds made during shooting.	Autofocus/self-timer: On Shutter: On	194
Auto power off	Choose the auto power off delay.	1 min	195
Shutter button AE lock	Choose whether exposure locks when the shutter-release button is pressed halfway.	Off	195
Control lock	Disable selected controls.	—	195
Location data	Record or view location data or use location data to set the clock, update assisted GPS files, and choose auto power off options for when the location data function is active.	Record location data: No Set clock from satellite: Yes Auto power off: Disable	107

Option	Description	Default	
Create log	Log location and depth in files saved to the memory card.	—	110
Delete log	Delete logs from the memory card.	—	113
Compass correction	Calibrate the built-in electronic compass.	—	114
Altitude/depth options	Choose whether the camera reports altitude or depth; calibrate the altimeter or depth gauge.	Altimeter/depth gauge: Altimeter Altitude/Depth Units: m	196
HDMI device control	Choose whether remote controls for HDMI-CEC devices to which the camera is connected can be used to operate the camera.	On	137
Flicker reduction	Reduce flicker or banding.	—	197
Reset file numbering	Reset file numbering.	—	197
Time zone and date	Set the camera clock.	Daylight saving time: Off	198
Language	Choose a language for the camera displays.	—	198
Auto image rotation	Record camera orientation with pictures.	On	199
Wireless mobile adapter*	Enable or disable the wireless mobile adapter.	—	99
Pixel mapping	Check and optimize the camera image sensor and image processors.	—	200
Firmware version	Display the current firmware version.	—	200

* Available only when optional WU-1b wireless mobile adapter is attached.



Reset Setup Options

Select **Yes** to reset all setup menu options other than **Flicker reduction**, **Time zone and date**, and **Language** to default values.

Format Memory Card

Select **Yes** to format the memory card. *Note that this permanently deletes all data on the card, including protected images; before proceeding, be sure to copy important pictures and other data to a computer (📖 130).* To exit without formatting the memory card, highlight **No** and press **OK**.

The message shown at right is displayed while the card is formatted; *do not remove the memory card or remove or disconnect the power source until formatting is complete.*

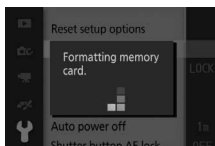

Slot Empty Release Lock

If **Enable release** is selected, the shutter can be released when no memory card is inserted. No pictures will be recorded, although they will be displayed in demo mode. Select **Release locked** to enable the shutter only when a card is inserted.



Display

Adjust the following display options.

Display Brightness

Press ▲ or ▼ to choose a value for monitor brightness. Choose higher values to brighten the display and lower values to make the display darker. **Hi** (maximum brightness) is automatically selected in outdoor mode (☞ 98).

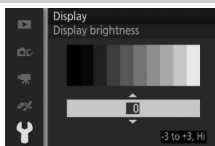

High Contrast Display

Select **On** to increase display contrast, making the display easier to read in sunlight or under bright lights. **On** is automatically selected in outdoor mode (☞ 98).

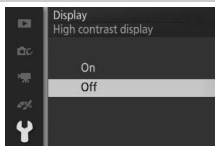

Grid Display

Select **On** to display a framing grid (☞ 30).



Sound Settings

Highlight items and press ► to select or deselect. If **Autofocus/self-timer** is selected, a beep will sound when the camera focuses and during self-timer photography; to mute the beep, remove the check from this item. Select **Shutter** to play a sound when the shutter is released, or remove the check from this item to mute the shutter. Press **OK** to exit when settings are complete.

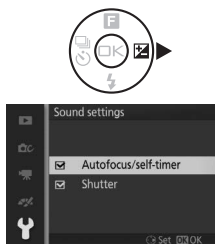

Auto Power Off

Choose how long the display remains on when no operations are performed (☞ 22). Choose shorter delays to reduce the drain on the battery. Once the display has turned off, it can be reactivated by pressing the shutter-release button.

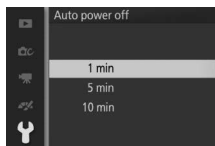

Location Data > Auto Power Off



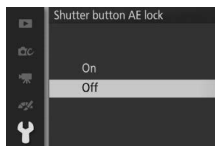

If **Disable** is selected for **Location data > Auto power off**, the display will remain on indefinitely while the location data function is enabled (☞ 107).

Shutter Button AE Lock

If **On** is selected, exposure will lock while the shutter-release button is pressed halfway.



Control Lock

Disable or enable any or all of the **Q**, , , , **DISP**, and  buttons. Highlight items and press **▶** to select or deselect; selected items are indicated by check marks. When your selection is complete, press **OK**. Controls marked with a check will be disabled, while those without checks will be enabled.

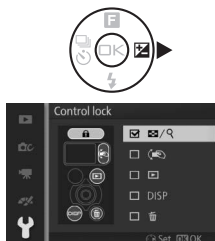

Altitude/Depth Options

Adjust settings for the altimeter and depth gauge.

Altimeter/Depth Gauge

Choose whether the display shows the altitude or depth (📖 57, 103).

Altitude/Depth Correction

Select **Alt./depth correction** to correct altitude or depth using one of the following methods (corrected values are indicated by an asterisk).

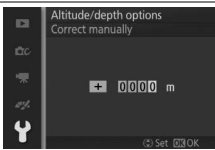
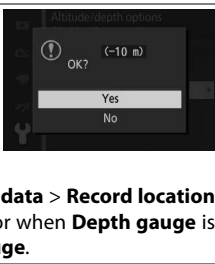
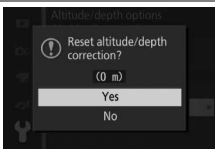
Correct manually	Enter a manual altitude or depth correction. Press ◀ or ▶ to highlight digits and ▲ or ▼ to change. Press OK to save changes and exit.	
Use location data	The camera will display an altitude correction based on current location data (📖 104); highlight Yes and press OK to accept the suggested value. This option is not available when location data are not available (for example, when No is selected for Location data > Record location data in the setup menu; 📖 104) or when Depth gauge is selected for Altimeter/depth gauge .	
Reset	To restore the uncorrected value, highlight Yes and press OK .	

Altitude/Depth Units

Choose whether the altitude and depth are displayed in meters (**m**) or feet (**ft**).



Flicker Reduction

Reduce flicker and banding in the display and in movies while shooting under fluorescent or mercury-vapor lighting. Choose a frequency which matches that of the local AC power supply.

Flicker Reduction

If you are unsure as to the frequency of the local power supply, test both options and choose the one that produces the best results. Flicker reduction may not produce the desired results if the subject is very bright, in which case you should select mode **A** or **M** and choose a smaller aperture (larger f-number). Flicker reduction is not available when **Underwater** is selected in creative mode.

Reset File Numbering

When a photograph is taken or a movie is recorded, the camera names the file by adding one to the number of the previous file (📖 158). If the current folder is numbered 999 and contains either 999 photographs or a photograph numbered 9999, the shutter-release button will be disabled and no further photographs can be taken. To reset file numbering to 0001, select **Yes** for **Reset file numbering** and then either format the current memory card or insert a new memory card.

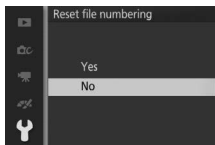

Time Zone and Date

Change time zones, set the camera clock, choose the date display order, or turn daylight saving time on or off (📖 24). Note that the clock can not be set while a track log is active (📖 110).

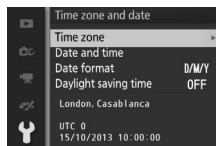

Time zone	Choose a time zone. The camera clock is automatically set to the time in the new time zone.
Date and time	Set the camera clock.
Date format	Choose the order in which the day, month, and year are displayed.
Daylight saving time	Turn daylight saving time on or off. The camera clock will automatically be advanced or set back one hour. The default setting is Off .

Language

Choose a language for camera messages and displays.



Auto Image Rotation

Photographs taken while **On** is selected contain information on camera orientation, allowing them to be rotated automatically during playback or when viewed in ViewNX 2 (supplied) or Capture NX 2 (available separately;  202). The following orientations are recorded:



*Landscape (wide)
orientation*



*Camera rotated 90°
clockwise*



*Camera rotated 90°
counterclockwise*

Camera orientation is not recorded when **Off** is selected. Choose this option when panning or taking photographs with the lens pointing up or down.

Auto Image Rotation

Image orientation is not recorded for movies, Motion Snapshots, or panoramas.

Rotate Tall

To automatically rotate “tall” (portrait-orientation) photographs for display during playback, select **On** for the **Rotate tall** option in the playback menu ( 146).



Pixel Mapping

Check and optimize the camera image sensor and image processors if you notice unexpected bright spots in your pictures (note that the camera comes with the sensor and processors already optimized). Before performing pixel mapping as described below, check that the battery is fully charged.

1 Attach a lens and lens cap.

Turn the camera off and attach a 1 NIKKOR lens. Do not remove the lens cap.

2 Select Pixel mapping.

Turn the camera on, press **MENU**, and select **Pixel mapping** in the setup menu.

3 Select Yes.

Pixel mapping begins immediately. Note that other operations can not be performed while pixel mapping is in progress. *Do not turn the camera off or remove or disconnect the power source until pixel mapping is complete.*

4 Turn the camera off.

Turn the camera off when pixel mapping is complete.

Firmware Version

View the current firmware version.



Technical Notes

Read this chapter for information on compatible accessories, cleaning and storing the camera, and what to do if an error message is displayed or you encounter problems using the camera.

Optional Accessories

At the time of writing, the following accessories were available for your camera.

Lenses	<ul style="list-style-type: none">• Waterproof 1 mount lenses• 1 mount lenses: Attach the supplied O-ring protector when using non-waterproof 1 mount lenses (□ 203).
Mount adapters	Mount Adapter FT1: The FT1 allows NIKKOR F mount lenses to be used with Nikon 1 interchangeable lens format digital cameras. The angle of view of an F mount lens mounted on the FT1 is equivalent to that of a 35 mm format lens with a focal length about 2.7 × longer. When using the FT1, attach the supplied O-ring protector. See page 243 for information on using the FT1. For information on attaching the FT1 and precautions for use, see the <i>FT1 Mount Adapter User's Manual</i> . For information on the lenses that can be used, see <i>Compatible NIKKOR F Mount Lenses</i> . The <i>FT1 Mount Adapter User's Manual</i> and <i>Compatible NIKKOR F Mount Lenses</i> are included with the FT1.
O-rings	O-Ring WP-02000: O-rings help maintain a waterproof seal when a special-purpose waterproof lens is attached. Grease O-rings before first use (□ 62).
O-ring protectors	O-Ring Protector PA-N1000: Protects the O-ring when a non-waterproof 1 NIKKOR lens is attached (□ 203).
O-ring removers	O-Ring Remover WP-OR1000: Remove O-rings (□ 62).
Silicon grease	Silicon Grease WP-G1000: Ensures that special-purpose waterproof lenses rotate freely during attachment and removal.



Power sources	<ul style="list-style-type: none"> • Rechargeable Li-ion Battery EN-EL20 (□ 14–16): Additional EN-EL20 batteries are available from local retailers and Nikon-authorized service representatives. • Battery Charger MH-27 (□ 14): Recharge EN-EL20 batteries. • Power Connector EP-5C, AC Adapter EH-5b: These accessories can be used to power the camera for extended periods (EH-5a and EH-5 AC adapters can also be used). An EP-5C power connector is required to connect the camera to the EH-5b, EH-5a, or EH-5; see page 208 for details.
Software	<p>Capture NX 2: A complete photo editing package offering such features as white balance adjustment and color control points.</p> <div style="border: 1px solid black; padding: 5px;"> <p>Note: Use the latest versions of Nikon software; see the websites listed on page xxiii for the latest information on supported operating systems. At default settings, Nikon Message Center 2 will periodically check for updates to Capture NX 2 and other Nikon software and firmware while you are logged in to an account on the computer and the computer is connected to the Internet. A message is automatically displayed when an update is found.</p> </div>
Body caps	<p>Body Cap BF-N2000: The body cap keeps the dust shield free of dust when a lens is not in place.</p>
Wireless mobile adapters	<p>Wireless Mobile Adapter WU-1b (□ 99): Supports two-way communication between the camera and smart devices running the Wireless Mobile Utility app. Use the Wireless Mobile Utility to take pictures remotely or download existing pictures to the smart device.</p>

 **Optional Accessories**

Availability may vary with country or region. See our website or brochures for the latest information.



Non-Waterproof 1 NIKKOR Lenses

The supplied O-ring protector must be attached to the camera lens mount before the camera can be used with non-waterproof 1 NIKKOR lenses like the 1 NIKKOR VR 10–30mm f/3.5–5.6 shown in the illustrations below. Use a soft cloth to remove any foreign matter from the inside of the protector before use, and be careful to prevent dust entering the camera or adhering to the O-ring protector.

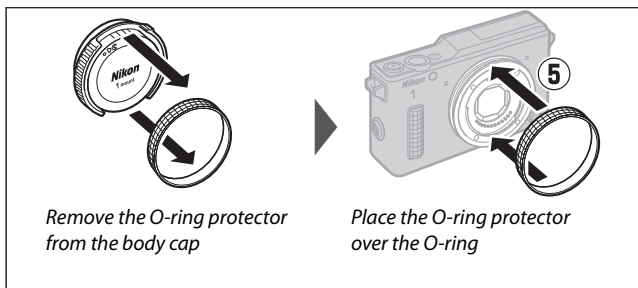
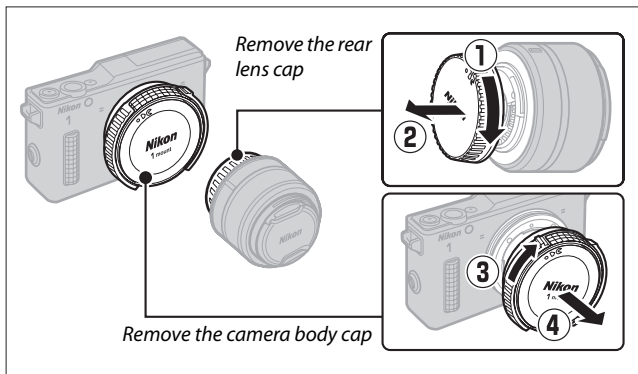

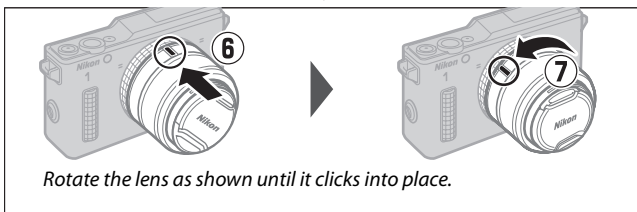
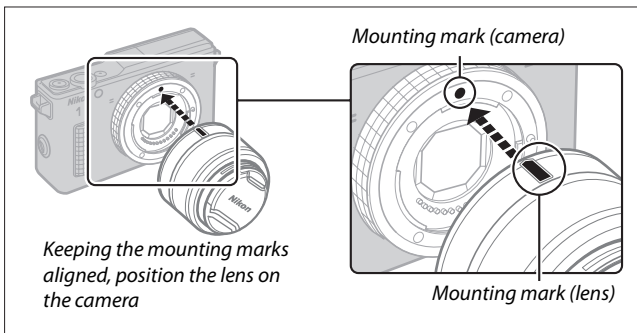

If the lens supports vibration reduction (VR), vibration reduction can be controlled from the camera (164). Note that lenses with retractable lens barrel buttons can not be used when retracted. To unlock and extend the lens readying the camera for use, keep the retractable lens barrel button pressed (1) while rotating the zoom ring as shown (2).

Zoom ring

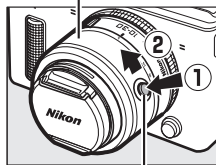

Retractable lens barrel button



Detaching Non-Waterproof Lenses

Before removing or exchanging lenses, turn the camera off. To remove the lens, press and hold the lens release button (1) while turning the lens as shown (2). After removing the O-ring protector from the camera, clean any foreign matter from the O-ring and replace the lens caps and camera body cap, and then clean the O-ring protector with a soft cloth and place the protector on the front of the body cap.

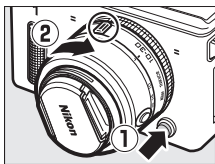

Lenses with Retractable Lens Barrel Buttons

The camera will turn on automatically when the retractable lens barrel lock is released; in addition, if the view through the lens is displayed or the monitor is off, the camera will turn off when the lens barrel is locked (in the case of 1 NIKKOR VR 10–30mm f/3.5–5.6 and 1 NIKKOR VR 30–110mm f/3.8–5.6 lenses, firmware version 1.10 or later is required if locking the lens barrel is to turn the camera off when the monitor is off; for information on updating lens firmware, visit the Nikon website for your area).

The lens can be retracted and the zoom ring locked by pressing the retractable lens barrel button and rotating the ring in the opposite direction. Be careful not to press the retractable lens barrel button while attaching or removing the lens.

Optional Lenses with Power Drive Zoom Switches

Slide the power drive zoom switch to **T** to zoom in and **W** to zoom out. The speed with which the camera zooms in and out varies with how far you slide the switch. The zoom position is shown by the zoom guide in the display.

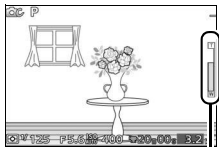

Zoom guide



Approved Memory Cards

The following cards have been tested and approved for use in the camera. Cards with class 6 or faster write speeds are recommended for movie recording. Recording may end unexpectedly when cards with slower write speeds are used.

	SD cards	SDHC cards ²	SDXC cards ³
SanDisk	2 GB ¹	4 GB, 8 GB, 16 GB, 32 GB	64 GB
Toshiba			
Panasonic			48 GB, 64 GB
Lexar Media	—	4 GB, 8 GB, 16 GB	—
Platinum II		4 GB, 8 GB, 16 GB, 32 GB	
Professional		4 GB, 8 GB, 16 GB	
Full-HD Video		4 GB, 8 GB, 16 GB	

- 1 Check that any card readers or other devices with which the card will be used support 2 GB cards.
- 2 Check that any card readers or other devices with which the card will be used are SDHC-compliant. The camera supports UHS-1.
- 3 Check that any card readers or other devices with which the card will be used are SDXC-compliant.  The camera supports UHS-1.





Other cards have not been tested. For more details on the above cards, please contact the manufacturer.



Approved Eye-Fi Cards

Eye-Fi cards can be inserted in the camera and used to upload photographs to a preselected destination. Eye-Fi cards are for use only in the country of purchase in accordance with local regulations. Eye-Fi cards may not be available in some countries or regions; consult the manufacturer for more information. Be sure the Eye-Fi card firmware has been updated to the latest version.

When an Eye-Fi card is inserted, its status is indicated by an icon in the display:

-  (static): Eye-Fi upload enabled; waiting to begin upload.
-  (animated): Eye-Fi upload enabled; uploading data.
- : Eye-Fi upload enabled but no pictures available for upload.
- : Error.

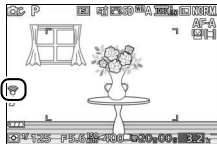

Eye-Fi Cards

Note that pictures will not be uploaded if signal strength is insufficient. In locations in which wireless devices are prohibited, turn the camera off and remove the card. See the manual provided with the Eye-Fi card, and direct any inquiries to the manufacturer.



Attaching a Power Connector and AC Adapter

Turn the camera off before attaching an optional power connector and AC adapter.

1 Ready the camera.

Open the battery-chamber/memory card slot cover.

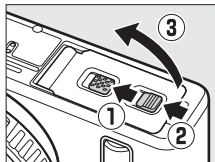

2 Insert the EP-5C power connector.

Be sure to insert the connector in the orientation shown, using the connector to keep the orange battery latch pressed to one side. The latch locks the connector in place when the connector is fully inserted. To prevent damage to the power connector cable, leave the battery-chamber/memory card slot cover open while the power connector is inserted.

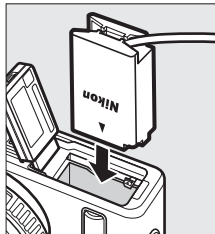

3 Connect the AC adapter.

Connect the AC adapter power cable to the AC socket on AC adapter (①) and the EP-5C power cable to the DC socket (②). A  icon is displayed in the monitor when the camera is powered by the AC adapter and power connector.

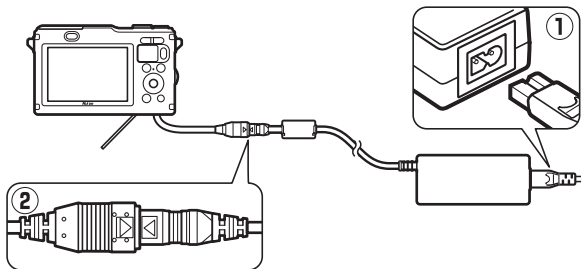

Storage and Cleaning

Underwater Use

For information on cleaning the camera after use under water or on the seashore, see page 60.

Storage

If the camera will not be used for an extended period, remove the battery and store it in a cool, dry area with the terminal cover in place. To prevent mold or mildew, store the camera in a dry, well-ventilated area. Do not store your camera with naphtha or camphor moth balls or in locations that:

- are poorly ventilated or subject to humidities of over 60%
- are next to equipment that produces strong electromagnetic fields, such as televisions or radios
- are exposed to temperatures above +50 °C (122 °F) or below -10 °C (14 °F)

Cleaning

Camera body	Use a blower to remove dust and lint, then wipe gently with a soft, dry cloth. After using the camera at the beach or sea-side, wipe off sand or salt with a cloth lightly dampened in distilled water and dry thoroughly. Important: <i>Dust or other foreign matter inside the camera may cause damage not covered under warranty.</i>
Lens	Lenses are easily damaged. Remove dust and lint with a blower. If using an aerosol blower, keep the can vertical to prevent the discharge of liquid. To remove fingerprints and other stains, apply a small amount of lens cleaner to a soft cloth and clean with care.
Monitor	Remove dust and lint with a blower. When removing fingerprints and other stains, wipe the surface lightly with a soft cloth or chamois leather. Do not apply pressure, as this could result in damage or malfunction.
Dust shield	The dust shield is easily damaged. Remove dust and lint with a blower.

Do not use alcohol, thinner, or other volatile chemicals.



Caring for the Camera and Battery: Cautions

Before using the camera, read the warnings on pages xi–xviii. Read pages 50–65 before using the camera under water.

Do not drop: The product may malfunction if subjected to strong shocks or vibration.

Avoid sudden changes in temperature: Sudden changes in temperature, such as those that occur when entering or leaving a heated building on a cold day, can cause condensation inside the device. To prevent condensation, place the device in a carrying case or plastic bag before exposing it to sudden changes in temperature.

Keep away from strong magnetic fields: Do not use or store this device in the vicinity of equipment that generates strong electromagnetic radiation or magnetic fields. Strong static charges or the magnetic fields produced by equipment such as radio transmitters could interfere with the display, damage data stored on the memory card, or affect the product's internal circuitry.

Keep the lens mount covered: Be sure to attach the body cap if the camera is without a lens.

Do not touch the dust shield: The dust shield covering the image sensor is easily damaged. Under no circumstances should you exert pressure on the shield or poke it with cleaning tools. These actions could scratch or otherwise damage the shield.

Turn the product off before removing or disconnecting the power source: Do not unplug the product or remove the battery while the product is on or while images are being recorded or deleted. Forcibly cutting power in these circumstances could result in loss of data or in damage to product memory or internal circuitry. To prevent an accidental interruption of power, avoid carrying the product from one location to another while the AC adapter is connected.



Cleaning: When cleaning the camera body, use a blower to gently remove dust and lint, then wipe gently with a soft, dry cloth. After using the camera at the beach or seaside, wipe off any sand or salt using a cloth lightly dampened in pure water and then dry the camera thoroughly.

Lenses are easily damaged. Dust and lint should be gently removed with a blower. When using an aerosol blower, keep the can vertical to prevent discharge of liquid. To remove fingerprints and other stains from the lens, apply a small amount of lens cleaner to a clean, soft cloth and wipe the lens carefully.

Storage: To prevent mold or mildew, store the camera in a cool, dry, well-ventilated area. If you are using an AC adapter, unplug the adapter to prevent fire. If the product will not be used for an extended period, remove the battery to prevent leakage and store the camera in a plastic bag containing a desiccant. Do not, however, store the camera case in a plastic bag, as this may cause the material to deteriorate. Note that desiccant gradually loses its capacity to absorb moisture and should be replaced at regular intervals.

To prevent mold or mildew, take the camera out of storage at least once a month. Turn the camera on and release the shutter a few times before putting it away.

Store the battery in a cool, dry place. Replace the terminal cover before putting the battery away.

Notes on the monitor: The monitor is constructed with extremely high precision; at least 99.99% of pixels are effective, with no more than 0.01% being missing or defective. Hence while these displays may contain pixels that are always lit (white, red, blue, or green) or always off (black), this is not a malfunction and has no effect on images recorded with the device.

Images in the monitor may be difficult to see in a bright light.

Do not apply pressure to the display, as this could cause damage or malfunction. Dust or lint on the display can be removed with a blower. Stains can be removed by wiping lightly with a soft cloth or chamois leather. Should the monitor break, care should be taken to avoid injury from broken glass and to prevent liquid crystal from the display touching the skin or entering the eyes and mouth.



Do not leave the lens pointed at the sun: Do not leave the lens pointed at the sun or other strong light source for an extended period. Intense light may cause the image sensor to deteriorate or produce a white blur effect in photographs.

Moiré: Moiré is an interference pattern created by the interaction of an image containing a regular, repeating grid, such as the pattern of weave in cloth or windows in a building, with the camera image sensor grid. In some cases, it may appear in the form of lines. If you notice moiré in your photographs, try changing the distance to the subject, zooming in and out, or changing the angle between the subject and the camera.

Lines: Noise in the form of lines may in rare cases appear in pictures of extremely bright or backlit subjects.

Batteries: Batteries may leak or explode if improperly handled. Observe the following precautions when handling batteries:

- Use only batteries approved for use in this equipment.
- Do not expose the battery to flame or excessive heat.
- Keep the battery terminals clean.
- Turn the product off before replacing the battery.
- Remove the battery from the camera or charger when not in use and replace the terminal cover. These devices draw minute amounts of charge even when off and could draw the battery down to the point that it will no longer function. If the battery will not be used for some time, insert it in the camera and run it flat before removing it and storing it in a location with an ambient temperature of 15 °C to 25 °C (59 °F to 77 °F; avoid hot or extremely cold locations). Repeat this process at least once every six months.
- Turning the camera on and off repeatedly when the battery is fully discharged will shorten battery life. Batteries that have been fully discharged must be charged before use.
- The internal temperature of the battery may rise while the battery is in use. Attempting to charge the battery while the internal temperature is elevated will impair battery performance, and the battery may not charge or charge only partially. Wait for the battery to cool before charging.
- Continuing to charge the battery after it is fully charged can impair battery performance.



- A marked drop in the time a fully charged battery retains its charge when used at room temperature indicates that it requires replacement. Purchase a new EN-EL20 battery.
- Charge the battery before use. When taking photographs on important occasions, ready a spare EN-EL20 battery and keep it fully charged. Depending on your location, it may be difficult to purchase replacement batteries on short notice. Note that on cold days, the capacity of batteries tends to decrease. Be sure the battery is fully charged before taking photographs outside in cold weather. Keep a spare battery in a warm place and exchange the two as necessary. Once warmed, a cold battery may recover some of its charge.
- Used batteries are a valuable resource; recycle in accord with local regulations.

Servicing the Camera and Accessories





The camera is a precision device and requires regular servicing. Nikon recommends that the camera be inspected by the original retailer or Nikon-authorized service representative once a year, and that it be serviced once every three to five years (note that fees apply to these services). Frequent inspection and servicing are particularly recommended if the camera is used professionally. Any accessories regularly used with the camera, such as lenses, should be included when the camera is inspected or serviced.



Available Settings

The following table lists the settings that can be adjusted in each mode.

Auto, Best Moment Capture, Advanced Movie, and Motion Snapshot Modes

												
			P	S	A	M		P	S	A	M	
Shooting, movie, and image processing menus	Exposure mode	—	—	—	—	—	✓	✓	✓	✓	✓	
	Image quality	✓ ¹	✓	—	—	—	—	—	—	—	—	
	Image size ²	✓ ¹	✓	—	—	—	—	—	—	—	—	
	Number of shots saved	—	✓ ³	—	—	—	—	—	—	—	—	
	Movie before/after	—	—	—	—	—	✓	✓	✓	✓	✓	
	File format	—	—	—	—	—	✓	✓	✓	✓	✓	
	Metering	—	—	✓ ⁴	✓ ⁴	✓ ⁴	✓ ⁴	—	✓	✓	✓	✓
	Auto distortion control	✓ ¹	✓	—	—	—	—	—	—	—	—	
	Color space	✓ ¹	✓	—	—	—	—	—	—	—	—	
	Active D-Lighting	—	—	—	—	—	—	—	—	—	—	
	HDR	—	—	—	—	—	—	—	—	—	—	
	Long exposure NR	✓	—	—	—	—	—	—	—	—	—	
	Optical VR ⁵	✓	✓	✓	✓	✓	✓	✓	✓	✓	✓	
	Electronic VR	—	—	—	—	—	—	✓	✓	✓	✓	
	Focus mode	—	—	✓	✓	✓	✓	—	—	—	—	
	AF-area mode	—	—	✓ ⁴	✓ ⁴	✓ ⁴	✓ ⁴	—	✓	✓	✓	✓
	Face-priority	—	—	✓ ⁴	✓ ⁴	✓ ⁴	✓ ⁴	—	✓	✓	✓	✓
	Built-in AF assist	✓	✓	—	—	—	—	✓	✓	✓	✓	✓
Flash control	—	—	—	—	—	—	—	—	—	—		
Flash compensation	—	—	—	—	—	—	—	—	—	—		



				P	S	A	M		P	S	A	M
Shooting, movie, and image processing menus	Frame rate ⁶	—	—	—	—	—	—	—	—	—	—	—
	Movie settings	✓	—	✓ ⁴	✓ ⁴	✓ ⁴	✓ ⁴	—	—	—	—	—
	Movie sound options	✓	—	✓ ⁴	✓ ⁴	✓ ⁴	✓ ⁴	—	—	—	—	—
	White balance	—	—	✓	✓	✓	✓	—	✓	✓	✓	✓
	ISO sensitivity	—	—	✓	✓	✓	✓	—	✓	✓	✓	✓
	Picture Control	—	—	✓	✓	✓	✓	—	✓	✓	✓	✓
	Custom Picture Control	—	—	✓	✓	✓	✓	—	✓	✓	✓	✓
	High ISO noise reduction	✓	✓	✓	✓	✓	✓	✓	✓	✓	✓	✓
Other settings	Focus area selection	—	—	✓ ⁴	✓ ⁴	✓ ⁴	✓ ⁴	—	✓	✓	✓	✓
	Flexible program	—	—	—	—	—	—	—	—	—	—	—
	Autoexposure lock	—	—	✓	✓	✓	—	—	✓	✓	✓	—
	Focus lock	—	—	✓	✓	✓	✓	—	✓	✓	✓	✓
	Continuous ⁷	✓	—	—	—	—	—	—	—	—	—	—
	Self-timer ⁷	✓	—	✓	✓	✓	✓	—	—	—	—	—
	Exposure compensation	✓	—	✓	✓	✓	—	✓	✓	✓	✓	—
	Flash mode	✓	—	—	—	—	—	—	—	—	—	—
	Advanced movie	—	—	✓	✓	✓	✓	—	—	—	—	—
Theme	—	—	—	—	—	—	✓	✓	✓	✓	✓	

1 Has no effect on movies recorded with movie-record button.

2 RAW images fixed at 4608 × 3072 pixels.

3 Smart Photo Selector mode only.

4 Not available when **Slow motion** is selected in advanced movie mode (72).

5 VR lenses only.

6 **Slow motion** selected in advanced movie mode.

7 Continuous and self-timer can not be used together.



Creative Mode

In the table below, creative modes are represented by the following icons: (∞,) underwater, night landscape, night portrait, backlighting, easy panorama, soft, miniature effect, and selective color.

		P	S	A	M								
Shooting, movie, and image processing menus	Exposure mode	—	—	—	—	—	—	—	—	—	—	—	—
	Image quality	✓ ¹	✓ ¹	✓ ¹	✓ ¹	✓ ^{1,2}	✓ ^{1,2}	✓ ^{1,2}	✓ ^{1,2}	✓ ^{1,2}	✓ ^{1,2}	✓ ^{1,2}	✓ ^{1,2}
	Image size	✓ ^{1,3}	✓ ^{1,3}	✓ ^{1,3}	✓ ^{1,3}	✓ ¹	✓ ¹	✓ ¹	✓ ¹	✓ ¹	✓ ¹	✓ ¹	✓ ¹
	Number of shots saved	—	—	—	—	—	—	—	—	—	—	—	—
	Movie before/after	—	—	—	—	—	—	—	—	—	—	—	—
	File format	—	—	—	—	—	—	—	—	—	—	—	—
	Metering	✓ ¹	✓ ¹	✓ ¹	✓ ¹	✓ ¹	—	—	—	—	—	—	—
	Auto distortion control	✓ ¹	✓ ¹	✓ ¹	✓ ¹	✓ ¹	✓ ¹	✓ ¹	✓ ¹	—	✓ ¹	✓ ¹	✓ ¹
	Color space	✓ ¹	✓ ¹	✓ ¹	✓ ¹	✓ ¹	✓ ¹	✓ ¹	✓ ¹	✓ ¹	✓ ¹	✓ ¹	✓ ¹
	Active D-Lighting	✓ ¹	✓ ¹	✓ ¹	✓ ¹	—	—	—	—	—	—	—	—
	HDR	—	—	—	—	—	—	✓	—	—	—	—	—
	Long exposure NR	✓ ⁴	✓ ⁴	✓ ⁴	✓ ⁴	—	—	—	—	—	—	—	—
	Optical VR ⁵	✓	✓	✓	✓	✓	✓	✓	✓	✓	✓	✓	✓
	Electronic VR	—	—	—	—	—	—	—	—	—	—	—	—
	Focus mode	✓ ¹	✓ ¹	✓ ¹	✓ ¹	—	—	—	—	—	—	—	—
	AF-area mode	✓ ¹	✓ ¹	✓ ¹	✓ ¹	✓ ¹	—	—	—	—	—	—	—
	Face-priority	✓	✓	✓	✓	✓	—	—	—	—	—	—	—
	Built-in AF assist	✓	✓	✓	✓	✓	✓	✓	✓	✓	✓	✓	✓
	Flash control	✓	✓	✓	✓	✓	—	—	—	—	—	—	—
	Flash compensation	✓ ⁴	✓ ⁴	✓ ⁴	✓ ⁴	✓	—	✓	✓ ⁶	—	✓	✓	✓



		P	S	A	M								
Shooting, movie, and image processing menus	Frame rate	—	—	—	—	—	—	—	—	—	—	—	—
	Movie settings	✓	✓	✓	✓	✓	✓	✓	✓	✓	✓	✓	✓
	Movie sound options	✓	✓	✓	✓	✓	✓	✓	✓	✓	✓	✓	✓
	White balance	✓	✓	✓	✓	—	—	—	—	—	—	—	—
	ISO sensitivity	✓ ¹	✓ ¹	✓ ¹	✓ ¹	✓ ¹	—	—	—	—	—	—	—
	Picture Control	✓	✓	✓	✓	—	—	—	—	—	—	—	—
	Custom Picture Control	✓	✓	✓	✓	—	—	—	—	—	—	—	—
	High ISO noise reduction	✓	✓	✓	✓	✓	—	—	—	—	—	—	—
Other settings	Focus area selection	✓	✓	✓	✓	—	—	—	—	—	—	—	—
	Flexible program	✓ ¹	—	—	—	—	—	—	—	—	—	—	—
	Autoexposure lock	✓	✓	✓	—	✓	✓	✓	✓	✓	✓	✓	✓
	Focus lock	✓	✓	✓	✓	—	—	—	—	—	—	—	—
	Continuous ⁷	✓	✓	✓	✓	✓	—	—	—	—	—	—	—
	Self-timer ⁷	✓	✓	✓	✓	✓	✓	✓	✓	—	✓	✓	✓
	Exposure compensation	✓	✓	✓	—	✓	✓	✓	✓	✓	✓	✓	✓
	Flash mode	✓ ⁴	✓ ⁴	✓ ⁴	✓ ⁴	✓ ⁴	—	✓	✓ ⁶	—	✓	✓	✓
	Advanced movie	—	—	—	—	—	—	—	—	—	—	—	—
Theme	—	—	—	—	—	—	—	—	—	—	—	—	

1 Has no effect on movies recorded with movie-record button.

2 NEF (RAW) and NEF (RAW) + JPEG fine not available.

3 RAW images fixed at 4608 × 3072 pixels.

4 Not available when 15, 30, or 60 fps is selected for self-timer/continuous.

5 VR lenses only.

6 Not available when HDR is on.

7 Continuous and self-timer can not be used together.



Defaults

Defaults for the options in the playback, shooting, movie, image processing, and setup menus may be found on pages 143, 153, 174, 177, and 191, respectively. Defaults for other settings are listed below.

Option	Default
Creative mode (☞ 37)	P Programmed auto
Focus area (☞ 170)	Center*
Flexible program (☞ 40)	Off
Focus lock (☞ 171)	Off
Continuous/self-timer (☞ 87, 89)	[S] (single frame)
Exposure compensation (☞ 90)	0.0
Flash mode (☞ 93)	Night portrait: Red-eye reduction Auto, P Programmed auto, S Shutter-priority auto, A Aperture-priority auto, M Manual, Underwater, Backlighting, Soft, Miniature effect, Selective color: Fill flash
Best moment capture (☞ 76)	Slow view
Advanced movie (☞ 66)	P Programmed auto
Theme (☞ 85)	Beauty
Picture Control settings (☞ 184)	Unmodified
Outdoor display (☞ 98)	Off

* Not displayed when **Auto-area** is selected for **AF-area mode**.



Memory Card Capacity

The following table shows the number of pictures or amount of movie footage that can be stored on a 16 GB Toshiba SD-E016GUX UHS-I SDHC card at different image quality, size, or movie settings. All figures are approximate; file size varies with the scene recorded.

■ ■ Auto, Creative (Easy Panorama Excluded), Slow View, and Smart Photo Selector¹

Image quality (□ 156)	Image size (□ 156)	File size	No. of images
NEF (RAW) + JPEG fine ^{2,3}	4608 × 3072	26.8 MB	591
	3456 × 2304	23.3 MB	681
	2304 × 1536	20.7 MB	765
NEF (RAW) ²	—	17.4 MB	902
JPEG fine	4608 × 3072	9.2 MB	1700
	3456 × 2304	5.6 MB	2700
	2304 × 1536	3.1 MB	5000
JPEG normal	4608 × 3072	4.6 MB	3300
	3456 × 2304	2.9 MB	5400
	2304 × 1536	1.6 MB	9800
JPEG basic	4608 × 3072	2.4 MB	6600
	3456 × 2304	1.5 MB	10700
	2304 × 1536	0.8 MB	18600

1 Number of shots saved set to 1.

2 Available in P, S, A, M mode only.

3 Image size applies to JPEG images only. Size of NEF (RAW) images can not be changed. File size is the total for NEF (RAW) and JPEG images.



Easy Panorama

Image quality (156)	Image size (156)		File size	No. of images
JPEG fine	Normal panorama	4800 × 920	4.5 MB	3400
		1536 × 4800	4.5 MB	3400
	Wide panorama	9600 × 920	8.6 MB	1800
		1536 × 9600	8.6 MB	1800
JPEG normal	Normal panorama	4800 × 920	2.3 MB	6800
		1536 × 4800	2.3 MB	6800
	Wide panorama	9600 × 920	4.4 MB	3500
		1536 × 9600	4.4 MB	3500
JPEG basic	Normal panorama	4800 × 920	1.2 MB	13200
		1536 × 4800	1.2 MB	13200
	Wide panorama	9600 × 920	2.2 MB	7000
		1536 × 9600	2.2 MB	7000

Smart Photo Selector¹

Image quality (156)	Image size (156)	File size	No. of shots
NEF (RAW) + JPEG fine ²	4608 × 3072	134.0 MB	118
	3456 × 2304	116.3 MB	136
	2304 × 1536	103.6 MB	153
NEF (RAW)	—	87.2 MB	180
JPEG fine	4608 × 3072	45.9 MB	342
	3456 × 2304	28.2 MB	556
	2304 × 1536	15.6 MB	1000
JPEG normal	4608 × 3072	23.2 MB	675
	3456 × 2304	14.3 MB	1000
	2304 × 1536	8.0 MB	1900
JPEG basic	4608 × 3072	11.8 MB	1300
	3456 × 2304	7.4 MB	2100
	2304 × 1536	4.2 MB	3700

1 Number of shots saved set to 5. File size is total for 5 images.

2 Image size applies to JPEG images only. Size of NEF (RAW) images can not be changed. File size is the total for NEF (RAW) and JPEG images.



■ ■ HD Movies

Movie settings (📖 175)	Maximum total length (approx.)*
1080/60i	1 hour 28 minutes
1080/30p	1 hour 28 minutes
720/60p	2 hours 12 minutes
720/30p	2 hours 56 minutes

*For information on the maximum length that can be recorded in a single clip, see page 175.

■ ■ Slow-Motion Movies

Frame rate (📖 175)	Maximum total recorded length (approx.)*
400 fps	1 hour 4 minutes
1200 fps	2 hours 8 minutes

*Up to 3 s of slow-motion footage can be recorded in a single clip. Playback length is about 13.2 (**400 fps**) or 40 (**1200 fps**) times the recorded length.

■ ■ Motion Snapshots

Image quality	Image size	Format (📖 160)	File size	No. of shots
—	—	NMS	21.6 MB *	729
—	—	MOV	30.8 MB	510

*File size is the total for a single photograph and movie.



Troubleshooting

If the camera fails to function as expected, check this list of common problems before consulting your retailer or Nikon representative.

Battery/Display

The camera is on but does not respond:

- Controls are locked (☐ 195).
 - The camera is busy. Wait for recording or any other processing to end. If the problem persists, turn the camera off. If the camera still does not respond, remove and replace the battery or disconnect and reconnect the AC adapter, but note that this will delete any data not yet saved. Data already saved to the memory card are unaffected.
-

The display is off:

- The camera is off (☐ 22) or the battery is exhausted (☐ 14, 27).
 - The display has turned off automatically to save power (☐ 195). The display can be reactivated by pressing the shutter-release button.
 - The camera is connected to a computer (☐ 130) or television (☐ 136).
-

The camera turns off without warning:

- The battery is low (☐ 14, 27).
 - The display has turned off automatically to save power (☐ 195). The display can be reactivated by pressing the shutter-release button.
 - The camera's internal temperature is high (☐ xxii, 230). Wait for the camera to cool before turning it on again.
-

Indicators are not displayed: Press the DISP button (☐ 7).

Shooting (All Modes)

The camera takes time to turn on: Delete files or format the memory card.

The shutter-release is disabled:

- The battery is exhausted (☐ 14, 27).
 - The memory card is locked (☐ 17) or full (☐ 27).
 - The flash is charging (☐ 92).
 - The camera is not in focus (☐ 29).
 - You are currently filming a slow-motion movie (☐ 69).
-

Only one picture is taken each time the shutter-release button is pressed in continuous release mode: 5 fps is selected for **Continuous/self-timer** and the built-in flash is raised.



The camera does not focus automatically:

- The subject is not suited to autofocus (☐ 167).
- The camera is in manual focus mode (☐ 165, 168).

Focus does not lock when the shutter-release button is pressed halfway: Set the focus mode to **AF-S** (☐ 165, 171).

Focus area selection is unavailable: Focus area selection is not available with face priority (☐ 34) or with auto-area or single-point (center) AF (☐ 170). In other AF-area modes, the focus area can be selected by pressing .

AF-area mode selection is unavailable: The camera is in auto or best moment capture mode (☐ 76), an option other than **P, S, A, M, Underwater** is selected in creative mode (☐ 37), manual focus mode is selected (☐ 165), or the  **Scene auto selector** is used (☐ 155).

Image size selection is unavailable: **NEF (RAW)** is selected for image quality (☐ 156).

The camera is slow to record photos: Turn long exposure noise reduction off (☐ 164). In creative mode, additional time may be needed to record photos when **Night landscape** (☐ 38), **Night portrait** (☐ 39) or **Easy panorama** (☐ 47) is selected or when **Backlighting** is selected and **HDR** is on (☐ 46).

Noise (bright spots, randomly-spaced bright pixels, fog, or lines) appears in photos:

- Lower ISO sensitivity or enable high ISO noise reduction (☐ 190).
- Use long exposure noise reduction at shutter speeds slower than 1 s (☐ 164).

Smudges appear in photographs: Clean the front and rear lens elements or the dust shield (☐ 210).

Flicker or banding appears in movies or in the display: Choose a **Flicker reduction** setting that matches the local AC power supply (☐ 197).

No flash: See page 95. The flash will not fire when off (☐ 93) or when low-ered.

Menu items are unavailable: Some options are only available in particular shooting or exposure modes (☐ 215) or when wireless mobile adapter is attached (☐ 99).



Shooting (P, S, A, and M Modes)

The shutter release is disabled: You selected mode **S** after choosing a shutter speed of “Bulb” in mode **M** (□ 41).

Some shutter speeds are not available: You are using the flash.

Colors are unnatural:

- Adjust white balance to match the light source (□ 178).
 - Adjust Picture Control settings (□ 184).
-

Cannot measure white balance: The subject is too dark or too bright (□ 181).

Picture Controls produce varying results: **A** (auto) is selected for sharpening, contrast, or saturation. For consistent results over a series of photos, choose another setting (□ 186, 187).

Noise (reddish areas and other artifacts) appears in long time-exposures: Enable long exposure noise reduction (□ 164).

Movies

Cannot record movies: The movie-record button can not be used to record movies in best moment capture or Motion Snapshot mode (□ 80, 85).

No sound is recorded for movies:

- **Microphone off** is selected for **Movie sound options > Microphone** (□ 176).
 - Live audio is not recorded with slow-motion movies (□ 72) or Motion Snapshots (□ 85).
-

Playback

NEF (RAW) images are not displayed: The camera displays only the JPEG copies of NEF (RAW) + JPEG fine images (□ 158).

“Tall” (portrait) orientation photos are displayed in “wide” (landscape) orientation:

- Select **On** for **Rotate tall** (□ 146).
 - The photos were taken with **Auto image rotation off** (□ 199).
 - Camera was pointed up or down when the photo was taken (□ 199).
 - Photo is displayed in image review (□ 146).
-



Cannot hear movie sound:

- Press the Q button to raise the volume (☞ 70). If the camera is connected to a television (☞ 136), use the controls for the TV to adjust the volume.
- Live audio is not recorded with slow-motion movies (☞ 72) or Motion Snapshots (☞ 85).

Cannot delete images:

- Remove protection from the files before deletion (☞ 146).
- The memory card is locked (☞ 17).

Cannot select photos for printing: The memory card is full (☞ 27) or locked (☞ 17) or the photos are in NEF (RAW) format. To print NEF (RAW) photos, transfer the pictures to a computer and use the supplied software or Capture NX 2 (☞ 130).

Pictures are not displayed on TV: The camera is not correctly connected (☞ 136).

Pictures cannot be transferred to a computer: If your system does not meet the requirements on page 128, you may still be able to transfer pictures to the computer using a card reader.

Photos are not displayed in Capture NX 2: Update to the latest version (☞ 202).

Location Data

The camera is slow to acquire location data or does not display location data:

- The camera may be unable or slow to acquire location data in some localities (☞ 104). The location data function works best in areas with a clear view of the sky.
- Some time may be needed to acquire location data on first use, after extended periods of disuse, or after the camera battery has been removed and reinserted (☞ 106).
- Update assisted GPS file (☞ 108).

Location data are not recorded with pictures: Location data will not be recorded if the satellite signal indicator shows 📶 or 📶 (☞ 105). Check satellite signal status before shooting.

Location data are recorded, but are not correct: Variations in local topography may result in errors of up to several hundred meters (☞ 106).

Cannot update assisted GPS file:

- Check that the memory card is inserted and contains an assisted GPS file.
- The assisted GPS file is corrupt. Download the file again (□ 108).
- The camera clock is not set. Set the camera clock (□ 24).

“Use location data” is not available for “Altitude/depth options” > “Alt./depth correction” in the setup menu:

- **No** is selected for **Location data > Record location data** in the setup menu (□ 107).
- Location data are available from fewer than three satellites (□ 105).

“Create log” is not available in the setup menu: Set the camera clock (□ 24, 198).

Cannot start location data log:

- **No** is selected for **Location data > Record location data** in the setup menu (□ 107).
- A location data log is already active. Select **Create log > End log** to end the current log before starting a new one (□ 111).

Cannot save the current log:

- Confirm that a memory card is inserted.
- The camera can record a maximum of 36 location data logs and 36 depth logs per day.
- Each memory card can store a maximum of 100 location data logs and 100 depth logs for a total of 200 logs. If necessary, delete unwanted logs (□ 113) or insert another memory card (□ 16).

Miscellaneous

The date of recording is not correct: Set the camera clock (□ 24, 198).

Menu items are unavailable: Some options are only available at particular settings (□ 215) or when a memory card is inserted (□ 16).

Error Messages

This section lists the error messages that appear in the display.

Message	Solution	
(Shutter-speed or aperture display flashes)	If the subject is too bright, lower ISO sensitivity or choose a faster shutter speed or smaller aperture (higher f-number).	41, 42, 43, 183
	If the subject is too dark, raise ISO sensitivity, use the flash, or choose a slower shutter speed or larger aperture (lower f-number).	41, 42, 43, 92, 183
Keeping the zoom ring button pressed, rotate the zoom ring to extend the lens.	A lens with a retractable lens barrel button is attached with the lens barrel retracted. Keeping the retractable lens barrel button pressed, rotate the zoom ring to extend the lens.	204, 205
Check lens. Pictures can only be taken when a lens is attached.	Attach a lens.	19, 203
Cannot take pictures. Insert fully-charged battery.	Turn the camera off and recharge the battery or insert a fully charged spare battery.	14, 16
The clock has been reset.	Set the camera clock.	24, 198
No memory card.	Turn the camera off and confirm that the card is correctly inserted.	16
This memory card is not formatted. Format the memory card?	Select Yes to format the card, or turn the camera off and insert another memory card.	16, 193



Message	Solution	
Memory card is locked (write protected).	Turn the camera off and slide the card write-protect switch to the "write" position.	17
Eye-Fi cards cannot be used with the write-protect switch in the "lock" position.		
Memory card is full.	• You may be able to record additional images if you reduce image quality or size.	156
	• Delete unwanted images.	121
	• Insert another memory card.	16, 206
This memory card cannot be used. Card may be damaged; insert a different card.	• Use an approved card.	206
	• Format the card. If the problem persists, the card may be damaged. Contact a Nikon-authorized service representative.	193
	• Insert a new memory card.	16, 206
Cannot create additional folders on memory card.	If the current folder is numbered 999 and contains either 999 photographs or a photograph numbered 9999, the shutter-release button will be disabled and no further photographs can be taken. Choose Yes for Reset file numbering and then either format the current memory card or insert a new memory card.	197
The movie-record button cannot be used in this mode.	The movie-record button can not be used in best moment capture or Motion Snapshot modes.	80, 85
Photographs cannot be recorded in this mode.	The shutter-release button can not be used to take photographs while a slow-motion movie is being recorded.	69



Message	Solution	
Photographs cannot be taken in shutter-priority auto mode at a shutter speed of "Bulb".	Choose a different shutter speed, or select mode M .	41, 43
Cannot shoot panorama with lens of this focal length.	Use a lens with a focal length of 6 to 30 mm to shoot panoramas. If you are using a zoom lens, choose a focal length between 6 and 30 mm.	47
Failed to update lens firmware. Try again after turning the camera off and on.	Turn the camera off and then on again and reattempt the update. If the problem persists or reoccurs frequently, contact a Nikon-authorized service representative.	—
No A-GPS file found on card	<ul style="list-style-type: none"> • No memory card is inserted. • The memory card does not contain an assisted GPS file. • The assisted GPS file has expired or has an earlier expiry date than the current file. 	108
Update failed	Assisted GPS file may be corrupt. Download the file again.	108
Unable to correct compass	Compass correction failed. Try again outdoors.	114
An error has occurred in the internal circuitry. Try again after turning the camera off and on.	Turn the camera off and then on again. If the problem persists or reoccurs frequently, contact a Nikon-authorized service representative.	—
The camera's internal temperature is high. The camera will now turn off.	Wait for the camera to cool.	xxii



Message	Solution	
Memory card contains no images.	To view pictures, insert a memory card containing images.	16
Cannot display this file.	The file has been created or modified on a computer or different make of camera, or is corrupt.	—
Check printer.	Check the printer.	—*
Check paper.	Select Resume after loading paper of the correct size.	—*
Paper jam.	Clear the jam and select Resume .	—*
Out of paper.	Insert paper and select Resume .	—*
Check ink supply.	Select Resume after checking the ink.	—*
Out of ink.	Replace the ink and select Resume .	—*

* See the printer manual for more information.



Specifications

Nikon 1 AW1 Digital Camera

Type	
Type	Digital camera with support for interchangeable lenses
Lens mount	Nikon waterproof 1 mount
Effective angle of view	Approx. 2.7× lens focal length (35 mm format equivalent)
Effective pixels	
Effective pixels	14.2 million
Image sensor	
Image sensor	13.2 mm × 8.8 mm CMOS sensor (Nikon CX format)
Storage	
Image size (pixels)	Still images (auto, best moment capture, and all creative modes other than Easy panorama; aspect ratio 3 : 2)
	• 4608 × 3072
	• 2304 × 1536
	• 3456 × 2304
	Still images (Normal panorama, camera panned horizontally; aspect ratio 120 : 23)
	• 4800 × 920
	Still images (Normal panorama, camera panned vertically; aspect ratio 8 : 25)
	• 1536 × 4800
	Still images (Wide panorama, camera panned horizontally; aspect ratio 240 : 23)
	• 9600 × 920
	Still images (Wide panorama, camera panned vertically; aspect ratio 4 : 25)
	• 1536 × 9600
Still images (taken during movie recording, aspect ratio 3 : 2)	
• 4608 × 3072 (1080/60i, 1080/30p)	
• 1280 × 856 (720/60p, 720/30p)	
Still images (Motion Snapshots; aspect ratio 16 : 9)	
• 4608 × 2592	



File format	<ul style="list-style-type: none"> • NEF (RAW): 12-bit, compressed • JPEG: JPEG-Baseline compliant with fine (approx. 1:4), normal (approx. 1:8), or basic (approx. 1:16) compression • NEF (RAW) + JPEG: Single photograph recorded in both NEF (RAW) and JPEG formats
Picture Control system	Standard, Neutral, Vivid, Monochrome, Portrait, Landscape; selected Picture Control can be modified; storage for custom Picture Controls
Media	SD (Secure Digital), SDHC, and SDXC memory cards
File system	DCF (Design Rule for Camera File System) 2.0, DPOF (Digital Print Order Format), Exif (Exchangeable Image File Format for Digital Still Cameras) 2.3, PictBridge
Shooting modes	auto; creative, with a choice of the following options: P , S , A , M , (∞, underwater, night landscape, night portrait, backlighting, easy panorama, soft, miniature effect, and selective color; best moment capture (slow view and Smart Photo Selector), advanced movie (HD— P , S , A , M only—and slow motion), Motion Snapshot
Shutter	
Type	Electronic shutter
Speed	1/16,000–30 s in steps of 1/3 EV; Bulb Note: Bulb ends automatically after approximately 2 minutes
Flash sync speed	Synchronizes with shutter at X=1/60 s or slower
Release	
Mode	<ul style="list-style-type: none"> • Single frame, continuous • Self-timer
Frame advance rate	Approx. 5, 15, 30, or 60 fps
Self-timer	2 s, 5 s, 10 s



Exposure	
Metering	TTL metering using image sensor
Metering method	<ul style="list-style-type: none"> • Matrix • Center-weighted: Meters 4.5 mm circle in center of frame • Spot: Meters 2 mm circle centered on selected focus area
Mode	P programmed auto with flexible program; S shutter-priority auto; A aperture-priority auto; M manual;  scene auto selector
Exposure compensation	-3 – +3 EV in increments of 1/3 EV
Exposure lock	Luminosity locked at metered value when shutter-release button is pressed halfway
ISO sensitivity (Recommended Exposure Index)	ISO 160–6400 in steps of 1 EV; auto ISO sensitivity control (ISO 160–6400, 160–3200, 160–800) available (user controlled when P , S , A , M , or underwater is selected in creative mode)
Active D-Lighting	On, off
Focus	
Autofocus	Hybrid autofocus (phase-detection/contrast-detect AF); AF-assist illuminator
Lens servo	<ul style="list-style-type: none"> • Autofocus (AF): Single AF (AF-S); continuous AF (AF-C); auto AF-S/AF-C selection (AF-A); full-time AF (AF-F) • Manual focus (MF)
AF-area mode	Single-point, single-point (center), auto-area, subject tracking
Focus area	<ul style="list-style-type: none"> • Single-point AF: 135 focus areas; the center 73 areas support phase-detection AF • Auto-area AF: 41 focus areas
Focus lock	Focus can be locked by pressing shutter-release button halfway (single AF)
Face priority	On, off



Flash	
Built-in flash	Manual pop-up
Guide Number (GN)	Approx. 5/16 (m/ft, ISO 100, 20 °C/68 °F; at ISO 160, Guide Number is approx. 6.3/20.7)
Control	i-TTL flash control using image sensor
Mode	Fill flash, red-eye reduction, fill flash + slow sync, red-eye reduction + slow sync, rear curtain + slow sync, rear-curtain sync, off
Flash compensation	-3–+1 EV in increments of 1/3 EV
Flash-ready indicator	Lights when built-in flash unit is fully charged
White balance	
	Auto, underwater, incandescent, fluorescent, direct sunlight, flash, cloudy, shade, preset manual, all except preset manual with fine tuning
Movie	
Metering	TTL metering using image sensor
Metering method	<ul style="list-style-type: none"> • Matrix • Center-weighted: Meters 4.5 mm circle in center of frame • Spot: Meters 2 mm circle centered on selected focus area
Frame size (pixels)/ recording rate	HD movies (aspect ratio 16 : 9)
	<ul style="list-style-type: none"> • 1920 × 1080/60i (59.94 fields/s*) • 1920 × 1080/30p (29.97 fps) • 1280 × 720/60p (59.94 fps) • 1280 × 720/30p (29.97 fps)
	Slow-motion movies (aspect ratio 8 : 3)
	<ul style="list-style-type: none"> • 640 × 240/400 fps (plays at 30p/29.97 fps) • 320 × 120/1200 fps (plays at 30p/29.97 fps)
	Motion Snapshot (aspect ratio 16 : 9)
	1920 × 1080/60p (59.94 fps) (plays at 24p/23.976 fps)
File format	MOV
Video compression	H.264/MPEG-4 Advanced Video Coding
Audio recording format	AAC
Audio recording device	Built-in stereo microphone; sensitivity adjustable

* Sensor output is about 60 fps.



Monitor	7.5 cm (3-in.), approx. 921k-dot, TFT LCD with brightness adjustment
Playback	Full-frame and thumbnail (4, 9, or 72 images or calendar) playback with playback zoom, movie and panorama playback, slide show, histogram display, auto image rotation, and rating option
Interface	
USB	Hi-Speed USB
HDMI output	Type C mini-pin HDMI connector
Electronic compass/location data/altimeter/depth gauge	
Electronic compass	16 headings (with 3-axis accelerometer attitude correction and automatic offset adjustment)
Location data	<ul style="list-style-type: none"> • Receiving frequency: 1575.4200 MHz (GPS)/1598.0625–1605.3750 MHz (GLONASS) • Geodesics: WGS84
Altimeter	Operating range approximately –500–+4500 m (–1640–+14,760 ft)
Depth gauge	Operating range approximately 0–20 m (0–65.6 ft)
Supported languages	Arabic, Bengali, Bulgarian, Chinese (Simplified and Traditional), Czech, Danish, Dutch, English, Finnish, French, German, Greek, Hindi, Hungarian, Indonesian, Italian, Japanese, Korean, Marathi, Norwegian, Persian, Polish, Portuguese (European and Brazilian), Romanian, Russian, Serbian, Spanish, Swedish, Tamil, Telugu, Thai, Turkish, Ukrainian, Vietnamese
Power source	
Battery	One rechargeable Li-ion EN-EL20 battery
AC adapter	EH-5b AC adapter; requires EP-5C power connector (available separately)
Tripod socket	1/4-in. (ISO 1222)
Dimensions/weight	
Dimensions (W × H × D)	Approx. 113.3 × 71.5 × 37.5 mm (4.5 × 2.9 × 1.5 in.), excluding projections
Weight	Approx. 356 g (12.6 oz) with battery and memory card but without body cap or O-ring protector; approx. 313 g (11.1 oz), camera body only



Operating environment	
Temperature	-10 °C–+40 °C (+14 °F–104 °F) on land, 0 °C–+40 °C (+32 °F–104 °F) in water
Humidity	85% or less (no condensation)
Shock-, water-, and dust-proofing	
Shockproof performance ^{1,2}	Has passed in-house tests ³ to MIL-STD-810F Method 516.5: Shock standard
Waterproof performance ²	In-house tests have demonstrated JIS/IEC Class 8 (IPX8) waterproofing; can be used at depths of up to 15 m (49 ft) for up to 60 minutes
Operating depth ²	Maximum 15 m (49 ft)
Dustproof performance ²	In-house tests have demonstrated JIS/IEC Class 6 (IP6X) dust-proofing

1 Does not apply when built-in flash is raised.

2 With special-purpose waterproof lens attached.

3 Using a test method derived from MIL-STD-810F Method 516.5: Shock, the product is dropped from a height of 200 cm (6.6 ft) onto a plywood surface 5 cm (2 in.) thick. Exterior deformation and surface damage are not tested. These in-house tests do not constitute blanket guarantees of invulnerability to damage or destruction.

- Unless otherwise stated, all figures are for a camera with a fully-charged battery operating at the temperature specified by the Camera and Imaging Products Association (CIPA): 23 ±3 °C (73.4 ±5.4 °F).
- Nikon reserves the right to change the specifications of the hardware and software described in this manual at any time and without prior notice. Nikon will not be held liable for damages that may result from any mistakes that this manual may contain.

MH-27 battery charger	
Rated input	AC 100–240 V, 50–60 Hz, 0.2 A
Rated output	DC 8.4 V/0.6 A
Supported batteries	Nikon EN-EL20 rechargeable Li-ion batteries
Charging time	Approx. 2 hours at an ambient temperature of 25 °C (77 °F) when no charge remains
Operating temperature	0 °C–40 °C (+32 °F–104 °F)
Dimensions (W × H × D)	Approx. 67.0 × 28.0 × 94.0 mm (2.6 × 1.1 × 3.7 in.), excluding plug adapter
Weight	Approx. 83 g (2.9 oz), excluding plug adapter



EN-EL20 rechargeable Li-ion battery	
Type	Rechargeable lithium-ion battery
Rated capacity	7.2 V, 1020 mAh
Operating temperature	0 °C–40 °C (+32 °F–104 °F)
Dimensions (W × H × D)	Approx. 30.7 × 50.0 × 14.0 mm (1.2 × 2.0 × 0.6 in.)
Weight	Approx. 41 g (1.4 oz), excluding terminal cover
1 NIKKOR AW 11–27.5mm f/3.5–5.6 Lens	
Type	Waterproof 1 mount lens
Focal length	11–27.5 mm
Maximum aperture	f/3.5–5.6
Construction	8 elements in 6 groups (including 1 ED lens element and 1 aspherical lens element), 1 protective glass element
Angle of view	72°–32° 20'
Minimum focus distance	0.3 m (1.0 ft) from focal plane at all zoom positions
Diaphragm blades	7 (rounded diaphragm opening)
Diaphragm	Fully automatic
Aperture range	<ul style="list-style-type: none"> • 11 mm focal length: f/3.5–16 • 27.5 mm focal length: f/5.6–16
Electronic compass	Electronic compass can be used when lens is attached to camera
Filter-attachment size	40.5 mm (P=0.5 mm)
Shockproof performance *	Has passed in-house tests to MIL-STD-810F Method 516.5: Shock standard when attached to camera; exterior deformation and surface damage are not tested
Waterproof performance *	In-house tests have demonstrated JIS/IEC Class 8 (IPX8) waterproofing
Operating depth *	Maximum 15 m (49 ft), but may not be used at depths that exceed camera's maximum operating depth
Dustproof performance *	In-house tests have demonstrated JIS/IEC Class 6 (IP6X) dust-proofing
Operating temperature	–10 °C–+40 °C (+14 °F–104 °F) on land, 0 °C–+40 °C (+32 °F–104 °F) in water
Dimensions	Approx. 63 mm diameter × 56.5 mm (distance from camera lens mount flange)
Weight	Approx. 182 g (6.5 oz)

* When attached to waterproof cameras.



1 NIKKOR AW 10mm f/2.8 Lens

Type	Waterproof 1 mount lens
Focal length	10 mm
Maximum aperture	f/2.8
Construction	6 elements in 5 groups (including 2 aspherical lens elements), 1 protective glass element
Angle of view	77°
Minimum focus distance	0.2 m (0.7 ft) from focal plane
Diaphragm blades	7 (rounded diaphragm opening)
Diaphragm	Fully automatic
Aperture range	f/2.8–11
Electronic compass	Electronic compass can be used when lens is attached to camera
Filter-attachment size	40.5 mm (P=0.5 mm)
Shockproof performance *	Has passed in-house tests to MIL-STD-810F Method 516.5: Shock standard when attached to camera; exterior deformation and surface damage are not tested
Waterproof performance *	In-house tests have demonstrated JIS/IEC Class 8 (IPX8) waterproofing
Operating depth *	Maximum 20 m (65.6 ft), but may not be used at depths that exceed camera's maximum operating depth
Dustproof performance *	In-house tests have demonstrated JIS/IEC Class 6 (IP6X) dust-proofing
Operating temperature	-10 °C–+40 °C (+14 °F–104 °F) on land, 0 °C–+40 °C (+32 °F–104 °F) in water
Dimensions	Approx. 61 mm diameter × 30 mm (distance from camera lens mount flange)
Weight	Approx. 118 g (4.2 oz)

*When attached to waterproof cameras.

Specifications subject to change without notice. Nikon will not be held liable for damages that may result from any mistakes that this manual may contain.



Waterproof 1 NIKKOR Lenses
1 NIKKOR AW 11–27.5mm f/3.5–5.6

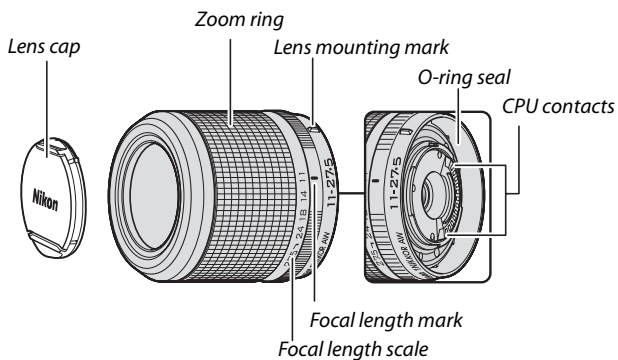

1 NIKKOR AW 10mm f/2.8

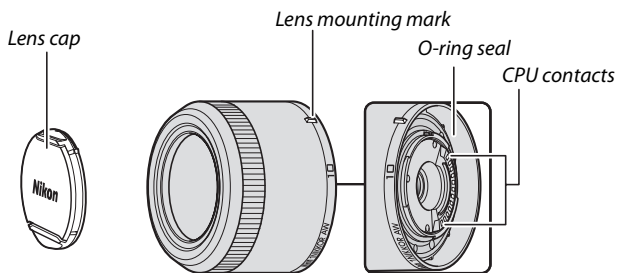

Waterproof 1 NIKKOR lenses are exclusively for Nikon 1 AW1 interchangeable lens format digital cameras. The angle of view is equivalent to a 35 mm format lens with a focal length about 2.7× longer. When attached to a waterproof camera, the water-, dust-, and shock-proof 1 NIKKOR AW 11–27.5mm f/3.5–5.6 and 1 NIKKOR AW 10mm f/2.8 lenses are compliant with the JIS/IEC Class 8 (IPX8) waterproofing standard, allowing the camera to be used at depths of up to 15 m (49 ft) for as long as 60 minutes at a time. They have also passed drop tests from a height of 2 m (6.6 ft) while attached to the camera. *These lenses are not water-, dust-, or shock-proof when not attached to the camera. The foregoing statement regarding water-, dust-, and shock-proofing is not a blanket guarantee that the product will be water- or dust-proof in all circumstances or invulnerable to damage or destruction.*

Use the zoom ring to zoom in and out.

Lens Care

- Use only with hoods, lens caps, and other accessories designated for use with this product.
- When using an optional lens hood, do not pick up or hold the lens or camera using only the hood.
- Keep the CPU contacts and O-ring seal clean and immediately remove any foreign matter with a blower.
- Contact a Nikon-authorized service representative should you notice that the O-ring seal is cracked, deformed, or otherwise damaged.
- Use a blower to remove dust and lint from the lens surfaces. To avoid scratches, do not use force when removing sand and other foreign objects.
- Never use organic solvents such as paint thinner or benzene to clean the lens.
- Attach the front and rear caps when the lens is not in use.
- If the lens will not be used for an extended period, store it in a cool, dry location to prevent mold and rust. Do not store in direct sunlight or with naphtha or camphor moth balls.
- Leaving the lens in extremely hot locations could damage or warp parts made from reinforced plastic.
- The lens features a built-in O-ring that should be replaced at least once a year by a Nikon-authorized service representative, regardless how frequently the lens is used. A fee is charged for this service.



✔ Using the Lens Under or Next to Water

- Never remove the lens under water.
- When attaching and removing the lens, carefully inspect the camera O-ring and the lens O-ring seal to be sure that they are free of threads, lint, hair, dust, sand, liquids, and other foreign matter. Be sure that the camera O-ring is not protruding, twisted, or out of position.
- Do not attach or remove the lens with wet or salt-covered hands or in areas exposed to spray, wind, sand, or dust.
- Immediately remove any water or other foreign matter from the lens and lens O-ring seal with a clean, soft, dry cloth.
- The amount of force needed to operate the zoom ring increases with depth.
- Should the product leak, cease use immediately, dry the camera and lens, and take them to a Nikon-authorized service representative.

✔ Supplied Accessories

- 40.5 mm snap-on Front Lens Cap LC-N40.5
- Rear Lens Cap LF-N2000

✔ Optional Accessories

40.5 mm screw-on Hood HN-N103 (attaches as shown below; note that the hood can not be used under water and that lens is not shockproof when hood is attached)

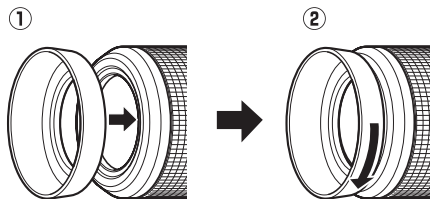

■ The Optional FT1 Mount Adapter

Read this section for information on using the optional FT1 mount adapter. Before proceeding, be sure that you have read and understood this manual and the documentation for the FT1 and lenses.

Autofocus

Autofocus is available only with AF-S lenses; other lenses support manual focus only. Set the camera focus mode to **AF-S** or (from firmware version L 1.10) **AF-C**. The only AF-area mode available is **Single-point** and the camera focuses on the subject in the center focus area only. Face priority is not supported. In some cases, a beep may sound, the in-focus indicator may be displayed, and pictures can be taken when the camera is not in focus; if this occurs, focus manually.

Manual Focus

Follow the steps below to focus manually when using the FT1 with a NIKKOR F mount lens.

1 Select manual focus mode.

In the shooting menu, select **Focus mode**, highlight **Manual focus**, press **▶**, and choose the magnification for the manual focus display from 10×, 5×, 2×, and 1× (zoom off) (📖 168).



2 Focus.

Rotate the lens focus ring until the subject is in focus.

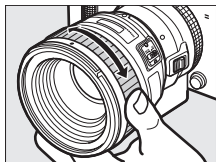

If the lens supports autofocus with manual override, you can focus using autofocus and then keep the shutter-release button pressed halfway and rotate the lens focus ring to fine-tune focus manually. To refocus using autofocus, press the shutter-release button halfway again.

To zoom in on the display for more precise focus, press  (note that this feature is not available during movie recording or in slow-motion movie mode). The display will be zoomed in to the magnification selected in Step 1 and a navigation window will appear in a gray frame at the bottom right of the display.

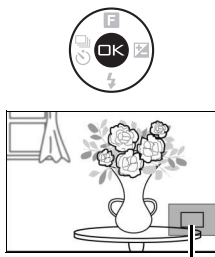

Navigation window

Use the multi selector to scroll to areas of the frame not visible in the display. Press  to exit zoom.



The Electronic Rangefinder

If a CPU lens is attached in manual focus mode, the focus indicator can be used to check whether the camera is focused on the subject in the center focus area.

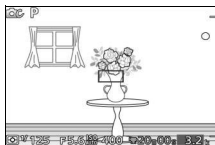

Focus indicator	Status
●	In focus.
▶	Camera focused in front of subject.
◀	Camera focused behind subject.
▶ ◀ (flashes)	Unable to determine focus.

Note that with some subjects, the in-focus indicator (●) may be displayed when the camera is not in focus. Check focus in the display before shooting.

Error Messages and Displays

The following warnings appear in the camera aperture display.

Display	Problem	Solution
FEE	Lens aperture ring is not locked at minimum aperture.	When using CPU lenses, lock aperture ring at minimum aperture (highest f-number).
F---	Non-CPU lens is attached, or no lens is attached.	When using non-CPU lens, rotate lens aperture ring to adjust aperture.

Restrictions

- Auto and best moment capture modes are not supported.
- Motion Snapshots can be recorded only when an AF-S lens is attached and **AF-S (Single AF)** is selected for focus mode and then only when the camera is in focus. Do not attempt to adjust focus using the focus ring.
- Shutter speeds of 1 s or slower are not available.
- The sound monitor switch and focus operation button (Focus Lock/MEMORY RECALL/AF Start) have no effect.



Precautions for Use

- Lenses over 380 g (13.4 oz) should be supported at all times. Do not hold the camera or carry the camera by the strap without supporting the lens. Failure to observe this precaution could damage the camera lens mount.
- Lines may appear in photographs taken with non-CPU lenses stopped down to minimum aperture.
- Select mode **A** or **M** to prevent sounds made by the lens being picked up by the microphone.
- Frame rates may slow when **5 fps** is selected for **Continuous/self-timer**.
- Certain lenses will block the AF-assist illuminator and, at some distances, the flash.
- The tops and bottoms may be missing from circular *bokeh* shapes created at wide apertures using lenses with a maximum aperture of f/1.4.
- The camera is not water- or shock-proof with the FT1 attached.



■ Supported Standards

- **DCF Version 2.0:** The Design Rule for Camera File Systems (DCF) is a standard widely used in the digital camera industry to ensure compatibility among different makes of camera.
- **DPOF: Digital Print Order Format (DPOF)** is an industry-wide standard that allows pictures to be printed from print orders stored on the memory card.
- **Exif version 2.3:** The camera supports Exif (**Exchangeable Image File Format for Digital Still Cameras**) version 2.3, a standard in which information stored with photographs is used for optimal color reproduction when the images are output on Exif-compliant printers.
- **PictBridge:** A standard developed through cooperation with the digital camera and printer industries, allowing photographs to be output directly to a printer without first transferring them to a computer.
- **HDMI: High-Definition Multimedia Interface** is a standard for multimedia interfaces used in consumer electronics and AV devices capable of transmitting audiovisual data and control signals to HDMI-compliant devices via a single cable connection.



Trademark Information

Mac OS and OS X are registered trademarks of Apple Inc. in the United States and/or other countries. Microsoft, Windows, and Windows Vista are either registered trademarks, or trademarks of Microsoft Corporation in the United States and/or other countries. The PictBridge logo is a trademark. The SD, SDHC, and SDXC logos are trademarks of SD-3C, LLC. HDMI, the HDMI logo and High-Definition Multimedia Interface are trademarks or registered trademarks of HDMI Licensing LLC.

HDMI

All other trade names mentioned in this manual or the other documentation provided with your Nikon product are trademarks or registered trademarks of their respective holders.

FreeType License (FreeType2)

Portions of this software are copyright © 2013 The FreeType Project (<http://www.freetype.org>). All rights reserved.

MIT License (HarfBuzz)

Portions of this software are copyright © 2013 The HarfBuzz Project (<http://www.freedesktop.org/wiki/Software/HarfBuzz>). All rights reserved.



Battery Life

The number of shots or movie footage that can be recorded with fully-charged batteries varies with the condition of the battery, temperature, the interval between shots, and the length of time menus are displayed. Sample figures for EN-EL20 (1020 mAh) batteries are given below.

- **Still images: Approximately 250 shots**
- **Movies: Approximately 55 minutes of HD footage at 1080/60i**

Measured according to CIPA standards at 23 ± 3 °C (73.4 ± 5.4 °F) with the camera at default settings, a fully-charged battery, a 1 NIKKOR AW 11–27.5mm f/3.5–5.6 lens, and a 16 GB Toshiba SD-E016GUX UHS-I SDHC card. Value for still images obtained under the following test conditions: photographs taken at intervals of 30 s with the built-in flash fired with every other shot and the camera turned off and then on after every ten shots. Value for movies obtained under the following test conditions: a series of 20 minute movies with a file size of up to 4 GB were recorded; recording was only interrupted when temperature warning was displayed.

The following can reduce battery life:

- Keeping the shutter-release button pressed halfway
- Repeated autofocus operations
- Taking NEF (RAW) photographs
- Slow shutter speeds
- Using a wireless mobile adapter or Eye-Fi cards
- Using vibration reduction mode with VR lenses
- Using zoom with power zoom lenses
- Using the location data or track log functions
- Setting monitor brightness to **Hi**



























To ensure that you get the most from rechargeable Nikon EN-EL20 batteries:









- Keep the battery contacts clean. Soiled contacts can reduce battery performance.
- Use batteries immediately after charging. Batteries will lose their charge if left unused.



Index

Symbols

-  (Auto mode) 11, 28
-  (Creative mode) 11, 37
-  (Best moment capture mode) 11, 76
-  (Advanced movie mode) .. 12, 66
-  (Motion Snapshot mode) ... 10, 83
-  (Scene auto selector) 155
- P** (Programmed auto) 38, 40, 66, 155
- S** (Shutter-priority auto) ... 38, 41, 66, 155
- A** (Aperture-priority auto) 38, 42, 66, 155
- M** (Manual) 38, 43, 66, 155
-  (Night landscape) 38
-  (Night portrait) 39
-  (Backlighting) 39, 46
-  (Easy panorama) 39, 47
-  (Soft) 39
-  (Miniature effect) 39
-  (Selective color) 39
-  (Slow motion) 72
-  (Portrait) 33
-  (Landscape) 33
-  (Night portrait) 33
-  (Close up) 33
-  (Night landscape) 33
-  (Auto) 33
-  (flexible program) 40
- MENU (menu) button 9, 143, 153, 174, 177, 191
-  (playback) button 31, 81, 86
-  (delete) button 32, 71, 82, 86, 121
- Q** (playback zoom in) button 120
-  (playback zoom out/thumbnail) button 118
- DISP (display) button 7
-  (OK) button 8, 49
-  (action) button 96
-  (feature) 12, 35, 37, 72, 78, 85, 122

-  (continuous shooting/self-timer) . 87, 89
-  (exposure compensation) 91
- PRE (Preset manual) 180
-  (matrix) 160
-  (centerweighted) 160
-  (spot) 160
-  (auto-area) 170
-  (single-point) 170
-  (subject tracking) 170
-  (flash-ready indicator) 92

A

- AC adapter 202, 208
- Accessories 201
- Active D-Lighting 163
- Adobe RGB 162
- Advanced movie mode 12, 66, 72
- AE lock 195
- AF 165, 170
- AF-A 165
- AF-area mode 170
- AF-assist illuminator 172
- AF-C 165
- AF-F 165
- AF-S 165
- A-GPS File 108
- Altimeter 101, 103
- Altimeter/Depth Gauge 196
- Altitude/Depth Correction 196
- Altitude/Depth Options 196
- Altitude/Depth Units 196
- Aperture 42, 43
- Aperture-priority auto 38, 42, 66, 155
- Attaching the lens 19, 203
- Auto distortion control 161
- Auto image rotation 199
- Auto mode 11, 28
- Auto power off 22, 107, 195



Auto-area (AF-area mode)	170
Autofocus	165, 170
Automatic scene selection	33
Auto-select AF	165
Available settings	215

B

Background track	86, 124, 134
Backlighting	39, 46
Battery	14, 16, 27, 238
Beep	29, 89, 194
Best moment capture mode	76
Best shot	78, 81
Body cap	2, 202
Border	141
Brightness	186
Buffering	79, 84
Built-in AF assist	172
Built-in flash	92
Bulb	44

C

Calendar	119, 123
Calendar playback	119
Capture NX 2	158, 189, 202
CEC	137
Center-weighted (Metering)	160
Change theme	152
Charging a battery	14
Clock	24, 25, 198
Clock battery	25
Close up	33
Close up (Underwater mode)	55
Color space	162
Color temperature	182
Compatible lens	201
Computer	126
Continuous AF	165
Contrast	163, 186
Control lock	195
Creating short movies	132, 134
Creative mode	37
Crop	141, 149

Custom Picture Control	185, 188
------------------------------	----------

D

Date and time	24, 198
Date format	24, 198
Daylight saving time	24, 198
DCF version 2.0	247
Defaults	219
Delete	32, 71, 82, 86, 121
Delete all images	121
Delete log	113
Delete selected images	121
Depth gauge	57, 103, 196
Depth log	110
Detailed display	7
Detailed photo information	7, 116
Digital Print Order Format	247
Display	194
Display brightness	194
D-Lighting	147
DPOF	140, 142, 247
DPOF print order	140, 142
Dust shield	210, 211

E

Easy panorama	39, 47
Edit movie	150
Electronic compass	102, 114, 236
Electronic VR	165
Exif version 2.3	247
Exposure	90, 155, 160
Exposure compensation	90
Exposure indicator	44
Exposure mode	155
Eye-Fi	207

F

Face priority	34, 172
Face-priority zoom	150
File format	160
Fill flash	93
Filter effects	186, 187
Fine-tuning white balance	179



Firmware version	200
Flash	92, 173
Flash compensation	173
Flash control	173
Flash mode	93
Flash range	95
Flash-ready indicator	92
Flexible program	40
Flicker reduction	197
Focal length	34, 116
Focal length scale	34, 240
Focal plane mark	2, 169
Focus	165, 170
Focus area	29, 170
Focus lock	171
Focus mode	165
Format	17, 193
Format memory card	17, 193
Frame rate	115, 175
FT1	243
Full-frame playback	31, 115
Full-time AF	165

G

Grid display	30
--------------------	----

H

H.264	235
HD movies	66, 67, 175
HDMI	136, 247
HDMI device control	137
HDMI-CEC	137
HDR	46
Heading	101, 102
High contrast display	194
High definition	136, 247
High ISO noise reduction	190
Histogram	117
Hue	186

I

Image processing menu	177
Image quality	156

Image review	146
Image selection	145
Image size	156
Index print	140
ISO sensitivity	183

J

JPEG	156
------------	-----

L

Landscape	33, 184
Language	24, 198
Lens	19, 34, 164, 201, 238, 239
Lens cap	19, 21, 205
Lens mount	169
Live image control	35
Load from/save to card	189
Location data	xviii, 104
Location data log	110
Long exposure NR	164

M

Manual	38, 43, 66, 155
Manual focus	168
Matrix (Metering)	160
Maximum aperture	238, 239
Memory card ...	16, 18, 193, 206, 220
Memory card access lamp	30
Memory card capacity	220
Metering	160
Microphone	68, 176
Miniature effect	39
Monitor	5, 7, 194
Monochrome	184
Motion Snapshot mode	83
Mount adapter	201, 243
MOV	158, 160, 222
Movie before/after	159
Movie menu	174
Movie settings	175
Movie sound options	176
Movie-record button	68, 73
Movies	66, 175



Multi selector 8

N

NEF 156, 158

NEF (RAW) 156, 158

Neutral 184

Night landscape 33, 38

Night portrait 33, 39

Nikon Transfer 2 131

NMS 158, 160, 222

Non-waterproof lenses 203

Normal panorama 157, 221

Number of shots saved 159

O

Optical VR 164

O-Ring 19, 62, 201

O-ring protector 203

Outdoor display 98

P

Photo information 7, 115

PictBridge 138, 247

Picture Control 184, 188

Pixel mapping 200

Playback 31, 115

Playback menu 143

Playback zoom 120

Portrait 33, 184

Power connector 202, 208

Power drive zoom switch 205

Power switch 22

Preset manual 178, 180

Press the shutter-release button all
the way down 30, 33

Press the shutter-release button
halfway 29, 33

Print date 142

Print DPOF print order 140

Printing 138

Programmed auto 38, 40, 66, 155

Protect 146

Q

Quick adjust 186

R

Rating 122, 146

Rear curtain + slow sync 93

Rear-curtain sync 93

Red-eye reduction 93

Red-eye reduction + slow sync 93

Removing the lens from the camera
21, 205

Reset file numbering 197

Reset movie options 175

Reset processing options 178

Reset setup options 193

Reset shooting options 155

Resize 148

Retractable lens barrel button ..204,
205

Rotate tall 146

S

Saturation 186

Scene auto selector 155

Scene selection 38

Scuba 55

SD card 206

Select images for printing 140

Selective color 39

Self-timer 89

Sensitivity 183

Setup menu 191

Sharpening 186

Shock-proofing xiv, xv

Shooting menu 153

Short Movie Creator 126, 132, 134

Shutter button AE lock 195

Shutter speed 41, 43

Shutter-priority auto 38, 41, 66, 155

Shutter-release button 29, 33, 77,
79, 84, 195

Silicon grease 21, 64, 201



Simple photo info	115
Simplified display	7
Single AF	165
Single-point	170
Size	148, 156, 175, 232, 235
Slide show	123
Slot empty release lock	193
Slow motion	72, 175
Slow view	76
Smart Photo Selector	78
Soft	39
Sound settings	194
Speaker	3
Spot (Metering)	160
sRGB	162
Standard	184
Standard (Underwater mode)	55
Strap for use exclusively on land	14
Subject tracking	170
System requirements	128

T

Television	136
Temperature warnings	xxii
Theme	85, 152
Thumbnail playback	118
Time	24, 198
Time stamp	141
Time zone	198
Time zone and date	198
Timer	89
Toning	186, 187
Track log	110
Trimming movies	150

U

Underwater (creative mode)	38, 55
USB	99, 130, 138
USB cable	130, 138
UTC	104, 107

V

ViewNX 2	126
----------------	-----

Virtual horizon	101, 102
Vivid	184
Volume	70, 125
VR	164

W

Water- and dust-proofing	xiv, xv
Waterproof lenses	19, 238, 239
White balance	178
Wide panorama	157, 221
Wind noise reduction	176
Wireless mobile adapter	99, 202

Z

Zoom guide	205
Zoom ring	34, 204, 240



No reproduction in any form of this manual, in whole or in part (except for brief quotation in critical articles or reviews), may be made without written authorization from NIKON CORPORATION.

NIKON CORPORATION

© 2013 Nikon Corporation



SB3H01(11)
6MVA5611-01