

# ***Nikon***

DIGITAL CAMERA

# COOLPIX L840

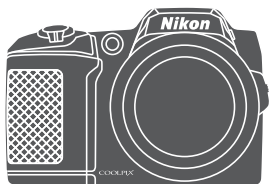

## Reference Manual

<b>Introduction</b>	<b>⇒ i</b>
<b>Table of Contents</b>	<b>⇒ xiii</b>
<b>Parts of the Camera</b>	<b>⇒ 1</b>
<b>Preparing for Shooting</b>	<b>⇒ 6</b>
<b>Basic Shooting and Playback Operations</b>	<b>⇒ 12</b>
<b>Shooting Features</b>	<b>⇒ 22</b>
<b>Playback Features</b>	<b>⇒ 57</b>
<b>Recording and Playing Back Movies</b>	<b>⇒ 68</b>
<b>Using Menus</b>	<b>⇒ 75</b>
<b>Using the Wi-Fi (Wireless LAN) Function</b>	<b>⇒ 116</b>
<b>Connecting the Camera to a TV, Printer, or Computer</b>	<b>⇒ 120</b>
<b>Technical Notes</b>	<b>⇒ 130</b>

# Introduction



## Read This First

To get the most from this Nikon product, be sure to read “For Your Safety” (v-vii) and “Wi-Fi (Wireless LAN Network)” (x), and all other instructions thoroughly and keep them where they will be read by all who use the camera.

- If you want to start using the camera right away, see “Preparing for Shooting” (6) and “Basic Shooting and Playback Operations” (12).

## Other Information

- Symbols and Conventions

Symbol	Description
	This icon marks cautions and information that should be read before using the camera.
	This icon marks notes and information that should be read before using the camera.
	This icon marks other pages containing relevant information.

- SD, SDHC, and SDXC memory cards are referred to as “memory cards” in this manual.
- The setting at the time of purchase is referred to as the “default setting.”
- The names of menu items displayed in the camera monitor, and the names of buttons or messages displayed on a computer monitor appear in bold.
- In this manual, images are sometimes omitted from monitor display samples so that monitor indicators can be more clearly shown.

## Information and Precautions

### Life-Long Learning

As part of Nikon's "Life-Long Learning" commitment to ongoing product support and education, continually updated information is available online at the following websites:

- For users in the U.S.A.: <http://www.nikonusa.com/>
- For users in Europe and Africa: <http://www.europe-nikon.com/support/>
- For users in Asia, Oceania, and the Middle East: <http://www.nikon-asia.com/>

Visit these websites to keep up-to-date with the latest product information, tips, answers to frequently asked questions (FAQs), and general advice on digital imaging and photography. Additional information may be available from the Nikon representative in your area. Visit the website below for contact information.

<http://imaging.nikon.com/>

### Use Only Nikon Brand Electronic Accessories

Nikon COOLPIX cameras are designed to the highest standards and include complex electronic circuitry. Only Nikon brand electronic accessories (including battery chargers, batteries, and AC adapters) certified by Nikon specifically for use with this Nikon digital camera are engineered and proven to operate within the operational and safety requirements of this electronic circuitry.

THE USE OF NON-NIKON ELECTRONIC ACCESSORIES COULD DAMAGE THE CAMERA AND MAY VOID YOUR NIKON WARRANTY.

For more information about Nikon brand accessories, contact a local authorized Nikon dealer.

### Before Taking Important Pictures

Before taking pictures on important occasions (such as at weddings or before taking the camera on a trip), take a test shot to ensure that the camera is functioning normally. Nikon will not be held liable for damages or lost profits that may result from product malfunction.

## About the Manuals

- No part of the manuals included with this product may be reproduced, transmitted, transcribed, stored in a retrieval system, or translated into any language in any form, by any means, without Nikon's prior written permission.
- Illustrations and monitor content shown in this manual may differ from the actual product.
- Nikon reserves the right to change the specifications of the hardware and software described in these manuals at any time and without prior notice.
- Nikon will not be held liable for any damages resulting from the use of this product.
- While every effort was made to ensure that the information in these manuals is accurate and complete, we would appreciate it were you to bring any errors or omissions to the attention of the Nikon representative in your area (address provided separately).

## Notice Concerning Prohibition of Copying or Reproduction

Note that simply being in possession of material that was digitally copied or reproduced by means of a scanner, digital camera or other device may be punishable by law.

### • Items prohibited by law from being copied or reproduced

Do not copy or reproduce paper money, coins, securities, government bonds or local government bonds, even if such copies or reproductions are stamped "Sample." The copying or reproduction of paper money, coins, or securities which are circulated in a foreign country is prohibited. Unless the prior permission of the government was obtained, the copying or reproduction of unused postage stamps or post cards issued by the government is prohibited.

The copying or reproduction of stamps issued by the government and of certified documents stipulated by law is prohibited.

### • Cautions on certain copies and reproductions

The government has issued cautions on copies or reproductions of securities issued by private companies (shares, bills, checks, gift certificates, etc.), commuter passes, or coupon tickets, except when a minimum of necessary copies are to be provided for business use by a company. Also, do not copy or reproduce passports issued by the government, licenses issued by public agencies and private groups, ID cards and tickets, such as passes and meal coupons.

### • Comply with copyright notices

The copying or reproduction of copyrighted creative works such as books, music, paintings, woodcut prints, maps, drawings, movies, and photographs is governed by national and international copyright laws. Do not use this product for the purpose of making illegal copies or to infringe copyright laws.

## Disposing of Data Storage Devices

Please note that deleting images or formatting data storage devices such as memory cards or built-in camera memory does not completely erase the original image data. Deleted files can sometimes be recovered from discarded storage devices using commercially available software, potentially resulting in the malicious use of personal image data. Ensuring the privacy of such data is the user's responsibility.

Before discarding a data storage device or transferring ownership to another person, erase all data using commercial deletion software, or format the device and then completely refill it with images containing no private information (for example, images of empty sky). Care should be taken to avoid injury or damage to property when physically destroying data storage devices.

To delete the Wi-Fi settings, select **Restore default settings** in the Wi-Fi options menu (📖75).

## Conformity Marking

Follow the procedure below to display some of the conformity markings that the camera complies with.

Press the **MENU** button → 🍴 menu icon → Conformity marking → Ⓞ button

## For Your Safety

To prevent damage to your Nikon product or injury to yourself or to others, read the following safety precautions in their entirety before using this equipment. Keep these safety instructions where all those who use the product will read them.



This icon marks warnings, information that should be read before using this Nikon product, to prevent possible injury.

## WARNINGS

### **Turn off in the event of malfunction**

Should you notice smoke or an unusual smell coming from the camera or AC adapter, unplug the AC adapter and remove the batteries immediately, taking care to avoid burns. Continued operation could result in injury. After removing or disconnecting the power source, take the equipment to a Nikon-authorized service representative for inspection.

### **Do not disassemble**

Touching the internal parts of the camera or AC adapter could result in injury. Repairs should be performed only by qualified technicians. Should the camera or AC adapter break open as the result of a fall or other accident, take the product to a Nikon-authorized service representative for inspection, after unplugging the product and/or removing the batteries.

### **Do not use the camera or AC adapter in the presence of flammable gas**

Do not use electronic equipment in the presence of flammable gas, as this could result in explosion or fire.

### **Handle the camera strap with care**

Never place the strap around the neck of an infant or child.

### **Keep out of reach of children**

Particular care should be taken to prevent infants from putting the batteries or other small parts into their mouths.

### **Do not remain in contact with the camera, battery charger, or AC adapter for extended periods while the devices are on or in use**

Parts of the devices become hot. Leaving the devices in direct contact with the skin for extended periods may result in low-temperature burns.

 **Do not leave the product where it will be exposed to extremely high temperatures, such as in an enclosed automobile or in direct sunlight**

Failure to observe this precaution could cause damage or fire.

 **Observe caution when handling batteries**

Batteries may leak or explode if improperly handled. Observe the following precautions when handling batteries for use in this product:

- Before replacing the batteries, turn the product off. If you are using an AC adapter, be sure it is unplugged.
- Use only the batteries approved for use in this product (📖7). Do not combine old and new batteries or batteries of different makes or types.
- When charging Nikon EN-MH2 rechargeable Ni-MH batteries, use only the specified charger and charge the batteries four at a time. When replacing the batteries with EN-MH2-B2 batteries (available separately), purchase two sets (total of four batteries).
- The EN-MH2 rechargeable batteries are for use with Nikon digital cameras only, and are compatible with COOLPIX L840.
- Insert batteries in the correct orientation.
- Do not short or disassemble batteries or attempt to remove or break battery insulation or casing.
- Do not expose batteries to flame or to excessive heat.
- Do not immerse in or expose to water.
- Do not transport or store with metal objects such as necklaces or hairpins.
- Batteries are prone to leakage when fully discharged. To avoid damage to the product, be sure to remove the batteries when no charge remains.
- Discontinue use immediately should you notice any change in the batteries, such as discoloration or deformation.
- If liquid from damaged batteries comes in contact with clothing or skin, rinse immediately with plenty of water.

 **Observe the following precautions when handling the Battery Chargers (available separately)**

- Keep dry. Failure to observe this precaution could result in fire or electric shock.
- Dust on or near the metal parts of the plug should be removed with a dry cloth. Continued use could result in fire.
- Do not handle the power cable or go near the battery charger during lightning storms. Failure to observe this precaution could result in electric shock.
- Do not damage, modify, forcibly tug or bend the power cable, place it under heavy objects, or expose it to heat or flames. Should the insulation be damaged and the wires become exposed, take it to a Nikon-authorized service representative for inspection. Failure to observe these precautions could result in fire or electric shock.



- Do not handle the plug or battery charger with wet hands. Failure to observe this precaution could result in electric shock.
- Do not use with travel converters or adapters designed to convert from one voltage to another or with DC-to-AC inverters. Failure to observe this precaution could damage the product or cause overheating or fire.

 **Use appropriate cables**

When connecting cables to the input and output jacks, use only the cables provided or sold by Nikon for the purpose, to maintain compliance with product regulations.

 **Do not touch the moving parts of the lens**

Failure to observe this precaution could result in injury.

 **Handle moving parts with care**

Be careful that your fingers or other objects are not pinched by the lens cover or other moving parts.

 **Using the flash close to your subject's eyes could cause temporary visual impairment**

The flash should be no less than 1 meter (3 ft 4 in.) from the subject. Particular care should be observed when photographing infants.

 **Do not operate the flash with the flash window touching a person or object**

Failure to observe this precaution could result in burns or fire.

 **Avoid contact with liquid crystal**

Should the monitor break, care should be taken to avoid injury caused by broken glass and to prevent liquid crystal from the monitor touching the skin or entering the eyes or mouth.

 **Follow the instructions of airline and hospital personnel**

# Notices

## Notices for Customers in the U.S.A.

### **Federal Communications Commission (FCC) Radio Frequency Interference Statement**

This equipment has been tested and found to comply with the limits for a Class B digital device, pursuant to Part 15 of the FCC rules. These limits are designed to provide reasonable

protection against harmful interference in a residential installation. This equipment generates, uses, and can radiate radio frequency energy and, if not installed and used in accordance with the instructions, may cause harmful interference to radio communications. However, there is no guarantee that interference will not occur in a particular installation. If this equipment does cause harmful interference to radio or television reception, which can be determined by turning the equipment off and on, the user is encouraged to try to correct the interference by one or more of the following measures:

- Reorient or relocate the receiving antenna.
- Increase the separation between the equipment and receiver.
- Connect the equipment into an outlet on a circuit different from that to which the receiver is connected.
- Consult the dealer or an experienced radio/television technician for help.



### **CAUTIONS**

#### **Modifications**

The FCC requires the user to be notified that any changes or modifications made to this device that are not expressly approved by Nikon Corporation may void the user's authority to operate the equipment.

#### **Interface Cables**

Use the interface cables sold or provided by Nikon for your equipment. Using other interface cables may exceed the limits of Class B Part 15 of the FCC rules.

## Notice for Customers in the State of California

### WARNING

Handling the cord on this product will expose you to lead, a chemical known to the State of California to cause birth defects or other reproductive harm.

### Wash hands after handling.

Nikon Inc.,

1300 Walt Whitman Road, Melville, New York 11747-3064, U.S.A.

Tel: 631-547-4200

## Notice for Customers in Canada

CAN ICES-3 B / NMB-3 B

## Notices for Customers in Europe

This symbol indicates that electrical and electronic equipment is to be collected separately.

The following apply only to users in European countries:

- This product is designated for separate collection at an appropriate collection point. Do not dispose of as household waste.
- Separate collection and recycling helps conserve natural resources and prevent negative consequences for human health and the environment that might result from incorrect disposal.
- For more information, contact the retailer or the local authorities in charge of waste management.



This symbol on the batteries indicates that the batteries are to be collected separately.

The following apply only to users in European countries:

- All batteries, whether marked with this symbol or not, are designated for separate collection at an appropriate collection point. Do not dispose of as household waste.
- For more information, contact the retailer or the local authorities in charge of waste management.



## Wi-Fi (Wireless LAN Network)

This product is controlled by the United States Export Administration Regulations, and you are required to obtain permission from the United States government if you export or re-export this product to any country to which the United States embargoes goods. The following countries were subject to embargo: Cuba, Iran, North Korea, Sudan, and Syria. Since the target countries are subject to change, please contact the United States Department of Commerce for the latest information.

### **Restrictions on Wireless Devices**

The wireless transceiver included in this product conforms to wireless regulations in the country of sale and is not for use in other countries (products purchased in the EU or EFTA can be used anywhere within the EU and EFTA). Nikon does not accept liability for use in other countries. Users who are unsure as to the original country of sale should consult with their local Nikon service center or Nikon-authorized service representative. This restriction applies to wireless operation only and not to any other use of the product.

### **Notice for Customers in the U.S.A. and Canada**

#### **Federal Communications Commission (FCC) and Industry of Canada (IC)**

#### **Declaration of Conformity**

This device complies with Part 15 of FCC Rules and Industry Canada licence-exempt RSS standard(s). Operation is subject to the following two conditions: (1) this device may not cause interference, and (2) this device must accept any interference, including interference that may cause undesired operation of this device.

#### **FCC/IC RF Exposure Statement**

This transmitter must not be co-located or operated in conjunction with any other antenna or transmitter.

The available scientific evidence does not show that any health problems are associated with using low power wireless devices. There is no proof, however, that these low power wireless devices are absolutely safe. Low power wireless devices emit low levels of radio frequency energy (RF) in the microwave range while being used. Whereas high levels of RF can produce health effects (by heating tissue), exposure of low-level RF that does not produce heating effects causes no known adverse health effects. Many studies of low-level RF exposures have not found any biological effects. Some studies have suggested that some biological effects might occur, but such findings have not been confirmed by additional research.

COOLPIX L840, which is equipped with a WSDB-686GN (FCC ID:2AAD3AA1G0J0 / IC ID:4634A-2150EC) Wireless LAN Module, has been tested and found to comply with FCC/IC radiation exposure limits set forth for an uncontrolled environment and meets the FCC radio frequency (RF) Exposure Guidelines in Supplement C to OET65 and RSS-102 of the IC radio frequency (RF) Exposure rules. Please refer to the SAR test report that was uploaded to FCC website.

### **Declaration of Conformity (Europe)**

Hereby, Nikon Corporation, declares that COOLPIX L840 is in compliance with the essential requirements and other relevant provisions of Directive 1999/5/EC. The declaration of conformity may be consulted at [http://imaging.nikon.com/support/pdf/DoC\\_L840.pdf](http://imaging.nikon.com/support/pdf/DoC_L840.pdf).

### **Notice for Customers in Singapore**

This device complies with radio-frequency regulations.

**Complies with  
IDA Standards  
DA103423**

### **Notice for Customers in Jamaica**

This product contains a Type Approved Module by Jamaica: "SMA – WSDB-686GN"

## Precautions when Using Radio Transmissions

Always keep in mind that radio transmission or reception of data is subject to interception by third parties. Note that Nikon is not responsible for data or information leaks that may occur during data transfer.

## Personal Information Management and Disclaimer

- User information registered and configured on the product, including wireless LAN connection settings and other personal information, is susceptible to alteration and loss resulting from operational error, static electricity, accident, malfunction, repair or other handling. Always keep separate copies of important information. Nikon is not responsible for any direct or indirect damages or lost profits resulting from alteration or loss of content that is not attributable to Nikon.
- Before discarding this product or transferring it to another owner, perform **Reset all** in the setup menu (📖75) to delete all user information registered and configured with the product, including wireless LAN connection settings and other personal information.

# Table of Contents

<b>Introduction</b> .....	<b>i</b>
<b>Read This First</b> .....	<b>i</b>
Other Information.....	i
Information and Precautions.....	ii
<b>For Your Safety</b> .....	<b>v</b>
WARNINGS .....	v
<b>Notices</b> .....	<b>viii</b>
<b>Wi-Fi (Wireless LAN Network)</b> .....	<b>x</b>
<hr/>	
<b>Parts of the Camera</b> .....	<b>1</b>
<b>The Camera Body</b> .....	<b>1</b>
<b>The Monitor</b> .....	<b>3</b>
Shooting Mode .....	3
Playback Mode .....	5
<hr/>	
<b>Preparing for Shooting</b> .....	<b>6</b>
<b>Attaching the Camera Strap and Lens Cap</b> .....	<b>6</b>
<b>Insert the Batteries and Memory Card</b> .....	<b>7</b>
Applicable Batteries.....	7
Removing the Batteries or Memory Card .....	8
Memory Cards and Internal Memory.....	8
<b>Turn the Camera On and Set the Display Language, Date, and Time</b> .....	<b>9</b>
Raising and Lowering the Flash.....	11
<hr/>	
<b>Basic Shooting and Playback Operations</b> .....	<b>12</b>
<b>Shooting with Scene Auto Selector Mode</b> .....	<b>12</b>
Using the Zoom.....	14
The Shutter-release Button.....	16
<b>Changing the Angle of the Monitor</b> .....	<b>16</b>
<b>Play Back Images</b> .....	<b>17</b>
<b>Delete Images</b> .....	<b>18</b>
<b>Changing the Shooting Mode</b> .....	<b>20</b>
<b>Using the Flash, Self-timer, Etc.</b> .....	<b>21</b>
<b>Recording Movies</b> .....	<b>21</b>

Shooting Features .....	22
<b>SCENE</b> ♥ (Scene Auto Selector) Mode .....	22
Scene Mode (Shooting Suited to Scenes) .....	23
Tips and Notes .....	24
Shooting with Easy Panorama .....	29
Playback with Easy Panorama .....	31
Special Effects Mode (Applying Effects When Shooting) .....	32
Smart Portrait Mode (Enhancing Human Faces When Shooting) .....	34
Using Smile Timer .....	35
Using Self-Collage .....	36
Short Movie Show Mode (Combining Movie Clips to Create Short Movies) ....	38
<b>📷</b> (Auto) Mode .....	41
Using the Creative Slider .....	42
Flash Mode .....	43
Self-timer .....	45
Macro Mode (Taking Close-up Pictures) .....	46
Exposure Compensation (Adjusting Brightness) .....	47
Default Settings (Flash, Self-timer, Etc.) .....	48
Focusing .....	50
Using Face Detection .....	50
Using Skin Softening .....	51
Using Target Finding AF .....	52
Subjects Not Suitable for Autofocus .....	53
Focus Lock .....	54
Functions That Cannot Be Used Simultaneously When Shooting .....	55



---

<b>Playback Features</b> .....	<b>57</b>
Playback Zoom .....	57
Thumbnail Playback/Calendar Display .....	58
List by Date Mode.....	59
<b>Viewing and Deleting Images Captured Continuously (Sequence)</b> .....	<b>60</b>
Viewing Images in a Sequence .....	60
Deleting Images in a Sequence .....	61
<b>Editing Images (Still Images)</b> .....	<b>62</b>
Before Editing Images .....	62
Quick Effects: Changing Hue or Mood .....	62
Quick Retouch: Enhancing Contrast and Saturation .....	63
D-Lighting: Enhancing Brightness and Contrast.....	64
Red-eye Correction: Correcting Red-eye When Shooting with the Flash .....	64
Glamour Retouch: Enhancing Human Faces.....	65
Small Picture: Reducing the Size of an Image .....	66
Crop: Creating a Cropped Copy .....	67

---

<b>Recording and Playing Back Movies</b> .....	<b>68</b>
Capturing Still Images While Recording Movies .....	71
Operations During Movie Playback .....	72
<b>Editing Movies</b> .....	<b>73</b>
Extracting Only the Desired Portions of a Movie .....	73
Saving a Frame from a Movie as a Still Image .....	74

Using Menus.....	75
<b>The Shooting Menu (for  (Auto) Mode)</b> .....	77
Image Mode (Image Size and Quality).....	77
White Balance (Adjusting Hue).....	79
Continuous Shooting.....	81
ISO Sensitivity.....	83
AF Area Mode.....	84
Autofocus Mode.....	87
<b>The Smart Portrait Menu</b> .....	88
Self-Collage.....	88
Blink Proof.....	89
<b>The Playback Menu</b> .....	90
Mark for Wi-Fi Upload.....	90
Slide Show.....	91
Protect.....	92
Rotate Image.....	92
Copy (Copy Between the Memory Card and Internal Memory).....	93
Sequence Display Options.....	94
The Image Selection Screen.....	95
<b>The Movie Menu</b> .....	96
Movie Options.....	96
Autofocus Mode.....	100
Movie VR.....	101
Wind Noise Reduction.....	101
Frame Rate.....	102
<b>The Wi-Fi Options Menu</b> .....	103
Operating the Text Input Keyboard.....	104

<b>The Setup Menu</b> .....	<b>105</b>
Time Zone and Date .....	105
Monitor Settings .....	107
Date Stamp .....	109
Photo VR .....	110
AF Assist .....	110
Digital Zoom .....	111
Sound Settings .....	111
Auto Off .....	112
Format Card/Format Memory .....	113
Language .....	114
Reset All .....	114
Battery Type .....	114
Conformity Marking .....	115
Firmware Version .....	115
<hr/>	
<b>Using the Wi-Fi (Wireless LAN) Function</b> .....	<b>116</b>
Installing the Software on the Smart Device .....	116
Connecting the Smart Device to the Camera .....	117
Preselecting Images in the Camera That You Want to Transfer to a Smart Device .....	119

---

<b>Connecting the Camera to a TV, Printer, or Computer</b> .....	120
<b>Connecting the Camera to a TV (Playback on a TV)</b> .....	122
<b>Connecting the Camera to a Printer (Direct Print)</b> .....	124
Connecting the Camera to a Printer .....	124
Printing Images One at a Time .....	125
Printing Multiple Images .....	126
<b>Using ViewNX 2 (Transferring Images to a Computer)</b> .....	128
Installing ViewNX 2 .....	128
Transferring Images to a Computer .....	128

---

<b>Technical Notes</b> .....	130
<b>Caring for the Product</b> .....	131
The Camera .....	131
Batteries.....	132
Memory Cards.....	133
<b>Cleaning and Storage</b> .....	134
Cleaning .....	134
Storage .....	134
<b>Error Messages</b> .....	135
<b>Troubleshooting</b> .....	138
<b>File Names</b> .....	144
<b>Optional Accessories</b> .....	145
<b>Specifications</b> .....	146
Approved Memory Cards.....	150
<b>Index</b> .....	152

# Parts of the Camera

## The Camera Body

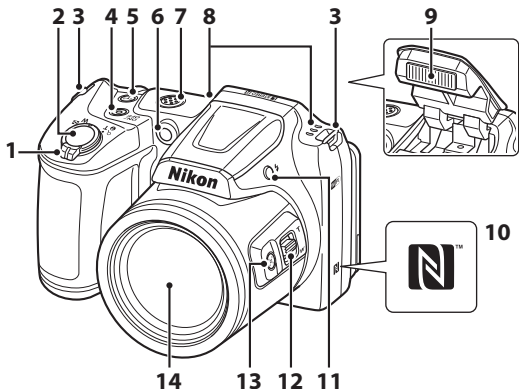

<b>1</b>	Zoom control..... 14	<b>7</b>	Speaker
	<b>W</b> : Wide-angle..... 14	<b>8</b>	Microphone (stereo)
	<b>T</b> : Telephoto..... 14	<b>9</b>	Flash..... 11, 43
	: Thumbnail playback..... 58	<b>10</b>	N-Mark (NFC antenna)..... 117, 119
	: Playback zoom..... 57	<b>11</b>	(flash pop-up) button..... 11, 43
	: Help ..... 23	<b>12</b>	Side zoom control ..... 14
<b>2</b>	Shutter-release button..... 13	<b>13</b>	(snap-back zoom) button..... 15
<b>3</b>	Eyelet for camera strap ..... 6	<b>14</b>	Lens
<b>4</b>	Power switch/power-on lamp..... 9		
<b>5</b>	(Wi-Fi) button..... 117, 119		
<b>6</b>	Self-timer lamp ..... 45		
	AF-assist illuminator		

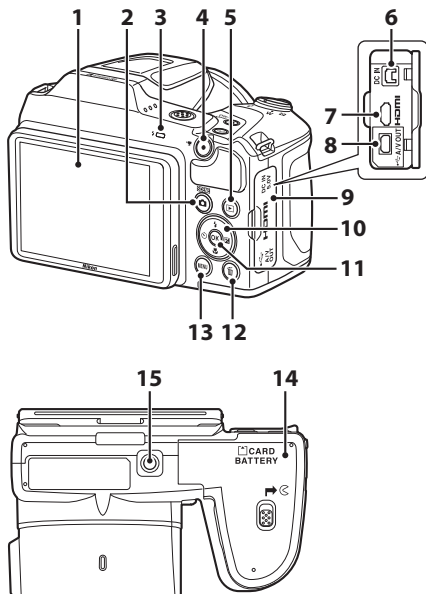

- |  |                        |  |     |
|--|------------------------|--|-----|
| <b>1</b> Monitor .....   | 3, 16                  | <b>9</b> Connector cover .....                             | 120 |
| <b>2</b> (shooting mode) button .....  | 22, 23, 32, 34, 38, 41 | <b>10</b> Multi selector .....                             | 75  |
| <b>3</b> Flash lamp .....  | 44                     | <b>11</b> (apply selection) button .....                   | 75  |
| <b>4</b> (movie-record) button .....   | 68                     | <b>12</b> (delete) button .....                            | 18  |
| <b>5</b> (playback) button .....   | 17                     | <b>13</b> MENU (menu) button .....                         | 75  |
| <b>6</b> DC input connector<br>(for AC adapter available<br>separately from Nikon) ..... | 145                    | <b>14</b> Battery-chamber/<br>memory card slot cover ..... | 7   |
| <b>7</b> HDMI micro connector<br>(Type D) .....  | 120                    | <b>15</b> Tripod socket .....                              | 148 |
| <b>8</b> USB/audio/video output<br>connector .....                                       | 120                    |  |     |

# The Monitor

The information that is displayed in the monitor during shooting and playback changes depending on the camera's settings and state of use.

By default, information is displayed when the camera is turned on and when you operate the camera, and turns off after a few seconds (when **Photo info** is set to **Auto info** in **Monitor settings** (107)).

## Shooting Mode

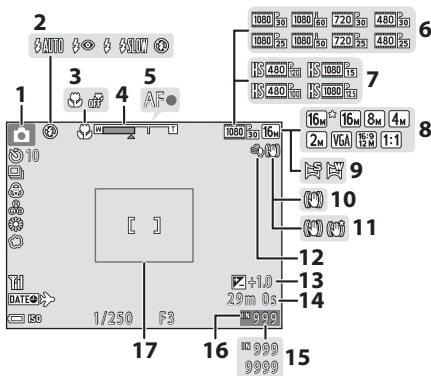

<b>1</b>	Shooting mode .....20, 22, 23, 32, 34, 38, 41	<b>10</b>	Photo VR icon ..... 110
<b>2</b>	Flash mode .....43	<b>11</b>	Movie VR icon ..... 101
<b>3</b>	Macro mode .....46	<b>12</b>	Wind noise reduction ..... 101
<b>4</b>	Zoom indicator ..... 14, 46	<b>13</b>	Exposure compensation value ..... 34, 42, 47
<b>5</b>	Focus indicator ..... 13	<b>14</b>	Remaining movie recording time ..... 68
<b>6</b>	Movie options (normal speed movies) .....96	<b>15</b>	Number of exposures remaining (still images) ..... 10
<b>7</b>	Movie options (HS movies) .....97	<b>16</b>	Internal memory indicator ..... 10
<b>8</b>	Image mode .....77	<b>17</b>	Framing border ( <b>Moon</b> or <b>Bird- watching</b> scene mode, or snap- back zoom) ..... 15, 28
<b>9</b>	Easy panorama .....29		

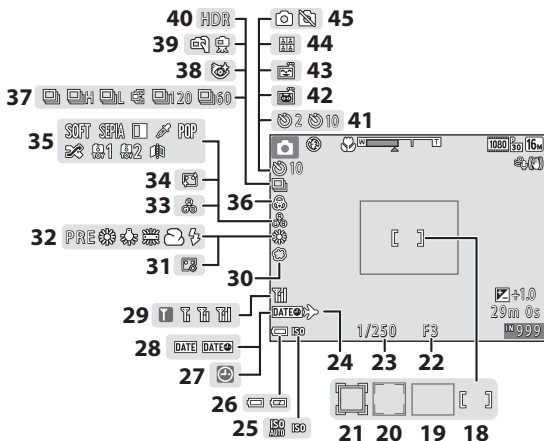

<b>18</b>	Focus area (manual or center) ..... 54, 84	<b>31</b>	Foundation makeup..... 34
<b>19</b>	Focus area (target finding AF) ..... 52, 85	<b>32</b>	White balance mode..... 79
<b>20</b>	Focus area (face detection, pet detection)..... 27, 34, 50, 84	<b>33</b>	Hue..... 42
<b>21</b>	Focus area (subject tracking) ..... 85, 86	<b>34</b>	Skin softening..... 34
<b>22</b>	Aperture value..... 16	<b>35</b>	Special effects..... 38
<b>23</b>	Shutter speed ..... 16	<b>36</b>	Vividness ..... 42
<b>24</b>	Travel destination icon..... 105	<b>37</b>	Continuous shooting mode ..... 27, 81
<b>25</b>	ISO sensitivity..... 83	<b>38</b>	Blink proof icon..... 89
<b>26</b>	Battery level indicator..... 10	<b>39</b>	Hand-held/tripod..... 24, 25
<b>27</b>	"Date not set" indicator ..... 139	<b>40</b>	Backlighting (HDR) ..... 26
<b>28</b>	Date stamp..... 109	<b>41</b>	Self-timer indicator..... 45
<b>29</b>	Wi-Fi communication indicator ..... 103, 117	<b>42</b>	Pet portrait auto release..... 27
<b>30</b>	Soft..... 34	<b>43</b>	Smile timer ..... 35
		<b>44</b>	Self-Collage ..... 36, 88
		<b>45</b>	Still image capture (during movie recording)..... 71



# Playback Mode

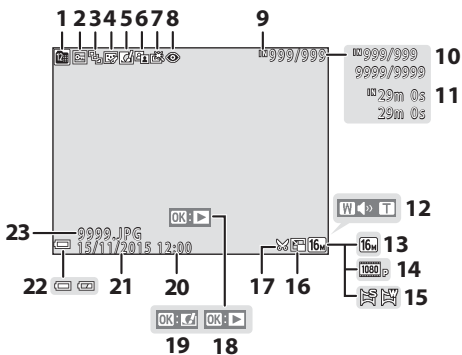

<b>1</b>	List by date icon .....	59	<b>13</b>	Image mode .....	77
<b>2</b>	Protect icon .....	92	<b>14</b>	Movie options .....	96
<b>3</b>	Sequence display (when <b>Individual pictures</b> is selected) .....	94	<b>15</b>	Easy panorama .....	31
<b>4</b>	Glamour retouch icon .....	65	<b>16</b>	Small picture icon .....	66
<b>5</b>	Quick effects icon .....	62	<b>17</b>	Crop icon .....	57, 67
<b>6</b>	D-Lighting icon .....	64	<b>18</b>	Easy panorama playback guide Sequence playback guide Movie playback guide	
<b>7</b>	Quick retouch icon .....	63	<b>19</b>	Quick effects guide	
<b>8</b>	Red-eye correction icon .....	64	<b>20</b>	Time of recording	
<b>9</b>	Internal memory indicator		<b>21</b>	Date of recording	
<b>10</b>	Current image number/ total number of images		<b>22</b>	Battery level indicator .....	10
<b>11</b>	Movie length or elapsed playback time		<b>23</b>	File number and type .....	144
<b>12</b>	Volume indicator .....	72			

# Preparing for Shooting

## Attaching the Camera Strap and Lens Cap

Attach the lens cap to the camera strap, and then attach the strap to the camera.

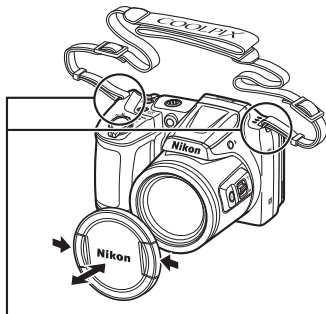
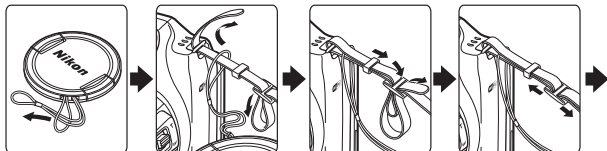

Attach them at two places.

### Lens Cap

When the camera is not in use, protect the lens by attaching the lens cap.

## Insert the Batteries and Memory Card

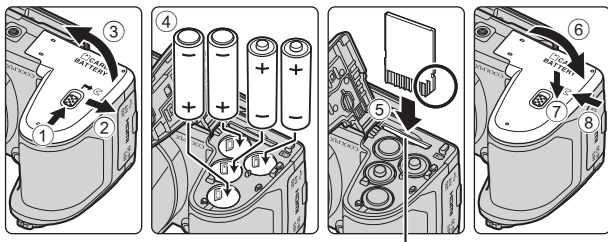

Memory card slot

- Hold the camera upside down to prevent the batteries from falling out, confirm that the positive (+) and negative (-) terminals of the batteries are oriented correctly, and insert the batteries.
- Slide the memory card in until it clicks into place (5).
- Be careful not to insert the batteries or memory card upside-down or backward, as this could cause a malfunction.
- When closing the cover, slide it while securely holding down the area marked (7).

### Formatting a Memory Card

The first time you insert a memory card that has been used in another device into this camera, make sure to format it with this camera. Insert the memory card into the camera, press the **MENU** button, and select **Format card** in the setup menu (75).

### Applicable Batteries

- Four LR6/L40 (AA-size) alkaline batteries (included batteries)
- Four FR6/L91 (AA-size) lithium batteries
- Four EN-MH2 rechargeable Ni-MH (nickel metal hydride) batteries
- \* EN-MH1 rechargeable Ni-MH batteries cannot be used.

## ✓ Notes About the Batteries

- Do not combine old and new batteries or batteries of different makes or types.
- Batteries with the following defects cannot be used:

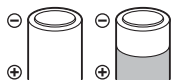

Batteries with peeling



Batteries with insulation that does not cover the area around the negative terminal

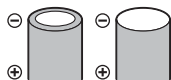

Batteries with a flat negative terminal

## ✓ Notes About EN-MH2 Rechargeable Ni-MH Batteries

When using EN-MH2 batteries with the camera, charge four batteries at a time using Battery Charger MH-73 (132).

## 📎 Alkaline Batteries

Performance of alkaline batteries may vary greatly depending on the manufacturer.

## Removing the Batteries or Memory Card

Turn the camera off and make sure that the power-on lamp and monitor have turned off, and then open the battery-chamber/memory card slot cover.

- Gently push the memory card into the camera to partially eject the memory card.
- Be careful when handling the camera, batteries, and memory card immediately after using the camera, as they may become hot.

## Memory Cards and Internal Memory

Camera data, including images and movies, can be saved either on a memory card or in the camera's internal memory. To use the camera's internal memory, remove the memory card.

# Turn the Camera On and Set the Display Language, Date, and Time

When the camera is turned on for the first time, the language-selection screen and the date and time setting screen for the camera clock are displayed.

- 1 Remove the lens cap, and then press the power switch to turn on the camera.

- The monitor turns on.
- To turn the camera off, press the power switch again.

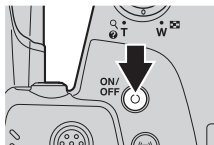

- 2 Use the multi selector ▲▼ to select the desired language and press the **OK** button.

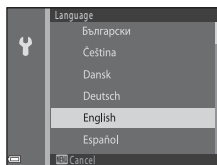

- 3 Select **Yes** and press the **OK** button.

- 4 Select your home time zone and press the **OK** button.

- Press ▲ to display ☀ above the map and enable daylight saving time. Press ▼ to disable it.

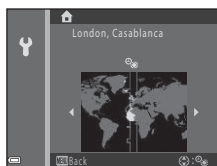

- 5 Use ▲▼ to select the date format and press the **OK** button.

## 6 Set the date and time, and press the **OK** button.

- Use **◀▶** to select a field and then use **▲▼** to set the date and time.
- Select the minute field and press the **OK** button to confirm the setting.

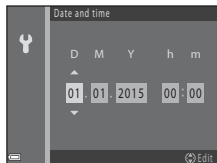

## 7 When the confirmation dialog is displayed, use **▲▼** to select **Yes** and press the **OK** button.

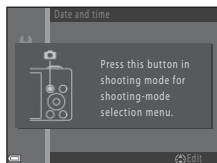

## 8 Press the **Ⓜ** (shooting mode) button.

- The lens extends.

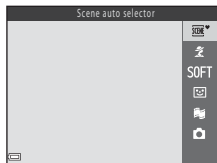

## 9 Select **Scene auto selector** and press the **OK** button.







- The shooting screen is displayed, and you can take pictures in scene auto selector mode. The camera automatically selects the optimum scene mode.
- Battery level indicator : The battery level is high.  
: The battery level is low.
- Number of exposures remaining  is displayed when no memory card is inserted in the camera, and images are saved in the internal memory.



Battery level indicator

Number of exposures remaining

## Changing the Language or the Date and Time Setting

- You can change these settings using the **Language** and **Time zone and date** settings in the  setup menu (📖75).
- You can enable or disable daylight saving time in the  setup menu by selecting **Time zone and date** followed by **Time zone**. Press the multi selector  and then  to enable daylight saving time and move the clock forward one hour, or  to disable daylight saving time and move the clock back one hour.

## The Clock Battery

- The camera's clock is powered by a built-in backup battery. The backup battery charges when the main batteries are inserted into the camera or when the camera is connected to an optional AC adapter, and it can run the clock for several days after about 10 hours of charging.
- If the camera's backup battery becomes exhausted, the date and time setting screen is displayed when the camera is turned on. Set the date and time again (📖9).

## Raising and Lowering the Flash

Press the  (flash pop-up) button to raise the flash.

- Push the flash down gently to lower the flash until it clicks into place when not in use.

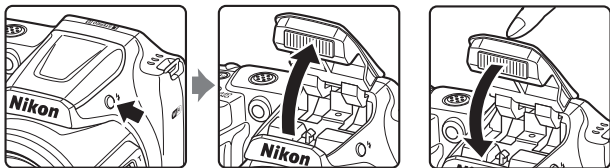

# Basic Shooting and Playback Operations

## Shooting with Scene Auto Selector Mode

### 1 Hold the camera steady.

- Keep fingers and other objects away from the lens, flash, AF-assist illuminator, microphone, and speaker.

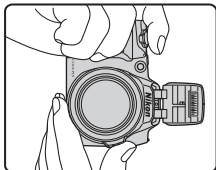
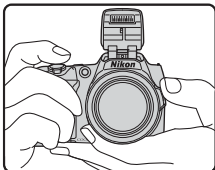

### 2 Frame the picture.

- Move the zoom control or side zoom control to change the zoom lens position.
- When the subject is lost at the telephoto zoom position, press the  (snap-back zoom) button to temporarily widen the angle of view so that you can frame the subject more easily.

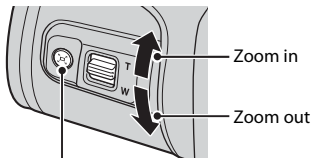
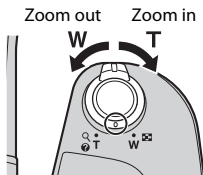

 (snap-back zoom) button

- When the camera recognizes the shooting scene, the shooting mode icon changes accordingly.

Shooting mode icon

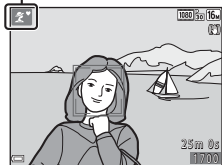



### 3 Press the shutter-release button halfway.

- When the subject is in focus, the focus area or focus indicator is displayed in green.
- When you are using digital zoom, the camera focuses in the center of the frame and the focus area is not displayed.
- If the focus area or focus indicator flashes, the camera is unable to focus. Modify the composition and try pressing the shutter-release button halfway again.

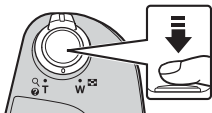

### 4 Without lifting your finger, press the shutter-release button the rest of the way down.



#### Notes About Saving Images or Movies

The indicator showing the number of exposures remaining or the indicator showing the remaining recording time flashes while images or movies are being saved. **Do not open the battery-chamber/memory card slot cover or remove the batteries or memory card** while an indicator is flashing. Doing this could result in loss of data, or in damage to the camera or the memory card.

#### The Auto Off Function

- When no operations are performed for about one minute, the monitor turns off, the camera enters standby mode, and then the power-on lamp flashes. The camera turns off after remaining in standby mode for about three minutes.
- To turn the monitor back on while the camera is in standby mode, perform an operation such as pressing the power switch or shutter-release button.

#### When Using a Tripod

- We recommend using a tripod to stabilize the camera in the following situations:
  - When the flash is lowered in dark locations or when using a shooting mode in which the flash does not fire
  - When the zoom is at a telephoto position
- When using a tripod to stabilize the camera during shooting, set **Photo VR** to **Off** in the setup menu (📖75) to prevent potential errors caused by this function.

## Using the Zoom

When you move the zoom control, the zoom lens position changes.

- To zoom in: Move toward **T**
  - To zoom out: Move toward **W**
- When you turn the camera on, the zoom moves to the maximum wide-angle position.
- Rotating the zoom control all the way in either direction adjusts the zoom quickly (except during movie recording).
  - The side zoom control (📖1) can also be moved toward **T** or **W** to operate the zoom.

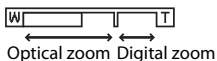
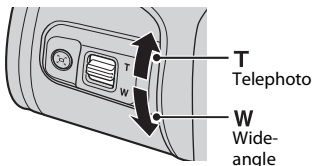
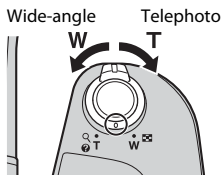

- A zoom indicator is displayed on the shooting screen when the zoom control is moved.
- Digital zoom, which allows you to further magnify the subject up to approximately 4x the maximum optical zoom ratio, can be activated by moving and holding the zoom control or the side zoom control toward **T** when the camera is zoomed in to the maximum optical zoom position.

### Digital Zoom

The zoom indicator changes to blue when the digital zoom is activated, and it changes to yellow when the zoom magnification is increased further.

- Zoom indicator is blue: Image quality is not noticeably reduced by using the Dynamic Fine Zoom.
- Zoom indicator is yellow: There may be cases in which image quality is noticeably reduced.
- The indicator remains blue across a wider area when the image size is smaller.
- The zoom indicator may not change to blue when using certain continuous shooting settings or other settings.

## Using the Snap-back Zoom

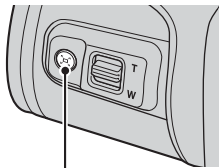

When the subject is lost at the telephoto zoom position, press the  (snap-back zoom) button to temporarily widen the angle of view so that you can frame the subject more easily.

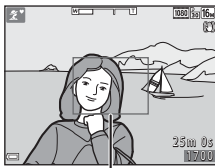

 button



Framing border

- While pressing the  button, frame the subject inside the framing border of the shooting screen.
- To change the angle of view further, move the zoom control while pressing the  button.
- Release the  button to return to the original zoom position.

### **Notes About Snap-back Zoom**

The snap-back zoom cannot be used during movie recording.

## The Shutter-release Button

Press halfway



To set focus and exposure (shutter speed and aperture value), press the shutter-release button lightly until you feel a slight resistance. Focus and exposure remain locked while the shutter-release button is pressed halfway.

Press all the way



Press the shutter-release button all the way to release the shutter and take a picture. Do not use force when pressing the shutter-release button, as this may result in camera shake and blurred images. Press the button gently.

## Changing the Angle of the Monitor

The angle of the monitor can be lowered down to approx. 85° or raised upward to approx. 90°. This is convenient when taking pictures with the camera held at high or low positions.

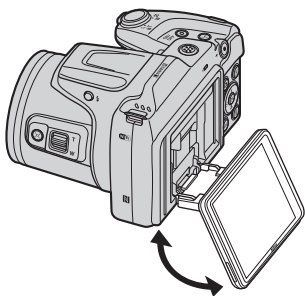
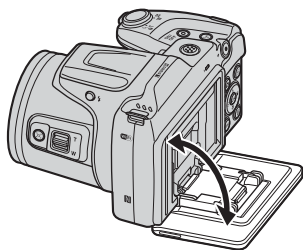

### ✓ Notes About Monitor

- Do not apply excessive force when changing the angle of the monitor.
- The monitor cannot be moved to the left or right.
- Put the monitor back in the original position when using in normal situations.





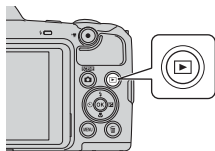

# Play Back Images

**1** Press the  (playback) button to enter playback mode.

- If you press and hold down the  button while the camera is turned off, the camera turns on in playback mode.



**2** Use the multi selector to select an image to display.

- Press and hold down    to scroll through the images quickly.
- To return to shooting mode, press the  button or shutter-release button.
- When :  is displayed in full-frame playback mode, you can press the  button to apply an effect to the image.

Display the previous image



Display the next image

- Move the zoom control toward  in full-frame playback mode to zoom in on an image.







- In full-frame playback mode, move the zoom control toward  to switch to thumbnail playback mode and display multiple images on the screen.

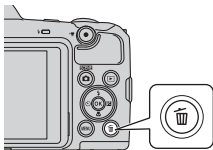

# Delete Images

- 1 Press the  (delete) button to delete the image currently displayed in the monitor.



- 2 Use the multi selector   to select the desired deletion method and press the  button.

- To exit without deleting, press the **MENU** button.

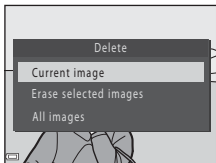

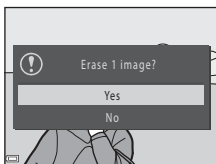

- 3 Select **Yes** and press the  button.

- Deleted images cannot be recovered.



## Deleting Images Captured Continuously (Sequence)

- Images captured continuously are saved as a sequence, and only the first image of the sequence (the key picture) is displayed in playback mode (default setting).
- If you press the  button while a key picture is displayed for a sequence of images, all images in the sequence are deleted.
- To delete individual images in a sequence, press the  button to display them one at a time and press the  button.



## Deleting the Image Captured While in Shooting Mode

When using shooting mode, press the  button to delete the last image that was saved.

## Operating the Erase Selected Images Screen

**1** Use the multi selector ◀▶ to select an image to be deleted, and then use ▲ to display 🗑️.

- To undo the selection, press ▼ to remove 🗑️.
- Move the zoom control (📖1) toward **T** (🔍) to switch to full-frame playback or **W** (📐) to switch to thumbnail playback.



**2** Add 🗑️ to all images that you want to delete and then press the **OK** button to confirm the selection.

- A confirmation dialog is displayed. Follow the on-screen instructions to complete operations.



# Changing the Shooting Mode

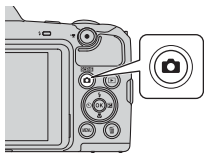

The shooting modes described below are available.

- **SCENE** **Scene auto selector**  
The camera automatically recognizes the shooting scene when you frame a picture, making it easier to take pictures using settings that suit the scene.
- **Scene mode**  
Camera settings are optimized according to the scene that you select.
- **SOFT Special effects**  
Effects can be applied to images during shooting.
- **Smart portrait**  
Use glamour retouch to enhance human faces during shooting, and use the smile timer or self-collage function to take pictures.
- **Short movie show**  
The camera creates a short movie that is up to 30 seconds long (**1080 P 1080/30p** or **1080 P 1080/25p**) by recording and automatically combining multiple movie clips that are several seconds long.
- **Auto mode**  
Used for general shooting. Settings can be changed to suit the shooting conditions and the type of shot you want to capture.

- 1 When the shooting screen is displayed, press the  (shooting mode) button.



- 2 Use the multi selector   to select a shooting mode and press the  button.

- When scene mode or special effects mode is selected, press  to select a scene mode or effect before pressing the  button.

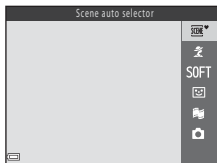



## Using the Flash, Self-timer, Etc.

When the shooting screen is displayed, you can press the multi selector ▲ (⚡) ◀ (🕒) ▼ (🌸) ▶ (📷) to set the functions described below.



- **⚡ Flash mode**  
You can select a flash mode to match the shooting conditions when the flash is raised.
- **🕒 Self-timer**  
The camera releases the shutter 10 seconds or 2 seconds after you press the shutter-release button.
- **🌸 Macro mode**  
Use macro mode when you take close-up pictures.
- **📷 Exposure compensation**  
You can adjust overall image brightness.

The functions that can be set vary depending on the shooting mode.

## Recording Movies

Display the shooting screen and press the ● (▶📷 movie-record) button to start recording a movie. Press the ● (▶📷) button again to end recording.



- To play back a movie, select a movie in full-frame playback mode and press the Ⓞ button.













# Shooting Features

## (Scene Auto Selector) Mode

The camera automatically recognizes the shooting scene when you frame a picture, making it easier to take pictures using settings that suit the scene.

Enter shooting mode →  (shooting mode) button →  (scene auto selector) mode →  button

When the camera automatically recognizes the shooting scene, the shooting mode icon displayed on the shooting screen changes accordingly.

	Portrait (for taking close-up portraits of one or two people)
	Portrait (for taking portraits of large numbers of people, or images in which the background takes up a large portion of the frame)
	Landscape
	Night portrait* (for taking close-up portraits of one or two people)
	Night portrait* (for taking portraits of large numbers of people, or images in which the background takes up a large portion of the frame)
	Night landscape*
	Close-up
	Backlighting (for taking pictures of subjects other than people)
	Backlighting (for taking portrait pictures)
	Other scenes

\* One image is captured at a slow shutter speed.

### Notes About (Scene Auto Selector) Mode





- Depending on shooting conditions, the camera may not select the desired scene mode. In this case, select another shooting mode (📖20).
- When the digital zoom is in effect, the shooting mode icon changes to .

### Functions Available in (Scene Auto Selector) Mode



















- Flash mode (📖43)
- Self-timer (📖45)
- Exposure compensation (📖47)
- Image mode (📖77)

## Scene Mode (Shooting Suited to Scenes)

When a scene is selected, camera settings are automatically optimized for the selected scene.

Enter shooting mode →  (shooting mode) button →  (second icon from the top\*) →  →  → select a scene → 

\* The icon of the last scene selected is displayed.

 Portrait (default setting)	 Night landscape <sup>1,2</sup> (📖25)
 Landscape <sup>1,2</sup>	 Close-up (📖25)
 Sports <sup>2</sup> (📖24)	 Food (📖25)
 Night portrait (📖24)	 Fireworks show <sup>1,3</sup> (📖25)
 Party/indoor <sup>2</sup> (📖24)	 Backlighting (📖26)
 Beach <sup>2</sup>	 Easy panorama <sup>2</sup> (📖29)
 Snow <sup>2</sup>	 Pet portrait (📖27)
 Sunset <sup>2,3</sup>	 Moon (📖28) <sup>1,2</sup>
 Dusk/dawn <sup>1,2,3</sup>	 Bird-watching (📖28) <sup>1,2</sup>

<sup>1</sup> The camera focuses at infinity.

<sup>2</sup> The camera focuses on the area in the center of the frame.

<sup>3</sup> Use of a tripod is recommended, because the shutter speed is slow. Set **Photo VR** (📖110) to **Off** in the setup menu when using a tripod to stabilize the camera during shooting.

### Displaying a Description of Each Scene Mode (Help Display)

Select a scene and move the zoom control (📖1) toward **T** (👉) to view a description of that scene. To return to the previous screen, move the zoom control toward **T** (👈) again.

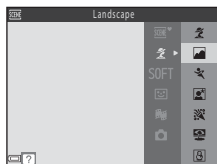







## Tips and Notes

### Sports

- While the shutter-release button is held all the way down, the camera shoots up to about 7 images continuously at a rate of about 7.4 fps (when **Image mode** is set to  **4608x3456**).
- The frame rate for continuous shooting may vary depending on the current image mode setting, the memory card used, or shooting conditions.
- Focus, exposure, and hue are fixed at the values determined with the first image in each series.

### Night portrait

- Raise the flash before shooting.
- On the screen displayed when  **Night portrait** is selected, select  **Hand-held** or  **Tripod**.
-  **Hand-held** (default setting):
  - While the  icon on the shooting screen is displayed in green, press the shutter-release button all the way to capture a series of images which are combined into a single image and saved.
  - Once the shutter-release button is pressed all the way, hold the camera still until a still image is displayed. After taking a picture, do not turn the camera off before the monitor switches to the shooting screen.
  - If the subject moves while the camera is shooting continuously, the image may be distorted, overlapped, or blurred.
-  **Tripod**:
  - One image is captured at a slow shutter speed when the shutter-release button is pressed all the way.
  - Vibration reduction is disabled even when **Photo VR** ( 110) in the setup menu is set to **On**.



### Party/indoor

- To avoid the effects of camera shake, hold the camera steady. Set **Photo VR** ( 110) to **Off** in the setup menu when using a tripod to stabilize the camera during shooting.





## Night landscape

- On the screen displayed when  **Night landscape** is selected, select  **Hand-held** or  **Tripod**.
-  **Hand-held** (default setting):
  - While the  icon on the shooting screen is displayed in green, press the shutter-release button all the way to capture a series of images which are combined into a single image and saved.
  - Once the shutter-release button is pressed all the way, hold the camera still until a still image is displayed. After taking a picture, do not turn the camera off before the monitor switches to the shooting screen.
  - The angle of view (i.e., the area visible in the frame) seen in the saved image is narrower than that seen in the monitor at the time of shooting.
-  **Tripod**:
  - One image is captured at a slow shutter speed when the shutter-release button is pressed all the way.
  - Vibration reduction is disabled even when **Photo VR** (📖110) in the setup menu is set to **On**.

## Close-up

- Macro mode (📖46) is enabled and the camera automatically zooms to the closest position at which it can focus.
- You can move the focus area. Press the  button, use the multi selector  to move the focus area, and press the  button to apply the setting.

## Food

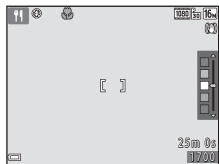

- Macro mode (📖46) is enabled and the camera automatically zooms to the closest position at which it can focus.
- You can adjust hue by using the multi selector . The hue setting is saved in the camera's memory even after the camera is turned off.
- You can move the focus area. Press the  button, use the multi selector  to move the focus area, and press the  button to apply the setting.







## Fireworks show

- The shutter speed is fixed at four seconds.



## Backlighting

- On the screen displayed when  **Backlighting** is selected, select **ON** or **OFF** to enable or disable the high dynamic range (HDR) function based on the type of image you want to capture.
- **OFF** (default setting): The flash fires to prevent the subject from being hidden in shadow. Raise the flash before shooting.
  - When the shutter-release button is pressed all the way down, one image is captured.
- **ON**: Use when taking pictures with very bright and dark areas in the same frame.
  - When the shutter-release button is pressed all the way, the camera shoots images continuously at high speed, and saves the following two images:
    - A non-HDR composite image
    - An HDR composite image in which the loss of details in highlights or shadows is minimized
  - If there is only enough memory to save one image, an image processed by D-Lighting (64) at the time of shooting, in which dark areas of the image are corrected, is the only image saved.
  - Once the shutter-release button is pressed all the way, hold the camera still until a still image is displayed. After taking a picture, do not turn the camera off before the monitor switches to the shooting screen.
  - The angle of view (i.e., the area visible in the frame) seen in the saved image is narrower than that seen in the monitor at the time of shooting.

## Pet portrait

- When you point the camera at a dog or cat, the camera detects the pet's face and focuses on it. By default, the camera detects a dog or cat face and automatically releases the shutter (pet portrait auto release).
- On the screen displayed when  **Pet portrait** is selected, select  **Single** or  **Continuous**.
  -  **Single**: The camera captures one image when a dog or cat face is detected.
  -  **Continuous**: The camera captures three images continuously when a dog or cat face is detected.

## **Pet Portrait Auto Release**

- Press the multi selector  to change the **Pet portrait auto release** setting.
  - : The camera detects a dog or cat face and automatically releases the shutter.
  - **OFF**: The camera does not release the shutter automatically, even if a dog or cat face is detected. Press the shutter-release button. The camera also detects human faces when **OFF** is selected.
- **Pet portrait auto release** is set to **OFF** after five bursts have been taken.
- Shooting is also possible by pressing the shutter-release button, regardless of the **Pet portrait auto release** setting. When  **Continuous** is selected, you can take pictures continuously while holding down the shutter-release button all the way.

## **Focus Area**

- When the camera detects a face, the face is displayed inside a yellow border. When the camera acquires focus on a face displayed inside a double border (focus area), the double border changes to green. If no faces are detected, the camera focuses on the subject in the center of the frame.
- Under some shooting conditions, the pet face may not be detected and other subjects may be displayed inside a border.

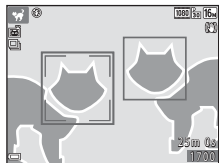

## ● Moon

- You can adjust hue by using the multi selector ▲▼. The hue setting is saved in the camera's memory even after the camera is turned off.
- Adjust the brightness with exposure compensation (☰47) according to shooting conditions such as the waxing and waning of the moon and shooting requirements.
- At the wide-angle zoom position, the framing border is displayed to indicate the angle of view equivalent to that of 855 mm lens (in 35mm [135] format). The angle of view becomes equivalent to that of 855 mm lens by pressing the OK button.

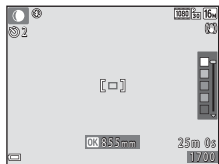





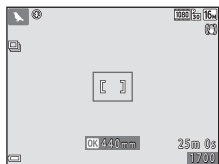

## 🐦 Bird-watching

- From the screen displayed after 🐦 **Bird-watching** is selected, select [S] **Single** or [C] **Continuous**.
- [S] **Single**: One image is shot each time the shutter-release button is pressed.
- [C] **Continuous** (default setting): While the shutter-release button is held all the way down, images are captured continuously.
  - The frame rate for continuous shooting is about 7.4 fps and the maximum number of continuous shots is about 7 (when image size is set to [6M] **4608x3456**).
- At the wide-angle zoom position, the framing border is displayed to indicate the angle of view equivalent to that of 440 mm lens (in 35mm [135] format). The angle of view becomes equivalent to that of 440 mm lens by pressing the OK button.







# Shooting with Easy Panorama

Enter shooting mode →  (shooting mode) button →  (second icon from the top\*) →  →  →  (easy panorama) →  button

\* The icon of the last scene selected is displayed.

## 1 Select **Normal** or **Wide** as the shooting range and press the button.

- When the camera is readied in the horizontal position, the image size (width × height) is as follows:
  -  **Normal**: 4800 × 920 when moved horizontally, 1536 × 4800 when moved vertically
  -  **Wide**: 9600 × 920 when moved horizontally, 1536 × 9600 when moved vertically

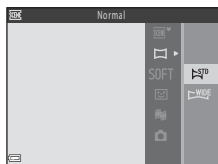

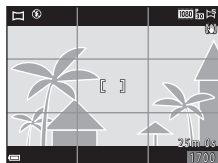

## 2 Frame the first edge of the panorama scene, and then press the shutter-release button halfway to focus.

- The zoom position is fixed at wide-angle position.
- The camera focuses in the center of the frame.



## 3 Press the shutter-release button all the way, and then remove your finger from the shutter-release button.

-    are displayed to indicate the direction of camera movement.



## 4 Move the camera in one of the four directions until the guide indicator reaches the end.

- When the camera detects which direction it is moving in, shooting begins.
- Shooting ends when the camera captures the specified shooting range.
- Focus and exposure are locked until shooting ends.

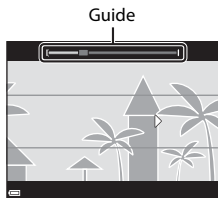

### Example of camera movement



- Using your body as the axis of rotation, move the camera slowly in an arc, in the direction of the marking (△▽◀▶).
- Shooting stops if the guide does not reach the edge within about 15 seconds (when **STD Normal** is selected) or within about 30 seconds (when **WIDE Wide** is selected) after shooting starts.

### ✓ Notes About Easy Panorama Shooting

- The range of the image seen in the saved image is narrower than that seen in the monitor at the time of shooting.
- If the camera is moved too quickly or shaken too much, or if the subject is too uniform (e.g. walls or darkness), an error may occur.
- If shooting is stopped before the camera reaches the half-way point in the panorama range, a panorama image is not saved.
- If more than half of the panorama range is captured but shooting ends before reaching the edge of the range, the range not captured is recorded and displayed in gray.

## Playback with Easy Panorama

Switch to playback mode (📖17), display an image captured using easy panorama in full-frame playback mode, and then press the **OK** button to scroll the image in the direction that was used when shooting.

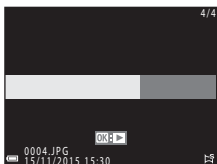

Playback controls are displayed in the monitor during playback. Use the multi selector **◀▶** to select a control, and then press the **OK** button to perform the operations described below.



Function	Icon	Description	
Rewind	◀◀	Hold down the <b>OK</b> button to scroll backward quickly.	
Advance	▶▶	Hold down the <b>OK</b> button to scroll forward quickly.	
Pause		Pause playback. The operations listed below can be performed while paused.	
		◀◀	Hold down the <b>OK</b> button to rewind.
		▶▶	Hold down the <b>OK</b> button to scroll.
		▶	Resume automatic scrolling.
End	■	Switch to full-frame playback mode.	

### ✓ Notes About Easy Panorama Images





- The images cannot be edited on this camera.
- This camera may not be able to scroll the playback of, or zoom in on, easy panorama images captured with another make or model of digital camera.

### ✓ Notes About Printing Panorama Images







The entire image may not be able to be printed depending on the printer's settings. Additionally, printing may not be possible depending on the printer.

## Special Effects Mode (Applying Effects When Shooting)

Effects can be applied to images during shooting.

Enter shooting mode →  (shooting mode) button → SOFT (third icon from the top\*) →  →  →  → select an effect →  button

\* The icon of the last effect selected is displayed.

Type	Description
<b>SOFT</b> Soft* (default setting)	Softens the image by adding a slight blur to the entire image.
<b>SEPIA</b> Nostalgic sepia*	Adds a sepia tone and reduces the contrast to simulate the qualities of an old photograph.
 <b>High-contrast monochrome*</b>	Changes the image to black and white and gives it sharp contrast.
 <b>Selective color</b>	Creates a black and white image in which only the specified color remains.
<b>POP</b> Pop	Increases the color saturation of the entire image to create a bright look.
 <b>Cross process</b>	Gives the image a mysterious appearance based on a specific color.
 <b>Toy camera effect 1*</b>	Gives the entire image a yellowish hue and darkens the image periphery.
 <b>Toy camera effect 2*</b>	Decreases the color saturation of the entire image and darkens the image periphery.
 <b>Mirror*</b>	Creates a bilaterally symmetric image whose right half is an inverted mirror image of the left half.



\* Certain **Movie options** () are not available.

- The camera focuses on the area in the center of the frame.
- When **Selective color** or **Cross process** is selected, use the multi selector ▲▼ to select the desired color, and press the OK button to apply the color. To change the color selection, press the OK button again.



# Smart Portrait Mode (Enhancing Human Faces When Shooting)





You can take a picture with the glamour retouch function to enhance human faces.





Enter shooting mode →  (shooting mode) button →  Smart portrait mode →  button



## 1 Press the multi selector .



## 2 Apply an effect.

- Use   to select the desired effect.
- Use   to select the amount of effect.
- You can simultaneously apply multiple effects.

 **Skin softening**,  **Foundation makeup**,  **Soft**,  **Vividness**,  
 **Brightness (Exp. +/-)**

- Select  **Exit** to hide the slider.
- Press the  button after checking the settings for all effects.

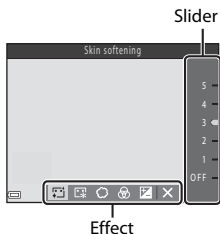







## 3 Frame the picture and press the shutter-release button.



### **Notes About Smart Portrait Mode**



- The amount of effect may differ between the image on the shooting screen and the saved image.
- When **Soft** is set, some **Movie options** (96) are not available.

### **Functions Available in Smart Portrait Mode**

- Glamour retouch (34)
- Smile timer (35)
- Self-Collage (36)
- Flash mode (43)
- Self-timer (45)
- Smart portrait menu (88)

## Using Smile Timer

Enter shooting mode →  (shooting mode) button →  Smart portrait mode →  button

When you press the multi selector  to select  **Smile timer** and press the  button, the camera automatically releases the shutter whenever a smiling face is detected.

- Set the glamour retouch function before selecting smile timer ( 34).
- When you press the shutter-release button to take a picture, smile timer is terminated.

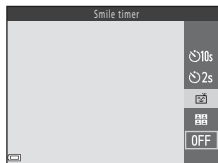

### **Notes About Smile Timer**

Under some shooting conditions, the camera may be unable to detect faces or smiles ( 50). The shutter-release button can also be used for shooting.

### **When the Self-timer Lamp Flashes**

When using smile timer, the self-timer lamp flashes when the camera detects a face and flashes quickly immediately after the shutter is released.

## Using Self-Collage

The camera can capture a series of four or nine images at intervals and save them as a one-frame image (a collage image).



Enter shooting mode → (shooting mode) button → Smart portrait mode → button

- 1 Press the multi selector to select **Self-Collage**, and press the button.



- A confirmation dialog is displayed.
- When you press the **MENU** button and select **Self-Collage** before pressing , you can configure the settings for **Number of shots**, **Interval**, and **Shutter sound** (📖88).
- If you want to apply glamour retouch when shooting, set the effect before selecting self-collage (📖34).

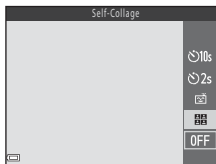

- 2 Take a picture.

- When you press the shutter-release button, a countdown starts (about five seconds) and the shutter is automatically released.
- The camera automatically releases the shutter for the remaining pictures. A countdown starts about three seconds before shooting.
- The number of shots is indicated by in the monitor. It is displayed in green during shooting and it changes to white after shooting.
- When the camera finishes taking the specified number of shots, the collage image is saved.
- Each captured image is saved as an individual image separate from the collage image. The individual images are saved as a sequence, and a one-frame collage image is used as the key picture (📖60).

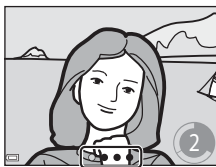





## **Notes About Self-Collage**

- If you press the shutter-release button before the camera takes the specified number of shots, shooting is canceled and the collage image is not saved. The pictures that were taken before shooting was canceled are saved as individual images.
- This function may not be available to use in combination with other functions (55).

# Short Movie Show Mode (Combining Movie Clips to Create Short Movies)

The camera creates a short movie that is up to 30 seconds long (**1080P 1080/30p** or **1080i 1080/25p**) by recording and automatically combining multiple movie clips that are several seconds long.

Enter shooting mode →  (shooting mode) button →  Short movie show mode →  button

## 1 Press the MENU (menu) button and configure the settings for recording movies.

- **Number of shots:** Set the number of movie clips that the camera records and the recording time for each movie clip. By default, the camera records 15 movie clips that are 2 seconds each to create a 30-second short movie.
- **Special effects** (📖32): Apply various effects to movies when shooting. Effects can be changed for each movie clip.
- **Background music:** Select the background music. You can preview it by moving the zoom control (📖1) toward **T** (📖).
- After the settings are complete, press the **MENU** button or shutter-release button to exit the menu.

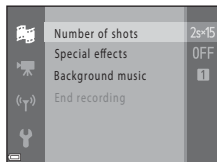

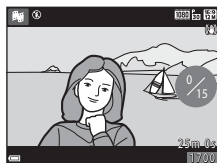

## 2 Press the (movie-record) button to record a movie clip.

- The camera automatically stops recording the movie clip when the time specified in step 1 elapses.
- Movie clip recording can be paused temporarily. See "Pausing Movie Recording" (📖40).



## 3 Check the recorded movie clip, or delete it.

- To check it, press the  button.
- To delete it, press the  button. The last recorded movie clip or all movie clips can be deleted.
- To continue recording movie clips, repeat the operation in step 2.
- To change the effects, return to step 1.

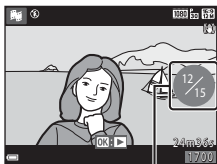

Number of movie clips recorded

## 4 Save the short movie show.

- The short movie show is saved when the camera finishes recording the specified number of movie clips.
- To save a short movie show before the camera finishes recording the specified number of movie clips, press the **MENU** button when the shooting standby screen is displayed, and then select **End recording**.
- Movie clips are deleted when a short movie show is saved.

### Operations During Movie Clip Playback

To adjust the volume, move the zoom control while a movie clip is playing (📖1). Playback controls are displayed in the monitor. The operations described below can be performed by using the multi selector ◀▶ to select a control and then pressing the **OK** button.

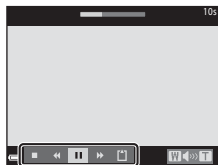

Playback controls

Function	Icon	Description	
Rewind	◀◀	Hold down the <b>OK</b> button to rewind the movie.	
Advance	▶▶	Hold down the <b>OK</b> button to advance the movie.	
Pause	⏸	Pause playback. The operations listed below can be performed while paused.	
		◀◀	Rewind the movie one frame. Hold down the <b>OK</b> button for continuous rewinding.
		▶▶	Advance the movie one frame. Hold down the <b>OK</b> button for continuous advancing.
	▶	Resume playback.	
End playback	■	Return to the shooting screen.	
End recording	📄	Save the short movie show using the recorded movie clips.	

### ✓ Notes About Recording a Short Movie Show





- The camera cannot record movies if a memory card is not inserted.
- Do not exchange the memory card until a short movie show is saved.



## Pausing Movie Recording



- A still image ( **4608×2592**) can be captured if you press the shutter-release button when the shooting standby screen is displayed.
- You can pause movie recording and play back images or enter other shooting modes to take pictures. Movie recording resumes when you enter short movie show mode again.



## Functions Available in Short Movie Show Mode

- Self-timer ( 45)
- Macro mode ( 46)
- Exposure compensation ( 47)
- Short movie show menu ( 38)
- Movie options menu ( 96)





## (Auto) Mode

Used for general shooting. Settings can be adjusted to suit the shooting conditions and the type of shot you want to capture.

Enter shooting mode →  (shooting mode) button →  (auto) mode →  button



- You can change how the camera selects the area of the frame to focus on by changing the **AF area mode** setting (84). The default setting is **Target finding AF** (52).

### Functions Available in (Auto) Mode

- Creative slider (42)
- Flash mode (43)
- Self-timer (45)
- Macro mode (46)
- Shooting menu (77)

## Using the Creative Slider



You can adjust the brightness (exposure compensation), vividness, and hue when shooting.

Enter shooting mode →  (shooting mode) button →  (auto) mode →  button

### 1 Press the multi selector ►.



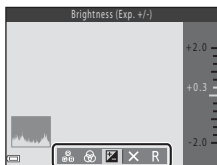

### 2 Use ◀▶ to select an item.

-  **Hue:** Adjust the hue (reddish/bluish) of the entire image.
-  **Vividness:** Adjust the vividness of the entire image.
-  **Brightness (Exp. +/-):** Adjust the brightness of the entire image.



### 3 Use ▲▼ to adjust the level.

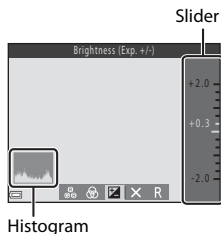

- You can preview the results on the monitor.
- To set another item, return to step 2.
- Select  **Exit** to hide the slider.
- To cancel all settings, select  **Reset** and press the  button. Return to step 2 and adjust the settings again.



### 4 Press the button when setting is complete.

- The settings are applied and the camera returns to the shooting screen.

#### **Creative Slider Settings**

- This function may not be available to use in combination with other functions (55).
- The settings for brightness (exposure compensation), vividness and hue are saved in the camera's memory even after the camera is turned off.
- See "Using the Histogram" (47) for more information.

# Flash Mode

You can select a flash mode to match the shooting conditions.

## 1 Press the ⚡ (flash pop-up) button.

- The flash pops up.
- The flash does not fire while it is lowered. ⚡ is displayed to indicate that the flash does not fire.

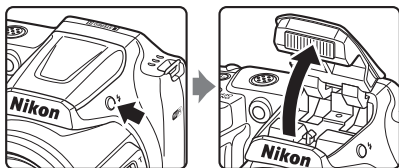

## 2 Press the multi selector ▲ (⚡).



## 3 Select the desired flash mode (📖44) and press the OK button.

- If the setting is not applied by pressing the OK button within a few seconds, the selection will be canceled.

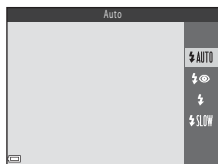

### ✓ Lowering the Flash

Push the flash down gently to lower the flash until it clicks into place when not in use (📖11).

## The Flash Lamp

- The status of the flash can be confirmed by pressing the shutter-release button halfway.
  - On: The flash fires when you press the shutter-release button all the way down.
  - Flashing: The flash is charging. The camera cannot shoot images.
  - Off: The flash does not fire when a picture is taken.
- If the battery level is low, the monitor turns off while the flash is charging.

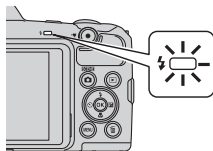

## Available Flash Modes

### AUTO Auto

The flash fires when necessary, such as in dim lighting.

- The flash mode icon on the shooting screen is displayed only immediately after the setting is made.

### Auto with red-eye reduction

Reduce “red-eye” in portraits caused by the flash.



### Fill flash

The flash fires whenever a picture is taken. Use to “fill-in” (illuminate) shadows and backlit subjects.

### SLOW Slow sync

Suited to evening and night portraits that include background scenery. The flash fires when necessary to illuminate the main subject; slow shutter speeds are used to capture background at night or under dim lighting.

## The Flash Mode Setting

- The setting may not be available with some shooting modes ( 48).
- The setting applied in  (auto) mode is saved in the camera’s memory even after the camera is turned off.

## Red-eye Reduction

If the camera detects red eye while saving an image, the affected area is processed to reduce red-eye before the image is saved.

Note the following when shooting:

- More time than usual is required to save images.
- Red-eye reduction may not produce the desired results in some situations.
- In rare cases, red-eye reduction may be applied unnecessarily to other areas of the image. In these cases, select another flash mode and take the picture again.



# Self-timer

The camera is equipped with a self-timer that releases the shutter 10 seconds or 2 seconds after you press the shutter-release button.

Set **Photo VR** (📖110) to **Off** in the setup menu when using a tripod to stabilize the camera during shooting.

**1** Press the multi selector ◀ (👁).



**2** Select 🕒10s or 🕒2s, and press the OK button.

- 🕒10s (10 seconds): Use on important occasions, such as weddings.
- 🕒2s (2 seconds): Use to prevent camera shake.
- If the setting is not applied by pressing the OK button within a few seconds, the selection will be canceled.
- When the shooting mode is **Pet portrait** scene mode, 🐾 (pet portrait auto release) is displayed (📖27). The self-timer cannot be used.
- When the shooting mode is smart portrait mode, you can also use 😊 **Smile timer** (📖35) and 📷 **Self-Collage** (📖36) in addition to the self-timer.

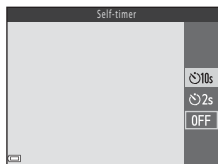

**3** Frame the picture and press the shutter-release button halfway.

- Focus and exposure are set.

**4** Press the shutter-release button the rest of the way down.

- Countdown starts. The self-timer lamp flashes and then glows steadily about one second before the shutter is released.
- When the shutter is released, the self-timer is set to **OFF**.\*
- To stop the countdown, press the shutter-release button again.

- \* When the shooting mode is **Moon** scene mode, the self-timer is not automatically set to **OFF**. To end the self-timer, select **OFF** in step 2.

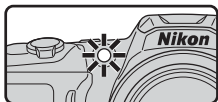

# Macro Mode (Taking Close-up Pictures)

Use macro mode when taking close-up pictures.

- 1 Press the multi selector ▼ (👉).



- 2 Select **ON** and press the **OK** button.

- If the setting is not applied by pressing the **OK** button within a few seconds, the selection will be canceled.



- 3 Move the zoom control to set the zoom ratio to a position where **👉** and the zoom indicator are displayed in green.

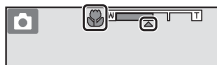

- When the zoom ratio is set to a position where the zoom indicator is displayed in green, the camera can focus on subjects as close as approximately 10 cm (4 in.) from the lens.
- When the zoom position is at the wide-angle and in the area indicated by ①, the camera can focus on subjects as close as approximately 1 cm (0.4 in.) from the lens.

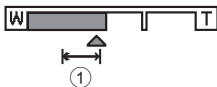

## ✓ Notes About Using the Flash

The flash may be unable to light the entire subject at distances of less than 50 cm (1 ft 8 in.).

## 📎 The Macro Mode Setting

- The setting may not be available with some shooting modes (📖48).
- If the setting is applied in **📷** (auto) mode, it will remain saved in the camera's memory even after the camera is turned off.

# Exposure Compensation (Adjusting Brightness)

You can adjust overall image brightness.

- 1 Press the multi selector ► (⊕).



- 2 Select a compensation value and press the **OK** button.

- To brighten the image, set a positive (+) value.
- To darken the image, set a negative (-) value.
- The compensation value is applied, even without pressing the **OK** button.
- When the shooting mode is smart portrait mode, the glamour retouch screen is displayed instead of the exposure compensation screen (📖34).
- When the shooting mode is 📷 (auto) mode, the creative slider is displayed instead of the exposure compensation screen (📖42).

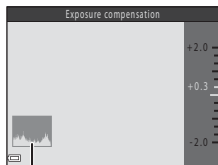

Histogram

## Exposure Compensation Value

The setting may not be available with some shooting modes (📖48).

## Using the Histogram











A histogram is a graph showing the distribution of tones in the image. Use as a guide when using exposure compensation and shooting without the flash.

- The horizontal axis corresponds to pixel brightness, with dark tones to the left and bright tones to the right. The vertical axis shows the number of pixels.
- Increasing exposure compensation shifts tone distribution to the right, and decreasing it shifts tone distribution to the left.

## Default Settings (Flash, Self-timer, Etc.)

Default settings for each shooting mode are listed below.

	Flash <sup>1</sup> (43)	Self-timer (45)	Macro (46)	Exposure compensation (47)
(scene auto selector)	AUTO <sup>2</sup>	Off	Off <sup>3</sup>	0.0
Scene				
(portrait)		Off	Off <sup>4</sup>	0.0
(landscape)	<sup>4</sup>	Off	Off <sup>4</sup>	0.0
(sports)	<sup>4</sup>	Off <sup>4</sup>	Off <sup>4</sup>	0.0
(night portrait)	<sup>5</sup>	Off	Off <sup>4</sup>	0.0
(party/indoor)	<sup>6</sup>	Off	Off <sup>4</sup>	0.0
(beach)	AUTO	Off	Off <sup>4</sup>	0.0
(snow)	AUTO	Off	Off <sup>4</sup>	0.0
(sunset)	<sup>4</sup>	Off	Off <sup>4</sup>	0.0
(dusk/dawn)	<sup>4</sup>	Off	Off <sup>4</sup>	0.0
(night landscape)	<sup>4</sup>	Off	Off <sup>4</sup>	0.0
(close-up)		Off	On <sup>4</sup>	0.0
(food)	<sup>4</sup>	Off	On <sup>4</sup>	0.0
(fireworks show)	<sup>4</sup>	Off <sup>4</sup>	Off <sup>4</sup>	0.0 <sup>4</sup>
(backlighting)	<sup>7</sup>	Off	Off <sup>4</sup>	0.0
(easy panorama)	<sup>4</sup>	Off <sup>4</sup>	Off <sup>4</sup>	0.0
(pet portrait)	<sup>4</sup>	<sup>8</sup>	Off	0.0
(moon)	<sup>4</sup>	2s	Off <sup>4</sup>	0.0
(bird-watching)	<sup>4</sup>	Off	Off	0.0
SOFT (special effects)		Off	Off	0.0
(smart portrait)	AUTO <sup>9</sup>	Off <sup>10</sup>	Off <sup>4</sup>	_11
(short movie show)	<sup>4</sup>	Off	Off	0.0
(auto)	AUTO	Off	Off	_12

- 1 The setting that is used when the flash is raised.
- 2 The camera automatically selects the flash mode appropriate for the scene it has selected.  (off) can be selected manually.
- 3 Cannot be changed. The camera enters macro mode when  is selected.
- 4 Cannot be changed.
- 5 Cannot be changed. When set to **Hand-held**, the flash mode setting is fixed at auto and slow sync with red-eye reduction. When set to **Tripod**, the flash mode setting is fixed at fill flash and slow sync with red-eye reduction.
- 6 Slow sync with red-eye reduction flash mode may be used.
- 7 Flash is fixed at  (fill flash) when **HDR** is set to **OFF**. The flash does not fire when **HDR** is set to **ON**.
- 8 Self-timer cannot be used. Pet portrait auto release can be turned on or off (27).
- 9 Cannot be used when **Blink proof** is set to **On**.
- 10  **Smile timer** (35) and  **Self-Collage** (36) can be used in addition to self-timer.
- 11 Glamour retouch is displayed (34).
- 12 Creative slider is displayed (42).

## Focusing

The focus area varies depending on the shooting mode.

### Using Face Detection

When the following shooting modes or settings are selected, the camera uses face detection to automatically focus on human faces.

- **SCENE** (scene auto selector) mode (📖22)
- **Portrait** or **Night portrait** scene mode (📖23)
- Smart portrait mode (📖34)
- When **AF area mode** (📖84) in  (auto) mode (📖41) is set to **Face priority**

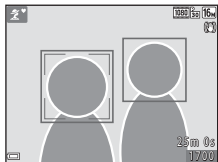

If the camera detects more than one face, a double border is displayed around the face that the camera focuses on, and single borders are displayed around the other faces.

If the shutter button is pressed halfway when no faces are detected:

- In **SCENE** (scene auto selector) mode, the focus area changes depending on the scene.
- In **Portrait** and **Night portrait** scene modes or in smart portrait mode, the camera focuses in the center of the frame.
- In  (auto) mode, the camera selects the focus area containing the subject closest to the camera.

### Notes About Face Detection

- The camera's ability to detect faces depends on a variety of factors, including the direction in which the faces are looking.
- The camera cannot detect faces in the following situations:
  - When faces are partially hidden by sunglasses or otherwise obstructed
  - When faces take up too much or too little of the frame

## Using Skin Softening

When the shutter is released while using one of the shooting modes listed below, the camera detects human faces and processes the image to soften facial skin tones (up to three faces).

- Smart portrait mode (📖34)
  - The amount of **Skin softening** effect can be adjusted.
- **SCENE** (scene auto selector) mode (📖22)
- **Portrait** or **Night portrait** in scene mode (📖23)

Editing functions such as **Skin softening** can be applied to saved images by using **Glamour retouch** (📖65) even after shooting.

### ✔ Notes About Skin Softening

- It may take more time than usual to save images after shooting.
- Under some shooting conditions, the desired skin softening results may not be achieved, and skin softening may be applied to areas of the image where there are no faces.

## Using Target Finding AF

When **AF area mode** (📖84) in 📷 (auto) mode is set to **Target finding AF**, the camera focuses in the manner described below when you press the shutter-release button halfway:

- The camera detects the main subject and focuses on it. When the subject is in focus, the focus area is displayed in green. If a human face is detected, the camera automatically sets focus priority on it.

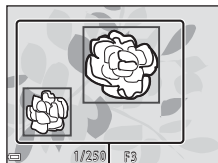

Focus areas

- If no main subject is detected, the camera automatically selects one or more of the nine focus areas containing the subject closest to the camera. When the subject is in focus, the focus areas that are in focus are displayed in green.

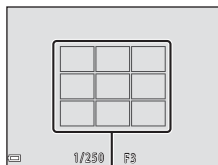

Focus areas

### ✓ Notes About Target Finding AF

- Depending on shooting conditions, the subject that the camera determines to be the main subject may vary.
- The main subject may not be detected when using certain **White balance** settings.
- The camera may not detect the main subject appropriately in the following situations:
  - When the subject is very dark or bright
  - When the main subject lacks clearly defined colors
  - When the shot is framed so that the main subject is at the edge of the monitor
  - When the main subject is composed of a repeating pattern



## Subjects Not Suitable for Autofocus

The camera may not focus as expected in the following situations. In rare cases, the subject may not be in focus despite the fact that the focus area or the focus indicator is displayed in green:

- Subject is very dark
- Objects of sharply differing brightness are included in the scene (e.g. the sun behind the subject makes that subject appear very dark)
- No contrast between the subject and surroundings (e.g. a portrait subject wearing a white shirt is standing in front of a white wall)
- Several objects are at different distances from the camera (e.g. the subject is inside a cage)
- Subjects with repeating patterns (window blinds, buildings with multiple rows of similarly shaped windows, etc.)
- Subject is moving rapidly

In the situations noted above, try pressing the shutter-release button halfway to refocus several times, or focus on another subject positioned at the same distance from the camera as the actual desired subject, and use focus lock (📖54).

## Focus Lock

Focus lock shooting is recommended when the camera does not activate the focus area that contains the desired subject.

**1** Set **AF area mode** to **Center** in  (auto) mode ( 84).

**2** Position the subject in the center of the frame and press the shutter-release button halfway.

- The camera focuses on the subject and the focus area is displayed in green.
- Exposure is also locked.

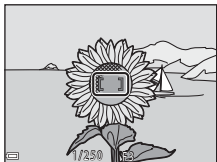

**3** Without lifting your finger, recompose the picture.

- Make sure to maintain the same distance between the camera and the subject.

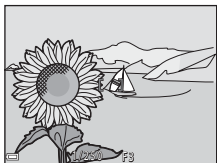

**4** Press the shutter-release button the rest of the way down to take the picture.



## Functions That Cannot Be Used Simultaneously When Shooting

Some functions cannot be used with other menu options.

Restricted function	Option	Description
Flash mode	Continuous (📖81)	When a setting other than <b>Single</b> is selected, the flash cannot be used.
	Blink proof (📖89)	When <b>Blink proof</b> is set to <b>On</b> , the flash cannot be used.
Self-timer	AF area mode (📖84)	When <b>Subject tracking</b> is selected, the self-timer cannot be used.
Macro mode	AF area mode (📖84)	When <b>Subject tracking</b> is selected, macro mode cannot be used.
Image mode	Continuous (📖81)	<p><b>Image mode</b> is set as follows depending on the continuous shooting setting:</p> <ul style="list-style-type: none"> <li>• <b>Pre-shooting cache: 2M</b> (image size: 1600 × 1200 pixels)</li> <li>• <b>Continuous H: 120 fps: VGA</b> (image size: 640 × 480 pixels)</li> <li>• <b>Continuous H: 60 fps: 1M</b> (image size: 1280 × 960 pixels)</li> </ul>
White balance	Hue (using the creative slider) (📖42)	When hue is adjusted using the creative slider, <b>White balance</b> in the shooting menu cannot be set. To set <b>White balance</b> , select <b>R</b> in the creative slider setting screen to reset the brightness, vividness, and hue.
Continuous	Self-timer (📖45)	If the self-timer is used when <b>Pre-shooting cache</b> is selected, the setting is fixed at <b>Single</b> .
ISO sensitivity	Continuous (📖81)	When <b>Pre-shooting cache</b> , <b>Continuous H: 120 fps</b> , or <b>Continuous H: 60 fps</b> is selected, <b>ISO sensitivity</b> is fixed at <b>Auto</b> .

Restricted function	Option	Description
AF area mode	White balance (📖79)	When a setting other than <b>Auto</b> is selected for <b>White balance</b> in <b>Target finding AF</b> mode, the camera does not detect the main subject.
Blink proof	Self-Collage (📖36)	When <b>Self-Collage</b> is selected, <b>Blink proof</b> is disabled.
Date stamp	Continuous (📖81)	When <b>Pre-shooting cache</b> , <b>Continuous H: 120 fps</b> , or <b>Continuous H: 60 fps</b> is selected, date and time cannot be stamped on images.
Digital zoom	AF area mode (📖84)	When <b>Subject tracking</b> is selected, digital zoom cannot be used.
Shutter sound	Continuous (📖81)	When a setting other than <b>Single</b> is selected, the shutter sound is disabled.

### ✓ Notes About Digital Zoom

- Depending on the shooting mode or the current settings, digital zoom may not be available (📖111).
- When digital zoom is in effect, the camera focuses in the center of the frame.

# Playback Features

## Playback Zoom

Moving the zoom control toward **T** (🔍 playback zoom) in full-frame playback mode (📖17) zooms in on the image.

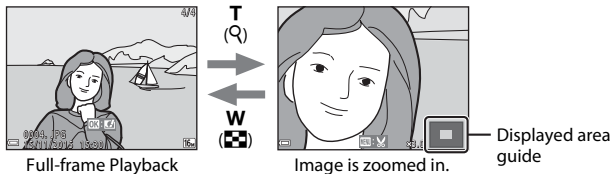

- You can change the magnification rate by moving the zoom control toward **W** (📐) or **T** (🔍).
- To view a different area of the image, press the multi selector ▲▼◀▶.
- When a zoomed image is displayed, press the **OK** button to return to full-frame playback mode.

### Cropping Images

When a zoomed image is displayed, you can press the **MENU** button to crop the image to include only the visible portion and save it as a separate file (📖67).

## Thumbnail Playback/Calendar Display

Moving the zoom control toward **W** (🗉) thumbnail playback) in full-frame playback mode (📖 17) displays images as thumbnails.







- You can change the number of thumbnails displayed by moving the zoom control toward **W** (🗉) or **T** (📅).
- While using thumbnail playback mode, press the multi selector **▲▼◀▶** to select an image and then press the **OK** button to display that image in full-frame playback mode.
- While using calendar display mode, press **▲▼◀▶** to select a date and then press the **OK** button to display the images captured on that day.



### ✓ Notes About Calendar Display

Images captured when the camera's date is not set are treated as images captured on January 1, 2015.



## List by Date Mode

Press the  button (playback mode) →  button →  List by date →  button

Use the multi selector ▲▼ to select a date and then press the  button to play back the images captured on the selected date.

- Functions in the playback menu (90) can be used for the images in the selected shooting date (except **Copy**).
- The following operations are available while the shooting date selection screen is displayed.
  - **MENU** button: The functions listed below are available.
    - Slide show
    - Protect\*
    - \* The same settings can be applied to all images captured on the selected date.
  -  button: Deletes all images captured on the selected date.



List by date		
	20/11/2015	[ 3 ]
	15/11/2015	[ 1 ]
	05/11/2015	[ 2 ]
	04/11/2015	[ 10 ]

### Notes About List by Date Mode

- Up to the most recent 29 dates can be selected. If images exist for more than 29 dates, all images saved earlier than the most recent 29 dates will be combined under **Others**.
- The 9,000 most recent images can be displayed.
- Images captured when the camera's date is not set are treated as images captured on January 1, 2015.

# Viewing and Deleting Images Captured Continuously (Sequence)

## Viewing Images in a Sequence

Images captured continuously or with the self-collage function are saved as a sequence.

The first image of a sequence is used as the key picture to represent the sequence when displayed in full-frame playback mode or thumbnail playback mode. For the self-collage function, a collage image is used as the key picture.

To display each image in the sequence individually, press the **OK** button.

After pressing the **OK** button, the operations listed below are available.

- To display the previous or next image, press the multi selector ◀▶.
- To display images that are not included in the sequence, press ▲ to return to the key picture display.
- To display images in a sequence as thumbnails, or to play them back in a slide show, set **Sequence display options** to **Individual pictures** in the playback menu (📖94).



### ✓ Sequence Display Options

Images captured continuously with cameras other than this camera cannot be displayed as a sequence.

### 📎 Playback Menu Options Available When Using Sequence

- When images in a sequence are displayed in full-frame playback mode, press the **MENU** button to select functions in playback menu (📖90).
- If you press the **MENU** button when a key picture is displayed, the following settings can be applied to all images in the sequence:
  - Mark for Wi-Fi upload, Protect, Copy



## Deleting Images in a Sequence

When the  (delete) button is pressed for images in a sequence, the images that are deleted vary depending on how the sequences are displayed.

- When the key picture is displayed:
  - **Current image:** All images in the displayed sequence are deleted.
  - **Erase selected images:** When a key picture is selected on the erase selected images screen (19), all images in that sequence are deleted.
  - **All images:** All images on the memory card or in the internal memory are deleted.
- When images in a sequence are displayed in full-frame playback mode:
  - **Current image:** The image currently displayed is deleted.
  - **Erase selected images:** Images that are selected in the sequence are deleted.
  - **Entire sequence:** All images in the displayed sequence are deleted.

# Editing Images (Still Images)

## Before Editing Images

You can easily edit images on this camera. Edited copies are saved as separate files. Edited copies are saved with the same shooting date and time as the original.

### Restrictions on Image Editing

- An image can be edited up to 10 times. Still images created by editing movies can be edited up to nine times.
- You may not be able to edit images of a certain size or with certain editing functions.

## Quick Effects: Changing Hue or Mood



Process images with a variety of effects.

You can select **Painting**, **Photo illustration**, **Soft portrait**, **Background monochrome portrait**, **Fisheye**, **Cross screen**, or **Miniature effect**.

- 1 Display the image to which you want to apply an effect in full-frame playback mode and press the **OK** button.



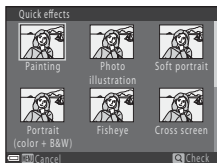

- 2 Use the multi selector **▲▼◀▶** to select the desired effect and press the **OK** button.

- Move the zoom control ( 1) toward **T** () to switch to full-frame playback or **W** () to switch to thumbnail playback.
- To exit without saving the edited image, press the **MENU** button.



- 3 Select **Yes** and press the **OK** button.
  - An edited copy is created.

## Quick Retouch: Enhancing Contrast and Saturation



Press the  button (playback mode) → select an image → MENU button  
→ Quick retouch →  button

Use the multi selector ▲▼ to select the amount of effect applied and press the  button.

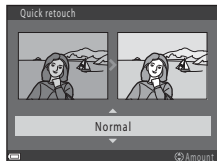
- The edited version is displayed on the right.
- To exit without saving the copy, press .



## D-Lighting: Enhancing Brightness and Contrast



Press the  button (playback mode) → select an image → MENU button → D-Lighting →  button

Use the multi selector ▲▼ to select **OK** and press the  button.

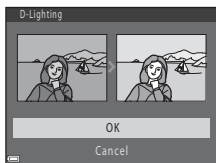
- The edited version is displayed on the right.
- To exit without saving the copy, select **Cancel** and press the  button.



## Red-eye Correction: Correcting Red-eye When Shooting with the Flash

Press the  button (playback mode) → select an image → MENU button → Red-eye correction →  button

Preview the result and press the  button.



- To exit without saving the copy, press the multi selector ◀.







### Notes About Red-eye Correction

- Red-eye correction can only be applied to images when red-eye is detected.
- Red-eye correction can be applied to pets (dogs or cats) even if their eyes are not red.
- Red-eye correction may not produce the desired results in some images.
- In rare cases, red-eye correction may be applied unnecessarily to other areas of the image.





# Glamour Retouch: Enhancing Human Faces

Press the  button (playback mode) → select an image → MENU button → Glamour retouch →  button

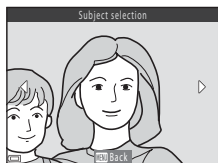
**1** Use the multi selector     to select the face that you want to retouch and press the  button.



- When only one face is detected, proceed to step 2.













**2** Use   to select the effect, use   to select the effect level, and press the  button.

- You can simultaneously apply multiple effects.

Adjust or check the settings for all effects before pressing the  button.

 **Small face**,  **Skin softening**,

 **Foundation makeup**,  **Glare reduction**,  **Hide eye bags**,  **Big eyes**,  **Whiten eyes**,  **Eye shadow**,  **Mascara**,  **Whiten teeth**,  **Lipstick**,  **Redden cheeks**

- Press the MENU button to return to the screen for selecting a person.

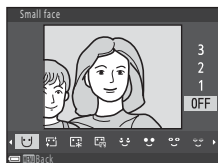

**3** Preview the result and press the  button.

- To change the settings, press  to return to step 2.
- To exit without saving the edited image, press the MENU button.



**4** Select **Yes** and press the  button.

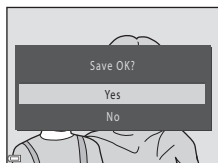

- An edited copy is created.







## ✓ Notes About Glamour Retouch

- One face can be edited at a time. To apply glamour retouch to another face, edit the edited image again.
- Depending on the direction in which faces are looking, or the brightness of faces, the camera may be unable to accurately detect faces, or the glamour retouch function may not perform as expected.
- If no faces are detected, a warning is displayed and the screen returns to the playback menu.
- The glamour retouch function is available only for images captured at an ISO sensitivity of 1600 or lower, and the image size of 640 × 480 or larger.

## Small Picture: Reducing the Size of an Image

Press the  button (playback mode) → select an image → MENU button → Small picture →  button

**1** Use the multi selector   to select the desired copy size and press the  button.

- For images captured at an image mode setting of  **4608×2592**, only **640×360** is displayed, and for those of  **3456×3456**, only **480×480** is displayed.

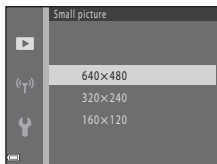

**2** Select **Yes** and press the  button.

- An edited copy is created (compression ratio of approximately 1:8).

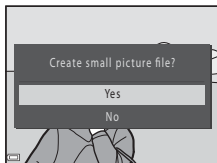

## Crop: Creating a Cropped Copy

**1** Move the zoom control to enlarge the image (📖57).

**2** Adjust the image so that only the portion that you want to keep is displayed, and then press the **MENU** (menu) button.

- Move the zoom control toward **T** (🔍) or **W** (📏) to adjust the magnification rate. Set a magnification rate at which **MENU**:🗂️ is displayed.
- Use the multi selector ▲▼◀▶ to scroll to the portion of the image that you want to display.



**3** Confirm the area that you want to keep, and press the **OK** button.

- To set the area again, press ◀.

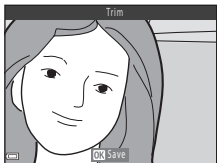

**4** Select **Yes** and press the **OK** button.

- An edited copy is created.



### Image Size

- The aspect ratio (horizontal to vertical) after cropping is the same as the original image.
- When the image size of the cropped copy is 320 × 240 or smaller, the image is displayed at a smaller size during playback.

# Recording and Playing Back Movies

## 1 Display the shooting screen.

- Check the remaining amount of movie recording time.

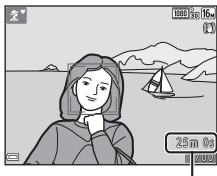



Remaining movie recording time

## 2 Lower the flash (111).

- Recording movies while the flash is raised may cause the audio to be muffled.

## 3 Press the button to start movie recording.

- The camera focuses in the center of the frame.
- Press the multi selector  to pause recording, and press  again to resume recording (except when an HS movie option is selected in **Movie options**). Recording automatically ends if it remains paused for about five minutes.

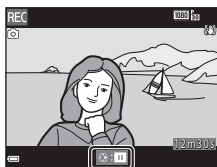
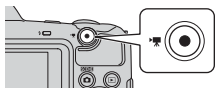

- You can capture a still image by pressing the shutter-release button while recording a movie (171).

## 4 Press the button again to end recording.

## 5 Select a movie in full-frame playback mode and press the button to play it back.

- An image with a movie options icon is a movie.



Movie options



## Area Captured in Movies

- The area that is captured in a movie varies depending on the **Movie options** settings in the movie menu.
- If **Photo info** in **Monitor settings** (📖107) in the setup menu is set to **Movie frame+auto info**, you can confirm the area that will be captured in a movie before you start recording.

## Maximum Movie Recording Time

Individual movie files cannot exceed 4 GB in size or 29 minutes in length, even when there is sufficient free space on the memory card for longer recording.

- The remaining recording time for a single movie is displayed on the shooting screen.
- The actual remaining recording time may vary depending on the movie content, subject movement, or type of memory card.
- Memory cards with an SD Speed Class rating of 6 or faster are recommended when recording movies (📖150). Movie recording may stop unexpectedly when memory cards with a lower Speed Class rating are used.

### **Notes About Camera Temperature**

- The camera may become hot when shooting movies for an extended period of time or when the camera is used in a hot area.
- If the inside of the camera becomes extremely hot when recording movies, the camera will automatically stop recording.

The amount of time remaining until the camera stops recording (🔥10s) is displayed.

After the camera stops recording, it turns itself off.

Leave the camera off until the inside of the camera has cooled.

## Notes About Movie Recording

### ✓ Notes About Saving Images or Movies

The indicator showing the number of exposures remaining or the indicator showing the remaining recording time flashes while images or movies are being saved. **Do not open the battery-chamber/memory card slot cover or remove the batteries or memory card** while an indicator is flashing. Doing this could result in loss of data, or in damage to the camera or the memory card.

### ✓ Notes About Recorded Movies

- When using the camera's internal memory, saving movies may take some time.
- There may be some degradation in image quality when digital zoom is used.
- The sounds of zoom control operation, zoom, autofocus lens drive movement, vibration reduction, and aperture operation when brightness changes may be recorded.
- The following phenomena may be seen in the monitor while recording movies. These phenomena are saved in the recorded movies.
  - Banding may occur in images under fluorescent, mercury-vapor, or sodium-vapor lighting.
  - Subjects that move quickly from one side of the frame to the other, such as a moving train or car, may appear skewed.
  - The entire movie image may be skewed when the camera is panned.
  - Lighting or other bright areas may leave residual images when the camera is moved.
- Depending on the distance to the subject or the amount of zoom applied, colored stripes may appear on subjects with repeating patterns (fabrics, lattice windows, etc.) during movie recording and playback. This occurs when the pattern in the subject and the layout of the image sensor interfere with each other; it is not a malfunction.

### ✓ Notes About Vibration Reduction During Movie Recording

- When **Movie VR** (📖101) in the movie menu is set to **On (hybrid)**, the angle of view (i.e., the area visible in the frame) becomes narrower during movie recording.
- When using a tripod to stabilize the camera during shooting, set **Movie VR** to **Off** to prevent potential errors caused by this function.



### ✓ Notes About Autofocus for Movie Recording

Autofocus may not perform as expected (📖53). Should this occur, try the following:

1. Set **Autofocus mode** in the movie menu to **Single AF** (default setting) before starting movie recording.
2. Frame another subject (positioned at the same distance from the camera as the intended subject) in the center of the frame, press the ● (📹 movie-record) button to start recording, and modify the composition.





## Capturing Still Images While Recording Movies

If the shutter-release button is pressed all the way while recording a movie, one frame is saved as a still image. Movie recording continues while the still image is being saved.

- While  is displayed in the monitor, still images can be captured. While  is displayed, still images cannot be captured.
- The size of the captured image varies depending on the **Movie options** setting (96).



### Notes About Capturing Still Images During Movie Recording

- Still images cannot be captured during a movie recording in the following situations:
  - When the remaining movie recording time is less than five seconds
  - When **Movie options** is set to  **1080/60i**,  **1080/50i**,  **480/30p**,  **480/25p**, or HS movie
- The sound of pressing the shutter-release button may be recorded in the movie.
- If the camera moves when the shutter-release button is pressed, the image may be blurred.

## Operations During Movie Playback

To adjust the volume, move the zoom control while a movie is playing (📖1).



Volume indicator

Playback controls are displayed in the monitor. The operations described below can be performed by using the multi selector ◀▶ to select a control and then pressing the Ⓚ button.



When paused

Function	Icon	Description	
Rewind	◀	Hold down the Ⓚ button to rewind the movie.	
Advance	▶	Hold down the Ⓚ button to advance the movie.	
Pause	⏸	Pause playback. The operations listed below can be performed while paused.	
		◀◀	Rewind the movie one frame. Hold down the Ⓚ button for continuous rewinding.
		▶▶	Advance the movie one frame. Hold down the Ⓚ button for continuous advancing.
		📄	Extract the desired portion of a movie and save it as a separate file.
		🖼️	One frame from a recorded movie can be extracted and saved as a still image.
	▶	Resume playback.	
End	■	Return to full-frame playback mode.	

# Editing Movies

## Extracting Only the Desired Portions of a Movie

The desired portion of a recorded movie can be saved as a separate file.

**1** Play back a movie and pause at the start point of the portion that you want to extract (📖72).

**2** Use the multi selector ◀▶ to select 📄 in the playback controls, and then press the Ⓞ button.

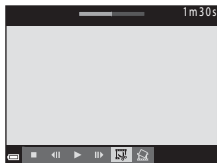

**3** Use ▲▼ to select 📄 (choose start point) in the editing controls.

- Use ◀▶ to move the start point.
- To cancel editing, select ↵ (return), and press the Ⓞ button.

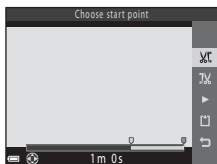

**4** Use ▲▼ to select 📄 (choose end point).

- Use ◀▶ to move the end point.
- To preview the specified portion, select ▶ and then press the Ⓞ button. Press the Ⓞ button again to stop previewing.

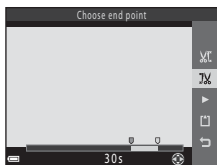

## 5 Use ▲▼ to select (save) and press the button.

- Follow the instructions on the screen to save the movie.

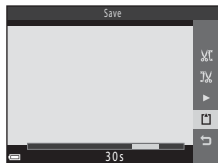





### Notes About Movie Editing





- Use batteries with a sufficient amount of charge remaining to prevent the camera from turning off during editing. When the battery level indicator is , movie editing is not possible.
- A movie that was created by editing cannot be trimmed again.
- The actual trimmed portion of a movie may differ slightly from the portion selected using the start and end points.
- Movies cannot be trimmed so that they are less than two seconds long.

## Saving a Frame from a Movie as a Still Image

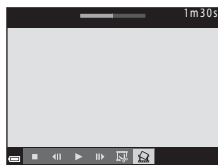
A frame from a recorded movie can be extracted and saved as a still image.

- Pause movie playback so that the frame to be extracted is displayed (72).
- Use the multi selector  to select  in the playback controls, and then press the  button.



- When the confirmation dialog is displayed, select **Yes** and press the  button to save.
- The image quality of the still images to be saved is normal (compression ratio of approximately 1:8). The size of the image varies depending on the type (image size; 96) of the original movie. For example, a still image saved from a movie recorded with  **1080/30p** or  **1080/25p** is  (1920 × 1080 pixels).

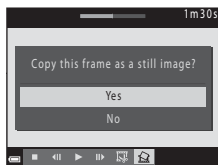

### Notes About Saving Still Images

Still images cannot be saved from movies recorded at  **1080/60i**,  **1080/50i**, or HS movie (96).

# Using Menus

You can set the menus listed below by pressing the **MENU** (menu) button.

- **📷 Shooting menu**

Available by pressing the **MENU** button when the shooting screen is displayed.

Allows you to change image size and quality, continuous shooting settings, etc.

- **▶ Playback menu**

Available by pressing the **MENU** button when viewing images in full-frame playback mode or thumbnail playback mode.

Allows you to edit images, play slide shows, etc.

- **🎬 Movie menu**

Available by pressing the **MENU** button when the shooting screen is displayed.

Allows you to change movie recording settings.

- **📶 Wi-Fi options menu**

Allows you to configure Wi-Fi settings for connecting the camera and a smart device.

- **🔧 Setup menu**

Allows you to adjust basic camera functions such as date and time, display language, etc.

## 1 Press the **MENU** (menu) button.

- The menu is displayed.

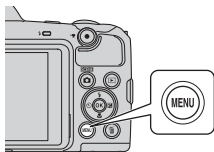

## 2 Press the multi selector ◀.

- The current menu icon is displayed in yellow.

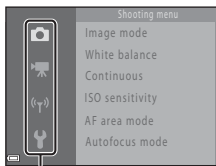

Menu icons

### 3 Select a menu icon and press the **OK** button.

- The menu options become selectable.

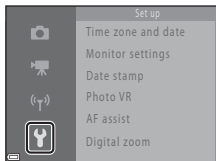

### 4 Select a menu option and press the **OK** button.

- Certain menu options cannot be set depending on the current shooting mode or the state of the camera.

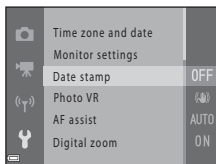

### 5 Select a setting and press the **OK** button.

- The setting you selected is applied.
- When you are finished using the menu, press the **MENU** button.
- When a menu is displayed, you can switch to shooting mode by pressing the shutter-release button, button, or button.

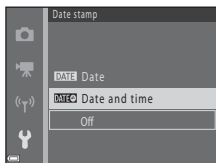



# The Shooting Menu (for (Auto) Mode)

## Image Mode (Image Size and Quality)

Enter shooting mode\* → MENU button → Image mode → 

\* This setting can also be changed in shooting modes other than auto. The changed setting is also applied to other shooting modes.

Select the combination of image size and compression ratio to be used when saving images.

The higher the image mode setting, the larger the size at which it can be printed, and the lower the compression ratio, the higher the quality of the images, but the number of images that can be saved is reduced.

Option*	Compression ratio	Aspect ratio (horizontal to vertical)
<b>16M</b> * 4608×3456★	Approx. 1:4	4:3
<b>16M</b> 4608×3456 (default setting)	Approx. 1:8	4:3
<b>8M</b> 3264×2448	Approx. 1:8	4:3
<b>4M</b> 2272×1704	Approx. 1:8	4:3
<b>2M</b> 1600×1200	Approx. 1:8	4:3
<b>VGA</b> 640×480	Approx. 1:8	4:3
<b>16:9</b> <b>12M</b> 4608×2592	Approx. 1:8	16:9
<b>1:1</b> 3456×3456	Approx. 1:8	1:1

\* The numerical values indicate the number of pixels that are captured.  
Example: **16M 4608×3456** = approx. 16 megapixels, 4608 × 3456 pixels

### **Notes About Printing Images at 1:1 Aspect Ratio**

Change the printer setting to “Border” when printing images at a 1:1 aspect ratio. Some printers may not be able to print images at a 1:1 aspect ratio.





### **Notes About Image Mode**

This function may not be available to use in combination with other functions (📖55).





### **Number of Images That Can Be Saved**

- The approximate number of images that can be saved can be checked in the monitor when shooting (📖10).
- Note that due to JPEG compression, the number of images that can be saved may vary greatly depending on the image content, even when using memory cards with the same capacity and the same image mode setting. In addition, the number of images that can be saved may vary depending on the make of the memory card.
- If the number of exposures remaining is 10,000 or more, the number of exposures remaining display shows “9999”.

## White Balance (Adjusting Hue)

Enter shooting mode →  (shooting mode) button →  (auto) mode  
→  button → MENU button → White balance →  button

Adjust white balance to suit the light source or weather conditions in order to make the colors in images match what you see with your eyes.

Option	Description
<b>AUTO</b> Auto (default setting)	White balance is automatically adjusted.
<b>PRE</b> Preset manual	Use when the desired result is not achieved with <b>Auto</b> , <b>Incandescent</b> , etc. (📖80).
 Daylight	Use under direct sunlight.
 Incandescent	Use under incandescent lighting.
 Fluorescent	Use under fluorescent lighting.
 Cloudy	Use under overcast skies.
 Flash	Use with the flash.

### Notes About White Balance

- Lower the flash when white balance is set to any setting other than **Auto** and **Flash** (📖11).
- This function may not be available to use in combination with other functions (📖55).

## Using Preset Manual

Use the procedure below to measure the white balance value under the lighting used during shooting.

**1** Place a white or gray reference object under the lighting that will be used during shooting.

**2** Use the multi selector ▲▼ to select **Preset manual** in the **White balance** menu, and press the **OK** button.

- The camera zooms in to the position for measuring white balance.

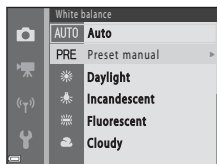

**3** Select **Measure**.

- To apply the last measured value, select **Cancel** and press the **OK** button.

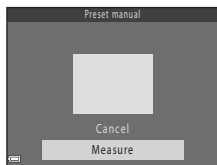

**4** Frame the white or gray reference object in the measuring window, and press the **OK** button to measure the value.

- The shutter is released and measurement is complete (no image is saved).

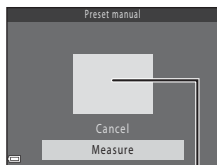

















Measuring window

### ✓ Notes About Preset Manual

A value for flash lighting cannot be measured with **Preset manual**. When shooting with the flash, set **White balance** to **Auto** or **Flash**.

# Continuous Shooting

Enter shooting mode →  (shooting mode) button →  (auto) mode  
→  button → MENU button → Continuous →  button

Option	Description
 Single (default setting)	One image is captured each time the shutter-release button is pressed.
 Continuous H	While the shutter-release button is held all the way down, images are captured continuously. <ul style="list-style-type: none"><li>The frame rate for continuous shooting is about 7.4 fps and the maximum number of continuous shots is about 7 (when image mode is set to  <b>4608×3456</b>).</li></ul>
 Continuous L	While the shutter-release button is held all the way down, images are captured continuously. <ul style="list-style-type: none"><li>The frame rate for continuous shooting is about 2 fps and the maximum number of continuous shots is about 7 (when image mode is set to  <b>4608×3456</b>).</li></ul>
 Pre-shooting cache	When the shutter-release button is pressed halfway, pre-shooting cache shooting begins. When the shutter-release button is pressed the rest of the way down, the camera saves the current image as well as the images captured immediately before the button is pressed (  82). This function helps you to avoid missing the shot. <ul style="list-style-type: none"><li>The frame rate for continuous shooting is about 15 fps and the maximum number of continuous shots is 25, including a maximum of 4 frames captured in the pre-shooting cache.</li><li><b>Image mode</b> is fixed at  (image size: 1600 × 1200 pixels).</li></ul>
 120 Continuous H: 120 fps	Each time the shutter-release button is pressed all the way, images are captured at a high speed rate. <ul style="list-style-type: none"><li>The frame rate for continuous shooting is about 120 fps and the maximum number of continuous shots is 50.</li><li><b>Image mode</b> is fixed at  (image size: 640 × 480 pixels).</li></ul>
 60 Continuous H: 60 fps	Each time the shutter-release button is pressed all the way, images are captured at a high speed rate. <ul style="list-style-type: none"><li>The frame rate for continuous shooting is about 60 fps and the maximum number of continuous shots is 25.</li><li><b>Image mode</b> is fixed at  (image size: 1280 × 960 pixels).</li></ul>

## ✓ Notes About Continuous Shooting

- Focus, exposure, and white balance are fixed at the values determined with the first image in each series.
- It may take some time to save the images after shooting.
- When ISO sensitivity increases, noise may appear in captured images.
- The frame rate for continuous shooting may vary depending on the current image mode setting, the memory card used, or shooting condition.
- When using **Pre-shooting cache**, **Continuous H: 120 fps**, or **Continuous H: 60 fps**, banding or variance in brightness or hue may occur in images that were captured under lighting that flickers at high speeds, such as fluorescent, mercury-vapor, or sodium-vapor lighting.
- This function may not be available to use in combination with other functions (📖).



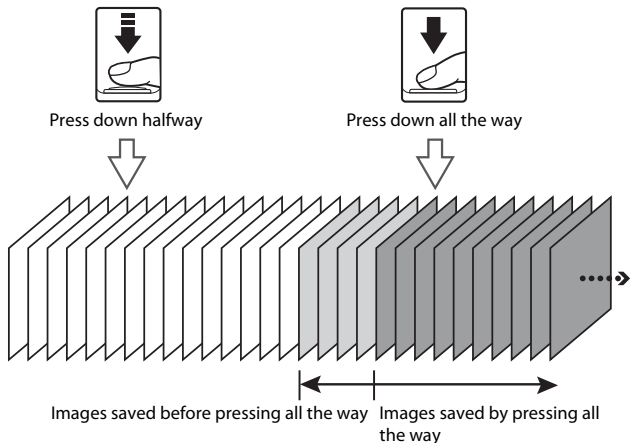

## 📎 Pre-shooting Cache

When the shutter-release button is pressed halfway or all the way down, images are saved as described below.



- The pre-shooting cache icon (📎) on the shooting screen changes to green while the shutter-release button is pressed halfway.

# ISO Sensitivity

Enter shooting mode →  (shooting mode) button →  (auto) mode  
→  button → MENU button → ISO sensitivity →  button

A higher ISO sensitivity allows darker subjects to be captured. Additionally, even with subjects of similar brightness, pictures can be taken at faster shutter speeds, and blurring caused by camera shake and subject movement can be reduced.

- When a higher ISO sensitivity is set, images may contain noise.

Option	Description
<b>AUTO</b> Auto (default setting)	Sensitivity is automatically selected from the range of ISO 125 to 1600.
<b>ISO AUTO</b> Fixed range auto	Select the range in which the camera automatically adjusts ISO sensitivity, from <b>ISO 125-400</b> or <b>ISO 125-800</b> .
125, 200, 400, 800, 1600, 3200, 6400	Sensitivity is locked at the specified value.





## Notes About ISO Sensitivity

This function may not be available to use in combination with other functions (55).





## ISO Sensitivity Display on the Shooting Screen

- When **Auto** is selected, **ISO** is displayed when the ISO sensitivity increases.
- When **Fixed range auto** is selected, the maximum value for ISO sensitivity is displayed.

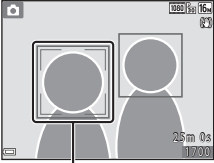
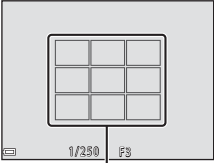

## AF Area Mode

Enter shooting mode →  (shooting mode) button →  (auto) mode  
→  button → MENU button → AF area mode →  button

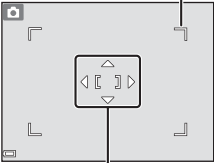
Set how the camera selects the focus area for autofocus.

Option	Description
 Face priority	<p>When the camera detects a human face, it focuses on that face. See “Using Face Detection” (📖50) for more information.</p>  <p style="text-align: center;">Focus area</p> <p>When framing a composition with no human subjects or detected faces, the camera automatically selects one or more of the nine focus areas containing the subject closest to the camera when the shutter-release button is pressed halfway.</p>  <p style="text-align: center;">Focus areas</p>
 Manual	<p>Use the multi selector  to move the focus area to where you want to focus.</p> <ul style="list-style-type: none"> <li>To use the multi selector to configure the flash mode or other settings, press the  button. To return to moving the focus area, press the  button again.</li> </ul>  <p style="text-align: center;">Scope of movable focus area</p> <p style="text-align: center;">Focus area</p>

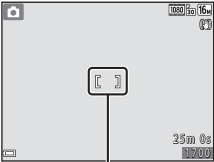

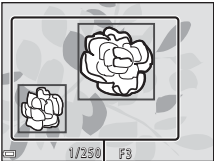





Option	Description
<p>[ ■ ] Center</p>	<p>The camera focuses on the subject in the center of the frame.</p>  <p>The image shows a camera viewfinder with a central focus area bracket. A line points from the text 'Focus area' below to the bracket. The viewfinder displays '1080 50 16w' in the top right, '25m 0s' and '17:00' in the bottom right, and a small camera icon in the top left.</p> <p style="text-align: center;">Focus area</p>
<p>[ ⊕ ] Subject tracking</p>	<p>Use this function to take pictures of moving subjects. Register the subject on which the camera focuses. The focus area automatically moves to track the subject.</p> <p>See "Using Subject Tracking" (📖86) for more information.</p>  <p>The image shows a camera viewfinder with a subject tracking focus area. A line points from the text 'Focus area' below to the tracking area. The viewfinder displays '1080 50 16w' in the top right, '25m 0s' and '17:00' in the bottom right, 'OK Start' and '1/250 F3' in the bottom center, and a small camera icon in the top left.</p> <p style="text-align: center;">Focus area</p>
<p>[ ■ ] Target finding AF (default setting)</p>	<p>When the camera detects the main subject, it focuses on that subject.</p> <p>See "Using Target Finding AF" (📖52).</p>  <p>The image shows a camera viewfinder with target finding AF focus areas. A line points from the text 'Focus areas' below to the focus areas. The viewfinder displays '1080 50 16w' in the top right, '25m 0s' and '17:00' in the bottom right, '1/250 F3' in the bottom center, and a small camera icon in the top left.</p> <p style="text-align: center;">Focus areas</p>

### ✓ Notes About AF Area Mode

- When digital zoom is in effect, the camera focuses in the center of the frame regardless of the **AF area mode** setting.
- This function may not be available to use in combination with other functions (📖55).

## Using Subject Tracking

Enter shooting mode →  (shooting mode) button →  (auto) mode  
→  button → MENU button → AF area mode →  button →  Subject  
tracking →  button → MENU button

### 1 Register a subject.

- Align the subject that you want to track with the border in the center of the monitor and press the  button.
- When the subject is registered, a yellow border (focus area) is displayed around it and the camera begins tracking the subject.
- If the subject cannot be registered, the border is displayed in red.

Change the composition and try registering the subject again.

- To cancel subject registration, press the  button.
- If the camera can no longer track the registered subject, the focus area disappears. Register the subject again.

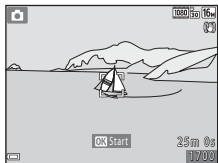

### 2 Press the shutter-release button fully to take the picture.



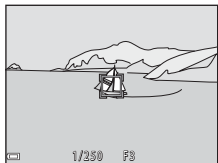

- If the shutter-release button is pressed while the focus area is not displayed, the camera focuses on the subject in the center of the frame.



### Notes About Subject Tracking

- If you perform operations such as zooming while the camera is tracking the subject, the registration is canceled.
- Subject tracking may not be possible in certain shooting conditions.

## Autofocus Mode

Enter shooting mode →  (shooting mode) button →  (auto) mode  
→  button → MENU button → Autofocus mode →  button

Set how the camera focuses when shooting still images.

Option	Description
<b>AF-S</b> Single AF	The camera focuses only when the shutter-release button is pressed halfway.
<b>AF-F</b> Full-time AF	The camera continues focusing even when the shutter-release button is not pressed halfway. The sound of lens drive movement is heard while the camera focuses.
<b>PREAF</b> Pre-focus (default setting)	Even when the shutter-release button is not pressed halfway, the camera focuses automatically if the composition of the framed image is significantly changed.



### Autofocus Mode for Movie Recording

Autofocus mode for movie recording can be set with **Autofocus mode** ( 100) in the movie menu.

## The Smart Portrait Menu





- See “Image Mode (Image Size and Quality)” (📖77) for information about **Image mode**.

### Self-Collage

Enter shooting mode → 📷 (shooting mode) button → 😊 Smart portrait mode → Ⓞ button → MENU button → Self-Collage → Ⓞ button

Option	Description
Number of shots	Set the number of shots that the camera automatically captures (number of captured images for an aggregated image). <ul style="list-style-type: none"><li>• <b>4</b> (default setting) or <b>9</b> can be selected.</li></ul>
Interval	Set the interval time between each shot. <ul style="list-style-type: none"><li>• <b>Short</b>, <b>Medium</b> (default setting), or <b>Long</b> can be selected.</li></ul>
Shutter sound	Set whether to activate the shutter sound when shooting with the self-collage function. <ul style="list-style-type: none"><li>• <b>Standard</b>, <b>SLR</b>, <b>Magic</b> (default setting), or <b>Off</b> can be selected.</li><li>• The same setting that is specified for <b>Shutter sound</b> in <b>Sound settings</b> in the setup menu is not applied to this setting.</li></ul>

## Blink Proof

Enter shooting mode →  (shooting mode) button →  Smart portrait mode →  button → MENU button → Blink proof →  button

Option	Description
 On	<p>The camera automatically releases the shutter twice with every shot and saves one image in which the subject's eyes are open.</p> <ul style="list-style-type: none"><li>• If the camera saved an image in which the subject's eyes may have been closed, the dialog shown on the right is displayed for a few seconds.</li><li>• The flash cannot be used.</li></ul>
Off (default setting)	Turns the blink proof off.



### Notes About Blink Proof



This function may not be available to use in combination with other functions ( 55).

## The Playback Menu

- See “Editing Images (Still Images)” (📖62) for information about image editing functions.

---

### Mark for Wi-Fi Upload



Press the  button (playback mode) → MENU button → Mark for Wi-Fi upload →  button

Select images in the camera that you want to transfer to a smart device in advance before transferring them.

On the image selection screen (📖95), select or deselect images for the **Mark for Wi-Fi upload** function.



Note that when you select **Reset all** (📖114) in the setup menu or **Restore default settings** (📖103) in the Wi-Fi options menu, the **Mark for Wi-Fi upload** settings that you made are canceled.

## Slide Show

Press the  button (playback mode) → MENU button → Slide show →  button



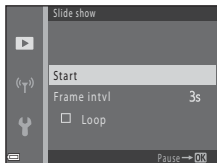

Play back images one by one in an automated “slide show.” When movie files are played back in the slide show, only the first frame of each movie is displayed.

### 1 Use the multi selector to select **Start** and press the button.

- The slide show begins.
- To change the interval between images, select **Frame intvl**, press the , and specify the desired interval time before selecting **Start**.
- To repeat the slide show automatically, select **Loop** and press the  button before selecting **Start**.
- The maximum playback time is up to about 30 minutes even if **Loop** is enabled.





### 2 End or restart the slide show.



- The screen shown on the right is displayed after the slide show ends or is paused. To exit the show, select  and then press the  button. To resume the slide show, select  and then press the  button.



## Operations During Playback

- Use the multi selector  to display the previous/next image. Press and hold to rewind/fast forward.
- Press the  button to pause or end the slide show.

## Protect



Press the  button (playback mode) → MENU button → Protect →  button

The camera protects selected images from accidental deletion.



Select images to protect or cancel protection from the image selection screen (95).

Note that formatting the memory card or the camera's internal memory permanently deletes all data including protected files (113).

## Rotate Image

Press the  button (playback mode) → MENU button → Rotate image →  button

Specify the orientation in which saved images are displayed during playback. Still images can be rotated 90 degrees clockwise or 90 degrees counterclockwise.

Select an image from the image selection screen (95). When the Rotate image screen is displayed, press the multi selector  to rotate the image 90 degrees.



Rotate 90 degrees counterclockwise

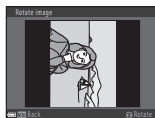



Rotate 90 degrees clockwise

Press the  button to finalize display orientation, and save orientation information with the image.





# Copy (Copy Between the Memory Card and Internal Memory)

Press the  button (playback mode) → MENU button → Copy →  button

Images can be copied between a memory card and the internal memory.

- When a memory card that contains no images is inserted and the camera is switched to playback mode, **Memory contains no images.** is displayed. In that case, press the MENU button to select **Copy**.

- 1 Use the multi selector   to select a destination option to which images are copied and press the  button.

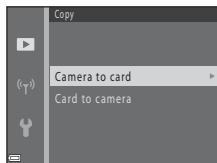

- 2 Select a copy option and press the  button.

- When you choose **Selected images**, use the image selection screen to specify images (95).

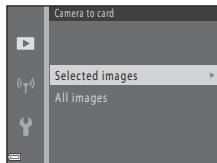



## Notes About Copying Images

- Only files in formats that this camera can record can be copied.
- Operation is not guaranteed with images captured with another make of camera or that have been modified on a computer.



## Copying Images in a Sequence

- If you select a key picture of a sequence in **Selected images**, all images in the sequence are copied.
- If you press the MENU button while images in a sequence are displayed, only the **Card to camera** copy option is available. All images in the sequence are copied if you select **Current sequence**.

## Sequence Display Options

Press the  button (playback mode) → MENU button → Sequence display options →  button

Select the method used to display images in the sequence (60).

Option	Description
 Individual pictures	Displays each image in a sequence individually.  is displayed on the playback screen.
 Key picture only (default setting)	Displays only the key picture for images in a sequence.

Settings are applied to all sequences, and the setting is saved in the camera's memory even if the camera is turned off.

## The Image Selection Screen

When an image selection screen such as the one shown on the right is displayed while operating the camera, follow the procedures described below to select the images.



### 1 Use the multi selector ◀▶ to select an image.

- Move the zoom control (1) toward **T** (🔍) to switch to full-frame playback or **W** (📐) to switch to thumbnail playback.
- Only one image can be selected for **Rotate image**. Proceed to step 3.



### 2 Use ▲▼ to select or deselect (or to specify the number of copies).

- When an image is selected, an icon is displayed with the image. Repeat steps 1 and 2 to select additional images.







### 3 Press the **OK** button to apply image selection.

- When a confirmation dialog is displayed, follow the on-screen instructions to operate.

# The Movie Menu





## Movie Options

Enter shooting mode → MENU button →  menu icon → Movie options  
→  button

Select the desired movie option to record. Select normal speed movie options to record at normal speed, or HS movie options (97) to record in slow or fast motion. The movie options that can be selected vary depending on the **Frame rate** setting (102).

- Memory cards with an SD Speed Class rating of 6 or faster are recommended for recording movies (150).

## Normal Speed Movie Options

Option (Image size/Frame rate <sup>1</sup> , File format)	Image size	Aspect ratio (horizontal to vertical)
 1080/30p  1080/25p (default setting)	1920 × 1080	16:9
 1080/60i <sup>2</sup>  1080/50i <sup>2</sup>	1920 × 1080	16:9
 720/30p  720/25p	1280 × 720	16:9
 480/30p  480/25p	640 × 480	4:3



<sup>1</sup> Interlaced format uses Fields per second.

<sup>2</sup> The setting is not available when using certain effects in special effects mode or glamour retouch.

## HS Movie Options

Recorded movies are played back in fast or slow motion.

See “Recording Movies in Slow Motion and Fast Motion (HS Movie)” (📖99).

Option	Image size Aspect ratio (horizontal to vertical)	Description
 HS 480/4x <sup>1</sup>	640 × 480 4:3	1/4-speed slow motion movies <ul style="list-style-type: none"><li>• Max. recording time<sup>2</sup>: 15 seconds (playback time: 1 minute)</li></ul>
 HS 1080/0.5x <sup>1</sup>	1920 × 1080 16:9	2x speed fast motion movies <ul style="list-style-type: none"><li>• Max. recording time<sup>2</sup>: 2 minutes (playback time: 1 minute)</li></ul>

<sup>1</sup> The setting is not available when using certain effects in special effects mode or glamour retouch.

<sup>2</sup> While recording movies, the camera can be switched between normal speed movie recording and slow motion or fast motion movie recording. The maximum recording time shown here refers only to the portion of the movie that is recorded in slow motion or fast motion.

### Notes About HS Movie

- Sound is not recorded.
- Zoom position, focus, exposure, and white balance are locked when movie recording starts.



## Playing Back in Slow Motion and Fast Motion

When recording at normal speed:

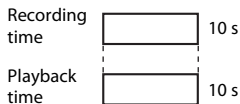

When recording at  $\frac{480\text{P}}{120}$  /  $\frac{480\text{P}}{60}$  HS 480/4x:

Movies are recorded at 4x normal speed.

They are played back in slow motion at 4x slower speed.

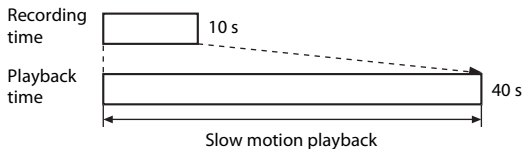



When recording at  $\frac{1080\text{P}}{120}$  /  $\frac{1080\text{P}}{60}$  HS 1080/0.5x:

Movies are recorded at 1/2 normal speed.

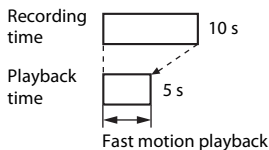

They are played back in fast motion at 2x faster speed.



## Recording Movies in Slow Motion and Fast Motion (HS Movie)

Enter shooting mode → MENU button →  menu icon → Movie options →  button



Movies recorded using HS movie can be played back in slow motion at 1/4 of the normal playback speed, or in fast motion at twice the normal playback speed.

**1** Use the multi selector  to select an HS movie option (97) and press the  button.

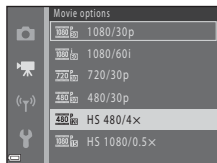
- After applying the option, press the **MENU** button to return to the shooting screen.



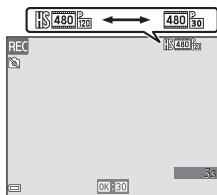

**2** Press the  (movie-record) button to start recording.

- The camera starts recording an HS movie.
- The camera switches between normal speed movie recording and HS movie recording each time the  button is pressed.
- The movie options icon changes when switching between HS movie recording and normal speed movie recording.
- When the maximum recording time for HS movies (97) is reached, the camera automatically switches to normal speed movie recording.



**3** Press the  (movie-record) button to end recording.

## Autofocus Mode

Enter shooting mode → MENU button →  menu icon → Autofocus mode →  button



Set how the camera focuses in movie mode.

Option	Description
<b>AF-S Single AF</b> (default setting)	Focus is locked when movie recording starts. Select this option when the distance between the camera and subject will remain fairly consistent during movie recording.
<b>AF-F Full-time AF</b>	The camera focuses continuously during movie recording. Select this option when the distance between the camera and subject will change significantly during recording. The sound of the camera focusing may be heard in the recorded movie. Use of <b>Single AF</b> is recommended to prevent the sound of the camera focusing from interfering with recording.



- When an HS movie option is selected in **Movie options**, the setting is fixed at **Single AF**.



## Movie VR

Enter shooting mode → MENU button →  menu icon → Movie VR →  button

Select the vibration reduction setting used when recording movies.  
Set to **Off** when using a tripod to stabilize the camera during shooting.



Option	Description
 * On (hybrid) (default setting)	Performs optical compensation for camera shake using lens shift VR and simultaneously performs electronic VR using image processing. The angle of view (i.e., the area visible in the frame) becomes narrower.
 On	Performs compensation for camera shake using lens shift VR.
Off	Vibration reduction is disabled.

- When an HS movie option is selected in **Movie options**, the setting is fixed at **Off**.

### Notes About Movie VR

The effects of camera shake may not be completely eliminated in some situations.

## Wind Noise Reduction

Enter shooting mode → MENU button →  menu icon → Wind noise reduction →  button

Option	Description
 On	Reduces the sound that is produced when wind passes over the microphone during movie recording. Other sounds may become difficult to hear during playback.
Off (default setting)	Wind noise reduction is disabled.

- When an HS movie option is selected in **Movie options**, the setting is fixed at **Off**.

## Frame Rate

Enter shooting mode → MENU button →  menu icon → Frame rate →  button

Select the frame rate (fields per second for the interlaced format) used when recording movies. When the frame rate setting is switched, options that can be set in **Movie options** () change.

Option	Description
30 fps (30p/60i)	Suited for playback on a TV using the NTSC standard.
25 fps (25p/50i)	Suited for playback on a TV using the PAL standard.

# The Wi-Fi Options Menu

Press the **MENU** button → «T» menu icon → **OK** button

Configure the Wi-Fi (wireless LAN) settings to connect the camera and a smart device.

Option	Description
Connect to smart device	Select when wirelessly connecting the camera and a smart device. See "Using the Wi-Fi (Wireless LAN) Function" (📖116) for more information.
Upload from camera	Select when wirelessly connecting the camera and a smart device. See "Using the Wi-Fi (Wireless LAN) Function" (📖116) for more information. <ul style="list-style-type: none"><li>The images to transfer can be selected on the image selection screen before establishing a Wi-Fi connection (📖95). The SSID and password of the camera are displayed on the screen after images are selected.</li></ul>
Disable Wi-Fi	Select to terminate the wireless connection between the camera and a smart device. See "Using the Wi-Fi (Wireless LAN) Function" (📖116) for more information.
Options	<b>SSID:</b> Change the SSID. The SSID configured here is displayed on the smart device. Set a 1- to 24-character alphanumeric SSID.
	<b>Auth./encrypt.:</b> Select whether or not to encrypt the communications between the camera and the connected smart device. Communications are not encrypted when <b>Open</b> (default setting) is selected.
	<b>Password:</b> Set the password. Set an 8- to 16-character alphanumeric password.
	<b>Channel:</b> Select the channel used for wireless connections.
Current settings	Display the current settings.
Restore default settings	Restore the Wi-Fi settings to their default values. The wireless connection is terminated if this option is performed while Wi-Fi is connected.

## Operating the Text Input Keyboard

- Use the multi selector ▲▼◀▶ to select alphanumeric characters. Press the **OK** button to enter the selected character in the text field and move the cursor to the next space.
- To move the cursor in the text field, select ← or → on the keyboard, and press the **OK** button.
- To delete one character, press the **⌫** button.
- To apply the setting, select ↶ on the keyboard and press the **OK** button.

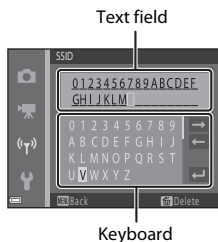

# The Setup Menu

## Time Zone and Date

Press the **MENU** button → **Y** menu icon → Time zone and date → **OK** button

Set the camera clock.

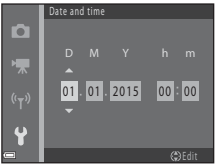
Option	Description
Date and time	<ul style="list-style-type: none"><li>• Select a field: Press the multi selector <b>◀▶</b>.</li><li>• Edit the date and time: Press <b>▲▼</b>.</li><li>• Apply the setting: Select the minute setting and press the <b>OK</b> button.</li></ul> 
Date format	Select <b>Year/Month/Day</b> , <b>Month/Day/Year</b> , or <b>Day/Month/Year</b> .
Time zone	Set time zone and daylight saving time. <ul style="list-style-type: none"><li>• When <b>Travel destination</b> (📍) is set after having set the home time zone (🏠), the time difference between the travel destination and the home time zone is automatically calculated, and the date and time are saved for the selected region.</li></ul>

## Setting the Time Zone

- 1 Use the multi selector ▲▼ to select **Time zone** and press the Ⓞ button.

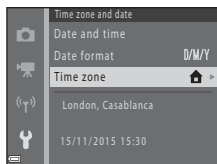

- 2 Select **Home time zone** or **Travel destination** and press the Ⓞ button.
  - The date and time displayed in the monitor changes depending on whether the home time zone or travel destination is selected.

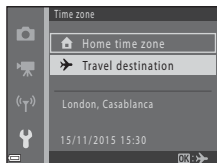

- 3 Press ►.

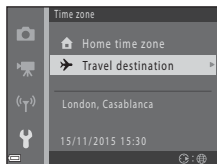

- 4 Use ◀▶ to select the time zone.

- Press ▲ to enable daylight saving time function, and ☀ is displayed. Press ▼ to disable the daylight saving time function.
- Press the Ⓞ button to apply the time zone.
- If the correct time is not displayed for the home or travel destination time zone setting, set the appropriate time in **Date and time**.

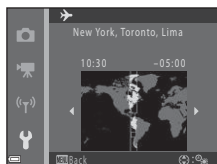









# Monitor Settings

Press the **MENU** button → **Y** menu icon → Monitor settings → **OK** button

Option	Description
Photo info	Set whether or not to display information in the monitor.
Image review	Set whether or not to display the captured image immediately after shooting. <ul style="list-style-type: none"><li>• Default setting: <b>On</b></li></ul>
Brightness	Adjust the brightness. <ul style="list-style-type: none"><li>• Default setting: <b>3</b></li></ul>

## Photo Info

	Shooting mode	Playback mode
Show info		
Auto info (default setting)	The same information as shown in <b>Show info</b> is displayed, and it is hidden as shown in <b>Hide info</b> if no operations are performed for a few seconds. The information is displayed again when an operation is performed.	
Hide info		

	Shooting mode	Playback mode
Framing grid+auto info	 <p>In addition to the information shown in <b>Auto info</b>, a framing grid is displayed to help frame pictures. The framing grid is not displayed while recording movies.</p>	 <p>Same as <b>Auto info</b>.</p>
Movie frame+auto info	 <p>In addition to the information shown in <b>Auto info</b>, a frame is displayed before movie recording begins that represents the area that will be captured when recording movies. The movie frame is not displayed while recording movies.</p>	 <p>Same as <b>Auto info</b>.</p>



## Date Stamp

Press the **MENU** button → **Y** menu icon → Date stamp → **OK** button

The shooting date and time can be stamped on images when shooting. The information can be printed even when using a printer that does not support the date imprinting function.



Option	Description
<b>DATE</b> Date	Date is stamped on images.
<b>DATE</b> Date and time	Date and time are stamped on images.
Off (default setting)	Date and time are not stamped on images.



### Notes About Date Stamp

- Stamped dates form a permanent part of image data and cannot be deleted. The date and time cannot be stamped on images after they have been captured.
- The date and time cannot be stamped in the following situations:
  - When using **Night portrait** (when **Hand-held** is selected), **Night landscape** (when **Hand-held** is selected), **Backlighting** (when **HDR** is set to **ON**), or **Easy panorama** scene mode
  - When the continuous shooting setting ( 81) is set to **Pre-shooting cache**, **Continuous H: 120 fps**, or **Continuous H: 60 fps**
  - When shooting movies
  - When saving still images during moving recording
  - When creating still images by editing movies
- The stamped date and time may be difficult to read when using a small image size.

### Printing a Shooting Date on Images Without a Date Stamp

You can transfer images to a computer and use the ViewNX 2 software ( 128) to imprint the shooting date on the images when they are printed.

## Photo VR

Press the **MENU** button →  menu icon → Photo VR →  button

Select the vibration reduction setting used when shooting still images. Set to **Off** when using a tripod to stabilize the camera during shooting.

Option	Description
 On (default setting)	Compensation for camera shake is performed using lens shift VR.
Off	Compensation is not performed.

### Notes About Photo VR

- After turning on the camera or after switching from playback mode to shooting mode, wait for the shooting mode screen to be displayed completely before taking pictures.
- Images in the camera monitor may be displayed blurry immediately after shooting.
- The effects of camera shake may not be completely eliminated in some situations.

## AF Assist

Press the **MENU** button →  menu icon → AF assist →  button

Option	Description
<b>AUTO</b> Auto (default setting)	The AF-assist illuminator automatically lights up when you press the shutter-release button under dim lighting. The illuminator has a range of about 2.0 m (6 ft 6 in.) at the maximum wide-angle position and about 1.6 m (5 ft 2 in.) at the maximum telephoto position. <ul style="list-style-type: none"><li>• The AF-assist illuminator may not light depending on the position of the focus area or the shooting mode.</li></ul>
Off	The AF-assist illuminator does not light.

## Digital Zoom

Press the MENU button →  menu icon → Digital zoom →  button

Option	Description
On (default setting)	Digital zoom is enabled.
Off	Digital zoom is disabled.

### Notes About Digital Zoom

- Digital zoom cannot be used in the following shooting modes:
  - **Portrait, Night portrait, Night landscape, Backlighting** (when **HDR** is set), **Easy panorama**, or **Pet portrait** scene mode
  - Smart portrait mode
- Digital zoom cannot be used in other shooting modes when using certain settings (56).

## Sound Settings

Press the MENU button →  menu icon → Sound settings →  button

Option	Description
Button sound	When <b>On</b> (default setting) is selected, the camera produces one beep when operations are performed, two beeps when focus is acquired on the subject, and three beeps when an error occurs. The welcome screen sound is also produced. <ul style="list-style-type: none"><li>• Sounds are disabled when using <b>Pet portrait</b> or <b>Bird-watching</b> scene mode.</li></ul>
Shutter sound	When <b>On</b> (default setting) is selected, the shutter sound is produced when the shutter is released. <ul style="list-style-type: none"><li>• The shutter sound is not produced when using continuous shooting mode, when recording movies, or when using <b>Pet portrait</b> or <b>Bird-watching</b> scene mode.</li></ul>

## Auto Off

Press the **MENU** button → **Y** menu icon → Auto off → **OK** button

Set the amount of time that elapses before the camera enters standby mode (📖13).

You can select **30 s**, **1 min** (default setting), **5 min**, or **30 min**.

### **Setting the Auto Off Function**

The time that passes before the camera enters standby mode is fixed in the following situations:

- When a menu is displayed: 3 minutes (when auto off is set to **30 s** or **1 min**)
- When shooting using **Pet portrait auto release**: 5 minutes (when auto off is set to **30 s** or **1 min**)
- When shooting using **Smile timer**: 5 minutes (when auto off is set to **30 s** or **1 min**)
- When the audio/video cable is connected: 30 minutes
- When an HDMI cable is connected: 30 minutes
- When the AC Adapter EH-67 is connected: 30 minutes

## Format Card/Format Memory

Press the **MENU** button → **Y** menu icon → Format card/Format memory → **OK** button

Use this option to format a memory card or the internal memory.

**Formatting the memory cards or internal memory permanently deletes all data. Data that has been deleted cannot be recovered.** Make sure to save important images to a computer before formatting.

### Formatting a Memory Card

- Insert a memory card into the camera.
- Select **Format card** in the setup menu and then press the **OK** button.

### Formatting the Internal Memory

- Remove the memory card from the camera.
- Select **Format memory** in the setup menu and then press the **OK** button.

To start formatting, select **Format** on the screen that is displayed and press the **OK** button.

- Do not turn the camera off or open the battery-chamber/memory card slot cover during formatting.
- This setting cannot be selected while Wi-Fi is connected.

## Language

Press the **MENU** button → **Y** menu icon → Language → **OK** button

Select a language for display of camera menus and messages.

## Reset All

Press the **MENU** button → **Y** menu icon → Reset all → **OK** button

When **Reset** is selected, the camera's settings are restored to their default values.

- Some settings, such as **Time zone and date** or **Language**, are not reset.
- This setting cannot be selected while Wi-Fi is connected.



### Resetting File Numbering

To reset file numbering to "0001", delete all images saved on the memory card or in the internal memory ( 18) before selecting **Reset all**.

## Battery Type

Press the **MENU** button → **Y** menu icon → Battery type → **OK** button

To ensure that the camera shows the correct battery level ( 10), select the type that matches the batteries currently in use.

Option	Description
 Alkaline (default setting)	LR6/L40 (AA-size) alkaline batteries
 COOLPIX (Ni-MH)	Nikon EN-MH2 rechargeable Ni-MH (nickel metal hydride) batteries
 Lithium	FR6/L91 (AA-size) lithium batteries

## Conformity Marking

Press the **MENU** button → **Y** menu icon → Conformity marking → **OK** button

View some of the conformity markings that the camera complies with.

---

## Firmware Version

Press the **MENU** button → **Y** menu icon → Firmware version → **OK** button

View the current camera firmware version.

- This setting cannot be selected while Wi-Fi is connected.

# Using the Wi-Fi (Wireless LAN) Function

You can perform the following functions if you install the dedicated software “Wireless Mobile Utility” on your smart device that runs on Android OS or iOS, and connect it to the camera.

## Take Photos

You can capture still images using the two methods described below.

- Release the shutter on the camera and save the captured images to a smart device.
- Use a smart device to remotely release the camera shutter and save images to the smart device.

## View Photos

Images that are saved in the camera’s memory card can be transferred and viewed on your smart device. You can also preselect the images in the camera that you want to transfer to your smart device.

### Notes

Security settings such as the password are not configured at the time of purchase. It is the user’s responsibility to configure the appropriate security settings in **Options** in the Wi-Fi options menu (📖75) if necessary.

## Installing the Software on the Smart Device

- 1** Use your smart device to connect to the Google Play Store, App Store or other online apps marketplace and search for “Wireless Mobile Utility.”
  - Check the user’s manual provided with your smart device for further details.
- 2** Check the description and other information and install the software.

### User’s Manual for Wireless Mobile Utility

Download the user’s manual from the website below.

- Android OS: <http://nikonimglib.com/ManDL/WMAU/>
- iOS: <http://nikonimglib.com/ManDL/WMAU-ios/>

To establish a connection with the camera, press the **(Wi-Fi)** (Wi-Fi) button on the camera, turn on the Wi-Fi function of the smart device, and then start the “Wireless Mobile Utility” while “Negotiating... Please wait.” is displayed on the camera.



# Connecting the Smart Device to the Camera

- 1 Press the  (Wi-Fi) button on the camera.



- The screen shown on the right is displayed.
- If no connection confirmation is received from the smart device within three minutes, **No access.** is displayed and the camera returns to the Wi-Fi options screen.
- You can also select **Connect to smart device** in the Wi-Fi options menu to display the screen shown on the right.

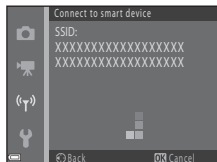

- 2 Set the Wi-Fi setting on the smart device to On.

- Check the user's manual provided with your smart device for further details.
- After the network names (SSIDs) that can be used for the smart device are displayed, select the SSID displayed on the camera.
- When **Auth./encrypt.** in the Wi-Fi options menu is set to **WPA2-PSK-AES**, the message for entering a password is displayed. Enter the password that is displayed on the camera.

- 3 Start the "Wireless Mobile Utility" in the smart device while "Negotiating... Please wait." is displayed on the camera.

- The screen for selecting "Take photos" or "View photos" is displayed.
- When the message "Cannot connect to camera." is displayed, return to step 1 and retry the procedure.
- "Installing the Software on the Smart Device" (📖116)

## Touching an NFC-compatible Smart Device to the Camera for a Wi-Fi Connection

When you use an Android OS smart device that is compatible with near field communication (NFC) functions, you can establish a Wi-Fi connection and start the "Wireless Mobile Utility" by touching the NFC antenna of the smart device to the  (N-Mark) on the camera.

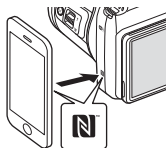

## To Terminate the Wi-Fi Connection

Perform one of the operations described below.

- Turn off the camera.
- Select **Disable Wi-Fi** in the Wi-Fi options menu on the camera (except when the camera is operated by remote control).
- Set the Wi-Fi setting on the smart device to Off.

### Notes About Wi-Fi Connection

- Wi-Fi connection operations are disabled in the following situations:
  - When the camera is connected to a TV, computer, or printer
  - While recording movies
  - While the camera is processing data such as saving images or recording movies
  - When the camera is connected to a smart device
- Select **Disable Wi-Fi** in areas where the use of radio waves is prohibited.
- When Wi-Fi is connected, **Auto off** is disabled.
- When Wi-Fi is connected, the battery drains faster than normal.
- The Wi-Fi connection is disconnected in the following situations:
  - When the battery level is low
  - When movie recording is started in short movie show mode

### Security Settings

If no security settings (encryption and password) are configured for the camera's Wi-Fi function, unauthorized third parties may access the network and cause harm. We strongly recommend performing the required security settings before using the Wi-Fi function.

Use **Options** in the Wi-Fi options menu (103) to perform the security settings.

# Preselecting Images in the Camera That You Want to Transfer to a Smart Device

You can preselect images in the camera that you want to transfer to a smart device. Movies cannot be preselected for transfer.

## 1 Select images to transfer.

You can preselect the images to transfer to a smart device in the following menus:

- **Mark for Wi-Fi upload** in the playback menu (📖90)
- **Upload from camera** in the Wi-Fi options menu (📖103)

When using **Upload from camera**, the SSID and password of the camera are displayed after images are selected.

## 2 Connect the camera and smart device (📖117).

Tap “View Photos” on the displayed confirmation screen to transfer the specified images to the smart device.

### **Preselecting Images to Transfer During Playback**

While the camera is in playback mode, press the (📶) (Wi-Fi) button or use the NFC function to establish a Wi-Fi connection, and preselect the displayed images that you want to transfer.

- In full-frame playback mode, you can add one image at a time. When a key picture is selected, all images in that sequence are added.
- In thumbnail playback mode, you can add one image that is selected by the cursor.
- In calendar display mode, you can add all images that were captured on the selected date.

This operation is not available when you use **Connect to smart device** in the Wi-Fi options menu to establish the Wi-Fi connection.

# Connecting the Camera to a TV, Printer, or Computer

You can enhance your enjoyment of images and movies by connecting the camera to a TV, printer, or computer.

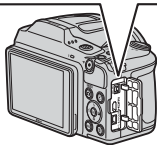
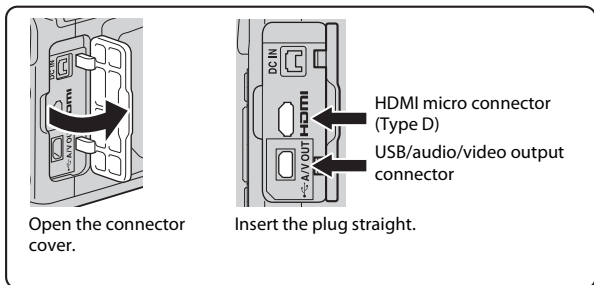

- Before connecting the camera to an external device, make sure the remaining battery level is sufficient and turn the camera off. Before disconnecting, make sure to turn the camera off.
- If the AC Adapter EH-67 (available separately) is used, this camera can be powered from an electrical outlet. Do not use any other make or model of AC adapter as it may cause the camera to heat up or malfunction.
- For information about the connection methods and subsequent operations, refer to the documentation included with the device in addition to this document.

**Viewing images on a TV**

📖 122



Images and movies captured with the camera can be viewed on a TV.

Connection method: Connect the video and audio plugs of the optional audio video cable to the TV's input jacks. Alternatively, connect a commercially available HDMI cable to the TV's HDMI input jack.

**Printing images without using a computer**

📖 124



If you connect the camera to a PictBridge-compatible printer, you can print images without using a computer.

Connection method: Connect the camera directly to the printer's USB port with the included USB cable.

**Viewing and organizing images on a computer**

📖 128



You can transfer images to a computer to perform simple retouching and manage image data.

Connection method: Connect the camera to the computer's USB port with the USB cable.

- Before connecting to a computer, install ViewNX 2 on the computer (📖 128).

# Connecting the Camera to a TV (Playback on a TV)

## 1 Turn off the camera and connect it to the TV.

- Make sure that the plugs are properly oriented. Do not insert or remove the plugs at an angle when connecting or disconnecting them.

### When using the audio/video cable

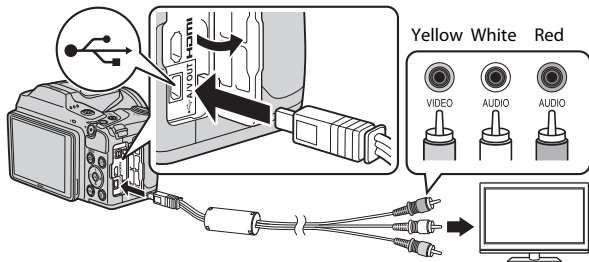

### When using a commercially available HDMI cable

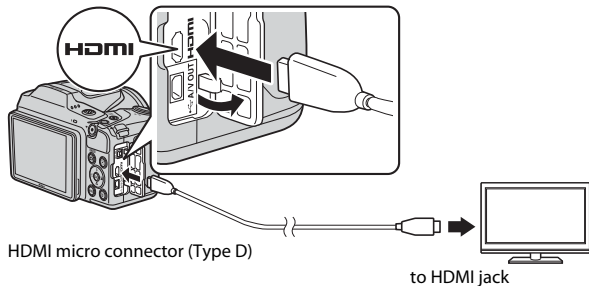

## 2 Set the TV's input to external input.

- See the documentation provided with your TV for details.

---

### 3 Hold down the (playback) button to turn on the camera.

- Images are displayed on the TV.
- The camera monitor does not turn on.

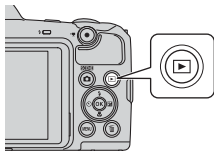

#### **Image Resolution During TV Output**

The option best suited to the TV to which the camera is connected is automatically selected from 1080i, 720p, or 480p.

#### **HDMI**

HDMI (High-Definition Multimedia Interface) is a multimedia interface.

# Connecting the Camera to a Printer (Direct Print)

Users of PictBridge-compatible printers can connect the camera directly to the printer and print images without using a computer.

## Connecting the Camera to a Printer

- 1 Turn on the printer.
- 2 Turn off the camera and connect it to the printer using the USB cable.
  - Make sure that the plugs are properly oriented. Do not insert or remove the plugs at an angle when connecting or disconnecting them.

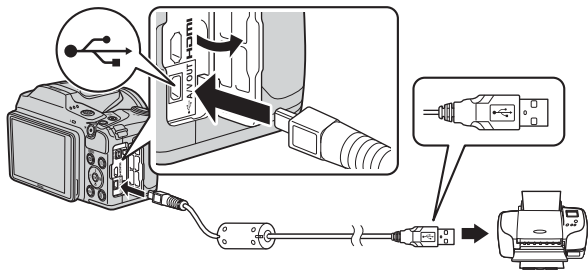

- 3 Turn on the camera.
  - The **PictBridge** startup screen (①) is displayed in the camera monitor, followed by the **Print selection** screen (②).

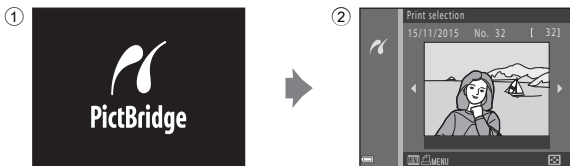



## Printing Images One at a Time

- 1 Use the multi selector ◀▶ to select the desired image and press the **OK** button.

- Move the zoom control toward **W** (📐) to switch to thumbnail playback or **T** (🔍) to switch to full-frame playback.

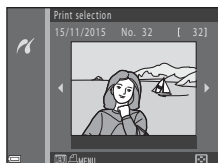

- 2 Use ▲▼ to select **Copies** and press the **OK** button.

- Use ▲▼ to set the desired number of copies (up to nine) and press the **OK** button.

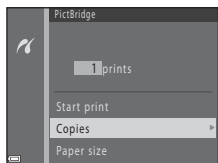

- 3 Select **Paper size** and press the **OK** button.

- Select the desired paper size and press the **OK** button.
- To print with the paper size setting configured on the printer, select **Default**.
- The paper size options available on the camera vary depending on the printer that you use.

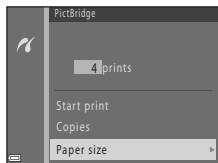

- 4 Select **Start print** and press the **OK** button.

- Printing starts.

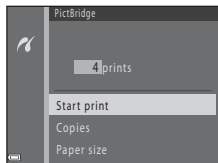

## Printing Multiple Images

- 1 When the **Print selection** screen is displayed, press the **MENU** (menu) button.



- 2 Use the multi selector ▲▼ to select **Paper size** and press the **OK** button.

- Select the desired paper size and press the **OK** button.
- To print with the paper size setting configured on the printer, select **Default**.
- The paper size options available on the camera vary depending on the printer that you use.
- To exit the print menu, press the **MENU** button.

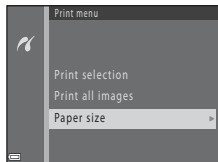

- 3 Select **Print selection** or **Print all images** and press the **OK** button.

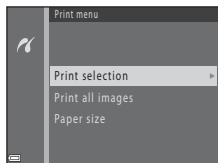

## Print selection

Select images (up to 99) and the number of copies (up to 9) of each.

- Use the multi selector ◀▶ to select images, and use ▲▼ to specify the number of copies to be printed.
- Images selected for printing are indicated by 📄 and the number of copies to be printed. To cancel the print selection, set the number of copies to 0.
- Move the zoom control toward **T** (📷) to switch to full-frame playback or **W** (📱) to switch to thumbnail playback.
- Press the **OK** button when setting is complete. When the screen for confirming the number of print copies is displayed, select **Start print** and press the **OK** button to start printing.



## Print all images

One copy each of all images saved in the internal memory, or on the memory card, is printed.

- When the screen for confirming the number of print copies is displayed, select **Start print** and press the **OK** button to start printing.

# Using ViewNX 2 (Transferring Images to a Computer)

## Installing ViewNX 2

ViewNX 2 is free software that enables you to transfer images and movies to your computer so that you can view, edit, or share them. To install ViewNX 2, download the ViewNX 2 installer from the website below and follow the on-screen installation instructions.

<http://nikonimglib.com/nvnx/>

For system requirements and other information, see the Nikon website for your region.

## Transferring Images to a Computer

### 1 Prepare a memory card that contains images.

You can use any of the methods below to transfer images from the memory card to a computer.

- **SD memory card slot/card reader:** Insert the memory card into the card slot of your computer or the card reader (commercially available) that is connected to the computer.
- **Direct USB connection:** Turn the camera off and ensure that the memory card is inserted in the camera. Connect the camera to the computer using the USB cable. Turn the camera on.

To transfer images that are saved in the camera's internal memory, remove the memory card from the camera before connecting it to the computer.

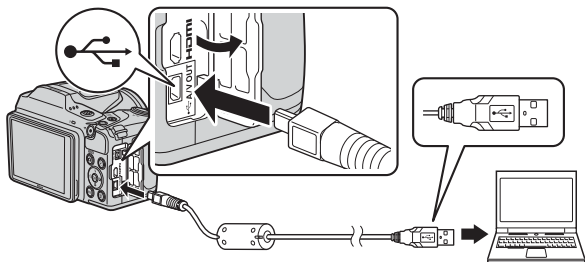

If a message is displayed prompting you to choose a program, select Nikon Transfer 2.

### • When using Windows 7

If the dialog shown at right is displayed, follow the steps below to select Nikon Transfer 2.

- 1 Under **Import pictures and videos**, click **Change program**.

A program selection dialog will be displayed; select **Import File using Nikon Transfer 2** and click **OK**.

- 2 Double-click **Import File**.



If the memory card contains a large number of images, it may take a while for Nikon Transfer 2 to start. Wait until Nikon Transfer 2 starts.

## ✓ Notes About Connecting the USB Cable

Operation is not guaranteed if the camera is connected to the computer via a USB hub.

## 2 After Nikon Transfer 2 starts, click **Start Transfer**.

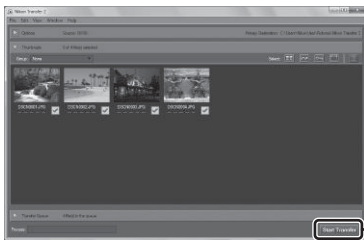

- Image transfer begins. When image transfer is complete, ViewNX 2 starts and the transferred images are displayed.
- Consult online help for more information on using ViewNX 2.

## 3 Terminate the connection.

- If you are using a card reader or card slot, choose the appropriate option in the computer operating system to eject the removable disk corresponding to the memory card and then remove the memory card from the card reader or card slot.
- If the camera is connected to the computer, turn the camera off and disconnect the USB cable.

# Technical Notes

Caring for the Product .....	131
The Camera.....	131
Batteries .....	132
Memory Cards.....	133
Cleaning and Storage .....	134
Cleaning.....	134
Storage .....	134
Error Messages .....	135
Troubleshooting .....	138
File Names .....	144
Optional Accessories.....	145
Specifications.....	146
Approved Memory Cards .....	150
Index.....	152

## Caring for the Product

Observe the precautions described below in addition to the warnings in “For Your Safety” (v–vii) when using or storing the device.

### The Camera

#### Do Not Apply Strong Impact to the Camera

The product may malfunction if subjected to strong shock or vibration. In addition, do not touch or apply force to the lens.

#### Keep Dry

The device will be damaged if immersed in water or subjected to high humidity.

#### Avoid Sudden Changes in Temperature

Sudden changes in temperature, such as when entering or leaving a heated building on a cold day, can cause condensation to form inside the device. To prevent condensation, place the device in a carrying case or a plastic bag before exposing it to sudden changes in temperature.

#### Keep Away from Strong Magnetic Fields

Do not use or store this device in the vicinity of equipment that generates strong electromagnetic radiation or magnetic fields. Doing so could result in loss of data or camera malfunction.

#### Do Not Point the Lens at Strong Light Sources for Extended Periods

Avoid pointing the lens at the sun or other strong light sources for extended periods when using or storing the camera. Intense light may cause the image sensor to deteriorate or produce a white blur effect in photographs.

#### Turn the Product Off Before Removing or Disconnecting the Power Source or Memory Card

Do not remove the batteries while the product is on, or while images are being saved or deleted. Forcibly cutting power in these circumstances could result in loss of data or in damage to product memory or internal circuitry.

#### Notes About the Monitor

- Monitors and electronic viewfinders are constructed with extremely high precision; at least 99.99% of pixels are effective, with no more than 0.01% being missing or defective. Hence while these displays may contain pixels that are always lit (white, red, blue, or green) or always off (black), this is not a malfunction and has no effect on images recorded with the device.
- Images in the monitor may be difficult to see under bright lighting.
- Do not apply pressure to the monitor, as this could cause damage or malfunction. Should the monitor break, care should be taken to avoid injury caused by broken glass and to prevent the liquid crystal from the display touching the skin or entering the eyes or mouth.

# Batteries

## Precautions for Use

- Note that the batteries may become hot after use.
- Do not use batteries beyond their recommended expiration date.
- Do not turn the camera on and off repeatedly if discharged batteries are inserted in the camera.

## Carrying Spare Batteries

We recommend carrying spare batteries depending on where you are shooting. It may be difficult to purchase batteries in certain areas.

## Charging Batteries

If using optional rechargeable batteries, charge the batteries before taking pictures. Batteries are not fully charged at the time of purchase.

Be sure to read and follow the warnings noted in the operating instructions included with the battery charger.

## Charging Rechargeable Batteries

- Do not mix batteries with different amounts of charge remaining, or batteries of a different make or model.
- When using EN-MH2 batteries with this camera, charge four batteries at a time using Battery Charger MH-73. Use only Battery Charger MH-73 to charge EN-MH2 batteries.
- When using Battery Charger MH-73, only charge EN-MH2 batteries.
- EN-MH1 rechargeable Ni-MH batteries cannot be used.

## Notes About Rechargeable Ni-MH Batteries

- If you repeatedly charge rechargeable Ni-MH batteries while they still have some charge remaining, the message **Battery exhausted.** may be displayed prematurely when using the batteries. This is due to the “memory effect,” in which the amount of charge the batteries can hold decreases temporarily. Use the batteries until there is no charge remaining and they will return to their normal behavior.
- Rechargeable Ni-MH batteries discharge even when not being used. We recommend charging the batteries just before using them.

## Using the Batteries When Cold

On cold days, the capacity of batteries tends to decrease. If exhausted batteries are used at a low temperature, the camera may not turn on. Keep spare batteries in a warm place and exchange as necessary. Once warmed, cold batteries may recover some of their charge.

## Battery Terminals

Dirt on the battery terminals may prevent the camera from functioning. Should the battery terminals become dirty, wipe them off with a clean, dry cloth before use.

## Remaining Battery Charge

If you insert discharged batteries into the camera, the camera may indicate that the batteries have adequate charge remaining. This is a characteristic of batteries.



## Recycling Used Batteries

Replace the batteries when they no longer hold a charge. Used batteries are a valuable resource. Please recycle used batteries in accordance with local regulations.

## Memory Cards

### Precautions for Use

- Use only Secure Digital memory cards. See “Approved Memory Cards” (📖150) for recommended memory cards.
- Be sure to follow the precautions described in the documentation included with the memory card.
- Do not put labels or stickers on memory cards.

### Formatting

- Do not format the memory card using a computer.
- The first time you insert a memory card that has been used in another device into this camera, be sure to format it with this camera.  
We recommend formatting new memory cards with this camera before using them with this camera.
- **Note that formatting a memory card permanently deletes all images and other data on the memory card.** Be sure to make copies of any images you wish to keep before formatting the memory card.
- If the message **Card is not formatted. Format card?** is displayed when the camera is turned on, the memory card must be formatted. If there is data that you do not want to delete, select **No**. Copy the necessary data to a computer, etc. If you want to format the memory card, select **Yes**. The confirmation dialog will be displayed. To start formatting, press the **OK** button.
- Do not perform the following during formatting, while data is being written to or deleted from the memory card, or during data transfer to a computer. Failure to observe this precaution could result in the loss of data or in damage to the camera or memory card:
  - Open the battery-chamber/memory card slot cover to remove/insert the batteries or memory card.
  - Turn off the camera.
  - Disconnect the AC adapter.

# Cleaning and Storage

## Cleaning

Do not use alcohol, thinner, or other volatile chemicals.

Lens	Avoid touching glass parts with your fingers. Remove dust or lint with a blower (typically a small device with a rubber bulb attached to one end that is pumped to produce a stream of air out the other end). To remove fingerprints or other stains that cannot be removed with a blower, wipe the lens with a soft cloth, using a spiral motion that starts at the center of the lens and working toward the edges. If this fails, clean the lens using a cloth lightly dampened with commercial lens cleaner.
Monitor	Remove dust or lint with a blower. To remove fingerprints and other stains, clean the monitor with a soft, dry cloth, being careful not to apply pressure.
Body	Use a blower to remove dust, dirt, or sand, then wipe gently with a soft, dry cloth. After using the camera at the beach or other sandy or dusty environment, wipe off any sand, dust, or salt with a dry cloth lightly dampened with fresh water and dry thoroughly. <b>Note that foreign matter inside the camera could cause damage not covered by the warranty.</b>



## Storage



Remove the batteries if the camera will not be used for an extended period. To prevent mold or mildew, take the camera out of storage at least once a month. Turn the camera on and release the shutter a few times before putting the camera away again. Do not store the camera in any of the following locations:









- Places that are poorly ventilated or subject to humidity of over 60%
- Exposed to temperatures above 50°C (122°F) or below -10°C (14°F)
- Next to equipment that produces strong electromagnetic fields, such as televisions or radios

## Error Messages

Refer to the table below if an error message is displayed.

Display	Cause/Solution	
Battery temperature is elevated. The camera will turn off.	The camera turns off automatically. Wait until the temperature has cooled before resuming use.	-
The camera will turn off to prevent overheating.		
Memory card is write protected.	The write-protect switch is in the "lock" position. Slide the write-protect switch to the "write" position.	-
This card cannot be used.	An error occurred while accessing the memory card. <ul style="list-style-type: none"> <li>• Use an approved memory card.</li> <li>• Check that the terminals are clean.</li> <li>• Confirm that the memory card is correctly inserted.</li> </ul>	7, 150
This card cannot be read.		
Card is not formatted. Format card?	The memory card has not been formatted for use in the camera. Formatting deletes all data saved on the memory card. If you need to keep copies of any images, make sure to select <b>No</b> and save the copies to a computer or other medium before formatting the memory card. Select <b>Yes</b> and press the  button to format the memory card.	133
Out of memory.	Delete images or insert a new memory card.	7, 18
Image cannot be saved.	An error occurred while saving the image. Insert a new memory card or format the memory card or internal memory.	113
	The camera has run out of file numbers. Insert a new memory card or format the memory card or internal memory.	113
	There is insufficient space to save the copy. Delete images from the destination.	18
Image cannot be modified.	Check that the images can be edited.	62, 142

Display	Cause/Solution	
Cannot record movie.	A time-out error occurred while saving the movie on the memory card. Select a memory card with a faster write speed.	69, 150
Memory contains no images.	There are no images in the internal memory or on the memory card. <ul style="list-style-type: none"> <li>Remove the memory card to play back images in the internal memory.</li> <li>To copy the images saved in the camera's internal memory to the memory card, press the <b>MENU</b> button to select <b>Copy</b> in the playback menu.</li> </ul>	8 93
File contains no image data.	The file was not created or edited with this camera. The file cannot be viewed on this camera. View the file using a computer or the device used to create or edit this file.	–
All images are hidden.	There are no images available for a slide show, etc.	91
This image cannot be deleted.	The image is protected. Disable protection.	92
No access.	The camera could not receive the signal from the smart device. Establish the wireless connection again. <ul style="list-style-type: none"> <li>Press the  (Wi-Fi) button.</li> <li>Touch an NFC-compatible smart device to the camera.</li> <li>Select <b>Connect to smart device</b> in the Wi-Fi options menu.</li> </ul>	103, 117
Could not connect.	The camera failed to establish the connection while receiving the signals from the smart device. Set a different channel in <b>Channel</b> under <b>Options</b> in the Wi-Fi options menu, and establish the wireless connection again.	103, 117
Wi-Fi connection terminated.	The Wi-Fi connection is terminated in the following situations: <ul style="list-style-type: none"> <li>The signal strength is poor.</li> <li>The battery level is low.</li> <li>A cable or memory card was inserted or removed.</li> </ul> Use batteries with a sufficient amount of charge remaining, disconnect the TV, computer, or printer, and then establish the wireless connection again.	103, 117
Raise the flash.	The flash is lowered. Raise the flash when shooting in <b>Night portrait</b> or <b>Backlighting</b> (when <b>HDR</b> is set to <b>OFF</b> ) scene mode.	24, 26, 43

Display	Cause/Solution	
Lens error. Try again after turning the camera off and on.	Remove the lens cap. If the error persists, contact your retailer or Nikon-authorized service representative.	6, 138
Communications error	An error occurred while communicating with the printer. Turn the camera off and reconnect the USB cable.	124
System error	An error occurred in the camera's internal circuitry. Turn the camera off, remove and reinsert the batteries, and turn the camera on. If the error persists, contact your retailer or Nikon-authorized service representative.	138
Printer error: check printer status.	After solving the problem, select <b>Resume</b> and press the  button to resume printing.*	–
Printer error: check paper.	Load the specified size of paper, select <b>Resume</b> , and press the  button to resume printing.*	–
Printer error: paper jam.	Remove the jammed paper, select <b>Resume</b> , and press the  button to resume printing.*	–
Printer error: out of paper.	Load the specified size of paper, select <b>Resume</b> , and press the  button to resume printing.*	–
Printer error: check ink.	There is a problem with the printer's ink. Check the ink, select <b>Resume</b> , and press the  button to resume printing.*	–
Printer error: out of ink.	Replace the ink cartridge, select <b>Resume</b> , and press the  button to resume printing.*	–
Printer error: file corrupt.	There is a problem with the image file to be printed. Select <b>Cancel</b> and press the  button to cancel printing.	–



\* See the documentation provided with your printer for further guidance and information.

# Troubleshooting



If the camera fails to function as expected, check the list of common problems below before consulting your retailer or Nikon-authorized service representative.

## Power, Display, Settings Issues

Problem	Cause/Solution	
The camera is on but does not respond.	Wait for recording to end. If the problem persists, turn the camera off. If the camera does not turn off, remove and reinsert the battery or batteries or, if you are using an AC adapter, disconnect and reconnect the AC adapter. Note that although any data currently being recorded will be lost, data that have already been recorded will not be affected by removing or disconnecting the power source.	–
The camera cannot be turned on.	The batteries are exhausted.	7, 132
The camera turns off without warning.	<ul style="list-style-type: none"><li>• The camera automatically turns off to save power (auto off function).</li><li>• The camera and batteries may not work properly at low temperatures.</li><li>• The inside of the camera has become hot. Leave the camera off until the inside of the camera has cooled, and then try turning it on again.</li></ul>	13 132 –
The monitor is blank.	<ul style="list-style-type: none"><li>• The camera is off.</li><li>• The camera automatically turns off to save power (auto off function).</li><li>• The flash lamp flashes while the flash is charging. Wait until charging is complete.</li><li>• The camera is connected to a TV or computer.</li><li>• The camera and smart device are connected using a Wi-Fi connection and the camera is being operated by remote control.</li></ul>	9 13 – – –
The camera becomes hot.	The camera may become hot when used for an extended period of time to shoot movies or when used in a hot environment; this is not a malfunction.	–
The monitor is hard to read.	<ul style="list-style-type: none"><li>• Adjust the monitor brightness.</li><li>• The monitor is dirty. Clean the monitor.</li></ul>	107 134





Problem	Cause/Solution	
 flashes on the screen.  Date and time of recording are not correct.	<ul style="list-style-type: none"> <li>If the camera clock has not been set,  flashes on the shooting screen, and images and movies saved before the clock is set are dated "00/00/0000 00:00" and "01/01/2015 00:00" respectively. Set the correct time and date for <b>Time zone and date</b> in the setup menu.</li> <li>The camera clock is not as accurate as ordinary watches or clocks. Periodically compare the time of the camera clock with that of a more accurate timepiece, and reset as required.</li> </ul>	3, 105
No indicators displayed in monitor.	<b>Hide info</b> is selected for <b>Photo info</b> in <b>Monitor settings</b> in the setup menu.	107
<b>Date stamp</b> not available.	<b>Time zone and date</b> has not been set in the setup menu.	105
Date not stamped on images even when <b>Date stamp</b> is enabled.	<ul style="list-style-type: none"> <li>The current shooting mode does not support <b>Date stamp</b>.</li> <li>The date cannot be stamped on movies.</li> </ul>	109
Screen for setting time zone and date is displayed when the camera is turned on.	The clock battery is exhausted; all settings were restored to their default values.	9, 11
The camera settings reset.		
The camera makes sound.	When <b>Autofocus mode</b> is set to <b>Full-time AF</b> or while in some shooting modes, the camera may produce an audible focusing sound.	20, 100

## Shooting Issues

Problem	Cause/Solution	
Cannot switch to shooting mode.	Disconnect the HDMI cable or USB cable.	120
Cannot take pictures or record movies.	<ul style="list-style-type: none"> <li>When the camera is in playback mode, press the  button, shutter-release button, or  button.</li> <li>When menus are displayed, press the <b>MENU</b> button.</li> <li>The flash is charging while the flash lamp is flashing.</li> <li>The batteries are exhausted.</li> </ul>	1, 17 75 44 7, 132

Problem	Cause/Solution	
The camera cannot focus.	<ul style="list-style-type: none"> <li>The subject is too close. Try shooting using scene auto selector mode, <b>Close-up</b> scene mode, or macro mode.</li> <li>The subject is hard to focus on.</li> <li>Set <b>AF assist</b> in the setup menu to <b>Auto</b>.</li> <li>Turn the camera off and then on again.</li> </ul>	20, 21, 22, 25, 46, 53, 110, –
Images are blurred.	<ul style="list-style-type: none"> <li>Use the flash.</li> <li>Increase the ISO sensitivity value.</li> <li>Enable <b>Photo VR</b> when shooting still images. Enable <b>Movie VR</b> when recording movies.</li> <li>Use a tripod to stabilize the camera (using the self-timer at the same time is more effective).</li> </ul>	43, 83, 101, 110, 45
Bright specks appear in images captured with flash.	The flash is reflecting off particles in the air. Lower the flash.	11, 43
Flash does not fire.	<ul style="list-style-type: none"> <li>The flash is lowered.</li> <li>A scene mode that restricts the flash is selected.</li> <li>A function that restricts the flash is enabled.</li> </ul>	11, 43, 48, 55
Digital zoom cannot be used.	<ul style="list-style-type: none"> <li><b>Digital zoom</b> is set to <b>Off</b> in the setup menu.</li> <li>Digital zoom cannot be used with certain shooting modes or when using certain settings in other functions.</li> </ul>	111, 56, 111
<b>Image mode</b> not available.	A function that restricts <b>Image mode</b> is enabled.	55
No sound when the shutter is released.	<ul style="list-style-type: none"> <li><b>Off</b> is selected for <b>Shutter sound</b> in <b>Sound settings</b> in the setup menu. No sound is produced with some shooting modes and settings, even when <b>On</b> is selected.</li> <li>Do not block the speaker.</li> </ul>	111, 1
AF-assist illuminator does not light.	<b>Off</b> is selected for <b>AF assist</b> in the setup menu. The AF-assist illuminator may not light depending on the position of the focus area or the shooting mode, even when <b>Auto</b> is selected.	110



Problem	Cause/Solution	
Images appear smeared.	The lens is dirty. Clean the lens.	134
Colors are unnatural.	White balance or hue is not adjusted properly.	25, 79
Randomly spaced bright pixels ("noise") appear in image.	The subject is dark and the shutter speed is too slow, or ISO sensitivity is too high. Noise can be reduced by: <ul style="list-style-type: none"> <li>Using the flash</li> <li>Specifying a lower ISO sensitivity setting</li> </ul>	43 83
Images are too dark (underexposed).	<ul style="list-style-type: none"> <li>The flash is lowered or a shooting mode that restricts the flash is selected.</li> <li>The flash window is blocked.</li> <li>The subject is beyond the range of the flash.</li> <li>Adjust exposure compensation.</li> <li>Increase ISO sensitivity.</li> <li>The subject is backlit. Select <b>Backlighting</b> scene mode or raise the flash and set the flash mode setting to  (fill flash).</li> </ul>	11, 43, 48 12 147 47 83 26, 43
Images are too bright (overexposed).	Adjust exposure compensation.	47
Unexpected results when flash set to  (auto with red-eye reduction).	Use any scene mode other than <b>Night portrait</b> , and change the flash mode to any setting other than  (auto with red-eye reduction) and try taking the picture again.	43, 48
Skin tones are not softened.	<ul style="list-style-type: none"> <li>In some shooting conditions, facial skin tones may not be softened.</li> <li>For images containing four or more faces, try using the <b>Skin softening</b> effect in <b>Glamour retouch</b> in the playback menu.</li> </ul>	51 65
Saving images takes time.	It may take more time to save images in the following situations: <ul style="list-style-type: none"> <li>When the noise reduction function is in operation, such as when shooting in a dark environment</li> <li>When the flash mode is set to  (auto with red-eye reduction)</li> <li>When shooting in <b>Night portrait</b>, <b>Night landscape</b>, or <b>Backlighting</b> (when <b>HDR</b> is set to <b>ON</b>) scene mode</li> <li>When the skin softening function is applied while shooting</li> <li>When using continuous shooting mode</li> </ul>	– 44 24, 25, 26 34, 51 81

## Playback Issues

Problem	Cause/Solution	
File cannot be played back.	<ul style="list-style-type: none"> <li>• This camera may not be able to play back images saved with another make or model of digital camera.</li> <li>• This camera cannot play back movies recorded with another make or model of digital camera.</li> <li>• This camera may not be able to play back data edited on a computer.</li> </ul>	–
Cannot zoom in on image.	<ul style="list-style-type: none"> <li>• Playback zoom cannot be used with movies.</li> <li>• When viewing small images, the playback zoom ratio that is displayed may not match the actual image zoom ratio.</li> <li>• This camera may not be able to zoom in on images captured with another make or model of digital camera.</li> </ul>	–
Cannot edit images.	<ul style="list-style-type: none"> <li>• Some images cannot be edited. Images that have already been edited may not be edited again.</li> <li>• There is not enough free space on the memory card or in the internal memory.</li> <li>• This camera is unable to edit images captured with other cameras.</li> <li>• Editing functions used for images are not available for movies.</li> </ul>	31, 62 – – –
Cannot rotate image.	This camera cannot rotate images captured with another make or model of digital camera.	–
Images are not displayed on TV.	<ul style="list-style-type: none"> <li>• A computer or printer is connected to the camera.</li> <li>• The memory card contains no images.</li> <li>• Remove the memory card to play back images in the internal memory.</li> </ul>	– – 8
Nikon Transfer 2 does not start when the camera is connected to a computer.	<ul style="list-style-type: none"> <li>• The camera is off.</li> <li>• The batteries are exhausted.</li> <li>• The USB cable is not correctly connected.</li> <li>• The camera is not recognized by the computer.</li> <li>• The computer is not set to start Nikon Transfer 2 automatically. For more information about Nikon Transfer 2, refer to help information contained in ViewNX 2.</li> </ul>	– 120 120, 128 – –

Problem	Cause/Solution	
Images to be printed are not displayed.	<ul style="list-style-type: none"> <li>• The memory card contains no images.</li> <li>• Remove the memory card to print images in the internal memory.</li> </ul>	– 8
Cannot select paper size with the camera.	<p>The camera cannot be used to select the paper size in the following situations, even when printing from a PictBridge-compatible printer. Use the printer to select the paper size.</p> <ul style="list-style-type: none"> <li>• The printer does not support the paper sizes specified by the camera.</li> <li>• The printer automatically selects the paper size.</li> </ul>	–

## File Names

Images or movies are assigned file names as follows.

**File name:** DSCN0001.JPG

(1) (2) (3)

(1) Identifier	Not shown on the screen of the camera. <ul style="list-style-type: none"><li>• DSCN: Original still images, movies, still images created by editing movies</li><li>• SSCN: Small picture copies</li><li>• RSCN: Cropped copies</li><li>• FSCN: Images created by an image editing function other than crop and small picture, movies created by the movie editing function</li></ul>
(2) File number	Assigned in ascending order, starting with "0001" and ending with "9999."
(3) Extension	Indicates file format. <ul style="list-style-type: none"><li>• .JPG: Still images</li><li>• .MOV: Movies</li></ul>

## Optional Accessories

Battery charger, rechargeable batteries*	<ul style="list-style-type: none"><li>• <b>Battery Charger MH-73</b> (includes four EN-MH2 rechargeable Ni-MH batteries)</li><li>• Replacement rechargeable batteries: Rechargeable Ni-MH batteries EN-MH2-B4 (set of four EN-MH2 batteries)</li></ul>
AC adapter	<b>AC Adapter EH-67</b>
Audio/video cable	<b>Audio Video Cable EG-CP16</b>
Hand strap	<b>Hand Strap AH-CP1</b>

\* When using EN-MH2 rechargeable Ni-MH batteries with the camera, charge the batteries four at a time using Battery Charger MH-73. Also, do not charge batteries at the same time if they have different amounts of charge remaining (📖132). EN-MH1 rechargeable Ni-MH batteries cannot be used.

Availability may vary with country or region.

See our website or brochures for the latest information.

# Specifications

## Nikon COOLPIX L840 Digital Camera

Type	Compact digital camera
Number of effective pixels	16.0 million (Image processing may reduce the number of effective pixels.)
Image sensor	$\frac{1}{2.3}$ -in. type CMOS; approx. 16.76 million total pixels
Lens	NIKKOR lens with 38x optical zoom
Focal length	4.0–152 mm (angle of view equivalent to that of 22.5–855 mm lens in 35mm [135] format)
f/-number	f/3–6.5
Construction	12 elements in 9 groups (3 ED lens elements)
Digital zoom magnification	Up to 4x (angle of view equivalent to that of approx. 3420 mm lens in 35mm [135] format)
Vibration reduction	Lens shift (still images) Lens shift and electronic VR (movies)
Autofocus (AF)	Contrast-detect AF
Focus range	<ul style="list-style-type: none"><li>• [W]: Approx. 30 cm (1 ft)–<math>\infty</math>,</li><li>  [T]: Approx. 3.5 m (11 ft)–<math>\infty</math></li><li>• Macro mode: Approx. 1 cm (0.4 in.)–<math>\infty</math> (wide-angle position)</li></ul> (All distances measured from center of front surface of lens)
Focus-area selection	Face priority, manual with 99 focus areas, center, subject tracking, target finding AF
Monitor	7.5 cm (3-in.), approx. 921k-dot, wide viewing angle TFT LCD with anti-reflection coating and 5-level brightness adjustment, tiltable approx. 85° downward, approx. 90° upward
Frame coverage (shooting mode)	Approx. 99% horizontal and vertical (compared to actual picture)
Frame coverage (playback mode)	Approx. 99% horizontal and vertical (compared to actual picture)
Storage	
Media	Internal memory (approx. 20 MB), SD/SDHC/SDXC memory card
File system	DCF and Exif 2.3 compliant
File formats	Still images: JPEG Movies: MOV (Video: H.264/MPEG-4 AVC, Audio: LPCM stereo)

Image size (pixels)	<ul style="list-style-type: none"> <li>• 16M (High) [4608 × 3456★]</li> <li>• 16M [4608 × 3456]</li> <li>• 8M [3264 × 2448]</li> <li>• 4M [2272 × 1704]</li> <li>• 2M [1600 × 1200]</li> <li>• VGA [640 × 480]</li> <li>• 16:9 [4608 × 2592]</li> <li>• 1:1 [3456 × 3456]</li> </ul>
ISO sensitivity (Standard output sensitivity)	<ul style="list-style-type: none"> <li>• ISO 125–1600</li> <li>• ISO 3200, 6400 (available when using Auto mode)</li> </ul>
Exposure	
Metering mode	Matrix, center-weighted (digital zoom less than 2×), spot (digital zoom 2× or more)
Exposure control	Programmed auto exposure and exposure compensation (-2.0 – +2.0 EV in steps of 1/3 EV)
Shutter	Mechanical and CMOS electronic shutter
Speed	<ul style="list-style-type: none"> <li>• 1/1500–1 s</li> <li>• 1/4000 s (maximum speed during high-speed continuous shooting)</li> <li>• 4 s (<b>Fireworks show</b> scene mode)</li> </ul>
Aperture	Electronically-controlled ND filter (-2 AV) selection
Range	2 steps (f/3 and f/6 [W])
Self-timer	Can be selected from 10 s and 2 s
Flash	
Range (approx.) (ISO sensitivity: Auto)	[W]: 0.5–6.9 m (1 ft 8 in.–22 ft) [T]: 3.5 m (11 ft)
Flash control	TTL auto flash with monitor preflashes
Interface	
USB connector	Hi-Speed USB <ul style="list-style-type: none"> <li>• Supports Direct Print (PictBridge)</li> <li>• Audio/video output connector (NTSC or PAL can be selected)</li> </ul>
HDMI output connector	HDMI micro connector (Type D)
DC input connector	For AC Adapter EH-67 (available separately)

<b>Wi-Fi (Wireless LAN)</b>	
Standards	IEEE 802.11b/g/n (standard wireless LAN protocol)
Range (line of sight)	Approx. 10 m (10 yd)
Operating frequency	2412–2462 MHz (1-11 channels)
Data rates (actual measured values)	IEEE 802.11b: 5 Mbps IEEE 802.11g: 20 Mbps IEEE 802.11n: 20 Mbps
Security	OPEN/WPA2
Access protocols	Infrastructure
Supported languages	Arabic, Bengali, Bulgarian, Chinese (Simplified and Traditional), Czech, Danish, Dutch, English, Finnish, French, German, Greek, Hindi, Hungarian, Indonesian, Italian, Japanese, Korean, Marathi, Norwegian, Persian, Polish, Portuguese (European and Brazilian), Romanian, Russian, Serbian, Spanish, Swedish, Tamil, Telugu, Thai, Turkish, Ukrainian, Vietnamese
Power sources	<ul style="list-style-type: none"> <li>• Four LR6/L40 (AA-size) alkaline batteries</li> <li>• Four FR6/L91 (AA-size) lithium batteries</li> <li>• Four EN-MH2 rechargeable Ni-MH batteries (available separately)</li> <li>• AC Adapter EH-67 (available separately)</li> </ul>
<b>Battery life<sup>1</sup></b>	
Still images	<ul style="list-style-type: none"> <li>• Approx. 590 shots when using alkaline batteries</li> <li>• Approx. 1240 shots when using lithium batteries</li> <li>• Approx. 740 shots when using EN-MH2 batteries</li> </ul>
Movies (actual battery life for recording) <sup>2</sup>	<ul style="list-style-type: none"> <li>• Approx. 1 h 35 min when using alkaline batteries</li> <li>• Approx. 4 h 30 min when using lithium batteries</li> <li>• Approx. 2 h 30 min when using EN-MH2 batteries</li> </ul>
Tripod socket	1/4 (ISO 1222)
Dimensions (W × H × D)	Approx. 113.5 × 78.3 × 96.0 mm (4.5 × 3.1 × 3.8 in.) (excluding projections)
Weight	Approx. 538 g (1 lb 3.0 oz) (including batteries and memory card)



## Operating environment

Temperature	0°C–40°C (32°F–104°F)
Humidity	85% or less (no condensation)

- Unless otherwise stated, all figures assume fresh LR6/L40 (AA-size) alkaline batteries and an ambient temperature of  $23 \pm 3^{\circ}\text{C}$  ( $73.4 \pm 5.4^{\circ}\text{F}$ ) as specified by the Camera and Imaging Products Association (CIPA).
  - <sup>1</sup> Battery life may vary depending on conditions of use, such as the interval between shots or the length of time that menus and images are displayed. The included batteries are for trial use only. Figures listed for lithium batteries are measured using commercially available FR6/L91 (AA-size) Energizer(R) Ultimate Lithium batteries.
  - <sup>2</sup> Individual movie files cannot exceed 4 GB in size or 29 minutes in length. Recording may end before this limit is reached if camera temperature becomes elevated.
- Nikon will not be held liable for any errors this manual may contain.
  - The appearance of this product and its specifications are subject to change without notice.

## Approved Memory Cards

The following Secure Digital (SD) memory cards have been tested and approved for use in this camera.

- Memory cards with an SD Speed Class rating of 6 or faster are recommended for recording movies. When using a memory card with a lower Speed Class rating, movie recording may stop unexpectedly.

	SD memory card	SDHC memory card	SDXC memory card
SanDisk	–	4 GB, 8 GB, 16 GB, 32 GB	64 GB, 128 GB
TOSHIBA	–	4 GB, 8 GB, 16 GB, 32 GB	64 GB
Panasonic	2 GB	4 GB, 8 GB, 16 GB, 32 GB	64 GB
Lexar	–	8 GB, 16 GB, 32 GB	64 GB, 128 GB

- Contact the manufacturer for details on the above cards. We cannot guarantee camera performance when using memory cards made by other manufacturers.
- If you use a card reader, make sure that it is compatible with your memory card.

## Trademark Information

- Windows is either a registered trademark or trademark of Microsoft Corporation in the United States and/or other countries.
- Adobe, the Adobe logo, and Reader are either trademarks or registered trademarks of Adobe Systems Incorporated in the United States and/or other countries.
- SDXC, SDHC, and SD Logos are trademarks of SD-3C, LLC.



- PictBridge is a trademark.
- HDMI, HDMI logo and High-Definition Multimedia Interface are trademarks or registered trademarks of HDMI Licensing LLC.

## HDMI

- Wi-Fi and the Wi-Fi logo are trademarks or registered trademarks of the Wi-Fi Alliance.
- Android and Google Play are trademarks or registered trademarks of Google, Inc.
- The N-Mark is a trademark or registered trademark of NFC Forum, Inc. in the United States and in other countries.
- All other trade names mentioned in this manual or the other documentation provided with your Nikon product are the trademarks or registered trademarks of their respective holders.

## **AVC Patent Portfolio License**

This product is licensed under the AVC Patent Portfolio License for the personal and non-commercial use of a consumer to (i) encode video in compliance with the AVC standard ("AVC video") and/or (ii) decode AVC video that was encoded by a consumer engaged in a personal and non-commercial activity and/or was obtained from a video provider licensed to provide AVC video. No license is granted or shall be implied for any other use.

Additional information may be obtained from MPEG LA, L.L.C.

See <http://www.mpegla.com>.

## **FreeType License (FreeType2)**

Portions of this software are copyright © 2012 The FreeType Project (<http://www.freetype.org>). All rights reserved.







## **MIT License (HarfBuzz)**









Portions of this software are copyright © 2015 The HarfBuzz Project (<http://www.freedesktop.org/wiki/Software/HarfBuzz>). All rights reserved.





# Index

## Symbols

- T** (Telephoto)..... 14
- W** (Wide-angle)..... 14
- Q** Playback zoom..... 17, 57
- 🖼️** Thumbnail playback..... 17, 58
- SCENE** Scene auto selector mode  
..... 20, 22
- 🌅** Scene mode..... 20, 23
- SOFT** Special effects mode... 20, 32
- 😊** Smart portrait mode..... 20, 34
- 🎬** Short movie show mode... 20, 38
- 📷** Auto mode..... 20, 41
- ▶** Playback mode..... 17
- 📅** List by date mode..... 59
- 📶** Wi-Fi options menu..... 75, 103
- 🔧** Setup menu..... 75, 105
- Ⓞ** Apply selection button..... 2, 75
- 📷** Shooting mode button..... 2, 20
- 🎥** (movie-record) button... 2, 21
- ▶** Playback button..... 2, 17
- 🗑️** Delete button..... 2, 18
- MENU** Menu button..... 2, 75
- ⚡** (flash pop-up) button..... 1, 11, 43
- 📷** (snap-back zoom) button..... 1
- 📶** (Wi-Fi) button..... 1, 117, 119
- ⚡** Flash mode..... 21, 43
- 🕒** Self-timer..... 21, 45
- 🌸** Macro mode..... 21, 46
- ±** Exposure compensation  
..... 21, 34, 42, 47
- ?** Help..... 23
- N** N-Mark..... 1, 117, 119
- A**
- AC adapter..... 145
- AF area mode..... 84
- AF assist..... 110
- AF-assist illuminator..... 1
- Alkaline batteries..... 7
- Aperture value..... 16
- Audio/video cable..... 121, 122, 145
- Audio/video-in jack..... 121, 122
- Auto flash..... 44
- Auto mode..... 20, 41
- Auto off..... 13, 112
- Autofocus..... 53, 100
- Autofocus mode..... 87, 100
- B**
- Background music..... 38
- Backlighting **📷**..... 23, 26
- Battery..... 7, 11
- Battery charger..... 145
- Battery level..... 10
- Battery type..... 114
- Battery-chamber/memory card slot cover..... 2
- Beach **🏖️**..... 23
- Bird-watching **🐦**..... 28
- Blink proof..... 89
- Brightness..... 107
- Button sound..... 111
- C**
- Calendar display..... 58
- Capturing still images while recording movies..... 71
- Close-up **🌸**..... 23, 25
- Compression ratio..... 77
- Computer..... 121, 128
- Conformity marking..... 115
- Connect to smart device... 103, 117
- Connector cover..... 2

- Continuous shooting..... 81
- Copy..... 93
- Creative slider..... 42
- Crop..... 57, 67
- Cross process ..... 32
- Current settings..... 103
- D**
- Date and time..... 9, 105
- Date format..... 9, 105
- Date stamp..... 109
- Daylight saving time..... 9, 106
- DC input connector..... 2
- Delete..... 18, 61
- Digital zoom..... 14, 111
- Direct print..... 121, 124
- Disable Wi-Fi..... 118
- D-Lighting..... 64
- Dusk/dawn ..... 23
- E**
- Easy panorama ..... 23, 29
- Easy panorama playback..... 31
- Editing images..... 62
- Editing movies..... 73
- End recording..... 39
- EN-MH2..... 132, 145
- Exposure compensation  
..... 21, 34, 42, 47
- Extracting still images..... 72, 74
- Eyelet for camera strap..... 1
- E**
- Face detection..... 50
- Face priority..... 84
- File names..... 144
- Fill flash..... 44
- Fireworks show ..... 23, 25
- Firmware version..... 115
- Fixed range auto..... 83
- Flash..... 1, 11, 43
- Flash lamp..... 2, 44
- Flash mode..... 21, 43
- Focus..... 50
- Focus area..... 13
- Focus indicator..... 3
- Focus lock..... 54
- Food ..... 23, 25
- Format internal memory..... 113
- Format memory cards..... 7, 113
- Formatting..... 7, 113
- Foundation makeup..... 34
- Frame rate..... 102
- Full-frame playback..... 17
- Full-time AF..... 100
- G**
- Glamour retouch..... 34, 65
- H**
- HDMI cable..... 121, 122
- HDMI micro connector..... 2, 120
- HDR..... 26
- Help..... 23
- High-contrast monochrome ..... 32
- High-speed continuous..... 81
- Histogram..... 47
- HS movie..... 97, 99
- Hue..... 42
- I**
- Image mode..... 77
- Image review..... 107
- Internal memory..... 8
- Interval..... 88
- ISO sensitivity..... 83
- L**
- Landscape ..... 23
- Language..... 114
- Lens..... 1, 146

List by date mode.....	59	PictBridge .....	121, 124
Lithium batteries .....	7	Playback .....	17, 60, 72
<b>M</b>		Playback menu.....	75, 90
Macro mode.....	21, 46	Playback mode.....	17
Mark for Wi-Fi upload .....	90	Playback zoom .....	17, 57
Memory card.....	7, 133, 150	Pop <b>POP</b> .....	32
Memory card slot.....	7	Portrait  .....	23
Microphone (stereo) .....	1	Power switch/power-on lamp... 1, 9	
Mirror  .....	32	Preset manual.....	80
Monitor.....	2, 3, 16, 134	Pre-shooting cache .....	81, 82
Monitor settings .....	107	Pressing halfway .....	16
Moon  .....	28	Print.....	121, 125, 126
Movie editing .....	74	Printer .....	121, 124
Movie menu .....	75, 96	Protect.....	92
Movie options .....	96	<b>Q</b>	
Movie recording .....	21, 68	Quick effects.....	62
Movie VR.....	101	Quick retouch.....	63
Multi selector .....	2, 75	<b>R</b>	
<b>N</b>		Rechargeable battery.....	145
Night landscape  .....	23, 25	Rechargeable nickel-metal hydride batteries.....	7
Night portrait  .....	23, 24	Recording movies .....	21, 68
Nikon Transfer 2 .....	129	Recording slow motion movies .....	97, 99
Nostalgic sepia <b>SEPIA</b> .....	32	Red-eye correction .....	64
Number of exposures remaining .....	10, 78	Red-eye reduction .....	44
Number of shots.....	38, 88	Remaining movie recording time .....	68, 69
<b>O</b>		Reset all.....	114
Optical zoom .....	14	Restore default settings.....	103
Optional accessories.....	145	Rotate image.....	92
Options.....	103	<b>S</b>	
<b>P</b>		Scene auto selector mode....	20, 22
Paper size .....	125, 126	Scene mode.....	20, 23
Party/indoor  .....	23, 24	SD memory card .....	7, 133, 150
Pet portrait auto release .....	27	Selective color  .....	32
Pet portrait  .....	23, 27	Self-Collage .....	36, 88
Photo info .....	107		
Photo VR.....	110		

- Self-timer ..... 21, 45
- Self-timer lamp ..... 1, 45
- Sequence display options ... 60, 94
- Setup menu ..... 75, 105
- Shooting ..... 12, 20
- Shooting menu ..... 75, 77
- Shooting mode ..... 20
- Short movie show menu ..... 38
- Short movie show mode ..... 20, 38
- Shutter sound ..... 88, 111
- Shutter speed ..... 16
- Shutter-release button ..... 1, 13
- Side zoom control ..... 1, 12, 14
- Single AF ..... 100
- Single-frame shooting ..... 81
- Skin softening ..... 34, 65
- Slide show ..... 91
- Slow sync ..... 44
- Small picture ..... 66
- Smart portrait menu ..... 75, 88
- Smart portrait mode ..... 20, 34
- Smile timer ..... 35
- Snow  ..... 23
- Soft ..... 34
- Soft **SOFT** ..... 32
- Sound settings ..... 111
- Speaker ..... 1
- Special effects ..... 38
- Special effects mode ..... 20, 32
- Sports  ..... 23, 24
- Strap ..... 6
- Subject tracking ..... 85, 86
- Sunset  ..... 23
- I**
- Target finding AF ..... 52, 85
- Telephoto ..... 14
- Thumbnail playback ..... 17, 58
- Time difference ..... 106
- Time zone ..... 9, 105
- Time zone and date ..... 9, 105
- Toy camera effect 1  ..... 32
- Toy camera effect 2  ..... 32
- Tripod socket ..... 2, 148
- TV ..... 121, 122
- U**
- Upload from camera ..... 103
- USB cable ..... 120, 124, 128
- USB/audio/video output connector  
..... 2, 120, 122, 124, 128
- V**
- ViewNX 2 ..... 128
- Vividness ..... 34, 42
- Volume ..... 72
- W**
- White balance ..... 79
- Wide-angle ..... 14
- Wi-Fi disconnection ..... 103
- Wi-Fi options menu ..... 75, 103
- Wind noise reduction ..... 101
- Wireless LAN ..... 116
- Wireless Mobile Utility ..... 116
- Z**
- Zoom ..... 14
- Zoom control ..... 1, 12, 14
- Zoom in ..... 14
- Zoom out ..... 14

No reproduction in any form of this manual, in whole or in part (except for brief quotation in critical articles or reviews), may be made without written authorization from NIKON CORPORATION.

**NIKON CORPORATION**

---

© 2015 Nikon Corporation



CT4L01(11)  
6MN50811-01