

# **Nikon**

DIGITAL CAMERA

# D500

## User's Manual



- Read this manual thoroughly before using the camera.
- To ensure proper use of the camera, be sure to read "For Your Safety" (page xiii).
- After reading this manual, keep it in a readily accessible place for future reference.

En

# SnapBridge

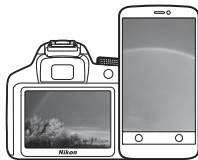

## Your images. The world. Connected

Welcome to SnapBridge — Nikon's new family of services to enrich your image experience. SnapBridge eliminates the barrier between your camera and compatible smart device, through a combination of *Bluetooth*® low energy (BLE) technology and a dedicated app. The stories you capture with your Nikon camera and lenses are automatically transferred to the device as they are taken. They can even be uploaded effortlessly to cloud storage services, inviting access across all your devices. You can share your excitement, when and where you want.

### Download the SnapBridge app to get started!

Take advantage of the wide-ranging convenience by downloading the SnapBridge app onto your smart device now. Through a few simple steps, this app connects your Nikon cameras with a compatible iPhone®, iPad® and/or iPod touch® or smart devices running on the Android™ operating system. SnapBridge is available free of charge from the Apple App Store®, on Google Play™, and from the following website:

<http://snapbridge.nikon.com>

For the latest information on SnapBridge, visit the Nikon website for your area (☎ xxi).



Download on the  
**App Store**



GET IT ON  
**Google Play**

## The exciting image experience that SnapBridge offers...



Automatic picture transfer from camera to smart device thanks to the constant connection between the two devices — making online photo sharing easier than ever

### NIKON IMAGE SPACE



Upload of photos and thumbnail images to the NIKON IMAGE SPACE cloud service

## A range of services that enriches your imaging life, including:

- Camera remote control
- Imprinting up to two pieces of credit information (e.g. copyright, comments, text and logos) on pictures
- Automatic update of camera's date and time info and location info
- Receive camera's firmware updates

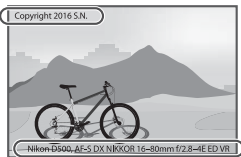

To get the most from your camera, please be sure to read all instructions thoroughly and keep them where they will be read by all who use the product.

## The Menu Guide

For more information on menu options and subjects such as how to connect the camera to a printer or television, download the camera *Menu Guide* from the Nikon website as described below. The *Menu Guide* is in pdf format and can be viewed using Adobe Reader or Adobe Acrobat Reader.

- 1 On your computer, launch a web browser and open the Nikon manual download site at <http://downloadcenter.nikonimglib.com/>
- 2 Navigate to the page for the desired product and download the manual.

### Nikon Manual Viewer 2



Install the Nikon Manual Viewer 2 app on your smartphone or tablet to view Nikon digital camera manuals, anytime, anywhere. Nikon Manual Viewer 2 can be downloaded free of charge from the App Store and on Google Play. Download of the app and any product manuals requires an Internet connection, for which fees may be levied by your phone or Internet service provider.

### For Your Safety

Before using the camera for the first time, read the safety instructions in “For Your Safety” (□ xiii–xvi).



## Symbols and Conventions

To make it easier to find the information you need, the following symbols and conventions are used:



This icon marks cautions; information that should be read before use to prevent damage to the camera.



This icon marks notes; information that should be read before using the camera.



This icon marks references to other pages in this manual.

Menu items, options, and messages displayed in the camera monitor are shown in **bold**.

## Camera Settings

The explanations in this manual assume that default settings are used.

## Nikon User Support for India and Australia

Contact a Nikon representative for technical assistance with the operation of your Nikon product or products. For information on the Nikon representatives in your area, visit <http://www.nikon-asia.com/support>.

## Package Contents

Be sure all items listed here were included with your camera.



*BF-1B body cap* (□ 18, 335)

*D500 digital camera*  
(□ 1)

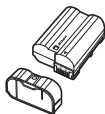

*EN-EL15 rechargeable Li-ion battery with terminal cover*  
(□ 13, 15)



*MH-25a battery charger (comes with either an AC wall adapter or power cable of a type and shape that varies with the country or region of sale; □ 13)*



*USB cable clip*



*HDMI cable clip*

*UC-E22 USB cable*  
 *AN-DC17 strap* (□ 13)

*User's Manual (this guide)*  
 *Warranty*

Purchasers of the lens kit option should confirm that the package also includes a lens. *Memory cards are sold separately.* Cameras purchased in Japan display menus and messages in English and Japanese only; other languages are not supported. We apologize for any inconvenience this may cause.

### **ViewNX-i and Capture NX-D Software**

Use ViewNX-i to fine-tune photos or to copy pictures to a computer for viewing. ViewNX-i is available for download from the following website:

*<http://downloadcenter.nikonimglib.com/>*

Use Capture NX-D to fine-tune pictures that have been copied to a computer and to convert NEF (RAW) images to other formats.

Capture NX-D is available for download from:

*<http://downloadcenter.nikonimglib.com/>*

You can also visit this website for the latest information on Nikon software, including system requirements.

# Table of Contents

Package Contents .....	iv
For Your Safety .....	xiii
Notices.....	xvii
Bluetooth and Wi-Fi (Wireless LAN).....	xxii
<b>Introduction</b> .....	<b>1</b>
<hr/>	
<b>Getting to Know the Camera</b> .....	<b>1</b>
Camera Body .....	1
The Control Panel .....	5
The Viewfinder Display .....	7
Using the Tilting Monitor.....	9
Using the Touch Screen .....	11
<b>First Steps</b> .....	<b>13</b>
<hr/>	
Attach the Camera Strap.....	13
Charge the Battery .....	13
Insert the Battery and a Memory Card .....	15
Attach a Lens.....	18
Camera Setup.....	20
Focus the Viewfinder.....	29
<b>Tutorial</b> .....	<b>30</b>
<hr/>	
<b>Camera Menus</b> .....	<b>30</b>
Using Camera Menus .....	31
<b>Basic Photography and Playback</b> .....	<b>35</b>
The Battery Level and Number of Exposures Remaining.....	35
“Point-and-Shoot” Photography.....	37
Viewing Photographs .....	40

<b>Live View Photography</b>	<b>43</b>
Autofocus .....	47
Manual Focus .....	49
Using the <b>i</b> Button .....	50
The Live View Display.....	53
The Information Display.....	54
Touch Photography (Touch Shutter).....	55
<b>Movies</b>	<b>58</b>
<b>Recording Movies</b> .....	<b>58</b>
Indices.....	63
Using the <b>i</b> Button .....	64
The Live View Display.....	66
Frame Size, Frame Rate, and Movie Quality.....	68
The Information Display.....	69
The Movie Crop .....	70
Taking Photos in Movie Mode .....	71
<b>Time-Lapse Movies</b> .....	<b>74</b>
<b>Viewing Movies</b> .....	<b>80</b>
<b>Editing Movies</b> .....	<b>82</b>
Trimming Movies.....	82
Saving Selected Frames .....	86
<b>Image Recording Options</b>	<b>88</b>
Image Area .....	88
Image Quality.....	91
Image Size.....	94
Using Two Memory Cards.....	96

<b>Focus</b>	<b>97</b>
<b>Autofocus</b> .....	<b>97</b>
Autofocus Mode .....	101
AF-Area Mode.....	103
Focus Point Selection .....	108
Focus Lock .....	111
<b>Manual Focus</b> .....	<b>114</b>
<b>Release Mode</b>	<b>116</b>
<b>Choosing a Release Mode</b> .....	<b>116</b>
<b>Self-Timer Mode</b> .....	<b>119</b>
<b>Mirror up Mode</b> .....	<b>121</b>
<b>ISO Sensitivity</b>	<b>123</b>
<b>Manual Adjustment</b> .....	<b>123</b>
<b>Auto ISO Sensitivity Control</b> .....	<b>125</b>
<b>Exposure</b>	<b>128</b>
<b>Metering</b> .....	<b>128</b>
<b>Exposure Mode</b> .....	<b>130</b>
<b>P: Programmed Auto</b> .....	132
<b>S: Shutter-Priority Auto</b> .....	133
<b>A: Aperture-Priority Auto</b> .....	134
<b>M: Manual</b> .....	135
<b>Long Time-Exposures (M Mode Only)</b> .....	<b>137</b>
<b>Shutter-Speed and Aperture Lock</b> .....	<b>140</b>
<b>Autoexposure (AE) Lock</b> .....	<b>141</b>
<b>Exposure Compensation</b> .....	<b>143</b>
<b>Bracketing</b> .....	<b>146</b>

<b>White Balance</b>	<b>159</b>
<hr/>	
White Balance Options.....	159
Fine-Tuning White Balance .....	163
Choosing a Color Temperature .....	166
Preset Manual .....	169
Viewfinder Photography.....	170
Live View (Spot White Balance) .....	174
Managing Presets .....	177
<b>Image Enhancement</b>	<b>180</b>
<hr/>	
Picture Controls .....	180
Selecting a Picture Control.....	180
Modifying Picture Controls .....	182
Creating Custom Picture Controls.....	185
Preserving Detail in Highlights and Shadows .....	189
Active D-Lighting.....	189
High Dynamic Range (HDR) .....	191
<b>Flash Photography</b>	<b>196</b>
<hr/>	
Using a Flash .....	196
On-Camera Flash Photography .....	199
Flash Modes .....	201
Flash Compensation .....	203
FV Lock .....	205
Remote Flash Photography .....	208
Setup .....	209
Taking Photos .....	214
Viewing Flash Info.....	222

**Other Shooting Options** **226**

---

The <b>info</b> Button .....	226
The <b>i</b> button .....	229
Two-Button Reset: Restoring Default Settings .....	230
Flicker Reduction .....	234
Multiple Exposure .....	236
Interval Timer Photography .....	243
Non-CPU Lenses .....	250
Location Data .....	253

**More About Playback** **255**

---









<b>Viewing Images</b> .....	<b>255</b>
Full-Frame Playback .....	255
Thumbnail Playback.....	255
Playback Controls.....	256
Using the Touch Screen .....	258
The <b>i</b> Button .....	260
<b>Photo Information</b> .....	<b>261</b>
<b>Taking a Closer Look: Playback Zoom</b> .....	<b>271</b>
<b>Protecting Photographs from Deletion</b> .....	<b>273</b>
<b>Rating Pictures</b> .....	<b>274</b>
<b>Selecting Photos for Upload</b> .....	<b>276</b>
Selecting Individual Photos.....	276
Selecting Multiple Photos .....	277
<b>Deleting Photographs</b> .....	<b>278</b>
Full-Frame and Thumbnail Playback.....	278
The Playback Menu .....	279



## Menu List

281

---

 The Playback Menu: Managing Images .....	281
 The Photo Shooting Menu: Shooting Options.....	283
 The Movie Shooting Menu: Movie Shooting Options ...	288
 Custom Settings: Fine-Tuning Camera Settings .....	292
 The Setup Menu: Camera Setup.....	304
 The Retouch Menu: Creating Retouched Copies .....	313
 My Menu/  Recent Settings .....	315
<b>Retouch Menu Options .....</b>	<b>316</b>
NEF (RAW) Processing.....	316
Trim.....	318
Image Overlay.....	319

## Technical Notes

322

---

Compatible Lenses.....	322
The Nikon Creative Lighting System (CLS).....	328
Other Accessories.....	335
Caring for the Camera .....	337
Storage .....	337
Cleaning .....	337
Image Sensor Cleaning.....	338
Caring for the Camera and Battery: Cautions.....	345

<b>Troubleshooting</b> .....	<b>350</b>
Battery/Display .....	350
Shooting .....	351
Playback.....	354
Bluetooth and Wi-Fi (Wireless Networks) .....	356
Miscellaneous .....	356
<b>Error Messages</b> .....	<b>357</b>
<b>Specifications</b> .....	<b>364</b>
<b>AF-S DX NIKKOR 16–80mm f/2.8–4E ED VR Lenses</b> .....	<b>377</b>
<b>Approved Memory Cards</b> .....	<b>387</b>
<b>Memory Card Capacity</b> .....	<b>389</b>
<b>Battery Life</b> .....	<b>392</b>
<b>Index</b> .....	<b>394</b>

## For Your Safety

To prevent damage to your Nikon product or injury to yourself or to others, read the following safety precautions in their entirety before using this equipment. Keep these safety instructions where all those who use the product will read them.

The consequences that could result from failure to observe the precautions listed in this section are indicated by the following symbol:



This icon marks warnings. To prevent possible injury, read all warnings before using this Nikon product.

### ■ ■ WARNINGS

#### **Keep the sun out of the frame**

Keep the sun well out of the frame when shooting backlit subjects. Sunlight focused into the camera when the sun is in or close to the frame could cause a fire.

#### **Do not look at the sun through the viewfinder**

Viewing the sun or other strong light source through the viewfinder could cause permanent visual impairment.

#### **Using the viewfinder diopter adjustment control**

When operating the viewfinder diopter adjustment control with your eye to the viewfinder, care should be taken not to put your finger in your eye accidentally.

#### **Turn off immediately in the event of malfunction**

Should you notice smoke or an unusual smell coming from the equipment or AC adapter (available separately), unplug the AC adapter and remove the battery immediately, taking care to avoid burns. Continued operation could result in injury. After removing the battery, take the equipment to a Nikon-authorized service center for inspection.

#### **Do not use in the presence of flammable gas**

Do not use electronic equipment in the presence of flammable gas, as this could result in explosion or fire.

#### **Keep out of reach of children**

Failure to observe this precaution could result in injury. In addition, note that small parts constitute a choking hazard. Should a child swallow any part of this equipment, consult a physician immediately.

**⚠ Do not disassemble**

Touching the product's internal parts could result in injury. In the event of malfunction, the product should be repaired only by a qualified technician. Should the product break open as the result of a fall or other accident, remove the battery and/or AC adapter and then take the product to a Nikon-authorized service center for inspection.

**⚠ Do not place the strap around the neck of an infant or child**

Placing the camera strap around the neck of an infant or child could result in strangulation.

**⚠ Do not remain in contact with the camera, battery, or charger for extended periods while the devices are on or in use**

Parts of the device become hot. Leaving the device in direct contact with the skin for extended periods may result in low-temperature burns.

**⚠ Do not leave the product where it will be exposed to extremely high temperatures, such as in an enclosed automobile or in direct sunlight**

Failure to observe this precaution could cause damage or fire.

**⚠ Do not aim a flash at the operator of a motor vehicle**

Failure to observe this precaution could result in accidents.

**⚠ Observe caution when using a flash**

- Using optional flash units in close contact with the skin or other objects could cause burns.
- Using optional flash units close to the subject's eyes could cause temporary visual impairment. The flash should be no less than one meter (3 ft 4 in.) from the subject. Particular care should be observed when photographing infants.

**⚠ Avoid contact with liquid crystal**

Should the monitor break, care should be taken to avoid injury due to broken glass and to prevent the liquid crystal from the monitor touching the skin or entering the eyes or mouth.

**⚠ Do not carry tripods with a lens or camera attached**

You could trip or accidentally strike others, resulting in injury.

**⚠ Observe proper precautions when handling batteries**

Batteries may leak, overheat, rupture, or catch fire if improperly handled. Observe the following precautions when handling batteries for use in this product:

- Use only batteries approved for use in this equipment.
- Do not short or disassemble the battery.
- Do not expose the battery or the camera in which it is inserted to powerful physical shocks.
- Be sure the product is off before replacing the battery. If you are using an AC adapter, be sure it is unplugged.
- Do not attempt to insert the battery upside down or backwards.
- Do not expose the battery to flame or to excessive heat.
- Do not immerse in or expose to water.
- Replace the terminal cover when transporting the battery. Do not transport or store the battery with metal objects such as necklaces or hairpins.
- Batteries are prone to leakage when fully discharged. To avoid damage to the product, be sure to remove the battery when no charge remains.

- When the battery is not in use, attach the terminal cover and store in a cool, dry place.
- The battery may be hot immediately after use or when the product has been used on battery power for an extended period. Before removing the battery turn the camera off and allow the battery to cool.
- Discontinue use immediately should you notice any changes in the battery, such as discoloration or deformation.

**⚠ Observe proper precautions when handling the charger**

- Keep dry. Failure to observe this precaution could result in injury or product malfunction due to fire or electric shock.
- Do not short the charger terminals. Failure to observe this precaution could result in overheating and damage to the charger.
- Dust on or near the metal parts of the plug should be removed with a dry cloth. Continued use could result in fire.

- Do not handle the power cable or go near the charger during thunderstorms. Failure to observe this precaution could result in electric shock.
- Do not damage, modify, or forcibly tug or bend the power cable. Do not place it under heavy objects or expose it to heat or flame. Should the insulation be damaged and the wires become exposed, take the power cable to a Nikon-authorized service representative for inspection. Failure to observe this precaution could result in fire or electric shock.
- Do not handle the plug or charger with wet hands. Failure to observe this precaution could result in injury or product malfunction due to fire or electric shock.
- Do not use with travel converters or adapters designed to convert from one voltage to another or with DC-to-AC inverters. Failure to observe this precaution could damage the product or cause overheating or fire.

 **Use appropriate cables**

When connecting cables to the input and output jacks, use only the cables provided or sold by Nikon for the purpose to maintain compliance with product regulations.

 **Follow the instructions of airline and hospital personnel**

## Notices

- No part of the manuals included with this product may be reproduced, transmitted, transcribed, stored in a retrieval system, or translated into any language in any form, by any means, without Nikon's prior written permission.
- Nikon reserves the right to change the appearance and specifications of the hardware and software described in these manuals at any time and without prior notice.
- Nikon will not be held liable for any damages resulting from the use of this product.
- While every effort has been made to ensure that the information in these manuals is accurate and complete, we would appreciate it were you to bring any errors or omissions to the attention of the Nikon representative in your area (address provided separately).

### Notices for Customers in Canada

CAN ICES-3 B / NMB-3 B

### Notices for Customers in Europe

**CAUTION: RISK OF EXPLOSION IF BATTERY IS REPLACED BY AN INCORRECT TYPE. DISPOSE OF USED BATTERIES ACCORDING TO THE INSTRUCTIONS.**

This symbol indicates that electrical and electronic equipment is to be collected separately.



This symbol on the battery indicates that the battery is to be collected separately.



The following apply only to users in European countries:

- This product is designated for separate collection at an appropriate collection point. Do not dispose of as household waste.
- Separate collection and recycling helps conserve natural resources and prevent negative consequences for human health and the environment that might result from incorrect disposal.
- For more information, contact the retailer or the local authorities in charge of waste management.

The following apply only to users in European countries:

- All batteries, whether marked with this symbol or not, are designated for separate collection at an appropriate collection point. Do not dispose of as household waste.
- For more information, contact the retailer or the local authorities in charge of waste management.

## **Notices for Customers in the U.S.A.**

### **Power Cable**

**At voltages over AC 125 V (U.S.A. only):** The power cable must be rated for the voltage in use, be at least AWG no. 18 gauge, and have SVG insulation or better with a NEMA 6P-15 plug rated for AC 250 V 15 A.

### **Federal Communications Commission (FCC) Radio Frequency Interference Statement**

This equipment has been tested and found to comply with the limits for a Class B digital device, pursuant to Part 15 of the FCC rules. These limits are designed to provide reasonable protection against harmful interference in a residential installation. This equipment generates, uses, and can radiate radio frequency energy and, if not installed and used in accordance with the instructions, may cause harmful interference to radio

communications. However, there is no guarantee that interference will not occur in a particular installation. If this equipment does cause harmful interference to radio or television reception, which can be determined by turning the equipment off and on, the user is encouraged to try to correct the interference by one or more of the following measures:

- Reorient or relocate the receiving antenna.
- Increase the separation between the equipment and receiver.
- Connect the equipment into an outlet on a circuit different from that to which the receiver is connected.
- Consult the dealer or an experienced radio/television technician for help.



**Nikon**  
D500

### **CAUTIONS**

#### ***Modifications***

The FCC requires the user to be notified that any changes or modifications made to this device that are not expressly approved by Nikon Corporation may void the user's authority to operate the equipment.

#### ***Interface Cables***

Use the interface cables sold or provided by Nikon for your equipment. Using other interface cables may exceed the limits of Class B Part 15 of the FCC rules.

Nikon Inc., 1300 Walt Whitman Road,  
Melville, New York 11747-3064, U.S.A.  
Tel.: 631-547-4200



## **Notice Concerning Prohibition of Copying or Reproduction**

Note that simply being in possession of material that has been digitally copied or reproduced by means of a scanner, digital camera, or other device may be punishable by law.

- **Items prohibited by law from being copied or reproduced**

Do not copy or reproduce paper money, coins, securities, government bonds, or local government bonds, even if such copies or reproductions are stamped "Sample."

The copying or reproduction of paper money, coins, or securities which are circulated in a foreign country is prohibited.

Unless the prior permission of the government has been obtained, the copying or reproduction of unused postage stamps or post cards issued by the government is prohibited.

The copying or reproduction of stamps issued by the government and of certified documents stipulated by law is prohibited.

- **Cautions on certain copies and reproductions**

The government has issued cautions on copies or reproductions of securities issued by private companies (shares, bills, checks, gift certificates, etc.), commuter passes, or coupon tickets, except when a minimum of necessary copies are to be provided for business use by a company. Also, do not copy or reproduce passports issued by the government, licenses issued by public agencies and private groups, ID cards, and tickets, such as passes and meal coupons.

- **Comply with copyright notices**

Under copyright law, photographs or recordings of copyrighted works made with the camera can not be used without the permission of the copyright holder. Exceptions apply to personal use, but note that even personal use may be restricted in the case of photographs or recordings of exhibits or live performances.

## **Disposing of Data Storage Devices**

Please note that deleting images or formatting memory cards or other data storage devices does not completely erase the original image data. Deleted files can sometimes be recovered from discarded storage devices using commercially available software, potentially resulting in the malicious use of personal image data. Ensuring the privacy of such data is the user's responsibility.

Before discarding a data storage device or transferring ownership to another person, erase all data using commercial deletion software, or format the device and then completely refill it with images containing no private information (for example, pictures of empty sky). Care should be taken to avoid injury when physically destroying data storage devices.

Before discarding the camera or transferring ownership to another person, you should also use the **Reset all settings** options in the camera setup menu to delete any personal network information.

## **AVC Patent Portfolio License**

THIS PRODUCT IS LICENSED UNDER THE AVC PATENT PORTFOLIO LICENSE FOR THE PERSONAL AND NON-COMMERCIAL USE OF A CONSUMER TO (i) ENCODE VIDEO IN COMPLIANCE WITH THE AVC STANDARD ("AVC VIDEO") AND/OR (ii) DECODE AVC VIDEO THAT WAS ENCODED BY A CONSUMER ENGAGED IN A PERSONAL AND NON-COMMERCIAL ACTIVITY AND/OR WAS OBTAINED FROM A VIDEO PROVIDER LICENSED TO PROVIDE AVC VIDEO. NO LICENSE IS GRANTED OR SHALL BE IMPLIED FOR ANY OTHER USE. ADDITIONAL INFORMATION MAY BE OBTAINED FROM MPEG LA, L.L.C. SEE <http://www.mpegla.com>

## **Use Only Nikon Brand Electronic Accessories**

Nikon cameras are designed to the highest standards and include complex electronic circuitry. Only Nikon brand electronic accessories (including chargers, batteries, AC adapters, and flash accessories) certified by Nikon specifically for use with this Nikon digital camera are engineered and proven to operate within the operational and safety requirements of this electronic circuitry.

The use of non-Nikon electronic accessories could damage the camera and may void your Nikon warranty. The use of third-party rechargeable Li-ion batteries not bearing the Nikon holographic seal shown at right could interfere with normal operation of the camera or result in the batteries overheating, igniting, rupturing, or leaking.

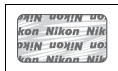

For more information about Nikon brand accessories, contact a local authorized Nikon dealer.

### ✔ Use Only Nikon Brand Accessories

Only Nikon brand accessories certified by Nikon specifically for use with your Nikon digital camera are engineered and proven to operate within its operational and safety requirements. THE USE OF NON-NIKON ACCESSORIES COULD DAMAGE YOUR CAMERA AND MAY VOID YOUR NIKON WARRANTY.

### ✔ Before Taking Important Pictures

Before taking pictures on important occasions (such as at weddings or before taking the camera on a trip), take a test shot to ensure that the camera is functioning normally. Nikon will not be held liable for damages or lost profits that may result from product malfunction.

### ✔ Life-Long Learning

As part of Nikon's "Life-Long Learning" commitment to ongoing product support and education, continually-updated information is available on-line at the following sites:

- **For users in the U.S.A.:** <http://www.nikonusa.com/>
- **For users in Europe and Africa:** <http://www.europe-nikon.com/support/>
- **For users in Asia, Oceania, and the Middle East:** <http://www.nikon-asia.com/>

Visit these sites to keep up-to-date with the latest product information, tips, answers to frequently-asked questions (FAQs), and general advice on digital imaging and photography. Additional information may be available from the Nikon representative in your area. See the following URL for contact information: <http://imaging.nikon.com/>

## Bluetooth and Wi-Fi (Wireless LAN)

This product is controlled by the United States Export Administration Regulations (EAR). The permission of the United States government is not required for export to countries other than the following, which as of this writing are subject to embargo or special controls: Cuba, Iran, North Korea, Sudan, and Syria (list subject to change).

The use of wireless devices may be prohibited in some countries or regions. Contact a Nikon-authorized service representative before using the wireless features of this product outside the country of purchase.

### **Notice for Customers in the U.S.A. and Canada**

This device complies with Part 15 of FCC Rules and Industry Canada licence-exempt RSS standard(s). Operation is subject to the following two conditions: (1) this device may not cause interference, and (2) this device must accept any interference, including interference that may cause undesired operation of the device.

### **FCC WARNING**

The FCC requires the user to be notified that any changes or modifications made to this device that are not expressly approved by Nikon Corporation may void the user's authority to operate the equipment.

### **FCC Radio Frequency Interference Statement**

Note: This equipment has been tested and found to comply with the limits for a Class B digital device, pursuant to part 15 of the FCC Rules. These limits are designed to provide reasonable protection against harmful interference in a residential installation. This equipment generates, uses and can radiate radio frequency energy and, if not installed and used in accordance with the instructions, may cause harmful interference to radio communications. However, there is no guarantee that interference will not occur in a particular installation. If this equipment does cause harmful interference to radio or television reception, which can be determined by turning the equipment off and on, the user is encouraged to try to correct the interference by one or more of the following measures:

- Reorient or relocate the receiving antenna.
- Increase the separation between the equipment and receiver.
- Connect the equipment into an outlet on a circuit different from that to which the receiver is connected.
- Consult the dealer or an experienced radio/TV technician for help.

### **Co-location**

This transmitter must not be co-located or operated in conjunction with any other antenna or transmitter.

Nikon Inc., 1300 Walt Whitman Road, Melville, New York 11747-3064, U.S.A.  
Tel.: 631-547-4200

### **FCC/IC RF Exposure Statement**

The available scientific evidence does not show that any health problems are associated with using low power wireless devices. There is no proof, however, that these low power wireless devices are absolutely safe. Low power wireless devices emit low levels of radio frequency energy (RF) in the microwave range while being used. Whereas high levels of RF can produce health effects (by heating tissue), exposure of low-level RF that does not produce heating effects causes no known adverse health effects. Many studies of low-level RF exposures have not found any biological effects. Some studies have suggested that some biological effects might occur, but such findings have not been confirmed by additional research. The D500, which is equipped with a LBEE5UW1FS (FCC ID:VPYLB1FS / IC ID:772C-LB1FS) Wireless LAN Module, has been tested and found to comply with FCC/IC radiation exposure limits set forth for an uncontrolled environment and meets the FCC radio frequency (RF) Exposure Guidelines in Supplement C to OET65 and RSS-102 of the IC radio frequency (RF) Exposure rules. Please refer to the SAR test report that was uploaded to FCC website.

### **Notices for Customers in Europe**

Hereby, Nikon Corporation declares that the radio equipment type D500 is in compliance with Directive 2014/53/EU. The full text of the EU declaration of conformity is available at the following internet address:

[http://imaging.nikon.com/support/pdf/DoC\\_D500.pdf](http://imaging.nikon.com/support/pdf/DoC_D500.pdf).

### **Notice for Customers in Singapore**

Trade Name: <b>Nikon</b> Model: D500
---

This device complies with radio-frequency regulations. The content of certification labels not affixed to the device is given below.

Complies with IMDA Standards DA103423
---



### **Notice for Customers in Jordan**

TRC/SS/2016/66
----------------

### **Notice for Customers in Oman**

OMAN-TRA
----------

R/3071/16
-----------

D090024
---------

### **Notice for Customers in the United Arab Emirates**

TRA
REGISTERED No: ER45171/16
DEALER No: DA39487/15

### **Security**

Although one of the benefits of this product is that it allows others to freely connect for the wireless exchange of data anywhere within its range, the following may occur if security is not enabled:

- Data theft: Malicious third-parties may intercept wireless transmissions to steal user IDs, passwords, and other personal information.
- Unauthorized access: Unauthorized users may gain access to the network and alter data or perform other malicious actions. Note that due to the design of wireless networks, specialized attacks may allow unauthorized access even when security is enabled.

# Introduction

## Getting to Know the Camera

Take a few moments to familiarize yourself with camera controls and displays. You may find it helpful to bookmark this section and refer to it as you read through the rest of the manual.

### Camera Body

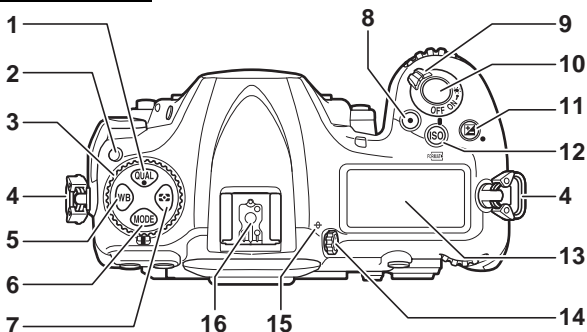

<b>1</b> QUAL button .....92, 95, 230	<b>9</b> Power switch ..... 6, 20
<b>2</b> Release mode dial lock release ..... 116	<b>10</b> Shutter-release button..... 38, 303
<b>3</b> Release mode dial ..... 116	<b>11</b> button..... 143, 230
<b>4</b> Eyelet for camera strap..... 13	<b>12</b> ISO/FORMAT button..... 123, 127, 304
<b>5</b> WB button ..... 159, 164, 168, 170	<b>13</b> Control panel..... 5
<b>6</b> MODE button..... 130	<b>14</b> Diopter adjustment control ..... 29
<b>7</b> button ..... 129	<b>15</b> Focal plane mark ( $\ominus$ )..... 115
<b>8</b> Movie-record button ..... 60, 301	<b>16</b> Accessory shoe (for optional flash unit)... 196, 335

## Camera Body (Continued)

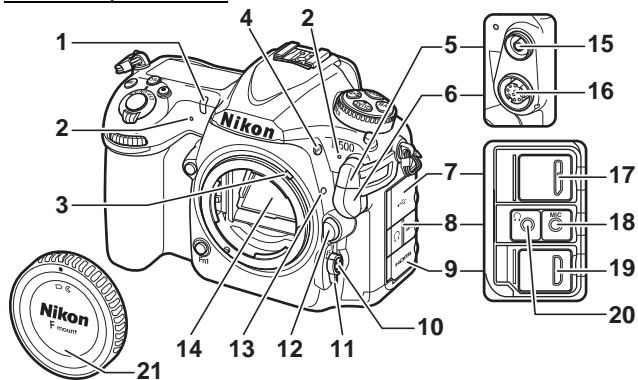

<b>1</b> Self-timer lamp ..... 120	<b>12</b> Lens release button ..... 19
<b>2</b> Stereo microphone ..... 60, 64, 290	<b>13</b> Lens mounting mark ..... 18
<b>3</b> Meter coupling lever ..... 367	<b>14</b> Mirror..... 121, 341
<b>4</b> <b>BKT</b> button ..... 147, 151, 155, 195, 238, 301	<b>15</b> Flash sync terminal ..... 197
<b>5</b> Flash sync terminal cover ..... 197	<b>16</b> Ten-pin remote terminal ..... 253, 336
<b>6</b> Ten-pin remote terminal cover ..... 253, 336	<b>17</b> USB connector
<b>7</b> USB connector cover	<b>18</b> Connector for external microphone ..... 65, 336
<b>8</b> Audio connector cover ..... 65, 336	<b>19</b> HDMI connector ..... 335
<b>9</b> HDMI connector cover	<b>20</b> Headphone connector ..... 65, 67
<b>10</b> AF-mode button ... 47, 49, 101, 105	<b>21</b> Body cap ..... 18, 335
<b>11</b> Focus-mode selector .... 47, 97, 114	

### **✓ Close the Connector Cover**

Close the connector cover when the connectors are not in use. Foreign matter in the connectors can interfere with data transfer.



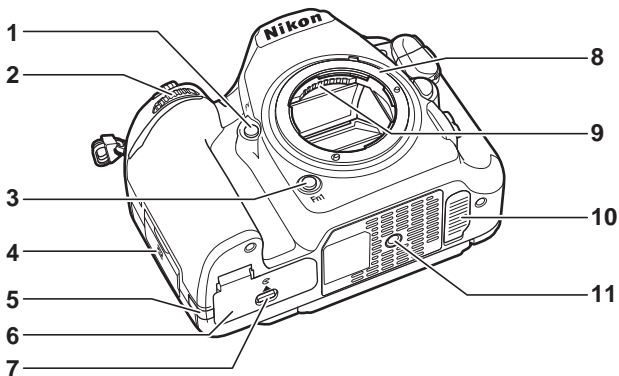

<b>1</b> P button..... 49, 131, 301, 303	<b>7</b> Battery-chamber cover latch..... 15
<b>2</b> Sub-command dial..... 302	<b>8</b> Lens mount ..... 18, 115
<b>3</b> Fn1 button ..... 301, 303	<b>9</b> CPU contacts
<b>4</b> N-Mark (NFC antenna)..... 22	<b>10</b> Contact cover for optional MB-D17 multi-power battery pack ..... 335
<b>5</b> Power connector cover	<b>11</b> Tripod socket
<b>6</b> Battery-chamber cover ..... 15, 17	

#### **✓ The Speaker**

Do not place the speaker in close proximity to magnetic devices. Failure to observe this precaution could affect the data recorded on the magnetic devices.

## Camera Body (Continued)

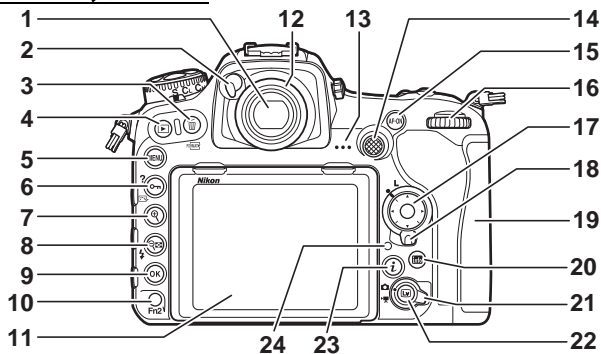

1 Viewfinder ..... 7, 29, 119	14 Sub-selector ..... 109, 111, 141, 301, 303
2 Eyepiece shutter lever ..... 119	15 <b>AF-ON</b> button ..... 102, 112, 293, 301
3 $\text{Fn}/\text{FORMAT}$ button ..... 42, 278, 304	16 Main command dial ..... 302
4 $\text{L}$ button ..... 40, 255	17 Multi selector ..... 31, 39, 301, 302
5 MENU button ..... 30, 281	18 Focus selector lock ..... 108
6 $\text{On}/\text{L}/\text{?}$ button ..... 31, 181, 273	19 Memory card slot cover ..... 15, 17
7 $\text{Q}$ button ..... 46, 271	20 info (info) button .... 54, 69, 222, 226
8 $\text{Q}/\text{Z}$ button ..... 202, 203, 255, 271	21 Live view selector ..... 43, 58
9 $\text{OK}$ (OK) button ..... 31, 256	22 $\text{Lv}$ button ..... 43, 58, 174, 303
10 Fn2 button ..... 275, 301, 303	23 $\text{z}$ button ..... 50, 64, 229, 260
11 Tilting monitor ..... 9, 11, 43, 58, 255, 304, 305	24 Memory card access lamp ..... 38, 118
12 Viewfinder eyepiece ..... 29, 119	
13 Speaker ..... 3, 81	

## The Control Panel

The control panel shows a variety of camera settings when the camera is on. The items shown here appear the first time the camera is turned on; information on other settings can be found in the relevant sections of this manual.

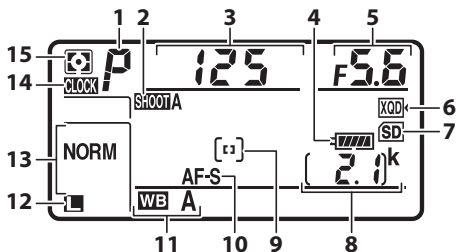

1	Exposure mode .....	130	9	AF-area mode .....	103
2	Photo shooting menu bank .....	283	10	Autofocus mode .....	101
3	Shutter speed .....	133, 135	11	White balance.....	159
4	Battery indicator .....	35	12	Image size (JPEG and TIFF images) .....	94
5	Aperture (f-number) .....	134, 135	13	Image quality .....	91
6	XQD card icon .....	15, 96	14	CLOCK indicator	
7	SD card icon .....	15, 96	15	Metering .....	129
8	Number of exposures remaining .....	36, 389			



### The CLOCK Indicator

The camera clock is powered by an independent, rechargeable power source, which is charged as necessary when the main battery is installed or the camera is powered by an optional power connector and AC adapter (□ 335). Two days of charging will power the clock for about three months. If the **CLOCK** icon flashes in the control panel, the clock has been reset and the date and time recorded with any new photographs will not be correct. Set the clock to the correct time and date using the **Time zone and date > Date and time** option in the setup menu (□ 304).

### LCD Illuminators

Rotating the power switch toward  activates the backlights for the buttons and control panel, making it easier to use the camera in the dark.

After the power switch is released, the backlights will remain lit for a few seconds while the standby timer is active

( 296) or until the shutter is released or the power switch is rotated toward  again.

Power switch

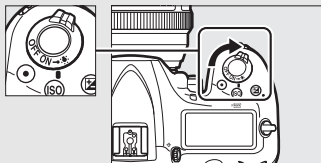

### The Control Panel and Viewfinder Displays

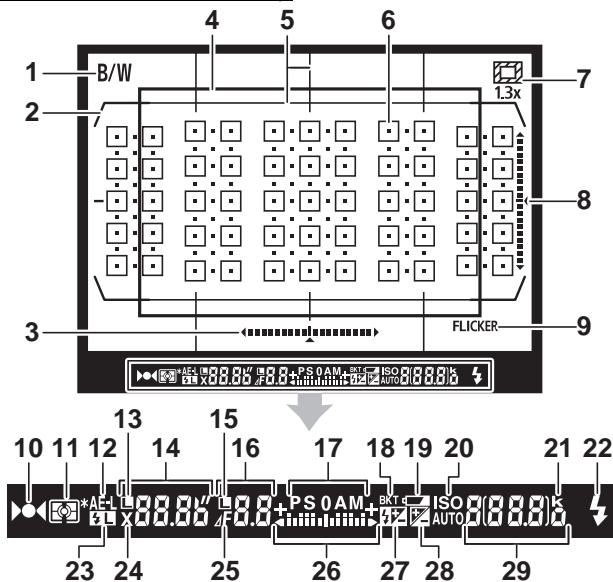

The brightness of the control panel and viewfinder displays varies with temperature, and the response times of the displays may drop at low temperatures. This is normal and does not indicate a malfunction.

## The Viewfinder Display



1	Monochrome indicator .....	180	10	Focus indicator .....	38, 111, 115
2	AF area brackets .....	29	11	Metering .....	128
3	Roll indicator <sup>1,2</sup>		12	Autoexposure (AE) lock .....	141
4	1.3× DX crop .....	88, 89	13	Shutter speed lock icon ...	140, 302
5	Framing grid (displayed when <b>On</b> is selected for Custom Setting d8, <b>Viewfinder grid display</b> ) ...	298	14	Shutter speed .....	133, 135
6	Focus points .....	97, 108, 293		Autofocus mode .....	101
7	1.3× DX crop indicator .....	88, 89	15	Aperture lock icon .....	140, 302
8	Pitch indicator <sup>1,3</sup>		16	Aperture (f-number) .....	134, 135
9	Flicker detection .....	234, 287		Aperture (number of stops) .....	134, 325

<p><b>17</b> Exposure mode ..... 130</p> <p><b>18</b> Exposure/flash bracketing indicator ..... 147</p> <p>WB bracketing indicator ..... 151</p> <p>ADL bracketing indicator..... 155</p> <p><b>19</b> Low battery warning .....35</p> <p><b>20</b> ISO sensitivity indicator ..... 123</p> <p>Auto ISO sensitivity indicator ..... 126</p> <p><b>21</b> "k" (appears when memory remains for over 1000 exposures).....36</p> <p><b>22</b> Flash-ready indicator<sup>4</sup> ..... 196, 206, 369</p> <p><b>23</b> FV lock indicator ..... 206</p> <p><b>24</b> Flash sync indicator..... 299</p> <p><b>25</b> Aperture stop indicator.... 134, 325</p> <p><b>26</b> Exposure indicator ..... 136</p> <p>Exposure compensation display..... 143</p>	<p><b>27</b> Flash compensation indicator ..... 203</p> <p><b>28</b> Exposure compensation indicator ..... 143</p> <p><b>29</b> Number of exposures remaining.....36, 389</p> <p>Number of shots remaining before memory buffer fills ..... 118, 389</p> <p>ISO sensitivity ..... 123</p> <p>Preset white balance recording indicator ..... 171</p> <p>Active D-Lighting amount</p> <p>AF-area mode ..... 105, 106</p> <p>Exposure compensation value ..... 143</p> <p>Flash compensation value ..... 203</p> <p>PC mode indicator</p>
--	--

- 1 Can be displayed by pressing a button to which **Viewfinder virtual horizon** has been assigned using Custom Setting f1 (**Custom control assignment**,  301).
- 2 Functions as a pitch indicator when camera is rotated to take pictures in "tall" (portrait) orientation.
- 3 Functions as a roll indicator when camera is rotated to take pictures in "tall" (portrait) orientation.
- 4 Displayed when an optional flash unit is attached ( 196). The flash-ready indicator lights when the flash is charged.

**Note:** Display shown with all indicators lit for illustrative purposes.

### **No Battery**

When the battery is totally exhausted or no battery is inserted, the display in the viewfinder will dim. This is normal and does not indicate a malfunction. The viewfinder display will return to normal when a fully-charged battery is inserted.

## Using the Tilting Monitor

The monitor can be angled and rotated as shown below.

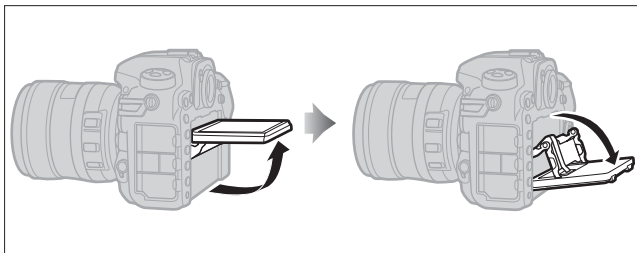

**Normal use:** The monitor is normally used in storage position.

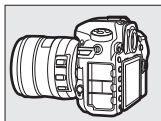

**Low-angle shots:** Tilt the monitor up to take shots in live view with the camera held low.

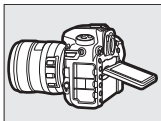

**High-angle shots:** Tilt the monitor down to take shots in live view with the camera held high.

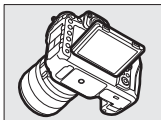

### ✔ Using the Monitor

Rotate the monitor gently, stopping when you feel resistance. *Do not use force.* Failure to observe these precautions could damage the camera or monitor. If the camera is mounted on a tripod, care should be taken to ensure that the monitor does not contact the tripod.

Do not lift or carry the camera by the monitor. Failure to observe this precaution could damage the camera. If the monitor is not being used to take photographs, return it to the storage position.

Do not touch the area to the rear of the monitor or allow liquid to contact the inner surface. Failure to observe these precautions could cause product malfunction.

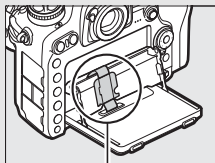

*Be particularly careful not to touch this area.*



## **Using the Touch Screen**

The touch-sensitive monitor supports the following operations:

---

### **Flick**

Flick a finger a short distance left or right across the monitor.

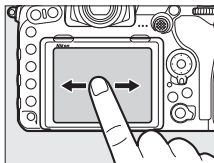

### **Slide**

Slide a finger over the monitor.

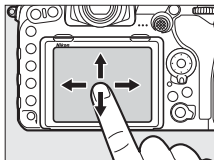

### **Stretch/Pinch**

Place two fingers on the monitor and move them apart or pinch them together.

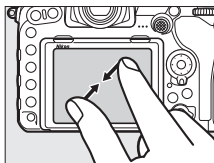
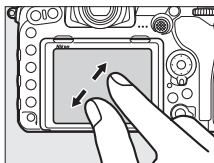

## ■ ■ *Using the Touch Screen*

During playback (📖 258), the touch screen can be used to:

- View other images
- Zoom in or out
- View thumbnails
- View movies

During live view, the touch screen can be used to take pictures (touch shutter; 📖 55) or to measure a value for spot white balance (📖 175). The touch screen can also be used for typing (📖 186).

### ✔ **The Touch Screen**

The touch screen responds to static electricity and may not respond when covered with third-party protective films or when touched with fingernails or gloved hands. Do not use excessive force or touch the screen with sharp objects.

### ✔ **Using the Touch Screen**

The touch screen may not respond as expected if you attempt to operate it while leaving your palm or another finger resting on it in second location. It may not recognize other gestures if your touch is too soft, your fingers are moved too quickly or too short a distance or do not remain in contact with the screen, or if the movement of the two fingers in a pinch or stretch is not correctly coordinated.

### ✍ **Enabling or Disabling Touch Controls**

Touch controls can be enabled or disabled using the **Touch controls** option in the setup menu (📖 306).

### ✍ **See Also**

The **Touch controls** option in the setup menu can be used to choose the direction you flick your finger to view other images in full-frame playback (📖 306).

# First Steps

## Attach the Camera Strap

Attach the strap securely to the camera eyelets.

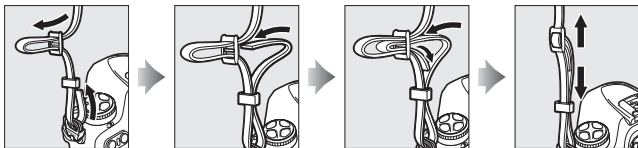

## Charge the Battery

Insert the battery and plug the charger in (depending on the country or region, the charger comes with either an AC wall adapter or a power cable). An exhausted battery will fully charge in about two hours and 35 minutes.

- **AC wall adapter:** Insert the AC wall adapter into the charger AC inlet (1). Slide the AC wall adapter latch as shown (2) and rotate the adapter 90° to fix it in place (3). Insert the battery and plug the charger in.

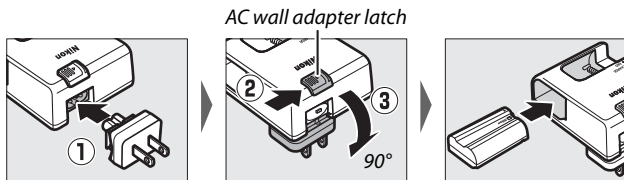

- **Power cable:** After connecting the power cable with the plug in the orientation shown, insert the battery and plug the cable in.

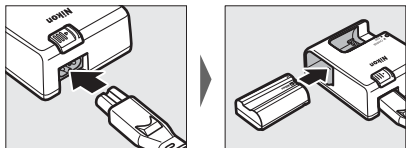

The **CHARGE** lamp will flash while the battery charges.

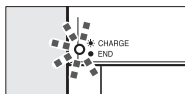

*Battery charging*

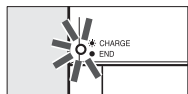

*Charging complete*

### **✓ The Battery and Charger**

*Read and follow the warnings and cautions on pages xiii–xvi and 345–349 of this manual.*

## Insert the Battery and a Memory Card

Before inserting or removing the battery or memory cards, confirm that power switch is in the **OFF** position. Insert the battery in the orientation shown, using the battery to keep the orange battery latch pressed to one side. The latch locks the battery in place when the battery is fully inserted.

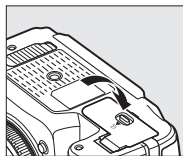
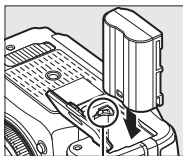
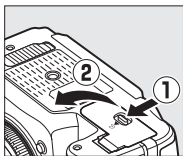

*Battery latch*

Memory cards are inserted as shown below. Slide the card in until it clicks into place.

### • XQD memory cards:

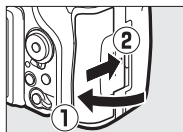
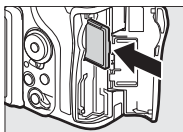
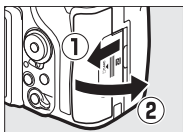

### • SD memory cards:

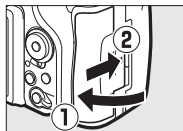
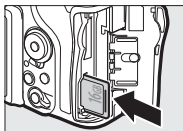
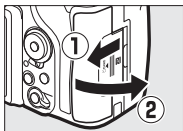

## ✔ Memory Cards

- Memory cards may be hot after use. Observe due caution when removing memory cards from the camera.
- Turn the power off before inserting or removing memory cards. Do not remove memory cards from the camera, turn the camera off, or remove or disconnect the power source during formatting or while data are being recorded, deleted, or copied to a computer. Failure to observe these precautions could result in loss of data or in damage to the camera or card.
- Do not touch the card terminals with your fingers or metal objects.
- Do not bend, drop, or subject to strong physical shocks.
- Do not apply force to the card casing. Failure to observe this precaution could damage the card.
- Do not expose to water, high levels of humidity, or direct sunlight.
- Do not format memory cards in a computer.

## ✔ The Write Protect Switch

SD memory cards are equipped with a write protect switch to prevent accidental loss of data. When this switch is in the “lock” position, the memory card can not be formatted and photos can not be deleted or recorded (a warning will be displayed in the monitor if you attempt to release the shutter). To unlock the memory card, slide the switch to the “write” position.

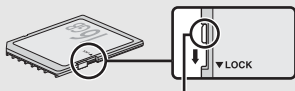

Write-protect switch

## ✔ No Memory Card

If no memory card is inserted, the control panel and viewfinder will show [-E-]. If the camera is turned off with a charged battery and no memory card inserted, [-E-] will be displayed in the control panel.

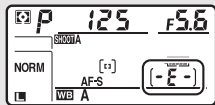

## ■ ■ Removing the Battery and Memory Cards

### Removing the Battery

Turn the camera off and open the battery-chamber cover. Press the battery latch in the direction shown by the arrow to release the battery and then remove the battery by hand.

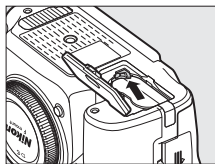

### Removing Memory Cards

After confirming that the memory card access lamp is off, turn the camera off and open the memory card slot cover. Press the card in and then release it (①). The memory card can then be removed by hand (②).

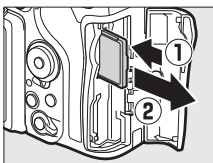

*XQD memory cards*

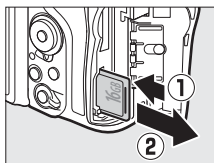

*SD memory cards*

## **Attach a Lens**

Be careful to prevent dust from entering the camera when the lens or body cap is removed. The lens generally used in this manual for illustrative purposes is an AF-S DX NIKKOR 16–80mm f/2.8–4E ED VR.

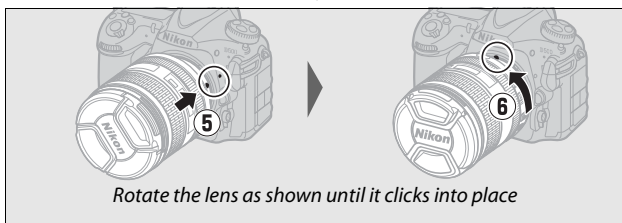
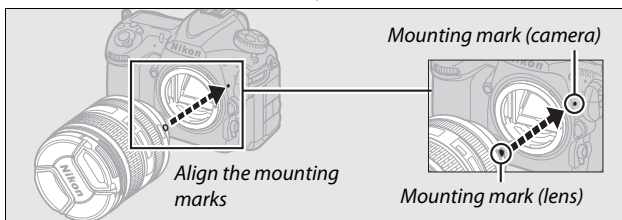
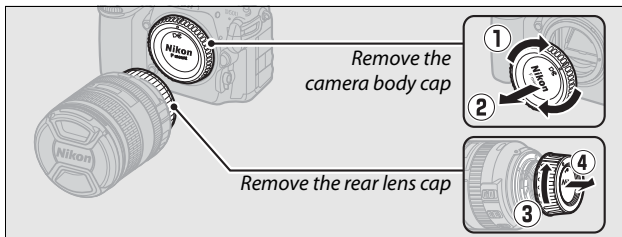

Be sure to remove the lens cap before taking pictures.



### **Detaching the Lens**

Be sure the camera is off when removing or exchanging lenses. To remove the lens, press and hold the lens release button (1) while turning the lens clockwise (2). After removing the lens, replace the lens caps and camera body cap.

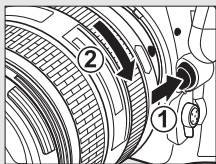

### **CPU Lenses with Aperture Rings**

In the case of CPU lenses equipped with an aperture ring (☐ 325), lock aperture at the minimum setting (highest f-number).

## Camera Setup

### ■ **Setup Using a Smartphone or Tablet**

Before proceeding, check the camera to ensure that the battery is fully charged and the memory card has space available. On your smartphone or tablet (below “smart device”), install the SnapBridge app as described inside the front cover and enable Bluetooth and Wi-Fi. Note that the actual connection to the camera will be made using the SnapBridge app; do not use Bluetooth settings in the settings app on your smart device. The instructions that follow refer to version 2.0 of the SnapBridge app; for information on the latest version, see the *SnapBridge Connection Guide* (pdf), available for download from the following website:



<http://downloadcenter.nikonimglib.com>



The actual camera and smart device displays may differ from those shown below.



- 1 Camera: Turn the camera on. A language-selection dialog will be displayed.**

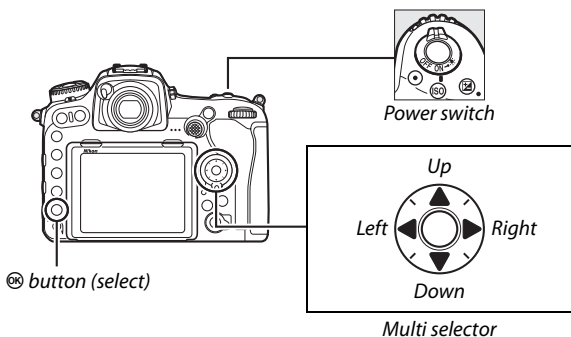

Use the multi selector and  button to navigate the menus.



Press  and  to highlight a language and press  to select. The language can be changed at any time using the **Language** option in the setup menu.

- 2** **Camera:** When the dialog at right is displayed, press . If you do not wish to use a smart device to configure the camera, press **MENU** ( 27). If the dialog at right is not displayed, select **Connect to smart device** in the setup menu, then highlight **Start** and press .



### 3 Camera/smart device: Start pairing.

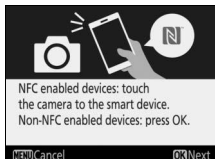

- **Android devices with NFC support:** After checking that NFC is enabled on the smart device, touch the camera  (N-Mark) to the NFC antenna on the smart device to launch the SnapBridge app, and then follow the on-screen instructions before proceeding to Step 7. If the SnapBridge download site is displayed, download and install the app before repeating the above steps.
- **iOS devices and Android devices without NFC support:** Press the camera  button to ready the camera for pairing.

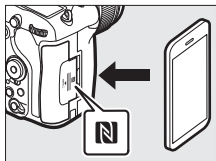

- 
- 4 Camera:** Confirm that the camera displays the message shown at right and ready the smart device.

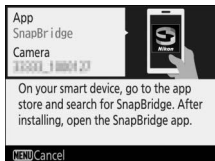

- 
- 5 Smart device:** Launch the SnapBridge app and tap **Pair with camera**. If prompted to choose a camera, tap the camera name.



- 
- 6 Smart device:** Tap the camera name in the "Pair with camera" dialog. Users who are pairing a camera with an iOS device for the first time will first be presented with pairing instructions; after reading the instructions, scroll to the bottom of the display and tap **Understood**. If you are then prompted to choose an accessory, tap the camera name again (there may be some delay before the camera name is displayed).

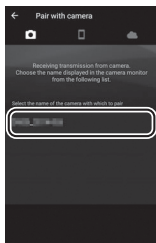

- 7** Camera/smart device: Confirm that the camera and smart device display the same six-digit number. Some versions of iOS may not display a number; if no number displayed, proceed to Step 8.

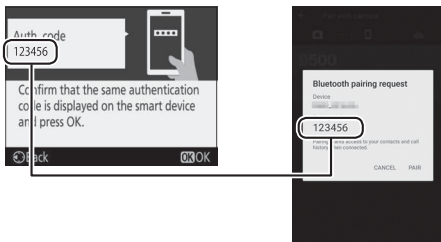

- 8** Camera/smart device: Press **OK** on the camera and tap **PAIR** on the smart device (the display varies with the device and operating system).



---

## 9 Camera/smart device: Complete pairing.

- **Camera:** Press **OK** when the message at right is displayed.



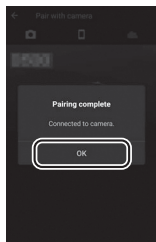

- **Smart device:** Tap **OK** when the message at right is displayed.



---

## 10 Camera: Follow the on-screen instructions to complete setup.

- **To allow the camera to add location data to photos**, select **Yes** in response to “Download location data from smart device?” and then enable location services on the smart device and enable **Auto link options > Synchronize location data** in the SnapBridge app  tab.
- **To synchronize the camera clock with the time provided by the smart device**, select **Yes** in response to “Sync clock with smart device?” and then enable **Auto link options > Synchronize clocks** in the SnapBridge app  tab.

*The smart device and camera are now connected. Any pictures you take with the camera will automatically be uploaded to the smart device.*

## ■ Setup from the Camera Menus

The camera clock can be set manually.

### 1 Turn the camera on.

A language-selection dialog will be displayed.

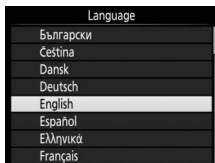

Use the multi selector and **OK** button to navigate the menus.

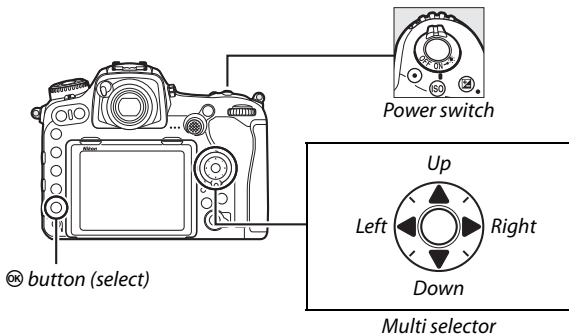

Press **▲** and **▼** to highlight a language and press **OK** to select. The language can be changed at any time using the **Language** option in the setup menu.



- 2** Press **MENU** when the dialog at right is displayed.

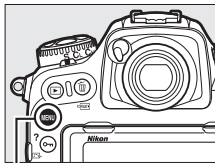
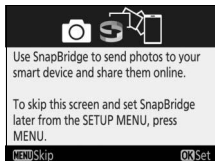

**MENU** button

- 3** Set the camera clock.  
Press the **MENU** button to display the setup menu.

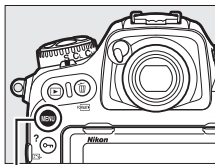





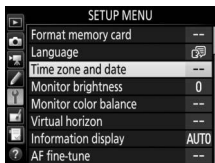

**MENU** button

Highlight **Time zone and date** and press  (the setup menu is automatically displayed with **Time zone and date** highlighted the first time the menus are displayed; for more information on using the menus, see page 304).



After using **Time zone** to choose a time zone and (if applicable) **Daylight saving time** to enable daylight saving time, highlight **Date and time** and press .

Press  or  to highlight items and press  or  to change, then press  to set the clock when adjustments are complete. The clock can be adjusted at any time using the **Time zone and date** > **Date and time** option in the setup menu ( 304).

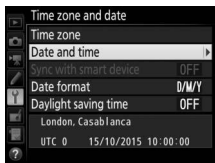

#### **Date Format**

To choose the order in which the date is displayed, use the **Date format** option in the **Time zone and date** menu ( 304).

## Focus the Viewfinder

Lift the diopter adjustment control and rotate it until the viewfinder display, focus points, and AF area brackets are in sharp focus. When operating the control with your eye to the viewfinder, be careful not to put your fingers or fingernails in your eye. Push the diopter adjustment control back in once you have adjusted focus to your satisfaction.

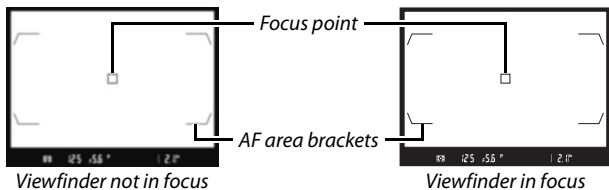
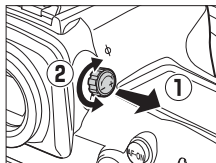

### Dioptric-Adjustment Viewfinder Lenses

Corrective lenses (available separately; □ 335) can be used to further adjust viewfinder diopter. Before attaching a diopter-adjustment viewfinder lens, remove the DK-17F viewfinder eyepiece by closing the viewfinder shutter to release the eyepiece lock (1) and then grasping the eyepiece lightly between your finger and thumb and unscrewing it as shown at right (2).

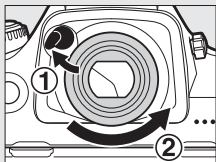

# Tutorial

## Camera Menu

Most shooting, playback, and setup options can be accessed from the camera menus. To view the menus, press the **MENU** button.

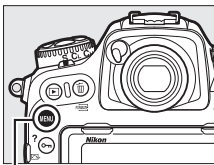

MENU button

### Tabs

Choose from the following menus:

- : **Playback** (📖 281)
- : **Photo Shooting** (📖 283)
- : **Movie Shooting** (📖 288)
- : **Custom Settings** (📖 292)
- : **Setup** (📖 304)
- : **Retouch** (📖 313)
- : **MY MENU** or **RECENT SETTINGS**  
(defaults to **MY MENU**; 📖 315)

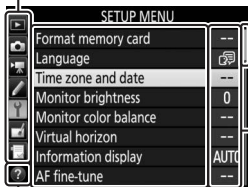

Slider shows position in current menu.

Current settings are shown by icons.

### Menu options

Options in current menu.

**Help icon** (📖 31)

# Using Camera Menus

## Menu Controls

The multi selector and **OK** button are used to navigate the menus.

### Multi selector

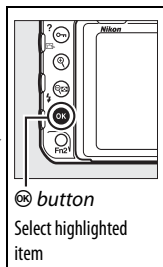
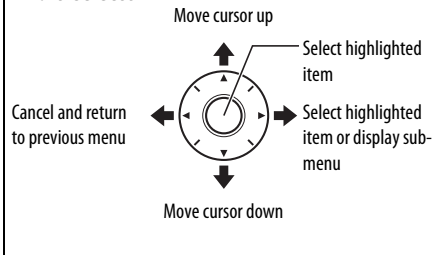

### The **?** (Help) Icon

If a **?** icon is displayed at the bottom left corner of the monitor, help can be displayed by pressing the **?** (**INFO**/?) button.

A description of the currently selected option or menu will be displayed while the button is pressed. Press **▲** or **▼** to scroll through the display.

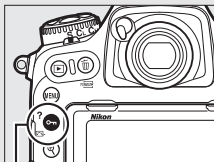

**?** (**INFO**/?) button

#### ? Multiple exposure

Record the specified number of shots as a single image using the selected overlay mode. The standby timer is extended by 30 s. If the timer expires, shooting will end and a multiple exposure will be created from any shots that have been taken.

## ■ Navigating the Menus

Follow the steps below to navigate the menus.

### 1 Display the menus.

Press the **MENU** button to display the menus.

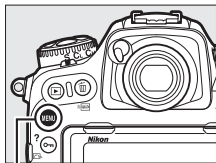

MENU button

### 2 Highlight the icon for the current menu.

Press  to highlight the icon for the current menu.

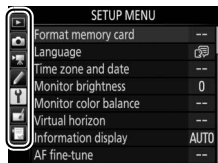

### 3 Select a menu.

Press  or  to select the desired menu.



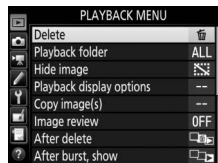

### 4 Position the cursor in the selected menu.

Press  to position the cursor in the selected menu.



## 5 Highlight a menu item.

Press  or  to highlight a menu item.

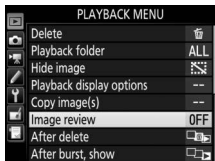



## 6 Display options.

Press  to display options for the selected menu item.



## 7 Highlight an option.

Press  or  to highlight an option.

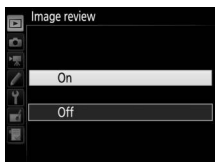

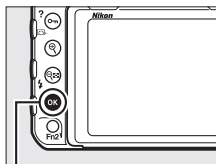

## 8 Select the highlighted item.

Press  to select the highlighted item.  
To exit without making a selection, press the MENU button.



 button

Note the following points:

- Menu items that are displayed in gray are not currently available.
- While pressing  or the center of the multi selector generally has the same effect as pressing , there are some items for which selection can only be made by pressing .
- To exit the menus and return to shooting mode, press the shutter-release button halfway.



## Basic Photography and Playback

### The Battery Level and Number of Exposures Remaining

Before taking photographs, check the battery level and number of exposures remaining as described below.

#### ■ **Battery Level**

The battery level is shown in the control panel and viewfinder.

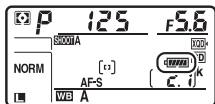

Control panel



Viewfinder

Icon		Description
Control panel	Viewfinder	
	—	Battery partially discharged.
	—	
	—	
	—	
		Low battery. Charge battery or ready spare battery.
 (flashes)	 (flashes)	Shutter release disabled. Charge or exchange battery.

#### ■ **Camera Off Display**

If the camera is turned off with a battery and memory card inserted, the memory card icon and number of exposures remaining will be displayed (some memory cards may in rare cases only display this information when the camera is on).



Control panel

## ■ Number of Exposures Remaining

The camera has two memory card slots: one for XQD cards and the other for SD cards. When two cards are inserted, the role played by each is determined by the options selected for **Primary slot selection** and **Secondary slot function**; when **Secondary slot function** is set to the default value of **Overflow** (☞ 96), the card in the secondary slot will only be used when the card in the primary slot is full.

The control panel display shows what cards are currently inserted (the example here shows the display when cards are inserted in both slots). If an error occurs (for example, if the memory card is full or the card in the SD slot is locked), the icon for the affected card will flash (☞ 357).

The control panel and viewfinder show the number of photographs that can be taken at current settings (values over 1000 are rounded down to the nearest hundred; e.g., values between 2100 and 2199 are shown as 2.1 k).

XQD card slot

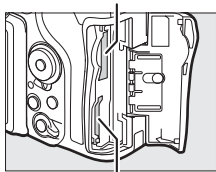

SD card slot

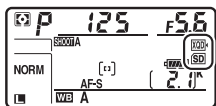

Control panel

Number of exposures remaining

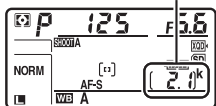

Control panel



Viewfinder

# **“Point-and-Shoot” Photography**

---

## **1 Ready the Camera.**

When framing photographs in the viewfinder, hold the handgrip in your right hand and cradle the camera body or lens with your left.

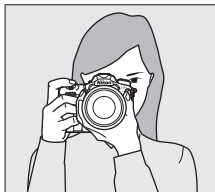

When framing photographs in portrait (tall) orientation, hold the camera as shown at right.



## **2 Frame the photograph.**

At default settings, the camera will focus on the subject in the center focus point. Frame a photograph in the viewfinder with the main subject in the center focus point.

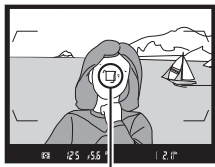

*Focus point*

### 3 Press the shutter-release button halfway.

Press the shutter-release button halfway to focus. The in-focus indicator (●) will appear in the viewfinder when the focus operation is complete.



Focus indicator

Viewfinder display	Description
●	Subject in focus.
▶	Focus point is between camera and subject.
◀	Focus point is behind subject.
▶ ◀ (flashes)	Camera unable to focus on subject in focus point using autofocus. See page 113.

### 4 Shoot.

Smoothly press the shutter-release-button the rest of the way down to take the photograph. The memory card access lamp will light and the photograph will be displayed in the monitor

for a few seconds. *Do not eject the memory card or remove or disconnect the power source until the lamp has gone out and recording is complete.*

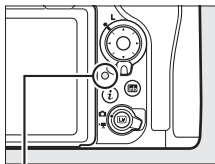

Memory card access lamp

### The Standby Timer (Viewfinder Photography)

The shutter speed and aperture displays in the control panel and viewfinder will turn off if no operations are performed for about six seconds, reducing the drain on the battery. Press the shutter-release button halfway to reactivate the displays.

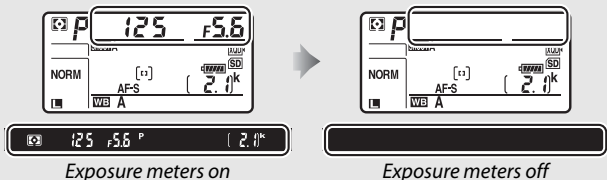

The length of time before the standby timer expires automatically can be adjusted using Custom Setting c2 (**Standby timer**,  296).

### The Multi Selector

The multi selector can be used to select the focus point while the exposure meters are on ( 108).

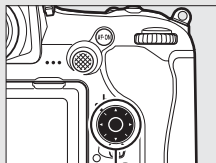

*Multi selector*

## Viewing Photographs

### 1 Press the button.



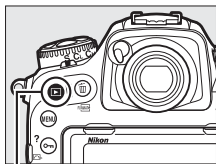

A photograph will be displayed in the monitor. The memory card containing the picture currently displayed is shown by an icon.



 button



### 2 View additional pictures.

Additional pictures can be displayed by pressing  or  or flicking a finger left or right over the display (📖 258). To view additional information on the current photograph, press  and  (📖 261).

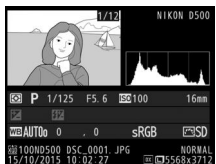

To end playback and return to shooting mode, press the shutter-release button halfway.



### **Image Review**

When **On** is selected for **Image review** in the playback menu (📖 282), photographs are automatically displayed in the monitor after shooting.

### **See Also**

See pages 256 and 257 for information on choosing a memory card slot.

## ■ Deleting Unwanted Photographs





To delete the photograph currently displayed in the monitor, press the  () button. *Note that photographs can not be recovered once deleted.*

### 1 Display the photograph.



Display the photograph you wish to delete as described on the preceding page. The location of the current image is shown by an icon at the bottom left corner of the display.

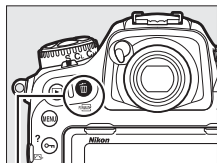

### 2 Delete the photograph.

Press the  () button. A confirmation dialog will be displayed; press the  () button again to delete the image and return to playback. To exit without deleting the picture, press .



 () button



### Delete

To delete multiple images or to select the memory card from which images will be deleted, use the **Delete** option in the playback menu ( 279).



# Live View Photography

Follow the steps below to take photographs in live view.

- 1 Rotate the live view selector to  (live view photography).**

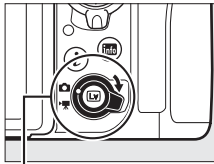

*Live view selector*

- 2 Press the  button.**  
The mirror will be raised and the view through the lens will be displayed in the camera monitor. The subject will no longer be visible in the viewfinder.

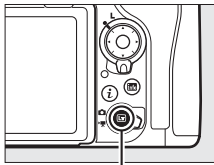

*Lv button*

- 3 Position the focus point.**  
Position the focus point over your subject as described on page 48.

## 4 Focus.

Press the shutter-release button halfway to focus.



The focus point will flash green and the shutter release will be disabled while the camera focuses. If the camera is able to focus, the focus point will be displayed in green; if the camera is unable to focus, the focus point will flash red (note that pictures can be taken even when the focus point flashes red; check focus in the monitor before shooting). Exposure can be locked by pressing the center of the sub-selector (📖 141); focus locks while the shutter-release button is pressed halfway.

### Using Autofocus in Live View

Use an AF-S or AF-P lens. The desired results may not be achieved with other lenses or teleconverters. Note that in live view, autofocus is slower and the monitor may brighten or darken while the camera focuses. The focus point may sometimes be displayed in green when the camera is unable to focus. The camera may be unable to focus in the following situations:

- The subject contains lines parallel to the long edge of the frame
- The subject lacks contrast
- The subject in the focus point contains areas of sharply contrasting brightness, or includes spot lighting or a neon sign or other light source that changes in brightness
- Flicker or banding appears under fluorescent, mercury-vapor, sodium-vapor, or similar lighting
- A cross (star) filter or other special filter is used
- The subject appears smaller than the focus point
- The subject is dominated by regular geometric patterns (e.g., blinds or a row of windows in a skyscraper)
- The subject is moving

## 5 Take the picture.

Press the shutter-release button the rest of the way down to shoot. The monitor will turn off.







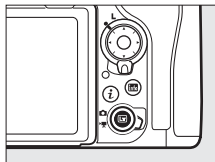



## 6 Exit live view.

Press the  button to exit live view.





### Exposure Preview

During live view, you can press  to preview the effects of shutter speed, aperture, and ISO sensitivity on exposure. Exposure can be adjusted by  $\pm 5$  EV ( 143), although only values between  $-3$  and  $+3$  EV are reflected in the preview display. Note that the preview may not accurately reflect the final results when flash lighting is used, Active D-Lighting ( 189), High Dynamic Range (HDR;  191), or bracketing is in effect, **A** (auto) is selected for the Picture Control **Contrast** parameter ( 183), or **x 250** is selected for shutter speed. If the subject is very bright or very dark, the exposure indicators will flash to warn that the preview may not accurately reflect exposure. Exposure preview is not available when    or **-** is selected for shutter speed.



### Live View Zoom Preview

Press the  button to magnify the view in the monitor up to a maximum of about 11×. A navigation window will appear in a gray frame at the bottom right corner of the display. Use the multi selector to scroll to areas of the frame not visible in the monitor, or press  (⚡) to zoom out.

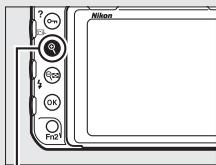

 button

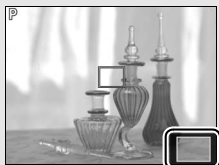







Navigation window

### HDMI

If the camera is connected to an HDMI video device during live view photography, the camera monitor will remain on and the video device will display the view through the lens.

### See Also

See Custom Setting c4 (**Monitor off delay**,  296) for information on choosing how long the monitor remains on during live view. For information on choosing the roles played by the movie-record button and command dials and by the center of the multi selector, see Custom Settings f1 (**Custom control assignment**) > **Movie record button** +  (  301) and f2 (**Multi selector center button**,  301). For information on preventing unintended operation of the  button, see Custom Setting f8 (**Live view button options**,  303).

## Autofocus

To take pictures using autofocus, rotate the focus-mode selector to **AF**.

Focus-mode selector

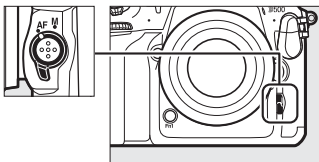

### ■ ■ Choosing a Focus Mode

The following autofocus modes are available in live view:

Mode	Description
AF-S	<b>Single-servo AF:</b> For stationary subjects. Focus locks when shutter-release button is pressed halfway.
AF-F	<b>Full-time-servo AF:</b> For moving subjects. Camera focuses continuously until shutter-release button is pressed. Focus locks when shutter-release button is pressed halfway.

To choose an autofocus mode, press the AF-mode button and rotate the main command dial until the desired mode is displayed in the monitor.

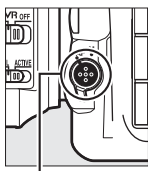

AF-mode button

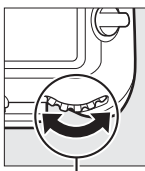





Main command dial



Monitor

## ■ ■ Choosing an AF-Area Mode

The following AF-area modes can be selected in live view:

Mode	Description
	<b>Face-priority AF:</b> Use for portraits. The camera automatically detects and focuses on portrait subjects; the selected subject is indicated by a double yellow border (if multiple faces, up to a maximum of 35, are detected, the camera will focus on the closest subject; to choose a different subject, use the multi selector). If the camera can no longer detect the subject (because, for example, the subject has turned to face away from the camera), the border will no longer be displayed.
	<b>Wide-area AF:</b> Use for hand-held shots of landscapes and other non-portrait subjects. Use the multi selector to move the focus point anywhere in the frame, or press the center of the multi selector to position the focus point in the center of the frame.
	<b>Normal-area AF:</b> Use for pin-point focus on a selected spot in the frame. Use the multi selector to move the focus point anywhere in the frame, or press the center of the multi selector to position the focus point in the center of the frame. A tripod is recommended.
	<b>Subject-tracking AF:</b> Position the focus point over your subject and press the center of the multi selector. The focus point will track the selected subject as it moves through the frame. To end tracking, press the center of the multi selector again. Note that the camera may be unable to track subjects if they move quickly, leave the frame or are obscured by other objects, change visibly in size, color, or brightness, or are too small, too large, too bright, too dark, or similar in color or brightness to the background.

To choose an AF-area mode, press the AF-mode button and rotate the sub-command dial until the desired mode is displayed in the monitor.

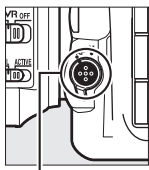

AF-mode button

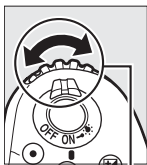

Sub-command dial



Monitor

## **Manual Focus**

To focus in manual focus mode (📖 114), rotate the lens focus ring until the subject is in focus. To magnify the view in the monitor for precise focus, press the  button (📖 46).

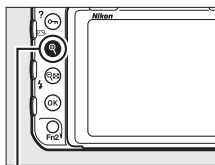
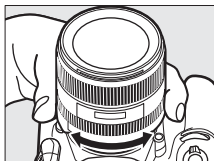

 button

### **Previewing Focus During Live View**

To temporarily select maximum aperture for an improved focus preview during live view, press the **Pv** button; the maximum aperture indicator (📖 53) will be displayed. To return aperture to its original value, press the button again or focus using autofocus. If the shutter-release button is pressed all the way down to take a picture during focus preview, aperture will return to the original value before the photo is taken.

## Using the *i* Button

The options listed below can be accessed by pressing the *i* button during live view photography. Highlight items using the multi selector and press  $\blacktriangleright$  to view options for the highlighted item. After choosing the desired setting, press  $\text{OK}$  to return to the *i*-button menu. Press the *i* button again to exit to the shooting display.

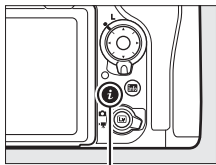



*i* button

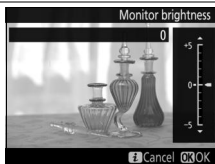

Option	Description
<b>Choose image area</b>	Choose an image area for live view photography (□ 88).
<b>Active D-Lighting</b>	Adjust Active D-Lighting (□ 189).
<b>Electronic front-curtain shutter</b>	Enable or disable the electronic front-curtain shutter for mirror-up photography (□ 298).
<b>Monitor brightness</b>	Press $\uparrow$ or $\downarrow$ to adjust monitor brightness for live view (note that this affects live view only and has no effect on photographs or movies or on the brightness of the monitor for menus or playback; to adjust the brightness of the monitor for menus and playback, use the <b>Monitor brightness</b> option in the setup menu as described on page 304).



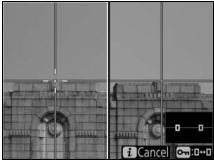

Option	Description
<p><b>Photo live view display WB</b></p>	<p>During live view photography, the white balance (hue) of the monitor can be set to a value different from that used for photographs (□ 159). This can be effective if the lighting under which shots are framed is different from that used when the photographs are taken, as is sometimes the case when a flash or preset manual white balance is used. Adjusting the photo live view display white balance to produce a similar effect to that used for the actual photographs makes it easier to picture the results. To use the same white balance for both the view in the monitor and the photograph, select <b>None</b>. Monitor white balance is reset when the camera is turned off, but the last value used can be selected by pressing the  button while pressing and holding the <b>WB</b> button.</p> 
<p><b>Split-screen display zoom</b></p>	<p>View two separate areas of the frame side-by-side (□ 52). This option can be used, for example, to align buildings with the horizon.</p> 

## ■ Split-Screen Display Zoom

Selecting **Split-screen display zoom** in the live view photography **i** button menu splits the display into two boxes showing separate areas of the frame side-by-side at a high zoom ratio. The positions of the magnified areas are shown in the navigation window.

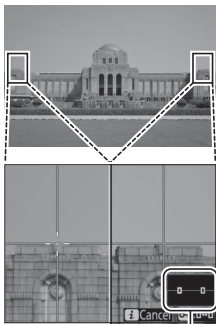

*Navigation window*

Use the **Q** and **Q** (**⚡**) buttons to zoom in and out, or use the **Q** (**⏪**/? ) button to select a box and press **Q** or **Q** to scroll the selected area left or right. Pressing **Q** or **Q** scrolls both areas up or down simultaneously. To focus on the subject at the center of the selected area, press the shutter-release button halfway. To exit the split-screen display, press the **i** button.

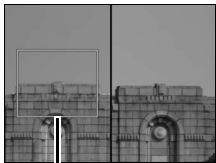

*Area in focus*

## The Live View Display

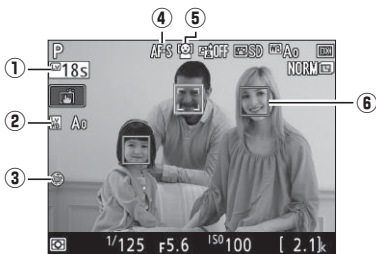

Item	Description	
① <b>Time remaining</b>	The amount of time remaining before live view ends automatically. Displayed if shooting will end in 30 s or less.	—
② <b>Photo live view display white balance indicator</b>	Monitor hue (photo live view display white balance).	51
③ <b>Maximum aperture indicator</b>	Displayed when the <b>Pv</b> button is pressed to select maximum aperture.	49
④ <b>Autofocus mode</b>	The current autofocus mode.	47
⑤ <b>AF-area mode</b>	The current AF-area mode.	48
⑥ <b>Focus point</b>	The current focus point. The display varies with the option selected for AF-area mode.	48

### The Count Down Display

A count down will be displayed 30 s before live view ends automatically (the timer turns red if live view is about to end to protect the internal circuits or, if an option other than **No limit** is selected for Custom Setting c4—**Monitor off delay > Live view**; 296—5 s before the monitor is due to turn off automatically). Depending on shooting conditions, the timer may appear immediately when live view is selected.

## The Information Display

To hide or display indicators in the monitor, press the **Info** button.

*Virtual horizon*

(**Info** 305)



*Information on*



*Information off*

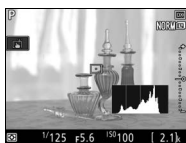

*Histogram (exposure preview only; **Info** 45)*

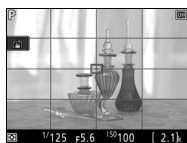

*Framing guides*



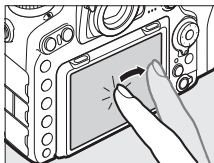

## Touch Photography (Touch Shutter)

Touch the monitor to focus and lift your finger to take the photograph.



Tap the icon shown at right to choose the operation performed by tapping the monitor in shooting mode. Choose from the following options:



Option	Description
 <b>(Touch shutter/AF: On)</b>	Touch the monitor to position the focus point and focus (autofocus only; the touch shutter can not be used to focus when the focus-mode selector is rotated to <b>M</b> to select manual focus as described on page 114). Focus locks while your finger remains on the monitor; to release the shutter, lift your finger from the screen.
 <b>(Touch AF: On)</b>	As above, except that lifting your finger from the screen does not release the shutter. If subject tracking (  48) is active, you can focus on the current subject by tapping the monitor.
 <b>(Touch shutter/AF: Off)</b>	Touch shutter and AF disabled.

### ✔ Taking Pictures Using Tap Shooting Options

Avoid moving the camera when releasing the shutter. Camera movement can result in blurred photographs.

The shutter-release button can be used to focus and take pictures even when the  icon is displayed to show that touch shooting options are active. Use the shutter-release button to take photographs in continuous shooting mode (☞ 116) and during movie recording. Touch shooting options can be used only to take pictures one at a time in continuous shooting mode and can not be used to take photographs during movie recording.

The touch screen can not be used to position the focus point when the focus selector lock is in the **L** (lock) position (☞ 108), but it can still be used to select the subject when face-priority AF is selected for AF-area mode (☞ 48).

In self-timer mode (☞ 119), focus locks on the selected subject when you touch the monitor and the timer starts when you lift your finger from the screen. At default settings, the shutter is released about 10 s after the timer starts; the delay and number of shots can be changed using Custom Setting c3 (**Self-timer**, ☞ 296). If the option selected for **Number of shots** is greater than 1, the camera will automatically take pictures one after the other until the selected number of shots is recorded.

### **Shooting in Live View**

To prevent light entering via the viewfinder from interfering with photographs or exposure, close the viewfinder eyepiece shutter (☐ 119).

Although they will not appear in the final picture, jagged edges, color fringing, moiré, and bright spots may appear in the monitor, while bright bands may appear in some areas with flashing signs and other intermittent light sources or if the subject is briefly illuminated by a strobe or other bright, momentary light source. In addition, distortion may occur if the camera is panned horizontally or an object moves at high speed through the frame. Flicker and banding visible in the monitor under fluorescent, mercury vapor, or sodium lamps can be reduced using the **Flicker reduction** option in the movie shooting menu (☐ 290), although they may still be visible in the final photograph at some shutter speeds. When shooting in live view, avoid pointing the camera at the sun or other strong light sources. Failure to observe this precaution could result in damage to the camera's internal circuitry.

Regardless of the option selected for Custom Setting c2 (**Standby timer**, ☐ 296), the standby timer will not expire during shooting.

# Movies

Read this section for information on recording and viewing movies.

## Recording Movies

Movies can be recorded in live view.

- 1 Rotate the live view selector to  (movie live view).

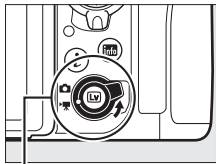

*Live view selector*

- 2 Press the  button.

The mirror will be raised and the view through the lens will be displayed in the camera monitor, modified for the effects of exposure. The subject will no longer be visible in the viewfinder.

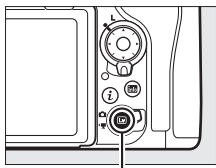

 button

### The icon

A  icon ([□ 66](#)) indicates that movies can not be recorded.

### White Balance

White balance can be set at any time by pressing the **WB** button and rotating the main command dial ([□ 159](#)).



### 3 Choose a focus mode (📖 47).



### 4 Choose an AF-area mode (📖 48).



### 5 Focus.

Frame the opening shot and press the **AF-ON** button to focus. Note that the number of subjects that can be detected in face-priority AF drops during movie recording.

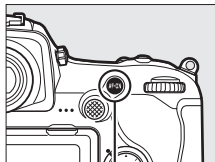

**AF-ON** button

#### Focusing

Focus can also be adjusted by pressing the shutter-release button halfway before beginning recording, or you can focus manually as described on page 49.

## 6 Start recording.

Press the movie-record button to start recording. A recording indicator and the time available are displayed in the monitor. Exposure can be locked by pressing the center of the sub-selector (📖 141) or altered by up to  $\pm 3$  EV using exposure compensation (📖 143); spot metering is not available. In autofocus mode, the camera can be refocused by pressing the **AF-ON** button or by tapping your subject in the monitor.

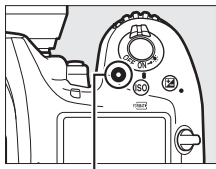

*Movie-record button*

*Recording indicator*



*Time remaining*

### **Audio**

The camera can record both video and sound; do not cover the microphone on the front of the camera during movie recording. Note that the built-in microphone may record sounds made by the camera or lens during autofocus, vibration reduction, or changes to aperture.

---

## 7 End recording.

Press the movie-record button again to end recording. Recording will end automatically when the maximum length is reached, or the memory card is full (note that depending on memory card write speed, shooting may end before the maximum length is reached).

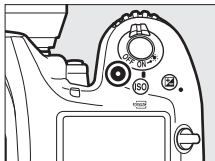

---

## 8 Exit live view.

Press the  button to exit live view.

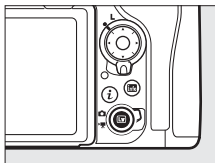

## Exposure Mode

The following exposure settings can be adjusted in movie mode:

	Aperture	Shutter speed	ISO sensitivity
<b>P, S</b>	—	—	— <sup>1,2</sup>
<b>A</b>	✓	—	— <sup>1,2</sup>
<b>M</b>	✓	✓	✓ <sup>2,3</sup>

- 1 The upper limit for ISO sensitivity can be selected using the **ISO sensitivity settings > Maximum sensitivity** option in the movie shooting menu (☐ 289).
- 2 Regardless of the option chosen for **ISO sensitivity settings > Maximum sensitivity** or for **ISO sensitivity (mode M)**, the upper limit when **On** is selected for **Electronic VR** in the movie shooting menu is ISO 51200.
- 3 If **On** is selected for **ISO sensitivity settings > Auto ISO control (mode M)** in the movie shooting menu, the upper limit for ISO sensitivity can be selected using the **Maximum sensitivity** option.

In exposure mode **M**, shutter speed can be set to values between  $\frac{1}{25}$  s and  $\frac{1}{8000}$  s (the slowest available shutter speed varies with the frame rate; ☐ 68). In other exposure modes, shutter speed is adjusted automatically. If the subject is over- or under-exposed in mode **P** or **S**, end live view and start live view again or select exposure **A** and adjust aperture.

## Indices

If **Index marking** is assigned to a control using Custom Setting g1 (**Custom control assignment**, [□ 303](#)), you can press the selected control during recording to add indices that can be used to locate frames during editing and playback ([□ 81](#)). Up to 20 indices can be added to each movie.



Index

### See Also

The role played by the center of the multi selector can be chosen using Custom Setting f2 (**Multi selector center button**; [□ 301](#)) and the roles of the **Fn1**, **Fn2**, and **Pv** buttons and the center of the sub-selector using Custom Setting g1 (**Custom control assignment**; [□ 303](#)). Custom Setting g1 (**Custom control assignment**) > **Shutter-release button** controls whether the shutter-release button can be used to start live view or to start and end movie recording. For information on preventing unintended operation of the  button, see Custom Setting f8 (**Live view button options**; [□ 303](#)).

## Using the *i* Button

The options listed below can be accessed by pressing the *i* button in movie mode. Highlight items using the multi selector and press  $\blacktriangleleft$  to view options for the highlighted item. After choosing the desired setting, press  $\text{OK}$  to return to the *i*-button menu. Press the *i* button again to exit to the shooting display.

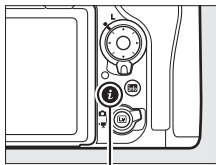

*i* button

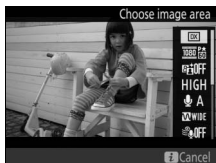

Option	Description
<b>Choose image area</b>	Choose image area for movies (📖 70).
<b>Frame size/frame rate</b>	Select a frame size and rate (📖 68).
<b>Active D-Lighting</b>	Adjust Active D-Lighting (📖 189). Not available at a frame size of 3840 × 2160 (📖 68).
<b>Movie quality</b>	Choose movie quality (📖 68).
<b>Microphone sensitivity</b>	Press $\blacktriangleleft$ or $\blacktriangleright$ to adjust microphone sensitivity (📖 290). Both the built-in and external microphones (📖 336) are affected.
<b>Frequency response</b>	Control the frequency response of the built-in or external microphones (📖 291).
<b>Wind noise reduction</b>	Enable or disable wind noise reduction using the built-in microphone's low-cut filter (📖 291).



Option	Description
<b>Destination</b>	When two memory cards are inserted, you can choose the card to which movies are recorded (☐ 288).
<b>Monitor brightness</b>	Press ☺ or ☹ to adjust monitor brightness (note that this affects live view only and has no effect on photographs or movies or on the brightness of the monitor for menus or playback; ☐ 50).
<b>Multi-selector power aperture</b>	Select <b>Enable</b> to enable power aperture. Press ☺ to widen the aperture, ☹ to narrow the aperture.
<b>Highlight display</b>	<p>Choose whether the brightest areas of the frame (highlights) are shown by slanting lines in the display.</p> <div data-bbox="650 419 930 666" style="text-align: center;"> <p><i>Highlights</i></p> </div>
<b>Headphone volume</b>	Press ☺ or ☹ to adjust headphone volume.
<b>Electronic VR</b>	Select <b>On</b> to enable electronic vibration reduction in movie mode. Not available at a frame size of 3840 × 2160 (☐ 68). Note that if the electronic vibration reduction is on and <b>DX</b> is selected for <b>Choose image area</b> , the angle of view is reduced and the edges of the frame will be cropped out.

### 🔧 Using an External Microphone

The optional ME-1 stereo microphone or ME-W1 wireless microphone can be used to record sound for movies (☐ 336).

### 🔧 Headphones

Third-party headphones can be used. Note that high sound levels may result in high volume; particular care should be taken when headphones are used.

## The Live View Display

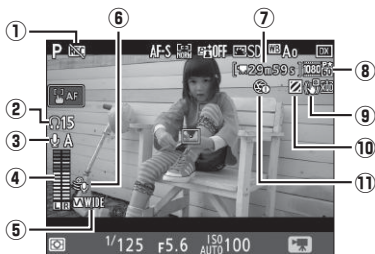

Item	Description	
① "No movie" indicator	Indicates that movies can not be recorded.	—
② Headphone volume	Volume of audio output to headphones. Displayed when third-party headphones are connected.	67
③ Microphone sensitivity	Microphone sensitivity.	64
④ Sound level	Sound level for audio recording. Displayed in red if level is too high; adjust microphone sensitivity accordingly.	—
⑤ Frequency response	The current frequency response.	64
⑥ Wind noise reduction	Displayed when wind noise reduction is on.	64
⑦ Time remaining	The recording time available for movies.	60
⑧ Movie frame size	The frame size for movie recording.	68
⑨ Electronic VR indicator	Displayed when electronic vibration reduction is on.	65
⑩ Highlight display indicator	Displayed when highlight display is on.	65
⑪ "No power aperture" indicator	Indicates that power aperture is unavailable.	65



### **The Count-Down Display**











A count down will be displayed 30 s before live view ends automatically (📖 53). Depending on shooting conditions, the timer may appear immediately when movie recording begins. Note that regardless of the amount of recording time available, live view will still end automatically when the timer expires. Wait for the internal circuits to cool before resuming movie recording.

### **Adjusting Settings During Movie Recording**

Headphone volume can not be adjusted during recording. If an option other than 🎧 (microphone off) is currently selected, microphone sensitivity can be changed to any setting other than 🎧 while recording is in progress.

## Frame Size, Frame Rate, and Movie Quality

The **Frame size/frame rate** option in the movie shooting menu is used to choose the movie frame size (in pixels) and frame rate. You can also choose from two **Movie quality** options: high and normal. Together, these options determine the maximum bit rate, as shown in the following table.

Option <sup>1</sup>	Maximum bit rate (Mbps) (★ high quality/Normal)	Maximum length
 <b>3840 × 2160 (4K UHD); 30p</b> <sup>2</sup>	144	29 min. 59 s <sup>3</sup>
 <b>3840 × 2160 (4K UHD); 25p</b> <sup>2</sup>		
 <b>3840 × 2160 (4K UHD); 24p</b> <sup>2</sup>		
 <b>1920 × 1080; 60p</b>	48/24	
 <b>1920 × 1080; 50p</b>		
 <b>1920 × 1080; 30p</b>	24/12	
 <b>1920 × 1080; 25p</b>		
 <b>1920 × 1080; 24p</b>		
 <b>1280 × 720; 60p</b>		
 <b>1280 × 720; 50p</b>		

- Actual frame rate is 29.97 fps for values listed as 30p, 23.976 fps for values listed as 24p, and 59.94 fps for values listed as 60p.
- When this option is selected,  is displayed in the monitor and movie quality is fixed at "high".
- Each movie will be recorded across up to 8 files of up to 4 GB each. The number of files and the length of each file vary with the options selected for **Frame size/frame rate** and **Movie quality**.



## The Movie Crop

Movies have an aspect ratio of 16 : 9 and are recorded using a crop that varies with the frame size and the option selected for **Choose image area** in the movie shooting menu (📖 68, 288).

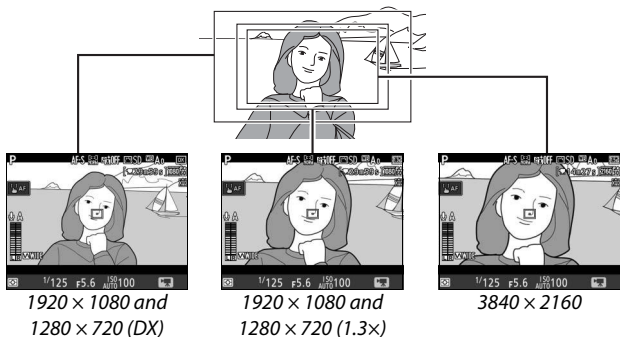

Movie crop sizes are given below:



- At a frame size of  $3840 \times 2160$ , the movie crop is approximately  $16.2 \times 9.1$  mm, regardless of the option selected for **Choose image area**. The apparent focal length is approximately 1.5x greater than that for DX format.
- With **DX** selected for **Choose image area** and a frame size of  $1920 \times 1080$  or  $1280 \times 720$ , the movie crop is approximately  $23.5 \times 13.3$  mm.
- With **1.3x** selected for **Choose image area** and a frame size of  $1920 \times 1080$  or  $1280 \times 720$ , the movie crop is approximately  $18.0 \times 10.1$  mm. The apparent focal length is approximately 1.3x greater than that for DX format.

## Taking Photos in Movie Mode

To take photos in movie mode (either in live view or during movie recording), select **Take photos** for Custom Setting g1 (**Custom control assignment**) >



**Shutter-release button** (☞ 303). Photos with an aspect ratio of 16 : 9 can then be taken at any time by pressing the shutter-release button all the way down. If movie recording is in progress, recording will end and the footage recorded to that point will be saved.

Except at a frame size of 3840 × 2160 (☞ 68), photographs are recorded in the format selected for **Image quality** in the photo shooting menu (☞ 91); photos taken at a frame size of 3840 × 2160 are recorded at an image quality of JPEG fine★. For information on image size, see page 72. Note that the exposure for photographs can not be previewed when the live view selector is rotated to ; mode **P**, **S**, or **A** is recommended but accurate results can be achieved in mode **M** by previewing exposure with the live view selector rotated to .

## ■ Image Size

The size of photos taken in movie mode varies with the movie frame size (☐ 68) and, in the case of photos taken at frame sizes of 1920 × 1080 and 1280 × 720, with the image area and the option selected for **Image size > JPEG/TIFF** in the photo shooting menu (☐ 94).

Frame size	Image area	Image size	Size (pixels)
3840 × 2160	—		3840 × 2160
1920 × 1080 1280 × 720	DX	Large	5568 × 3128
		Medium	4176 × 2344
		Small	2784 × 1560
	1.3×	Large	4272 × 2400
		Medium	3200 × 1800
		Small	2128 × 1192

### ☑ Recording Movies

Movies are recorded in the sRGB color space. Flicker, banding, or distortion may be visible in the monitor and in the final movie under fluorescent, mercury vapor, or sodium lamps or if the camera is panned horizontally or an object moves at high speed through frame (for information on reducing flicker and banding, see **Flicker reduction**, ☐ 290). Flicker may also appear while power aperture is in use.

Jagged edges, color fringing, moiré, and bright spots may also appear. Bright bands may appear in some areas of the frame with flashing signs and other intermittent light sources or if the subject is briefly illuminated by a strobe or other bright, momentary light source. When recording movies, avoid pointing the camera at the sun or other strong light sources. Failure to observe this precaution could result in damage to the camera's internal circuitry. Note that noise (randomly-spaced bright pixels, fog, or lines) and unexpected colors may appear if you zoom in on the view through the lens (☐ 46) in movie mode.

Flash lighting can not be used.

Recording ends automatically if the lens is removed or the live view selector is rotated to a new setting.

### **Wireless Remote Controllers and Remote Cords**

If **Record movies** is selected for Custom Setting g1 (**Custom control assignment**) > **Shutter-release button** (☞ 303), the shutter-release buttons on optional wireless remote controllers and remote cords (☞ 335, 336) can be used to start live view and to start and end movie recording.

## Time-Lapse Movies

The camera automatically takes photos at selected intervals to create a silent time-lapse movie using the options currently selected for **Choose image area**, **Frame size/frame rate**, **Movie quality**, and **Destination** in the movie shooting menu (📖 288).

### 🔪 Before Shooting

Before shooting a time-lapse movie, take a test shot at current settings and view the results in the monitor (time-lapse movies are shot using the movie crop; use live view so that you can check the composition). For consistent coloration, choose a white balance setting other than auto (📖 159).

Use of a tripod is recommended. Mount the camera on a tripod before shooting begins. To ensure that shooting is not interrupted, use an optional AC adapter and power connector or a fully-charged battery. To prevent light entering via the viewfinder interfering with photographs and exposure, close the viewfinder eyepiece shutter (📖 119).

### 1 Select Time-lapse movie.

Highlight **Time-lapse movie** in the movie shooting menu and press **▶** to display time-lapse movie settings.

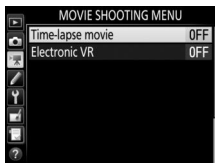



## 2 Adjust time-lapse movie settings.

Choose an interval, total shooting time, and exposure smoothing option.

- To choose the interval between frames:



Highlight **Interval** and press .



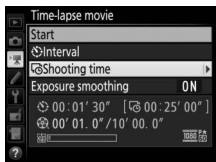

Choose an interval longer than the slowest anticipated shutter speed (minutes and seconds) and press .

- To choose the total shooting time:

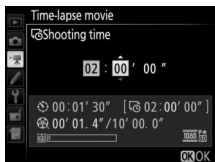

Highlight **Shooting time** and press .



Choose shooting time (up to 7 hours 59 minutes) and press .

- To enable or disable exposure smoothing:

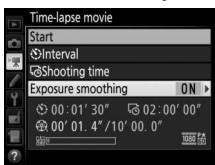

Highlight **Exposure smoothing** and press  $\odot$ .

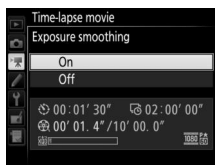

Highlight an option and press  $\odot$ .

Selecting **On** smooths abrupt changes in exposure in modes other than **M** (note that exposure smoothing only takes effect in mode **M** if auto ISO sensitivity control is enabled in the photo shooting menu).

### 3 Start shooting.

Highlight **Start** and press  $\odot$ .

Shooting starts after about 3 s. The camera takes photographs at the selected interval for the selected shooting time. When complete, time-lapse movies are recorded to the memory card selected for **Destination** in movie shooting menu (□ 288).



#### 3840 × 2160

If an option with a frame size 3840 × 2160 is selected for **Frame size/frame rate** in the movie shooting menu, the 1.3× DX crop indicator and 1.3× DX crop will be displayed in the viewfinder; rotate the live view selector to  and frame the shot in live view (□ 70).

### Calculating the Length of the Final Movie

The total number of frames in the final movie can be calculated by dividing the shooting time by the interval and rounding up. The length of the final movie can then be calculated by dividing the number of shots by the frame rate selected for **Frame size/frame rate** in movie shooting menu (p. 68). A 48 frame movie recorded at **1920 x 1080; 24p**, for example, will be about two seconds long. The maximum length for time-lapse movies is 20 minutes.

*Length recorded/  
maximum length*

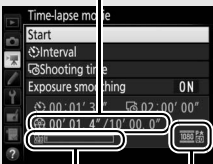

*Memory card  
indicator*

*Frame size/frame rate*

## ■ ■ *Ending Shooting*

To end shooting before all the photos are taken, highlight **Off** in the time-lapse movie menu and press **OK**, or press **OK** between frames or immediately after a frame is recorded. A movie will be created from the frames shot to the point where shooting ended. Note that shooting will end and no movie will be recorded if the power source is removed or disconnected or the destination memory card is ejected.

## ■ ■ *No Photograph*

The camera will skip the current frame if the camera is unable to focus in **AF-S** (note that the camera focuses again before each shot). Shooting will resume with the next frame.

## ✓ *Time-Lapse Movies*

Time-lapse is not available during live view (□ 43) or movie recording (□ 58), at a shutter speed of **b u 1 b** or **- -** (□ 137) or when bracketing (□ 146), High Dynamic Range (HDR, □ 191), multiple exposure (□ 236), or interval timer photography (□ 243) is active. Note that because shutter speed and the time needed to record the image to the memory card may vary from shot to shot, the interval between a shot being recorded and the start of the next shot may vary. Shooting will not begin if a time-lapse movie can not be recorded at current settings (for example, if the memory card is full, the interval or shooting time is zero, or the interval is longer than the shooting time).

Shooting may end if camera controls are used or settings are changed or HDMI cable is connected. A movie will be created from the frames shot to the point where shooting ended. To end shooting and record a photograph, press the shutter-release button all the way down.

### ✎ During Shooting

During shooting, **INTVL** will flash and the time-lapse recording indicator will be displayed in the control panel. The time remaining (in hours and minutes) appears in the shutter-speed display immediately before each frame is recorded. At other times, the time remaining can be viewed by pressing the shutter-release button halfway. Regardless of the option selected for Custom Setting c2 (**Standby timer**, □ 296), the standby timer will not expire during shooting.

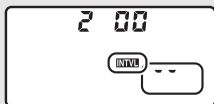

To view current time-lapse movie settings or end shooting (□ 78), press the **MENU** button between shots. While shooting is in progress, the time-lapse movie menu will show exposure smoothing, the interval, and the time remaining. These settings can not be changed while shooting is in progress, nor can pictures be played back or other menu settings adjusted.

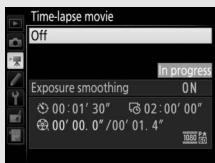

### ✎ Image Review

The **▶** button can not be used to view pictures while shooting is in progress, but the current frame will be displayed for a few seconds after each shot if **On** is selected for **Image review** in the playback menu (□ 282). Other playback operations can not be performed while the frame is displayed.



### ✎ Release Mode

Regardless of the release mode selected, the camera will take one shot at each interval. The self-timer can not be used.

### ✎ See Also



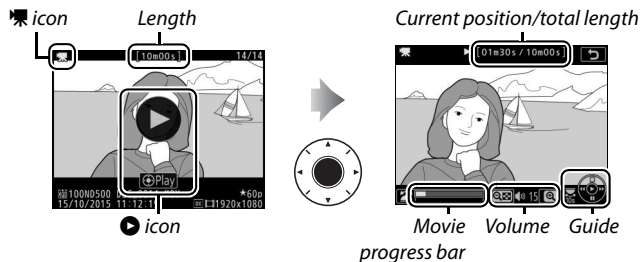

The **Beep** option in the setup menu controls whether a beep sounds when shooting is complete (□ 306).

## Viewing Movies

Movies are indicated by a  icon in full-frame playback (255). Tap the  icon in the monitor or press the center of the multi selector to start playback; your current position is indicated by the movie progress bar.



The following operations can be performed:

To	Use	Description
Pause		Pause playback.
Play		Resume playback when movie is paused or during rewind/advance.
Rewind/ advance		Speed increases with each press, from 2x to 4x to 8x to 16x; keep pressed to skip to beginning or end of movie (first frame is indicated by  in top right corner of monitor, last frame by  ). If playback is paused, movie rewinds or advances one frame at a time; hold for continuous rewind or advance.

To	Use	Description
Start slow-motion playback		Press  while the movie is paused to start slow-motion playback.
Skip 10 s		Rotate the main command dial to skip ahead or back 10 s.
Skip ahead/back		Rotate the sub-command dial to skip to next or previous index, or to skip to the last or first frame if the movie contains no indices.
Adjust volume		Press  to increase volume,  to decrease.
Trim movie		See page 82 for more information.
Exit		Exit to full-frame playback.
Return to shooting mode		Press the shutter-release button halfway to exit to shooting mode.

### The Icon

Movies with indices ( 63) are indicated by a icon in full-frame playback.





### The Icon

is displayed in full-frame and movie playback if the movie was recorded without sound ( 290).



## Editing Movies

Trim footage to create edited copies of movies or save selected frames as JPEG stills.

Option	Description
 <b>Choose start/end point</b>	Create a copy from which unwanted footage has been removed.
 <b>Save selected frame</b>	Save a selected frame as a JPEG still.

## Trimming Movies



To create trimmed copies of movies:

**1** Display a movie full frame (📖 255).

**2** Pause the movie on the new opening frame.

Play the movie back as described on page 80, pressing the center of the multi selector to start and resume playback and ⏸ to pause and pressing ⏮ or ⏭ or rotating the main or sub-command dial to locate the desired frame. Your approximate position in the movie can be ascertained from the movie progress bar. Pause playback when you reach the new opening frame.



*Movie progress bar*



### 3 Select **Choose start/end point**.

Press **i** or **OK**, then highlight **Choose start/end point** and press **▶**.



### 4 Select **Start point**.

To create a copy that begins from the current frame, highlight **Start point** and press **OK**. The frames before the current frame will be removed when you save the copy in Step 9.

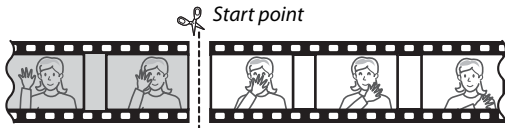
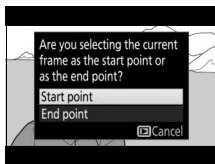

### 5 Confirm the new start point.

If the desired frame is not currently displayed, press **◀** or **▶** to advance or rewind (to skip to 10 s ahead or back, rotate the main command dial; to skip to an index, or to the first or last frame if the movie contains no indices, rotate the sub-command dial).



## 6 Choose the end point.

Press **○** **○** (□→/? ) to switch from the start point (▾) to the end point (▾) selection tool and then select the closing frame as described in Step 5. The frames after the selected frame will be removed when you save the copy in Step 9.

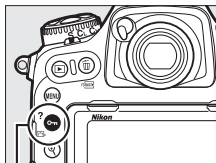

**○** **○** (□→/? ) button

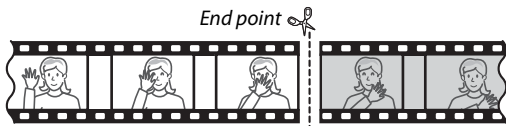

## 7 Create the copy.

Once the desired frame is displayed, press **○**.

## 8 Preview the movie.

To preview the copy, highlight **Preview** and press **○** (to interrupt the preview and return to the save options menu, press **○**). To abandon the current copy and select a new start point or end point as described on the foregoing pages, highlight **Cancel** and press **○**; to save the copy, proceed to Step 9.

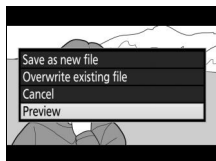

## 9 Save the copy.

Highlight **Save as new file** and press **OK** to save the copy to a new file. To replace the original movie file with the edited copy, highlight **Overwrite existing file** and press **OK**.

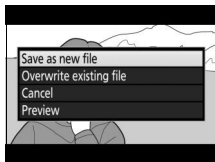

### Trimming Movies

Movies must be at least two seconds long. The copy will not be saved if there is insufficient space available on the memory card.

Copies have the same time and date of creation as the original.

### Removing Opening or Closing Footage

To remove only the opening footage from the movie, proceed to Step 7 without pressing the **OK** (**↵**/? ) button in Step 6. To remove only the closing footage, select **End point** in Step 4, select the closing frame, and proceed to Step 7 without pressing the **OK** (**↵**/? ) button in Step 6.

## Saving Selected Frames



To save a copy of a selected frame as a JPEG still:

### 1 Pause the movie on the desired frame.

Play the movie back as described on page 80, pressing the center of the multi selector to start and resume playback and  to pause. Pause the movie at the frame you intend to copy.



### 2 Choose Save selected frame.

Press  or , then highlight **Save selected frame** and press .

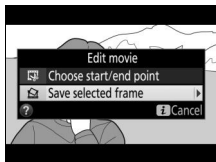



### 3 Create a still copy.

Press  to create a still copy of the current frame.



### 4 Save the copy.

Highlight **Yes** and press  to create a fine★-quality ( 91) JPEG copy of the selected frame.

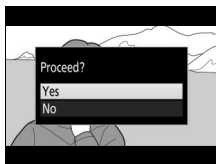

### ✔ Save Selected Frame

JPEG movie stills created with the **Save selected frame** option can not be retouched. JPEG movie stills lack some categories of photo information (☞ 261).



### ✔ The Retouch Menu

Movies can also be edited using the **Edit movie** option in the retouch menu (☞ 314).

# Image Recording Options

## Image Area

Choose an image area from **DX (24×16)** and **1.3× (18×12)**.

Option	Description
 <b>DX (24×16)</b>	Pictures are recorded using a 23.5 × 15.7 mm image area (DX format).
 <b>1.3× (18×12)</b>	Pictures are recorded using an 18.0 × 12.0 mm image area, producing a telephoto effect without the need to change lenses.

*Viewfinder display*

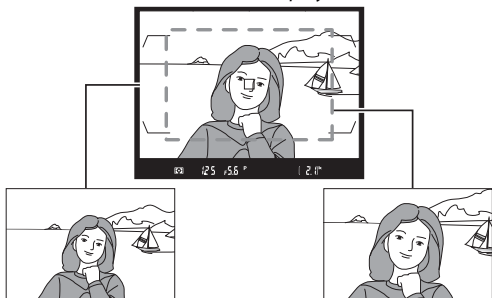

*Photo with DX image area  
(24×16)*

*Photo with image area of  
1.3× (18×12)*

### Image Area

The selected option is shown in the information display.



The image area can be selected using the **Choose image area** option in the photo shooting menu or by pressing a control and rotating a command dial.

## ■ The Choose Image Area Menu

- 1 Select Choose image area.**  
Highlight **Choose image area** in the photo shooting menu and press .

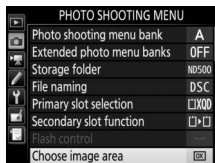

- 2 Adjust settings.**  
Choose an option and press . The selected crop is displayed in the viewfinder.

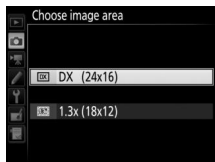

### ■ The Viewfinder Display

The viewfinder display for the 1.3× DX crop is shown at right. A  icon is displayed in the viewfinder when the 1.3× DX crop is selected.



1.3x DX crop

### ■ Image Size

Image size varies with the option selected for image area.

### 1 Assign image area selection to a camera control.

Use Custom Setting f1 (**Custom control assignment**,  301) to assign **Choose image area** to a control.

---

### 2 Use the selected control to choose an image area.

The image area can be selected by pressing the selected control and rotating the main or sub-command dial until the desired crop is displayed in the viewfinder ( 88).

The option currently selected for image area can be viewed by pressing the control to display the image area in the control panel or information display. DX format is displayed as "24- 16" and 1.3× as "18- 12".

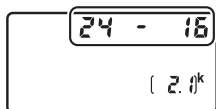

#### See Also

See page 70 for information on the crops available for movie recording.



## Image Quality

The D500 supports the following image quality options. See page 389 for information on the number of pictures that can be stored at different image quality and size settings.

Option	File type	Description
NEF (RAW)	NEF	RAW data from the image sensor are saved without additional processing. Settings such as white balance and contrast can be adjusted after shooting.
NEF (RAW)+ JPEG fine★/ NEF (RAW)+ JPEG fine	NEF/ JPEG	Two images are recorded, one NEF (RAW) image and one fine-quality JPEG image.
NEF (RAW)+ JPEG normal★/ NEF (RAW)+ JPEG normal		Two images are recorded, one NEF (RAW) image and one normal-quality JPEG image.
NEF (RAW)+ JPEG basic★/ NEF (RAW)+ JPEG basic		Two images are recorded, one NEF (RAW) image and one basic-quality JPEG image.
JPEG fine★/ JPEG fine	JPEG	Record JPEG images at a compression ratio of roughly 1:4 (fine quality).
JPEG normal★/ JPEG normal		Record JPEG images at a compression ratio of roughly 1:8 (normal quality).
JPEG basic★/ JPEG basic		Record JPEG images at a compression ratio of roughly 1:16 (basic quality).
TIFF (RGB)	TIFF (RGB)	Record uncompressed TIFF-RGB images at a bit depth of 8 bits per channel (24-bit color). TIFF is supported by a wide variety of imaging applications.

Image quality is set by pressing the **QUAL** button and rotating the main command dial until the desired setting is displayed in the control panel.

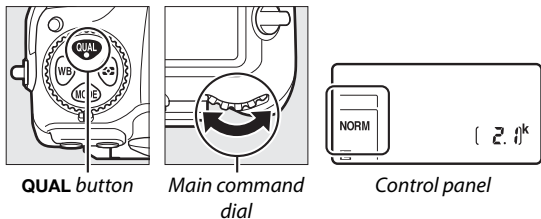

#### **JPEG Compression**

Image quality options with a star (“★”) use compression intended to ensure maximum quality; the size of the files varies with the scene. Options without a star use a type of compression designed to produce smaller files; files tend to be roughly the same size regardless of the scene recorded.

#### **NEF+JPEG**



When photographs taken at settings of NEF (RAW) + JPEG are viewed on the camera with only one memory card inserted, only the JPEG image will be displayed. If both copies are recorded to the same memory card, both copies will be erased when the photo is deleted. If the JPEG copy is recorded to a separate memory card using the **Secondary slot function > RAW primary - JPEG secondary** option, each copy must be deleted separately.

#### **The Image Quality Menu**

Image quality can also be adjusted using the **Image quality** option in the photo shooting menu (☞ 284).

## ■■ NEF (RAW) Compression

To choose the type of compression for NEF (RAW) images, highlight **NEF (RAW) recording > NEF (RAW) compression** in the photo shooting menu and press .

Option	Description
ON  <b>Lossless compressed</b>	NEF images are compressed using a reversible algorithm, reducing file size by about 20–40% with no effect on image quality.
ON  <b>Compressed</b>	NEF images are compressed using a non-reversible algorithm, reducing file size by about 35–55% with almost no effect on image quality.
<b>Uncompressed</b>	NEF images are not compressed.

## ■■ NEF (RAW) Bit Depth

To choose a bit depth for NEF (RAW) images, highlight **NEF (RAW) recording > NEF (RAW) bit depth** in the photo shooting menu and press .

Option	Description
12-bit <b>12-bit</b>	NEF (RAW) images are recorded at a bit-depth of 12 bits.
14-bit <b>14-bit</b>	NEF (RAW) images are recorded at a bit depth of 14 bits, producing files larger than those with a bit depth of 12 bits but increasing the color data recorded.

### NEF (RAW) Images

JPEG copies of NEF (RAW) images can be created using Capture NX-D or other software or the **NEF (RAW) processing** option in the retouch menu ( 313).

## Image Size

Image size is measured in pixels. Choose from  **Large**,  **Medium**, or  **Small** (note that image size varies depending on the option selected for **Choose image area**,  88):

Image area	Option	Size (pixels)	Print size (cm/in.)*
DX (24×16)	<b>Large</b>	5568 × 3712	47.1 × 31.4/18.6 × 12.4
	<b>Medium</b>	4176 × 2784	35.4 × 23.6/13.9 × 9.3
	<b>Small</b>	2784 × 1856	23.6 × 15.7/ 9.3 × 6.2
1.3× (18×12)	<b>Large</b>	4272 × 2848	36.2 × 24.1/14.2 × 9.5
	<b>Medium</b>	3200 × 2136	27.1 × 18.1/10.7 × 7.1
	<b>Small</b>	2128 × 1424	18.0 × 12.1/ 7.1 × 4.7

\* Approximate size when printed at 300 dpi. Print size in inches equals image size in pixels divided by printer resolution in dots per inch (dpi; 1 inch = approximately 2.54 cm).

Image size for JPEG and TIFF images can be set by pressing the **QUAL** button and rotating the sub-command dial until the desired option is displayed in the control panel. To choose the size of NEF (RAW) images, use the **Image size > NEF (RAW)** option in the photo shooting menu.

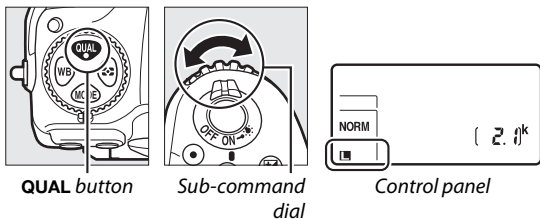

### The Image Size Menu

Image size for JPEG and TIFF images can also be adjusted using the **Image size > JPEG/ TIFF** option in the photo shooting menu (284). Small and medium sized NEF (RAW) images are recorded in lossless compressed 12-bit format, regardless of the options selected for **NEF (RAW) compression** and **NEF (RAW) bit depth** in the **NEF (RAW) recording** menu.

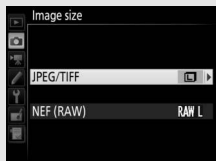

## Using Two Memory Cards

When two memory cards are inserted in the camera, you can choose one as the primary card using the **Primary slot selection** item in the photo shooting menu. Select **XQD card slot** to designate the card in the XQD card slot as the primary card, **SD card slot** to choose the SD card. The roles played by the primary and secondary cards can be chosen using the **Secondary slot function** option in the photo shooting menu. Choose from **Overflow** (the secondary card is used only when the primary card is full), **Backup** (each picture is recorded to both the primary and secondary card), and **RAW primary - JPEG secondary** (as for **Backup**, except that the NEF/RAW copies of photos shot at settings of NEF/RAW + JPEG are recorded only to the primary card and the JPEG copies only to the secondary card).

### "Backup" and "RAW Primary - JPEG Secondary"

The camera shows the number of exposures remaining on the card with the least amount of memory. Shutter release will be disabled when either card is full.

### Recording Movies

When two memory cards are inserted in the camera, the slot used to record movies can be selected using the **Destination** option in the movie shooting menu (☐ 288).

# Focus

This section describes the focus options available when photographs are framed in the viewfinder. Focus can be adjusted automatically (see below) or manually (📖 114). The user can also select the focus point for automatic or manual focus (📖 108) or use focus lock to focus and recompose photographs after focusing (📖 111).

## Autofocus

To use autofocus, rotate the focus-mode selector to **AF**.

Focus-mode selector

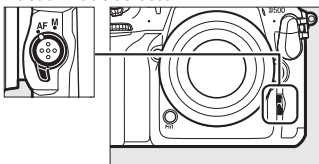

The camera focuses using 153 focus points, of which the 55 shown by □ in the illustration at right can be selected by the user (📖 108).



User-selectable focus points

### 1.3x (18x12)

When **1.3x (18x12)** is selected for **Choose image area** (📖 89), the camera focuses using 117 focus points, of which 45 can be selected by the user. The remaining focus points at the left and right edges of the focus point display are not used.

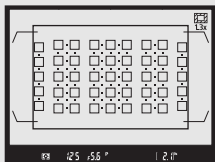

Focus points available when **1.3x (18x12)** is selected

## Cross Sensors

The availability of cross-sensor focus points varies with the lens used.

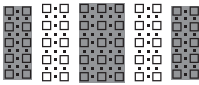
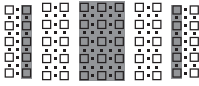
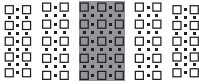
Lens	Cross sensors (cross-sensor focus points highlighted in gray <sup>2,3</sup> )
AF-S lenses other than those listed below with maximum apertures of f/4 or faster <sup>1</sup>	 <p>99 cross sensors</p>
<ul style="list-style-type: none"><li>• AF-S DX Zoom-Nikkor 12–24mm f/4G IF-ED</li><li>• AF-S Micro NIKKOR 60mm f/2.8G ED</li><li>• AF-S NIKKOR 600mm f/4G ED VR</li><li>• AF-S NIKKOR 600mm f/4E FL ED VR</li><li>• AF-S Nikkor 600mm f/4D IF-ED II</li><li>• AF-S Nikkor 600mm f/4D IF-ED</li></ul>	 <p>63 cross sensors</p>
<ul style="list-style-type: none"><li>• AF-S NIKKOR 200–400mm f/4G ED VR II</li><li>• AF-S VR Zoom-Nikkor 200–400mm f/4G IF-ED</li><li>• AF-S NIKKOR 500mm f/4G ED VR</li><li>• AF-S Nikkor 500mm f/4D IF-ED II</li><li>• AF-S Nikkor 500mm f/4D IF-ED</li><li>• AF-S lenses with maximum apertures slower than f/4<sup>1</sup></li><li>• Non-AF-S lenses</li></ul>	 <p>45 cross sensors</p>

1 At maximum zoom, in the case of zoom lenses.

2 Other focus points use line sensors, which detect horizontal lines.

3 The focus points at the left and right edges of the focus point display are not used when **1.3× (18×12)** is selected for **Choose image area** ( 89).



### 🔍 AF-S/AF-I Teleconverters and Available Focus Points

When an AF-S or AF-I teleconverter is attached, the focus points shown in the illustrations can be used for autofocus and electronic rangefinding (note that at maximum combined apertures slower than f/5.6, the camera may not be able to focus on dark or low-contrast subjects).

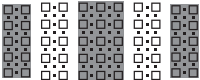
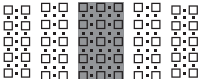
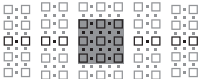
Teleconverter	Max. lens aperture <sup>1</sup>	Available focus points (cross-sensor focus points highlighted in gray <sup>2</sup> )
TC-14E, TC-14E II, TC-14E III TC-17E II TC-20E, TC-20E II, TC-20E III	f/2	
TC-14E, TC-14E II, TC-14E III	f/2.8	153 focus points (55 selectable) with 99 cross sensors
TC-17E II TC-20E, TC-20E II, TC-20E III	f/2.8	
TC-14E, TC-14E II, TC-14E III	f/4	153 focus points (55 selectable) with 45 cross sensors
TC-17E II	f/4	
TC-800-1.25E ED	f/5.6	37 focus points (17 selectable) with 25 cross sensors

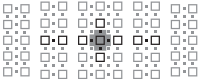
Teleconverter	Max. lens aperture <sup>1</sup>	Available focus points (cross-sensor focus points highlighted in gray <sup>2</sup> )
TC-20E, TC-20E II, TC-20E III	f/4	
TC-14E, TC-14E II, TC-14E III	f/5.6	15 focus points (9 selectable) with 5 cross sensors

1 At maximum zoom, in the case of zoom lenses.

2 Other focus points use line sensors, which detect horizontal lines, but note that if there are only 5 cross sensors, only those shown by  detect vertical lines.

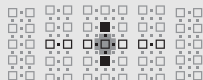

Autofocus is not available when teleconverters are used with AF-S VR Micro-Nikkor 105mm f/2.8G IF-ED lenses.

## Autofocus Mode

Choose from the following autofocus modes:

Mode	Description
AF-S	<b>Single-servo AF:</b> For stationary subjects. Focus locks when shutter-release button is pressed halfway. At default settings, shutter can only be released when in-focus indicator (●) is displayed ( <i>focus priority</i> ; □ 292).
AF-C	<b>Continuous-servo AF:</b> For moving subjects. Camera focuses continuously while shutter-release button is pressed halfway; if subject moves, camera will engage <i>predictive focus tracking</i> (□ 102) to predict final distance to subject and adjust focus as necessary. At default settings, shutter can be released whether or not subject is in focus ( <i>release priority</i> ; □ 292).

Autofocus mode can be selected by pressing the AF-mode button and rotating the main command dial until the desired setting is displayed in the viewfinder and control panel.

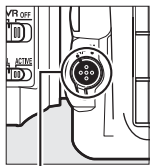

AF-mode button

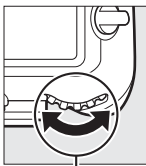

Main command dial

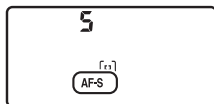

Control panel



Viewfinder

## See Also

For information on using focus priority in continuous-servo AF, see Custom Setting a1 (**AF-C priority selection**, [□ 292](#)). For information on using release priority in single-servo AF, see Custom Setting a2 (**AF-S priority selection**, [□ 292](#)). For information on preventing the camera from focusing when the shutter-release button is pressed halfway, see Custom Setting a8 (**AF activation**, [□ 293](#)). See Custom Setting a10 (**Autofocus mode restrictions**, [□ 294](#)) for information on limiting focus-mode selection to **AF-S** or **AF-C** and f4 (**Customize command dials**) > **Change main/sub** ([□ 302](#)) for information on using the sub-command dial to choose the focus mode. See page 47 for information on the autofocus options available in live view or during movie recording.

## The AF-ON Button

For the purpose of focusing the camera, pressing the **AF-ON** button has the same effect as pressing the shutter-release button halfway.

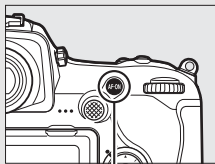

**AF-ON** button

## Predictive Focus Tracking

In **AF-C** mode, the camera will initiate predictive focus tracking if the subject moves toward or away from the camera while the shutter-release button is pressed halfway or the **AF-ON** button is pressed. This allows the camera to track focus while attempting to predict where the subject will be when the shutter is released.

## **AF-Area Mode**

Choose how the focus point for autofocus is selected.

- **Single-point AF:** Select the focus point as described on page 108; the camera will focus on the subject in the selected focus point only. Use with stationary subjects.
- **Dynamic-area AF:** Select the focus point as described on page 108. In **AF-C** focus mode, the camera will focus based on information from surrounding focus points if the subject briefly leaves the selected point. The number of focus points varies with the mode selected:
  - **25-point dynamic-area AF:** Choose when there is time to compose the photograph or when photographing subjects that are moving predictably (e.g., runners or race cars on a track).
  - **72-point dynamic-area AF:** Choose when photographing subjects that are moving unpredictably (e.g., players at a football game).
  - **153-point dynamic-area AF\*:** Choose when photographing subjects that are moving quickly and can not be easily framed in the viewfinder (e.g., birds).

- **3D-tracking\***: Select the focus point as described on page 108. In **AF-C** focus mode, the camera will track subjects that leave the selected focus point and select new focus points as required. Use to quickly compose pictures with subjects that are moving erratically from side to side (e.g., tennis players). If the subject leaves viewfinder, remove your finger from the shutter-release button and recompose the photograph with the subject in the selected focus point.



- **Group-area AF**: The camera focuses using a group of focus points selected by the user, reducing the risk of the camera focusing on the background instead of on the main subject. Choose for subjects that are difficult to photograph using a single focus point. If faces are detected in **AF-S** focus mode, the camera will give priority to portrait subjects.
- **Auto-area AF**: The camera automatically detects the subject and selects the focus point; if a face is detected, the camera will give priority to the portrait subject. The active focus points are highlighted briefly after the camera focuses; in **AF-C** mode, the main focus point is displayed after the other focus points have turned off.



- \* Note that when **1.3x (18x12)** is selected for **Choose image area** (☐ 89), the camera focuses using 117 focus points. The remaining focus points at the left and right edges of the focus point display are not used.

AF-area mode can be selected by pressing the AF-mode button and rotating the sub-command dial until the desired setting is displayed in the viewfinder and control panel.

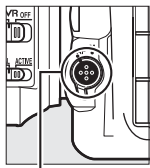

AF-mode button

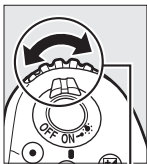

Sub-command dial

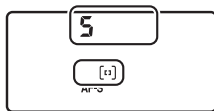

Control panel

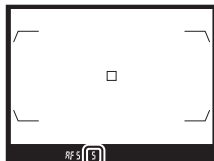

Viewfinder











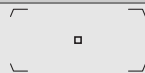

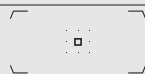
### 3D-tracking

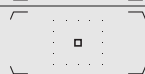
When the shutter-release button is pressed halfway, the colors in the area surrounding the focus point are stored in the camera.

Consequently 3D-tracking may not produce the desired results with subjects that are similar in color to the background or that occupy a very small area of the frame.

## AF-Area Mode

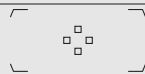
AF-area mode is shown in the control panel and viewfinder.

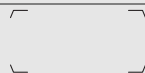
AF-area mode	Control panel	Viewfinder	Viewfinder focus-point display
Single-point AF	S		
25-point dynamic-area AF*	d 25		
72-point dynamic-area AF*	d 72		
153-point dynamic-area AF*	d 153		
3D-tracking	3d		
Group-area AF	GrP		
Auto-area AF	Auto		

\* Only active focus point is displayed in the viewfinder. Remaining focus points provide information to assist focus operation.



### 🔍 AF-S/AF-I Teleconverters

If 3D-tracking or auto-area AF is selected for AF-area mode when an AF-S/AF-I teleconverter is used, single-point AF will automatically be selected at combined apertures slower than f/5.6.

### 🔍 Manual Focus

Single-point AF is automatically selected when manual focus is used.

### 🔍 See Also

For information on how autofocus adjusts to changes in the distance to the subject, see Custom Setting a3 (**Focus tracking with lock-on**, □ 292). To adjust settings for 3D-tracking, use Custom Settings a4 (**3D-tracking face-detection**, □ 293) and a5 (**3D-tracking watch area**, □ 293). See Custom Settings a7 (**Store by orientation**, □ 293) for information on choosing different focus points and/or AF-area modes for portrait- and landscape-orientation photographs, a9 (**Limit AF-area mode selection**, □ 293) for information on limiting AF-area mode selection, a12 (**Focus point options**, □ 294) for information on choosing how the focus point is displayed, and f4 (**Customize command dials**) > **Change main/sub** (□ 302) for information on using the main command dial to choose the AF-area mode. See page 48 for information on the autofocus options available in live view or during movie recording.

## Focus Point Selection

The camera focuses using 153 focus points, of which 55 shown at right can be selected manually, allowing



photographs to be composed with the main subject positioned almost anywhere in the frame (when **1.3x (18x12)** is selected for **Choose image area**, the camera focuses using 117 focus points, of which 45 can be selected manually;  89). Follow the steps below to choose the focus point (in group-area AF, you can follow these steps to choose a group of focus points).

### 1 Rotate the focus selector lock to ●.

This allows the multi selector to be used to select the focus point.

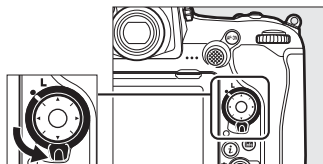

Focus selector lock

### 2 Select the focus point.

Use the multi selector to select the focus point in the viewfinder while the exposure meters are on. The center focus point can be selected by pressing the center of the multi selector.

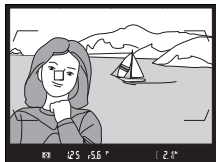

The focus selector lock can be rotated to the locked (L) position following selection to prevent the selected focus point from changing when the multi selector is pressed.

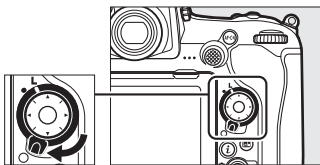

### The Sub-selector

The sub-selector can be used in place of the multi selector to select the focus point. Focus and exposure lock while the center of the sub-selector is pressed (☐ 111, 141). Use the sub-selector as shown at right; pressing the sides may not have the desired effect. Be careful not to put your fingers or fingernails in your eye when using the sub-selector.

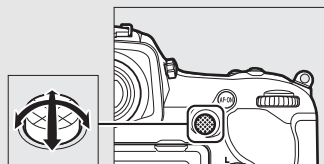

*Sub-selector*

### Auto-area AF

The focus point for auto-area AF is selected automatically; manual focus-point selection is not available.

### See Also

For information on choosing the number of focus points that can be selected using the multi selector, see Custom Setting a6 (**Number of focus points**, [□ 293](#)). For information on choosing separate focus points and/or AF-area modes for vertical and horizontal orientations, see Custom Setting a7 (**Store by orientation**, [□ 293](#)). For information on setting focus-point selection to “wrap around,” see Custom Setting a11 (**Focus point wrap-around**, [□ 294](#)). For information on choosing when the focus point is illuminated, see Custom Setting a12 (**Focus point options**, [□ 294](#)). For information on changing the role played by the sub-selector, see Custom Setting f1 (**Custom control assignment**) > **Sub-selector** ([□ 301](#)) and **Sub-selector center** ([□ 301](#)). For information on changing the role of the multi selector center button, see Custom Setting f2 (**Multi selector center button**, [□ 301](#)).

## Focus Lock

Focus lock can be used to change the composition after focusing, making it possible to focus on a subject that will not be in a focus point in the final composition. If the camera is unable to focus using autofocus (☐ 113), focus lock can also be used to recompose the photograph after focusing on another object at the same distance as your original subject. Focus lock is most effective when an option other than auto-area AF is selected for AF-area mode (☐ 103).

### 1 Focus.

Position the subject in the selected focus point and press the shutter-release button halfway to initiate focus. Check that the in-focus indicator (●) appears in the viewfinder.



### 2 Lock focus.

**AF-C focus mode** (☐ 101): With the shutter-release button pressed halfway (①), press the center of the sub-selector (②) to lock both focus and exposure (an **AE-L** icon will be displayed in the viewfinder). Focus will remain locked while the center of the sub-selector is pressed, even if you later remove your finger from the shutter-release button.

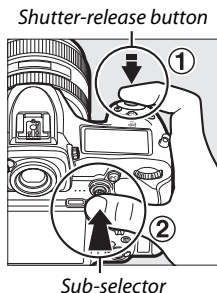

**AF-S focus mode:** Focus locks automatically when the in-focus indicator (●) appears, and remains locked until you remove your finger from the shutter-release button. Focus can also be locked by pressing the center of the sub-selector as described on the previous page.

### 3 Recompose the photograph and shoot.

Focus will remain locked between shots if you keep the shutter-release button pressed halfway (**AF-S**) or keep the center of the sub-selector pressed, allowing several photographs in succession to be taken at the same focus setting.



Do not change the distance between the camera and the subject while focus lock is in effect. If the subject moves, focus again at the new distance.

#### Locking Focus with the AF-ON Button

During viewfinder photography, focus can be locked using the **AF-ON** button in place of the shutter-release button (□ 102). If **AF-ON only** is selected for Custom Setting a8 (**AF activation**, □ 293), the camera will not focus when the shutter-release button is pressed halfway; instead, the camera will focus when the **AF-ON** button is pressed, at which point focus will lock and remain locked until the **AF-ON** button is pressed again.

#### See Also

See Custom setting c1 (**Shutter-release button AE-L**, □ 296) for information on using the shutter-release button to lock exposure.

## Getting Good Results with Autofocus

Autofocus does not perform well under the conditions listed below. The shutter release may be disabled if the camera is unable to focus under these conditions, or the in-focus indicator (●) may be displayed and the camera may sound a beep, allowing the shutter to be released even when the subject is not in focus. In these cases, use manual focus (📖 114) or use focus lock (📖 111) to focus on another subject at the same distance and then recompose the photograph.



*There is little or no contrast between the subject and the background.*

**Example:** Subject is the same color as the background.



*The focus point contains objects at different distances from the camera.*

**Example:** Subject is inside a cage.



*The subject is dominated by regular geometric patterns.*

**Example:** Blinds or a row of windows in a skyscraper.

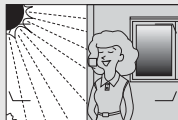

*The focus point contains areas of sharply contrasting brightness.*

**Example:** Subject is half in the shade.



*Background objects appear larger than the subject.*

**Example:** A building is in the frame behind the subject.

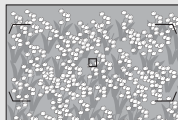

*The subject contains many fine details.*

**Example:** A field of flowers or other subjects that are small or lack variation in brightness.

## Manual Focus

Manual focus is available for lenses that do not support autofocus (non-AF NIKKOR lenses) or when the autofocus does not produce the desired results (🗨 113).

- **AF lenses:** Set the lens focus mode switch (if present) and camera focus-mode selector to **M**.

*Focus-mode selector*

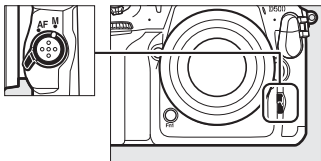

### AF Lenses

Do not use AF lenses with the lens focus-mode switch set to **M** and the camera focus-mode selector set to **AF**. Failure to observe this precaution could damage the camera or lens. This does not apply to AF-S lenses, which can be used in **M** mode without setting the camera focus-mode selector to **M**.

- **Manual focus lenses:** Focus manually.

To focus manually, adjust the lens focus ring until the image displayed on the clear matte field in the viewfinder is in focus. Photographs can be taken at any time, even when the image is not in focus.

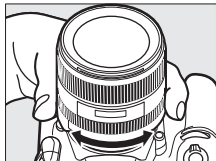



## ■ The Electronic Rangefinder

The viewfinder focus indicator can be used to confirm whether the subject in the selected focus point is in focus.

Choose from 55 focus points, or from 45 points if **1.3x (18x12)** is selected for

**Choose image area** (📖 89). After

positioning the subject in the selected

focus point, press the shutter-release button halfway and rotate the lens focus ring until the in-focus indicator (●) is displayed.

Note that with the subjects listed on page 113, the in-focus indicator may sometimes be displayed when the subject is not in focus; confirm focus in the viewfinder before shooting. For

information on using the electronic rangefinder with optional AF-S/AF-I teleconverters, see page 99.



### 🔍 AF-P DX NIKKOR 18–55mm f/3.5–5.6G and G VR Lenses

When an AF-P DX NIKKOR 18–55mm f/3.5–5.6G VR or AF-P DX NIKKOR 18–55mm f/3.5–5.6G lens is used in manual focus mode, the in-focus indicator will flash in the viewfinder (or in live view, the focus point will flash in the monitor) to warn that continuing to rotate the focus ring in the current direction will not bring the subject into focus.

### 🔍 Focal Plane Position

To determine the distance between your subject and the camera, measure from the focal plane mark (⊖) on the camera body. The distance between the lens mounting flange and the focal plane is 46.5 mm (1.83 in.).

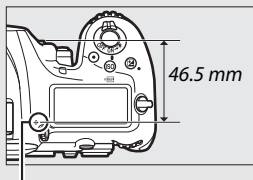

Focal plane mark

# Release Mode

## Choosing a Release Mode

To choose a release mode, press the release mode dial lock release and turn the release mode dial so that the pointer aligns with the desired setting.

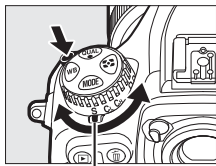

Pointer

Mode	Description
<b>S</b>	<b>Single frame:</b> The camera takes one photograph each time the shutter-release button is pressed.
<b>CL</b>	<b>Continuous low speed:</b> While shutter-release button is held down, camera records 1–9 frames per second. * Frame rate can be chosen using Custom Setting d1 ( <b>CL mode shooting speed</b> , □ 297).
<b>CH</b>	<b>Continuous high speed:</b> While shutter-release button is held down, camera records up to 10 frames per second. * Use for active subjects.
<b>Q</b>	<b>Quiet shutter-release:</b> As for single frame, except that the mirror does not click back into place while the shutter-release button is fully pressed, allowing the user to control the timing of the click made by the mirror, which is also quieter than in single frame mode. In addition, a beep does not sound regardless of the setting selected for <b>Beep</b> in the setup menu (□ 306).
<b>Qc</b>	<b>Qc (quiet continuous) shutter-release:</b> While shutter-release button is held down, camera records up to 3 frames per second. * Camera noise is reduced.

Mode	Description
	<b>Self-timer:</b> Take pictures with the self-timer (☞ 119).
<b>MUP</b>	<b>Mirror up:</b> Choose this mode to minimize camera shake in telephoto or close-up photography or in other situations in which the slightest camera movement can result in blurred photographs (☞ 121).

\* Average frame rate with an EN-EL15 battery, continuous-servo AF, manual or shutter-priority auto exposure, a shutter speed of  $\frac{1}{250}$  s or faster, remaining settings (or in the case of **CL**, remaining settings other than Custom Setting d1) at default values, and memory remaining in memory buffer. The stated rates may not be available under some conditions. Frame rates may drop at high ISO sensitivities (Hi 0.3–Hi 5) or at extremely small apertures (high f-numbers) or slow shutter speeds, when vibration reduction (available with VR lenses) or auto ISO sensitivity control (☞ 125) is on, or if the battery is low, a non-CPU lens is attached, **Aperture ring** is selected for Custom Setting f4 (**Customize command dials**) > **Aperture setting** (☞ 302), or flicker is detected when flicker reduction is enabled in the photo shooting menu (☞ 234).

## The Memory Buffer

The camera is equipped with a memory buffer for temporary storage, allowing shooting to continue while photographs are being saved to the memory card. Note, however, that frame rate will drop when the buffer is full ()

The approximate number of images that can be stored in the memory buffer at current settings is shown in the exposure-count displays in the viewfinder and control panel while the shutter-release button is pressed halfway. The illustration at right shows the display when space remains in the buffer for about 99 pictures.

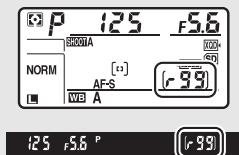

While photographs are being recorded to the memory card, the memory card access lamp will light. Depending on shooting conditions and memory card performance, recording may take from a few seconds to a few minutes. *Do not remove the memory card or remove or disconnect the power source until the access lamp has gone out.* If the camera is switched off while data remain in the buffer, the power will not turn off until all images in the buffer have been recorded. If the battery is exhausted while images remain in the buffer, the shutter release will be disabled and the images transferred to the memory card.

## See Also

For information on choosing the order in which the photos in each burst are displayed after shooting, see **After burst, show** (□ 282). For information on choosing the maximum number of photographs that can be taken in a single burst, see Custom Setting d2 (**Max. continuous release**, □ 297). For information on the number of pictures that can be taken in a single burst, see page 389.

## Self-Timer Mode



The self-timer can be used to reduce camera shake or for self-portraits.

### 1 Select self-timer mode.

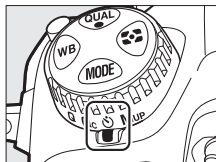
Press the release mode dial lock release and turn the release mode dial to .



### 2 Frame the photograph and focus.

In single-servo AF ( 101), photographs can only be taken if the in-focus () indicator appears in the viewfinder.



#### Close the Viewfinder Eyepiece Shutter

When taking photos without your eye to the viewfinder, close the viewfinder eyepiece shutter to prevent light entering via the viewfinder from appearing in photographs or interfering with exposure.

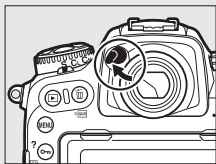

### 3 Start the timer.

Press the shutter-release button all the way down to start the timer. The self-timer lamp will start to flash. Two seconds before the photograph is taken, the self-timer lamp will stop flashing. The shutter will be released about ten seconds after the timer starts.



To turn the self-timer off before a photograph is taken, turn the release mode dial to another setting.

#### See Also

For information on choosing the duration of the self-timer, the number of shots taken, and the interval between shots, see Custom Setting c3 (**Self-timer**, [□ 296](#)). The beeps that sound when the self-timer is used can be controlled using the **Beep** option in the setup menu ([□ 306](#)).

## Mirror up Mode

Choose this mode to minimize blurring caused by camera movement when the mirror is raised. To use mirror-up mode, press the release mode dial lock release and rotate the release mode dial to **MUP** (mirror up). After pressing the shutter-release button halfway to set focus and exposure, press the shutter-release button the rest of the way down to raise the mirror. **r dY** will be displayed in the control panel; press the shutter-release button all the way down again to take the picture (in live view, there is no need to raise the mirror; the picture is taken the first time the shutter-release button is pressed all the way down). A beep will sound, unless **Off** is selected for **Beep** in the setup menu (☐ 306). The mirror lowers when shooting ends.

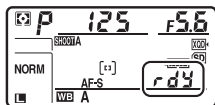
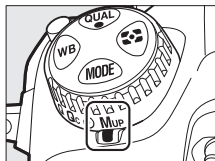

### ✔ **Mirror Up**

While the mirror is raised, photos can not be framed in the viewfinder and autofocus and metering will not be performed.

### ✍ **Mirror up Mode**

A picture will be taken automatically if no operations are performed for about 30 s after the mirror is raised.

### ✍ **Preventing Blur**

To prevent blurring caused by camera movement, press the shutter-release button smoothly. Use of a tripod is recommended.

### ✍ **See Also**

For information on using the electronic front-curtain shutter to further reduce blur, see Custom Setting d6 (**Electronic front-curtain shutter**,  298).



# ISO Sensitivity

## Manual Adjustment

The camera's sensitivity to light can be adjusted according to the amount of light available. Choose from settings that range from ISO 100 and ISO 51200 in steps equivalent to  $\frac{1}{3}$  EV. Settings of from about 0.3 to 1 EV below ISO 100 and 0.3 to 5 EV above ISO 51200 are also available for special situations. The higher the ISO sensitivity, the less light needed to make an exposure, allowing higher shutter speeds or smaller apertures.

ISO sensitivity can be adjusted by pressing the **ISO** (FORMAT) button and rotating the main command dial until the desired setting is displayed in the control panel and viewfinder.

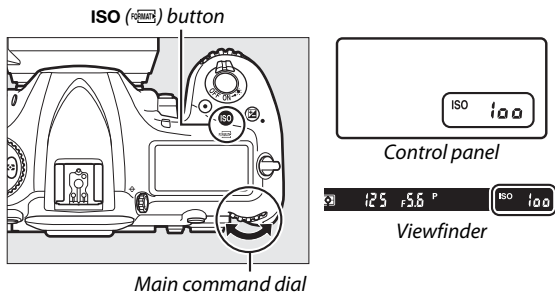

### The ISO Sensitivity Menu

ISO sensitivity can also be adjusted using the **ISO sensitivity settings** option in the photo shooting menu (☞ 285).

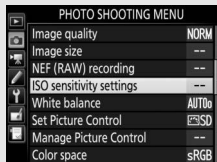

### **ISO Sensitivity**

The higher the ISO sensitivity, the less light needed to make an exposure, allowing faster shutter speeds or smaller apertures, but the more likely the image is to be affected by noise (randomly-spaced bright pixels, fog, or lines). Noise is particularly likely at settings between **Hi 0.3** and **Hi 5**.



### **Hi 0.3–Hi 5**

The settings **Hi 0.3** through **Hi 5** correspond to ISO sensitivities 0.3–5 EV over ISO 51200 (ISO 64000–1640000 equivalent).

### **Lo 0.3–Lo 1**

The settings **Lo 0.3** through **Lo 1** correspond to ISO sensitivities 0.3–1 EV below ISO 100 (ISO 80–50 equivalent). Use for larger apertures when lighting is bright. Contrast is slightly higher than normal; in most cases, ISO sensitivities of ISO 100 or above are recommended.

### **See Also**

For information on choosing the ISO sensitivity step size, see Custom Setting b1 (**ISO sensitivity step value**;  294). See Custom Setting d3 (**ISO display**;  297) for information on displaying ISO sensitivity in the control panel and viewfinder. For information on using the **High ISO NR** options in the photo and movie shooting menus to reduce noise at high ISO sensitivities, see pages 286 (photos) and 290 (movies).

## Auto ISO Sensitivity Control

If **On** is selected for **ISO sensitivity settings** > **Auto ISO sensitivity control** in the photo shooting menu, ISO sensitivity will automatically be adjusted if optimal exposure can not be achieved at the value selected by the user (ISO sensitivity is adjusted appropriately when the flash is used).

- 1 Select Auto ISO sensitivity control.**  
Select **ISO sensitivity settings** in the photo shooting menu, highlight **Auto ISO sensitivity control** and press .

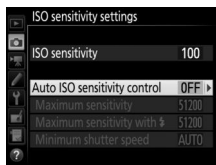

- 2 Select On.**  
Highlight **On** and press  (if **Off** is selected, ISO sensitivity will remain fixed at the value selected by the user).

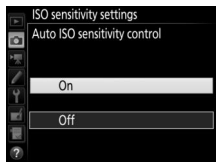

### 3 Adjust settings.

The maximum value for auto ISO sensitivity can be selected using **Maximum sensitivity** (the minimum value for auto ISO sensitivity is automatically set to ISO 100; note that if the ISO sensitivity selected by the user is higher than that chosen for **Maximum sensitivity**, the value selected by the user will be used instead). In exposure modes **P** and **A**, sensitivity will only be adjusted if underexposure would result at the shutter speed selected for **Minimum shutter speed** (1/4000–30 s, or **Auto**; in modes **S** and **M**, ISO sensitivity will be adjusted for optimal exposure at the shutter speed selected by the user). If **Auto** is selected, the camera will choose the minimum shutter speed based on the focal length of the lens. Press **OK** to exit when settings are complete.



To choose the maximum ISO sensitivity for photos taken using an optional flash unit (□ 328), use **Maximum sensitivity with flash**. Selecting **Same as without flash** sets the maximum ISO sensitivity for flash photography to the value currently selected for **Maximum sensitivity**.

When **On** is selected, the viewfinder and control panel show **ISO-AUTO**. When sensitivity is altered from the value selected by the user, these indicators flash and the altered value is shown in the viewfinder and control panel.

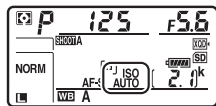

### Minimum Shutter Speed

Auto shutter-speed selection can be fine-tuned by highlighting **Auto** and pressing  $\odot$ : for example, values faster than those usually selected automatically can be used with telephoto lenses to reduce blur. Note, however, that **Auto** functions only with CPU lenses; if a non-CPU lens is used without lens data, minimum shutter speed is fixed at  $1/30$  s. Shutter speeds may drop below the selected minimum if optimum exposure can not be achieved at the ISO sensitivity chosen for **Maximum sensitivity**.

### Turning Auto ISO Sensitivity Control On or Off

You can turn auto ISO sensitivity control on or off by pressing the **ISO** (FORMAT) button and rotating the sub-command dial. The control panel and viewfinder display **ISO-AUTO** icons when auto ISO sensitivity control is on and **ISO** when it is off.



### Auto ISO Sensitivity Control

When a flash is used, minimum shutter speed will be set to the value selected for **Minimum shutter speed** unless this value is faster than Custom Setting e1 (**Flash sync speed**,  $\square$  299) or slower than Custom Setting e2 (**Flash shutter speed**,  $\square$  300), in which case the value selected for Custom Setting e2 will be used instead. Note that ISO sensitivity may be raised automatically when auto ISO sensitivity control is used in combination with slow sync flash modes (available with optional flash units;  $\square$  201), possibly preventing the camera from selecting slow shutter speeds.





### See Also

For information on choosing the reference used to set exposure when a flash is used with auto ISO sensitivity control, see Custom Setting e4 (**Auto  $\downarrow$  ISO sensitivity control**,  $\square$  300).

# Exposure

## Metering



Metering determines how the camera sets exposure. The following options are available:

Option	Description
	<b>Matrix:</b> Produces natural results in most situations. Camera meters wide area of the frame and sets exposure according to tone distribution, color, composition, and, with type G, E, or D lenses (□ 322), distance information (3D color matrix metering III; with other CPU lenses, camera uses color matrix metering III, which does not include 3D distance information).
	<b>Center-weighted:</b> Camera meters entire frame but assigns greatest weight to center area (if CPU lens is attached, size of area can be selected using Custom Setting b6, <b>Center-weighted area</b> , □ 295; if non-CPU lens is attached, area is equivalent to circle 8 mm in diameter). Classic meter for portraits; recommended when using filters with an exposure factor (filter factor) over 1×.
	<b>Spot:</b> Camera meters circle 3.5 mm (0.14 in.) in diameter (approximately 2.5% of frame). Circle is centered on current focus point, making it possible to meter off-center subjects (if non-CPU lens is used or if auto-area AF is in effect, camera will meter center focus point). Ensures that subject will be correctly exposed, even when background is much brighter or darker.
 *	<b>Highlight-weighted:</b> Camera assigns greatest weight to highlights. Use to reduce loss of detail in highlights, for example when photographing spotlight performers on-stage.

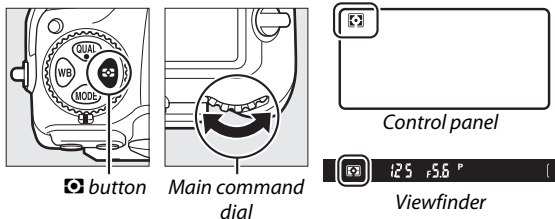

To choose a metering option, press the  button and rotate the main command dial until the desired setting is displayed in the viewfinder and control panel.



### **Non-CPU Lens Data**

Specifying the focal length and maximum aperture of non-CPU lenses using the **Non-CPU lens data** option in the setup menu ( 251) allows the camera to use color matrix metering when matrix is selected and improves the accuracy of center-weighted and spot metering. Center-weighted metering will be used if highlight-weighted metering is selected with non-CPU lenses or if matrix metering is selected with non-CPU lenses for which lens data have not been supplied. Note that center-weighted metering may also be used if highlight-weighted metering is selected with certain CPU lenses (AI-P NIKKOR lenses and AF lenses that are not of type G, E, or D;  325).

### **See Also**

See Custom Setting b5 (**Matrix metering**,  295) for information on choosing whether matrix metering uses face detection. For information on making separate adjustments to optimal exposure for each metering method, see Custom Setting b7 (**Fine-tune optimal exposure**,  295).

## Exposure Mode

To determine how the camera sets shutter speed and aperture when adjusting exposure, press the **MODE** button and rotate the main command dial until the desired option appears in the control panel.

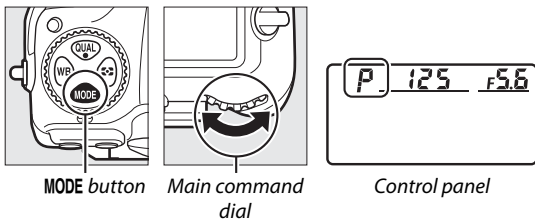

Mode	Description
<b>P</b>	<b>Programmed auto</b> (☐ 132): Camera sets shutter speed and aperture for optimal exposure. Recommended for snapshots and in other situations in which there is little time to adjust camera settings.
<b>S</b>	<b>Shutter-priority auto</b> (☐ 133): User chooses shutter speed; camera selects aperture for best results. Use to freeze or blur motion.
<b>A</b>	<b>Aperture-priority auto</b> (☐ 134): User chooses aperture; camera selects shutter speed for best results. Use to blur background or bring both foreground and background into focus.
<b>M</b>	<b>Manual</b> (☐ 135): User controls both shutter speed and aperture. Set shutter speed to Bulb (b u l b) or Time (- -) for long time-exposures.



### **Lens Types**

When using a CPU lens equipped with an aperture ring (☐ 325), lock the aperture ring at the minimum aperture (highest f-number). Type G and E lenses are not equipped with an aperture ring.

When using non-CPU lenses (☐ 250), select exposure mode **A** (aperture-priority auto) or **M** (manual). In other modes, exposure mode **A** is automatically selected when a non-CPU lens is attached (☐ 325). The exposure mode indicator (**P** or **S**) will flash in the control panel and **A** will be displayed in the viewfinder.

### **Depth-of-Field Preview**

To preview the effects of aperture, press and hold the **Pv** button. The lens will be stopped down to the aperture value selected by the camera (modes **P** and **S**) or the value chosen by the user (modes **A** and **M**), allowing depth of field to be previewed in the viewfinder.

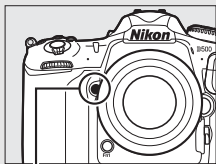

**Pv** button

### **Custom Setting e5—Modeling Flash**

This setting controls whether optional flash units that support the Nikon Creative Lighting System (CLS; ☐ 328) will emit a modeling flash when the **Pv** button is pressed.

## **P: Programmed Auto**

In this mode, the camera automatically adjusts shutter speed and aperture according to a built-in program to ensure optimal exposure in most situations.

### **Flexible Program**

In exposure mode **P**, different combinations of shutter speed and aperture can be selected by rotating the main command dial while the exposure meters are on (“flexible program”). All combinations produce the same exposure. While flexible program is in effect, an asterisk (“\*”) appears in the control panel. To restore default shutter speed and aperture settings, rotate the dial until the asterisk is no longer displayed, choose another mode, or turn the camera off.

### **See Also**

For information on activating the exposure meters, see “The Standby Timer (Viewfinder Photography)” on page 39.

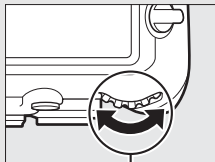

*Main command dial*

## **S: Shutter-Priority Auto**

In shutter-priority auto, you choose the shutter speed while the camera automatically selects the aperture that will produce the optimal exposure.

To choose a shutter speed, rotate the main command dial while the exposure meters are on. Shutter speed can be set to "x 250" or to values between 30 s and  $1/8000$  s. Shutter speed can be locked at the selected setting (☞ 140).

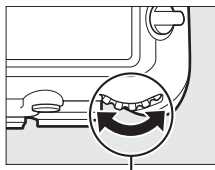

*Main command dial*

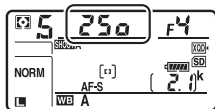

## **A: Aperture-Priority Auto**

In aperture-priority auto, you choose the aperture while the camera automatically selects the shutter speed that will produce the optimal exposure.

To choose an aperture between the minimum and maximum values for the lens, rotate the sub-command dial while the exposure meters are on. Aperture can be locked at the selected setting (☞ 140).

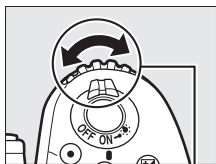

*Sub-command dial*

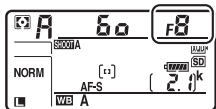

### **Non-CPU Lenses** (☞ 323, 325)

Use the lens aperture ring to adjust aperture. If the maximum aperture of the lens has been specified using the **Non-CPU lens data** item in setup menu (☞ 251) when a non-CPU lens is attached, the current f-number will be displayed in the viewfinder and control panel, rounded to the nearest full stop.

Otherwise the aperture displays will show only the number of stops (**ΔF**, with maximum aperture displayed as **ΔF0**) and the f-number must be read from the lens aperture ring.

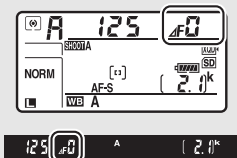

## **M: Manual**

In manual exposure mode, you control both shutter speed and aperture. While the exposure meters are on, rotate the main command dial to choose a shutter speed, and the sub-command dial to set aperture. Shutter speed can be set to “x 250” or to values between 30 s and  $1/8000$  s, or the shutter can be held open indefinitely for a long time-exposure (b u l b or - -, 137). Aperture can be set to values between the minimum and maximum values for the lens. Use the exposure indicators to check exposure.

*Aperture*

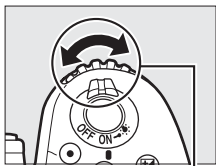

*Sub-command dial*

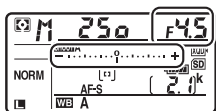

*Shutter speed*

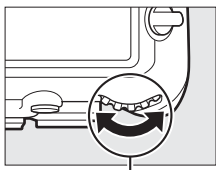

*Main command dial*

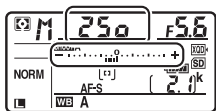







Shutter speed and aperture can be locked at the selected setting (140).

## AF Micro NIKKOR Lenses

Provided that an external exposure meter is used, the exposure ratio need only be taken into account when the lens aperture ring is used to set aperture.

## Exposure Indicators

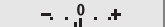
The exposure indicators in the viewfinder and control panel show whether the photograph would be under- or over-exposed at current settings. Depending on the option chosen for Custom Setting b2 (**EV steps for exposure ctrl**,  294), the amount of under- or over-exposure is shown in increments of  $\frac{1}{3}$  EV,  $\frac{1}{2}$  EV, or 1 EV. If the limits of the exposure metering system are exceeded, the displays will flash.

Custom Setting b2 set to 1/3 step			
	Optimal exposure	Underexposed by $\frac{1}{3}$ EV	Overexposed by over 3 EV
Control panel			
Viewfinder			

## See Also

For information on reversing the exposure indicators so that negative values are displayed on the right and positive values on the left, see Custom Setting f7 (**Reverse indicators**,  303).

## Long Time-Exposures (M Mode Only)

Select the following shutter speeds for long time-exposures of moving lights, the stars, night scenery, or fireworks.

- **Bulb** (Ⓛ): The shutter remains open while the shutter-release button is held down. To prevent blur, use a tripod or an optional wireless remote controller (☐ 335) or remote cord (☐ 336).
- **Time** (- -): Start the exposure by using the shutter-release button on the camera or on an optional remote cord, or wireless remote controller. The shutter remains open until the button is pressed a second time.



*Length of exposure: 35 s  
Aperture: f/25*

### 1 Ready the camera.

Mount the camera on a tripod or place it on a stable, level surface.

#### Long Time-Exposures

Close the viewfinder eyepiece shutter to prevent the photograph being affected by light entering via the viewfinder (☐ 119). Nikon recommends using a fully charged battery or an optional AC adapter and power connector to prevent loss of power while the shutter is open. Note that noise (bright spots, randomly-spaced bright pixels or fog) may be present in long exposures. Bright spots and fog can be reduced by choosing **On** for **Long exposure NR** in the photo shooting menu (☐ 286).

---

## 2 Select exposure mode M.

Press the **MODE** button and rotate the main command dial until **M** is displayed in the control panel.

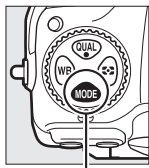

MODE button

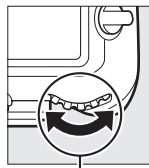

Main command dial

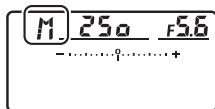

Control panel

---

## 3 Choose a shutter speed.

While the exposure meters are on, rotate the main command dial to choose a shutter speed of Bulb (**b u l b**) or Time (**- -**). The exposure indicators do not appear when Bulb (**b u l b**) or Time (**- -**) is selected.

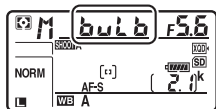

Bulb

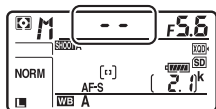

Time

---

## 4 Open the shutter.

**Bulb:** After focusing, press the shutter-release button on the camera or optional remote cord or wireless remote controller all the way down. Keep the shutter-release button pressed until the exposure is complete.

**Time:** Press the shutter-release button all the way down.



---

## 5 Close the shutter.

**Bulb:** Take your finger off the shutter-release button.

**Time:** Press the shutter-release button all the way down.



## Shutter-Speed and Aperture Lock

Shutter speed lock is available in shutter-priority auto and manual exposure modes, aperture lock in aperture-priority auto and manual exposure modes. Shutter speed and aperture lock are not available in programmed auto exposure mode.

- 1 Assign shutter speed and aperture lock to a camera control.**  
Assign **Shutter spd & aperture lock** to a control using Custom Setting f1 (**Custom control assignment**,  301).

- 2 Lock shutter speed and/or aperture.**

### Shutter speed (exposure modes S and M):

Press the selected control and rotate the main command dial until  icons appear in the viewfinder and control panel.

To unlock shutter speed, press the control and rotate the main command dial until the  icons disappear from the displays.

**Aperture (exposure modes A and M):** Press the selected control and rotate the sub-command dial until  icons appear in the viewfinder and the control panel.

To unlock aperture, press the control and rotate the sub-command dial until the  icons disappear from the displays.

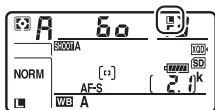
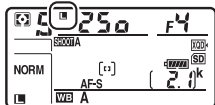

### See Also

Use Custom Setting f3 (**Shutter spd & aperture lock**;  302) to keep shutter speed and/or aperture locked at the selected values.

## Autoexposure (AE) Lock

Use autoexposure lock to recompose photographs after using center-weighted metering and spot metering (128) to meter exposure.

### 1 Lock exposure.

Position the subject in the selected focus point and press the shutter-release button halfway. With the shutter-release button pressed halfway and the subject positioned in the focus point, press the center of the sub-selector to lock exposure (if you are using autofocus, confirm that the ● in-focus indicator appears in the viewfinder).

Shutter-release button

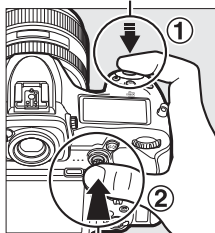

Sub-selector

While exposure lock is in effect, an **AE-L** indicator will appear in the viewfinder.



### 2 Recompose the photograph.

Keeping the center of the sub-selector pressed, recompose the photograph and shoot.



### Metered Area

In spot metering, exposure will be locked at the value metered at the selected focus point (☞ 128). In center-weighted metering, exposure will be locked at the value metered in an 8-mm circle in the center of the viewfinder.

### Adjusting Shutter Speed and Aperture

While exposure lock is in effect, the following settings can be adjusted without altering the metered value for exposure:

Exposure mode	Setting
P	Shutter speed and aperture (flexible program; ☞ 132)
S	Shutter speed
A	Aperture

The new values can be confirmed in the viewfinder and control panel. Note that the metering method can not be changed while exposure lock is in effect.

### See Also

If **On (half press)** is selected for Custom Setting c1 (**Shutter-release button AE-L**, ☞ 296), exposure will lock when the shutter-release button is pressed halfway.

## Exposure Compensation

Exposure compensation is used to alter exposure from the value suggested by the camera, making pictures brighter or darker. It is most effective when used with center-weighted or spot metering (☐ 128). Choose from values between  $-5$  EV (underexposure) and  $+5$  EV (overexposure) in increments of  $\frac{1}{3}$  EV. In general, positive values make the subject brighter while negative values make it darker.



*-1 EV*



*No exposure compensation*



*+1 EV*

To choose a value for exposure compensation, press the  button and rotate the main command dial until the desired value is displayed in the viewfinder or control panel.

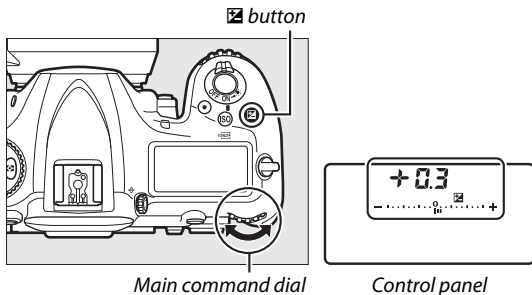

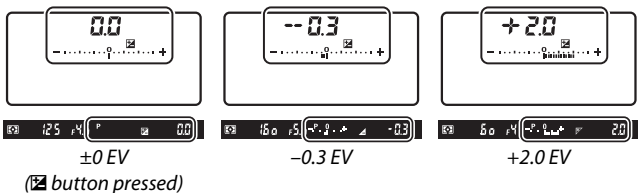

At values other than  $\pm 0.0$ , the 0 at the center of the exposure indicators will flash (exposure modes **P**, **S**, and **A** only) and a +/- icon will be displayed in the viewfinder and control panel after you release the +/- button. The current value for exposure compensation can be confirmed in the exposure indicator by pressing the +/- button.

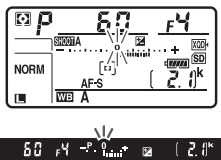

Normal exposure can be restored by setting exposure compensation to  $\pm 0.0$ . Exposure compensation is not reset when the camera is turned off.



### Exposure Mode M

In exposure mode **M**, exposure compensation affects only the exposure indicator; shutter speed and aperture do not change.

### Using a Flash

When a flash is used, exposure compensation affects both flash level and exposure, altering the brightness of both the main subject and the background. Custom Setting e3 (**Exposure comp. for flash**, 300) can be used to restrict the effects of exposure compensation to the background only.

### See Also

For information on choosing the size of the increments available for exposure compensation, see Custom Setting b3 (**Exp./flash comp. step value**,  294). For information on making adjustments to exposure compensation without pressing the  button, see Custom Setting b4 (**Easy exposure compensation**,  295). For information on automatically varying exposure, flash level, white balance, or Active D-Lighting, see page 147.

## Bracketing

Bracketing automatically varies exposure, flash level, **Active D-Lighting (ADL)**, or white balance slightly with each shot, “bracketing” the current value. Choose in situations in which getting the right settings is difficult and there is not time to check results and adjust settings with each shot, or to experiment with different settings for the same subject.

Bracketing is adjusted using the **Auto bracketing set** option in the photo shooting menu, which contains the following options:

- **AE & flash:** The camera varies exposure and flash level over a series of photographs (□ 147). Note that flash bracketing is available in i-TTL and, where supported, auto aperture (⊗A) flash control modes only (□ 198, 328).
- **AE only:** The camera varies exposure over a series of photographs.
- **Flash only:** The camera varies flash level over a series of photographs.
- **WB bracketing:** The camera creates multiple copies of each photograph, each with a different white balance (□ 151).
- **ADL bracketing:** The camera varies Active D-Lighting over a series of photographs (□ 155).

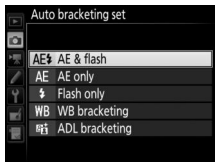



## ■ ■ Exposure and Flash Bracketing

To vary exposure and/or flash level over a series of photographs:



Exposure modified by:  
0 EV



Exposure modified by:  
-1 EV



Exposure modified by:  
+1 EV

### 1 Choose the number of shots.

Pressing the **BKT** button, rotate the main command dial to choose the number of shots in the bracketing sequence. The number of shots is shown in the control panel.



**BKT** button

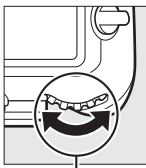

Main command dial

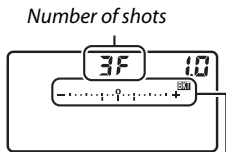

Control panel

Exposure and flash bracketing indicator

At settings other than zero, a **BKT** icon and exposure and flash bracketing indicator will appear in the control panel and **BKT** will be displayed in the viewfinder.



## 2 Select an exposure increment.

Pressing the **BKT** button, rotate the sub-command dial to choose the exposure increment.

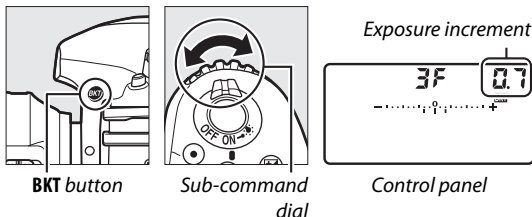

At default settings, the size of the increment can be chosen from 0.3 ( $\frac{1}{3}$ ), 0.7 ( $\frac{2}{3}$ ), 1, 2, and 3 EV. The bracketing programs with an increment of 0.3 ( $\frac{1}{3}$ ) EV are listed below.

Control panel display	No. of shots	Bracketing order (EVs)
0F 0.3	0	0
+ 3F 0.3	3	0/+0.3/+0.7
-- 3F 0.3	3	0/-0.7/-0.3
+ 2F 0.3	2	0/+0.3
-- 2F 0.3	2	0/-0.3
3F 0.3	3	0/-0.3/+0.3
5F 0.3	5	0/-0.7/-0.3/+0.3/+0.7
7F 0.3	7	0/-1.0/-0.7/-0.3/+0.3/+0.7/+1.0
9F 0.3	9	0/-1.3/-1.0/-0.7/-0.3/+0.3/+0.7/+1.0/+1.3

Note that for exposure increments of 2 EV or more, the maximum number of shots is 5; if a higher value was selected in Step 1, the number of shots will automatically be set to 5.

### 3 Frame a photograph, focus, and shoot.



The camera will vary exposure and/or flash level shot-by-shot according to the bracketing program selected. Modifications to exposure are added to those made with exposure compensation (see page 143).

While bracketing is in effect, a bracketing progress indicator will be displayed in the viewfinder and control panel. A segment will disappear from the indicator after each shot.

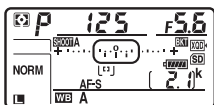

No. shots: 3; increment: 0.7

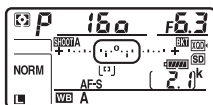

Display after first shot

### ■ Canceling Bracketing

To cancel bracketing, press the **BKT** button and rotate the main command dial until the number of shots in the bracketing sequence is zero (**0F**) and **BKT** is no longer displayed. The program last in effect will be restored the next time bracketing is activated. Bracketing can also be cancelled by performing a two-button reset (☐ 230), although in this case the bracketing program will not be restored the next time bracketing is activated.

#### ■ See Also

For information on choosing the size of the exposure increment, see Custom Setting b2 (**EV steps for exposure cntrl**, ☐ 294). For information on choosing the order in which bracketing is performed, see Custom Setting e7 (**Bracketing order**, ☐ 301). For information on choosing the role of the **BKT** button, see Custom Setting f1 (**Custom control assignment**) > **BKT button** +  (☐ 301).

### Exposure and Flash Bracketing

In continuous low speed, continuous high speed, and quiet continuous modes, shooting will pause after the number of shots specified in the bracketing program have been taken. Shooting will resume the next time the shutter-release button is pressed. In self-timer mode, the camera will take the number of shots selected in Step 1 on page 147 each time the shutter-release button is pressed, regardless of the option selected for Custom Setting c3 (**Self-timer**) > **Number of shots** (☐ 296); the interval between shots is however controlled by Custom Setting c3 (**Self-timer**) > **Interval between shots**. In other modes, one shot will be taken each time the shutter-release button is pressed.

If the memory card fills before all shots in the sequence have been taken, shooting can be resumed from the next shot in the sequence after the memory card has been replaced or shots have been deleted to make room on the memory card. If the camera is turned off before all shots in the sequence have been taken, bracketing will resume from the next shot in the sequence when the camera is turned on.

### Exposure Bracketing

The camera modifies exposure by varying shutter speed and aperture (programmed auto), aperture (shutter-priority auto), or shutter speed (aperture-priority auto, manual exposure mode). If **On** is selected for **ISO sensitivity settings** > **Auto ISO sensitivity control** (☐ 125) in modes **P**, **S**, and **A**, the camera will automatically vary ISO sensitivity for optimum exposure when the limits of the camera exposure system are exceeded; in mode **M**, the camera will first use auto ISO sensitivity control to bring exposure as close as possible to the optimum and then bracket this exposure by varying shutter speed. Custom Setting e6 (**Auto bracketing (mode M)**, ☐ 301) can be used to change how the camera performs exposure and flash bracketing in manual exposure mode. Bracketing can be performed by varying flash level together with shutter speed and/or aperture, or by varying flash level alone.

## ■ ■ White Balance Bracketing

The camera creates multiple copies of each photograph, each with a different white balance.

### 1 Choose the number of shots.

Pressing the **BKT** button, rotate the main command dial to choose the number of shots in the bracketing sequence. The number of shots is shown in the control panel.

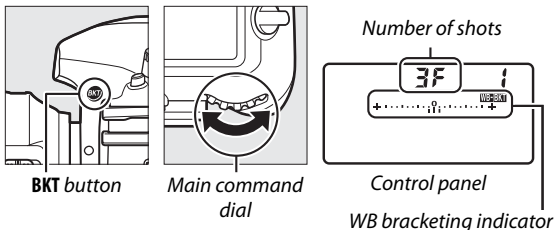

At settings other than zero, a **WB-BKT** icon and WB bracketing indicator will appear in the control panel and **BKT** will be displayed in the viewfinder.



## 2 Select a white balance increment.

Pressing the **BKT** button, rotate the sub-command dial to choose the white balance adjustment. Each increment is roughly equivalent to 5 mired.

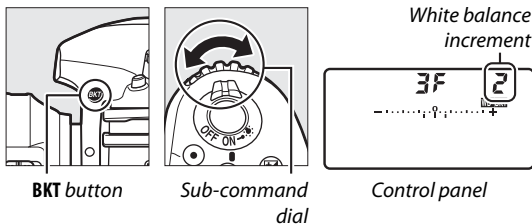

Choose from increments of 1 (5 mired), 2 (10 mired), or 3 (15 mired). Higher **B** values correspond to increased amounts of blue, higher **A** values to increased amounts of amber (□ 163). The bracketing programs with an increment of 1 are listed below.

Control panel display	No. of shots	White balance increment	Bracketing order
0F 1+.....°.....+	0	1	0
b3F 1+.....;i.....+	3	1 B	0/1 B/2 B
A3F 1+.....;i.....+	3	1 A	0/2 A/1 A
b2F 1+.....;i.....+	2	1 B	0/1 B
A2F 1+.....;i.....+	2	1 A	0/1 A
3F 1+.....;i.....+	3	1 A, 1 B	0/1 A/1 B
5F 1+.....;i.....+	5	1 A, 1 B	0/2 A/1 A/1 B/ 2 B
7F 1+.....;i.....+	7	1 A, 1 B	0/3 A/2 A/1 A/ 1 B/2 B/3 B
9F 1+.....;i.....+	9	1 A, 1 B	0/4 A/3 A/2 A/ 1 A/1 B/2 B/3 B/ 4 B

### 3 Frame a photograph, focus, and shoot.



Each shot will be processed to create the number of copies specified in the bracketing program, and each copy will have a different white balance. Modifications to white balance are added to the white balance adjustment made with white balance fine-tuning.

If the number of shots in the bracketing program is greater than the number of exposures remaining, **FULL** and the icon for the affected card will flash in the control panel, a flashing **FuL** icon will appear in the viewfinder as shown at right, and the shutter release will be disabled. Shooting can begin when a new memory card is inserted.

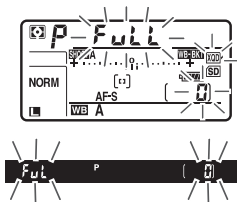

## ■ **Canceling Bracketing**

To cancel bracketing, press the **BKT** button and rotate the main command dial until the number of shots in the bracketing sequence is zero (0F) and **WB-BKT** is no longer displayed. The program last in effect will be restored the next time bracketing is activated. Bracketing can also be cancelled by performing a two-button reset (☐ 230), although in this case the bracketing program will not be restored the next time bracketing is activated.

### ✍ **White Balance Bracketing**

White balance bracketing is not available at an image quality of NEF (RAW). Selecting an NEF (RAW) or NEF (RAW) + JPEG option cancels white balance bracketing.

White balance bracketing affects only color temperature (the amber-blue axis in the white balance fine-tuning display, ☐ 163). No adjustments are made on the green-magenta axis.

In self-timer mode, the number of copies specified in the bracketing program will be created each time the shutter is released, regardless of the option selected for Custom Setting c3 (**Self-timer**) > **Number of shots** (☐ 296).

If the camera is turned off while the memory card access lamp is lit, the camera will power off only after all photographs in the sequence have been recorded.



## ■ ■ ADL Bracketing

The camera varies Active D-Lighting over a series of exposures.

### 1 Choose the number of shots.

Pressing the **BKT** button, rotate the main command dial to choose the number of shots in the bracketing sequence. The number of shots is shown in the control panel.

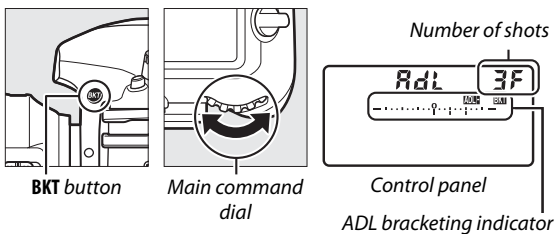

At settings other than zero, a **ADL-BKT** icon and an ADL bracketing indicator appear in the control panel and **BKT** will be displayed in the viewfinder. Choose two shots to take one photograph with Active D-Lighting off and another at a selected value. Choose three to five shots to take a series of photographs with Active D-Lighting set to **Off**, **Low**, and **Normal** (three shots), **Off**, **Low**, **Normal**, and **High** (four shots), or **Off**, **Low**, **Normal**, **High**, and **Extra high** (five shots). If you choose more than two shots, proceed to Step 3.

## 2 Select Active D-Lighting.

Pressing the **BKT** button, rotate the sub-command dial to choose Active D-Lighting.

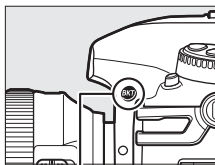

*BKT button*

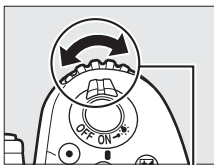

*Sub-command dial*

Active D-Lighting is shown in the control panel.

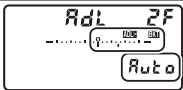
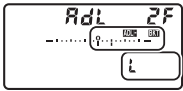
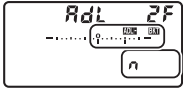
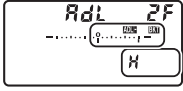
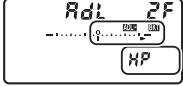
Control panel display	ADL
	暗A Auto
	暗L Low
	暗N Normal
	暗H High
	暗H* Extra high

### 3 Frame a photograph, focus, and shoot.



The camera will vary Active D-Lighting shot-by-shot according to the bracketing program selected. While bracketing is in effect, a bracketing progress indicator will be displayed in the control panel. A segment will disappear from the indicator after each shot.

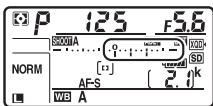

*No. shots: 3*

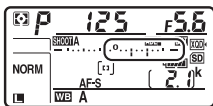

*Display after first shot*

## ■ ■ *Canceling Bracketing*

To cancel bracketing, press the **BKT** button and rotate the main command dial until the number of shots in the bracketing sequence is zero (0F) and **ADL-BKT** is no longer displayed. The program last in effect will be restored the next time bracketing is activated. Bracketing can also be cancelled by performing a two-button reset (☐ 230), although in this case the bracketing program will not be restored the next time bracketing is activated.

### 🔪 **ADL Bracketing**



In continuous low speed, continuous high speed, and quiet continuous modes, shooting will pause after the number of shots specified in the bracketing program have been taken. Shooting will resume the next time the shutter-release button is pressed. In self-timer mode, the camera will take the number of shots selected in Step 1 on page 155 each time the shutter-release button is pressed, regardless of the option selected for Custom Setting c3 (**Self-timer**) > **Number of shots** (☐ 296); the interval between shots is however controlled by Custom Setting c3 (**Self-timer**) > **Interval between shots**. In other modes, one shot will be taken each time the shutter-release button is pressed.





If the memory card fills before all shots in the sequence have been taken, shooting can be resumed from the next shot in the sequence after the memory card has been replaced or shots have been deleted to make room on the memory card. If the camera is turned off before all shots in the sequence have been taken, bracketing will resume from the next shot in the sequence when the camera is turned on.

# White Balance

## White Balance Options

White balance ensures that colors are unaffected by the color of the light source. Auto white balance is recommended with most light sources. If the desired results can not be achieved with auto white balance, choose an option from the list below or use preset white balance.

Option	Color temp. *	Description
<b>AUTO Auto</b>	3500–8000 K	White balance is adjusted automatically. For best results, use type G, E or D lens. If optional flash fires, results are adjusted appropriately.
<b>Keep white (reduce warm colors)</b>		
<b>Normal</b>		
<b>Keep warm lighting colors</b>		
 <b>Incandescent</b>	3000 K	Use under incandescent lighting.
 <b>Fluorescent</b>		Use with:
<b>Sodium-vapor lamps</b>	2700 K	• Sodium-vapor lighting (found in sports venues).
<b>Warm-white fluorescent</b>	3000 K	• Warm-white fluorescent lights.
<b>White fluorescent</b>	3700 K	• White fluorescent lights.
<b>Cool-white fluorescent</b>	4200 K	• Cool-white fluorescent lights.
<b>Day white fluorescent</b>	5000 K	• Daylight white fluorescent lights.
<b>Daylight fluorescent</b>	6500 K	• Daylight fluorescent lights.
<b>High temp. mercury-vapor</b>	7200 K	• High color temperature light sources (e.g. mercury-vapor lamps).

Option	Color temp.*	Description
 <b>Direct sunlight</b>	5200 K	Use with subjects lit by direct sunlight.
 <b>Flash</b>	5400 K	Use with optional flash units.
 <b>Cloudy</b>	6000 K	Use in daylight under overcast skies.
 <b>Shade</b>	8000 K	Use in daylight with subjects in the shade.
 <b>Choose color temp.</b>	2500–10,000 K	Choose color temperature from list of values (☞ 166).
<b>PRE Preset manual</b>	—	Use subject, light source, or existing photograph as reference for white balance (☞ 169).

\* All values are approximate and do not reflect fine-tuning (if applicable).

White balance can be selected by pressing the **WB** button and rotating the main command dial until the desired setting is displayed in the control panel.

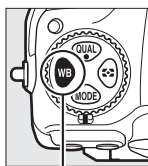

**WB button**

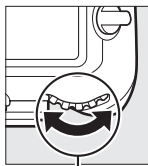

**Main command dial**

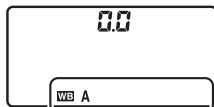

**Control panel**

### ✎ The Photo Shooting Menu

White balance can also be adjusted using the **White balance** option in the photo or movie shooting menu (☐ 285, 289), which also can be used to fine-tune white balance (☐ 163) or manage white-balance presets (☐ 169). The **Auto** option in the **White balance** menu offers a choice of **Keep white (reduce warm colors)**, **Normal**, and **Keep warm lighting colors**. **Keep white (reduce warm colors)** makes whites recorded under incandescent lighting appear white, while **Keep warm lighting colors** preserves the warm tints we normally perceive under incandescent lighting. The ☀ **Fluorescent** option can be used to select the light source from the bulb types.

### ✎ Studio Flash Lighting

Auto white balance may not produce the desired results with large studio flash units. Use preset white balance or set white balance to **Flash** and use fine-tuning to adjust white balance.

### ✎ See Also

White balance bracketing (☐ 151) creates several copies of each photograph taken, varying white balance to “bracket” the current value.













## Color Temperature

The perceived color of a light source varies with the viewer and other conditions. Color temperature is an objective measure of the color of a light source, defined with reference to the temperature to which an object would have to be heated to radiate light in the same wavelengths. While light sources with a color temperature in the neighborhood of 5000–5500 K appear white, light sources with a lower color temperature, such as incandescent light bulbs, appear slightly yellow or red. Light sources with a higher color temperature appear tinged with blue.

*"Warmer" (redder) colors*

*"Cooler" (bluer) colors*



①	 (sodium-vapor lamps): 2700 K
②	 (incandescent)/  (warm-white fluorescent.): 3000 K
③	 (white fluorescent): 3700 K
④	 (cool-white fluorescent): 4200 K
⑤	 (day white fluorescent): 5000 K
⑥	 (direct sunlight): 5200 K
⑦	 (flash): 5400 K
⑧	 (cloudy): 6000 K
⑨	 (daylight fluorescent): 6500 K
⑩	 (high temp. mercury-vapor): 7200 K
⑪	 (shade): 8000 K

**Note:** All figures are approximate.



## Fine-Tuning White Balance

At settings other than **K (Choose color temp.)**, white balance can be “fine-tuned” to compensate for variations in the color of the light source or to introduce a deliberate color cast into an image.

### ■ The White Balance Menu

To fine-tune white balance from the photo shooting menu, select **White balance** and follow the steps below.

#### 1 Display fine-tuning options.

Highlight a white balance option and press **⏏** (if a sub-menu is displayed, select the desired option and press **⏏** again to display fine-tuning options; for information on fine-tuning preset manual white balance, see page 179).

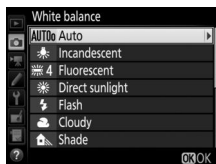

#### 2 Fine-tune white balance.

Use the multi selector to fine-tune white balance. White balance can be fine-tuned on the amber (A)–blue (B) axis in steps of 0.5 and the green (G)–magenta (M) axis in steps of 0.25. The horizontal (amber–blue) axis corresponds to color temperature, while the vertical (green–magenta) axis has the similar effects to the corresponding color compensation (CC) filters. The horizontal axis is ruled in increments equivalent to about 5 mired, the vertical axis in increments of about 0.05 diffuse density units.

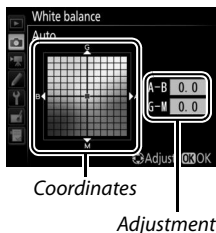

### 3 Press **OK**.

Press **OK** to save settings and return to the photo shooting menu. If white balance has been fine-tuned, an asterisk (“\*”) will be displayed in the control panel.

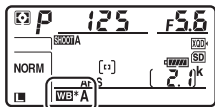

### ■ The WB Button

At settings other than **☑ (Choose color temp.)** and **PRE (Preset manual)**, the **WB** button can be used to fine-tune white balance on the amber (A)–blue (B) axis (☐ 163; to fine-tune white balance when **PRE** is selected, use the photo shooting menu as described on page 179). Press the **WB** button and rotate the sub-command dial to fine-tune white balance in steps of 0.5 (with each full increment equivalent to about 5 mired) until the desired value is displayed in the control panel. Rotating the sub-command dial to the left increases the amount of amber (A). Rotating the sub-command dial to the right increases the amount of blue (B). At settings other than 0, an asterisk (“\*”) appears in the control panel.

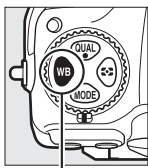

**WB** button

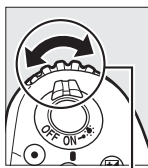

Sub-command  
dial

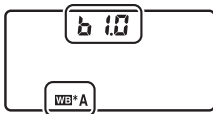

Control panel

### The Information Display

During viewfinder photography, you can press the **WB** button to adjust white balance settings in the information display. Rotate the main command dial to choose the white balance mode and rotate the sub-command dial to choose the color temperature (mode **K**, “choose color temperature”) or white balance preset (preset manual mode), or use the multi-selector to fine-tune white balance on the amber (A)–blue (B) and green (G)–magenta (M) axes (other white balance modes).

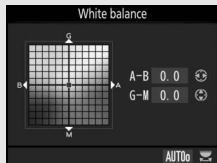

### White Balance Fine-Tuning

The colors on the fine-tuning axes are relative, not absolute. For example, moving the cursor to **B** (blue) when a “warm” setting such as  (**Incandescent**) is selected for white balance will make photographs slightly “colder” but will not actually make them blue.

### “Mired”

Any given change in color temperature produces a greater difference in color at low color temperatures than it would at higher color temperatures. For example, a change of 1000 K produces a much greater change in color at 3000 K than at 6000 K. Mired, calculated by multiplying the inverse of the color temperature by  $10^6$ , is a measure of color temperature that takes such variation into account, and as such is the unit used in color-temperature compensation filters. E.g.:

- 4000 K–3000 K (a difference of 1000 K)=83 mired
- 7000 K–6000 K (a difference of 1000 K)=24 mired

## Choosing a Color Temperature

Follow the steps below to choose a color temperature when **K** (**Choose color temp.**) is selected for white balance.

### ✔ Choose Color Temperature

Note that the desired results will not be obtained with flash or fluorescent lighting. Choose **⚡ (Flash)** or **☀ (Fluorescent)** for these sources. With other light sources, take a test shot to determine if the selected value is appropriate.

### ■ The White Balance Menu

Color temperature can be selected using the **White balance** options in the photo shooting menu. Enter values for the amber–blue and green–magenta axes as described below.

#### 1 Select Choose color temp.

Select **White balance** in the photo shooting menu, then highlight **Choose color temp.** and press **▶**.

#### 2 Select a value for amber-blue.

Press **◀** or **▶** to highlight digits and press **▲** or **▼** to change.

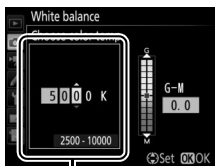

*Value for amber (A)-blue (B) axis*

---

### 3 Select a value for green-magenta.

Press or to highlight the **G** (green) or **M** (magenta) axis and press or to select a value.

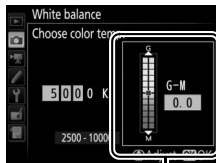

*Value for green (G)-magenta (M) axis*



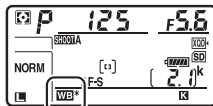

---

### 4 Press .

Press to save changes and return to the photo shooting menu. If a value other than 0 is selected for the green (G)–magenta (M) axis, an asterisk (“\*”) will be displayed in the control panel.



## ■ The WB Button

When **[X]** (**Choose color temp.**) is selected, the **WB** button can be used to select the color temperature, although only for the amber (A)–blue (B) axis. Press the **WB** button and rotate the sub-command dial until the desired value is displayed in the control panel (adjustments are made in mireds;  165). To enter a color temperature directly, press the **WB** button and press  or  to highlight a digit and press  or  to change.

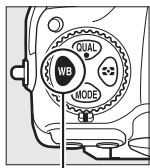

**WB** button

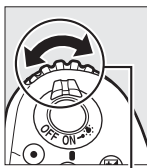

*Sub-command dial*



*Control panel*

## Preset Manual

Preset manual is used to record and recall custom white balance settings for shooting under mixed lighting or to compensate for light sources with a strong color cast. The camera can store up to six values for preset white balance in presets d-1 through d-6. Two methods are available for setting preset white balance:

Method	Description
<b>Direct measurement</b>	Neutral gray or white object is placed under lighting that will be used in final photograph and white balance is measured by camera (☐ 170). During live view (☐ 43, 58), white balance can be measured in a selected area of the frame (spot white balance, ☐ 174).
<b>Copy from existing photograph</b>	White balance is copied from photo on memory card (☐ 177).

### White Balance Presets

Changes to white balance presets apply to all photo shooting menu banks (☐ 283).

## Viewfinder Photography

---

### **1** Light a reference object.

Place a neutral gray or white object under the lighting that will be used in the final photograph. In studio settings, a standard gray panel can be used as a reference object. Note that exposure is automatically increased by 1 EV when measuring white balance; in exposure mode **M**, adjust exposure so that the exposure indicator shows  $\pm 0$  (📖 136).

---

### **2** Set white balance to **PRE** (Preset manual).

Press the **WB** button and rotate the main command dial until **PRE** is displayed in the control panel.

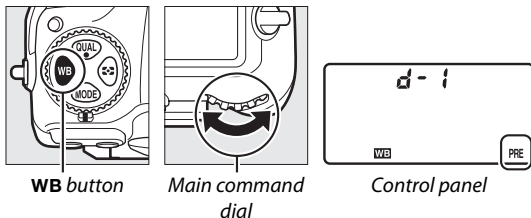

#### **🔧 Measuring Preset Manual White Balance (Viewfinder Photography)**

Preset manual white balance can not be measured while you are shooting an HDR photograph (📖 191) or multiple exposure (📖 236).



### 3 Select a preset.

Press the **WB** button and rotate the sub-command dial until the desired white balance preset (d-1 to d-6) is displayed in the control panel.

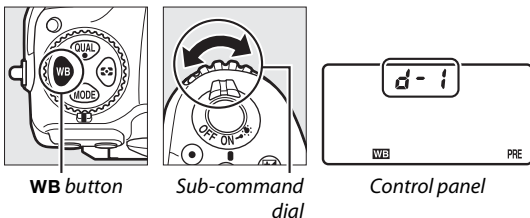

### 4 Select direct measurement mode.

Release the **WB** button briefly and then press the button until the **PRE** icon in the control panel starts to flash. A flashing **P-E** will also appear in the viewfinder.

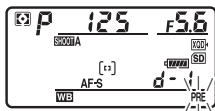

*Control panel*



*Viewfinder*

### 5 Measure white balance.

In the few seconds before the indicators stop flashing, frame the reference object so that it fills the viewfinder and press the shutter-release button all the way down. The camera will measure a value for white balance and store it in the preset selected in Step 3. No photograph will be recorded; white balance can be measured accurately even when the camera is not in focus.



## 6 Check the results.

If the camera was able to measure a value for white balance, **Good** will flash in the control panel, while the viewfinder will show a flashing **Wd**. Press the shutter-release button halfway to exit to shooting mode.

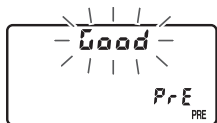

Control panel



Viewfinder

If lighting is too dark or too bright, the camera may be unable to measure white balance. A flashing **no Wd** will appear in the control panel and viewfinder. Press the shutter-release button halfway to return to Step 5 and measure white balance again.

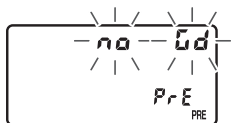

Control panel



Viewfinder

### Direct Measurement Mode

If no operations are performed during viewfinder photography while the displays are flashing, direct measurement mode will end in the time selected for Custom Setting c2 (**Standby timer**,  296).

### Protected Presets

If the current preset is protected ( 179), **PrE** will flash in the control panel and viewfinder if you attempt to measure a new value.

### Selecting a Preset

Selecting **Preset manual** for the **White balance** option in the photo shooting menu displays the dialog shown at right; highlight a preset and press . If no value currently exists for the selected preset, white balance will be set to 5200 K, the same as **Direct sunlight**.



## **Live View (Spot White Balance)**

During live view (📖 43, 58), white balance can be measured in a selected area of the frame, eliminating the need to prepare a reference object or change lenses during telephoto photography.

---

### **1 Press the **Lv** button.**

The mirror will be raised and the view through the lens will be displayed in the camera monitor.

---

### **2 Set white balance to PRE (Preset manual).**

Press the **WB** button and rotate the main command dial until **PRE** is displayed in the monitor.

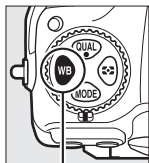

**WB** button

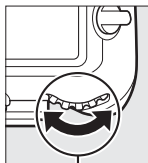

Main command  
dial

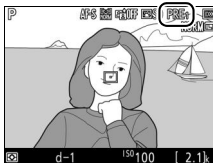

Monitor

### 3 Select a preset.

Press the **WB** button and rotate the sub-command dial until the desired white balance preset (d-1 to d-6) is displayed in the monitor.

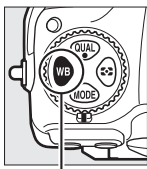

**WB** button

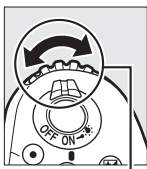

Sub-command  
dial



Monitor

### 4 Select direct measurement mode.

Release the **WB** button briefly and then press the button until the **PRE** icon in the monitor starts to flash. A spot white balance target (□) will be displayed at the selected focus point.



### 5 Position the target over a white or grey area.

While **PRE** flashes in the display, use the multi selector to position the □ over a white or grey area of the subject. To zoom the area around the target in for more precise positioning, press the  $\oplus$  button. You can also measure white balance anywhere in the frame by tapping your subject in the monitor, in which case there is no need to press the center of the multi selector or the shutter-release button as described in Step 6.



## 6 Measure white balance.

Press the center of the multi selector or press the shutter-release button all the way down to measure white balance. The time available to measure white balance is that selected for Custom Setting c4 (**Monitor off delay**) > **Live view** (☞ 296).

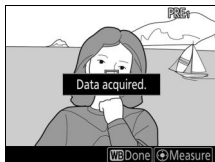

If the camera is unable to measure white balance, the message shown at right will be displayed. Choose a new white balance target and repeat the process from Step 5.



## 7 Exit direct measurement mode.

Press the **WB** button to exit direct measurement mode.

White balance presets can be viewed by selecting **Preset manual** for **White balance** in the photo or movie shooting menu. The position of the targets used to measure preset white balance is displayed on presets recorded during live view.



### ☑ Measuring Preset Manual White Balance (Live View)

Preset manual white balance can not be measured while an HDR exposure is in progress (☞ 191) or when **None** is selected for **Photo live view display WB** (☞ 51).

## Managing Presets

### ■ Copying White Balance from a Photograph

Follow the steps below to copy a value for white balance from an existing photograph to a selected preset.

#### 1 Select **Preset manual**.

Select **White balance** in the photo shooting menu, then highlight **Preset manual** and press .

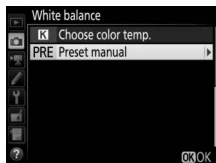

#### 2 Select a destination.

Highlight the destination preset (d-1 to d-6) and press the center of the multi selector.



#### 3 Choose **Select image**.

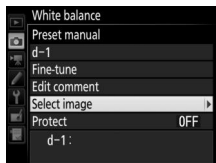

Highlight **Select image** and press .



---

## 4 Highlight a source image.

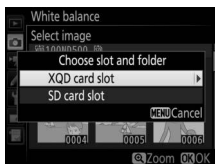

Highlight the source image. To view the highlighted image full frame, press and hold the  button.

To view images in other locations, press  () and select the desired card and folder ( 256).



---

## 5 Copy white balance.

Press  to copy the white balance value for the highlighted photograph to the selected preset. If the highlighted photograph has a comment ( 306), the comment will be copied to the comment for the selected preset.



### ✎ Choosing a White Balance Preset

Highlight the current white balance preset (d-1 – d-6) and press **Change** to select another preset.

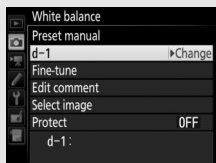

### ✎ Fine-Tuning Preset White Balance

The selected preset can be fine-tuned by selecting **Fine-tune** and adjusting white balance as described on page 163.

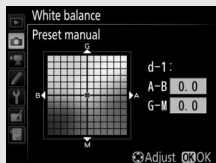

### ✎ Edit Comment

To enter a descriptive comment of up to 36 characters for the current white-balance preset, select **Edit comment** in the preset manual white balance menu and enter a comment as described on page 186.



### ✎ Protect

To protect the current white-balance preset, select **Protect** in the preset manual white balance menu, then highlight **On** and press **OK**. Protected presets can not be modified and the **Fine-tune** and **Edit comment** options can not be used.

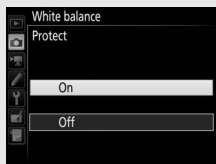







# Image Enhancement

## Picture Controls

### Selecting a Picture Control

Choose a Picture Control according to the subject or type of scene.

Option	Description
 <b>SD Standard</b>	Standard processing for balanced results. Recommended for most situations.
 <b>NL Neutral</b>	Minimal processing for natural results. Choose for photographs that will later be processed or retouched.
 <b>VI Vivid</b>	Pictures are enhanced for a vivid, photoprint effect. Choose for photographs that emphasize primary colors.
 <b>MC Monochrome</b>	Take monochrome photographs.
 <b>PT Portrait</b>	Process portraits for skin with natural texture and a rounded feel.
 <b>LS Landscape</b>	Produces vibrant landscapes and cityscapes.
 <b>FL Flat</b>	Details are preserved over a wide tone range, from highlights to shadows. Choose for photographs that will later be extensively processed or retouched.

# 1 Press **Q** (P/?).

A list of Picture Controls will be displayed.

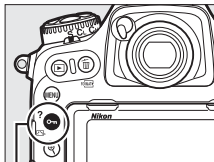

**Q** (P/?)  
button

# 2 Select a Picture Control.

Highlight the desired Picture Control and press **OK**.

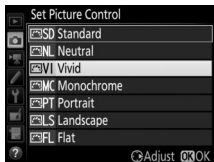

## **Custom Picture Controls**

Custom Picture Controls are created through modifications to existing Picture Controls using the **Manage Picture Control** option in the photo or movie shooting menu (☞ 185). Custom Picture Controls can be saved to a memory card for sharing among other cameras of the same model and compatible software.

## **The Picture Control Indicator**

The current Picture Control is shown in the information display when the **info** button is pressed.

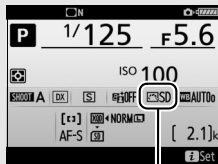

*Picture Control indicator*

## **The Shooting Menus**

Picture Controls can also be selected using the **Set Picture Control** option in the photo or movie shooting menu (☞ 285, 289).

## Modifying Picture Controls





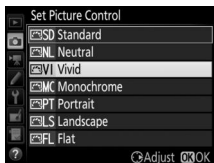

Existing preset or custom Picture Controls (📖 185) can be modified to suit the scene or the user's creative intent. Choose a balanced combination of settings using **Quick adjust**, or make manual adjustments to individual settings.

### 1 Select a Picture Control.

Highlight the desired Picture Control in the Picture Control list (📖 180) and press .



### 2 Adjust settings.

Press  or  to highlight the desired setting and press  or  to choose a value in increments of 1, or rotate the sub-command dial to choose a value in increments of 0.25 (📖 183). Repeat this step until all settings have been adjusted, or select a preset combination of settings by highlighting **Quick adjust** and pressing  or . Default settings can be restored by pressing the  (FORMAT) button.



### 3 Press .

#### Modifications to Original Picture Controls

Picture Controls that have been modified from default settings are indicated by an asterisk ("\*") in the **Set Picture Control** menu.

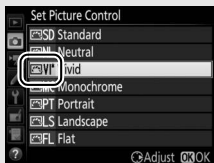

## Picture Control Settings

Option	Description	
Quick adjust	Mute or heighten the effect of the selected Picture Control (note that this resets all manual adjustments). Not available with <b>Neutral</b> , <b>Monochrome</b> , <b>Flat</b> , or custom Picture Controls (☐ 185).	
Manual adjustments (all Picture Controls)	<b>Sharpening</b>	Control the sharpness of outlines. Select <b>A</b> to adjust sharpening automatically according to the type of scene.
	<b>Clarity</b>	Adjust clarity manually or select <b>A</b> to let the camera adjust clarity automatically. Depending on the scene, shadows may appear around bright objects or halos may appear around dark objects at some settings. Clarity is not applied to movies.
	<b>Contrast</b>	Adjust contrast manually or select <b>A</b> to let the camera adjust contrast automatically.
	<b>Brightness</b>	Raise or lower brightness without loss of detail in highlights or shadows.
Manual adjustments (non-monochrome only)	<b>Saturation</b>	Control the vividness of colors. Select <b>A</b> to adjust saturation automatically according to the type of scene.
	<b>Hue</b>	Adjust hue.
Manual adjustments (monochrome only)	<b>Filter effects</b>	Simulate the effect of color filters on monochrome photographs (☐ 184).
	<b>Toning</b>	Choose the tint used in monochrome photographs (☐ 184).

## ✔ "A" (Auto)

Results for auto sharpening, clarity, contrast, and saturation vary with exposure and the position of the subject in the frame. Use a type G, E, or D lens for best results.

## ✎ Switching Between Manual and Auto

Press the  button to switch back and forth between manual and auto (A) settings for sharpening, clarity, contrast, and saturation.

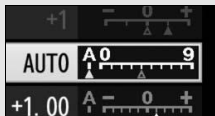

## ✎ Previous Settings

The  indicator under the value display in the Picture Control setting menu indicates the previous value for the setting. Use this as a reference when adjusting settings.

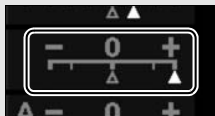



## ✎ Filter Effects (Monochrome Only)

The options in this menu simulate the effect of color filters on monochrome photographs. The following filter effects are available:

Option	Description
Y Yellow	Enhances contrast. Can be used to tone down the brightness of the sky in landscape photographs. Orange produces more contrast than yellow, red more contrast than orange.
O Orange	
R Red	
G Green	Softens skin tones. Can be used for portraits.

## ✎ Toning (Monochrome Only)

Pressing  when **Toning** is selected displays saturation options. Press  or  to adjust saturation. Saturation control is not available when **B&W** (black-and-white) is selected.



## ✎ Custom Picture Control Options

The options available with custom Picture Controls are the same as those on which the custom Picture Control was based.

## Creating Custom Picture Controls

The Picture Controls supplied with the camera can be modified and saved as custom Picture Controls.

- 1 Select Manage Picture Control.**  
Highlight **Manage Picture Control** in the photo shooting menu and press **OK**.

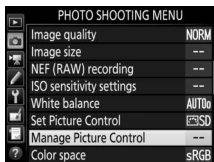

- 2 Select Save/edit.**  
Highlight **Save/edit** and press **OK**.

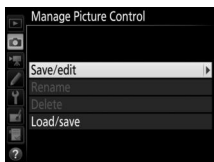

- 3 Select a Picture Control.**  
Highlight an existing Picture Control and press **OK**, or press **OK** to proceed to Step 5 to save a copy of the highlighted Picture Control without further modification.

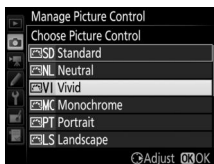

- 4 Edit the selected Picture Control.**  
See page 183 for more information. To abandon any changes and start over from default settings, press the **Reset** button. Press **OK** when settings are complete.





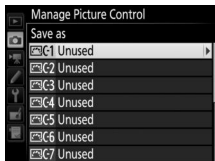

## 5 Select a destination.

Choose a destination for the custom Picture Control (C-1 through C-9) and press .



## 6 Name the Picture Control.

The text-entry dialog shown at right will be displayed. By default, new Picture Controls are named by adding a two-digit number (assigned automatically) to the name of the existing Picture Control; to use the default name, proceed to Step 7. To move the cursor in the name area, tap the display or hold the  button and press  or . To enter a new letter at the current cursor position, tap the letters on the touch-screen keyboard (tap the keyboard selection button to cycle through the upper-case, lower-case, and symbol keyboards). You can also use the multi selector to highlight the desired character in the keyboard area and press the center of the multi selector. To delete the character at the current cursor position, press the  () button.

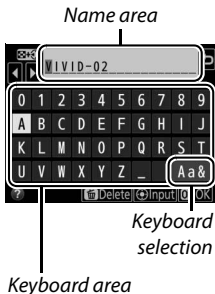

Custom Picture Control names can be up to nineteen characters long. Any characters after the nineteenth will be deleted.



## 7 Save changes and exit.

Press **OK** to save changes and exit. The new Picture Control will appear in the Picture Control list.



### Manage Picture Control > Rename

Custom Picture Controls can be renamed at any time using the **Rename** option in the **Manage Picture Control** menu.

### Manage Picture Control > Delete

The **Delete** option in the **Manage Picture Control** menu can be used to delete selected custom Picture Controls when they are no longer needed.

### The Original Picture Control Icon

The original preset Picture Control on which the custom Picture Control is based is indicated by an icon in the top right corner of the edit display.

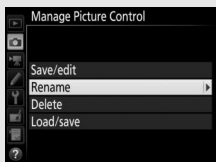

*Original  
Picture Control icon*



## Sharing Custom Picture Controls

The **Load/save** item in the **Manage Picture Control** menu offers the options listed below. Use these options to copy custom Picture Controls to and from memory cards (if two memory cards are inserted, the card in the primary slot will be used;  96). Once copied to memory cards, Picture Controls can be used with other cameras or compatible software.

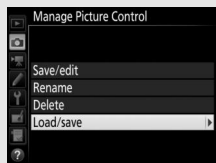

- **Copy to camera:** Copy custom Picture Controls from the memory card to custom Picture Controls C-1 through C-9 on the camera and name them as desired.
- **Delete from card:** Delete selected custom Picture Controls from the memory card.
- **Copy to card:** Copy a custom Picture Control (C-1 through C-9) from the camera to a selected destination (1 through 99) on the memory card.

## Preserving Detail in Highlights and Shadows

### Active D-Lighting

Active D-Lighting preserves details in highlights and shadows, creating photographs with natural contrast. Use for high contrast scenes, for example when photographing brightly lit outdoor scenery through a door or window or taking pictures of shaded subjects on a sunny day. It is most effective when used with matrix metering (☐ 128).



*Active D-Lighting off*



*Active D-Lighting: ☐ A Auto*

#### "Active D-Lighting" versus "D-Lighting"

The **Active D-Lighting** options in the photo and movie shooting menus adjust exposure before shooting to optimize the dynamic range, while the **D-Lighting** option in the retouch menu (☐ 313) brightens shadows in images after shooting.

#### **Active D-Lighting**

Noise (randomly-spaced bright pixels, fog, or lines) may appear in photographs taken with Active D-Lighting. Uneven shading may be visible with some subjects. Active D-Lighting does not apply at high ISO sensitivities (Hi 0.3–Hi 5).



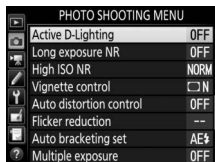

To use Active D-Lighting:

## 1 Select Active D-Lighting.

Highlight **Active D-Lighting** in the photo shooting menu and press .



## 2 Choose an option.

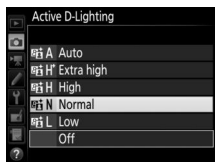

Highlight the desired option and press . If  **Auto** is selected, the camera will automatically adjust Active D-Lighting according to shooting conditions (in exposure mode **M**, however,  **Auto** is equivalent to  **Normal**).



### Active D-Lighting and Movies

If **Same as photo settings** is selected for **Active D-Lighting** in the movie shooting menu and **Auto** is selected in the photo shooting menu, movies will be shot at a setting equivalent to **Normal**. Active D-Lighting does not apply at a frame size of 3840 × 2160.

### See Also

When **ADL bracketing** is selected for **Auto bracketing set** in photo shooting menu ( 146), the camera varies Active D-Lighting over a series of shots ( 155).

## **High Dynamic Range (HDR)**

Used with high-contrast subjects, **High Dynamic Range (HDR)** preserves details in highlights and shadows by combining two shots taken at different exposures. HDR is most effective when used with matrix metering (☞ 128; with spot or center-weighted metering and a non-CPU lens, an exposure differential of **Auto** is equivalent to about 2 EV). It can not be used to record NEF (RAW) images. Flash lighting (☞ 196), bracketing (☞ 146), multiple exposure (☞ 236), and time lapse (☞ 74) can not be used while HDR is in effect and shutter speeds of  $\frac{1}{200}$  and - are not available.

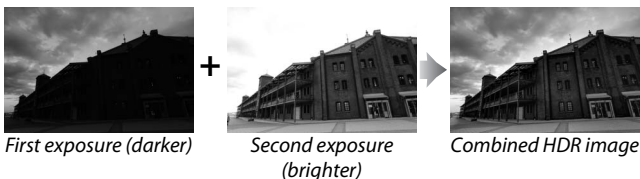



- 1 Select HDR (high dynamic range).** Highlight **HDR (high dynamic range)** in the photo shooting menu and press .

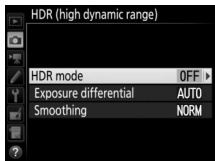

## 2 Select a mode.

Highlight **HDR mode** and press .



Highlight one of the following and press .

- **To take a series of HDR photographs, select **ON**  **On (series)**.** HDR shooting will continue until you select **Off** for **HDR mode**.
- **To take one HDR photograph, select **On** (single photo).** Normal shooting will resume automatically after you have created a single HDR photograph.
- **To exit without creating additional HDR photographs, select **Off**.**

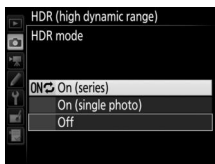

If **On (series)** or **On (single photo)** is selected, a  icon will be displayed in the control panel.

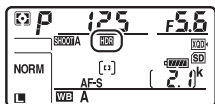

---

### 3 Choose the exposure differential.

To choose the difference in exposure between the two shots, highlight **Exposure differential** and press .

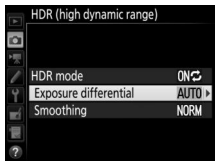

The options shown at right will be displayed. Highlight an option and press . Choose higher values for high-contrast subjects, but note that choosing a value higher than required may not produce the desired results; if

**Auto** is selected, the camera will automatically adjust exposure to suit the scene.

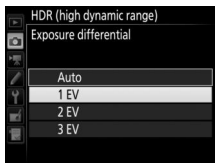

---

### 4 Choose the amount of smoothing.

To choose how much the boundaries between the two images are smoothed, highlight **Smoothing** and press .

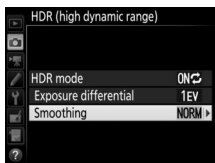

The options shown at right will be displayed. Highlight an option and press . Higher values produce a smoother composite image. Uneven shading may be visible with some subjects.



## 5 Frame a photograph, focus, and shoot.

The camera takes two exposures when the shutter-release button is pressed all the way down.

"Job HDR" will flash in the control panel and *Job Hdr* in the viewfinder while the images are combined; no photographs can be taken until recording is complete. Regardless of the option currently selected for release mode, only one photograph will be taken each time the shutter-release button is pressed.

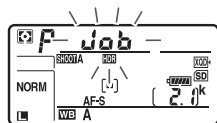

Control panel



Viewfinder







If **On (series)** is selected, HDR will only turn off when **Off** is selected for **HDR mode**; if **On (single photo)** is selected, HDR turns off automatically after the photograph is taken. The **HDR** icon clears from the display when HDR shooting ends.

### Framing HDR Photographs

The edges of the image will be cropped out. The desired results may not be achieved if the camera or subject moves during shooting. Use of a tripod is recommended. Depending on the scene, the effect may not be visible, shadows may appear around bright objects, or halos may appear around dark objects; this effect can be reduced by adjusting the amount of smoothing.



### 🔍 The BKT Button

If **HDR (high dynamic range)** is selected for Custom Setting f1 (**Custom control assignment**) > **BKT button** +  (☐ 301), you can select the HDR mode by pressing the **BKT** button and rotating the main command dial and the exposure differential by pressing the **BKT** button and rotating the sub-command dial. The mode and exposure differential are shown in the control panel: the icons representing the mode are    for **Off**,  for **On (single photo)**, and  for **On (series)**.

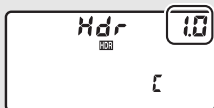

### 🔍 Interval Timer Photography

If **On (series)** is selected for **HDR mode** before interval timer shooting begins, the camera will continue to shoot HDR photographs at the selected interval (if **On (single photo)** is selected, interval timer shooting will end after a single shot).

### 🔍 Photo Shooting Menu Banks

HDR settings can be adjusted separately for each bank (☐ 283), but switching to a bank in which HDR is active during multiple exposure (☐ 236) or interval timer shooting (☐ 243) disables HDR. HDR is also disabled if you switch to a bank in which an NEF (RAW) option is selected for image quality.

# Flash Photography

To take photos with a flash, attach an optional flash unit (📖 328) to the camera accessory shoe. You can also use one or more remote flash units for off-camera flash photography. For information on using flash units, see the documentation provided with the device.

## Using a Flash

Follow the steps below to mount an optional flash unit on the camera and take photographs using the flash.

---

### 1 Mount the unit on the accessory shoe.

See the manual provided with the unit for details.

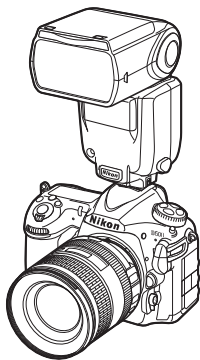

---

### 2 Turn on the camera and flash unit.

The flash will begin charging; the flash-ready indicator (⚡) will be displayed in the viewfinder when charging is complete.

---

### 3 Adjust flash settings.

Choose the flash mode (📖 201) and flash control mode (📖 199).

---

## 4 Adjust shutter speed and aperture.

---

## 5 Take pictures.

### ✔ Use Only Nikon Flash Accessories

Use only Nikon flash units. Negative voltages or voltages over 250 V applied to the accessory shoe could not only prevent normal operation, but damage the sync circuitry of the camera or flash. Before using a Nikon flash unit not listed in this section, contact a Nikon-authorized service representative for more information.

### ✔ Shutter Speed

Shutter speed can be set as follows when an optional flash unit is used:

Mode	Shutter speed
P, A	Set automatically by camera ( $1/250$ s– $1/60$ s)*
S	Value selected by user ( $1/250$ s–30 s)
M	Value selected by user ( $1/250$ s–30 s, Bulb (b u l b), Time (- -))

\* Shutter speed may be set as slow as 30 s if slow sync, slow rear-curtain sync, or slow sync with red-eye reduction is selected for flash mode.

### ✔ The Sync Terminal

A sync cable can be connected to the sync terminal as required. Do not connect another flash unit via a sync cable when performing rear-curtain sync flash photography with a flash unit mounted on the camera accessory shoe.



### ✔ Unified Flash Control

Unified flash control allows the camera and flash unit to share settings. If a flash unit that supports unified flash control is mounted on the camera, changes to flash settings made with either the camera or flash unit are reflected on both devices, as are changes made using optional Camera Control Pro 2 software.

### i-TTL Flash Control

When a CLS-compatible flash unit is set to TTL, the camera automatically selects one of the following types of flash control:



- **i-TTL balanced fill-flash for digital SLR:** Flash unit emits series of nearly invisible preflashes (monitor preflashes) immediately before main flash. Preflashes reflected from objects in all areas of frame are picked up by RGB sensor with approximately 180K (180,000) pixels and are analyzed in combination with range information from matrix metering system to adjust flash output for natural balance between main subject and ambient background lighting. If type G, E, or D lens is used, distance information is included when calculating flash output. Precision of calculation can be increased for non-CPU lenses by providing lens data (focal length and maximum aperture; see page 250). Not available when spot metering is used.
- **Standard i-TTL fill-flash for digital SLR:** Flash output adjusted to bring lighting in frame to standard level; brightness of background is not taken into account. Recommended for shots in which main subject is emphasized at expense of background details, or when exposure compensation is used. Standard i-TTL fill-flash for digital SLR is activated automatically when spot metering is selected.

## On-Camera Flash Photography

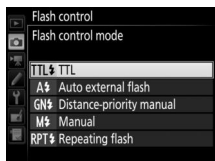
When an SB-5000, SB-500, SB-400, or SB-300 is mounted on the camera, the flash control mode, flash level, and other flash settings can be adjusted using the **Flash control > Flash control mode**









item in the photo shooting menu (in the case of the SB-5000, these settings can also be adjusted using the controls on the flash unit). The options available vary with the flash used (📖 328), while the options displayed under **Flash control mode** vary with the mode selected. Settings for other flash units can only be adjusted using flash unit controls.

- **TTL:** i-TTL mode. In the cases of the SB-500, SB-400, and SB-300, flash compensation can be adjusted using the  button (📖 203).
- **Auto external flash:** In this mode, output is adjusted automatically according to the amount of light reflected by the subject; flash compensation is also available. Auto external flash supports “auto aperture” (A) and “non-TTL auto” (A) modes; non-TTL auto is selected automatically if a non-CPU lens is attached without specifying the focal length and maximum aperture using the **Non-CPU lens data** option in the setup menu (📖 250). See the flash unit manual for details.
- **Distance-priority manual:** Choose the distance to the subject; flash output will be adjusted automatically. Flash compensation is also available.

- **Manual:** Choose the flash level manually.
- **Repeating flash:** The flash fires repeatedly while the shutter is open, producing a multiple-exposure effect. Choose the flash level (**Output**), the number of times the units fire (**Times**), and the number of times the flash fires per second (**Frequency**, measured in Hertz). Note that the number of times the units fire in total may vary depending on the options selected for **Output** and **Frequency**; see the documentation provided with the flash unit for details.

## Flash Modes



The camera supports the following flash modes:

Flash mode	Description
 Front-curtain sync	This mode is recommended for most situations. In programmed auto and aperture-priority auto modes, shutter speed will automatically be set to values between $\frac{1}{250}$ s and $\frac{1}{60}$ s ( $\frac{1}{8000}$ s to $\frac{1}{60}$ s with Auto FP High-Speed Sync;  299).
 Red-eye reduction	If flash unit supports red-eye reduction, choose this mode to reduce “red-eye” effect sometimes caused by flash. Not recommended with moving subjects or in other situations in which quick shutter response is required. Do not move camera during shooting.
 Red-eye reduction with slow sync	Combines red-eye reduction with slow sync. Use for portraits taken against a backdrop of night scenery. This mode is only available in programmed auto and aperture-priority auto exposure modes. Use of tripod is recommended to prevent blurring caused by camera shake.
 Slow sync	Flash is combined with shutter speeds as slow as 30 s to capture both subject and background at night or under dim light. This mode is only available in programmed auto and aperture-priority auto exposure modes. Use of tripod is recommended to prevent blurring caused by camera shake.
 Rear-curtain sync	In shutter-priority auto or manual exposure mode, flash fires just before the shutter closes. Use to create effect of a stream of light behind moving objects. In programmed auto and aperture-priority auto, slow rear-curtain sync is used to capture both subject and background. Use of tripod is recommended to prevent blurring caused by camera shake.
 Flash off	Flash does not fire.

## ■ Choosing a Flash Mode

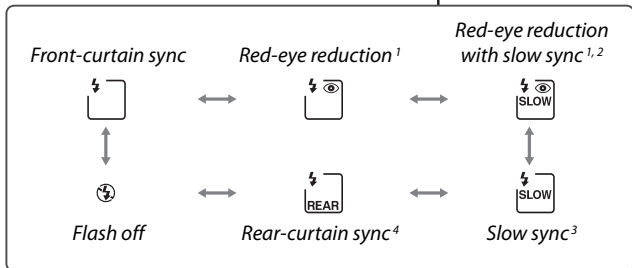
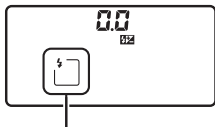
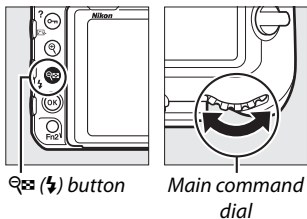
To choose the flash mode, press the  button and rotate the main command dial until the desired flash mode is selected in the control panel:



- 1  icon flashes if flash unit does not support red-eye reduction.
- 2 Red-eye reduction with slow sync is available only in exposure modes **P** and **A**. In modes **S** and **M**, red-eye reduction with slow sync becomes red-eye reduction.
- 3 Available only in exposure modes **P** and **A**. In modes **S** and **M**, slow sync becomes front-curtain sync.
- 4 In exposure modes **P** and **A**, flash-sync mode will be set to slow rear-curtain sync when the  button is released.



## ■ Studio Flash Systems

Rear-curtain sync can not be used with studio flash systems, as the correct synchronization can not be obtained.



## Flash Compensation

Flash compensation is used to alter flash output by from  $-3$  EV to  $+1$  EV in increments of  $\frac{1}{3}$  EV, changing the brightness of the main subject relative to the background. Flash output can be increased to make the main subject appear brighter, or reduced to prevent unwanted highlights or reflections. In general, choose positive values to make the main subject brighter, negative values to make it darker.

To choose a value for flash compensation, press the  button and rotate the sub-command dial until the desired value is displayed in the control panel.

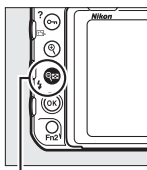

 button

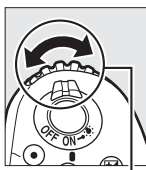

Sub-command dial

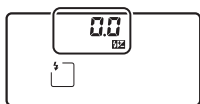

$\pm 0$  EV

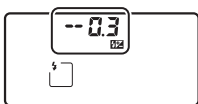

( button pressed)

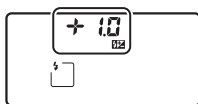

$-0.3$  EV



$+1.0$  EV



At values other than  $\pm 0.0$ , a  icon will be displayed in the control panel and viewfinder after you release the  button. The current value for flash compensation can be confirmed by pressing the  button.

Normal flash output can be restored by setting flash compensation to  $\pm 0.0$ . Flash compensation is not reset when the camera is turned off.

### **Optional Flash Units**

In i-TTL and auto aperture (⊕A) flash control modes, the flash compensation selected with the optional flash unit or the **Flash control** option in the photo shooting menu is added to the flash compensation selected with the  button and command dial.

### **See Also**

For information on choosing the size of the increments available for flash compensation, see Custom Setting b3 (**Exp./flash comp. step value**,  294). For information on choosing whether flash compensation is applied in addition to exposure compensation when the flash is used, see Custom Setting e3 (**Exposure comp. for flash**,  300). For information on automatically varying flash level over a series of shots, see page 147.

## FV Lock

This feature is used to lock flash output, allowing photographs to be recomposed without changing the flash level and ensuring that flash output is appropriate to the subject even when the subject is not positioned in the center of the frame. Flash output is adjusted automatically for any changes in ISO sensitivity and aperture. FV lock is available with CLS compatible flash units only (📖 328, 330).

To use FV lock:

### 1 Assign FV lock to a camera control.

Assign **FV lock** to a control using Custom Setting f1 (**Custom control assignment**, 📖 301).

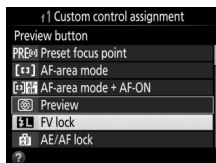

### 2 Attach a CLS-compatible flash unit.

Mount a CLS-compatible flash unit (📖 328) on the camera accessory shoe.

### 3 Set the flash unit to the appropriate mode.

Turn the flash unit on and set the flash mode to TTL, monitor pre-flash  $\text{⊗A}$ , or monitor pre-flash A. See the documentation provided with the flash unit for details.

### 4 Focus.

Position the subject in the center of the frame and press the shutter-release button halfway to focus.



---

## 5 Lock flash level.

After confirming that the flash-ready indicator (⚡) is displayed in the viewfinder, press the control selected in Step 1. The flash will emit a monitor preflash to determine the appropriate flash level. Flash output will be locked at this level and FV lock icon (🔒) will appear in the viewfinder.



---

## 6 Recompose the photograph.



---

## 7 Take the photograph.

Press the shutter-release button the rest of the way down to shoot. If desired, additional pictures can be taken without releasing FV lock.



---

## 8 Release FV lock.

Press the control selected in Step 1 to release FV lock. Confirm that the FV lock icon (🔒) is no longer displayed in the viewfinder.

## Metering

The metering areas for FV lock are as follows:

Flash unit	Flash mode	Metered area
Stand-alone flash unit	i-TTL	6-mm circle in center of frame
	 A	Area metered by flash exposure meter
Used with other flash units (Advanced Wireless Lighting)	i-TTL	Entire frame
	 A	Area metered by flash exposure meter
	A (master flash)	

## Remote Flash Photography

Use remotely controlled flash units for off-camera lighting (Advanced Wireless Lighting, or AWL; [□ 328](#)). The camera supports two types of remote flash control: optical AWL, in which the master flash controls the remote flash units using optical signals (low-intensity flash pulses), and radio AWL, in which the remote flash units are controlled by means of radio signals emitted by a WR-R10 mounted on the camera. When an SB-5000 or SB-500 flash unit or a WR-R10 wireless remote controller is mounted on the camera, the remote flash control mode can be selected using the **Flash control > Wireless flash options** item in the camera photo shooting menu.

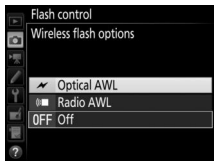

Option	Description
<b>Optical AWL</b>	The remote flash units are controlled using low-intensity flashes emitted by the master flash. Available only with an SB-5000 or SB-500 mounted on the camera accessory shoe and remote flash units that support optical AWL ( <a href="#">□ 209</a> ).
<b>Optical/radio AWL</b>	This option is for flash photography using both optically- and radio-controlled flash units and is available when a WR-R10 is attached and an SB-500, or an SB-910, SB-900, SB-800, SB-700, or SU-800 configured to serve as the master flash, is mounted on the camera accessory shoe ( <a href="#">□ 213</a> ). <b>Remote flash control</b> is automatically set to <b>Group flash</b> ( <a href="#">□ 214</a> ).
<b>Radio AWL</b>	The remote flash units are controlled by radio signals emitted by a WR-R10 attached to the camera ( <a href="#">□ 210</a> ). Available only with the WR-R10 and remote flash units that support radio AWL.
<b>Off</b>	Remote flash photography disabled.

## Setup

This section details the steps involved in setting up a WR-R10 or a master flash mounted on the camera accessory shoe (📷) and remote flash units (📷) for wireless flash photography. More information on using optional flash units can be found in the documentation provided with the devices.

### ■ ■ *Optical AWL*

The following instructions assume that the master flash is an SB-5000 or SB-500. When an SB-910, SB-900, SB-800, SB-700, or SU-800 is used as a master flash, settings must be adjusted using the controls on the individual flash units; see the flash unit manuals for details.

---

#### 1 📷: Connect the master flash.

Mount an SB-5000 or SB-500 on the camera accessory shoe.

---

#### 2 📷: Enable optical AWL.

In the photo shooting menu, select **Optical AWL for Flash control > Wireless flash options**.

You can now take photos as described on page 214.

## ■ Radio AWL

Radio AWL is available with compatible remote flash units when a WR-R10 is attached to the camera.

### 1 Connect the WR-R10.

For more information, see the documentation provided with the WR-R10.

### 2 Enable radio AWL.

In the photo shooting menu, select **Radio AWL for Flash control** > **Wireless flash options**.

### 3 Set the WR-R10 to the desired channel.

Set the WR-R10 channel selector to the desired channel.

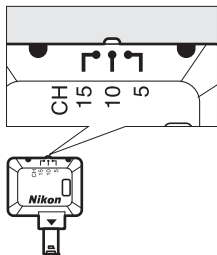

## Radio AWL

A WR-A10 adapter is required when using the WR-R10. Be sure to update the WR-R10 firmware to the latest version; for information on firmware updates, see the Nikon website for your area.



---

#### 4 : Choose a link mode.

Select **Wireless remote (WR)**

**options** > **Link mode** in the setup menu (📖 307) and choose from the following options:

- **Pairing:** Pair the flash unit with the WR-R10.
- **PIN:** Connect the camera and flash unit using a four-digit PIN.

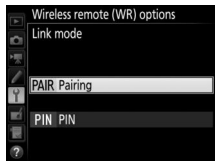

---

#### 5 : Establish a wireless connection.

Set the flash units to remote mode and set the devices to the channel you selected in Step 3, then pair the flash units with the WR-R10 according to the option selected in Step 4:

- **Pairing:** Initiate pairing on the flash unit and press the WR-R10 pairing button. Pairing is complete when the LINK lamps on the WR-R10 and flash unit flash orange and green; once a connection is established, the flash unit LINK lamp will light green.
- **PIN:** Use the flash unit controls to enter the PIN you selected in Step 4. The flash unit LINK lamp lights green once a connection is established.

Repeat Step 5 until all the remote flash units have been paired.

You can now take photos as described on page 214.

### Reconnecting

As long as the channel, link mode, and other settings remain the same, the camera will automatically connect to previously paired flash units when you select remote mode and Steps 3–5 can be omitted. The flash unit LINK lamp lights green when a connection is established.

### Radio-Controlled Flash Units

Radio-controlled flash units can be combined with any of the following flash units mounted on the camera accessory shoe:

- **SB-5000:** Before attaching the flash unit, set it to radio-controlled master flash mode (a  icon will appear at the top left corner of the display) and choose group or remote repeating flash control. Once the unit is attached, settings can be adjusted using the controls on the flash unit or the options listed in the camera menus under **Group flash options > Master flash** or under “M” in the **Remote repeating options** display.
- **SB-910, SB-900, SB-800, SB-700:** Configure the flash for stand-alone use and use the controls on the flash unit to adjust flash settings.
- **SB-500, SB-400, SB-300:** Mount the unit on the camera and adjust settings using the camera **Group flash options > Master flash** option.

## ■ ■ *Optical/Radio AWL*

For remote flash lighting that incorporates both optically- and radio-controlled flash units, select **Optical/radio AWL** for **Flash control** > **Wireless flash options** in the photo shooting menu and set up the radio-controlled units as described under “Radio AWL”(☰ 210). Place optically-controlled units in group A, B, or C and radio-controlled units in group D, E, or F. You can now take photos as described on page 214.

### ✎ **Remote Flash Info**

To view the flash units currently controlled using radio AWL, select **Flash control** > **Radio remote flash info** in the photo shooting menu. The identifier (“remote flash name”) for each unit can be changed using flash unit controls.

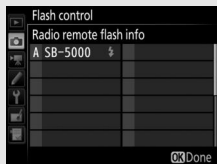

## Taking Photos

The **Flash control** > **Remote flash control** item in the photo shooting menu offers three options for remote flash photography: **Group flash**, **Quick wireless control**, and **Remote repeating**.



### ■ Group Flash

Select this option to adjust settings separately for each group.

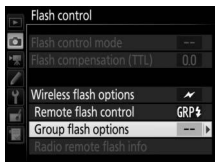
- 1** : **Select Group flash options.**  
Highlight **Group flash options** in the flash control display and press .



- 2** : **Choose the flash control mode.**  
Choose the flash control mode and flash level for the master flash and the flash units in each group:

- **TTL**: i-TTL flash control ( 198).
-  **A**: Auto aperture (available only with compatible flash units).
- **M**: Choose the flash level manually.
- -- (**off**): The units do not fire and the flash level can not be adjusted.

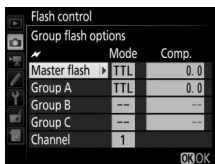

If **Optical AWL** or **Optical/radio AWL** is selected for **Flash control** >

**Wireless flash options** in the photo shooting menu (☰ 284), choose a channel for the master flash. If the remote flash units include an SB-500, you must choose channel 3, but otherwise you can choose any channel between 1 and 4.

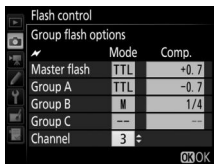

---

### 3 : Set the channel (optical AWL only).

Set the remote flash units to the channel selected in Step 2.

---

### 4 : Group the remote flash units.

#### Optical AWL

Choose a group (A, B, or C, or if you are using an SB-500 master flash, A or B) for each remote flash unit. Although there is no limit on the number of remote flash units that may be used, the practical maximum is three per group. With more than this number, the light emitted by the remote flash units will interfere with performance.

#### Radio AWL

Choose a group (A–F) for each of the remote flash units. The master flash can control up to 18 flash units in any combination.

---

## 5 : Compose the shot.

Compose the shot and arrange the flash units. See the documentation provided with the flash units for more information. After arranging the units, take a test shot to confirm that all flash units are functioning. You can also test-fire radio-controlled flash units by pressing the **i** button in the flash info display ([□ 222](#)) and selecting **⚡ Test flash**.

---

## 6 : Frame the photograph, focus, and shoot.

In radio AWL, the flash-ready indicator will light in the camera viewfinder ([□ 196](#)) or flash information display when all flash units are ready. The status of radio-controlled units can also be viewed by selecting **Flash control > Radio remote flash info** in the photo shooting menu.

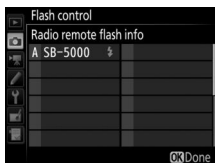

## **Quick Wireless Control**

Select this option to control overall flash compensation for, and the relative balance between, groups A and B, while setting output for group C manually.

---

## 1 : Select **Quick wireless control options**.

Highlight **Quick wireless control options** in the flash control display and press **⏪**.

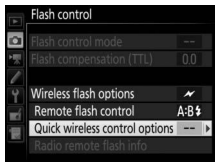

## 2 Adjust flash settings.

Choose the balance between groups A and B.

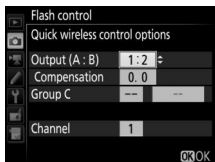

Adjust flash compensation for groups A and B.

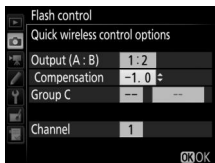

Choose a flash control mode and flash level for the units in group C:

- **M**: Choose the flash level manually.
- **--**: The units in group C do not fire.

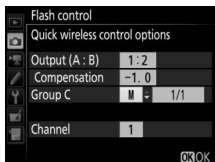

If **Optical AWL** is selected for **Flash control > Wireless flash options** in the photo shooting menu (📖 284), choose a channel for the master flash. If the remote flash units include an SB-500, you must choose channel 3, but otherwise you can choose any channel between 1 and 4.

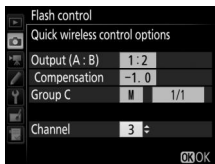

## 3 Set the channel (optical AWL only).

Set the remote flash units to the channel selected in Step 2.

---

## 4 : Group the remote flash units.

Choose a group (A, B, or C).

### Optical AWL

Although there is no limit on the number of remote flash units that may be used, the practical maximum is three per group. With more than this number, the light emitted by the remote flash units will interfere with performance.

### Radio AWL

The master flash can control up to 18 flash units in any combination.

---

## 5 / : Compose the shot.

Compose the shot and arrange the flash units. See the documentation provided with the flash units for more information. After arranging the units, take a test shot to confirm that all flash units are functioning. You can also test-fire radio-controlled flash units by pressing the **i** button in the flash info display ([□ 222](#)) and selecting **⚡ Test flash**.

---

## 6 / : Frame the photograph, focus, and shoot.

In radio AWL, the flash-ready indicator will light in the camera viewfinder ([□ 196](#)) or flash information display when all flash units are ready. The status of radio-controlled units can also be viewed by selecting **Flash control > Radio remote flash info** in the photo shooting menu.

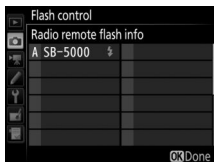



## ■ Remote Repeating

When this option is selected, the flash units fire repeatedly while the shutter is open, producing a multiple-exposure effect.

### 1 Select Remote repeating options.

Highlight **Remote repeating options** in the flash control display menu and press .

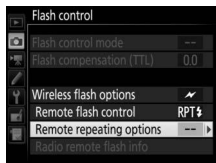

### 2 Adjust flash settings.

Choose the flash level (**Output**), the maximum number of times the flash units fire (**Times**), and the number of times the flash units fire per second (**Frequency**).

Enable or disable selected groups. Select **ON** to enable the selected group, **--** to disable the selected group.

If **Optical AWL** is selected for **Flash control > Wireless flash options** in the photo shooting menu (📖 284), choose a channel for the master flash. If the remote flash units include an SB-500, you must choose channel 3, but otherwise you can choose any channel between 1 and 4.

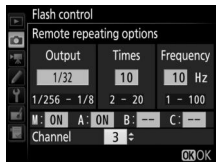
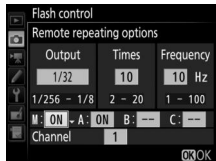
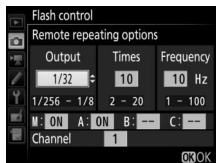

---

### 3 : Set the channel (optical AWL only).

Set the remote flash units to the channel selected in Step 2.

---

### 4 : Group the remote flash units.

#### Optical AWL



Choose a group (A, B, or C) for each remote flash unit. Although there is no limit on the number of remote flash units that may be used, the practical maximum is three per group. With more than this number, the light emitted by the remote flash units will interfere with performance.

#### Radio AWL

Choose a group (A–F) for each of the remote flash units. The master flash can control up to 18 flash units in any combination.

---

### 5 : Compose the shot.

Compose the shot and arrange the flash units. See the documentation provided with the flash units for more information. After arranging the units, take a test shot to confirm that all flash units are functioning. You can also test-fire radio-controlled flash units by pressing the  button in the flash info display (📖 222) and selecting  **Test flash**.

---

### 6 : Frame the photograph, focus, and shoot.

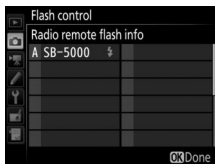

In radio AWL, the flash-ready indicator will light in the camera viewfinder (📖 196) or flash information display when all flash units are ready. The status of radio-controlled units can also be viewed by selecting **Flash control > Radio remote flash info** in the photo shooting menu.



### **Optical AWL**

Position the sensor windows on the remote flash units to pick up the light from the master flash (particular care is required if the camera is not mounted on a tripod). Be sure that direct light or strong reflections from the remote flash units do not enter the camera lens (in TTL mode) or the photocells on the remote flash units (⊗A mode), as this may interfere with exposure. To prevent low-intensity flashes emitted by the master flash from appearing in photographs taken at short range, choose low ISO sensitivities or small apertures (high f-numbers) or rotate the flash head on the master flash to point upwards. After positioning the remote flash units, take a test shot and view the results in the camera monitor.

### **Flash Compensation**

The flash compensation value selected with the  button and sub-command dial is added to the flash compensation values selected in the wireless flash options menu.  icons blink in the control panel and viewfinder when a flash compensation value other than  $\pm 0$  is selected for the master or remote flash units in TTL or ⊗A mode.

## Viewing Flash Info

The camera can display flash info for SB-5000, SB-500, SB-400, and SB-300 flash units mounted on the camera accessory shoe and for remote flash units controlled via radio AWL using a WR-R10. To view flash info, press the **info** button in the information display ( 226). The information displayed varies with the flash control mode.

### TTL

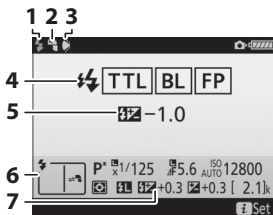

- 1 Flash-ready indicator..... 196
- 2 Bounce icon (displayed if flash head is tilted)
- 3 Flash angle warning (displayed if angle of illumination is sub-optimal)
- 4 Flash control mode ..... 199  
FP indicator ..... 299
- 5 Flash compensation (TTL)  
..... 199, 203
- 6 Flash mode ..... 201
- 7 Flash compensation ..... 203

### Auto External Flash

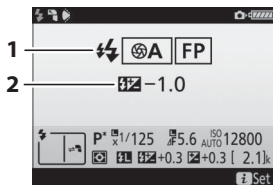

- 1 Flash control mode ..... 199  
FP indicator ..... 299
- 2 Flash compensation (auto aperture) ..... 199, 203

## Distance-Priority Manual

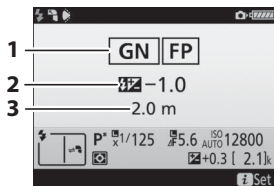

- 1 Flash control mode ..... 199  
FP indicator ..... 299
- 2 Flash compensation (distance-priority manual)..... 199, 203
- 3 Distance ..... 199

## Manual

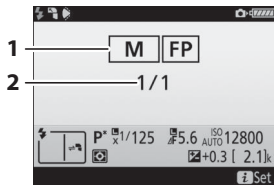

- 1 Flash control mode ..... 199, 200  
FP indicator ..... 299
- 2 Flash level ..... 200

## Repeating Flash

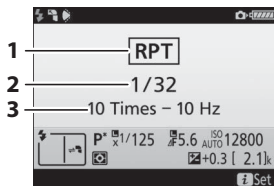

- 1 Flash control mode ..... 199, 200
- 2 Flash level (output) ..... 200
- 3 Number emitted (times) ..... 200  
Frequency ..... 200

## Flash Info and Camera Settings

The flash information display shows selected camera settings, including exposure mode, shutter speed, aperture, and ISO sensitivity.



## ■ ■ Group Flash

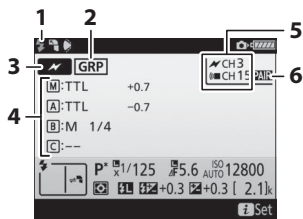

1	Flash-ready indicator <sup>1</sup> .....	196
2	Remote flash control .....	214
3	Remote flash control mode <sup>2</sup> ...	208
4	Group flash control mode <sup>2,3</sup> ....	214
	Group flash mode .....	214
	Flash level/ flash compensation .....	203, 214
5	Channel <sup>2</sup> .....	210, 211, 215
6	Link mode .....	211

## ■ ■ Quick Wireless Control

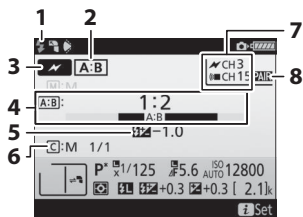

1	Flash-ready indicator <sup>1</sup> .....	196
2	Remote flash control .....	214, 216
3	Remote flash control mode <sup>2</sup> ...	208
4	A : B ratio .....	217
5	Flash compensation .....	203, 217
6	Group C flash control mode and flash level .....	217
7	Channel <sup>2</sup> .....	210, 211, 217
8	Link mode .....	211

## Remote Repeating

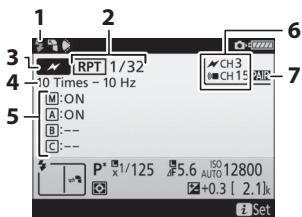

1	Flash-ready indicator <sup>1</sup> .....	196
2	Remote flash control .....	214, 219
	Flash level (output) .....	219
3	Remote flash control mode <sup>2</sup> ...	208
4	Number emitted (times).....	219
	Frequency .....	219
5	Group status (enabled/disabled) .....	219
6	Channel <sup>2</sup> .....	210, 211, 220
7	Link mode .....	211

- 1 Displayed in radio AWL when all flash units are ready.
- 2 Optical AWL is indicated by ⚡, radio AWL by ⚡, joint optical and radio AWL by ⚡ and ⚡. Optical AWL channel for joint optical and radio AWL is displayed only when SB-500 is used as master flash.
- 3 Icons are displayed for each group when joint optical and radio AWL is used.

## Changing Flash Settings

Flash settings can be changed by pressing the **i** button in the flash info display. The options available vary with the flash unit and the settings selected. You can also test-fire the flash.

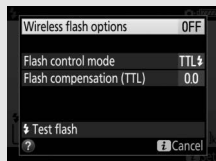

# Other Shooting Options

## The **Info** Button

Pressing the **Info** button during viewfinder photography displays shooting information in the monitor including shutter speed, aperture, number of exposures remaining, and AF-area mode.

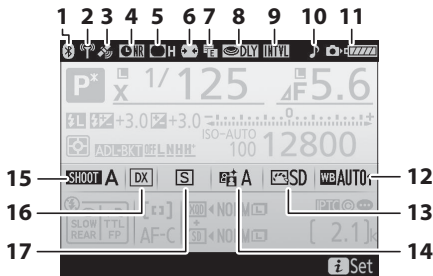

<p><b>1</b> Bluetooth connection indicator ..... 308 Airplane mode ..... 307</p> <p><b>2</b> Wi-Fi connection indicator ..... 308 Eye-Fi connection indicator ..... 308</p> <p><b>3</b> Satellite signal indicator ..... 253</p> <p><b>4</b> Long exposure noise reduction indicator ..... 286</p> <p><b>5</b> Vignette control indicator ..... 286</p> <p><b>6</b> Auto distortion control ..... 286</p> <p><b>7</b> Electronic front-curtain shutter ..... 298</p> <p><b>8</b> Exposure delay mode ..... 297</p>	<p><b>9</b> Interval timer ..... 246 Time-lapse indicator ..... 74 ☺ indicator ..... 5, 304</p> <p><b>10</b> “Beep” indicator ..... 306</p> <p><b>11</b> Camera battery indicator ..... 35 MB-D17 battery type display .. 309 MB-D17 battery indicator</p> <p><b>12</b> White balance ..... 159</p> <p><b>13</b> Picture Control indicator ..... 181</p> <p><b>14</b> Active D-Lighting indicator ..... 190</p> <p><b>15</b> Photo shooting menu bank ..... 283</p> <p><b>16</b> Image area indicator ..... 88</p> <p><b>17</b> Release mode ..... 116</p>
--	--



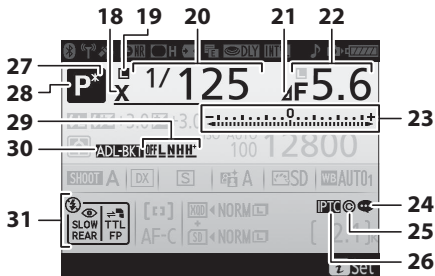

18	Flash sync indicator.....	299	27	Flexible program indicator.....	132
19	Shutter-speed lock icon .....	140	28	Exposure mode .....	130
20	Shutter speed .....	133, 135	29	Position of current frame in bracketing sequence .....	149, 153
21	Aperture stop indicator....	134, 325		ADL bracketing amount .....	156
22	Aperture (f-number).....	134, 135		HDR exposure differential.....	195
	Aperture (number of stops).....	134, 325		HDR (series) indicator.....	192
23	Exposure indicator .....	136		Number of exposures (multiple exposure) .....	238
	Exposure compensation display .....	143		Multiple exposure (series) indicator .....	237
	Bracketing progress indicator: Exposure and flash bracketing.....	147	30	Exposure and flash bracketing indicator .....	147
	WB bracketing.....	151		WB bracketing indicator .....	151
24	Image comment indicator .....	306		ADL bracketing indicator .....	155
25	Copyright information indicator .....	306		HDR indicator .....	192
26	IPTC indicator .....	306		Multiple exposure indicator ....	237
			31	Flash mode .....	201

### Turning the Monitor Off

To clear shooting or flash information from the monitor, press the **info** button or press the shutter-release button halfway. The monitor will turn off automatically if no operations are performed for about 10 seconds.

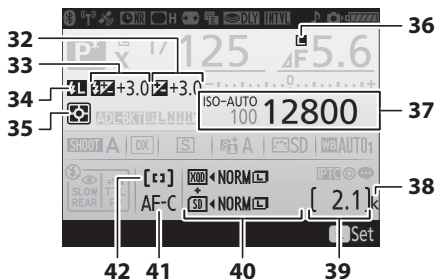

<p><b>32</b> Exposure compensation indicator..... 143 Exposure compensation value ... 143</p> <p><b>33</b> Flash compensation indicator ..... 203 Flash compensation value..... 203</p> <p><b>34</b> FV lock indicator..... 206</p> <p><b>35</b> Metering ..... 128</p> <p><b>36</b> Aperture lock icon ..... 140</p> <p><b>37</b> ISO sensitivity ..... 123 ISO sensitivity indicator..... 123 Auto ISO sensitivity indicator ..... 127</p>	<p><b>38</b> "k" (appears when memory remains for over 1000 exposures)..... 36</p> <p><b>39</b> Number of exposures remaining ..... 36, 389 Manual lens number..... 252</p> <p><b>40</b> Image quality ..... 91 Secondary slot function..... 96 Image size..... 94 XQD card icon..... 15, 96 SD card icon ..... 15, 96</p> <p><b>41</b> Autofocus mode ..... 101</p> <p><b>42</b> AF-area mode ..... 103, 106</p>
--	---

**Note:** Display shown with all indicators lit for illustrative purposes.

#### See Also

For information on choosing how long the monitor stays on, see Custom Setting c4 (**Monitor off delay**, 296). The color of the lettering in the information display can be changed using the **Information display** option in the setup menu (305).

## The *i* button

To access the options below, press the *i* button during viewfinder photography. Highlight items using the multi selector and press  $\odot$  to view options for the highlighted item. To return to shooting mode, press the shutter-release button halfway.

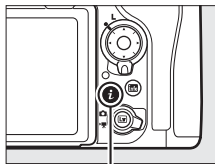

*i* button

Option	
Photo shooting menu bank	283
Custom settings bank	292
Custom control assignment	301
Active D-Lighting	190
Choose image area	89
Long exposure NR	286
High ISO NR	286



## Two-Button Reset: Restoring Default Settings

The camera settings listed below can be restored to default values by holding the **QUAL** and **☒** buttons down together for more than two seconds (these buttons are marked by a green dot). The control panel turns off briefly while settings are reset.



**QUAL** button

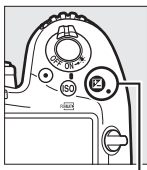

**☒** button

## ■ ■ Settings Accessible from the Photo Shooting Menu<sup>1</sup>

Option	Default
Extended photo menu banks	Off
Image quality	JPEG normal
Image size	
JPEG/TIFF	Large
NEF (RAW)	Large
ISO sensitivity settings	
ISO sensitivity	100
Auto ISO sensitivity control	Off
White balance	Auto > Keep white (reduce warm colors)
Fine-tuning	A-B: 0, G-M: 0
Picture Control settings <sup>2</sup>	Unmodified
Multiple exposure	Off <sup>3</sup>
HDR (high dynamic range)	Off <sup>4</sup>
Interval timer shooting	Off <sup>5</sup>
Flicker reduction	
Flicker reduction setting	Disable
Flicker reduction indicator	On

- 1 With the exception of multiple exposure and interval timer settings, only settings in the bank currently selected using the **Photo shooting menu bank** option will be reset (☞ 283). Settings in the remaining banks are unaffected.
- 2 Current Picture Control only.
- 3 If multiple exposure is currently in progress, shooting will end and multiple exposure will be created from exposures recorded to that point. Overlay mode and number of shots are not reset.
- 4 Exposure differential and smoothing are not reset.
- 5 If interval timer shooting is currently in progress, shooting will end. Starting time, shooting interval, number of intervals and shots, and exposure smoothing are not reset.



## ■ Settings Accessible from the Movie Shooting Menu

Option	Default
ISO sensitivity settings	
ISO sensitivity (mode M)	100
Auto ISO control (mode M)	Off
Maximum sensitivity	51200
White balance	Same as photo settings
Active D-Lighting	Off
Electronic VR	Off

## ■ Other Settings

Option	Default
Focus point <sup>1</sup>	Center
Preset focus point	Center
Exposure mode	Programmed auto
Flexible program	Off
Exposure compensation	Off
AE lock hold	Off
Shutter speed lock	Off
Aperture lock	Off
Autofocus mode	AF-S
AF-area mode	
Viewfinder	Single-point AF
Live view	Normal-area AF
Photo live view display WB	None
Multi-selector power aperture	Disable
Highlight display	Off

Option	Default
Headphone volume	15
Metering	Matrix metering
Bracketing	Off <sup>2</sup>
Flash mode	Front-curtain sync
Flash compensation	Off
FV lock	Off
Exposure delay mode	Off <sup>3</sup>

- 1 Focus point not displayed if auto-area AF is selected for AF-area mode.
- 2 Number of shots is reset to zero. Bracketing increment is reset to 1EV (exposure/flash bracketing) or 1 (white balance bracketing).  **A Auto** is selected for the second shot of two-shot ADL bracketing programs.
- 3 Only settings in the bank currently selected using the **Custom settings bank** option will be reset ( 292). Settings in the remaining banks are unaffected.

## Flicker Reduction

The camera offers two **Flicker reduction** options for reducing the effects of flicker due to fluorescent or mercury-vapor lighting. The first is located in the photo shooting menu and is used to reduce flicker in photos taken during viewfinder photography, while the second is in the movie shooting menu and is used to reduce flicker in live view and movie mode.

### ■ Viewfinder Photography

Choose from the following options:

- **Flicker reduction setting:** When **Enable** is selected, the camera will time photographs to reduce the effects of flicker.
- **Flicker reduction indicator:** When **On** is selected, a **FLICKER** icon will be displayed in the viewfinder if flicker is detected when the shutter-release button is pressed halfway. If flicker is detected when **Disable** is selected for **Flicker reduction setting**, the icon will flash; to enable flicker reduction, select **Enable** for **Flicker reduction setting**.

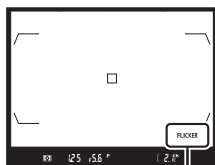
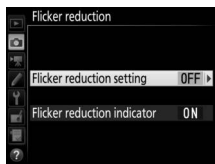

FLICKER icon

### ■ Live View and Movie Mode

The **Flicker reduction** option in the movie shooting menu can be used to reduce flicker and banding during live view and movie recording (📖 290).

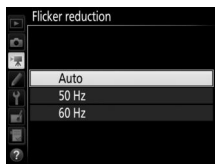



### **Flicker Reduction in the Photo Shooting Menu**

Take a test shot and view the results before taking additional photographs. Flicker reduction can detect flicker at 100 and 120 Hz (associated respectively with AC power supplies of 50 and 60 Hz). Flicker may not be detected or the desired results may not be achieved with dark backgrounds, bright light sources, or decorative lighting displays and other non-standard lighting. Depending on the light source, there may be a slight delay before the shutter is released. During burst shooting, the frame rate may slow or become erratic; in addition, the desired results may not be achieved if the frequency of the power supply changes during shooting.

Flicker detection will not take effect at shutter speeds slower than  $\frac{1}{100}$  s (including Bulb and Time) or when **MUP** is selected for release mode or exposure delay mode is on. Flicker detection is available during flash photography but can not be used with remote wireless flash units.

## Multiple Exposure

Follow the steps below to record a series of two to ten exposures in a single photograph.

### ■ Creating a Multiple Exposure

Multiple exposures can not be recorded in live view. Exit live view before proceeding.

#### ✎ Extended Recording Times

If the monitor turns off during playback or menu operations and no operations are performed for about 30 s, shooting will end and a multiple exposure will be created from the exposures that have been recorded to that point. The time available to record the next exposure can be extended by choosing longer times for Custom Setting c2 (**Standby timer**,  296).

### 1 Select Multiple exposure.

Highlight **Multiple exposure** in the photo shooting menu and press .

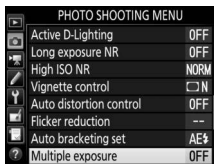

## 2 Select a mode.

Highlight **Multiple exposure mode** and press .

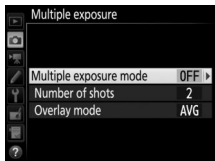

Highlight one of the following and press :

- **To take a series of multiple exposures, select  On (series).** Multiple exposure shooting will continue until you select **Off** for **Multiple exposure mode**.
- **To take one multiple exposure, select **On (single photo)**.** Normal shooting will resume automatically after you have created a single multiple exposure.
- **To exit without creating additional multiple exposures, select **Off**.**

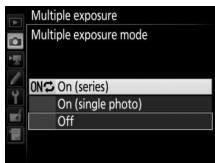

If **On (series)** or **On (single photo)** is selected, a  icon will be displayed in the control panel.

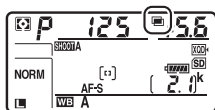

**3 Choose the number of shots.**  
Highlight **Number of shots** and press  $\odot$ .

Press  $\odot$  or  $\odot$  to choose the number of exposures that will be combined to form a single photograph and press  $\odot$ .

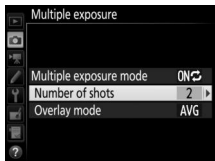

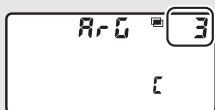

#### The BKT Button

If **Multiple exposure** is selected for Custom Setting f1 (**Custom control assignment**) > **BKT button** + (301), you can select the multiple exposure mode by pressing the **BKT** button and rotating the main command dial and the number of shots by pressing the **BKT** button and rotating the sub-command dial. The mode and number of shots are shown in the control panel: the icons representing the mode are for **Off**, for **On (single photo)**, and for **On (series)**.

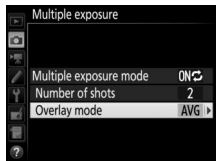

- 4 Choose the overlay mode.**  
Highlight **Overlay mode** and press .



The following options will be displayed. Highlight an option and press .

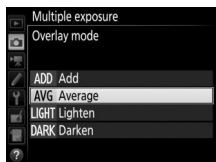

- **Add:** The exposures are overlaid without modification; gain is not adjusted.
- **Average:** Before the exposures are overlaid, the gain for each is divided by the total number of exposures taken (gain for each exposure is set to  $\frac{1}{2}$  for 2 exposures,  $\frac{1}{3}$  for 3 exposures, etc).
- **Lighten:** The camera compares the pixels in each exposure and uses only the brightest.

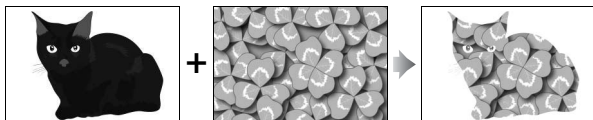

- **Darken:** The camera compares the pixels in each exposure and uses only the darkest.

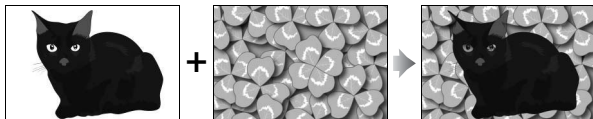

## 5 Frame a photograph, focus, and shoot.

In continuous release modes (☐ 116), the camera records all exposures in a single burst. If **On (series)** is selected, the camera will continue to record multiple exposures while the shutter-release button is pressed; if **On (single photo)** is selected, multiple exposure shooting will end after the first photograph. In self-timer mode, the camera will automatically record the number of exposures selected in Step 3 on page 238, regardless of the option selected for Custom Setting c3 (**Self-timer**) > **Number of shots** (☐ 296); the interval between shots is however controlled by Custom Setting c3 (**Self-timer**) > **Interval between shots**. In other release modes, one photograph will be taken each time the shutter-release button is pressed; continue shooting until all exposures have been recorded (for information on interrupting a multiple exposure before all photographs are recorded, see page 241).



The  icon will flash until shooting ends. If **On (series)** is selected, multiple exposure shooting will only end when **Off** is selected for multiple exposure mode; if **On (single photo)**

is selected, multiple exposure shooting ends automatically when the multiple exposure is complete. The  icon clears from the display when multiple exposure shooting ends.

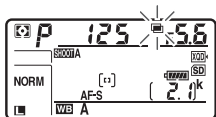

## ■ Ending Multiple Exposures

To end a multiple exposure before the specified number of exposures have been taken, select **Off** for multiple exposure mode. If shooting ends before the specified number of exposures have been taken, a multiple exposure will be created from the exposures that have been recorded to that point. If **Average** is selected for **Overlay mode**, gain will be adjusted to reflect the number of exposures actually recorded. Note that shooting will end automatically if:

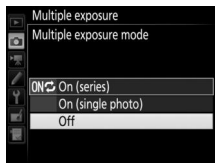

- A two-button reset is performed (📖 230)
- The camera is turned off
- The battery is exhausted
- Pictures are deleted

### ☑ Multiple Exposure

Multiple exposures may be affected by noise (randomly-spaced bright pixels, fog, or lines).

Do not remove or replace the memory card while recording a multiple exposure.

Live view is not available while shooting is in progress. Selecting live view resets **Multiple exposure mode** to **Off**.

The shooting information listed in the playback photo information display (including metering, exposure, exposure mode, focal length, date of recording and camera orientation) is for the first shot in the multiple exposure.

### Interval Timer Photography

If interval timer photography is activated before the first exposure is taken, the camera will record exposures at the selected interval until the number of exposures specified in the multiple exposure menu have been taken (the number of shots listed in the interval timer shooting menu is ignored). These exposures will then be recorded as a single photograph and interval timer shooting will end (if **On (single photo)** is selected for multiple exposure mode, multiple exposure shooting will also end automatically).

### Other Settings

While a multiple exposure is being shot, memory cards can not be formatted and some menu items are grayed out and can not be changed.



## Interval Timer Photography

The camera is equipped to take photographs automatically at preset intervals.

### ☑ Before Shooting

Select a release mode other than self-timer (⌚) when using the interval timer. Before beginning interval timer photography, take a test shot at current settings and view the results in the monitor. Once settings have been adjusted to your satisfaction, close the viewfinder eyepiece shutter to prevent light entering via the viewfinder interfering with photographs and exposure (📖 119).

Before choosing a starting time, select **Time zone and date** in the setup menu and make sure that the camera clock is set to the correct time and date (📖 304).

Use of a tripod is recommended. Mount the camera on a tripod before shooting begins. To ensure that shooting is not interrupted, be sure the camera battery is fully charged. If in doubt, charge the battery before use or use an AC adapter and power connector (available separately).

## 1 Select Interval timer shooting.

Highlight **Interval timer shooting** in the photo shooting menu and press  to display interval timer settings.

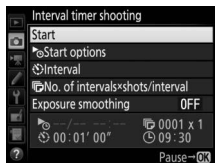

## 2 Adjust interval timer settings.

Choose a start option, interval, number of shots per interval, and exposure smoothing option.

- **To choose a start option:**

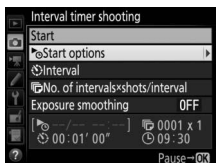

Highlight **Start options** and press  $\odot$ .

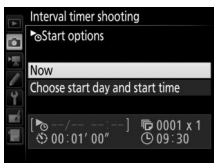

Highlight an option and press  $\odot$ .

To start shooting immediately, select **Now**. To start shooting at a chosen date and time, select **Choose start day and start time**, then choose the date and time and press  $\odot$ .

- **To choose the interval between shots:**

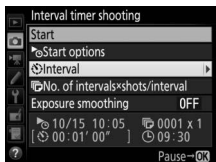

Highlight **Interval** and press  $\odot$ .

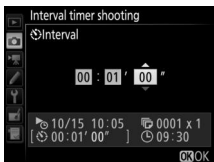

Choose an interval (hours, minutes, and seconds) and press  $\odot$ .

- To choose the number of shots per interval:

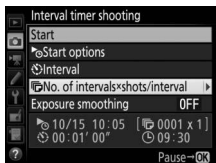

Highlight **No. of intervals × shots/interval** and press  $\odot$ .

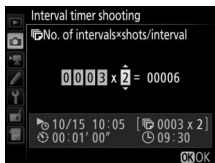

Choose the number of intervals and the number of shots per interval and press  $\odot$ .

In **S** (single frame) mode, the photographs for each interval will be taken at the rate chosen for Custom Setting d1 (**CL mode shooting speed**;  $\square$  297).

- To enable or disable exposure smoothing:

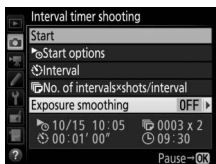

Highlight **Exposure smoothing** and press  $\odot$ .

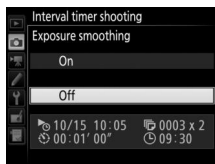

Highlight an option and press  $\odot$ .

Selecting **On** allows the camera to adjust exposure to match previous shot in modes other than **M** (note that exposure smoothing only takes effect in mode **M** if auto ISO sensitivity control is on).

### 3 Start shooting.

Highlight **Start** and press  $\odot$ . The first series of shots will be taken at the specified starting time, or after about 3 s if **Now** was selected for **Start options** in Step 2. Shooting will continue at the selected interval until all shots have been taken.

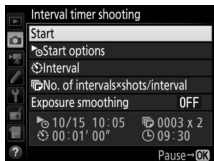

#### During Shooting

During interval timer photography, the **INTVL** icon will flash in the control panel.

Immediately before the next shooting interval begins, the shutter speed display will show the number of intervals remaining, and the aperture display will show the number of shots remaining in the current interval. At other times, the number of intervals remaining and the number of shots in each interval can be viewed by pressing the shutter-release button halfway (once the button is released, the shutter speed and aperture will be displayed until the standby timer expires).

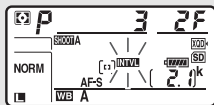

Settings can be adjusted, the menus used, and pictures played back while interval timer photography is in progress. The monitor will turn off automatically about four seconds before each interval. Note that changing camera settings while the interval timer is active may cause shooting to end.

#### Release Mode

Regardless of the release mode selected, the camera will take the specified number of shots at each interval.

## ■ Pausing Interval Timer Photography

Interval timer photography can be paused between intervals by pressing **OK** or selecting **Pause** in the interval timer menu.

## ■ Resuming Interval Timer Shooting

To resume shooting:

### • Starting Now

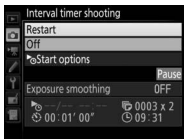

Highlight **Restart**  
and press **OK**.

### • Starting at a Specified Time

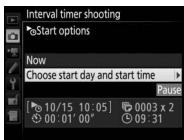

For **Start options**,  
highlight **Choose**  
**start day and start**  
**time** and press **OK**.

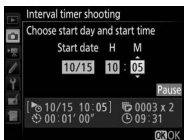

Choose a starting  
date and time and  
press **OK**.

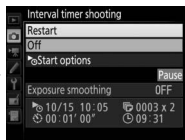

Highlight **Restart**  
and press **OK**.

## ■ Ending Interval Timer Shooting

To end interval timer photography before all the photos are taken, select **Off** in the interval timer menu.

## ■ No Photograph

The camera will skip the current interval if any of the following situations persist for eight seconds or more after the interval was due to start: the photograph or photographs for the previous interval have yet to be taken, the memory card is full, or the camera is unable to focus in **AF-S** (note that the camera focuses again before each shot). Shooting will resume with the next interval.

### ✓ Out of Memory

If the memory card is full, the interval timer will remain active but no pictures will be taken. Resume shooting (☐ 247) after deleting some pictures or turning the camera off and inserting another memory card.

### ✍ Photo Shooting Menu Banks

Changes to interval timer settings apply to all photo shooting menu banks (☐ 283), meaning that interval timer shooting will continue even if you switch menu banks. If photo shooting menu settings are reset using the **Photo shooting menu bank** item in the photo shooting menu, interval timer shooting will end and interval timer settings will be reset as follows:

- Start options: Now
- Interval: 00:01:00"
- Number of intervals: 1
- Number of shots: 1
- Exposure smoothing: Off

### ✍ Bracketing

Adjust bracketing settings before starting interval timer photography. If exposure, flash, or ADL bracketing is active while interval timer photography is in effect, the camera will take the number of shots in the bracketing program at each interval, regardless of the number of shots specified in the interval timer menu. If white balance bracketing is active while interval timer photography is in effect, the camera will take one shot at each interval and process it to create the number of copies specified in the bracketing program.

### Interval Timer Photography

Choose an interval longer than the time needed to take the selected number of shots and, if you are using a flash, the time needed for the flash to charge. If the interval is too short, the number of photos taken may be less than the total listed in Step 2 (the number of intervals multiplied by the number of shots per interval) or the flash may fire at less than the power needed for full exposure. Flash output may also fall below the desired level if more than one shot is taken per interval. Interval timer photography can not be combined with long time-exposures (bulb or time photography, [□□ 137](#)) or time-lapse movies ([□□ 74](#)) and is not available in live view ([□□ 43, 58](#)) or when **Record movies** is selected for Custom Setting g1 (**Custom control assignment**) > **Shutter-release button** ([□□ 303](#)). Note that because the shutter speed, frame rate, and time needed to record images may vary from one interval to the next, the time between the end of one interval and the beginning of the next may vary. If shooting can not proceed at current settings (for example, if a shutter speed of **b** or **-** is currently selected in manual exposure mode, the interval is zero, or the start time is in less than a minute), a warning will be displayed in the monitor.

Interval timer shooting will pause when  (self-timer) is selected or if the camera is turned off and then on again (when the camera is off, batteries and memory cards can be replaced without ending interval timer photography). Pausing shooting does not affect interval timer settings.

## Non-CPU Lenses

Non-CPU lenses can be used in exposure modes **A** and **M**, with aperture set using the lens aperture ring. By specifying lens data (lens focal length and maximum aperture), the user can gain access to the following CPU lens functions.

*If the focal length of the lens is known:*

- Power zoom can be used with optional flash units
- Lens focal length is listed (with an asterisk) in the playback photo info display

*If the maximum aperture of the lens is known:*

- The aperture value is displayed in the control panel and viewfinder
- Flash level is adjusted for changes in aperture if the flash unit supports A (auto aperture) mode
- Aperture is listed (with an asterisk) in the playback photo info display

*Specifying both the focal length and maximum aperture of the lens:*

- Enables color matrix metering (note that it may be necessary to use center-weighted or spot metering to achieve accurate results with some lenses, including Reflex-NIKKOR lenses)
- Improves the precision of center-weighted and spot metering and i-TTL balanced fill-flash for digital SLR





To enter or edit data for a non-CPU lens:

### 1 Select Non-CPU lens data.

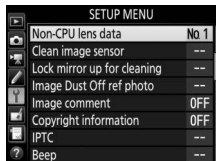
Highlight **Non-CPU lens data** in the setup menu and press .



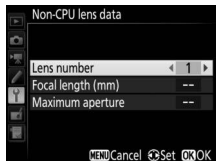

### 2 Select a lens number.

Highlight **Lens number** and press  or  to choose a lens number.



### 3 Enter the focal length and aperture.

Highlight **Focal length (mm)** or **Maximum aperture** and press  or  to edit the highlighted item.

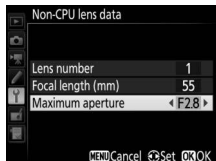

### 4 Save settings and exit.

Press . The specified focal length and aperture will be stored under the chosen lens number.

To recall lens data when using a non-CPU lens:

**1 Assign non-CPU lens number selection to a camera control.**

Assign **Choose non-CPU lens number** to a control using Custom Setting f1 (**Custom control assignment**,  301).

**2 Use the selected control to choose a lens number.**

Press the selected control and rotate the main or sub-command dial until the desired lens number is displayed in the control panel.

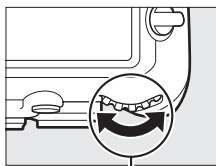

*Main command dial*

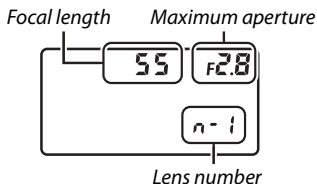

 **Focal Length Not Listed**

If the correct focal length is not listed, choose the closest value greater than the actual focal length of the lens.

 **Teleconverters and Zoom Lenses**

The maximum aperture for teleconverters is the combined maximum aperture of the teleconverter and the lens. Note that lens data are not adjusted when non-CPU lenses are zoomed in or out. The data for different focal lengths can be entered as separate lens numbers, or the data for the lens can be edited to reflect the new values for lens focal length and maximum aperture each time zoom is adjusted.

## Location Data

A GPS unit can be connected to the ten-pin remote terminal, allowing the current latitude, longitude, altitude, Coordinated Universal Time (UTC), and heading to be recorded with each photograph taken. The camera can be used with optional GP-1 and GP-1A GPS units (see below; note that these units do not provide the compass heading), or with compatible third-party units connected via an optional MC-35 GPS adapter cord (📖 336).

### ■ GP-1/GP-1A GPS Units

These optional GPS units are designed for use with Nikon digital cameras. For information on connecting the unit, see the manual provided with the device.

#### 🔍 The 📶 Icon

Connection status is shown by the 📶 icon in the information display:

- 📶 (static): Location data acquired.
- 📶 (flashing): The GPS device is searching for a signal. Pictures taken while the icon is flashing do not include location data.
- No icon: No new location data have been received from the GPS device for at least two seconds. Pictures taken when the 📶 icon is not displayed do not include location data.



#### 🔍 Smart Devices

To download location data from a smart device and embed it in subsequent photographs, establish a wireless connection and select **Yes** for **Location data > Download from smart device** in the setup menu (📖 307).

#### 🔍 Coordinated Universal Time (UTC)

UTC data is provided by the GPS device and is independent of the camera clock.

## ■ Setup Menu Options

The **Location data** item in the setup menu contains the options listed below.

- **Position:** The current latitude, longitude, altitude, Coordinated Universal Time (UTC), and heading (if supported) as reported by the source device.
- **External GPS device options > Standby timer:** Choose whether or not the standby timer is enabled when a GPS unit is attached.

Option	Description
Enable	Standby timer enabled. The timer expires automatically if no operations are performed for the period specified in Custom Setting c2 ( <b>Standby timer</b> , □ 296), reducing the drain on the battery. If a GP-1 or GP-1A unit is connected, the unit will remain active for a set period after the timer expires; to allow the camera time to acquire location data, the delay is extended by up to one minute after exposure meters are activated or the camera is turned on.
Disable	Standby timer disabled, ensuring uninterrupted recording of location data.

- **External GPS device options > Set clock from satellite:** Select **Yes** to synchronize the camera clock with the time reported by the GPS device.

### ✎ Heading

The heading is only recorded if the GPS device is equipped with a digital compass (note that the GP-1 and GP-1A are not equipped with a compass). Keep the GPS device pointing in the same direction as the lens and at least 20 cm (8 in.) from the camera.

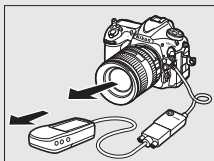



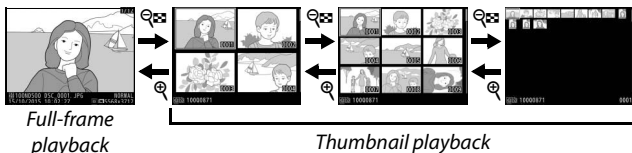

# More About Playback

## Viewing Images





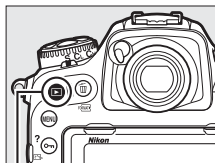

### Full-Frame Playback

To play photographs back, press the  button. The most recent photograph will be displayed in the monitor. Additional pictures can be displayed by flicking left or right or pressing  or ; to view additional information on the current photograph, press  or  (book 261).





 button

### Thumbnail Playback

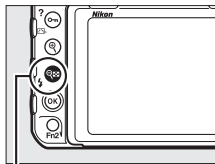
To view multiple images, press the  () button when a picture is displayed full frame. The number of images displayed increases from 4 to 9 to 72 each time the  () button is pressed, and decreases with each press of the  button. Slide a finger over the touch screen to scroll up or down or use the multi selector to highlight images.



 () button

## Playback Controls

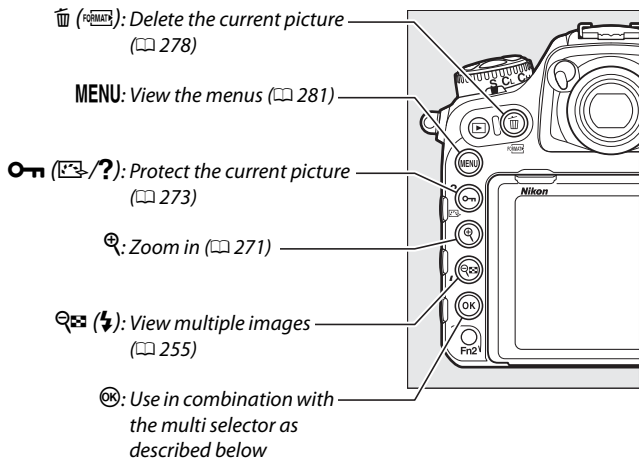

+	Display slot/folder selection dialog. To choose card and folder from which pictures are played back, highlight slot and press  to display list of folders, then highlight folder and press .
+	Create retouched copy of current photograph or create edited copy of current movie (☞ 82, 313).
+	View the IPTC presets stored on the camera (☞ 306). To embed IPTC preset in current photo, highlight preset and press  (any preset already embedded in current photo will be replaced).
+	Upload photographs over a wireless or Ethernet network when a WT-7 is attached to the camera (☞ 335).

### Two Memory Cards

If two memory cards are inserted, you can select a memory card for playback by pressing the  button when 72 thumbnails are displayed.

### Rotate Tall

To display “tall” (portrait-orientation) photographs in tall orientation, select **On** for the **Rotate tall** option in the playback menu (☰ 282).



### Image Review



When **On** is selected for **Image review** in the playback menu (☰ 282), photographs are automatically displayed in the monitor after shooting (because the camera is already in the correct orientation, images are not rotated automatically during image review). In continuous release mode, display begins when shooting ends, with the first photograph in the current series displayed.

### See Also

For information on choosing how long the monitor will remain on when no operations are performed, see Custom Setting c4 (**Monitor off delay**, ☰ 296). For information on choosing the role played by the center of the multi selector, see Custom Setting f2 (**Multi selector center button**, ☰ 301). For information on using the command dials for image or menu navigation, see Custom Setting f4 (**Customize command dials**) > **Menus and playback** (☰ 302).

## Using the Touch Screen

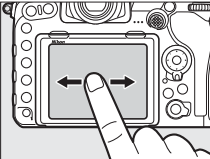
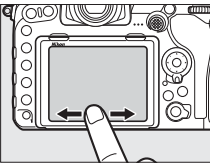
During playback, the touch-sensitive monitor can be used to:

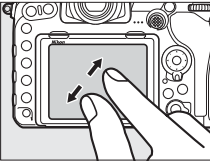
<b>View other images</b>	Flick left or right to view other images.	
<b>Scroll rapidly to other images</b>	In full frame view, you can touch the bottom of the display to display a frame advance bar, then slide your finger left or right to scroll rapidly to other images.	  <i>Frame advance bar</i>
<b>Zoom in (photos only)</b>	Use stretch and pinch gestures to zoom in and out and slide to scroll (see 271). You can also give the display two quick taps to zoom in from full-frame playback or cancel zoom.	



## View thumbnails

To “zoom out” to a thumbnail view (☐ 255), use a pinch gesture in full-frame playback. Use pinch and stretch to choose the number of images displayed from 4, 9, and 72 frames.

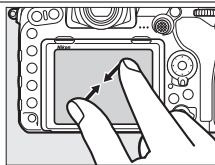

## View movies

Tap the on-screen guide to start movie playback (movies are indicated by a 🎬 icon). Tap the display to pause or resume, or tap ⏪ to exit to full-frame playback (note that some of the icons in the movie playback display do not respond to touch-screen operations).



Guide



## The *i* Button

Pressing the *i* button during full-frame or thumbnail playback displays the options listed below.

- **Rating:** Rate the current picture (📖 274).
- **Select to send to smart device/deselect (photographs only):** Select photos for upload to a smart device.
- **IPTC (photographs only):** Embed an IPTC preset in the current image (📖 306).
- **Retouch (photographs only):** Use the options in the retouch menu (📖 313) to create a retouched copy of the current photograph.
- **Edit movie (movies only):** Edit movies using the options in the edit movie menu (📖 82). Movies can also be edited by pressing the *i* button when movie playback is paused.
- **Choose slot and folder:** Choose a folder for playback. Highlight a slot and press  $\blacktriangleright$  to list the folders on the selected card, then highlight a folder and press  $\text{OK}$  to view the pictures in the highlighted folder.

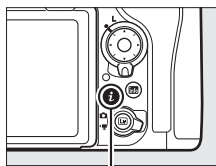

*i* button

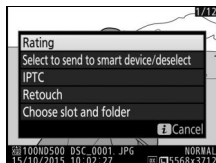

To exit the *i*-button menu and return to playback, press the *i* button again.

## Photo Information

Photo information is superimposed on images displayed in full-frame playback. Press or to cycle through photo information as shown below. Note that “image only”, shooting data, RGB histograms, and highlights are only displayed if corresponding option is selected for **Playback display options** (📖 281). Location data (📖 253) and IPTC presets (📖 306) are displayed only if embedded in the photo.

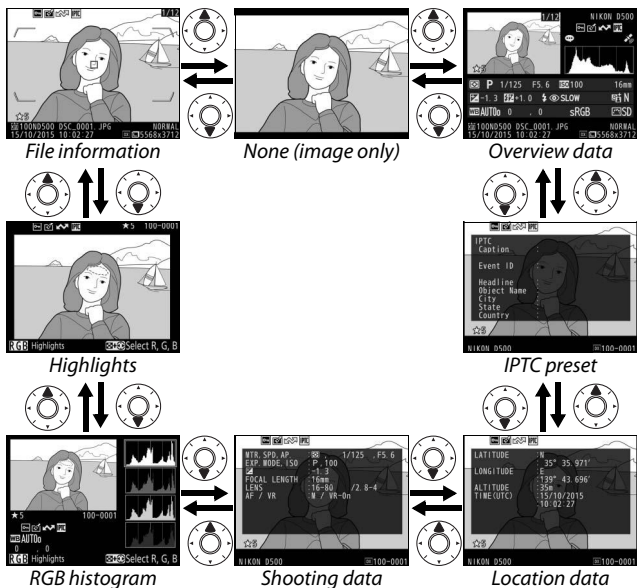

## File Information

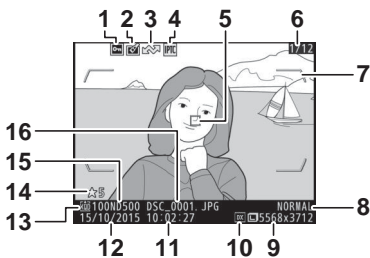

<b>1</b> Protect status.....	273	<b>9</b> Image size .....	94
<b>2</b> Retouch indicator .....	313	<b>10</b> Image area .....	88
<b>3</b> Upload marking .....	276	<b>11</b> Time of recording .....	304
<b>4</b> IPTC preset indicator .....	256, 306	<b>12</b> Date of recording .....	304
<b>5</b> Focus point <sup>1,2</sup> .....	97, 108	<b>13</b> Current card slot .....	40, 96
<b>6</b> Frame number/total number of frames		<b>14</b> Rating .....	274
<b>7</b> AF area brackets <sup>1</sup> .....	29	<b>15</b> Folder name.....	283
<b>8</b> Image quality .....	91	<b>16</b> File name .....	283

- 1 Displayed only if **Focus point** is selected for **Playback display options** (☐ 281) and selected photograph was taken using viewfinder.
- 2 If photograph was taken using manual focus or single-point, dynamic-area, or group-area AF, display shows focus point selected by user. If photograph was taken using 3D-tracking or auto-area AF, display shows focus point selected by camera.



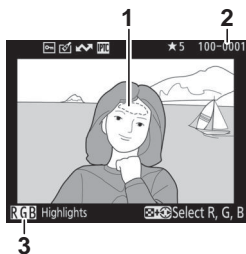

## Highlights



**1** Image highlights\*

**2** Folder number–frame number

**3** Current channel\*

\* Flashing areas indicate highlights (areas that may be overexposed) for current channel. Hold the  () button and press  or  to cycle through channels as follows:

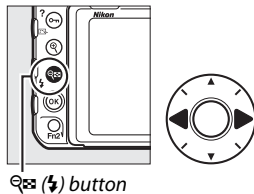

## RGB Histogram

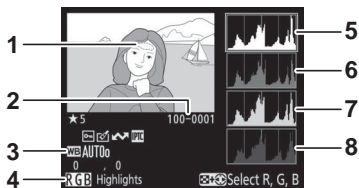

- |  |  |
|--|--|
| <p><b>1</b> Image highlights*</p> <p><b>2</b> Folder number–frame number</p> <p><b>3</b> White balance ..... 159<br/>           Color temperature ..... 166<br/>           White balance fine-tuning ..... 163<br/>           Preset manual ..... 169</p> <p><b>4</b> Current channel*</p> | <p><b>5</b> Histogram (RGB channel). In all histograms, horizontal axis gives pixel brightness, vertical axis number of pixels.</p> <p><b>6</b> Histogram (red channel)</p> <p><b>7</b> Histogram (green channel)</p> <p><b>8</b> Histogram (blue channel)</p> |
|--|--|

\* Flashing areas indicate highlights (areas that may be overexposed) for current channel. Hold the button and press or to cycle through channels as follows:

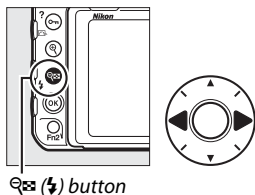

## Playback Zoom

To zoom in on the photograph when the histogram is displayed, press . Use the and buttons to zoom in and out and scroll the image with the multi selector. The histogram will be updated to show only the data for the portion of the image visible in the monitor.



## Histograms

Camera histograms are intended as a guide only and may differ from those displayed in imaging applications. Some sample histograms are shown below:

If the image contains objects with a wide range of brightnesses, the distribution of tones will be relatively even.



If the image is dark, tone distribution will be shifted to the left.



If the image is bright, tone distribution will be shifted to the right.



Increasing exposure compensation shifts the distribution of tones to the right, while decreasing exposure compensation shifts the distribution to the left. Histograms can provide a rough idea of overall exposure when bright ambient lighting makes it difficult to see photographs in the monitor.

## ■ Shooting Data

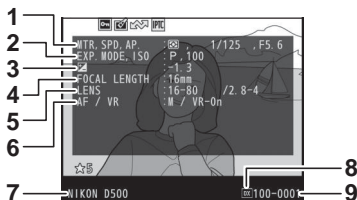

<b>1</b> Metering .....	128	<b>4</b> Focal length .....	250
Shutter speed .....	133, 135	<b>5</b> Lens data .....	250
Aperture.....	134, 135	<b>6</b> Focus mode .....	47, 97
<b>2</b> Exposure mode .....	130	Lens VR (vibration reduction) <sup>3</sup>	
ISO sensitivity <sup>1</sup> .....	123	<b>7</b> Camera name	
<b>3</b> Exposure compensation .....	143	<b>8</b> Image area .....	88
Optimal exposure tuning <sup>2</sup> .....	295	<b>9</b> Folder number–frame number	

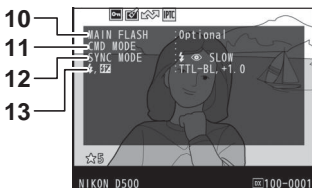

<b>10</b> Flash type <sup>4</sup>		<b>13</b> Flash settings <sup>4</sup> .....	199, 214
<b>11</b> Remote flash control <sup>4</sup> .....	208	Flash compensation <sup>4</sup> .....	203
<b>12</b> Flash mode <sup>4</sup> .....	201		



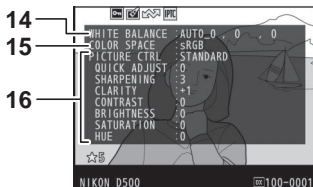

<b>14</b>	White balance.....	159	<b>15</b>	Color space.....	286
	Color temperature.....	166	<b>16</b>	Picture Control <sup>5</sup> .....	180
	White balance fine-tuning				
	.....	163			
	Preset manual.....	169			

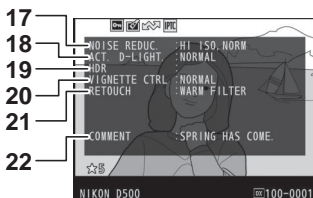

<b>17</b>	High ISO noise reduction .....	286	<b>19</b>	HDR exposure differential .....	193
	Long exposure noise			HDR smoothing.....	193
	reduction .....	286	<b>20</b>	Vignette control .....	286
<b>18</b>	Active D-Lighting.....	189	<b>21</b>	Retouch history.....	313
			<b>22</b>	Image comment .....	306

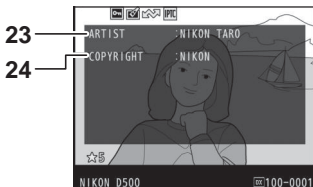

**23** Name of photographer<sup>6</sup> ..... 306    **24** Copyright holder<sup>6</sup> ..... 306

- 1 Displayed in red if photo was taken with auto ISO sensitivity control on.
- 2 Displayed if Custom Setting b7 (**Fine-tune optimal exposure**, 295) has been set to a value other than zero for any metering method.
- 3 Displayed only if VR lens is attached.
- 4 Displayed only if optional flash unit ( 196) is used.
- 5 The items displayed vary with the Picture Control selected when the picture was taken.
- 6 Copyright information is only displayed if recorded with the photograph using the **Copyright information** option in the setup menu.

### ■ Location Data\* ( 253)

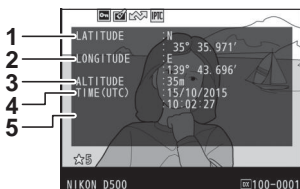

**1** Latitude

**2** Longitude

**3** Altitude

**4** Coordinated Universal Time (UTC)

**5** Heading

\* Data for movies are for start of recording. The items recorded vary with the device from which they were acquired.

## ■ IPTC Preset (📖 306)

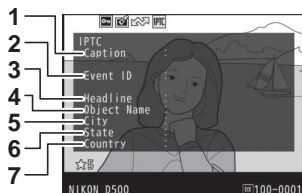

- 1 Caption
- 2 Event ID
- 3 Headline
- 4 Object Name

- 5 City
- 6 State
- 7 Country

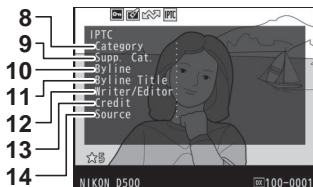

- 8 Category
- 9 Supplemental Categories (Supp. Cat.)
- 10 Byline

- 11 Byline Title
- 12 Writer/Editor
- 13 Credit
- 14 Source

## Overview Data

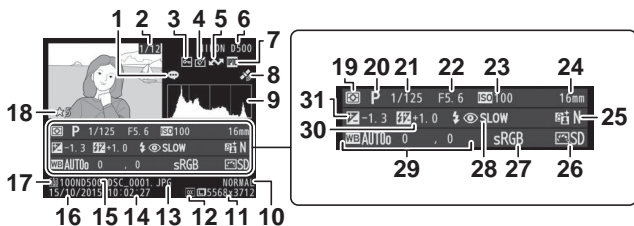

<b>1</b> Image comment indicator.....	306	<b>17</b> Current card slot .....	40, 96
<b>2</b> Frame number/total number of frames		<b>18</b> Rating .....	274
<b>3</b> Protect status .....	273	<b>19</b> Metering .....	128
<b>4</b> Retouch indicator .....	313	<b>20</b> Exposure mode .....	130
<b>5</b> Upload marking .....	276	<b>21</b> Shutter speed .....	133, 135
<b>6</b> Camera name		<b>22</b> Aperture.....	134, 135
<b>7</b> IPTC preset indicator .....	256, 306	<b>23</b> ISO sensitivity <sup>1</sup> .....	123
<b>8</b> Location data indicator .....	253	<b>24</b> Focal length .....	250
<b>9</b> Histogram showing the distribution of tones in the image (□ 265).		<b>25</b> Active D-Lighting .....	189
<b>10</b> Image quality.....	91	<b>26</b> Picture Control .....	180
<b>11</b> Image size.....	94	<b>27</b> Color space.....	286
<b>12</b> Image area.....	88	<b>28</b> Flash mode <sup>2</sup> .....	201
<b>13</b> File name .....	283	<b>29</b> White balance.....	159
<b>14</b> Time of recording .....	304	Color temperature .....	166
<b>15</b> Folder name .....	283	White balance fine-tuning .....	163
<b>16</b> Date of recording .....	304	Preset manual .....	169
		<b>30</b> Flash compensation <sup>2</sup> .....	203
		Commander mode <sup>2</sup> .....	
		<b>31</b> Exposure compensation .....	143

1 Displayed in red if photo was taken with auto ISO sensitivity control.





2 Displayed only if photo was taken with optional flash unit (□ 196).

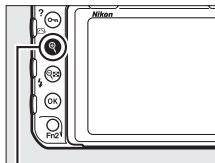

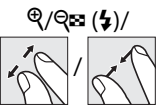

## Taking a Closer Look: Playback Zoom

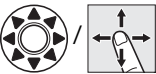
To zoom in on an image displayed in full-frame playback, press the  button or the center of the multi selector or give the display two quick taps. The following operations can be performed while zoom is in effect:





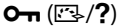

 button

To	Use	Description
Zoom in or out		<p>Press  or use stretch gestures to zoom in to maximum of approximately 21× (large images in 24 × 16/DX format), 16× (medium images) or 10× (small images). Press  or use pinch gestures to zoom out. While photo is zoomed in, use multi selector or slide finger over screen to view areas of image not visible in monitor. Keep multi selector pressed to scroll rapidly to other areas of frame. Navigation window is displayed when zoom ratio is altered; area currently visible in monitor is indicated by yellow border. Bar under navigation window shows zoom ratio; turns green at ratio of 1 : 1.</p>
View other areas of image		

To	Use	Description
Select faces		Faces (up to 35) detected during zoom are indicated by white borders in navigation window. Rotate sub-command dial or tap on-screen guide to view other faces.  <i>On-screen guide</i> 
View other images		Rotate main command dial or tap ◀ or ▶ icons at bottom of display to view same location in other photos at current zoom ratio. Playback zoom is cancelled when a movie is displayed.
Change protect status		See page 273 for more information.
Return to shooting mode		Press the shutter-release button halfway or press the ▶ button to exit to shooting mode.
Display menus	<b>MENU</b>	See page 281 for more information.

## Protecting Photographs from Deletion



In full-frame, zoom, and thumbnail playback, the  (/?) button can be used to protect photographs from accidental deletion. Protected files can not be deleted using the  ( **FORMAT**) button or the **Delete** option in the playback menu. Note that protected images *will* be deleted when the memory card is formatted ( 304).

To protect a photograph:



### 1 Select an image.

Display the image in full-frame playback or playback zoom and highlight it in the thumbnail list.

### 2 Press the (/?) button.

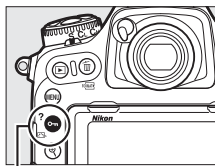



The photograph will be marked with a  icon. To remove protection from the photograph so that it can be deleted, display the photograph or highlight it in the thumbnail list and then press the  (/?) button.



 (/?) button



### Removing Protection from All Images

To remove protection from all images in the folder or folders currently selected in the **Playback folder** menu, press the  (/?) and  ( **FORMAT**) buttons together for about two seconds during playback.

## Rating Pictures

Rate pictures or mark them as candidates for later deletion. Ratings can also be viewed in ViewNX-i and Capture NX-D. Rating is not available with protected images.

### 1 Select an image.

Display the image or highlight it in the thumbnail list in thumbnail playback.

### 2 Display playback options.

Press the **i** button to display playback options.

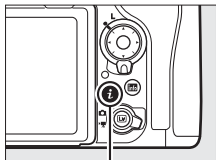

*i* button

### 3 Select Rating.

Highlight **Rating** and press **▶**.

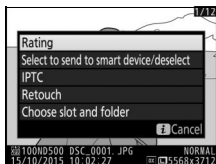



### 4 Choose a rating.

Press **◀** or **▶** to choose a rating of from zero to five stars, or select **☒** to mark the picture as a candidate for later deletion. Press **OK** to complete the operation.





### **Rating Pictures with the Fn2 Button**

If **Rating** is selected for Custom Setting f1 (**Custom control assignment**) > **Fn2 button**, pictures can be rated by keeping the **Fn2** button pressed and pressing  or  (☞ 301).

## Selecting Photos for Upload

Follow the steps below to select photos for upload to the smart device before connecting. Movies can not be selected for upload.

### Selecting Individual Photos

#### 1 Select a photo.

Display the photo or highlight it in the thumbnail list in thumbnail playback.

#### 2 Display playback options.

Press the **i** button to display playback options.

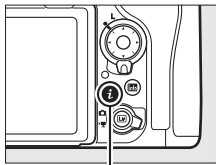

*i* button

#### 3 Choose **Select to send to smart device/deselect**.

Highlight **Select to send to smart device/deselect** and press **OK**.

Pictures selected for upload are indicated by a  icon; to deselect, display or highlight the image and repeat Steps 2 and 3.

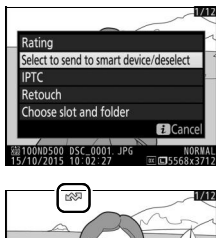

## Selecting Multiple Photos

Follow the steps below to change the upload status of multiple photos.

### 1 Choose **Select image(s)**.

In the playback menu, select **Select to send to smart device**, then highlight **Select image(s)** and press **OK**.



### 2 Select photos.

Use the multi selector to highlight photos and press the center of the multi selector to select or deselect (to view the highlighted picture full screen, press and hold the **Q** button). Selected photos are marked by a **↕** icon.

### 3 Press **OK**.

Press **OK** to complete the operation.

## Deleting Photographs

To delete all photographs in the current folder or the photograph displayed in full-frame playback or highlighted in the thumbnail list, press the  (FORMAT) button. To delete multiple selected photographs, use the **Delete** option in the playback menu. Once deleted, photographs can not be recovered. Note that pictures that are protected or hidden can not be deleted.

### Full-Frame and Thumbnail Playback

Press the  (FORMAT) button to delete the current photograph.

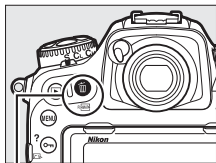

#### 1 Press the (FORMAT) button.

A confirmation dialog will be displayed.



 (FORMAT) button

#### 2 Press the (FORMAT) button again.

To delete the photograph, press the  (FORMAT) button. To exit without deleting the photograph, press the  button.

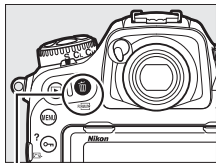

 (FORMAT) button

#### See Also

The **After delete** option in the playback menu determines whether the next image or the previous image is displayed after an image is deleted ( 282).

## The Playback Menu

The **Delete** option in the playback menu contains the following options. Note that depending on the number of images, some time may be required for deletion.

Option	Description
 <b>Selected</b>	Delete selected pictures.
<b>ALL All</b>	Delete all pictures in the folder currently selected for playback (☐ 281). If two cards are inserted, you can select the card from which pictures will be deleted.

### ■ Selected: Deleting Selected Photographs

#### 1 Choose **Delete > Selected**.

Select **Delete** in the playback menu. Highlight **Selected** and press .

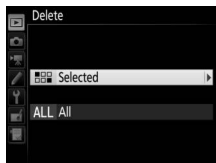

#### 2 Highlight a picture.

Use the multi selector to highlight a picture (to view the highlighted picture full screen, press and hold the  button).



---

### 3 Select the highlighted picture.

Press the center of the multi selector to select the highlighted picture.

Selected pictures are marked by a  icon. Repeat steps 2 and 3 to select additional pictures; to deselect a picture, highlight it and press the center of the multi selector.

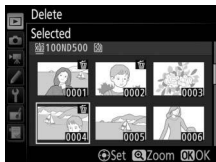

---

### 4 Press to complete the operation.

A confirmation dialog will be displayed; highlight **Yes** and press .

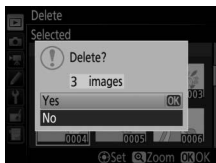

# Menu List

This section lists the options available in the camera menus. For more information, see the *Menu Guide*.

## **The Playback Menu: *Managing Images***

### Delete

Selected \_\_\_\_\_ Delete multiple images (☐ 279).

All \_\_\_\_\_

### Playback folder

(defaults to **All**)

(Folder name) \_\_\_\_\_ Choose a folder for playback.

All \_\_\_\_\_

Current \_\_\_\_\_

### Hide image

Select/set \_\_\_\_\_ Hide or reveal images. Hidden images are displayed only in the “Hide image” menu and cannot be played back.

Deselect all \_\_\_\_\_

### Playback display options

Basic photo info \_\_\_\_\_ Choose the information available in the playback photo information display (☐ 261).

Focus point \_\_\_\_\_

Additional photo info \_\_\_\_\_

None (image only) \_\_\_\_\_

Highlights \_\_\_\_\_

RGB histogram \_\_\_\_\_

Shooting data \_\_\_\_\_

Overview \_\_\_\_\_

<b>Copy image(s)</b>	
Select source	Copy pictures from one memory card to another. This option is only available when two memory cards are inserted in the camera.
Select image(s)	
Select destination folder	
Copy image(s)?	
<b>Image review</b> (defaults to <b>Off</b> )	
On	Choose whether pictures are automatically displayed in the monitor immediately after shooting (☞ 257).
Off	
<b>After delete</b> (defaults to <b>Show next</b> )	
Show next	Choose the picture displayed after an image is deleted.
Show previous	
Continue as before	
<b>After burst, show</b> (defaults to <b>Last image in burst</b> )	
First image in burst	Choose whether the camera displays the first or the last photo in the burst after photos are taken in continuous release mode.
Last image in burst	
<b>Auto image rotation</b> (defaults to <b>On</b> )	
On	Choose whether to record camera orientation when taking photographs.
Off	
<b>Rotate tall</b> (defaults to <b>On</b> )	
On	Choose whether to rotate “tall” (portrait-orientation) pictures for display during playback (☞ 257).
Off	
<b>Slide show</b>	
Start	View a slide show of the pictures in the current playback folder.
Image type	
Frame interval	
<b>Select to send to smart device</b>	
Select image(s)	Select photos for upload to a smart device (☞ 277).
Deselect all	



## The Photo Shooting Menu: *Shooting Options*

### Photo shooting menu bank

A	Recall photo shooting menu settings previously stored in a photo shooting menu bank. Changes to settings are stored in the current bank.
B	
C	
D	

### Extended photo menu banks

(defaults to **Off**)

On	Choose whether photo shooting menu banks store exposure mode, shutter speed (exposure modes <b>S</b> and <b>M</b> ), aperture (modes <b>A</b> and <b>M</b> ), and flash mode.
Off	

### Storage folder

Rename	Select the folder in which subsequent images will be stored.
Select folder by number	
Select folder from list	

### File naming

File naming	Choose the three-letter prefix used in naming the image files in which photographs are stored. The default prefix is "DSC".
-------------	---

### Primary slot selection

(defaults to **XQD card slot**)

XQD card slot	Choose the slot that serves as the primary slot when two memory cards are inserted.
SD card slot	

### Secondary slot function

(defaults to **Overflow**)

Overflow	Choose the role played by the card in the secondary slot when two memory cards are inserted (☐ 96).
Backup	
RAW primary - JPEG secondary	

**Flash control**

Flash control mode	Choose the flash control mode for optional flash units mounted on the camera accessory shoe or adjust settings for wireless flash photography (□ 199, 208).
Wireless flash options	
Remote flash control	
Radio remote flash info	

**Choose image area**(defaults to **DX (24×16)**)

DX (24×16)	Choose the image area (□ 88).
1.3× (18×12)	

**Image quality**(defaults to **JPEG normal**)

NEF (RAW) + JPEG fine ★	Choose a file format and compression ratio (image quality, □ 91). The compression for options indicated by a star ("★") prioritizes quality, while that for images without a star gives priority to reducing file size.
NEF (RAW) + JPEG fine	
NEF (RAW) + JPEG normal ★	
NEF (RAW) + JPEG normal	
NEF (RAW) + JPEG basic ★	
NEF (RAW) + JPEG basic	
NEF (RAW)	
JPEG fine ★	
JPEG fine	
JPEG normal ★	
JPEG normal	
JPEG basic ★	
JPEG basic	
TIFF (RGB)	

**Image size**

JPEG/TIFF	Choose the image size, in pixels (□ 94). Separate options are available for JPEG/TIFF and for NEF (RAW) images.
NEF (RAW)	

### NEF (RAW) recording

NEF (RAW) compression	Choose the type of compression and the bit depth for NEF (RAW) images (☞ 93).
NEF (RAW) bit depth	

### ISO sensitivity settings

ISO sensitivity	Adjust ISO sensitivity settings for photographs (☞ 123, 125).
Auto ISO sensitivity control	

### White balance

(defaults to **Auto**)

Auto	Match white balance to the light source (☞ 159).
Incandescent	
Fluorescent	
Direct sunlight	
Flash	
Cloudy	
Shade	
Choose color temp.	
Preset manual	

### Set Picture Control

(defaults to **Standard**)

Standard	Choose how new photos will be processed. Select according to the type of scene or your creative intent (☞ 180).
Neutral	
Vivid	
Monochrome	
Portrait	
Landscape	
Flat	

### Manage Picture Control

Save/edit	Create custom Picture Controls (☞ 185).
Rename	
Delete	
Load/save	

<b>Color space</b> (defaults to <b>sRGB</b> )	
sRGB	Choose a color space for photographs.
Adobe RGB	
<b>Active D-Lighting</b> (defaults to <b>Off</b> )	
Auto	Preserve details in highlights and shadows, creating photographs with natural contrast (□ 189).
Extra high	
High	
Normal	
Low	
Off	
<b>Long exposure NR</b> (defaults to <b>Off</b> )	
On	Reduce “noise” (bright spots or fog) in photos taken at slow shutter speeds.
Off	
<b>High ISO NR</b> (defaults to <b>Normal</b> )	
High	Reduce “noise” (randomly-spaced bright pixels) in photos taken at high ISO sensitivities.
Normal	
Low	
Off	
<b>Vignette control</b> (defaults to <b>Normal</b> )	
High	Reduce the drop in brightness at the edges of photographs when using type G, E, and D lenses (PC lenses excluded).
Normal	
Low	
Off	The effect is most noticeable at maximum aperture.
<b>Auto distortion control</b> (defaults to <b>Off</b> )	
On	Reduce barrel distortion when shooting with wide-angle lenses and to reduce pin-cushion distortion when shooting with long lenses.
Off	

## Flicker reduction

Flicker reduction setting	This option takes effect during viewfinder photography (☞ 234). Select <b>Enable</b> for <b>Flicker reduction setting</b> to adjust shot timing to reduce the effects of flicker under fluorescent or mercury vapor lighting. The <b>Flicker reduction indicator</b> item controls whether a <b>FLICKER</b> icon is displayed in the viewfinder when flicker is detected.
Flicker reduction indicator	

## Auto bracketing set

(defaults to **AE & flash**)

AE & flash	Choose the setting or settings bracketed when auto bracketing is in effect (☞ 146).
AE only	
Flash only	
WB bracketing	
ADL bracketing	

## Multiple exposure

Multiple exposure mode	Record from two to ten NEF (RAW) exposures as a single photograph (☞ 236).
Number of shots	
Overlay mode	

## HDR (high dynamic range)

HDR mode	Preserve details in highlights and shadows when photographing high-contrast scenes (☞ 191).
Exposure differential	
Smoothing	

## Interval timer shooting

Start	Take photographs at the selected interval until the specified number of shots has been recorded (☞ 243).
Start options	
Interval	
No. of intervals×shots/interval	
Exposure smoothing	

## The Movie Shooting Menu: *Movie Shooting Options*

### Reset movie shooting menu

Yes	Select <b>Yes</b> to restore movie shooting menu options to their default values.
No	

### File naming

Choose the three-letter prefix used in naming the image files in which movies are stored. The default prefix is "DSC".

### Destination (defaults to **XQD card slot**)

XQD card slot	Choose the slot to which movies are recorded.
SD card slot	

### Choose image area (defaults to **DX**)

DX	Choose the image area (  70).
1.3×	

### Frame size/frame rate (defaults to **1920×1080; 60p**)

3840×2160; 30p	Choose movie frame size (in pixels) and frame rate (  68).
3840×2160; 25p	
3840×2160; 24p	
1920×1080; 60p	
1920×1080; 50p	
1920×1080; 30p	
1920×1080; 25p	
1920×1080; 24p	
1280× 720; 60p	
1280× 720; 50p	

<b>Movie quality</b>	(defaults to <b>High quality</b> )
High quality	Choose movie quality (☐ 68).
Normal	
<b>ISO sensitivity settings</b>	
ISO sensitivity (mode M)	Adjust ISO sensitivity settings for movies.
Auto ISO control (mode M)	
Maximum sensitivity	
<b>White balance</b>	(defaults to <b>Same as photo settings</b> )
Same as photo settings	Choose the white balance for movies (☐ 159). Select <b>Same as photo settings</b> to use the option currently selected for photos.
Auto	
Incandescent	
Fluorescent	
Direct sunlight	
Cloudy	
Shade	
Choose color temp.	
Preset manual	
<b>Set Picture Control</b>	(defaults to <b>Same as photo settings</b> )
Same as photo settings	Choose a Picture Control for movies (☐ 180). Select <b>Same as photo settings</b> to use the option currently selected for photos.
Standard	
Neutral	
Vivid	
Monochrome	
Portrait	
Landscape	
Flat	

<b>Manage Picture Control</b>	
Save/edit	Create custom Picture Controls (□ 185).
Rename	
Delete	
Load/save	
<b>Active D-Lighting</b> (defaults to <b>Off</b> )	
Same as photo settings	Preserve details in highlights and shadows, creating movies with natural contrast (□ 189). Select <b>Same as photo settings</b> to use the option currently selected for photos.
Extra high	
High	
Normal	
Low	
Off	
<b>High ISO NR</b> (defaults to <b>Normal</b> )	
High	Reduce “noise” (randomly-spaced bright pixels) in movies recorded at high ISO sensitivities.
Normal	
Low	
Off	
<b>Flicker reduction</b> (defaults to <b>Auto</b> )	
Auto	Reduce flicker and banding caused by fluorescent or mercury-vapor lighting during live view (□ 43) and movie recording (□ 58).
50 Hz	
60 Hz	
<b>Microphone sensitivity</b> (defaults to <b>Auto sensitivity</b> )	
Auto sensitivity	Turn the built-in or external microphones (□ 336) on or off or adjust microphone sensitivity.
Manual sensitivity	
Microphone off	



<b>Frequency response</b> (defaults to <b>Wide range</b> )	
Wide range	Choose the frequency response for the built-in and external microphones (☞ 336).
Vocal range	
<b>Wind noise reduction</b> (defaults to <b>Off</b> )	
On	Choose whether to enable the built-in microphone's low-cut filter to reduce wind noise.
Off	
<b>Time-lapse movie</b>	
Start	The camera automatically takes photos at selected intervals to create a silent time-lapse movie (☞ 74). Available with viewfinder photography only.
Interval	
Shooting time	
Exposure smoothing	
<b>Electronic VR</b> (defaults to <b>Off</b> )	
On	Choose whether to enable electronic vibration reduction in movie mode.
Off	

## Custom Settings: Fine-Tuning Camera Settings

### Custom settings bank

A	Recall Custom Settings previously stored in a Custom Settings menu bank.
B	
C	Changes to settings are stored in the current bank.
D	

### a Autofocus

#### a1 AF-C priority selection (defaults to **Release**)

Release	When <b>AF-C</b> is selected for viewfinder photography, this option controls whether photographs can be taken whenever the shutter-release button is pressed ( <i>release priority</i> ) or only when the camera is in focus ( <i>focus priority</i> ).
Focus + release	
Release + focus	
Focus	

#### a2 AF-S priority selection (defaults to **Focus**)



Release	When <b>AF-S</b> is selected for viewfinder photography, this option controls whether photographs can be taken only when the camera is in focus ( <i>focus priority</i> ) or whenever the shutter-release button is pressed ( <i>release priority</i> ).
Focus	

#### a3 Focus tracking with lock-on

Blocked shot AF response	Control how autofocus adjusts to changes in the distance to the subject when <b>AF-C</b> is selected for viewfinder photography.
Subject motion	

<b>a4 3D-tracking face-detection</b> (defaults to <b>Off</b> )	
On	Choose whether the camera detects and focuses on faces when 3D-tracking is selected for AF-area mode (□ 104).
Off	
<b>a5 3D-tracking watch area</b> (defaults to <b>Normal</b> )	
Wide	Choose the area monitored by pressing the shutter-release button halfway when 3D-tracking is selected for AF-area mode (□ 104).
Normal	
<b>a6 Number of focus points</b> (defaults to <b>55 points</b> )	
55 points	Choose the number of focus points available for manual focus-point selection in the viewfinder.
15 points	
<b>a7 Store by orientation</b> (defaults to <b>Off</b> )	
Focus point	Choose whether the viewfinder stores the focus points and AF-area mode for vertical and horizontal orientations separately.
Focus point and AF-area mode	
Off	
<b>a8 AF activation</b> (defaults to <b>Shutter/AF-ON</b> )	
Shutter/AF-ON	Choose whether the camera focuses when the shutter-release button is pressed halfway. If <b>AF-ON only</b> is selected, the camera will not focus when the shutter-release button is pressed halfway.
AF-ON only	
<b>a9 Limit AF-area mode selection</b>	
Single-point AF	Choose the AF-area modes that can be selected using the AF-mode button and sub-command dial in viewfinder photography (□ 103).
Dynamic-area AF (25 points)	
Dynamic-area AF (72 points)	
Dynamic-area AF (153 points)	
3D-tracking	
Group-area AF	
Auto-area AF	

<b>a10 Autofocus mode restrictions</b> (defaults to <b>No restrictions</b> )	
AF-S	Choose the autofocus modes available in viewfinder photography (☐ 101).
AF-C	
No restrictions	
<b>a11 Focus point wrap-around</b> (defaults to <b>No wrap</b> )	
Wrap	Choose whether viewfinder focus-point selection “wraps around” from one edge of the display to another.
No wrap	
<b>a12 Focus point options</b>	
Manual focus mode	Adjust settings for the focus-point display in the viewfinder.
Dynamic-area AF assist	
Group-area AF display	
Focus point illumination	
<b>a13 Manual focus ring in AF mode</b> (defaults to <b>Enable</b> )	
Enable	This option is available with compatible lenses. Select <b>Disable</b> to disable focus using the focus ring in autofocus mode.
Disable	
<b>b Metering/exposure</b>	
<b>b1 ISO sensitivity step value</b> (defaults to <b>1/3 step</b> )	
1/3 step	Select the increments used when making adjustments to ISO sensitivity.
1/2 step	
1 step	
<b>b2 EV steps for exposure cntrl</b> (defaults to <b>1/3 step</b> )	
1/3 step	Select the increments used when making adjustments to shutter speed, aperture, and bracketing.
1/2 step	
1 step	
<b>b3 Exp./flash comp. step value</b> (defaults to <b>1/3 step</b> )	
1/3 step	Select the increments used when making adjustments to exposure and flash compensation.
1/2 step	
1 step	

<b>b4 Easy exposure compensation</b> (defaults to <b>Off</b> )	
On (Auto reset)	Choose whether exposure compensation can be adjusted solely by rotating a command dial, without pressing the  button.
On	
Off	
<b>b5 Matrix metering</b> (defaults to <b>Face detection on</b> )	
Face detection on	Choose <b>Face detection on</b> to enable face detection when shooting portraits with matrix metering during viewfinder photography (  128).
Face detection off	
<b>b6 Center-weighted area</b> (defaults to $\phi$ <b>8 mm</b> )	
$\phi$ 6 mm	Choose the size of the area given the most weight when center-weighted metering is used in viewfinder photography. If a non-CPU lens is attached, the size of the area is fixed at 8 mm.
$\phi$ 8 mm	
$\phi$ 10 mm	
$\phi$ 13 mm	
Average	
<b>b7 Fine-tune optimal exposure</b>	
Matrix metering	Fine-tune exposure for each metering method. Higher values produce brighter exposures, lower values darker exposures.
Center-weighted metering	
Spot metering	
Highlight-weighted metering	

**c Timers/AE lock****c1 Shutter-release button AE-L** (defaults to **Off**)

On (half press)	Choose whether exposure locks when the shutter-release button is pressed.
On (burst mode)	
Off	

**c2 Standby timer** (defaults to **6 s**)

4 s	Choose how long the camera continues to meter exposure when no operations are performed (☐ 39).
6 s	
10 s	
30 s	
1 min	
5 min	
10 min	
30 min	
No limit	

**c3 Self-timer**

Self-timer delay	Choose the length of the shutter release delay, the number of shots taken, and the interval between shots in self-timer mode.
Number of shots	
Interval between shots	

**c4 Monitor off delay**

Playback	Choose how long the monitor remains on when no operations are performed.
Menus	
Information display	
Image review	
Live view	

**d Shooting/display****d1 CL mode shooting speed**(defaults to **5 fps**)

9 fps	Choose the frame advance rate for <b>CL</b> (continuous low-speed) mode.
8 fps	
7 fps	
6 fps	
5 fps	
4 fps	
3 fps	
2 fps	
1 fps	

**d2 Max. continuous release**(defaults to **200**)

1–200	Choose the maximum number of shots that can be taken in a single burst in continuous release mode.
-------	--

**d3 ISO display**(defaults to **Show frame count**)

Show ISO sensitivity	Choose whether ISO sensitivity is displayed in the control panel and viewfinder in place of the number of exposures remaining.
Show frame count	

**d4 Sync. release mode options**(defaults to **Sync**)

Sync	Choose whether the shutter releases on remote cameras synchronize with the shutter release on the master camera.
No sync	

**d5 Exposure delay mode**(defaults to **Off**)

3 s	In situations where the slightest camera movement can blur pictures, select <b>1 s</b> , <b>2 s</b> , or <b>3 s</b> to delay shutter release until approximately one, two, or three seconds after the mirror is raised.
2 s	
1 s	
Off	

<b>d6 Electronic front-curtain shutter</b> (defaults to <b>Disable</b> )	
Enable	Enable or disable the electronic front-curtain shutter in <b>MUP</b> mode, eliminating blur caused by shutter motion.
Disable	
<b>d7 File number sequence</b> (defaults to <b>On</b> )	
On	Choose how the camera assigns file numbers.
Off	
Reset	
<b>d8 Viewfinder grid display</b> (defaults to <b>Off</b> )	
On	Choose whether to display a framing grid in the viewfinder.
Off	
<b>d9 LCD illumination</b> (defaults to <b>Off</b> )	
On	Choose whether the control panel and button backlights are illuminated while the standby timer is active.
Off	
<b>d10 Optical VR</b> (defaults to <b>On</b> )	
On	Turn vibration control on or off. This item is available only with lenses that support it.
Off	

### The Electronic Front-Curtain Shutter

A type G, E, or D lens is recommended; select **Disable** if you notice lines or fog when shooting with other lenses. The fastest shutter speed and maximum ISO sensitivity available with the electronic front-curtain shutter are  $\frac{1}{2000}$  s and ISO 51200, respectively.



## e Bracketing/flash

### e1 Flash sync speed

(defaults to 1/250 s)

1/250 s (Auto FP)

Choose a flash sync speed.

1/250 s

1/200 s

1/160 s

1/125 s

1/100 s

1/80 s

1/60 s

#### Fixing Shutter Speed at the Flash Sync Speed Limit

To fix shutter speed at the sync speed limit in shutter-priority auto or manual exposure modes, select the next shutter speed after the slowest possible shutter speed (30 s or - -). An X (flash sync indicator) will be displayed in the viewfinder and control panel.

#### Auto FP High-Speed Sync

Auto FP high-speed sync allows the flash to be used at the highest shutter speed supported by the camera, making it possible to choose the maximum aperture for reduced depth of field even when the subject is backlit in bright sunlight. The information display flash mode indicator shows "FP" when auto FP high-speed sync is active.

<b>e2 Flash shutter speed</b> (defaults to <b>1/60 s</b> )	
1/60 s	Choose the slowest shutter available when the flash is used in modes <b>P</b> and <b>A</b> .
1/30 s	
1/15 s	
1/8 s	
1/4 s	
1/2 s	
1 s	
2 s	
4 s	
8 s	
15 s	
30 s	
<b>e3 Exposure comp. for flash</b> (defaults to <b>Entire frame</b> )	
Entire frame	Choose how the camera adjusts flash level when exposure compensation is used.
Background only	
<b>e4 Auto <math>\frac{1}{2}</math> ISO sensitivity control</b> (defaults to <b>Subject and background</b> )	
Subject and background	Choose whether auto ISO sensitivity control for flash photography is adjusted to correctly expose both the subject and background or the main subject only.
Subject only	
<b>e5 Modeling flash</b> (defaults to <b>On</b> )	
On	Choose whether optional CLS-compatible flash units (□ 328) emit a modeling flash when the camera <b>Pv</b> button is pressed during viewfinder photography.
Off	





**e6 Auto bracketing (mode M)** (defaults to **Flash/speed**)

Flash/speed	Choose the settings affected when exposure/flash bracketing is enabled in exposure mode <b>M</b> .
Flash/speed/aperture	
Flash/aperture	
Flash only	

**e7 Bracketing order** (defaults to **MTR > under > over**)

MTR > under > over	Choose the bracketing order for exposure, flash, and white balance bracketing.
Under > MTR > over	

**f Controls****f1 Custom control assignment**

Preview button	Choose the roles assigned to camera controls, either alone or in combination with the command dials.
Preview button + 	
Fn1 button	
Fn1 button + 	
Fn2 button	
AF-ON button	
Sub-selector	
Sub-selector center	
Sub-selector center + 	
BKT button + 	
Movie record button + 	
Lens focus function buttons	

**f2 Multi selector center button**

Shooting mode	Choose the role played by the center of the multi selector.
Playback mode	
Live view	

### **f3 Shutter spd & aperture lock**

Shutter speed lock	Lock shutter speed at the value currently selected in mode <b>S</b> or <b>M</b> , or aperture at the value currently selected in mode <b>A</b> or <b>M</b> .
Aperture lock	

### **f4 Customize command dials**

Reverse rotation	Choose the roles played by the main and sub-command dials.
Change main/sub	
Aperture setting	
Menus and playback	
Sub-dial frame advance	

### **f5 Multi selector** (defaults to **Do nothing**)



Restart standby timer	Choose whether using the multi selector activates the standby timer (☞ 39).
Do nothing	

### **f6 Release button to use dial** (defaults to **No**)

Yes	Selecting <b>Yes</b> allows adjustments that are normally made by holding a button and rotating a command dial to be made by rotating the command dial after the button is released. Setting ends when the button is pressed again, the shutter-release button is pressed halfway, or the standby timer expires.
No	

## f7 Reverse indicators (defaults to )





If  (-0+) is selected, the exposure indicators in the control panel, viewfinder, and information display are displayed with negative values on the left and positive values on the right. Select  (+0-) to display positive values on the left and negative values on the right.

## f8 Live view button options (defaults to **Enable**)

Enable	The  button can be disabled to prevent live view starting accidentally.
Enable (standby timer active)	
Disable	

## f9 switch (defaults to **LCD backlight** ())





LCD backlight (  )	Choose displays illuminated by rotating the power switch to  .
 and information display	

## f10 Assign MB-D17 buttons

Fn button	Choose the functions assigned to the controls on the optional MB-D17 multi-power battery pack.
Fn button + 	
AF-ON button	
Multi selector	

## g Movie

### g1 Custom control assignment

Preview button	Choose the roles assigned to camera controls, either alone or in combination with the command dials, when the live view selector is rotated to  in live view. Note that if <b>Record movies</b> is selected for <b>Shutter-release button</b> , the shutter-release button can not be used for any operation other than recording movies.
Preview button + 	
Fn1 button	
Fn1 button + 	
Fn2 button	
Sub-selector center	
Sub-selector center + 	
Shutter-release button	

## Y The Setup Menu: *Camera Setup*

### Format memory card

XQD card slot	To begin formatting, choose a memory card slot and select <b>Yes</b> . <i>Note that formatting permanently deletes all pictures and other data on the card in the selected slot.</i> Before formatting, be sure to make backup copies as required.
SD card slot	

### Language

Choose a language for camera menus and messages.

### Time zone and date



Time zone	Change time zones, set the camera clock, synchronize the clock with the clock on a smart device, choose the date display order, and turn daylight saving time on or off.
Date and time	
Sync with smart device	
Date format	
Daylight saving time	

### Monitor brightness

Menus/playback	Adjust the brightness of the menu, playback, and live view displays.
Live view	

### Formatting Memory Cards

Do not turn the camera off or remove the battery or memory cards during formatting.

In addition to the **Format memory card** option in the setup menu, memory cards can be formatted using the **ISO** () and  () buttons: keep both buttons pressed simultaneously until formatting indicators are displayed and then press the buttons again to format the card. If two memory cards are inserted when the buttons are first pressed, the card to be formatted will be shown by a flashing icon. Rotate the main command dial to choose a different slot.

**Monitor color balance**

Adjust monitor color balance.

**Virtual horizon**

View a virtual horizon based on information from the camera tilt sensor.

**Information display**

(defaults to **Auto**)

Auto

Adjust the information display for different viewing conditions.

Manual

**AF fine-tune**

AF fine-tune (On/Off)

Fine-tune focus for different lens types; for information on auto AF fine-tuning, see page 310. AF tuning is not recommended in most situations and may interfere with normal focus; use only when required.

Saved value

Default

List saved values

**Non-CPU lens data**

Lens number

Record the focal length and maximum aperture of non-CPU lenses, allowing them to be used with functions normally reserved for CPU lenses (☞ 251).

Focal length (mm)

Maximum aperture

**Clean image sensor**

Clean now

Vibrate the image sensor to remove dust (☞ 338).

Clean at startup/shutdown

**Lock mirror up for cleaning**

Lock the mirror up so that dust can be removed from the image sensor with a blower (☞ 341). Not available when the battery is low (☞ 338) or lower) or when the camera is connected to a smart device via Bluetooth or to a wireless or Ethernet network.

<b>Image Dust Off ref photo</b>	
Start	Acquire reference data for the Image Dust Off option in Capture NX-D (□ v).
Clean sensor and then start	
<b>Image comment</b>	
Attach comment	Add a comment to new photographs as they are taken. Comments can be viewed as metadata in ViewNX-i or Capture NX-D (□ v).
Input comment	
<b>Copyright information</b>	
Attach copyright information	Add copyright information to new photographs as they are taken. Copyright information can be viewed as metadata in ViewNX-i or Capture NX-D (□ v).
Artist	
Copyright	
<b>IPTC</b>	
Edit/save	Create or modify IPTC presets and choose whether to embed them in new photos.
Delete	
Auto embed during shooting	
Load/save	
<b>Beep</b>	
Volume	Choose the pitch and volume of the beep.
Pitch	
<b>Touch controls</b>	
Enable/disable touch controls	Adjust touch control settings (□ 11).
Full-frame playback flicks	
<b>HDMI</b>	
Output resolution	Adjust settings for connection to HDMI devices.
Advanced	



## Location data

Download from smart device Adjust location data settings (☰ 253).

Position

External GPS device options

## Wireless remote (WR) options

LED lamp Adjust LED lamp and link mode settings for optional wireless remote controllers.

Link mode

## Assign remote (WR) Fn button

(defaults to **None**)

Preview Choose the role played by the **Fn** button on optional wireless remote controllers.

FV lock

AE/AF lock

AE lock only

AE lock (Reset on release)

AF lock only

AF-ON

⚡ Disable/enable

+ NEF (RAW)

Live view

None

## Airplane mode

(defaults to **Disable**)

Enable Enable airplane mode to disable the wireless features of Eye-Fi cards and Bluetooth and Wi-Fi connections to smart devices. Connections to other devices using a wireless transmitter can only be disabled by removing the transmitter from the camera.

Disable

<b>Connect to smart device</b>	
Start	To connect a smart device, select <b>Start</b> and follow the on-screen guide. <b>Password protection</b> controls whether Bluetooth connections are password protected.
Password protection	
<b>Send to smart device (auto)</b> (defaults to <b>Off</b> )	
On	Select <b>On</b> to upload photos to a smart device as they are taken.
Off	
<b>Wi-Fi</b>	
Network settings	Adjust Wi-Fi (wireless LAN) settings for connection to smart devices.
Current settings	
Reset connection settings	
<b>Bluetooth</b>	
Network connection	Adjust settings for Bluetooth connections to smart devices.
Paired devices	
Send while off	
<b>Network</b>	
Choose hardware	Adjust ftp and network settings for Ethernet and wireless LANs using a WT-7. This option is available only when a WT-7 is attached.
Network settings	
Options	
<b>Eye-Fi upload</b> (defaults to <b>Enable</b> )	
Enable	Upload pictures to a preselected destination. This option is displayed only when a supported Eye-Fi card is inserted.
Disable	

<b>Conformity marking</b>	
	View a selection of the standards with which the camera complies.
<b>MB-D17 battery type</b> (defaults to <b>LR6 (AA alkaline)</b> )	
LR6 (AA alkaline)	To ensure that the camera functions as expected when the optional MB-D17 multi-power battery pack is used with AA batteries, match the option selected in this menu to the type of batteries inserted in the battery pack. There is no need to adjust this option when using EN-EL15b/EN-EL15a/EN-EL15 or optional EN-EL18c/EN-EL18b/EN-EL18a/EN-EL18 batteries.
HR6 (AA Ni-MH)	
FR6 (AA lithium)	
<b>Battery order</b> (defaults to <b>Use MB-D17 batteries first</b> )	
Use MB-D17 batteries first	Choose whether the battery in the camera or the batteries in the battery pack are used first when an optional MB-D17 multi-power battery pack is attached.
Use camera battery first	
<b>Battery info</b>	
	View information on the battery currently inserted in the camera.
<b>Slot empty release lock</b> (defaults to <b>Enable release</b> )	
Release locked	Choose whether the shutter can be released when no memory card is inserted.
Enable release	
<b>Save/load settings</b>	
Save settings	Save camera settings to or load camera settings from a memory card. Settings files can be shared with other D500 cameras.
Load settings	

## Reset all settings

Reset	Reset all settings apart from the options selected for <b>Language</b> and <b>Time zone and date</b> in the setup menu.
Do not reset	

## Firmware version

View the current camera firmware version.

### Reset All Settings

Copyright information, IPTC presets, and other user-generated entries are also reset. We recommend that you save settings using the **Save/load settings** option in the setup menu before performing a reset.

## ■ Auto AF Fine-Tuning

Auto AF fine-tuning is performed as described below.

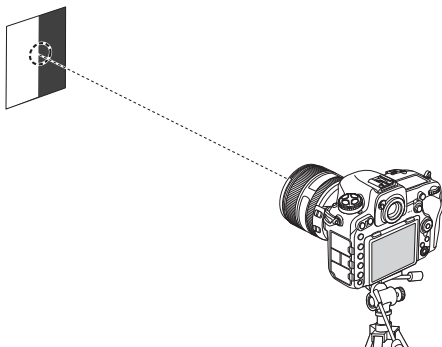

### 1 Ready the camera.

Mount the camera on a tripod and aim the camera at a flat, high-contrast subject parallel to the camera focal plane. Note that auto AF fine-tuning works best at maximum aperture and may not function in dark surroundings.



---

## 2 Start live view.

Rotate the live view selector to  and press the  button.

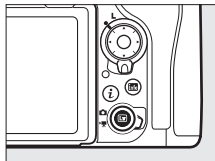

---

## 3 Adjust focus settings.

Rotate the focus-mode selector to **AF** and use the AF-mode button and command dials to select the following:

- **Autofocus mode: AF-S**
- **AF-area mode:**  (wide) or  (normal)

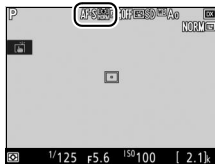

---

## 4 Select the center focus point.

Press the center of the multi selector to select the center focus point.

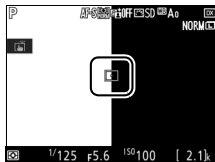

---

## 5 Focus.

Press the shutter-release button halfway to focus, then zoom in on the view through the lens to confirm that the subject is in focus.

---

## 6 Perform auto AF fine-tuning.

Press the AF-mode and movie-record buttons simultaneously and keep them pressed until the dialog shown in Step 7 is displayed (this should take slightly over two seconds).

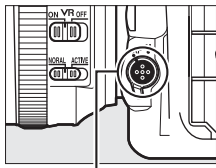

*AF-mode button*

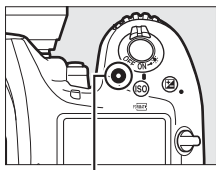

*Movie-record button*

---

## 7 Save the new value.

Highlight **Yes** and press **OK** to add the AF fine-tuning value for the current lens to the saved values list (CPU lenses only). Note that only one value can be stored for each type of lens.

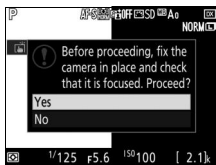

---

## 8 Enable AF fine-tuning.

In the camera setup menu, select **AF fine-tune** > **AF fine-tune (On/Off)**, then highlight **On** and press **OK**.

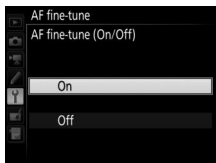

## **The Retouch Menu: Creating Retouched Copies**

### **NEF (RAW) processing**

Create JPEG copies of NEF (RAW) photographs (📖 316).

### **Trim**

Create a cropped copy of the selected photograph (📖 318).

### **Resize**

Select image

Create small copies of selected photographs.

Choose destination

Choose size

### **D-Lighting**

Brighten shadows. Choose for dark or backlit photographs.

### **Red-eye correction**

Correct “red-eye” in photos taken with a flash.

### **Straighten**

Create straightened copies. Copies can be straightened by up to 5° in increments of approximately 0.25°.

### **Distortion control**

Auto

Manual

Create copies with reduced peripheral distortion. Use to reduce barrel distortion in photos taken with wide-angle lenses or pin-cushion distortion in photos taken with telephoto lenses. Select **Auto** to let the camera correct distortion automatically.

## Perspective control

Create copies that reduce the effects of perspective taken from the base of a tall object.

## Filter effects

Skylight

Warm filter

Create the effects of the following filters:

- **Skylight:** A skylight filter effect
- **Warm filter:** A warm tone filter effect

## Monochrome

Black-and-white

Sepia

Cyanotype

Copy photographs in **Black-and-white**, **Sepia**, or **Cyanotype** (blue and white monochrome).

## Image overlay

Image overlay combines two existing NEF (RAW) photographs to create a single picture that is saved separately from the originals (☞ 319). **Image overlay** can only be selected by pressing MENU and selecting  tab.



## Edit movie

Choose start/end point

Save selected frame

Trim footage to create edited copies of movies or save selected frames as JPEG stills (☞ 82).

## Side-by-side comparison

Compare retouched copies to the original photographs. **Side-by-side comparison** is only available if the retouch menu is displayed by pressing  while pressing and holding the  button or by pressing  and selecting **Retouch** in full-frame playback when a retouched image or original is displayed.



## My Menu/ Recent Settings

### Add items

PLAYBACK MENU	Create a custom menu of up to 20 items selected from the playback, photo shooting, movie shooting, Custom Setting, setup, and retouch menus.
PHOTO SHOOTING MENU	
MOVIE SHOOTING MENU	
CUSTOM SETTING MENU	
SETUP MENU	
RETOUCH MENU	

### Remove items

Delete items from My Menu.

### Rank items

Rank items in My Menu.

### Choose tab

(defaults to **MY MENU**)

MY MENU	Choose the menu displayed in the “My Menu/Recent Settings” tab. Select <b>RECENT SETTINGS</b> to display a menu listing the 20 most recently-used settings.
RECENT SETTINGS	

## Retouch Menu Options

### NEF (RAW) Processing

Create JPEG copies of NEF (RAW) photographs.

#### 1 Select NEF (RAW) processing.

Highlight **NEF (RAW) processing** in the retouch menu and press **▶** to display a picture selection dialog listing only NEF (RAW) images created with this camera.

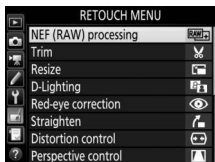

#### 2 Select a photograph.

Use the multi selector to highlight a photograph (to view the highlighted photograph full frame, press and hold the **Q** button). Press **OK** to select the highlighted photograph and proceed to the next step.

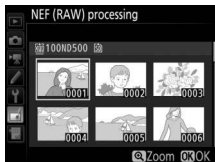

### 3 Choose settings for the JPEG copy.

Adjust the settings listed below. Note that white balance and vignette control are not available with multiple exposures or pictures created with image overlay and that exposure compensation can only be set to values between  $-2$  and  $+2$  EV.

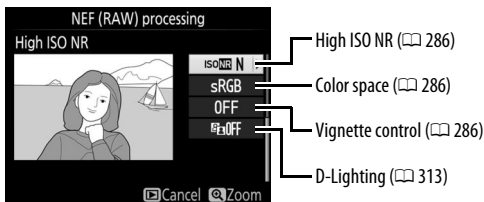
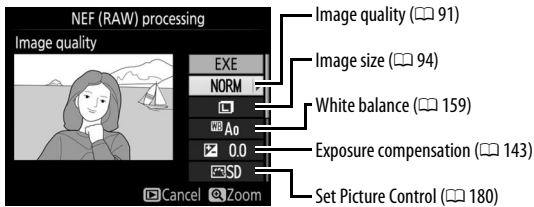









### 4 Copy the photograph.

Highlight **EXE** and press **OK** to create a JPEG copy of the selected photograph. To exit without copying the photograph, press the **MENU** button.



## Trim

Create a cropped copy of the selected photograph. The selected photograph is displayed with the selected crop shown in yellow; create a cropped copy as described in the following table.

To	Use	Description
Reduce size of crop		Press  to reduce the size of the crop.
Increase size of crop		Press  to increase the size of the crop.
Change crop aspect ratio		Rotate the main command dial to choose the aspect ratio.
Position crop		Use multi selector to position the crop. Press and hold to move the crop rapidly to the desired position.
Preview crop		Press center of multi selector to preview cropped image.
Create copy		Save the current crop as a separate file.

### Trim: Image Quality and Size

Copies created from NEF (RAW), NEF (RAW) + JPEG, or TIFF (RGB) photos have an image quality (📄 91) of JPEG fine★; cropped copies created from JPEG photos have the same image quality as the original. The size of the copy varies with crop size and aspect ratio and appears at upper left in the crop display.

### Viewing Cropped Copies

Playback zoom may not be available when cropped copies are displayed.



## Image Overlay

Image overlay combines two existing NEF (RAW) photographs to create a single picture that is saved separately from the originals; the results, which make use of RAW data from the camera image sensor, are noticeably better than photographs combined in an imaging application. The new picture is saved at current image quality and size settings; before creating an overlay, set image quality and size (☐ 91, 94; all options are available). To create a NEF (RAW) copy, choose an image quality of **NEF (RAW)** and an image size of **Large** (the overlay will be saved as a large NEF/RAW image even if **Small** or **Medium** is selected).

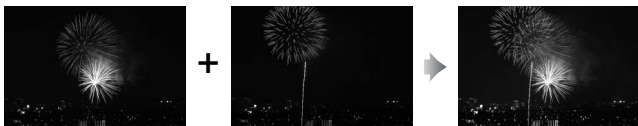

### **1** Select **Image overlay**.

Highlight **Image overlay** in the retouch menu and press . The dialog shown at right will be displayed, with **Image 1** highlighted; press to display a picture selection dialog listing only large NEF (RAW) images created with this camera (small and medium NEF/RAW images can not be selected).

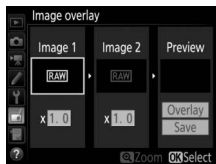

---

## 2 Select the first image.

Use the multi selector to highlight the first photograph in the overlay. To view the highlighted photograph full frame, press and hold the  $\text{Q}$  button.

To view images in other locations, press  $\text{Q}$  (⚡) and select the desired card and folder as described on page 256. Press  $\text{OK}$  to select the highlighted photograph and return to the preview display.



---

## 3 Select the second image.

The selected image will appear as **Image 1**. Highlight **Image 2** and press  $\text{OK}$ , then select the second photo as described in Step 2.

---

## 4 Adjust gain.

Highlight **Image 1** or **Image 2** and optimize exposure for the overlay by pressing  $\uparrow$  or  $\downarrow$  to select the gain from values between 0.1 and 2.0. Repeat for the second image. The default value is 1.0; select 0.5 to halve gain or 2.0 to double it. The effects of gain are visible in the **Preview** column.

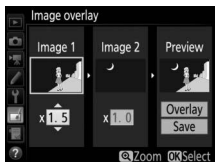

## 5 Preview the overlay.

To preview the composition as shown at right, press  $\odot$  or  $\odot$  to place the cursor in the **Preview** column, then press  $\odot$  or  $\odot$  to highlight **Overlay** and press  $\odot$  (note that colors and brightness in the preview may differ from the final image). To save the overlay without displaying a preview, select **Save**. To return to Step 4 and select new photos or adjust gain, press  $\odot$  ( $\odot$ ).



## 6 Save the overlay.

Press  $\odot$  while the preview is displayed to save the overlay. After an overlay is created, the resulting image will be displayed full-frame in the monitor.

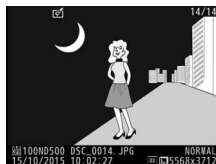

### Image Overlay





Only large NEF (RAW) photographs with the same image area and bit-depth can be combined.

The overlay has the same photo info (including date of recording, metering, shutter speed, aperture, exposure mode, exposure compensation, focal length, and image orientation) and values for white balance and Picture Control as the photograph selected for **Image 1**. The current image comment is appended to the overlay when it is saved; copyright information, however, are not copied. Overlays saved in NEF (RAW) format use the compression selected for **NEF (RAW) compression** in the **NEF (RAW) recording** menu and have the same bit depth as the original images.





# Technical Notes

Read this chapter for information on compatible accessories, cleaning and storing the camera, and what to do if an error message is displayed or you encounter problems using the camera.

## Compatible Lenses

Camera setting  Lens/accessory		Focus mode		Exposure mode		Metering system				
		AF	M (with electronic rangefinder) <sup>1</sup>	P S	A M	 <sup>2</sup>		 <sup>3</sup>	 <sup>4</sup>	 <sup>5</sup>
						3D	Color			
CPU lenses <sup>6</sup>	Type G, E, or D AF NIKKOR <sup>7</sup> AF-S, AF-P, AF-I NIKKOR	✓	✓	✓	✓	✓	—	✓ <sup>8</sup>	✓	
	PC-E NIKKOR series	—	✓ <sup>9</sup>	✓ <sup>9</sup>	✓ <sup>9</sup>	✓ <sup>9</sup>	—	✓ <sup>8,9</sup>	✓	
	PC Micro 85mm f/2.8D <sup>10</sup>	—	✓ <sup>9</sup>	—	✓ <sup>11</sup>	✓	—	✓ <sup>8,9</sup>	✓	
	AF-S / AF-I Teleconverter <sup>12</sup>	✓	✓	✓	✓	✓	—	✓ <sup>8</sup>	✓	
	Other AF NIKKOR (except lenses for F3AF)	✓ <sup>13</sup>	✓ <sup>13</sup>	✓	✓	—	✓	✓ <sup>8</sup>	—	
	AI-P NIKKOR	—	✓ <sup>14</sup>	✓	✓	—	✓	✓ <sup>8</sup>	—	



Camera setting Lens/accessory		Focus mode		Exposure mode		Metering system				
		AF	M (with electronic rangefinder) <sup>1</sup>	P S	A M	 <sup>2</sup>		 <sup>3</sup>	 <sup>4</sup>	 <sup>5</sup> *
						3D	Color			
Non-CPU lenses <sup>15</sup>	AI-, AI-modified NIKKOR or Nikon Series E lenses <sup>16</sup>	—	✓ <sup>14</sup>	—	✓ <sup>17</sup>	—	✓ <sup>18</sup>	✓ <sup>19</sup>	—	
	Medical-NIKKOR 120mm f/4	—	✓	—	✓ <sup>20</sup>	—	—	—	—	
	Reflex-NIKKOR	—	—	—	✓ <sup>17</sup>	—	—	✓ <sup>19</sup>	—	
	PC-NIKKOR	—	✓ <sup>9</sup>	—	✓ <sup>21</sup>	—	—	✓	—	
	AI-type Teleconverter <sup>22</sup>	—	✓ <sup>23</sup>	—	✓ <sup>17</sup>	—	✓ <sup>18</sup>	✓ <sup>19</sup>	—	
	PB-6 Bellows Focusing Attachment <sup>24</sup>	—	✓ <sup>23</sup>	—	✓ <sup>25</sup>	—	—	✓	—	
	Auto extension rings (PK-series 11A, 12, or 13; PN-11)	—	✓ <sup>23</sup>	—	✓ <sup>17</sup>	—	—	✓	—	

- 1 Manual focus available with all lenses.
- 2 Matrix.
- 3 Center-weighted.
- 4 Spot.
- 5 Highlight-weighted.
- 6 IX-NIKKOR lenses can not be used.
- 7 Vibration Reduction (VR) supported with VR lenses.
- 8 Spot metering meters selected focus point ( 128).
- 9 Can not be used with shifting or tilting.
- 10 The camera's exposure metering and flash control systems do not work properly when shifting and/or tilting the lens, or when an aperture other than the maximum aperture is used.
- 11 Manual exposure mode only.
- 12 For information on the focus points available for autofocus and electronic rangefinding, see page 99.

- 13 When focusing at minimum focus distance with AF 80–200mm f/2.8, AF 35–70mm f/2.8, AF 28–85mm f/3.5–4.5 <New>, or AF 28–85mm f/3.5–4.5 lens at maximum zoom, in-focus indicator may be displayed when image on matte screen in viewfinder is not in focus. Adjust focus manually until image in viewfinder is in focus.
- 14 With maximum aperture of f/5.6 or faster.
- 15 Some lenses can not be used (see page 326).
- 16 Range of rotation for AI 80–200mm f/2.8 ED tripod mount is limited by camera body. Filters can not be exchanged while AI 200–400mm f/4 ED is mounted on camera.
- 17 If maximum aperture is specified using **Non-CPU lens data** (□ 250), aperture value will be displayed in viewfinder and control panel.
- 18 Can be used only if lens focal length and maximum aperture are specified using **Non-CPU lens data** (□ 250). Use spot or center-weighted metering if desired results are not achieved.
- 19 For improved precision, specify lens focal length and maximum aperture using **Non-CPU lens data** (□ 250).
- 20 Can be used in manual exposure mode at shutter speeds slower than flash sync speed by one step or more.
- 21 Exposure determined by presetting lens aperture. In aperture-priority auto exposure mode, preset aperture using lens aperture ring before performing AE lock and shifting lens. In manual exposure mode, preset aperture using lens aperture ring and determine exposure before shifting lens.
- 22 Exposure compensation required when used with AI 28–85mm f/3.5–4.5, AI 35–105mm f/3.5–4.5, AI 35–135mm f/3.5–4.5, or AF-S 80–200mm f/2.8D.
- 23 With maximum effective aperture of f/5.6 or faster.
- 24 Requires PK-12 or PK-13 auto extension ring. PB-6D may be required depending on camera orientation.
- 25 Use preset aperture. In aperture-priority auto exposure mode, set aperture using focusing attachment before determining exposure and taking photograph.

- PF-4 Reprocopy Outfit requires PA-4 Camera Holder.
- Noise in the form of lines may appear during autofocus at high ISO sensitivities. Use manual focus or focus lock. Lines may also appear at high ISO sensitivities when aperture is adjusted during movie recording or live view photography.

### ☑ Recognizing CPU and Type G, E, and D Lenses

CPU lenses (particularly types G, E, and D) are recommended, but note that IX-NIKKOR lenses can not be used. CPU lenses can be identified by the presence of CPU contacts, type G, E, and D lenses by a letter on the lens barrel. Type G and E lenses are not equipped with a lens aperture ring.

*CPU contacts*

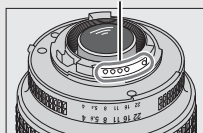

*CPU lens*

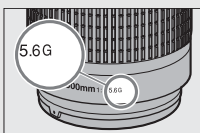

*Type G/E lens*

*Aperture ring*

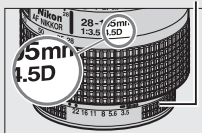

*Type D lens*

### ☑ Lens f-number

The f-number given in lens names is the maximum aperture of the lens.

### ☑ Compatible Non-CPU Lenses

**Non-CPU lens data** (☞ 250) can be used to enable many of the features available with CPU lenses, including color matrix metering; if no data are provided, center-weighted metering will be used in place of color matrix metering, while if the maximum aperture is not provided, the camera aperture display will show the number of stops from maximum aperture and the actual aperture value must be read off the lens aperture ring.

## ❑ Incompatible Accessories and Non-CPU Lenses

The following can NOT be used with the D500:

- TC-16A AF teleconverter
- Non-AI lenses
- Lenses that require the AU-1 focusing unit (400mm f/4.5, 600mm f/5.6, 800mm f/8, 1200mm f/11)
- Fisheye (6mm f/5.6, 7.5mm f/5.6, 8mm f/8, OP 10mm f/5.6)
- 2.1cm f/4
- Extension Ring K2
- 180–600mm f/8 ED (serial numbers 174041–174180)
- 360–1200mm f/11 ED (serial numbers 174031–174127)
- 200–600mm f/9.5 (serial numbers 280001–300490)
- AF lenses for the F3AF (AF 80mm f/2.8, AF 200mm f/3.5 ED, AF Teleconverter TC-16)
- PC 28mm f/4 (serial number 180900 or earlier)
- PC 35mm f/2.8 (serial numbers 851001–906200)
- PC 35mm f/3.5 (old type)
- Reflex 1000mm f/6.3 (old type)
- Reflex 1000mm f/11 (serial numbers 142361–143000)
- Reflex 2000mm f/11 (serial numbers 200111–200310)

## ✍ VR Lenses

The lenses listed below are not recommended for long exposures or photographs taken at high ISO sensitivities, as due to the design of the vibration reduction (VR) control system the resulting photos may be marred by fog. We recommend turning vibration reduction off when using other VR lenses.

- AF-S VR Zoom-Nikkor 24–120mm f/3.5–5.6G IF-ED
- AF-S VR Zoom-Nikkor 70–200mm f/2.8G IF-ED
- AF-S VR Zoom-Nikkor 70–300mm f/4.5–5.6G IF-ED
- AF-S VR Nikkor 200mm f/2G IF-ED
- AF-S VR Nikkor 300mm f/2.8G IF-ED
- AF-S NIKKOR 16–35mm f/4G ED VR
- AF-S NIKKOR 24–120mm f/4G ED VR
- AF-S NIKKOR 28–300mm f/3.5–5.6G ED VR
- AF-S NIKKOR 400mm f/2.8G ED VR
- AF-S NIKKOR 500mm f/4G ED VR
- AF-S DX VR Zoom-Nikkor 18–200mm f/3.5–5.6G IF-ED
- AF-S DX NIKKOR 16–85mm f/3.5–5.6G ED VR
- AF-S DX NIKKOR 18–200mm f/3.5–5.6G ED VR II
- AF-S DX Micro NIKKOR 85mm f/3.5G ED VR
- AF-S DX NIKKOR 55–300mm f/4.5–5.6G ED VR

### Calculating Angle of View

The size of the area exposed by a 35mm camera is  $36 \times 24$  mm. The size of the area exposed by the D500 when **DX (24×16)** is selected for **Choose image area** in the photo shooting menu, in contrast, is  $23.5 \times 15.7$  mm, meaning that the angle of view of a 35mm camera is approximately 1.5 times that of the D500 (when **1.3× (18×12)** is selected, the size of the area exposed decreases, further reducing the angle of view by about 1.3×).

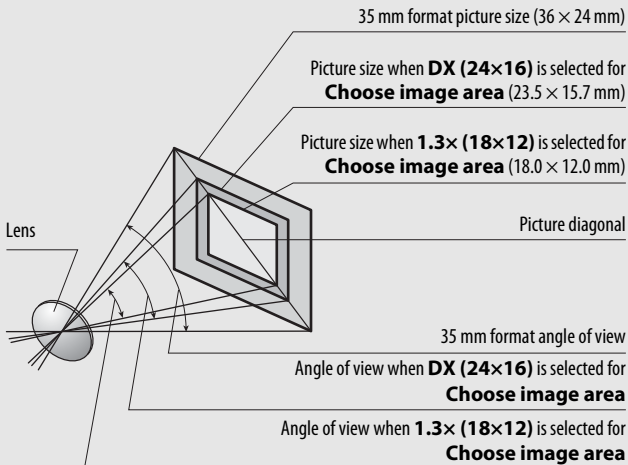



## The Nikon Creative Lighting System (CLS)

Nikon's advanced Creative Lighting System (CLS) offers improved communication between the camera and compatible flash units for improved flash photography.





### ■ CLS-Compatible Flash Units

The following features are available with CLS-compatible flash units:

		SB-5000	SB-910, SB-900, SB-800	SB-700	SB-600	SB-500	SU-800	SB-R200	SB-400	SB-300	
Single flash	i-TTL	i-TTL balanced fill-flash for digital SLR <sup>1</sup>	✓	✓	✓	✓	—	—	✓	✓	
		Standard i-TTL fill-flash for digital SLR	✓ <sup>2</sup>	✓ <sup>2</sup>	✓	✓ <sup>2</sup>	✓	—	—	✓	✓
	 A	Auto aperture	✓	✓ <sup>3</sup>	—	—	—	—	—	—	—
	A	Non-TTL auto	— <sup>4</sup>	✓ <sup>3</sup>	—	—	—	—	—	—	—
	GN	Distance-priority manual	✓	✓	✓	—	—	—	—	—	—
	M	Manual	✓	✓	✓	✓	✓ <sup>5</sup>	—	—	✓ <sup>5</sup>	✓ <sup>5</sup>
	RPT	Repeating flash	✓	✓	—	—	—	—	—	—	—

		SB-5000	SB-910, SB-900, SB-800	SB-700	SB-600	SB-500	SU-800	SB-R200	SB-400	SB-300	
Optical Advanced Wireless Lighting	Master	Remote flash control	✓	✓	✓	—	✓ <sup>5</sup>	✓	—	—	
		i-TTL i-TTL	✓	✓	✓	—	✓ <sup>5</sup>	—	—	—	
		[A:B] Quick wireless flash control	✓	—	✓	—	—	✓ <sup>6</sup>	—	—	—
		 A Auto aperture	✓	✓	—	—	—	—	—	—	—
		A Non-TTL auto	—	— <sup>7</sup>	—	—	—	—	—	—	—
		M Manual	✓	✓	✓	—	✓ <sup>5</sup>	—	—	—	—
		RPT Repeating flash	✓	✓	—	—	—	—	—	—	—
	Remote	i-TTL i-TTL	✓	✓	✓	✓	✓	—	✓	—	—
		[A:B] Quick wireless flash control	✓	✓	✓	✓	✓	—	✓	—	—
		 A/A Auto aperture/ Non-TTL auto	✓ <sup>8</sup>	✓ <sup>8</sup>	—	—	—	—	—	—	—
		M Manual	✓	✓	✓	✓	✓	—	✓	—	—
		RPT Repeating flash	✓	✓	✓	✓	✓	—	—	—	—
	Radio-controlled Advanced Wireless Lighting		✓ <sup>9</sup>	—	—	—	—	—	—	—	—
	Color Information Communication (flash)		✓	✓	✓	✓	✓	—	—	✓	✓
	Color Information Communication (LED light)		—	—	—	—	✓	—	—	—	—

	SB-5000	SB-910, SB-900, SB-800	SB-700	SB-600	SB-500	SU-800	SB-R200	SB-400	SB-300
Auto FP High-Speed Sync <sup>10</sup>	✓	✓	✓	✓	✓	✓	✓	—	—
FV lock <sup>11</sup>	✓	✓	✓	✓	✓	✓	✓	✓	✓
AF-assist for multi-area AF	✓	✓	✓	✓	—	✓ <sup>12</sup>	—	—	—
Red-eye reduction	✓	✓	✓	✓	✓	—	—	✓	—
Camera modeling illumination	✓	✓	✓	✓	✓	✓	✓	—	—
Unified flash control	✓	—	—	—	✓	—	—	✓	✓
Camera flash unit firmware update	✓	✓ <sup>13</sup>	✓	—	✓	—	—	—	✓

- 1 Not available with spot metering.
- 2 Can also be selected with flash unit.
- 3  A/A mode selection performed on flash unit using custom settings. Unless lens data have been provided using the **Non-CPU lens data** option in the setup menu, “A” will be selected when a non-CPU lens is used.
- 4 Unless lens data have been provided using the **Non-CPU lens data** option in the setup menu, non-TTL auto will be selected when a non-CPU lens is used.
- 5 Can only be selected with camera.
- 6 Available only during close-up photography.
- 7 Unless lens data have been provided using the **Non-CPU lens data** option in the setup menu, non-TTL auto (A) is used with non-CPU lenses, regardless of mode selected with flash unit.
- 8 Choice of  A and A depends on the option selected with master flash.
- 9 Supports the same features as remote flash units with optical AWL.
- 10 Available only in i-TTL, , A, GN, and M flash-control modes.
- 11 Available only in i-TTL flash control mode or when flash is set to emit monitor pre-flashes in  A or A flash control mode.
- 12 Available only in commander mode.
- 13 Firmware updates for the SB-910 and SB-900 can be performed from the camera.



**The SU-800 Wireless Speedlight Commander:** When mounted on a CLS-compatible camera, the SU-800 can be used as a commander for SB-5000, SB-910, SB-900, SB-800, SB-700, SB-600, SB-500, or SB-R200 flash units in up to three groups. The SU-800 itself is not equipped with a flash.

#### **Modeling Illumination**

CLS-compatible flash units emit a modeling flash when the camera **Pv** button is pressed. This feature can be used with Advanced Wireless Lighting to preview the total lighting effect achieved with multiple flash units. Modeling illumination can be turned off using Custom Setting e5 (**Modeling flash**,  300).

## ■ Other Flash Units

The following flash units can be used in non-TTL auto and manual modes.

Flash unit	SB-80DX, SB-28DX, SB-28, SB-26, SB-25, SB-24	SB-50DX	SB-30, SB-27 <sup>1</sup> , SB-22S, SB-22, SB-20, SB-16B, SB-15	SB-23, SB-29 <sup>2</sup> , SB-21B <sup>2</sup> , SB-29S <sup>2</sup>
<b>A</b> Non-TTL auto	✓	—	✓	—
<b>M</b> Manual	✓	✓	✓	✓
 Repeating flash	✓	—	—	—
<b>REAR</b> Rear-curtain sync <sup>3</sup>	✓	✓	✓	✓

- 1 Flash mode is automatically set to TTL and shutter-release is disabled. Set flash unit to **A** (non-TTL auto flash).
- 2 Autofocus is available with AF-S VR Micro-Nikkor 105mm f/2.8G IF-ED and AF-S Micro NIKKOR 60mm f/2.8G ED lenses only.
- 3 Available when camera is used to select flash mode.

### **✓ Notes on Optional Flash Units**

Refer to the flash unit manual for detailed instructions. If the unit supports CLS, refer to the section on CLS-compatible digital SLR cameras. The D500 is not included in the “digital SLR” category in the SB-80DX, SB-28DX, and SB-50DX manuals.

i-TTL flash control can be used at ISO sensitivities between 100 and 12800. At values over 12800, the desired results may not be achieved at some ranges or aperture settings. If the flash-ready indicator (⚡) flashes for about three seconds after a photograph is taken in i-TTL or non-TTL auto mode, the flash has fired at full power and the photograph may be underexposed (CLS-compatible flash units only).

When an SC-series 17, 28, or 29 sync cable is used for off-camera flash photography, correct exposure may not be achieved in i-TTL mode. We recommend that you select standard i-TTL fill-flash. Take a test shot and view the results in the monitor.

In i-TTL, use the flash panel or bounce adapter provided with the flash unit. Do not use other panels such as diffusion panels, as this may produce incorrect exposure.

In exposure mode **P**, the maximum aperture (minimum f-number) is limited according to ISO sensitivity, as shown below:

<b>Maximum aperture at ISO equivalent of:</b>							
<b>100</b>	<b>200</b>	<b>400</b>	<b>800</b>	<b>1600</b>	<b>3200</b>	<b>6400</b>	<b>12800</b>
4	5	5.6	7.1	8	10	11	13



If the maximum aperture of the lens is smaller than given above, the maximum value for aperture will be the maximum aperture of the lens.

Noise in the form of lines may appear in flash photographs taken with an SD-9 or SD-8A power pack attached directly to the camera. Reduce ISO sensitivity or increase the distance between the camera and the power pack.



## Notes on Optional Flash Units (Continued)

The SB-5000, SB-910, SB-900, SB-800, SB-700, SB-600, SB-500, and SB-400 provide red-eye reduction, while the SB-5000, SB-910, SB-900, SB-800, SB-700, SB-600, and SU-800 provide AF-assist illumination with the following restrictions:



- **SB-5000:** AF-assist illumination is available when 24–135 mm AF lenses are used with the focus points shown below.

24–49 mm	50–84 mm	85–135 mm
		



- **SB-910 and SB-900:** AF-assist illumination is available when 17–135 mm AF lenses are used with the focus points shown below.

17–19 mm	20–135 mm
	

- **SB-800, SB-600, and SU-800:** AF-assist illumination is available when 24–105 mm AF lenses are used with the focus points shown below.

24–34 mm	35–49 mm	50–105 mm
		

- **SB-700:** AF-assist illumination is available when 24–135 mm AF lenses are used with the focus points shown below.

24–27 mm	28–135 mm
	

Depending on the lens used and scene recorded, the in-focus indicator (●) may be displayed when the subject is not in focus, or the camera may be unable to focus and the shutter release will be disabled.

## Other Accessories

At the time of writing, the following accessories were available for the D500.

<b>Power sources</b>	<ul style="list-style-type: none"><li>• Rechargeable Li-ion Battery EN-EL15 (☞ 13, 375; EN-EL15b and EN-EL15a batteries can also be used)</li><li>• Battery Charger MH-25a (☞ 13, 375)</li><li>• Multi-Power Battery Pack MB-D17</li><li>• Power Connector EP-5B, AC Adapter EH-5b</li></ul>
<b>Wireless transmitters</b> (☞ 308)	Wireless Transmitter WT-7
<b>Wireless remote controllers</b>	<ul style="list-style-type: none"><li>• Wireless Remote Controller WR-R10/WR-T10</li><li>• Wireless Remote Controller WR-1</li></ul>
<b>Viewfinder eyepiece accessories</b>	<ul style="list-style-type: none"><li>• Rubber Eyecup DK-19</li><li>• Diopter-Adjustment Viewfinder Lens DK-17C</li><li>• Magnifying Eyepiece DK-17M</li><li>• Eyepiece Magnifier DG-2</li><li>• Eyepiece Adapter DK-18</li><li>• Antifog Finder Eyepiece DK-14/Antifog Finder Eyepiece DK-17A</li><li>• Fluorine-Coated Finder Eyepiece DK-17F</li><li>• Right-Angle Viewing Attachment DR-5/Right-Angle Viewing Attachment DR-4</li></ul>
<b>HDMI cables</b>	HDMI Cable HC-E1
<b>Accessory shoe covers</b>	<ul style="list-style-type: none"><li>• Accessory Shoe Cover BS-3</li><li>• Accessory Shoe Cover BS-1</li></ul>
<b>Body caps</b>	Body Cap BF-1B/Body Cap BF-1A

<b>Software</b>	Camera Control Pro 2
<b>Remote terminal accessories</b>	<ul style="list-style-type: none"> <li>• Remote Cord MC-22/MC-22A (length 1 m/3 ft 3 in.*)"</li> <li>• Remote Cord MC-30/MC-30A (length 80 cm/2 ft 7 in.*)"</li> <li>• Remote Cord MC-36/MC-36A (length 85 cm/2 ft 9 in.*)"</li> <li>• Extension Cord MC-21/MC-21A (length 3 m/9 ft 10 in.*)"</li> <li>• Connecting Cord MC-23/MC-23A (length 40 cm/1 ft 4 in.*)"</li> <li>• Adapter Cord MC-25/MC-25A (length 20 cm/8 in.*)"</li> <li>• WR Adapter WR-A10</li> <li>• GPS Unit GP-1/GP-1A (☐ 253)</li> <li>• GPS Adapter Cord MC-35 (length 35 cm/1 ft 2 in.*)"</li> <li>• Modulite Remote Control Set ML-3</li> </ul> <p>* All values are approximate.</p>
<b>Microphones (☐ 65)</b>	<ul style="list-style-type: none"> <li>• Stereo Microphone ME-1</li> <li>• Wireless Microphone ME-W1</li> </ul>
<b>Connector covers</b>	<ul style="list-style-type: none"> <li>• UF-8 Connector Cover for Stereo Mini-Plug Cables</li> <li>• USB Connector Cover UF-7</li> </ul>

Availability may vary with country or region. See our website or brochures for the latest information.

## Caring for the Camera

### Storage

When the camera will not be used for an extended period, remove the battery and store it in a cool, dry area with the terminal cover in place. To prevent mold or mildew, store the camera in a dry, well-ventilated area. Do not store your camera with naphtha or camphor moth balls or in locations that:

- are poorly ventilated or subject to humidities of over 60%
- are next to equipment that produces strong electromagnetic fields, such as televisions or radios
- are exposed to temperatures above 50 °C (122 °F) or below -10 °C (14 °F)

### Cleaning

<b>Camera body</b>	Use a blower to remove dust and lint, then wipe gently with a soft, dry cloth. After using the camera at the beach or seaside, wipe off sand or salt with a cloth lightly dampened in distilled water and dry thoroughly. <b>Important:</b> <i>Dust or other foreign matter inside the camera may cause damage not covered under warranty.</i>
<b>Lens, mirror, and viewfinder</b>	These glass elements are easily damaged. Remove dust and lint with a blower. If using an aerosol blower, keep the can vertical to prevent the discharge of liquid. To remove fingerprints and other stains, apply a small amount of lens cleaner to a soft cloth and clean with care.
<b>Monitor</b>	Remove dust and lint with a blower. When removing fingerprints and other stains, wipe the surface lightly with a soft cloth or chamois leather. Do not apply pressure, as this could result in damage or malfunction.

*Do not use alcohol, thinner, or other volatile chemicals.*

## Image Sensor Cleaning

If you suspect that dirt or dust on the image sensor is appearing in photographs, you can clean the sensor using the **Clean image sensor** option in the setup menu. The sensor can be cleaned at any time using the **Clean now** option, or cleaning can be performed automatically when the camera is turned on or off.

### ■ *“Clean Now”*

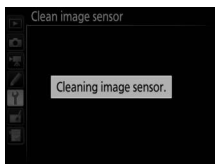
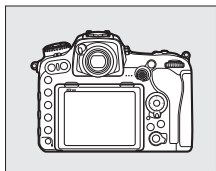

Holding the camera base down, select **Clean image sensor** in the setup menu, then highlight **Clean now** and press **OK**. The camera will check the image sensor and then begin cleaning. **b u S Y** flashes in the control panel and other operations can not be performed while cleaning is in progress. Do not remove or disconnect the power source until cleaning ends and the setup menu is displayed.





## ■ ■ “Clean at Startup/Shutdown”

Choose from the following options:

Option	Description
 <b>Clean at startup</b>	The image sensor is automatically cleaned each time the camera is turned on.
 <b>Clean at shutdown</b>	The image sensor is automatically cleaned during shutdown each time the camera is turned off.
 <b>Clean at startup &amp; shutdown</b>	The image sensor is cleaned automatically at startup and at shutdown.
<b>Cleaning off</b>	Automatic image sensor cleaning off.

### 1 Select **Clean at startup/shutdown**.

Display the **Clean image sensor** menu as described on page 338. Highlight **Clean at startup/shutdown** and press .

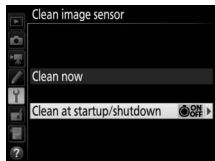

### 2 Select an option.

Highlight an option and press .

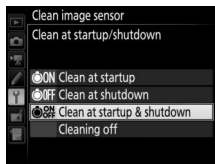

### ✔ Image Sensor Cleaning

Using camera controls during startup interrupts image sensor cleaning.

If dust can not be fully removed using the options in the **Clean image sensor** menu, clean the image sensor manually (☐ 341) or consult a Nikon-authorized service representative.

If image sensor cleaning is performed several times in succession, image sensor cleaning may be temporarily disabled to protect the camera's internal circuitry. Cleaning can be performed again after a short wait.

## Manual Cleaning

If foreign matter can not be removed from the image sensor using the **Clean image sensor** (☞ 338) option in the setup menu, the sensor can be cleaned manually as described below. Note, however, that the sensor is extremely delicate and easily damaged. Nikon recommends that the sensor be cleaned only by Nikon-authorized service personnel.

---

### 1 Charge the battery or connect an AC adapter.

A reliable power source is required when inspecting or cleaning the image sensor. Turn the camera off and insert a fully-charged battery or connect an optional AC adapter and power connector. The **Lock mirror up for cleaning** option is only available in the setup menu at battery levels over .

---

### 2 Remove the lens.

Turn the camera off and remove the lens.

---

### 3 Select **Lock mirror up for cleaning**.

Turn the camera on and highlight **Lock mirror up for cleaning** in the setup menu and press .



#### 4 Press .

The message shown at right will be displayed in the monitor and a row of dashes will appear in the control panel and viewfinder. To restore normal operation without inspecting the image sensor, turn the camera off.

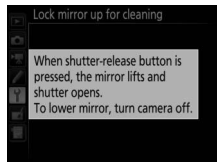

#### 5 Raise the mirror.

Press the shutter-release button all the way down. The mirror will be raised and the shutter curtain

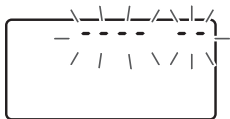

will open, revealing the image sensor. The display in the viewfinder will turn off and the row of dashes in the control panel will flash.

#### 6 Examine the image sensor.

Holding the camera so that light falls on the image sensor, examine the sensor for dust or lint. If no foreign objects are present, proceed to Step 8.

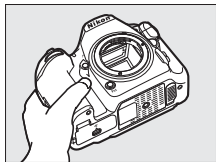

---

## 7 Clean the sensor.

Remove any dust and lint from the sensor with a blower. Do not use a blower-brush, as the bristles could damage the sensor. Dirt that can not be removed with a blower can only be removed by Nikon-authorized service personnel. Under no circumstances should you touch or wipe the sensor.

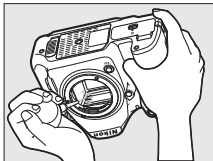

---

## 8 Turn the camera off.

The mirror will return to the down position and the shutter curtain will close. Replace the lens or body cap.

### Use a Reliable Power Source

The shutter curtain is delicate and easily damaged. If the camera powers off while the mirror is raised, the curtain will close automatically. To prevent damage to the curtain, observe the following precautions:

- Do not turn the camera off or remove or disconnect the power source while the mirror is raised.
- If the battery runs low while the mirror is raised, a beep will sound and the self-timer lamp will flash to warn that the shutter curtain will close and the mirror will be lowered after about two minutes. End cleaning or inspection immediately.

### **✔ Foreign Matter on the Image Sensor**

Foreign matter entering the camera when lenses or body caps are removed or exchanged (or in rare circumstances lubricant or fine particles from the camera itself) may adhere to the image sensor, where it may appear in photographs taken under certain conditions. To protect the camera when no lens is in place, be sure to replace the body cap provided with the camera, being careful to first remove all dust and other foreign matter that may be adhering to the camera mount, lens mount, and body cap. Avoid attaching the body cap or exchanging lenses in dusty environments.

Should foreign matter find its way onto the image sensor, use the image sensor cleaning option as described on page 338. If the problem persists, clean the sensor manually (☐ 341) or have the sensor cleaned by authorized Nikon service personnel. Photographs affected by the presence of foreign matter on the sensor can be retouched using the clean image options available in some imaging applications.

### **✔ Servicing the Camera and Accessories**

The camera is a precision device and requires regular servicing. Nikon recommends that the camera be inspected by the original retailer or a Nikon-authorized service representative once every one to two years, and that it be serviced once every three to five years (note that fees apply to these services). Frequent inspection and servicing are particularly recommended if the camera is used professionally. Any accessories regularly used with the camera, such as lenses or optional flash units, should be included when the camera is inspected or serviced.

## Caring for the Camera and Battery: Cautions

**Do not drop:** The product may malfunction if subjected to strong shocks or vibration.

**Keep dry:** This product is not waterproof, and may malfunction if immersed in water or exposed to high levels of humidity. Rusting of the internal mechanism can cause irreparable damage.

**Avoid sudden changes in temperature:** Sudden changes in temperature, such as those that occur when entering or leaving a heated building on a cold day, can cause condensation inside the device. To prevent condensation, place the device in a carrying case or plastic bag before exposing it to sudden changes in temperature.

**Keep away from strong magnetic fields:** Do not use or store this device in the vicinity of equipment that generates strong electromagnetic radiation or magnetic fields. Strong static charges or the magnetic fields produced by equipment such as radio transmitters could interfere with the monitor, damage data stored on the memory card, or affect the product's internal circuitry.

**Do not leave the lens pointed at the sun:** Do not leave the lens pointed at the sun or other strong light source for an extended period. Intense light may cause the image sensor to deteriorate or produce a white blur effect in photographs.

**Cleaning:** When cleaning the camera body, use a blower to gently remove dust and lint, then wipe gently with a soft, dry cloth. After using the camera at the beach or seaside, wipe off any sand or salt using a cloth lightly dampened in pure water and then dry the camera thoroughly. In rare instances, static electricity may cause the LCD displays to light up or go dark. This does not indicate a malfunction, and the display will soon return to normal.

The lens and mirror are easily damaged. Dust and lint should be gently removed with a blower. When using an aerosol blower, keep the can vertical to prevent discharge of liquid. To remove fingerprints and other stains from the lens, apply a small amount of lens cleaner to a soft cloth and wipe the lens carefully.

See “Image Sensor Cleaning” (📖 338, 341) for information on cleaning the image sensor.

**Lens contacts:** Keep the lens contacts clean.

**Do not touch the shutter curtain:** The shutter curtain is extremely thin and easily damaged. Under no circumstances should you exert pressure on the curtain, poke it with cleaning tools, or subject it to powerful air currents from a blower. These actions could scratch, deform, or tear the curtain.

The shutter curtain may appear to be unevenly colored, but this has no effect on pictures and does not indicate a malfunction.



**Storage:** To prevent mold or mildew, store the camera in a dry, well-ventilated area. If you are using an AC adapter, unplug the adapter to prevent fire. If the product will not be used for an extended period, remove the battery to prevent leakage and store the camera in a plastic bag containing a desiccant. Do not, however, store the camera case in a plastic bag, as this may cause the material to deteriorate. Note that desiccant gradually loses its capacity to absorb moisture and should be replaced at regular intervals.

To prevent mold or mildew, take the camera out of storage at least once a month. Turn the camera on and release the shutter a few times before putting it away.

Store the battery in a cool, dry place. Replace the terminal cover before putting the battery away.

**Turn the product off before removing or disconnecting the power source:** Do not unplug the product or remove the battery while the product is on or while images are being recorded or deleted. Forcibly cutting power in these circumstances could result in loss of data or in damage to product memory or internal circuitry. To prevent an accidental interruption of power, avoid carrying the product from one location to another while the AC adapter is connected.

**Notes on the monitor:** The monitor is constructed with extremely high precision; at least 99.99% of pixels are effective, with no more than 0.01% being missing or defective. Hence while these displays may contain pixels that are always lit (white, red, blue, or green) or always off (black), this is not a malfunction and has no effect on images recorded with the device.

Images in the monitor may be difficult to see in a bright light.

Do not apply pressure to the monitor, as this could cause damage or malfunction. Dust or lint on the monitor can be removed with a blower. Stains can be removed by wiping lightly with a soft cloth or chamois leather. Should the monitor break, care should be taken to avoid injury from broken glass and to prevent liquid crystal from the monitor touching the skin or entering the eyes and mouth.

**The battery and charger:** Batteries may leak or explode if improperly handled. Observe the following precautions when handling batteries and chargers:

- Use only batteries approved for use in this equipment.
- Do not expose the battery to flame or excessive heat.
- Keep the battery terminals clean.
- Turn the product off before replacing the battery.
- Remove the battery from the camera or charger when not in use and replace the terminal cover. These devices draw minute amounts of charge even when off and could draw the battery down to the point that it will no longer function. If the battery will not be used for some time, insert it in the camera and run it flat before removing it from the camera for storage. The battery should be stored in a cool location with an ambient temperature of 15 °C to 25 °C (59 °F to 77 °F; avoid hot or extremely cold locations). Repeat this process at least once every six months.
- Turning the camera on or off repeatedly when the battery is fully discharged will shorten battery life. Batteries that have been fully discharged must be charged before use.
- The internal temperature of the battery may rise while the battery is in use. Attempting to charge the battery while the internal temperature is elevated will impair battery performance, and the battery may not charge or charge only partially. Wait for the battery to cool before charging.
- Charge the battery indoors at ambient temperatures of 5 °C–35 °C (41 °F–95 °F). Do not use the battery at ambient temperatures below 0 °C (32 °F) or above 40 °C (104 °F); failure to observe this precaution could damage the battery or impair its performance. Capacity may be reduced and charging times increase at battery temperatures from 0 °C (32 °F) to 15 °C (59 °F) and from 45 °C (113 °F) to 60 °C (140 °F). The battery will not charge if its temperature is below 0 °C (32 °F) or above 60 °C (140 °F).

- If the **CHARGE** lamp flashes quickly (about eight times a second) during charging, confirm that the temperature is in the correct range and then unplug the charger and remove and reinsert the battery. If the problem persists, cease use immediately and take battery and charger to your retailer or a Nikon-authorized service representative.
- Do not move the charger or touch the battery during charging. Failure to observe this precaution could in very rare instances result in the charger showing that charging is complete when the battery is only partially charged. Remove and reinsert the battery to begin charging again.
- Battery capacity may temporarily drop if the battery is charged at low temperatures or used at a temperature below the temperature at which it was charged. If the battery is charged at a temperature below 5 °C (41 °F), the battery life indicator in the **Battery info** (□ 309) display may show a temporary decrease.
- Continuing to charge the battery after it is fully charged can impair battery performance.
- A marked drop in the time a fully charged battery retains its charge when used at room temperature indicates that it requires replacement. Purchase a new battery.
- The supplied power cable and AC wall adapter are for use with the MH-25a only. Use the charger with compatible batteries only. Unplug when not in use.
- Charge the battery before use. When taking photographs on important occasions, ready a spare battery and keep it fully charged. Depending on your location, it may be difficult to purchase replacement batteries on short notice. Note that on cold days, the capacity of batteries tends to decrease. Be sure the battery is fully charged before taking photographs outside in cold weather. Keep a spare battery in a warm place and exchange the two as necessary. Once warmed, a cold battery may recover some of its charge.
- Used batteries are a valuable resource; recycle in accord with local regulations.

## Troubleshooting

If the camera fails to function as expected, check the list of common problems below before consulting your retailer or Nikon-authorized service representative.

### **Battery/Display**

---

**The camera is on but does not respond:** Wait for recording to end. If the problem persists, turn the camera off. If the camera does not turn off, remove and reinsert the battery or, if you are using an AC adapter, disconnect and reconnect the AC adapter. Note that although any data currently being recorded will be lost, data that have already been recorded will not be affected by removing or disconnecting the power source.

---

**Viewfinder is out of focus:** Adjust viewfinder focus (☐ 29). If this does not correct the problem, select single-servo AF (**AF-S**; ☐ 101), single-point AF (☐ 103), and the center focus point (☐ 108), and then frame a high-contrast subject in the center focus point and press the shutter-release button halfway to focus the camera. With the camera in focus, use the diopter adjustment control to bring the subject into clear focus in the viewfinder. If necessary, viewfinder focus can be further adjusted using optional corrective lenses (☐ 335).

---

**Viewfinder is dark:** Insert a fully-charged battery (☐ 13, 35).

---

**Displays turn off without warning:** Choose longer delays for Custom Setting c2 (**Standby timer**) or c4 (**Monitor off delay**) (☐ 296).

---

**Displays in control panel or viewfinder are unresponsive and dim:** The response times and brightness of these displays vary with temperature.

---







## Shooting

---

**Camera takes time to turn on:** Delete files or folders.

---

**Shutter-release disabled:**

- Memory card is locked (SD cards only;  16), full, or not inserted ( 36).
  - **Release locked** is selected for **Slot empty release lock** in the setup menu ( 309) and no memory card is inserted ( 15).
  - Aperture ring for CPU lens not locked at highest f-number (does not apply to type G and E lenses). If **F $\bar{E}$  E** is displayed in the control panel, select **Aperture ring** for Custom Setting f4 (**Customize command dials**) > **Aperture setting** to use lens aperture ring to adjust aperture ( 302).
  - Exposure mode **S** selected with **b $\bar{u}$  L b** or **- -** selected for shutter speed ( 359).
- 



**Camera is slow to respond to shutter-release button:** Select **Off** for Custom Setting d5 (**Exposure delay mode**;  297).

---



**Only one shot taken each time shutter-release button is pressed in continuous release mode:** Turn HDR off ( 191).

---

**Photos are out of focus:**

- Rotate focus-mode selector to **AF** ( 97).
  - Camera unable to focus using autofocus: use manual focus or focus lock ( 111, 114).
- 

**Beep does not sound:**

- **Off** is selected for **Beep** in setup menu ( 306).
  - **AF-C** is selected for AF mode ( 101).
- 

**Full range of shutter speeds not available:** Flash in use. Flash sync speed can be selected using Custom Setting e1 (**Flash sync speed**); when using compatible flash units, choose **1/250 s (Auto FP)** for full range of shutter speeds ( 299).

---

**Focus does not lock when shutter-release button is pressed halfway:** Camera is in focus mode **AF-C**: use the center of the sub-selector to lock focus ( 111).

---

---

**Can not select focus point:**

- Unlock focus selector lock (☐ 108).
- Auto-area AF selected for AF-area mode or face-priority AF selected in live view; choose another mode (☐ 48, 103).
- Camera is in playback mode (☐ 255).
- Menus are in use (☐ 281).
- Press shutter-release button halfway to start standby timer (☐ 39).

---

**Can not select AF mode:** Select **No restrictions** for Custom Setting a10 (**Autofocus mode restrictions**, ☐ 294).

---

**Camera is slow to record photos:** Turn long exposure noise reduction off (☐ 286).

---

**Noise (bright spots, randomly-spaced bright pixels, fog, or lines) appear in photos:**

- Bright spots, randomly-spaced bright pixels, fog, and lines can be reduced by lowering ISO sensitivity.
  - Use the **Long exposure NR** option in the photo shooting menu to limit the occurrence of bright spots or fog in photos taken at shutter speeds slower than 1 s (☐ 286).
  - Fog and bright spots may indicate that the camera's internal temperature has become elevated due to high ambient temperatures, long exposures, or similar causes: turn the camera off and wait for it to cool before resuming shooting.
  - At high ISO sensitivities, lines may appear in photos taken with some optional flash units; if this occurs, choose a lower value.
  - At high ISO sensitivities, including high values selected with auto ISO sensitivity control, randomly-spaced bright pixels can be reduced by selecting **High, Normal, or Low** for **High ISO NR** in the photo or movie shooting menu (☐ 286, 290).
  - At high ISO sensitivities, bright spots, randomly-spaced bright pixels, fog, or lines may be more noticeable in long exposures, multiple exposures, and photos taken at high ambient temperatures or with Active D-Lighting enabled, **Flat** selected for **Set Picture Control** (☐ 180) or extreme values selected for Picture Control parameters (☐ 183).
-

---

**Flicker or banding appears during movie recording:** Choose an option for **Flicker reduction** that matches the frequency of the local AC power supply (□ 290).

---

**Bright regions or bands appear in live view:** A flashing sign, flash, or other light source with brief duration was used during live view.

---

**Smudges appear in photographs:** Clean front and rear lens elements. If problem persists, perform image sensor cleaning (□ 338).

---

**Live view ends unexpectedly or does not start:** Live view may end automatically to prevent damage to the camera's internal circuits if:

- The ambient temperature is high
- The camera has been used for extended periods in live view or to record movies
- The camera has been used in continuous release modes for extended periods

If live view does not start when you press the  button, wait for the internal circuits to cool and then try again. Note that the camera may feel warm to the touch, but this does not indicate a malfunction.

---

**Image artifacts appear during live view:** "Noise" (randomly-spaced bright pixels, fog, or lines) and unexpected colors may appear if you zoom in on the view through the lens (□ 46) during live view; in movies, the amount and distribution of randomly-spaced bright pixels, fog, and bright spots are affected by frame size and rate (□ 68). Randomly-spaced bright pixels, fog, or bright spots may also arise as a result of increases in the temperature of the camera's internal circuits during live view; exit live view when the camera is not in use.

---

**Can not measure white balance:** Subject is too dark or too bright (□ 170).

---

**Image can not be selected as source for preset white balance:** Image was not created with D500 (□ 177).

---

---

**White balance bracketing unavailable:**

- NEF (RAW) or NEF+JPEG image quality option selected for image quality (☐ 91).
- Multiple exposure mode is in effect (☐ 236).

---

**Photographs and movies do not appear to have the same exposure as the preview shown in the monitor during live view:** Changes to monitor brightness during live view have no effect on images recorded with the camera (☐ 50).

---

**Effects of Picture Control differ from image to image:** **A** (auto) is selected for sharpening, clarity, contrast, or saturation. For consistent results over a series of photographs, choose another setting (☐ 184).

---

**Metering can not be changed:** Autoexposure lock is in effect (☐ 142).

---

**Exposure compensation can not be used:** Choose exposure mode **P**, **S**, or **A** (☐ 130, 144).

---

**Noise (reddish areas or other artifacts) appears in long time-exposures:** Enable long exposure noise reduction (☐ 286).

---

**Sound is not recorded with movies:** **Microphone off** is selected for **Microphone sensitivity** in the movie shooting menu (☐ 290).

---

## **Playback**

---

**NEF (RAW) image is not played back:** Photo was taken at image quality of NEF + JPEG (☐ 92).

---

**Can not view pictures recorded with other cameras:** Pictures recorded with other makes of camera may not be displayed correctly.

---

**Some photos are not displayed during playback:** Select **All** for **Playback folder** (☐ 281).

---

**“Tall” (portrait) orientation photos are displayed in “wide” (landscape) orientation:**

- Photo was taken with **Off** selected for **Auto image rotation** (☐ 282).
  - Select **On** for **Rotate tall** (☐ 282).
  - Photo is displayed in image review (☐ 282).
  - Camera was pointed up or down when photo was taken.
-



---

**Can not delete photo:** Picture is protected. Remove protection (☐ 273).

**Can not retouch picture:** Photo can not be further edited with this camera (☐ 362).

**The camera displays a message stating that the folder contains no images:** Select **All** for **Playback folder** (☐ 281).

**Can not print photos:** NEF (RAW) and TIFF photos can not be printed by direct USB connection. Transfer photos to computer and print using Capture NX-D (☐ v). NEF (RAW) photos can be saved in JPEG format using **NEF (RAW) processing** (☐ 313).

**Photo is not displayed on high-definition video device:** Confirm that HDMI cable (available separately) is connected (☐ 335).

**Image Dust Off option in Capture NX-D does not have desired effect:** Image sensor cleaning changes the position of dust on the image sensor. Dust off reference data recorded before image sensor cleaning is performed can not be used with photographs taken after image sensor cleaning is performed. Dust off reference data recorded after image sensor cleaning is performed can not be used with photographs taken before image sensor cleaning is performed (☐ 305).

**Computer displays NEF (RAW) images differently from camera:** Third-party software does not display effects of Picture Controls, Active D-Lighting, or vignette control. Use Capture NX-D (☐ v).

**Can not transfer photos to computer:** OS not compatible with camera or transfer software. Use card reader to copy photos to computer.

---

## **Bluetooth and Wi-Fi (Wireless Networks)**

---

**Smart devices do not display the camera SSID (network name):**

- Confirm that **Disable** is selected for **Airplane mode** in the camera setup menu (☞ 307).
  - Confirm that **Enable** is selected for **Bluetooth > Network connection** in the camera setup menu.
  - Try turning the smart device Wi-Fi off and then on again.
- 

**Can not connect to smart devices using NFC:** Choose another connection method.

---

**Can not connect to wireless printers and other wireless devices:** This camera can connect only to devices to which the SnapBridge app has been installed.

---

## **Miscellaneous**

---

**Date of recording is not correct:** Set camera clock (☞ 304).







---

**Menu item can not be selected:** Some options are not available at certain combinations of settings or when no memory card is inserted. Note that **Battery info** option is not available when camera is powered by an optional power connector and AC adapter.

---







## Error Messages

This section lists the indicators and error messages that appear in the viewfinder, control panel, and monitor.

Indicator		Problem	Solution	
Control panel	Viewfinder			
 (flashes)		Lens aperture ring is not set to minimum aperture.	Set ring to minimum aperture (highest f-number).	131
		Low battery.	Ready a fully-charged spare battery.	13, 35
 (flashes)	 (flashes)	<ul style="list-style-type: none"> <li>Battery exhausted.</li> <li>Battery can not be used.</li> <li>An extremely exhausted rechargeable Li-ion battery or a third-party battery is inserted either in the camera or in the optional MB-D17 multi-power battery pack.</li> <li>High battery temperature.</li> </ul>	<ul style="list-style-type: none"> <li>Recharge or replace battery.</li> <li>Contact Nikon-authorized service representative.</li> <li>Replace the battery, or recharge the battery if the rechargeable Li-ion battery is exhausted.</li> <li>Remove battery and wait for it to cool.</li> </ul>	xx, 13, 35, 335  —

Indicator		Problem	Solution	
Control panel	View-finder			
	$\Delta f$	No lens attached, or non-CPU lens attached without specifying maximum aperture. Aperture shown in stops from maximum aperture.	Aperture value will be displayed if maximum aperture is specified.	250
—	▶ ◀ (flashes)	Camera unable to focus using autofocus.	Change composition or focus manually.	38, 114
(Exposure indicators and shutter speed or aperture display flash)		Subject too bright; photo will be overexposed.	<ul style="list-style-type: none"> <li>• Use a lower ISO sensitivity.</li> <li>• Use optional ND filter. In exposure mode:               <ul style="list-style-type: none"> <li><b>S</b> Increase shutter speed</li> <li><b>A</b> Choose a smaller aperture (higher f-number)</li> </ul> </li> </ul>	123 133 134
		Subject too dark; photo will be underexposed.	<ul style="list-style-type: none"> <li>• Use a higher ISO sensitivity.</li> <li>• Use optional flash. In exposure mode:               <ul style="list-style-type: none"> <li><b>S</b> Lower shutter speed</li> <li><b>A</b> Choose a larger aperture (lower f-number)</li> </ul> </li> </ul>	123 196 133 134

Indicator		Problem	Solution	📖
Control panel	Viewfinder			
b u l b (flashes)		b u l b selected in exposure mode S.	Change shutter speed or select manual exposure mode.	133, 135
- - (flashes)		- - selected in exposure mode S.	Change shutter speed or select manual exposure mode.	133, 135
b u s y (flashes)	b s y (flashes)	Processing in progress.	Wait until processing is complete.	—
—	⚡ (flashes)	If indicator flashes for 3s after flash fires, photo may be underexposed.	Check photo in monitor; if underexposed, adjust settings and try again.	333
👁️ (flashes)	—	Flash unit that does not support red-eye reduction attached and flash sync mode set to red-eye reduction.	Change flash sync mode or use flash unit that supports red-eye reduction.	202, 330
F u l l (flashes)	F u l (flashes)	Memory insufficient to record further photos at current settings, or camera has run out of file or folder numbers.	<ul style="list-style-type: none"> <li>• Reduce quality or size.</li> <li>• Delete photographs after copying important images to computer or other device.</li> <li>• Insert new memory card.</li> </ul>	91, 94 278  15
E r r (flashes)		Camera malfunction.	Release shutter. If error persists or appears frequently, consult Nikon-authorized service representative.	—

Indicator		Problem	Solution	
Monitor	Control panel			
<b>No memory card.</b>	 (- E -)	Camera cannot detect memory card.	Turn camera off and confirm that card is correctly inserted.	15
<b>Cannot access this memory card. Insert another card.</b>	 ,  (flashes)	<ul style="list-style-type: none"> <li>• Error accessing memory card.</li> <li>• Unable to create new folder.</li> </ul>	<ul style="list-style-type: none"> <li>• Use Nikon-approved card.</li> <li>• Check that contacts are clean. If card is damaged, contact retailer or Nikon-authorized service representative.</li> <li>• Delete files or insert new memory card after copying important images to computer or other device.</li> </ul>	387 — 15,278,387
	 ,  (flashes)	Camera can not control Eye-Fi card.	<ul style="list-style-type: none"> <li>• Check that Eye-Fi card firmware is up to date.</li> <li>• Copy files on Eye-Fi card to a computer or other device and format card, or insert new card.</li> </ul>	— —

Indicator		Problem	Solution	📖
Monitor	Control panel			
Memory card is locked. Slide lock to "write" position.  Not available if Eye-Fi card is locked.	Ⓛ Ⓜ Ⓡ Ⓛ, - - - (flashes)	Memory card is locked (write protected).	Slide card write-protect switch to "write" position.	16
	Ⓛ Ⓜ Ⓡ Ⓛ, ⓔ Ⓡ Ⓡ (flashes)	Eye-Fi card is locked (write protected).		
This card is not formatted. Format the card.	[F o r] (flashes)	Memory card has not been formatted for use in camera.	Format memory card or insert new memory card.	304, 387
Unable to start live view. Please wait.	—	The internal temperature of the camera is high.	Wait for the internal circuits to cool before resuming live view photography or movie recording.	353
Folder contains no images.	—	No images on memory card or in folder(s) selected for playback.	Select folder containing images from <b>Playback folder</b> menu or insert memory card containing images.	15, 281
All images are hidden.	—	All photos in current folder are hidden.	No images can be played back until another folder has been selected or <b>Hide image</b> used to allow at least one image to be displayed.	281

Indicator		Problem	Solution	
Monitor	Control panel			
<b>Cannot display this file.</b>	—	File has been created or modified using a computer or different make of camera, or file is corrupt.	File can not be played back on camera.	—
<b>Cannot select this file.</b>	—	Selected image can not be retouched.	Images created with other devices can not be retouched.	—
<b>This movie cannot be edited.</b>	—	The selected movie can not be edited.	<ul style="list-style-type: none"> <li>• Movies created with other devices can not be edited.</li> <li>• Movies must be at least two seconds long.</li> </ul>	85
<b>Check printer.</b>	—	Printer error.	Check printer. To resume, select <b>Continue</b> (if available).	—*
<b>Check paper.</b>	—	Paper in printer is not of selected size.	Insert paper of correct size and select <b>Continue</b> .	—*



Indicator		Problem	Solution	📖
Monitor	Control panel			
<b>Paper jam.</b>	—	Paper is jammed in printer.	Clear jam and select <b>Continue</b> .	—*
<b>Out of paper.</b>	—	Printer is out of paper.	Insert paper of selected size and select <b>Continue</b> .	—*
<b>Check ink supply.</b>	—	Ink error.	Check ink. To resume, select <b>Continue</b> .	—*
<b>Out of ink.</b>	—	Printer is out of ink.	Replace ink and select <b>Continue</b> .	—*

\* See printer manual for more information.

# Specifications

## ■ Nikon D500 Digital Camera

<b>Type</b>	
Type	Single-lens reflex digital camera
Lens mount	Nikon F mount (with AF coupling and AF contacts)
Effective angle of view	Nikon DX format; focal length in 35 mm [135] format equivalent to approx. 1.5× that of lenses with FX format angle of view
<b>Effective pixels</b>	
Effective pixels	20.9 million
<b>Image sensor</b>	
Image sensor	23.5 × 15.7 mm CMOS sensor
Total pixels	21.51 million
Dust-reduction System	Image sensor cleaning, Image Dust Off reference data (Capture NX-D software required)
<b>Storage</b>	
Image size (pixels)	<ul style="list-style-type: none"><li>• <b>DX (24×16) image area</b> 5568 × 3712 (L)      4176 × 2784 (M) 2784 × 1856 (S)</li><li>• <b>1.3× (18×12) image area</b> 4272 × 2848 (L)      3200 × 2136 (M) 2128 × 1424 (S)</li><li>• <b>Photographs with image area of DX taken during movie recording</b> 5568 × 3128 (L)      4176 × 2344 (M) 2784 × 1560 (S)</li><li>• <b>Photographs with image area of 1.3× taken during movie recording</b> 4272 × 2400 (L)      3200 × 1800 (M) 2128 × 1192 (S)</li><li>• <b>Photographs taken during movie recording at a frame size of 3840 × 2160:</b> 3840 × 2160</li></ul>

Storage	
<b>File format</b>	<ul style="list-style-type: none"> <li>• <b>NEF (RAW):</b> 12 or 14 bit (lossless compressed, compressed, or uncompressed); large, medium, and small available (medium and small images are recorded at a bit depth of 12 bits using lossless compression)</li> <li>• <b>TIFF (RGB)</b></li> <li>• <b>JPEG:</b> JPEG-Baseline compliant with fine (approx. 1 : 4), normal (approx. 1 : 8), or basic (approx. 1 : 16) compression; optimal quality compression available</li> <li>• <b>NEF (RAW)+JPEG:</b> Single photograph recorded in both NEF (RAW) and JPEG formats</li> </ul>
<b>Picture Control System</b>	Standard, Neutral, Vivid, Monochrome, Portrait, Landscape, Flat; selected Picture Control can be modified; storage for custom Picture Controls
<b>Media</b>	XQD and SD (Secure Digital) and UHS-II compliant SDHC and SDXC memory cards
<b>Dual card slots</b>	Either card can be used for primary or backup storage or for separate storage of NEF (RAW) and JPEG images; pictures can be copied between cards.
<b>File system</b>	DCF 2.0, Exif 2.3, PictBridge
Viewfinder	
<b>Viewfinder</b>	Eye-level pentaprism single-lens reflex viewfinder
<b>Frame coverage</b>	<ul style="list-style-type: none"> <li>• <b>DX (24×16) image area:</b> Approx. 100% horizontal and 100% vertical</li> <li>• <b>1.3× (18×12) image area:</b> Approx. 98% horizontal and 98% vertical</li> </ul>
<b>Magnification</b>	Approx. $1.0 \times$ (50 mm f/1.4 lens at infinity, $-1.0 \text{ m}^{-1}$ )



Viewfinder	
<b>Eyepoint</b>	16 mm ( $-1.0 \text{ m}^{-1}$ ; from center surface of viewfinder eyepiece lens)
<b>Diopter adjustment</b>	$-2$ – $+1 \text{ m}^{-1}$
<b>Focusing screen</b>	Type B BriteView Clear Matte Mark II screen with AF area brackets (framing grid can be displayed)
<b>Reflex mirror</b>	Quick return
<b>Depth-of-field preview</b>	Pressing <b>Pv</b> button stops lens aperture down to value selected by user ( <b>A</b> and <b>M</b> modes) or by camera ( <b>P</b> and <b>S</b> modes)
<b>Lens aperture</b>	Instant return, electronically controlled
Lens	
<b>Compatible lenses</b>	<p>Compatible with AF NIKKOR lenses, including type G, E, and D lenses (some restrictions apply to PC lenses), and DX lenses, AI-P NIKKOR lenses, and non-CPU AI lenses (exposure modes <b>A</b> and <b>M</b> only). IX NIKKOR lenses, lenses for the F3AF, and non-AI lenses can not be used.</p> <p>The electronic rangefinder can be used with lenses that have a maximum aperture of <math>f/5.6</math> or faster (the electronic rangefinder supports 15 focus points with lenses that have a maximum aperture of <math>f/8</math> or faster, of which 9 points are available for selection).</p>
Shutter	
<b>Type</b>	Electronically-controlled vertical-travel focal-plane mechanical shutter; electronic front-curtain shutter available in mirror up release mode
<b>Speed</b>	$1/8000$ – 30 s in steps of $1/3$ , $1/2$ , or 1 EV, bulb, time, X250
<b>Flash sync speed</b>	$X=1/250$ s; synchronizes with shutter at $1/250$ s or slower

Release	
<b>Release mode</b>	<b>S</b> (single frame), <b>CL</b> (continuous low speed), <b>CH</b> (continuous high speed), <b>Q</b> (quiet shutter-release), <b>Qc</b> (quiet continuous shutter-release), <b>⌚</b> (self-timer), <b>MUP</b> (mirror up)
<b>Approximate frame advance rate</b>	<ul style="list-style-type: none"> <li>• <b>CL:</b> 1–9 fps</li> <li>• <b>CH:</b> 10 fps</li> <li>• <b>Qc:</b> 3 fps</li> </ul>
<b>Self-timer</b>	2 s, 5 s, 10 s, 20 s; 1–9 exposures at intervals of 0.5, 1, 2, or 3 s
Exposure	
<b>Metering</b>	TTL exposure metering using RGB sensor with approximately 180K (180,000) pixels
<b>Metering method</b>	<ul style="list-style-type: none"> <li>• <b>Matrix:</b> 3D color matrix metering III (type G, E, and D lenses); color matrix metering III (other CPU lenses); color matrix metering available with non-CPU lenses if user provides lens data</li> <li>• <b>Center-weighted:</b> Weight of 75% given to 8 mm circle in center of frame. Diameter of circle can be changed to 6, 10, or 13 mm, or weighting can be based on average of entire frame (non-CPU lenses use 8-mm circle)</li> <li>• <b>Spot:</b> Meters 3.5 mm circle (about 2.5% of frame) centered on selected focus point (on center focus point when non-CPU lens is used)</li> <li>• <b>Highlight-weighted:</b> Available with type G, E, and D lenses</li> </ul>
<b>Range (ISO 100, f/1.4 lens, 20 °C/68 °F)</b>	<ul style="list-style-type: none"> <li>• <b>Matrix or center-weighted metering:</b> –3–+20 EV</li> <li>• <b>Spot metering:</b> 2–20 EV</li> <li>• <b>Highlight-weighted metering:</b> 0–20 EV</li> </ul>
<b>Exposure meter coupling</b>	Combined CPU and AI

Exposure	
<b>Exposure mode</b>	Programmed auto with flexible program ( <b>P</b> ); shutter-priority auto ( <b>S</b> ); aperture-priority auto ( <b>A</b> ); manual ( <b>M</b> )
<b>Exposure compensation</b>	-5 – +5 EV in increments of 1/3, 1/2, or 1 EV
<b>Exposure lock</b>	Luminosity locked at detected value
<b>ISO sensitivity (Recommended Exposure Index)</b>	ISO 100 – 51200 in steps of 1/3, 1/2, or 1 EV. Can also be set to approx. 0.3, 0.5, 0.7, or 1 EV (ISO 50 equivalent) below ISO 100 or to approx. 0.3, 0.5, 0.7, 1, 2, 3, 4, or 5 EV (ISO 1640000 equivalent) above ISO 51200; auto ISO sensitivity control available
<b>Active D-Lighting</b>	Can be selected from <b>Auto, Extra high, High, Normal, Low, or Off</b>

Focus	
<b>Autofocus</b>	Multi-CAM 20K autofocus sensor module with TTL phase detection, fine-tuning, and 153 focus points (including 99 cross-type sensors and 15 sensors that support f/8), of which 55 (35 cross-type sensors and 9 f/8 sensors) are available for selection
<b>Detection range</b>	-4 – +20 EV (ISO 100, 20 °C/68 °F)
<b>Lens servo</b>	<ul style="list-style-type: none"> <li>• <b>Autofocus (AF):</b> Single-servo AF (<b>AF-S</b>); continuous-servo AF (<b>AF-C</b>); predictive focus tracking automatically activated according to subject status</li> <li>• <b>Manual focus (M):</b> Electronic rangefinder can be used</li> </ul>
<b>Focus point</b>	153 focus points, of which 55 or 15 are available for selection

<b>Focus</b>	
<b>AF-area mode</b>	Single-point AF, 25-, 72-, or 153- point dynamic-area AF, 3D-tracking, group-area AF, auto-area AF
<b>Focus lock</b>	Focus can be locked by pressing shutter-release button halfway (single-servo AF) or by pressing the center of the sub-selector
<b>Flash</b>	
<b>Flash control</b>	<b>TTL:</b> i-TTL flash control using RGB sensor with approximately 180K (180,000) pixels; i-TTL balanced fill-flash for digital SLR is used with matrix, center-weighted, and highlight-weighted metering, standard i-TTL fill-flash for digital SLR with spot metering
<b>Flash mode</b>	Front-curtain sync, slow sync, rear-curtain sync, red-eye reduction, red-eye reduction with slow sync, slow rear-curtain sync, off, Auto FP High-Speed Sync supported
<b>Flash compensation</b>	-3 – +1 EV in increments of $\frac{1}{3}$ , $\frac{1}{2}$ , or 1 EV
<b>Flash-ready indicator</b>	Lights when optional flash unit is fully charged; flashes after flash is fired at full output
<b>Accessory shoe</b>	ISO 518 hot-shoe with sync and data contacts and safety lock
<b>Nikon Creative Lighting System (CLS)</b>	i-TTL flash control, radio-controlled Advanced Wireless Lighting, optical Advanced Wireless Lighting, modeling illumination, FV lock, Color Information Communication, Auto FP High-Speed Sync, AF-assist for multi-area AF, unified flash control
<b>Sync terminal</b>	ISO 519 sync terminal with locking thread

White balance	
<b>White balance</b>	Auto (3 types), incandescent, fluorescent (7 types), direct sunlight, flash, cloudy, shade, preset manual (up to 6 values can be stored, spot white balance measurement available during live view), choose color temperature (2500 K–10000 K), all with fine-tuning.
Bracketing	
<b>Bracketing types</b>	Exposure, flash, white balance, and ADL
Live view	
<b>Modes</b>	 (photo live view),  (movie live view)
<b>Lens servo</b>	<ul style="list-style-type: none"> <li>• <b>Autofocus (AF):</b> Single-servo AF (<b>AF-S</b>); full-time-servo AF (<b>AF-F</b>)</li> <li>• <b>Manual focus (M)</b></li> </ul>
<b>AF-area mode</b>	Face-priority AF, wide-area AF, normal-area AF, subject-tracking AF
<b>Autofocus</b>	Contrast-detect AF anywhere in frame (camera selects focus point automatically when face-priority AF or subject-tracking AF is selected)
Movie	
<b>Metering</b>	TTL exposure metering using main image sensor
<b>Metering method</b>	Matrix, center-weighted, or highlight-weighted
<b>Frame size (pixels) and frame rate</b>	<ul style="list-style-type: none"> <li>• 3840 × 2160 (4K UHD); 30p (progressive), 25p, 24p</li> <li>• 1920 × 1080; 60p, 50p, 30p, 25p, 24p</li> <li>• 1280 × 720; 60p, 50p</li> </ul> <p>Actual frame rates for 60p, 50p, 30p, 25p, and 24p are 59.94, 50, 29.97, 25, and 23.976 fps respectively; ★ high quality available at all frame sizes, normal quality available at all sizes except 3840 × 2160</p>



<b>Movie</b>	
<b>File format</b>	MOV
<b>Video compression</b>	H.264/MPEG-4 Advanced Video Coding
<b>Audio recording format</b>	Linear PCM
<b>Audio recording device</b>	Built-in stereo or external microphone; sensitivity adjustable
<b>ISO sensitivity</b>	<ul style="list-style-type: none"> <li>• <b>Exposure modes P, S, and A:</b> Auto ISO sensitivity control (ISO 100 to Hi 5) with selectable upper limit</li> <li>• <b>Exposure mode M:</b> Auto ISO sensitivity control (ISO 100 to Hi 5) available with selectable upper limit; manual selection (ISO 100 to 51200 in steps of 1/3, 1/2, or 1 EV) with additional options available equivalent to approximately 0.3, 0.5, 0.7, 1, 2, 3, 4, or 5 EV (ISO 1640000 equivalent) above ISO 51200</li> </ul>
<b>Active D-Lighting</b>	Can be selected from <b>Extra high, High, Normal, Low, or Off</b>
<b>Other options</b>	Index marking, time-lapse movies, electronic vibration reduction
<b>Monitor</b>	
<b>Monitor</b>	8-cm/3.2-in., approx. 2359k-dot (XGA) tilting TFT touch-sensitive LCD with 170° viewing angle, approximately 100% frame coverage, and manual monitor brightness control
<b>Playback</b>	
<b>Playback</b>	Full-frame and thumbnail (4, 9, or 72 images) playback with playback zoom, movie playback, photo and/or movie slide shows, histogram display, highlights, photo information, location data display, auto image rotation, picture rating, and IPTC information embedding and display

Interface	
<b>USB</b>	SuperSpeed USB (USB 3.0 Micro-B connector); connection to built-in USB port is recommended
<b>HDMI output</b>	Type C HDMI connector
<b>Audio input</b>	Stereo mini-pin jack (3.5 mm diameter; plug-in power supported)
<b>Audio output</b>	Stereo mini-pin jack (3.5 mm diameter)
<b>Ten-pin remote terminal</b>	Can be used to connect optional remote control, WR-R10 (requires WR-A10 adapter) or WR-1 wireless remote controller, GP-1/GP-1A GPS unit, or GPS device compliant with NMEA0183 version 2.01 or 3.01 (requires MC-35 GPS adapter cord and cable with D-sub 9-pin connector)
Wireless/Bluetooth	
<b>Wireless</b>	<ul style="list-style-type: none"> <li>• <b>Standards:</b> IEEE 802.11b, IEEE 802.11g</li> <li>• <b>Operating frequency:</b> 2412–2462 MHz (channels 1–11)</li> <li>• <b>Maximum output power:</b> 3.0 dBm (EIRP)</li> <li>• <b>Authentication:</b> Open system, WPA2-PSK</li> </ul>
<b>Bluetooth</b>	<ul style="list-style-type: none"> <li>• <b>Communication protocols:</b> Bluetooth Specification Version 4.1</li> <li>• <b>Operating frequency:</b> Bluetooth: 2402–2480 MHz Bluetooth Low Energy: 2402–2480 MHz</li> <li>• <b>Maximum output power (EIRP):</b> Bluetooth: 1.0 dBm Bluetooth Low Energy: 1.0 dBm</li> </ul>
<b>Range (line of sight)</b>	Approximately 10 m (32 ft) without interference; range may vary with signal strength and presence or absence of obstacles
NFC	
<b>Operation</b>	NFC Forum Type 3 Tag
<b>Operating frequency</b>	13.56 MHz

**Supported languages**

<b>Supported languages</b>	Arabic, Bengali, Bulgarian, Chinese (Simplified and Traditional), Czech, Danish, Dutch, English, Finnish, French, German, Greek, Hindi, Hungarian, Indonesian, Italian, Japanese, Korean, Marathi, Norwegian, Persian, Polish, Portuguese (Portugal and Brazil), Romanian, Russian, Serbian, Spanish, Swedish, Tamil, Telugu, Thai, Turkish, Ukrainian, Vietnamese
----------------------------	--

**Power source**

<b>Battery</b>	One rechargeable Li-ion EN-EL15 battery; EN-EL15b and EN-EL15a batteries can also be used
<b>Battery pack</b>	Optional MB-D17 multi-power battery pack with one rechargeable Nikon EN-EL18c/EN-EL18b/EN-EL18a/EN-EL18 Li-ion battery (available separately), one rechargeable Nikon EN-EL15 Li-ion battery, or eight AA alkaline, Ni-MH, or lithium batteries. An MH-26a or MH-26 battery charger and a BL-5 battery-chamber cover (both available separately) are required when using EN-EL18c, EN-EL18b, EN-EL18a, or EN-EL18 batteries (note that fewer pictures can be taken on a single charge with an EN-EL18 than with an EN-EL18c, EN-EL18b, or EN-EL18a). EN-EL15b and EN-EL15a batteries can also be used.
<b>AC adapter</b>	EH-5b AC adapter; requires EP-5B power connector (available separately)

**Tripod socket**

<b>Tripod socket</b>	1/4 in. (ISO 1222)
----------------------	--------------------

<b>Dimensions/weight</b>	
<b>Dimensions (W × H × D)</b>	Approx. 147 × 115 × 81 mm (5.8 × 4.6 × 3.2 in.)
<b>Weight</b>	Approx. 850 g (1 lb. 14.0 oz.) with battery and XQD memory card but without body cap; approx. 760 g/1 lb. 10.9 oz. (camera body only)
<b>Operating environment</b>	
<b>Temperature</b>	0 °C–40 °C (+32 °F–104 °F)
<b>Humidity</b>	85% or less (no condensation)

- Unless otherwise stated, all measurements are performed in conformity with Camera and Imaging Products Association (CIPA) standards or guidelines.
- All figures are for a camera with a fully-charged battery.
- The sample images displayed on the camera and the images and illustrations in the manual are for expository purposes only.
- Nikon reserves the right to change the appearance and specifications of the hardware and software described in this manual at any time and without prior notice. Nikon will not be held liable for damages that may result from any mistakes that this manual may contain.

## ■ ■ MH-25a Battery Charger

<b>Rated input (in North America)</b>	AC 120 V, 60 Hz, 0.2 A
<b>Rated input (in other regions)</b>	AC 100–240 V, 50/60 Hz, 0.23–0.12 A
<b>Rated output</b>	DC 8.4 V/1.2 A
<b>Supported batteries</b>	Nikon EN-EL15b, EN-EL15a, and EN-EL15 rechargeable Li-ion batteries
<b>Charging time</b>	Approx. 2 hours and 35 minutes at an ambient temperature of 25 °C (77 °F) when no charge remains
<b>Operating temperature</b>	0 °C–40 °C (+32 °F–104 °F)
<b>Dimensions (W × H × D)</b>	Approx. 95 × 33.5 × 71 mm (3.7 × 1.3 × 2.8 in.), excluding projections
<b>Length of power cable (if supplied)</b>	Approx. 1.5 m (4.9 ft)
<b>Weight</b>	Approx. 115 g (4.1 oz), excluding supplied power connector (power cable or AC wall adapter)

The symbols on this product represent the following:

~ AC, --- DC,  Class II equipment (The construction of the product is double-insulated.)

## ■ ■ EN-EL15 Rechargeable Li-ion Battery

<b>Type</b>	Rechargeable lithium-ion battery
<b>Rated capacity</b>	7.0 V/1900 mAh
<b>Operating temperature</b>	0 °C–40 °C (+32 °F–104 °F)
<b>Dimensions (W × H × D)</b>	Approx. 40 × 56 × 20.5 mm (1.6 × 2.2 × 0.8 in.)
<b>Weight</b>	Approx. 78 g (2.8 oz), excluding terminal cover

## ■ AF-S DX NIKKOR 16–80mm f/2.8–4E ED VR Lens

Type	Type E AF-S DX lens with built-in CPU and F mount
Focal length	16–80 mm
Maximum aperture	f/2.8–4
Lens construction	17 elements in 13 groups (including 4 ED elements, 3 aspherical elements, and elements with Nano-Crystal or fluorine coatings)
Angle of view	83°–20°
Focal length scale	Graduated in millimeters (16, 24, 35, 50, 80)
Distance information	Output to camera
Zoom	Manual zoom using independent zoom ring
Focusing	Nikon Internal Focusing (IF) System with autofocus controlled by Silent Wave Motor and separate focus ring for manual focus
Vibration reduction	Lens shift using voice coil motors (VCMs)
Focus distance indicator	0.35 m–∞
Minimum focus distance	0.35 m (1.15 ft) from focal plane (☐ 115) at all zoom positions
Diaphragm blades	7 (rounded diaphragm opening)
Diaphragm	Automatic electronic aperture control
Aperture range	<ul style="list-style-type: none"><li>• 16 mm focal length: f/2.8–22</li><li>• 80 mm focal length: f/4–32</li></ul> The minimum aperture displayed may vary depending on the size of the exposure increment selected with the camera.
Metering	Full aperture
Filter-attachment size	72 mm (P=0.75 mm)
Dimensions	Approx. 80 mm maximum diameter × 85.5 mm (distance from camera lens mount flange)
Weight	Approx. 480 g (1 lb 1 oz)

Nikon reserves the right to change the appearance and specifications of the hardware and software described in this manual at any time and without prior notice. Nikon will not be held liable for damages that may result from any mistakes that this manual may contain.

## AF-S DX NIKKOR 16–80mm f/2.8–4E ED VR Lenses

Read this section if you purchased the camera with the AF-S DX NIKKOR 16–80mm f/2.8–4E ED VR lens kit available in some countries or regions. The parts of the lens are listed below.

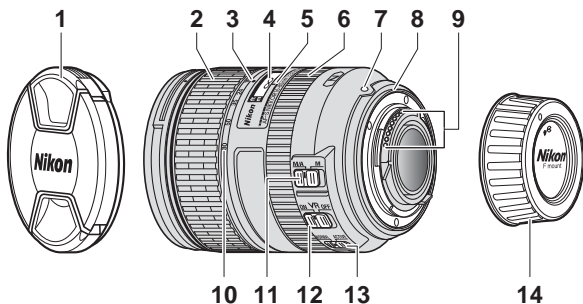

<b>1</b> Lens cap	<b>9</b> CPU contacts..... 325
<b>2</b> Zoom ring	<b>10</b> Focal length scale
<b>3</b> Focal length mark	<b>11</b> Focus-mode switch ..... 114, 378
<b>4</b> Focus distance indicator	<b>12</b> Vibration reduction switch ..... 380
<b>5</b> Focus distance mark	<b>13</b> Vibration reduction mode switch ..... 381
<b>6</b> Focus ring..... 114	<b>14</b> Rear lens cap
<b>7</b> Lens mounting mark..... 18	
<b>8</b> Rubber lens-mount gasket	

The AF-S DX NIKKOR 16–80mm f/2.8–4E ED VR is for use exclusively with Nikon DX format digital cameras. SLR film cameras and D2- and D1-series, D200, D100, D90, D80, D70-series, D60, D50, D40-series, and D3000 digital SLR cameras are not supported.

### ✔ Focus Distance Indicator

Note that the focus distance indicator is intended only as a guide and may not accurately show the distance to the subject and may, due to depth of field or other factors, not show ∞ when the camera is focused on a distant object.

### ✔ Using M/A (Autofocus with Manual Override) with AF-S DX NIKKOR 16–80mm f/2.8–4E ED VR Lenses

To focus using autofocus with manual override (M/A):

- 1 Slide the lens focus-mode switch (📖 377) to M/A.
- 2 Focus.

If desired, you can over-ride autofocus by rotating the lens focus ring while keeping the shutter-release button pressed halfway (or, if the camera is equipped with an **AF-ON** button, while the **AF-ON** button is pressed). To refocus using autofocus, press the shutter-release button halfway or press the **AF-ON** button again.



## Lens Care

- The lens returns to maximum aperture when removed from the camera. To protect the interior of the lens, store it out of direct sunlight or replace the lens caps.
- Do not pick up or hold the lens or camera using only the lens hood.
- Keep the CPU contacts clean.
- Should the rubber lens-mount gasket be damaged, cease use immediately and take the lens to a Nikon-authorized service center for repair.
- Use a blower to remove dust and lint from the lens surfaces.
- The fluorine-coated front and rear elements can be cleaned simply by wiping them with a dry cloth. Smudges and fingerprints can be removed using a soft, clean cotton cloth or lens cleaning tissue; clean from the center outwards using a circular motion, taking care not to leave smears or touch the glass surface with your fingers. To remove stubborn stains, wipe gently using a soft cloth dampened with a small amount of distilled water, ethanol, or lens cleaner. Drop-shaped stains on the water- and oil-repellent fluorine-coated elements can be removed with a dry cloth.
- Never use organic solvents such as paint thinner or benzene to clean the lens.
- The lens hood or NC filters can be used to protect the front lens element.
- Attach the front and rear caps before placing the lens in its flexible pouch.
- If the lens will not be used for an extended period, store it in a cool, dry location to prevent mold and rust. Do not store in direct sunlight or with naphtha or camphor moth balls.
- Keep the lens dry. Rusting of the internal mechanism can cause irreparable damage.
- Leaving the lens in extremely hot locations could damage or warp parts made from reinforced plastic.

## ■ ■ **Vibration Reduction (VR)**

AF-S DX NIKKOR 16–80mm f/2.8–4E ED VR lenses support vibration reduction (VR), which reduces blur caused by camera shake even when the camera is panned, allowing shutter speeds to be slowed by approximately 4.0 stops. This increases the range of shutter speeds available and permits hand-held, tripod-free photography in a wide range of situations. The stated value of 4.0 stops is based on measurements made in **NORMAL** mode according to Camera and Imaging Products Association (CIPA) standards; FX-format lenses are assessed using FX-format digital cameras, DX-format lenses using DX-format cameras, and zoom lenses at maximum zoom.

To use vibration reduction, slide the vibration reduction switch to **ON**. Vibration reduction is activated when the shutter-release button is pressed halfway, reducing the effects of camera shake on the image in the viewfinder and simplifying the process of framing the subject and focusing.

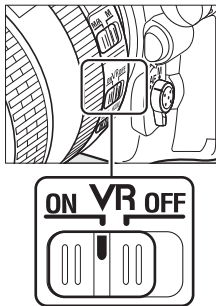

### ✔ **Vibration Reduction**

- When using vibration reduction, press the shutter-release button halfway and wait for the image in the viewfinder to stabilize before pressing the shutter-release button the rest of the way down.
- When vibration reduction is active, the image in the viewfinder may jiggle after the shutter is released. This does not indicate a malfunction.
- Do not turn the camera off or remove the lens while vibration reduction is in effect. If power to the lens is cut while vibration reduction is on, the lens may rattle when shaken. This is not a malfunction, and can be corrected by reattaching the lens and turning the camera on.
- If the camera is equipped with a built-in flash, vibration reduction will be disabled while the flash charges.
- **ON** is generally recommended when the camera is mounted on a monopod or a tripod with an unsecured head, although **OFF** may be preferred depending shooting conditions and the type of tripod.

### ✎ **The Vibration Reduction Mode Switch (AF-S DX NIKKOR 16–80mm f/2.8–4E ED VR Lenses)**

The vibration reduction mode switch is used to select the vibration reduction mode when vibration reduction is on.

- **Select NORMAL** to reduce the effects of vibration when photographing from a fixed position and in other situations with comparatively little camera motion.
- **Select ACTIVE** to reduce the effects of vibration when shooting from a moving vehicle, while walking, and in other situations with active camera motion.

Slide the vibration reduction mode switch to **NORMAL** for panning shots. When the camera is panned, vibration reduction applies only to motion that is not part of the pan (if the camera is panned horizontally, for example, vibration reduction will be applied only to vertical shake), making it much easier to pan the camera smoothly in a wide arc.

### Using Built-in Flash Units

If the camera is equipped with a built-in flash, be sure the subject is at a range of at least 0.6 m (2 ft) and remove lens hoods to prevent vignetting (shadows created where the end of the lens obscures the built-in flash).

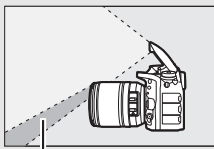

*Shadow*



*Vignetting*

Camera	Zoom position	Minimum distance without vignetting
D7200, D7100, D7000	18 mm	1.0 m/3 ft 4 in.
	24 mm, 35 mm, 50 mm, 80 mm	0.6 m/2 ft
D5500, D5300, D5200, D5100, D5000, D3300, D3200, D3100	24 mm	1.0 m/3 ft 4 in.
	35 mm, 50 mm, 80 mm	0.6 m/2 ft
D300 series	18 mm	1.5 m/5 ft
	24 mm, 35 mm, 50 mm, 80 mm	0.6 m/2 ft

### Supplied Accessories for AF-S DX NIKKOR 16–80mm f/2.8–4E ED VR Lenses

- 72 mm Snap-on Front Lens Cap LC-72
- Rear Lens Cap LF-4
- Bayonet Hood HB-75

Align the lens hood mounting mark (●) with the lens hood alignment mark (♣) as shown in Figure ① and then rotate the hood (②) until the ● mark is aligned with the lens hood lock mark (—○).

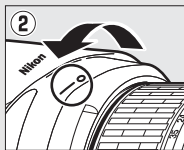
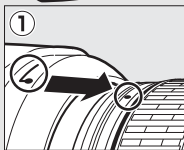
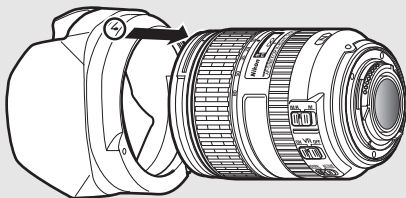

When attaching or removing the hood, hold it near the symbol on its base and avoid gripping it too tightly. Vignetting may occur if the hood is not correctly attached. The hood can be reversed and mounted on the lens when not in use.

To detach the lens hood, press the lens hood lock release button (①), rotate the hood in the direction shown by the arrow (②), and remove it as shown (③).

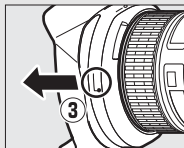
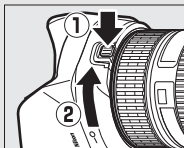

## Optional Accessories for AF-S DX NIKKOR 16–80mm f/2.8–4E ED VR Lenses

- 72 mm screw-on filters
- Lens Case CL-1218

## A Note on Wide- and Super Wide-Angle Lenses

Autofocus may not provide the desired results in situations like those shown below.

### 1 Objects in the background occupy more of the focus point than the main subject:

If the focus point contains both foreground and background objects, the camera may focus on the background and the subject may be out of focus.



**Example:** *A far-off portrait subject at some distance from the background*

### 2 The subject contains many fine details.

The camera may have difficulty focusing on subjects that lack contrast or appear smaller than objects in the background.



**Example:** *A field of flowers*

In these cases, use manual focus, or use focus lock to focus on another subject at the same distance and then recompose the photograph. For more information, see “Getting Good Results with Autofocus” (□ 113).

## Trademark Information

IOS is a trademark or registered trademark of Cisco Systems, Inc., in the United States and/or other countries and is used under license. Windows is either a registered trademark or a trademark of Microsoft Corporation in the United States and/or other countries. Mac, OS X, Apple®, App Store®, the Apple logos, iPhone®, iPad®, and iPod touch® are trademarks of Apple Inc. registered in the U.S. and/or other countries. Android, Google Play and the Google Play logo are trademarks of Google LLC. The Android robot is reproduced or modified from work created and shared by Google and used according to terms described in the Creative Commons 3.0 Attribution License. PictBridge is a trademark. XQD is a trademark of Sony Corporation. The SD, SDHC, and SDXC logos are trademarks of the SD-3C, LLC. HDMI, the HDMI logo and High-Definition Multimedia Interface are trademarks or registered trademarks of HDMI Licensing, LLC.

## **HDMI**

Wi-Fi and the Wi-Fi logo are trademarks or registered trademarks of the Wi-Fi Alliance. N-Mark is a trademark or registered trademark of NFC Forum, Inc., in the United States and/or other countries.

The Bluetooth® word mark and logos are registered trademarks owned by Bluetooth SIG, Inc. and any use of such marks by Nikon Corporation is under license.

All other trade names mentioned in this manual or the other documentation provided with your Nikon product are trademarks or registered trademarks of their respective holders.

Use of the Made for Apple badge means that an accessory has been designed to connect specifically to the Apple products identified in the badge, and has been certified by the developer to meet Apple performance standards. Apple is not responsible for the operation of this device or its compliance with safety and regulatory standards. Please note that the use of this accessory with an Apple product may affect wireless performance.

### **Supported Standards**

- **DCF Version 2.0:** The Design Rule for Camera File System (DCF) is a standard widely used in the digital camera industry to ensure compatibility among different makes of camera.
- **Exif version 2.3:** The camera supports Exif (Exchangeable Image File Format for Digital Still Cameras) version 2.3, a standard in which information stored with photographs is used for optimal color reproduction when the images are output on Exif-compliant printers.
- **PictBridge:** A standard developed through cooperation with the digital camera and printer industries, allowing photographs to be output directly to a printer without first transferring them to a computer.
- **HDMI:** High-Definition Multimedia Interface is a standard for multimedia interfaces used in consumer electronics and AV devices capable of transmitting audiovisual data and control signals to HDMI-compliant devices via a single cable connection.

### **Conformity Marking**

The standards with which the camera complies can be viewed using the **Conformity marking** option in the setup menu (📖 309).

### **FreeType License (FreeType2)**

Portions of this software are copyright © 2012 The FreeType Project (<http://www.freetype.org>). All rights reserved.

### **MIT License (HarfBuzz)**

Portions of this software are copyright © 2016 The HarfBuzz Project (<http://www.freedesktop.org/wiki/Software/HarfBuzz>). All rights reserved.



## Approved Memory Cards

### ■ ■ *XQD Memory Cards*

The camera can be used with XQD memory cards. Cards with write speeds of 45 MB/s (300×) or better are recommended for movie recording; slower speeds may interrupt recording or cause jerky, uneven playback. For information on compatibility and operation, contact the manufacturer.

## ■ ■ *SD Memory Cards*

The camera supports SD, SDHC, and SDXC memory cards, including SDHC and SDXC cards compliant with UHS-I and UHS-II. Cards rated UHS Speed Class 3 or better are recommended for movie recording; using slower cards may result in recording being interrupted. When choosing cards for use in card readers, be sure they are compatible with the device. Contact the manufacturer for information on features, operation, and limitations on use.



## Memory Card Capacity

The following table shows the approximate number of pictures that can be stored on a 64 GB Lexar Professional 2933× XQD 2.0 card at different image quality, image size, and image area settings (as of April 2016).

### ■ DX (24×16) Image Area

Image quality	Image size	File size <sup>1</sup>	No. of images <sup>1</sup>	Buffer capacity <sup>2</sup>
NEF (RAW), Lossless compressed, 12-bit	Large	20.1 MB	1700	200
	Medium	14.5 MB	2400	200
	Small	11.0 MB	3200	200
NEF (RAW), Lossless compressed, 14-bit	Large	25.0 MB	1300	200
NEF (RAW), Compressed, 12-bit	Large	17.2 MB	2400	200
NEF (RAW), Compressed, 14-bit	Large	21.3 MB	2000	200
NEF (RAW), Uncompressed, 12-bit	Large	33.1 MB	1700	200
NEF (RAW), Uncompressed, 14-bit	Large	43.1 MB	1300	79
TIFF (RGB)	Large	62.5 MB	975	48
	Medium	35.6 MB	1600	56
	Small	16.4 MB	3600	64
JPEG fine <sup>3</sup>	Large	10.4 MB	4400	200
	Medium	6.4 MB	7300	200
	Small	3.4 MB	13,700	200
JPEG normal <sup>3</sup>	Large	5.3 MB	8600	200
	Medium	3.3 MB	14,100	200
	Small	1.8 MB	25,900	200
JPEG basic <sup>3</sup>	Large	2.8 MB	16,600	200
	Medium	1.8 MB	26,600	200
	Small	1.0 MB	46,500	200

## ■ 1.3× (18×12) Image Area

Image quality	Image size	File size <sup>1</sup>	No. of images <sup>1</sup>	Buffer capacity <sup>2</sup>
NEF (RAW), Lossless compressed, 12-bit	Large	12.4 MB	2900	200
	Medium	9.1 MB	3900	200
	Small	7.0 MB	5100	200
NEF (RAW), Lossless compressed, 14-bit	Large	15.4 MB	2300	200
NEF (RAW), Compressed, 12-bit	Large	10.7 MB	3900	200
NEF (RAW), Compressed, 14-bit	Large	13.1 MB	3300	200
NEF (RAW), Uncompressed, 12-bit	Large	20.1 MB	2900	200
NEF (RAW), Uncompressed, 14-bit	Large	25.9 MB	2300	200
TIFF (RGB)	Large	37.2 MB	1600	135
	Medium	21.4 MB	2700	200
	Small	10.0 MB	5700	200
JPEG fine <sup>3</sup>	Large	6.5 MB	7000	200
	Medium	4.2 MB	11,100	200
	Small	2.4 MB	19,200	200
JPEG normal <sup>3</sup>	Large	3.4 MB	13,600	200
	Medium	2.2 MB	21,200	200
	Small	1.3 MB	35,700	200
JPEG basic <sup>3</sup>	Large	1.8 MB	25,600	200
	Medium	1.2 MB	39,200	200
	Small	0.8 MB	60,600	200

1 All figures are approximate. File size varies with scene recorded.

2 Maximum number of exposures that can be stored in memory buffer at ISO 100. Drops at image qualities marked with a star ("★") or if auto distortion control is on.

3 Figures assume size-priority JPEG compression. Selecting an image-quality option marked with a star ("★"; optimal compression) increases the file size of JPEG images; number of images and buffer capacity drop accordingly.

 **d2—Max. Continuous Release** (📖 297)

The maximum number of photographs that can be taken in a single burst can be set to any amount between 1 and 200.

## Battery Life

The movie footage or number of shots that can be recorded with fully-charged batteries varies with the condition of the battery, temperature, interval between shots, and the length of time menus are displayed. In the case of AA batteries, capacity also varies with make and storage conditions; some batteries can not be used. Sample figures for the camera and optional MB-D17 multi-power battery pack are given below.

- **Photographs, single-frame release mode (CIPA standard<sup>1</sup>)**
  - **One EN-EL15 battery<sup>2</sup> (camera):** Approximately 1240 shots
  - **One EN-EL15 battery<sup>2</sup> (MB-D17):** Approximately 1240 shots
  - **One EN-EL18a battery<sup>3</sup> (MB-D17):** Approximately 2510 shots
  - **Eight AA alkaline batteries (MB-D17):** Approximately 1140 shots
- **Photographs, continuous release mode (Nikon standard<sup>4</sup>)**
  - **One EN-EL15 battery<sup>2</sup> (camera):** Approximately 2740 shots
  - **One EN-EL15 battery<sup>2</sup> (MB-D17):** Approximately 2740 shots
  - **One EN-EL18a battery<sup>3</sup> (MB-D17):** Approximately 6570 shots
  - **Eight AA alkaline batteries (MB-D17):** Approximately 2620 shots
- **Movies<sup>5</sup>**
  - **One EN-EL15 battery<sup>2</sup> (camera):** Approximately 50 minutes of HD footage
  - **One EN-EL15 battery<sup>2</sup> (MB-D17):** Approximately 50 minutes of HD footage
  - **One EN-EL18a battery<sup>3</sup> (MB-D17):** Approximately 130 minutes of HD footage
  - **Eight AA alkaline batteries (MB-D17):** Approximately 60 minutes of HD footage

- 1 Measured at 23 °C/73.4 °F ( $\pm 2$  °C/3.6 °F) with an AF-S DX NIKKOR 16–80mm f/2.8–4E ED VR lens under the following test conditions: lens cycled from infinity to minimum range and one photograph taken at default settings once every 30 s. Live view not used.
- 2 EN-EL15b and EN-EL15a batteries can also be used in place of the EN-EL15.
- 3 Requires MH-26a or MH-26 battery charger and BL-5 battery-chamber cover (both available separately). EN-EL18c, EN-EL18b, and EN-EL18 batteries can be used in place of the EN-EL18a, but note that fewer pictures can be taken on a single charge with an EN-EL18 than with an EN-EL18c/EN-EL18b/EN-EL18a.
- 4 Measured at 23 °C/73.4 °F with an AF-S NIKKOR 70–200mm f/2.8G ED VR II lens under the following test conditions: vibration reduction off, image quality set to JPEG normal, image size set to **Large**, shutter speed  $\frac{1}{250}$  s, focus cycled from infinity to minimum range three times after shutter-release button has been pressed halfway for 3 s; six shots are then taken in succession and monitor turned on for 5 s and then turned off; cycle repeated once standby timer has expired.
- 5 Measured at 23 °C/73.4 °F ( $\pm 2$  °C/3.6 °F) with the camera at default settings and an AF-S DX NIKKOR 16–80mm f/2.8–4E ED VR lens under conditions specified by the Camera and Imaging Products Association (CIPA). Individual movies are composed of one or more files, each up to 4 GB in size, and can total up to 29 minutes 59 seconds in length; recording may end before these limits are reached if the camera temperature rises.

The following can reduce battery life:



















- Using the monitor
- Keeping the shutter-release button pressed halfway
- Repeated autofocus operations
- Taking NEF (RAW) or TIFF (RGB) photographs
- Slow shutter speeds
- Using camera Wi-Fi (wireless LAN) and Bluetooth features
- Using the camera with optional accessories connected
- Using VR (vibration reduction) mode with VR lenses
- Repeatedly zooming in and out with an AF-P lens.

To ensure that you get the most from rechargeable Nikon EN-EL15 batteries:

- Keep the battery contacts clean. Soiled contacts can reduce battery performance.
- Use batteries immediately after charging. Batteries will lose their charge if left unused.

# Index

## Symbols

<b>P</b> (Programmed auto) .....	130, 132
<b>S</b> (Shutter-priority auto) .....	130, 133
<b>A</b> (Aperture-priority auto).....	130, 134
<b>M</b> (Manual) .....	130, 135
<b>S</b> (Single frame) .....	116
<b>Cl</b> (Continuous low speed) ...	116, 297
<b>Ch</b> (Continuous high speed).....	116
<b>Q</b> (Quiet shutter-release).....	116
<b>Qc</b> (Quiet continuous shutter- release).....	116
 (Self-timer).....	117, 119, 296
<b>MUP</b> .....	117, 121
 (Single-point AF) .....	103
 (Dynamic-area AF) .....	103
 (3D-tracking).....	104
 (Group-area AF) .....	104
 (Auto-area AF) .....	104
 (Face-priority AF) .....	48
 (Wide-area AF).....	48
 (Normal-area AF) .....	48
 (Subject-tracking AF).....	48
 (Matrix) .....	128
 (Center-weighted).....	128
 (Spot).....	128
 * (Highlight-weighted) .....	128
 (Info) button.....	54, 69, 226
 (Live view) .....	43, 58, 174, 303
<b>?</b> (Help).....	31
 (Memory buffer) .....	118, 389
<b>i</b> button .....	50, 64, 225, 229, 260
 switch .....	6, 303
 (Focus indicator) .....	38, 111, 115
<b>PRE</b> (Preset manual) .....	160, 169

## Numerics

1.3x .....	70, 88, 97
------------	------------

12-bit .....	93
14-bit .....	93
3D color matrix metering III .....	128
3D-tracking .....	104, 105, 293
3D-tracking face-detection .....	293
3D-tracking watch area .....	293

## A

AC adapter .....	335
Accessories.....	335
Accessory shoe .....	196, 335
Active D-Lighting.....	50, 64, 155, 189, 286, 290
Add items (My Menu).....	315
ADL bracketing (Auto bracketing set).....	146, 155
Adobe RGB.....	286
Advanced Wireless Lighting.....	208
AE & flash (Auto bracketing set). 146, 147	
AE only (Auto bracketing set) .....	146, 147
AF .....	47–49, 97–113, 292–294
AF activation.....	293
AF area brackets.....	7, 29
AF fine-tune .....	305
AF-area mode .....	48, 103, 293
AF-C .....	101, 292
AF-F.....	47
<b>AF-ON</b> button.....	102, 293, 301
AF-S.....	47, 101, 292
After burst, show .....	282
After delete .....	282
Airplane mode .....	307
Angle of view .....	327
Aperture.....	134, 135, 140, 302
Aperture lock.....	140, 302
Aperture-priority auto .....	134



Aspect ratio .....	70, 318
Assign MB-D17 buttons .....	303
Assign remote (WR) Fn button ....	307
Attaching the lens.....	18
Audio .....	60
Audio output .....	372
Auto (White balance) .....	159, 161
Auto bracketing.....	146, 287, 301
Auto bracketing (mode M) .....	301
Auto bracketing set.....	146, 287
Auto distortion control .....	286
Auto external flash.....	199, 222
Auto FP high-speed sync.....	299
Auto image rotation.....	282
Auto ISO sensitivity control .	125, 289
Auto  ISO sensitivity control .....	300
Auto-area AF .....	104, 106
Autofocus... 47–49, 97–113, 292–294	
Autofocus mode .....	47, 101, 294
Autofocus mode restrictions .....	294

## B

Backlight.....	6
Backup (Secondary slot function) .	96
Battery .....	13, 15, 35, 309, 375
Battery info .....	309
Battery order .....	309
Battery pack .....	303, 309, 335
Beep .....	306
<b>BKT</b> button .... 147, 148, 151, 152, 155, 156, 195, 238, 301	
Black-and-white (Monochrome).	314
Blocked shot AF response.....	292
Bluetooth .....	xxii, 308
Body cap.....	335
Bracketing.....	146, 287, 301
Bracketing order .....	301
Bulb .....	137
Burst.....	282, 297
Button backlights.....	6, 298

## C

Camera Control Pro 2.....	336
Capture NX-D .....	v
Center-weighted metering .	128, 295
Charging the battery .....	13
Choose color temp. (White balance) 160, 166	
Choose image area... 70, 89, 284, 288	
Choose start/end point .....	82
Choose tab .....	315
CL mode shooting speed.....	297
Clean image sensor.....	305, 338
Cloudy (White balance) .....	160
CLS.....	328
Color space.....	286
Color temperature	159, 160, 162, 166
Compatible lenses.....	322
Compressed (NEF (RAW) compression).....	93
Conformity marking .....	309, 386
Connect to smart device .....	308
Connector for external microphone. 2	
Continuous high speed .....	116
Continuous low speed.....	116, 297
Continuous release mode .....	116
Continuous-servo AF.....	101, 292
Control panel.....	5
Copy image(s) .....	282
Copyright information.....	306
CPU contacts .....	325
CPU lens .....	19, 322, 325
Creative Lighting System.....	328
Crop .....	70, 318
Custom control assignment	301, 303
Custom Settings.....	292
Custom settings bank .....	292
Customize command dials.....	302
Cyanotype (Monochrome) .....	314

## D

Date and time.....	304
Date format.....	304
Daylight saving time.....	304
DCF.....	386
Default settings.....	230, 288, 310
Delete.....	42, 278
Delete all images.....	279
Delete current image.....	42, 278
Depth of field.....	131
Destination.....	288
Diopter.....	29, 335
Direct sunlight (White balance)..	160
Distance-priority manual ....	199, 223, 328
Distortion control.....	313
D-Lighting.....	313
DX format.....	70, 88
Dynamic-area AF.....	103, 106, 294

## E

Easy exposure compensation.....	295
Edit movie.....	82, 86, 314
Electronic front-curtain shutter ....	50, 298
Electronic rangefinder.....	115
Electronic VR.....	65, 291
EV steps for exposure cntrl.....	294
Exif.....	386
Exp./flash comp. step value.....	294
Exposure.....	128, 130, 141, 143, 294
Exposure bracketing ....	146, 147, 287, 301
Exposure comp. for flash.....	300
Exposure compensation.....	143, 295
Exposure delay mode.....	297
Exposure differential.....	193
Exposure indicator.....	136
Exposure lock.....	141
Exposure meters.....	39, 296

Exposure mode.....	130
Exposure preview.....	45
Exposure smoothing.....	76, 245
Extended photo menu banks.....	283
External GPS device options.....	254, 307
External microphone.....	65, 336
Eye-Fi upload.....	308

## F

Face detection.....	293, 295
Face-priority AF.....	48
File information.....	262
File naming.....	283, 288
File number sequence.....	298
Filter effects.....	184, 314
Fine-tune optimal exposure.....	295
Firmware version.....	310
Flash.....	196, 201, 203, 205, 208, 299, 328
Flash (White balance).....	160
Flash bracketing....	146, 147, 287, 301
Flash compensation.....	203
Flash control.....	198, 199, 214, 284
Flash info.....	222
Flash mode.....	201, 202
Flash only (Auto bracketing set) .	146
Flash shutter speed.....	300
Flash sync speed.....	299
Flash sync terminal.....	197
Flash-ready indicator..	196, 206, 333, 369
Flat (Set Picture Control).....	180
Flexible program.....	132
Flick.....	11, 306
Flicker reduction.....	234, 287, 290
Fluorescent (White balance).....	159
<b>Fn1</b> button.....	301, 303
<b>Fn2</b> button.....	275, 301, 303
f-number.....	134, 325
Focal length.....	252
Focal length scale.....	377

Focal plane mark ..... 115  
 Focus..... 47–49, 97–115, 292–294  
 Focus indicator..... 38, 111, 115  
 Focus lock ..... 111  
 Focus mode..... 47, 97, 114  
 Focus point 37, 48, 97, 103, 108, 293, 294  
 Focus point options ..... 294  
 Focus point wrap-around ..... 294  
 Focus tracking ..... 102, 292  
 Focus tracking with lock-on ..... 292  
 Focusing screen ..... 366  
 Focus-mode selector ..... 47, 97, 114  
 Focus-mode switch ..... 114  
 Format..... 304  
 Format memory card ..... 304  
 Frame interval (Slide show) ..... 282  
 Frame rate.....68  
 Frame size/frame rate..... 68, 288  
 Frequency response..... 64, 291  
 Front-curtain sync.....201  
 Full-frame playback.....255  
 Full-frame playback flicks..... 306  
 Full-time-servo AF.....47  
 FV lock ..... 205

## G

GPS ..... 253, 254, 268  
 GPS unit ..... 253, 336  
 Group flash ..... 214, 224  
 Group-area AF ..... 104, 106, 294

## H

H.264..... 371  
 HDMI.....306, 386  
 HDR (high dynamic range) ..... 191  
 Headphone volume .....65  
 Headphones.....65  
 Help .....31  
 Hi ..... 124  
 Hide image ..... 281

High definition.....386  
 High Dynamic Range (HDR) 191, 287  
 High ISO NR..... 286, 290  
 Highlight display..... 65  
 Highlights .....263  
 Highlight-weighted metering..... 128  
 Histogram ..... 54, 69, 264, 265

## I

Image area.....50, 64, 88, 89, 94, 284, 288  
 Image comment.....306  
 Image Dust Off ref photo .....306  
 Image overlay..... 314, 319  
 Image quality .....91, 284  
 Image review ..... 257, 282  
 Image size.....94, 284  
 Incandescent (White balance).....159  
 Index marking ..... 63  
 In-focus indicator ..... 38, 111, 115  
 Information display . 54, 69, 222, 226, 305  
 Interval timer shooting..... 243, 287  
 IPTC ..... 256, 260, 269, 306  
 ISO display.....297  
 ISO sensitivity..... 123, 125, 285, 289  
 ISO sensitivity settings..... 285, 289  
 ISO sensitivity step value .....294  
 i-TTL ..... 198, 199, 214, 222, 328

## J

JPEG ..... 91, 95, 313, 316  
 JPEG basic..... 91  
 JPEG fine ..... 91  
 JPEG normal..... 91

## L

L (large) ..... 72, 94  
 LAN.....335  
 Landscape (Set Picture Control) ..180  
 Language .....304

LCD illumination..... 6, 298  
LED lamp ..... 307  
Lens ..... 18, 19, 250, 305, 322, 377  
Lens focus ring ..... 49, 114, 377  
Lens mount ..... 3, 18, 115  
Lens mounting mark..... 2, 18  
Lens vibration reduction switch. 380  
Limit AF-area mode selection..... 293  
LINK mode ..... 211, 307  
Live view..... 43, 58  
Live view button options ..... 303  
Live view photography ..... 43–57  
Live view selector..... 43, 58  
Lo ..... 124  
Location data..... 253, 268  
Lock mirror up for cleaning. 305, 341  
Long exposure NR ..... 286  
Lossless compressed (NEF (RAW)  
compression) ..... 93

## M

**M** (Manual focus)..... 49, 114  
**M** (medium) ..... 72, 94  
Manage Picture Control..... 185, 285,  
290  
Manual (Exposure mode)..... 135  
Manual (Flash control)..200, 214, 223  
Manual focus ..... 49, 114  
Manual focus ring in AF mode .... 294  
Matrix metering ..... 128, 295  
Max. continuous release..... 297  
Maximum aperture.. 49, 53, 250, 325,  
333  
Maximum sensitivity..... 126, 289  
Memory buffer ..... 118  
Memory card..... 15, 96, 304, 387  
Memory card capacity..... 389  
Metering..... 128  
Microphone..... 2, 64, 65, 290, 336  
Microphone sensitivity ..... 64, 290  
Minimum aperture ..... 19, 131

Minimum shutter speed..... 126  
Mired ..... 165  
Mirror ..... 117, 121, 341  
Mirror up mode ..... 117, 121  
Modeling flash ..... 131, 300  
Monitor.. 9, 11, 43, 255, 296, 304, 305  
Monitor brightness ..... 50, 65, 304  
Monitor color balance..... 305  
Monitor off delay ..... 296  
Monochrome ..... 180, 314  
Mounting mark..... 18, 377  
Movie mode..... 58, 288, 303  
Movie quality..... 68, 289  
Movie shooting menu..... 288  
Movie-record button..... 60, 301  
Multi selector ..... 31, 301, 302  
Multi selector center button..... 301  
Multiple exposure ..... 236, 287  
Multi-power battery pack... 303, 309,  
335  
Multi-selector power aperture..... 65  
My Menu ..... 315

## N

NEF (RAW) ..... 91, 93, 95, 313, 316  
NEF (RAW) bit depth..... 93  
NEF (RAW) compression..... 93  
NEF (RAW) processing..... 313, 316  
NEF (RAW) recording..... 93, 285  
Network..... 308  
Neutral (Set Picture Control) ..... 180  
Non-CPU lens ..... 250, 323, 325  
Non-CPU lens data ..... 250, 251, 305  
Normal-area AF ..... 48  
Number of focus points..... 293

## O

Optical AWL ..... 208, 209  
Optical VR ..... 298  
Optical/radio AWL ..... 208, 213

Overflow (Secondary slot function) ..	96
Overlay mode .....	239
Overview data .....	270

## P

Pairing .....	211
Perspective control.....	314
Photo information .....	261, 281
Photo live view display WB.....	51
Photo shooting menu .....	283
Photo shooting menu bank .....	283
PictBridge.....	386
Picture Controls .....	180
PIN .....	211
Playback.....	40, 80, 255
Playback display options.....	281
Playback folder.....	281
Playback information.....	261, 281
Playback menu.....	281
Playback zoom .....	271
Portrait (Set Picture Control).....	180
Power aperture .....	65
Power connector .....	335
Predictive focus tracking.....	102
Preset manual (White balance) ..	160, 169
Press the shutter-release button	
halfway.....	38
Primary slot selection .....	96, 283
Programmed auto.....	132
Protecting photographs .....	273
<b>Pv</b> button .....	49, 131, 300, 301, 303

## Q

Quick wireless control .....	216, 224
Quiet continuous shutter-release .....	116
Quiet shutter-release .....	116

## R

Radio AWL .....	208, 210
Radio remote flash info .....	213
Rank items (My Menu) .....	315
Rating.....	274
RAW primary - JPEG secondary (Secondary slot function).....	96
Rear-curtain sync .....	201
Recent settings .....	315
Rechargeable Li-ion battery .....	iv, 13, 35, 375
Red-eye correction .....	313
Red-eye reduction .....	201
Release button to use dial .....	302
Release mode.....	116
Remote cord .....	73, 137, 336
Remote flash control .....	214
Remote flash photography .....	208
Remote repeating.....	219, 225
Remove items (My Menu).....	315
Removing the lens from the camera	
19	
Repeating flash.....	200, 223
Reset .....	230, 288, 310
Reset all settings .....	310
Reset movie shooting menu.....	288
Resize .....	313
Restoring default settings ..	230, 288, 310
Retouch menu .....	313
Reverse indicators .....	303
RGB.....	91, 264, 286
RGB Histogram.....	264
Rotate tall.....	282

## S

<b>S</b> (small).....	72, 94
Save selected frame .....	82, 86
Save/load settings.....	309
SD memory card.....	15, 96

Secondary slot function..... 96, 283  
 Select to send to smart device .... 282  
 Self-timer..... 117, 119, 296  
 Send to smart device (auto)..... 308  
 Sensitivity..... 123, 125, 285, 289  
 Set clock from satellite ..... 254  
 Set Picture Control..... 180, 285, 289  
 Setup menu..... 304  
 Shade (White balance) ..... 160  
 Shooting data..... 266  
 Shutter speed..... 133, 135, 140  
 Shutter speed lock..... 140, 302  
 Shutter-priority auto..... 133  
 Shutter-release button.. 38, 111, 141,  
 303  
 Shutter-release button AE-L..... 296  
 Side-by-side comparison ..... 314  
 Single frame..... 116  
 Single-point AF..... 103, 106  
 Single-servo AF..... 47, 101, 292  
 Size ..... 72, 94, 313, 318  
 Skylight..... 314  
 Slide show..... 282  
 Slot ..... 96, 256, 288  
 Slot empty release lock..... 309  
 Slot selection ..... 96, 257  
 Slow sync ..... 201  
 Slow-motion playback ..... 81  
 Smart device ..... 253, 282, 308  
 Smoothing..... 193  
 Speedlights ..... 196, 328  
 Split-screen display zoom..... 51, 52  
 Spot..... 128  
 Spot white balance..... 174  
 sRGB..... 286  
 Standard (Set Picture Control) .... 180  
 Standard i-TTL fill-flash for digital  
 SLR..... 198, 328  
 Standby timer..... 39, 254, 296  
 Storage folder..... 283  
 Store by orientation..... 293

Straighten..... 313  
 Sub-dial frame advance ..... 302  
 Subject motion..... 292  
 Sub-selector.. 109, 111, 141, 301, 303  
 Sync with smart device..... 304  
 Sync. release mode options..... 297  
 Synchronized release ..... 297

## T

---

Ten-pin remote terminal.. 2, 253, 336  
 Thumbnail ..... 255  
 TIFF (RGB) ..... 91, 95  
 Tilting monitor..... 9  
 Time..... 304  
 Time zone ..... 304  
 Time zone and date ..... 304  
 Time-lapse movie ..... 74, 291  
 Timer ..... 119, 243  
 Toning (Set Picture Control) ..... 184  
 Touch controls..... 11, 186, 258, 306  
 Touch screen ..... 11, 55, 186, 258  
 Touch shutter..... 55  
 Trim..... 313, 318  
 Two-button reset..... 230  
 Type D lens..... 322, 325  
 Type E lens ..... 322, 325  
 Type G lens..... 322, 325

## U

---

Uncompressed (NEF (RAW)  
 compression)..... 93  
 USB cable..... iv  
 UTC ..... 253, 268

## V

---

Vibration reduction 65, 291, 298, 380  
 Viewfinder ..... 7, 29, 365  
 Viewfinder eyepiece..... 29, 119  
 Viewfinder focus ..... 29, 335  
 Viewfinder grid display..... 298  
 ViewNX-i ..... v

Vignette control.....	286
Virtual horizon.....	54, 69, 305
Vivid (Set Picture Control) .....	180

## **W**

---

Warm filter .....	314
WB.....	151, 159, 285, 289
WB bracketing (Auto bracketing set) 146, 151	
White balance.....	151, 159, 285, 289
White balance bracketing ....	146, 151
Wide-area AF.....	48
Wi-Fi .....	xxii, 308
Wind noise reduction .....	64, 291
Wireless remote (WR) options .....	307
Wireless remote controller ...	73, 210, 307, 335
Wireless transmitter .....	335

## **X**

---

XQD card .....	15, 96, 387
----------------	-------------

No reproduction in any form of this manual, in whole or in part (except for brief quotation in critical articles or reviews), may be made without written authorization from NIKON CORPORATION.

**NIKON CORPORATION**

---

Printed in Thailand

© 2016 Nikon Corporation



6MB34011-06