

Nikon

DIGITAL CAMERA

D800
D800E

User's Manual

En

Thank you for your purchase of a Nikon single-lens reflex (SLR) digital camera. This manual is for both D800 and D800E digital cameras; save where otherwise noted, operations are identical. Illustrations show the D800. To get the most from your camera, please be sure to read all instructions thoroughly and keep them where they will be read by all those who use the product.

Symbols and Conventions

To make it easier to find the information you need, the following symbols and conventions are used:



This icon marks cautions; information that should be read before use to prevent damage to the camera.



This icon marks notes; information that should be read before using the camera.



This icon marks references to other pages in this manual.

Menu items, options, and messages displayed in the camera monitor are shown in **bold**.

Camera Settings

The explanations in this manual assume that default settings are used.

Help

Use the camera's on-board help feature for help on menu items and other topics. See page 18 for details.

Digitutor

Digitutor, a series of "watch and learn" manuals in movie form, is available from the following website:

http://www.nikondigitutor.com/index_eng.html













































For Your Safety

Before using the camera for the first time, read the safety instructions in "For Your Safety" (□ xiii–xv).

Where to Find It

Find what you're looking for from:

 The Table of Contents		iv
 The Q&A Index		ii
 The Quick Start Guide		xxi
 The Index		441
 Error Messages		417
 Troubleshooting		412

 Introduction		1
 Tutorial		15
 Live View Photography		45
 Movie Live View		59
 Image Recording Options		79
 Focus		91
 Release Mode		103
 ISO Sensitivity		109
 Exposure		115
 White Balance		145
 Image Enhancement		163
 Flash Photography		181
 Other Shooting Options		193
 More About Playback		219
 Connections		239
 Menu Guide		259
 Technical Notes		371

Q&A Index

Find what you're looking for using this "question and answer" index.



Taking Photographs



Shooting and Framing Options

Is there a quick and easy way to take snapshots?	xxi, 37
Can I frame photos in the monitor (📹 live view photography)?	45
Can I shoot movies (🎬 movie live view)?	59
Can I join photographs taken at regular intervals to create a time-lapse movie?	207



Release Modes

Can I take photos in quick succession?	103
How do I take pictures with the self-timer?	106



Focus

Can I choose how the camera focuses?	91
Can I choose the focus point?	96



Exposure

Can I make photos brighter or darker?	130
How do I preserve details in shadows and highlights?	174, 176



Using the Flash

How do I use the flash?	181
-------------------------	-----



Image Quality and Size

How do I take pictures for printing at large sizes?	84–87
How can I get more pictures on the memory card?	



Viewing Photographs



Playback

How do I view photographs on the camera?	219
How do I view more information about a photo?	222
Can I view photos in an automatic slide show?	267
Can I view photos on a TV?	256
Can I protect photos from accidental deletion?	233



Deletion

How do I delete unwanted photos?	234
----------------------------------	-----



Retouching Photographs



How do I create retouched copies of photos?	341
How do I make JPEG copies of RAW (NEF) photos?	353
Can I create a copy of a photo that looks like a painting?	359
Can I trim movie footage on the camera or save movie stills?	74



Menus and Settings



How do I use the menus?	15
How do I keep the displays from turning off?	291, 292
How do I focus the viewfinder?	35
How do I set the camera clock?	27, 329
How do I format memory cards?	32
How do I restore default settings?	193, 270, 280
How do I get help for a menu or message?	18



Connections



How do I copy photos to a computer?	239
How do I print photos?	247
Can I print the date of recording on my photos?	250



Maintenance and Optional Accessories



What memory cards can I use?	434
What lenses can I use?	371
What optional flash units (Speedlights) can I use?	380
What other accessories are available for my camera?	387, 389
What software is available for my camera?	
How do I clean the camera?	393
Where should I take my camera for servicing and repairs?	400

Table of Contents

Q&A Index	ii
For Your Safety	xiii
Notices.....	xvi
Quick Start Guide.....	xxi

Introduction **1**

Package Contents.....	1
Getting to Know the Camera.....	2
Camera Body	2
The Control Panel.....	6
The Viewfinder Display.....	8
The Information Display.....	10
The BM-12 Monitor Cover	14

Tutorial **15**

Camera Menus.....	15
Using Camera Menus	16
Help	18
First Steps	19
Charge the Battery	19
Insert the Battery	21
Attach a Lens.....	24
Basic Setup.....	26
Insert a Memory Card.....	29
Format the Memory Card	32
Adjust Viewfinder Focus	35

Basic Photography and Playback	37
Turn the Camera On.....	37
Ready the Camera.....	39
Focus and Shoot.....	40
Viewing Photographs.....	43
Deleting Unwanted Photographs.....	44
Live View Photography	45
<hr/>	
Focusing in Live View	48
The Live View Display: Live View Photography	51
The Information Display: Live View Photography.....	54
Manual Focus	55
Movie Live View	59
<hr/>	
Indices.....	63
The Live View Display: Movie Live View	64
The Information Display: Movie Live View.....	66
Image Area	67
Movie Settings	70
Viewing Movies	72
Editing Movies	74
Trimming Movies	74
Saving Selected Frames.....	77
Image Recording Options	79
<hr/>	
Image Area.....	79
Image Quality.....	84
Image Size	87
Using Two Memory Cards	89

Focus 91

Autofocus	91
Autofocus Mode	91
AF-Area Mode	93
Focus Point Selection	96
Focus Lock	98
Manual Focus	101

Release Mode 103

Choosing a Release Mode	103
Power Source and Frame Rate	104
Self-Timer Mode	106
Mirror up Mode	108

ISO Sensitivity 109

Manual Adjustment	109
Auto ISO Sensitivity Control	111

Exposure 115

Metering	115
Exposure Mode	117
<i>P</i> : Programmed Auto	118
<i>S</i> : Shutter-Priority Auto	119
<i>A</i> : Aperture-Priority Auto	120
<i>M</i> : Manual	122
Long Time-Exposures	124
Shutter-Speed and Aperture Lock	126
Autoexposure (AE) Lock	128
Exposure Compensation	130
Bracketing	132

White Balance **145**

White Balance Options	145
Fine-Tuning White Balance	148
Choosing a Color Temperature	152
Preset Manual	154

Image Enhancement **163**

Picture Controls.....	163
Selecting a Picture Control	163
Modifying Existing Picture Controls.....	165
Creating Custom Picture Controls	169
Sharing Custom Picture Controls.....	172
Preserving Detail in Highlights and Shadows	174
Active D-Lighting	174
High Dynamic Range (HDR)	176

Flash Photography **181**

Using the Built-in Flash.....	181
Flash Modes	183
Flash Compensation.....	188
FV Lock	190

Other Shooting Options **193**

Two-Button Reset: Restoring Default Settings	193
Multiple Exposure	195
Interval Timer Photography	201
Time-Lapse Photography	207
Non-CPU Lenses.....	212
Using a GPS Unit	215

More About Playback **219**



Viewing Images	219
Full-Frame Playback	219
Thumbnail Playback	219
Playback Controls	220
Photo Information	222
Taking a Closer Look: Playback Zoom	231
Protecting Photographs from Deletion	233
Deleting Photographs	234
Full-Frame and Thumbnail Playback	234
The Playback Menu	236


Connections **239**

Connecting to a Computer	239
Before Connecting the Camera	239
Direct USB Connection	243
Ethernet and Wireless Networks	245
Printing Photographs	247
Connecting the Printer	248
Printing Pictures One at a Time	249
Printing Multiple Pictures	251
Creating a DPOF Print Order: Print Set	254
Viewing Photographs on TV	256
HDMI Options	257



Menu Guide **259**

▶ The Playback Menu: Managing Images	259
Playback Folder	260
Hide Image	260
Playback Display Options	261
Copy Image(s)	262
Image Review	265
After Delete	266

Rotate Tall	266
Slide Show.....	267
 The Shooting Menu: Shooting Options	268
Shooting Menu Bank.....	269
Extended Menu Banks	270
Storage Folder	271
File Naming.....	273
Color Space.....	274
Vignette Control	275
Auto Distortion Control	276
Long Exposure NR (Long Exposure Noise Reduction)	277
High ISO NR	277
 Custom Settings: Fine-Tuning Camera Settings	278
Custom Settings Bank.....	280
a: Autofocus	281
a1: AF-C Priority Selection	281
a2: AF-S Priority Selection	282
a3: Focus Tracking with Lock-On	283
a4: AF Activation	283
a5: AF point Illumination	284
a6: Focus Point Wrap-Around	284
a7: Number of Focus Points.....	285
a8: Built-in AF-assist Illuminator.....	286
b: Metering/Exposure.....	287
b1: ISO Sensitivity Step Value	287
b2: EV Steps for Exposure Cntrl	287
b3: Exp./Flash Comp. Step Value	287
b4: Easy Exposure Compensation	288
b5: Center-Weighted Area	289
b6: Fine-Tune Optimal Exposure	290
c: Timers/AE Lock.....	290
c1: Shutter-Release Button AE-L	290
c2: Auto Meter-off Delay	291
c3: Self-Timer.....	291
c4: Monitor off Delay.....	292

d: Shooting/Display	292
d1: Beep	292
d2: CL Mode Shooting Speed	293
d3: Max. Continuous Release	293
d4: Exposure Delay Mode	293
d5: File Number Sequence	294
d6: Viewfinder Grid Display	295
d7: ISO Display and Adjustment	295
d8: Screen Tips	295
d9: Information Display	296
d10: LCD Illumination	296
d11: MB-D12 Battery Type	297
d12: Battery Order	298
e: Bracketing/Flash	299
e1: Flash Sync Speed	299
e2: Flash Shutter Speed	300
e3: Flash Cntrl for Built-in Flash	301
e4: Modeling Flash	307
e5: Auto Bracketing Set	307
e6: Auto Bracketing (Mode M)	308
e7: Bracketing Order	308
f: Controls	309
f1:  Switch	309
f2: Multi Selector Center Button	309
f3: Multi Selector	310
f4: Assign Fn Button	311
f5: Assign Preview Button	315
f6: Assign AE-L/AF-L button	315
f7: Shutter Spd & Aperture Lock	316
f8: Assign BKT Button	316
f9: Customize Command Dials	317
f10: Release Button to Use Dial	318
f11: Slot Empty Release Lock	319
f12: Reverse Indicators	319
f13: Assign MB-D12 AF-ON	320

g: Movie	321
g1: Assign Fn Button	321
g2: Assign Preview Button	322
g3: Assign AE-L/AF-L button	323
g4: Assign Shutter Button	324
Y The Setup Menu: Camera Setup.....	325
Format Memory Card	326
Monitor Brightness	326
Image Dust Off Ref Photo	327
Flicker Reduction	329
Time Zone and Date	329
Language.....	330
Auto Image Rotation	331
Battery Info	332
Image Comment.....	333
Copyright Information.....	334
Save/Load Settings	335
Virtual Horizon.....	337
AF Fine-Tune	338
Eye-Fi Upload.....	339
Firmware Version.....	340
✓ The Retouch Menu: Creating Retouched Copies	341
D-Lighting	344
Red-Eye Correction	345
Trim.....	346
Monochrome	347
Filter Effects	348
Color Balance	349
Image Overlay.....	350
NEF (RAW) Processing.....	353
Resize	355
Quick Retouch	357
Straighten.....	357
Distortion Control	358
Fisheye	358
Color Outline.....	359
Color Sketch	359
Perspective Control	360

Miniature Effect	361
Selective Color	362
Side-by-Side Comparison	364
 My Menu/  Recent Settings	366

Technical Notes

371

Compatible Lenses.....	371
Optional Flash Units (Speedlights).....	380
The Nikon Creative Lighting System (CLS).....	381
Other Accessories.....	387
Attaching a Power Connector and AC Adapter.....	391
Caring for the Camera.....	393
Storage.....	393
Cleaning.....	393
The Low-Pass Filter	394
“Clean Now”	394
“Clean at Startup/Shutdown”	396
Manual Cleaning	397
Caring for the Camera and Battery: Cautions.....	401
Defaults	405
Exposure Program.....	411
Troubleshooting	412
Error Messages.....	417
Specifications	423
Approved Memory Cards	434
Memory Card Capacity	436
Battery Life	439
Index.....	441

For Your Safety

To prevent damage to your Nikon product or injury to yourself or to others, read the following safety precautions in their entirety before using this equipment. Keep these safety instructions where all those who use the product will read them.

The consequences that could result from failure to observe the precautions listed in this section are indicated by the following symbol:



This icon marks warnings. To prevent possible injury, read all warnings before using this Nikon product.

■ WARNINGS

- ⚠ Keep the sun out of the frame**
Keep the sun well out of the frame when shooting backlit subjects. Sunlight focused into the camera when the sun is in or close to the frame could cause a fire.
- ⚠ Do not look at the sun through the viewfinder**
Viewing the sun or other strong light source through the viewfinder could cause permanent visual impairment.
- ⚠ Using the viewfinder diopter adjustment control**
When operating the viewfinder diopter adjustment control with your eye to the viewfinder, care should be taken not to put your finger in your eye accidentally.
- ⚠ Turn off immediately in the event of malfunction**
Should you notice smoke or an unusual smell coming from the equipment or AC adapter (available separately), unplug the AC adapter and remove the battery immediately, taking care to avoid burns. Continued operation could result in injury. After removing the battery, take the equipment to a Nikon-authorized service center for inspection.
- ⚠ Do not disassemble**
Touching the product's internal parts could result in injury. In the event of malfunction, the product should be repaired only by a qualified technician. Should the product break open as the result of a fall or other accident, remove the battery and/or AC adapter and then take the product to a Nikon-authorized service center for inspection.

⚠ Do not use in the presence of flammable gas

Do not use electronic equipment in the presence of flammable gas, as this could result in explosion or fire.

⚠ Keep out of reach of children

Failure to observe this precaution could result in injury. In addition, note that small parts constitute a choking hazard. Should a child swallow any part of this equipment, consult a physician immediately.

⚠ Do not place the strap around the neck of an infant or child

Placing the camera strap around the neck of an infant or child could result in strangulation.

⚠ Do not remain in contact with the camera, battery, or charger for extended periods while the devices are on or in use

Parts of the device become hot. Leaving the device in direct contact with the skin for extended periods may result in low-temperature burns.

⚠ Observe proper precautions when handling batteries

Batteries may leak or explode if improperly handled. Observe the following precautions when handling batteries for use in this product:

- Use only batteries approved for use in this equipment.
- Do not short or disassemble the battery.

- Be sure the product is off before replacing the battery. If you are using an AC adapter, be sure it is unplugged.
- Do not attempt to insert the battery upside down or backwards.
- Do not expose the battery to flame or to excessive heat.
- Do not immerse in or expose to water.
- Replace the terminal cover when transporting the battery. Do not transport or store the battery with metal objects such as necklaces or hairpins.
- Batteries are prone to leakage when fully discharged. To avoid damage to the product, be sure to remove the battery when no charge remains.
- When the battery is not in use, attach the terminal cover and store in a cool, dry place.
- The battery may be hot immediately after use or when the product has been used on battery power for an extended period. Before removing the battery turn the camera off and allow the battery to cool.
- Discontinue use immediately should you notice any changes in the battery, such as discoloration or deformation.

⚠ Observe proper precautions when handling the charger

- Keep dry. Failure to observe this precaution could result in fire or electric shock.
- Dust on or near the metal parts of the plug should be removed with a dry cloth. Continued use could result in fire.
- Do not handle the power cable or go near the charger during thunderstorms. Failure to observe this precaution could result in electric shock.
- Do not damage, modify, or forcibly tug or bend the power cable. Do not place it under heavy objects or expose it to heat or flame. Should the insulation be damaged and the wires become exposed, take the power cable to a Nikon-authorized service representative for inspection. Failure to observe this precaution could result in fire or electric shock.
- Do not handle the plug or charger with wet hands. Failure to observe this precaution could result in electric shock.
- Do not use with travel converters or adapters designed to convert from one voltage to another or with DC-to-AC inverters. Failure to observe this precaution could damage the product or cause overheating or fire.

⚠ Use appropriate cables

When connecting cables to the input and output jacks, use only the cables provided or sold by Nikon for the purpose to maintain compliance with product regulations.

⚠ CD-ROMs

CD-ROMs containing software or manuals should not be played back on audio CD equipment. Playing CD-ROMs on an audio CD player could cause hearing loss or damage the equipment.

⚠ Do not aim a flash at the operator of a motor vehicle

Failure to observe this precaution could result in accidents.

⚠ Observe caution when using the flash

- Using the camera with the flash in close contact with the skin or other objects could cause burns.
- Using the flash close to the subject's eyes could cause temporary visual impairment. Particular care should be observed when photographing infants, when the flash should be no less than one meter (39 in.) from the subject.

⚠ Avoid contact with liquid crystal

Should the monitor break, care should be taken to avoid injury due to broken glass and to prevent the liquid crystal from the monitor touching the skin or entering the eyes or mouth.

Notices

- No part of the manuals included with this product may be reproduced, transmitted, transcribed, stored in a retrieval system, or translated into any language in any form, by any means, without Nikon's prior written permission.
- Nikon reserves the right to change the specifications of the hardware and software described in these manuals at any time and without prior notice.
- Nikon will not be held liable for any damages resulting from the use of this product.
- While every effort has been made to ensure that the information in these manuals is accurate and complete, we would appreciate it were you to bring any errors or omissions to the attention of the Nikon representative in your area (address provided separately).

Notices for Customers in Canada

CAUTION

This Class B digital apparatus complies with Canadian ICES-003.

ATTENTION

Cet appareil numérique de la classe B est conforme à la norme NMB-003 du Canada.

Notices for Customers in Europe

CAUTION

RISK OF EXPLOSION IF BATTERY IS REPLACED BY AN INCORRECT TYPE. DISPOSE OF USED BATTERIES ACCORDING TO THE INSTRUCTIONS.

This symbol indicates that this product is to be collected separately.

The following apply only to users in European countries:

- This product is designated for separate collection at an appropriate collection point. Do not dispose of as household waste.
- For more information, contact the retailer or the local authorities in charge of waste management.



This symbol on the battery indicates that the battery is to be collected separately.



The following apply only to users in European countries:

- All batteries, whether marked with this symbol or not, are designated for separate collection at an appropriate collection point. Do not dispose of as household waste.
- For more information, contact the retailer or the local authorities in charge of waste management.

Notices for Customers in the U.S.A.

Power Cable

At voltages over AC 125 V (U.S.A. only): The power cable must be rated for the voltage in use, be at least AWG no. 18 gauge, and have SVG insulation or better with a NEMA 6P-15 plug rated for AC 250 V 15 A.

Federal Communications Commission (FCC) Radio Frequency Interference Statement

This equipment has been tested and found to comply with the limits for a Class B digital device, pursuant to Part 15 of the FCC rules. These limits are designed to provide reasonable protection against harmful interference in a residential installation. This equipment generates, uses, and can radiate radio frequency energy and, if not installed and used in accordance with the instructions, may cause harmful interference to radio communications. However, there is no guarantee that interference will not occur in a particular installation. If this equipment does cause harmful interference to radio or television reception, which can be determined by turning the equipment off and on, the user is encouraged to try to correct the interference by one or more of the following measures:

- Reorient or relocate the receiving antenna.
- Increase the separation between the equipment and receiver.
- Connect the equipment into an outlet on a circuit different from that to which the receiver is connected.
- Consult the dealer or an experienced radio/television technician for help.



CAUTIONS

Modifications

The FCC requires the user be notified that any changes or modifications made to this device that are not expressly approved by Nikon Corporation may void the user's authority to operate the equipment.

Interface Cables

Use the interface cables sold or provided by Nikon for your equipment. Using other interface cables may exceed the limits of Class B Part 15 of the FCC rules.

Notice for Customers in the State of California

WARNING: Handling the cord on this product may expose you to lead, a chemical known to the State of California to cause birth defects or other reproductive harm. *Wash hands after handling.*

Nikon Inc., 1300 Walt Whitman Road,
Melville, New York 11747-3064, U.S.A.
Tel.: 631-547-4200

Disposing of Data Storage Devices

Please note that deleting images or formatting memory cards or other data storage devices does not completely erase the original image data. Deleted files can sometimes be recovered from discarded storage devices using commercially available software, potentially resulting in the malicious use of personal image data. Ensuring the privacy of such data is the user's responsibility.

Before discarding a data storage device or transferring ownership to another person, erase all data using commercial deletion software, or format the device and then completely refill it with images containing no private information (for example, pictures of empty sky). Be sure to also replace any pictures selected for preset manual (□ 158). Care should be taken to avoid injury when physically destroying data storage devices.

Notice Concerning Prohibition of Copying or Reproduction

Note that simply being in possession of material that has been digitally copied or reproduced by means of a scanner, digital camera, or other device may be punishable by law.

• Items prohibited by law from being copied or reproduced

Do not copy or reproduce paper money, coins, securities, government bonds, or local government bonds, even if such copies or reproductions are stamped "Sample."

The copying or reproduction of paper money, coins, or securities which are circulated in a foreign country is prohibited.

Unless the prior permission of the government has been obtained, the copying or reproduction of unused postage stamps or post cards issued by the government is prohibited.

The copying or reproduction of stamps issued by the government and of certified documents stipulated by law is prohibited.

• Cautions on certain copies and reproductions

The government has issued cautions on copies or reproductions of securities issued by private companies (shares, bills, checks, gift certificates, etc.), commuter passes, or coupon tickets, except when a minimum of necessary copies are to be provided for business use by a company. Also, do not copy or reproduce passports issued by the government, licenses issued by public agencies and private groups, ID cards, and tickets, such as passes and meal coupons.

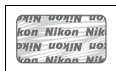
• Comply with copyright notices

The copying or reproduction of copyrighted creative works such as books, music, paintings, woodcuts, prints, maps, drawings, movies, and photographs is governed by national and international copyright laws. Do not use this product for the purpose of making illegal copies or to infringe copyright laws.

Use Only Nikon Brand Electronic Accessories

Nikon cameras are designed to the highest standards and include complex electronic circuitry. Only Nikon brand electronic accessories (including chargers, batteries, AC adapters, and flash accessories) certified by Nikon specifically for use with this Nikon digital camera are engineered and proven to operate within the operational and safety requirements of this electronic circuitry.

The use of non-Nikon electronic accessories could damage the camera and may void your Nikon warranty. The use of third-party rechargeable Li-ion batteries not bearing the Nikon holographic seal shown at right could interfere with normal operation of the camera or result in the batteries overheating, igniting, rupturing, or leaking.



For more information about Nikon brand accessories, contact a local authorized Nikon dealer.

AVC Patent Portfolio License

THIS PRODUCT IS LICENSED UNDER THE AVC PATENT PORTFOLIO LICENSE FOR THE PERSONAL AND NON-COMMERCIAL USE OF A CONSUMER TO (i) ENCODE VIDEO IN COMPLIANCE WITH THE AVC STANDARD ("AVC VIDEO") AND/OR (ii) DECODE AVC VIDEO THAT WAS ENCODED BY A CONSUMER ENGAGED IN A PERSONAL AND NON-COMMERCIAL ACTIVITY AND/OR WAS OBTAINED FROM A VIDEO PROVIDER LICENSED TO PROVIDE AVC VIDEO. NO LICENSE IS GRANTED OR SHALL BE IMPLIED FOR ANY OTHER USE. ADDITIONAL INFORMATION MAY BE OBTAINED FROM MPEG LA, L.L.C. SEE

<http://www.mpegla.com>

✔ Use Only Nikon Brand Accessories

Only Nikon brand accessories certified by Nikon specifically for use with your Nikon digital camera are engineered and proven to operate within its operational and safety requirements. THE USE OF NON-NIKON ACCESSORIES COULD DAMAGE YOUR CAMERA AND MAY VOID YOUR NIKON WARRANTY.

✔ Servicing the Camera and Accessories

The camera is a precision device and requires regular servicing. Nikon recommends that the camera be inspected by the original retailer or a Nikon-authorized service representative once every one to two years, and that it be serviced once every three to five years (note that fees apply to these services). Frequent inspection and servicing are particularly recommended if the camera is used professionally. Any accessories regularly used with the camera, such as lenses or optional flash units, should be included when the camera is inspected or serviced.

Before Taking Important Pictures

Before taking pictures on important occasions (such as at weddings or before taking the camera on a trip), take a test shot to ensure that the camera is functioning normally. Nikon will not be held liable for damages or lost profits that may result from product malfunction.

Life-Long Learning

As part of Nikon's "Life-Long Learning" commitment to ongoing product support and education, continually-updated information is available on-line at the following sites:

- **For users in the U.S.A.:** <http://www.nikonusa.com/>
- **For users in Europe and Africa:** <http://www.europe-nikon.com/support/>
- **For users in Asia, Oceania, and the Middle East:** <http://www.nikon-asia.com/>

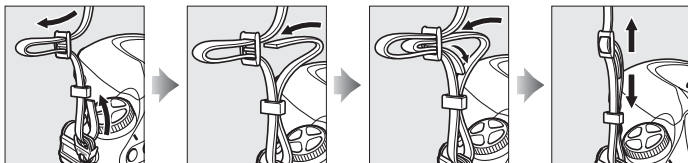
Visit these sites to keep up-to-date with the latest product information, tips, answers to frequently-asked questions (FAQs), and general advice on digital imaging and photography. Additional information may be available from the Nikon representative in your area. See the following URL for contact information: <http://imaging.nikon.com/>

Quick Start Guide

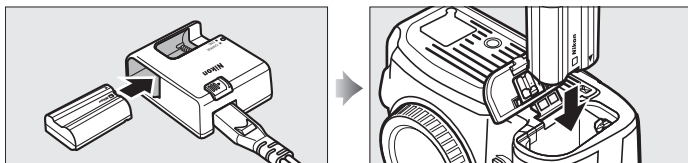
Follow these steps for a quick start with the D800.

1 Attach the camera strap.

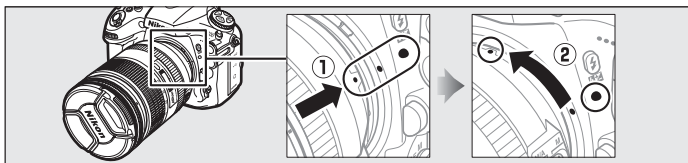
Attach the strap securely to the camera eyelets.



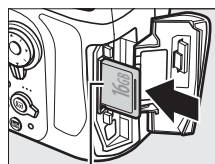
2 Charge (19) and insert the battery (21).



3 Attach a lens (24).



4 Insert a memory card (29).

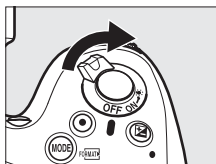


Front

5 Turn the camera on (📖 37).

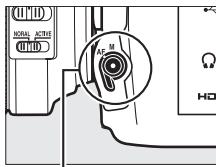
See Also

For information on choosing a language and setting the time and date, see page 26. See page 35 for information on adjusting viewfinder focus.



6 Select autofocus (📖 91).

Rotate the focus-mode selector to **AF** (autofocus).



Focus-mode selector

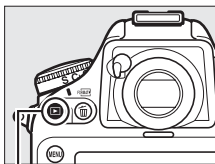
7 Focus and shoot (📖 40, 41).

Press the shutter-release button halfway to focus, then press the shutter-release button the rest of the way down to take the photograph.



Focus indicator

8 View the photograph (📖 43).



 button



Introduction

Package Contents

Be sure all items listed here were included with your camera.
Memory cards are sold separately.



- BF-1B body cap (☐ 24, 389)

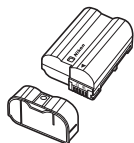


- BS-1 accessory shoe cover (☐ 380)

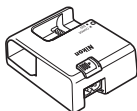


- BM-12 monitor cover (☐ 14)

- D800/D800E digital camera (☐ 2)



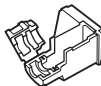
- EN-EL15 rechargeable Li-ion battery with terminal cover (☐ 19, 21)



- MH-25 battery charger (AC wall adapter supplied only in countries or regions where required. Shape of power cable depends on country of sale; ☐ 19)



- UC-E14 USB cable (☐ 243, 248)



- USB cable clip (☐ 243)

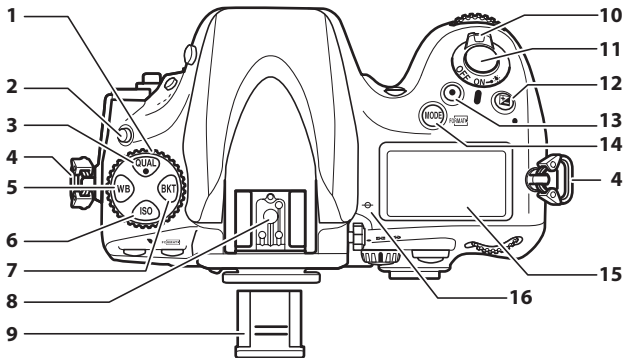
- Strap (AN-DC6 for D800, AN-DC6E for D800E; ☐ xxi)
- Warranty
- *User's Manual* (this guide)

- *Quick Guide*
- ViewNX 2 installer CD (☐ 239)

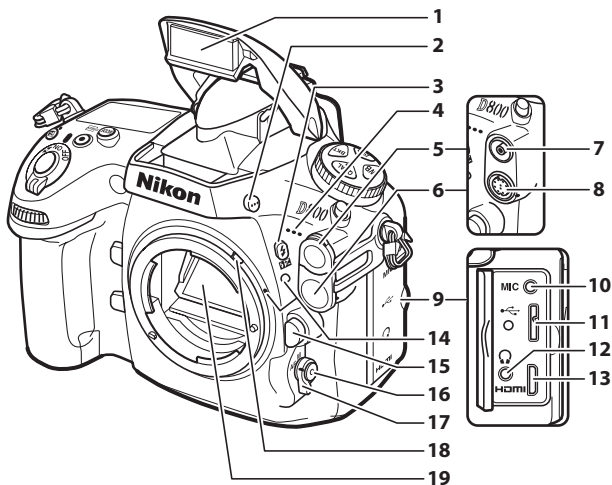
Getting to Know the Camera

Take a few moments to familiarize yourself with camera controls and displays. You may find it helpful to bookmark this section and refer to it as you read through the rest of the manual.

Camera Body



1	Release mode dial	103	8	Accessory shoe (for optional flash unit)	380
2	Release mode dial lock release	103	9	Accessory shoe cover	380
3	QUAL button Image quality	84	10	Power switch	26
	Image size	87	11	Shutter-release button.....	40, 41
	Two-button reset.....	193	12	Z button Exposure compensation	130
4	Eyelet for camera strap	xxi		Two-button reset.....	193
5	WB button White balance	146, 151, 153	13	Movie-record button	61
6	ISO button ISO sensitivity	109	14	MODE/FORMAT button Exposure mode	117
	Auto ISO sensitivity control ...	111		Formatting memory cards	32
7	BKT button Bracketing	133, 137, 141, 316	15	Control panel.....	6
			16	Focal plane mark (☉).....	102

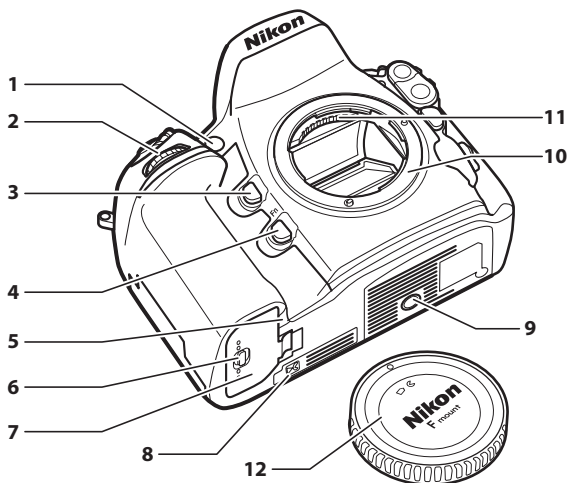


1 Built-in flash.....	181	10 Connector for external	microphone.....	65
2 Flash pop-up button.....	181	11 USB connector.....	243, 248	
3 button		12 Headphone connector	65	
Flash mode	182	13 HDMI mini-pin connector.....	256	
Flash compensation	188	14 Mounting index	25	
4 Built-in microphone.....	65, 70	15 Lens release button.....	25	
5 Flash sync terminal cover	380	16 AF-mode button	48, 50, 92, 94	
6 Ten-pin remote terminal		17 Focus-mode selector	48, 91, 101	
cover	215, 390	18 Meter coupling lever.....	426	
7 Flash sync terminal.....	380	19 Mirror	108, 398	
8 Ten-pin remote terminal... ..	215, 390			
9 Connector cover.....	243, 248, 256			

The Microphone and Speaker



Do not place the microphone or speaker in close proximity to magnetic devices. Failure to observe this precaution could affect the data recorded on the magnetic devices.

Camera Body (Continued)

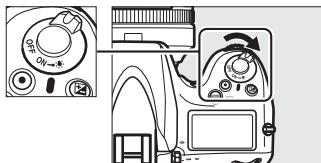


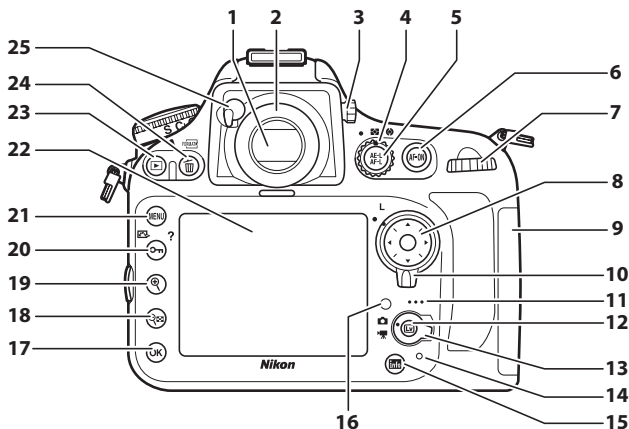
<p>1 AF-assist illuminator286 Self-timer lamp 107 Red-eye reduction lamp 183</p>	<p>6 Battery-chamber cover latch 21 7 Battery-chamber cover 21 8 Contact cover for optional MB-D12 battery pack387</p>
<p>2 Sub-command dial317</p>	<p>9 Tripod socket</p>
<p>3 Depth-of-field preview button 63, 117, 315, 322</p>	<p>10 Lens mount 25, 102</p>
<p>4 Fn (function) button 83, 191, 311, 321</p>	<p>11 CPU contacts</p>
<p>5 Power connector cover391</p>	<p>12 Body cap 24, 389</p>

LCD Illuminators

Rotating the power switch toward  activates the exposure meters and control panel backlight (LCD illuminator), allowing the display to be read in the dark. After the power switch is released, the illuminators will remain lit for six seconds while the exposure meters are active or until the shutter is released or the power switch is rotated toward  again.

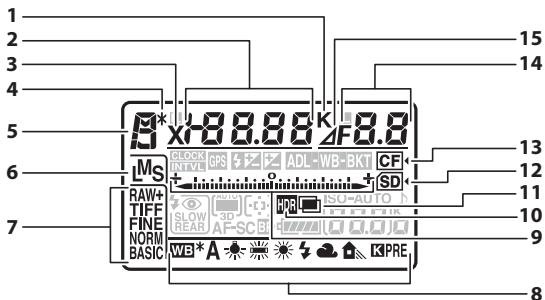
Power switch



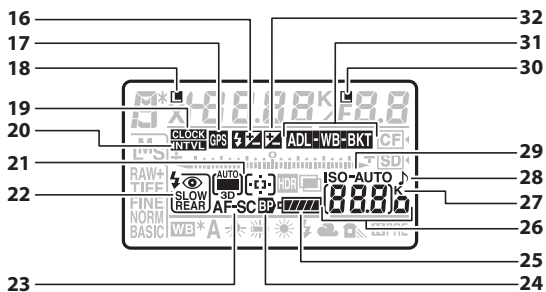


1	Viewfinder	35	17	OK (OK) button	18
2	Viewfinder eyepiece	36, 106	18	☒ button	
3	Diopter adjustment control	35		Thumbnail	219
4	Metering selector	116		Playback zoom out	231
5	AE/AF lock	98, 128, 315, 323	19	⊕ button	
6	AF-ON button			Playback zoom in	231
	AF-ON	46, 60, 92	20	⊖/L/3/? button	
7	Main command dial	317		Protect	233
8	Multi selector	16, 42, 221		Picture Control	163
9	Memory card slot cover	29, 31		Help	18
10	Focus selector lock	96	21	MENU button	
11	Speaker	73		Menu	15, 259
12	Lv button		22	Monitor	43, 45, 53, 219, 326
	Live view	45, 59	23	▶ button	
13	Live view selector	45, 59		Playback	43, 219
14	Memory card access lamp	30, 31	24	☒/FORMAT button	
15	Info (info) button	10, 13		Delete	44, 234
16	Ambient brightness sensor for automatic monitor brightness control	53, 326		Formatting memory cards	32
			25	Eye-piece shutter lever	36, 106

The Control Panel

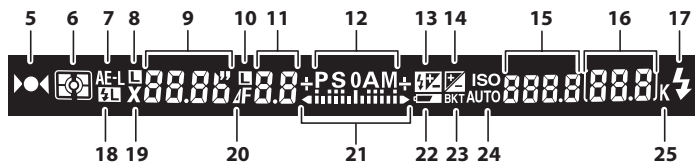
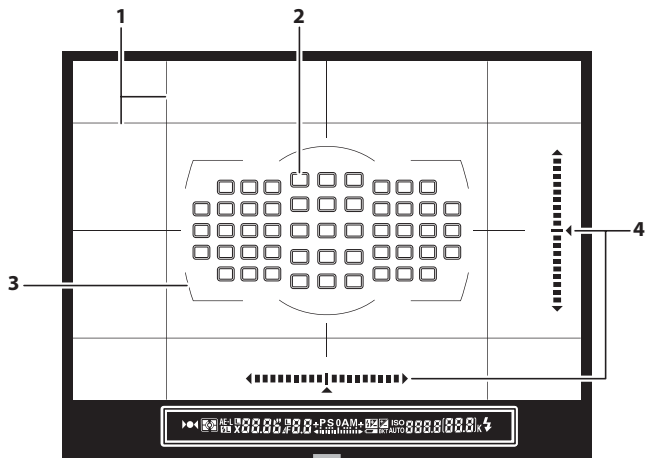


1	Color temperature indicator	153	8	White balance.....	145
2	Shutter speed	119, 122		White balance fine-tuning indicator.....	151
	Exposure compensation value	130	9	Exposure indicator	123
	Flash compensation value	188		Exposure compensation indicator.....	130
	White balance fine-tuning.....	148		Bracketing progress indicator: Exposure and flash bracketing..	133
	Color temperature	146, 153		WB bracketing	137
	White balance preset number	154		ADL bracketing.....	141
	Number of shots in exposure and flash bracketing sequence.....	133		PC connection indicator	246
	Number of shots in WB bracketing sequence	137	10	HDR indicator.....	177
	HDR exposure differential.....	180	11	Multiple exposure indicator.....	196
	Number of shots in multiple exposure.....	197	12	SD card indicator	31, 32
	Number of intervals for interval timer photography.....	204	13	CompactFlash card indicator....	31, 32
	Focal length (non-CPU lenses)	214	14	Aperture (f-number)	120, 122
3	Flash sync indicator	299		Aperture (number of stops)...	121, 374
4	Flexible program indicator	118		Bracketing increment.....	134, 138
5	Exposure mode.....	117		Number of shots in ADL bracketing sequence	141
6	Image size.....	87		Number of shots per interval.....	204
7	Image quality.....	84		Maximum aperture (non-CPU lenses)	214
				PC mode indicator.....	246
			15	Aperture stop indicator.....	121, 374



16	Flash compensation indicator	188	27	"K" (appears when memory remains for over 1000 exposures)	38
17	GPS connection indicator	217	28	"Beep" indicator	292
18	Shutter-speed lock icon	126	29	ISO sensitivity indicator	109
19	"Clock not set" indicator	28, 417		Auto ISO sensitivity indicator	111
20	Interval timer indicator	201, 204	30	Aperture lock icon	127
	Time-lapse indicator	207, 210		HDR (series) indicator	180
21	AF-area mode indicator	93, 95		Multiple exposure (series) indicator	197
	Auto-area AF indicator	94, 95	31	Exposure and flash bracketing indicator	133
	3D-tracking indicator	93, 95		WB bracketing indicator	137
22	Flash mode	182, 183		ADL bracketing indicator	141
23	Autofocus mode	91		Active D-Lighting indicator	175
24	MB-D12 battery indicator	298	32	Exposure compensation indicator	130
25	Battery indicator	37			
26	Number of exposures remaining	38, 436			
	Number of shots remaining before memory buffer fills	105, 436			
	ISO sensitivity	109			
	Preset white balance recording indicator	156			
	ADL bracketing amount	142, 314			
	Time-lapse recording indicator	207, 210			
	Manual lens number	214			
	Capture mode indicator	246			

The Viewfinder Display



<p>1 Framing grid (displayed when On is selected for Custom Setting d6)295</p> <p>2 Focus points.....40, 96, 284, 285 AF-area mode.....93, 94</p> <p>3 AF area brackets 35, 223</p> <p>4 Virtual horizon display313</p> <p>5 Focus indicator..... 40, 102</p>	<p>6 Metering 115</p> <p>7 Autoexposure (AE) lock..... 128</p> <p>8 Shutter speed lock icon 126</p> <p>9 Shutter speed 119, 122 Autofocus mode.....91</p> <p>10 Aperture lock icon..... 127</p> <p>11 Aperture (f-number).....120, 122 Aperture (number of stops) 121, 374</p>
---	--

12	Exposure mode	117	18	FV lock indicator	191
13	Flash compensation indicator..	188	19	Flash sync indicator.....	299
14	Exposure compensation indicator.....	130	20	Aperture stop indicator.....	121, 374
15	ISO sensitivity	109	21	Exposure indicator.....	123
	Preset white balance recording indicator.....	156		Exposure compensation display	130
	ADL bracketing amount	314	22	Low battery warning	37
	AF-area mode	93, 94, 95	23	Exposure and flash bracketing indicator.....	133
16	Number of exposures remaining	38, 436		WB bracketing indicator	137
	Number of shots remaining before memory buffer fills.....	105, 436	24	ADL bracketing indicator.....	141
	Exposure compensation value....	130	24	Auto ISO sensitivity indicator ...	112
	Flash compensation value.....	188	25	"K" (appears when memory remains for over 1000 exposures)	38
17	Flash-ready indicator	181			



✓ No Battery

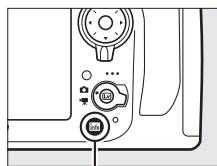
When the battery is totally exhausted or no battery is inserted, the display in the viewfinder will dim. This is normal and does not indicate a malfunction. The viewfinder display will return to normal when a fully-charged battery is inserted.

✓ The Control Panel and Viewfinder Displays

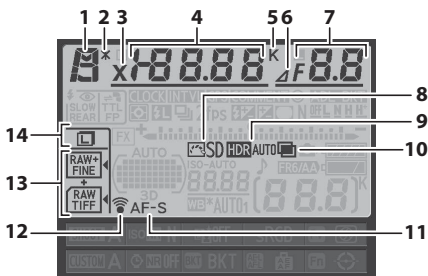
The brightness of the control panel and viewfinder displays varies with temperature, and the response times of the displays may drop at low temperatures. This is normal and does not indicate a malfunction.

The Information Display

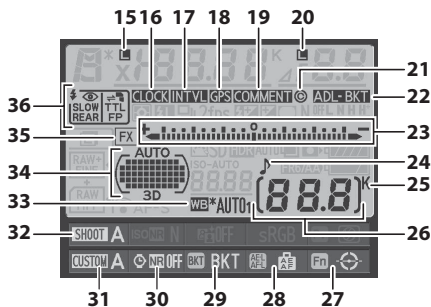
Shooting information, including shutter speed, aperture, number of exposures remaining, and AF-area mode, is displayed in the monitor when the **info** button is pressed.



info button



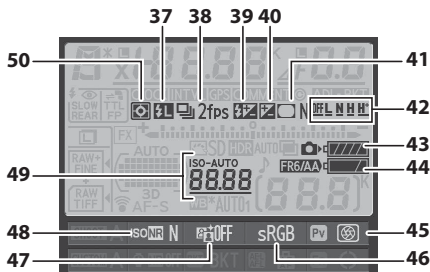
1	Exposure mode.....	117	6	Aperture stop indicator.....	121, 374
2	Flexible program indicator	118	7	Aperture (f-number)	120, 122
3	Flash sync indicator	299		Aperture (number of stops)....	121, 374
4	Shutter speed	119, 122		Bracketing increment	134, 138
	Exposure compensation value	130		Number of shots in ADL bracketing	
	Flash compensation value	188		sequence	141
	White balance fine-tuning.....	148		Maximum aperture	
	Color temperature	146, 152		(non-CPU lenses)	214
	Number of shots in exposure and		8	Picture Control indicator	164
	flash bracketing sequence	133	9	HDR indicator	177
	Number of shots in WB bracketing			HDR exposure differential	180
	sequence.....	137	10	Multiple exposure indicator.....	196
	Number of shots in multiple		11	Autofocus mode indicator.....	91
	exposure.....	197	12	Eye-Fi connection indicator	339
	Focal length (non-CPU lenses)	214	13	Image quality.....	84
5	Color temperature indicator			Secondary slot function.....	89
	145, 152, 153	14	Image size.....	87



15	Shutter-speed lock icon	126	25	"K" (appears when memory remains for over 1000 exposures)	38
16	"Clock not set" indicator.....	28, 417	26	Number of exposures remaining	38
17	Interval timer indicator.....	201, 204		Manual lens number.....	214
	Time-lapse indicator	207, 210		Time-lapse recording indicator	207, 210
18	GPS connection indicator	217	27	Fn button assignment.....	311
19	Image comment indicator	333	28	AE-L/AF-L button assignment.....	315
20	Aperture lock icon	127	29	BKT button assignment.....	316
	HDR (series) indicator	180	30	Long exposure noise reduction indicator	277
	Multiple exposure (series) indicator	197	31	Custom settings bank.....	280
21	Copyright information indicator	334	32	Shooting menu bank.....	269
22	Exposure and flash bracketing indicator	133	33	White balance.....	145
	WB bracketing indicator.....	137		White balance fine-tuning indicator	149
	ADL bracketing indicator	141	34	Auto-area AF indicator	94
23	Exposure indicator	123		Focus points indicator	96
	Exposure compensation indicator ...	130		AF-area mode indicator	93
	Bracketing progress indicator:			3D-tracking indicator.....	93
	Exposure and flash bracketing....	133	35	Image area indicator.....	79
	WB bracketing	137	36	Flash mode.....	183
	ADL bracketing	141			
24	"Beep" indicator	292			




The Information Display (Continued)





37 FV lock indicator..... 191	44 MB-D12 battery type display..... 297
38 Release mode indicator..... 103	MB-D12 battery indicator..... 298
Continuous shooting speed 104	45 Depth-of-field preview button assignment 315
39 Flash compensation indicator 188	46 Color space indicator 274
40 Exposure compensation indicator 130	47 Active D-Lighting indicator..... 175
41 Vignette control indicator.....275	48 High ISO noise reduction indicator..... 277
42 ADL bracketing amount 142	49 ISO sensitivity indicator 109
43 Camera battery indicator 37	Auto ISO sensitivity indicator 111
	50 Metering 115

Turning the Monitor Off

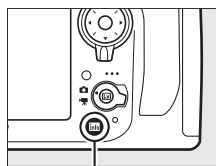
To clear shooting information from the monitor, press the  button twice more or press the shutter-release button halfway. The monitor will turn off automatically if no operations are performed for about 10 seconds.

See Also

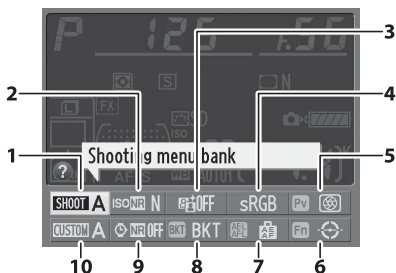
For information on choosing how long the monitor stays on, see Custom Setting c4 (**Monitor off delay**,  292). For information on changing the color of the lettering in the information display, see Custom Setting d9 (**Information display**,  296).

■ Changing Settings in the Information Display

To change settings for the items listed below, press the **Info** button in the information display. Highlight items using the multi selector and press **OK** to view options for the highlighted item.




Info button



1 Shooting menu bank.....	269	7 AE-L/AF-L button assignment.....	315
2 High ISO noise reduction.....	277	8 BKT button assignment	316
3 Active D-Lighting.....	175	9 Long exposure noise reduction	277
4 Color space.....	274	10 Custom settings bank.....	280
5 Depth-of-field preview button assignment.....	315		
6 Fn button assignment	311		

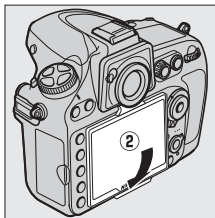
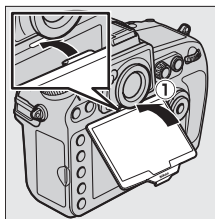
Tool Tips

A tool tip giving the name of the selected item appears in the information display. Tool tips can be turned off using Custom Setting d8 (**Screen tips**;  295).

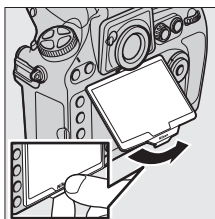


The BM-12 Monitor Cover

A clear plastic cover is provided with the camera to keep the monitor clean and protect it when the camera is not in use. To attach the cover, insert the projection on the top of the cover into the matching indentation above the camera monitor (①) and press the bottom of the cover until it clicks into place (②).



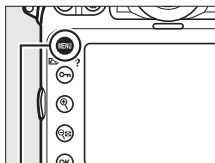
To remove the cover, hold the camera firmly and pull the bottom of the cover gently outwards as shown at right.



Tutorial

Camera Menu

Most shooting, playback, and setup options can be accessed from the camera menu. To view the menu, press the **MENU** button.

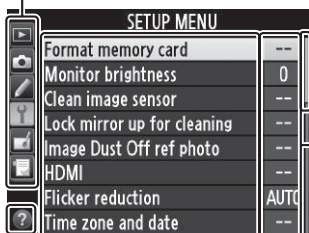


MENU button

Tabs

Choose from the following menus:

- ▶ **Playback** (📖 259)
- 📷 **Shooting** (📖 268)
- 🔧 **Custom Settings** (📖 278)
- ⚙️ **Setup** (📖 325)
- 🖌️ **Retouch** (📖 341)
- 📁/📅 **My Menu** or **Recent settings** (defaults to **My Menu**; 📖 366)



Slider shows position in current menu.

Current settings are shown by icons.

Menu options

Options in current menu.



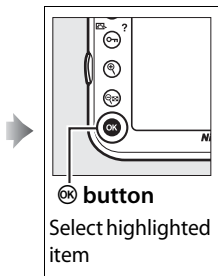
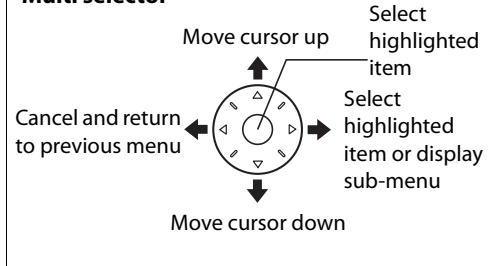
If icon is displayed, help for current item can be viewed by pressing button (📖 18).

Using Camera Menu

Menu Controls

The multi selector and **OK** button are used to navigate the menus.

Multi selector

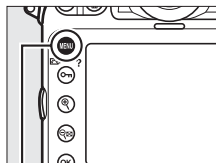


Navigating the Menus

Follow the steps below to navigate the menus.

1 Display the menus.

Press the **MENU** button to display the menus.



MENU button

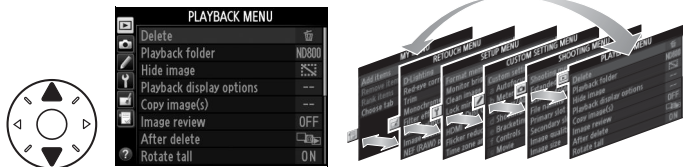
2 Highlight the icon for the current menu.

Press **◀** to highlight the icon for the current menu.



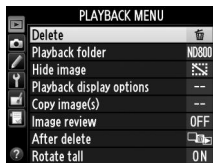
3 Select a menu.

Press ▲ or ▼ to select the desired menu.



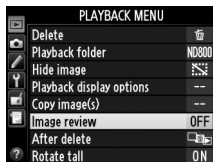
4 Position the cursor in the selected menu.

Press ► to position the cursor in the selected menu.



5 Highlight a menu item.

Press ▲ or ▼ to highlight a menu item.



6 Display options.

Press ► to display options for the selected menu item.



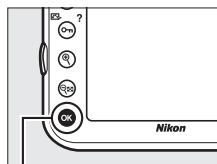
7 Highlight an option.

Press ▲ or ▼ to highlight an option.



8 Select the highlighted item.

Press **OK** to select the highlighted item. To exit without making a selection, press the **MENU** button.



OK button

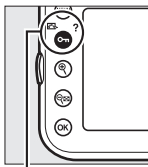
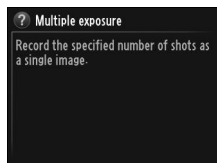
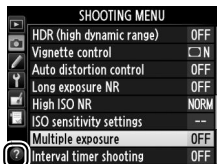
Note the following points:

- Menu items that are displayed in gray are not currently available.
- While pressing **▶** or the center of the multi selector generally has the same effect as pressing **OK**, there are some cases in which selection can only be made by pressing **OK**.
- To exit the menus and return to shooting mode, press the shutter-release button halfway (□ 41).

Help

If a **?** icon is displayed at the bottom left corner of the monitor, help can be displayed by pressing the **?** (**INFO**/?) button.

A description of the currently selected option or menu will be displayed while the button is pressed. Press **▲** or **▼** to scroll through the display.



? (**INFO**/?) button

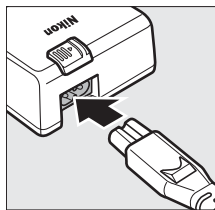
First Steps

Charge the Battery

The camera is powered by an EN-EL15 rechargeable Li-ion battery (supplied). To maximize shooting time, charge the battery in the supplied MH-25 battery charger before use. About 2 hours and 35 minutes are required to fully recharge the battery when no charge remains.

1 Connect the AC power cable.

Connect the power cable. The AC adapter plug should be in the position shown at right; do not rotate.

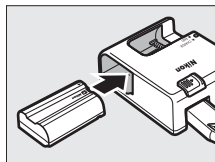


2 Remove the terminal cover.

Remove the terminal cover from the battery.

3 Insert the battery.

Place the battery in the battery bay as shown in the illustration on the charger.



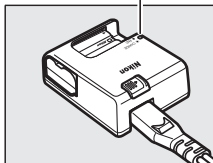
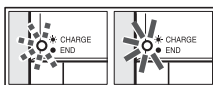
4 Plug the charger in.

The **CHARGE** lamp will blink while the battery charges.

Charging the Battery

Charge the battery indoors at ambient temperatures between 5–35 °C (41–95 °F). The battery will not charge if its temperature is below 0 °C (32 °F) or above 60 °C (140 °F).

Battery Charging complete

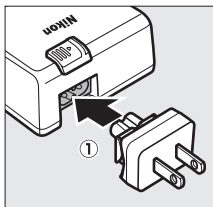


5 Remove the battery when charging is complete.

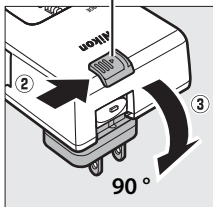
Charging is complete when the **CHARGE** lamp stops blinking. Unplug the charger and remove the battery.

The AC Wall Adapter

Depending on the country or region of purchase, an AC wall adapter may also be supplied with the charger. To use the adapter, insert it into the charger AC inlet (1). Slide the AC wall adapter latch in the direction shown (2) and rotate the adapter 90° to fix it in the position shown (3). Reverse these steps to remove the adapter.



AC wall adapter latch



Insert the Battery

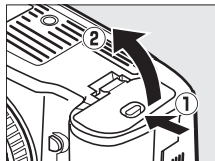
1 Turn the camera off.

Inserting and Removing Batteries

Always turn the camera off before inserting or removing batteries.

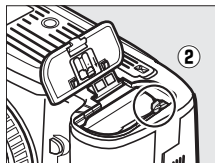
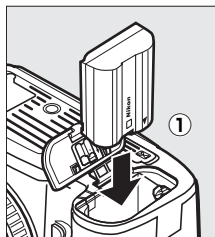
2 Open the battery-chamber cover.

Unlatch (1) and open (2) the battery-chamber cover.



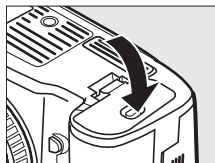
3 Insert the battery.

Insert the battery in the orientation shown (1), using the battery to keep the orange battery latch pressed to one side. The latch locks the battery in place when the battery is fully inserted (2).



Battery latch

4 Close the battery-chamber cover.



Removing the Battery

Turn the camera off and open the battery-chamber cover. Press the battery latch in the direction shown by the arrow to release the battery and then remove the battery by hand. Note that the battery may be hot after use; observe due caution when removing the battery. To prevent short-circuits, replace the terminal cover when the battery is not in use.



EN-EL15 Rechargeable Li-ion Batteries

The supplied EN-EL15 shares information with compatible devices, enabling the camera to show battery charge state in six levels (☐ 37).

The **Battery info** option in the setup menu details battery charge, battery life, and the number of pictures taken since the battery was last charged (☐ 332).



The Battery and Charger

Read and follow the warnings and cautions on pages xiii–xv and 401–404 of this manual. Do not use the battery at ambient temperatures below 0 °C/32 °F or above 40 °C/104 °F; failure to observe this precaution could damage the battery or impair its performance. Capacity may be reduced and charging times increase at battery temperatures from 0 °C/32 °F to 15 °C/59 °F and from 45 °C/113 °F to 60 °C/140 °F.

If the **CHARGE** lamp flickers (i.e., flashes about eight times a second) during charging, confirm that the temperature is in the correct range and then unplug the charger and remove and reinsert the battery. If the problem persists, cease use immediately and take battery and charger to your retailer or a Nikon-authorized service representative.

Do not short the charger terminals; failure to observe this precaution could result in overheating and damage to the charger. Do not move the charger or touch the battery during charging. Failure to observe this precaution could in very rare instances result in the charger showing that charging is complete when the battery is only partially charged. Remove and reinsert the battery to begin charging again. Battery capacity may temporarily drop if the battery is charged at low temperatures or used at a temperature below the temperature at which it was charged. If the battery is charged at a temperature below 5 °C (41 °F), the battery life indicator in the **Battery info** (📖 332) display may show a temporary decrease.

The battery may be hot immediately after use. Wait for the battery to cool before recharging.

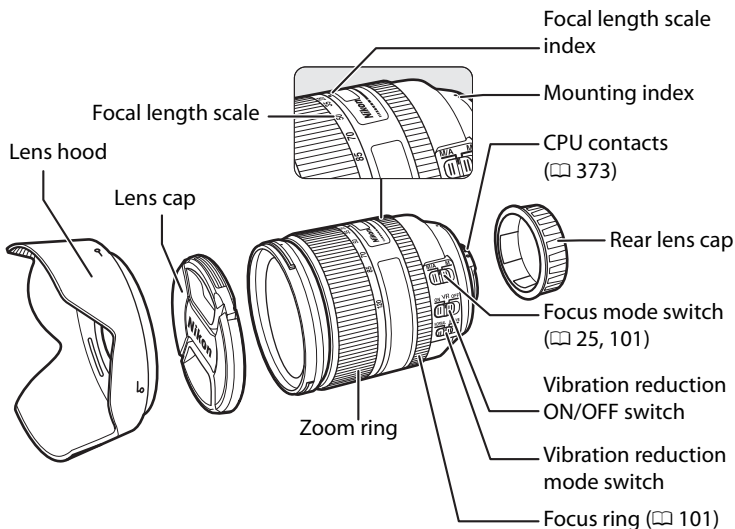
The supplied power cable and AC wall adapter are for use with the MH-25 only. Use the charger with compatible batteries only. Unplug when not in use.

A marked drop in the time a fully charged battery retains its charge when used at room temperature indicates that it requires replacement. Purchase a new EN-EL15 battery.



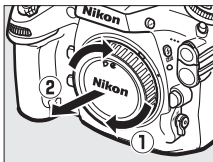
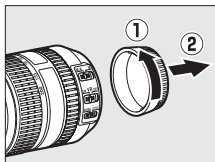
Attach a Lens

Care should be taken to prevent dust from entering the camera when the lens is removed. The lens generally used in this manual for illustrative purposes is an AF-S NIKKOR 24-120mm f/4G ED VR.



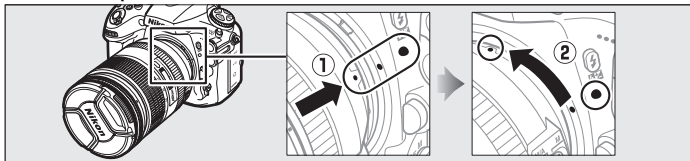
1 Turn the camera off.

2 Remove the rear lens cap and the camera body cap.



3 Attach the lens.

Keeping the mounting index on the lens aligned with the mounting index on the camera body, position the lens in the camera's bayonet mount (①). Being careful not to press the lens-release button, rotate the lens counter-clockwise until it clicks into place (②).

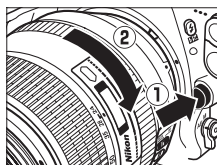


If the lens is equipped with an **A-M** or **M/A-M** mode switch, select **A** (autofocus) or **M/A** (autofocus with manual override).



Detaching the Lens

Be sure the camera is off when removing or exchanging lenses. To remove the lens, press and hold the lens release button (①) while turning the lens clockwise (②). After removing the lens, replace the lens caps and camera body cap.



CPU Lenses with Aperture Rings

In the case of CPU lenses equipped with an aperture ring (☞ 373), lock aperture at the minimum setting (highest f-number).

Image Area

The DX format image area is automatically selected when a DX lens is attached (☞ 79).



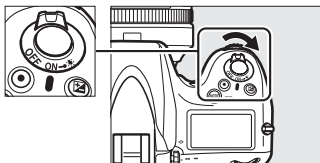
Image area

Basic Setup

The language option in the setup menu is automatically highlighted the first time menus are displayed. Choose a language and set the time and date. Note that if the time and date are not set, **CLOCK** will blink in the monitor and the time and date recorded with photographs will be incorrect.

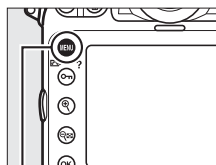
1 Turn the camera on.

Power switch



2 Select Language in the setup menu.

Press **MENU** to display the camera menus, then select **Language** in the setup menu. For information on using menus, see “Using Camera Menus” (16).



MENU button



3 Select a language.

Press **▲** or **▼** to highlight the desired language and press **OK**.



OK button



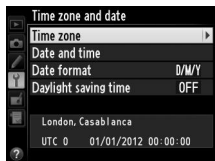
4 Select Time zone and date.

Select **Time zone and date** and press ►.



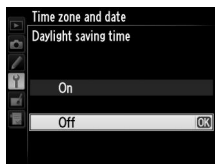
5 Set time zone.

Select **Time zone** and press ►. Press ◀ or ▶ to highlight the local time zone (the **UTC** field shows the difference between the selected time zone and Coordinated Universal Time, or UTC, in hours) and press OK.



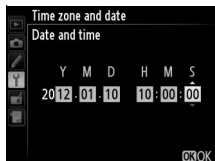
6 Turn daylight saving time on or off.

Select **Daylight saving time** and press ►. Daylight saving time is off by default; if daylight saving time is in effect in the local time zone, press ▲ to highlight **On** and press OK.



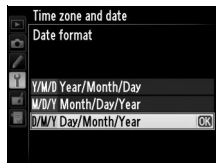
7 Set the date and time.

Select **Date and time** and press ►. Press ◀ or ▶ to select an item, ▲ or ▼ to change. Press OK when the clock is set to the current date and time.



8 Set date format.

Select **Date format** and press **▶**. Press **▲** or **▼** to choose the order in which the year, month, and day will be displayed and press **OK**.



9 Exit to shooting mode.

Press the shutter-release button halfway to exit to shooting mode.



The Clock Battery

The camera clock is powered by an independent, rechargeable power source, which is charged as necessary when the main battery is installed or the camera is powered by an optional EP-5B power connector and EH-5b AC adapter (📖 387). Two days of charging will power the clock for about three months. If the **CLOCK** icon flashes in the control panel, the clock battery is exhausted and the clock has been reset. Set the clock to the correct time and date.

The Camera Clock

The camera clock is less accurate than most watches and household clocks. Check the clock regularly against more accurate time pieces and reset as necessary.

GPS Units (📖 215)

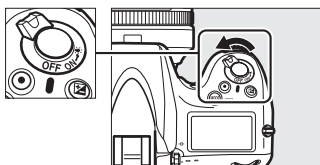
If a GPS unit is connected, the camera clock will be set to the time and date provided by the GPS unit (📖 218).

Insert a Memory Card

Pictures are stored on memory cards (available separately; □ 434). The camera is equipped with two card slots, one for SD and the other for Type I CompactFlash cards. Type II cards and microdrives can not be used.

1 Turn the camera off.

Power switch

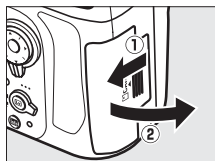


Inserting and Removing Memory Cards

Always turn the camera off before inserting or removing memory cards.

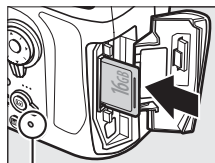
2 Open the card slot cover.

Slide the card slot cover out (①) and open the card slot (②).



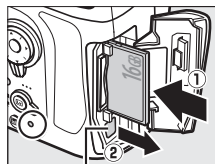
3 Insert the memory card.

SD memory cards: Holding the card as shown, slide it into the SD card slot until it clicks into place. The green access lamp will light briefly.



Access lamp

CompactFlash memory cards: Insert the card into the CompactFlash card slot with the front label toward the monitor (1). When the memory card is fully inserted, the eject button will pop up (2) and the green access lamp will light briefly.



Eject button

Inserting Memory Cards

Insert the memory card terminals first. Inserting the card upside down or backwards could damage the camera or the card. Check to be sure that the card is in the correct orientation.

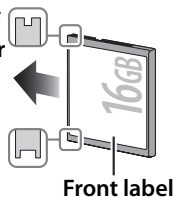
SD memory card

Direction of
insertion for
left (SD)
card slot



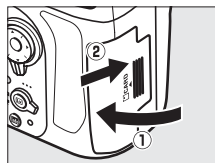
CompactFlash card

Direction of
insertion for
right (Com-
pactFlash)
card slot



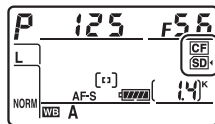
4 Close the card slot cover.

If this is the first time the memory card will be used after being used or formatted in another device, format the card as described on page 32.



✔ Memory Card Icons

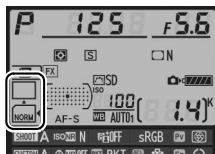
The memory cards currently inserted in the camera are indicated as shown (the example at right shows the icons displayed when both an SD and a CompactFlash card are inserted). If the memory card is full or an error has occurred, the icon for the affected card will blink (☐ 419).



Control panel

✎ Using Two Memory Cards

See page 89 for information on choosing the roles played by each card when two cards are inserted in the camera.

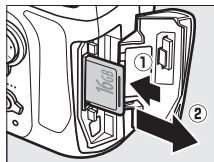


Information display

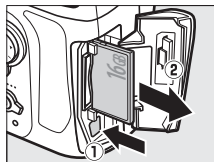
✎ Removing Memory Cards

After confirming that the access lamp is off, turn the camera off and open the memory card slot cover.

SD memory cards: Press the card in to eject it (①). The memory card can then be removed by hand.



CompactFlash memory cards: Press the eject button (①) to partially eject the card (②). The memory card can then be removed by hand. Do not push on the memory card while pressing the eject button. Failure to observe this precaution could damage the camera or memory card.



Format the Memory Card

Memory cards must be formatted before first use or after being used or formatted in other devices.



✓ Formatting Memory Cards

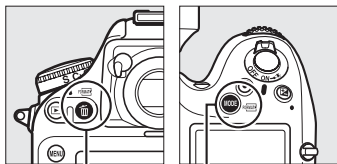
Formatting memory cards permanently deletes any data they may contain.

Be sure to copy any photographs and other data you wish to keep to a computer before proceeding (📖 239).

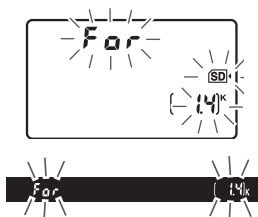
1 Turn the camera on.

2 Press the MODE (FORMAT) and (FORMAT) buttons.

Hold the MODE (FORMAT) and  (FORMAT) buttons down simultaneously until a blinking **F o r** (format) appears in the shutter-speed displays in the control panel and viewfinder. If two memory cards are inserted, the card to be formatted is shown by a flashing icon. By default, the primary card slot (📖 89) will be selected; you can choose the secondary slot by rotating the main command dial. To exit without formatting the memory card, wait until **F o r** stops blinking (about six seconds) or press any button other than the MODE (FORMAT) and  (FORMAT) buttons.



 (FORMAT) button MODE (FORMAT) button



3 Press the **MODE** (FORMAT) and **DISCARD** (FORMAT) buttons again.

Press the **MODE** (FORMAT) and **DISCARD** (FORMAT) buttons together a second time while **F a r** is blinking to format the memory card. *Do not remove the memory card or remove or disconnect the power source during formatting.*

When formatting is complete, the control panel and viewfinder will show the number of photographs that can be recorded at current settings.

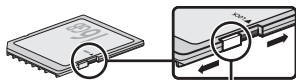


✔ Memory Cards

- Memory cards may be hot after use. Observe due caution when removing memory cards from the camera.
- Turn the power off before inserting or removing memory cards. Do not remove memory cards from the camera, turn the camera off, or remove or disconnect the power source during formatting or while data are being recorded, deleted, or copied to a computer. Failure to observe these precautions could result in loss of data or in damage to the camera or card.
- Do not touch the card terminals with your fingers or metal objects.
- Do not bend, drop, or subject to strong physical shocks.
- Do not apply force to the card casing. Failure to observe this precaution could damage the card.
- Do not expose to water, high levels of humidity, or direct sunlight.
- Do not format memory cards in a computer.

✔ The Write Protect Switch

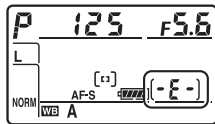
SD memory cards are equipped with a write protect switch to prevent accidental loss of data. When this switch is in the “lock” position, the memory card can not be formatted and photos can not be deleted or recorded (a warning will be displayed in the monitor if you attempt to release the shutter). To unlock the memory card, slide the switch to the “write” position.



Write-protect switch

✔ No Memory Card

If no memory card is inserted, the control panel and viewfinder will show [-E-]. If the camera is turned off with a charged EN-EL15 battery and no memory card inserted, [-E-] will be displayed in the control panel.



✔ See Also

See page 326 for information on formatting memory cards using the **Format memory card** option in the setup menu.

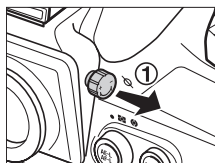
Adjust Viewfinder Focus

The camera is equipped with diopter adjustment to accommodate individual differences in vision. Check that the display in the viewfinder is in focus before shooting.

1 Turn the camera on.

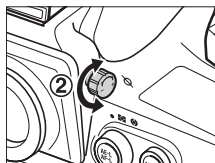
Remove the lens cap and turn the camera on.

2 Lift the diopter adjustment control (1).



3 Focus the viewfinder.

Rotate the diopter adjustment control (2) until the viewfinder display, focus points, and AF area brackets are in sharp focus. When operating the control with your eye to the viewfinder, be careful not to put your fingers or fingernails in your eye.



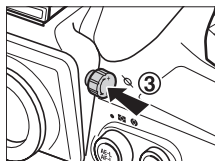
AF area brackets







Focus point

4 Replace the diopter adjustment control.


Push the diopter adjustment control back in (3).

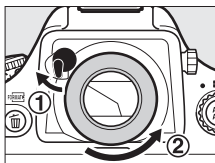


Adjusting Viewfinder Focus

If you are unable to focus the viewfinder as described above, select single-servo autofocus (AF-S;  91), single-point AF ( 93), and the center focus point ( 96), and then frame a high-contrast subject in the center focus point and press the shutter-release button halfway to focus the camera. With the camera in focus, use the diopter adjustment control to bring the subject into clear focus in the viewfinder. If necessary, viewfinder focus can be further adjusted using optional corrective lenses ( 388).

Diopter-Adjustment Viewfinder Lenses

Corrective lenses (available separately;  388) can be used to further adjust viewfinder diopter. Before attaching a diopter-adjustment viewfinder lens, remove the DK-17 viewfinder eyepiece by closing the viewfinder shutter to release the eyepiece lock (1) and then unscrewing the eyepiece as shown at right (2).



Basic Photography and Playback

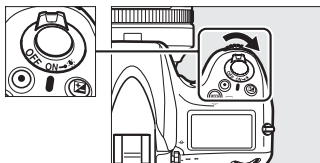
Turn the Camera On

Before taking photographs, turn the camera on and check the battery level and number of exposures remaining as described below.

1 Turn the camera on.

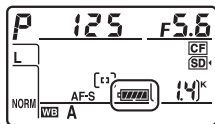
Turn the camera on. The control panel will turn on and the display in the viewfinder will light.

Power switch



2 Check the battery level.

Check the battery level in the control panel or viewfinder.

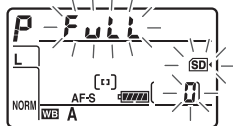
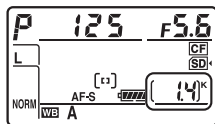


Icon*		Description
Control panel	Viewfinder	
	—	Battery fully charged.
	—	
	—	
	—	
		Low battery. Charge battery or ready spare battery.
		Shutter release disabled. Charge or exchange battery.

* No icon displayed when camera is powered by optional EP-5B power connector and EH-5b AC adapter.

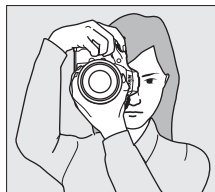
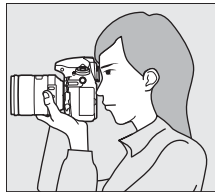
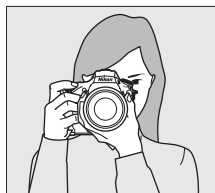
3 Check the number of exposures remaining.

The control panel and viewfinder show the number of photographs that can be taken at current settings (values over 1,000 are rounded down to the nearest hundred; e.g., values between 1,400 and 1,499 are shown as 1.4 K). If two memory cards are inserted, the displays show the space available on the card in the primary slot (📖 89). When the number of exposures remaining reaches 0, the number will flash, **F u L L** or **F u L** will blink in the shutter-speed displays, and the icon for the affected card will blink. Insert another memory card or delete some photos (📖 234).



Ready the Camera

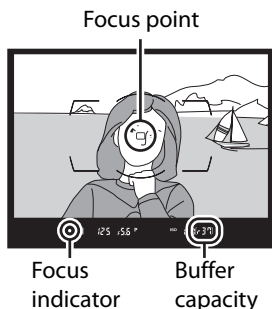
When framing photographs in the viewfinder, hold the handgrip in your right hand and cradle the camera body or lens with your left. Keep your elbows propped lightly against your torso for support and place one foot half a pace ahead of the other to keep your upper body stable. When framing photographs in portrait (tall) orientation, hold the camera as shown in the bottom of the three illustrations at right.



Focus and Shoot

1 Press the shutter-release button halfway (📖 41).

At default settings, the camera will focus on the subject in the center focus point. Frame a photo in the viewfinder with the main subject positioned in the center focus point and press the shutter-release button halfway. If the subject is poorly lit, the AF-assist illuminator may light.



2 Check indicators in the viewfinder.

When the focus operation is complete, the in-focus indicator (●) will appear in the viewfinder.

Viewfinder display	Description
●	Subject in focus.
▶	Focus point is between camera and subject.
◀	Focus point is behind subject.
▶◀ (blinks)	Camera unable to focus on subject in focus point using autofocus.

While the shutter-release button is pressed halfway, focus will lock and the number of exposures that can be stored in the memory buffer ("⚡"; 📖 105) will be shown in the viewfinder display.

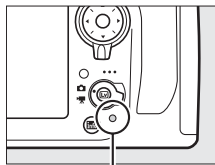


For information on what to do if the camera is unable to focus using autofocus, see "Getting Good Results with Autofocus" (📖 100).

3 Shoot.

Smoothly press the shutter-release-button the rest of the way down to release the shutter and record the photograph.

While the photograph is being recorded to the memory card, the access lamp will light. *Do not eject the memory card or remove or disconnect the power source until the lamp has gone out and recording is complete.*



Access lamp



The Shutter-Release Button

The camera has a two-stage shutter-release button. The camera focuses when the shutter-release button is pressed halfway. To take the photograph, press the shutter-release button the rest of the way down.




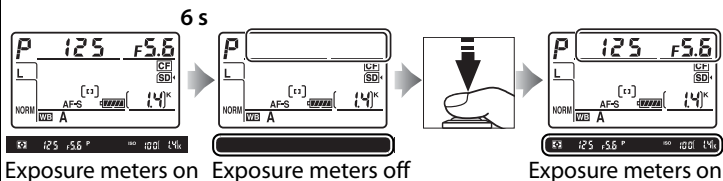
Focus





Take photograph


Auto Meter Off

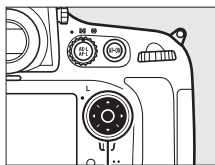
The shutter speed and aperture displays in the control panel and viewfinder will turn off if no operations are performed for about six seconds, reducing the drain on the battery. Press the shutter-release button halfway to reactivate the display in the viewfinder ( 41).



 The length of time before the exposure meters turn off automatically can be adjusted using Custom Setting c2 (**Auto meter-off delay**,  291).

The Multi Selector

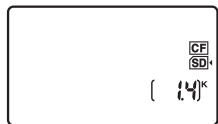
The multi selector can be used to select the focus point while the exposure meters are on ( 96).



Multi selector

Camera Off Display

If the camera is turned off with a battery and memory card inserted, the memory card icon and number of exposures remaining will be displayed (some memory cards may in rare cases only display this information when the camera is on).



Control panel

Viewing Photographs

1 Press the button.





A photograph will be displayed in the monitor. The memory card containing the picture currently displayed is shown by an icon.

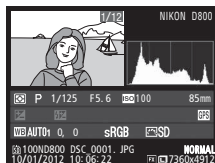


 button



2 View additional pictures.

Additional pictures can be displayed by pressing  or . To view additional information on the current photograph, press  and  (📖 222).



To end playback and return to shooting mode, press the shutter-release button halfway.


Image Review

When **On** is selected for **Image review** in the playback menu (📖 265), photographs are automatically displayed in the monitor after shooting.

See Also

See page 221 for information on choosing a memory card slot.

Deleting Unwanted Photographs




Unwanted photographs can be deleted by pressing the  (FORMAT) button. Note that photographs can not be recovered once deleted.

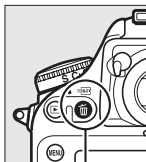
1 Display the photograph.


Display the photograph you wish to delete as described in “Viewing Photographs” on the previous page. The location of the current image is shown by an icon at the bottom left corner of the display.



2 Delete the photograph.

Press the  (FORMAT) button. A confirmation dialog will be displayed; press the  (FORMAT) button again to delete the image and return to playback. To exit without deleting the picture, press .



 (FORMAT) button



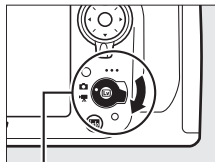
Delete

To delete multiple images or to select the memory card from which images will be deleted, use the **Delete** option in the playback menu (236).

Live View Photography

Follow the steps below to take photographs in live view.

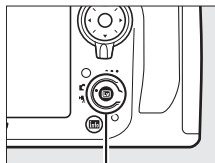
- 1 Rotate the live view selector to  (live view photography).**



Live view selector

- 2 Press the  button.**

The mirror will be raised and the view through the lens will be displayed in the camera monitor. The subject will no longer be visible in the viewfinder.



Lv button

- 3 Position the focus point.**

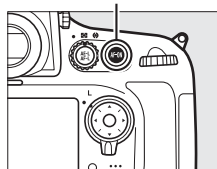
Position the focus point over your subject as described on page 48.

4 Focus.

Press the shutter-release button halfway or press the **AF-ON** button to focus.

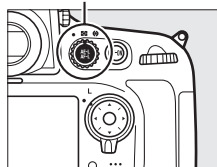


AF-ON button




The focus point will blink green while the camera focuses. If the camera is able to focus, the focus point will be displayed in green; if the camera is unable to focus, the focus point will blink red (note that pictures can be taken even when the focus point blinks red; check focus in the monitor before shooting). Exposure can be locked by pressing the **AE-L/AF-L** button (□ 128); focus locks while the shutter-release button is pressed halfway.

AE-L/AF-L button



Exposure Preview

During live view photography, you can press  to preview the effects of shutter speed, aperture, and ISO sensitivity on exposure. Exposure can be adjusted by ± 5 EV (□ 130), although only values between -3 and $+3$ EV are reflected in the preview display. Note that the preview may not accurately reflect the final results when flash lighting is used, Active D-Lighting (□ 174), High Dynamic Range (HDR; □ 176), or bracketing is in effect, **A** (auto) is selected for the Picture Control **Contrast** parameter (□ 166), or **x 25 a** is selected for shutter speed. If the subject is very bright or very dark, the exposure indicators will flash to warn that the preview may not accurately reflect exposure. Exposure preview is not available when **b u l b** is selected for shutter speed.




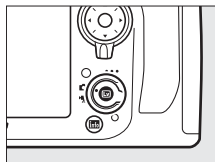
5 Take the picture.

Press the shutter-release button the rest of the way down to shoot. The monitor will turn off.



6 Exit live view mode.

Press the  button to exit live view mode.



Using Autofocus in Live View

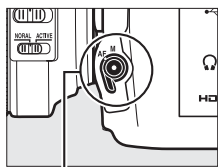
Use an AF-S lens. The desired results may not be achieved with other lenses or teleconverters. Note that in live view, autofocus is slower and the monitor may brighten or darken while the camera focuses. The focus point may sometimes be displayed in green when the camera is unable to focus. The camera may be unable to focus in the following situations:

- The subject contains lines parallel to the long edge of the frame
- The subject lacks contrast
- The subject in the focus point contains areas of sharply contrasting brightness, or includes spot lighting or a neon sign or other light source that changes in brightness
- Flicker or banding appears under fluorescent, mercury-vapor, sodium-vapor, or similar lighting
- A cross (star) filter or other special filter is used
- The subject appears smaller than the focus point
- The subject is dominated by regular geometric patterns (e.g., blinds or a row of windows in a skyscraper)
- The subject is moving



Focusing in Live View

To focus using autofocus, rotate the focus-mode selector to **AF** and follow the steps below to choose autofocus and AF-area modes. For information on focusing manually, see page 55.



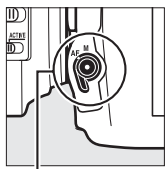
Focus-mode selector

■ ■ Choosing a Focus Mode

The following autofocus modes are available in live view:

Mode	Description
AF-S	Single-servo AF: For stationary subjects. Focus locks when shutter-release button is pressed halfway.
AF-F	Full-time servo AF: For moving subjects. Camera focuses continuously until shutter-release button is pressed. Focus locks when shutter-release button is pressed halfway.

To choose an autofocus mode, press the AF-mode button and rotate the main command dial until the desired mode is displayed in the monitor.



AF-mode button







Main command dial



Monitor

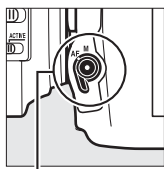
Choosing an AF-Area Mode

The following AF-area modes can be selected in live view:

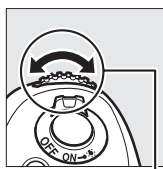
Mode	Description
	Face-priority AF: Use for portraits. The camera automatically detects and focuses on portrait subjects; the selected subject is indicated by a double yellow border (if multiple faces, up to a maximum of 35, are detected, the camera will focus on the closest subject; to choose a different subject, use the multi selector). If the camera can no longer detect the subject (because, for example, the subject has turned to face away from the camera), the border will no longer be displayed.
	Wide-area AF: Use for hand-held shots of landscapes and other non-portrait subjects. Use the multi selector to move the focus point anywhere in the frame, or press the center of the multi selector to position the focus point in the center of the frame.
	Normal-area AF: Use for pin-point focus on a selected spot in the frame. Use the multi selector to move the focus point anywhere in the frame, or press the center of the multi selector to position the focus point in the center of the frame. A tripod is recommended.
	Subject-tracking AF: Position the focus point over your subject and press the center of the multi selector. The focus point will track the selected subject as it moves through the frame. To end tracking, press the center of the multi selector again.



To choose an AF-area mode, press the AF-mode button and rotate the sub-command dial until the desired mode is displayed in the monitor.



**AF-mode
button**



**Sub-command
dial**

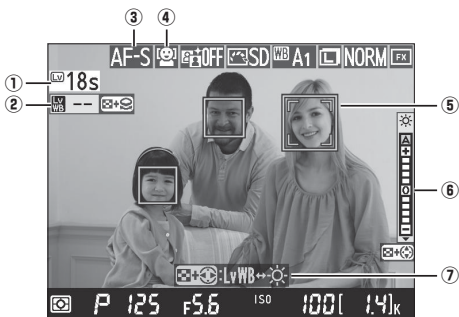


Monitor

✓ Subject Tracking

The camera may be unable to track subjects if they move quickly, leave the frame or are obscured by other objects, change visibly in size, color, or brightness, or are too small, too large, too bright, too dark, or similar in color or brightness to the background.

The Live View Display: Live View Photography






Item	Description	
① Time remaining	The amount of time remaining before live view ends automatically. Displayed if shooting will end in 30 s or less.	56, 57
② Monitor hue indicator	Displayed if monitor hue differs from the hue produced by the current white balance setting.	52
③ Autofocus mode	The current autofocus mode.	48
④ AF-area mode	The current AF-area mode.	49
⑤ Focus point	The current focus point. The display varies with the option selected for AF-area mode.	49
⑥ Monitor brightness indicator	A monitor brightness indicator.	53
⑦ Guide	A guide to the options available during live view photography.	52, 53

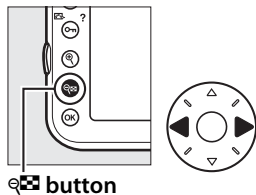


Adjusting Monitor Hue


If flash lighting is used with **Flash** or **Preset manual** white balance (📖 145), the colors in the monitor may differ from those in the final photograph. Monitor hue can be adjusted to reduce the effects of ambient lighting on the display in the monitor during live view photography, for example when using a flash.

1 Highlight the monitor hue indicator.

Press and hold  and press  or  to highlight the monitor hue indicator at the left side of the display.




2 Adjust monitor hue.




Keeping the  button pressed, rotate the main command dial to adjust monitor hue (select -- to preview the hue of the final photograph in the monitor; if another option is selected, the hue seen in the monitor during live view photography will differ from that seen in the final image). Monitor hue is reset when the camera is turned off.





Recalling Monitor Hue

To restore the most recently selected hue when starting live view, hold the **WB** button while pressing .

Choosing a Picture Control

Pressing  (/?) during live view displays a list of Picture Controls. Highlight the desired Picture Control and press  to adjust Picture Control settings (📖 163).




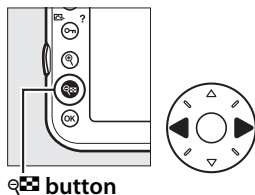
 (/?) button

Adjusting Monitor Brightness


Monitor brightness can be adjusted as described below. Note that brightness adjustment is not available during exposure preview.

1 Highlight the monitor brightness indicator.

Press and hold  and press ◀ or ▶ to highlight the monitor brightness indicator at the right side of the display.



2 Adjust monitor brightness.

Keeping the  button pressed, press ▲ or ▼ to adjust monitor brightness (note that monitor brightness has no effect on photographs taken with the camera). If **A** (auto) is selected and the monitor is on, the camera will automatically adjust brightness in response to ambient lighting conditions as measured by the ambient brightness sensor (📖 5).

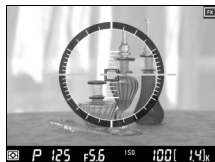


The Information Display: Live View Photography

To hide or display indicators in the monitor during live view photography, press the **info** button.

Virtual horizon

(book 337)



Information on

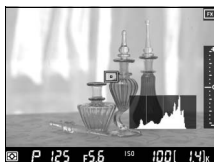


Information off

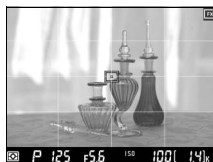


LV

Histogram
(exposure
preview only;
book 46)





Framing
guides

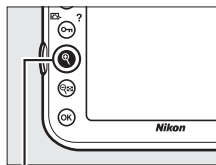


Manual Focus

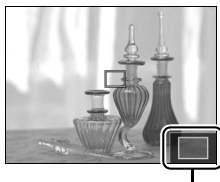
To focus in manual focus mode (📖 101), rotate the lens focus ring until the subject is in focus.



To magnify the view in the monitor up to about 23× for precise focus, press the  button. While the view through the lens is zoomed in, a navigation window will appear in a gray frame at the bottom right corner of the display. Use the multi selector to scroll to areas of the frame not visible in the monitor (available only if wide- or normal-area AF is selected for AF-area mode), or press  to zoom out.



 button



Navigation window

Non-CPU Lenses


When using non-CPU lenses, be sure to enter the focal length and maximum aperture using the **Non-CPU lens data** option in the setup menu (📖 212). Non-CPU lenses can be used only in exposure modes **A** and **M** (📖 117); aperture can be adjusted using the lens aperture ring.


Exposure

Depending on the scene, exposure may differ from that which would be obtained when live view is not used. Metering in live view is adjusted to suit the live view display, producing photographs with exposure close to what is seen in the monitor.



Shooting in Live View Mode

To prevent light entering via the viewfinder from interfering with exposure, close the viewfinder eyepiece shutter ( 106).


Although they will not appear in the final picture, flicker, banding, or distortion may be visible in the monitor under fluorescent, mercury vapor, or sodium lamps or if the camera is panned horizontally or an object moves at high speed through frame (flicker and banding can be reduced using **Flicker reduction**;  329). Bright light sources may leave after-images in the monitor when the camera is panned. Bright spots may also appear. When shooting in live view mode, avoid pointing the camera at the sun or other strong light sources. Failure to observe this precaution could result in damage to the camera's internal circuitry.




Live view ends automatically if the lens is removed.

Live view may end automatically to prevent damage to the camera's internal circuits; exit live view when the camera is not in use. Note that the temperature of the camera's internal circuits may rise and noise (bright spots, randomly-spaced bright pixels, or fog) may be displayed in the following instances (the camera may also become noticeably warm, but this does not indicate a malfunction):

- The ambient temperature is high
- The camera has been used for extended periods in live view or to record movies
- The camera has been used in continuous release mode for extended periods

If live view does not start when you press the  button, wait for the internal circuits to cool and then try again.

Movie recording is not available during live view photography. Select movie live view ( 59) to shoot movies.

✓ The Count Down Display

A count down will be displayed 30 s before live view ends automatically (☐ 51; the timer turns red if live view is about to end to protect the internal circuits or, if an option other than **No limit** is selected for Custom Setting c4—**Monitor off delay**; ☐ 292—5 s before the monitor is due to turn off automatically). Depending on shooting conditions, the timer may appear immediately when live view is selected. Note that although the count down does not appear during playback, live view will still end automatically when the timer expires.

📎 HDMI

If the camera is attached to an HDMI video device during live view photography, the camera monitor will remain on and the video device will display the view through the lens as shown at right. Press the **Info** button to turn the histogram display on and off during exposure preview (☐ 46).



📎 See Also


For information on choosing the role played by the center of the multi selector, see Custom Setting f2 (**Multi selector center button**, ☐ 309).

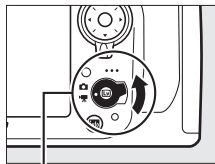




Movie Live View

Movies can be recorded in live view.

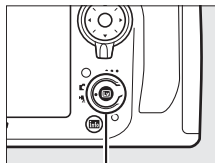
- 1 Rotate the live view selector to  (movie live view).



Live view selector


- 2 Press the  button.

The mirror will be raised and the view through the lens will be displayed in the camera monitor, modified for the effects of exposure. The subject will no longer be visible in the viewfinder.



Lv button

The Icon

A  icon (□ 64) indicates that movies can not be recorded.

Before Recording

Before recording, choose a color space (□ 274) and Picture Control (□ 163). White balance can be set at any time by pressing the **WB** button and rotating the main command dial (□ 145).

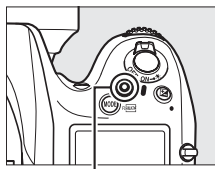
- 3 Choose a focus mode.

Choose a focus mode as described in “Choosing a Focus Mode” (□ 48).



6 Start recording.

Press the movie-record button to start recording. A recording indicator and the time available are displayed in the monitor. Exposure is set using matrix metering and can be locked by pressing the AE-L/AF-L button (□ 128) or altered by up to ± 3 EV using exposure compensation (□ 130). In autofocus mode, the camera can be refocused by pressing the **AF-ON** button.



Movie-record button

Recording indicator



Time remaining

Audio

The camera can record both video and sound; do not cover the microphone on the front of the camera during movie recording. Note that the built-in microphone may record sounds made by the lens during autofocus, vibration reduction, or changes to aperture.

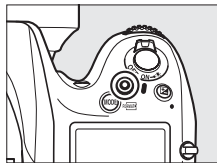
See Also

Frame size, microphone sensitivity, and card slot options are available in the **Movie settings** menu (□ 70). Focus can be adjusted manually as described on page 55. The roles played by the center of the multi selector, the **Fn**, depth-of-field preview, and AE-L/AF-L buttons can be chosen using Custom Settings f2 (**Multi selector center button**; □ 309), g1 (**Assign Fn button**; □ 321), g2 (**Assign preview button**; □ 322), and g3 (**Assign AE-L/AF-L button**, □ 323; this option also allows exposure to be locked without keeping the AE-L/AF-L button pressed), respectively. Custom Setting g4 (**Assign shutter button**; □ 324) controls whether the shutter-release button can be used to start movie live view or to start and end movie recording.



7 End recording.


Press the movie-record button again to end recording. Recording will end automatically when the maximum length is reached, or the memory card is full.



Maximum Length

The maximum length for individual movie files is 4 GB (for maximum recording times, see page 70); note that depending on memory card write speed, shooting may end before this length is reached (📖 434).


Taking Photographs

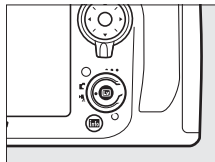
To take a photograph while recording is in progress, press the shutter-release button all the way down. Movie recording will end (the footage recorded to that point will be saved) and the camera will return to live view. The photograph will be recorded at the current image area setting using a crop with an aspect ratio of 16 : 9. Note that the exposure for photographs can not be previewed during movie live view; mode **P**, **S**, or **A** is recommended but accurate results can be achieved in mode **M** by adjusting exposure during live view photography (📖 45) and then rotating the live view selector to  and checking the image area. Exposure compensation for the photograph can be set to values between -5 and +5 EV, but only values between -3 and +3 can be previewed in the monitor (📖 130).

The Count-Down Display



A count down will be displayed 30 s before movie recording ends automatically (📖 51). Depending on shooting conditions, the timer may appear immediately when movie recording begins. Note that regardless of the amount of recording time available, live view will still end automatically when the timer expires. Wait for the internal circuits to cool before resuming movie recording.

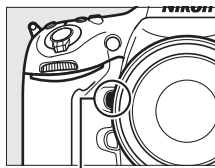
8 Exit live view mode.

Press the  button to exit live view mode.



Indices

If **Index marking** is selected for Custom Setting g2 (**Assign preview button**,  322), you can press the depth-of-field preview button during recording to add indices that can be used to locate frames during editing and playback ( 73). Up to 20 indices can be added to each movie.



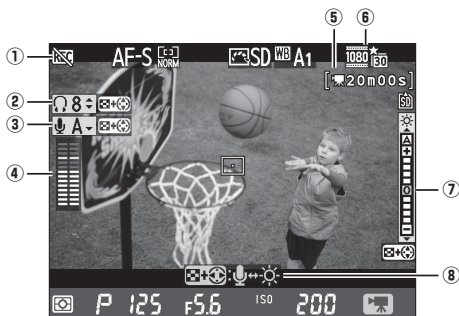
Depth-of-field
preview button



Index



The Live View Display: Movie Live View




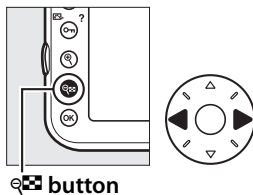
Item	Description	
① "No movie" icon	Indicates that movies can not be recorded.	59
② Headphone volume	Volume of audio output to headphones.	65
③ Microphone sensitivity	Microphone sensitivity for movie recording.	65
④ Sound level	Sound level for audio recording. Displayed in red if level is too high; adjust microphone sensitivity accordingly. Left (L) and right (R) channel indicators appear when optional ME-1 or other stereo microphone is used.	65
⑤ Time remaining (movie live view)	The recording time available for movies.	61
⑥ Movie frame size	The frame size for movie recording.	70
⑦ Monitor brightness indicator	A monitor brightness indicator.	65
⑧ Guide	A guide to the options available during movie live view.	65

■ ■ *Adjusting Settings in the Live View Display*


Microphone sensitivity, headphone volume, and monitor brightness can be adjusted as described below. Note that microphone sensitivity and headphone volume can not be adjusted during recording, and that brightness affects the monitor only (📖 53); movies recorded with the camera are unaffected.

1 Highlight a setting.

Press and hold  and press ◀ or ▶ to highlight the indicator for the desired setting.



2 Adjust the highlighted setting.

Keeping the  button pressed, press ▲ or ▼ to adjust the highlighted setting.




Using an External Microphone

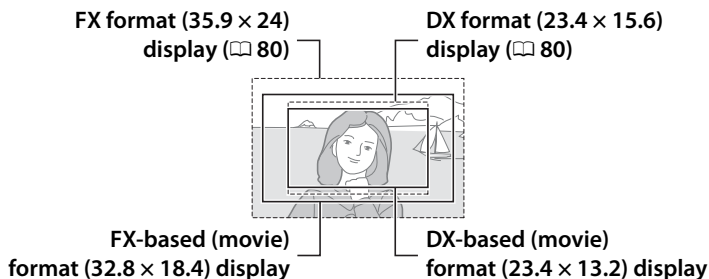
The optional ME-1 stereo microphone can be used to record sound in stereo or to avoid recording lens noise caused by autofocus.

Headphones


Third-party headphones can be used. Note that high sound levels may result in high volume; particular care should be taken when headphones are used.

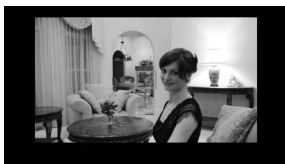
Image Area

Regardless of the option selected for **Image area** in the shooting menu (☞ 79), all movies and photographs recorded in movie live view (☞ 59) have an aspect ratio of 16 : 9. Images recorded with **On** selected for **Image area > Auto DX crop** and a DX lens attached use a DX-based movie format, as do images recorded with **DX (24×16) 1.5×** selected for **Image area > Choose image area**. Other images use an FX-based movie format. A  icon is displayed when the DX-based movie format is selected.



HDMI

If the camera is connected to an HDMI device (☞ 57), the view through the lens will appear both in the camera monitor and on the HDMI device. The indicators that appear in the HDMI device during movie recording are shown at right. The camera monitor does not show the sound level, virtual horizon, or histogram; indicators in the monitor and on the HDMI device can not be hidden or displayed using the  button.



Movie Live View Photographs

The following table shows the size of photographs taken in movie live view:



Image area	Option	Size (pixels)	Print size (cm/in.)*
FX-based format	L	6,720 × 3,776	56.9 × 32.0/22.4 × 12.6
	M	5,040 × 2,832	42.7 × 24.0/16.8 × 9.4
	S	3,360 × 1,888	28.4 × 16.0/ 11.2 × 6.3
DX-based format	L	4,800 × 2,704	40.6 × 22.9/16.0 × 9.0
	M	3,600 × 2,024	30.5 × 17.1/12.0 × 6.7
	S	2,400 × 1,352	20.3 × 11.4/ 8.0 × 4.5

* Approximate size when printed at 300 dpi. Print size in inches equals image size in pixels divided by printer resolution in dots per inch (dpi; 1 inch = approximately 2.54 cm).


Image quality is determined by the option selected for **Image quality** in the shooting menu (☐ 84).



Remote Cords

If **Record movies** is selected for Custom Setting g4 (**Assign shutter button**,  324), the shutter-release buttons on optional remote cords ( 390) can be used to start movie live view and to start and end movie recording.

Recording Movies


Flicker, banding, or distortion may be visible in the monitor and in the final movie under fluorescent, mercury vapor, or sodium lamps or if the camera is panned horizontally or an object moves at high speed through frame (flicker and banding can be reduced using **Flicker reduction**  329). Bright light sources may leave after-images when the camera is panned. Jagged edges, false colors, moiré, and bright spots may also appear. Bright bands may appear at the top or bottom of the frame if the subject is briefly illuminated by a strobe or other bright, momentary light source. When recording movies, avoid pointing the camera at the sun or other strong light sources. Failure to observe this precaution could result in damage to the camera's internal circuitry.

Flash lighting can not be used during movie live view.

Recording ends automatically if the lens is removed.

Live view may end automatically to prevent damage to the camera's internal circuits; exit live view when the camera is not in use. Note that the temperature of the camera's internal circuits may rise and noise (bright spots, randomly-spaced bright pixels, or fog) may be displayed in the following instances (the camera may also become noticeably warm, but this does not indicate a malfunction):

- The ambient temperature is high
- The camera has been used for extended periods in live view or to record movies
- The camera has been used in continuous release mode for extended periods

If live view does not start when you press the  button, wait for the internal circuits to cool and then try again.



Movie Settings

Use the **Movie settings** option in the shooting menu to adjust the following settings.

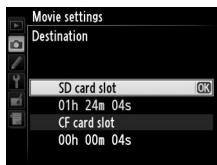
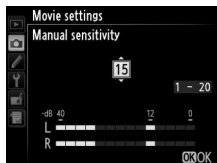
- **Frame size/frame rate, Movie quality:** Choose from the following options:

Option ¹	Maximum bit rate (Mbps)		Maximum length
	★ high quality	Normal	
1080 (60) 1920 × 1080; 30 fps ²	24	12	29 min. 59 s
1080 (25) 1920 × 1080; 25 fps ²	24	12	
1080 (24) 1920 × 1080; 24 fps ²	24	12	
720 (60) 1280 × 720; 60 fps ²	24	12	
720 (50) 1280 × 720; 50 fps ²	24	12	
720 (30) 1280 × 720; 30 fps	12	8	
720 (25) 1280 × 720; 25 fps	12	8	

1 Actual frame rate is 29.97 fps for values listed as 30 fps, 23.976 fps for values listed as 24 fps, and 59.94 fps for values listed as 60 fps.

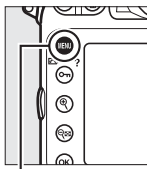
2 Maximum length for ★ **High quality** movies is 20 minutes.

- **Microphone:** Turn the built-in or optional ME-1 stereo microphones on or off or adjust microphone sensitivity. Choose **Auto sensitivity** to adjust sensitivity automatically, **Microphone off** to turn sound recording off; to select microphone sensitivity manually, select **Manual sensitivity**, then highlight an option and press **OK**.
- **Destination:** Choose the slot to which movies are recorded. The menu shows the time available on each card; recording ends automatically when no time remains. Note that regardless of the option selected, photographs are recorded to the card in the primary slot (□ 89).

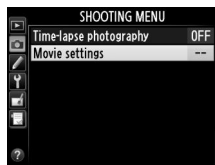


1 Select Movie settings.

Press the **MENU** button to display the menus. Highlight **Movie settings** in the shooting menu and press **▶**.

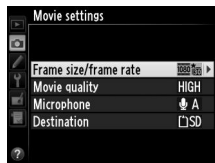


MENU button





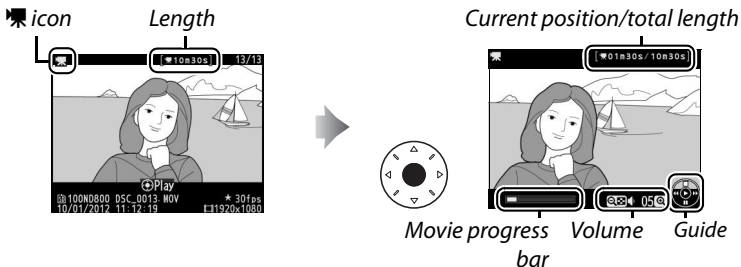
2 Choose movie options.

Highlight the desired item and press **▶**, then highlight an option and press **OK**.















Viewing Movies

Movies are indicated by a  icon in full-frame playback ( 219). Press the center of the multi selector to start playback.





The following operations can be performed:

To	Use	Description
Pause		Pause playback.
Play		Resume playback when movie is paused or during rewind/advance.
Rewind/advance		Speed increases with each press, from 2× to 4× to 8× to 16×; keep pressed to skip to beginning or end of movie (first frame is indicated by  in top right corner of monitor, last frame by ). If playback is paused, movie rewinds or advances one frame at a time; keep pressed for continuous rewind or advance.

To	Use	Description
Skip ahead/ back		Use main command dial to skip to next or previous index, or to skip to the last or first frame if the movie contains no indices (if the movie is more than 30 s long, rotating the main command dial when the last frame is displayed skips back 30 s.).
Adjust volume		Press  to increase volume,  to decrease.
Trim movie		See page 74 for more information.
Exit		Exit to full-frame playback.
Return to shooting mode		Press the shutter-release button halfway to exit to shooting mode.
Display menus	MENU	See page 259 for more information.




The Icon

Movies with indices ( 63) are indicated by a  icon in full-frame playback.





The Icon

 is displayed in full-frame and movie playback if the movie was recorded without sound.



Editing Movies




Trim footage to create edited copies of movies or save selected frames as JPEG stills.

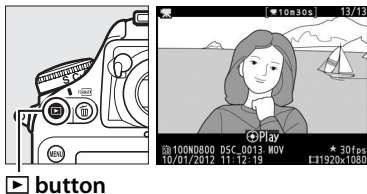
Option	Description
 Choose start/end point	Create a copy from which the opening or closing footage has been removed.
 Save selected frame	Save a selected frame as a JPEG still.

Trimming Movies


To create trimmed copies of movies:

1 Display a movie full frame.

Press the  button to display pictures full frame in the monitor and press  and  to scroll through pictures until the movie you wish to edit is displayed.



2 Choose a starting or end point.

Play the movie back as described on page 72, pressing the center of the multi selector to start and resume playback and  to pause, or rotating the main command dial to skip to an index. Your approximate position in the movie can be ascertained from the movie progress bar.



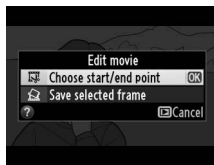
Movie progress bar

3 Display movie edit options.

Press **OK** to display movie edit options.

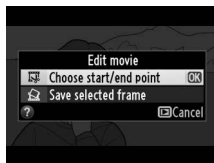


OK button

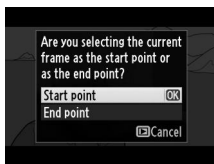


4 Select Choose start/end point.

Highlight **Choose start/**
end point and press **OK**.

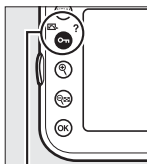


The dialog shown at right will be displayed; choose whether the current frame will be the starting or end point of the copy and press **OK**.



5 Delete frames.

If the desired frame is not currently displayed, press **◀** or **▶** to advance or rewind (to skip to an index, rotate the main command dial).



OK (**↵**/?) button



To switch the current selection from start point (**↵**) to end point (**↶**) or vice versa, press **OK** (**↵**/?).

Once you have selected the start point and/or end point, press **▲**. All frames before the selected start point and after the selected end point will be removed from the copy.




6 Save the copy.

Highlight one of the following and press **OK**:

- **Save as new file:** Save the copy to a new file.
- **Overwrite existing file:** Replace the original movie file with the edited copy.
- **Cancel:** Return to Step 5.
- **Preview:** Preview the copy.



Edited copies are indicated by a  icon in full-frame playback.




Trimming Movies

Movies must be at least two seconds long. If a copy can not be created at the current playback position, the current position will be displayed in red in Step 5 and no copy will be created. The copy will not be saved if there is insufficient space available on the memory card.

Copies have the same time and date of creation as the original.

The Retouch Menu

Movies can also be edited using the **Edit movie** option in the retouch menu ( 341).



Saving Selected Frames

To save a copy of a selected frame as a JPEG still:

1 View the movie and choose a frame.

Play the movie back as described on page 72; your approximate position in the movie can be ascertained from the movie progress bar. Pause the movie at the frame you intend to copy.

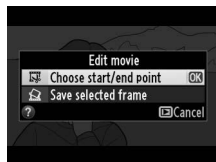


2 Display movie edit options.

Press **OK** to display movie edit options.

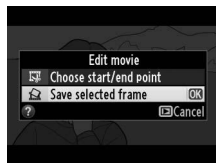


OK button



3 Choose Save selected frame.

Highlight **Save selected frame** and press **OK**.




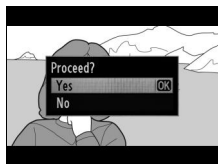
4 Create a still copy.

Press **▲** to create a still copy of the current frame.



5 Save the copy.

Highlight **Yes** and press **OK** to create a fine-quality (84) JPEG copy of the selected frame. Movie stills are indicated by a  icon in full-frame playback.



Save Selected Frame

JPEG movie stills created with the **Save selected frame** option can not be retouched. JPEG movie stills lack some categories of photo information (222).

Image Recording Options

Image Area

Choose the aspect ratio and angle of view (image area). Thanks to the camera's FX format (35.9 × 24 mm) image sensor, you can choose from angles of view as wide as those supported by 35 mm (135) format film cameras, while automatically cropping pictures to the DX angle of view when using DX format lenses. See page 437 for information on the number of pictures that can be stored at different image area settings.

■ ■ *Auto DX Crop*

Choose whether to automatically select a DX crop when a DX lens is attached.







Option	Description
On	Camera automatically selects DX crop when DX lens is attached. If another lens is attached, the crop selected for Choose image area will be used.
Off	Crop selected for Choose image area is used.

Choose Image Area

Choose the image area used when a non-DX lens is attached or a DX-lens is attached with **Off** selected for **Auto DX crop** (82).



Option	Description
 FX (36×24) 1.0× (FX format)	Images are recorded in FX format using the full area of the image sensor (35.9 × 24.0 mm), producing an angle of view equivalent to a NIKKOR lens on a 35mm format camera.
 1.2× (30×20) 1.2×	A 30.0 × 19.9 mm area at the center of the image sensor is used to record photographs. To calculate the approximate focal length of the lens in 35mm format, multiply by 1.2.
 DX (24×16) 1.5× (DX format)	An area at the center of the image sensor 23.4 × 15.6 mm is used to record pictures in DX format. To calculate the approximate focal length of the lens in 35mm format, multiply by 1.5.
 5 : 4 (30×24)	Pictures are recorded with an aspect ratio of 5 : 4 (30.0 × 24.0 mm).

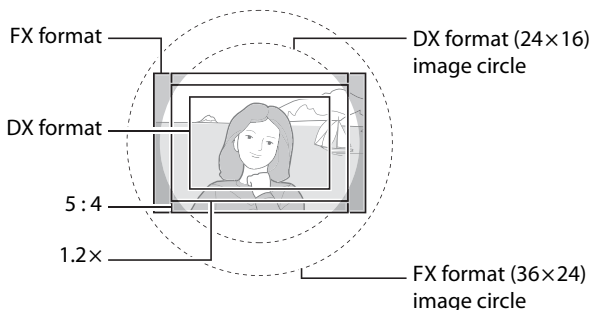
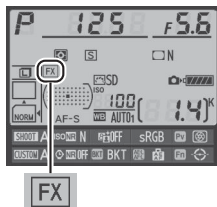


Image Area


The selected option is shown in the information display.



DX Lenses

DX lenses are designed for use with DX format cameras and have a smaller angle of view than lenses for 35mm format cameras. If **Auto DX crop** is off and an option other than **DX (24×16)** (DX format) is selected for **Image area** when a DX lens is attached, the edges of the image may be eclipsed. This may not be apparent in the viewfinder, but when the images are played back you may notice a drop in resolution or that the edges of the picture are blacked out.

The Viewfinder Display

The 1.2×, DX format, and 5 : 4 crops are shown below; the area outside the crop can be viewed in gray when **Off** is selected for Custom Setting a5 (**AF point illumination**,  284).



1.2×



DX format



5 : 4

See Also

See page 67 for information on the crops available in movie live view.

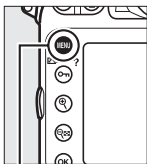


Image area can be set using the **Image area** option in the shooting menu or by pressing a control and rotating a command dial.

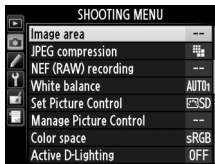
The Image Area Menu

1 Select Image area in the shooting menu.

Press **MENU** to display the menus. Highlight **Image area** in the shooting menu (☞ 268) and press **▶**.



MENU button



2 Choose an option.

Highlight **Auto DX crop** or **Choose image area** and press **▶**.



3 Adjust settings.

Choose an option and press **OK**. The selected crop is displayed in the viewfinder (☞ 81).



OK button



✓ Auto DX Crop

The **Fn** button can not be used to select image area when a DX lens is attached and **Auto DX crop** is on.

✎ Image Size

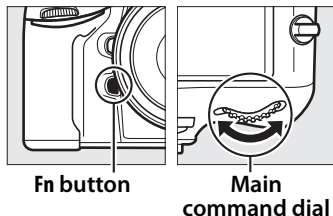
Image size varies with the option selected for image area.

1 Assign image area selection to a camera control.

Select **Choose image area** as the “button + command dials” option for a camera control in the Custom Settings menu (☞ 278). Image area selection can be assigned to the **Fn** button (Custom Setting f4, **Assign Fn button**, ☞ 311), the depth of field preview button (Custom Setting f5, **Assign preview button**, ☞ 315), or the ^{AE-L}/_{AF-L} **AE-L/AF-L button** (Custom Setting f6, **Assign AE-L/AF-L button**, ☞ 315).

2 Use the selected control to choose an image area.

The image area can be selected by pressing the selected button and rotating the main or sub-command dial until the desired crop is displayed in the viewfinder (☞ 81).



The option currently selected for image area can be viewed by pressing the button to display the image area in the control panel, viewfinder, or information display. FX format is displayed as “36 – 24”, 1.2 × as “30 – 20”, DX format as “24 – 16”, and 5 : 4 as “30 – 24”.

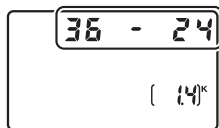


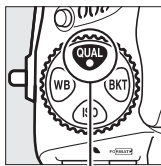
Image Quality

The D800 supports the following image quality options. See page 436 for information on the number of pictures that can be stored at different image quality and size settings.

Option	File type	Description
NEF (RAW)	NEF	RAW data from the image sensor are saved directly to the memory card in Nikon Electronic Format (NEF). Settings such as white balance and contrast can be adjusted on a computer after shooting.
TIFF (RGB)	TIFF (RGB)	Record uncompressed TIFF-RGB images at a bit depth of 8 bits per channel (24-bit color). TIFF is supported by a wide variety of imaging applications.
JPEG fine	JPEG	Record JPEG images at a compression ratio of roughly 1:4 (fine image quality).*
JPEG normal		Record JPEG images at a compression ratio of roughly 1:8 (normal image quality).*
JPEG basic		Record JPEG images at a compression ratio of roughly 1:16 (basic image quality).*
NEF (RAW)+ JPEG fine	NEF/ JPEG	Two images are recorded, one NEF (RAW) image and one fine-quality JPEG image.
NEF (RAW)+ JPEG normal		Two images are recorded, one NEF (RAW) image and one normal-quality JPEG image.
NEF (RAW)+ JPEG basic		Two images are recorded, one NEF (RAW) image and one basic-quality JPEG image.

* **Size priority** selected for **JPEG compression**.

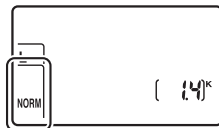
Image quality is set by pressing the **QUAL** button and rotating the main command dial until the desired setting is displayed in the control panel.



QUAL button





**Main
command dial**



Control panel


NEF (RAW) Images

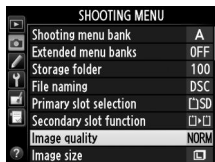
NEF (RAW) images can be viewed on the camera or using software such as Capture NX 2 (available separately;  389) or ViewNX 2 (available on the supplied ViewNX 2 installer CD). JPEG copies of NEF (RAW) images can be created using the **NEF (RAW) processing** option in the retouch menu ( 353).

NEF+JPEG

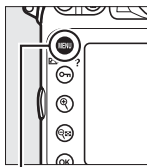
When photographs taken at settings of NEF (RAW) + JPEG are viewed on the camera with only one memory card inserted, only the JPEG image will be displayed. If both copies are recorded to the same memory card, both copies will be erased when the photo is deleted. If the JPEG copy is recorded to a separate memory card using the **Secondary slot function** > **RAW primary, JPEG secondary** option, deleting the JPEG copy will not delete the NEF (RAW) image.

The Image Quality Menu

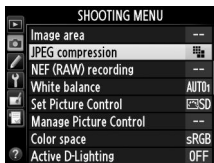
Image quality can also be adjusted using the **Image quality** option in the shooting menu ( 268).



The following options can be accessed from the shooting menu. Press the **MENU** button to display the menus, highlight the desired option and press ►.





MENU button





JPEG Compression

Choose the type of compression for JPEG images.

Option	Description
 Size priority	Images are compressed to produce relatively uniform file size.
 Optimal quality	Optimal image quality. File size varies with scene recorded.

NEF (RAW) Recording > Type

Choose the type of compression for NEF (RAW) images.

Option	Description
 Lossless compressed	NEF images are compressed using a reversible algorithm, reducing file size by about 20–40% with no effect on image quality.
 Compressed	NEF images are compressed using a non-reversible algorithm, reducing file size by about 35–55% with almost no effect on image quality.
Uncompressed	NEF images are not compressed.

NEF (RAW) Recording > NEF (RAW) Bit Depth

Choose a bit depth for NEF (RAW) images.

Option	Description
12-bit 12-bit	NEF (RAW) images are recorded at a bit depth of 12 bits.
14-bit 14-bit	NEF (RAW) images are recorded at a bit depth of 14 bits, producing files larger than those with a bit depth of 12 bits but increasing the color data recorded.

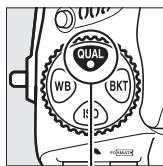
Image Size

Image size is measured in pixels. Choose from **Large**, **Medium**, or **Small** (note that image size varies depending on the option selected for **Image area**, □ 79):

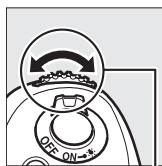
Image area	Option	Size (pixels)	Print size (cm/in.)*
FX (36×24) 1.0× (FX format)	L	7,360 × 4,912	62.3 × 41.6/24.5 × 16.4
	M	5,520 × 3,680	46.7 × 31.2/18.4 × 12.3
	S	3,680 × 2,456	31.2 × 20.8/12.3 × 8.2
1.2× (30×20) 1.2×	L	6,144 × 4,080	52.0 × 34.5/20.5 × 13.6
	M	4,608 × 3,056	39.0 × 25.9/15.4 × 10.2
	S	3,072 × 2,040	26.0 × 17.3/10.2 × 6.8
DX (24×16) 1.5× (DX format)	L	4,800 × 3,200	40.6 × 27.1/16.0 × 10.7
	M	3,600 × 2,400	30.5 × 20.3/12.0 × 8.0
	S	2,400 × 1,600	20.3 × 13.5/ 8.0 × 5.3
5 : 4 (30×24)	L	6,144 × 4,912	52.0 × 41.6/20.5 × 16.4
	M	4,608 × 3,680	39.0 × 31.2/15.4 × 12.3
	S	3,072 × 2,456	26.0 × 20.8/10.2 × 8.2

* Approximate size when printed at 300 dpi. Print size in inches equals image size in pixels divided by printer resolution in **dots per inch** (dpi; 1 inch = approximately 2.54 cm).

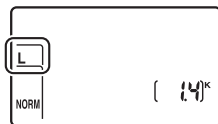
Image size can be set by pressing the **QUAL** button and rotating the sub-command dial until the desired option is displayed in the control panel.



QUAL button



Sub-command dial




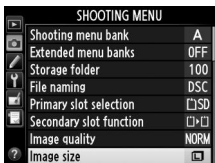
Control panel

NEF (RAW) Images

Note that the option selected for image size does not affect the size of NEF (RAW) images. When opened in software such as ViewNX 2 (supplied) or Capture NX 2 (available separately), NEF (RAW) images have the dimensions given for large (L-size) images in the table on the previous page.

The Image Size Menu

Image size can also be adjusted using the **Image size** option in the shooting menu ( 268).



Using Two Memory Cards

When two memory cards are inserted in the camera, you can choose one as the primary card using the **Primary slot selection** item in the shooting menu. Select **SD card slot** to designate the card in the SD card slot as the primary card, **CF card slot** to choose the CompactFlash card. The roles played by the primary and secondary cards can be chosen using the **Secondary slot function** option in the shooting menu. Choose from **Overflow** (the secondary card is used only when the primary card is full), **Backup** (each picture is recorded to both the primary and secondary card), and **RAW primary, JPEG secondary** (as for **Backup**, except that the NEF/RAW copies of photos recorded at settings of NEF/RAW + JPEG are recorded only to the primary card and the JPEG copies only to the secondary card).



“Backup” and “RAW Primary, JPEG Secondary”

The camera shows the number of exposures remaining on the card with the least amount of memory. Shutter release will be disabled when either card is full.

Recording Movies

When two memory cards are inserted in the camera, the slot used to record movies can be selected using the **Movie settings** > **Destination** option in the shooting menu (☞ 70).

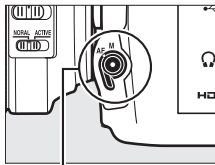


Focus

This section describes the options that control how your camera focuses when photographs are framed in the viewfinder. Focus can be adjusted automatically (see below) or manually (□ 101). The user can also select the focus point for automatic or manual focus (□ 96) or use focus lock to focus to recompose photographs after focusing (□ 98).

Autofocus

To use autofocus, rotate the focus-mode selector to **AF**.



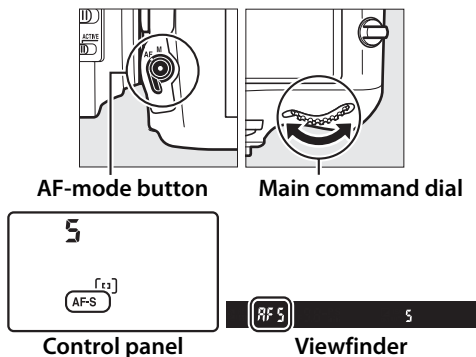
Focus-mode selector

Autofocus Mode

Choose from the following autofocus modes:

Mode	Description
AF-S	Single-servo AF: For stationary subjects. Focus locks when shutter-release button is pressed halfway. At default settings, shutter can only be released when in-focus indicator (●) is displayed (<i>focus priority</i> ; □ 282).
AF-C	Continuous-servo AF: For moving subjects. Camera focuses continuously while shutter-release button is pressed halfway; if subject moves, camera will engage <i>predictive focus tracking</i> (□ 92) to predict final distance to subject and adjust focus as necessary. At default settings, shutter can be released whether or not subject is in focus (<i>release priority</i> ; □ 281).

Autofocus mode can be selected by pressing the AF-mode button and rotating the main command dial until the desired setting is displayed in the viewfinder and control panel.






The AF-ON Button

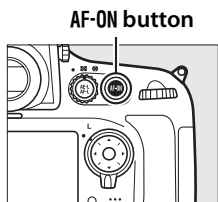
For the purpose of focusing the camera, pressing the **AF-ON** button has the same effect as pressing the shutter-release button halfway.

Predictive Focus Tracking

In **AF-C** mode, the camera will initiate predictive focus tracking if the subject moves toward or away from the camera while the shutter-release button is pressed halfway or the **AF-ON** button is pressed. This allows the camera to track focus while attempting to predict where the subject will be when the shutter is released.

See Also

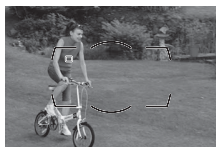
For information on using focus priority in continuous-servo AF, see Custom Setting a1 (**AF-C priority selection**,  281). For information on using release priority in single-servo AF, see Custom Setting a2 (**AF-S priority selection**,  282). For information on preventing the camera from focusing when the shutter-release button is pressed halfway, see Custom Setting a4 (**AF activation**,  283). See page 48 for information on the autofocus options available in live view or during movie recording.



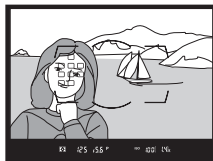
AF-Area Mode

Choose how the focus point for autofocus is selected.

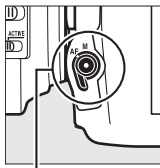
- **Single-point AF:** Select the focus point as described on page 96; the camera will focus on the subject in the selected focus point only. Use with stationary subjects.
- **Dynamic-area AF:** Select the focus point as described on page 96. In **AF-C** focus mode, the camera will focus based on information from surrounding focus points if the subject briefly leaves the selected point. The number of focus points varies with the mode selected:
 - **9-point dynamic-area AF:** Choose when there is time to compose the photograph or when photographing subjects that are moving predictably (e.g., runners or race cars on a track).
 - **21-point dynamic-area AF:** Choose when photographing subjects that are moving unpredictably (e.g., players at a football game).
 - **51-point dynamic-area AF:** Choose when photographing subjects that are moving quickly and can not be easily framed in the viewfinder (e.g., birds).
- **3D-tracking:** Select the focus point as described on page 96. In **AF-C** focus mode, the camera will track subjects that leave the selected focus point and select new focus points as required. Use to quickly compose pictures with subjects that are moving erratically from side to side (e.g., tennis players). If the subject leaves viewfinder, remove your finger from the shutter-release button and recompose the photograph with the subject in the selected focus point.



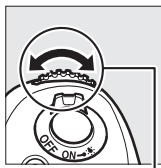
- **Auto-area AF:** The camera automatically detects the subject and selects the focus point; if a face is detected, the camera will give priority to the portrait subject. The active focus points are highlighted briefly after the camera focuses; in **AF-C** mode, the main focus point remains highlighted after the other focus points have turned off.



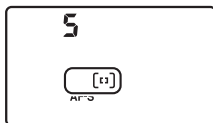
AF-area mode can be selected by pressing the AF-mode button and rotating the sub-command dial until the desired setting is displayed in the viewfinder and control panel.



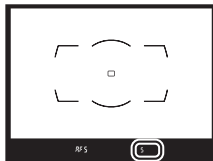
AF-mode button



Sub-command dial



Control panel



Viewfinder

3D-tracking

When the shutter-release button is pressed halfway, the colors in the area surrounding the focus point are stored in the camera. Consequently 3D-tracking may not produce the desired results with subjects that are the same color as the background or that occupy a very small area of the frame.

AF-Area Mode

AF-area mode is shown in the control panel and viewfinder.


AF-area mode	Control panel	Viewfinder	AF-area mode	Control panel	Viewfinder
Single-point AF	S	S	51-point dynamic-area AF*	d5 1	d5 1
9-point dynamic-area AF*	d 9	d 9	3D-tracking	3d	3d
21-point dynamic-area AF*	d2 1	d2 1	Auto-area AF	Auto	Auto

*Only active focus point is displayed in the viewfinder. Remaining focus points provide information to assist focus operation.

Manual Focus

Single-point AF is automatically selected when manual focus is used.

See Also

For information on adjusting how long the camera waits before refocusing when an object moves in front of the camera, see Custom Setting a3 (**Focus tracking with lock-on**,  283). See page 49 for information on the autofocus options available in live view or during movie recording.

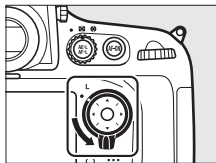


Focus Point Selection

The camera offers a choice of 51 focus points that can be used to compose photographs with the main subject positioned almost anywhere in the frame.

1 Rotate the focus selector lock to ●.

This allows the multi selector to be used to select the focus point.



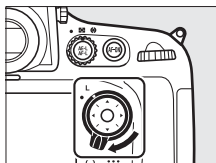
Focus selector lock

2 Select the focus point.

Use the multi selector to select the focus point in the viewfinder while the exposure meters are on. The center focus point can be selected by pressing the center of the multi selector.







The focus selector lock can be rotated to the locked (L) position following selection to prevent the selected focus point from changing when the multi selector is pressed.



Auto-area AF

The focus point for auto-area AF is selected automatically; manual focus-point selection is not available.

See Also

For information on choosing when the focus point is illuminated, see Custom Setting a5 (**AF point illumination**,  284). For information on setting focus-point selection to “wrap around,” see Custom Setting a6 (**Focus point wrap-around**,  284). For information on choosing the number of focus points that can be selected using the multi selector, see Custom Setting a7 (**Number of focus points**,  285). For information on changing the role of the multi selector center button, see Custom Setting f2 (**Multi selector center button**,  309).

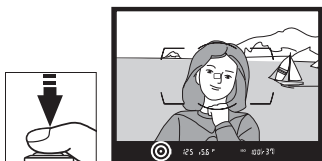


Focus Lock

Focus lock can be used to change the composition after focusing, making it possible to focus on a subject that will not be in a focus point in the final composition. If the camera is unable to focus using autofocus (☐ 91), you can also focus on another subject at the same distance and then use focus lock to recompose the photograph. Focus lock is most effective when an option other than auto-area AF is selected for AF-area mode (☐ 93).

1 Focus.

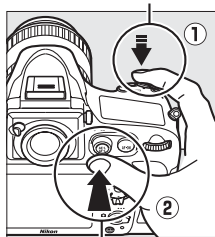
Position the subject in the selected focus point and press the shutter-release button halfway to initiate focus. Check that the in-focus indicator (●) appears in the viewfinder.



2 Lock focus.

AE-C focus mode (☐ 91): With the shutter-release button pressed halfway (①), press the **AE-L/AF-L** button (②) to lock both focus and exposure (an **AE-L** icon will be displayed in the viewfinder). Focus will remain locked while the **AE-L/AF-L** button is pressed, even if you later remove your finger from the shutter-release button.

Shutter-release button



AE-L/AF-L button



AF-S focus mode: Focus locks automatically when the in-focus indicator appears, and remain locked until you remove your finger from the shutter-release button. Focus can also be locked by pressing the **AE-L/AF-L** button (see above).

3 Recompose the photograph and shoot.



Focus will remain locked between shots if you keep the shutter-release button pressed halfway (**AF-S**) or keep the **AE-L/AF-L** button pressed, allowing several photographs in succession to be taken at the same focus setting.



Do not change the distance between the camera and the subject while focus lock is in effect. If the subject moves, focus again at the new distance.

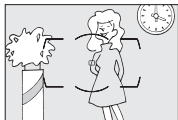


See Also

See Custom Setting c1 (**Shutter-release button AE-L**,  290) for information on using the shutter-release button to lock exposure, Custom Setting f6 (**Assign AE-L/AF-L button**,  315) for information on choosing the role played by **AE-L/AF-L** button.

Getting Good Results with Autofocus

Autofocus does not perform well under the conditions listed below. The shutter release may be disabled if the camera is unable to focus under these conditions, or the in-focus indicator (●) may be displayed and the camera may sound a beep, allowing the shutter to be released even when the subject is not in focus. In these cases, use manual focus (☐ 101) or use focus lock (☐ 98) to focus on another subject at the same distance and then recompose the photograph.



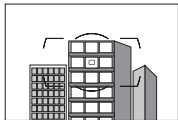
There is little or no contrast between the subject and the background.

Example: Subject is the same color as the background.



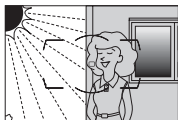
The focus point contains objects at different distances from the camera.

Example: Subject is inside a cage.



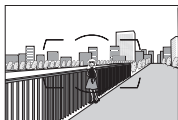
The subject is dominated by regular geometric patterns.

Example: Blinds or a row of windows in a skyscraper.



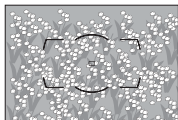
The focus point contains areas of sharply contrasting brightness.

Example: Subject is half in the shade.



Background objects appear larger than the subject.

Example: A building is in the frame behind the subject.



The subject contains many fine details.

Example: A field of flowers or other subjects that are small or lack variation in brightness.

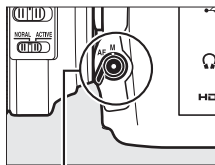
Manual Focus

Manual focus is available for lenses that do not support autofocus (non-AF NIKKOR lenses) or when the autofocus does not produce the desired results (☞ 100).

- **AF-S lenses:** Set the lens focus mode switch to **M**.
- **AF lenses:** Set the lens focus mode switch (if present) and camera focus-mode selector to **M**.

☑ AF Lenses

Do not use AF lenses with the lens focus mode switch set to **M** and the camera focus-mode selector set to **AF**. Failure to observe this precaution could damage the camera or lens.



Focus-mode selector

- **Manual focus lenses:** Set the camera focus-mode selector to **M**.

To focus manually, adjust the lens focus ring until the image displayed on the clear matte field in the viewfinder is in focus. Photographs can be taken at any time, even when the image is not in focus.



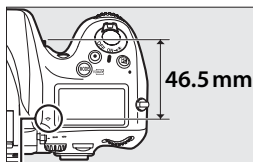
The Electronic Rangefinder

If the lens has a maximum aperture of $f/5.6$ or faster, the viewfinder focus indicator can be used to confirm whether the subject in the selected focus point is in focus (the focus point can be selected from any of the 51 focus points). After positioning the subject in the selected focus point, press the shutter-release button halfway and rotate the lens focus ring until the in-focus indicator (●) is displayed. Note that with the subjects listed on page 100, the in-focus indicator may sometimes be displayed when the subject is not in focus; confirm focus in the viewfinder before shooting.



Focal Plane Position

To determine the distance between your subject and the camera, measure from the focal plane mark (⊖) on the camera body (📖 2). The distance between the lens mounting flange and the focal plane is 46.5 mm (1.83 in.).

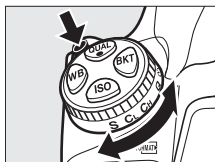



Focal plane mark

Release Mode

Choosing a Release Mode

To choose a release mode, press the release mode dial lock release and turn the release mode dial to the desired setting.



Mode	Description
S Single frame	Camera takes one photograph each time shutter-release button is pressed.
CL Continuous low speed	While shutter-release button is held down, camera takes photographs at frame rate selected for Custom Setting d2 (CL mode shooting speed , □ 293). Lower built-in flash (□ 182); continuous release is not available while flash is raised.
CH Continuous high speed	While shutter-release button is held down, camera records photographs at frame rate given on page 104. Use for moving subjects. Lower built-in flash (□ 182); continuous release is not available while flash is raised.
Q Quiet shutter-release	As for single frame except that noise is reduced by disabling beeps and minimizing sound produced when mirror drops back into place. Beep does not sound when camera focuses regardless of setting selected for Custom Setting d1 (Beep ; □ 292) and mirror does not drop back into place until shutter-release button is returned to halfway position after shooting, allowing you to delay noise made by mirror. Mirror is quieter than in single-frame mode.
 Self-timer	Use self-timer for self-portraits or to reduce blurring caused by camera shake (□ 106).

Mode	Description
Mup Mirror up	Choose this mode to minimize camera shake in telephoto or close-up photography or in other situations in which the slightest camera movement can result in blurred photographs (☞ 108).

Power Source and Frame Rate

The maximum frame advance rate varies with the power source used. The figures below are the average maximum frame rates available with continuous-servo AF, manual or shutter-priority auto exposure, a shutter speed of $1/250$ s or faster, settings other than Custom Setting d2 at default values, and memory remaining in the memory buffer.

Power source	Maximum frame rate ¹
Battery (EN-EL15)	5 fps
EH-5b AC adapter and EP-5B power connector ²	6 fps
MB-D12 battery pack with EN-EL15 battery	5 fps
MB-D12 battery pack with EN-EL18 battery ²	6 fps
MB-D12 battery pack with AA-size batteries ^{2,3}	6 fps

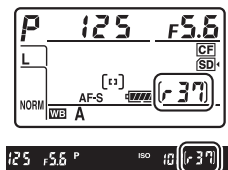


- 1 Regardless of the option selected for Custom Setting d2 (**CL mode shooting speed**), the maximum frame rate when **FX (36×24) 1.0x** or **5 : 4 (30×24)** is selected for image area (☞ 79) is 4 fps.
- 2 The maximum frame advance rate for **C#** is 5 fps when **1.2x (30×20) 1.2x** is selected for image area.
- 3 Frame rates may drop at low temperatures or when the battery is low.

Frame rate drops at slow shutter speeds or when vibration reduction (available with VR lenses) or auto ISO sensitivity control is on (☞ 111), or when the battery is low.

Buffer Size

The approximate number of images that can be stored in the memory buffer at current settings is shown in the exposure-count displays in the viewfinder and control panel while the shutter-release button is pressed halfway. The illustration at right shows the display when space remains in the buffer for about 37 pictures.




The Memory Buffer

The camera is equipped with a memory buffer for temporary storage, allowing shooting to continue while photographs are being saved to the memory card. Up to 100 photographs can be taken in succession; note, however, that frame rate will drop when the buffer is full (r00).

While photographs are being recorded to the memory card, the access lamp will light. Depending on shooting conditions and memory card performance, recording may take from a few seconds to a few minutes. *Do not remove the memory card or remove or disconnect the power source until the access lamp has gone out.* If the camera is switched off while data remain in the buffer, the power will not turn off until all images in the buffer have been recorded. If the battery is exhausted while images remain in the buffer, the shutter release will be disabled and the images transferred to the memory card.

See Also

For information on choosing the maximum number of photographs that can be taken in a single burst, see Custom Setting d3 (**Max. continuous release**,  293). For information on the number of pictures that can be taken in a single burst, see page 436.




Self-Timer Mode

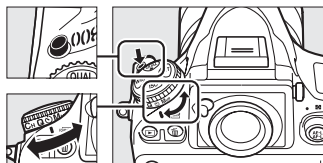
The self-timer can be used to reduce camera shake or for self-portraits.

1 Mount the camera on a tripod.

Mount the camera on a tripod or place the camera on a stable, level surface.

2 Select self-timer mode.

Press the release mode dial lock release and turn the release mode dial to .



Release mode dial

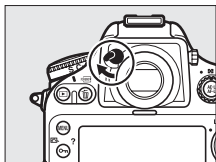
3 Frame the photograph and focus.

In single-servo autofocus (□ 91), photographs can only be taken if the in-focus (●) indicator appears in the viewfinder.



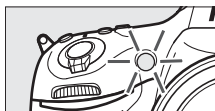
Close the Viewfinder Eyepiece Shutter

When taking photos without your eye to the viewfinder, close the viewfinder eyepiece shutter to prevent light entering via the viewfinder from appearing in photographs or interfering with exposure.



4 Start the timer.

Press the shutter-release button all the way down to start the timer. The self-timer lamp will start to blink. Two seconds before the photograph is taken, the self-timer lamp will stop blinking. The shutter will be released about ten seconds after the timer starts.




To turn the self-timer off before a photograph is taken, turn the release mode dial to another setting.

bulb

Time (bulb) exposures can not be recorded using the self-timer. A fixed shutter speed will be used if a speed of **bulb** is selected in exposure mode *M*.

Using the Built-in Flash

Before taking a photograph with the flash, press the flash pop-up button to raise the flash and wait for the  indicator to be displayed in the viewfinder (□ 181). Shooting will be interrupted if the flash is raised after the self-timer has started. Note that only one photograph will be taken when the flash fires, regardless of the number of exposures selected for Custom Setting c3 (**Self-timer**; □ 291).

See Also

For information on choosing the duration of the self-timer, the number of shots taken, and the interval between shots, see Custom Setting c3 (**Self-timer**, □ 291). For information on setting a beep to sound during the timer count-down, see Custom Setting d1 (**Beep**, □ 292).

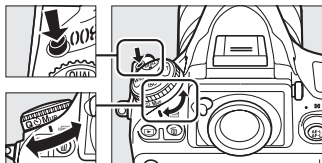


Mirror up Mode

Choose this mode to minimize blurring caused by camera movement when the mirror is raised. Use of a tripod is recommended.

1 Select mirror up mode.

Press the release mode dial lock release and turn the release mode dial to **MUP**.



Release mode dial

2 Raise the mirror.

Frame the picture, focus, and then press the shutter-release button the rest of the way down to raise the mirror.



Mirror Up

While the mirror is raised, photos can not be framed in the viewfinder and autofocus and metering will not be performed.

3 Take a picture.

Press the shutter-release button all the way down again to take a picture. To prevent blurring caused by camera movement, press the shutter-release button smoothly, or use an optional remote cord (☐ 390). The mirror lowers when shooting ends.



Mirror up Mode

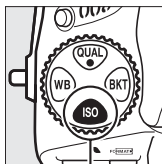
A picture will be taken automatically if no operations are performed for about 30 s after the mirror is raised.

ISO Sensitivity

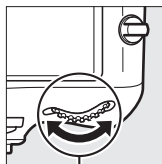
Manual Adjustment

“ISO sensitivity” is the digital equivalent of film speed. Choose from settings that range from ISO 100 to ISO 6400 in steps equivalent to $\frac{1}{3}$ EV. Settings of from about 0.3 to 1 EV below ISO 100 and 0.3 to 2 EV above ISO 6400 are also available for special situations. The higher the ISO sensitivity, the less light needed to make an exposure, allowing higher shutter speeds or smaller apertures.

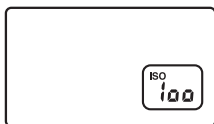
ISO sensitivity can be adjusted by pressing the **ISO** button and rotating the main command dial until the desired setting is displayed in the control panel or viewfinder.



ISO button



Main command dial



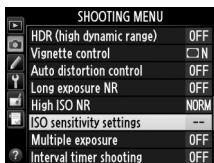
Control panel



Viewfinder

The ISO Sensitivity Menu

ISO sensitivity can also be adjusted using the **ISO sensitivity** option in the shooting menu (☰ 268).



Note that ISO sensitivity can not be adjusted from the shooting menu in movie live view. In exposure mode **M**, ISO sensitivity can however be adjusted using the **ISO** button and main command dial (☰ 109).

Hi 0.3–Hi 2

The settings **Hi 0.3** through **Hi 2** correspond to ISO sensitivities 0.3–2 EV over ISO 6400 (ISO 8000–25600 equivalent). Pictures taken at these settings are more likely to be subject to noise (randomly-spaced bright pixels, fog, or lines).

Lo 0.3–Lo 1

The settings **Lo 0.3** through **Lo 1** correspond to ISO sensitivities 0.3–1 EV below ISO 100 (ISO 80–50 equivalent). Use for larger apertures when lighting is bright. Contrast is slightly higher than normal; in most cases, ISO sensitivities of ISO 100 or above are recommended.

See Also

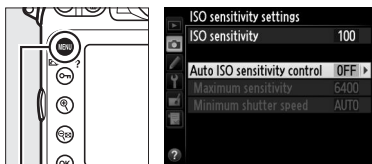
For information on Custom Setting b1 (**ISO sensitivity step value**), see page 287. For information on displaying ISO sensitivity in the control panel or adjusting ISO sensitivity without using the **ISO** button, see Custom Setting d7 (**ISO display and adjustment**; ☰ 295). For information on using the **High ISO NR** option in the shooting menu to reduce noise at high ISO sensitivities, see page 277.

Auto ISO Sensitivity Control

If **On** is selected for **ISO sensitivity settings > Auto ISO sensitivity control** in the shooting menu, ISO sensitivity will automatically be adjusted if optimal exposure can not be achieved at the value selected by the user (ISO sensitivity is adjusted appropriately when the flash is used).

1 Select Auto ISO sensitivity control for ISO sensitivity settings in the shooting menu.

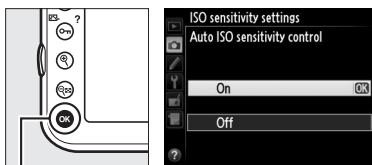
To display the menus, press the **MENU** button. Select **ISO sensitivity settings** in the shooting menu, highlight **Auto ISO sensitivity control**, and press ►.



MENU button

2 Select On.

Highlight **On** and press **OK** (if **Off** is selected, ISO sensitivity will remain fixed at the value selected by the user).



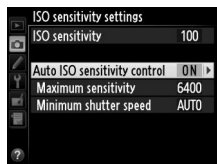
OK button

Auto ISO Sensitivity Control

Noise (randomly-spaced bright pixels, fog, or lines) is more likely at higher sensitivities. Use the **High ISO NR** option in the shooting menu to reduce noise (see page 277). When a flash is used, the value selected for **Minimum shutter speed** is ignored in favor of the option selected for Custom Setting e1 (**Flash sync speed**, □ 299). Note that ISO sensitivity may be raised automatically when auto ISO sensitivity control is used in combination with slow sync flash modes (available with the built-in flash and the optional flash units listed on page 381), possibly preventing the camera from selecting slow shutter speeds.

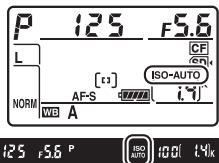
3 Adjust settings.

The maximum value for auto ISO sensitivity can be selected using **Maximum sensitivity** (the minimum value for auto



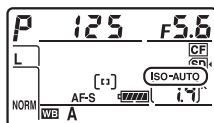
ISO sensitivity is automatically set to ISO 100; note that if the value selected for **Maximum sensitivity** is lower than the value currently selected for **ISO sensitivity**, the value selected for **Maximum sensitivity** will be used). In exposure modes **P** and **A**, sensitivity will only be adjusted if underexposure would result at the shutter speed selected for **Minimum shutter speed** ($1/4000$ – 1 s, or **Auto**; in modes **S** and **M**, ISO sensitivity will be adjusted for optimal exposure at the shutter speed selected by the user). If **Auto** (available only with CPU lenses; equivalent to $1/30$ s when a non-CPU lens is used) is selected, the camera will choose the minimum shutter speed based on the focal length of the lens (auto shutter-speed selection can be fine-tuned by highlighting **Auto** and pressing **▶**; for example, faster values can be used with telephoto lenses to reduce blur). Shutter speeds slower than the minimum value may be used if optimum exposure can not be achieved at the ISO sensitivity value selected for **Maximum sensitivity**. Press **OK** to exit when settings are complete.

When **On** is selected, the viewfinder and control panel show **ISO-AUTO**. When sensitivity is altered from the value selected by the user, these indicators blink and the altered value is shown in the viewfinder.



Turning Auto ISO Sensitivity Control on or Off

You can turn auto ISO sensitivity control on or off by pressing the **ISO** button and rotating the sub-command dial. **ISO-AUTO** is displayed when auto ISO sensitivity control is on.








Exposure

Metering

Metering determines how the camera sets exposure. The following options are available:

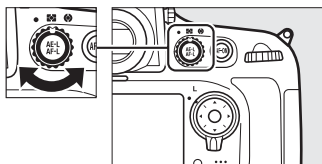
Option	Description
	Matrix: Produces natural results in most situations. Camera meters a wide area of the frame and set exposure according to tone distribution, color, composition, and, with type G or D lenses (☐ 373), distance information (3D color matrix metering III; with other CPU lenses, camera uses color matrix metering III, which does not include 3D distance information). With non-CPU lenses, camera uses color matrix metering if focal length and maximum aperture are specified using Non-CPU lens data option in setup menu (☐ 213); otherwise camera uses center-weighted metering.
	Center-weighted: Camera meters entire frame but assigns greatest weight to center area (if CPU lens is attached, size of area can be selected using Custom Setting b5, Center-weighted area , ☐ 289; if non-CPU lens is attached, area is 12 mm in diameter). Classic meter for portraits; recommended when using filters with an exposure factor (filter factor) over 1x.*
	Spot: Camera meters circle 4 mm (0.16 in.) in diameter (approximately 1.5% of frame). Circle is centered on current focus point, making it possible to meter off-center subjects (if non-CPU lens is used or if auto-area AF is in effect, camera will meter center focus point). Ensures that subject will be correctly exposed, even when background is much brighter or darker.*

* For improved precision with non-CPU lenses, specify lens focal length and maximum aperture in **Non-CPU lens data** menu (☐ 213).



To choose a metering method, rotate the metering selector until the desired setting is displayed in the viewfinder.


Metering selector




Viewfinder



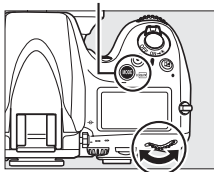
See Also

For information on making separate adjustments to optimal exposure for each metering method, see Custom Setting b6 (**Fine-tune optimal exposure**,  290).

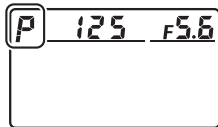
Exposure Mode

To determine how the camera sets shutter speed and aperture when adjusting exposure, press the **MODE** () button and rotate the main command dial until the desired option appears in the control panel.


MODE () button




Main command dial



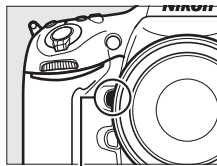
Lens Types

When using a CPU lens equipped with an aperture ring () 373), lock the aperture ring at the minimum aperture (highest f-number). Type G lenses are not equipped with an aperture ring.

Non-CPU lenses can only be used in exposure mode **A** (aperture-priority auto) and **M** (manual). In other modes, exposure mode **A** is automatically selected when a non-CPU lens is attached () 371, 374). The exposure mode indicator (**P** or **S**) will blink in the control panel and **A** will be displayed in the viewfinder.


Depth-of-Field Preview

To preview the effects of aperture, press and hold the depth-of-field preview button. The lens will be stopped down to the aperture value selected by the camera (modes **P** and **S**) or the value chosen by the user (modes **A** and **M**), allowing depth of field to be previewed in the viewfinder.



**Depth-of-field
preview button**

Custom Setting e4—Modeling Flash

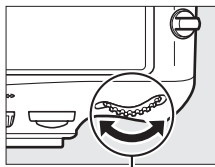
This setting controls whether the built-in flash and optional flash units such as the SB-910, SB-900, SB-800, SB-700, and SB-600 () 381) will emit a modeling flash when the depth-of-field preview button is pressed. See page 307 for more information.

P: Programmed Auto

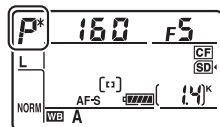
In this mode, the camera automatically adjusts shutter speed and aperture according to a built-in program to ensure optimal exposure in most situations. This mode is recommended for snapshots and other situations in which you want to leave the camera in charge of shutter speed and aperture.

Flexible Program

In exposure mode **P**, different combinations of shutter speed and aperture can be selected by rotating the main command dial while the exposure meters are on (“flexible program”). Rotate the dial to the right for large apertures (small f-numbers) that blur background details or fast shutter speeds that “freeze” motion. Rotate the dial to the left for small apertures (large f-numbers) that increase depth of field or slow shutter speeds that blur motion. All combinations produce the same exposure. While flexible program is in effect, an asterisk (“*”) appears in the control panel. To restore default shutter speed and aperture settings, rotate the dial until the asterisk is no longer displayed, choose another mode, or turn the camera off.



Main command dial



See Also

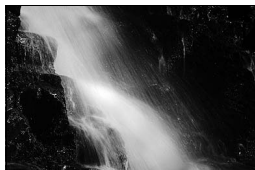
See page 411 for information on the built-in exposure program. For information on activating the exposure meters, see “Auto Meter Off” on page 42.

5: Shutter-Priority Auto

In shutter-priority auto, you choose the shutter speed while the camera automatically selects the aperture that will produce the optimal exposure. Use slow shutter speeds to suggest motion by blurring moving objects, fast shutter speeds to “freeze” motion.

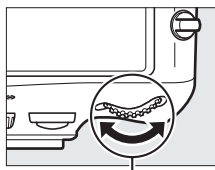


Fast shutter speed ($1/1,600$ s)

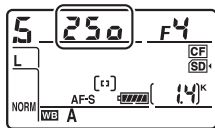


Slow shutter speed ($1/6$ s)

To choose a shutter speed, rotate the main command dial while the exposure meters are on. Shutter speed can be set to “x 250” or to values between 30 s and $1/8,000$ s. Shutter speed can be locked at the selected setting (📖 126).

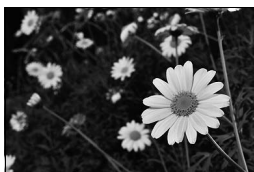


Main command dial



A: Aperture-Priority Auto

In aperture-priority auto, you choose the aperture while the camera automatically selects the shutter speed that will produce the optimal exposure. Large apertures (low f-numbers) increase flash range (📖 187) and reduce depth of field, blurring objects behind and in front of the main subject. Small apertures (high f-numbers) increase depth of field, bringing out details in the background and foreground. Short field depths are generally used in portraits to blur background details, long field depths in landscape photographs to bring the foreground and background into focus.

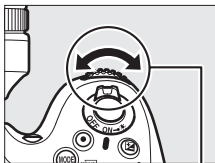


Small aperture (f/36)

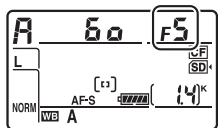


Large aperture (f/2.8)

To choose an aperture between the minimum and maximum values for the lens, rotate the sub-command dial while the exposure meters are on. Aperture can be locked at the selected setting (📖 126).

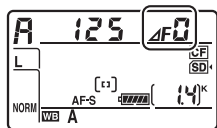


Sub-command dial



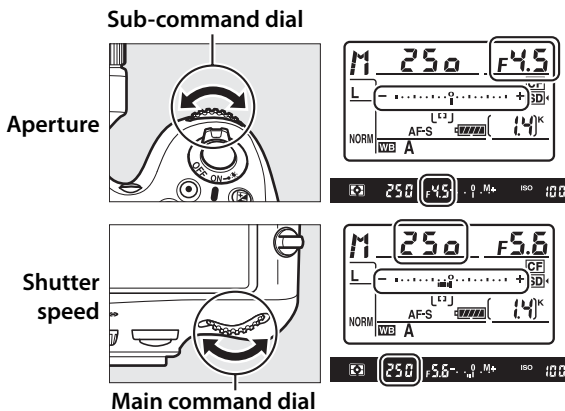
Non-CPU Lenses (📖 371, 374)

Use the lens aperture ring to adjust aperture. If the maximum aperture of the lens has been specified using the **Non-CPU lens data** item in setup menu (📖 213) when a non-CPU lens is attached, the current f-number will be displayed in the viewfinder and control panel, rounded to the nearest full stop. Otherwise the aperture displays will show only the number of stops (**ΔF**, with maximum aperture displayed as **ΔF0**) and the f-number must be read from the lens aperture ring.



M: Manual

In manual exposure mode, you control both shutter speed and aperture. While the exposure meters are on, rotate the main command dial to choose a shutter speed, and the sub-command dial to set aperture. Shutter speed can be set to “x 250” or to values between 30 s and $\frac{1}{8,000}$ s, or the shutter can be held open indefinitely for a long time-exposure (bulb, [124](#)). Aperture can be set to values between the minimum and maximum values for the lens. Use the exposure indicators to check exposure.




Shutter speed and aperture can be locked at the selected setting ([126](#)).

AF Micro NIKKOR Lenses


Provided that an external exposure meter is used, the exposure ratio need only be taken into account when the lens aperture ring is used to set aperture.

Exposure Indicators

The exposure indicators in the viewfinder and control panel show whether the photograph would be under- or over-exposed at current settings. Depending on the option chosen for Custom Setting b2 (**EV steps for exposure cntrl**,  287), the amount of under- or over-exposure is shown in increments of $\frac{1}{3}$ EV, $\frac{1}{2}$ EV, or 1 EV. If the limits of the exposure metering system are exceeded, the exposure indicators and the shutter speed (modes **P** and **A**) and/or aperture (modes **P** and **S**) displays will flash.

Custom Setting b2 set to 1/3 step			
	Optimal exposure	Underexposed by $\frac{1}{3}$ EV	Overexposed by over 3 EV
Control panel	- 0 +	- 0 +	- 0 +
Viewfinder	- . . 0 . . +	- . . 0 . . +	- . . 0 . . +

See Also

For information reversing the exposure indicators so that negative values are displayed on the right and positive values on the left, see Custom Setting f12 (**Reverse indicators**,  319).



Long Time-Exposures

At a shutter speed of $\frac{1}{30}$ s, the shutter will remain open while the shutter-release button is held down. Use for long time-exposure photographs of moving lights, the stars, night scenery, or fireworks. A tripod and optional remote cord (☐ 390) are recommended to prevent blur.



Shutter speed: 35 s; aperture: f/25

1 Ready the camera.

Mount the camera on a tripod or place it on a stable, level surface. If you are using an optional remote cord, attach it to the camera.

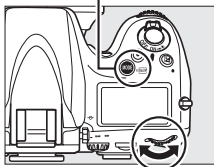
Long Time-Exposures

Close the viewfinder eyepiece shutter to prevent light entering via the viewfinder from appearing in the photograph or interfering with exposure. Nikon recommends using a fully charged EN-EL15 battery or an optional EH-5b AC adapter and EP-5B power connector to prevent loss of power while the shutter is open. Note that noise (bright spots, randomly-spaced bright pixels or fog) may be present in long exposures; before shooting, choose **On** for the **Long exposure NR** option in the shooting menu (☐ 277).

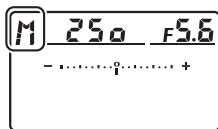
2 Select exposure mode *M*.

Press the **MODE** (FORMAT) button and rotate the main command dial until *M* is displayed in the control panel.

MODE (FORMAT) button

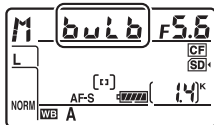


Main command dial



3 Choose a shutter speed.

While the exposure meters are on, rotate the main command dial until “*bulb*” appears in the shutter-speed displays. The exposure indicators do not appear when “*bulb*” is selected.



4 Press the shutter-release button all the way down.

Press the shutter-release button on the camera or remote cord all the way down. The shutter will remain open while the shutter-release button is pressed.

5 Release the shutter-release button.

Remove your finger from the shutter-release button to record the photograph.




Shutter-Speed and Aperture Lock

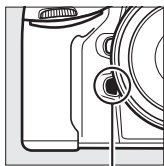
Shutter speed lock is available in shutter-priority auto and manual exposure modes, aperture lock in aperture-priority auto and manual exposure modes. Shutter speed and aperture lock are not available in programmed auto exposure mode.

1 Assign shutter speed and aperture lock to a camera control.

Select **Shutter spd & aperture lock** as the “button + command dials” option in the Custom Settings menu (☞ 314). Shutter speed and aperture lock can be assigned to the **Fn** button (Custom Setting f4, **Assign Fn button**, ☞ 311), the depth-of-field preview button (Custom Setting f5, **Assign preview button**, ☞ 315), or the $\overline{\text{AE-L}}$ **AE-L/AF-L** button (Custom Setting f6, **Assign AE-L/AF-L button**, ☞ 315).

2 Lock shutter speed and/or aperture.

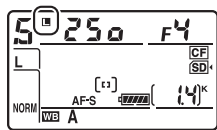
Shutter speed (exposure modes S and M): Press the selected button and rotate the main command dial until  icons appear in the viewfinder and control panel.





Fn button

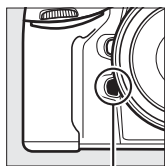


Main command dial

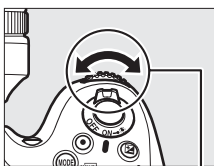


To unlock shutter speed, press the button and rotate the main command dial until the  icons disappear from the displays.

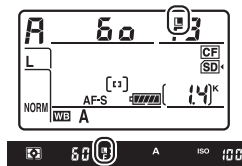
Aperture (exposure modes *A* and *M*): Press the selected button and rotate the sub-command dial until  icons appear in the viewfinder and the control panel.





Fn button



Sub-command dial



To unlock aperture, press the button and rotate the sub-command dial until the  icons disappear from the displays.

 **See Also**

Use Custom Setting f7 (**Shutter spd & aperture lock**;  316) to keep shutter speed and/or aperture locked at the selected values.

Autoexposure (AE) Lock

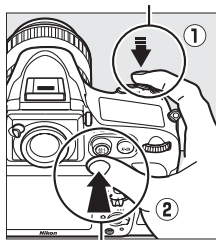
Use autoexposure lock to recompose photographs after using center-weighted metering and spot metering to meter exposure. Note that matrix metering will not produce the desired results.

1 Lock exposure.

Position the subject in the selected focus point and press the shutter-release button halfway. With the shutter-release button pressed halfway and the subject positioned in the focus point, press the AE-L/AF-L button to lock exposure (if you are using autofocus, confirm that the \bullet in-focus indicator appears in the viewfinder).

While exposure lock is in effect, an **AE-L** indicator will appear in the viewfinder.

Shutter-release button

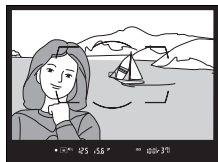


AE-L/AF-L button



2 Recompose the photograph.

Keeping the AE-L/AF-L button pressed, recompose the photograph and shoot.




Metered Area

In spot metering, exposure will be locked at the value metered in a 4-mm (0.16 in.) circle centered on the selected focus point. In center-weighted metering, exposure will be locked at the value metered in a 12-mm circle in the center of the viewfinder.




Adjusting Shutter Speed and Aperture

While exposure lock is in effect, the following settings can be changed without altering the metered value for exposure:

Exposure mode	Setting
P	Shutter speed and aperture (flexible program;  118)
S	Shutter speed
A	Aperture

The new values can be confirmed in the viewfinder and control panel. Note that the metering method can not be changed while exposure lock is in effect (changes to metering take effect when the lock is released).

See Also

If **On** is selected for Custom Setting c1 (**Shutter-release button AE-L**,  290), exposure will lock when the shutter-release button is pressed halfway. For information on changing the role of the  **AE-L/AF-L** button, see Custom Setting f6 (**Assign AE-L/AF-L button**,  315).

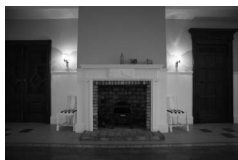


Exposure Compensation

Exposure compensation is used to alter exposure from the value suggested by the camera, making pictures brighter or darker. It is most effective when used with center-weighted or spot metering (115). Choose from values between -5 EV (underexposure) and $+5$ EV (overexposure) in increments of $1/3$ EV. In general, positive values make the subject brighter while negative values make it darker.




-1 EV

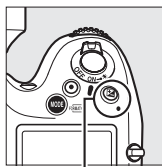


No exposure compensation



+1 EV

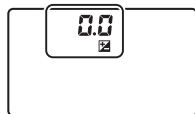
To choose a value for exposure compensation, press the  button and rotate the main command dial until the desired value is displayed in the viewfinder or control panel.



 button

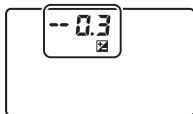


Main command dial

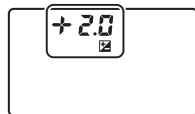


± 0 EV




( button pressed)

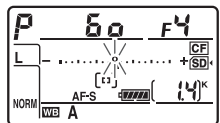


-0.3 EV



+2.0 EV

At values other than ± 0.0 , the 0 at the center of the exposure indicators will flash (exposure modes *P*, *S*, and *A* only) and a  icon will be displayed in the viewfinder and control panel after you release the  button. The current value for exposure compensation can be confirmed in the exposure indicator by pressing the  button.



Normal exposure can be restored by setting exposure compensation to ± 0.0 . Exposure compensation is not reset when the camera is turned off.




Exposure Mode M

In exposure mode *M*, exposure compensation affects only the exposure indicator; shutter speed and aperture do not change.

Using a Flash

When a flash is used, exposure compensation affects both background exposure and flash level.

See Also

For information on choosing the size of the increments available for exposure compensation, see Custom Setting b3 (**Exp./flash comp. step value**,  287). For information on making adjustments to exposure compensation without pressing the  button, see Custom Setting b4 (**Easy exposure compensation**,  288). For information on automatically varying exposure, flash level, white balance, or Active D-Lighting, see page 132.



Bracketing

Bracketing automatically varies exposure, flash level, Active D-Lighting (ADL), or white balance slightly with each shot, “bracketing” the current value. Choose in situations in which it is difficult to set exposure, flash level (i-TTL and, where supported, auto aperture flash control modes only; see pages 185, 301, and 382), Active D-Lighting, or white balance and there is not time to check results and adjust settings with each shot, or to experiment with different settings for the same subject.

■ ■ *Exposure and Flash Bracketing*

To vary exposure and/or flash level over a series of photographs:



Exposure modified by:
0 EV



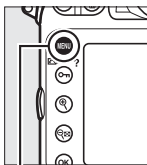
Exposure modified by:
-1 EV



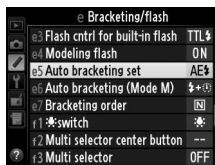
Exposure modified by:
+1 EV



1 Select flash or exposure bracketing for Custom Setting e5 (Auto bracketing set) in the Custom Settings menu.



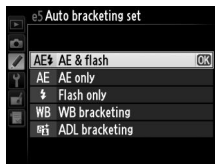
MENU button



To display the menus, press the MENU button. Select Custom Setting e5 (**Auto bracketing set**) in the Custom Settings menu, highlight an option, and press OK.



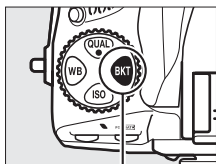
OK button



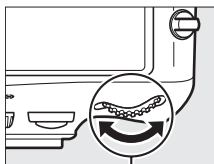
Choose **AE & flash** to vary both exposure and flash level, **AE only** to vary only exposure, or **Flash only** to vary only flash level.

2 Choose the number of shots.

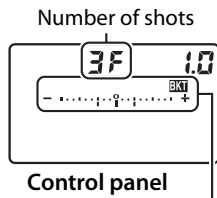
Pressing the BKT button, rotate the main command dial to choose the number of shots in the bracketing sequence. The number of shots is shown in the control panel.



BKT button



Main command dial



Control panel

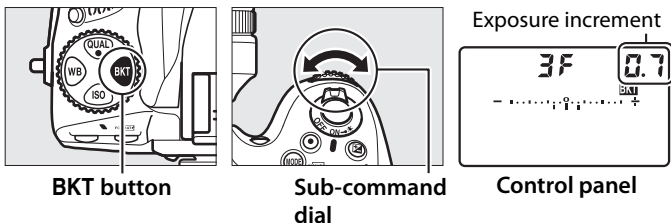
Exposure and flash bracketing indicator

At settings other than zero, a **BKT** icon and exposure and flash bracketing indicators will appear in the control panel and **BKT** will be displayed in the viewfinder.



3 Select an exposure increment.

Pressing the **BKT** button, rotate the sub-command dial to choose the exposure increment.



At default settings, the size of the increment can be chosen from $\frac{1}{3}$, $\frac{2}{3}$, and 1 EV. The bracketing programs with an increment of $\frac{1}{3}$ EV are listed below.

Control panel display	No. of shots	Bracketing order (EVs)
0F 0.3 -o..... +	0	0
+ 3F 0.3 -i... +	3	0/+0.3/+0.7
-- 3F 0.3 -i... +	3	0/-0.7/-0.3
+ 2F 0.3 -i... +	2	0/+0.3
-- 2F 0.3 -i... +	2	0/-0.3
3F 0.3 -i... +	3	0/-0.3/+0.3
5F 0.3 -i... +	5	0/-0.7/-0.3/+0.3/+0.7
7F 0.3 -i... +	7	0/-1.0/-0.7/-0.3/+0.3/ +0.7/+1.0
9F 0.3 -i... +	9	0/-1.3/-1.0/-0.7/-0.3/ +0.3/+0.7/+1.0/+1.3

See Also

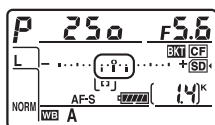
For information on choosing the size of the exposure increment, see Custom Setting b2 (**EV steps for exposure cntrl**, [□ 287](#)). For information on choosing the order in which bracketing is performed, see Custom Setting e7 (**Bracketing order**, [□ 308](#)). For information on choosing the role of the BKT button, see Custom Setting f8 (**Assign BKT button**, [□ 316](#)).

4 Frame a photograph, focus, and shoot.

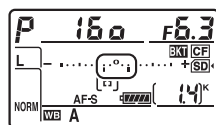


The camera will vary exposure and/or flash level shot-by-shot according to the bracketing program selected. Modifications to exposure are added to those made with exposure compensation (see page 130), making it possible to achieve exposure compensation values of more than 5 EV.

While bracketing is in effect, a bracketing progress indicator will be displayed in the control panel. A segment will disappear from the indicator after each shot.



No. shots: 3; increment: 0.7



Display after first shot

Canceling Bracketing

To cancel bracketing, press the **BKT** button and rotate the main command dial until the number of shots in the bracketing sequence is zero (0F) and **BKT** is no longer displayed. The program last in effect will be restored the next time bracketing is activated. Bracketing can also be cancelled by performing a two-button reset (193), although in this case the bracketing program will not be restored the next time bracketing is activated.



Exposure and Flash Bracketing

In continuous low speed and continuous high speed modes, shooting will pause after the number of shots specified in the bracketing program have been taken. Shooting will resume the next time the shutter-release button is pressed. In self-timer mode, the camera will take the number of shots selected in Step 2 on page 133 each time the shutter-release button is pressed, regardless of the option selected for Custom Setting c3 (**Self-timer**) > **Number of shots** (☐ 291); the interval between shots is however controlled by Custom Setting c3 (**Self-timer**) > **Interval between shots**. In other modes, one shot will be taken each time the shutter-release button is pressed.

If the memory card fills before all shots in the sequence have been taken, shooting can be resumed from the next shot in the sequence after the memory card has been replaced or shots have been deleted to make room on the memory card. If the camera is turned off before all shots in the sequence have been taken, bracketing will resume from the next shot in the sequence when the camera is turned on.

Exposure Bracketing

The camera modifies exposure by varying shutter speed and aperture (programmed auto), aperture (shutter-priority auto), or shutter speed (aperture-priority auto, manual exposure mode). If **On** is selected for **ISO sensitivity settings > Auto ISO sensitivity control** (☐ 111) in modes **P**, **S**, and **A**, the camera will automatically vary ISO sensitivity for optimum exposure when the limits of the camera exposure system are exceeded. Custom Setting e6 (**Auto bracketing (mode M)**, ☐ 308) can be used to change how the camera performs exposure and flash bracketing in manual exposure mode. Bracketing can be performed by varying flash level together with shutter speed and/or aperture, or by varying flash level alone.

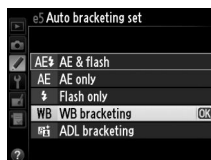


White Balance Bracketing

The camera creates multiple copies of each photograph, each with a different white balance. For more information on white balance, see page 145.

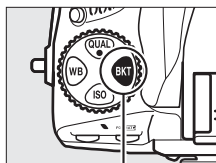
1 Select white balance bracketing.

Choose **WB bracketing** for Custom Setting e5 **Auto bracketing set**.

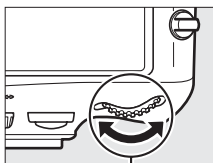


2 Choose the number of shots.

Pressing the **BKT** button, rotate the main command dial to choose the number of shots in the bracketing sequence. The number of shots is shown in the control panel.

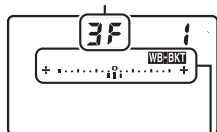


BKT button



Main command dial

Number of shots



Control panel

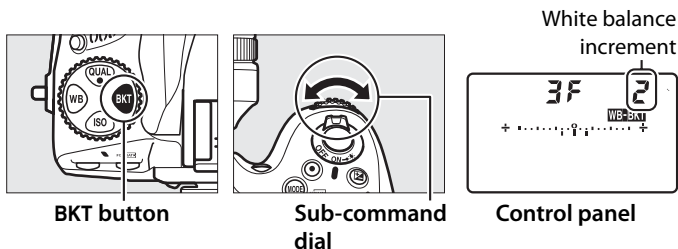
WB bracketing indicator

At settings other than zero, a **WB-BKT** icon and WB bracketing indicator will appear in the control panel and **BKT** will be displayed in the viewfinder.



3 Select a white balance increment.

Pressing the **BKT** button, rotate the sub-command dial to choose the white balance adjustment. Each increment is roughly equivalent to 5 mired.



Choose from increments of 1 (5 mired), 2 (10 mired), or 3 (15 mired). Higher **B** values correspond to increased amounts of blue, higher **A** values to increased amounts of amber (□ 149). The bracketing programs with an increment of 1 are listed below.

Control panel display	No. of shots	White balance increment	Bracketing order
0F 1 +°..... +	0	1	0
63F 1 +:..... +	3	1 B	1 B / 0 / 2 B
A3F 1 +:..... +	3	1 A	1 A / 2 A / 0
62F 1 +:..... +	2	1 B	0 / 1 B
A2F 1 +:..... +	2	1 A	0 / 1 A
3F 1 +:..... +	3	1 A, 1 B	0 / 1 A / 1 B
5F 1 +:..... +	5	1 A, 1 B	0 / 2 A / 1 A / 1 B / 2 B
7F 1 +:..... +	7	1 A, 1 B	0 / 3 A / 2 A / 1 A / 1 B / 2 B / 3 B
9F 1 +:..... +	9	1 A, 1 B	0 / 4 A / 3 A / 2 A / 1 A / 1 B / 2 B / 3 B / 4 B

See Also

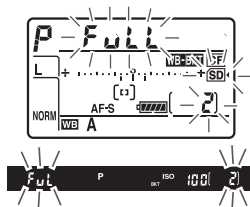
See page 150 for a definition of “mired.”

4 Frame a photograph, focus, and shoot.



Each shot will be processed to create the number of copies specified in the bracketing program, and each copy will have a different white balance. Modifications to white balance are added to the white balance adjustment made with white balance fine-tuning.

If the number of shots in the bracketing program is greater than the number of exposures remaining, **FULL** and the icon for the affected card will flash in the control panel, a flashing **FuLL** icon will appear in the viewfinder as shown at right, and the shutter release will be disabled.



Shooting can begin when a new memory card is inserted.



Canceling Bracketing

To cancel bracketing, press the **BKT** button and rotate the main command dial until the number of shots in the bracketing sequence is zero (0) and **WB-BKT** is no longer displayed. The program last in effect will be restored the next time bracketing is activated. Bracketing can also be cancelled by performing a two-button reset (☐ 193), although in this case the bracketing program will not be restored the next time bracketing is activated.

White Balance Bracketing

White balance bracketing is not available at an image quality of NEF (RAW). Selecting **NEF (RAW)**, **NEF (RAW)+JPEG fine**, **NEF (RAW)+JPEG normal**, or **NEF (RAW)+JPEG basic** cancels white balance bracketing.

White balance bracketing affects only color temperature (the amber-blue axis in the white balance fine-tuning display, ☐ 149). No adjustments are made on the green-magenta axis.

In self-timer mode, the number of copies specified in the white-balance program will be created each time the shutter is released, regardless of the option selected for Custom Setting c3 (**Self-timer**) > **Number of shots** (☐ 291).

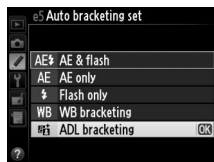
If the camera is turned off while the memory card access lamp is lit, the camera will power off only after all photographs in the sequence have been recorded.

ADL Bracketing

The camera varies Active D-Lighting over a series of exposures. For more information on Active D-Lighting, see page 174.

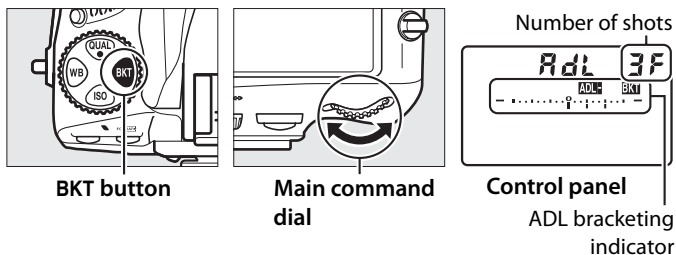
1 Select ADL bracketing.

Choose **ADL bracketing** for Custom Setting e5 **Auto bracketing set**.



2 Choose the number of shots.

Pressing the **BKT** button, rotate the main command dial to choose the number of shots in the bracketing sequence. The number of shots is shown in the control panel.

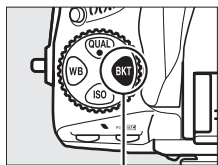


At settings other than zero, a **ADL-BKT** icon and an ADL bracketing indicator will appear in the control panel and **BKT** will be displayed in the viewfinder. Choose two shots to take one photograph with Active D-Lighting off and another at a selected value. Choose three to five shots to take a series of photographs with Active D-Lighting set to **Off**, **Low**, and **Normal** (three shots), **Off**, **Low**, **Normal**, and **High** (four shots), or **Off**, **Low**, **Normal**, **High**, and **Extra high** (five shots). If you choose more than two shots, proceed to Step 4.

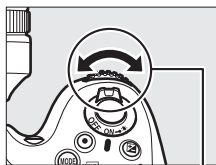


3 Select Active D-Lighting.

Pressing the **BKT** button, rotate the sub-command dial to choose Active D-Lighting.



BKT button



Sub-command dial

Active D-Lighting is shown in the control panel.

Control panel display	Active D-Lighting
The control panel display shows 'AdL 2F' at the top. Below it, a horizontal bar with a dot in the center indicates the current setting. At the bottom, a button labeled 'Auto' is highlighted.	暗A Auto
The control panel display shows 'AdL 2F' at the top. Below it, a horizontal bar with a dot in the center indicates the current setting. At the bottom, a button labeled 'L' is highlighted.	暗L Low
The control panel display shows 'AdL 2F' at the top. Below it, a horizontal bar with a dot in the center indicates the current setting. At the bottom, a button labeled 'n' is highlighted.	暗N Normal
The control panel display shows 'AdL 2F' at the top. Below it, a horizontal bar with a dot in the center indicates the current setting. At the bottom, a button labeled 'H' is highlighted.	暗H High
The control panel display shows 'AdL 2F' at the top. Below it, a horizontal bar with a dot in the center indicates the current setting. At the bottom, a button labeled 'HP' is highlighted.	暗H* Extra high

4 Frame a photograph, focus, and shoot.



The camera will vary Active D-Lighting shot-by-shot according to the bracketing program selected. While bracketing is in effect, a bracketing progress indicator will be displayed in the control panel. A segment will disappear from the indicator after each shot.



Canceling Bracketing

To cancel bracketing, press the **BKT** button and rotate the main command dial until the number of shots in the bracketing sequence is zero (0) and **ADL BKT** is no longer displayed. The program last in effect will be restored the next time bracketing is activated. Bracketing can also be cancelled by performing a two-button reset (☐ 193), although in this case the bracketing program will not be restored the next time bracketing is activated.

ADL Bracketing







In continuous low speed and continuous high speed modes, shooting will pause after the number of shots specified in the bracketing program have been taken. Shooting will resume the next time the shutter-release button is pressed. In self-timer mode, the camera will take the number of shots selected in Step 2 on page 141 each time the shutter-release button is pressed, regardless of the option selected for Custom Setting c3 (**Self-timer**) > **Number of shots** (☐ 291); the interval between shots is however controlled by Custom Setting c3 (**Self-timer**) > **Interval between shots**. In other modes, one shot will be taken each time the shutter-release button is pressed.

If the memory card fills before all shots in the sequence have been taken, shooting can be resumed from the next shot in the sequence after the memory card has been replaced or shots have been deleted to make room on the memory card. If the camera is turned off before all shots in the sequence have been taken, bracketing will resume from the next shot in the sequence when the camera is turned on.

White Balance

White Balance Options

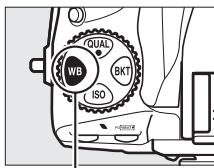
White balance ensures that colors are unaffected by the color of the light source. Auto white balance is recommended with most light sources. If the desired results can not be achieved with auto white balance, choose an option from the list below or use preset white balance.

Option	Color temp. *	Description
AUTO Auto		White balance is adjusted automatically. For best results, use type G or D lens. If built-in or optional flash fires, results are adjusted appropriately.
Normal	3,500–	
Keep warm lighting colors	8,000 K	
 Incandescent	3,000 K	Use under incandescent lighting.
 Fluorescent		Use with:
Sodium-vapor lamps	2,700 K	• Sodium-vapor lighting (found in sports venues).
Warm-white fluorescent	3,000 K	• Warm-white fluorescent lights.
White fluorescent	3,700 K	• White fluorescent lights.
Cool-white fluorescent	4,200 K	• Cool-white fluorescent lights.
Day white fluorescent	5,000 K	• Daylight white fluorescent lights.
Daylight fluorescent	6,500 K	• Daylight fluorescent lights.
High temp. mercury-vapor	7,200 K	• High color temperature light sources (e.g. mercury-vapor lamps).
 Direct sunlight	5,200 K	Use with subjects lit by direct sunlight.
 Flash	5,400 K	Use with built-in or optional flash units.
 Cloudy	6,000 K	Use in daylight under overcast skies.
 Shade	8,000 K	Use in daylight with subjects in the shade.

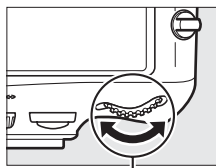
Option	Color temp.*	Description
K Choose color temp.	2,500–10,000 K	Choose color temperature from list of values (☞ 152).
PRE Preset manual	—	Use subject, light source, or existing photograph as reference for white balance (☞ 154).

* All values are approximate and do not reflect fine-tuning (if applicable).

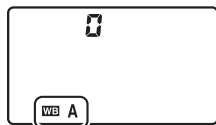
White balance can be selected by pressing the **WB** button and rotating the main command dial until the desired setting is displayed in the control panel.



WB button



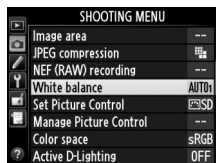
Main command dial




Control panel

The Shooting Menu

White balance can also be adjusted using the **White balance** option in the shooting menu (☞ 268), which also can be used to fine-tune white balance (☞ 148) or measure a value for preset white balance (☞ 154). The **Auto** option in the **White balance** menu offers a choice of




Normal and **Keep warm lighting colors**, which preserves the warm colors produced by incandescent lighting, while the  **Fluorescent** option can be used to select the light source from the bulb types.

Studio Flash Lighting













Auto white balance may not produce the desired results with large studio flash units. Use preset white balance or set white balance to **Flash** and use fine-tuning to adjust white balance.

See Also

When **WB bracketing** is selected for Custom Setting e5 (**Auto bracketing set**,  307), the camera will create several images each time the shutter is released. White balance will be varied with each image, “bracketing” the value currently selected for white balance. See page 137 for more information.

Color Temperature

The perceived color of a light source varies with the viewer and other conditions. Color temperature is an objective measure of the color of a light source, defined with reference to the temperature to which an object would have to be heated to radiate light in the same wavelengths. While light sources with a color temperature in the neighborhood of 5,000–5,500 K appear white, light sources with a lower color temperature, such as incandescent light bulbs, appear slightly yellow or red. Light sources with a higher color temperature appear tinged with blue. The camera white balance options are adapted to the following color temperatures:

- | | |
|--|--|
| <ul style="list-style-type: none">•  (sodium-vapor lamps): 2,700 K•  (incandescent)/
 (warm-white fluorescent):
3,000 K•  (white fluorescent): 3,700 K•  (cool-white fluorescent):
4,200 K•  (day white fluorescent):
5,000 K | <ul style="list-style-type: none">•  (direct sunlight): 5,200 K•  (flash): 5,400 K•  (cloudy): 6,000 K•  (daylight fluorescent): 6,500 K•  (high temp. mercury-vapor):
7,200 K•  (shade): 8,000 K |
|--|--|

Fine-Tuning White Balance

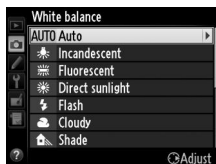
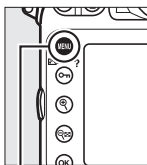
White balance can be “fine-tuned” to compensate for variations in the color of the light source or to introduce a deliberate color cast into an image. White balance is fine-tuned using the **White balance** option in the shooting menu or by pressing the **WB** button and rotating the sub-command dial.

The White Balance Menu

- 1 Select a white balance option in the shooting menu.

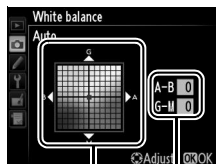
To display the menus, press the **MENU** button. Select

White balance in the shooting menu, then highlight a white balance option and press **▶**. If an option other than **Auto**, **Fluorescent**, **Choose color temp.**, or **Preset manual** is selected, proceed to Step 2. If **Auto** or **Fluorescent** is selected, highlight a lighting type and press **▶**. For information on fine-tuning preset white balance, see page 159.

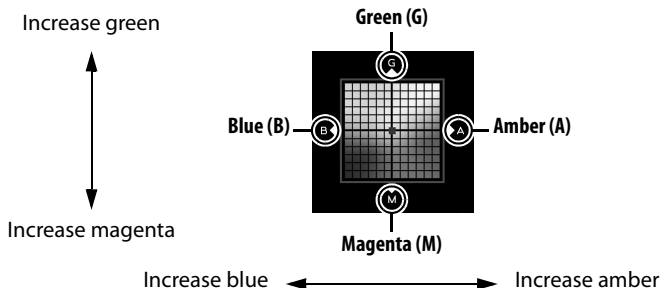


2 Fine-tune white balance.

Use the multi selector to fine-tune white balance. White balance can be fine-tuned on the amber (A)–blue (B) axis and the green (G)–magenta (M) axis. The horizontal (amber–blue) axis corresponds to color temperature, with each increment equivalent to about 5 mired. The vertical (green–magenta) axis has the similar effects to the corresponding color compensation (CC) filters.

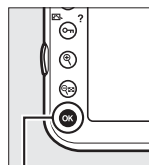


Coordinates Adjustment

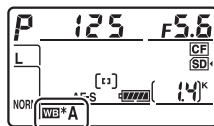


3 Press **OK**.


Press **OK** to save settings and return to the shooting menu. If white balance has been fine-tuned, an asterisk ("*****") will be displayed in the control panel.



OK button



White Balance Fine-Tuning

The colors on the fine-tuning axes are relative, not absolute. For example, moving the cursor to **B** (blue) when a “warm” setting such as  (**Incandescent**) is selected for white balance will make photographs slightly “colder” but will not actually make them blue.

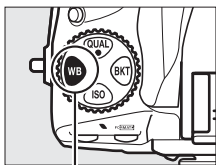
“Mired”

Any given change in color temperature produces a greater difference in color at low color temperatures than it would at higher color temperatures. For example, a change of 1000 K produces a much greater change in color at 3000 K than at 6000 K. Mired, calculated by multiplying the inverse of the color temperature by 10^6 , is a measure of color temperature that takes such variation into account, and as such is the unit used in color-temperature compensation filters. E.g.:

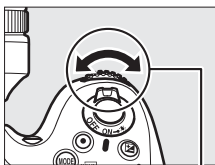
- 4000 K–3000 K (a difference of 1000 K)=83 mired
- 7000 K–6000 K (a difference of 1000 K)=24 mired

The WB Button

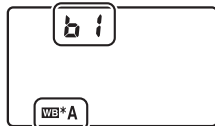
At settings other than **☑ (Choose color temp.)** and **PRE (Preset manual)**, the **WB** button can be used to fine-tune white balance on the amber (A)–blue (B) axis (☐ 149; to fine-tune white balance when **PRE** is selected, use the shooting menu as described on page 148). Six settings in both directions are available; each increment is equivalent to about 5 mired (☐ 150). Press the **WB** button and rotate the sub-command dial until the desired value is displayed in the control panel. Rotating the sub-command dial to the left increases the amount of amber (A). Rotating the sub-command dial to the right increases the amount of blue (B). At settings other than 0, an asterisk (“*”) appears in the control panel.



WB button



Sub-command dial



Control panel



Choosing a Color Temperature

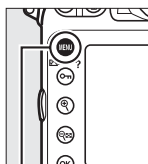
When **☑ (Choose color temp.)** is selected for white balance, color temperature can be selected using the **White balance** option in the shooting menu or by using the **WB** button, multi selector, and sub-command dial.

The White Balance Menu

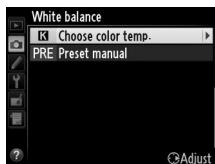
Enter values for the amber-blue and green-magenta axes (📖 149).

1 Select Choose color temp.

Press the **MENU** button and select **White balance** in the shooting menu. Highlight **Choose color temp.** and press **▶**.

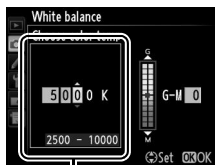


MENU button



2 Select a value for amber-blue.

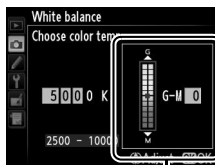
Press **◀** or **▶** to highlight digits and press **▲** or **▼** to change.



Value for amber (A)-blue (B) axis


3 Select a value for green-magenta.

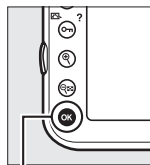
Press **◀** or **▶** to highlight the G (green) or M (magenta) axis and press **▲** or **▼** to select a value.



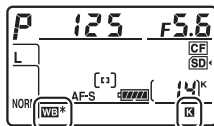
Value for green (G)-magenta (M) axis

4 Press .






Press  to save changes and return to the shooting menu. If a value other than 0 is selected for the green (G)–magenta (M) axis, an asterisk (“*”) will be displayed in the control panel.

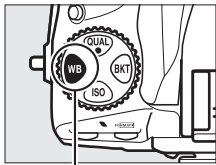


 button

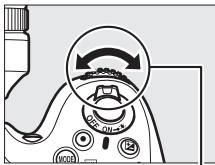


The WB Button

The **WB** button can be used to select the color temperature for the amber (A)–blue (B) axis only. Press the **WB** button and rotate the sub-command dial until the desired value is displayed in the control panel (adjustments are made in mireds;  150). To enter a color temperature directly in increments of 10 K., press the **WB** button and press  or  to highlight a digit and press  or  to change.



WB button





Sub-command dial



Control panel

Choose Color Temperature

Note that the desired results will not be obtained with flash or fluorescent lighting. Choose  (**Flash**) or  (**Fluorescent**) for these sources. With other light sources, take a test shot to determine if the selected value is appropriate.

Preset Manual

Preset manual is used to record and recall custom white balance settings for shooting under mixed lighting or to compensate for light sources with a strong color cast. The camera can store up to four values for preset white balance in presets d-1 through d-4. Two methods are available for setting preset white balance:

Method	Description
Direct measurement	Neutral gray or white object is placed under lighting that will be used in final photograph and white balance is measured by camera (☞ 155).
Copy from existing photograph	White balance is copied from photo on memory card (☞ 158).



White Balance Presets

Changes to white balance presets apply to all shooting menu banks (☞ 269). A confirmation dialog will be displayed if the user attempts to change a white balance preset created in another shooting menu bank.

Measuring Preset White Balance

Preset manual white balance can not be measured during live view (☞ 45, 59), while you are shooting an HDR photograph (☞ 176) or multiple exposure (☞ 195), or when **Record movies** is selected for Custom Setting g4 (**Assign shutter button**, ☞ 324).

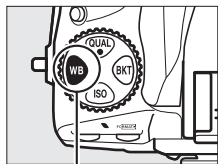
Measuring a Value for White Balance

1 Light a reference object.

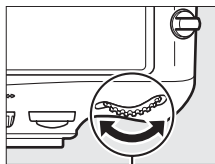
Place a neutral gray or white object under the lighting that will be used in the final photograph. In studio settings, a standard gray panel can be used as a reference object. Note that exposure is automatically increased by 1 EV when measuring white balance; in exposure mode *M*, adjust exposure so that the exposure indicator shows ± 0 (☞ 123).

2 Set white balance to PRE (Preset manual).

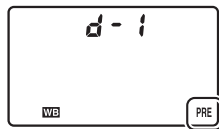
Press the **WB** button and rotate the main command dial until **PRE** is displayed in the control panel.



WB button



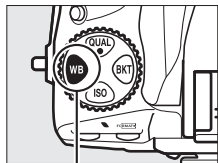
Main command dial



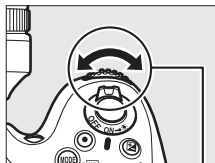
Control panel

3 Select a preset.

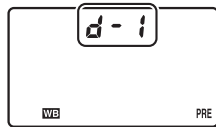
Press the **WB** button and rotate the sub-command dial until the desired white balance preset (d-1 to d-4) is displayed in the control panel.



WB button



Sub-command dial

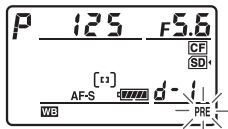


Control panel



4 Select direct measurement mode.

Release the **WB** button briefly and then press the button until the **PRE** icon in the control panel starts to flash. A flashing **P-E** will also appear in the viewfinder. The displays will flash for about six seconds.



Control panel



Viewfinder

5 Measure white balance.

Before the indicators stop flashing, frame the reference object so that it fills the viewfinder and press the shutter-release button all the way down. The camera will measure a value for white balance and store it in the preset selected in Step 3. No photograph will be recorded; white balance can be measured accurately even when the camera is not in focus.



Protected Presets

If the current preset is protected (☐ 161), **P-E** will flash in the control panel and viewfinder if you attempt to measure a new value.

6 Check the results.

If the camera was able to measure a value for white balance, **Good** will flash in the control panel for about six seconds, while the viewfinder will show a flashing **Wd**.

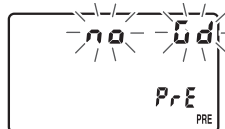


Control panel



Viewfinder

If lighting is too dark or too bright, the camera may be unable to measure white balance. A flashing **no Wd** will appear in the control panel and viewfinder for about six seconds. Press the shutter-release button halfway to return to Step 5 and measure white balance again.



Control panel



Viewfinder

Direct Measurement Mode

If no operations are performed while the displays are flashing, direct measurement mode will end in the time selected for Custom Setting c2 (**Auto meter-off delay**, 291).

Selecting a Preset

Selecting **Preset manual** for the **White balance** option in the shooting menu displays the dialog shown at right; highlight a preset and press **OK**. If no value currently exists for the selected preset, white balance will be set to 5,200 K, the same as **Direct sunlight**.

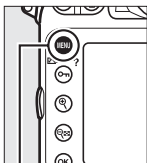


Copying White Balance from a Photograph

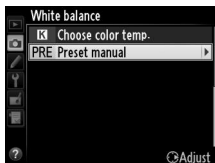
Follow the steps below to copy a value for white balance from an existing photograph to a selected preset.

1 Select PRE (Preset manual) for White balance in the shooting menu.

Press the **MENU** button and select **White balance** in the shooting menu. Highlight **Preset manual** and press **▶**.



MENU button



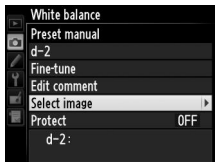
2 Select a destination.

Highlight the destination preset (d-1 to d-4) and press the center of the multi selector.




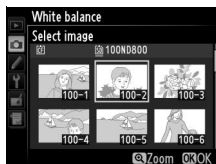
3 Choose Select image.



Highlight **Select image** and press **▶**.

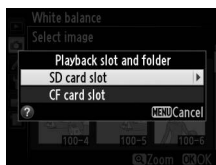


4 Highlight a source image.



Highlight the source image. To view the highlighted image full frame, press the  button.

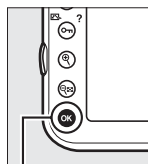


To view images in other locations, press  and select the desired card and folder ( 221).





5 Copy white balance.

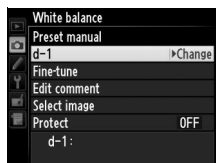
Press  to copy the white balance value for the highlighted photograph to the selected preset. If the highlighted photograph has a comment ( 333), the comment will be copied to the comment for the selected preset.



 **OK button**

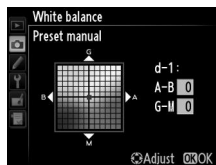
Choosing a White Balance Preset

Press  to highlight the current white balance preset (d-1 – d-4) and press  to select another preset.



Fine-Tuning Preset White Balance

The selected preset can be fine-tuned by selecting **Fine-tune** and adjusting white balance as described on page 149.

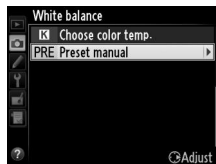


Entering a Comment

Follow the steps below to enter a descriptive comment of up to thirty-six characters for a selected white balance preset.

1 Select PRE (Preset manual).

Highlight **Preset manual** in the white balance menu (📖 158) and press ►.



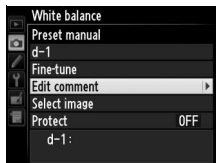
2 Select a preset.

Highlight the desired preset and press the center of the multi selector.



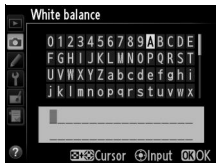
3 Select Edit comment.

Highlight **Edit comment** and press ►.



4 Edit the comment.

Edit the comment as described on page 170.

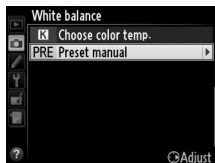


Protecting a White Balance Preset

Follow the steps below to protect the selected white balance preset. Protected presets can not be modified and the **Fine-tune** and **Edit comment** options can not be used.

1 Select PRE (Preset manual).

Highlight **Preset manual** in the white balance menu (📖 158) and press ▶.



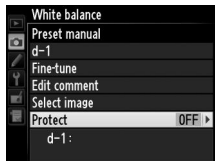
2 Select a preset.

Highlight the desired preset and press the center of the multi selector.



3 Select Protect.

Highlight **Protect** and press ▶.



4 Select On.

Highlight **On** and press **OK** to protect the selected white balance preset. To remove protection, select **Off**.



OK button

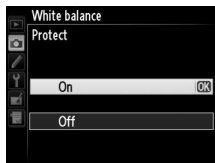








Image Enhancement

Picture Controls

Nikon's unique Picture Control system makes it possible to share image processing settings, including sharpening, contrast, brightness, saturation, and hue, among compatible devices and software.

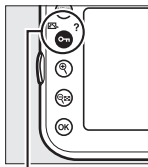
Selecting a Picture Control


The camera offers a choice of preset Picture Controls. Choose a Picture Control according to the subject or type of scene.

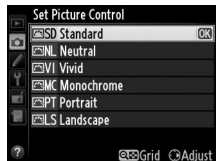
Option	Description
 SD Standard	Standard processing for balanced results. Recommended for most situations.
 NL Neutral	Minimal processing for natural results. Choose for photographs that will later be extensively processed or retouched.
 VI Vivid	Pictures are enhanced for a vivid, photoprint effect. Choose for photographs that emphasize primary colors.
 MC Monochrome	Take monochrome photographs.
 PT Portrait	Process portraits for skin with natural texture and a rounded feel.
 LS Landscape	Produces vibrant landscapes and cityscapes.

1 Press (P/?).


A list of Picture Controls will be displayed.



 (P/?)

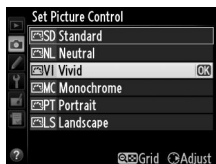


2 Select a Picture Control.

Highlight the desired Picture Control and press .




 button

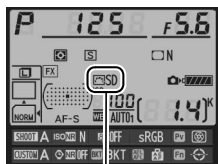


Preset Picture Controls Versus Custom Picture Controls

The Picture Controls supplied with the camera are referred to as *preset Picture Controls*. *Custom Picture Controls* are created through modifications to existing Picture Controls using the **Manage Picture Control** option in the shooting menu (📖 169). Custom Picture Controls can be saved to a memory card for sharing among other D800 cameras and compatible software (📖 172).

The Picture Control Indicator

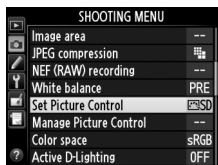
The current Picture Control is shown in the information display when the  button is pressed.



Picture Control indicator

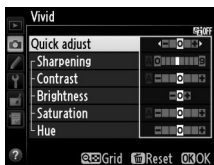
The Shooting Menu

Picture Controls can also be selected using the **Set Picture Control** option in the shooting menu (📖 268).



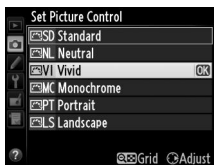
Modifying Existing Picture Controls

Existing preset or custom Picture Controls (📖 169) can be modified to suit the scene or the user's creative intent. Choose a balanced combination of settings using **Quick adjust**, or make manual adjustments to individual settings.



1 Select a Picture Control.

Highlight the desired Picture Control in the Picture Control list (📖 163) and press ►.



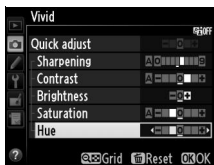
2 Adjust settings.

Press ▲ or ▼ to highlight the desired setting and press ◀ or ▶ to choose a value (📖 166).



Repeat this step until all settings have been adjusted, or

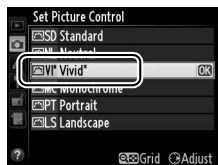
select **Quick adjust** to choose a preset combination of settings. Default settings can be restored by pressing the 🗑️ (FORMAT) button.



3 Press OK.

📌 Modifications to Original Picture Controls

Picture Controls that have been modified from default settings are indicated by an asterisk ("*") in the **Set Picture Control** menu.



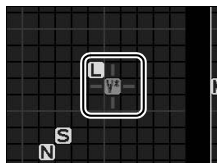
Picture Control Settings

Option	Description	
Quick adjust	Choose from options between -2 and +2 to reduce or exaggerate the effect of the selected Picture Control (note that this resets all manual adjustments). For example, choosing positive values for Vivid makes pictures more vivid. Not available with Neutral , Monochrome , or custom Picture Controls.	
Manual adjustments (all Picture Controls)	Sharpening	Control the sharpness of outlines. Select A to adjust sharpening automatically according to the type of scene, or choose from values between 0 (no sharpening) and 9 (the higher the value, the greater the sharpening).
	Contrast	Select A to adjust contrast automatically according to the type of scene, or choose from values between -3 and +3 (choose lower values to prevent highlights in portrait subjects from being “washed out” in direct sunlight, higher values to preserve detail in misty landscapes and other low-contrast subjects).
	Brightness	Choose -1 for reduced brightness, +1 for enhanced brightness. Does not affect exposure.
Manual adjustments (non-monochrome only)	Saturation	Control the vividness of colors. Select A to adjust saturation automatically according to the type of scene, or choose from values between -3 and +3 (lower values reduce saturation and higher values increase it).
	Hue	Choose negative values (to a minimum of -3) to make reds more purple, blues more green, and greens more yellow, positive values (up to +3) to make reds more orange, greens more blue, and blues more purple.
Manual adjustments (monochrome only)	Filter effects	Simulate the effect of color filters on monochrome photographs. Choose from OFF , yellow, orange, red, and green (□ 167).
	Toning	Choose the tint used in monochrome photographs from B&W (black-and-white), Sepia , Cyanotype (blue-tinted monochrome), Red , Yellow , Green , Blue Green , Blue , Purple Blue , Red Purple (□ 168).





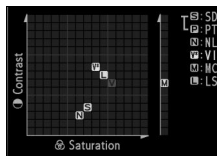
✓ “A” (Auto)

Results for auto sharpening, contrast, and saturation vary with exposure and the position of the subject in the frame. Use a type G or D lens for best results. The icons for Picture Controls that use auto contrast and saturation are displayed in green in the Picture Control grid, and lines appear parallel to the axes of the grid.



✎ The Picture Control Grid

Pressing the  button in Step 2 on page 165 displays a Picture Control grid showing the contrast and saturation for the selected Picture Control in relation to the other Picture Controls (only contrast is displayed when **Monochrome** is selected). Release the  button to return to the Picture Control menu.



✎ Previous Settings

The line under the value display in the Picture Control setting menu indicates the previous value for the setting. Use this as a reference when adjusting settings.



✎ Filter Effects (Monochrome Only)

The options in this menu simulate the effect of color filters on monochrome photographs. The following filter effects are available:

Option	Description
Y Yellow	Enhances contrast. Can be used to tone down the brightness of the sky in landscape photographs.
O Orange	Orange produces more contrast than yellow, red more contrast than orange.
R Red	
G Green	Softens skin tones. Can be used for portraits.

Note that the effects achieved with **Filter effects** are more pronounced than those produced by physical glass filters.



Toning (Monochrome Only)

Pressing ▼ when **Toning** is selected displays saturation options. Press ◀ or ▶ to adjust saturation. Saturation control is not available when **B&W** (black-and-white) is selected.



Custom Picture Controls

The options available with custom Picture Controls are the same as those on which the custom Picture Control was based.



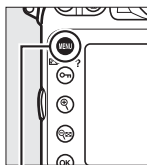
Creating Custom Picture Controls

The preset Picture Controls supplied with the camera can be modified and saved as custom Picture Controls.

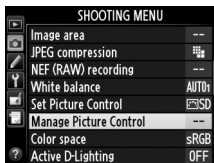
1 Select Manage Picture Control in the shooting menu.

To display the menus, press the MENU button. Highlight **Manage**

Picture Control in the shooting menu and press ►.

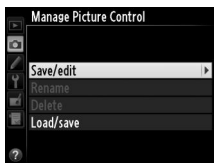


MENU button



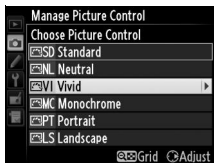
2 Select Save/edit.

Highlight **Save/edit** and press ►.





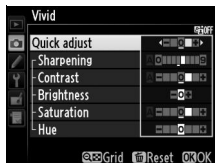
3 Select a Picture Control.

Highlight an existing Picture Control and press ►, or press OK to proceed to Step 5 to save a copy of the highlighted Picture Control without further modification.




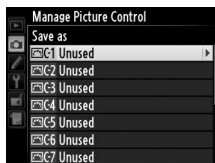
4 Edit the selected Picture Control.

See page 166 for more information. To abandon any changes and start over from default settings, press the  (FORMAT) button. Press  when settings are complete.



5 Select a destination.

Choose a destination for the custom Picture Control (C-1 through C-9) and press .







6 Name the Picture Control.

The text-entry dialog shown at right will be displayed. By default, new Picture



Keyboard area

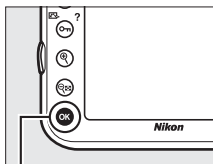
Name area

Controls are named by adding a two-digit number (assigned automatically) to the name of the existing Picture Control; to use the default name, proceed to Step 7. To move the cursor in the name area, hold the  button and press  or . To enter a new letter at the current cursor position, use the multi selector to highlight the desired character in the keyboard area and press the center of the multi selector. To delete the character at the current cursor position, press the  (FORMAT) button.

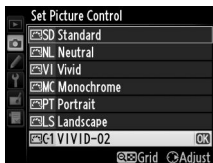
Custom Picture Control names can be up to nineteen characters long. Any characters after the nineteenth will be deleted.

7 Save changes and exit.

Press **OK** to save changes and exit. The new Picture Control will appear in the Picture Control list.



OK button



Manage Picture Control > Rename

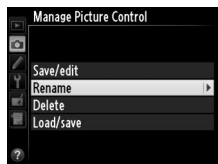
Custom Picture Controls can be renamed at any time using the **Rename** option in the **Manage Picture Control** menu.

Manage Picture Control > Delete

The **Delete** option in the **Manage Picture Control** menu can be used to delete selected custom Picture Controls when they are no longer needed.

The Original Picture Control Icon

The original preset Picture Control on which the custom Picture Control is based is indicated by an icon in the top right corner of the edit display.



Original Picture Control icon



Sharing Custom Picture Controls

Custom Picture Controls created using the Picture Control Utility available with ViewNX 2 or optional software such as Capture NX 2 can be copied to a memory card and loaded into the camera, or custom Picture Controls created with the camera can be copied to the memory card to be used in other D800 cameras and compatible software and then deleted when no longer needed (if two memory cards are inserted, the card in the primary slot will be used; □ 89).

To copy custom Picture Controls to or from the memory card, or to delete custom Picture Controls from the memory card, highlight

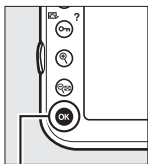
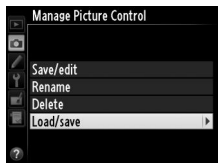
Load/Save in the **Manage**

Picture Control menu and press ►. The following options will be displayed:

- **Copy to camera:** Copy custom Picture Controls from the memory card to custom Picture Controls C-1 through C-9 on the camera and name them as desired.

- **Delete from card:** Delete selected custom Picture Controls from the memory card. The confirmation dialog shown at right will be displayed before a Picture Control is deleted; to delete the selected Picture Control, highlight **Yes** and press **OK**.

- **Copy to card:** Copy a custom Picture Control (C-1 through C-9) from the camera to a selected destination (1 through 99) on the memory card.



OK button



Saving Custom Picture Controls

Up to 99 custom Picture Controls can be stored on the memory card at any one time. The memory card can only be used to store user-created custom Picture Controls. The preset Picture Controls supplied with the camera (📖 163) can not be copied to the memory card, renamed, or deleted.



Preserving Detail in Highlights and Shadows

Active D-Lighting

Active D-Lighting preserves details in highlights and shadows, creating photographs with natural contrast. Use for high contrast scenes, for example when photographing brightly lit outdoor scenery through a door or window or taking pictures of shaded subjects on a sunny day. It is most effective when used with matrix metering (📖 115).



Active D-Lighting off



Active D-Lighting: 暗A Auto



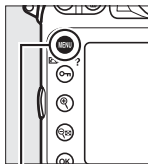
“Active D-Lighting” versus “D-Lighting”

The **Active D-Lighting** option in the shooting menu adjusts exposure before shooting to optimize the dynamic range, while the **D-Lighting** option in the retouch menu optimizes dynamic range in images after shooting.

To use Active D-Lighting:

1 Select Active D-Lighting in the shooting menu.

To display the menus, press the MENU button. Highlight **Active D-Lighting** in the shooting menu and press

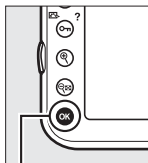


MENU button



2 Choose an option.

Highlight the desired option and press **OK**. If **A Auto** is selected, the camera will automatically adjust Active D-Lighting according to shooting conditions (in exposure mode *M*, however, **A Auto** is equivalent to **N Normal**).




OK button



Active D-Lighting

Active D-Lighting can not be used with movies. Noise (randomly-spaced bright pixels, fog, or lines) may appear in photographs taken with Active D-Lighting. Uneven shading may be visible with some subjects. Active D-Lighting can not be used at ISO sensitivities of Hi 0.3 or above.

See Also

When **ADL bracketing** is selected for Custom Setting e5 (**Auto bracketing set**,  307), the camera varies Active D-Lighting over a series of shots. See page 141 for more information.



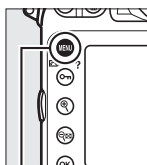
High Dynamic Range (HDR)

High Dynamic Range (HDR) combines two exposures to form a single image that captures a wide range of tones from shadows to highlights, even with high-contrast subjects. HDR is most effective when used with matrix metering (☞ 115; with other metering methods, an exposure differential of **Auto** is equivalent to about 2 EV). It can not be used to record NEF (RAW) images. Movie recording (☞ 59), flash lighting, bracketing (☞ 132), multiple exposure (☞ 195), and time-lapse photography (☞ 207) can not be used while HDR is in effect and a shutter speed of $\frac{1}{200}$ is not available.



1 Select HDR (high dynamic range).

Press the MENU button to display the menus. Highlight **HDR (high dynamic range)** in the shooting menu and press **▶**.



MENU button



2 Select a mode.

Highlight **HDR mode** and press **▶**.



Highlight one of the following and press **OK**.

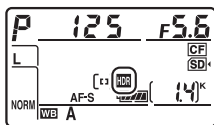
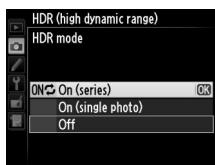
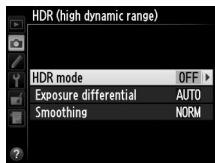
- **To take a series of HDR photographs**, select **ON↻ On (series)**. HDR shooting will continue until you select **Off** for **HDR mode**.



OK button

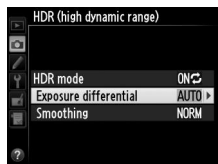
- **To take one HDR photograph**, select **On (single photo)**. Normal shooting will resume automatically after you have created a single HDR photograph.
- **To exit without creating additional HDR photographs**, select **Off**.

If **On (series)** or **On (single photo)** is selected, a **HDR** icon will be displayed in the control panel.



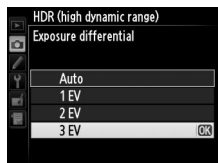
3 Choose the exposure differential.

To choose the difference in exposure between the two shots, highlight **Exposure differential** and press ►.



The options shown at right will be displayed.

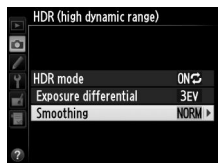
Highlight an option and press **OK**. Choose higher values for high-contrast subjects, but note that



choosing a value higher than required may not produce the desired results; if **Auto** is selected, the camera will automatically adjust exposure to suit the scene.

4 Choose the amount of smoothing.

To choose how much the boundaries between the two images are smoothed, highlight **Smoothing** and press ►.



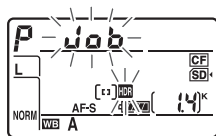
The options shown at right will be displayed.

Highlight an option and press **OK**. Higher values produce a smoother composite image. Uneven shading may be visible with some subjects.



5 Frame a photograph, focus, and shoot.

The camera takes two exposures when the shutter-release button is pressed all the way down. **Job HDR** will be displayed in the control panel and **Job Hdr** in the viewfinder while the images are combined; no photographs can be taken until recording is complete. Regardless of the option currently selected for release mode, only one photograph will be taken each time the shutter-release button is pressed.



Control panel



Viewfinder

If **On (series)** is selected, HDR will only turn off when **Off** is selected for **HDR mode**; if **On (single photo)** is selected, HDR turns off automatically after the photograph is taken. The **HDR** icon clears from the display when HDR shooting ends.

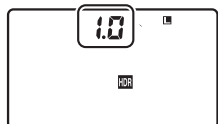


✓ Framing HDR Photographs

The edges of the image may be cropped out. The desired results may not be achieved if the camera or subject moves during shooting. Use of a tripod is recommended. Depending on the scene, shadows may appear around bright objects or halos may appear around dark objects; this effect can be reduced by adjusting the amount of smoothing.

✎ The BKT Button

If **HDR (high dynamic range)** is selected for Custom Setting f8 (**Assign BKT button**; 316), you can select the HDR mode by pressing the **BKT** button and rotating the main command dial and the exposure differential by pressing the **BKT** button and rotating the sub-command dial. The mode and exposure differential are shown in the control panel: **HDR** and **1.0** appear when **On (series)** is selected and **HDR** when **On (single photo)** is selected; no icon appears when HDR is off.



✎ Interval Timer Photography

If **On (series)** is selected for **HDR mode** before interval timer shooting begins, the camera will continue to shoot HDR photographs at the selected interval (if **On (single photo)** is selected, interval timer shooting will end after a single shot). Ending HDR photography ends interval timer shooting.

✎ Shooting Menu Banks

HDR settings can be adjusted separately for each bank (269), but switching to a bank in which HDR is active during multiple exposure (195) or interval timer shooting (201) disables HDR. HDR is also disabled if you switch to a bank in which an NEF (RAW) option is selected for image quality.



Flash Photography

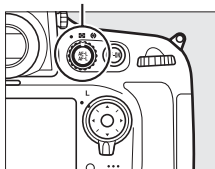
Using the Built-in Flash

The built-in flash has a Guide Number (GN) 12/39 (m/ft, ISO 100, 20 °C/68 °F) and provides coverage for the angle of view of 24 mm lens, or a 16 mm lens in DX format. It can be used not only when natural lighting is inadequate but to fill in shadows and backlit subjects or to add a catch light to the subject's eyes.

1 Choose a metering method (📖 115).

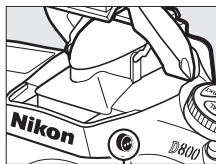
Select matrix or center-weighted metering to activate i-TTL balanced fill-flash for digital SLR. Standard i-TTL flash for digital SLR is activated automatically when spot metering is selected.

Metering selector



2 Press the flash pop-up button.


The built-in flash will pop up and begin charging. When the flash is fully charged, the flash-ready indicator (⚡) will light.

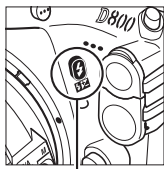



Flash pop-up button



3 Choose a flash mode.

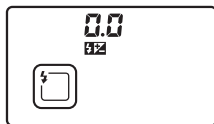
Press the  button and rotate the main command dial until the desired flash mode icon is displayed in the control panel ([□ 183](#)).



 button



Main command dial



Control panel

4 Check exposure (shutter speed and aperture).

Press the shutter-release button halfway and check shutter speed and aperture. The settings available when the built-in flash is raised are listed in “Shutter Speeds and Apertures Available with the Built-in Flash” ([□ 184](#)).

The effects of the flash can be previewed by pressing the depth-of-field preview button to emit a modeling flash ([□ 307](#)).

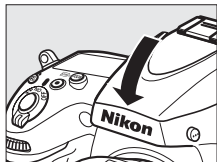
5 Take the picture.



Compose the photograph, focus, and shoot.








Lowering the Built-in Flash

To save power when the flash is not in use, press it gently downward until the latch clicks into place.



Flash Modes

The D800 supports the following flash modes:

Flash mode	Description
 Front-curtain sync	This mode is recommended for most situations. In programmed auto and aperture-priority auto modes, shutter speed will automatically be set to values between $1/250$ and $1/60$ s ($1/8,000$ to $1/60$ s when an optional flash unit is used with Auto FP High-Speed Sync;  299).
 Red-eye reduction	Red-eye reduction lamp lights for approximately one second before main flash. Pupils in subject's eyes contract, reducing "red-eye" effect sometimes caused by flash. Owing to one-second shutter-release delay, this mode is not recommended with moving subjects or in other situations in which quick shutter response is required. Avoid moving camera while red-eye reduction lamp is lit.
 Red-eye reduction with slow sync	Combines red-eye reduction with slow sync. Use for portraits taken against a backdrop of night scenery. Available only in programmed auto and aperture-priority auto exposure modes. Use of a tripod is recommended to prevent blurring caused by camera shake.
 Slow sync	Flash is combined with shutter speeds as slow as 30 s to capture both subject and background at night or under dim light. This mode is only available in programmed auto and aperture-priority auto exposure modes. Use of tripod is recommended to prevent blurring caused by camera shake.
 Rear-curtain sync	In shutter-priority auto or manual exposure mode, flash fires just before the shutter closes. Use to create effect of a stream of light behind moving objects. In programmed auto and aperture-priority auto, slow rear-curtain sync is used to capture both subject and background. Use of tripod is recommended to prevent blurring caused by camera shake. 



Shutter Speeds and Apertures Available with the Built-in Flash


Mode	Shutter speed	Aperture	See page
<i>P</i>	Set automatically by camera ($1/250$ s– $1/60$ s) ^{1,2}	Set automatically by camera	118
<i>S</i>	Value selected by user ($1/250$ s–30 s) ²		119
<i>A</i>	Set automatically by camera ($1/250$ s– $1/60$ s) ^{1,2}	Value selected by user ³	120
<i>M</i>	Value selected by user ($1/250$ s–30 s, b – 1 , b) ²		122


- 1 Shutter speed may be set as slow as 30s in slow sync, slow rear-curtain sync, and slow sync with red-eye reduction flash modes.
- 2 Speeds as fast as $1/8,000$ s are available with optional flash units (□ 382) when **1/320 s (Auto FP)** or **1/250 s (Auto FP)** is selected for Custom Setting e1 (**Flash sync speed**, □ 299).
- 3 Flash range varies with aperture and ISO sensitivity. Consult table of flash ranges (□ 187) when setting aperture in *A* and *M* modes.





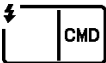



Flash Control Mode

The camera supports the following i-TTL flash control modes:

- **i-TTL balanced fill-flash for digital SLR:** Flash emits series of nearly invisible preflashes (monitor preflashes) immediately before main flash. Preflashes reflected from objects in all areas of frame are picked up by RGB sensor with approximately 91K (91,000) pixels and are analyzed in combination with range information from matrix metering system to adjust flash output for natural balance between main subject and ambient background lighting. If type G or D lens is used, distance information is included when calculating flash output. Precision of calculation can be increased for non-CPU lenses by providing lens data (focal length and maximum aperture; see  212). Not available when spot metering is used.
- **Standard i-TTL flash for digital SLR:** Flash output adjusted to bring lighting in frame to standard level; brightness of background is not taken into account. Recommended for shots in which main subject is emphasized at expense of background details, or when exposure compensation is used. Standard i-TTL flash for digital SLR is activated automatically when spot metering is selected.

The flash control mode for the built-in flash can be selected using Custom Setting e3 (**Flash cntrl for built-in flash**,  301). The information display shows the flash control mode for the built-in flash as follows:

	Flash sync	Auto FP ( 299, 300)
i-TTL		—
Manual		—
Repeating flash		—
Commander mode		



The Built-in Flash

Use with lenses with focal lengths of 24–300 mm in FX format (☐ 375). Remove lens hoods to prevent shadows. The flash has a minimum range of 0.6 m (2 ft) and can not be used in the macro range of macro zoom lenses.

i-TTL flash control is available at ISO sensitivities between 100 and 6400; at other sensitivities, the desired results may not be achieved at some ranges or aperture values.

If the flash fires in continuous release mode (☐ 103), only one photograph will be taken each time the shutter-release button is pressed.

The shutter release may be briefly disabled to protect the flash after it has been used for several consecutive shots. The flash can be used again after a short pause.

See Also

See page 190 for information on locking flash value (FV) for a metered subject before recomposing a photograph.

For information on auto FP high-speed sync and choosing a flash sync speed, see Custom Setting e1 (**Flash sync speed**, ☐ 299). For information on choosing the slowest shutter speed available when using the flash, see Custom Setting e2 (**Flash shutter speed**, ☐ 300). For information on flash control and using the built-in flash in commander mode, see Custom Setting e3 (**Flash cntrl for built-in flash**, ☐ 301).

See page 380 for information on using optional flash units.



Aperture, Sensitivity, and Flash Range

The range of the built-in flash varies with sensitivity (ISO equivalency) and aperture.

Aperture at ISO equivalent of							Range	
100	200	400	800	1600	3200	6400	m	ft
1.4	2	2.8	4	5.6	8	11	0.7–8.5	2ft 4in.–27ft 11in.
2	2.8	4	5.6	8	11	16	0.6–6.0	2ft 0in.–19ft 8in.
2.8	4	5.6	8	11	16	22	0.6–4.2	2ft 0in.–13ft 9in.
4	5.6	8	11	16	22	32	0.6–3.0	2ft 0in.– 9ft 10in.
5.6	8	11	16	22	32	—	0.6–2.1	2ft 0in.– 6ft 11in.
8	11	16	22	32	—	—	0.6–1.5	2ft 0in.– 4ft 11in.
11	16	22	32	—	—	—	0.6–1.1	2ft 0in.– 3ft 7in.
16	22	32	—	—	—	—	0.6–0.8	2ft 0in.– 2ft 7in.

The built-in flash has a minimum range of 0.6 m (2 ft).

In exposure mode P , the maximum aperture (minimum f-number) is limited according to ISO sensitivity, as shown below:

Maximum aperture at ISO equivalent of:						
100	200	400	800	1600	3200	6400
2.8	3.5	4	5	5.6	7.1	8

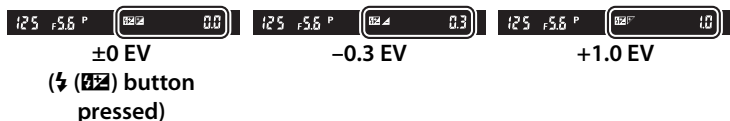
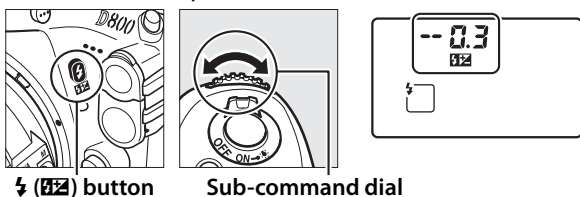
If the maximum aperture of the lens is smaller than given above, the maximum value for aperture will be the maximum aperture of the lens.



Flash Compensation

Flash compensation is used to alter flash output by from -3 EV to $+1$ EV in increments of $\frac{1}{3}$ EV, changing the brightness of the main subject relative to the background. Flash output can be increased to make the main subject appear brighter, or reduced to prevent unwanted highlights or reflections. If flash compensation is combined with exposure compensation (☞ 130), the exposure values will be added together.

To choose a value for flash compensation, press the **⚡ (FLC)** button and rotate the sub-command dial until the desired value is displayed in the control panel.




At values other than ± 0.0 , a **FLC** icon will be displayed in the control panel and viewfinder after you release the **⚡ (FLC)** button. The current value for flash compensation can be confirmed by pressing the **⚡ (FLC)** button.

Normal flash output can be restored by setting flash compensation to ± 0.0 . Flash compensation is not reset when the camera is turned off.

Optional Flash Units

The SB-910, SB-900, SB-800, SB-700, and SB-600 also allow flash compensation to be set using the controls on the flash unit; the value selected with the flash unit is added to the value selected with the camera.

See Also

For information on choosing the size of the increments available for flash compensation, see Custom Setting b3 (**Exp./flash comp. step value**,  287). For information on automatically varying flash level over a series of shots, see page 132.



FV Lock

This feature is used to lock flash output, allowing photographs to be recomposed without changing the flash level and ensuring that flash output is appropriate to the subject even when the subject is not positioned in the center of the frame. Flash output is adjusted automatically for any changes in ISO sensitivity and aperture.

To use FV lock:

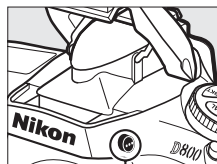
1 Assign FV lock to the Fn button.

Select **FV lock** for Custom Setting f4 (Assign Fn button > Fn button press,  311).



2 Press the flash pop-up button.

The built-in flash will pop up and begin charging.



Flash pop-up button

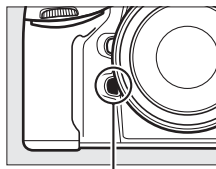
3 Focus.

Position the subject in the center of the frame and press the shutter-release button half way to focus.



4 Lock flash level.

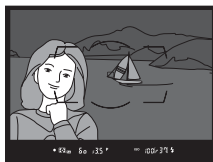
After confirming that the flash ready indicator (⚡) is displayed in the viewfinder, press the **Fn** button. The flash will emit a monitor preflash to determine the appropriate flash level. Flash output will be locked at this level and FV lock icon (🔒) will appear in the viewfinder.



Fn button



5 Recompose the photograph.



6 Take the photograph.


Press the shutter-release button the rest of the way down to shoot. If desired, additional pictures can be taken without releasing FV lock.

7 Release FV lock.


Press the **Fn** button to release FV lock. Confirm that the FV lock icon (🔒) is no longer displayed in the viewfinder.



Using FV Lock with the Built-in Flash

FV lock is only available with the built-in flash when TTL is selected for Custom Setting e3 (**Flash cntrl for built-in flash**,  301).

Using FV Lock with Optional Flash Units

FV lock is also available with optional flash units in TTL and (where supported) monitor pre-flash AA and monitor pre-flash A flash control modes. Note that when commander mode is selected for Custom Setting e3 (**Flash cntrl for built-in flash**,  301), you will need to set the flash control mode for the master or at least one remote group to TTL or AA.

Metering

The metering areas for FV lock when using optional flash unit are as follows:

Flash unit	Flash mode	Metered area
Stand-alone flash unit	i-TTL	6-mm circle in center of frame
	AA	Area metered by flash exposure meter
Used with other flash units (Advanced Wireless Lighting)	i-TTL	Entire frame
	AA	Area metered by flash exposure meter
	A (master flash)	


See Also

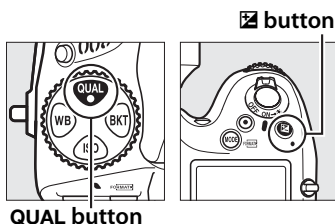
For information on using the depth-of-field preview button or ^{AE-L}/_{AF-L} **AE-L/AF-L** button for FV lock, see Custom Setting f5 (**Assign preview button**,  315) or Custom Setting f6 (**Assign AE-L/AF-L button**,  315).



Other Shooting Options

Two-Button Reset: Restoring Default Settings

The camera settings listed below can be restored to default values by holding the **QUAL** and  buttons down together for more than two seconds (these buttons are marked by a green dot). The control panel turns off briefly while settings are reset.



■ Settings Accessible from the Shooting Menu¹

Option	Default	Option	Default
Image quality	JPEG normal	HDR (high dynamic range)	Off ³
Image size	Large	ISO sensitivity	100
White balance	Auto > Normal	Auto ISO sensitivity control	Off
Fine-tuning	A-B: 0, G-M: 0	Multiple exposure	Off ⁴
Picture Control settings ²	Unmodified	Interval timer shooting	Off ⁵

- 1 With the exception of multiple exposure and interval timer settings, only settings in the bank currently selected using the **Shooting menu bank** option will be reset (☞ 269). Settings in the remaining banks are unaffected.
- 2 Current Picture Control only.
- 3 Exposure differential and smoothing are not reset.
- 4 If multiple exposure is currently in progress, shooting will end and multiple exposure will be created from exposures recorded to that point. Gain and number of shots are not reset.
- 5 If interval timer shooting is currently in progress, shooting will end. Starting time, shooting interval, and number of intervals and shots are not reset.

Other Settings

Option	Default	Option	Default
Focus point ¹	Center	AF-area mode	
Exposure mode	Programmed auto	Viewfinder	Single-point AF
Flexible program	Off	Live view/movie	Normal-area AF
Exposure compensation	Off	Bracketing	Off ²
AE lock hold	Off	Flash mode	Front-curtain sync
Aperture lock	Off	Flash compensation	Off
Shutter-speed lock	Off	FV lock	Off
Autofocus mode	AF-S	Exposure delay mode ³	Off
		+ NEF (RAW)	Off

- 1 Focus point not displayed if auto-area AF is selected for AF-area mode.
- 2 Number of shots is reset to zero. Bracketing increment is reset to 1EV (exposure/flash bracketing) or 1 (white balance bracketing). **Auto** is selected for the second shot of two-shot ADL bracketing programs.
- 3 Only settings in the bank currently selected using the **Custom settings bank** option will be reset (☐ 280). Settings in the remaining banks are unaffected.



See Also

See page 405 for a list of default settings.


Multiple Exposure

Follow the steps below to record a series of two to ten exposures in a single photograph. Multiple exposures can make use of RAW data from the camera image sensor to produce colors noticeably superior to those in software-generated photographic overlays.

Creating a Multiple Exposure

Multiple exposures can not be recorded in live view. Exit live view before proceeding. Note that at default settings, shooting will end and a multiple exposure will be recorded automatically if no operations are performed for 30 s.


Extended Recording Times

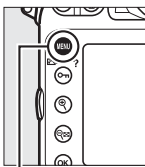
For an interval between exposures of more than 30 s, extend the meter-off delay using Custom Setting c2 (**Auto meter-off delay**,  291). The maximum interval between exposures is 30 s longer than the option selected for Custom Setting c2. If no operations are performed for 30 s after the monitor has turned off during playback or menu operations, shooting will end and a multiple exposure will be created from the exposures that have been recorded to that point.

1 **Select Multiple exposure in the shooting menu.**

Press the **MENU** button to display the menus.

Highlight **Multiple**

exposure in the shooting menu and press .

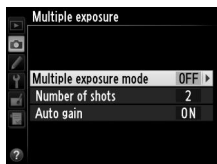


MENU button



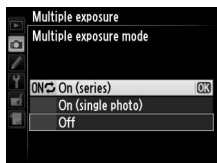
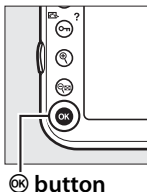
2 Select a mode.


Highlight **Multiple exposure mode** and press **▶**.

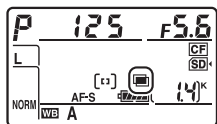


Highlight one of the following and press **OK**:

- **To take a series of multiple exposures, select ON (series).** Multiple exposure shooting will continue until you select **Off for Multiple exposure mode.**
- **To take one multiple exposure, select On (single photo).** Normal shooting will resume automatically after you have created a single multiple exposure.
- **To exit without creating additional multiple exposures, select Off.**



If **On (series)** or **On (single photo)** is selected, a  icon will be displayed in the control panel.

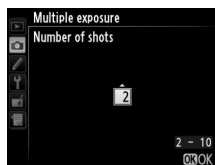
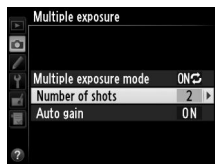


3 Choose the number of shots.





Highlight **Number of shots** and press ►.

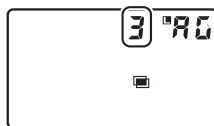
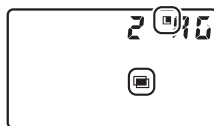


Press ▲ or ▼ to choose the number of exposures that will be combined to form a single photograph and press **OK**.



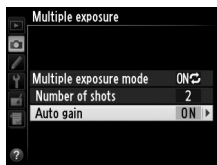
The BKT Button

If **Multiple exposure** is selected for Custom Setting f8 (**Assign BKT button;**  316), you can select the multiple exposure mode by pressing the **BKT** button and rotating the main command dial and the number of shots by pressing the **BKT** button and rotating the sub-command dial. The mode and number of shots are shown in the control panel:  and  appear when **On (series)** is selected and  when **On (single photo)** is selected; no icon appears when multiple exposure is off.

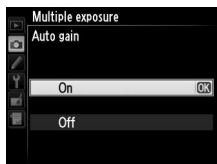


4 Choose the amount of gain.

Highlight **Auto gain** and press **▶**.



The following options will be displayed. Highlight an option and press **OK**.





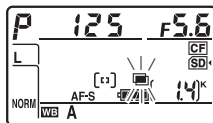
- **On:** Gain is adjusted according to number of exposures actually recorded (gain for each exposure is set to $1/2$ for 2 exposures, $1/3$ for 3 exposures, etc.).
- **Off:** Gain is not adjusted when recording multiple exposure. Recommended if background is dark.

5 Frame a photograph, focus, and shoot.

In continuous high-speed and continuous low-speed release modes (📖 103), the camera records all exposures in a single burst. If **On (series)** is selected, the camera will continue to record multiple exposures while the shutter-release button is pressed; if **On (single photo)** is selected, multiple exposure shooting will end after the first photograph. In self-timer mode, the camera will automatically record the number of exposures selected in Step 3 on page 197, regardless of the option selected for Custom Setting c3 (**Self-timer**) > **Number of shots** (📖 291); the interval between shots is however controlled by Custom Setting c3 (**Self-timer**) > **Interval between shots**. In other release modes, one photograph will be taken each time the shutter-release button is pressed; continue shooting until all exposures have been recorded (for information on interrupting a multiple exposure before all photographs are recorded, see page 199).

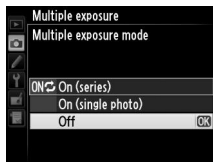


The  icon will blink until shooting ends. If **On (series)** is selected, multiple exposure shooting will only end when **Off** is selected for multiple exposure mode; if **On (single photo)** is selected, multiple exposure shooting ends automatically when the multiple exposure is complete. The  icon clears from the display when multiple exposure shooting ends.



■ Interrupting Multiple Exposures

To interrupt a multiple exposure before the specified number of exposures have been taken, select **Off** for multiple exposure mode. If shooting ends before the specified number of exposures have been taken, a multiple exposure will be created from the exposures that have been recorded to that point. If **Auto gain** is on, gain will be adjusted to reflect the number of exposures actually recorded. Note that shooting will end automatically if:



- A two-button reset is performed (☞ 193)
- The camera is turned off
- The battery is exhausted
- Pictures are deleted



Multiple Exposure

Do not remove or replace the memory card while recording a multiple exposure.

Multiple exposures can not be recorded in live view. Taking photographs in live view resets **Multiple exposure mode** to **Off**.

The information listed in the playback photo information display (including date of recording and camera orientation) is for the first shot in the multiple exposure.

Interval Timer Photography

If interval timer photography is activated before the first exposure is taken, the camera will record exposures at the selected interval until the number of exposures specified in the multiple exposure menu have been taken (the number of shots listed in the interval timer shooting menu is ignored). These exposures will then be recorded as a single photograph and interval timer shooting will end (if **On (single photo)** is selected for multiple exposure mode, multiple exposure shooting will also end automatically). Cancelling multiple exposure cancels interval timer shooting.

Other Settings

While a multiple exposure is being shot, memory cards can not be formatted and some menu items are grayed out and can not be changed.

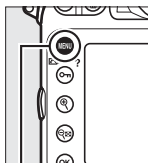


Interval Timer Photography

The camera is equipped to take photographs automatically at preset intervals.

1 Select Interval timer shooting in the shooting menu.

Press the **MENU** button to display the menus. Highlight **Interval timer shooting** in the shooting menu and press **▶**.



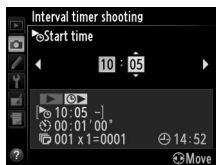
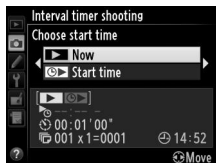
MENU button



2 Choose a starting time.

Choose from the following starting triggers.

- **To start shooting immediately**, highlight **Now** and press **▶**. Shooting begins about 3 s after settings are completed; proceed to Step 3.
- **To choose a starting time**, highlight **Start time** and press **▶** to display the start time options shown at right. Press **◀** or **▶** to highlight hours or minutes and press **▲** or **▼** to change. Press **▶** to continue.



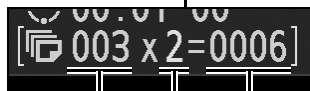
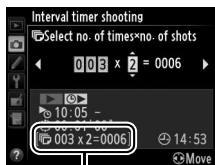
3 Choose the interval.

Press ◀ or ▶ to highlight hours, minutes, or seconds; press ▲ or ▼ to change. Choose an interval longer than the slowest anticipated shutter speed. Press ▶ to continue.



4 Choose the number of intervals and number of shots per interval.

Press ◀ or ▶ to highlight number of intervals or number of shots; press ▲ or ▼ to change. Press ▶ to continue.



Number of intervals Number of shots/interval Total number of shots

Before Shooting

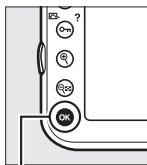
Select a release mode other than self-timer (⊙) or **MUP** when using the interval timer. Before beginning interval timer photography, take a test shot at current settings and view the results in the monitor.

Before choosing a starting time, select **Time zone and date** in the setup menu and make sure that the camera clock is set to the correct time and date (□ 27).

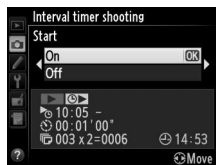
Use of a tripod is recommended. Mount the camera on a tripod before shooting begins. To ensure that shooting is not interrupted, be sure the camera EN-EL15 battery is fully charged. If in doubt, charge the battery before use or use an EH-5b AC adapter and EP-5B power connector (available separately).

5 Start shooting.

Highlight **On** and press **OK** (to return to the shooting menu without starting the interval timer, highlight **Off** and press **OK**). The first series of shots will be taken



OK button



at the specified starting time, or after about 3 s if **Now** was selected for **Choose start time** in Step 2. Shooting will continue at the selected interval until all shots have been taken. Note that because shutter speed and the time needed to record the image to the memory card may vary from shot to shot, the interval between a shot being recorded and the start of the next shot may vary. If shooting can not proceed at current settings (for example, if a shutter speed of $\frac{1}{4}$ is currently selected in manual exposure mode or the start time is in less than a minute), a warning will be displayed in the monitor.

Cover the Viewfinder

To prevent light entering via the viewfinder interfering with exposure, close the viewfinder eyepiece shutter (📖 106).

Out of Memory

If the memory card is full, the interval timer will remain active but no pictures will be taken. Resume shooting (📖 205) after deleting some pictures or turning the camera off and inserting another memory card.

Interval Timer Photography

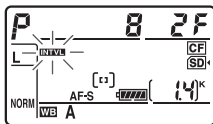
Interval timer photography can not be combined with long time-exposures (bulb photography, 📖 124) or time-lapse photography (📖 207) and is not available when **Record movies** is selected for Custom Setting g4 (**Assign shutter button**, 📖 324).

Bracketing

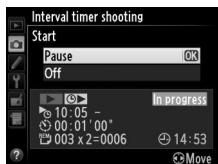
Adjust bracketing settings before starting interval timer photography. If exposure, flash, or ADL bracketing is active while interval timer photography is in effect, the camera will take the number of shots in the bracketing program at each interval, regardless of the number of shots specified in the interval timer menu. If white balance bracketing is active while interval timer photography is in effect, the camera will take one shot at each interval and process it to create the number of copies specified in the bracketing program.


During Shooting

During interval timer photography, the **INTV** icon will blink in the control panel. Immediately before the next shooting interval begins, the shutter speed display will show the number of intervals remaining, and the aperture display will show the number of shots remaining in the current interval. At other times, the number of intervals remaining and the number of shots in each interval can be viewed by pressing the shutter-release button halfway (once the button is released, the shutter speed and aperture will be displayed until the exposure meters turn off).



To view current interval timer settings, select **Interval timer shooting** between shots. While interval timer photography is in progress, the interval timer menu will show the starting time, the shooting interval, and the number of intervals and shots remaining. None of these items can be changed while interval timer photography is in progress.



 Pictures can be played back and shooting and menu settings can be adjusted freely while interval timer photography is in progress. The monitor will turn off automatically about four seconds before each interval.

■ ■ Pausing Interval Timer Photography

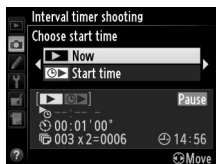
Interval timer photography can be paused by:

- Pressing the **OK** button between intervals
- Highlighting **Start > Pause** in the interval timer menu and pressing **OK**
- Turning the camera off and then on again (if desired, the memory card can be replaced while the camera is off)
- Selecting self-timer (☺) or **MUP** release mode

To resume shooting:

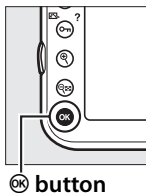
1 Choose a new starting time.

Choose a new starting time as described on page 201.



2 Resume shooting.

Highlight **Restart** and press **OK**. Note that if interval timer photography was paused during shooting, any shots remaining in the current interval will be canceled.



■ Interrupting Interval Timer Photography

Interval timer shooting will end automatically if the battery is exhausted. Interval timer photography can also be ended by:

- Selecting **Start > Off** in the interval timer menu
- Performing a two button reset (☞ 193)
- Resetting settings for the current shooting menu bank using the **Shooting menu bank** item in the shooting menu (☞ 270)
- Changing bracketing settings (☞ 132)
- Terminating HDR (☞ 176) or multiple exposure shooting (☞ 195)

Normal shooting will resume when interval timer photography ends.

■ No Photograph

The camera will skip the current interval if any of the following situations persist for eight seconds or more after the interval was due to start: the photograph or photographs for the previous interval have yet to be taken, the memory buffer is full, or the camera is unable to focus in **AF-S** (note that the camera focuses again before each shot). Shooting will resume with the next interval.

Release Mode

Regardless of the release mode selected, the camera will take the specified number of shots at each interval. In **C_H** (continuous high speed) mode, photographs will be taken at the rate given on page 104. In **S** (single frame) and **C_L** (continuous low-speed) modes, photographs will be taken at the rate chosen for Custom Setting d2 (**CL mode shooting speed**, ☞ 293) in mode **Q**, camera noise will be reduced.

Shooting Menu Banks

Changes to interval timer settings apply to all shooting menu banks (☞ 269). If shooting menu settings are reset using the **Shooting menu bank** item in the shooting menu (☞ 270), interval timer settings will be reset as follows:

- Choose start time: Now
- Interval: 00:01:00"
- Number of intervals: 1
- Number of shots: 1
- Start shooting: Off

Time-Lapse Photography

The camera automatically takes photos at selected intervals to create a silent time-lapse movie using the options currently selected for **Movie settings** in the shooting menu (▢ 70).

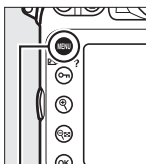
Before Shooting

Before beginning time-lapse photography, take a test shot at current settings (framing the photo in the viewfinder for an accurate exposure preview) and view the results in the monitor. To record changes in brightness, choose manual exposure (▢ 122); for consistent coloration, choose a white balance setting other than auto (▢ 145). We recommend that you briefly switch to movie live view and check the current image area crop in the monitor (▢ 59); note, however, that time-lapse photography is not available in live view.

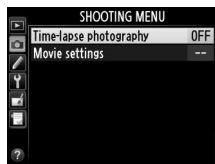
Use of a tripod is recommended. Mount the camera on a tripod before shooting begins. To ensure that shooting is not interrupted, use an optional EH-5b AC adapter and EP-5B power connector or a fully-charged EN-EL15 battery.

1 Select Time-lapse photography in the shooting menu.

Press the **MENU** button to display the menus. Highlight **Time-lapse photography** in the shooting menu and press ►.



MENU button



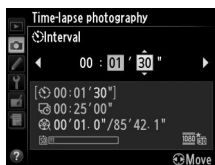
2 Press ►.

Press ► to proceed to Step 3 and choose an interval and shooting time. To record a time-lapse movie using the default interval of 5 seconds and shooting time of 25 minutes, proceed to step 5.



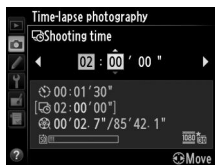
3 Choose the interval.

Press ◀ or ▶ to highlight minutes or seconds; press ▲ or ▼ to change. Choose an interval longer than the slowest anticipated shutter speed. Press ► to continue.



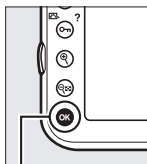
4 Select the shooting time.

Press ◀ or ▶ to highlight hours or minutes; press ▲ or ▼ to change. The maximum shooting time is 7 hours and 59 minutes. Press ► to continue.

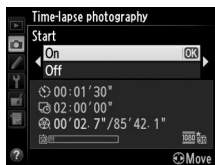


5 Start shooting.

Highlight **On** and press **OK** (to return to the shooting menu without starting time-lapse photography, highlight **Off** and press **OK**).



OK button



Time-lapse photography starts after 3 s. The camera takes photographs at the interval selected in Step 3 for the time selected in Step 4. The memory card access lamp lights while each shot is recorded; note that because shutter speed and the time needed to record the image to the memory card may vary from shot to shot, the interval between a shot being recorded and the start of the next shot may vary. Shooting will not begin if a time-lapse movie can not be recorded at current settings (for example, if the memory card is full, the interval or shooting time is zero, or the interval is longer than the shooting time).

When complete, time-lapse movies are recorded to the memory card selected for **Movie settings > Destination** (□ 70).

✓ Time-Lapse Photography

Time-lapse is not available in live view (□ 45, 59), at a shutter speed of **b** **u** **L** **b** (□ 124), when bracketing (□ 132), High Dynamic Range (HDR, □ 176), multiple exposure (□ 195), or interval timer photography (□ 201) is active.

✎ Release Mode

Regardless of the release mode selected, the camera will take one shot at each interval. The self-timer can not be used.



✎ Calculating the Length of the Final Movie

The total number of frames in the final movie can be calculated by dividing the shooting time by the interval and rounding up. The length of the final movie can then be calculated by dividing the number of shots by the frame rate selected for **Movie settings > Frame size/frame rate**. A 48 frame movie recorded at **1920 × 1080; 24 fps**, for example, will be about two seconds long. The maximum length for movies recorded using time-lapse photography is 20 minutes.

Length recorded/
maximum length



Memory card
indicator

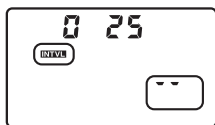
Frame size/
frame rate

✎ Cover the Viewfinder

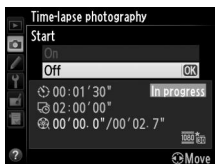
To prevent light entering via the viewfinder interfering with exposure, close the viewfinder eyepiece shutter (📖 106).

✎ During Shooting

During time-lapse photography, a **INTVL** icon will blink and the time-lapse recording indicator will be displayed in the control panel. The time remaining (in hours and minutes) appears in the shutter-speed display immediately before each frame is recorded. At other times, the time remaining can be viewed by pressing the shutter-release button halfway. Regardless of the option selected for Custom Setting c2 (**Auto meter-off delay**, 📖 291), the exposure meters will not turn off during shooting.




To view current time-lapse photography settings, press the **MENU** button between shots. While time-lapse photography is in progress, the time-lapse photography menu will show the interval and the time remaining. These settings can not be changed while time-lapse photography is in progress, nor can pictures be played back or other menu settings adjusted.



■ Interrupting Time-Lapse Photography

Time-lapse photography will end automatically if the battery is exhausted. The following will also end time-lapse photography:



- Selecting **Start** > **Off** in the **Time-lapse photography** menu
- Pressing the  button between frames or immediately after a frame is recorded
- Turning the camera off
- Removing the lens
- Connecting a USB or HDMI cable
- Inserting a memory card into an empty slot
- Pressing the shutter-release button all the way down to take a photograph

A movie will be created from the frames shot to the point where time-lapse photography ended. Note that time-lapse photography will end and no movie will be recorded if the power source is removed or disconnected or the destination memory card is ejected.


■ No Photograph

The camera will skip the current frame if the camera is unable to focus in **AF-S** (note that the camera focuses again before each shot). Shooting will resume with the next frame.

Image Review

The  button can not be used to view pictures while time-lapse photography is in progress, but the current frame will be displayed for a few seconds after each shot if **On** is selected for **Image review** in the playback menu ( 265). Other playback operations can not be performed while the frame is displayed.

See Also

For information on setting a beep to sound when time-lapse photography is complete, see Custom Setting d1 (**Beep**,  292).



Non-CPU Lenses

By specifying lens data (lens focal length and maximum aperture), the user can gain access to a variety of CPU lens functions when using a non-CPU lens.

If the focal length of the lens is known:

- Power zoom can be used with optional flash units (☞ 382)
- Lens focal length is listed (with an asterisk) in the playback photo info display

If the maximum aperture of the lens is known:

- The aperture value is displayed in the control panel and viewfinder
- Flash level is adjusted for changes in aperture
- Aperture is listed (with an asterisk) in the playback photo info display

Specifying both the focal length and maximum aperture of the lens:

- Enables color matrix metering (note that it may be necessary to use center-weighted or spot metering to achieve accurate results with some lenses, including Reflex-NIKKOR lenses)
- Improves the precision of center-weighted and spot metering and i-TTL balanced fill-flash for digital SLR

Focal Length Not Listed

If the correct focal length is not listed, choose the closest value greater than the actual focal length of the lens.

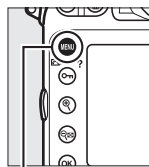
Teleconverters and Zoom Lenses

The maximum aperture for teleconverters is the combined maximum aperture of the teleconverter and the lens. Note that lens data are not adjusted when non-CPU lenses are zoomed in or out. The data for different focal lengths can be entered as separate lens numbers, or the data for the lens can be edited to reflect the new values for lens focal length and maximum aperture each time zoom is adjusted.

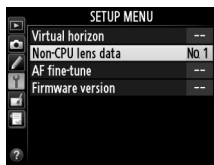
The camera can store data for up to nine non-CPU lenses. To enter or edit data for a non-CPU lens:

1 Select Non-CPU lens data in the setup menu.

Press the **MENU** button to display the menus. Highlight **Non-CPU lens data** in the setup menu and press ►.

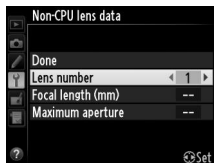


MENU button



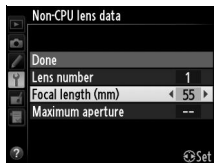
2 Select a lens number.

Highlight **Lens number** and press ◀ or ▶ to choose a lens number between 1 and 9.




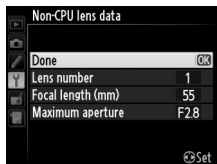
3 Enter the focal length and aperture.

Highlight **Focal length (mm)** or **Maximum aperture** and press ◀ or ▶ to edit the highlighted item. Focal length can be selected from values between 6 and 4,000 mm, maximum aperture from values between f/1.2 and f/22.



4 Select Done.

Highlight **Done** and press . The specified focal length and aperture will be stored under the chosen lens number.



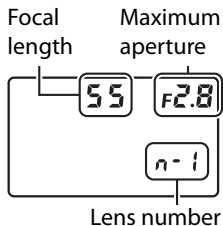
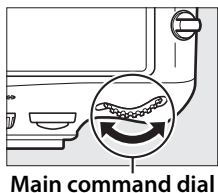
To recall lens data when using a non-CPU lens:

1 Assign non-CPU lens number selection to a camera control.

Select **Choose non-CPU lens number** as the “button + command dials” option for a camera control in the Custom Settings menu (📖 314). Non-CPU lens number selection can be assigned to the **Fn** button (Custom Setting f4, **Assign Fn button**, 📖 311), the depth-of-field preview button (Custom Setting f5, **Assign preview button**, 📖 315), or the ^{AE-L}/_{AF-L} **AE-L/AF-L** button (Custom Setting f6, **Assign AE-L/AF-L button**, 📖 315).

2 Use the selected control to choose a lens number.

Press the selected button and rotate the main or sub-command dial until the desired lens number is displayed in the control panel.



Using a GPS Unit

A GPS unit can be connected to the ten-pin remote terminal, allowing the current latitude, longitude, altitude, Coordinated Universal Time (UTC), and heading to be recorded with each photograph taken. The camera can be used with an optional GP-1 GPS unit (see below; note that the GP-1 does not provide the compass heading), or with third-party units connected via an optional MC-35 GPS adapter cord (☞ 216).

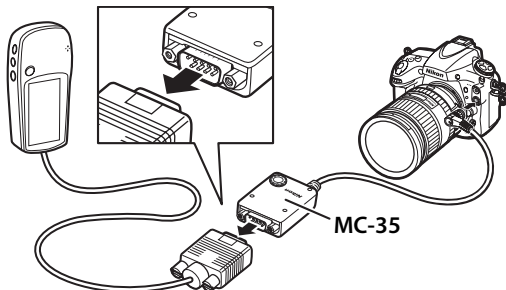
■ ■ *The GP-1 GPS Unit*

The GP-1 is an optional GPS unit designed for use with Nikon digital cameras. For information on connecting the unit, see the manual provided with the GP-1.






■ ■ Other GPS Units

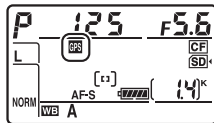
Garmin GPS units that conform to version 2.01 or 3.01 of the National Marine Electronics Association NMEA0183 data format can be connected to the camera's ten-pin remote terminal using an MC-35 GPS adapter cord (available separately; □ 390). Operation has been confirmed with Garmin eTrex and Garmin geko series devices equipped with a PC interface cable connector. These devices connect to the MC-35 using a cable with a D-sub 9-pin connector provided by the manufacturer of the GPS device. See the MC-35 instruction manual for details. Before turning the camera on, set the GPS device to NMEA mode (4800 baud); see the documentation provided with the GPS device for more information.




The Icon

Connection status is shown by the  icon:

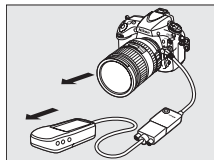
-  **(static)**: Camera has established communication with a GPS device. Photo information for pictures taken while this icon is displayed include an additional page of GPS data (📖 229).
-  **(flashing)**: The GPS device is searching for a signal. Pictures taken while the icon is flashing do not include GPS data.
- **No icon**: No new GPS data have been received from the GPS device for at least two seconds.



Pictures taken when the  icon is not displayed do not include GPS data.

Heading

The heading is only recorded if the GPS device is equipped with a digital compass (note that the GP-1 is not equipped with a compass). Keep the GPS device pointing in the same direction as the lens and at least 20cm (8 in.) from the camera.



Coordinated Universal Time (UTC)

UTC data is provided by the GPS device and is independent of the camera clock.



■ ■ Setup Menu Options

The **GPS** item in the setup menu contains the options listed below.

- **Auto meter-off:** Choose whether or not the exposure meters will turn off automatically when a GPS unit is attached.

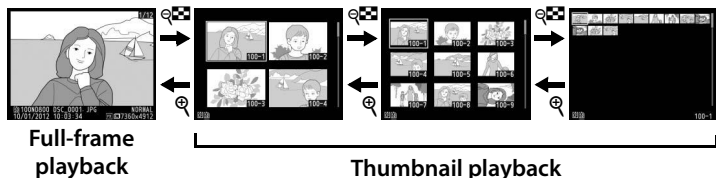
Option	Description
Enable	Exposure meters will turn off automatically if no operations are performed for the period specified in Custom Setting c2 (Auto meter-off delay , □ 291; to allow the camera time to acquire GPS data when a GP-1 is connected, the delay is extended by up to one minute after exposure meters are activated or the camera is turned on). This reduces the drain on the battery.
Disable	Exposure meters will not turn off while a GPS unit is connected; GPS data will always be recorded.

- **Position:** This item is only available if a GPS device is connected, when it displays the current latitude, longitude, altitude, Coordinated Universal Time (UTC), and heading (if supported) as reported by the GPS device.
- **Use GPS to set camera clock:** Select **Yes** to synchronize the camera clock with the time reported by the GPS device.








More About Playback

Viewing Images






Full-Frame Playback

To play photographs back, press the  button. The most recent photograph will be displayed in the monitor. Additional pictures can be displayed by pressing  or ; to view additional information on the current photograph, press  or  (📖 222).



 button

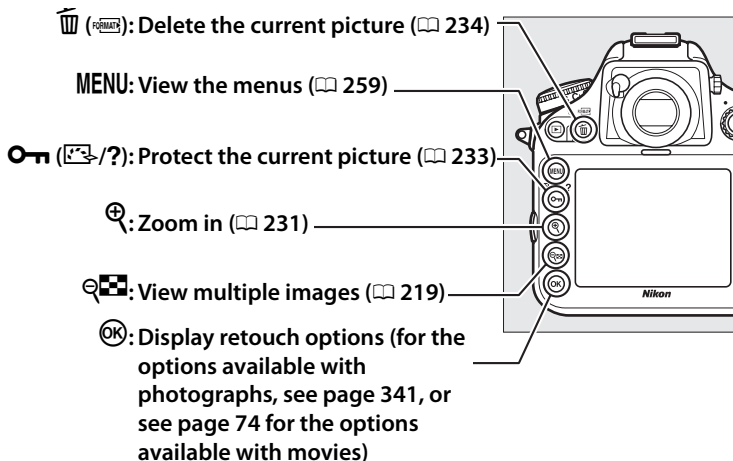
Thumbnail Playback

To view multiple images, press the  button when a picture is displayed full frame. The number of images displayed increases from 4 to 9 to 72 each time the  button is pressed, and decreases with each press of the  button. Use the multi selector to highlight images and press the center of the multi selector to view the highlighted image full frame.



 button

Playback Controls



Rotate Tall







To display “tall” (portrait-orientation) photographs in tall orientation, select **On** for the **Rotate tall** option in the playback menu (📖 266).



Image Review


When **On** is selected for **Image review** in the playback menu (📖 265), photographs are automatically displayed in the monitor after shooting (because the camera is already in the correct orientation, images are not rotated automatically during image review). In continuous release mode, display begins when shooting ends, with the first photograph in the current series displayed.

Two Memory Cards

If two memory cards are inserted, you can select a memory card for playback by pressing the  button when 72 thumbnails are displayed. The dialog shown at right will be displayed; Highlight the desired slot and press  to display a list of folders, then highlight a folder and press  to view the pictures in the selected folder. The same method can be used to choose a slot when selecting images for operations in the playback ( 259) or retouch menus ( 341) or when choosing an image as the source for preset white balance ( 159).



Resuming Shooting

To turn the monitor off and return to shooting mode, press  or press the shutter-release button halfway.

The Multi Selector

The multi selector can be used to highlight pictures in the thumbnail display and in displays like that shown at right.



See Also




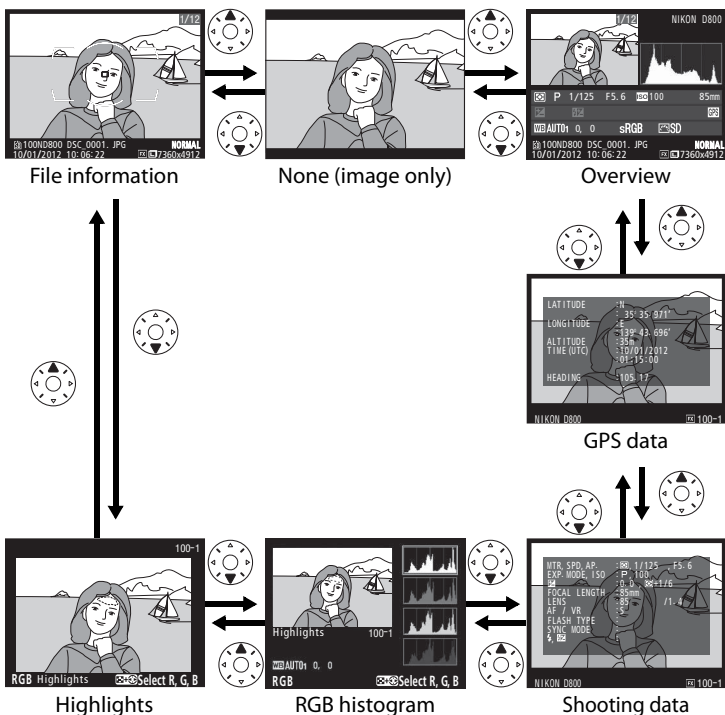
For information on choosing how long the monitor will remain on when no operations are performed, see Custom Setting c4 (**Monitor off delay**,  292). For information on choosing the role played by the center of the multi selector, see Custom Setting f2 (**Multi selector center button**,  309). For information on using the command dials for image or menu navigation, see Custom Setting f9 (**Custom command dials**) > **Menus and playback** ( 318).

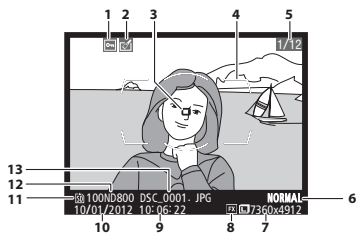


Photo Information

Photo information is superimposed on images displayed in full-frame playback. Press ▲ or ▼ to cycle through photo information as shown below. Note that “image only”, shooting data, RGB histograms, and highlights are only displayed if corresponding option is selected for **Playback display options** (📖 261). GPS data are only displayed if a GPS device was used when the photo was taken.



File Information

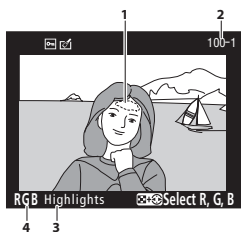


1	Protect status.....	233
2	Retouch indicator.....	341
3	Focus point ^{1,2}	96
4	AF-area brackets ¹	35
5	Frame number/total number of frames	
6	Image quality	84
7	Image size	87
8	Image area ³	79
9	Time of recording	27
10	Date of recording	27
11	Current card slot	31
12	Folder name	271
13	File name.....	273




- 1 Displayed only if **Focus point** is selected for **Playback display options** (□ 261).
- 2 If photograph was taken using **AF-S**, display shows point where focus first locked. If photograph was taken using **AF-C**, focus point is only displayed if option other than auto-area AF was selected for AF-area mode and camera was able to focus.
- 3 Displayed in yellow if picture is in non-FX format (including DX-based movie format; □ 67, 79).

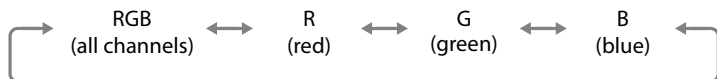
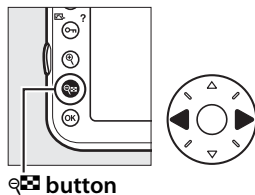



■ Highlights



- 1 Image highlights¹
- 2 Folder number–frame number²..... 271
- 3 Highlight display indicator
- 4 Current channel¹

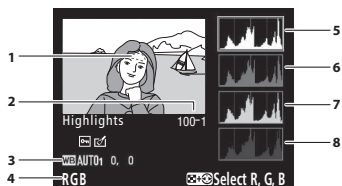
- 1 Blinking areas indicate highlights (areas that may be overexposed) for current channel. Hold  button and press  or  to cycle through channels as follows:



- 2 Displayed in yellow if picture is in non-FX format (including DX-based movie format;  67, 79).

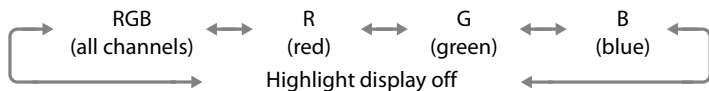
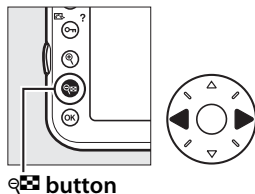


RGB Histogram



- | | |
|---|---|
| 1 | Image highlights ¹ |
| 2 | Folder number–frame number ²271 |
| 3 | White balance145 |
| | Color temperature152 |
| | White balance fine-tuning148 |
| | Preset manual154 |
| 4 | Current channel ¹ |
| 5 | Histogram (RGB channel). In all histograms, horizontal axis gives pixel brightness, vertical axis number of pixels. |
| 6 | Histogram (red channel) |
| 7 | Histogram (green channel) |
| 8 | Histogram (blue channel) |




- 1 Blinking areas indicate highlights (areas that may be overexposed) for current channel. Hold button and press or to cycle through channels as follows:



- 2 Displayed in yellow if picture is in non-FX format (including DX-based movie format; 67, 79).



Playback Zoom

To zoom in on the photograph when the histogram is displayed, press . Use the  and  buttons to zoom in and out and scroll the image with the multi selector. The histogram will be updated to show only the data for the portion of the image visible in the monitor.



Histograms

Camera histograms are intended as a guide only and may differ from those displayed in imaging applications. Some sample histograms are shown below:

If the image contains objects with a wide range of brightnesses, the distribution of tones will be relatively even.



If the image is dark, tone distribution will be shifted to the left.



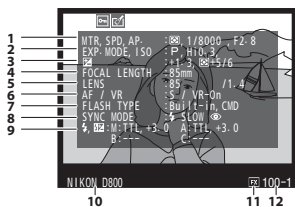
If the image is bright, tone distribution will be shifted to the right.



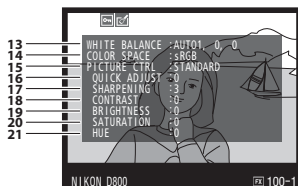
Increasing exposure compensation shifts the distribution of tones to the right, while decreasing exposure compensation shifts the distribution to the left. Histograms can provide a rough idea of overall exposure when bright ambient lighting makes it difficult to see photographs in the monitor.



Shooting Data

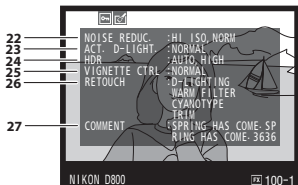


1	Metering method	115
	Shutter speed	119, 122
	Aperture	120, 122
2	Exposure mode	117
	ISO sensitivity ¹	109

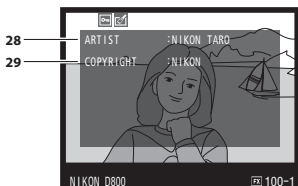


13	White balance	145
	Color temperature	152
	White balance fine-tuning	148
	Preset manual	154

3	Exposure compensation	130
	Optimal exposure tuning ²	290
4	Focal length	212, 379
5	Lens data	212
6	Focus mode	91
	Lens VR (vibration reduction) ³	
7	Flash type	181, 380
	Commander mode	303
8	Flash mode	183
9	Flash control	301
	Flash compensation	188
10	Camera name	
11	Image area ⁴	79
12	Folder number-frame number ⁴	271
14	Color space	274
15	Picture Control	163
16	Quick adjust ⁵	166
	Original Picture Control ⁶	163
17	Sharpening	166
18	Contrast	166
19	Brightness	166
20	Saturation ⁷	166
	Filter effects ⁸	166
21	Hue ⁷	166
	Toning ⁸	166



22	High ISO noise reduction.....	277
23	Long exposure noise reduction	277
23	Active D-Lighting	174
24	HDR exposure differential	178
	HDR smoothing	178
25	Vignette control.....	275
26	Retouch history.....	341
27	Image comment	333



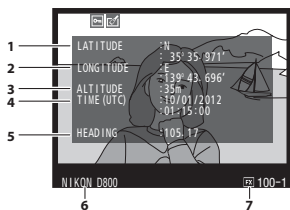
28	Name of photographer	334
29	Copyright holder	334

The fourth page of the shooting data is only displayed if copyright information was recorded with the photograph as described on page 334.

- 1 Displayed in red if photo was taken with auto ISO sensitivity control on.
- 2 Displayed if Custom Setting b6 (**Fine-tune optimal exposure**, 290) has been set to a value other than zero for any metering method.
- 3 Displayed only if VR lens is attached.
- 4 Displayed in yellow if picture is in non-FX format (including DX-based movie format; 67, 79).
- 5 **Standard Vivid, Portrait, and Landscape** Picture Controls only.
- 6 **Neutral, Monochrome**, and custom Picture Controls.
- 7 Not displayed with monochrome Picture Controls.
- 8 Monochrome Picture Controls only.



GPS Data¹

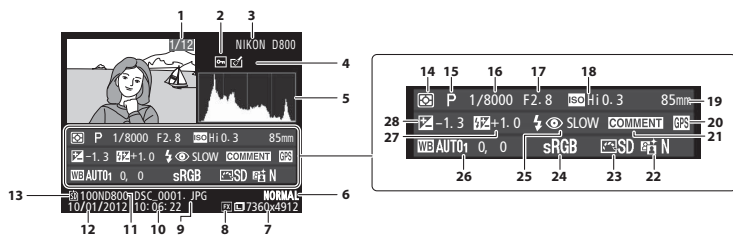


1	Latitude
2	Longitude
3	Altitude
4	Coordinated Universal Time (UTC)
5	Heading ²
6	Camera name
7	Image area ³79

- 1 Data for movies are for start of recording.
- 2 Displayed only if GPS device is equipped with electronic compass.
- 3 Displayed in yellow if picture is in non-FX format (including DX-based movie format; □ 67, 79).




Overview

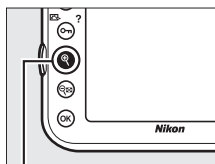


1 Frame number/total number of frames	16 Shutter speed 119, 122
2 Protect status 233	17 Aperture 120, 122
3 Camera name	18 ISO sensitivity ² 109
4 Retouch indicator 341	19 Focal length 212, 379
5 Histogram showing the distribution of tones in the image (□ 226).	20 GPS data indicator 215
6 Image quality 84	21 Image comment indicator 333
7 Image size 87	22 Active D-Lighting 174
8 Image area ¹ 79	23 Picture Control 163
9 File name 273	24 Color space 274
10 Time of recording 27	25 Flash mode 183
11 Folder name 271	26 White balance 145
12 Date of recording 27	Color temperature 152
13 Current card slot 31	White balance fine-tuning 148
14 Metering method 115	Preset manual 154
15 Exposure mode 117	27 Flash compensation 188
	Commander mode 303
	28 Exposure compensation 130







- 1 Non-FX formats (including DX-based movie format) displayed in yellow (□ 67, 79).
- 2 Displayed in red if photo was taken with auto ISO sensitivity control on.

Taking a Closer Look: Playback Zoom


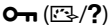


Press the  button to zoom in on the image displayed in full-frame playback or on the image currently highlighted in thumbnail playback. The following operations can be performed while zoom is in effect:



 button



To	Use	Description
Zoom in or out	 / 	Press  to zoom in to maximum of approximately 46× (large images in 36 × 24/3 : 2 format), 34× (medium images) or 22× (small images). Press  to zoom out. While photo is zoomed in, use multi selector to view areas of image not visible in monitor. Keep multi selector pressed to scroll rapidly to other areas of frame. Navigation window is displayed when zoom ratio is altered; area currently visible in monitor is indicated by yellow border.
View other areas of image		
Select faces		Faces (up to 35) detected during zoom are indicated by white borders in navigation window. Rotate sub-command dial to view other faces.



To	Use	Description
View other images		Rotate main command dial to view same location in other images at current zoom ratio. Playback zoom is cancelled when a movie is displayed.
Change protect status		See page 233 for more information.
Return to shooting mode		Press the shutter-release button halfway or press the  button to exit to shooting mode.
Display menus	MENU	See page 259 for more information.



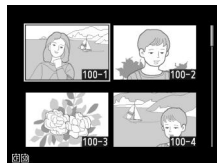
Protecting Photographs from Deletion

In full-frame, zoom, and thumbnail playback, the **Protect** () button can be used to protect photographs from accidental deletion. Protected files can not be deleted using the **Format** () button or the **Delete** option in the playback menu. Note that protected images *will* be deleted when the memory card is formatted (see 32, 326).



To protect a photograph:

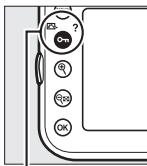
1 Select an image.


Display the image in full-frame playback or playback zoom or highlight it in the thumbnail list.



2 Press the **Protect** () button.



The photograph will be marked with a  icon. To remove protection from the photograph so that it can be deleted, display the photograph or highlight it in the thumbnail list and then press the **Protect** () button.




Protect () button



Removing Protection from All Images

To remove protection from all images in the folder or folders currently selected in the **Playback folder** menu, press the **Protect** () and **Format** () buttons together for about two seconds during playback.

Deleting Photographs

To delete the photograph displayed in full-frame playback or highlighted in the thumbnail list, press the  button. To delete multiple selected photographs or all photographs in the current playback folder, use the **Delete** option in the playback menu. Once deleted, photographs can not be recovered. Note that pictures that are protected or hidden can not be deleted.

Full-Frame and Thumbnail Playback

Press the  button to delete the current photograph.

1 Select an image.

Display the image or highlight it in the thumbnail list.

2 Press the button.

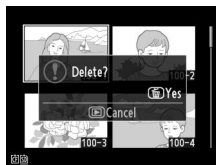
A confirmation dialog will be displayed.




button





Full-frame playback

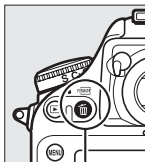


Thumbnail playback




3 Press the button again.

To delete the photograph, press the  button. To exit without deleting the photograph, press the  button.




button



See Also

The **After delete** option in the playback menu determines whether the next image or the previous image is displayed after an image is deleted ( 266).



The Playback Menu

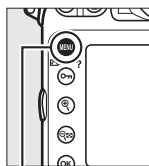
The **Delete** option in the playback menu contains the following options. Note that depending on the number of images, some time may be required for deletion.

Option	Description
 Selected	Delete selected pictures.
ALL All	Delete all pictures in the folder currently selected for playback ( 260). If two cards are inserted, you can select the card from which pictures will be deleted.

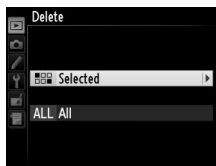
■ Selected: Deleting Selected Photographs

1 Choose Selected for the Delete option in the playback menu.



Press the **MENU** button and select **Delete** in the playback menu. Highlight **Selected** and press **▶**.

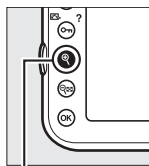


MENU button



2 Highlight a picture.


Use the multi selector to highlight a picture (to view the highlighted picture full screen, press and hold the  button; to view images in other locations, press  and select the desired card and folder as described on page 221).



 button




3 Select the highlighted picture.

Press the center of the multi selector to select the highlighted picture. Selected pictures are marked by a  icon. Repeat steps 2 and 3 to select additional pictures; to deselect a picture, highlight it and press the center of the multi selector.



4 Press to complete the operation.

A confirmation dialog will be displayed; highlight **Yes** and press .



 button







Connections

Connecting to a Computer

This section describes how to use the supplied UC-E14 USB cable to connect the camera to a computer.

Before Connecting the Camera

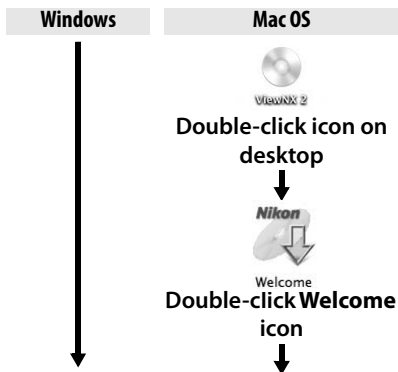
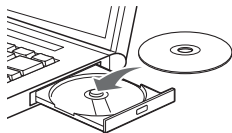
Before connecting the camera, install the software on the supplied ViewNX 2 installer CD. To ensure that data transfer is not interrupted, be sure the camera EN-EL15 battery is fully charged. If in doubt, charge the battery before use or use an EH-5b AC adapter and EP-5B power connector (available separately).

■ ■ *Supplied Software*

ViewNX 2 includes a “Nikon Transfer 2” function for copying pictures from the camera to the computer, where ViewNX 2 can be used to view and print selected images or to edit photographs and movies. Before installing ViewNX 2, confirm that your computer meets the system requirements on page 242.



1 Start the computer and insert the ViewNX 2 installer CD.



2 Select a language.

If the desired language is not available, click **Region Selection** to choose a different region and then choose the desired language (region selection is not available in the European release).

① Select region (if required)



② Select language

③ Click Next

3 Start the installer.

Click **Install** and follow the on-screen instructions.

Installation Guide

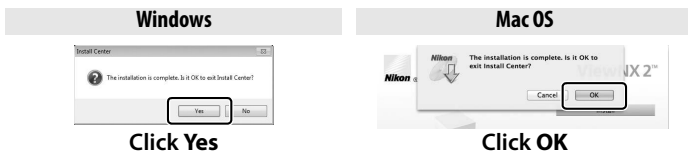
For help installing ViewNX 2, click Installation Guide in Step 3.

Click Install



4 Exit the installer.

Click **Yes** (Windows) or **OK** (Mac OS) when installation is complete.



The following software is installed:

- ViewNX 2
- Apple QuickTime (Windows only)

5 Remove the installer CD from the CD-ROM drive.

✓ Connecting Cables

Be sure the camera is off when connecting or disconnecting interface cables. Do not use force or attempt to insert the connectors at an angle. Close the connector cover when the connector is not in use.

✎ Windows

To visit the Nikon website after installing ViewNX 2, select **All Programs > Link to Nikon** from the Windows start menu (Internet connection required).



System Requirements

Windows

CPU	<ul style="list-style-type: none">• Photos/JPEG movies: Intel Celeron, Pentium 4, or Core series, 1.6 GHz or better• H.264 movies (playback): 3.0 GHz or better Pentium D; Intel Core i5 or better recommended when viewing movies with a frame size of 1,280 × 720 or more at a frame rate of 30 fps or above or movies with a frame size of 1,920 × 1,080 or more• H.264 movies (editing): 2.6 GHz or better Core 2 Duo
OS	Pre-installed versions of Windows 7 Home Basic/Home Premium/Professional/Enterprise/Ultimate (Service Pack 1), Windows Vista Home Basic/Home Premium/Business/Enterprise/Ultimate (Service Pack 2), or 32-bit editions of Windows XP Home Edition/Professional (Service Pack 3). All installed programs run as 32-bit applications in 64-bit editions of Windows 7 and Windows Vista.
RAM	<ul style="list-style-type: none">• Windows 7/Windows Vista: 1 GB or more (2 GB or more recommended)• Windows XP: 512 MB or more (2 GB or more recommended)
Hard-disk space	A minimum of 500 MB available on the startup disk (1 GB or more recommended)
Monitor	<ul style="list-style-type: none">• Resolution: 1024 × 768 pixels (XGA) or more (1280 × 1024 pixels (SXGA) or more recommended)• Color: 24-bit color (True Color) or more

Mac OS

CPU	<ul style="list-style-type: none">• Photos/JPEG movies: PowerPC G4 (1 GHz or better), G5, Intel Core, or Xeon series• H.264 movies (playback): PowerPC G5 Dual or Core Duo, 2 GHz or better; Intel Core i5 or better recommended when viewing movies with a frame size of 1,280 × 720 or more at a frame rate of 30 fps or above or movies with a frame size of 1,920 × 1,080 or more• H.264 movies (editing): 2.6 GHz or better Core 2 Duo• GPU that supports QuickTime H.264 hardware acceleration recommended
OS	Mac OS X version 10.5.8, 10.6.8, or 10.7.2
RAM	512 MB or more (2 GB or more recommended)
Hard-disk space	A minimum of 500 MB available on the startup disk (1 GB or more recommended)
Monitor	<ul style="list-style-type: none">• Resolution: 1024 × 768 pixels (XGA) or more (1280 × 1024 pixels (SXGA) or more recommended)• Color: 24-bit color (millions of colors) or more

Direct USB Connection

Connect the camera using the supplied UC-E14 USB cable.

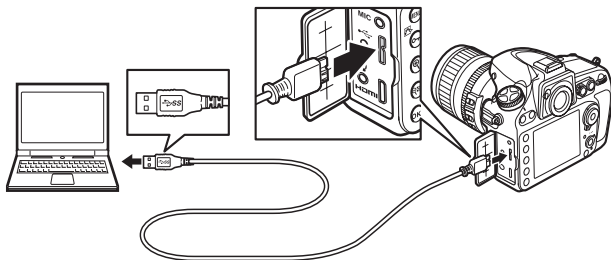
1 Turn the camera off.

2 Turn the computer on.

Turn the computer on and wait for it to start up.

3 Connect the USB cable.

Connect the USB cable as shown.

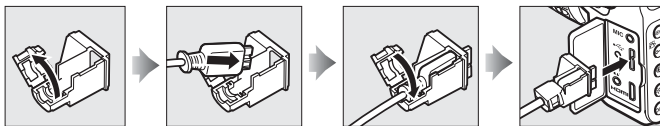


USB Hubs

Connect the camera directly to the computer; do not connect the cable via a USB hub or keyboard.

The USB Cable Clip

To prevent cable from being disconnected, attach the clip as shown.



4 Turn the camera on.

5 Start Nikon Transfer 2.

If a message is displayed prompting you to choose a program, select Nikon Transfer 2.

Windows 7

If the following dialog is displayed, select Nikon Transfer 2 as described below.

- 1 Under **Import pictures and videos**, click **Change program**. A program selection dialog will be displayed; select **Import file using Nikon Transfer 2** and click **OK**.
- 2 Double-click **Import file**.



6 Click Start Transfer.

At default settings, all the pictures on the memory card will be copied to the computer (for more information on using Nikon Transfer 2, start ViewNX 2 or Nikon Transfer 2 and select **ViewNX 2 Help** from the **Help** menu).



Start Transfer

7 Turn the camera off and disconnect the USB cable when transfer ends.

Nikon Transfer 2 will close automatically when transfer is complete.

During Transfer

Do not turn the camera off or disconnect the USB cable while transfer is in progress.


Ethernet and Wireless Networks

If the optional WT-4 wireless transmitter (☐ 387) is attached, photographs can be transferred or printed over wireless or Ethernet networks and the camera can also be controlled from network computers running Camera Control Pro 2 (available separately). The WT-4 can be used in any of the following modes:

Mode	Function
Transfer mode	Upload new or existing photographs to computer or ftp server.
Thumbnail select mode	Preview photographs on computer monitor before upload.
PC mode	Control camera from computer using Camera Control Pro 2 (available separately).
Print mode	Print JPEG photographs on printer connected to network computer.

For more information, see the WT-4 user's manual. Be sure to update to the latest versions of the wireless transmitter firmware and supplied software.

Transfer Mode

When **Wireless transmitter > Mode > Transfer mode** is selected in the camera setup menu, the  button is used during playback to select pictures for upload, preventing it from being used to select pictures for other operations, such as side-by-side comparison (☐ 364). To restore normal operation, select another option for **Wireless transmitter > Mode**.

Recording and Viewing Movies During Transfer

Movies can not be recorded or played back in image transfer mode when a WT-4 is connected to the camera ("image transfer mode" applies when images are being transferred and when images remain to be sent).




Movies

The WT-4 can be used to upload movies in transfer mode if **Auto send** or **Send folder** is not selected for **Transfer settings**. Movies can not be uploaded in thumbnail select mode.

Thumbnail Select Mode

Camera settings can not be changed from the computer in thumbnail select mode.

Camera Control Pro 2

Camera Control Pro 2 software (available separately; □ 389) can be used to control the camera from a computer. When Camera Control Pro 2 is used to capture photographs directly to the computer, the PC connection indicator () will appear in the control panel.



Printing Photographs

Selected JPEG images can be printed on a PictBridge printer (☞ 433) connected directly to the camera.

✔ **Selecting Photographs for Printing**

Images created at image quality settings of NEF (RAW) or TIFF (RGB) (☞ 84) can not be selected for printing. JPEG copies of NEF (RAW) images can be created using the **NEF (RAW) processing** option in the retouch menu (☞ 353).

✎ **Printing Via Direct USB Connection**

Be sure the battery is fully charged or use an optional EH-5b AC adapter and EP-5B power connector. When taking photographs to be printed via direct USB connection, set **Color space** to **sRGB** (☞ 274).

✎ **See Also**

See page 422 for information on what to do if an error occurs during printing.



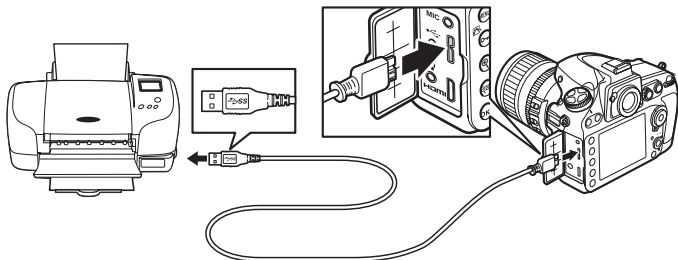
Connecting the Printer

Connect the camera using the supplied UC-E14 USB cable.

1 Turn the camera off.

2 Connect the USB cable.

Turn the printer on and connect the USB cable as shown. Do not use force or attempt to insert the connectors at an angle.

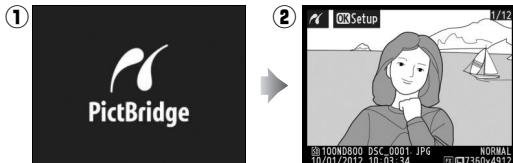


USB Hubs

Connect the camera directly to the printer; do not connect the cable via a USB hub.

3 Turn the camera on.

A welcome screen will be displayed in the monitor, followed by a PictBridge playback display.



Printing Pictures One at a Time

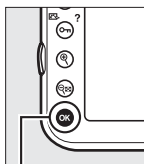
1 Select a picture.

Press ◀ or ▶ to view additional pictures. Press ▲ or ▼ to view photo information (□ 222), or press the Ⓞ button to zoom in on the current frame (□ 231, press ▶ to exit zoom). To view six pictures at a time, press the center of the multi selector. Use the multi selector to highlight pictures, or press the center of the multi selector again to display the highlighted picture full frame. To view images in other locations, press Ⓞ when thumbnails are displayed and select the desired card and folder as described on page 221.

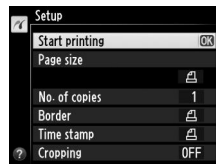


2 Display printing options.

Press Ⓞ to display PictBridge printing options.



Ⓞ button



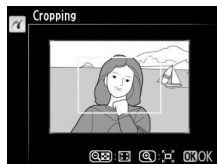
3 Adjust printing options.

Press ▲ or ▼ to highlight an option and press ▶ to select.

Option	Description
Page size	Highlight a page size (only sizes supported by the current printer are listed) and press Ⓞ to select and exit to the previous menu (to print at the default page size for the current printer, select Printer default).
No. of copies	Press ▲ or ▼ to choose number of copies (maximum 99), then press Ⓞ to select and return to the previous menu.

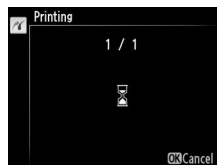


Option	Description
Border	This option is available only if supported by the printer. Highlight Printer default (use current printer settings), Print with border (print photo with white border), or No border and press OK to select and exit to the previous menu.
Time stamp	Highlight Printer default (use current printer settings), Print time stamp (print times and dates of recording on photos), or No time stamp and press OK to select and exit to the previous menu.
Cropping	<p>This option is available only if supported by the printer. To exit without cropping, highlight No cropping and press OK. To crop the current picture, highlight Crop and press ▶.</p> <p>Selecting Crop displays the dialog shown at right. Press ↶ to increase the size of the crop, ↷ to decrease. Position the crop using the multi selector and press OK. Note that print quality may drop if small crops are printed at large sizes.</p>



4 Start printing.

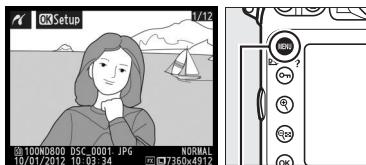
Select **Start printing** and press **OK** to start printing. To cancel before all copies have been printed, press **OK**.



Printing Multiple Pictures

1 Display the PictBridge menu.

Press the **MENU** button in the PictBridge playback display (see Step 3 on page 248).

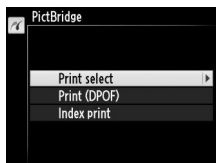


MENU button




2 Choose an option.






Highlight one of the following options and press **▶**.

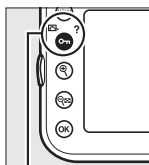
- **Print select:** Select pictures for printing.
- **Print (DPOF):** Print an existing print order created with the **DPOF print order** option in the playback menu (□ 254). The current print order will be displayed in Step 3.
- **Index print:** To create an index print of all JPEG pictures on the memory card, proceed to Step 4. Note that if the memory card contains more than 256 pictures, only the first 256 images will be printed.





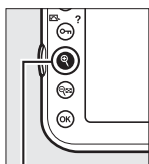
3 Select pictures.

Use the multi selector to scroll through the pictures on the memory card (to view images in other locations, press  and select the desired card and folder as described on page 221). To display the current picture full screen, press and hold the  button. To select the current picture for printing, press the  () button and press . The picture will be marked with a  icon and the number of prints will be set to 1.

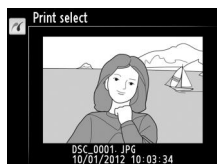
Keeping the  () button pressed, press  or  to specify the number of prints (up to 99; to deselect the picture, press  when the number of prints is 1). Continue until all the desired pictures have been selected.




 () button

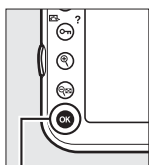


 button

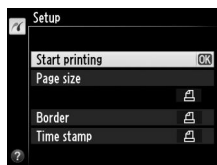


4 Display printing options.

Press  to display PictBridge printing options.



 button



5 Adjust printing options.

Choose page size, border, and time stamp options as described on page 249 (a warning will be displayed if the selected page size is too small for an index print).

6 Start printing.

Select **Start printing** and press **OK** to start printing.
To cancel before all copies have been printed, press **OK**.

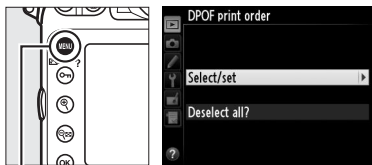


Creating a DPOF Print Order: Print Set

The **DPOF print order** option in the playback menu is used to create digital “print orders” for PictBridge-compatible printers and devices that support DPOF (📖 433).

1 Choose **Select/set** for the **DPOF print order** item in the playback menu.

Press the **MENU** button and select **DPOF print order**

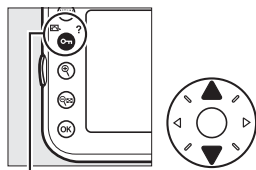


MENU button

in the playback menu. Highlight **Select/set** and press ► (to remove all photographs from the print order, select **Deselect all?**).

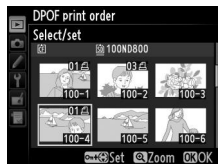
2 Select pictures.

Use the multi selector to scroll through the pictures on the memory card (to view images in other locations, press and select the desired card and folder as described on page 221). To display the current picture in full screen, press and hold the button. To select the current picture for printing, press the button and press ▲.



(/?) button

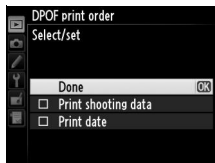
The picture will be marked with a icon and the number of prints will be set to 1. Keeping the button pressed, press ▲ or ▼ to specify the number of prints (up to 99; to deselect the picture, press ▼ when the number of prints is 1). Press when all the desired pictures have been selected.



3 Select imprint options.

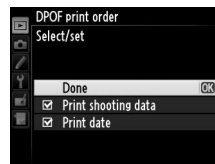
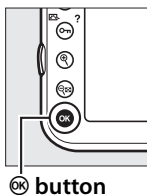
Highlight the following options and press **▶** to toggle the highlighted option on or off (to complete the print order without including this information, proceed to Step 4).

- **Print shooting data:** Print shutter speed and aperture on all pictures in print order.
- **Print date:** Print date of recording on all pictures in print order.



4 Complete the print order.

Highlight **Done** and press **OK** to complete the print order.



Print Set

To print the current print order when the camera is connected to a PictBridge printer, select **Print (DPOF)** in the PictBridge menu and follow the steps in "Printing Multiple Pictures" to modify and print the current order (□ 251). DPOF date and shooting data imprint options are not supported when printing via direct USB connection; to print the date of recording on photographs in the current print order, use the PictBridge **Time stamp** option.

The Print Set option can not be used if there is not enough space on the memory card to store the print order.

Images created at image quality settings of NEF (RAW; □ 84) can not be selected for printing using this option.

Print orders may not print correctly if images are deleted using a computer or other device after the print order is created.



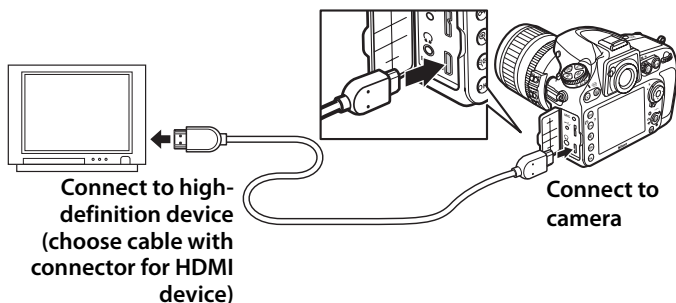
Viewing Photographs on TV

A type C mini-pin High-Definition Multimedia Interface (HDMI) cable (available separately from commercial sources) can be used to connect the camera to high-definition video devices.

1 Turn the camera off.

Always turn the camera off before connecting or disconnecting an HDMI cable.

2 Connect the HDMI cable as shown.



3 Tune the device to the HDMI channel.

4 Turn the camera on and press button.

During playback, images will be displayed both in the camera monitor and on the high-definition television or monitor screen.

Close the Connector Cover

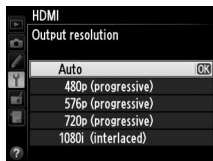
Close the connector cover when the connectors are not in use. Foreign matter in the connectors can interfere with data transfer.

HDMI Options

The **HDMI** option in the setup menu (☰ 325) controls output resolution and other advanced HDMI options.

■ ■ Output Resolution

Choose the format for images output to the HDMI device. If **Auto** is selected, the camera will automatically select the appropriate format. Regardless of the option selected, **Auto** will be used for movie live view, movie recording, and playback.



■ ■ Advanced

Option	Description
Output range	<p>Auto is recommended in most situations. If the camera is unable to determine the correct RGB video signal output range for the HDMI device, you can choose from the following options:</p> <ul style="list-style-type: none">• Limited range: For devices with an RGB video signal input range of 16 to 235. Choose this option if you notice loss of detail in shadows.• Full range: For devices with an RGB video signal input range of 0 to 255. Choose this option if shadows are “washed out” or too bright.
Output display size	Choose horizontal and vertical frame coverage for HDMI output from 95% or 100%.
Live view on-screen display	If Off is selected when the camera is connected to an HDMI device, shooting information will not be displayed in the monitor during live view photography.



Television Playback

Use of an EH-5b AC adapter and EP-5B power connector (available separately) is recommended for extended playback. Note that the edges may not be visible when photographs are viewed on a television screen.

Slide Shows

The **Slide show** option in the playback menu can be used for automated playback (📖 267).

Audio

Stereo sound recorded with optional ME-1 (📖 65, 389) stereo microphones plays in stereo when movies are viewed on HDMI devices using a camera connected via an HDMI cable (note that audio will not be played back over headphones connected to the camera). Volume can be adjusted using television controls; the camera controls can not be used.


HDMI and Live View

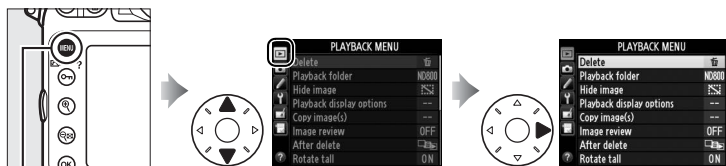
When the camera is connected via an HDMI cable, HDMI displays can be used for live view photography and movie live view (📖 57, 67). During movie live view and movie recording and playback, HDMI output will be adjusted according to the option selected for **Movie settings > Frame size/frame rate** in the shooting menu (📖 70). Note that some HDMI devices may not support the selected setting; in this case, select **1080i (interlaced)** for **HDMI > Output resolution** (📖 257).




Menu Guide

▶ The Playback Menu: *Managing Images*

To display the playback menu, press **MENU** and select the  (playback menu) tab.



MENU button


Option	
Delete	236
Playback folder	260
Hide image	260
Playback display options	261
Copy image(s)	262
Image review	265
After delete	266
Rotate tall	266
Slide show	267
DPOF print order	254

See Also

Menu defaults are listed on page 405.

Playback Folder

MENU button →  playback menu

Choose a folder for playback ( 219).

Option	Description
ND800	Pictures in all folders created with the D800 will be visible during playback.
All	Pictures in all folders will be visible during playback.
Current	Only pictures in the current folder will be visible during playback.

Hide Image

MENU button →  playback menu

Hide or reveal selected pictures as described below. Hidden pictures are visible only in the **Hide image** menu and can only be deleted by formatting the memory card.

Protected and Hidden Images




Revealing a protected image will also remove protection from the image.

1 Choose Select/set.

Highlight **Select/set** and press **▶** (to skip the remaining steps and reveal all pictures, highlight **Deselect all?** and press **OK**).



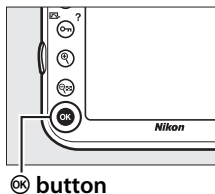
2 Select pictures.

Use the multi selector to scroll through the pictures on the memory card (to view the highlighted picture full screen, press and hold the  button; to view images in other locations, press  and select the desired card and folder as described on page 221) and press the center of the multi selector to select the current picture. Selected pictures are marked by a  icon; to deselect a picture, highlight it and press the center of the multi selector.










3 Press .

Press  to complete the operation.



Playback Display Options

MENU button →  playback menu

Choose the information available in the playback photo information display ( 222). Press  or  to highlight an option, then press  to select the option for the photo information display. A  appears next to selected items; to deselect, highlight and press . To return to the playback menu, highlight **Done** and press .

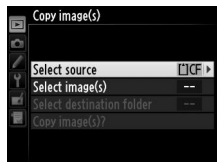


Copy pictures from one memory card to another.

Option	Description
Select source	Choose card from which pictures will be copied.
Select image(s)	Select pictures to be copied.
Select destination folder	Select destination folder on remaining card.
Copy image(s)?	Copy selected pictures to specified destination.

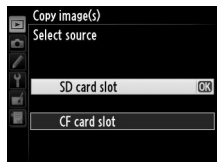
1 Choose Select source.

Highlight **Select source** and press ►.



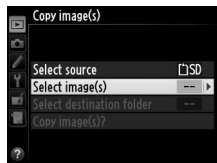
2 Select the source card.

Highlight the slot for the card containing the images to be copied and press OK.



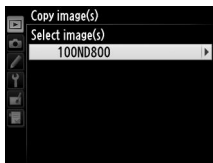
3 Choose Select image(s).

Highlight **Select image(s)** and press ►.



4 Select the source folder.

Highlight the folder containing the images to be copied and press ►.





5 Make the initial selection.

Before going on select or deselect individual images, you can mark all or all protected images in the folder for copying by choosing **Select all images** or **Select protected images**. To mark only individually selected images for copying, choose **Deselect all** before proceeding.



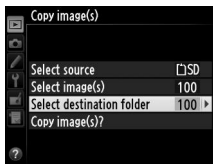
6 Select additional images.

Highlight pictures and press the center of the multi selector to select or deselect (to view the highlighted picture full screen, press and hold the  button). Selected images are marked with a ✓. Press  to proceed to Step 7 when your selection is complete.



7 Choose **Select destination folder**.

Highlight **Select destination folder** and press ►.

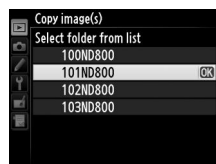


8 Select a destination folder.

To enter a folder number, choose **Select folder by number**, enter the number (□ 271), and press **OK**.



To choose from a list of existing folders, choose **Select folder from list**, highlight a folder, and press **OK**.

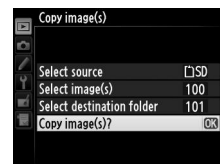


9 Copy the images.

Highlight **Copy image(s)?** and press **OK**.



OK button



A confirmation dialog will be displayed; highlight **Yes** and press **OK**. Press **OK** again to exit when copying is complete.



✔ Copying Images

Images will not be copied if there is insufficient space on the destination card. Be sure the battery is fully charged before copying movies.

If the destination folder contains an image with the same name as one of the images to be copied, a confirmation dialog will be displayed.

Select **Replace existing image** to replace the image with the image to be copied, or select **Replace all** to replace all existing images with the same names without further prompting. To continue without replacing the image, select **Skip**, or select **Cancel** to exit without copying any further images. Hidden or protected files in the destination folder will not be replaced.



Protect status is copied with the images but print marking (📄 254) is not. Hidden images can not be copied.

Image Review

MENU button → ▶ playback menu




Choose whether pictures are automatically displayed in the monitor immediately after shooting. If **Off** is selected, pictures can only be displayed by pressing the ▶ button.




After Delete

MENU button →  playback menu


Choose the picture displayed after an image is deleted.

Option	Description
 Show next	Display following picture. If deleted picture was last frame, previous picture will be displayed.
 Show previous	Display previous picture. If deleted picture was first frame, following picture will be displayed.
 Continue as before	If user was scrolling through pictures in order recorded, following picture will be displayed as described for Show next . If user was scrolling through pictures in reverse order, previous picture will be displayed as described for Show previous .



Rotate Tall

MENU button →  playback menu


Choose whether to rotate “tall” (portrait-orientation) pictures for display during playback. Note that because the camera itself is already in the appropriate orientation during shooting, images are not rotated automatically during image review.

Option	Description
On	“Tall” (portrait-orientation) pictures are automatically rotated for display in the camera monitor. Pictures taken with Off selected for Auto image rotation ( 331) will be displayed in “wide” (landscape) orientation.
Off	“Tall” (portrait-orientation) pictures are displayed in “wide” (landscape) orientation.













Create a slide show of the pictures in the current playback folder ( 260). Hidden images ( 260) are not displayed.

Option	Description
Start	Start slide show.
Image type	Choose type of image displayed from Still images and movies , Still images only , and Movies only .
Frame interval	Choose how long each photo will be displayed.

To start the slide show, highlight **Start** and press . The following operations can be performed while the slide show is in progress:




To	Press	Description
Skip back/skip ahead		Press  to return to previous frame,  to skip to next frame.
View additional photo info		Change photo info displayed (still images only;  222).
Pause/resume		Pause or resume slide show.
Exit to playback menu	MENU	End slide show and return to playback menu.
Exit to playback mode		End slide show and exit to full-frame ( 219) or thumbnail playback ( 219).
Exit to shooting mode		Press shutter-release button halfway to return to shooting mode.

The dialog shown at right is displayed when the show ends. Select **Restart** to restart or **Exit** to return to the playback menu.





The Shooting Menu: *Shooting Options*

To display the shooting menu, press **MENU** and select the  (shooting menu) tab.



MENU button


Option	
Shooting menu bank	269
Extended menu banks	270
Storage folder	271
File naming	273
Primary slot selection	89
Secondary slot function	89
Image quality	84
Image size	87
Image area	79
JPEG compression	86
NEF (RAW) recording	86
White balance	145
Set Picture Control	163

Option	
Manage Picture Control	169
Color space	274
Active D-Lighting	174
HDR (high dynamic range)	176
Vignette control	275
Auto distortion control	276
Long exposure NR	277
High ISO NR	277
ISO sensitivity settings	109
Multiple exposure	195
Interval timer shooting	201
Time-lapse photography	207
Movie settings	70

See Also

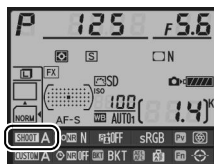
Menu defaults are listed on page 405.

Shooting menu options are stored in one of four banks. With the exceptions of **Extended menu banks**, **Interval timer shooting**, **Multiple exposure**, **Time-lapse photography**, and modifications to Picture Controls (quick adjust and other manual adjustments), changes to settings in one bank have no effect on the others. To store a particular combination of frequently-used settings, select one of the four banks and set the camera to these settings. The new settings will be stored in the bank even when the camera is turned off, and will be restored the next time the bank is selected. Different combinations of settings can be stored in the other banks, allowing the user to switch instantly from one combination to another by selecting the appropriate bank from the bank menu.


The default names for the four shooting menu banks are A, B, C, and D. A descriptive caption of up to 20 characters in length can be added by highlighting the menu bank and pressing  as described on page 170.

Shooting Menu Bank



The information display shows the current shooting menu bank.

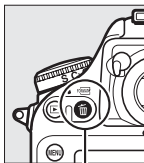



See Also

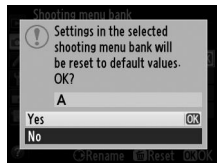
Exposure mode, shutter speed, and aperture can be included in shooting menu banks using the **Extended menu banks** option in the shooting menu ( 270).

■ Restoring Default Settings

To restore default settings, highlight a bank in the **Shooting menu bank** menu and press  (FORMAT). A confirmation dialog will be displayed; highlight **Yes** and press  to restore default settings for the selected bank. See page 405 for a list of default settings.



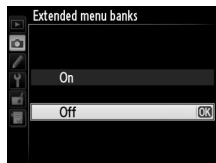
 (FORMAT) button



Extended Menu Banks

MENU button →  shooting menu



Select **On** to include exposure mode, shutter speed (modes **S** and **M** only), and aperture (modes **A** and **M** only) in the information recorded in each of the four shooting menu banks, to be recalled whenever the bank is selected. Selecting **Off** restores the values in effect before **On** was selected.



Select the folder in which subsequent images will be stored.








■ ■ *Select Folder by Number*




1 Choose **Select folder by number**.

Highlight **Select folder by number** and press . The dialog shown at right will be displayed, with the current primary slot ( 89) underlined.




2 Choose a folder number.

Press  or  to highlight a digit, press  or  to change. If a folder with the selected number already exists, a , , or  icon will be displayed to the left of the folder number:

-  : Folder is empty.
-  : Folder is partially full.
-  : Folder contains 999 pictures or a picture numbered 9999. No further pictures can be stored in this folder.

3 Save changes and exit.

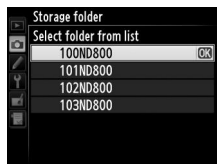
Press  to complete the operation and return to the shooting menu (to exit without changing the storage folder, press the MENU button). If a folder with the specified number does not already exist, a new folder will be created on the card in the primary slot. Subsequent photographs will be stored in the selected folder unless it is already full.



■ Select Folder from List

1 Choose **Select folder from list**.

Highlight **Select folder from list** and press ►.



2 Highlight a folder.

Press ▲ or ▼ to highlight a folder.

3 Select the highlighted folder.

Press **OK** to select the highlighted folder and return to the shooting menu. Subsequent photographs will be stored in the selected folder.

Folder and File Numbers

If the current folder is numbered 999 and contains 999 pictures or a picture numbered 9999, the shutter-release will be disabled and no further photographs can be taken. To continue shooting, create a folder with a number less than 999, or select an existing folder with a number less than 999 and less than 999 images.

Startup Time

Additional time may be required for camera startup if the memory card contains a very large number of files or folders.



Photographs are saved using file names consisting of “DSC_” or, in the case of images that use the Adobe RGB color space (☐ 274), “_DSC”, followed by a four-digit number and a three-letter extension (e.g., “DSC_0001.JPG”). The **File naming** option is used to select three letters to replace the “DSC” portion of the file name. For information on editing file names, see page 170.

Extensions

The following extensions are used: “.NEF” for NEF (RAW) images, “.TIF” for TIFF (RGB) images, “.JPG” for JPEG images, “.MOV” for movies, and “.NDF” for dust off reference data. In each pair of photographs recorded at image-quality settings of NEF (RAW)+JPEG, the NEF and JPEG images have the same file names but different extensions.



The color space determines the gamut of colors available for color reproduction. Choose **sRGB** for photographs that will be printed or used “as is,” with no further modification. **Adobe RGB** has a wider color gamut and is recommended for images that will be extensively processed or retouched after leaving the camera.

Color Space

Color spaces define the correspondence between colors and the numeric values that represent them in a digital image file. The sRGB color space is widely used, while the Adobe RGB color space is typically used in publishing and commercial printing. sRGB is recommended when taking photographs that will be printed without modification or viewed in applications that do not support color management, or when taking photographs that will be printed with ExifPrint, the direct printing option on some household printers, or kiosk printing or other commercial print services. Adobe RGB photographs can also be printed using these options, but colors will not be as vivid.

JPEG photographs taken in the Adobe RGB color space are DCF compliant; applications and printers that support DCF will select the correct color space automatically. If the application or device does not support DCF, select the appropriate color space manually. An ICC color profile is embedded in TIFF photographs taken in the Adobe RGB color space, allowing applications that support color management to automatically select the correct color space. For more information, see the documentation provided with the application or device.




Nikon Software

ViewNX 2 (supplied) and Capture NX 2 (available separately) automatically select the correct color space when opening photographs created with this camera.



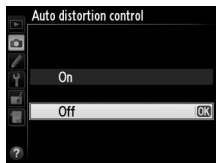
“Vignetting” is a drop in brightness at the edges of a photograph. **Vignette control** reduces vignetting for type G and D lenses (DX and PC lenses excluded). Its effects vary from lens to lens and are most noticeable at maximum aperture. Choose from **High**, **Normal**, **Low**, and **Off**.

Vignette Control

Depending on the scene, shooting conditions, and type of lens, TIFF and JPEG images may exhibit noise (fog) or variations in peripheral brightness, while custom Picture Controls and preset Picture Controls that have been modified from default settings may not produce the desired effect. Take test shots and view the results in the monitor. Vignette control does not apply to movies ( 59) or multiple exposures ( 195) or DX-format images ( 79).



Select **On** to reduce barrel distortion in photos taken with wide-angle lenses and to reduce pin-cushion distortion in photos taken with long lenses (note that the edges of the area visible in the viewfinder may be cropped out of the final photograph, and that the time needed to process photographs before recording begins may increase). This option does not apply to movies and is available only with type G and D lenses (PC, fisheye, and certain other lenses excluded); results are not guaranteed with other lenses. Before using auto distortion control with DX lenses, select **On** for **Auto DX crop** or choose an image area of **DX (24×16) 1.5×** (📖 80); selecting other options may result in heavily cropped photographs or in photographs with severe peripheral distortion.



Retouch: Distortion Control

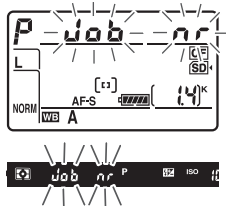
For information on creating copies of existing photographs with reduced barrel and pin-cushion distortion, see page 358.



Long Exposure NR (Long Exposure Noise Reduction)

MENU button →  shooting menu

If **On** is selected, photographs taken at shutter speeds slower than 1 s will be processed to reduce noise (bright spots, randomly-spaced bright pixels, or fog). The time required for processing roughly doubles; during processing, “**LoB NR**” will blink in the shutter speed/aperture displays and pictures can not be taken (if the camera is turned off before processing is complete, the picture will be saved but noise reduction will not be performed). In continuous release mode, frame rates will slow and while photographs are being processed, the capacity of the memory buffer will drop. Long exposure noise reduction is not available during movie recording.



High ISO NR


MENU button →  shooting menu

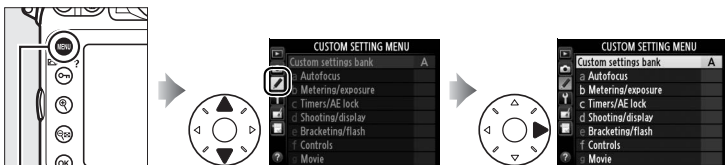
Photographs taken at high ISO sensitivities can be processed to reduce noise.

Option	Description
High	Reduce noise (randomly-spaced bright pixels, lines, or fog), particularly in photographs taken at high ISO sensitivities.
Normal	Choose the amount of noise reduction performed from High ,
Low	Normal , and Low .
Off	Noise reduction is performed only at sensitivities of 1600 and higher. The amount of noise reduction is less than the amount performed when Low is selected for High ISO NR .



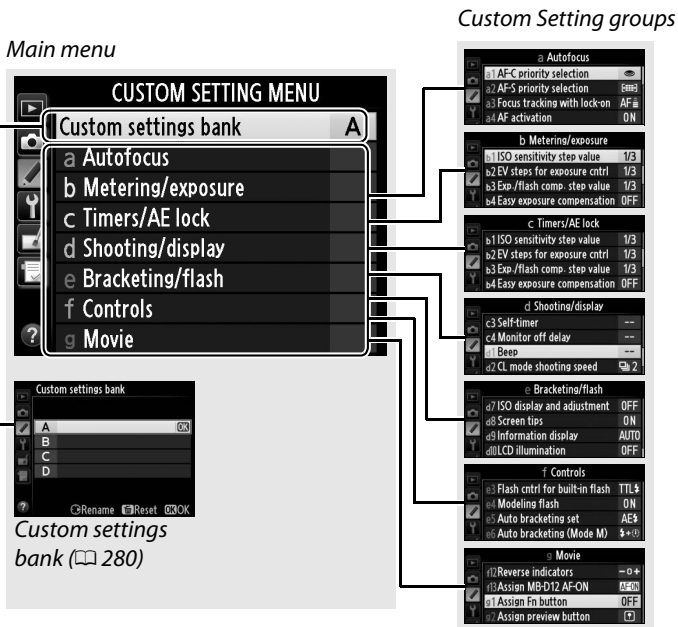
Custom Settings: Fine-Tuning Camera Settings

To display the Custom Settings menu, press **MENU** and select the  (Custom Settings menu) tab.



MENU button

Custom Settings are used to customize camera settings to suit individual preferences.



The following Custom Settings are available:

Custom Setting		📖
Custom settings bank		280
a Autofocus		
a1	AF-C priority selection	281
a2	AF-S priority selection	282
a3	Focus tracking with lock-on	283
a4	AF activation	283
a5	AF point illumination	284
a6	Focus point wrap-around	284
a7	Number of focus points	285
a8	Built-in AF-assist illuminator	286
b Metering/exposure		
b1	ISO sensitivity step value	287
b2	EV steps for exposure cntrl	287
b3	Exp./flash comp. step value	287
b4	Easy exposure compensation	288
b5	Center-weighted area	289
b6	Fine-tune optimal exposure	290
c Timers/AE lock		
c1	Shutter-release button AE-L	290
c2	Auto meter-off delay	291
c3	Self-timer	291
c4	Monitor off delay	292
d Shooting/display		
d1	Beep	292
d2	CL mode shooting speed	293
d3	Max. continuous release	293
d4	Exposure delay mode	293
d5	File number sequence	294
d6	Viewfinder grid display	295
d7	ISO display and adjustment	295
d8	Screen tips	295
d9	Information display	296
d10	LCD illumination	296
d11	MB-D12 battery type	297
d12	Battery order	298

Custom Setting		📖
e Bracketing/flash		
e1	Flash sync speed	299
e2	Flash shutter speed	300
e3	Flash control for built-in flash	301
e4	Modeling flash	307
e5	Auto bracketing set	307
e6	Auto bracketing (Mode M)	308
e7	Bracketing order	308
f Controls		
f1	☛ switch	309
f2	Multi selector center button	309
f3	Multi selector	310
f4	Assign Fn button	311
f5	Assign preview button	315
f6	Assign AE-L/AF-L button	315
f7	Shutter spd & aperture lock	316
f8	Assign BKT button	316
f9	Customize command dials	317
f10	Release button to use dial	318
f11	Slot empty release lock	319
f12	Reverse indicators	319
f13	Assign MB-D12 AF-ON	320
g Movie		
g1	Assign Fn button	321
g2	Assign preview button	322
g3	Assign AE-L/AF-L button	323
g4	Assign shutter button	324

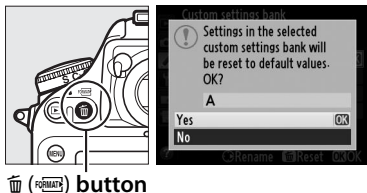


Custom Settings are stored in one of four banks. Changes to settings in one bank have no effect on the others. To store a particular combination of frequently-used settings, select one of the four banks and set the camera to these settings. The new settings will be stored in the bank even when the camera is turned off, and will be restored the next time the bank is selected. Different combinations of settings can be stored in the other banks, allowing the user to switch instantly from one combination to another by selecting the appropriate bank from the bank menu.

The default names for the four Custom Settings banks are A, B, C, and D. A descriptive caption of up to 20 characters in length can be added by highlighting the menu bank and pressing as described on page 170.

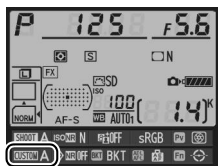
Restoring Default Settings

To restore default settings, highlight a bank in the **Custom settings bank** menu and press (FORMAT). A confirmation dialog will be displayed; highlight **Yes** and press to restore default settings for the selected bank (407).



Custom Settings Bank

The information display shows the current Custom Settings bank.




See Also




Menu defaults are listed on page 407. If settings in the current bank have been modified from default values, an asterisk will be displayed adjacent to the altered settings in the second level of the Custom Settings menu.

a: Autofocus

a1: AF-C Priority Selection


MENU button →  Custom Settings menu



When **AF-C** (☐ 91) is selected for viewfinder photography, this option controls whether photographs can be taken whenever the shutter-release button is pressed (*release priority*) or only when the camera is in focus (*focus priority*).

Option	Description
 Release	Photos can be taken whenever the shutter-release button is pressed.
 Release + focus	Photos can be taken even when the camera is not in focus. In continuous mode, frame rate slows for improved focus if the subject is dark or low contrast.
 Focus	Photos can only be taken when the in-focus indicator (●) is displayed.

Regardless of the option selected, focus will not lock when **AF-C** is selected for autofocus mode. The camera will continue to adjust focus until the shutter is released.




When **AF-S** ( 91) is selected for viewfinder photography, this option controls whether photographs can be taken only when the camera is in focus (*focus priority*) or whenever the shutter-release button is pressed (*release priority*) in single-servo AF.






Option	Description
 Release	Photos can be taken whenever the shutter-release button is pressed.
 Focus	Photos can only be taken when the in-focus indicator (●) is displayed.

Regardless of the option selected, if the in-focus indicator (●) is displayed when **AF-S** is selected for autofocus mode, focus will lock while the shutter-release button is pressed halfway. Focus lock continues until the shutter is released.



a3: Focus Tracking with Lock-On MENU button → Custom Settings menu

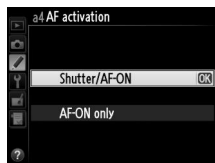
This option controls how autofocus adjusts to sudden large changes in the distance to the subject when **AF-C** ( 91) is selected during viewfinder photography.

Option	Description
AF  5 (Long)	When the distance to the subject changes abruptly, the camera waits for the specified period before adjusting the distance to the subject. This prevents the camera from refocusing when the subject is briefly obscured by objects passing through the frame.
AF  4	
AF  3 (Normal)	
AF  2	
AF  1 (Short)	
Off	The camera immediately adjusts focus when the distance to the subject changes. Use when photographing a series of subjects at varying distances in quick succession.

a4: AF Activation

MENU button →  Custom Settings menu

If **Shutter/AF-ON** is selected, both the shutter-release button and the **AF-ON** button can be used to initiate autofocus. If **AF-ON only** is selected, autofocus is only initiated when the **AF-ON** button is pressed.



a5: AF point Illumination

MENU button →  Custom Settings menu

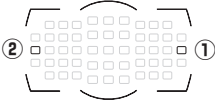
Choose whether the active focus point is highlighted in red in the viewfinder.

Option	Description
Auto	The selected focus point is automatically highlighted as needed to establish contrast with the background.
On	The selected focus point is always highlighted, regardless of the brightness of the background. Depending on the brightness of the background, the selected focus point may be difficult to see.
Off	The selected focus point is not highlighted. The area outside the current crop is shown in grey (☐ 81).

a6: Focus Point Wrap-Around

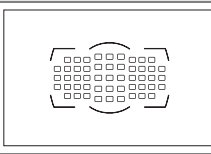
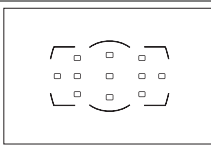
MENU button →  Custom Settings menu

Choose whether focus-point selection “wraps around” from one edge of the viewfinder to another.

Option	Description
Wrap	Focus-point selection “wraps around” from top to bottom, bottom to top, right to left, and left to right, so that, for example, pressing ► when a focus point at the right edge of the viewfinder display is highlighted (①) selects the corresponding focus point at the left edge of the display (②). 
No wrap	The focus-point display is bounded by the outermost focus points so that, for example, pressing ► when a focus point at the right edge of the display is selected has no effect.



Choose the number of focus points available for manual focus-point selection.

Option	Description	
AF51 51 points	Choose from the 51 focus points shown at right.	
AF11 11 points	Choose from the 11 focus points shown at right. Use for quick focus-point selection.	



Choose whether the built-in AF-assist illuminator lights to assist the focus operation when lighting is poor.



Option	Description
On	The AF-assist illuminator lights when lighting is poor (viewfinder photography only). AF-assist illumination is only available when both of the following conditions are met: <ol style="list-style-type: none"><li data-bbox="194 473 918 501">1 AF-S is selected for autofocus mode (☞ 91).<li data-bbox="194 505 918 599">2 Auto-area AF is chosen for AF-area mode (☞ 93), or an option other than auto-area AF is chosen and the center focus point is selected.
Off	The AF-assist illuminator does not light to assist the focus operation. The camera may not be able to focus using autofocus when lighting is poor.

The AF-Assist Illuminator

The AF-assist illuminator has a range of about 0.5–3.0 m (1 ft 8 in.–9 ft 10 in.); when using the illuminator, use a lens with a focal length of 24–200 mm and remove the lens hood.

See Also

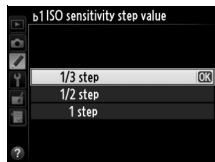
See page 377 for restrictions on the lenses that can be used with AF assist.

b: Metering/Exposure


b1: ISO Sensitivity Step Value

MENU button →  Custom Settings menu

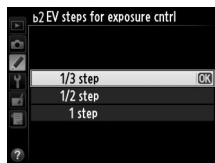
Select the increments used when making adjustments to ISO sensitivity (📖 109). If possible, the current ISO sensitivity setting is maintained when the step value is changed. If the current ISO sensitivity setting is not available at the new step value, ISO sensitivity will be rounded to the nearest available setting.



b2: EV Steps for Exposure Cntrl

MENU button →  Custom Settings menu

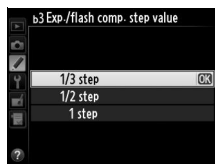
Select the increments used when making adjustments to shutter speed, aperture, and bracketing.






b3: Exp./Flash Comp. Step Value

MENU button →  Custom Settings menu

Select the increments used when making adjustments to exposure and flash compensation.



This option controls whether the  button is needed to set exposure compensation (□ 130). If **On (Auto reset)** or **On** is selected, the 0 at the center of the exposure display will blink even when exposure compensation is set to ± 0 .

Option	Description
On (Auto reset)	Exposure compensation is set by rotating one of the command dials (see note below). The setting selected using the command dial is reset when the camera or exposure meters turn off (exposure compensation settings selected using the  button are not reset).
On	As above, except that the exposure compensation value selected using the command dial is not reset when the camera or exposure meters turn off.
Off	Exposure compensation is set by pressing the  button and rotating the main command dial.

Change Main/Sub

The dial used to set exposure compensation when **On (Auto reset)** or **On** is selected for Custom Setting b4 (**Easy exposure compensation**) depends on the option selected for Custom Setting f9 (**Customize command dials**) > **Change main/sub** (□ 317).

		Customize command dials > Change main/sub	
		Off	On
Exposure mode	P	Sub-command dial	Sub-command dial
	S	Sub-command dial	Main command dial
	A	Main command dial	Sub-command dial
	M	N/A	



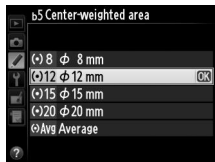
Show ISO/Easy ISO

Custom Setting b4 (**Easy exposure compensation**) can not be used with Custom Setting d7 (**ISO display and adjustment**) > **Show ISO/Easy ISO** (📖 295). Adjustments to either of these items reset the remaining item; a message is displayed when the item is reset.

b5: Center-Weighted Area

MENU button →  Custom Settings menu

When calculating exposure, center-weighted metering assigns the greatest weight to a circle in the center of the frame. The diameter (ϕ) of this circle can be set to 8, 12, 15, or 20 mm or to the average of the entire frame.

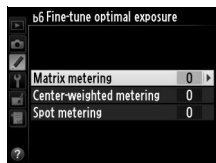


Note that unless **Average** is selected, the diameter is fixed at 12 mm when a non-CPU lens is used, regardless of the setting selected for **Non-CPU lens data** in the setup menu (📖 212). When **Average** is selected, the average of the entire frame will be used for both CPU and non-CPU lenses.





b6: Fine-Tune Optimal Exposure MENU button → Custom Settings menu

Use this option to fine-tune the exposure value selected by the camera. Exposure can be fine-tuned separately for each metering method by from +1 to -1 EV in steps of $\frac{1}{6}$ EV.



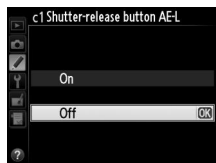
Fine-Tuning Exposure

Exposure can be fine-tuned separately for each Custom Settings bank and is not affected by two-button resets. Note that as the exposure compensation () icon is not displayed, the only way to determine how much exposure has been altered is to view the amount in the fine-tuning menu. Exposure compensation ( 130) is preferred in most situations.

c: Timers/AE Lock

c1: Shutter-Release Button AE-L MENU button → Custom Settings menu

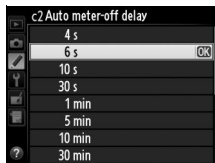
If **On** is selected, exposure will lock when the shutter-release button is pressed halfway.



c2: Auto Meter-off Delay


MENU button →  Custom Settings menu


Choose how long the camera continues to meter exposure when no operations are performed. The shutter-speed and aperture displays in the control panel and viewfinder turn off automatically when the exposure meters turn off.



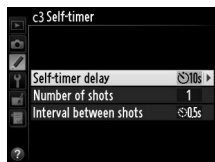
Choose a shorter meter-off delay for longer battery life.

c3: Self-Timer

MENU button →  Custom Settings menu

Choose the length of the shutter release delay, the number of shots taken, and the interval between shots in self-timer mode ( 106).

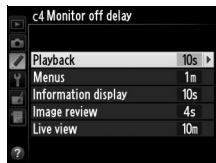
- **Self-timer delay:** Choose the length of the shutter-release delay.
- **Number of shots:** Press ▲ and ▼ to choose the number of shots taken each time the shutter-release button is pressed.
- **Interval between shots:** Choose the interval between shots when the **Number of shots** is more than 1.



c4: Monitor off Delay

MENU button →  Custom Settings menu

Choose how long the monitor remains on when no operations are performed during playback (**Playback**; defaults to 10 s) and image review (**Image review**; defaults to 4 s), when menus (**Menus**; defaults to 1 minute) or information (**Information display**; defaults to 10 s) are displayed, or during live view and movie recording (**Live view**; defaults to 10 minutes). Choose a shorter monitor-off delay for longer battery life.




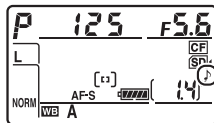
d: Shooting/Display

d1: Beep

MENU button →  Custom Settings menu

Choose the pitch and volume of the beep that sounds when the camera focuses using single-servo AF (📖 91), when focus locks during live view photography, while the release timer is counting down in self-timer mode (📖 106), when time-lapse photography ends (📖 207), or if you attempt to take a photograph when the memory card is locked (📖 34). Note that a beep will not sound in movie live view (📖 59) or quiet-shutter release mode (mode **Q**; 📖 103), regardless of the option selected.

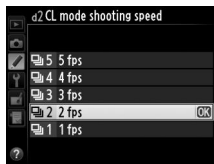
- **Volume:** Choose **3** (high), **2** (medium), **1** (low) or **Off** (mute). When an option other than **Off** is selected,  appears in the control panel and information display.
- **Pitch:** Choose **High** or **Low**.



d2: CL Mode Shooting Speed

MENU button →  Custom Settings menu

Choose the maximum frame advance rate in CL (continuous low speed) mode (📖 104; during interval timer photography, this setting also determines the frame advance rate for single-frame).



d3: Max. Continuous Release

MENU button →  Custom Settings menu

The maximum number of shots that can be taken in a single burst in continuous mode can be set to any value between 1 and 100.



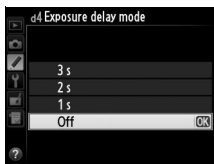
The Memory Buffer

Regardless of the option selected for Custom Setting d3, shooting will slow when the memory buffer fills (📖 00). See page 436 for more information on the capacity of the memory buffer.

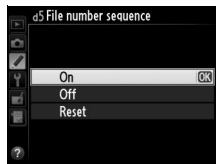
d4: Exposure Delay Mode

MENU button →  Custom Settings menu

In situations where the slightest camera movement can blur pictures, select **1 s**, **2 s**, or **3 s** to delay shutter release until one, two, or three seconds after the mirror is raised.



When a photograph is taken, the camera names the file by adding one to the last file number used. This option controls whether file numbering continues from the last number used when a new folder is created, the memory card is formatted, or a new memory card is inserted in the camera.




Option	Description
On	When a new folder is created, the memory card formatted, or a new memory card inserted in the camera, file numbering continues from the last number used or from the largest file number in the current folder, whichever is higher. If a photograph is taken when the current folder contains a photograph numbered 9999, a new folder will be created automatically and file numbering will begin again from 0001.
Off	File numbering is reset to 0001 when a new folder is created, the memory card is formatted, or a new memory card is inserted in the camera. Note that a new folder is created automatically if a photograph is taken when the current folder contains 999 photographs.
Reset	As for On , except that the next photograph taken is assigned a file number by adding one to the largest file number in the current folder. If the folder is empty, file numbering is reset to 0001.

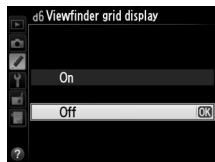
File Number Sequence

If the current folder is numbered 999 and contains either 999 photographs or a photograph numbered 9999, the shutter-release button will be disabled and no further photographs can be taken. Choose **Reset** for Custom Setting d5 (**File number sequence**) and then either format the current memory card or insert a new memory card.

d6: Viewfinder Grid Display

MENU button →  Custom Settings menu

Choose **On** to display on-demand grid lines in the viewfinder for reference when composing photographs (📖 8).



d7: ISO Display and Adjustment

MENU button →  Custom Settings menu

If **Show ISO sensitivity** or **Show ISO/Easy ISO** is selected, the control panel will show ISO sensitivity in place of the number of exposures remaining. If **Show ISO/Easy ISO** is selected, ISO sensitivity can be set in exposure modes **P** and **S** by rotating the sub-command dial or in mode **A** by rotating the main command dial. Select **Show frame count** to display the number of exposures remaining in the viewfinder and control panel.


d8: Screen Tips

MENU button →  Custom Settings menu

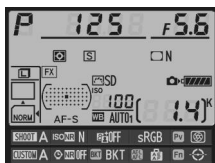
Choose **On** to display tool tips for items selected in the information display (📖 13).



d9: Information Display

MENU button →  Custom Settings menu

If **Auto (AUTO)** is selected, the color of the lettering in the information display (☞ 10) will automatically change from black to white or white to black to maintain contrast with the background. To always use the same color lettering, select **Manual** and choose **Dark on light (B; black lettering)** or **Light on dark (W; white lettering)**. Monitor brightness will automatically be adjusted for maximum contrast with the selected text color.





Dark on light



Light on dark




d10: LCD Illumination

MENU button →  Custom Settings menu

If **Off** is selected, the control panel backlight (LCD illuminator) will only light while the power switch is rotated toward . If **On** is selected, the control panel will be illuminated whenever the exposure meters are active (☞ 42). Select **Off** for increased battery life.








To ensure that the camera functions as expected when the optional MB-D12 battery pack is used with AA batteries, match the option selected in this menu to the type of batteries inserted in the battery pack. There is no need to adjust this option when using EN-EL15 or optional EN-EL18 batteries.

Option	Description
 LR6 (AA alkaline)	Select when using LR6 alkaline AA batteries.
 HR6 (AA Ni-MH)	Select when using HR6 Ni-MH AA batteries.
 FR6 (AA lithium)	Select when using FR6 lithium AA batteries.

Using AA Batteries

The capacity of AA batteries drops sharply at temperatures below 20 °C (68 °F) and varies with make and storage conditions; in some cases, batteries may cease to function before their expiry date. Some AA batteries can not be used; due to their performance characteristics and limited capacity, alkaline batteries have less capacity than some other types and should only be used if no alternative is available and then only at warmer temperatures. The camera shows the level of AA batteries as follows:

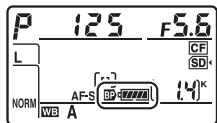
Control panel	Viewfinder	Description
	—	Batteries fully charged.
		Low battery. Ready fresh batteries.
 (blinks)	 (blinks)	Shutter release disabled. Change batteries.



Choose whether the battery in the camera or the batteries in the battery pack are used first when an optional MB-D12 battery pack is attached. Note that if the MB-D12 is powered by an optional EH-5b AC adapter and EP-5B power connector, the AC adapter will be used regardless of the option selected.



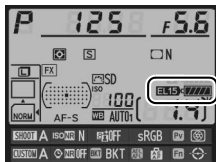
A icon is displayed in the camera control panel when the batteries in the MB-D12 are in use.



The MB-D12 Battery Pack

The MB-D12 takes one EN-EL15 or EN-EL18 rechargeable Li-ion battery or eight AA alkaline, Ni-MH, or lithium batteries (an EN-EL15 is supplied with the camera; EN-EL18 and AA batteries are available separately).

The information display shows the type of battery inserted in the MB-D12 as follows:



MB-D12 battery type display	Battery type
	EN-EL15 rechargeable Li-ion battery
	EN-EL18 rechargeable Li-ion battery
	AA batteries

e: Bracketing/Flash

e1: Flash Sync Speed

MENU button →  Custom Settings menu

This option controls flash sync speed.

Option	Description
1/320 s (Auto FP)	Auto FP high-speed sync is used when a compatible flash unit is attached (☐ 382). If the built-in flash or other flash units are used, shutter speed is set to $1/320$ s. When the camera shows a shutter speed of $1/320$ s in exposure mode P or A , auto FP high-speed sync will be activated if the actual shutter speed is faster than $1/320$ s.
1/250 s (Auto FP)	Auto FP high-speed sync is used when a compatible flash unit is attached (☐ 382). If the built-in flash or other flash units are used, shutter speed is set to $1/250$ s. When the camera shows a shutter speed of $1/250$ s in exposure mode P or A , auto FP high-speed sync will be activated if the actual shutter speed is faster than $1/250$ s.
1/250 s–1/60 s	Flash sync speed set to selected value.

Fixing Shutter Speed at the Flash Sync Speed Limit

To fix shutter speed at the sync speed limit in shutter-priority auto or manual exposure modes, select the next shutter speed after the slowest possible shutter speed (30 s or bulb). An X (flash sync indicator) will be displayed in the viewfinder and control panel.

Auto FP High-Speed Sync

Allows the flash to be used at the highest shutter speed supported by the camera, making it possible to choose the maximum aperture for reduced depth of field even when the subject is backlit in bright sunlight. The information display flash mode indicator shows “FP” when auto FP high-speed sync is active (☐ 185).



■ Auto FP High-Speed Sync

When **1/320 s (Auto FP)** or **1/250 s (Auto FP)** is selected for Custom Setting e1 (**Flash sync speed**, □ 299), the built-in flash can be used at shutter speeds as fast as $1/320$ s or $1/250$ s, while compatible optional flash units (□ 382) can be used at any shutter speed (Auto FP High-Speed Sync).


Flash sync speed \ Shutter speed	1/320 s (Auto FP)		1/250 s (Auto FP)		1/250 s	
	Built-in flash	Optional flash unit	Built-in flash	Optional flash unit	Built-in flash	Optional flash unit
From $1/8,000$ to but not including $1/320$ s	—	Auto FP	—	Auto FP	—	—
From $1/320$ to but not including $1/250$ s	Flash sync *		—	Auto FP	—	—
$1/250$ –30 s	Flash sync					

* Flash range drops as shutter speed increases. Flash range will nevertheless be greater than that obtained at the same speeds with Auto FP.

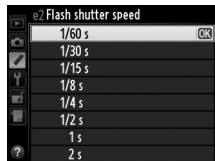
☑ The Flash-Ready Indicator

When the flash fires at full power, the flash-indicator in the camera viewfinder will blink to warn that the resulting photograph may be underexposed. Note that the flash-ready indicators on optional flash units will not display this warning when **1/320 s (Auto FP)** is selected.

e2: Flash Shutter Speed






MENU button →  Custom Settings menu

This option determines the slowest shutter speed available when using front- or rear-curtain sync or red-eye reduction in programmed auto or aperture-priority auto exposure modes (regardless of the setting chosen, shutter speeds can be as slow as 30 s in shutter-priority auto and manual exposure modes or at flash



settings of slow sync, slow rear-curtain sync, or red-eye reduction with slow sync). Options range from $1/60$ s (**1/60 s**) to 30 s (**30 s**).





Choose the flash mode for the built-in flash.

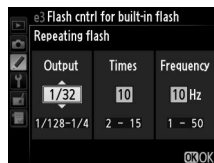
Option	Description
TTL  TTL	Flash output is adjusted automatically in response to shooting conditions.
 Manual	Choose the flash level. The camera does not emit monitor pre-flashes.
RPT  Repeating flash	The flash fires repeatedly while the shutter is open, producing a strobe-light effect.
CMD  Commander mode	Use the built-in flash as a master flash controlling remote optional flash units in one or more groups ( 303).

Manual

Choose a flash level between **Full** and **1/128** ($1/128$ of full power). At full power, the built-in flash has a Guide Number of 12/39 (m/ft, ISO 100, 20 °C/68 °F).

Repeating Flash

The flash fires repeatedly while the shutter is open, producing a strobe-light effect. Press  or  to highlight the following options,  or  to change.

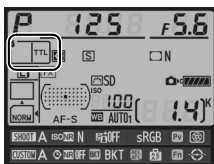


Option	Description
Output	Choose flash output (expressed as a fraction of full power).
Times	Choose the number of times the flash fires at the selected output. Note that depending on shutter speed and the option selected for Frequency , the actual number of flashes may be less than selected.
Frequency	Choose how often the flash fires per second.



Flash Control Mode

The flash control mode for the built-in flash is shown in the information display.



“Manual” and “Repeating Flash”

Icons blink in the control panel and viewfinder when these options are selected.

The SB-400

When an optional SB-400 flash unit is attached and turned on, Custom Setting e3 changes to **Optional flash**, allowing the flash control mode for the SB-400 to be selected from **TTL** and **Manual** (**Repeating flash** and **Commander mode** options are not available).



“Times”

The options available for **Repeating Flash > Times** are determined by flash output.

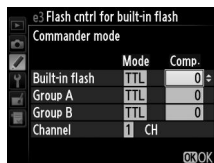
Output	Options available for “Times”	Output	Options available for “Times”
1/4	2	1/32	2–10, 15
1/8	2–5	1/64	2–10, 15, 20, 25
1/16	2–10	1/128	2–10, 15, 20, 25, 30, 35



■ ■ Commander Mode

Use the built-in flash as a master flash controlling one or more remote optional flash units in up to two groups (A and B) using advanced wireless lighting (□ 382).

Selecting this option displays the menu shown at right. Press ◀ or ▶ to highlight the following options, ▲ or ▼ to change.



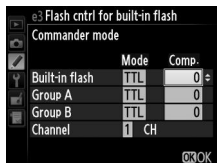
Option	Description
Built-in flash	Choose a flash mode for the built-in flash (commander flash).
TTL	i-TTL mode. Choose flash compensation from values between +3.0 and -3.0 EV in increments of $\frac{1}{3}$ EV.
M	Choose the flash level from values between 1/1 and 1/128 ($\frac{1}{128}$ of full power).
--	The built-in flash does not fire, although remote flash units do. The built-in flash must be raised so that it can emit monitor pre-flashes.
Group A	Choose a flash mode for all flash units in group A.
TTL	i-TTL mode. Choose flash compensation from values between +3.0 and -3.0 EV in increments of $\frac{1}{3}$ EV.
AA	Auto aperture (available only with compatible flash units; □ 382). Choose flash compensation from values between +3.0 and -3.0 EV in increments of $\frac{1}{3}$ EV.
M	Choose the flash level from values between 1/1 and 1/128 ($\frac{1}{128}$ of full power).
--	The flash units in this group do not fire.
Group B	Choose a flash mode for all flash units in group B. The options available are the same as those listed for Group A , above.
Channel	Choose from channels 1-4. All flash units in both groups must be set to the same channel.



Follow the steps below to take photographs in commander mode.

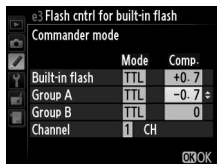
1 Adjust settings for the built-in flash.

Choose the flash control mode and output level for the built-in flash. Note that output level can not be adjusted in -- mode.



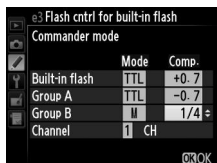
2 Adjust settings for group A.

Choose the flash control mode and output level for the flash units in group A.

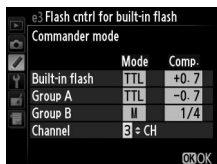


3 Adjust settings for group B.

Choose the flash control mode and output level for the flash units in group B.



4 Select the channel.

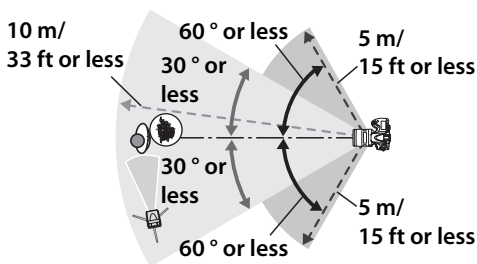


5 Press **OK**.



6 Compose the shot.

Compose the shot and arrange the flash units as shown below. Note that the maximum distance at which the remote flash units can be placed may vary with shooting conditions.



Wireless remote sensors on flash units should face camera.

7 Configure the remote flash units.

Turn all the remote flash units on, adjust group settings as desired, and set them to the channel selected in Step 4. See the flash unit instruction manuals for details.

8 Raise the built-in flash.


Press the flash pop-up button to raise the built-in flash. Note that even if -- is selected for **Built-in flash > Mode**, the built-in flash must be raised so that monitor preflashes will be emitted.

9 Frame the photograph, focus, and shoot.





After confirming that the camera flash-ready light and the flash-ready lights for all other flash units are lit, frame the photograph, focus, and shoot. FV lock (📖 190) can be used if desired.



The Flash Sync Mode Display

 does not appear in the control panel flash sync mode display when -- is selected for **Built-in flash > Mode**.

Flash Compensation

The flash compensation value selected with the  () button and sub-command dial is added to the flash compensation values selected for the built-in flash, group A, and group B in the **Commander mode** menu. A  icon is displayed in the control panel and viewfinder when a flash compensation value other than ± 0 is selected for **Built-in flash > TTL**. The  icon flashes when the built-in flash is in mode **M**.

Commander Mode

Position the sensor windows on the remote flash units to pick up the light from the built-in flash (particular care is required if the camera is not mounted on a tripod). Be sure that direct light or strong reflections from the remote flash units do not enter the camera lens (in TTL mode) or the photocells on the remote flash units (AA mode), as this may interfere with exposure. To prevent timing flashes emitted by the built-in flash from appearing in photographs taken at short range, choose low ISO sensitivities or small apertures (large f-numbers) or use an optional SG-3IR infrared panel for the built-in flash. An SG-3IR is required for best results with rear-curtain sync, which produces brighter timing flashes. After positioning the remote flash units, take a test shot and view the results in the camera monitor.

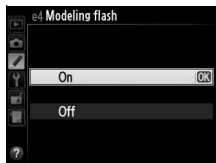
Although there is no limit on the number of remote flash units that may be used, the practical maximum is three. With more than this number, the light emitted by the remote flash units will interfere with performance.



e4: Modeling Flash

MENU button →  Custom Settings menu

If **On** is selected when the camera is used with the built-in flash or an optional CLS-compatible flash unit (📖 381), a modeling flash will be emitted when the camera depth-of-field preview button is pressed (📖 117). No modeling flash is emitted if **Off** is selected.



e5: Auto Bracketing Set

MENU button →  Custom Settings menu





Choose the setting or settings bracketed when auto bracketing (📖 132) is in effect. Choose **AE & flash** (AE) to perform both exposure and flash-level bracketing, **AE only** (AE) to bracket only exposure, **Flash only** (f) to perform only flash-level bracketing, **WB bracketing** (WB) to perform white balance bracketing (📖 137), or **ADL bracketing** to perform bracketing using Active D-Lighting (📖 141). Note that white balance bracketing is not available at image quality settings of NEF (RAW) or NEF (RAW) + JPEG.



e6: Auto Bracketing (Mode M)

MENU button →  Custom Settings menu

This option determines which settings are affected when **AE & flash** or **AE only** is selected for Custom Setting e5 in manual exposure mode.

Option	Description
 Flash/speed	Camera varies shutter speed (Custom Setting e5 set to AE only) or shutter speed and flash level (Custom Setting e5 set to AE & flash).
 Flash/speed/aperture	Camera varies shutter speed and aperture (Custom Setting e5 set to AE only) or shutter speed, aperture, and flash level (Custom Setting e5 set to AE & flash).
 Flash/aperture	Camera varies aperture (Custom Setting e5 set to AE only) or aperture and flash level (Custom Setting e5 set to AE & flash).
 Flash only	Camera varies flash level only (Custom Setting e5 set to AE & flash).

Flash bracketing is performed only with i-TTL or AA flash control. If a setting other than **Flash only** is selected and the flash is not used, ISO sensitivity will be fixed at the value for the first shot, regardless of the setting selected for auto ISO sensitivity control (📖 111).

e7: Bracketing Order

MENU button →  Custom Settings menu

At the default setting of **MTR>under>over** (📄), exposure, flash, and white balance bracketing are performed in the order described on pages 134 and 138. If **Under>MTR>over** (→+) is selected, shooting will proceed in order from the lowest to the highest value. This setting has no effect on ADL bracketing.







f: Controls

f1: Switch

MENU button →  Custom Settings menu

Choose what happens when the power switch is rotated to .


Option	Description
 LCD backlight ()	Control panel backlight illuminates for 6 s.
  and information display	Control panel backlight illuminates and shooting information is displayed in monitor.

f2: Multi Selector Center Button

MENU button →  Custom Settings menu





This option determines the role assigned to the center of the multi selector during viewfinder photography, playback, and live view (regardless of the option selected, pressing the center of the multi selector when a movie is displayed full frame starts movie playback).

■■ Shooting Mode


Option	Role assigned to center of multi selector
RESET Select center focus point	Select center focus point.
 Highlight active focus point	Highlight the active focus point.
Not used	None.



■ Playback Mode

Option	Role assigned to center of multi selector
 Thumbnail on/off	Toggle between full-frame and thumbnail playback.
 View histograms	In both full-frame and thumbnail playback, a histogram is displayed while the center of the multi selector is pressed.
 Zoom on/off	Toggle between full-frame or thumbnail playback and playback zoom. Choose the initial zoom setting from Low magnification , Medium magnification , and High magnification . The zoom display will center on the active focus point.
 Choose slot and folder	Display the slot and folder selection dialog (📖 221).

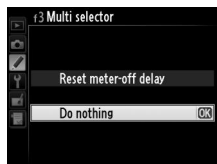
■ Live View

Option	Role assigned to center of multi selector
RESET Select center focus point	Pressing the center of the multi selector in live view selects the center focus point.
 Zoom on/off	Press the center of the multi selector to toggle zoom on and off. Choose the initial zoom setting from Low magnification , Medium magnification , and High magnification . The zoom display will center on the active focus point.
Not used	Pressing the center of the multi selector has no effect in live view.

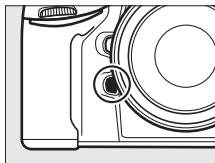
f3: Multi Selector

MENU button →  Custom Settings menu

If **Reset meter-off delay** is selected, operating the multi selector when the exposure meters are off (📖 42) will activate the exposure meters. If **Do nothing** is selected, the exposure meters will not be activated when the multi selector is pressed.














Choose the role played by the **Fn** button, either by itself (**Fn button press**) or when used in combination with the command dials (**Fn button + command dials**).












■ ■ Fn button press

Selecting **Fn button press** displays the following options:

Option	Description
 Preview *	Press the Fn button to preview depth of field ( 117).
 FV lock *	Press the Fn button to lock flash value (built-in flash and compatible optional flash units only,  190, 382). Press again to cancel FV lock.
 AE/AF lock	Focus and exposure lock while the Fn button is pressed.
 AE lock only	Exposure locks while the Fn button is pressed.
 AE lock (Reset on release) *	Exposure locks when the Fn button is pressed, and remains locked until the button is pressed a second time, the shutter is released, or the exposure meters turn off.
 AE lock (Hold) *	Exposure locks when the Fn button is pressed, and remains locked until the button is pressed a second time or the exposure meters turn off.
 AF lock only	Focus locks while the Fn button is pressed.
 AF-ON AF-ON *	Pressing the Fn button initiates autofocus.
 Flash off	The flash will not fire in photos taken while the Fn button is pressed.


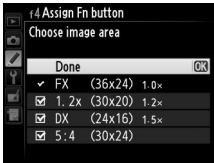






Option	Description
 Bracketing burst	If the Fn button is pressed while exposure, flash, or ADL bracketing is active in single frame or quiet shutter-release mode, all shots in the current bracketing program will be taken each time the shutter-release button is pressed. If white balance bracketing is active or continuous release mode (mode CH or CL) is selected, the camera will repeat the bracketing burst while the shutter-release button is held down.
 Matrix metering	Matrix metering is activated while the Fn button is pressed.
 Center-weighted metering	Center-weighted metering is activated while the Fn button is pressed.
 Spot metering	Spot metering is activated while the Fn button is pressed.
 Playback*	Fn button performs same function as  button. Select when using a telephoto lens or in other circumstances in which it is difficult to operate the  button with your left hand.
 Access top item in MY MENU*	Press the Fn button to jump to the top item in "MY MENU." Select this option for quick access to a frequently-used menu item.
 + NEF (RAW)*	If image quality is set to JPEG fine , JPEG normal , or JPEG basic , "RAW" will be displayed in the control panel and an NEF (RAW) copy will be recorded with the next picture taken after the Fn button is pressed (to record NEF/RAW copies with a series of photographs, keep the shutter-release button pressed halfway between shots). To exit without recording an NEF (RAW) copy, press the Fn button again.




■ ■ Fn button + command dials

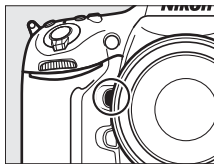
Selecting **Fn button + command dials** displays the following options:

Option	Description
 Choose image area	<p>Press the Fn button and rotate a command dial to choose from pre-selected image areas (☞ 79). Selecting Choose image area displays a list of image areas; highlight options and press the multi selector right to select or deselect, then highlight Done and press OK.</p> 
 Shutter speed & aperture lock	<p>Press the Fn button and rotate the main command dial to lock shutter speed in modes S and M; press the Fn button and rotate the sub-command dial to lock aperture in modes A and M. See page 126 for more information.</p>
 1 step spd/aperture	<p>If the Fn button is pressed when the command dials are rotated, changes to shutter speed (exposure modes S and M) and aperture (exposure modes A and M) are made in increments of 1 EV, regardless of the option selected for Custom Setting b2 (EV steps for exposure cntrl, ☞ 287).</p>
 Choose non-CPU lens number	<p>Press the Fn button and rotate a command dial to choose a lens number specified using the Non-CPU lens data option (☞ 212).</p>
 Active D-Lighting	<p>Press the Fn button and rotate the command dials to adjust Active D-Lighting (☞ 174).</p>
None	<p>No operation is performed when the command dials are rotated while the Fn button is pressed.</p>

f5: Assign Preview Button


MENU button →  Custom Settings menu

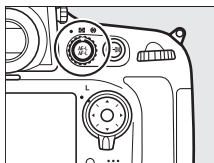
Choose the role played by the depth-of-field preview button, either by itself (**Preview button press**) or when used in combination with the command dials (**Preview + command dials**). The options available are the same as for **Assign Fn button** (☞ 311), except that **AF-ON** is not available for **Assign preview button**. The default options for **Preview button press** and **Preview + command dials** are **Preview** and **None**, respectively.



f6: Assign AE-L/AF-L button

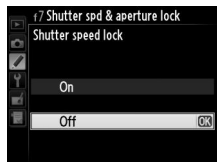
MENU button →  Custom Settings menu

Choose the role played by the  **AE-L/AF-L button press** or when used in combination with the command dials (**AE-L/AF-L + command dials**). The options available are the same as for **Assign Fn button** (☞ 311), except that **1 stp spd/aperture** and **Active D-Lighting** are not available. The default options for **AE-L/AF-L button press** and **AE-L/AF-L + command dials** are **AE/AF lock** and **None**, respectively.



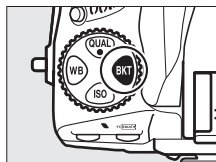
f7: Shutter Spd & Aperture Lock MENU button → Custom Settings menu


Selecting **On** for **Shutter speed lock** locks shutter speed at the value currently selected in mode **S** or **M**. Selecting **On** for **Aperture lock** locks aperture at the value currently selected in mode **A** or **M**. Shutter speed and aperture lock are not available in mode **P**.



f8: Assign BKT Button MENU button → Custom Settings menu

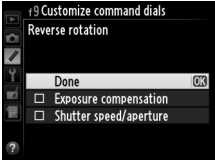
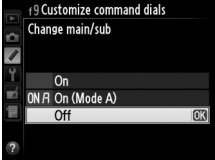
Choose the role played by the **BKT** button. If high dynamic range or multiple exposure is active while another function is assigned to the **BKT** button, the **BKT** button can not be used until high dynamic range or multiple exposure photography ends.



Option	Description
BKT Auto bracketing	Press the BKT button and rotate the command dials to choose the bracketing increment and number of shots in the bracketing sequence (📖 132).
 Multiple exposure	Press the BKT button and rotate the command dials to choose the mode and number of shots for multiple exposures (📖 197).
HDR HDR (high dynamic range)	Press the BKT button and rotate the command dials to choose the mode and the exposure differential (📖 176).




This option controls the operation of the main and sub-command dials.






Option	Description
Reverse rotation	<p>Reverse the direction of rotation of the command dials when they are used to make adjustments to Exposure compensation and/or Shutter speed/aperture. Highlight options and press the multi selector right to select or deselect, then highlight Done and press OK. This setting also applies to the command dials for optional MB-D12 multi-power battery packs.</p> 
Change main/sub	<p>If Off is selected, the main command dial controls shutter speed and the sub-command dial controls aperture. If On is selected, the main command dial will control aperture and the sub-command dial shutter speed. If On (Mode A) is selected, the main command dial will be used to set aperture in exposure mode A only. This setting also applies to the command dials for the MB-D12.</p> 
Aperture setting	<p>If Sub-command dial is selected, aperture can only be adjusted with the sub-command dial (or with the main command dial if On is selected for Change main/sub). If Aperture ring is selected, aperture can only be adjusted with the lens aperture ring and the camera aperture display will show aperture in increments of 1 EV (aperture for type G lenses is still set using the sub-command dial). Note that regardless of the setting chosen, the aperture ring must be used to adjust aperture when a non-CPU lens is attached.</p>



Option	Description
Menus and playback	<p>If Off is selected, the multi selector is used to choose the picture displayed during full-frame playback, highlight thumbnails, and navigate menus. If On or On (image review excluded) is selected, the main command dial can be used to choose the picture displayed during full-frame playback, move the cursor left or right during thumbnail playback, and move the menu highlight bar up or down. The sub-command dial is used to display additional photo information in full-frame playback and to move the cursor up or down during thumbnail playback. Select On (image review excluded) to prevent the command dials from being used for playback during image review. While menus are displayed, rotating the sub-command dial right displays the sub-menu for the selected option, while rotating it left displays the previous menu. To make a selection, press ▶, the center of the multi selector, or Ⓚ.</p>

f10: Release Button to Use Dial

MENU button →  Custom Settings menu

Selecting **Yes** allows adjustments that are normally made by holding the **MODE** () ,  ,  , **BKT**, **ISO**, **QUAL**, **WB**, or **AF-mode** button and rotating a command dial to be made by rotating the command dial after the button is released (this also applies to the **Fn** and depth-of-field preview buttons if they have been assigned **Active D-Lighting** using Custom Setting f4, **Assign Fn button**;  314, or Custom Setting f5, **Assign preview button**;  315). Setting ends when any of the affected buttons is pressed again or the shutter-release button is pressed halfway. Except when **No limit** is selected for Custom Setting c2 **Auto meter-off delay**, setting will also end when the exposure meters turn off.





f11: Slot Empty Release Lock

MENU button →  Custom Settings menu

Selecting **Enable release** allows the shutter to be released when no memory card is inserted, although no pictures will be recorded (they will however be displayed in the monitor in demo mode). If **Release locked** is selected, the shutter-release button is only enabled when a memory card is inserted in the camera.

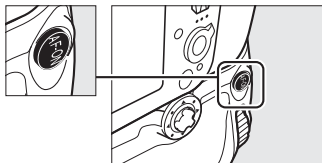
f12: Reverse Indicators











MENU button →  Custom Settings menu

If  is selected, the exposure indicators in the control panel, viewfinder, and information display are displayed with negative values on the left and positive values on the right. Select  to display positive values on the left and negative values on the right.



Choose the function assigned to the **AF-ON** button on the optional MB-D12 battery pack.







Option	Description
 AF-ON	Pressing the MB-D12 AF-ON button initiates autofocus.
 FV lock	Press the MB-D12 AF-ON button to lock flash value (built-in flash and compatible optional flash units only,  190, 382). Press again to cancel FV lock.
 AE/AF lock	Focus and exposure lock while the MB-D12 AF-ON button is pressed.
 AE lock only	Exposure locks while the MB-D12 AF-ON button is pressed.
 AE lock (Reset on release)	Exposure locks when the MB-D12 AF-ON button is pressed, and remains locked until the button is pressed a second time, the shutter is released or the exposure meters turn off.
 AE lock (Hold)	Exposure locks when the MB-D12 AF-ON button is pressed, and remains locked until the button is pressed a second time or the exposure meters turn off.
 AF lock only	Focus locks while the MB-D12 AF-ON button is pressed.
 Same as Fn button	The MB-D12 AF-ON button performs the function selected for Custom Setting f4 ( 311).

g: Movie

g1: Assign Fn Button




MENU button →  Custom Settings menu

Choose the role played by the **Fn** button during movie live view.


Option	Description
 Power aperture (open)	Aperture widens while the button is pressed. Use in combination with Custom Setting g2 (Assign preview button) > Power aperture (close) for button-controlled aperture adjustment.
 Index marking	Press the button during movie recording to add an index at the current position ( 63). Indices can be used when viewing and editing movies.
 View photo shooting info	Press the button to display information on shutter speed, aperture, and other photo settings in place of movie recording information. Press again to return to the movie recording display.
None	Pressing the button has no effect.









Choose the role played by the depth-of-field preview button during movie live view.

Option	Description
 Power aperture (close)	Aperture narrows while the button is pressed. Use in combination with Custom Setting g1 (Assign Fn button) > Power aperture (open) for button-controlled aperture adjustment.
 Index marking	Press the button during movie recording to add an index at the current position (☐ 63). Indices can be used when viewing and editing movies.
 View photo shooting info	Press the button to display information on shutter speed, aperture, and other photo settings in place of movie recording information. Press again to return to the movie recording display.
None	Pressing the button has no effect.


Power Aperture





Power aperture is available only in exposure modes **A** and **M** and can not be used during recording or while photo shooting info is displayed (a  icon indicates that power aperture can not be used). The display may flicker while aperture is adjusted.

Choose the role played by the ^{AE-L}/_{AF-L} AE-L/AF-L button during movie live view.



Option	Description
 Index marking	Press the button during movie recording to add an index at the current position (📖 63). Indices can be used when viewing and editing movies.
 View shooting photo info	Press the button to display information on shutter speed, aperture, and other photo settings in place of movie recording information. Press again to return to the movie recording display.
 AE/AF lock	Focus and exposure lock while the button is pressed.
 AE lock only	Exposure locks while the button is pressed.
 AE lock (Hold)	Exposure locks when the button is pressed, and remains locked until the button is pressed a second time or the exposure meters turn off.
 AF lock only	Focus locks while the button is pressed.
None	Pressing the button has no effect.



Choose the role played by pressing the shutter-release button when  is selected with the live view selector.

Option	Description
 Take photos	Press the shutter-release button all the way down to end movie recording and take a photograph with an aspect ratio of 16 : 9 (for information on image size, see page 68).
 Record movies	Press the shutter-release button halfway to start movie live view. You can then press the shutter-release button halfway to focus and press it all the way down to start or end recording. To end movie live view, press the  button. The shutter-release buttons on optional remote cords ( 390) function in the same way as the camera shutter-release button.

Record Movies

When this option is selected, interval timer photography ( 201) is not available and any functions assigned to the shutter release button (such as taking photographs, measuring preset white balance, and taking image dust-off reference photos) can not be used when  is selected with the live view selector. Select **Take photos** to use these options.

Y The Setup Menu: *Camera Setup*

To display the setup menu, press **MENU** and select the **Y** (setup menu) tab.



MENU button

Option		Option	
Format memory card	326	Wireless transmitter	245
Monitor brightness	326	Image comment	333
Clean image sensor	394	Copyright information	334
Lock mirror up for cleaning ¹	397	Save/load settings	335
Image Dust Off ref photo	327	GPS	218
HDMI	256	Virtual horizon	337
Flicker reduction	329	Non-CPU lens data	212
Time zone and date	329	AF fine-tune	338
Language	330	Eye-Fi upload ²	339
Auto image rotation	331	Firmware version	340
Battery info	332		

¹ Not available when battery is low.

² Only available when compatible Eye-Fi memory card is inserted (📖 340).



See Also

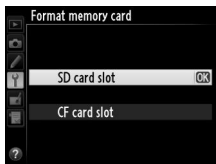
Menu defaults are listed on page 410.



Format Memory Card

MENU button → Y setup menu


To begin formatting, choose a memory card slot and select **Yes**. *Note that formatting permanently deletes all pictures and other data on the card in the selected slot.* Before formatting, be sure to make backup copies as required.



During Formatting

Do not turn the camera off or remove memory cards during formatting.

Two-Button Format

Memory cards can also be formatted by pressing the  (FORMAT) and **MODE** (FORMAT) buttons for more than two seconds (□ 32).

Monitor Brightness

MENU button → Y setup menu

Adjust the brightness of the monitor for playback, menus, and the information display.

Option	Description
Auto	When the monitor is on, monitor brightness is automatically adjusted according to ambient lighting conditions. Care should be taken not to cover the ambient brightness sensor (□ 5).
Manual	Press ▲ or ▼ to choose monitor brightness. Choose higher values for increased brightness, lower values for reduced brightness.

See Also

For information on adjusting monitor brightness in live view, see page 53.



Acquire reference data for the Image Dust Off option in Capture NX 2 (available separately; for more information, see the Capture NX 2 manual).

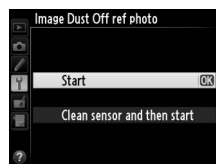
Image Dust Off ref photo is available only when a CPU lens is mounted on the camera. A non-DX lens with a focal length of at least 50 mm is recommended. When using a zoom lens, zoom all the way in.

1 Choose a start option.

Highlight one of the following options and press **OK**. To exit without acquiring image dust off data, press **MENU**.



OK button



- **Start:** The message shown at right will be displayed and “rEF” will appear in the viewfinder and control panel displays.
- **Clean sensor and then start:** Select this option to clean the image sensor before starting. The message shown at right will be displayed and “rEF” will appear in the viewfinder and control panel displays when cleaning is complete.

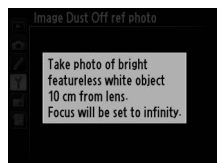


Image Sensor Cleaning

Dust off reference data recorded before image sensor cleaning is performed can not be used with photographs taken after image sensor cleaning is performed. Select **Clean image sensor and then start** only if the dust off reference data will not be used with existing photographs.



2 Frame a featureless white object in the viewfinder.

With the lens about ten centimeters (four inches) from a well-lit, featureless white object, frame the object so that it fills the viewfinder and then press the shutter-release button halfway.

In autofocus mode, focus will automatically be set to infinity; in manual focus mode, set focus to infinity manually.

3 Acquire dust off reference data.

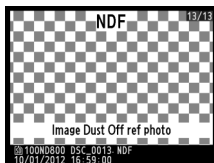
Press the shutter-release button the rest of the way down to acquire Image Dust Off reference data. The monitor turns off when the shutter-release button is pressed.

If the reference object is too bright or too dark, the camera may be unable to acquire Image Dust Off reference data and the message shown at right will be displayed. Choose another reference object and repeat the process from Step 1.




Image Dust Off Reference Data

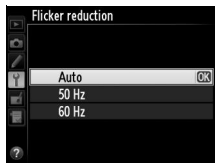
The same reference data can be used for photographs taken with different lenses or at different apertures. Reference images can not be viewed using computer imaging software. A grid pattern is displayed when reference images are viewed on the camera.



Flicker Reduction

MENU button →  setup menu

Reduce flicker and banding when shooting under fluorescent or mercury-vapor lighting during live view or movie recording. Choose **Auto** to allow the camera to automatically choose the correct frequency, or manually match the frequency to that of the local AC power supply.





Flicker Reduction

If **Auto** fails to produce the desired results and you are unsure as to the frequency of the local power supply, test both the 50 and 60 Hz options and choose the one that produces the best results. Flicker reduction may not produce the desired results if the subject is very bright, in which case you should try choosing a smaller aperture (larger f-number). To prevent flicker, select mode **M** and choose a shutter speed adapted to the frequency of the local power supply:

$1/125$ s, $1/60$ s, or $1/30$ s for 60 Hz; $1/100$ s, $1/50$ s, or $1/25$ s for 50 Hz.

Time Zone and Date

MENU button →  setup menu

Change time zones, set the camera clock, choose the date display order, and turn daylight saving time on or off ( 27).

Option	Description
Time zone	Choose a time zone. The camera clock is automatically set to the time in the new time zone.
Date and time	Set the camera clock.
Date format	Choose the order in which the day, month, and year are displayed.
Daylight saving time	Turn daylight saving time on or off. The camera clock will automatically be advanced or set back one hour. The default setting is Off .

CLOCK blinks in the control panel when the clock is not set.



Choose a language for camera menus and messages. The following options are available.

Čeština	Czech
Dansk	Danish
Deutsch	German
English	English
Español	Spanish
Français	French
Indonesia	Indonesian
Italiano	Italian
Nederlands	Dutch
Norsk	Norwegian
Polski	Polish
Português	Portuguese

Русский	Russian
Română	Romanian
Suomi	Finnish
Svenska	Swedish
Türkçe	Turkish
Українська	Ukrainian
عربي	Arabic
中文 (繁體)	Traditional Chinese
中文 (简体)	Simplified Chinese
日本語	Japanese
한국	Korean
ภาษาไทย	Thai



Photographs taken while **On** is selected contain information on camera orientation, allowing them to be rotated automatically during playback (📖 266) or when viewed in ViewNX 2 (supplied) or in Capture NX 2 (available separately; 📖 389). The following orientations are recorded:



Landscape (wide) orientation



Camera rotated 90° clockwise



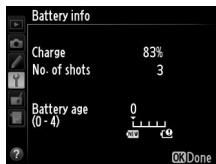
Camera rotated 90° counter-clockwise

Camera orientation is not recorded when **Off** is selected. Choose this option when panning or taking photographs with the lens pointing up or down.

Rotate Tall

To automatically rotate “tall” (portrait-orientation) photographs for display during playback, select **On** for the **Rotate tall** option in the playback menu (📖 266).

View information on the battery currently inserted in the camera.



Item	Description
Charge	The current battery level expressed as a percentage.
No. of shots	The number of times the shutter has been released with the current battery since the battery was last charged. Note that the camera may sometimes release the shutter without recording a photograph, for example when measuring preset white balance.
Calibration	<ul style="list-style-type: none"> This item is displayed only when the camera is powered by an optional MB-D12 battery pack equipped with an EN-EL18 (available separately). CAL: Due to repeated use and recharging, calibration is required to ensure that battery level can be measured accurately; recalibrate battery before charging. —: Calibration not required.
Battery age	<p>A five-level display showing battery age. 0 () indicates that battery performance is unimpaired, 4 () that the battery has reached the end of its charging life and should be replaced.</p> <p>Note that fresh batteries charged at temperatures under about 5 °C (41 °F) may show a temporary drop in charging life; the battery age display will however return to normal once the battery has been recharged at a temperature of about 20 °C (68 °F) or higher.</p>



The MB-D12 Battery Pack

The display for the MB-D12 is shown at right. In the case of EN-EL18 batteries, the display shows whether calibration is required. If AA batteries are used, the battery level will be shown by a battery level icon; other items will not be displayed.

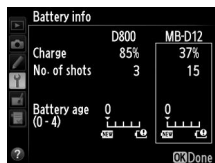




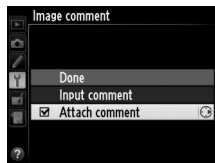


Image Comment

MENU button →  setup menu

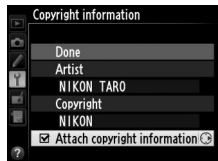
Add a comment to new photographs as they are taken. Comments can be viewed as metadata in ViewNX 2 (supplied) or Capture NX 2 (available separately;  389). The comment is also visible on the shooting data page in the photo information display ( 228).

- **Done:** Save changes and return to the setup menu.
- **Input comment:** Input a comment as described on page 170. Comments can be up to 36 characters long.
- **Attach comment:** Select this option to attach the comment to all subsequent photographs. **Attach comment** can be turned on and off by highlighting it and pressing .



Add copyright information to new photographs as they are taken. Copyright information is included in the shooting data shown in the photo information display (□ 228) and can be viewed as metadata in ViewNX 2 (supplied) or in Capture NX 2 (available separately; □ 389).

- **Done:** Save changes and return to the setup menu.
- **Artist:** Enter a photographer name as described on page 170. Photographer names can be up to 36 characters long.
- **Copyright:** Enter the name of the copyright holder as described on page 170. Copyright holder names can be up to 54 characters long.
- **Attach copyright information:** Select this option to attach copyright information to all subsequent photographs. **Attach copyright information** can be turned on and off by highlighting it and pressing ►.



✔ Copyright Information

To prevent unauthorized use of the artist or copyright holder names, make sure that **Attach copyright information** is not selected and that the **Artist** and **Copyright** fields are blank before lending or transferring the camera to another person. Nikon does not accept liability for any damages or disputes arising from the use of the **Copyright information** option.



Select **Save settings** to save the following settings to the memory card, or to the memory card in the primary card slot if two memory cards are inserted (□ 89; if the card is full, an error will be displayed). Use this option to share settings among D800 cameras.

Menu	Option
Playback	Playback display options
	Image review
	After delete
	Rotate tall
Shooting (all banks)	Shooting menu bank
	Extended menu banks
	File naming
	Primary slot selection
	Secondary slot function
	Image quality
	Image size
	Image area
	JPEG compression
	NEF (RAW) recording
	White balance (with fine-tuning and presets d-1-d-4)
	Set Picture Control
	Color space
	Active D-Lighting
	Vignette control
	Auto distortion control
	Long exposure NR
High ISO NR	
ISO sensitivity settings	
Movie settings	
Custom settings (all banks)	All Custom Settings



Menu	Option
Setup	Clean image sensor
	HDMI
	Flicker reduction
	Time zone and date (excepting date and time)
	Language
	Auto image rotation
	Image comment
	Copyright information
	GPS
	Non-CPU lens data
Eye-Fi upload	
My Menu/ Recent Settings	All My Menu items
	All recent settings
	Choose tab

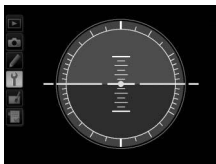
Settings saved using the D800 can be restored by selecting **Load settings**. Note that **Save/load settings** is only available when a memory card is inserted in the camera, and that the **Load settings** option is only available if the card contains saved settings.

Saved Settings

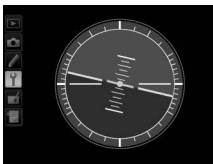
Settings are saved in a file named NCSETUP8. The camera will not be able to load settings if the file name is changed.



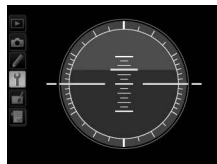
Display roll and pitch information based on information from the camera tilt sensor. If the camera is tilted neither left nor right, the roll reference line will turn green, while if the camera is tilted neither forward nor back, the pitch reference line will turn green and a dot will appear in the center of the display. Each division is equivalent to 5°.



Camera level



Camera tilted left or right



Camera tilted forward or back

✓ Tilting the Camera


The virtual horizon display is not accurate when the camera is tilted at a sharp angle forward or back. If the camera is unable to measure tilt, the amount of tilt will not be displayed.

📎 See Also

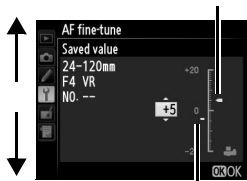
For information on viewing a virtual horizon display in the viewfinder, see Custom Setting f4 (**Assign Fn button > Fn button press**; 311, 313). For information on displaying a virtual horizon in live view, see pages 54 and 66.



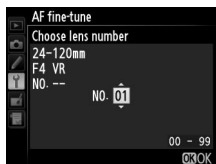
Fine-tune focus for up to 20 lens types. AF tuning is not recommended in most situations and may interfere with normal focus; use only when required.

Option	Description
AF fine-tune (On/Off)	<ul style="list-style-type: none"> • On: Turn AF tuning on. • Off: Turn AF tuning off.
Saved value	<p>Tune AF for the current lens (CPU lenses only). Press ▲ or ▼ to choose a value between +20 and -20. Values for up to 20 lens types can be stored. Only one value can be stored for each type of lens.</p>
Default	<p>Choose the AF tuning value used when no previously saved value exists for the current lens (CPU lenses only).</p>
List saved values	<p>List previously saved AF tuning values. To delete a lens from the list, highlight the desired lens and press  (DELETE). To change a lens identifier (for example, to choose an identifier that is the same as the last two digits of the lens serial number to distinguish it from other lenses of the same type in light of the fact that Saved value can be used with only one lens of each type), highlight the desired lens and press ►.</p> <p>The menu shown at right will be displayed; press ▲ or ▼ to choose an identifier and press OK to save changes and exit.</p>

Move focal point away from camera. Current value



Move focal point toward camera. Previous value



✓ AF Tuning

The camera may be unable to focus at minimum range or at infinity when AF tuning is applied.

✓ Live View

Tuning is not applied to autofocus during live view (☐ 45).

✎ Saved Value

Only one value can be stored for each type of lens. If a teleconverter is used, separate values can be stored for each combination of lens and teleconverter.

Eye-Fi Upload

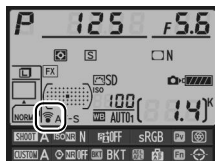
MENU button → Y setup menu

This option is displayed only when an Eye-Fi memory card (available separately from third-party suppliers) is inserted in the camera. Choose **Enable** to upload photographs to a preselected destination. Note that pictures will not be uploaded if signal strength is insufficient.

Observe all local laws concerning wireless devices and choose **Disable** where wireless devices are prohibited.

When an Eye-Fi card is inserted, its status is indicated by an icon in the information display:

- 🚫: Eye-Fi upload disabled.
- 📶: Eye-Fi upload enabled but no pictures available for upload.
- 📶 (static): Eye-Fi upload enabled; waiting to begin upload.
- 📶 (animated): Eye-Fi upload enabled; uploading data.
- 🚫: Error — camera can not control Eye-Fi card. If a blinking **Card** appears in the control panel or viewfinder, refer to page 420; if this indicator is not blinking, pictures can be taken normally but you may be unable to change Eye-Fi settings.



Eye-Fi Cards

Eye-Fi cards may emit wireless signals when **Disable** is selected. If a warning is displayed in the monitor (☐ 420), turn the camera off and remove the card.

See the manual provided with the Eye-Fi card, and direct any inquiries to the manufacturer. The camera can be used to turn Eye-Fi cards on and off, but may not support other Eye-Fi functions.

Supported Eye-Fi Cards

As of September 2011, the camera supports 8 GB SDHC Pro X2 Eye-Fi cards. Some cards may not be available in some countries or regions; consult the manufacturer for more information. Eye-Fi cards are for use only in the country of purchase. Be sure the Eye-Fi card firmware has been updated to the latest version.

Using Eye-Fi Cards in Ad Hoc Mode

Additional time may be required when connecting using Eye-Fi cards that support ad hoc mode, such as the Eye-Fi Pro X2 SDHC 8 GB. Set Custom Setting c2 (**Auto meter-off delay**, ☐ 291) to 30 s or longer.


Firmware Version

MENU button →  *setup menu*

View the current camera firmware version.























The Retouch Menu: Creating Retouched Copies


To display the retouch menu, press **MENU** and select the  (retouch menu) tab.




MENU button

The options in the retouch menu are used to create trimmed, or retouched copies of existing pictures. The retouch menu is only displayed when a memory card containing photographs is inserted in the camera (note that if the memory card is being used to store both RAW/NEF and JPEG copies of the same photographs as described on page 84, retouch other than **Image overlay** and **NEF (RAW) processing** apply only to the JPEG copies).

Option		Option	
 D-Lighting	344	 Straighten	357
 Red-eye correction	345	 Distortion control	358
 Trim	346	 Fisheye	358
 Monochrome	347	 Color outline	359
 Filter effects	348	 Color sketch	359
 Color balance	349	 Perspective control	360
 Image overlay ¹	350	 Miniature effect	361
 NEF (RAW) processing	353	 Selective color	362
 Resize	355	 Edit movie	74
 Quick retouch	357	 Side-by-side comparison ²	364

1 Can only be selected by pressing **MENU** and selecting  tab.

2 Available only if  button is pressed in full-frame playback when a retouched image or original is displayed.

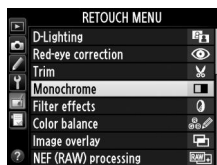


Creating Retouched Copies

To create a retouched copy:

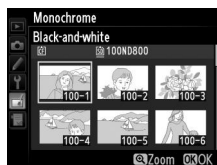
1 Select an item in the retouch menu.

Press ▲ or ▼ to highlight an item, ► to select.

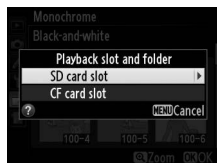


2 Select a picture.

Highlight a picture and press OK (to view the highlighted picture full screen, press and hold the button).



To view images in other locations, press and select the desired card and folder as described on page 221.



Retouch

The camera may not be able to display or retouch images created with other devices.


3 Select retouch options.

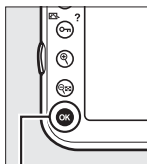
For more information, see the section for the selected item. To exit without creating a retouched copy, press MENU.

Monitor off Delay

The monitor will turn off automatically if no operations are performed for a brief period. Any unsaved changes will be lost. To increase the time the monitor remains on, choose a longer menu display time for Custom Setting c4 (**Monitor off delay**, 292).

4 Create a retouched copy.

Press **OK** to create a retouched copy. Retouched copies are indicated by a  icon.



OK button



Creating Retouched Copies During Playback

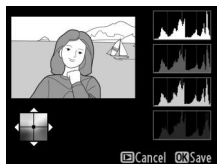
Retouched copies can also be created during playback.



*Display picture full frame and press **OK**.*



*Highlight option and press **OK**.*



Create retouched copy.

Retouching Copies

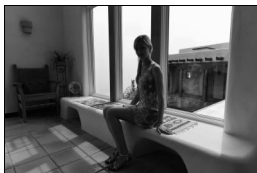
Most options can be applied to copies created using other retouch options, although with the exceptions of **Image overlay** and **Edit movie > Choose start/end point** each option can be applied only once (note that multiple edits may result in loss of detail). Options that can not be applied to the current image are grayed out and unavailable.

Image Quality

Except in the case of copies created with **Trim**, **Image overlay**, **NEF (RAW) processing**, and **Resize**, copies created from JPEG images are the same size and quality as the original, copies created from NEF (RAW) photos are saved as large fine-quality JPEG images, and copies created from TIFF (RGB) photos are saved as fine-quality JPEG images of the same size as the original. Size-priority compression is used when copies are saved in JPEG format.




D-Lighting brightens shadows, making it ideal for dark or backlit photographs.

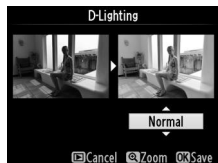


Before











After

Press ▲ or ▼ to choose the amount of correction performed. The effect can be previewed in the edit display. Press  to copy the photograph.











This option is used to correct “red-eye” caused by the flash and is available only with photographs taken using a flash. The photograph selected for red-eye correction can be previewed in the edit display. Confirm the effects of red-eye correction and create a copy as described in the following table. Note that red-eye correction may not always produce the expected results and may in very rare circumstances be applied to portions of the image that are not affected by red-eye; check the preview thoroughly before proceeding.

To	Use	Description
Zoom in		Press  to zoom in,  to zoom out. While photo is zoomed in, use multi selector to view areas of image not visible in monitor. Keep multi selector pressed to scroll rapidly to other areas of frame. Navigation window is displayed when zoom buttons or multi selector are pressed; area currently visible in monitor is indicated by yellow border. Press  to cancel zoom.
Zoom out		
View other areas of image		
Cancel zoom		
Create copy		



Create a cropped copy of the selected photograph. The selected photograph is displayed with the selected crop shown in yellow; create a cropped copy as described in the following table.



To	Use	Description
Reduce size of crop		Press  to reduce the size of the crop.
Increase size of crop		Press  to increase the size of the crop.
Change crop aspect ratio		Rotate the main command dial to switch between aspect ratios of 3 : 2, 4 : 3, 5 : 4, 1 : 1, and 16 : 9.
Position crop		Use multi selector to position the crop. Press and hold to move the crop rapidly to the desired position.
Preview crop		Press center of multi selector to preview cropped image.
Create copy		Save the current crop as a separate file.

Trim: Image Quality and Size

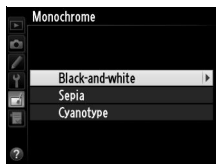
Copies created from NEF (RAW), NEF (RAW) + JPEG, or TIFF (RGB) photos have an image quality (84) of JPEG fine; cropped copies created from JPEG photos have the same image quality as the original. The size of the copy varies with crop size and aspect ratio and appears at upper left in the crop display.



Viewing Cropped Copies

Playback zoom may not be available when cropped copies are displayed.

Copy photographs in **Black-and-white**, **Sepia**, or **Cyanotype** (blue and white monochrome).




Selecting **Sepia** or **Cyanotype** displays a preview of the selected image; press ▲ to increase color saturation, ▼ to decrease. Press Ⓚ to create a monochrome copy.







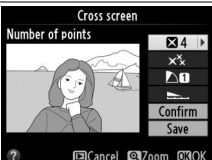


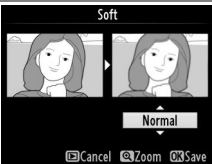
Increase saturation




Decrease saturation



Choose from the following filter effects. After adjusting filter effects as described below, press  to copy the photograph.

Option	Description
Skylight	Creates the effect of a skylight filter, making the picture less blue. The effect can be previewed in the monitor as shown at right. 
Warm filter	Creates a copy with warm tone filter effects, giving the copy a “warm” red cast. The effect can be previewed in the monitor. 
Red intensifier Green intensifier Blue intensifier	Intensify reds (Red intensifier), greens (Green intensifier), or blues (Blue intensifier). Press  to increase the effect,  to decrease. 
Cross screen	Add starburst effects to light sources. <ul style="list-style-type: none"> • Number of points: Choose from four, six, or eight. • Filter amount: Choose the brightness of the light sources affected. • Filter angle: Choose the angle of the points. • Length of points: Choose the length of points. • Confirm: Preview the effects of the filter as shown at right. Press  to preview the copy full frame. • Save: Create a retouched copy. 
Soft	Add a soft filter effect. Press  or  to choose the filter strength. 

Use the multi selector to create a copy with modified color balance as shown below. The effect is displayed in the monitor together with red, green, and blue histograms (📖 225) giving the distribution of tones in the copy. Press  to copy the photograph.



Increase amount of green



Zoom







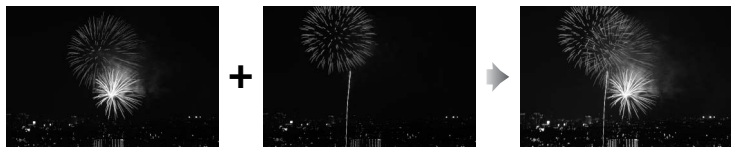
To zoom in on the image displayed in the monitor, press . The histogram will be updated to show data only for the portion of the image displayed in the monitor. While the image is zoomed in, press  (//?) to toggle back and forth between color balance and zoom. When zoom is selected, you can zoom in and out with the  and  buttons and scroll the image with the multi selector.

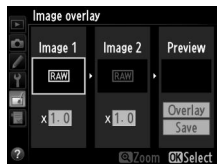


Image overlay combines two existing NEF (RAW) photographs to create a single picture that is saved separately from the originals; the results, which make use of RAW data from the camera image sensor, are noticeably better than photographs combined in an imaging application. The new picture is saved at current image quality and size settings; before creating an overlay, set image quality and size (☐ 84, 87; all options are available). To create a NEF (RAW) copy, choose an image quality of **NEF (RAW)**.




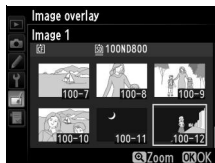
1 Select Image overlay.



Highlight **Image overlay** and press ►. The dialog shown at right will be displayed, with **Image 1** highlighted; press **OK** to display a picture selection dialog listing only NEF (RAW) images created with this camera.




2 Select the first image.

Use the multi selector to highlight the first photograph in the overlay. To view the highlighted photograph full frame, press and hold the 





button. To view images in other locations, press  and select the desired card and folder as described on page 221. Press  to select the highlighted photograph and return to the preview display.

3 Select the second image.

The selected image will appear as **Image 1**. Highlight **Image 2** and press , then select the second photo as described in Step 2.

4 Adjust gain.

Highlight **Image 1** or **Image 2** and optimize exposure for the overlay by pressing  or  to select the gain from values between 0.1 and 2.0. Repeat for the second image. The default value is 1.0; select 0.5 to halve gain or 2.0 to double it. The effects of gain are visible in the **Preview** column.



5 Preview the overlay.

Press ◀ or ▶ to place the cursor in the **Preview** column and press ▲ or ▼ to highlight **Overlay**. Press **OK** to preview the overlay as shown at right (to save the overlay without displaying a preview, select **Save**). To return to Step 4 and select new photos or adjust gain, press **Q**.



6 Save the overlay.

Press **OK** while the preview is displayed to save the overlay. After an overlay is created, the resulting image will be displayed full-frame in the monitor.



OK button



Image Overlay


Only NEF (RAW) photographs with the same image area and bit depth can be combined.

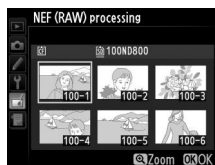
The overlay has the same photo info (including date of recording, metering, shutter speed, aperture, exposure mode, exposure compensation, focal length, and image orientation) and values for white balance and Picture Control as the photograph selected for **Image 1**. The current image comment is appended to the overlay when it is saved; copyright information, however, is not copied. Overlays saved in NEF (RAW) format use the compression selected for **Type** in the **NEF (RAW) recording** menu and have the same bit depth as the original images; JPEG overlays are saved using size-priority compression.






Create JPEG copies of NEF (RAW) photographs.

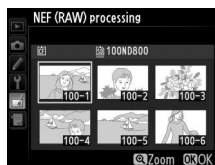
1 Select NEF (RAW) processing.

Highlight **NEF (RAW) processing** and press  to display a picture selection dialog listing only NEF (RAW) images created with this camera.



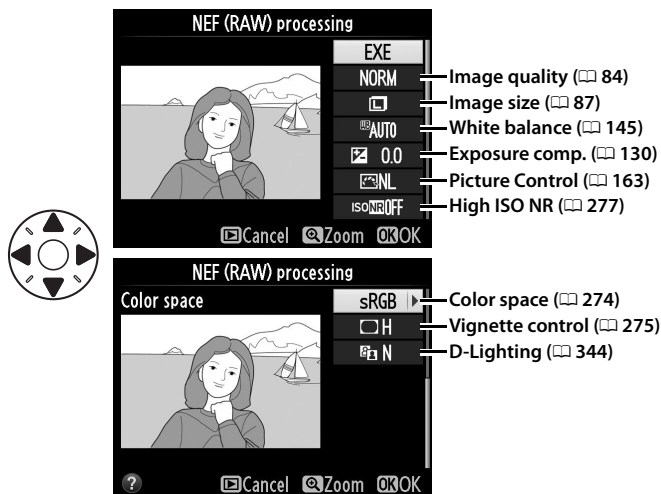
2 Select a photograph.

Highlight a photograph (to view the highlighted photograph full frame, press and hold the  button; to view images in other locations as described on page 221, press ). Press  to select the highlighted photograph and proceed to the next step.



3 Adjust NEF (RAW) processing settings.

Adjust the settings listed below. Note that white balance and vignette control are not available with multiple exposures or pictures created with image overlay and that exposure compensation can only be set to values between -2 and $+2$ EV. If **Auto** is selected for white balance, it will be set to whichever of **Normal** and **Keep warm lighting colors** was in effect when the picture was taken. The Picture Control grid is not displayed when Picture Controls are adjusted.



4 Copy the photograph.

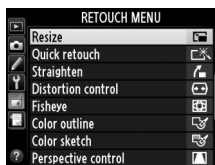
Highlight **EXE** and press **OK** to create a JPEG copy of the selected photograph. To exit without copying the photograph, press the **MENU** button.



Create small copies of selected photographs.

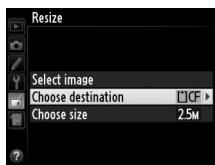
1 Select Resize.

To resize selected images, press **MENU** to display the menus and select **Resize** in the retouch menu.



2 Choose a destination.

If two memory cards are inserted, you can choose a destination for the resized copies by highlighting **Choose destination** and pressing **▶** (if only one memory card is inserted, proceed to Step 3).



The menu shown at right will be displayed; highlight a card slot and press **OK**.



3 Choose a size.

Highlight **Choose size** and press **▶**.



The options shown at right will be displayed; highlight an option and press **OK**.





4 Choose pictures.

Highlight **Select image** and press **▶**.



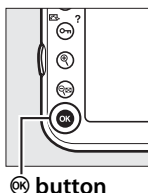
Highlight pictures and press the center of the multi selector to select or deselect (to view the highlighted picture full screen, press and hold the **Q** button; to view pictures in other locations



as described on page 221, press **Q**). Selected pictures are marked by a  icon. Press **OK** when the selection is complete. Note that photographs taken at an image-area setting of 5 : 4 ( 80) can not be resized.

5 Save the resized copies.

A confirmation dialog will be displayed. Highlight **Yes** and press **OK** to save the resized copies.




Viewing Resized Copies

Playback zoom may not be available when resized copies are displayed.

Image Quality

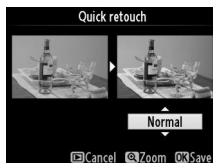
Copies created from NEF (RAW), NEF (RAW) + JPEG, or TIFF (RGB) photos have an image quality (📄 84) of JPEG fine; copies created from JPEG photos have the same image quality as the original.

Quick Retouch


MENU button →  retouch menu

Create copies with enhanced saturation and contrast. D-Lighting is applied as required to brighten dark or backlit subjects.

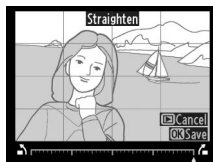
Press ▲ or ▼ to choose the amount of enhancement. The effect can be previewed in the edit display. Press Ⓞ to copy the photograph.



Straighten

MENU button →  retouch menu

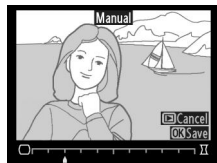
Create a straightened copy of the selected image. Press ► to rotate the image clockwise by up to five degrees in increments of approximately 0.25 degrees, ◀ to rotate it counterclockwise (the effect can be previewed in the edit display; note that edges of the image will be trimmed to create a square copy). Press Ⓞ to copy the photograph, or press ▶ to exit to playback without creating a copy.



Distortion Control

MENU button →  retouch menu


Create copies with reduced peripheral distortion. Select **Auto** to let the camera correct distortion automatically and then make fine adjustments using the multi selector, or select **Manual** to reduce distortion manually (note that **Auto** is not available with photos taken using auto distortion control; see page 276). Press **▶** to reduce barrel distortion, **◀** to reduce pincushion distortion (the effect can be previewed in the edit display; note that greater amounts of distortion control result in more of the edges being cropped out). Press **Ⓚ** to copy the photograph, or press **▶** to exit to playback without creating a copy. Note that distortion control may heavily crop or distort the edges of copies created from photographs taken with DX lenses at image areas other than **DX (24×16) 1.5x**.



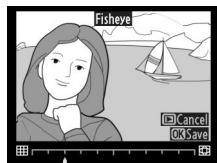
Auto

Auto is for use only with pictures taken with type G and D lenses (PC, fisheye, and certain other lenses excluded). Results are not guaranteed with other lenses.


Fisheye


MENU button →  retouch menu

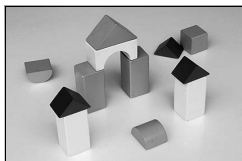
Create copies that appear to have been taken with a fisheye lens. Press **▶** to increase the effect (this also increases the amount that will be cropped out at the edges of the image), **◀** to reduce it. The effect can be previewed in the edit display. Press **Ⓚ** to copy the photograph, or press **▶** to exit to playback without creating a copy.



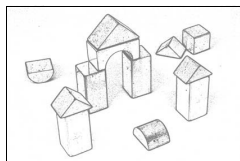
Color Outline

MENU button →  retouch menu

Create an outline copy of a photograph to use as a base for painting. The effect can be previewed in the edit display. Press  to copy the photograph.










Before

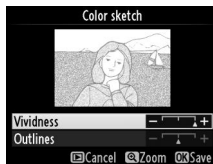




After

Color Sketch

MENU button →  retouch menu

Create a copy of a photograph that resembles a sketch made with colored pencils. Press  or  to highlight **Vividness** or **Outlines** and press  or  to change. Vividness can be increased to make colors more saturated, or decreased for a washed-out, monochromatic effect, while outlines can be made thicker or thinner. Thicker outlines makes colors more saturated. The results can be previewed in the edit display. Press  to copy the photograph, or press  to exit to playback without creating a copy.



Create copies that reduce the effects of perspective taken from the base of a tall object. Use the multi selector to adjust perspective (note that greater amounts of perspective control result in more of the edges being cropped out). The results can be previewed in the edit display. Press  to copy the photograph, or press  to exit to playback without creating a copy.



Before



After

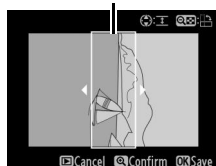


Create a copy that appears to be a photo of a diorama. Works best with photos taken from a high vantage point.

To	Press	Description
Choose orientation		Press to choose orientation of area that is in focus.
Choose position		If photo is displayed in wide orientation, press ▲ or ▼ to position frame showing area of copy that will be in focus.
		If photo is displayed in tall orientation (, press ◀ or ▶ to position frame showing area of copy that will be in focus.
Choose size		If area of effect is in wide orientation, press ◀ or ▶ to choose height.
		If area of effect is in tall orientation, press ▲ or ▼ to choose width.
Preview copy		Preview copy.
Cancel		Exit to full-frame playback without creating copy.
Create copy		Create copy.



Area in focus



Create a copy in which only selected hues appear in color.

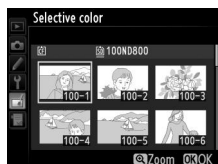
1 Select Selective color.

Highlight **Selective color** in the retouch menu and press to display a picture selection dialog.



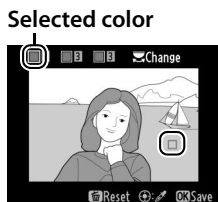
2 Select a photograph.

Highlight a photograph (to view the highlighted photograph full frame, press and hold the button; to view images in other locations as described on page 221, press). Press to select the highlighted photograph and proceed to the next step.



3 Select a color.

Use the multi selector to position the cursor over an object and press center of multi selector to select the color of the object as one that will remain in the final copy (the camera may have difficulty detecting unsaturated colors; choose a saturated color). To zoom in on the picture for precise color selection, press . Press to zoom out.



4 Highlight the color range.

Rotate the main command dial to highlight the color range for the selected color.



Color range



5 Choose the color range.

Press ▲ or ▼ to increase or decrease the range of similar hues that will be included in the final photograph or movie.



Choose from values between 1 and 7; note that higher values may include hues from other colors. The effect can be previewed in the edit display.

6 Select additional colors.

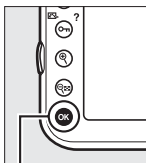
To select additional colors, rotate the main command dial to highlight another of the three color boxes at the top of the display and repeat Steps 3–5 to select another color.



Repeat for a third color if desired. To deselect the highlighted color, press (FORMAT), or press and hold (FORMAT) to remove all colors.

7 Save the edited copy.

Press to copy the photograph.




button



Side-by-Side Comparison

Compare retouched copies to the original photographs. This option is only available if the **OK** button is pressed to display the retouch menu when a copy or original is played back full frame.

1 Select a picture.

Select a retouched copy (shown by a ) or a photograph that has been retouched in full-frame playback and press **OK**.



OK button



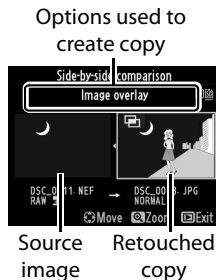
2 Select Side-by-side comparison.

Highlight **Side-by-side comparison** and press **OK**.



3 Compare the copy with the original.

The source image is displayed on the left, the retouched copy on the right, with the options used to create the copy listed at the top of the display. Press ◀ or ▶ to switch between the source image and the




retouched copy. To view the highlighted picture full frame, press and hold the button. If the copy was created from two images using **Image overlay**, press ▲ or ▼ to view the other source image. If multiple copies exist for the current source image, press ▲ or ▼ to view the other copies. To exit to playback, press the button, or press to exit to playback with the highlighted image selected.

Side-by-Side Comparison


The source image will not be displayed if the copy was created from a photograph that was protected (233), is on a locked memory card, or has since been deleted or hidden (260).



My Menu / Recent Settings

To display My Menu, press **MENU** and select the  (My Menu) tab.



The **My Menu** option can be used to create and edit a customized list of options from the playback, shooting, Custom Settings, setup, and retouch menus for quick access (up to 20 items). If desired, recent settings can be displayed in place of My Menu ( 370).

Options can be added, deleted, and reordered as described on the following pages.



■ Adding Options to My Menu

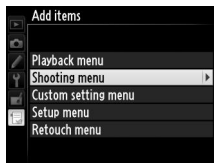
1 Select Add items.

In My Menu (M), highlight **Add items** and press **▶**.



2 Select a menu.

Highlight the name of the menu containing the option you wish to add and press **▶**.

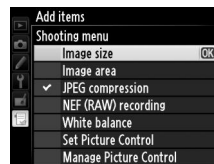


3 Select an item.

Highlight the desired menu item and press **OK**.



OK button




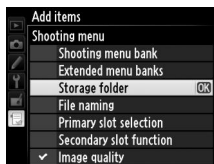
4 Position the new item.

Press **▲** or **▼** to move the new item up or down in My Menu. Press **OK** to add the new item.



5 Add more items.

The items currently displayed in My Menu are indicated by a check mark. Items indicated by a  icon can not be selected. Repeat steps 1–4 to select additional items.



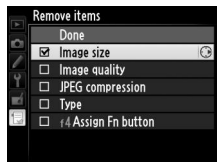
■ Deleting Options from My Menu

1 Select Remove items.

In My Menu (MENU), highlight **Remove items** and press ►.

2 Select items.

Highlight items and press ► to select or deselect. Selected items are indicated by a check mark.

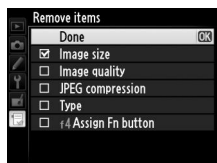


3 Select Done.

Highlight **Done** and press OK. A confirmation dialog will be displayed.

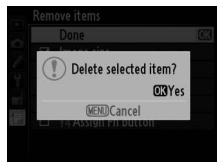


OK button





4 Delete the selected items.

Press OK to delete the selected items.



Deleting Items in My Menu

To delete the item currently highlighted in My Menu, press the  (FORMAT) button. A confirmation dialog will be displayed; press  (FORMAT) again to remove the selected item from My Menu.



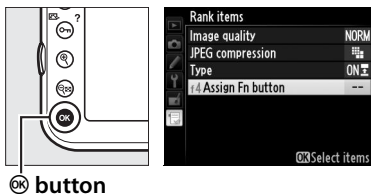
■ Reordering Options in My Menu

1 Select Rank items.

In My Menu (☰), highlight **Rank items** and press ►.

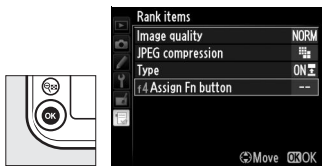
2 Select an item.

Highlight the item you wish to move and press OK.



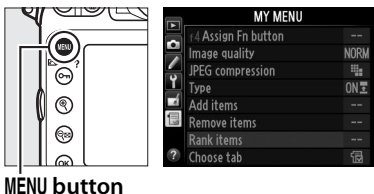
3 Position the item.

Press ▲ or ▼ to move the item up or down in My Menu and press OK. Repeat Steps 2–3 to reposition additional items.





4 Exit to My Menu.



Press the MENU button to return to My Menu.



Recent Settings



To display the twenty most recently used settings, select  **Recent settings** for  **My Menu** > **Choose tab**.

1 Select Choose tab.

In My Menu () , highlight **Choose tab** and press .

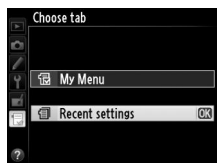




2 Select Recent settings.

Highlight  **Recent settings** and press . The name of the menu will change from “MY MENU” to “RECENT SETTINGS.”





 **button**



Menu items will be added to the top of the recent settings menu as they are used. To view My Menu again, select  **My Menu** for  **Recent settings** > **Choose tab**.

Removing Items from the Recent Settings Menu

To remove an item from the recent settings menu, highlight it and press the  (**FORMAT**) button. A confirmation dialog will be displayed; press  (**FORMAT**) again to delete the selected item.



Technical Notes

Read this chapter for information on compatible accessories, cleaning and storing the camera, and what to do if an error message is displayed or you encounter problems using the camera.

Compatible Lenses

Camera setting Lens/accessory		Focus mode			Exposure mode		Metering system		
		AF	M (with electronic rangefinder)	M	P	A	☒		☒
					S	M	3D	Color	☐
CPU lenses ¹	Type G or D AF NIKKOR ² AF-S, AF-I NIKKOR	✓	✓	✓	✓	✓	✓	—	✓ ³
	PC-E NIKKOR series	—	✓ ⁵	✓	✓ ⁵	✓ ⁵	✓ ⁵	—	✓ ^{3,5}
	PC Micro 85mm f/2.8D ⁴	—	✓ ⁵	✓	—	✓ ⁶	✓	—	✓ ^{3,5}
	AF-S / AF-I Teleconverter ⁷	✓	✓	✓	✓	✓	✓	—	✓ ³
	Other AF NIKKOR (except lenses for F3AF)	✓ ⁹	✓ ⁹	✓	✓	✓	—	✓	✓ ³
	AI-P NIKKOR	—	✓ ¹⁰	✓	✓	✓	—	✓	✓ ³
Non-CPU lenses ¹¹	AI-, AI-modified, NIKKOR or Nikon Series E lenses ¹²	—	✓ ¹⁰	✓	—	✓ ¹³	—	✓ ¹⁴	✓ ¹⁵
	Medical-NIKKOR 120mm f/4	—	✓	✓	—	✓ ¹⁶	—	—	—
	Reflex-NIKKOR	—	—	✓	—	✓ ¹³	—	—	✓ ¹⁵
	PC-NIKKOR	—	✓ ⁵	✓	—	✓ ¹⁷	—	—	✓
	AI-type Teleconverter ¹⁸	—	✓ ⁸	✓	—	✓ ¹³	—	✓ ¹⁴	✓ ¹⁵
	PB-6 Bellows Focusing Attachment ¹⁹	—	✓ ⁸	✓	—	✓ ²⁰	—	—	✓
Auto extension rings (PK-series 11A, 12, or 13; PN-11)	—	✓ ⁸	✓	—	✓ ¹³	—	—	✓	

- 1 IX-NIKKOR lenses can not be used.
 - 2 Vibration Reduction (VR) supported with VR lenses.
 - 3 Spot metering meters selected focus point (☐ 115).
 - 4 The camera's exposure metering and flash control systems do not work properly when shifting and/or tilting the lens, or when an aperture other than the maximum aperture is used.
 - 5 Can not be used with shifting or tilting.
 - 6 Manual exposure mode only.
 - 7 Can be used with AF-S and AF-I lenses only (☐ 373). For information on the focus points available for autofocus and electronic rangefinding, see page 373.
 - 8 With maximum effective aperture of f/5.6 or faster.
 - 9 When focusing at minimum focus distance with AF 80–200mm f/2.8, AF 35–70mm f/2.8, AF 28–85mm f/3.5–4.5 <New>, or AF 28–85mm f/3.5–4.5 lens at maximum zoom, in-focus indicator may be displayed when image on matte screen in viewfinder is not in focus. Adjust focus manually until image in viewfinder is in focus.
 - 10 With maximum aperture of f/5.6 or faster.
 - 11 Some lenses can not be used (see page 374).
 - 12 Range of rotation for AI 80–200mm f/2.8 ED tripod mount is limited by camera body. Filters can not be exchanged while AI 200–400mm f/4 ED is mounted on camera.
 - 13 If maximum aperture is specified using **Non-CPU lens data** (☐ 212), aperture value will be displayed in viewfinder and control panel.
 - 14 Can be used only if lens focal length and maximum aperture are specified using **Non-CPU lens data** (☐ 212). Use spot or center-weighted metering if desired results are not achieved.
 - 15 For improved precision, specify lens focal length and maximum aperture using **Non-CPU lens data** (☐ 212).
 - 16 Can be used in manual exposure modes at shutter speeds slower than flash sync speed by one step or more.
 - 17 Exposure determined by presetting lens aperture. In aperture-priority auto exposure mode, preset aperture using lens aperture ring before performing AE lock and shifting lens. In manual exposure mode, preset aperture using lens aperture ring and determine exposure before shifting lens.
 - 18 Exposure compensation required when used with AI 28–85mm f/3.5–4.5, AI 35–105mm f/3.5–4.5, AI 35–135mm f/3.5–4.5, or AF-S 80–200mm f/2.8D. See teleconverter manual for details.
 - 19 Requires PK-12 or PK-13 auto extension ring. PB-6D may be required depending on camera orientation.
 - 20 Use preset aperture. In aperture-priority auto exposure mode, set aperture using focusing attachment before determining exposure and taking photograph.
- PF-4 Reprocopy Outfit requires PA-4 Camera Holder.
 - Noise in the form of horizontal lines may appear in pictures taken with AF-S Zoom Nikkor 24–85 mm f/3.5–4.5G (IF) lenses at ISO sensitivities over 6400; use manual focus or focus lock.



Lens f-number

The f-number given in lens names is the maximum aperture of the lens.

Compatible Non-CPU Lenses

When using non-CPU lenses and accessories, select exposure mode **A** or **M** and set aperture using the lens aperture ring. In other modes, the shutter-release is disabled. **Non-CPU lens data** (☐ 212) can be used to enable many of the features available with CPU lenses, including color matrix metering; if no data are provided, center-weighted metering will be used in place of color matrix metering, while if the maximum aperture is not provided, the camera aperture display will show the number of stops from maximum aperture and the actual aperture value must be read off the lens aperture ring.

Incompatible Accessories and Non-CPU Lenses

The following can NOT be used with the D800:

- TC-16AS AF teleconverter
- Non-AI lenses
- Lenses that require the AU-1 focusing unit (400mm f/4.5, 600mm f/5.6, 800mm f/8, 1200mm f/11)
- Fisheye (6mm f/5.6, 7.5mm f/5.6, 8mm f/8, OP 10mm f/5.6)
- 2.1cm f/4
- Extension Ring K2
- 180–600mm f/8 ED (serial numbers 174041–174180)
- 360–1200mm f/11 ED (serial numbers 174031–174127)
- 200–600mm f/9.5 (serial numbers 280001–300490)
- AF lenses for the F3AF (AF 80mm f/2.8, AF 200mm f/3.5 ED, AF Teleconverter TC-16)
- PC 28mm f/4 (serial number 180900 or earlier)
- PC 35mm f/2.8 (serial numbers 851001–906200)
- PC 35mm f/3.5 (old type)
- Reflex 1000mm f/6.3 (old type)
- Reflex 1000mm f/11 (serial numbers 142361–143000)
- Reflex 2000mm f/11 (serial numbers 200111–200310)



The Built-in Flash

The built-in flash can be used with CPU lenses with focal lengths of 24mm (16mm in DX format) to 300mm, although in some cases the flash may be unable to entirely light the subject at some ranges or focal lengths due to shadows cast by the lens, while lenses that block the subject's view of the red-eye reduction lamp may interfere with red-eye reduction. Remove lens hoods to prevent shadows. The flash has a minimum range of 0.6 m (2 ft) and can not be used in the macro range of macro zoom lenses. The flash may be unable to light the entire subject with the following lenses at ranges less than those given below:

	Lens	Zoom position	Minimum distance without vignetting
DX	AF-S DX Zoom-Nikkor 12–24mm f/4G IF-ED	18–24mm	No vignetting
	AF-S DX Zoom-Nikkor 17–55mm f/2.8G IF-ED	20mm	1.5 m/4 ft 11 in.
		24–55mm	No vignetting
FX	AF-S NIKKOR 16–35mm f/4G ED VR	35mm	1.0 m/3 ft 3 in.
	AF-S Zoom-Nikkor 17–35mm f/2.8D IF-ED	28mm	1.0 m/3 ft 3 in.
		35mm	No vignetting
	AF Zoom-Nikkor 18–35mm f/3.5–4.5D IF-ED	24mm	1.0 m/3 ft 3 in.
		28–35mm	No vignetting
	AF Zoom-Nikkor 20–35mm f/2.8D IF	24mm	1.0 m/3 ft 3 in.
		28–35mm	No vignetting
	AF-S NIKKOR 24–70mm f/2.8G ED	35mm	1.0 m/3 ft 3 in.
		50–70mm	No vignetting
	AF-S VR Zoom-Nikkor 24–120mm f/3.5–5.6G IF-ED	24mm	1.0 m/3 ft 3 in.
		28–120mm	No vignetting
	AF-S NIKKOR 24–120mm f/4G ED VR	28mm	1.0 m/3 ft 3 in.
35–120mm		No vignetting	
AF-S Zoom-Nikkor 28–70mm f/2.8D IF-ED	35mm	1.5 m/4 ft 11 in.	
	50–70mm	No vignetting	
AF-S NIKKOR 28–300mm f/3.5–5.6G ED VR	35mm	1.0 m/3 ft 3 in.	
	50–300mm	No vignetting	
	PC-E NIKKOR 24mm f/3.5D ED *	24mm	1.5 m/4 ft 11 in.

* When not shifted or tilted.



When used with the AF-S NIKKOR 14–24mm f/2.8G ED, the flash will be unable to light the entire subject at all ranges.

The built-in flash can also be used with AI-S, AI-, AI-modified NIKKOR, Nikon Series E and non-CPU lenses with a focal length of 24–300mm. AI 50–300mm f/4.5, modified AI 50–300mm f/4.5, and AI-S 50–300mm f/4.5 ED lenses must be used at a zoom position of 180mm or above, and AI 50–300mm f/4.5 ED lenses at a zoom position of 135mm or above.



AF-Assist Illumination

AF-assist illumination is available with lenses with focal lengths of 24–200 mm. It can not however be used to assist the focus operation with the following lenses:

- AF-S VR Nikkor 200mm f/2G IF-ED
- AF-S NIKKOR 200mm f/2G ED VR II
- AF-S VR Zoom-Nikkor 200–400mm f/4G IF-ED
- AF-S NIKKOR 200–400mm f/4G ED VR II

At ranges under 0.7 m (2 ft 4 in.), the following lenses may block the AF-assist illuminator and interfere with autofocus when lighting is poor:

- AF-S NIKKOR 16–35mm f/4G ED VR
- AF-S Zoom-Nikkor 17–35mm f/2.8D IF-ED
- AF-S DX Zoom-Nikkor 17–55mm f/2.8G IF-ED
- AF-S DX NIKKOR 18–200mm f/3.5–5.6G ED VR II
- AF-S NIKKOR 24–70mm f/2.8G ED
- AF-S VR Zoom-Nikkor 24–120mm f/3.5–5.6G IF-ED
- AF-S Zoom Nikkor ED 28–70mm f/2.8D (IF)
- AF Micro-Nikkor 200mm f/4D IF-ED

At ranges under 1.1 m (3 ft 7 in.), the following lenses may block the AF-assist illuminator and interfere with autofocus when lighting is poor:

- AF-S NIKKOR 24–120mm f/4G ED VR
- AF-S NIKKOR 28–300mm f/3.5–5.6G ED VR
- AF-S DX Zoom-Nikkor 55–200mm f/4–5.6G ED

At ranges under 1.5 m (4 ft 11 in.), the following lenses may block the AF-assist illuminator and interfere with autofocus when lighting is poor:


- AF-S NIKKOR 14–24mm f/2.8G ED
- AF-S VR Zoom-Nikkor ED 70–200mm f2.8G (IF)
- AF-S NIKKOR 70–200mm f/2.8G ED VR II
- AF Zoom-Nikkor 70–300mm f/4–5.6G
- AF Zoom-Nikkor 80–200mm f/2.8D ED
- AF-S Zoom-Nikkor 80–200mm f/2.8D IF-ED

At ranges under 2.3 m (7 ft 7 in.), the following lenses may block the AF-assist illuminator and interfere with autofocus when lighting is poor:

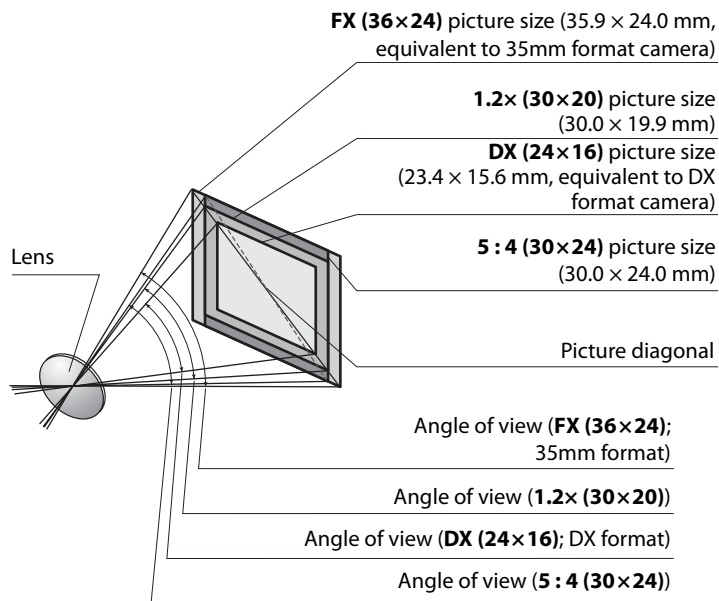
- AF VR Zoom-Nikkor 80–400mm f/4.5–5.6D ED



Calculating Angle of View

The D800 can be used with Nikon lenses for 35mm (135) format cameras. If **Auto DX crop** is on ( 79) and a 35mm format lens is attached, the angle of view will be the same as a frame of 35mm film (35.9 × 24.0 mm); if a DX lens is attached, the angle of view will automatically be adjusted to 23.4 × 15.6 mm (DX format).

To choose an angle of view different from that of the current lens, turn **Auto DX crop** off and select from **FX (36×24)**, **1.2× (30×20)**, **DX (24×16)**, and **5 : 4 (30×24)**. If a 35mm format lens is attached, the angle of view could be reduced by 1.5 × by selecting **DX (24×16)** or by 1.2 × by selecting **1.2× (30×20)**, to expose a smaller area, or the aspect ratio could be changed by selecting **5 : 4 (30×24)**.



Calculating Angle of View (Continued)

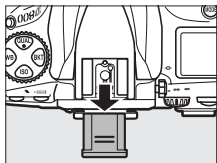
The **DX (24×16)** angle of view is about 1.5 times smaller than the 35mm format angle of view, while the **1.2× (30×20)** angle of view is about 1.2 times smaller and the **5 : 4 (30×24)** angle of view is about 1.1 times smaller. To calculate the focal length of lenses in 35mm format when **DX (24×16)** is selected, multiply the focal length of the lens by about 1.5, by about 1.2 when is **1.2× (30×20)** selected, or by about 1.1 when **5 : 4 (30×24)** is selected (for example, the effective focal length of a 50mm lens in 35mm format would be 75 mm when **DX (24×16)** is selected, 60 mm when **1.2× (30×20)** is selected, or 55 mm when **5 : 4 (30×24)** is selected).



Optional Flash Units (Speedlights)

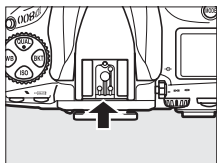
The camera supports the Nikon Creative Lighting System (CLS) and can be used with CLS-compatible flash units. Optional flash units can be attached directly to the camera accessory shoe as described below. The accessory shoe is equipped with a safety lock for flash units with a locking pin.

1 Remove the accessory shoe cover.



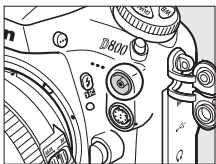
2 Mount the flash unit on the accessory shoe.

See the manual provided with the flash unit for details. The built-in flash will not fire when an optional flash unit is attached.



The Sync Terminal

A sync cable can be connected to the sync terminal as required. Do not connect another flash unit via a sync cable when performing rear-curtain sync flash photography with a flash unit mounted on the camera accessory shoe.



The Nikon Creative Lighting System (CLS)

Nikon's advanced Creative Lighting System (CLS) offers improved communication between the camera and compatible flash units for improved flash photography.

■ CLS-Compatible Flash Units

The camera can be used with the following CLS-compatible flash units:

• The SB-910, SB-900, SB-800, SB-700, SB-600, SB-400, and SB-R200:

Flash unit		SB-910 ¹	SB-900 ¹	SB-800	SB-700 ¹	SB-600	SB-400 ²	SB-R200 ³
Guide	ISO 100	34/111	34/111	38/125	28/92	30/98	21/69	10/33
No. ⁴	ISO 200	48/157	48/157	53/174	39/128	42/138	30/98	14/46


- 1 If a color filter is attached to the SB-910, SB-900, or SB-700 when AUTO or $\frac{1}{2}$ (flash) is selected for white balance, the camera will automatically detect the filter and adjust white balance appropriately.
 - 2 Wireless flash control is not available with the SB-400.
 - 3 Controlled remotely with built-in flash in commander mode or using optional SB-910, SB-900, SB-800, or SB-700 flash unit or SU-800 wireless Speedlight commander.
 - 4 m/ft, 20 °C (68 °F), SB-910, SB-900, SB-800, SB-700, and SB-600 at 35 mm zoom head position; SB-910, SB-900, and SB-700 with standard illumination.
- **SU-800 Wireless Speedlight Commander:** When mounted on a CLS-compatible camera, the SU-800 can be used as a commander for remote SB-910, SB-900, SB-800, SB-700, SB-600, or SB-R200 flash units in up to three groups. The SU-800 itself is not equipped with a flash.


Guide Number

To calculate the range of the flash at full power, divide the Guide Number by the aperture. For example, at ISO 100 the SB-800 has a Guide Number of 38 m or 125 ft (35mm zoom head position); its range at an aperture of f/5.6 is $38 \div 5.6$ or about 6.8 meters (or in feet, $125 \div 5.6 =$ approximately 23 ft 7 in.). For each twofold increase in ISO sensitivity, multiply the Guide Number by the square root of two (approximately 1.4).



The following features are available with CLS-compatible flash units:


Flash unit		Advanced Wireless Lighting									
							Master/commander			Remote	
		SB-910 SB-900 SB-800	SB-700	SB-600	SB-400	SB-910 SB-900 SB-800	SB-700	SU-800 ¹	SB-910 SB-900 SB-800	SB-700 SB-600	SB-R200
Flash mode/feature											
i-TTL	i-TTL balanced fill-flash for digital SLR	✓ ²	✓ ³	✓ ²	✓ ³	✓	✓	✓	✓	✓	✓
AA	Auto aperture	✓ ⁴	—	—	—	✓ ⁵	—	✓ ⁵	✓ ⁵	—	—
A	Non-TTL auto	✓ ⁴	—	—	—	✓ ⁵	—	—	✓ ⁵	—	—
GN	Distance-priority manual	✓	✓	—	—	—	—	—	—	—	—
M	Manual	✓	✓	✓	✓ ⁶	✓	✓	✓	✓	✓	✓
RPT	Repeating flash	✓	—	—	—	✓	—	✓	✓	✓	—
Auto FP High-Speed Sync ⁷		✓	✓	✓	—	✓	✓	✓	✓	✓	✓
FV lock		✓	✓	✓	✓	✓	✓	✓	✓	✓	✓
AF-assist for multi-area AF ⁸		✓	✓	✓	—	✓	✓	✓	—	—	—
Flash Color Information Communication		✓	✓	✓	✓	✓	✓	—	—	—	—
REAR	Rear-curtain sync	✓	✓	✓	✓	✓	✓	✓	✓	✓	✓
	Red-eye reduction	✓	✓	✓	✓	✓	✓	—	—	—	—
Power zoom		✓	✓	✓	—	✓	✓	—	—	—	—

- 1 Only available when SU-800 is used to control other flash units. The SU-800 itself is not equipped with a flash.
- 2 Standard i-TTL flash for digital SLR is used with spot metering or when selected with flash unit.
- 3 Standard i-TTL flash for digital SLR is used with spot metering.
- 4 Selected with flash unit.
- 5 Auto aperture (AA) is used regardless of mode selected with flash unit.
- 6 Can be selected with camera.
- 7 Select **1/320s (Auto FP)** or **1/250 s (Auto FP)** for Custom Setting e1 (**Flash sync speed**,  299).
- 8 CPU lens required.



Other Flash Units

The following flash units can be used in non-TTL auto and manual modes.

Flash unit		SB-80DX, SB-28DX, SB-28, SB-26, SB-25, SB-24	SB-50DX	SB-30, SB-27 ¹ , SB-22S, SB-22, SB-20, SB-16B, SB-15	SB-23, SB-29 ² , SB-21B ² , SB-29S ²
		Flash mode			
A	Non-TTL auto	✓	—	✓	—
M	Manual	✓	✓	✓	✓
	Repeating flash	✓	—	—	—
REAR ³	Rear-curtain sync	✓	✓	✓	✓

- 1 Flash mode is automatically set to TTL and shutter-release is disabled. Set flash unit to **A** (non-TTL auto flash).
- 2 Autofocus is available with AF-S VR Micro-Nikkor 105mm f/2.8G IF-ED and AF-S Micro NIKKOR 60mm f/2.8G ED lenses only.
- 3 Available when camera is used to select flash mode.

Auto Aperture/Non-TTL Auto

Unless the focal length and maximum aperture are specified using the **Non-CPU lens data** option in the setup menu (□ 213), choosing auto aperture (**AA**) when a non-CPU lens is attached automatically selects non-TTL auto (**A**).



Notes on Optional Flash Units

Refer to the flash unit manual for detailed instructions. If the unit supports CLS, refer to the section on CLS-compatible digital SLR cameras. The D800 is not included in the “digital SLR” category in the SB-80DX, SB-28DX, and SB-50DX manuals.

i-TTL flash control can be used at ISO sensitivities between 100 and 6400. At values over 6400, the desired results may not be achieved at some ranges or aperture settings. If the flash-ready indicator blinks for about three seconds after a photograph is taken, the flash has fired at full power and the photograph may be underexposed. View the photograph in the monitor; if it is underexposed, adjust aperture, ISO sensitivity, or the distance to the subject and try again.

When an SC-series 17, 28, or 29 sync cable is used for off-camera flash photography, correct exposure may not be achieved in i-TTL mode. We recommend that you select standard i-TTL flash control. Take a test shot and view the results in the monitor.

In i-TTL, use the flash panel or bounce adapter provided with the flash unit. Do not use other panels such as diffusion panels, as this may produce incorrect exposure.



The SB-910, SB-900, SB-800, SB-700, SB-600, and SB-400 provide red-eye reduction, while the SB-910, SB-900, SB-800, SB-700, SB-600, and SU-800 provide AF-assist illumination with the following restrictions:

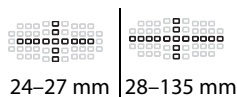
- **SB-910 and SB-900:** AF-assist illumination is available with 17–135 mm AF lenses, however, autofocus is available only with the focus points shown at right.



- **SB-800, SB-600, and SU-800:** AF-assist illumination is available with 24–105 mm AF lenses, however, autofocus is available only with the focus points shown at right.



- **SB-700:** AF-assist illumination is available with 24–135 mm AF lenses, however, autofocus is available only with the focus points shown at right.



In exposure mode **P**, the maximum aperture (minimum f-number) is limited according to ISO sensitivity, as shown below:














Maximum aperture at ISO equivalent of:						
100	200	400	800	1600	3200	6400
4	5	5.6	7.1	8	10	11

If the maximum aperture of the lens is smaller than given above, the maximum value for aperture will be the maximum aperture of the lens.



Flash Control Mode

The information display shows the flash control mode for optional flash units as follows:

	Flash sync	Auto FP (📖 300)
i-TTL		
Auto aperture (AA)		
Non-TTL auto flash (A)		
Distance-priority manual (GN)		
Manual		
Repeating flash		—
Advanced wireless lighting		

Use Only Nikon Flash Accessories

Use only Nikon flash units. Negative voltages or voltages over 250 V applied to the accessory shoe could not only prevent normal operation, but damage the sync circuitry of the camera or flash. Before using a Nikon flash unit not listed in this section, contact a Nikon-authorized service representative for more information.



Other Accessories

At the time of writing, the following accessories were available for the D800.

Power sources	<ul style="list-style-type: none">• Rechargeable Li-ion Battery EN-EL15 (☞ 19, 21): Additional EN-EL15 batteries are available from local retailers and Nikon service representatives. These batteries can be recharged using an MH-25 battery charger.• Battery Charger MH-25 (☞ 19): The MH-25 can be used to recharge EN-EL15 batteries.• Multi-Power Battery Pack MB-D12: The MB-D12 is equipped with a shutter-release button, AF-ON button, multi selector, and main- and sub-command dials for improved operation when taking photographs in portrait (tall) orientation. When attaching the MB-D12, remove the camera MB-D12 contact cover. A BL-5 battery-chamber cover and an MH-26 battery charger are required when using EN-EL18 batteries.• Power Connector EP-5B, AC Adapter EH-5b: These accessories can be used to power the camera for extended periods (EH-5a and EH-5 AC adapters can also be used). A power connector EP-5B is required to connect the camera to the EH-5b, EH-5a, or EH-5; see page 391 for details. Note that when the camera is used with an MB-D12, the EP-5B must be inserted into the MB-D12, not the camera. Do not attempt to use the camera with power connectors inserted into both the camera and MB-D12.
Wireless LAN adapters (☞ 245)	<p>Wireless Transmitter WT-4: Connects the camera to wireless and Ethernet networks. The photographs on the camera memory card can be viewed by computers on the same network or copied to a computer for long-term storage. The camera can also be controlled from any computer on the network using Camera Control Pro 2 (available separately). Note that the WT-4 requires an independent power source in the form of an optional EH-6b AC adapter or EN-EL3e battery. See the WT-4 manual for details. Always use the latest version of the WT-4 software.</p>



Viewfinder eyepiece accessories

- **Rubber Eyecup DK-19:** The DK-19 makes the image in the viewfinder easier to see, preventing eye fatigue.
- **Dioptr-Adjustment Viewfinder Lens DK-17C:** To accommodate individual differences in vision, viewfinder lenses are available with diopters of -3 , -2 , 0 , $+1$, and $+2 \text{ m}^{-1}$. Use diopter adjustment lenses only if the desired focus can not be achieved with the built-in diopter adjustment control (-3 to $+1 \text{ m}^{-1}$). Test diopter adjustment lenses before purchase to ensure that the desired focus can be achieved. The DK-17C is equipped with a safety lock.
- **Magnifying Eyepiece DK-17M:** The DK-17M magnifies the view through the viewfinder by approximately $1.2 \times$ for greater precision when framing. The DK-17M is equipped with a safety lock.
- **Eyepiece Magnifier DG-2:** The DG-2 magnifies the scene at the center of the viewfinder for more accurate focus. DK-18 eyepiece adapter (available separately) required.
- **Eyepiece Adapter DK-18:** The DK-18 is used when attaching the DG-2 magnifier or DR-3 right-angle viewing attachment to the D800.
- **Antifog Finder Eyepiece DK-14/Antifog Finder Eyepiece DK-17A:** These viewfinder eyepieces prevent fogging in humid or cold conditions. The DK-17A is equipped with a safety lock.
- **Right-Angle Viewing Attachment DR-5/Right-Angle Viewing Attachment DR-4:** The DR-5 and DR-4 attach to the viewfinder eyepiece at a right angle, allowing the image in the viewfinder to be viewed from above when the camera is in the horizontal shooting position. The DR-5 supports diopter adjustment and can also magnify the view through the viewfinder by $2 \times$ for greater precision when framing (note that the edges of the frame will not be visible when the view is magnified).



Filters	<ul style="list-style-type: none"> • Filters intended for special-effects photography may interfere with autofocus or the electronic rangefinder. • The D800 can not be used with linear polarizing filters. Use the C-PL or C-PLII circular polarizing filter instead. • Use NC filters to protect the lens. • To prevent ghosting, use of a filter is not recommended when the subject is framed against a bright light, or when a bright light source is in the frame. • Center-weighted metering is recommended with filters with exposure factors (filter factors) over 1 × (Y44, Y48, Y52, O56, R60, X0, X1, C-PL, ND2S, ND4, ND4S, ND8, ND8S, ND400, A2, A12, B2, B8, B12). See the filter manual for details.
PC card adapters	<p>PC Card Adapter EC-AD1: The EC-AD1 PC card adapter allows Type I CompactFlash memory cards to be inserted in PCMCIA card slots.</p>
Software	<ul style="list-style-type: none"> • Capture NX 2: A complete photo editing package with such advanced editing features as selection control points and an auto retouch brush. • Camera Control Pro 2: Control the camera remotely from a computer and save photographs directly to the computer hard disk. <p>Note: Use the latest versions of Nikon software; see the websites listed on page xx for the latest information on supported operating systems. At default settings, Nikon Message Center 2 will periodically check for updates to Nikon software and firmware while you are logged in to an account on the computer and the computer is connected to the Internet. A message is automatically displayed when an update is found.</p>
Body caps	<p>Body Cap BF-1B/Body Cap BF-1A: The body cap keeps the mirror, viewfinder screen, and low-pass filter free of dust when a lens is not in place.</p>
Microphones	<p>Stereo Microphone ME-1 (□ 65): Connect the ME-1 to the camera microphone jack to record stereo sound while reducing the noise caused by lens vibration being recorded with movies during autofocus.</p>



**Remote
terminal
accessories**

The D800 is equipped with a ten-pin remote terminal (□ 3) for remote control and automatic photography. The terminal is provided with a cap, which protects the contacts when the terminal is not in use. The following accessories can be used (all lengths are approximate):

- **Remote Cord MC-22:** Remote shutter release with blue, yellow, and black terminals for connection to a remote shutter-triggering device, allowing control via sound or electronic signals (length 1 m/3 ft 3 in.).
- **Remote Cord MC-30:** Remote shutter release; can be used to reduce camera shake (length 80 cm/2 ft 7 in.).
- **Remote Cord MC-36:** Remote shutter release; can be used for interval timer photography or to reduce camera shake or keep the shutter open during a time exposure (length 85 cm/2 ft 9 in.).
- **Extension Cord MC-21:** Can be connected to ML-3 or MC-series 20, 22, 23, 25, 30, or 36. Only one MC-21 can be used at a time (length 3 m/9 ft 10 in.).
- **Connecting Cord MC-23:** Connects two cameras for simultaneous operation (length 40 cm/1 ft 4 in.).
- **Adapter Cord MC-25:** Ten-pin to two-pin adapter cord for connection to devices with two-pin terminals, including the MW-2 radio control set, MT-2 intervalometer, and ML-2 modulite control set (length 20 cm/8 in.).
- **GPS Unit GP-1** (□ 215): Record latitude, longitude, altitude, and UTC time with pictures.
- **GPS Adapter Cord MC-35** (□ 216): Connects GPS devices to D800 via PC cable supplied by manufacturer of GPS device (length 35 cm/1 ft 2 in.).
- **Modulite Remote Control Set ML-3:** Allows infrared remote control at ranges of up to 8 m (26 ft 3 in.).

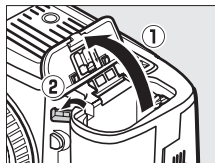


Attaching a Power Connector and AC Adapter

Turn the camera off before attaching an optional power connector and AC adapter.

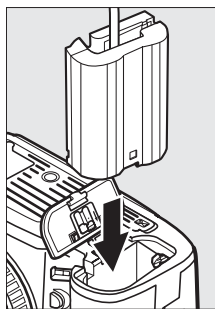
1 Ready the camera.

Open the battery-chamber (①) and power connector (②) covers.



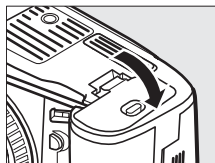
2 Insert the EP-5B power connector.

Be sure to insert the connector in the orientation shown, using the connector to keep the orange battery latch pressed to one side. The latch locks the connector in place when the connector is fully inserted.



3 Close the battery-chamber cover.

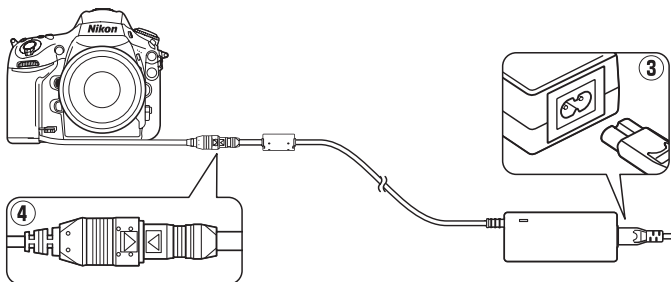
Position the power connector cable so that it passes through the power connector slot and close the battery-chamber cover.



4 Connect the AC adapter.

Connect the AC adapter power cable to the AC socket on AC adapter (3) and the EP-5B power cable to the DC socket (4).

When the camera is powered by the AC adapter and power connector, the battery level display in the monitor turns off.



Caring for the Camera

Storage

When the camera will not be used for an extended period, remove the battery and store it in a cool, dry area with the terminal cover in place. To prevent mold or mildew, store the camera in a dry, well-ventilated area. Do not store your camera with naphtha or camphor moth balls or in locations that:

- are poorly ventilated or subject to humidities of over 60%
- are next to equipment that produces strong electromagnetic fields, such as televisions or radios
- are exposed to temperatures above 50 °C (122 °F) or below -10 °C (14 °F)

Cleaning

Camera body	Use a blower to remove dust and lint, then wipe gently with a soft, dry cloth. After using the camera at the beach or seaside, wipe off sand or salt with a cloth lightly dampened in distilled water and dry thoroughly. Important: <i>Dust or other foreign matter inside the camera may cause damage not covered under warranty.</i>
Lens, mirror, and viewfinder	These glass elements are easily damaged. Remove dust and lint with a blower. If using an aerosol blower, keep the can vertical to prevent the discharge of liquid. To remove fingerprints and other stains, apply a small amount of lens cleaner to a soft cloth and clean with care.
Monitor	Remove dust and lint with a blower. When removing fingerprints and other stains, wipe the surface lightly with a soft cloth or chamois leather. Do not apply pressure, as this could result in damage or malfunction.

Do not use alcohol, thinner, or other volatile chemicals.



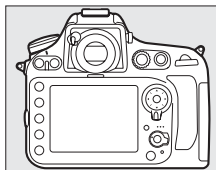
The Low-Pass Filter

The image sensor that acts as the camera's picture element is fitted with a low-pass filter to prevent moiré. If you suspect that dirt or dust on the filter is appearing in photographs, you can clean the filter using the **Clean image sensor** option in the setup menu. The filter can be cleaned at any time using the **Clean now** option, or cleaning can be performed automatically when the camera is turned on or off.

■ "Clean Now"

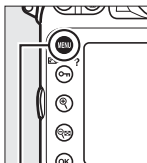
1 Place the camera base down.

Image sensor cleaning is most effective when the camera is placed base down as shown at right.



2 Select Clean image sensor in the setup menu.

Press **MENU** to display the menus. Highlight **Clean image sensor** in the setup menu and press **▶**.



MENU button

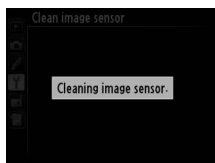


3 Select **Clean now**.

Highlight **Clean now** and press **OK**. The camera will check the image sensor and then begin cleaning. This process takes about ten seconds; during this time, **buSy** is displayed in the control panel and other operations can not be performed. Do not remove or disconnect the power source until cleaning is complete and **buSy** is no longer displayed.






OK button



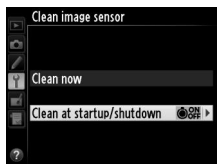
■ “Clean at Startup/Shutdown”

Choose from the following options:


Option	Description
 Clean at startup	The image sensor is automatically cleaned each time the camera is turned on.
 Clean at shutdown	The image sensor is automatically cleaned during shutdown each time the camera is turned off.
 Clean at startup & shutdown	The image sensor is cleaned automatically at startup and at shutdown.
Cleaning off	Automatic image sensor cleaning off.

1 Select Clean at startup/ shutdown.

Display the **Clean image sensor** menu as described in Step 2 on the previous page. Highlight **Clean at startup/shutdown** and press ►.



2 Select an option.

Highlight an option and press .



 button

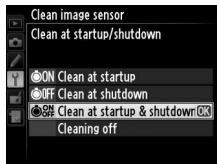


Image Sensor Cleaning

Using camera controls during startup interrupts image sensor cleaning. Image sensor cleaning may not be performed at startup if the flash is charging.

Cleaning is performed by vibrating the low-pass filter. If dust can not be fully removed using the options in the **Clean image sensor** menu, clean the image sensor manually (see below) or consult a Nikon-authorized service representative.

If image sensor cleaning is performed several times in succession, image sensor cleaning may be temporarily disabled to protect the camera's internal circuitry. Cleaning can be performed again after a short wait.

Manual Cleaning

If foreign matter can not be removed from the low-pass filter using the **Clean image sensor** (🗨 394) option in the setup menu, the filter can be cleaned manually as described below. Note, however, that the filter is extremely delicate and easily damaged. Nikon recommends that the filter be cleaned only by Nikon-authorized service personnel.

1 Charge the battery or connect an AC adapter.

A reliable power source is required when inspecting or cleaning the low-pass filter. Turn the camera off and insert a fully-charged EN-EL15 battery or connect an optional EP-5B power connector and EH-5b AC adapter.

2 Remove the lens.


Turn the camera off and remove the lens.

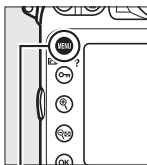


3 Select Lock mirror up for cleaning.

Turn the camera on and press the MENU button to display the menus.

Highlight **Lock mirror up**

for cleaning in the setup menu and press ► (note that this option is not available at battery levels of  or below).

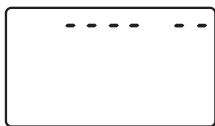
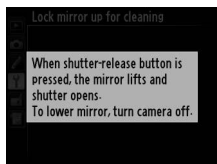


MENU button



4 Press .

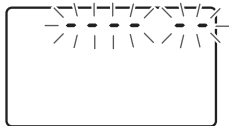
The message shown at right will be displayed in the monitor and a row of dashes will appear in the control panel and viewfinder. To restore normal operation without inspecting the low-pass filter, turn the camera off.



5 Raise the mirror.

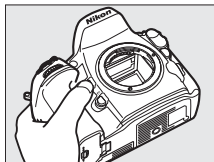
Press the shutter-release button all the way down. The mirror will be raised and the shutter curtain will open,

revealing the low-pass filter. The display in the viewfinder will turn off and the row of dashes in the control panel will blink.



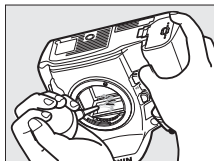
6 Examine the low-pass filter.

Holding the camera so that light falls on the low-pass filter, examine the filter for dust or lint. If no foreign objects are present, proceed to Step 8.



7 Clean the filter.

Remove any dust and lint from the filter with a blower. Do not use a blower-brush, as the bristles could damage the filter. Dirt that can not be removed with a blower can only be removed by Nikon-authorized service personnel. Under no circumstances should you touch or wipe the filter.



8 Turn the camera off.

The mirror will return to the down position and the shutter curtain will close. Replace the lens or body cap.



Use a Reliable Power Source

The shutter curtain is delicate and easily damaged. If the camera powers off while the mirror is raised, the curtain will close automatically. To prevent damage to the curtain, observe the following precautions:

- Do not turn the camera off or remove or disconnect the power source while the mirror is raised.
- If the battery runs low while the mirror is raised, a beep will sound and the self-timer lamp will blink to warn that the shutter curtain will close and the mirror will be lowered after about two minutes. End cleaning or inspection immediately.

Foreign Matter on the Low-Pass Filter

Nikon takes every possible precaution to prevent foreign matter from coming into contact with the low-pass filter during production and shipping. The D800, however, is designed to be used with interchangeable lenses, and foreign matter may enter the camera when lenses are removed or exchanged. Once inside the camera, this foreign matter may adhere to the low-pass filter, where it may appear in photographs taken under certain conditions. To protect the camera when no lens is in place, be sure to replace the body cap provided with the camera, being careful to first remove all dust and other foreign matter that may be adhering to the body cap.

Should foreign matter find its way onto the low-pass filter, clean the filter as described above, or have the filter cleaned by authorized Nikon service personnel. Photographs affected by the presence of foreign matter on the filter can be retouched using Capture NX 2 (available separately; □ 389) or the clean image options available in some third-party imaging applications.

Servicing the Camera and Accessories

The camera is a precision device and requires regular servicing. Nikon recommends that the camera be inspected by the original retailer or Nikon service representative once every one to two years, and that it be serviced once every three to five years (note that fees apply to these services). Frequent inspection and servicing are particularly recommended if the camera is used professionally. Any accessories regularly used with the camera, such as lenses or optional flash units, should be included when the camera is inspected or serviced.



Caring for the Camera and Battery: Cautions

Do not drop: The product may malfunction if subjected to strong shocks or vibration.

Keep dry: This product is not waterproof, and may malfunction if immersed in water or exposed to high levels of humidity. Rusting of the internal mechanism can cause irreparable damage.

Avoid sudden changes in temperature: Sudden changes in temperature, such as those that occur when entering or leaving a heated building on a cold day, can cause condensation inside the device. To prevent condensation, place the device in a carrying case or plastic bag before exposing it to sudden changes in temperature.

Keep away from strong magnetic fields: Do not use or store this device in the vicinity of equipment that generates strong electromagnetic radiation or magnetic fields. Strong static charges or the magnetic fields produced by equipment such as radio transmitters could interfere with the monitor, damage data stored on the memory card, or affect the product's internal circuitry.

Do not leave the lens pointed at the sun: Do not leave the lens pointed at the sun or other strong light source for an extended period. Intense light may cause the image sensor to deteriorate or produce a white blur effect in photographs.



Cleaning: When cleaning the camera body, use a blower to gently remove dust and lint, then wipe gently with a soft, dry cloth. After using the camera at the beach or seaside, wipe off any sand or salt using a cloth lightly dampened in pure water and then dry the camera thoroughly. In rare instances, static electricity may cause the LCD displays to light up or go dark. This does not indicate a malfunction, and the display will soon return to normal.

The lens and mirror are easily damaged. Dust and lint should be gently removed with a blower. When using an aerosol blower, keep the can vertical to prevent discharge of liquid. To remove fingerprints and other stains from the lens, apply a small amount of lens cleaner to a soft cloth and wipe the lens carefully.

See “The Low-Pass Filter” (☐ 394) for information on cleaning the low-pass filter.

Lens contacts: Keep the lens contacts clean.

Do not touch the shutter curtain: The shutter curtain is extremely thin and easily damaged. Under no circumstances should you exert pressure on the curtain, poke it with cleaning tools, or subject it to powerful air currents from a blower. These actions could scratch, deform, or tear the curtain.

The shutter curtain may appear to be unevenly colored, but this has no affect on pictures and does not indicate a malfunction.

Storage: To prevent mold or mildew, store the camera in a dry, well-ventilated area. If you are using an AC adapter, unplug the adapter to prevent fire. If the product will not be used for an extended period, remove the battery to prevent leakage and store the camera in a plastic bag containing a desiccant. Do not, however, store the camera case in a plastic bag, as this may cause the material to deteriorate. Note that desiccant gradually loses its capacity to absorb moisture and should be replaced at regular intervals.

To prevent mold or mildew, take the camera out of storage at least once a month. Turn the camera on and release the shutter a few times before putting it away.

Store the battery in a cool, dry place. Replace the terminal cover before putting the battery away.



Turn the product off before removing or disconnecting the power source: Do not unplug the product or remove the battery while the product is on or while images are being recorded or deleted. Forcibly cutting power in these circumstances could result in loss of data or in damage to product memory or internal circuitry. To prevent an accidental interruption of power, avoid carrying the product from one location to another while the AC adapter is connected.

Notes on the monitor: The monitor is constructed with extremely high precision; at least 99.99% of pixels are effective, with no more than 0.01% being missing or defective. Hence while these displays may contain pixels that are always lit (white, red, blue, or green) or always off (black), this is not a malfunction and has no effect on images recorded with the device.

Images in the monitor may be difficult to see in a bright light.

Do not apply pressure to the monitor, as this could cause damage or malfunction. Dust or lint on the monitor can be removed with a blower. Stains can be removed by wiping lightly with a soft cloth or chamois leather. Should the monitor break, care should be taken to avoid injury from broken glass and to prevent liquid crystal from the monitor touching the skin or entering the eyes and mouth.

Replace the monitor cover when transporting the camera or leaving it unattended.

Batteries: Batteries may leak or explode if improperly handled. Observe the following precautions when handling batteries:

- Use only batteries approved for use in this equipment.
- Do not expose the battery to flame or excessive heat.
- Keep the battery terminals clean.
- Turn the product off before replacing the battery.
- Remove the battery from the camera or charger when not in use and replace the terminal cover. These devices draw minute amounts of charge even when off and could draw the battery down to the point that it will no longer function. If the battery will not be used for some time, insert it in the camera and run it flat before removing it from the camera for storage. The battery should be stored in a cool location with an ambient temperature of 15 to 25 °C (59 to 77 °F; avoid hot or extremely cold locations). Repeat this process at least once every six months.



- Turning the camera on or off repeatedly when the battery is fully discharged will shorten battery life. Batteries that have been fully discharged must be charged before use.
- The internal temperature of the battery may rise while the battery is in use. Attempting to charge the battery while the internal temperature is elevated will impair battery performance, and the battery may not charge or charge only partially. Wait for the battery to cool before charging.
- Continuing to charge the battery after it is fully charged can impair battery performance.
- A marked drop in the time a fully charged battery retains its charge when used at room temperature indicates that it requires replacement. Purchase a new EN-EL15 battery.
- Charge the battery before use. When taking photographs on important occasions, ready a spare EN-EL15 battery and keep it fully charged. Depending on your location, it may be difficult to purchase replacement batteries on short notice. Note that on cold days, the capacity of batteries tends to decrease. Be sure the battery is fully charged before taking photographs outside in cold weather. Keep a spare battery in a warm place and exchange the two as necessary. Once warmed, a cold battery may recover some of its charge.
- Used batteries are a valuable resource; recycle in accord with local regulations.



Defaults

The default settings for the options in the camera menus are listed below. For information on two-button reset, see page 193.

■ Playback Menu Defaults

Option	Default
Playback folder (☞ 260)	ND800
Image review (☞ 265)	Off
After delete (☞ 266)	Show next
Rotate tall (☞ 266)	On
Slide show (☞ 267)	
Image type (☞ 267)	Still images and movies
Frame interval (☞ 267)	2 s

■ Shooting Menu Defaults ¹

Option	Default
Extended menu banks (☞ 270)	Off
File naming (☞ 273)	DSC
Primary slot selection (☞ 89)	SD card slot
Secondary slot function (☞ 89)	Overflow
Image quality (☞ 84)	JPEG normal
Image size (☞ 87)	Large
Image area (☞ 79)	
Auto DX crop (☞ 79)	On
Choose image area (☞ 80)	FX (36×24)
JPEG compression (☞ 86)	Size priority
NEF (RAW) recording (☞ 86)	
Type (☞ 86)	Lossless compressed
NEF (RAW) bit depth (☞ 86)	14-bit
White balance (☞ 145)	Auto > Normal
Fine-tuning (☞ 148)	A-B: 0, G-M: 0
Choose color temp. (☞ 152)	5000 K
Preset manual (☞ 154)	d-1



Option	Default
Set Picture Control (📖 163)	Standard
Color space (📖 274)	sRGB
Active D-Lighting (📖 174)	Off
HDR (high dynamic range) (📖 176)	
HDR mode (📖 177)	Off
Exposure differential (📖 178)	Auto
Smoothing (📖 178)	Normal
Vignette control (📖 275)	Normal
Auto distortion control (📖 276)	Off
Long exposure NR (📖 277)	Off
High ISO NR (📖 277)	Normal
ISO sensitivity settings (📖 109)	
ISO sensitivity (📖 109)	100
Auto ISO sensitivity control (📖 111)	Off
Multiple exposure (📖 195) ²	
Multiple exposure mode (📖 196)	Off
Number of shots (📖 197)	2
Auto gain (📖 198)	On
Interval timer shooting (📖 201)	Reset ³
Time-lapse photography (📖 207)	Reset ⁴
Movie settings (📖 70)	
Frame size/frame rate (📖 70)	1920 × 1080; 30 fps
Movie quality (📖 70)	High quality
Microphone (📖 70)	Auto sensitivity
Destination (📖 70)	SD card slot

- 1 Default settings can be restored using **Shooting menu bank** (📖 269). With the exception of **Extended menu banks**, **Multiple exposure**, **Interval timer shooting**, and **Time-lapse photography**, only settings in the current shooting menu bank will be reset.
- 2 Applies to all banks. Shooting menu reset is not available while shooting is in progress.
- 3 Applies to all banks. Shooting ends when reset is performed.
- 4 Applies to all banks. Interval reset to 5 s, recording time to 25 minutes.




■ Custom Settings Menu Defaults *

	Option	Default
a1	AF-C priority selection (☞ 281)	Release
a2	AF-S priority selection (☞ 282)	Focus
a3	Focus tracking with lock-on (☞ 283)	3 (Normal)
a4	AF activation (☞ 283)	Shutter/AF-ON
a5	AF point illumination (☞ 284)	Auto
a6	Focus point wrap-around (☞ 284)	No wrap
a7	Number of focus points (☞ 285)	51 points
a8	Built-in AF-assist illuminator (☞ 286)	On
b1	ISO sensitivity step value (☞ 287)	1/3 step
b2	EV steps for exposure cntrl (☞ 287)	1/3 step
b3	Exp./flash comp. step value (☞ 287)	1/3 step
b4	Easy exposure compensation (☞ 288)	Off
b5	Center-weighted area (☞ 289)	∅ 12 mm
b6	Fine-tune optimal exposure (☞ 290)	
	Matrix metering	0
	Center-weighted metering	0
	Spot metering	0
c1	Shutter-release button AE-L (☞ 290)	Off
c2	Auto meter-off delay (☞ 291)	6 s
c3	Self-timer (☞ 291)	
	Self-timer delay	10 s
	Number of shots	1
	Interval between shots	0.5 s
c4	Monitor off delay (☞ 292)	
	Playback	10 s
	Menus	1 min
	Information display	10 s
	Image review	4 s
	Live view	10 min



Option		Default
d1	Beep (☐ 292)	
	Volume	Off
	Pitch	High
d2	CL mode shooting speed (☐ 293)	2 fps
d3	Max. continuous release (☐ 293)	100
d4	Exposure delay mode (☐ 293)	Off
d5	File number sequence (☐ 294)	On
d6	Viewfinder grid display (☐ 295)	Off
d7	ISO display and adjustment (☐ 295)	Show frame count
d8	Screen tips (☐ 295)	On
d9	Information display (☐ 296)	Auto
d10	LCD illumination (☐ 296)	Off
d11	MB-D12 battery type (☐ 297)	LR6 (AA alkaline)
d12	Battery order (☐ 298)	Use MB-D12 batteries first
e1	Flash sync speed (☐ 299)	1/250 s
e2	Flash shutter speed (☐ 300)	1/60 s
e3	Flash cntrl for built-in flash/Optional flash (☐ 301, 302)	TTL
e4	Modeling flash (☐ 307)	On
e5	Auto bracketing set (☐ 307)	AE & flash
e6	Auto bracketing (Mode M) (☐ 308)	Flash/speed
e7	Bracketing order (☐ 308)	MTR > under > over
f1	☼ switch (☐ 309)	LCD backlight (☼)
f2	Multi selector center button (☐ 309)	
	Shooting mode	Select center focus point
	Playback mode	Thumbnail on/off
	Live view	Select center focus point
f3	Multi selector (☐ 310)	Do nothing
f4	Assign Fn button (☐ 311)	
	Fn button press (☐ 311)	Viewfinder virtual horizon
	Fn button + command dials (☐ 314)	None



	Option	Default
f5	Assign preview button (☞ 315)	
	Preview button press	Preview
	Preview + command dials	None
f6	Assign AE-L/AF-L button (☞ 315)	
	AE-L/AF-L button press	AE/AF lock
	AE-L/AF-L + command dials	None
f7	Shutter spd & aperture lock (☞ 316)	
	Shutter speed lock	Off
	Aperture lock	Off
f8	Assign BKT button (☞ 316)	Auto bracketing
f9	Customize command dials (☞ 317)	
	Reverse rotation (☞ 317)	Exposure compensation: <input type="checkbox"/> Shutter speed/aperture: <input type="checkbox"/>
	Change main/sub (☞ 317)	Off
	Aperture setting (☞ 317)	Sub-command dial
	Menus and playback (☞ 318)	Off
f10	Release button to use dial (☞ 318)	No
f11	Slot empty release lock (☞ 319)	Enable release
f12	Reverse indicators (☞ 319)	
f13	Assign MB-D12 AF-ON (☞ 320)	AF-ON
g1	Assign Fn button (☞ 321)	
	Fn button press	None
g2	Assign preview button (☞ 322)	
	Preview button press	Index marking
g3	Assign AE-L/AF-L button (☞ 323)	
	AE-L/AF-L button press	AE/AF lock
g4	Assign shutter button (☞ 324)	Take photos

* Defaults for the current Custom Settings bank can be restored using **Custom settings bank** (☞ 280).



■ ■ Setup Menu Defaults

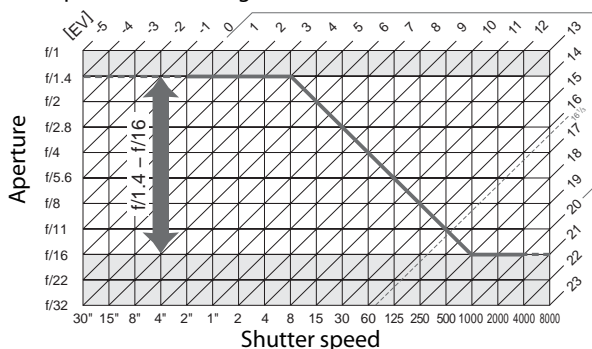
Option	Default
Monitor brightness (☞ 326)	Manual
Manual	0
Clean image sensor (☞ 394)	
Clean at startup/shutdown (☞ 396)	Clean at startup & shutdown
HDMI (☞ 256)	
Output resolution (☞ 257)	Auto
Advanced (☞ 257)	
Output range	Auto
Output display size	95%
Live view on-screen display	On
Flicker reduction (☞ 329)	Auto
Time zone and date (☞ 329)	
Daylight saving time (☞ 329)	Off
Auto image rotation (☞ 331)	On
GPS (☞ 218)	
Auto meter-off	Enable
Use GPS to set camera clock	Yes
Eye-Fi upload (☞ 339)	Enable



Exposure Program

The exposure program for programmed auto (☒ 118) is shown in the following graph:

— ISO 100; lens with maximum aperture of f/1.4 and minimum aperture of f/16 (e.g., AF 50mm f/1.4D)



The maximum and minimum values for EV vary with ISO sensitivity; the above graph assumes an ISO sensitivity of ISO 100 equivalent. When matrix metering is used, values over $16 \frac{1}{3}$ EV are reduced to $16 \frac{1}{3}$ EV.



Troubleshooting

If the camera fails to function as expected, check the list of common problems below before consulting your retailer or Nikon representative.

■ Display

Viewfinder is out of focus: Adjust viewfinder focus or use optional diopter adjustment lenses (☞ 35, 388).

Viewfinder is dark: Insert a fully-charged battery (☞ 19, 37).

Displays turn off without warning: Choose longer delays for Custom Setting c2 (**Auto meter-off delay**) or c4 (**Monitor off delay**) (☞ 291, 292).

Displays in control panel or viewfinder are unresponsive and dim: The response times and brightness of these displays vary with temperature.

If the Camera Stops Responding

In extremely rare instances, the displays may not respond as expected and the camera may stop functioning. In most cases, this phenomenon is caused by a strong external static charge. Turn the camera off, remove and replace the battery, taking care to avoid burns, and turn the camera on again, or, if you are using an AC adapter (available separately), disconnect and reconnect the adapter and turn the camera on again. If the problem persists, contact your retailer or Nikon-authorized service representative.

■ Shooting

Camera takes time to turn on: Delete files or folders.

Shutter-release disabled:

- Memory card is full (☞ 29, 38).
- **Release locked** is selected for Custom Setting f11 (**Slot empty release lock**; ☞ 319) and no memory card is inserted (☞ 29).
- CPU lens with aperture ring attached but aperture not locked at highest f-number. If **fE E** is displayed in the control panel, select **Aperture ring** for Custom Setting f9 (**Customize command dials**) > **Aperture setting** to use lens aperture ring to adjust aperture (☞ 317).
- Exposure mode **S** selected with **bM L b** selected for shutter speed (☞ 418).

Camera is slow to respond to shutter-release button: Select **Off** for Custom Setting d4 (**Exposure delay mode**; ☞ 293).

Only one shot taken each time shutter-release button is pressed in continuous release mode:

- Lower the built-in flash (☞ 107).
- Turn HDR off (☞ 176).

Photos are out of focus:

- Rotate focus-mode selector to **AF** (☞ 91).
- Camera unable to focus using autofocus: use manual focus or focus lock (☞ 98, 101).

Full range of shutter speeds not available: Flash in use. Flash sync speed can be selected using Custom Setting e1 (**Flash sync speed**); when using compatible flash units, choose **1/320 s (Auto FP)** or **1/250 s (Auto FP)** for full range of shutter speeds (☞ 299).

Focus does not lock when shutter-release button is pressed halfway: Camera is in focus mode **AF-C**: use **AE-L/AF-L** button to lock focus (☞ 98).

Can not select focus point:

- Unlock focus selector lock (☞ 96).
- Auto-area AF or face-priority AF selected for AF-area mode; choose another mode (☞ 49, 93).
- Camera is in playback mode (☞ 219).
- Menus are in use (☞ 259).
- Press shutter-release button halfway to activate exposure meters (☞ 42).

Image size can not be changed: **Image quality** set to **NEF (RAW)** (☞ 84).

Camera is slow to record photos: Turn long exposure noise reduction off (☞ 277).



AF-assist illuminator does not light:

- AF-assist lamp does not light if **AF-C** is selected for autofocus mode (□ 91). Choose **AF-S**. If an option other than auto-area AF is selected for AF-area mode, select center focus point (□ 96).
- The camera is currently in live view or a movie is being recorded.
- **Off** selected for Custom Setting a8 (**Built-in AF-assist illuminator**) (□ 286).
- Illuminator has turned off automatically. Illuminator may become hot with continued use; wait for lamp to cool down.

Flicker or banding appear during live view or movie recording: Choose an option for **Flicker reduction** that matches the frequency of the local AC power supply (□ 329).

Bright bands appear during live view or movie recording: A flash or other light source with brief duration was used during live view or movie recording.

Noise (bright spots, randomly-spaced bright pixels, fog, lines, or reddish areas) appears in photos:

- To reduce randomly-spaced bright pixels, fog, or lines, choose lower ISO sensitivity or use high ISO noise reduction (□ 109, 277).
- To reduce bright spots, randomly-spaced bright pixels, or fog at shutter speeds slower than 1 s or to reduce reddish areas and other artifacts in long time-exposures, enable long exposure noise reduction (□ 277).
- Turn **Active D-Lighting** off to avoid heightening the effects of noise (□ 175).

Photos are blotched or smeared:

- Clean lens.
- Clean low-pass filter (□ 394).

Colors are unnatural:

- Adjust white balance to match light source (□ 145).
- Adjust **Set Picture Control** settings (□ 163).

Can not measure white balance: Subject is too dark or too bright (□ 157).



Image can not be selected as source for preset white balance: Image was not created with D800 (☐ 158).

White balance bracketing unavailable:

- NEF (RAW) or NEF+JPEG image quality option selected for image quality (☐ 84).
 - Multiple exposure mode is in effect (☐ 195).
-

Effects of Picture Control differ from image to image: A (auto) is selected for sharpening, contrast, or saturation. For consistent results over a series of photographs, choose a setting other than A (auto) (☐ 167).

Metering can not be changed: Autoexposure lock or movie live view is in effect (☐ 59, 129).

Exposure compensation can not be used: Choose exposure mode P, S, or A (☐ 131).

Sound is not recorded with movies: **Microphone off** is selected for **Movie settings > Microphone** (☐ 70).

■■ Playback

NEF (RAW) image is not played back: Photo was taken at image quality of NEF + JPEG (☐ 85).

Can not view pictures recorded with other cameras: Pictures recorded with other makes of camera may not be displayed correctly.

Some photos are not displayed during playback: Select **All** for **Playback folder** (☐ 260).

“Tall” (portrait) orientation photos are displayed in “wide” (landscape) orientation:

- Select **On** for **Rotate tall** (☐ 266).
 - Photo was taken with **Off** selected for **Auto image rotation** (☐ 331).
 - Photo is displayed in image review (☐ 220).
 - Camera was pointed up or down when photo was taken (☐ 331).
-

Can not delete photo:

- Picture is protected: remove protection (☐ 233).
 - Memory card is locked (☐ 34).
-

Can not retouch picture: Picture was not created with D800 (☐ 342).

Message is displayed stating that no images are available for playback: Select **All** for **Playback folder** (☐ 260).



Can not change print order:

- Memory card is full: delete pictures (☞ 38, 234).
- Memory card is locked (☞ 34).

Can not select photo for printing: NEF (RAW) and TIFF photos can not be printed by direct USB connection. Use DPOF print service (TIFF images only), create JPEG copy using **NEF (RAW) processing** (☞ 353), or transfer to computer and print using ViewNX 2 (supplied) or Capture NX 2 (available separately; ☞ 389).

Photo is not displayed on high-definition video device: Confirm that HDMI cable (available separately) is connected (☞ 256).

Photos are not displayed in Capture NX 2: Update to latest version (☞ 389).

Image Dust Off option in Capture NX 2 does not have desired effect: Image sensor cleaning changes the position of dust on the low-pass filter. Dust off reference data recorded before image sensor cleaning is performed can not be used with photographs taken after image sensor cleaning is performed. Dust off reference data recorded after image sensor cleaning is performed can not be used with photographs taken before image sensor cleaning is performed (☞ 327).

Computer displays NEF (RAW) images differently from camera: Third-party software does not display effects of Picture Controls, Active D-Lighting, or vignette control. Use ViewNX 2 (supplied) or optional Nikon software such as Capture NX 2 (available separately).

Can not transfer photos to computer: OS not compatible with camera or transfer software. Use card reader to copy photos to computer (☞ 242).







■ Miscellaneous

Date of recording is not correct: Set camera clock (☞ 27).

Menu item can not be selected: Some options are not available at certain combinations of settings or when no memory card is inserted. Note that **Battery info** option is not available when camera is powered by an optional EP-5B power connector and EH-5b AC adapter (☞ 332).

Error Messages




This section lists the indicators and error messages that appear in the viewfinder, control panel, and monitor.

Indicator		Problem	Solution	
Control panel	Viewfinder			
FE E (blinks)		Lens aperture ring is not set to minimum aperture.	Set ring to minimum aperture (largest f-number).	25
		Low battery.	Ready a fully-charged spare battery.	19, 37
 (blinks)	 (blinks)	<ul style="list-style-type: none"> • Battery exhausted. • Battery can not be used. • An extremely exhausted rechargeable Li-ion battery or a third-party battery is inserted either in the camera or in the optional MB-D12 battery pack. 	<ul style="list-style-type: none"> • Recharge or replace battery. • Contact Nikon-authorized service representative. • Replace the battery, or recharge the battery if the rechargeable Li-ion battery is exhausted. 	xix, 19, 21, 387
 (blinks)	—	Camera clock is not set.	Set camera clock.	27
ΔF		No lens attached, or non-CPU lens attached without specifying maximum aperture. Aperture shown in stops from maximum aperture.	Aperture value will be displayed if maximum aperture is specified.	212



Indicator		Problem	Solution	📖
Control panel	View-finder			
—	▶ ◀ (blinks)	Camera unable to focus using autofocus.	Change composition or focus manually.	40, 101
(Exposure indicators and shutter speed or aperture display blink)		Subject too bright; photo will be overexposed.	• Use a lower ISO sensitivity.	109
			• Use optional ND filter.	389
			In exposure mode: S Increase shutter speed	119
			A Choose a smaller aperture (larger f-number)	120
		Subject too dark; photo will be underexposed.	• Use a higher ISO sensitivity.	109
			• Use flash.	181, 380
			In exposure mode: S Lower shutter speed	119
			A Choose a larger aperture (smaller f-number)	120
bulb (blinks)		bulb selected in exposure mode S.	Change shutter speed or select manual exposure mode.	119, 122
b55 (blinks)	b55 (blinks)	Images are being processed.	Wait until processing is complete.	—














Indicator		Problem	Solution	
Control panel	Viewfinder			
—	 (blinks)	If indicator blinks for 3s after flash fires, photo may be underexposed.	Check photo in monitor; if underexposed, adjust settings and try again.	187
Full  (blinks)	Ful (blinks)	Memory insufficient to record further photos at current settings, or camera has run out of file or folder numbers.	<ul style="list-style-type: none"> • Reduce quality or size. • Delete photographs after copying important images to computer or other device. • Insert new memory card. 	84, 87 234 29
Err (blinks)		Camera malfunction.	Release shutter. If error persists or appears frequently, consult Nikon-authorized service representative.	—


 **The CF and SD Icons**

These icons flash to show the card affected.




Indicator		Problem	Solution	📖
Monitor	Control panel			
No memory card.	(- E -)	Camera cannot detect memory card.	Turn camera off and confirm that card is correctly inserted.	29
This memory card cannot be used. Card may be damaged. Insert another card.	   (blinks)	<ul style="list-style-type: none"> • Error accessing memory card. • Unable to create new folder. 	<ul style="list-style-type: none"> • Use Nikon-approved card. • Check that contacts are clean. If card is damaged, contact retailer or Nikon representative. • Delete files or insert new memory card after copying important images to computer or other device. 	434 — 29, 234
	  (blinks)	Camera can not control Eye-Fi card.	<ul style="list-style-type: none"> • Check that Eye-Fi card firmware is up to date. • Copy files on Eye-Fi card to a computer or other device and format card, or insert new card. 	340 29, 239
Memory card is locked. Slide lock to "write" position.	  (blinks)	Memory card is locked (write protected).	Slide card write-protect switch to "write" position.	34
Not available if Eye-Fi card is locked.	   (blinks)	Eye-Fi card is locked (write protected).		



Indicator		Problem	Solution	
Monitor	Control panel			
This card is not formatted. Format the card.	[F o r] (blinks)	Memory card has not been formatted for use in camera.	Format memory card or insert new memory card.	29, 32, 326
Failed to update flash unit firmware. Flash cannot be used. Contact a Nikon-authorized service representative.	—	Firmware for flash unit mounted on camera was not updated correctly.	Contact a Nikon-authorized service representative.	—
Unable to start live view. Please wait.	—	The internal temperature of the camera is high.	Wait for the internal circuits to cool before resuming live view or movie recording.	56, 69
Folder contains no images.	—	No images on memory card or in folder(s) selected for playback.	Select folder containing images from Playback folder menu or insert memory card containing images.	29, 260
All images are hidden.	—	All photos in current folder are hidden.	No images can be played back until another folder has been selected or Hide image used to allow at least one image to be displayed.	260



Indicator		Problem	Solution	
Monitor	Control panel			
Cannot display this file.	—	File has been created or modified using a computer or different make of camera, or file is corrupt.	File can not be played back on camera.	—
Cannot select this file.	—	Selected image can not be retouched.	Images created with other devices can not be retouched.	342
Check printer.	—	Printer error.	Check printer. To resume, select Continue (if available).	248 *
Check paper.	—	Paper in printer is not of selected size.	Insert paper of correct size and select Continue .	248 *
Paper jam.	—	Paper is jammed in printer.	Clear jam and select Continue .	248 *
Out of paper.	—	Printer is out of paper.	Insert paper of selected size and select Continue .	248 *
Check ink supply.	—	Ink error.	Check ink. To resume, select Continue .	248 *
Out of ink.	—	Printer is out of ink.	Replace ink and select Continue .	248 *

* See printer manual for more information.



Specifications

■ Nikon D800/D800E Digital Camera

Type	
Type	Single-lens reflex digital camera
Lens mount	Nikon F mount (with AF coupling and AF contacts)
Effective pixels	
Effective pixels	36.3 million
Image sensor	
Image sensor	35.9 × 24.0 mm CMOS sensor (Nikon FX format)
Total pixels	36.8 million
Dust-reduction System	Image sensor cleaning, Image Dust Off reference data (requires optional Capture NX 2 software)
Storage	
Image size (pixels)	<ul style="list-style-type: none">• FX (36×24) image area 7,360 × 4,912 (L) 5,520 × 3,680 (M) 3,680 × 2,456 (S)• 1.2× (30×20) image area 6,144 × 4,080 (L) 4,608 × 3,056 (M) 3,072 × 2,040 (S)• DX (24×16) image area 4,800 × 3,200 (L) 3,600 × 2,400 (M) 2,400 × 1,600 (S)• 5 : 4 (30×24) image area 6,144 × 4,912 (L) 4,608 × 3,680 (M) 3,072 × 2,456 (S)• FX-format photographs taken in movie live view 6,720 × 3,776 (L) 5,040 × 2,832 (M) 3,360 × 1,888 (S)• DX-format photographs in movie live view 4,800 × 2,704 (L) 3,600 × 2,024 (M) 2,400 × 1,352 (S) <p>Note: Photographs taken in movie live view have an aspect ratio of 16 : 9. A DX-based format is used for photographs taken using the DX (24 × 16) 1.5× image area; an FX-based format is used for all other photographs.</p>



Storage

File format	<ul style="list-style-type: none">• NEF (RAW): 12 or 14 bit, lossless compressed, compressed, or uncompressed• TIFF (RGB)• JPEG: JPEG-Baseline compliant with fine (approx. 1 : 4), normal (approx. 1 : 8), or basic (approx. 1 : 16) compression (Size priority); Optimal quality compression available• NEF (RAW)+JPEG: Single photograph recorded in both NEF (RAW) and JPEG formats
Picture Control System	Can be selected from Standard, Neutral, Vivid, Monochrome, Portrait, Landscape; selected Picture Control can be modified; storage for custom Picture Controls
Media	SD (Secure Digital) and UHS-I compliant SDHC and SDXC memory cards; Type I CompactFlash memory cards (UDMA compliant)
Dual card slots	Either card can be used for primary or backup storage or for separate storage of NEF (RAW) and JPEG images; pictures can be copied between cards.
File system	DCF (Design Rule for Camera File System) 2.0, DPOF (Digital Print Order Format), Exif (Exchangeable Image File Format for Digital Still Cameras) 2.3, PictBridge

Viewfinder

Viewfinder	Eye-level pentaprism single-lens reflex viewfinder
Frame coverage	<ul style="list-style-type: none">• FX (36 × 24): Approx. 100% horizontal and 100% vertical• 1.2x (30 × 20): Approx. 97% horizontal and 97% vertical• DX (24 × 16): Approx. 97% horizontal and 97% vertical• 5:4 (30 × 24): Approx. 97% horizontal and 100% vertical
Magnification	Approx. $0.7 \times$ (50 mm f/1.4 lens at infinity, -1.0 m^{-1})
Eyepoint	17 mm (-1.0 m^{-1} ; from center surface of viewfinder eyepiece lens)
Diopter adjustment	-3 – $+1 \text{ m}^{-1}$
Focusing screen	Type B BriteView Clear Matte Mark VIII screen with AF area brackets and framing grid
Reflex mirror	Quick return



Viewfinder	
Depth-of-field preview	When depth-of-field preview button is pressed, lens aperture is stopped down to value selected by user (A and M modes) or by camera (P and S modes)
Lens aperture	Instant return, electronically controlled

Lens	
Compatible lenses	<p>Compatible with AF NIKKOR lenses, including type G and D lenses (some restrictions apply to PC Micro-NIKKOR lenses) and DX lenses (using DX 24 × 16 1.5× image area), AI-P NIKKOR lenses, and non-CPU AI lenses (exposure modes A and M only). IX NIKKOR lenses, lenses for the F3AF, and non-AI lenses can not be used.</p> <p>The electronic rangefinder can be used with lenses that have a maximum aperture of f/5.6 or faster (the electronic rangefinder supports the 11 focus points with lenses that have a maximum aperture of f/8 or faster).</p>

Shutter	
Type	Electronically-controlled vertical-travel focal-plane shutter
Speed	$1/8000$ – 30 s in steps of $1/3$, $1/2$, or 1 EV, bulb, X250
Flash sync speed	X= $1/250$ s; synchronizes with shutter at $1/320$ s or slower (flash range drops at speeds between $1/250$ and $1/320$ s)


Release	
Release mode	S (single frame), CL (continuous low speed), CH (continuous high speed), Q (quiet shutter-release), ☺ (self-timer), MUP (mirror up)




Release		
Approximate frame advance rate	With EN-EL15 batteries Image area: FX/5 : 4 CL: 1–4 fps CH: 4 fps Image area: DX/1.2× CL: 1–5 fps CH: 5 fps	Other power sources Image area: FX/5 : 4 CL: 1–4 fps CH: 4 fps Image area: 1.2× CL: 1–5 fps CH: 5 fps Image area: DX CL: 1–5 fps CH: 6 fps
Self-timer	2 s, 5 s, 10 s, 20 s; 1–9 exposures at intervals of 0.5, 1, 2, or 3 s	

Exposure	
Metering	TTL exposure metering using RGB sensor with approximately 91K (91,000) pixels
Metering method	<ul style="list-style-type: none"> • Matrix: 3D color matrix metering III (type G and D lenses); color matrix metering III (other CPU lenses); color matrix metering available with non-CPU lenses if user provides lens data • Center-weighted: Weight of 75% given to 12 mm circle in center of frame. Diameter of circle can be changed to 8, 15, or 20 mm, or weighting can be based on average of entire frame (non-CPU lenses use 12-mm circle or average of entire frame) • Spot: Meters 4 mm circle (about 1.5% of frame) centered on selected focus point (on center focus point when non-CPU lens is used)
Range (ISO 100, f/1.4 lens, 20 °C/68 °F)	<ul style="list-style-type: none"> • Matrix or center-weighted metering: 0–20 EV • Spot metering: 2–20 EV
Exposure meter coupling	Combined CPU and AI
Exposure mode	Programmed auto with flexible program (P); shutter-priority auto (S); aperture-priority auto (A); manual (M)
Exposure compensation	–5 – +5 EV in increments of $\frac{1}{3}$, $\frac{1}{2}$, or 1 EV
Exposure bracketing	2–9 frames in steps of $\frac{1}{3}$, $\frac{1}{2}$, $\frac{2}{3}$, or 1 EV
Flash bracketing	2–9 frames in steps of $\frac{1}{3}$, $\frac{1}{2}$, $\frac{2}{3}$, or 1 EV



Exposure	
White balance bracketing	2–9 frames in steps of 1, 2, or 3
ADL bracketing	2 frames using selected value for one frame or 3–5 frames using preset values for all frames
Exposure lock	Luminosity locked at detected value with  AE-L/AF-L button
ISO sensitivity (Recommended Exposure Index)	ISO 100 – 6400 in steps of $\frac{1}{3}$, $\frac{1}{2}$, or 1 EV. Can also be set to approx. 0.3, 0.5, 0.7, or 1 EV (ISO 50 equivalent) below ISO 100 or to approx. 0.3, 0.5, 0.7, 1, or 2 EV (ISO 25600 equivalent) above ISO 6400; auto ISO sensitivity control available
Active D-Lighting	Can be selected from Auto, Extra high, High, Normal, Low, or Off

Focus	
Autofocus	Nikon Advanced Multi-CAM 3500FX autofocus sensor module with TTL phase detection, fine-tuning, 51 focus points (including 15 cross-type sensors; f/8 supported by 11 sensors), and AF-assist illuminator (range approx. 0.5–3 m/1 ft 8 in.–9 ft 10 in.)
Detection range	–2 – +19 EV (ISO 100, 20 °C/68 °F)
Lens servo	<ul style="list-style-type: none"> • Autofocus (AF): Single-servo AF (AF-S); continuous-servo AF (AF-C); predictive focus tracking automatically activated according to subject status • Manual focus (M): Electronic rangefinder can be used
Focus point	Can be selected from 51 or 11 focus points
AF-area mode	Single-point AF, 9-, 21-, or 51- point dynamic-area AF, 3D-tracking, auto-area AF
Focus lock	Focus can be locked by pressing shutter-release button halfway (single-servo AF) or by pressing  AE-L/AF-L button



Flash	
Built-in flash	Manual pop-up with button release and a Guide Number of 12/39, 12/39 with manual flash (m/ft, ISO 100, 20 °C/68 °F)
Flash control	TTL: i-TTL flash control using RGB sensor with approximately 91K (91,000) pixels is available with built-in flash and SB-910, SB-900, SB-800, SB-700, SB-600, or SB-400; i-TTL balanced fill-flash for digital SLR is used with matrix and center-weighted metering, standard i-TTL flash for digital SLR with spot metering
Flash mode	Front curtain sync, slow sync, rear-curtain sync, red-eye reduction, red-eye reduction with slow sync, slow rear-curtain sync; Auto FP High-Speed Sync supported
Flash compensation	-3 – +1 EV in increments of $\frac{1}{3}$, $\frac{1}{2}$, or 1 EV
Flash-ready indicator	Lights when built-in flash or optional flash unit is fully charged; blinks for 3 s after flash is fired at full output
Accessory shoe	ISO 518 hot-shoe with sync and data contacts and safety lock
Nikon Creative Lighting System (CLS)	Advanced Wireless Lighting supported with built-in flash, SB-910, SB-900, SB-800, or SB-700 as a master flash and SB-600 or SB-R200 as remotes, or SU-800 as commander; built-in flash can serve as master flash in commander mode; Auto FP High-Speed Sync and modeling illumination supported with all CLS-compatible flash units except SB-400; Flash Color Information Communication and FV lock supported with all CLS-compatible flash units
Sync terminal	ISO 519 sync terminal with locking thread
White balance	
White balance	Auto (2 types), incandescent, fluorescent (7 types), direct sunlight, flash, cloudy, shade, preset manual (up to 4 values can be stored), choose color temperature (2500 K–10000 K), all with fine-tuning.



Live view	
Modes	Live view photography (still images), movie live view (movies)
Lens servo	<ul style="list-style-type: none"> • Autofocus (AF): Single-servo AF (AF-S); full-time servo AF (AF-F) • Manual focus (M)
AF-area mode	Face-priority AF, wide-area AF, normal-area AF, subject-tracking AF
Autofocus	Contrast-detect AF anywhere in frame (camera selects focus point automatically when face-priority AF or subject-tracking AF is selected)

Movie	
Metering	TTL exposure metering using main image sensor
Frame size (pixels) and frame rate	<ul style="list-style-type: none"> • 1,920 × 1,080; 30 p (progressive), 25 p, 24 p • 1,280 × 720; 60 p, 50 p, 30 p, 25 p Actual frame rates for 60 p, 50 p, 30 p, 25 p, and 24 p are 59.94, 50, 29.97, 25, and 23.976 fps respectively; options support both ★high and normal image quality
File format	MOV
Video compression	H.264/MPEG-4 Advanced Video Coding
Audio recording format	Linear PCM
Audio recording device	Built-in monaural or external stereo microphone; sensitivity adjustable
Other options	Index marking, time-lapse photography

Monitor	
Monitor	8-cm/3.2-in., approx. 921k-dot (VGA) TFT LCD with 170 ° viewing angle, approx. 100% frame coverage, and automatic monitor brightness control using ambient brightness sensor



Playback	
Playback	Full-frame and thumbnail (4, 9, or 72 images) playback with playback zoom, movie playback, photo and/or movie slide shows, highlights, histogram display, auto image rotation, and image comment (up to 36 characters)

Interface	
USB	SuperSpeed USB (USB 3.0 Micro-B connector)
HDMI output	Type C mini-pin HDMI connector; can be used simultaneously with camera monitor
Audio input	Stereo mini-pin jack (3.5 mm diameter)
Audio output	Stereo mini-pin jack (3.5 mm diameter)
Ten-pin remote terminal	Can be used to connect optional remote control, GP-1 GPS unit, or GPS device compliant with NMEA0183 version 2.01 or 3.01 (requires optional MC-35 GPS adapter cord and cable with D-sub 9-pin connector)

Supported languages	
Supported languages	Arabic, Chinese (Simplified and Traditional), Czech, Danish, Dutch, English, Finnish, French, German, Indonesian, Italian, Japanese, Korean, Norwegian, Polish, Portuguese, Romanian, Russian, Spanish, Swedish, Thai, Turkish, Ukrainian

Power source	
Battery	One rechargeable Li-ion EN-EL15 battery
Battery pack	Optional MB-D12 multi-power battery pack with one rechargeable Nikon EN-EL18 Li-ion battery (available separately), one rechargeable Nikon EN-EL15 Li-ion battery, or eight AA alkaline, Ni-MH, or lithium batteries. A BL-5 battery-chamber cover is required when using EN-EL18 batteries.
AC adapter	EH-5b AC adapter; requires EP-5B power connector (available separately)

Tripod socket	
Tripod socket	1/4 in. (ISO 1222)



Dimensions/weight	
Dimensions (W × H × D)	Approx. 146 × 123 × 81.5 mm (5.7 × 4.8 × 3.2 in.)
Weight	Approx. 1,000 g (2 lb 3.3 oz) with battery and SD memory card but without body cap; approx. 900 g/1 lb 15.7 oz (camera body only)

Operating environment	
Temperature	0–40 °C (+32–104 °F)
Humidity	Less than 85% (no condensation)

- Unless otherwise stated, all figures are for a camera with a fully-charged battery operating at an ambient temperature of 20 °C (68 °F).
- Nikon reserves the right to change the specifications of the hardware and software described in this manual at any time and without prior notice. Nikon will not be held liable for damages that may result from any mistakes that this manual may contain.



MH-25 battery charger	
Rated input (in North America)	AC 120 V, 60 Hz, 0.2 A
Rated input (in other regions)	AC 100–240 V, 50/60 Hz, 0.23–0.12 A
Rated output	DC 8.4 V/1.2 A
Supported batteries	Nikon EN-EL15 rechargeable Li-ion batteries
Charging time	Approx. 2 hours and 35 minutes at an ambient temperature of 25 °C/77 °F when no charge remains
Operating temperature	0–40 °C (+32–104 °F)
Dimensions (W × H × D)	Approx. 91.5 × 33.5 × 71 mm/3.6 × 1.3 × 2.8 in., excluding projections
Length of cord	Approx. 1.8 m/6 ft (U.S.A. and Canada) or 1.5 m/4.9 ft (other countries)
Weight	Approx. 110 g/3.9 oz, excluding power cable and AC wall adapter

EN-EL15 rechargeable Li-ion battery	
Type	Rechargeable lithium-ion battery
Rated capacity	7.0 V, 1,900 mAh
Operating temperature	0–40 °C (+32–104 °F)
Dimensions (W × H × D)	Approx. 40 × 56 × 20.5 mm/1.6 × 2.2 × 0.8 in.
Weight	Approx. 88 g/3.1 oz, excluding terminal cover



Supported Standards

- **DCF Version 2.0:** The Design Rule for Camera File System (DCF) is a standard widely used in the digital camera industry to ensure compatibility among different makes of camera.
- **DPOF:** Digital Print Order Format (DPOF) is an industry-wide standard that allows pictures to be printed from print orders stored on the memory card.
- **Exif version 2.3:** The camera supports Exif (Exchangeable Image File Format for Digital Still Cameras) version 2.3, a standard in which information stored with photographs is used for optimal color reproduction when the images are output on Exif-compliant printers.
- **PictBridge:** A standard developed through cooperation with the digital camera and printer industries, allowing photographs to be output directly to a printer without first transferring them to a computer.
- **HDMI:** High-Definition Multimedia Interface is a standard for multimedia interfaces used in consumer electronics and AV devices capable of transmitting audiovisual data and control signals to HDMI-compliant devices via a single cable connection.

Trademark Information

Macintosh, Mac OS, and QuickTime are registered trademarks of Apple Inc. in the United States and/or other countries. Microsoft, Windows and Windows Vista are either registered trademarks, or trademarks of Microsoft Corporation in the United States and/or other countries. The SD, SDHC, and SDXC logos are trademarks of the SD-3C, LLC. CompactFlash is a trademark of SanDisk Corporation. HDMI, the **HDMI** logo and High-Definition Multimedia Interface are trademarks or registered trademarks of HDMI Licensing LLC. PictBridge is a trademark. All other trade names mentioned in this manual or the other documentation provided with your Nikon product are trademarks or registered trademarks of their respective holders.



Approved Memory Cards

The camera accepts the SD and CompactFlash memory cards listed in the following sections. Other cards have not been tested. For more details on the cards listed below, please contact the manufacturer.

■ SD Memory Cards

The following cards have been tested and approved for use in the camera. Cards with class 6 or faster write speeds are recommended for movie recording. Recording may end unexpectedly when cards with slower write speeds are used.

	SD cards	SDHC cards ²	SDXC cards ³
SanDisk	2 GB ¹	4 GB, 8 GB, 16 GB, 32 GB	64 GB
Toshiba			
Panasonic		4 GB, 6 GB, 8 GB, 12 GB, 16 GB, 24 GB, 32 GB	48 GB, 64 GB
Lexar Media		4 GB, 8 GB, 16 GB	—
Platinum II		4 GB, 8 GB, 16 GB, 32 GB	
Professional			
Full-HD Video	—	4 GB, 8 GB, 16 GB	

1 Check that any card readers or other devices with which the card will be used support 2 GB cards.

2 Check that any card readers or other devices with which the card will be used are SDHC-compliant. The camera supports UHS-1.

3 Check that any card readers or other devices with which the card will be used are SDXC-compliant. The camera supports UHS-1.



■ ■ CompactFlash Memory Cards

The following Type I CompactFlash memory cards have been tested and approved for use in the camera. Type II cards and microdrives can not be used.

SanDisk	Extreme Pro	SDCFXP	16 GB, 32 GB, 64 GB, 128 GB
	Extreme	SDCFX	8 GB, 16 GB, 32 GB
	Extreme IV	SDCFX4	2 GB, 4 GB, 8 GB, 16 GB
	Extreme III	SDCFX3	2 GB, 4 GB, 8 GB, 16 GB
	Ultra II	SDCFH	2 GB, 4 GB, 8 GB
	Standard	SDCFB	2 GB, 4 GB
Lexar Media	Professional UDMA	600 ×	8 GB, 16 GB, 32 GB
		400 ×	8 GB, 16 GB, 32 GB
		300 ×	2 GB, 4 GB, 8 GB, 16 GB
	Professional	233 ×	2 GB, 4 GB, 8 GB
		133 ×	2 GB, 4 GB, 8 GB
		80 ×	2 GB, 4 GB
	Platinum II	80 ×	2 GB, 4 GB, 8 GB, 16 GB
		60 ×	4 GB



Memory Card Capacity

The following table shows the approximate number of pictures that can be stored on an 8 GB Toshiba R95 W80MB/s UHS-I SDHC card at different image quality (☐ 84), image size (☐ 87), and image area settings (☐ 79).

■ FX (36×24) Image Area *

Image quality	Image size	File size ¹	No. of images ¹	Buffer capacity ²
NEF (RAW), Lossless compressed, 12-bit	—	32.4 MB	133	21
NEF (RAW), Lossless compressed, 14-bit	—	41.3 MB	103	17
NEF (RAW), Compressed, 12-bit	—	29.0 MB	182	25
NEF (RAW), Compressed, 14-bit	—	35.9 MB	151	20
NEF (RAW), Uncompressed, 12-bit	—	57.0 MB	133	18
NEF (RAW), Uncompressed, 14-bit	—	74.4 MB	103	16
TIFF (RGB)	L	108.2 MB	71	16
	M	61.5 MB	126	18
	S	28.0 MB	277	26
JPEG fine ³	L	16.3 MB	360	56
	M	10.4 MB	616	100
	S	5.2 MB	1200	100
JPEG normal ³	L	9.1 MB	718	100
	M	5.3 MB	1200	100
	S	2.6 MB	2400	100
JPEG basic ³	L	4.0 MB	1400	100
	M	2.7 MB	2400	100
	S	1.4 MB	4800	100

* Includes images taken with non-DX lenses when **On** is selected for **Auto DX crop**.

■ ■ DX (24×16) Image Area *

Image quality	Image size	File size ¹	No. of images ¹	Buffer capacity ²
NEF (RAW), Lossless compressed, 12-bit	—	14.9 MB	303	38
NEF (RAW), Lossless compressed, 14-bit	—	18.6 MB	236	29
NEF (RAW), Compressed, 12-bit	—	13.2 MB	411	54
NEF (RAW), Compressed, 14-bit	—	16.2 MB	343	41
NEF (RAW), Uncompressed, 12-bit	—	25.0 MB	303	30
NEF (RAW), Uncompressed, 14-bit	—	32.5 MB	236	25
TIFF (RGB)	L	46.6 MB	165	21
	M	26.8 MB	289	26
	S	12.5 MB	616	41
JPEG fine ³	L	8.0 MB	796	100
	M	5.1 MB	1200	100
	S	2.7 MB	2300	100
JPEG normal ³	L	4.1 MB	1500	100
	M	2.6 MB	2500	100
	S	1.4 MB	4600	100
JPEG basic ³	L	2.0 MB	3000	100
	M	1.3 MB	5000	100
	S	0.7 MB	8900	100

* Includes images taken with DX lenses when **On** is selected for **Auto DX crop**.



- 1 All figures are approximate. File size varies with scene recorded.
- 2 Maximum number of exposures that can be stored in memory buffer at ISO 100. Drops if **Optimal quality** is selected for **JPEG compression**, ISO sensitivity is set to Hi 0.3 or higher, **High ISO NR** is on when auto ISO sensitivity control is on or ISO sensitivity is set to ISO 1600 or higher, or long exposure noise reduction, Active D-Lighting, or auto distortion control is on.
- 3 Figures assume **JPEG compression** is set to **Size priority**. Selecting **Optimal quality** increases the file size of JPEG images; number of images and buffer capacity drop accordingly.

 **d3—Max. Continuous Release (📖 293)**

The maximum number of photographs that can be taken in a single burst can be set to any amount between 1 and 100.

Battery Life

The number of shots that can be taken with fully-charged batteries varies with the condition of the battery, temperature, and how the camera is used. In the case of AA batteries, capacity also varies with make and storage conditions; some batteries can not be used. Sample figures for the camera and optional MB-D12 multi-power battery pack are given below.

- **CIPA standard**¹

- One EN-EL15 battery (camera):** Approximately 900 shots

- One EN-EL15 battery (MB-D12):** Approximately 900 shots

- One EN-EL18 battery (MB-D12):** Approximately 1,400 shots

- Eight AA alkaline batteries (MB-D12):** Approximately 1,000 shots

- **Nikon standard**²

- One EN-EL15 battery (camera):** Approximately 2,400 shots

- One EN-EL15 battery (MB-D12):** Approximately 2,400 shots

- One EN-EL18 battery (MB-D12):** Approximately 3,800 shots

- Eight AA alkaline batteries (MB-D12):** Approximately 2,400 shots

1 Measured at 23 °C/73.4 °F (±2 °C/3.6 °F) with an AF-S NIKKOR 24-120mm f/4G ED VR lens under the following test conditions: lens cycled from infinity to minimum range and one photograph taken at default settings once every 30 s; flash fired once every other shot. Live view not used.

2 Measured at 20 °C/68 °F with an AF-S NIKKOR 70-200mm f/2.8G ED VR II lens under the following test conditions: vibration reduction off, image quality set to JPEG normal, image size set to **L** (large), shutter speed 1/250 s, shutter-release button pressed halfway for three seconds and focus cycled from infinity to minimum range three times; six shots are then taken in succession and monitor turned on for five seconds and then turned off; cycle repeated once exposure meters have turned off.



The following can reduce battery life:

- Using the monitor
- Keeping the shutter-release button pressed halfway
- Repeated autofocus operations
- Taking NEF (RAW) or TIFF (RGB) photographs
- Slow shutter speeds
- Using an optional WT-4 wireless transmitter
- Using the optional GP-1 GPS unit
- Using VR (vibration reduction) mode with VR lenses
















To ensure that you get the most from rechargeable Nikon EN-EL15 batteries:

- Keep the battery contacts clean. Soiled contacts can reduce battery performance.
- Use batteries immediately after charging. Batteries will lose their charge if left unused.



Index

Symbols

P (Programmed auto)	118
S (Shutter-priority auto)	119
R (Aperture-priority auto)	120
M (Manual).....	122
S	103
CL	103, 293
CH	103
Q	103
☺ (Self-timer).....	103, 106
MUP	104, 108
[] (Single-point AF)	93
[] (Dynamic-area AF)	93
[] (Auto-area AF)	94
[] (Face-priority AF)	49
[] (Wide-area AF)	49
[] (Normal-area AF)	49
[] (Subject-tracking AF)	49
[] (Matrix)	115
[] (Center-weighted)	115, 289
[] (Spot).....	115
Fn button	311, 321
[] (Info) button.....	10, 13
[] (Live view) button	45, 59
? (Help)	15, 18
[] (Memory buffer)	40, 105
[] switch	4, 309
[] (Focus indicator).....	40, 98, 102
PRE (Preset manual)	146, 154

Numerics

1.2x (30x20) 1.2x	80
12-bit	86
14-bit	86
3D color matrix metering III	115
3D-tracking	94, 95
5 : 4 (30 x 24).....	80

A

AC adapter	387, 391
Accessories	387

Accessory shoe	380
Active D-Lighting.....	141, 174
Add items (My Menu).....	367
ADL bracketing.....	141, 307
Adobe RGB (Color space)	274
AE & flash (Auto bracketing set)	132, 307
AE only (Auto bracketing set)	132, 307
AE-L/AF-L button	98, 315, 323
AF	48–50, 91–100, 281–286
AF activation.....	283
AF area brackets.....	8, 35
AF fine-tune	338
AF-area mode.....	49, 93
AF-assist	286, 377, 385
AF-C	91, 281
AF-F	48
AF-mode button	48, 50, 92, 94
AF-ON button	92, 283
AF-S.....	48, 91, 282
After delete	266
A-M switch	25
Ambient brightness sensor.....	5, 326
Angle of view	79, 378–379
Aperture.....	120–122, 126
Aperture lock.....	126
Aperture-priority auto	120
Approved memory cards	434
Aspect ratio.....	67, 79, 346
Assign MB-D12 AF-ON	320
Attaching the lens	24
Auto (White balance)	145
Auto bracketing	132, 307, 308
Auto bracketing (Mode M)	308
Auto bracketing set.....	307
Auto distortion control.....	276
Auto DX crop.....	79, 82
Auto FP high-speed sync.	299, 300
Auto image rotation	331
Auto ISO sensitivity control.....	111
Auto meter off.....	42, 218, 291

Auto-area AF 94, 95
Autofocus..... 48–50, 91–100, 281–286
Autofocus mode 48, 91

B

Backlight..... 4, 296
Backup..... 89
Battery 19, 21, 37, 297, 298, 332, 387
Battery charger 19, 387, 432
Battery info 332
Battery order..... 298
Battery pack 104, 297, 298, 320, 387
Beep 292
Bit depth for NEF (RAW) images 86
BKT button 133, 137, 141, 180, 197, 316
Black-and-white (Monochrome).... 347
Blue intensifier 348
Body cap..... 1, 24, 389
Border..... 250
Bracketing 132, 307, 308
Bracketing order 308
Brightness 166
Built-in AF-assist Illuminator 286
Built-in flash 181, 375
Bulb 122, 124
Burst..... 293, 312

C

Camera Control Pro 2..... 246, 389
Capture NX 2..... 85, 327, 389
Center-weighted metering..... 115, 289
Charging the battery 19–20
Choose color temp. (White balance).... 146, 152
Choose image area 80, 82
Choose start/end point..... 74
CL mode shooting speed 293
Clean image sensor 394
Clock 27, 329
Clock battery..... 28
Cloudy (White balance) 145
CLS 381
Color balance..... 349
Color outline 359

Color sketch 359
Color space..... 274
Color temperature 146, 147, 152
Commander mode 301, 303
CompactFlash 29, 326, 434
Compatible lenses 371
Compressed (Type) 86
Computer..... 239
Continuous high speed 103
Continuous low speed 103, 293
Continuous release mode..... 103
Continuous-servo AF 91, 281
Contrast..... 166
Control panel..... 6–7
Coordinated Universal Time (UTC) . 27, 217
Copy image(s) 262
Copyright information 228, 334
CPU contacts 373
CPU lens 25, 371
Creative Lighting System 381
Cropping (PictBridge [Setup] menu) 250
Cross screen 348
Custom setting bank 280
Custom Settings 278
Customize command dials 317
Cyanotype (Monochrome) 347

D

Date and time..... 27, 329
Date format 28, 329
Daylight saving time..... 27, 329
DCF 274, 433
Default settings 193, 405
Delete..... 44, 234
Delete all images..... 236
Delete current image..... 44, 234
Deleting selected photographs..... 236
Depth-of-field 117, 120
Depth-of-field preview button 63, 117, 315, 322
Destination (Movie settings)..... 70



Digital Print Order Format (DPOF) 251, 254, 433	Fine-tune optimal exposure	290
Dioper..... 35, 388	Firmware version	340
Direct sunlight (White balance)..... 145	Fisheye.....	358
Distortion control..... 358	Flash..... 181, 188, 190, 380, 381	
D-Lighting..... 344	Flash (White balance).....	145
DPOF..... 251, 254, 433	Flash bracketing.....	132, 307, 308
DPOF print order..... 254	Flash cntrl for built-in flash.....	301
Dust off ref photo..... 327	Flash compensation.....	188
DX (24 × 16) 1.5 ×..... 67, 80	Flash mode.....	183
DX format..... 80	Flash only (Auto bracketing set)....	132, 307
DX-based (movie) format..... 68	Flash pop-up button	181
Dynamic-area AF..... 93, 95	Flash range.....	187
E	Flash shutter speed.....	184, 300
Easy exposure compensation..... 288	Flash sync speed	299, 300, 413
Edit movie..... 74, 341	Flash sync terminal.....	380
Electronic rangefinder..... 102	Flash-ready indicator. 9, 181, 191, 305, 384, 428	
Ethernet..... 245, 387	Flexible program.....	118
EV steps for exposure cntrl..... 287	Flicker reduction	329
Exif..... 274, 433	Fluorescent (White balance).....	145
Exp./flash comp. step value..... 287	f-number.....	121, 374
Exposure..... 115, 117, 128, 130, 132	Focal length	212, 378–379
Exposure bracketing..... 132, 307, 308	Focal length scale	24
Exposure compensation..... 130	Focal length scale index.....	24
Exposure delay mode..... 293	Focal plane mark.....	102
Exposure differential..... 178	Focus.....	91–102
Exposure indicator..... 123	Focus indicator	40, 98, 102
Exposure lock	Focus lock.....	98
Exposure meters..... 42, 291	Focus mode	48, 91, 281, 282
Exposure mode..... 117	Focus mode switch	24, 25
Exposure program..... 411	Focus point	49, 93, 96, 285
Extended menu banks	Focus point wrap-around	284
External microphone	Focus tracking.....	92, 283
Eye-Fi upload..... 339	Focus tracking with lock-on.....	283
F	Focusing screen.....	424
Face-priority AF	Focus-mode selector	48, 91, 101
File information	Format	32, 326
File naming..... 273	Format memory card.....	326
File number sequence..... 294	Frame interval (Slide show).....	267
Filter effects..... 348	Frame rate	70, 104, 210
Filter effects (Set Picture Control). 166, 167	Framing grid	8, 295
	Front-curtain sync	183
	Full-frame playback.....	219



Full-time servo AF	48
FV lock	190
FX (36 × 24) 1.0 ×	80
FX format	67, 80
FX-based (movie) format	67, 68

G

GPS	215, 229
GPS data	229
GPS unit	215
Green intensifier	348

H

H.264	429
HDMI	256, 433
HDMI mini-pin connector	3, 256
Headphones	65
Help	15, 18
Hi	110
Hide image	260
High definition	256, 433
High Dynamic Range (HDR)	176
High ISO NR	277
Highlights	224
Histogram	225, 226, 310
Hue	166

I

Image area	25, 67, 68, 79, 82, 87
Image comment	333
Image Dust Off ref photo	327
Image overlay	350
Image quality	84
Image review	211, 220, 265
Image size	87
Incandescent (White balance)	145
Index	63, 73
Index print	251
In-focus indicator	40, 98, 102
Information	222, 261
Information display	10, 295, 296
Interval timer shooting	201
ISO display and adjustment	295
ISO sensitivity	109, 111
ISO sensitivity step value	287

i-TTL	181, 185, 382
-------------	---------------

J

JPEG	84
JPEG basic	84
JPEG compression	86
JPEG fine	84
JPEG normal	84

L

L (large)	68, 87
LAN	387
Landscape	163
Language	26, 330
LCD	4, 296, 326
LCD brightness	326
LCD illumination	296
Lens	24–25, 212, 338, 371
Lens cap	24
Lens distance information	185
Lens focus ring	24, 55, 101
Lens mount	4, 25
Live view	45–57, 59–69
Live view photography	45
Live view selector	45, 59
Lo	110
Lock mirror up for cleaning	398
Long exposure NR	277
Lossless compressed (Type)	86

M

M (Manual focus)	101
M (medium)	68, 87
Magnifying eyepiece	388
Manage Picture Control	169
Manual (Exposure mode)	122
Manual flash	301
Manual focus	55, 101
Matrix	115
Max. continuous release	293
Maximum aperture	102, 212
Maximum sensitivity	112
MB-D12	297, 298
Memory buffer	40, 105
Memory card	29, 32, 326, 434



Memory card capacity.....	436
Metering.....	115
Microphone.....	3, 65, 70
Miniature effect.....	361
Minimum aperture.....	25, 117
Minimum shutter speed.....	112
Mired.....	150
Mirror.....	108, 398
Mirror up.....	108, 398
Mirror up mode.....	104, 108
Modeling flash.....	117, 301, 307
Monitor.....	10, 43, 45, 219, 326
Monitor cover.....	14
Monitor off delay.....	292
Monitor pre-flash.....	185, 301
Monochrome.....	347
Monochrome (Set Picture Control).....	163
Mounting index.....	3, 25
Movie live view.....	59, 321–324
Movie settings.....	70
Movie-record button.....	61
Movies.....	59
Multi selector.....	16, 310
Multiple exposure.....	195
Multi-selector center button.....	309
My Menu.....	366

N

NEF.....	84, 85, 86
NEF (RAW).....	84, 85, 86, 353
NEF (RAW) bit depth.....	86
NEF (RAW) processing.....	353
NEF (RAW) recording.....	86
Neutral (Set Picture Control).....	163
Nikon Transfer 2.....	239
No. of copies (PictBridge [Setup] menu).....	249
Noise reduction.....	277
Non-CPU lens.....	212, 371
Normal-area AF.....	49
Number of focus points.....	285

O

Optimal quality (JPEG compression).....	86
---	----

Optional flash.....	380
Overflow.....	89
Overview data.....	230

P

Page size.....	249
Perspective control.....	360
Photo info.....	222, 261
PictBridge.....	247, 433
Picture Control Utility.....	172
Picture Controls.....	163
Picture size.....	378
Playback.....	43, 219
Playback display options.....	261
Playback folder.....	260
Playback information.....	222, 261
Playback menu.....	259
Playback zoom.....	231
Portrait.....	163
Power connector.....	387, 391
Predictive focus tracking.....	92
Preset manual (White balance).....	146, 154
Press the shutter-release button halfway.....	41, 128
Preview button.....	63, 117, 315, 322
Primary slot.....	38, 89
Print (DPOF).....	251
Print options (PictBridge [Setup] menu).....	249
Print select.....	251
Printing.....	247
Programmed auto.....	118
Protecting photographs.....	233

Q

Quick adjust.....	166
Quick retouch.....	357

R

Rank items (My Menu).....	369
Rear-curtain sync.....	183
Recent settings.....	370
Red intensifier.....	348
Red-eye correction.....	345



Red-eye reduction 183
Release button to use dial..... 318
Release mode 103
Remote cord..... 124, 390
Remove items (My Menu) 368
Removing the lens from the camera 25
Repeating flash 301
Reset 193
Resize 355
Restoring default settings..... 193, 405
Retouch menu..... 341
Reverse indicators..... 319
RGB 84, 225, 274
RGB Histogram 225
Rotate tall..... 266

S

S (small) 68, 87
Saturation 166
Save selected frame 74, 77
Save/load settings..... 335
Screen tips 295
SD memory card..... 30, 326, 434
Secondary slot function..... 89
Selective color 362
Self-timer 103, 106, 291
Sensitivity..... 109, 111
Sepia (Monochrome) 347
Set Picture Control 163
Setup menu 325
Shade (White balance) 145
Sharpening 166
Shooting data 227
Shooting menu 268
Shooting menu bank..... 269
Shutter speed 119, 122, 126
Shutter speed lock 126
Shutter-priority auto 119
Shutter-release button 40, 41, 98, 128,
290, 324
Shutter-release button AE-L..... 290
Side-by-side comparison..... 364
Single frame 103
Single-point AF 93, 95

Single-servo AF..... 48, 91, 282
Size 68, 87, 346
Size priority (JPEG compression)..... 86
Skylight..... 348
Slide show 267
Slot 29
Slot empty release lock..... 318
Slot selection 159, 221, 342
Slow sync 183
Smoothing..... 178
Soft..... 348
Speedlights 181, 380
Spot..... 115
sRGB (Color space) 274
Standard (Set Picture Control) 163
Standard i-TTL flash for digital SLR185,
382
Start printing 250, 253
Storage folder..... 271
Straighten 357

T

Television 256
Ten-pin remote terminal 3, 215, 390
Thumbnail 219, 310
TIFF (RGB)..... 84
Time 27, 329
Time stamp (PictBridge) 250
Time zone 27, 329
Time zone and date 27, 329
Time-lapse photography 207
Timer..... 106, 201
Toning (Set Picture Control)... 166, 168
Transfer photographs..... 243
Trim 346
Tripod..... 49, 106, 124
Two-button reset 193
Type D lens 371, 373
Type G lens..... 371, 373

U

Uncompressed (Type) 86
USB..... 243, 248
USB cable 1, 243, 248

USB cable clip	1, 243
Use GPS to set camera clock	218
UTC	27, 217, 229

V

Vibration reduction mode switch	24
Viewfinder.....	8, 35, 424
Viewfinder eyepiece.....	36, 106, 203
Viewfinder focus.....	35, 388
Viewing photographs on TV	256
ViewNX 2	85, 239, 274, 331, 334
Vignette control.....	275
Virtual horizon.....	54, 66, 313, 337
Vivid (Set Picture Control)	163

W

Warm filter	348
WB.....	137, 145
WB bracketing (Auto bracketing set)....	137, 307
White balance.....	137, 145
White balance bracketing	137
Wide-area AF	49
Wireless.....	245, 387
Wireless network.....	245, 387
Wireless transmitter	245, 387



Nikon

No reproduction in any form of this manual, in whole or in part (except for brief quotation in critical articles or reviews), may be made without written authorization from NIKON CORPORATION.



NIKON CORPORATION

Printed in Thailand