

**Nikon**

**N70**



INSTRUCTION MANUAL



# CONTENTS

<b>FOREWORD</b> .....	4	<b>EXPOSURE MODE</b> .....	46-60
<b>NOMENCLATURE</b> .....	5-11	SELECTING EXPOSURE MODE .....	46-49
<b>BASIC OPERATION</b> .....	12-25	SETTING EXPOSURE MODE .....	50
<b>MOUNTING LENS</b> .....	13	FLEXIBLE PROGRAM .....	51
<b>INSTALLING BATTERIES</b> .....	14	OPERATION IN SHUTTER-PRIORITY AUTO	
<b>CHECKING BATTERY POWER</b> .....	15	EXPOSURE MODE .....	52-54
<b>LOADING FILM</b> .....	16-18	OPERATION IN APERTURE-PRIORITY AUTO	
<b>BASIC SHOOTING</b> .....	19-24	EXPOSURE MODE .....	55-57
<b>REWINDING FILM</b> .....	24-25	OPERATION IN MANUAL EXPOSURE MODE .....	58-60
<b>GENERAL FUNCTIONS</b> .....	26-71	<b>USING VARI-PROGRAM</b> .....	61-67
<b>FILM SPEED SETTING MODE</b> .....	27	WHAT IS VARI-PROGRAM? .....	61
<b>FILM ADVANCE MODE</b> .....	28	SETTING VARI-PROGRAM .....	62-63
SINGLE-FRAME SHOOTING .....	28	VARI-PROGRAM SELECTION GUIDE .....	64-67
CONTINUOUS SHOOTING .....	28	<b>FLASH SYNC MODE</b> .....	68-69
<b>FOCUS AREA</b> .....	29-30	<b>QR (QUICK RECALL) FUNCTION</b> .....	70-71
<b>FOCUS MODE</b> .....	31-42	<b>SPECIAL FUNCTIONS</b> .....	72-84
AUTOFOCUS .....	31-36	<b>EXPOSURE COMPENSATION</b> .....	73-81
AUTOFOCUS WITH MAIN SUBJECT OFF CENTER .....	36-37	AUTO EXPOSURE LOCK FUNCTION	
SPECIAL FOCUSING SITUATIONS .....	38-39	WITH AE-L BUTTON .....	74-75
MANUAL FOCUS .....	40-42	TO OBTAIN METER READING FOR A PARTICULAR	
<b>EXPOSURE METERING SYSTEM</b> .....	43-45	SUBJECT IN MANUAL EXPOSURE MODE .....	76-77
SELECTING METERING SYSTEM .....	43-44	EXPOSURE COMPENSATION FUNCTION .....	78-79
SETTING METERING SYSTEM .....	45	ALL MODE EXPOSURE BRACKETING .....	80-82

SELF-TIMER OPERATION .....	83	EV CHARTS FOR FLASH PHOTOGRAPHY .....	102
LONG TIME EXPOSURE—Using <i>bulb</i> setting .....	84	<b>MISCELLANEOUS</b> .....	103-127
<b>FLASH PHOTOGRAPHY</b> .....	85-102	LENSES .....	104-106
<b>USING BUILT-IN FLASH</b> .....	86-96	ACCESSORY COMPATIBILITY .....	107
AUTOMATIC BALANCED FILL-FLASH WITH TTL MULTI SENSOR—3D MULTI-SENSOR BALANCED FILL-FLASH AND MULTI-SENSOR BALANCED FILL-FLASH .....	86	CAMERA CARE TIPS .....	108-110
CENTER-WEIGHTED/SPOT FILL-FLASH .....	87	NOTES ON BATTERIES .....	111
BUILT-IN FLASH OPERATION .....	88-89	SPECIFICATIONS .....	112-115
FLASH SHOOTING DISTANCE RANGE .....	90	LCD PANEL/VIEWFINDER INDICATIONS .....	116-121
SHUTTER SPEED/APERTURE FOR EACH EXPOSURE MODE .....	91	<b>GLOSSARY</b> .....	122-127
FLASH OUTPUT LEVEL COMPENSATION—TO MAKE FLASH-ILLUMINATED SUBJECT BRIGHTER OR DARKER .....	92-93		
FLASH EXPOSURE BRACKETING .....	94-95		
USABLE LENSES WITH BUILT-IN FLASH .....	96		
<b>USING ACCESSORY NIKON SPEEDLIGHTS</b> .....	97-102		
SPEEDLIGHT COMPATIBILITY .....	97		
TYPE OF TTL AUTO FLASH .....	98-99		
WHAT YOU CAN DO WITH NIKON SPEEDLIGHTS .....	100		
NOTES ON FLASH PHOTOGRAPHY .....	101		

# FOREWORD

Thank you for purchasing the new Nikon N70 camera.

Although the N70 offers many exciting features, it is easy to operate. The N70's Command Control Input System enables you to set camera function and shooting mode by just pressing buttons that are color-coordinated with their corresponding images in the large LCD.

With the built-in flash, which offers many advanced functions including 3D Multi-Sensor Balanced Fill-Flash, you will enjoy advanced flash photography and make better flash pictures than ever before.

Get to know your N70, but before using it, be sure to read this manual thoroughly; then turn your vision into reality with the N70 camera.

# **NOMENCLATURE**

Once you know the names of the parts of your new Nikon N70, as well as their functions and the camera's other controls, you will be surprised how simple and logical the N70's operation can be.

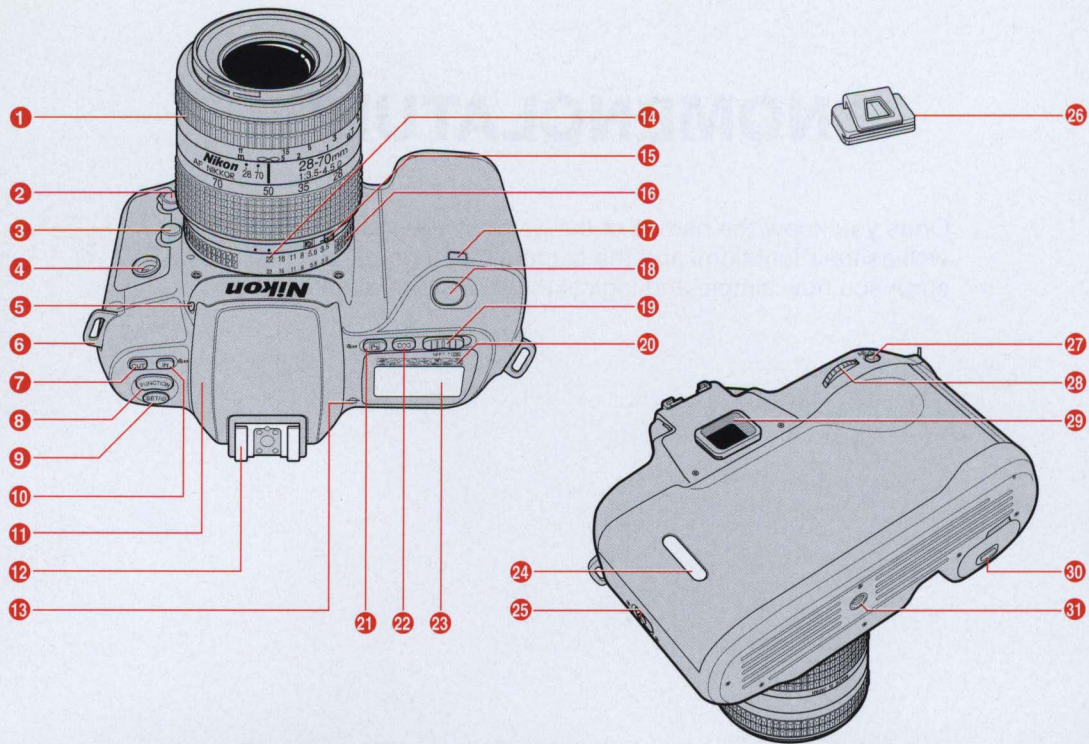

- ① **Focusing ring:** Used for manual focus (pp. 40-42)
- ② **Focus mode selector: AF** for Autofocus (pp. 31-37); **M** for Manual focus (pp. 40-42)
- ③ **Lens release button**
- ④ **Remote terminal:** For optional Nikon Remote Cord MC-12B
- ⑤ **Flash lock-release button**
- ⑥ **Camera strap eyelet**
- ⑦ **QR call (OUT) button**
- ⑧ **Function button (FUNCTION button)\***
- ⑨ **Function set\*/self-timer button (SET/⏻ button)\***
- ⑩ **QR set (IN)/film rewind button** (p. 20 and pp.70-71 for Quick Recall function)
- ⑪ **Built-in flash** (pp. 86-96)
- ⑫ **Accessory shoe:** For Nikon dedicated Speedlights.
- ⑬ **Film plane indicator:** Exact distance from lens mounting flange to film plane is 46.5mm
- ⑭ **Aperture scale**
- ⑮ **Minimum aperture lock:** Lock for Programmed Auto or Shutter-Priority Auto
- ⑯ **Aperture ring**
- ⑰ **Self-timer indicator LED** (p. 83)
- ⑱ **Shutter release button**
- ⑲ **Power switch**
- ⑳ **Vari-Program symbols**
- ㉑ **Vari-Program (Ps)/film rewind button** (pp. 62-67 for Vari-Program)
- ㉒ **Focus area button** (pp. 29-30)
- ㉓ **LCD panel** (p. 8)
- ㉔ **Film cartridge confirmation window**
- ㉕ **Camera back lock release**
- ㉖ **Eyepiece cover (provided):** Prevents stray light from entering viewfinder.
- ㉗ **AE-L (auto exposure lock) button** (pp. 74-75)
- ㉘ **Command input control dial (command dial)\***
- ㉙ **Viewfinder eyepiece**
- ㉚ **Battery chamber cover lock release**
- ㉛ **Tripod socket**

\* Used for N70's Command Control Input System. See pages 10 to 11.

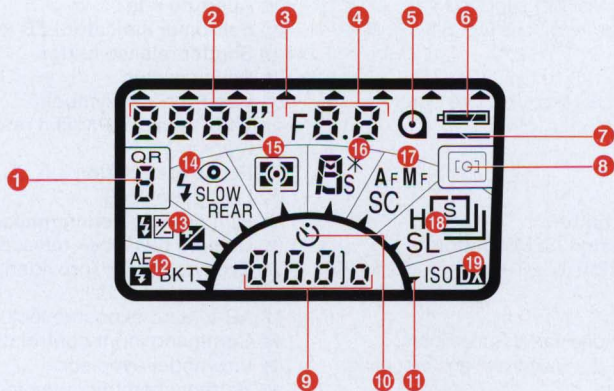

### LCD panel indications

- |  |  |
|--|--|
| ① Quick Recall function  | ⑪ Function Area indicator                                |
| ② Shutter speed  | ⑫ Auto Exposure Bracketing/Flash Exposure Bracketing*    |
| ③ Vari-Program set indicator   | ⑬ Exposure compensation/Flash Output Level Compensation* |
| ④ Aperture   | ⑭ Flash sync mode*                                       |
| ⑤ Film loading   | ⑮ Metering system*                                       |
| ⑥ Battery  | ⑯ Exposure mode*/Flexible Program                        |
| ⑦ Film advance/rewind  | ⑰ Focus mode*  |
| ⑧ Focus area   | ⑱ Film advance mode*                                     |
| ⑨ Frame counter/ISO speed/self-timer duration/<br>compensation value | ⑲ Film speed setting mode*                               |
| ⑩ Self-timer   |  |

\* These symbols displayed in each Area in the Function Zone, are selected with Nikon Command Input Control System. See pages 10 to 11.



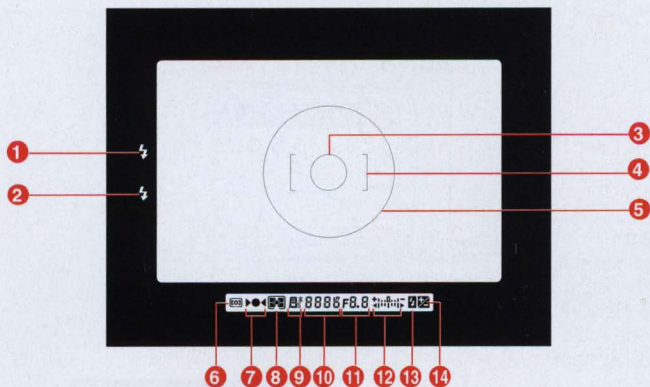

### Viewfinder indication

- ① Flash ready-light (red)
- ② Flash recommend light (green)
- ③ 3mm-dia. reference circle for Spot Metering/Spot Area AF
- ④ Wide Area focus brackets
- ⑤ 12mm-dia. reference circle for Center-Weighted Metering
- ⑥ Focus area
- ⑦ Focus indicators:
  - indicates a stationary subject is in focus.
  - ▶ ◀ shows Focus Tracking; also indicates that a moving subject is

- expected to be in focus.
- Blinking ▶ ◀ indicates autofocus is impossible.
- ▶ and ◀ arrows indicate front and rear focus, respectively, in manual focus mode
- ⑧ Metering system
- ⑨ Exposure mode/Flexible Program
- ⑩ Shutter speed
- ⑪ Aperture
- ⑫ Electronic analog display
- ⑬ Flash Output Level Compensation
- ⑭ Exposure compensation

Turning the camera power on or lightly pressing shutter release button to activate the exposure meter switches on the viewfinder illuminator. When the camera's power is turned off or when the exposure meter is automatically switched off, the illuminator turns off.

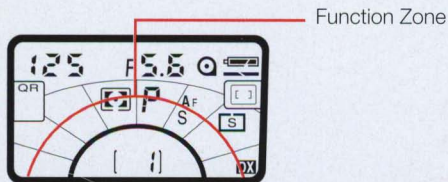

### N70's Command Input Control System

Using FUNCTION and SET/⊙ buttons plus command dial, set desired functions/modes indicated in LCD panel Function Zone. The Function Zone contains eight Function Areas—Film Speed Setting Mode Area, Film Advance Mode Area, Focus Mode Area, Exposure Mode Area, Metering System Area, Flash Sync Mode Area, Exposure Compensation/Flash Output Level Compensation Area, and Auto Exposure Bracketing/Flash Exposure Bracketing Area. (The example illustrated in the following procedure shows the setting of Shutter-Priority Auto exposure mode.)

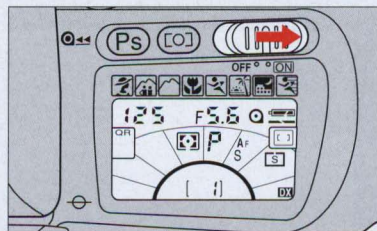

- 1 Turn on the camera.

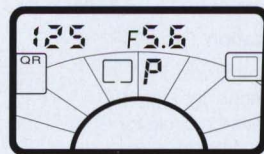

- 4 Remove finger from FUNCTION button, then press SET/⊙ button.

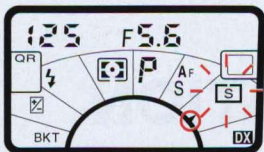

- 2 Press and hold FUNCTION button. The Function Area indicator appears in the last selected area and the symbol in the area starts blinking.

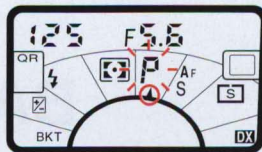

- 3 While holding FUNCTION button, rotate command dial until the Function Area indicator appears in the desired area and the symbol in the area blinks.

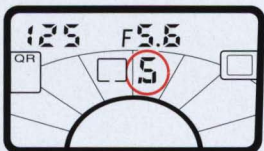

- 5 While holding SET/OK button, rotate command dial until your desired symbol appears.

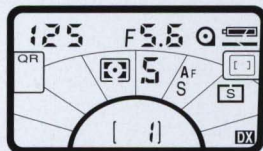

- 6 Remove finger from SET/OK button to complete the setting.

# **BASIC OPERATION**

This section shows you how to prepare the camera for shooting—e.g., how to mount lens, load film, etc.—as well as how to actually take pictures. Whether you're a beginner or a seasoned photographer, you should master this section before proceeding further.

# MOUNTING LENS

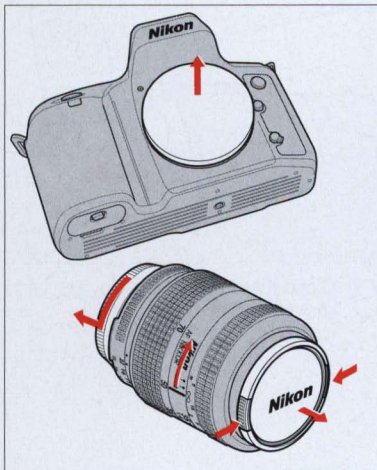

- 1 Remove camera body cap and front and rear lens caps.

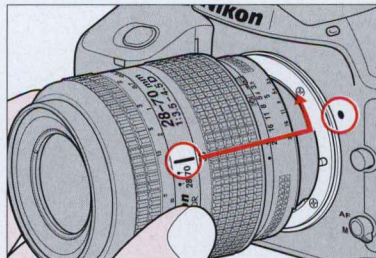

- 2 Position lens in the camera's bayonet mount so that the mounting indexes on lens and camera body are aligned. Taking care not to press lens release button, twist lens counterclockwise until it locks into place.

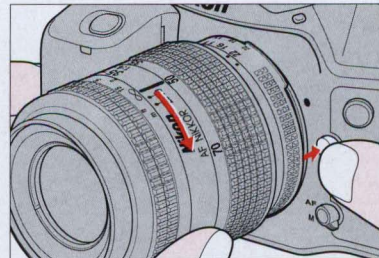

## To remove

Push and hold lens release button and turn lens clockwise.

- When mounting/removing lens, make sure that the camera's power is turned off and avoid direct sunlight.
- See page 104 for Nikon lens compatibility chart.

# INSTALLING BATTERIES

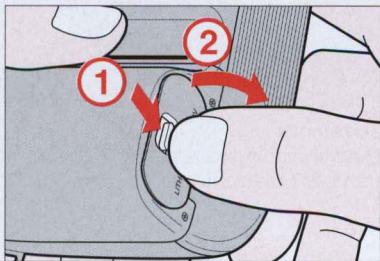
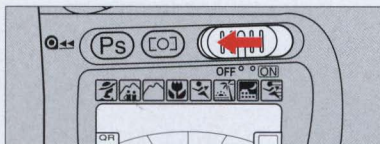

- 1 Make sure the power switch is set at OFF position, then open battery chamber cover by sliding the lock release.

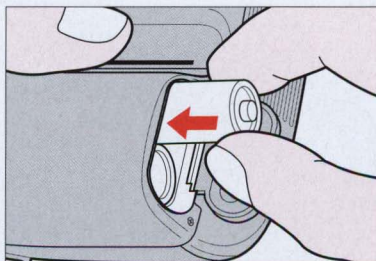

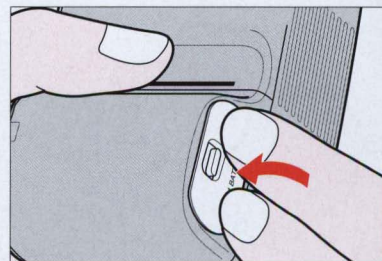

- 2 Insert two CR123A lithium batteries with "+" and "-" ends positioned as illustrated inside the cover.



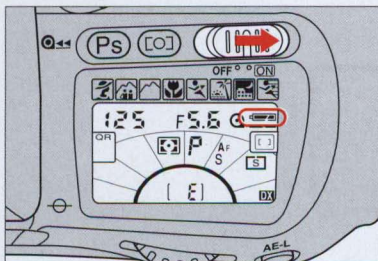

- 3 Close the cover by pushing until it clicks.

# CHECKING BATTERY POWER



Slide power switch to ON position, and confirm that a full battery mark (  ) appears on LCD panel, indicating sufficient battery power. The battery mark and exposure indications automatically turn off after 8 sec.

If  blinks: Batteries are nearing exhaustion. Have a fresh set ready.

If  blinks: Batteries are just about exhausted. Slide power switch to OFF and replace batteries with a fresh set.

If no indication/mark appears, batteries are completely exhausted or improperly installed. Replace.

When installing/replacing batteries, always read "NOTES ON BATTERIES" on page 111.

## About exposure meter

You can check battery power anytime by lightly pressing shutter release button. This action activates the exposure meter; LCD panel and viewfinder LCD show aperture/shutter speed indications, and autofocus operation starts (unless camera is set for manual focusing). The exposure indications and battery mark stay on for approx. 8 sec. after you take your finger off shutter release button, then automatically turn off. If you remove your finger from the button, these LCD readouts go off approx. 2 sec. after the shutter is released without the flash. With the built-in flash or accessory Speedlight activated, these LCD readouts stay on for approx. 8 sec. after shutter release.

## LOADING FILM

The loading film procedure on pages 16 to 17 shows how to load film with auto film speed setting for DX-coded films.

- To avoid fogging film (especially high-ISO film), do not load/unload film in direct sunlight.
- Usable film speed range for DX-coded film is ISO 25 to 5000.
- For non-DX coded film, see p. 27.

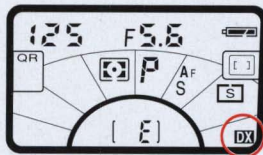

- 1 Confirm whether DX for DX-coded film is shown on LCD panel.
- If not, set auto film speed setting mode by using FUNCTION button, SET/⊙ button and command dial ( see page 27).



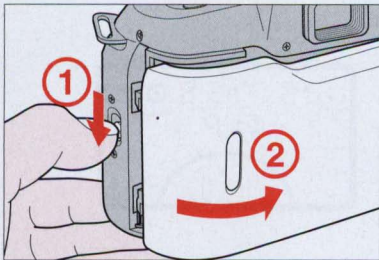

2 Slide camera back lock release down to open camera back.

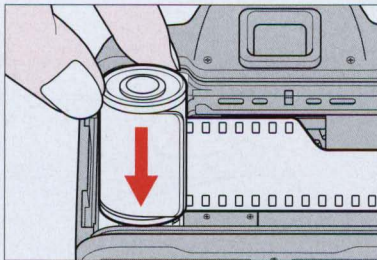

3 Install film. Insert the film cartridge by placing the cartridge spindle on the fork at the bottom of the film cartridge chamber.



Do not touch shutter curtains with your finger or with film leader.

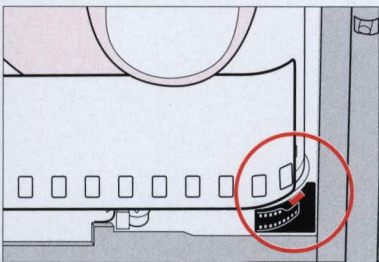

4 Pull film leader out to red index mark.

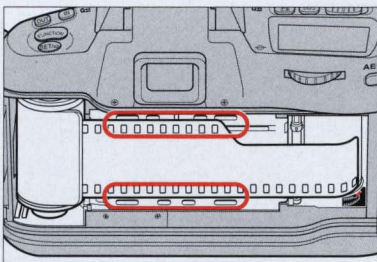

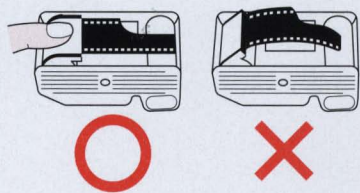

5 Check to ensure film is properly positioned with no slack (see illustration).

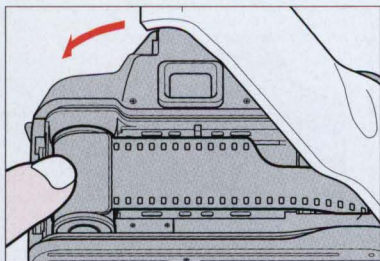

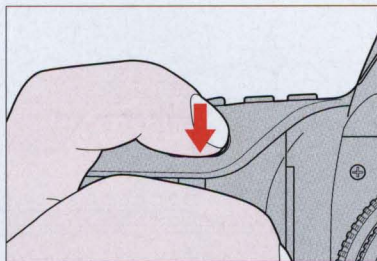

6 Gently close camera back until lock release snaps closed.



7 Fully depress shutter release button to advance film to frame #1. Confirm frame counter shows 1 and  symbol appears on LCD panel.

- If film is incorrectly positioned, **E** remains,  symbol blinks and shutter is locked. Open camera back and reload film properly.
- If non-DX-coded film or film with an unacceptable DX code is loaded, the **Err**, ISO and **DX** marks in LCD panel blink and the shutter is locked. Set ISO speed manually (see p. 27).

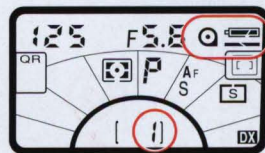

## BASIC SHOOTING

This section features the settings for most common picture-taking situations when AF Nikkor (including AF-S/AF-I Nikkor) lenses are used:

Film advance mode: single-frame shooting 

Metering: Matrix Metering 

Focus Area: Wide 

Focus mode: Single Servo AF **AF-S**

Exposure mode: Auto-Multi Program **P**

- If you are using AI-P-Nikkor lens, use manual focus (see pp. 40-42). If you are using other non-AF Nikkor lenses, use Center-Weighted or Spot Metering (see pp. 43-45), manual focus, and Aperture-Priority Auto or Manual Exposure mode (see pp. 55-57 or 58-60). To confirm usable mode by lens, see chart on p. 104.

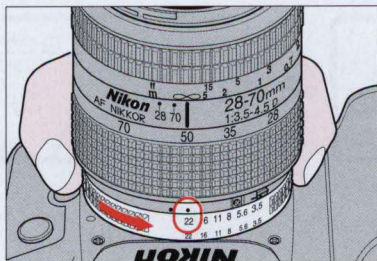

**1** Set lens to its minimum aperture (highest f-number marked in orange on AF Nikkor lenses) and lock lens aperture of AF Nikkor lens at its minimum setting (see lens instruction manual).

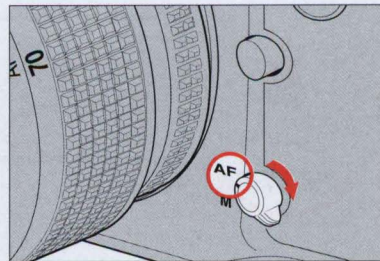

**2** Set focus mode selector to **AF** for Autofocus. If lens has an A-M switch, set switch to A.

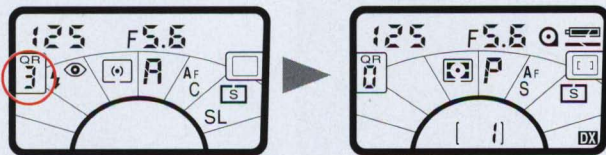

**3** Hold the **OUT** button and rotate command dial until **0** appears in the QR (Quick Recall) window on LCD panel. Remove your finger from the **OUT** button. The camera's settings are automatically reset to factory initial settings (as shown below) for basic shooting:

Film advance mode:	Single frame ( <b>T</b> )
Focus area:	Wide ( <b>L</b> )
Focus mode	Single Servo AF ( <b>A</b> -S)
Metering system:	Matrix ( <b>☉</b> )
Exposure mode (including Vari-Program):	Auto-Multi Program ( <b>P</b> )
Flash sync mode	Normal (If accessory Nikon Speedlight attached is set at Rear-Curtain Sync, Rear-Curtain Sync will be performed.)
Flexible Program setting	Cancel
Exposure compensation function	Cancel
All Mode Exposure Bracketing	Cancel
Flash Exposure Bracketing	Cancel

For details about QR function, see pages 70 to 71.

For details about each function/mode, see following pages:

• Film advance mode	p. 28
• Metering system	pp. 43-45
• Exposure mode	pp. 46-60
• Focus area	pp. 29-30
• Focus mode	pp. 31 -42
• Flexible Program	p. 51
• Flash sync mode	pp. 68-69
• Exposure compensation function	pp. 78-79
• All Mode Exposure Bracketing	pp. 80-82
• Flash Exposure Bracketing	pp. 94-95

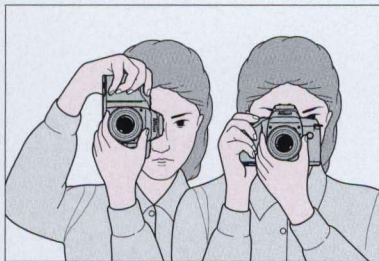

**4** Hold camera. Grasp the camera handgrip with your right hand. Use your left hand to cradle the camera with the elbow propped against your body for support, as you look through the viewfinder. Use your right hand index finger to press shutter release button.



**5** Look through the viewfinder and position focus brackets on main subject.

Although the viewfinder covers approx. 92% of the image area of the actual photograph, a negative film will show you an image larger than what you see through the viewfinder.

Note: The image in a slide film may be partially cropped by the mount. Also, the edges of negative film are partially cropped by most labs.

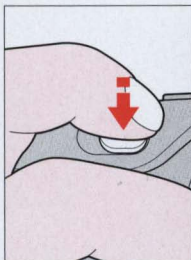

**6** Lightly press shutter release button to start autofocus operation and switch exposure meter on. With a stationary subject, confirm that the in-focus indicator ● appears on the viewfinder's LCD readout. With a moving subject, confirm that Focus Tracking indicator ► ◀ appears. Confirm, too, that the shutter speed and aperture indications are shown inside viewfinder. (Exposure readouts also appear in the camera's external LCD panel.)

- If ◀ appears, subject is located closer than the lens' closest focusing distance. Move away from the subject and refocus.
- If ► ◀ blinks in the viewfinder, autofocus is not possible (p. 38).

**Note on Single Servo AF with a stationary subject**

After focusing is achieved and in-focus indicator ● appears, focus is locked as long as the shutter release button is lightly pressed. If the distance between you and the stationary subject changes, remove your finger from shutter release button, then lightly press it again to refocus.

For details about Single Servo AF, see page 32.

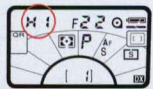

P H 1/200

If **H** appears in the shutter speed position—**Overexposure alert:** Use Nikon ND or similar filter.

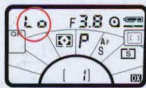

P L F3.8

If **L** appears in the shutter speed position—**Underexposure alert:** Use a Nikon Speedlight, higher ISO film or lens with faster aperture, whichever is suitable.



P FE F3.8

If **FE** blinks in the aperture position—**Lens setting error alert:** Lens is not set to smallest aperture setting, so shutter is locked. Set lens to smallest aperture.

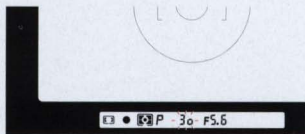

If shutter speed indication blinks inside viewfinder—**picture blur possibility:** The automatically selected shutter speed is 1/50 sec. or slower and picture blur may occur due to camera shake. To reduce possibility of blur, hold camera very steady, use a tripod or use the built-in flash or an accessory Nikon Speedlight.



If green lightning bolt mark appears—**Flash-photography recommended:** If available light is insufficient, lightning bolt mark appears. Use built-in flash or accessory Nikon Speedlight.

## REWINDING FILM

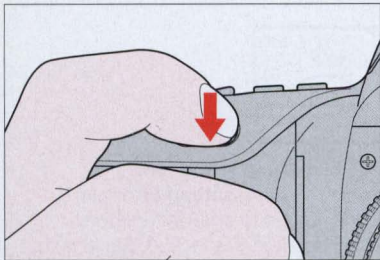

**7** To take picture, fully depress shutter release button. Camera automatically advances film by one frame, and LCD frame counter increases by one.

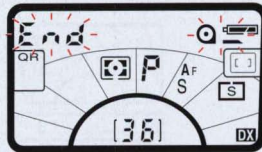

**1** When film reaches its end of roll, film advance stops automatically and shutter locks. *End* and  $\odot$  symbol blink in LCD panel, and *End* blinks inside viewfinder. (Those symbols stop blinking and stay on when the exposure meter is automatically switched off.)

Shutter speed/aperture indications in LCD panel and inside viewfinder turn off approx. 2 sec. after you release shutter and take your finger off shutter release button.

### Silent film rewind

With the film advance mode set at SL for Single Silent, you can rewind film in very quiet environments. (For film advance mode, see p.28).



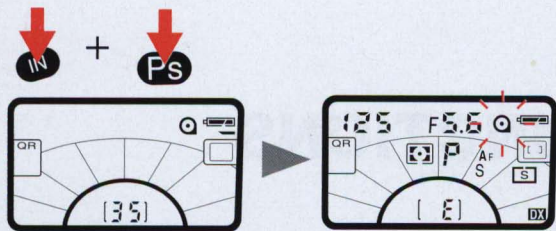

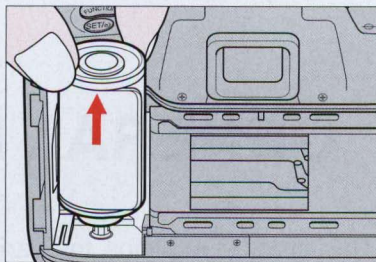

2 Press **IN** button and **Ps** button to start film rewind. During film rewind,  appears on LCD panel, and frame counter counts backwards until rewind is complete.

- You can rewind film, before it reaches end of roll, in the same manner.
- If film does not start rewind or if film rewind has stopped at mid-roll, check battery power. If battery power is insufficient, turn power switch off, replace batteries with a fresh set, turn power on, then press **IN** and **Ps** buttons again to restart film rewind. (When replacing batteries, read "NOTES ON BATTERIES" on page 111.)
- Do not open camera back during film rewind. If camera back is opened, film rewind will stop at mid-roll and **Err** and  blink in LCD panel; to restart film rewind, press **IN** button and **Ps** button again.



3 After rewind automatically stops, confirm the frame counter shows **E** and film installation symbol  blinks for a few seconds.

Open camera back and remove film cartridge.

- To remove film, pull out the upper part of the cartridge then lift up.
- With an exposed film cartridge left in the film cartridge chamber, depressing shutter release button causes  to blink in LCD panel.

To conserve battery power, turn off power switch when you are not using the camera. Always remove batteries before storing the camera to prevent damage due to leaking batteries.

# GENERAL FUNCTIONS

This chapter explains the various modes of the N70 camera's operation. Please review it thoroughly.

# FILM SPEED SETTING MODE

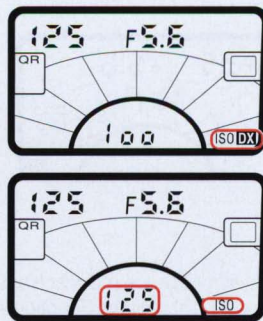
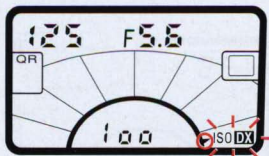

Automatic film speed setting (with a DX-coded film installed)

Manual film speed setting

The N70 offers two ways to set film speed—automatic film speed setting for DX-coded film and manual film speed setting.

## Automatic film speed setting for DX-coded films

Usable film speed range for DX-coded film is ISO 25 to ISO 5000.

Make sure **DX** is shown on the LCD panel. If not, hold FUNCTION button and rotate command dial until the Function Area indicator appears in the Film Speed Setting Mode Area and ISO blinks. Then hold SET/OK button and rotate command dial until ISO **DX** appears.

## Manual film speed setting

Usable range for manual film speed setting is ISO 6 to 6400. Hold FUNCTION button and rotate command dial until the Function Area indicator appears in the Film Speed Setting Mode Area and ISO **DX** or ISO blinks. Then hold SET/OK button

and rotate command dial until desired film speed is shown in place of frame counter with ISO in the film Film Speed Setting Mode Area.

- If DX-coded film is loaded but manual film speed setting is selected, camera gives priority to the manually set ISO number.

### To check ISO film speed setting

Hold FUNCTION button and rotate command dial until the Function Area indicator appears in the Film Speed Setting Mode Area and ISO **DX** or ISO blinks. Then hold SET/OK button.

# FILM ADVANCE MODE

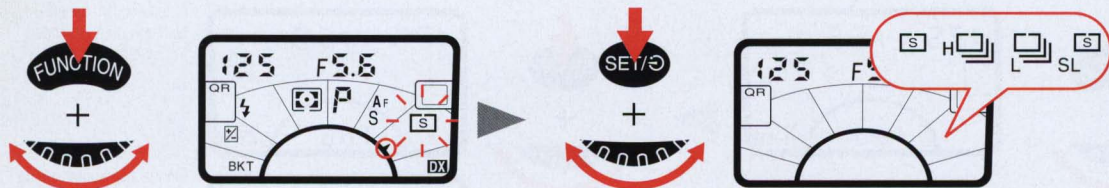

There are four automatic film advance modes. Hold FUNCTION button and rotate command dial until the Function Area indicator appears in the Film Advance Mode Area and  $\boxed{S}$ ,  $\text{H}$ ,  $\text{L}$ , or  $\text{SL}$  blinks, then hold SET/OK button and rotate command dial until desired symbol appears. Set  $\boxed{S}$  for single-frame shooting,  $\text{H}$  for continuous low-speed shooting,  $\text{H}$  for continuous high-speed shooting, or  $\text{SL}$  for silent rewind, and so on.

## $\boxed{S}$ Single-frame shooting and $\text{SL}$ silent rewind

Fully depressing shutter release button takes one picture and automatically advances film by one frame. Film is advanced immediately after shutter closes whether you remove your finger from shutter release button or keep the button depressed. To take the next shot, lift your finger from the button, then fully depress it again.

$\text{SL}$  for silent rewind is for times when conditions require a minimum of operating noise. You can rewind film very quietly.

## $\text{H}$ Continuous low-speed and $\text{H}$ continuous high-speed shooting



Shots are taken continuously as long as you keep shutter release button fully depressed. You have a choice of shooting speeds: approx. 3.7 fps (frames per second) in the  $\text{H}$  mode, and approx. 2.0 fps in the  $\text{L}$  mode—with fresh lithium batteries at normal temperature (20°C or 68°F) and at shutter speeds of 1/250 sec. or higher in the Manual exposure and Manual focus modes. With shutter speeds slower than 1/250 sec., the framing rate becomes progressively slower in proportion to the shutter speed in use.

- When built-in flash is activated, continuous shooting is automatically switched over to single-frame shooting ( $\boxed{S}$ ). In this case,  $\text{H}$  or  $\text{L}$  blinks in LCD panel.

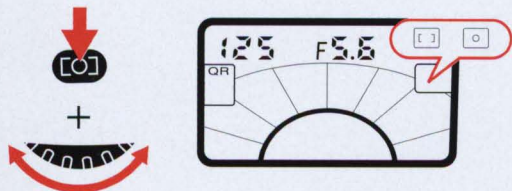

## FOCUS AREA



The N70's autofocus system offers a choice of two focus areas: Wide and Spot.

While pressing focus area button, rotate command dial until the desired symbol— for Wide Area or  for Spot Area—appears in LCD panel.

### For flash photography

When built-in flash is activated or accessory Nikon Speedlight is turned on, Wide Area is automatically switched over to Spot Area. In this case,  blinks in LCD panel and  appears inside viewfinder.

### Wide Area AF

The Wide-Area focus brackets delineate the focus detecting area in the viewfinder. Subjects of sufficient brightness and detail can be detected within these brackets. In addition to general photography, autofocus using Wide-Area focus brackets is suited to action photography in which the moving subject requires a wide-range focus detection area. However, focus detection may not be possible if the subject is too small to fully cover the Wide-Area focus brackets. If various subjects, each at a different distance, fall within the focus detection area, focus will be confirmed for a single subject as follows:

- For subjects of equal brightness: the closer one will be focused.
- For subjects of unequal brightness: the brighter one will be focused.

## ☐ Spot Area AF

Spot Area AF, in which the focus detecting area is shown by the 3mm-dia. circle at the center of the viewfinder, is recommended in the following situations:

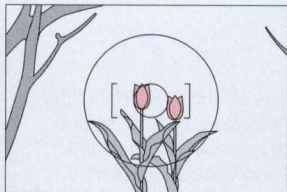

**a.** Subject considerably smaller than the Wide-Area focus brackets\*



**b.** Subject obscured by an object, such as a fence, in the foreground



**c.** A particular portion of the subject must be in focus, such as the eyes in a portrait



**d.** Strongly backlit subject, such as someone standing beside bright window\*\*

\* Lock focus. See "AUTOFOCUS WITH MAIN SUBJECT OFF CENTER" on pages 36 to 37.

\*\* To give correct exposure on your subject, see "AUTO EXPOSURE LOCK FUNCTION WITH AE-L BUTTON" on pages 74 to 75 or "TO OBTAIN METER READING FOR A PARTICULAR SUBJECT IN MANUAL EXPOSURE MODE" on pages 76 to 77.

# FOCUS MODE

## AUTOFOCUS

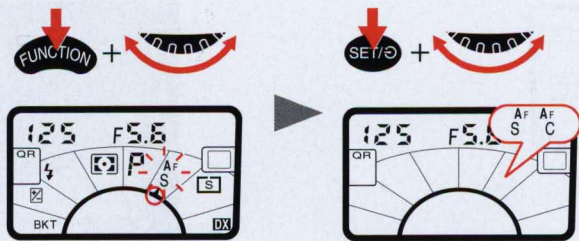
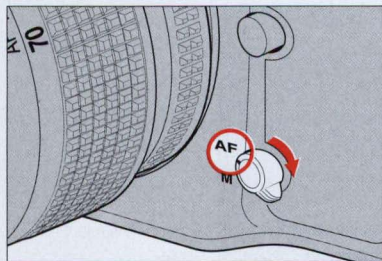

For autofocus, set the focus mode selector at **AF**. The Nikon N70 has two autofocus modes, focus-priority Single Servo AF and release-priority Continuous Servo AF. Hold **FUNCTION** button and rotate command dial until the Function Area indicator appears in the Focus Mode Area and **AF-S** or **AF-C** blinks, then hold **SET/☉** button and rotate command dial until desired symbol appears. Set **AF-S** for Single Servo AF or **AF-C** for Continuous Servo AF.

In either autofocus mode and in any film advance mode, Focus Tracking automatically activates when the subject starts moving. You can obtain correctly focused pictures for many moving subjects.

- If you set focus mode selector to **AF** with a non-AF Nikkor lens, **AF-S** or **AF-C** blinks in LCD panel, telling you to set manual focus mode.

### Caution

Do *not* attempt to turn the lens focusing ring or impede its rotation when the focus mode selector is set to **AF**.

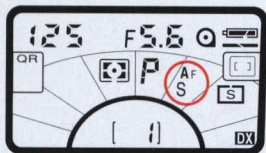

## AF-S Single Servo AF

You lightly press shutter release button, the lens starts adjusting for focus. Because the priority is on correct focus, the shutter locks until the stationary subject is in focus (with ●) or until the moving subjects expected to be in focus (with ► ◀). After focus is achieved with a stationary subject, the focus remains locked for as long as shutter release button is lightly pressed. This feature is useful, especially when recomposing the picture with the main subject off center. However, if the camera-to-subject distance changes, you have to refocus.



Stationary subject is in focus

**With a stationary subject:** Lightly press shutter release button. When the subject is in focus, the lens stops moving, the in-focus indication ● appears in the viewfinder, and focus is locked. If the subject moves, remove your finger from shutter release button, then lightly press it again to restart autofocus.

### If ◀ stays in the viewfinder

Subject is located closer than the closest focusing distance of the lens. Move away from subject and refocus.





Moving subject is expected to be in focus

### With a moving subject:

Lightly press shutter release button and Focus Tracking is automatically activated. Confirm **▶ ◀** appears in the viewfinder, then fully depress shutter release button.

Focus Tracking remains activated as long as you keep lightly pressing shutter release button. If subject stops and ● appears, focus is locked. If subject moves again, remove your finger from shutter release button and lightly press it again to start autofocus with Focus Tracking.

### If **▶ ◀** blinks in the viewfinder:

Autofocus is not possible (see page 38) and shutter locks.

- Single Servo AF is convenient for off-center subjects. See pages 36 to 37.
- After shooting with the film advance mode selector set at **[S]** or **[SL]**, you do not have to remove your finger from shutter release button for the next shot. Slightly lift your finger from the button (but maintaining the button in the half-depressed position) then fully depress it to release the shutter again. The focus setting will have remained unchanged from the prior setting. In the Single Servo AF mode, focus remains locked even after shutter is released, unless you remove your finger from shutter release button. With film advance mode set at **[M]** or **[A]**, camera detects focus every time the shutter is released.
- With a moving subject, depending on subject status and lens in use, slightly out-of-focus pictures may result.

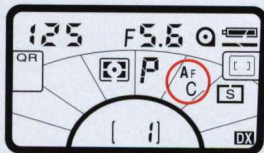

### AF-C Continuous Servo AF with Release-Priority

Under some conditions, such as very fast action situations, you may want to take a picture even if focus has not been successfully accomplished. In such cases, use this mode. In Continuous Servo autofocus mode, as you lightly press shutter release button, focus detection begins and the lens focuses for as long as you keep shutter release button lightly pressed. Since the priority is on shutter release, you can fully depress shutter release button regardless of focus status.



Stationary subject is in focus

**With a stationary subject:** Lightly press shutter release button to start autofocus operation. When the subject is in focus, the camera's autofocus motor (or the built-in motor of an AF-S/AF-I Nikkor lens) stops driving the autofocus lens and ● lights up. Unless you remove your finger from shutter release button, the motor will start driving the lens again to obtain an in-focus picture if the subject moves.

#### If ◀ appears in the viewfinder

Subject is located closer than the closest focusing distance of the lens. Move away from subject and refocus.

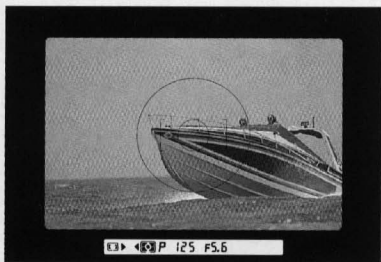

Moving subject is expected to be in focus

**With a moving subject:** Lightly press shutter release button and Focus Tracking is automatically activated. Confirm  $\blacktriangleright \blacktriangleleft$  appears in the viewfinder, then fully depress shutter release button.

Focus Tracking remains activated as long as you keep lightly pressing shutter release button. When the subject stops, the viewfinder shows  $\bullet$ .

- As focus is not locked in Continuous Servo AF, to take an off-center subject, select Single Servo AF. (Pages 36 to 37).
- With a moving subject, depending on subject status and lens in use, slightly out-of-focus pictures may result. ✖

**If  $\blacktriangleright \blacktriangleleft$  blinks in the viewfinder:**

Autofocus is not possible (see page 38).

## AUTOFOCUS WITH MAIN SUBJECT OFF CENTER

As previously noted, in Single Servo autofocus, focus is locked as long as shutter release button is kept lightly pressed. Use this feature for off-center subjects.

- If there is substantial difference of brightness between subject and background, switch to Center-Weighted or Spot Metering and use AE-L button. See pages 74 to 75.



- 1 Position reference circle for Spot AF on the subject and lightly press shutter release button to start autofocus operation.

- In the following procedures, Spot-Area AF and Spot Metering are used for demonstration photos .
- With a moving subject, focus cannot be locked.



2 Confirm in-focus indicator ● appears in viewfinder.

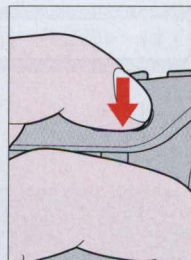

3 Keeping shutter release button lightly pressed, recompose, then fully depress shutter release button to take pictures.

## SPECIAL FOCUSING SITUATIONS

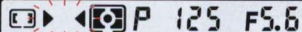

AF-ON AF-L/AF-ON P 125 F5.6

Autofocus operation depends on general lighting, subject contrast and detail, and other technical factors. In rare situations where autofocus (and manual focus with Electronic Rangefinder) is not possible, **▶ ◀** blinks telling you to focus manually with clear matte field (p. 42) or perform autofocus on another subject located at same distance.



### A. Very dark subject

Focus manually with clear matte field, or for Single Servo AF, focus on another brighter subject located at same distance, lock focus, then recompose (pp. 36-37). Or, use a Nikon AF Speedlight (SB-28, SB-27, SB-26, SB-25, SB-23, SB-22 or SB-20) to perform autofocus with Speedlight's AF illuminator.



### B. Low-contrast subject

Focus manually with clear matte field, or for Single Servo AF, focus on another subject at same distance but with more contrast, lock focus, then recompose (pp. 36-37).

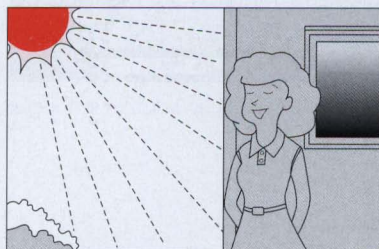

### C. Strongly backlit subject or bright subject with shiny surface such as silver or aluminum, or scene in which there is a pronounced difference in brightness.

Focus manually with clear matte field.

In the following situations, ignore in-focus indicator ●.

- **Scene with subject located at different distances. (For example, when shooting a person over a fence or when shooting animals inside a cage)**

Use Spot Area for autofocus (page 30) or focus manually with clear matte field.

- **With an extremely bright object near your subject**

Use Spot Area for autofocus (page 30) or focus manually with clear matte field.

- **When using a linear polarizing filter\*, or other special filter such as a soft-focus filter.**

Focus manually with clear matte field.

\* *Circular polarizing filter can be used in connection with autofocus operation.*

## MANUAL FOCUS

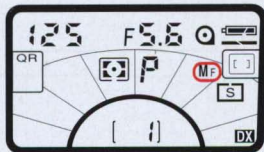
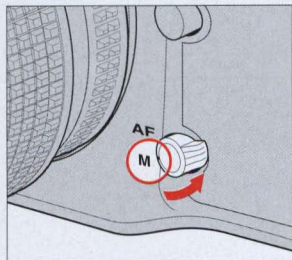

To focus manually, set the focus mode selector to **M**. (If the lens has an A-M switch, set it to M. If you are using an AF-S/AF-I Nikkor lens, set the focus mode ring to M or M/A.) There are two ways of assuring precise manual focus: with the Electronic Rangefinder or with the viewfinder's clear matte field.

### Manual focus with Electronic Rangefinder

The Electronic Rangefinder enables you to see focus status with the viewfinder indications while you are rotating the lens focusing ring. It works with most Nikon lenses (including AF Nikkor when operated manually) which have a maximum aperture of f/5.6 or faster. (For a complete list of usable lenses, see LENS COMPATIBILITY CHART on p. 104).

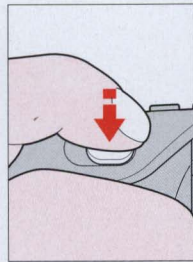

- 1 Look through viewfinder and position focus brackets on main subject. Then lightly press shutter release button.



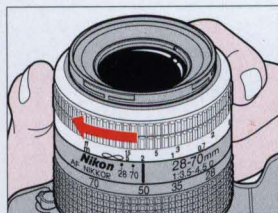

◀ P 125 F5.6

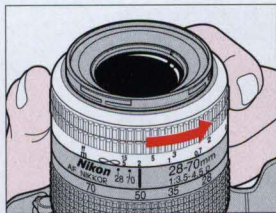

▶ P 125 F5.6

2 Keeping shutter release button lightly pressed, rotate lens focusing ring in direction indicated by focus-to-left arrow (◀) or focus-to-right arrow (▶), until arrow disappears and in-focus indicator ● appears.

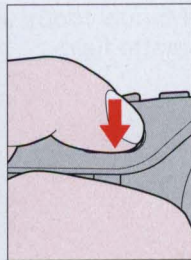

3 Confirm in-focus indicator ● appears, then fully depress shutter release button to take picture.

For special focusing situations shown on page 38, ▶ ◀ blinks to indicate that the Electronic Rangefinder does not correctly work. Focus with clear matte field (p. 42).

## Manual focus using clear matte field

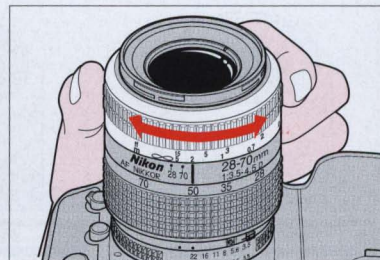

Look through viewfinder and rotate lens focusing ring until image on clear matte field appears sharp.

# EXPOSURE METERING SYSTEM

## SELECTING METERING SYSTEM

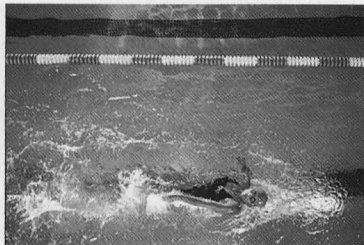
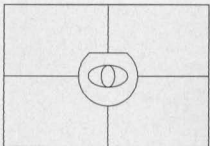

### Matrix Metering

This system is ideal for quick operation in any exposure mode (pages 46 to 60). With D-type AF Nikkor lenses (including AF-S/AF-I Nikkor lenses), 3D Matrix Metering is automatically activated. 3D Matrix Metering uses three types of data: (1) scene brightness, (2) scene contrast and (3) focused subject's distance (Distance Information). Data on scene brightness and contrast are detected by the camera's eight-segment Advanced Matrix Sensor, while data on the focused subject's distance is detected and relayed by the D-type AF Nikkor lens in use. In addition, the information sent by the camera's

autofocus system indicating whether the main subject is centered is also considered in the computation. By analyzing these data, the N70's built-in microcomputer is able to provide correct exposure even in extremely complex lighting situations. If a non-D-type lens is used, Advanced Matrix Metering is performed. Although lens' Distance Information is not given, eight-segment Advanced Matrix Sensor provides the correct exposure in most lighting situations. Note that Matrix Metering system can be used only with lenses that have a built-in CPU (such as AF Nikkor and AI-P lenses.)

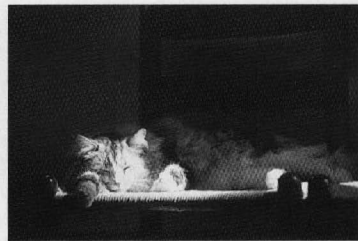
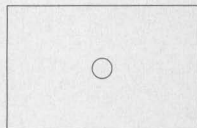
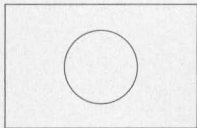

### **Center-Weighted Metering**



With approx. 75% of the meter's sensitivity concentrated on the 12mm-dia. circle in the viewfinder and approx. 25% outside this circle, this meter becomes useful in situations where you want to base exposure on a specific area in the scene. In the auto exposure mode, to measure the brightness of the pictures off-center portion, use the AE-L button (pp. 74-75).

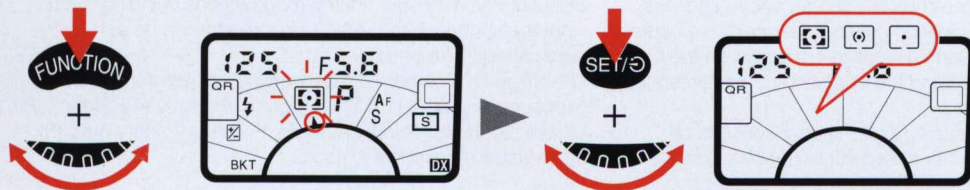

### **Spot Metering**

Nearly 100% of the meter's sensitivity is concentrated on the 3mm circle in the center of the viewfinder. Use this meter for really selective exposure control—achieving the best results requires experience.

## SETTING METERING SYSTEM



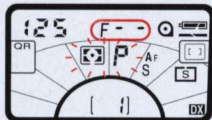

The Nikon N70 has three type of exposure metering systems—Matrix Metering, Center-Weighted Metering and Spot Metering. Hold FUNCTION button and rotate command dial until the Function Area indicator appears in the Metering System Area and ,  or  blinks. Then hold SET/OK button and rotate

command dial to set desired symbol. Set  for Matrix Metering,  for Center-Weighted Metering or  for Spot Metering.



### If you are using a lens without CPU, or accessories such as bellows or extension rings

Matrix Metering cannot be set. If you set  on the LCD panel,  blinks and metering system switches to Center-Weighted Metering. (If Auto-Multi Program or Shutter-Priority Auto is set on the camera, the exposure mode also switches automatically to Aperture-Priority Auto with F-- and blinking P or S.) In this case, use Center-Weighted Metering /Spot Metering and Aperture-Priority-Auto/Manual exposure mode.

## EXPOSURE MODE

---

Light reaching the film is controlled by shutter speed and lens aperture. The proper combination results in a correct exposure. Shutter speed and lens aperture settings are based on the ISO speed set for the film in use and the operation of the camera's exposure control system.

The relationship between aperture and shutter speed is as follows: One change in shutter speed either doubles or halves the amount of light transmitted. For example, a shutter speed of 1/500 sec. passes half the light of 1/250 and double the light of 1/1000 sec. The aperture f/8 passes half the light of f/5.6 and double the light of f/11. If the correct exposure for a scene is 1/500 at f/8, then we can also select 1/250 at f/11 or 1/1000 at f/5.6 and achieve the same exposure results, and so on.

## SELECTING EXPOSURE MODE

Selecting the exposure control mode means deciding if you want the shutter speed and/or lens aperture to be set automatically or manually.

The Nikon N70 camera offers two types of programmed auto exposure modes, Auto-Multi Program (P) and Vari-Program (P<sub>s</sub>), as well as Shutter-Priority Auto (S), Aperture-Priority Auto (R), and Manual (M) exposure modes.

## Programmed Auto exposure modes (P/P<sub>s</sub>)

With the N70's microcomputer choosing the combination of shutter speed and aperture automatically, you can concentrate on picture composition, without worrying about exposure.

*Note that programmed auto exposure modes operate only with Nikon lenses that have a built-in CPU (AF Nikkor and AI-P Nikkor lenses).*

When P<sub>s</sub> for Vari-Program is selected, you have a choice of eight options: (1) Portrait Program, (2) Hyperfocal Program, (3) Landscape Program, (4) Close-Up Program, (5) Sport Program, (6) Silhouette Program, (7) Night Scene Program and (8) Motion Effect Program.

For details about Vari-Program, see pages 61 to 67.

Auto-Multi Program (P) is used for most common picture-taking situations. The chart at right shows the shutter speed/aperture combinations for Auto-Multi Program that are selected at each EV (exposure value) brightness level.

In Programmed Auto exposure mode, you can use the Flexible Program function to temporarily shift an automatically selected shutter speed/aperture combination and obtain the desired shutter speed/aperture (p. 51).

## Program chart of Auto-Multi Program (at ISO 100)

To check shutter speed and aperture values, follow either the black or red line to where it intersects the diagonal line.



- With 50mm f/1.4
- With 180mm f/2.8
- With 300mm f/4
- With AF Zoom-Nikkor 35-80mm f/4-5.6D at 35mm and 80mm focal length settings.
- - - - High-brightness limit for Matrix Metering

## Shutter-Priority Auto exposure mode

You manually set the shutter speed you want. To freeze the action, use a high shutter speed; to create motion effects, choose a slower shutter speed. The N70's microcomputer automatically sets the proper aperture to match the manually selected shutter speed for correct exposure. See pages 52 to 54 for Shutter-Priority Auto operation.

*Note that Shutter-Priority Auto exposure mode operates only with Nikon lenses that have a built-in CPU (AF Nikkor and AI-P Nikkor lenses).*

## Aperture-Priority Auto exposure mode

You can control depth of field by varying the aperture. Smaller apertures make the background and foreground sharper (recommended for landscape pictures) while larger apertures tend to blur the background (recommended for portraits).

Your selected aperture will determine the shutter speed that is automatically set by the camera's microcomputer. When using smaller apertures with correspondingly slower shutter speeds, remember that, generally, any speed below  $1/(\text{focal length in use})$  second, requires the use of a tripod to prevent picture blur due to camera shake. The higher the corresponding shutter speed to the aperture you set, the easier it is to stop action. Adjust the selected aperture if the speed is not appropriate for conditions or the specific effect you want.

For Aperture-Priority Auto operation, see pages 55 to 57.

## Manual exposure mode

Manual exposure control allows you to make both aperture and shutter speed settings. For a technically correct exposure, follow the recommendation of the camera's light meter, as indicated by LCD readout. To achieve a specific creative effect (e.g., intentional blur, intentional under- or over-exposure), disregard the LCD and modify the recommended exposure settings.

For Manual exposure operation, see pages 58 to 60



### Pictures taken at different shutter speeds



High shutter speed



Slow shutter speed

### Pictures taken at different apertures



Large aperture



Small aperture

## SETTING EXPOSURE MODE

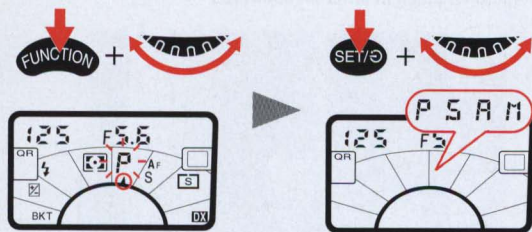

Hold FUNCTION button and rotate command dial until the Function Area indicator appears in the Exposure Mode Area and **P**, **S**, **A** or **M** blinks. Then hold SET/OK button and rotate command dial until desired symbol appears.

- P** for Auto-Multi Program
- S** for Shutter-Priority Auto
- A** for Aperture-Priority Auto
- M** for Manual

To activate Vari-Program, use **Ps** button. For details, see page 62.

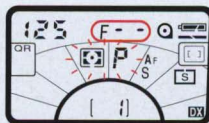

### For users of lenses that have no CPU, or accessories such as bellows attachment or extension rings

Use Aperture-Priority Auto or Manual exposure mode. Programmed Auto (including Vari-Program) or Shutter-Priority Auto exposure mode automatically shifts to Aperture-Priority Auto exposure mode with **F - -** and blinking **P** or **S**. (If Matrix Metering is set on the camera, metering system is also automatically shifted to Center-Weighted and  blinks).

## FLEXIBLE PROGRAM

If you want to change the shutter speed/aperture combination in Programmed Auto exposure mode (including Vari-Program), use the Flexible Program function. Flexible Program enables you to temporarily change an automatically set shutter speed/aperture combination in 1/3 EV steps\*, while maintaining the correct exposure.

\* Although aperture is shifted in 1/3 EV steps, aperture indication in the LCD panel and viewfinder changes in 1 EV steps.

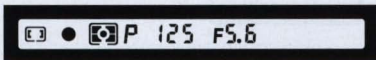
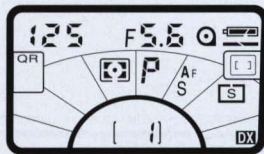
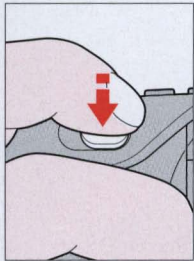

1 Lightly press shutter release button.

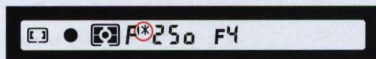
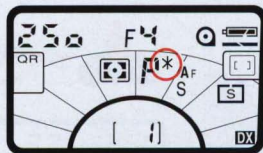

2 Turn command dial until desired shutter speed or aperture value appears in viewfinder and in LCD panel. The Flexible Program indicator (\*) appears to indicate the program has been shifted or changed.

- As soon as the meter switches off (i.e., the viewfinder and LCD panel displays disappear), Flexible Program is canceled. Flexible Program is also canceled when you switch the exposure mode to another mode, when you change Vari-Program option, when the built-in flash pops up/returns to down-position, when an accessory Nikon Speedlight is turned off, when QR number is recalled, or when camera power is turned off.

## OPERATION IN SHUTTER-PRIORITY AUTO EXPOSURE MODE

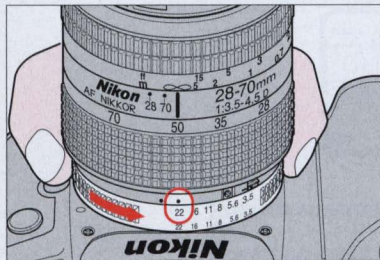

1 Set lens to its minimum aperture setting (highest f-number). With AF Nikkor and AI-P Nikkor lenses, lock lens aperture at minimum setting (refer to lens instruction manual).

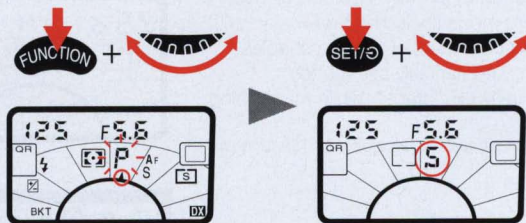

2 Hold FUNCTION button and rotate command dial until the Function Area indicator appears in the Exposure Mode Area and exposure mode symbol blinks. Hold SET/OK button and rotate command dial until S appears on LCD panel. S also appears in the viewfinder.



If lens is not set to its minimum aperture setting and you set the Shutter-Priority Auto, FEE blinks in the LCD panel and viewfinder as lens setting error alert.

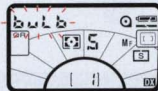

If "bulb" is set on the camera, selecting the Shutter-Priority Auto exposure mode will cause bulb to blink—a warning that the "bulb" setting cannot be used in Shutter-Priority Auto exposure mode.

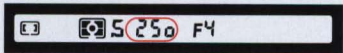
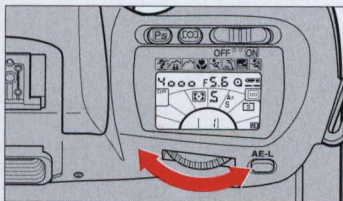

**3** Remove finger from SET/⏏ button, and rotate command dial to select desired shutter speed.

Shutter speed indication changes 1/3 step at a time in the following sequence:

30" 25" 20" 15" 13" 10" 8" 6" 5" 4" 3" 2.5" 2" 1.6"  
 1.3" 1" 1.3 1.6 2 2.5 3 4 5 6 8 10 13 15 20 25 30  
 40 50 60 80 100 125 160 200 250 320 400 500 640  
 800 1000 1250 1600 2000 2500 3200 4000

If meter has automatically turned off, along with LCD indications, turn on meter—and LCD readout—again by lightly pressing shutter release button.

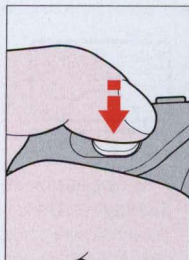

**4** Look inside viewfinder, compose and lightly press shutter release button. Confirm the automatically set aperture value.

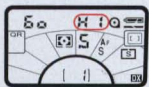

60 HI

If **HI** appears with electronic analog display\*—**Overexposure alert:** Select higher shutter speed or use Nikon ND filter.

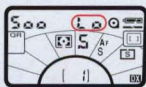

500 LO

If **LO** appears with electronic analog display\*—**Underexposure alert:** Select slower shutter speed, or use built-in flash or accessory Nikon Speedlight.



If green **⚡** mark appears—**Flash photography is recommended:** If subject brightness is insufficient, flash recommend light lights up. Use built-in flash or accessory Nikon Speedlight.

\* Shows value difference from correct exposure. If difference is beyond  $\pm 1$  EV, **▶** for underexposure or **◀** for overexposure appears.

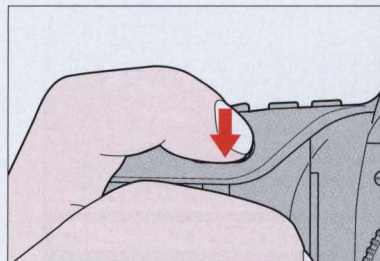

**5** To take a picture, fully depress shutter release button.

## OPERATION IN APERTURE-PRIORITY AUTO EXPOSURE MODE

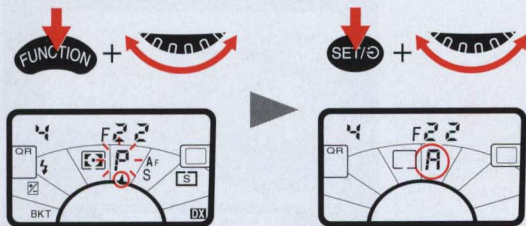

1 Hold FUNCTION button and rotate command dial until the Function Area indicator appears in Exposure Mode Area and exposure mode symbol blinks. Hold SET/☺ button and rotate command dial until **A** appears on LCD panel. **A** also appears in the viewfinder.

- If using an AF Nikkor or AI-P lens, make sure it is not locked to smallest aperture before next step.

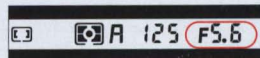
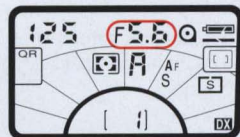
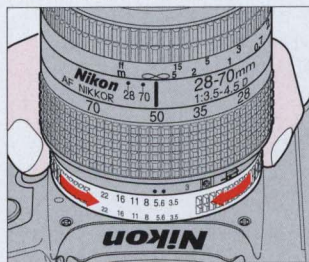

2 Remove finger from SET/☺ button and set lens to desired f-number by rotating lens aperture ring. Aperture set on lens is indicated in LCD panel and viewfinder as follows:

**F 1.4 F 2 F 2.8 F 4 F 5.6 F 8 F 11 F 16 F 22 F 32**

(Available apertures limited to those of lens in use.)

- Intermediate figure (e.g. **F 1.8**, **F 3.3**) displayed indicates maximum aperture of lens in use. Also, with zoom lenses, the maximum aperture for different focal length settings appears in 1/6 EV steps.

If meter has automatically turned off and LCD panel is off, turn meter on again by lightly pressing shutter release button.

**With lenses having no CPU, F - - appears instead of aperture value in LCD panel and viewfinder.**

**With AI-type lenses including AI-modified Nikkor lenses:** Confirm aperture value on lens barrel.

**With lenses having fixed aperture, such as Reflex-Nikkor lenses:** Aperture cannot be changed.

**With lenses having no auto diaphragm such as PC-Nikkor lenses:** Switch to Manual exposure mode (pages 58 to 60).

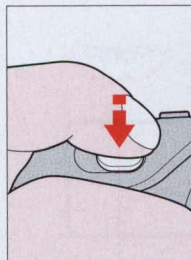

**3** Look inside viewfinder, compose and lightly press shutter release button. Confirm automatically set shutter speed.

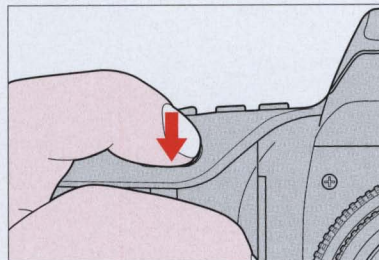

**4** To take the picture, fully depress shutter release button.



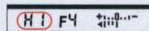
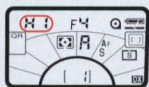

If **H 1** appears in the shutter speed position with **electronic analog display\***—**Overexposure alert:** Select a smaller aperture (larger f-number) or use ND filter.

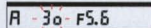

If shutter speed indication blinks inside viewfinder—**picture blur possibility:** The automatically selected shutter speed is 1/50 sec. or slower and picture blur may occur due to camera shake. To reduce possibility of blur, hold camera very steady, use a tripod or use the built-in flash or an accessory Nikon Speedlight. Selecting a wider aperture (smaller f-number) results in a higher shutter speed.

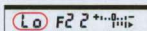
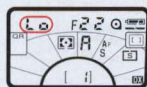

If **L 0** appears in the shutter speed position with **electronic analog display\***—**Underexposure alert:** Select a wider aperture (smaller f-number), or use built-in flash or accessory Nikon Speedlight.

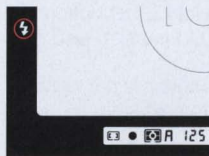

If green **⚡** mark appears—**Flash photography recommended:** If subject brightness is insufficient, flash recommended light lights up. Use built-in flash or accessory Nikon Speedlight.

\* Shows value difference from correct exposure. If difference is beyond  $\pm 1$  EV, **▶** for underexposure or **◀** for overexposure appears.

## OPERATION IN MANUAL EXPOSURE MODE

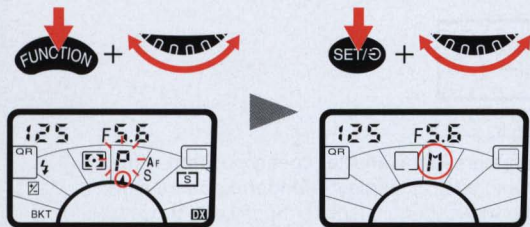

**1** Hold FUNCTION button and rotate command dial until the Function Area indicator appears in the Exposure Mode Area and exposure mode symbol blinks. Hold SET/OK button and rotate command dial until **M** appears on LCD panel. **M** also appears in the viewfinder.

- If using an AF Nikkor or AI-P lens, make sure it is not locked to smallest aperture before proceeding to next step.

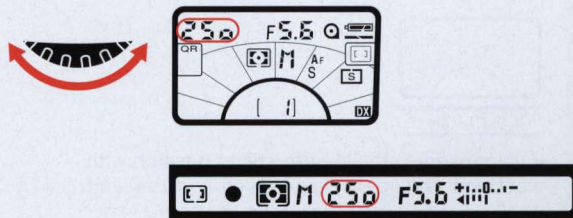

**2** Remove finger from SET/OK button, set shutter speed by rotating command dial.

- In Manual exposure mode, you can set shutter speed to **bulb** for long time exposure by rotating command dial. For details about **bulb** setting, see page 84.

If meter has automatically turned off and LCD readout is off, turn meter on again by lightly pressing shutter release button.

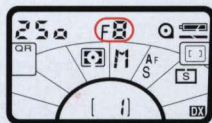
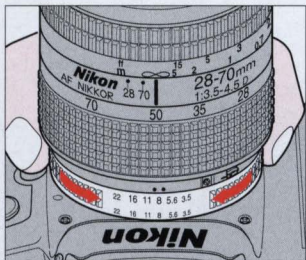

Set aperture by rotating lens aperture ring.



3 Look into viewfinder, compose and lightly press shutter release button.  
Adjust aperture and/or shutter speed (by rotating lens aperture ring/command dial) until electronic analog display shows "0" or desired amount.

### Electronic analog display examples

Over +1EV	+1EV	+1/3EV
±0EV	-2/3EV	Below -1EV

Electronic analog display blinks when the shutter speed/aperture set on the camera is beyond the metering range of the N70.

With lenses having no CPU, F-- appears instead of aperture value in LCD panel and viewfinder.

**With AI-type lenses including AI-modified Nikkor lenses:** Confirm aperture value on lens barrel.

**With lenses having fixed aperture, such as Reflex-Nikkor lenses:** Aperture cannot be changed. Adjust exposure by changing shutter speed.

**With lenses having no auto diaphragm such as PC-Nikkor lenses:** Lens is stopped down when a smaller aperture (larger f-number) is selected. Focus manually with the lens set at maximum aperture.

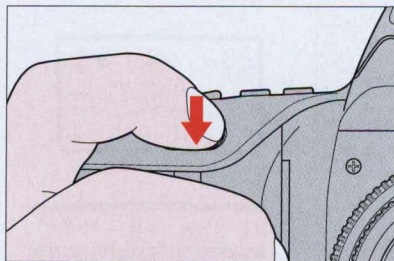

4 To take the picture, fully depress shutter release button.

# USING VARI-PROGRAM









## WHAT IS VARI-PROGRAM?

Programmed exposure control enables the camera's computer to automatically adjust both lens aperture and shutter speed for the correct exposure. The N70 camera's Matrix Metering System determines the correct exposure, applying exposure compensation as deemed necessary by the computer's program. However, other factors can affect the picture, including the use of different shutter speeds and different apertures.

The N70's Auto-Multi Program is designed to coordinate the selection of shutter speed and aperture for average situations. It guides the exposure control system into using reasonably high shutter speeds to avoid blur due to camera shake. The N70 incorporates a versatile Vari-Program System that gives you the option to choose from different programs, each designed to accommodate different picture-taking situations. Please review the concept behind and recommended use for each program, using each as described, or in a different way to express your own picture-taking creativity. Once you understand how each program operates, you'll be able to experiment, using each program for an application different from its originally intended use.

Please note that the effect achieved by using each Vari-Program can be reproduced with the use of other exposure control methods such as Shutter-Priority Auto, Aperture-Priority Auto and Manual. But with Vari-Program control, you allow the camera's computer to take care of all exposure control tasks while you concentrate on composition. This versatility is one of the highlights of the N70 camera's advanced exposure control system.

The N70's Vari-Program control offers eight programs:

-  Portrait Program
-  Hyperfocal Program
-  Landscape Program
-  Close-Up Program
-  Sport Program
-  Silhouette Program
-  Night Scene Program
-  Motion Effect Program

For features of each program, see "VARI-PROGRAM SELECTION GUIDE" on pages 64 to 67.

## SETTING VARI-PROGRAM

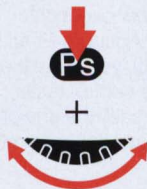

**Use Nikkor lenses with CPU such as AF Nikkor or AI-P-Nikkor lenses and be sure to set lens aperture to the minimum setting.**

Press Vari-Program (**Ps**) button and confirm exposure mode symbol (**P**, **S**, **A** or **M**) starts blinking. While holding **Ps** button, rotate command dial until **Ps** appears in the Exposure Mode Area and Vari-Program set indicator appears under your desired Vari-Program symbol. Then remove your finger from **Ps** button.

When Vari-Program is set, camera settings are automatically reset as follows:

Metering system  
Focus area

Matrix\*

Wide\*, or  Spot with flash

Flexible Program  
Sync mode



Cancel\*

Slow Sync for Night Scene Program and Motion Effect Program, or normal sync for others\*\*

Exposure compensation function

Cancel\*

\* You can change setting as desired.

\*\* You can set Red-Eye Reduction with built-in flash or SB-28/SB-27/SB-26, without canceling Slow Sync. If an accessory Speedlight other than the SB-28/SB-27/SB-26 is attached, setting sync mode to Red-Eye Reduction causes  and  to blink in the LCD panel. In this case, Slow Sync will be performed without Red-Eye Reduction.

### **To cancel Vari-Program**

While pressing **Ps** button and rotate command dial until Vari-Program set indicator disappears. Then remove your finger from the **Ps** button. The previously set exposure mode (**P**, **S**, **A** or **M**) will activate.

If you want to change exposure mode: Without pressing **Ps** button, hold FUNCTION button and rotate command dial until Function Area indicator appears in the exposure mode area and **P**, **S**, **A** or **M** blinks. Then hold SET/ button to set desired exposure mode.

### **For Flash photography with Vari-Program**

Use ISO 100 to ISO 400 films. Films having film speed over ISO 400 may cause overexposed background.

## VARI-PROGRAM SELECTION GUIDE



### Portrait Program

Use this Program whenever you are taking pictures of people. It creates an artistically blurred background to accentuate your main subject.

**Recommended AF Nikkor lenses:** To obtain pronounced blurred background effect, use 85mm to 200mm telephoto lenses.



### Hyperfocal Program

Use this Program when photographing landscapes and other subjects that encompass great depth. The effect becomes more pronounced if there is an interesting foreground within the scene.

Hyperfocal Program tends to select a *slow shutter speed* and smaller aperture to assure both subject and background in focus. To avoid camera shake, use a tripod.

**Recommended AF Nikkor lenses:** 50mm or wider angle lenses.





## Landscape Program

Use this Program whenever you're making a picture of a distant scene. Don't use flash—the scene may be too far.

Landscape Program tends to select a *slow shutter speed* and smaller aperture to assure sharply focused landscape pictures. To avoid camera shake, use a tripod.

**Recommended AF Nikkor lenses:** Select lens according to the desired effect. If you want an expansive view, use a wideangle lens. If you prefer to emphasize your subject by magnifying it, use a telephoto lens.



## Close-Up Program

Use this Program when you are taking pictures up close—a flower, an ornamental detail, a butterfly, or if you are copying a picture. Do not use flash.

To avoid camera shake, use a tripod.

**Recommended AF Nikkor lenses:** AF Micro-Nikkor lenses.



## Sport Program

Use to freeze the action. Recommended for use with Continuous Servo AF (page 34). Do not use flash because it restricts the available shutter speed.

**Recommended AF Nikkor lenses:** For a more pronounced blurred background effect, use 80mm to 300mm telephoto lenses.



## Silhouette Program

Effective only when the background is bright and the subject is in shadow or comparatively dark. The result is dramatic with a wideangle lens although a telephoto can also be used. Excellent for sunsets with dark foreground silhouette or pictures of people against the sky. Do not use flash. Silhouette Program tends to select a *slow shutter speed* to produce effectively silhouetted pictures. To avoid camera shake, use a tripod.

**Recommended AF Nikkor lenses:** Choose your lens according to the desired effect.



## Night Scene Program

Use this Program in the evening or at night.

To capture the beauty of a night scene in available light, such as an illuminated monument, traffic lights or neon signs, shoot without flash. As the automatically set shutter speed is rather slow, use a tripod to avoid camera shake.

With flash, this Program captures all the lighting in the scene, including the foreground subject which is illuminated by the flash, and the background.

**Recommended AF Nikkor lenses:** Select lens according to the desired effect.



## Motion Effect Program

Use this Program to express movement. Stationary subjects will come out in sharp images and moving subjects in blurred images. Also suitable for when your subject is moving and you are following along with your camera in a panning motion. The subject will come out relatively sharp, with the background becoming a blurred streak of colors and shades.

**Recommended AF Nikkor lenses:** For a more pronounced blurred background effect, use 80mm to 300mm telephoto lenses.

# FLASH SYNC MODE

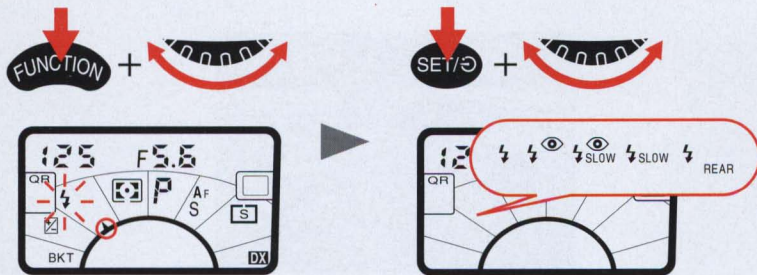

For flash photography with the built-in flash, the N70 offers five flash sync modes. Hold **FUNCTION** button and rotate command dial until the Function Area indicator appears in the Flash Sync Mode Area and ⚡ blinks in the area. Then hold **SET/OK** button and rotate command dial until desired symbol appears. Set ⚡ for Normal Sync\*, ⚡<sup>⊙</sup> for Red-Eye Reduction, ⚡<sup>⊙</sup><sub>SLOW</sub> for Red-Eye Reduction with Slow Sync, ⚡<sub>SLOW</sub> for Slow Sync, or ⚡<sub>REAR</sub> for Rear-Curtain Sync.

\* After removing your finger from **SET/OK** button to complete setting, ⚡ disappears.



## ⚡ Normal Sync

For most flash-shooting situations.

For built-in flash operation, see page 86 to 96.

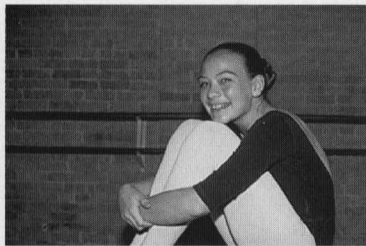

### **Red-Eye Reduction**

When shooting people or animals in dim light using a flash, the subject's eye may sometimes appear red in color pictures or white in B&W pictures. The Red-Eye Reduction function reduces the possibility of "red-eye".

### **Red-Eye Reduction with Slow Sync**

Lets you can set Red-Eye Reduction and Slow Sync simultaneously.

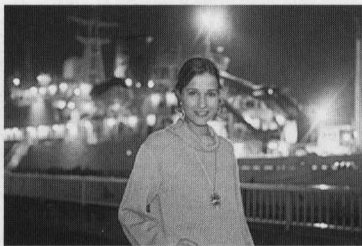

### **Slow Sync**

When flash pictures are taken at high shutter speeds in dim light, the background may come out dark. To improve background exposure, use Slow Sync. Setting Slow Sync extends the automatic controlled shutter speed range down to 30 sec., enabling background details to come out.



### **Rear-Curtain Sync**

When Rear-Curtain Sync is set, flash fires at the end of the exposure, turning available light into a stream of light that follows the flash-illuminated moving subject.

# QR (QUICK RECALL) FUNCTION

Settings for film advance mode, focus area, focus mode, metering system, exposure mode (including Vari-Program), flash sync mode and exposure compensation function can be

memorized on the N70's microcomputer for easy recall. Four numbers are provided: 0 for the permanent default settings; 1, 2 and 3 for the custom settings.

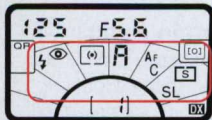

## To memorize

**1** Confirm film advance mode, focus area, focus mode, metering system, exposure mode (including Vari-Program) and flash sync mode set on the camera. If necessary, change settings as desired.

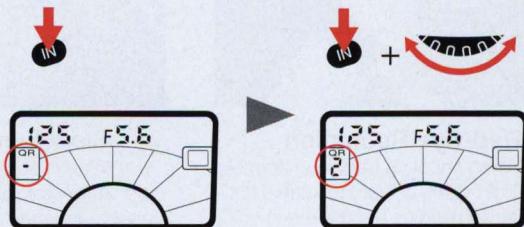

**2** Press **IN** button and confirm "-" appears in the QR window of LCD panel. While holding **IN** button, rotate command dial until your desired custom setting number (from 1 to 3) appears in the QR window. Remove finger from **IN** button.

- If you have already customized the QR number and selected the same number to memorize another customized setting, the previous settings will be cleared.

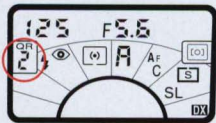

## To recall

While pressing **OUT** button\*, rotate command dial until "0" or the number representing your previously memorised settings appears. Remove finger from **OUT** button.

\* If any QR number is shown in the QR window, "-" appears when you press **OUT** button.

- For AF mode, make sure the focus mode selector is set at **AF**. With focus mode selector set at **M**, AF mode cannot be recalled.
- Recalling QR number 1, 2 or 3 cancels Flexible Program function. All Mode Exposure Bracketing, Flash Output Level Compensation and Flash Exposure Bracketing are not canceled.

## About No. 0

QR No. 0 is for the following factory-set initial settings and cannot be customized.

Film advance mode:	Single frame (S)
Focus area:	Wide (L)
Focus mode	Single Servo AF
Metering system:	Matrix (M)
Exposure mode	Auto-Multi Program (P)
Flash sync mode:	Normal (If accessory Nikon Speedlight attached is set at Rear-Curtain Sync, Rear-Curtain Sync will be performed.)
Flexible program setting:	Cancel
Exposure compensation function	Cancel
All Mode Exposure Bracketing	Cancel
Flash Exposure Bracketing	Cancel

Once you have recalled one of the QR numbers (0, 1, 2 or 3), adjusting film advance mode, focus area, focus mode, metering system, exposure mode, flash sync mode or exposure compensation value will make the QR number disappear from the QR window. (This does not cancel memorisation. To recall the settings again, simply press **OUT** button.)

# **SPECIAL FUNCTIONS**

This chapter explains advanced photographic techniques and applications including exposure compensation methods. It also shows you how to use the self-timer and how to perform long time exposure.



# EXPOSURE COMPENSATION

Exposure compensation is a photographic technique that enables you to vary the final exposure settings from those measured by the camera's light meter. Nikon's 3D Matrix Metering employs methods of exposure calculation that automatically apply exposure compensation, depending upon scene brightness and contrast, and distance information. As a result, your subject, whether it is centered in the viewfinder or not, is given corrected exposure in most lighting situations. We do not recommend using any manually or automatically applied exposure compensation when using Matrix Metering. If you identify an extreme condition under which Matrix may have some difficulty, such as a severely backlit scene or one with extremes of contrast, we recommend using your camera's other built-in meters, Center-Weighted or Spot. Ultimately, only you know what the subject or a part of it requires in terms of exposure measurement. That's why the N70 camera incorporates three meters plus a variety of exposure compensation systems. The photographer's creativity is always the final deciding and controlling factor. To use the various exposure compensation functions, please refer to the following.

- Using auto exposure lock function with AE-L button (pages 74 to 75)
- To obtain meter reading for a particular subject in Manual exposure mode (pages 76 to 77)
- Modifying exposure control by exposure compensation function (pages 78 to 79)
- All Mode Exposure Bracketing (pages 80 to 81)

Results will vary, depending on conditions, so you will want to experiment with each method.

## About reflectance

When using the Center-Weighted or Spot Meter, always keep in mind that the exposure indicated will assume that the subject's reflectance is equivalent to 18%. If the subject varies from this reflectance, you must make an adjustment to exposure. Generally speaking, a white subject will have about a 90% reflectance, and an adjustment of 2.5 f/stops (further open) will bring the exposure back to the equivalent of an 18% reading. As another rule of thumb, when shooting a landscape, the light meter reading from green grass is roughly equivalent to 18% reflectance.

## AUTO EXPOSURE LOCK FUNCTION WITH AE-L BUTTON

In the auto exposure mode, when you want to control exposure based on the brightness of a specific area within the scene, use Auto Exposure Lock function. For Auto Exposure Lock function, it is recommended that you should switch the metering system to Center-Weighted or Spot.

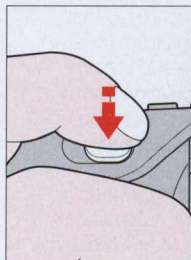

- 2 Lightly press shutter release button, and confirm shutter speed and aperture in viewfinder.



- 1 Center main subject inside viewfinder and/or move in closer until reference circle for Center-Weighted metering or Spot metering is fully covered by the subject.

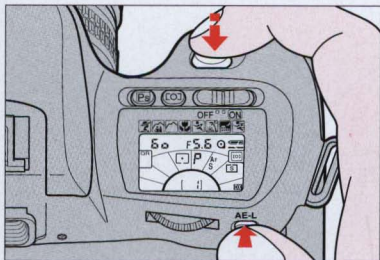

- 3** Keep shutter release button lightly pressed, push AE-L button and hold it in to lock auto exposure.
- While AE-L button is held in, the flash recommended light (green ) does not light up.
  - While AE-L button is held in, shutter speed indication does not blink for picture-blur alert even if a shutter speed is set at 1/50 sec. or slower.

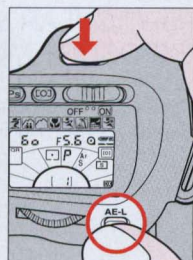

- 4** Recompose picture and shoot.
- In Single Servo AF mode, if recomposing the picture could change subject-to-camera distance, refocus by briefly removing your finger from shutter release button and lightly pressing it.
  - Continuous Servo AF is not recommended if the subject becomes off-centered after recomposing with AE-lock.

## TO OBTAIN METER READING FOR A PARTICULAR SUBJECT IN MANUAL EXPOSURE MODE

In Manual exposure mode, if you want to set exposure as desired on a particular subject, switch metering system to Center-Weighted or Spot and use the following method.

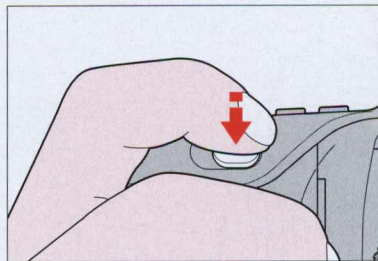

2 Lightly press shutter release button.



1 Center main subject inside viewfinder and/or move in closer until reference circle for Center-Weighted metering or Spot metering is fully covered by the subject.



- 3 Adjust shutter speed and aperture until electronic analog display shows desired exposure.



- 4 Recompose picture and shoot.
- In Single Servo AF mode, if recomposing the picture could change subject-to-camera distance, refocus by briefly removing your finger from shutter release button and lightly pressing it.
  - Continuous Servo AF is not recommended if the subject becomes off-centered after recomposing.

## EXPOSURE COMPENSATION FUNCTION

To modify exposure control (i.e., from the ISO standard) use the exposure compensation function. You can modify exposure control from -5EV to +5EV in  $1/3$  steps is possible. In flash photography, flash output level is also compensated. After taking your photographs, be sure to reset the control to "0" to resume normal operation.

(Center-Weighted Metering)





Without compensation



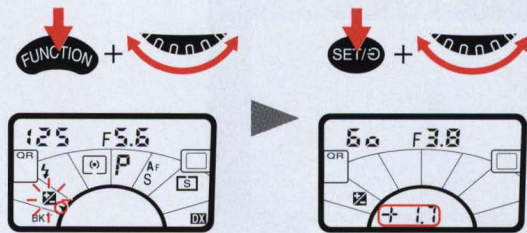

With compensation

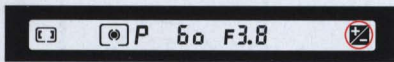
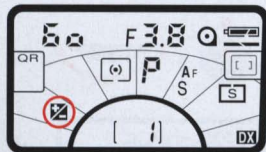

- 1 Hold FUNCTION button and rotate command dial until the Function Area indicator indicates blinking  in the Exposure Compensation Area. Then hold SET/OK button and rotate command dial until desired compensation value appears in place of frame counter on LCD panel.  also appears inside viewfinder. (In the example above,  $+1^{2/3}$  compensation is set.)



2 To complete setting, remove your finger from SET/⊙ button. Once set, exposure compensation remains fixed until reset. Although  stays on to indicate that exposure compensation is on, the compensation value disappears from the readout when you remove your finger from SET/⊙ button. Inside the viewfinder,  appears.

**To confirm compensation value on the LCD panel,** Hold FUNCTION button and rotate command dial so that the Function Area indicator indicates blinking , then press SET/⊙ button.

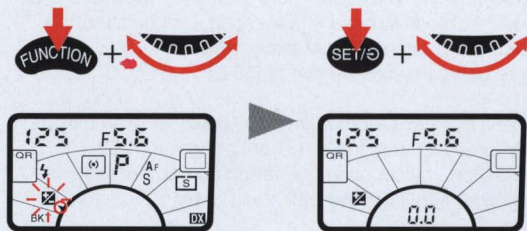

3 After shooting, be sure to reset amount of compensation to "0" to resume normal operation.

- You can cancel exposure compensation function by setting QR number to "0". In this case camera resets to the factory-set initial settings ( page 70).

## ALL MODE EXPOSURE BRACKETING

In situations where you might find it difficult to obtain a proper exposure, All Mode Exposure Bracketing lets you shoot the same subject at three different exposures, with a varying exposure compensation degree of 0.3 EV, 0.5 EV, 0.7 EV or 1 EV.

If you set a compensation degree of 0.5 EV, for example, you will take three pictures, the first shot having a -0.5 EV compensation, the second shot having no compensation and the third shot with a compensation of 0.5 EV.

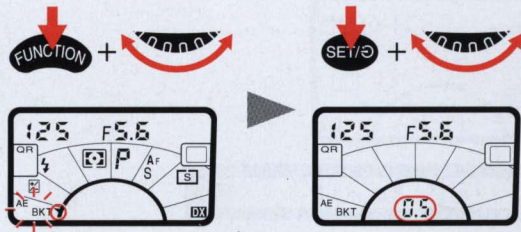

1 While pressing FUNCTION button, rotate command dial until the Function Area indicator indicates blinking **AE BKT** in the Bracketing Area. Then hold SET/OK button and rotate command dial until your desired compensation degree appears in place of frame counter.

- If Flash Exposure Bracketing has already been set, setting All Mode Exposure Bracketing cancels Flash Exposure Bracketing.
- When "bulb" is set, setting All Mode Exposure Bracketing locks shutter and makes **bulb** indication blink in LCD panel and viewfinder.
- When All Mode Exposure Bracketing is set, "bulb" cannot be set.



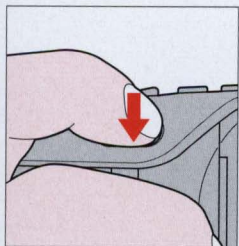

First shot is taken.

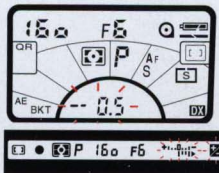

Second shot is taken.

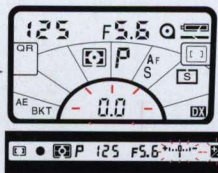

Third shot is taken.

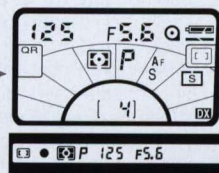
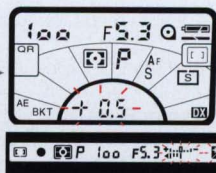

- 2 Remove your finger from SET/OK button to complete setting.
- 3 Compose picture, confirm focus and exposure then fully depress shutter release button.

Inside the viewfinder, and the electronic analog display showing direction of compensation blink.

With film advance mode at or : Fully depress shutter release button three times to take the three shots.

With film advance mode at or : Fully depress shutter release button and hold it in until three shots are taken.

- 4 After three shots are taken, All Mode Exposure Bracketing is automatically canceled.

If you want to take one more set of exposure bracketing shooting with the same degree of compensation, press FUNCTION button then SET/OK button.

- If film reaches end of roll during shooting, rewind film, load a new roll of film, fully depress shutter release button to advance film to frame 1, then fully depress shutter release button again to resume operation.

- In Programmed Auto exposure mode, shutter speed and aperture will vary.  
In Shutter-Priority Auto exposure mode, aperture will vary.  
In Aperture-Priority Auto and Manual exposure mode, shutter speed will vary.
- When using All Mode Exposure Bracketing with Exposure Compensation function, the compensated value will be added. For example, If exposure has been compensated at +1 EV and you set All Mode Exposure Bracketing with 0.5 EV degree, the first shot will be taken with +0.5 EV compensation, the second shot with +1 EV compensation and the third shot with +1.5 EV compensation.
- In flash shooting, All Mode Exposure Bracketing compensates background exposure, not affecting flash light output level.
- Turning the camera's power off cancels All Mode Exposure Bracketing.
- If you set self-timer immediately after setting All Mode Exposure Bracketing, you can perform self-timer shooting without bracketing. After self-timer shooting, fully depress shutter release button to perform All Mode Exposure Bracketing.



# SELF-TIMER OPERATION

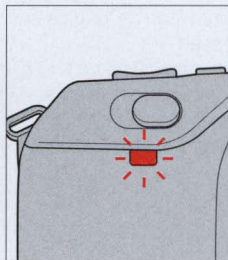
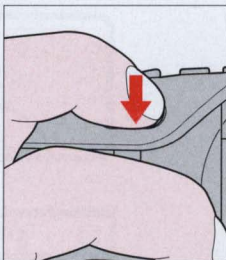
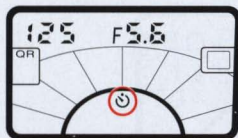

1 Press self-timer (SET/⊙) button and confirm that ⊙ starts blinking in LCD panel. While pressing SET/⊙ button, rotate command dial one click so that ⊙ stops blinking. Then remove finger from SET/⊙ button.

• To cancel self-timer, press SET/⊙ button and rotate command dial so that ⊙ disappears.

2 Look through the viewfinder, lightly press shutter release button, and confirm focus and exposure.

3 Fully depress shutter release button. The self-timer LED starts blinking. The shutter will release after 10 seconds. The self-timer LED blinks for eight seconds, then stops blinking to tell you get ready for the shot.

**To cancel self-timer operation before shooting:** Turn the camera's power off.

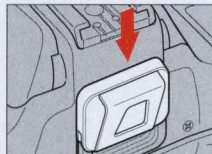

- When using any Auto exposure mode, attach the eyepiece cover (provided) to the viewfinder eyepiece before setting self-timer. The eyepiece cover prevents stray light from entering viewfinder and affecting exposure.
- In Single Servo AF mode, self-timer operates only when in-focus indicator (●) appears inside viewfinder.
- Regardless of film advance mode setting, continuous shooting is not performed.
- At **bulb** setting, shutter will release at around 1/30 sec.

## LONG TIME EXPOSURE USING *bulb* SETTING

At *bulb* setting, shutter remains open as long as shutter release button remains depressed.

To avoid camera shake, which may cause picture blur, use a tripod. Use of remote control accessories such as Nikon Remote Cord MC-12B, Modulite Remote Control Set ML-2, etc. is also recommended to avoid camera shake.

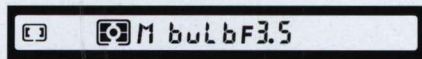
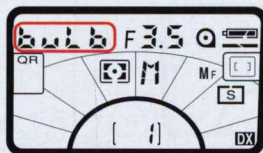

- 1 Hold FUNCTION button until the Function Area indicator shows Exposure Mode Area and exposure mode symbol starts blinking. Then hold SET/☺ button and rotate command dial until *M* for Manual exposure mode appears on LCD panel and viewfinder.
- 2 Remove your finger from SET/☺ button, rotate command dial until *bulb* appears in LCD panel and viewfinder.
- 3 Fully depress shutter release button and hold it as long as desired.

# FLASH PHOTOGRAPHY

Flash can be used not only in dim light, but also in bright conditions to fill in shadows with extra light. This technique is called "fill-flash."

With the N70's built-in flash or any dedicated Nikon Speedlight, you can perform advanced fill-flash technique, Automatic Balanced Fill-Flash with TTL Multi-Sensor. This assures a correct and well-balanced exposure of both the main subject and the background. Make fill-flash a standard part of your photography. You can make better flash pictures than ever before.

## USING BUILT-IN FLASH



When subject brightness is insufficient, the flash-recommended light (green ⚡) lights up inside the viewfinder when you lightly press shutter release button to activate the exposure meter.

You can use the built-in flash anytime, regardless of ambient lighting. For example, if your subject is backlit, you can use the built-in flash to illuminate your subject and fill in shadows.

### **AUTOMATIC BALANCED FILL-FLASH WITH TTL MULTI SENSOR—3D MULTI-SENSOR BALANCED FILL-FLASH AND MULTI-SENSOR BALANCED FILL-FLASH**

Combined with a D-type AF Nikkor lens, in automatic exposure mode, the N70's built-in flash performs 3D Multi-Sensor Balanced Fill-Flash. In 3D Multi-Sensor Balanced Fill-Flash operation, just after you depress shutter release button and before the shutter is activated, the built-in flash will fire a series of weak pre-flashes (Monitor Pre-flashes) that are detected by the camera's TTL Multi Sensor, then analyzed for brightness and contrast. Additionally, Distance Information from the D-type AF Nikkor lens in use, along with other exposure control information, is integrated, thus automatically compensating flash output level so that flash output and ambient light are balanced. The Monitor Pre-flashes enable 3D Multi-Sensor Balanced Fill-Flash to ensure correct exposure even in difficult situations, including scenes with a very reflective object such as a mirror or a white wall, and scenes with a very dark backgrounds.

3D Multi-Sensor Fill-Flash is performed with all the meters—Matrix, Center-Weighted and Spot.

When the camera and the built-in flash are used with a non-D-type AF Nikkor lens, Multi-Sensor Balanced Fill-Flash, which offers the same flash output control system but without Distance Information, is performed.

## CENTER-WEIGHTED/SPOT FILL-FLASH

If you are using a lens without CPU (a lens other than AF Nikkor and AI-P-Nikkor), in automatic exposure mode, Center-Weighted Fill-Flash with Center-Weighted Metering and Spot Fill-Flash with Spot Metering are performed as Automatic Balanced Fill-Flash. Flash output is properly compensated to produce a natural fill-flash effect.

## STANDARD TTL FLASH

In Manual exposure mode, standard TTL Flash will be performed, regardless of metering system and lens in use. To cancel Monitor Pre-flashes, perform Standard TTL Flash by setting exposure mode to Manual.

### Using 3D Multi-Sensor Balanced Fill-Flash with two subjects at greatly different distances.

If you first focus on one subject and then, with the focus locked, recompose the shot on another subject, it may result in an incorrect exposure. This is because the focusing distance for the first subject only was sent to the camera's computer. To correct this, refocus on the second subject or cancel the 3D Multi-Sensor Balanced Fill-Flash to activate the Standard TTL Flash.

### Important!

- Do not touch the flash when it is firing; normal operation can cause it to heat up.
- Never fire the flash more than 20 consecutive times at intervals of 5 sec. or shorter. This may impair flash performance. If you fire the flash 20 consecutive times at intervals of 5 sec. or shorter, let the flash rest at least 10 minutes before firing again.

When you continuously fire the flash, the camera's handgrip may become hot; this is normal. Continuous firing will result in a longer interval before the ready-light lights up because it takes longer for the flash to recharge automatically.

- When the built-in flash is activated, an accessory Speedlight will not fire. When using a Speedlight, keep the built-in flash in the locked down position.
- For usable lenses with built-in flash, see page 96.

### Built-in flash specifications

Usable film speed: ISO 25 to ISO 800  
Guide number: 14 (m) or 46 (ft.) at ISO 100 at  
20°C/68°F  
Angle or coverage: 28mm or longer lens

## BUILT-IN FLASH OPERATION

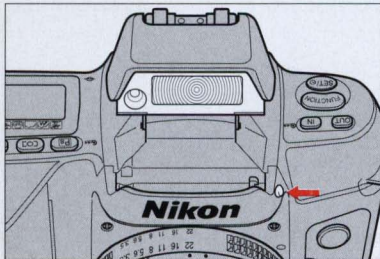

**1** Press the flash lock-release to release and activate the built-in flash.

- If continuous shooting (☞ or ☞) is set on the camera, it automatically switches over to single-frame shooting (☞) when the built-in flash pops up. In this case, ☞ or ☞ blinks in LCD panel.
- If Wide Area focus is set on the camera, it automatically switches over to Spot Area focus when the built-in flash pops up. In this case, ☞ blinks in LCD panel, and ☞ appears inside the viewfinder.

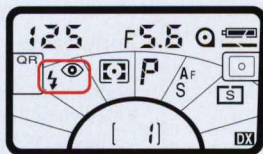

**2** Set metering system to Matrix (☞) and set exposure mode as desired. Then set flash sync mode as desired. (See page 68). In the example illustration, Red-Eye Reduction mode is set.

**3** Set shutter speed and aperture. (See table on page 91).

### For Slow Sync

- Set exposure mode to Programmed Auto (P) or Aperture-Priority Auto (A).
- Slow Sync is automatically set with Night Scene Program and Motion Effect Program.
- Use a tripod to prevent camera shake.

### For Rear-Curtain Sync

- Since Rear-Curtain Sync is especially effective at a slow shutter speed, Slow Sync is automatically set at the same time that Rear-Curtain Sync is set in Programmed or Aperture-Priority Auto exposure mode.
- When selecting a slower shutter speed, use a tripod to prevent camera shake.



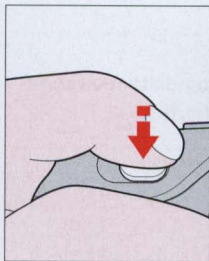

**4** Compose and lightly press shutter release button. Confirm that ready-light (red ⚡) lights up.

- If electronic analog display is shown in Shutter-Priority, Aperture-Priority Auto or Manual exposure mode, background may be underexposed. To obtain correct exposure for background:

**In Shutter-Priority Auto exposure mode:** Set a slower shutter speed.

**In Aperture-Priority Auto exposure mode:** Set flash sync mode to Slow Sync to extend the automatically controlled shutter speed range, or set a wider aperture.

**In Manual exposure mode:** Set a slower shutter speed and/or a wider aperture.

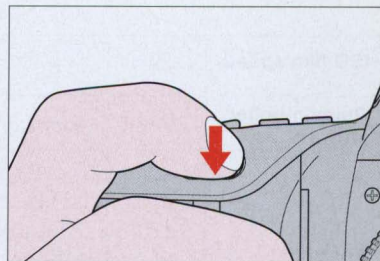

**5** Make sure the subject is within the flash shooting distance range (page 90), then fully depress shutter release button to take a shot with flash. After shooting, check ready-light again. If it blinks for a few seconds after shooting, the light might have been insufficient. Confirm shooting distance and if necessary, move closer to the subject or select a wider aperture.

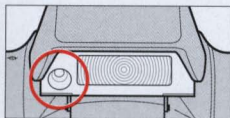

### With Red-Eye Reduction

Before shutter release, the red-eye reduction lamp lights up for approx. one second to make the subject's eye pupils become smaller, thus reducing the appearance of red-eye.

## FLASH SHOOTING DISTANCE RANGE

ISO film speed	25	50	100	200	400	800	Flash shooting distance range (m/ft.)
Guide number (m/ft.)	7/23	9.9/32.5	14/46	19.8/65	28/91.9	39.6/129.9	
Aperture	—	—	1.4	2	2.8	4	2.0 – 9.9 (6.6 – 32.5)
	—	1.4	2	2.8	4	5.6	1.4 – 7.0 (4.6 – 23)
	1.4	2	2.8	4	5.6	8	1.0 – 5.0 (3.3 – 16.4)
	2	2.8	4	5.6	8	11	0.7 – 3.5 (2.3 – 11.5)
	2.8	4	5.6	8	11	16	0.6 – 2.5 (2.0 – 8.2)
	4	5.6	8	11	16	22	0.6 – 1.8 (2.0 – 5.9)
	5.6	8	11	16	22	32	0.6 – 1.3 (2.0 – 4.3)
	8	11	16	22	32	—	0.6 – 0.9 (2.0 – 3.0)

## SHUTTER SPEED/APERTURE FOR EACH EXPOSURE MODE

When setting shutter speed and aperture, refer to the following table.

Camera's exposure mode	Shutter speed	Aperture
Programmed Auto (P, P <sub>s</sub> )	Automatically controlled from 1/125 sec. to 1/60 sec.*1	Set lens to its minimum aperture. Aperture is automatically controlled between f/2.8 and lens minimum aperture.
Shutter-Priority Auto (S)	Manually set as desired from 1/125 sec. to 30 sec.*2	
Aperture-Priority Auto (A)	Automatically controlled from 1/125 sec. to 1/60 sec.*1	Manually set as desired.
Manual (M)	Manually set as desired from 1/125 sec. to 30 sec.*2	

\*1 With Slow Sync or Rear-Curtain Sync, automatically controlled shutter speed range is extended down to 30 sec.

\*2 If you set shutter speed at 1/250 sec., or faster, camera automatically shifts to 1/125 sec., as soon as Speedlight is turned on. In this case, blinking shutter speed indication in LCD panel shows manually set shutter speed while shutter speed indication inside viewfinder shows 1/25.

## FLASH OUTPUT LEVEL COMPENSATION— TO MAKE FLASH-ILLUMINATED SUBJECT BRIGHTER OR DARKER

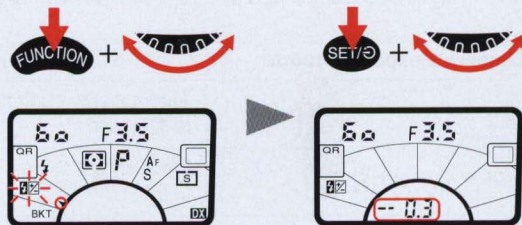

To manually adjust the flash light output level, use Flash Output Level Compensation. You can adjust the light output level from -3 EV to +1 EV in 1/3 steps.

- Flash Output Level Compensation can be set only when the built-in flash is activated or when attached Nikon Speedlight is turned on.

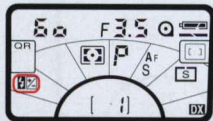

- 1 Activate the built-in flash or turn on the attached Nikon Speedlight.
- 2 Hold FUNCTION button and rotate command dial until the Function Area indicator indicates blinking **BKT** in the Compensation Area. Then hold SET/OK button and rotate command dial until desired compensation value appears in place of frame counter on LCD panel.  
(In the example above, -1/3 compensation is set.)



3 To complete setting, remove your finger from SET/☺ button. Once set, Flash Output Level Compensation remains fixed until reset. Although  stays on to indicate that Flash Output Level Compensation is set, the compensation value disappears from LCD readout when you remove your finger from SET/☺ button. Inside the viewfinder,  appears.

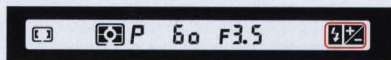
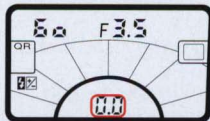

4 After shooting, be sure to reset amount of compensation to "0" to resume normal operation. If you store the built-in flash in the down position or turn off the attached Speedlight, compensation value is automatically reset to "0".

## FLASH EXPOSURE BRACKETING

To bracket exposure in flash photography, use Flash Exposure Bracketing function. You can shoot the same subject at three different flash light output level, with a varying flash output level compensation degree of 0.3 EV, 0.5 EV, 0.7 EV or 1 EV.

If you set a compensation degree of 0.5 EV, for example, you will take three pictures, the first shot having a -0.5 EV compensation, the second shot having no compensation and the third shot with a compensation of +0.5 EV.

- Flash Exposure Bracketing can be set only when the built-in flash is activated or when attached Nikon Speedlight is turned on.
- When using Flash Exposure Bracketing with Exposure Compensation function, the compensated value will be added. For example, if exposure has been compensated at +1 EV and you set Flash Exposure Bracketing with 0.5 EV degree, the first shot will be taken with +0.5 EV compensation, the second shot with +1 EV compensation and the third shot with +1.5 EV compensation.

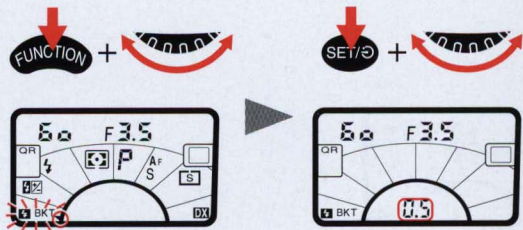

- 1 Activate the built-in flash or turn on the attached Nikon Speedlight.
  - With the accessory Nikon Speedlight, set the flash exposure mode to TTL auto.
- 2 Hold FUNCTION button and rotate command dial until the Function Area indicator indicates blinking **BKT** in the Bracketing Area. Then hold SET/OK button and rotate command dial until your desired compensation degree appears in place of frame counter.
  - If All Mode Exposure Bracketing has already been set, setting Flash Exposure Bracketing cancels All Mode Exposure Bracketing.

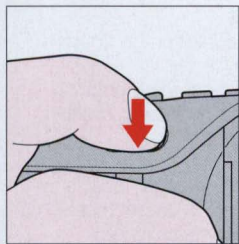

First shot is taken.

Second shot is taken.

Third shot is taken.

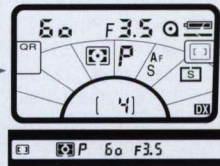
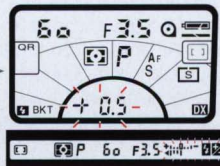
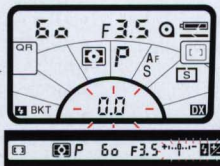
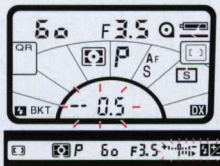

3 Remove your finger from SET/OK button to complete setting.

4 Compose picture, lightly press shutter release button, confirm focus and exposure, and confirm the ready-light comes on.

Inside the viewfinder, and the electronic analog display showing direction of compensation blink.

5 Regardless of the film advance mode setting, fully depress shutter release button three times to take the three shots.

- If film reaches end of roll during shooting, rewind film, load a new roll of film, fully depress shutter release button to advance film to frame 1, then fully depress shutter release button again to resume operation.
- Turning the camera's power off, storing the built-in flash to down position or turning off the attached Speedlight cancels Flash Exposure Bracketing.

6 After three shots are taken, Flash Exposure Bracketing is automatically canceled. If you want to take one more set of exposure bracketing shooting with the same degree of compensation, press FUNCTION button then SET/OK button.

- If you set self-timer immediately after setting Flash Exposure Bracketing, you can perform self-timer shooting without bracketing. After self-timer shooting, fully depress shutter release button to perform Flash Exposure Bracketing.

## USABLE LENSES WITH BUILT-IN FLASH

### Usable AF Nikkor lenses (including D-type lenses)

- 28mm to 300mm non-zoom AF Nikkor lenses (AF Nikkor 28mm f/1.4 cannot be used when shooting a subject within 0.7m or 2.3 ft.; AF Nikkor 300mm f/2.8 cannot be used when shooting a subject within 3.2m or 10.5 ft.)
- AF 20-35mm f/2.8 at 35mm focal length\*1
- AF 24-50mm f/3.3-4.5 at 28mm or longer focal length
- AF 24-120mm f/3.5-5.6 at 35mm or longer focal length\*2
- AF 28-70mm f/3.5-4.5
- AF 28-80mm f/3.5-5.6
- AF 28-85mm f/3.5-4.5 at 35mm or longer focal length
- AF 35-70mm f/2.8\*3
- AF 35-70mm f/3.3-4.5
- AF 35-80mm f/4-5.6
- AF 35-105mm f/3.5-4.5
- AF 35-135mm f/3.5-4.5
- AF Micro 70-180mm f/4.5-5.6 ED\*4
- AF 70-210mm f/4-5.6
- AF 75-300mm f/4.5-5.6
- AF 80-200mm f/2.8
- AF 80-200mm f/4.5-5.6

\*1 Cannot be used when shooting a subject within 0.8m (2.6 ft.) .

\*2 Cannot be used when shooting a subject within 0.8m (2.6 ft.) at 35mm focal length.

\*3 Cannot be used when shooting a subject within 1m (3.3 ft.) at 35mm focal length .

\*4 Cannot be used when shooting a subject within 0.8m (2.6 ft.) at 85mm or less focal length.

\*5 Cannot be used when shooting a subject within 1m (3.3 ft.) at 28mm focal length.

### Usable non-AF Nikkor lenses

- AI-type (including AI-S and AI-modified) 28mm to 200mm non-zoom lenses except 200mm f/2
- AI or AI-S 25-50mm f4 at 40mm or longer focal length\*1
- AI-S 28-85mm f/3.5-4.5 at 35mm or longer focal length
- AI 28-45mm f/4.5\*5
- AI 35-70mm f/3.5 \*3
- AI-S or AI 50-300mm f/4.5 at 135mm or longer focal length
- AI-modified 50-300mm f/4.5 at 200mm or longer focal length
- AI 80-200mm f/2.8 at 105mm or longer focal length
- AI-modified 85-250mm f/4 at 135mm or longer focal length

- Do not use a lens hood; it could cause slight vignetting.
- With zoom lenses, do not shoot within the macro range (indicated by the orange line on the lens).



# USING ACCESSORY NIKON SPEEDLIGHTS

## SPEEDLIGHT COMPATIBILITY

The table below shows the available flash modes for each Nikon Speedlight.

Speedlight	Connection	Available flash mode		
		TTL auto <sup>*1</sup>	Non-TTL Auto <sup>*2</sup>	Manual <sup>*2</sup>
SB-28, SB-27, SB-26, SB-25, SB-24, SB-22, SB-21B <sup>*3</sup> , SB-20, SB-16B and SB-15	Direct	Yes	Yes	Yes
SB-23	Direct	Yes	No	Yes
SB-21A and SB-16A <sup>*3</sup>	Via Flash Unit Coupler AS-6	No	Yes	Yes
SB-11, SB-14 and SB-140 <sup>*4</sup>	Via TTL Remote Cord SC-23	Yes	Yes	Yes
	Via Sensor Remote Cord SC-13 with sensor unit or Sync Cord (SC-11/SC-15) with AS-15 coupled	No	Yes	Yes

<sup>\*1</sup> In TTL auto flash mode, N70 camera performs Automatic Balanced Fill-Flash or Standard TTL Flash. For details, see pp. 98-99. For TTL auto flash mode, usable film speed range is ISO 25 to ISO 1000.

<sup>\*2</sup> Set the camera's exposure mode to Aperture-Priority Auto or Manual.

<sup>\*3</sup> The difference between SB-21A and SB-21B, or between SB-16A and SB-16B, is the type of controller attached. (For details, see specific Speedlight's manual).

<sup>\*4</sup> Ultraviolet and infrared photography can be performed in manual flash mode only.

### When using Programmed Auto exposure mode

Only TTL auto flash mode can be used. If a flash mode other than TTL auto is set on the Speedlight, turning on the Speedlight locks the shutter. In this case **FEE** and exposure mode indicator (**P** or **P<sub>s</sub>**) blink in LCD panel, warning that the flash mode should be set to TTL auto.

## TYPE OF TTL AUTO FLASH

With the Nikon Speedlight set for TTL auto flash (see chart on page 97 for compatibility), Automatic Balanced Fill-Flash (including 3D Multi-Sensor Balanced Fill-Flash, Multi-Sensor Balanced Fill-Flash and Center-Weighted Fill-Flash/Spot Fill-Flash) or Standard TTL Flash is performed.

Speedlight	Lens	Camera exposure mode			
		Programmed Auto	Shutter-Priority Auto	Aperture-Priority Auto	Manual
SB-28, SB-27, SB-26 or SB-25 <sup>1</sup>	D-type AF Nikkor lens	3D Multi-Sensor Balanced Fill-Flash			
	Non-D-type AF Nikkor lens (except AF-Nikkor lens for F3AF)/AI-P-Nikkor lens	Multi-Sensor Balanced Fill-Flash			
	Other lenses (or with accessories)	—		Center-Weighted Fill-Flash/ Spot Fill-Flash	
SB-24 <sup>2</sup>	AF Nikkor lens (except AF-Nikkor lens for F3AF)/AI-P-Nikkor lens	Multi-Sensor Balanced Fill-Flash			
	Other lenses (or with accessories)	—		Center-Weighted Fill-Flash/ Spot Fill-Flash	
SB-23, SB-22, SB-20, SB-21B <sup>3</sup> , SB-16B, SB-15, SB-14 <sup>4</sup> , SB-11 <sup>4</sup> or SB-140 <sup>4</sup>	AF Nikkor lens (except AF-Nikkor lens for F3AF)/AI-P-Nikkor lens	Multi-Sensor Balanced Fill-Flash			Standard TTL Flash
	Other lenses (or with accessories)	—		Center-Weighted Fill-Flash/ Spot Fill-Flash	

- \*1 In the Speedlight's LCD readout,  and  appear for 3D Multi-Sensor Balanced Fill-Flash/Multi-Sensor Balanced Fill-Flash, or  and  appear for Center-Weighted/Spot Fill-Flash.  
By pressing the Speedlight's M button(or MODE button with the SB-28), you can cancel Automatic Balanced Fill-Flash control to perform Standard TTL Flash operation. For Standard TTL Flash, the Speedlight's LCD panel shows  without /. For details, see instruction manual of SB-28/SB-27/SB-26/SB-25.
- \*2 In the Speedlight's LCD readout,  and  appears for Multi-Sensor Balanced Fill-Flash or Center-Weighted/Spot Fill-Flash.  
By pressing the Speedlight's M button, you can cancel Automatic Balanced Fill-Flash control to perform Standard TTL Flash operation. For Standard TTL Flash, the Speedlight's LCD panel shows  without .  
For details, see SB-24's instruction manual
- \*3 Although possible with SB-21B, Automatic Balanced Fill-Flash is not recommended.
- \*4 Via TTL Remote Cord SC-23

## WHAT YOU CAN DO WITH NIKON SPEEDLIGHTS

The main features and functions are listed below.

Speedlight	Slow Sync <sup>*1</sup>	Rear-Curtain Sync <sup>*2</sup>	Repeating Flash <sup>*3</sup>	Flash Output Level Compensation <sup>*4</sup>	Flash Exposure Bracketing <sup>*5</sup>	Red-Eye Reduction <sup>*6</sup>
SB-28	Yes <sup>*7</sup>	Yes <sup>*7</sup>	Yes	Yes	Yes <sup>*8</sup>	Yes
SB-27	Yes <sup>*7</sup>	Yes <sup>*7</sup>	No	Yes	Yes <sup>*8</sup>	Yes
SB-26	Yes <sup>*7</sup>	Yes	Yes	Yes	Yes <sup>*8</sup>	Yes
SB-25	Yes <sup>*7</sup>	Yes	Yes	Yes	Yes <sup>*8</sup>	No
SB-24	Yes <sup>*7</sup>	Yes	Yes	Yes	Yes <sup>*8</sup>	No
SB-23, SB-22 and SB-20	Yes <sup>*7</sup>	Yes <sup>*7</sup>	No	No	Yes <sup>*8</sup>	No
SB-16B, SB-15, SB-11, SB-14 or SB-140	Yes <sup>*7</sup>	Yes <sup>*7</sup>	No	No	Yes <sup>*8</sup>	No
SB-21B	Yes <sup>*7</sup>	Yes <sup>*7</sup>	No	No	No	No

<sup>\*1</sup> See p.68.

<sup>\*2</sup> See p.68. With SB-28, SB-27, SB-26, SB-25 or SB-24, set the Speedlight's sync mode selector to **REAR**. Normal Sync/Rear-Curtain Sync set on the camera is ignored.

<sup>\*3</sup> See Speedlight manual.

<sup>\*4</sup> See Speedlight manual..

<sup>\*5</sup> See p.94.

<sup>\*6</sup> See p.68.

<sup>\*7</sup> Set on the camera side.

<sup>\*8</sup> Set on the camera side; in TTL auto flash exposure mode only.

## NOTES ON FLASH PHOTOGRAPHY

- Use only Nikon Speedlights. Other units may damage the camera's electrical circuits due to incompatible voltage requirements\*, electric contact alignment or switch phase.  
\* *Not compatible with 250V or higher.*
- When using a special Speedlight such as a studio strobe system, with a time-lag provision or one with a long flash duration (i.e., Medical-Nikkor 120mm f/4), adjust shutter speed down to 1/100 sec. or slower.
- Available maximum aperture for each film speed in Auto-Multi Program is:

ISO film speed						
25	50	100	200	400	800	1000
2.8	3.3	4	4.8	5.6	6.7	7.1

*If you are using a lens with a maximum aperture smaller than listed, of course, the automatically controlled aperture range is from the lens maximum aperture to its minimum aperture (i.e., its entire range.)*

- For multiple flash photography using the N70, if the electric current in the synchro circuit exceeds a certain level, you may not be able to take a second shot after taking the first shot. Take care that the combined total of the coefficient (numbers shown in parentheses below) for all Speedlights used at any one time does not exceed 20 at 20°C/68°F or 13 at 40°C/104°F.

SB-28 (1)	SB-27 (1)	SB-26 (1)	SB-25 (1)
SB-24 (1)	SB-23 (4)	SB-22 (6)	SB-21 (4)
SB-20 (9)	SB-19 (2)	SB-18 (16)	SB-17 (4)
SB-16 (4)	SB-15 (4)	SB-14 (1)	SB-12 (1)
SB-11 (1)			

If you are unable to take a second shot, disconnect the master Speedlight from the camera, or turn each of the Speedlights off and on at once. This resets the circuits so you can resume shooting.  
This also applies when using any non-Nikon studio speedlight system.

# EV CHARTS FOR FLASH PHOTOGRAPHY

For your reference, the following charts show shutter speed/aperture combination at each EV in flash photography with built-in flash:

- (a) Auto-Multi Program
- (b) Shutter-Priority Auto
- (c) Aperture-Priority Auto

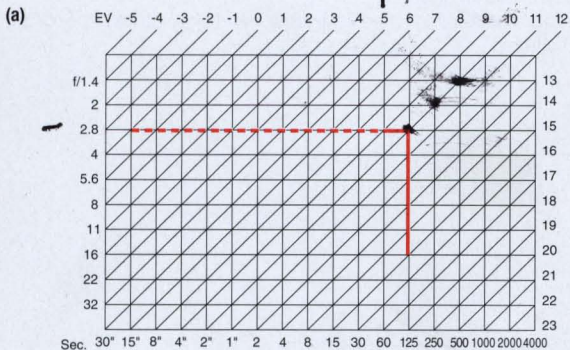

----- Slow Sync

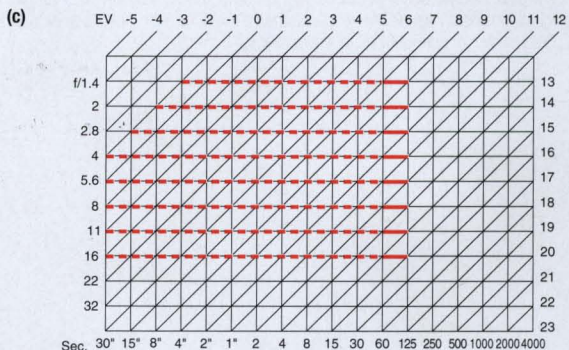
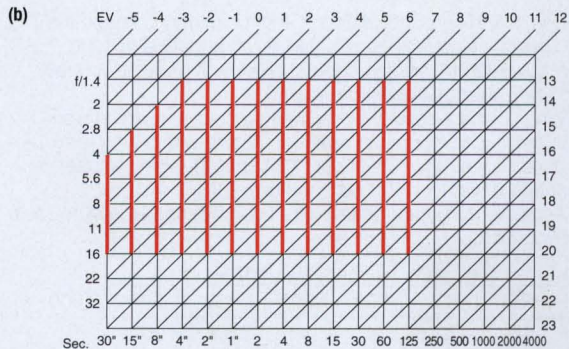

----- Slow Sync

# MISCELLANEOUS

The Nikon N70 is a high-performance, precision instrument, designed to give you superior pictures. You'll want to take good care of your camera to ensure the best performance. Take time to review this section thoroughly, and you will add to the pleasure of taking pictures.

We've also included information about Nikkor lenses and a detailed section with technical specifications. Please read them carefully.

# LENSES

## LENS COMPATIBILITY CHART

The Nikon N70 is designed for autofocus photography with AF Nikkor lenses (except AF-Nikkor lenses for F3AF). However, most other Nikon lenses can be used for standard photography according to the conditions listed in the following chart.

Lens Accessory	Focusing			Exposure mode				Metering system		
	Autofocus	Manual with Electronic Rangefinder	Manual with matte field	Programmed Auto	Shutter-Priority Auto	Aperture-Priority Auto	Manual	Matrix	Center-Weighted	Spot
AF Nikkor including D-type AF Nikkor (except AF Nikkor for F3AF)	○	○	○	○	○	○	○	○*1	○	○
AF-S/AF-I Nikkor	○	○	○	○	○	○	○	○	○	○
AF-I Teleconverter	○	○*2	○	○	○	○	○	○	○	○
AI-P-type Nikkor	×	○*3	○	○	○	○	○	○	○	○
AI- or AI-S type Nikkor	×	○*3	○	×	×	○	○	×	○	○
AI-modified Nikkor*4	×	○*3	○	×	×	○	○	×	○	○
Medical-Nikkor 120mm f/4	×	○	○	×	×	×	○*5	×	×	×
Reflex-Nikkor*7	×	×	○	×	×	○*8	○*8	×	○	○
PC-Nikkor*7	×	×	○	×	×	○*9	○*10	×	○	○
AI- or AI-S type Teleconverters (except for TC-16A)	×	○*2	○	×	×	○	○	×	○	○
Bellows Focusing Attachment PB-6	×	○*2	○	×	×	○*11	○*11	×	○	○
K Ring Set (K1, K3, K4 and K5)*12	×	○*2	○	×	×	○*13	○*13	×	○	○
Auto Extension Rings (PK-11A, PK-12, PK-13 and PN-11)*14	×	○*2	○	×	×	○	○	×	○	○

- Compatible  
 × Incompatible



- \*1 *3D Matrix Metering is selected with D-type AF Nikkor lenses and Advanced Matrix Metering is selected with non-D-type lenses.*
- \*2 *With maximum effective aperture of f/5.6 or faster.*
- \*3 *With maximum aperture of f/5.6 or faster.*
- \*4 *AI-modification is no longer available.*
- \*5 *Set shutter speed to 1/100 sec. or slower.*
- \*6 *Because the diaphragm is coupled to the focusing ring, determining exposure is independent from camera's metering system.*
- \*7 *Some lenses cannot be attached to the N70 camera. (See page 106).*
- \*8 *Aperture cannot be selected.*
- \*9 *Set preset ring, then use AE-lock lever before shifting.*
- \*10 *Set preset ring, then determine exposure before shifting.*
- \*11 *Shutter should be released after exposure is measured by stopping down PB-6.*
- \*12 *K1 Ring cannot be attached to AF Nikkor lenses. The ring may damage CPU contacts. Use PK-11A or BR-6 instead.*
- \*13 *Stop-down exposure measurement will be performed.*
- \*14 *PK-1, PK-2, PK-3 and PN-1 Rings cannot be attached to the N70 camera. PK-11 Ring cannot be attached to AF Nikkor lenses. Those rings may damage CPU contacts. Use PK-11A for AF Nikkor lenses instead of PK-11.*

● **The following Nikkor lenses cannot be attached to the N70 (camera body or lens may be damaged):**

- Non-AI lenses
- Fisheye 6mm f/5.6
- Fisheye OP 10mm f/5.6
- 200-600mm f/9.5 (Factory Serial No. 300490 or smaller)
- ED 180-600mm f/8 (No. 174166 or smaller)
- ED 360-1200mm f/11 (No. 174087 or smaller)
- 400mm f/4.5 and 600mm f/5.6 with Focusing Unit AU-1
- PC 28mm f/4 (No. 180900 or smaller)\*
- PC 35mm f/2.8 (No. 906200 or smaller)\*
- Reflex 1000mm f/11 (No. 142361 to 143000)\*
- Reflex 2000mm f/11 (No. 200310 or smaller)\*
- AF Teleconverter TC-16A

\* *Can be modified, at nominal charge, for use with the N70. Contact an authorised Nikon dealer or service facility.*

● **The following teleconverters and lenses cannot be used with the N70 (correct exposure is unobtainable):**

- AF Nikkor 80mm f/2.8
- AF Nikkor 200mm f/3.5 IF
- AF Teleconverter TC-16

**About D-type AF Nikkor lenses**

D-type AF Nikkor lenses enable you to maximize the N70's performance. They send information on lens focusing distance (e.g., Distance Information) to the N70's microcomputer for inclusion in the computations for 3D Matrix Metering. If built-in flash or Nikon Speedlight SB-28/SB-27/SB-26/SB-25 is used, this information will also contribute to 3D Multi-Sensor Balanced Fill-Flash. D-type AF Nikkor lenses are identified by the letter "D" which follows information on maximum aperture (e.g., AF Zoom-Nikkor 28-70mm f/3.5-4.5D). All AF-S/AF-I Nikkor lenses are D-type.

## ACCESSORY COMPATIBILITY

---

The following accessories cannot be used with the Nikon N70 camera:

PK-1, PK-2, PK-3, PN-1, K2 BR-2 Rings

Body Cap BF-1

Eye-piece Accessories for F3HP/F3T

- PK-1, PK-11, BR-4 and K1 Rings cannot be mounted directly on AF Nikkor lenses.
- The advanced Nikon Matrix meter evaluates scene brightness and contrast using an eight-segment sensor. Since colored filters and neutral density filters which have a high exposure factor will also significantly affect a scene's contrast rendition, they may cause the meter to incorrectly identify the scene's actual contrast/brightness condition. The blue (B12), orange (O56) and red (R60) filters are examples of such colored filters.
- Linear polarizing filters are not compatible with the viewing system used in Nikon autofocus cameras. For the best results and to maintain autofocus and exposure operation, we recommend using a circular polarizer, which is fully compatible with the Nikon system. Using a linear polarizer, however, will not damage the Nikon system, and it may be used for fully manual focusing and exposure settings made without using the built-in meter or Electronic Rangefinder.
- Special filters, such as soft focus filters, cannot be used for autofocus or for manual focus with Electronic Rangefinder.

## CAMERA CARE TIPS



1. **Do not** touch the camera's reflex mirror or focusing screen. Remove dust with a blower brush.

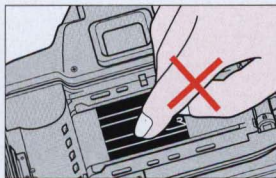

2. **Do not** touch the shutter curtains.

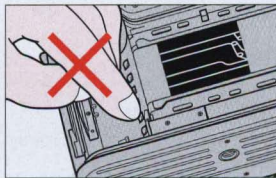

3. **Do not** touch the DX contacts. Keep them clean with a blower brush.



4. Clean the viewfinder eyepiece with a soft, clean cloth. **Do not** use alcohol.

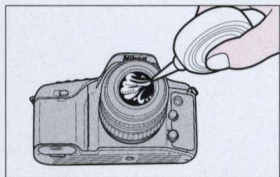

5. Clean lens surface with a blower brush. To remove dirt and smudges, use a soft, clean cotton cloth or lens tissue moistened with ethanol (alcohol) or lens cleaner. Wipe in a circular motion from center to outer edge, taking care not to leave traces and not to touch the other lens parts.

### Caution!

A spray gun-type blower may damage the optical glass if used to clean the lens, especially if ED glass is used for the front lens element. To avoid damage, hold the blower upright with its nozzle more than 30cm (approx. 12 inches) from the lens surface, and keep the nozzle moving so the stream of air is not concentrated in one spot.

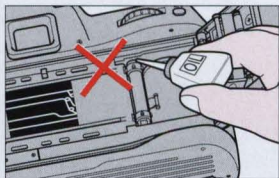

**6.** Do not lubricate the camera.

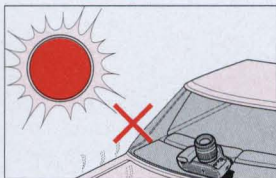

**7.** Do not leave the camera in an excessively hot place.



**8.** Keep the camera away from water or moisture. When using the camera near water, guard against splashes, especially salt water spray.



**9.** Make sure not to drop or bump the camera body/lens against a hard surface. Strong shock may cause malfunction.



**10.** If the camera malfunctions, take it immediately to an authorized Nikon dealer or service center.



**11.** Store the camera in a cool, dry place away from naphthalene or camphor (moth repellent). In a humid environment, store the camera inside a vinyl bag with a desiccant to keep out dust, moisture and salt. Note, however, that storing leather cases in vinyl bags may cause the leather to deteriorate.

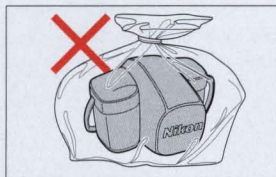

**12.** To maintain the built-in flash condenser in peak condition, fire the flash a few times every month. Thereby you can use the flash for many years.

In certain cases, due to static electricity or poorly loaded batteries, the N70 camera's microcomputer may turn the camera off, even with fresh properly installed batteries. For the same reason, film may not advance properly. In each of these cases, to resume operation, simply turn the power off, then turn it on again, or remove batteries and install them again.

Nikon cannot be held responsible for any malfunction resulting from the use of the camera other than as specified in this manual.

# NOTES ON BATTERIES



1. Keep batteries out of children's reach. If someone accidentally swallows batteries, call a doctor immediately.

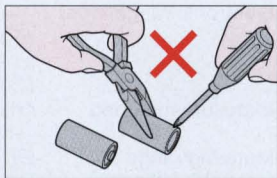

2. **Do not** disassemble, short circuit or heat batteries. **Do not** charge dry cells.

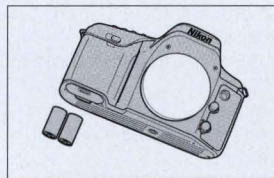

3. If you do not intend to use the camera for a long time, remove the batteries.



4. Battery power diminishes at extremely low temperatures—make sure the batteries you buy are new, and wrap the camera body in something warm.

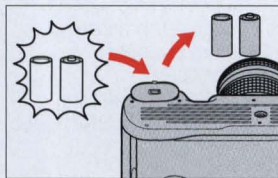

5. When replacing batteries, be sure to replace **all** batteries at the same time. Always use fresh batteries of the **same** brand.

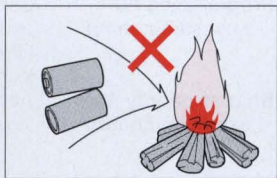

6. **Do not** throw used batteries into a fire.



7. If the battery chamber is contaminated by battery leakage, take the camera to an authorized Nikon dealer.

# SPECIFICATIONS

<b>Type of camera</b>	Integral-motor autofocus 35mm single-lens reflex	<b>Electronic rangefinder</b>	Available in Manual focus mode with AF Nikkor and other AI-type Nikkor lens with a maximum aperture of f/5.6 or faster
<b>Picture format</b>	24mm x 36mm (standard 35mm film format)	<b>Exposure metering</b>	Three built-in exposure meters —Matrix, Center-Weighted and Spot
<b>Lens mount</b>	Nikon F mount	<b>Metering range</b> (at ISO 100 with f/1.4 lens)	EV -1 to EV 20 for Matrix and Center-Weighted metering; EV 3 to EV 20 for Spot metering
<b>Lens</b>	Nikkor and Nikon lenses having Nikon F mount* <i>* With limitation; see chart on p. 104</i>	<b>Exposure meter</b>	Activated by lightly pressing shutter release button; stays on for 8 sec., after finger leaves button
<b>Focus modes</b>	Autofocus, and Manual with Electronic Rangefinder	<b>Exposure modes</b>	Programmed Auto (Auto-Multi Program and Vari-Program), Shutter-Priority Auto, Aperture-Priority Auto and Manual
<b>Autofocus area</b>	Wide and Spot selectable	<b>Programmed Auto exposure control</b>	Camera sets both shutter speed and lens aperture automatically; Flexible Program possible in increments of 1/3 EV
<b>Autofocus modes</b>	Single Servo AF and Continuous Servo AF	<b>Shutter-priority Auto exposure control</b>	Aperture automatically selected to match manually set shutter speed
<b>Focus Tracking</b>	Automatically activated when subject moves		
<b>Autofocus detection system</b>	Nikon CAM274 autofocus module		
<b>Autofocus detection range</b>	Approx. EV -1 to EV 19 (at ISO 100)		
<b>Autofocus lock</b>	Possible once stationary subject is in focus in Single Servo AF		



<b>Aperture-priority Auto exposure control</b>	Shutter speed automatically selected to match manually set aperture	<b>Viewfinder</b>	Fixed eyelevel pentaprism high-eyepoint type; 0.77X magnification with 50mm lens set at infinity; approx. 92% frame coverage
<b>Manual exposure control</b>	Both aperture and shutter speed are set manually	<b>Eyepoint</b>	Approx. 18mm
<b>Vari-Program</b>	Eight kinds built-in: Portrait Program, Hyperfocal Program, Landscape Program, Close-Up Program, Sport Program, Silhouette Program, Night Scene Program, and Motion Effect Program; each has its own program line	<b>Focusing screen</b>	New Nikon advanced B-type BriteView screen III; fixed
<b>Quick Recall function</b>	By QR button the original or favorite camera settings can be recalled; up to three settings can be memorized	<b>Viewfinder information</b>	Focus area, focus indications, exposure metering system, exposure mode, Flexible Program, shutter speed, aperture, electronic analog display, exposure compensation and flash output compensation are all shown in LCD readout; also shows flash recommended light and ready light LED
<b>Exposure compensation</b>	With exposure compensation button; $\pm 5$ EV range, in 1/3 steps	<b>LCD panel information</b>	Shutter speed, aperture, QR, focus area, film speed setting mode, film advance mode, focus mode, exposure mode, exposure metering system, flash sync mode, exposure compensation/flash output compensation, All Mode Exposure Bracketing/Flash Exposure Bracketing and frame counter/compensation value, film loading, film rewind, self-timer and battery power
<b>Auto exposure lock</b>	By pressing AE-L (auto exposure lock) button while exposure meter is activated		
<b>Shutter</b>	Electromagnetically controlled vertical-travel focal-plane shutter		
<b>Shutter release</b>	By motor trigger		
<b>Shutter speeds</b>	Lithium niobate oscillator-controlled speeds from 1/4000 to 30 sec in 1/3 EV steps; electromagnetically controlled bulb setting is provided		

<b>Viewfinder illumination</b>	Automatically activates when exposure meter is on	<b>Film rewind</b>	By pressing IN and Ps button; fast rewind or silent rewind is selectable; for fast rewind, rewind speed is approx. 12 sec. with 36-exposure film or approx. 9 sec. with 24-exposure film, and for silent rewind approx. 22 sec. with 36-exposure film or approx. 18 sec. with 24-exposure film
<b>Film speed range</b>	ISO 25 to 5000 for DX-coded film; ISO 6 to 6400 can be manually set	<b>Frame counter</b>	Additive type; counts back while film is being rewound
<b>Film speed setting</b>	At DX position, automatically set to ISO speed of DX-coded film used; manual setting possible	<b>Self-timer</b>	Electronically controlled; blinking LED indicates self-timer operation; cancelable
<b>Film loading</b>	Film automatically advances to first frame when shutter release button is depressed once	<b>Reflex mirror</b>	Automatic, instant-return type
<b>Film advance</b>	In single-frame and single-frame silent rewind mode, film automatically advances one frame when shutter is released; in continuous high or continuous low shooting mode, shots are taken as long as shutter release button is depressed; in continuous high mode, shooting speed is approx. 3.7 fps*, and in continuous low approx. 2.0 fps*; in Focus Tracking, approx. 3.1 fps for Continuous Servo AF	<b>Camera back</b>	Hinged back; unchangeable
	<i>* At shutter speeds of 1/250 sec. or higher in the Manual exposure and Manual focus modes.</i>	<b>Accessory shoe</b>	Standard ISO-type hot-shoe contact; ready-light contact, TTL flash contact, monitor contact; Mount receptacle for SB-28/SB-27/SB-26/SB-25's Posi-Mount System is provided
		<b>Built-in TTL flash</b>	Guide number: 14m or 46 ft. (at ISO 100); flash coverage: 28mm or longer lens; Red-Eye Reduction, TTL flash control including 3D Multi-Sensor Balanced Fill-Flash, Slow Sync and Rear-Curtain Sync are possible
		<b>Flash synchronisation</b>	Up to 1/125 sec.
		<b>TTL Multi Sensor</b>	Five-segment multi sensor used for TTL auto flash control

**Automatic Balanced  
Fill-Flash with TTL  
Multi Sensor**

Possible when AF Nikkor or AI-P Nikkor lens is used with built-in flash or Nikon Speedlight SB-28, SB-27, SB-26, SB-25, SB-24, SB-23, SB-22, SB-20, etc.

**Monitor Pre-flash**

Built-in flash or Nikon Speedlight SB-28/SB-27/SB-26/SB-25 fires Monitor Pre-flash(es) for TTL multi sensor when AF Nikkor or AI-P Nikkor lens is used

**Flash recommended  
light**

Lights up when flash is recommended

**Flash ready-light**



Lights up when flash is ready

**Number of 36-exposure (24-exposure) film rolls per set of fresh batteries**

	At 20°C (68°F)	At -10°C (14°F)
Without flash	115 (150)	80 (100)
With flash for half of all exposures	25 (30)	20 (25)

\* For autofocus operation using AF Zoom-Nikkor 28-70mm f/3.5-4.5D lens covering the full range from infinity (∞) to the closest distance and back to infinity (∞) before each shot, in Continuous Servo AF mode with film advance mode at CH and a shutter speed of 1/125 sec. or faster.

**Power source  
Battery power  
confirmation**

Two CR123A-type lithium batteries  for sufficient power; blinking  indicates batteries are nearing exhaustion;  indicates batteries are just about exhausted; no indication/symbol appears when batteries are completely exhausted or improperly installed

**Dimensions (WxHxD)**

Approx. 151 x 103 x 70mm or 5.9 x 4.1 x 2.8 in.







**Weight  
(without batteries)**

Approx. 585 g or 20.6 oz.

*All specifications apply when fresh CR123A-type batteries are used, at normal temperature (20°C or 68°F).*

*Specifications and design are subject to change without notice.*

# LCD PANEL/VIEWFINDER INDICATIONS

LCD Panel/Viewfinder	Shutter	Cause and Remedy
 blinks in the LCD panel.	Can be released.	Batteries are nearing exhaustion. Have a fresh one ready.
 blinks in the LCD panel (with or without blinking Err in the LCD panel and viewfinder).	Locked.	Batteries are just about exhausted. Turn the power off and replace battery with new one.
Err and  blink in the LCD panel.*	Locked.	Film is not correctly positioned. Reload film.
Err  and ISO blink in the LCD panel.*	Locked.	Non-DX-coded film or film with unacceptable DX code is loaded although auto film speed setting mode is activated. Set film speed manually.
Err and  blink in the LCD panel.*	Locked.	Camera back is opened during film rewind and film rewind will stop at mid-roll. To restart film rewind, press the <b>IN</b> button and <b>Ps</b> button.
 blinks in the LCD panel.	Locked.	An exposed DX-coded film left in the film cartridge chamber. Remove film cartridge.

\* "Err" also blinks in the viewfinder.

LCD Panel/Viewfinder	Shutter	Cause and Remedy
<p><b>Err</b> blinks in the LCD panel.</p>	<p>Can be released.</p>	<p>Matrix meter is set even though lens attached has no CPU; camera automatically resets metering system to Center-Weighted metering.</p>
<p><b>P</b> or <b>S</b> blinks and <b>F--</b> appears in the LCD panel.</p>	<p>Can be released.</p>	<p>Auto-Multi Program or Shutter-Priority Auto exposure mode is set even though lens attached has no CPU. Camera automatically resets exposure mode to Aperture-Priority Auto.</p>
<p><b>P<sub>s</sub></b> blinks and <b>F--</b> appears in the LCD panel.</p>	<p>Locked.</p>	<p>Vari-Program is set even though lens attached has no CPU.</p>
<p><b>FEE</b> blinks in the LCD panel in Programmed Auto or Shutter-Priority Auto exposure mode.*</p>	<p>Locked.</p>	<p>Lens is not set to the smallest aperture setting. Set lens to the smallest aperture.</p>
<p><b>FEE</b> and Programmed Auto exposure indicator (<b>P</b> or <b>P<sub>s</sub></b>) blink in the LCD panel* when accessory Nikon Speedlight is used.</p>	<p>Locked.</p>	<p>Attached Speedlight is not set at TTL Auto flash. Set the Speedlight flash mode to TTL, or set the camera's exposure to a mode other than Programmed Auto.</p>

\* "Err" also blinks in the viewfinder.

LCD Panel/Viewfinder	Shutter	Cause and Remedy
A <sub>F</sub> -S or A <sub>F</sub> -C blinks.	Locked.	Focus mode selector is set at <b>AF</b> even though a non-AF Nikkor lens is attached. Set focus mode selector to <b>M</b> .
▶ ◀ blinks in the viewfinder.	Depends on AF mode. Locked in Single Servo AF or can be released in Continuous Servo AF.	Autofocus is impossible with the subject. Set focus mode selector to <b>M</b> and focus manually using clear matte field.
◀ stays in the viewfinder in AF mode.	Depends on AF mode. Locked in Single Servo AF or can be released in Continuous Servo AF.	Subject is located closer than the closest focusing distance of the lens. Move away from subject and refocus.
H I blinks in Auto exposure mode.	Can be released.	Overexposure possible.
L O blinks in Auto exposure mode.	Can be released.	Underexposure possible.

LCD Panel/Viewfinder	Shutter	Cause and Remedy
bulb blinks.	Locked.	<p>a) "Bulb" is set in the Shutter-Priority Auto exposure mode. Set exposure mode to Manual or set another shutter speed.</p> <p>b) You set All Mode Exposure Bracketing with a shutter speed set at "Bulb". To use All Mode Exposure Bracketing, select another shutter speed setting.</p>
Shutter speed indication blinks inside viewfinder in Programmed Auto or Aperture-Priority Auto Exposure mode.	Can be released.	Automatically selected shutter speed is 1/50 sec. or slower and picture blur may occur due to camera shake. To reduce possibility of blur, hold camera very steady, use a tripod or use the built-in flash or an accessory Nikon Speedlight. Selecting a wider aperture (smaller f-number) results in a faster shutter speed.
Shutter speed indication in the LCD panel and viewfinder blinks.	Can be released.	You are performing All Mode Exposure Bracketing in Manual exposure mode.

LCD Panel/Viewfinder	Shutter	Cause and Remedy
Shutter speed indication in the LCD panel blinks and 1/25 is indicated inside viewfinder in flash photography.	Can be released.	You set shutter speed faster than 1/125 sec. and shutter speed automatically shifts to 1/125 sec.
" or " blinks in the LCD panel.	Can be released.	Built-in flash or accessory Nikon Speedlight is turned on with film advance mode set for continuous shooting. Camera automatically resets film advance mode to single-frame shooting (S).
" blinks in LCD panel and " appears inside the viewfinder.	Can be released.	Built-in flash or accessory Nikon Speedlight is turned on with Wide Area focus. Camera automatically resets focus area to Spot.
Green " lights up inside the viewfinder.	Can be released.	Your subject is too dark. Use built-in flash or Nikon Speedlight.
Red " blinks inside the viewfinder after flash shooting.	Can be released.	Light might have been insufficient. Confirm shooting distance and, if necessary, move closer to the subject or select a wider aperture.



LCD Panel/Viewfinder	Shutter	Cause and Remedy
⚡ and 👁 blink in the LCD panel.	Can be released.	Red-Eye Reduction is set with Speedlight other than the Nikon SB-28/SB-27/SB-26. Camera automatically switches flash sync mode to Normal Sync.
⚡, 👁 and SLOW blink in the LCD panel.	Can be released.	<ul style="list-style-type: none"> <li>• Red-Eye Reduction with Slow Sync is set with Speedlight other than the Nikon SB-28/SB-27/SB-26. Slow Sync will be performed without Red-Eye Reduction.</li> <li>• When Night Scene Program or Motion Effect Program is selected, you try to set Red-Eye Reduction with Speedlight other than SB-28/SB-27/SB-26. Slow Sync will be performed without Red-Eye Reduction.</li> </ul>

#### ABOUT LCD

- The N70 uses a Liquid Crystal Display (LCD) of the highest quality which, under conditions of normal use, should provide several years of reliable operation. After this period, contrast may deteriorate and display information may start to fade. You can have the LCD replaced at a nominal charge by contacting an authorized Nikon dealer or service facility.
- At high temperatures of 60°C /140°F or above, the display turns black, making it impossible to read. It returns to normal when the temperature drops to 20°C/68°F.
- At temperatures below freezing, the LCD's response time slows down; it goes back to normal when the temperature rises.

## **AE (Automatic Exposure) lock**

Used to hold an automatically controlled shutter speed and/or aperture. Recommended when the photographer wants to control an exposure based on a scene's particular brightness area with Center-Weighted or Spot Metering.

## **All Mode Exposure Bracketing**

All Mode Exposure Bracketing performs automatic exposure bracketing with varied shutter speed and/or aperture in all exposure modes. (See "Exposure bracketing".)

## **Automatic Balanced Fill-Flash**

A type of TTL auto flash operation which uses the camera's exposure meter to control ambient light exposure settings, integrated with flash exposure control. That is, flash output level is automatically compensated to balance with ambient light, resulting in a better exposure for both subject and background. Nikon's Automatic Balanced Fill-Flash system includes: 3D Multi-Sensor Balanced Fill-Flash, Multi-Sensor Balanced Fill-Flash, Matrix Balanced Fill-Flash\*, Center-Weighted Fill-Flash and Spot Fill-Flash. 3D Multi-Sensor Balanced Fill-Flash and Multi-Sensor Balanced Fill-Flash together comprise Automatic Balanced Fill-Flash with TTL Multi-Sensor (p. 86). Performance varies with the combination of camera body, Speedlight and lens used

\* Not available with N70 camera.

With the built-in flash or dedicated Nikon Speedlight, the N70 performs Automatic Balanced Fill-Flash with TTL Multi-Sensor for a built-in flash or compatible Nikon TTL Speedlight (p. 98).

## **Auto-Multi Program**

With Auto-Multi Program, more than two combinations of shutter speed/aperture are applied. When lens focal length in use is shifted, shutter speed/aperture combination shifts while maintaining correct exposure.

## **Balanced fill-flash operation**

A technique in flash photography in which flash illumination is controlled to balance it with the ambient light on the scene.

## **Continuous Servo AF**

Focus detection continues for as long as the shutter release button is lightly pressed and the reflex mirror is in the viewing position. Useful when camera-to-subject distance is likely to change.

## **CPU**

Central Processing Unit. The electronic component which controls an electronic product's functions. AF Nikkor (including D-type AF Nikkor) and AI-P-Nikkor lenses have built-in CPUs.

### **Depth of field**

The zone of sharpest focus in front of, behind and around the subject on which the lens is focused. When this zone of sharpness is large, the depth of field is said to be deep; when it is small, the depth of field is said to be shallow. Depth of field varies according to numerous factors such as focal length, aperture, shooting distance, etc.

### **D-type AF Nikkor lenses**

AF Nikkor lenses that send to the N70's microcomputer the Distance Information used for 3D Matrix Metering or 3D Multi-Sensor Balanced Fill-Flash (with Nikon SB-28/SB-27/SB-26/SB-25 Speedlight).

Identified by the letter "D" which follows information on maximum aperture (e.g., AF Zoom-Nikkor 35-80mm f/4-5.6D). All AF-S/AF-I Nikkor lenses are D-type.

### **DX code**

Film information code printed on film cartridge. The N70, when set to automatic film speed setting mode, senses the film speed (ISO 25 to 5000) of DX-coded film when it is loaded.

### **EV**

Exposure Value: A number representing the available combinations of shutter speeds and apertures that give the same exposure effect under conditions of similar scene brightness and ISO.

At ISO 100, the combination of a one-second shutter speed and an aperture of f/1.4 is defined as EV 1.

The camera may be used only within the EV range of the exposure meter. For example, with the N70, the exposure metering range is from EV -1 to EV 20 for Matrix metering and Center-Weighted metering, at ISO 100 with an f/1.4 lens.

### **Exposure bracketing**

Shooting the same subject at a range of different exposures. The N70 camera provides All Mode Exposure Bracketing and Flash Exposure Bracketing.

### **Exposure compensation**

Exposure compensation for available light is activated by changing shutter speed and/or lens aperture— by Auto exposure lock button, by exposure compensation function or by exposure bracketing.

In flash photography with a Nikon-dedicated TTL Speedlight, exposure compensation can also be performed by varying the amount of flash output. (See "Flash Output Level Compensation.")

### **Exposure control**

Programmed Auto: Camera sets both shutter speed and aperture for correct exposure. N70 camera applies two Programmed Auto Exposure Control, Auto-Multi Program and Vari-Program.

Shutter-Priority Auto: User selects shutter speed and camera sets matching lens aperture for correct exposure.

Aperture-Priority Auto: User selects aperture and camera sets matching shutter speed for correct exposure.

Manual: User selects both shutter speed and aperture, following or ignoring the meter's recommendations (by LCD readout) to achieve the desired exposure.

### **Fill-flash**

A method of flash photography which combines flash illumination and ambient light, but does not necessarily attempt to balance these two types of illumination.

### **Flash Exposure Bracketing**

Enables a photographer to automatically bracket exposures at varied flash output levels, in TTL auto flash shooting, without changing the shutter speed and/or aperture. (See "Exposure bracketing".)

### **Flash Output Level Compensation**

A control used to adjust a TTL auto flash operation, enabling an increase or decrease of flash output to lighten or darken the flash effect.

### **Flash shooting distance range**

The distance range over which a flash can effectively provide light. Flash shooting distance range is controlled by the amount of flash output available. Each automatic Speedlight's flash output varies from maximum duration to minimum duration. Close-up subjects will require lower (to minimum) output, while more distant subjects will require more light up to the maximum output.

The flash shooting distance range varies with the aperture, film speed, etc.

### **Flash sync speed**

Shutter speed at which the entire film frame to be open when the flash is fired in flash shooting. The N70's flash sync speed is 1/125 sec. or slower.

### **Flexible Program**

Flexible Program function temporarily shifts an automatically selected shutter speed/aperture combination while maintaining correct exposure. That is, a desired shutter speed or aperture can be selected in Programmed Auto exposure mode.

### Focus Tracking

Enables the camera to analyze the speed of the moving subject according to the focus data detected, and to obtain correct focus by anticipating the subject's position—and driving the lens to that position—at the exact moment of exposure.

### f-number

The numbers on the lens aperture ring and on the camera's LCD which indicate the relative size of the lens aperture opening. The f-number series is a geometric progression based on changes in the size of the lens aperture, as it is opened and closed. As the scale rises, each number is multiplied by the factor 1.4. The standard numbers for calibration are 1.0, 1.4, 2, 2.8, 4, 5.6, 8, 11, 16, 22, 32, etc., and each change results in a doubling or halving of the amount of light transmitted by the lens.

### Focal length

The distance from the principal point to the focal point. In 35mm-format cameras, lenses with a focal length of approx. 50mm are called normal or standard lenses. Lenses with a focal length less than approx. 35mm are called wideangle lenses, and lenses with a focal length more than approx. 85mm are called telephoto lenses. Lenses which allow the user to continuously vary the focal length without changing focus are called zoom lenses.

### Front-Curtain Sync

The flash fires an instant after the front curtain of a focal plane shutter has completed its travel across the film plane. This is the way the N70 operates with the flash sync mode at Normal Sync. (See "Rear-Curtain Sync".)

### Guide number

The guide number indicates the power of a flash in relation to ISO film speed. Guide numbers are quoted in either meters or feet. Guide numbers are used to calculate the f/stop for correct exposure as follows:

$$f/stop = \frac{\text{guide number}}{\text{flash-to-subject distance}}$$

Using a selected aperture, we can calculate the required flash-to-subject distance with the formula:

$$\text{flash-to-subject distance} = \frac{\text{guide number}}{f/stop}$$

Useful for determining the maximum flash-to-subject distance for flash photography.

### **Hyperfocal distance**

The closest point a photographer can focus on where the depth of field includes infinity. When the lens is focused for hyperfocal distance, the deepest depth of field, covering from 1/2 the hyperfocal distance to infinity, can be obtained at each f/stop. The longer the focal length, the longer the hyperfocal distance; the smaller the aperture (the larger the f/number), the shorter the hyperfocal distance.

### **ISO film speed**

The international standard for representing film sensitivity. The higher the number, the greater the sensitivity, and vice versa. A film speed of ISO 200 is twice as sensitive as ISO 100, and half that of ISO 400 film.

### **Matrix metering system**

An advanced camera light metering system using a multi-segment sensor and computer; available in the N70 and other Nikon SLRs cameras.

When N70 camera is used with D-type AF Nikkor lenses, 3D Matrix Metering will be performed.

### **Monitor Pre-flash(es)**

When performing Automatic Balanced Fill-Flash with TTL Multi Sensor, the N70's built-in flash/dedicated Nikon Speedlight fires a series of scarcely visible preflashes to enable the camera's computer to pre-analyze the scene. The TTL Multi Sensor inside the camera body reads the amount of reflected light, then the camera's microcomputer determines the area of

the TTL sensor to be used for flash output control and adjusts the flash output level. The Monitor Pre-flashes are visible but not recognizable.

### **Rear-Curtain Sync**

Flash fires an instant before the second (rear) curtain of the focal plane shutter begins to move. When slow shutter speeds are used, this feature can create a blur effect from the ambient light, i.e., a flowing-light patterns following a moving subject with subject movement frozen at the end of the light flow. (See "Front-Curtain Sync".)

### **Single Servo AF**

Once the subject is in focus, focus is locked. Useful for recomposing the picture.

### **Slow Sync**

A flash technique for using the flash at a slow shutter speed. Flash shooting in dim light or at night at a fast shutter speed often results in a flash-illuminated subject against a dark background. Using a slower shutter speed with the flash brings out the background details in the picture. Use of a slow shutter speed with Rear-Curtain Sync is particularly effective for illustrating the movement of a stream of light. The N70's Slow Sync mode extends the automatically controlled shutter speed range (in Programmed Auto and Aperture-Priority Auto) down to 30 sec.

### **Standard TTL Flash**

A type of TTL auto flash that does not apply any automatic flash output level compensation. Flash output is controlled independently from the ambient light exposure measurement and, in most cases, illuminates a subject somewhat more strongly than with Automatic Balanced Fill-Flash, making the subject stand out distinctly from the background.

### **TTL auto flash**

The camera's light sensor measures flash illumination, as reflected by the subject on the film and shuts off the flash when measurement indicates correct exposure. Because the sensor that controls the flash receives light through the lens, TTL auto flash can be used for bounce flash photography, fill-flash, multiple flash photography, etc. An additional advantage of TTL auto flash is that you can use a wide range of aperture settings, while ensuring correct exposure.

With built-in flash or dedicated Nikon TTL Speedlight, the N70 camera performs Automatic Balanced Fill-Flash and Standard TTL Flash.

### **Vari-Program**

Provides variable Programs for specific picture-taking situations. Eight Programs are available with the N70 camera. (See pp. 61-67.)

### **Vignetting**

Progressively diminished illumination on the film from the center to the corners. There are two kinds of vignetting—natural vignetting caused by the lens, and vignetting that is caused by improper use of accessories such as a lens hood or filter.

No reproduction in any form of this manual, in whole or in part (except for brief quotation in critical articles or reviews), may be made without written authorization from NIKON CORPORATION.

***Nikon***

**NIKON CORPORATION**

FUJI BLDG., 2-3, MARUNOUCHI 3-CHOME, CHIYODA-KU, TOKYO 100, JAPAN

**PHONE:** 81-3-3214-5311 **TELEX:** NIKON J22601 **FAX:** 81-3-3201-5856

Printed in Japan N7L0300402