

OLYMPUS®

DIGITAL CAMERA

E-300

ADVANCED MANUAL

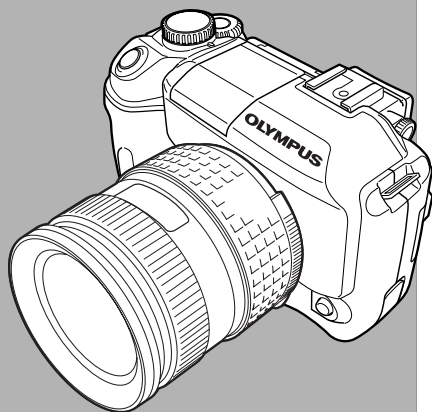

Basic operations

Things to know before shooting

Selecting the right mode for shooting conditions

Various shooting functions

Focusing functions

Exposure, image and color

Playback

Customizing the settings/ functions of your camera

Printing

Transferring images to a computer

Appendix

Information

-
- Thank you for purchasing an Olympus digital camera. Before you start to use your new camera, please read these instructions carefully to enjoy optimum performance and a longer service life.
 - This manual explains advanced techniques such as shooting and playback functions, customizing functions or settings and transferring recorded images to a computer, etc.
 - We recommend that you take test shots to get accustomed to your camera before taking important photographs.
 - The screen and camera illustrations shown in this manual were produced during the development stages and may differ from the actual product.

How to use this manual

This manual includes a table of contents, index and menu list to help you easily locate the information you need.

Searching the table of contents P. 4

All section titles and chapter headings are listed in the table of contents so that you can quickly find the information you need. There is a chapter containing information you need to know before using your camera for the first time, a chapter that describes basic shooting procedures, etc.

For example

When you want to play back the images you have just taken.



Go to Chapter 7 Playback and look for the page titled "Viewing still images.....108".

7 Playback	107
Viewing still images	108
Single-frame playback	108
Clear all playback	109
Index display	111
Information display INFO	112
Slideshow	114
Rotating images	115
Playback on TV	116
Printing still images	117
Protecting images - Preventing accidental erases	119
Erasing images	120
Single-frame erase	120
All-frame erase	121
8 Customizing the settings/functions of your camera	123
ALL SETTINGS	124
BY STEP	124

Searching the index P. 207

Terms used in this manual (such as the names of functions) are listed in alphabetical order. When you come across a term that you are not familiar with or about which you want to learn more, you can search the index to find the relevant page. Camera part names and monitor indications are listed at the end of the manual.

For example

If you want to know more about the term "HQ"



Go to the index at the end of this manual and look under H for "HQ.....36".

Auto Flash	34	Flash lock	36
B		FRONT/REAR	40
BEHIND & SHOOT	42	Flash memory control	40
Beep sound	101	FLASH MODE	44
Self-timer	44	FOCUS RING	108
C		Flash mode	36
Card	42	FORMAT	106
Card protect	42	GRABUTTON	104
CHARGE/SCRIPT	42	H	
Center-weighted averaging	105	HIGH KEY	40
Cleaning	89	HQ	36
CLEANING MODE	82	Image release	115
Color calibration	103	Image Release	111
COLOR SPACE	106	ISO BOOST	30
Compass Flash	112	ISO BOOST	30
Compressor	34	JPG	35
CONFIRM	40		

Searching the list of menus P. 192

The camera's menus are listed in a tree structure. When you come across a menu whose name is unfamiliar on the menu screen, you can find the relevant pages for this menu function in the menu list.

For example

When you want to know how to make settings for WB in the menu screen



Go through the menus until you find WB and look for the reference page number.

Menu directory		
● Shooting Menu		
●	Setting	Ref. Page
1	1.1	192
1	1.2	192
1	1.3	192
1	1.4	192
1	1.5	192
1	1.6	192
1	1.7	192
1	1.8	192
1	1.9	192
1	1.10	192
1	1.11	192
1	1.12	192
1	1.13	192
1	1.14	192
1	1.15	192
1	1.16	192
1	1.17	192
1	1.18	192
1	1.19	192
1	1.20	192
1	1.21	192
1	1.22	192
1	1.23	192
1	1.24	192
1	1.25	192
1	1.26	192
1	1.27	192
1	1.28	192
1	1.29	192
1	1.30	192
1	1.31	192
1	1.32	192
1	1.33	192
1	1.34	192
1	1.35	192
1	1.36	192
1	1.37	192
1	1.38	192
1	1.39	192
1	1.40	192
1	1.41	192
1	1.42	192
1	1.43	192
1	1.44	192
1	1.45	192
1	1.46	192
1	1.47	192
1	1.48	192
1	1.49	192
1	1.50	192
1	1.51	192
1	1.52	192
1	1.53	192
1	1.54	192
1	1.55	192
1	1.56	192
1	1.57	192
1	1.58	192
1	1.59	192
1	1.60	192
1	1.61	192
1	1.62	192
1	1.63	192
1	1.64	192
1	1.65	192
1	1.66	192
1	1.67	192
1	1.68	192
1	1.69	192
1	1.70	192
1	1.71	192
1	1.72	192
1	1.73	192
1	1.74	192
1	1.75	192
1	1.76	192
1	1.77	192
1	1.78	192
1	1.79	192
1	1.80	192
1	1.81	192
1	1.82	192
1	1.83	192
1	1.84	192
1	1.85	192
1	1.86	192
1	1.87	192
1	1.88	192
1	1.89	192
1	1.90	192
1	1.91	192
1	1.92	192
1	1.93	192
1	1.94	192
1	1.95	192
1	1.96	192
1	1.97	192
1	1.98	192
1	1.99	192
1	1.100	192

* For information on how to read the instructions in this manual, refer to "How to read the instruction pages" (P. 3)

How to read the instruction pages

CARD SETUP — Formatting the card

Lets you format a card. Formatting prepares cards to receive data.
Non-Olympus cards or cards formatted on a computer must be formatted with the camera before they can be used.
All data stored on the card, including protected images, is erased when the card is formatted. When formatting a used card, confirm there are no images that you still want to keep on the card.

Available modes **P A S M** **SCENE**

1 Menu → → CARD SETUP
☰ "How to use the menus" (P. 25)

2 Press .
• The CARD SETUP screen is displayed.

3 Press to select **FORMAT**. Press .
• The **FORMAT** screen is displayed.

4 Press to select **YES**. Press **OK**.
• **FORMAT** is performed.

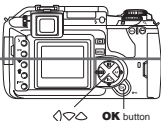

OK button



8

Customizing the settings/functions of your camera

Sets the camera to any of the modes shown.

Step through the menus in the order of the arrows (P. 25)

















This represents the arrow pad. Only arrows applicable to the operation are shown.

135

This sample page is only for your reference. It may differ from the actual page in this manual.







Indications used in this manual

	Important information on factors which may lead to a malfunction or operational problems. Also warns of operations that should be absolutely avoided.
TIPS	Useful information and hints that will help you get the most out of your camera.
	Reference pages describing details or related information.

How to use this manual	2
How to read the instruction pages	3
For your safety	10
1 Basic operations	17
How to use the mode dial	18
How to use the buttons and control dial	19
Types of buttons	20
How to use the menus	25
Types of the menus	28
2 Things to know before shooting	29
If correct focus cannot be obtained	30
How to focus on a difficult subject — Focus lock	30
Subjects that are difficult to focus on	32
Selecting the record mode 	33
Types of record modes	33
How to select the record mode 	36
Setting HQ/SQ	36
3 Selecting the right mode for shooting conditions	37
Selecting the right mode for shooting situation	38
 LANDSCAPE	39
 LANDSCAPE+PORTRAIT	39
 NIGHT SCENE	39
 NIGHT+PORTRAIT	39
 FIREWORKS	40
 SUNSET	40
 PORTRAIT	40
 HIGH KEY	40
 MACRO	41
 DOCUMENTS	41
 MUSEUM	41
 SPORT — Capturing a fast-moving subject	41
 BEACH & SNOW — Shooting seascapes or snow-capped mountain landscapes	42
 CANDLE	42

Selecting the right mode for shooting technique — P, A, S and M	43
P : Program shooting	43
A : Aperture priority shooting	45
S : Shutter priority shooting	47
M : Manual shooting	49
PREVIEW function	52



4 Various shooting functions 53







Flash shooting	54
Flash modes 	54
Setting the flash mode 	58
Using the built-in flash	59
Flash intensity control 	60
Optional electronic flashes	61
Using the electronic flash	62
Super FP flash	63
Using commercially available flashes	64
Non-specified commercial flashes	65
Drive mode DRIVE	66
Sequential shooting 	66
Auto bracketing BKT	68
Self-timer shooting  /Remote control shooting  (with optional remote control)	72
MONOTONE shooting	75

5 Focusing functions 77

AF frame selection 	78
Focus mode	79
AF ILLUMINATOR	84







6 Exposure, image and color 85

Metering mode — Changing the metering area ESP  	86
Exposure compensation — Varying the image brightness 	88
AE lock — Locking the exposure AEL	90

ISO sensitivity — Setting the desired sensitivity to light	91
Setting the ISO sensitivity	91
ISO BOOST	92
White balance — Adjusting the color tone	93
Setting the white balance WB	95
Setting the one-touch white balance 	97
WB compensation 	98
CUSTOM WB	100
SHARPNESS 	101
CONTRAST 	102
SATURATION 	103
GRADATION 	104
NOISE REDUCTION 	105
COLOR SPACE sRGB, Adobe RGB	106





7 Playback

107



Viewing still images	108
Single-frame playback	108
Close-up playback 	109
Index display 	111
Information display INFO	112
Slideshow 	114
Rotating images 	115
Playback on TV	116
Editing still images	117
Protecting images — Preventing accidental erasure 	119
Erasing images	120
Single-frame erase 	120
All-frame erase 	121

8 Customizing the settings/functions of your camera 123

AEL METERING	124
EV STEP	124
MANUAL FLASH	124
CUSTOM OK	125
RESET LENS	126
FOCUS RING	126

Date/time setting 	127
RESET — Restoring the factory default setting	128
ERASE SETTING	128
FILE NAME	129
REC VIEW — Checking the picture immediately after shooting	130
Setting the warning tone 	131
Monitor brightness adjustment 	131
SLEEP	132
PC MODE	132
Changing the display language 	133
VIDEO OUT — Selecting the video signal type before TV connection	134
CARD SETUP — Formatting the card	135

9 Printing 137

Print reservation (DPOF) 	138
Flowchart for printing reservation	140
Selecting the print reservation mode 	142
Selecting pictures you want to print	142
Setting printing data	143
Confirming your print setting	143
Resetting print reservation	144
Direct printing (PictBridge)	146
Connecting the camera to a printer	147
Flowchart for printing	148
Selecting the print mode	150
Setting the print paper items	151
Selecting pictures you want to print	151
Setting printing data	152
Printing	152
If an error code is displayed	153

10 Transferring images to a computer 155

Flowchart	156
Using the provided OLYMPUS Master software	158
What is OLYMPUS Master?	158
Installing OLYMPUS Master	159

Connecting the camera to a computer	163
Starting OLYMPUS Master	165
Displaying the camera's images on your computer	166
Downloading images to save on your computer	166
Disconnecting the camera from your computer	167
Viewing still images	168
Printing images	169
Transferring images to your computer without using OLYMPUS Master	170

11 Appendix **171**

Card basics	172
Lens basics	173
If you encounter problems	174
Error codes	174
Troubleshooting	176
Camera maintenance	181
Cleaning and storing the camera	181
CLEANING MODE — Removing dust on the CCD	182
PIXEL MAPPING — Checking the image processing functions	183
Safety precautions	184
Glossary	186

12 Information **191**

Menu directory	192
Available functions by shooting mode	196
Names of parts	198
Camera	198
Viewfinder indications	200
Monitor indications (only for playback)	201
Control panel screen	202
Memory gauge	203
Battery check	203
Specifications	204
Index	207

For customers in North and South America

For customers in USA

Declaration of Conformity

Model Number : E-300
Trade Name : OLYMPUS
Responsible Party : **OLYMPUS IMAGING AMERICA INC.**
Address : 2 Corporate Center Drive, PO Box 9058, Melville,
New York 11747-9058 U.S.A.
Telephone Number : 1-631-844-5000

Tested To Comply With FCC Standards
FOR HOME OR OFFICE USE

This device complies with Part 15 of the FCC rules. Operation is subject to the following two conditions:

- (1) This device may not cause harmful interference.
- (2) This device must accept any interference received, including interference that may cause undesired operation.

For customers in Canada

This Class B digital apparatus meets all requirements of the Canadian Interference-Causing Equipment Regulations.

For customers in Europe



“CE” mark indicates that this product complies with the European requirements for safety, health, environment and customer protection.

“CE” mark cameras are intended for sales in Europe.

Trademarks

- IBM is a registered trademark of International Business Machines Corporation.
- Microsoft and Windows are registered trademarks of Microsoft Corporation.
- Macintosh is a trademark of Apple Computer Inc.
- All other company and product names are registered trademarks and/or trademarks of their respective owners.
- The standards for camera file systems referred to in this manual are the “Design Rule for Camera File System/DCF” standards stipulated by the Japan Electronics and Information Technology Industries Association (JEITA).

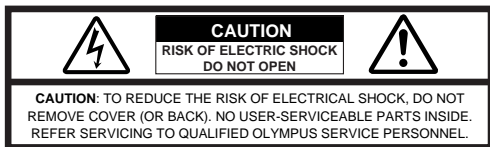

Lightning flash with an arrowhead, enclosed in a triangle, alerts you to the presence of uninsulated voltage points inside the product which could cause a serious electrical shock.



An exclamation mark enclosed in a triangle alerts you to important operating and maintenance instructions in the documentation provided with the product.

WARNING!

TO AVOID THE RISK OF FIRE OR ELECTRICAL SHOCK, NEVER EXPOSE THIS PRODUCT TO WATER OR OPERATE IN A HIGH HUMIDITY ENVIRONMENT.

General precautions

Read All Instructions — Before you use the product, read all operating instructions. For more information on accessories such as the lithium ion battery, refer to the manuals provided with those products.

Save These Instructions — Save all safety and operating instructions for future reference.

Heed Warnings — Read carefully and follow all warning labels on the product and those described in the instructions.

Follow Instructions — Follow all instructions provided with this product.

Cleaning — Always unplug this product from the wall outlet before cleaning. Use only a damp cloth for cleaning. Never use any type of liquid or aerosol cleaner, or any type of organic solvent to clean this product.

Attachments — For your safety, and to avoid damaging the product, use only accessories recommended by Olympus.

Water and Moisture — Never use this product around water (near a bathtub, kitchen sink, laundry tub, wet basement, swimming pool or in the rain).

Location — To avoid damage to the product and prevent personal injury, never place this product on an unstable stand, tripod, bracket, table or cart. Mount only on a stable tripod, stand, or bracket. Follow the instructions that describe how to safely mount the product, and use only the mounting devices recommended by the manufacturer.

Power Sources — Connect this product only to the power source described on the product label. If you are not sure about the type of power supply in your home, consult your local power company.

Refer to instruction pages for information on using the product with a battery.

Grounding, Polarization — If this product is used with a specified AC adapter, the adapter may be equipped with a polarized alternating current line plug (a plug with one blade wider than the other). This safety feature allows the plug to fit into the power outlet only one way. If you cannot insert the plug into the wall outlet, pull it out, reverse it, and then reinsert it. If the plug still fails to fit, contact an electrician and have the receptacle replaced.

Protecting the Power Cord — The power supply cord should be placed so it will not be walked on. Never put a heavy object on the power cord or wrap it around the leg of a table or chair. Keep the area around the power cord connection points, at the power outlet, and at the product connection, free of all AC adapter or accessory power cords.

Lightning — If a lightning storm occurs while using a specified AC adapter, remove it from the wall outlet immediately. To avoid damage from unexpected power surges, always unplug the AC adapter from the power outlet and disconnect it from the camera when the camera is not in use.

Overloading — Never overload wall outlets, extension cords, power strips, or other power connection points with too many plugs.

Foreign Objects, Liquid Spillage — To avoid personal injury caused by fire or electrical shock from contact with internal high voltage points, never insert a metal object into the product. Avoid using the product where there is a danger of spillage.

Heat — Never use or store this product near any heat source such as a radiator, heat register, stove, or any type of equipment or appliance that generates heat, including stereo amplifiers.

Servicing — Refer all servicing to qualified personnel. Attempting to remove the covers or disassemble the product, could expose you to dangerous high voltage points.

Damage Requiring Service — If you notice any of the conditions described below while using a specified AC adapter, unplug it from the wall outlet and refer servicing to qualified service personnel:

- Liquid has been spilled onto the product or some other object has fallen into the product.
- The product has been exposed to water.
- The product does not operate normally despite following operating instructions. Adjust only the controls described in the operating instructions as improper adjustment of other controls could damage the product and require extensive repair work by a qualified technician.
- The product has been dropped or damaged in any way.
- The product exhibits a distinct change in performance.

Replacement Parts — When replacement parts are required, make sure that the authorized service center uses only parts with the same characteristics as the originals, as recommended by the manufacturer. Unauthorized substitution of parts could result in fire, electrical shock, or create other hazards.

Safety Check — Upon completion of servicing or repairs, ask the service technician to perform safety checks to determine that the product is in good working order.



DANGER

If the product is used without observing the information given under this symbol, serious injury or death may result.



WARNING

If the product is used without observing the information given under this symbol, injury or death may result.



CAUTION

If the product is used without observing the information given under this symbol, minor personal injury, damage to the equipment, or the loss of valuable data may result.

Handling the camera



WARNING

- ☞ **Do not use the camera in areas exposed to flammable or explosive gases.**
 - A fire or explosion may result.
- ☞ **Do not use the flash on people (infants, small children, etc.) at close range.**
 - When you fire the flash, you must be at least 1 m (3 ft) away from the faces of your subjects. Firing the flash too close to the subject's eyes could cause a momentary loss of vision.
- ☞ **Keep young children and infants away from the camera.**
 - If not, the following dangerous situations may occur:
 - Becoming entangled in the camera strap or power cords, causing strangulation. If this happens, follow the doctor's instructions.
 - Accidentally swallowing the battery or other small parts.
 - Accidentally firing the flash into their own eyes or those of another child.
 - Accidentally being injured by the moving parts of the camera.
- ☞ **Do not use or store the camera in dusty or humid places.**
 - Using or storing the camera in dusty or humid places may result in a fire or electric shock.
- ☞ **Do not cover the flash with a hand while firing.**
 - Do not cover the flash or touch it after it has just been fired sequentially. It may be hot and cause minor burns.
- ☞ **Do not take apart or modify the camera.**
 - Never attempt to disassemble the camera. The internal circuits contain high voltage points which could cause serious burns or electrical shock.
- ☞ **Do not let water or foreign objects inside the camera.**
 - A fire or electric shock may result. If the camera is accidentally dropped in water, or if liquid is spilled into the camera, stop using it, allow it to dry, and then remove the battery. Contact the nearest authorized Olympus service center.
- ☞ **Do not touch the battery or the battery charger while battery charging is in progress. Wait until charging is complete and the battery has cooled.**
 - The battery and battery charger become hot while charging. The specified AC adapter also becomes hot when used for a long time. At these times, they may cause minor burns.
- ☞ **Do not use a non-specified lithium-ion battery and/or charger.**
 - Use of a non-designated lithium-ion battery and/or re-charger may lead to camera or battery failure as well as other unexpected accidents. Any accidents resulting from use of non-designated equipment will not be compensated.



CAUTION

- ☞ **Stop using the camera immediately if you notice any unusual odors, noise, or smoke around it.**
 - If you notice any unusual odors, noise, or smoke around the camera during operation, switch it off immediately — and disconnect the specified AC adapter (if attached). Allow the camera to sit idle for a few minutes to cool. Take the camera outdoors, away from flammable objects, and carefully remove the battery. Never remove the battery with bare hands. Contact the nearest Olympus service center immediately.
- ☞ **Do not use the camera with wet hands.**
 - Damage or electric shock may result. Also, do not connect or disconnect the power plug with wet hands.

- ☞ **Be careful with the strap when you carry the camera**
 - It could easily catch on stray objects—and cause serious damage.
- ☞ **Do not leave the camera in areas subject to extremely high temperature.**
 - Doing so may cause parts to deteriorate and, in some circumstances, cause the camera to catch fire.
- ☞ **Use only the AC adapter specified by Olympus.**
 - Using a different AC adapter may damage the camera or power source, or result in accidents or fire. Ensure the adapter used is designed for your region or country. For more information, contact the nearest Olympus service center or the store of purchase. Olympus makes no representations or warranties regarding any damages caused by AC adapters not recommended by Olympus.
- ☞ **Handle the camera with care to avoid getting a low-temperature burn.**
 - When the camera contains metal parts, overheating can result in a low-temperature burn. Pay attention to the following:
 - When used for a long period, the camera will get hot. If you hold on to the camera in this state, a low-temperature burn may be caused.
 - In places subject to extremely cold temperatures, the temperature of the camera's body may be lower than the environmental temperature. If possible, wear gloves when handling the camera in cold temperatures.
- ☞ **Do not damage the AC adapter's cable.**
 - Do not pull on the AC adapter's cable or add another cable to it. Be sure to connect or disconnect the AC adapter's cable while holding the power plug. If the following cases occur, stop using and contact an Olympus dealer or customer support center.
 - The power plug or cable produces heat, burning smell, or smoke.
 - The power plug or cable is cracked or broken. The contact is bad on the power plug.

Battery handling precautions

Follow these important guidelines to prevent the battery from leaking, overheating, burning, exploding, or causing electrical shocks or burns.



DANGER

- ☞ **Never heat or incinerate the battery.**
- ☞ **Do not connect the (+) and (-) terminals to each other using metal objects.**
- ☞ **Do not carry or store the battery where it may come into contact with metal objects such as jewelry, pins, fasteners, etc.**
- ☞ **Never store the battery where it will be exposed to direct sunlight, or subjected to high temperatures in a hot vehicle, near a heat source, etc.**
- ☞ **Never attempt to disassemble the battery or modify it in any way, such as by soldering.**
 - Doing so may break the terminals or cause battery fluid to splash, resulting in potential fire, explosion, battery leakage, overheating or other damage.
- ☞ **If battery fluid gets in your eyes, loss of eyesight may result.**
 - If battery fluid gets in your eyes, do not rub them. Flush them immediately with clear, cold running water and seek medical attention straight away.

 **WARNING**

- ☞ **Keep the battery dry at all times. Never allow it to come into contact with fresh or salt water.**
- ☞ **Do not touch or hold the battery with wet hands.**
- ☞ **If the rechargeable battery does not recharge within the specified time, stop charging it and do not use it.**
 - If you do not, fire, explosion, ignition or overheating may result.
- ☞ **Do not use the battery if it is cracked or broken.**
 - Doing so may cause explosion or overheating.
- ☞ **Never subject the battery to strong shocks or continuous vibration.**
 - Doing so may cause explosion or overheating.
- ☞ **Never attempt to modify the battery compartment on the camera, never insert anything (other than the specified battery) into the compartment.**
- ☞ **If the battery leaks, becomes discolored or deformed, or appears abnormal in any way during operation, stop using the camera immediately.**
 - Contact your dealer or an authorized Olympus service center. Continued use may result in fire or electric shock.
- ☞ **If the battery leaks fluid onto your clothing or skin, remove the clothing and flush the affected area with clean, running cold water immediately. If the fluid burns your skin, seek medical attention immediately.**

 **CAUTION**

- ☞ **Do not remove the battery from the camera immediately after operating the camera on battery power for a long time.**
 - Doing so may cause burns.
- ☞ **Remove the battery from the camera if it is not going to be used for a long time.**
 - Otherwise, battery leakage or overheating may cause a fire or injury.

Charger handling precautions

 **DANGER**

- ☞ **Do not put the charger in water or use it when wet. Do not touch or hold it with wet hands.**
 - Doing so may cause malfunction or electric shock.
- ☞ **Do not use the charger if it is covered with cloth such as a blanket.**
 - Do not use the charger if something is covering it (such as a blanket). Heat may be kept in, causing the charger to deform. This may cause fire, ignition or overheating.
- ☞ **Do not disassemble or modify the charger.**
 - This may cause electric shock or injury.
- ☞ **Use an charger designed to operate on the AC voltage in the area where you are using the camera.**
 - Otherwise, fire, explosion, smoke, overheat, electric shock or burns may result.

 **WARNING** **Do not damage the charger's cable.**

- Do not pull on the charger's cable or add another cable to it. Be sure to connect or disconnect the charger's cable while holding the power plug. If the following cases occur, stop using and contact an Olympus dealer or authorized customer support center.
 - The power plug or cable produces heat, burning smell, or smoke.
 - The power plug or cable is cracked or broken. The contact is bad on the power plug.

 **CAUTION** **Unplug the AC adapter's cable from the outlet before cleaning the camera.**

- Otherwise, electric shock or injury may result.

FCC Notice**● Radio and Television Interference**

Change or modifications not expressly approved by the manufacturer may void the user's authority to operate this equipment. This equipment has been tested and found to comply with the limits for a Class B digital device, pursuant to Part 15 of the FCC Rules. These limits are designed to provide reasonable protection against harmful interference in a residential installation.

This equipment generates, uses, and can radiate radio frequency energy and, if not installed and used in accordance with the instructions, may cause harmful interference to radio communications.

However, there is no guarantee that interference will not occur in a particular installation. If this equipment does cause harmful interference to radio or television reception, which can be determined by turning the equipment off and on, the user is encouraged to try to correct the interference by one or more of the following measures:

- Adjust or relocate the receiving antenna.
 - Increase the distance between the camera and receiver.
 - Connect the equipment to an outlet on a circuit different from that to which the receiver is connected.
 - Consult your dealer or an experienced radio/TV technician for help.
- Only the OLYMPUS-supplied USB cables should be used to connect the camera to USB-enabled personal computers (PC).

Any unauthorized changes or modifications to this equipment would void the user's authority to operate.

Legal and other notices

- Olympus makes no representations or warranties regarding any damages, or benefit expected by using this unit lawfully, or any request from a third person, which are caused by the inappropriate use of this product.
- Olympus makes no representations or warranties regarding any damages or any benefit expected by using this unit lawfully which are caused by erasing picture data.

Disclaimer of Warranty

- Olympus makes no representations or warranties, either expressed or implied, by or concerning any content of these written materials or software, and in no event shall be liable for any implied warranty of merchantability or fitness for any particular purpose or for any consequential, incidental or indirect damages (including but not limited to damages for loss of business profits, business interruption and loss of business information) arising from the use or inability to use these written materials or software or equipment. Some countries do not allow the exclusion or limitation of liability for consequential or incidental damages, so the above limitations may not apply to you.
- Olympus reserves all rights to this manual.

WARNING

Unauthorized photographing or use of copyrighted material may violate applicable copyright laws. Olympus assumes no responsibility for unauthorized photographing, use or other acts that infringe upon the rights of copyright owners.

Be sure to read the "Safety Precautions" at the end of the manual.

1

Basic operations

The advanced shooting techniques used by professional photographers are drawn from years of experience.

Now, with your digital camera, you'll be able to take advantage of those same advanced techniques simply by pressing a few buttons.

You'll find a wide choice of shooting functions listed in the camera's menu that make it easy to change the focusing area, adjust the white balance, etc. The menus can be navigated simply by pressing buttons while viewing the monitor.

But before you can use these functions, you first need to learn how to operate the buttons and menus.

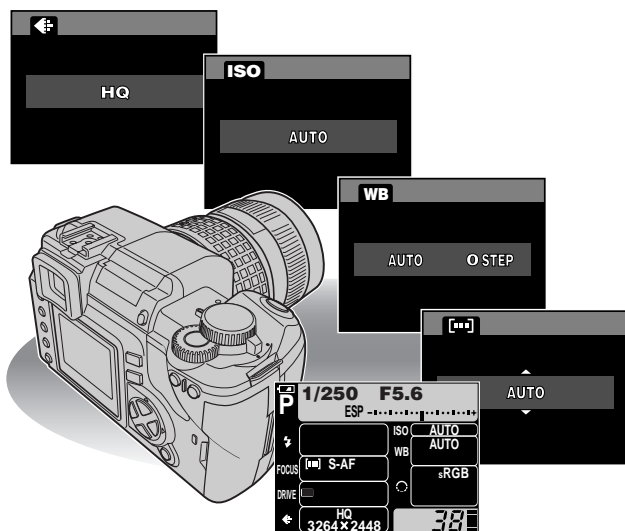

How to use the mode dial

This camera has the following shooting modes, which can be switched using the mode dial.

When the camera is turned on with the mode dial set to **SCENE**, the shooting mode selection screen is displayed.

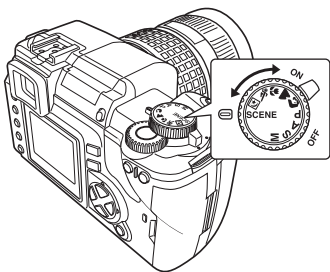

P Program shooting

Allows you to shoot using an aperture and shutter speed that the camera sets.

☞ P. 43

A Aperture priority shooting

Allows you to set the aperture manually. The camera sets the shutter speed automatically. ☞ P. 45

S Shutter priority shooting

Allows you to set the shutter speed manually. The camera sets the aperture automatically. ☞ P. 47

M Manual shooting

Allows you to set the aperture and shutter speed manually. ☞ P. 49

Portrait shooting

Suitable for shooting a portrait-style image of a person. ☞ P. 40

Landscape shooting

Suitable for shooting landscapes and other outdoor scenes. ☞ P. 39

Macro shooting

Suitable for taking close-up pictures (macro shooting). ☞ P. 41

Sport shooting

Suitable for capturing fast-moving action without blurring. ☞ P. 41

Night scene shooting

Suitable for shooting images of outdoor scenes in the evening or at night. ☞ P. 39

SCENE

More than 10 different shooting modes are available to suit a wide range of shooting situations. When the mode dial is set to this mode, the shooting mode selection screen is displayed. ☞ P. 38

How to use the buttons and control dial

1

Basic operations

This camera has a variety of functions to make optimal settings for various shooting conditions. You can set the function settings using the buttons, control dial, or menu.

Functions available using the buttons : Change camera settings with the buttons and control dial, while referring to the monitor menus or control panel screen.

Functions available using the monitor menus : Change camera settings with the monitor menu while referring to the monitor.

1 Press the button for the function you want to set.

- When the control panel screen (☞ P. 202) is displayed on the monitor:
The current setting of the function you have selected lights in green.
When the control panel screen is not displayed:
The menu of the function you have selected appears.

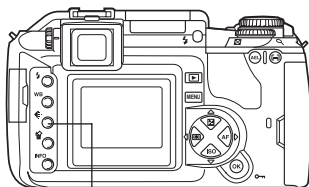

button

Example: When pressing the  (record mode) button

When setting on the control panel screen

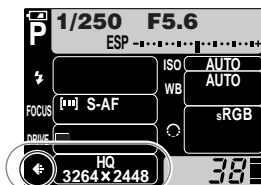

Record mode

When setting on the function menu
(control panel screen is off)

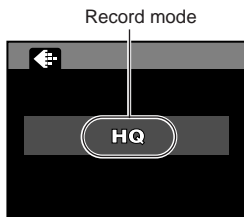

Record mode

2 After pressing the button, rotate the control dial.

- If you do not operate the dial within 3 seconds, your setting is confirmed.
- If you press the button again, you can confirm the setting and exit the menu immediately.

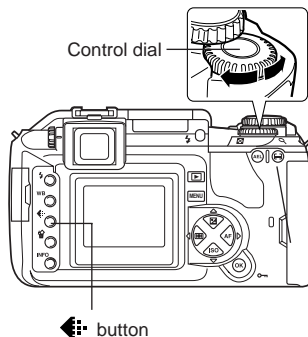

When setting on the control panel screen

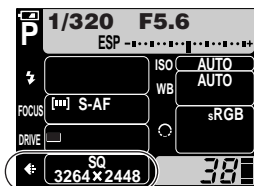

When setting on the function menu



Types of buttons

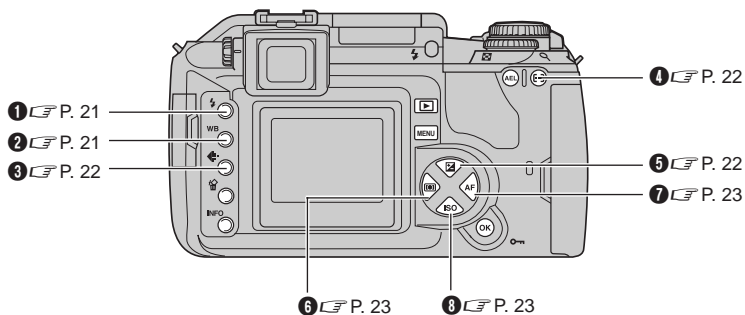

1 **⚡ (Flash mode) button** ☞ P. 58

Selects a flash mode from auto-flash, red-eye reduction flash, slow synchronization or fill-in flash.

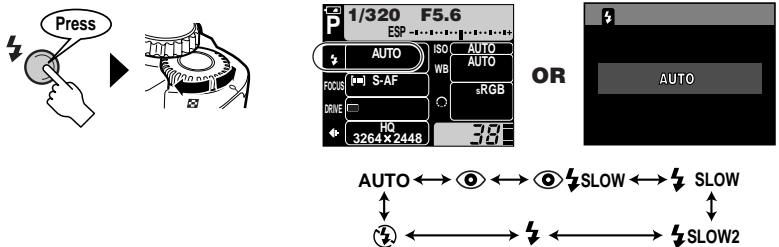

2 **WB (White balance) button** ☞ P. 95

Selects the white balance appropriate to the light source from the following options: Auto, preset white balance settings, customized white balance settings or registered white balance.

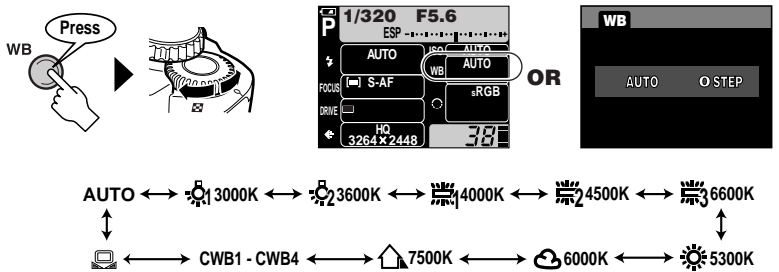

1 Basic operations

3  (Record mode) button P. 36

Selects image quality.

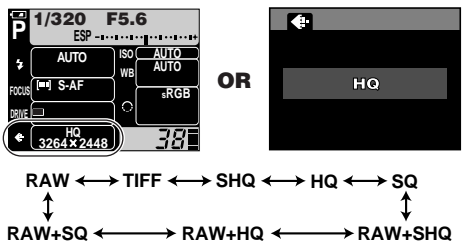
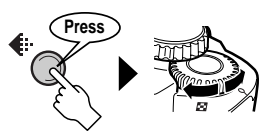

- You can select the compression and number of pixels in the SQ/HQ mode.
☞ "Setting SQ/HQ" (P. 36)

4  (AF frame selection) button P. 78

Selects the AF frame, allowing you to perform multiple AF or to perform AF using one of the 3 frames.

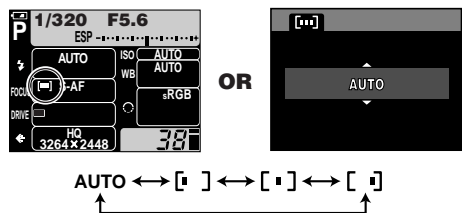
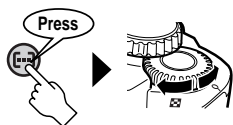

5  (Exposure compensation) button P. 88

Sets the exposure compensation value.

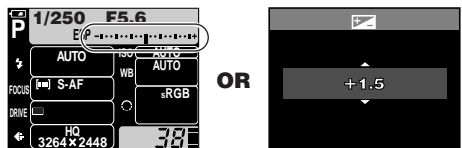
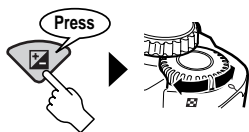

- The exposure can be adjusted within a range of ± 5.0 EV.
 Available EV steps are: 1/3EV, 1/2EV, 1EV. Changing the EV value changes the amount of exposure compensation. ☞ "EV STEP" (P. 124)

6 [METERING] (Metering) button

P. 86

Selects the metering mode.

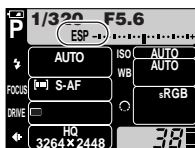
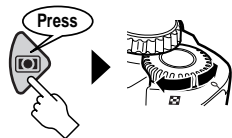

OR



1

Basic operations

7 AF (focus mode) button

P. 79

Selects the focus mode.

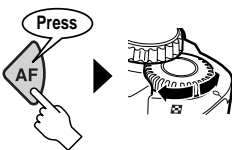

OR

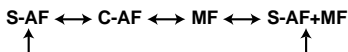
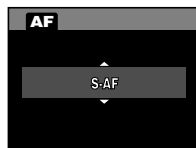
**8** ISO button

P. 91

Sets the ISO sensitivity.

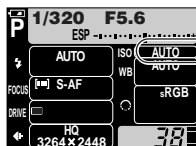
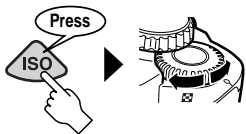

OR

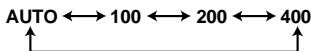
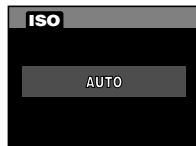

- Setting ISO BOOST allows you to add 800 and 1600 to the ISO value options.

☞ "ISO BOOST" (P. 92)

Other buttons

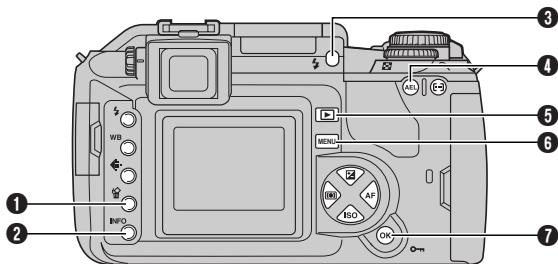
1  **(Erase) button**  **P. 120**

Erases unwanted images.

2 **INFO (Information display) button**  **P. 112**

Shooting: Displays shooting information on the control panel screen.

Playback: Displays shooting information or histogram of the recorded image.

Each time this button is pressed, the information display is changed.

3  **(flash) switch**  **P. 58**

Raises the flash.

4 **AEL button**  **P. 90**

Locks the exposure.

5  **(Playback mode) button**  **P. 108**

Plays back images on the monitor.

6 **MENU button**  **P. 25**

Displays the menu.

7 **OK/Protect button**  **P. 119, 125**

Shooting: Allows you to use the function that you previously assigned to the menu's CUSTOM OK.

Playback: Protects images from being accidentally erased.

How to use the menus

The camera's functions can be set. Display the menus on the monitor and select or set them.

This section explains how the menu works using the **P** mode.

- 1 Press the **MENU** button to display the menu on the monitor.

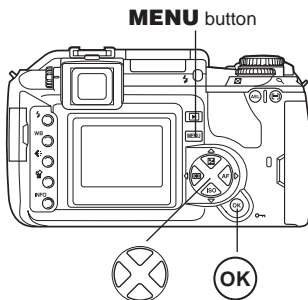
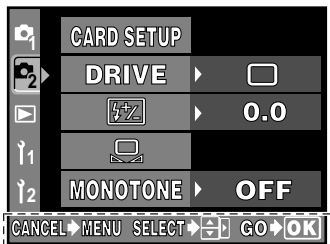



Operation guide is displayed at the bottom of the screen.

CANCEL → **MENU**: Press **MENU** to cancel the setting.

SELECT →  : Press   to select the item. The illustration displayed corresponds to the arrow pad shown below.



GO →  : Press  to confirm your setting.

2 Press to select a tab.

- The functions are categorized under tabs.

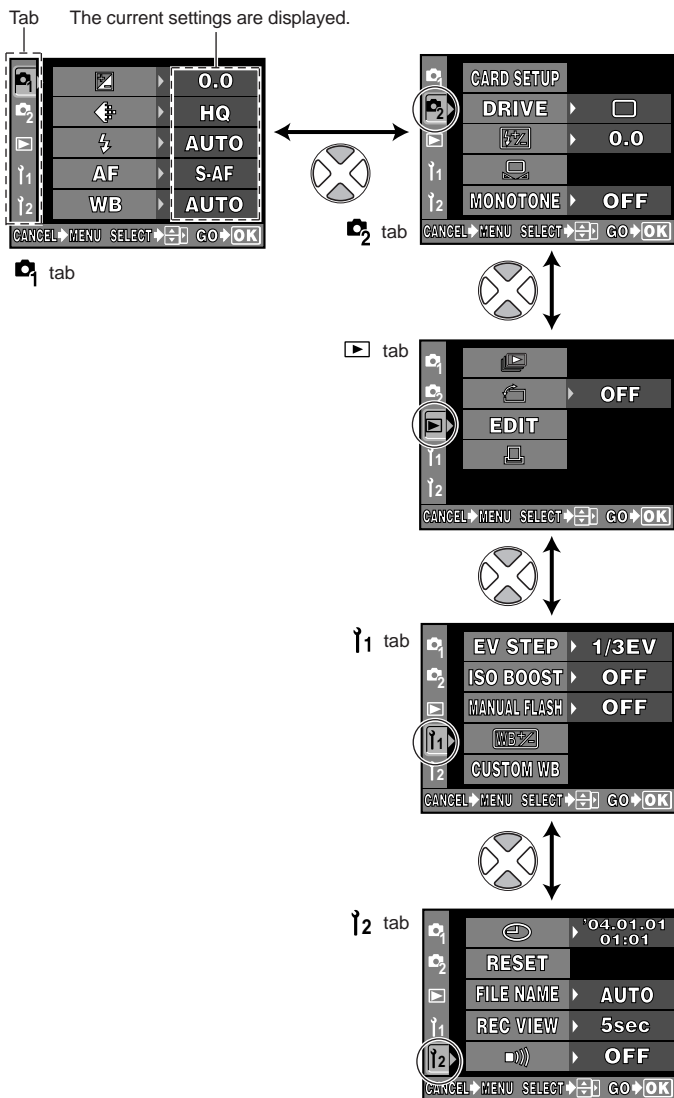

3 Press  to move to the functions of the tab you have selected.



4 Press  to select a function.

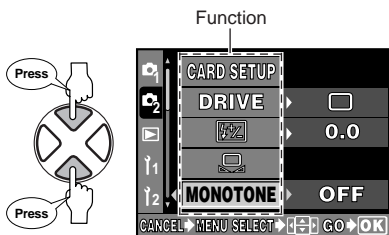

5 Press  to move to the settings of the function you have selected.



6 Press  to select a setting.

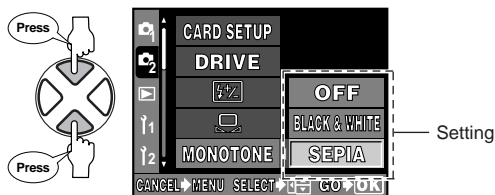

7 Press **OK** repeatedly until the menu disappears.

- Normal shooting screen is restored.

1

Basic operations

TIPS

To return to the previous item on the menus

- Press the **MENU** button.

Explanations for menu operation

This manual uses the following explanations for menu operations.

Example : Menu →  → MONOTONE → OFF, BLACK & WHITE, SEPIA.

Types of the menus

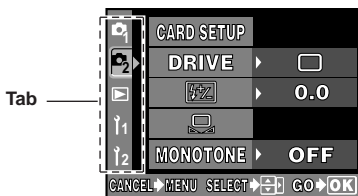

 : Sets the functions that are available using the buttons and control dial.

 : Sets shooting functions.

 : Sets playback functions.

 : Customizes shooting functions.

 : Sets functions that allow you to use the camera efficiently.

2

Things to know before shooting

The camera focuses automatically if you simply press the shutter button in the **P** mode. However, sometimes you may come across a subject that is difficult to focus on. This chapter explains how to deal with those hard-to-focus subjects.

Another important thing is to select the appropriate record mode before you start shooting. Remember that depending on what you are going to do with your shots later, you may find that the image looks grainy in large prints, the file size is too big for e-mail, etc. To avoid this kind of problem, always check the record mode before shooting.

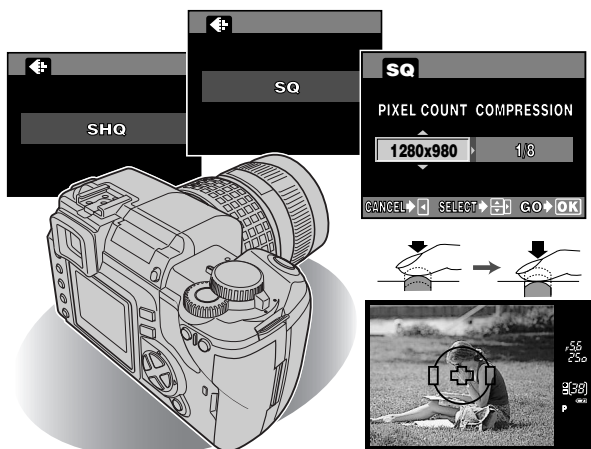

If correct focus cannot be obtained

The camera uses three AF frames to automatically detect the subject to focus on. Because the camera uses contrast level to detect the subject, it may not be able to correctly detect the desired subject if its contrast is lower than the surroundings or it is positioned higher in the composition. In this case, the easiest solution is to use focus lock.



2

Things to know before shooting

How to focus on a difficult subject – Focus lock

Available modes



- 1 Position the AF frame on the subject you want to focus on.

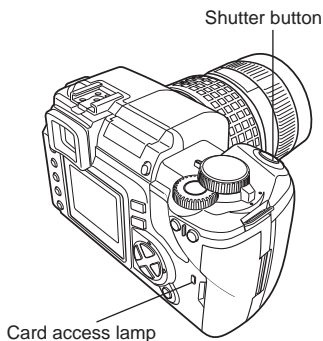
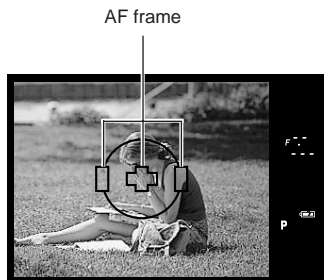

2 Press the shutter button halfway until the AF confirmation mark lights.

- The focus is locked. The AF confirmation mark and the AF focusing frame light up in the viewfinder.
- If the AF confirmation mark blinks, the focus and exposure are not locked. Release your finger from the shutter button, re-position your subject and press the shutter button halfway again.
- The control panel screen disappears.

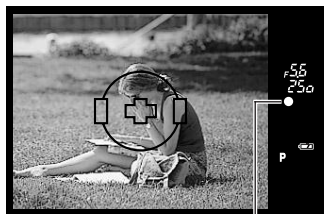
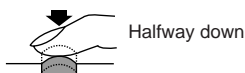

AF confirmation mark

3 While keeping the shutter button pressed halfway, re-compose your shot.



4 Press the shutter button all the way.

- A picture is taken.
- The card access lamp blinks while the picture is being stored on the card.

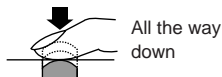

Subjects that are difficult to focus on

Under the following conditions, AF may not work properly. Take a picture using focus lock (☞ P. 30), manual focus (☞ P. 83), or by selecting an AF frame (☞ P. 78).

The AF confirmation mark blinks. The subject cannot be brought into focus.

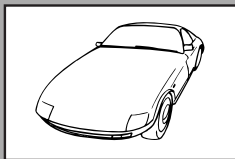

Subjects with low contrast

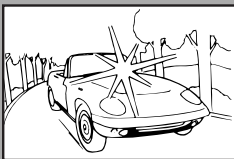

Subjects in excessively bright light in the center of the frame

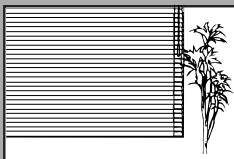

Subject with repeated patterns

The AF mark stays lit, but the subject cannot be brought into focus.



Subjects with different distances

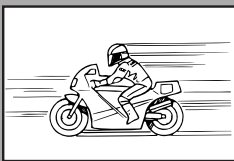

Fast-moving subjects



The subject is not positioned within the AF frames.

If this happens, focus on a high-contrast object the same distance away as the intended subject, recompose your shot and then take the picture. If the subject has no vertical lines, hold the camera vertically and adjust the focus, then return the camera to the horizontal position to take the picture.



You can select a record mode in which to take pictures. Choose the record mode that's best for your purpose (printing, editing on a PC, website editing, etc.). For details about record modes and number of pixels, refer to the table on P. 35.

Types of record modes

Record mode allows you to select a combination of pixel count and compression rate for the images you record. An image consists of pixels (dots). When you enlarge an image with a low pixel count, it will be displayed as a mosaic. If an image has a high pixel count, the file size (amount of data) will be larger and the number of storable still pictures will be lower. The higher the compression, the smaller the file size. However, the image will have less clarity when played back.

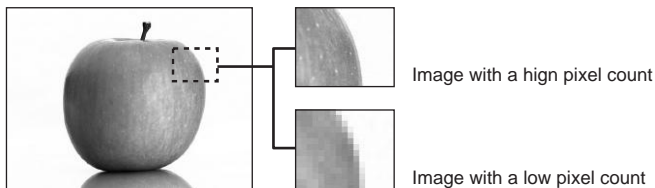

Image becomes clearer ←

Application	Quality (Compression)	Non-compression 1/1	Low compression 1/2.7	High compression 1/4	High compression 1/8
	Number of pixels				
Select for the print size	3264 × 2448	TIFF	SHQ	HQ	
	3200 × 2400 2560 × 1920 1600 × 1200 1280 × 960 1024 × 768	-	SQ		
For small-sized print and website	640 × 480				

Number of pixels increases
(Number of storable pictures decreases)

Number of pixels

The number of pixels (horizontal x vertical) used when saving an image. If the image is going to be printed, higher resolutions (larger numbers) are recommended so that the image will be clearer.

2

Compression

In record modes other than RAW/TIFF, image data are compressed. The higher the compression, the less clear the image will be.

Number of pixels and picture size on a computer screen

When a picture is transferred to a computer, the size of the picture on the computer screen varies depending on the computer's monitor setting. For instance, a picture taken in 1024 x 768 resolution is the same size as the screen if you set the picture to 1x when the monitor setting is 1024 x 768. However, if the monitor setting is over 1024 x 768 (such as 1280 x 1024), the picture only takes up part of the screen.

RAW

Raw data is original, unprocessed data, i.e. it has not been subject to image processing such as white balance, sharpness, contrast and color space, etc. OLYMPUS Master software is required to display RAW images on a PC. A Photoshop plug-in is also available to allow you to open RAW images in Photoshop (you can download it from our website). It is not possible to display RAW data using commercially available software applications or to apply print reservation to RAW data. With this camera, pictures taken in RAW record mode can be edited.  "Editing still images" (P. 117)

Record mode

Record mode	Number of pixels (PIXEL COUNT)	Compression	File format	File size (MB)
RAW	3264 x 2448	Uncompressed	ORF	13.5
TIFF		Uncompressed	TIFF	23.3
SHQ		1/2.7	JPEG	6.1
HQ	1/4	4.3		
	1/8	1.9		
	3200 x 2400	1/2.7		5.9
1/4		4.1		
1/8		1.9		
2560 x 1920	1/2.7	4.0		
	1/4	2.4		
	1/8	1.2		
	1600 x 1200	1/2.7		1.4
		1/4		0.9
		1/8		0.5
1280 x 960	1/2.7	0.9		
	1/4	0.6		
	1/8	0.3		
1024 x 768	1/2.7	0.6		
	1/4	0.4		
	1/8	0.2		
640 x 480	1/2.7	0.2		
	1/4	0.2		
	1/8	0.1		

The file size in the table is approximate.

Note

- The number of remaining pictures may change according to the subject or factors like whether print reservations have been made or not. In certain instances, the number of remaining pictures displayed on the viewfinder or the monitor does not change even when you take pictures or stored images are erased.
- The actual file size varies depending on the subject.

How to select the record mode



Available modes **P** **A** **S** **M** **SCENE**

2

Things to know before shooting

1 Press the (record mode) button.

- The current setting is displayed on the monitor.

2 Rotate the control dial until the setting you want to select is displayed.



When the control panel screen is off

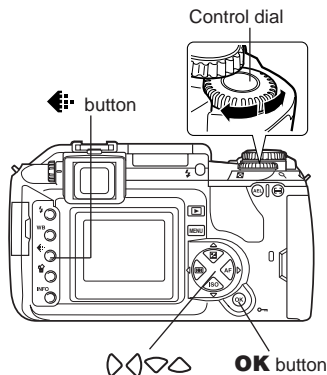

Setting HQ/SQ

You can select the number of pixels (PIXEL COUNT) and compression rate (COMPRESSION).

Available modes **P** **A** **S** **M** **SCENE**

1 Menu → → HQ, SQ. “How to use the menus” (P. 25)

2 Press to move to the setting.

Press to select a setting. Press the OK button.

To select both COMPRESSION and PIXEL COUNT, press to move from PIXEL COUNT to COMPRESSION.

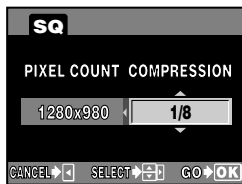

PIXEL COUNT: Selects the number of pixels. (SQ only)

COMPRESSION: Selects compression rate.

3

Selecting the right mode for shooting conditions

Close-ups of small objects like flowers or jewelry, capturing a fast-moving subject like a child running around, shooting with a natural-looking illuminated background at night — did you ever wonder how to achieve the results you want without complicated and time-consuming camera settings?

With this camera, you will find a new way of capturing all those special moments and effects in an instant. All you have to do is to select the appropriate mode, and concentrate on your composition; no complicated settings as with other cameras.

You can also select the exposure mode, which allows you to set the aperture value and shutter speed. With precise value setting, images come out better. The more you shoot, the more possibilities you will discover.



This camera has 4 different exposure modes (Program shooting, aperture shooting, shutter speed, manual shooting) and more than 10 different situation-related shooting modes. The shooting modes can be set using the mode dial and menus.

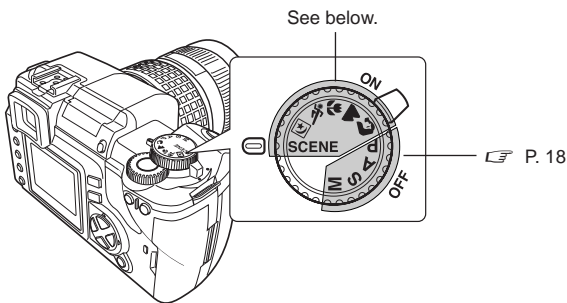

3

Selecting the right mode for shooting conditions

Selecting the right mode for the shooting situation

When you select a mode to suit the shooting situation, the camera optimizes the settings for the shooting situations and conditions.

1 Set the mode dial to the situation-related mode you want to use.

When you select : The camera enters the selected mode.

When you select **SCENE** : The SCENE menu appears.

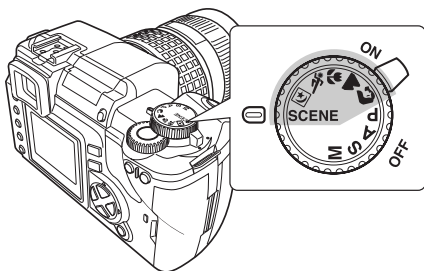

2 Press to select the situation-related mode. (For SCENE only)

"How to use the menus" (P. 25)

- A sample image of the selected mode is displayed.

3 Press the **OK** button.

- The camera enters the shooting stand-by mode.
- To change the setting, press the **OK** button again. The SCENE menu appears.



LANDSCAPE

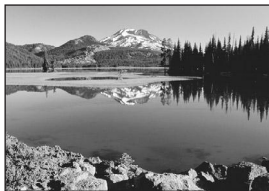

Suitable for shooting landscapes and other outdoor scenes. Vivid reproduction of blues and greens.



LANDSCAPE+PORTRAIT



Suitable for shooting both main subject and background. The camera brings both of them into focus.



NIGHT SCENE



Suitable for shooting images of outdoor scenes in the evening or at night.

Usually a street at night makes a dark image with only the sparkle of lights such as street lamps due to the lack of brightness. This mode allows you to capture the true appearance of the street.

- Since the shutter speed is slow, be sure to stabilize the camera.



NIGHT+PORTRAIT



Suitable for shooting both the main subject and background at night.

- Since the shutter speed is slow, be sure to stabilize the camera.
- The flash fires in the red-eye reduction mode.
- ☞ "Flash modes" (P. 54)



FIREWORKS



Suitable for shooting fireworks.

- Since the shutter speed is slow, be sure to stabilize the camera.
- The flash cannot be used.
- AF is not possible. Use manual focus (MF).



SUNSET



Suitable for taking sunset pictures.

Vivid red and yellow color reproduction.

- The flash cannot be used.
- Since the shutter speed is slow, be sure to stabilize the camera.



PORTRAIT



Suitable for shooting a portrait-style image of a person. Only the subject is brought into focus with a blurred background.



HIGH KEY



Suitable for shooting a bright subject. Subject brightness is enhanced, producing an image with more impact.



MACRO



Suitable for taking close-up pictures (macro shooting).

- If you use the flash, shadows may be noticeable and the correct exposure may not be achieved.



DOCUMENTS

Motion JPEG Image & Sound Recording*

With the provided 8MB SmartMedia, Motion JPEG image & sound recording up to 15 seconds in HQ mode (320x240 pixels) or 62 seconds in SQ mode (160x120 pixels) is possible.

*Sound is recorded in Wave format.

Built-In Microphone

With the built-in microphone, you can record up to 4 seconds of sound per still image.

Picture Effects

Black & White, Sepia, White Board, or Black Board can be selected, giving you greater control over image style. With White Board and Black Board modes, pictures of letters can be taken extra-clearly.

Suitable for shooting documents, etc. Increases contrast between letters and background.

- The flash cannot be used.



MUSEUM



For shooting with no beep sound and flash. Useful in art gallery, museum, etc.

- SHQ and HQ cannot be selected
- ☞ "Selecting the record mode" (P. 33)



SPORT



Suitable for capturing fast-moving action without blurring.



BEACH & SNOW



Suitable for shooting snow-capped mountain landscapes, white sand beaches, seascapes, etc.



CANDLE



Suitable for shooting under candlelight. Warm colors are reproduced.

- The flash cannot be used.
 - SHQ and HQ cannot be selected.
-  "Selecting the record mode" (P. 33)

P : Program shooting

The camera sets the optimum aperture value and shutter speed automatically according to the subject brightness.

You can also perform program shift as needed to change the combination of aperture and shutter speed while keeping the correct EV (exposure value).

1 Set the mode dial to P.

2 Press the shutter button halfway.

- Focusing is performed and the AF confirmation mark lights on the viewfinder.
- The shutter speed and aperture value that have been set automatically by the camera are displayed on the viewfinder.

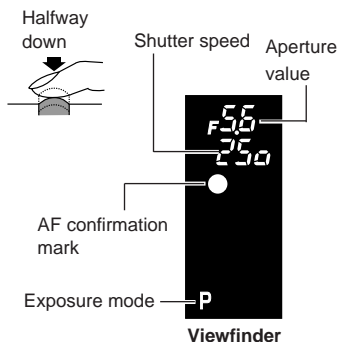

3 Press the shutter button all the way.

- A picture is taken.

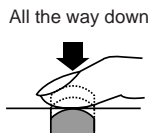

Aperture values and shutter speeds in the P (Program) mode

In the P (Program) mode, the camera is programmed so that the aperture value and shutter speed are selected automatically according to the subject brightness as shown below. The below diagram depends on the attached lens.

ED 50mm f2 MACRO

Example: When EV is 7, the aperture value is set to F2 and the shutter speed to 1/30.

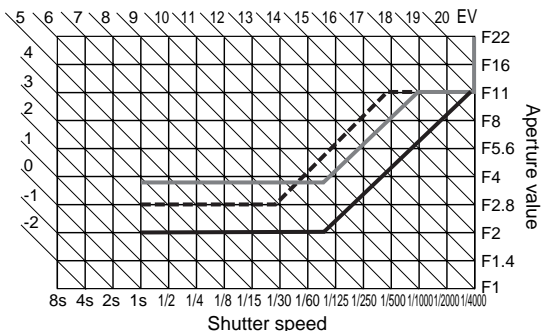

- : When using the fixed focal lens (ED 50mm f2 MACRO)
- : Maximum wide setting when using the zoom lens (14mm-54mm f2.8-f3.5)
- : Maximum tele setting when using the zoom lens (14mm-54mm f2.8-f3.5)

Program shift (Ps)

By rotating the control dial in the P mode, you can change the combination of aperture and shutter speed while keeping the optimum exposure.

The program shift setting will not be canceled after shooting. To cancel program shift setting, rotate the control dial so that the viewfinder indication Ps changes to P or turn off the power. Program shift is not available when you are using a flash.

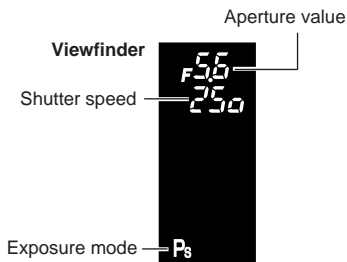

A : Aperture priority shooting

The camera sets the optimum shutter speed automatically for the aperture value you have selected. When you decrease the aperture value (F-number), the camera will focus within a shorter range (shallow depth of field) and produce a picture with a blurred background. Conversely, when you increase the aperture value, the camera will focus over a wider range in the forward and backward directions (more depth of field), producing a picture with clear focus throughout the image area. Before shooting, you can use the preview function to check how the background will look in your picture.



Aperture value (F-number) is decreased



Aperture value (F-number) is increased

- 1** Set the mode dial to **A**.
- 2** Rotate the control dial to set the aperture value.

Large aperture (F-number is decreased)

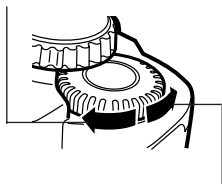

Small aperture (F-number is increased)

3 Press the shutter button halfway.

- Focusing is performed and the AF confirmation mark lights on the viewfinder.
- The shutter speed that has been set automatically by the camera is displayed on the viewfinder.

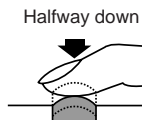

3

Selecting the right mode for shooting conditions

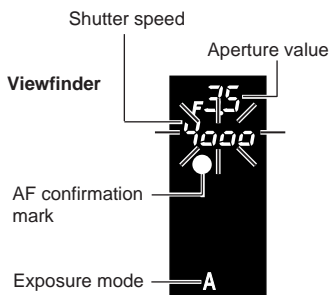

Overexposed when the shutter speed indication is blinking. Increase the aperture value (F-number).

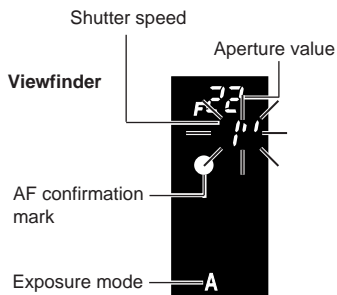

Underexposed when the shutter speed indication is blinking. Decrease the aperture value (F-number).

4 Press the shutter button all the way.

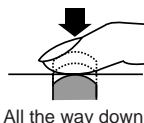

TIPS

The shutter speed indication does not stop blinking after the aperture value is changed.

- If a fast shutter speed indication is blinking, set the ISO sensitivity to a lower value or use an ND filter (for adjusting the amount of light).
 - ☞ “ISO sensitivity — Setting the desired sensitivity to light” (P. 91)
- If a slow shutter speed indication is blinking, set the ISO sensitivity to a higher value.
 - ☞ “ISO sensitivity — Setting the desired sensitivity to light” (P. 91)

To change the EV step interval:

- In the menu, set the EV step interval to 1/3EV, 1/2EV or 1EV.
 - ☞ “EV STEP” (P. 124)

To check the depth of field with the selected aperture value:

- ☞ “PREVIEW function” (P. 52)

S : Shutter priority shooting

The camera sets the optimum aperture value automatically for the shutter speed you have selected. Set the shutter speed depending on the type of effect you want: a higher speed shutter allows you to capture a fast-moving subject without blur, and a slower shutter speed blurs a moving subject, creating a feeling of speed or motion.



A fast shutter speed can freeze a fast action scene without any blur.



A slow shutter speed blurs a moving subject, generating a sense of movement to create a more powerful visual impact.

1 Set the mode dial to **S**.

2 Rotate the control dial to set the shutter speed.

Slower shutter speed

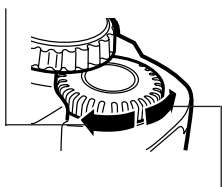

Faster shutter speed

3 Press the shutter button halfway.

- Focusing is performed and the AF confirmation mark lights on the viewfinder.
- The aperture value that has been set automatically by the camera is displayed on the viewfinder.

Halfway down

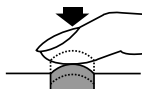

3

Selecting the right mode for shooting conditions

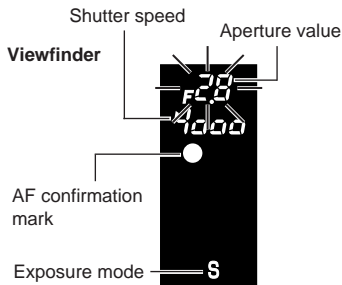

If the aperture value indication at the minimum value is blinking, the correct exposure is not attained (underexposed). Set the shutter speed slower.

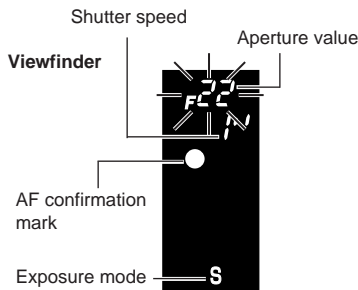

If the aperture value indication at the maximum value is blinking, the correct exposure is not attained (overexposed). Set the shutter speed higher.

4 Press the shutter button all the way.

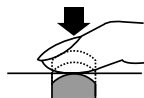

All the way down



Shutter speed indication

If the selected shutter speed is less than 1 second, only its denominator will be displayed such as 200 for 1/200 sec., and if more than 1 second, a double-quote mark " will be displayed such as 1" for 1 sec.

TIPS**The picture looks blurred.**

- The possibility of camera shake spoiling your picture increases greatly during macro or ultra-telephoto shooting. Set the shutter speed higher or use a monopod or tripod to stabilize the camera.

The aperture value indication does not stop blinking after the shutter speed is changed.

- If the aperture value indication at the maximum value is blinking, set the ISO sensitivity to a lower value or use an ND filter (for adjusting the amount of light).  “ISO sensitivity — Setting the desired sensitivity to light” (P. 91)
- If the aperture value indication at the minimum value is blinking, set the ISO sensitivity to a higher value.  “ISO sensitivity — Setting the desired sensitivity to light” (P. 91)

To change the EV step interval:

- In the menu, set the EV step interval to 1/3EV, 1/2EV or 1EV.
 “EV STEP” (P. 124)

M : Manual shooting

You can set both aperture value and shutter speed manually, while referring to the exposure level indicator. This mode gives you more creative control, allowing you to make whatever settings you like, regardless of the correct exposure. Bulb shooting is also possible, allowing you to take astronomical or fireworks pictures.

1 Set the mode dial to M.

2 Rotate the control dial to set the aperture value.

Press the  (exposure compensation) button, then rotate the control dial to set the shutter speed (30 sec. - 1/4000 sec.).

- The aperture value and shutter speed change in 1/3 EV increments as the dial is rotated.
- The exposure level indicator appears on the control panel screen, showing the difference (ranging from -3 EV to +3 EV) between the exposure value calculated by the currently selected aperture and shutter speed compared to the exposure value considered optimum by the camera.

Decrease the aperture value (F-number)

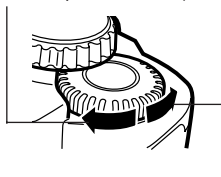

Increase the aperture value (F-number)

Slow shutter speed

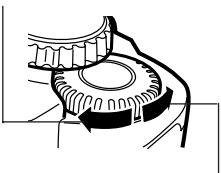

Fast shutter speed

Control panel screen

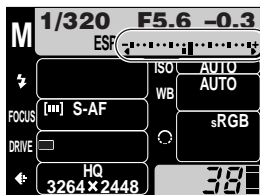

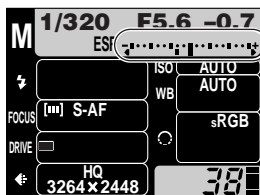

Exposure level indicator



Exposure level indicator

If the difference between the currently set exposure and the optimum exposure is outside the range of available indicator levels, “◀” or “▶” will blink on the left or right end of the exposure level indicator.

- • •  • • + Underexposure
- • •  • • + Overexposure
- • •  • • + Optimum exposure

3 Take the picture.

Noise in images

During shooting at slow shutter speeds of 30 or more seconds, noise may appear on-screen or the image may be overly bright in the top left part of the screen. These phenomena are caused when current is generated in those sections of the CCD that are not normally exposed to light, resulting in a rise in temperature in the CCD or CCD drive circuit. This can also occur when shooting with a high ISO setting in an environment exposed to heat. The NOISE REDUCTION function helps reduce this noise.  “NOISE REDUCTION” (P. 105)

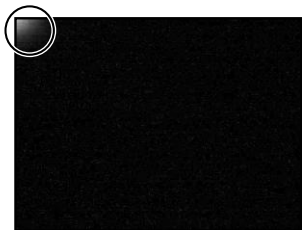

Bulb shooting

You can take a picture with a bulb exposure time in which the shutter stays open as long as you hold down the shutter button (up to 8 minutes). Set the shutter speed to [bulb] in the M mode. Bulb shooting can also be done using the optional power battery holder and remote cable.

TIPS

The picture looks blurred.

- The possibility of camera shake spoiling your picture increases greatly when you take a picture at slow shutter speed. Use a monopod or tripod to stabilize the camera.

To change the EV step interval:

- In the menu, set the EV step interval to 1/3EV, 1/2EV or 1EV.  “EV STEP” (P. 124)

PREVIEW function

If you press the **OK** button, the viewfinder shows the actual depth of field (the distance from the nearest to the furthest point of perceived “sharp” focus) in a picture, with the selected aperture value. Assign preview function to the **OK** button beforehand.  “CUSTOM OK” (P. 125)

Available modes



3

1 Press the **OK** button.

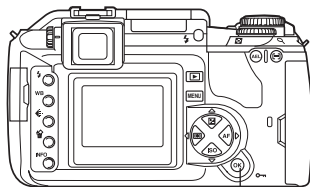

OK button

Note

The metering values cannot be changed in the preview mode.

4

Various shooting functions

The flash and drive modes (sequential shooting) are the keys to advanced shooting techniques. Selecting a flash mode to suit a specific shooting situation or adjusting the amount of light emitted by the flash will produce an image that is different from what would be obtained when less precise settings are used. Similarly, using an optional external flash together with the built-in flash will create yet another impression. With drive mode you can take several pictures of the same scene in sequence with different exposure or white balance settings. There's no need to change the settings before taking each picture.

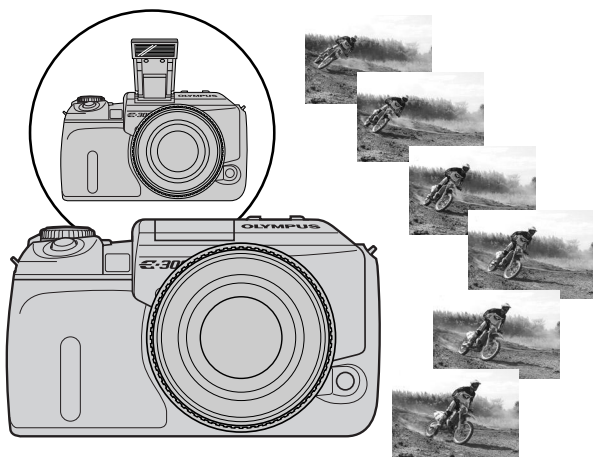

Flash modes



The camera sets the flash mode according to various factors such as firing pattern and flash timing. Available flash modes depend on the exposure mode.

The flash modes are available to optional external flashes.

Auto-flash AUTO

The flash fires automatically in low light or backlight conditions.

To shoot a subject with backlighting, position the AF frame over the subject.

4

Red-eye reduction flash

The light from the flash may make the subject's eyes appear red in the picture. The red-eye reduction flash mode significantly reduces this phenomenon by emitting pre-flashes before firing the regular flash. This helps accustom the subject's eyes to the bright light and minimizes the red-eye phenomenon.

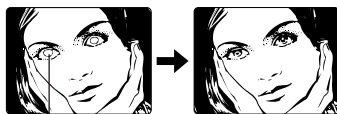

The subject's eyes appear red.

Various shooting functions

Note

- After the pre-flashes, it takes about 1 second before the shutter is released. Hold the camera firmly to avoid camera movement.
- Effectiveness may be limited if the subject is not looking directly at pre-flashes, or if the shooting range is too far. Individual physical characteristics may also limit effectiveness.

Slow synchronization (1st curtain) SLOW

The slow synchronization flash is designed for slow shutter speeds. Normally, when shooting with a flash, shutter speeds cannot go below a certain level to prevent camera movement. But when shooting a subject against a night scene, fast shutter speeds can make the background too dark. Slow synchronization allows you to capture both the background and the subject. Since the shutter speed is slow, be sure to stabilize the camera by using a tripod so as not to cause the picture to be blurred.

1st curtain

Usually, regardless of the shutter speed, the flash fires right after the shutter fully opens. This is called 1st curtain. Unless you change it, this is how the flash always fires.

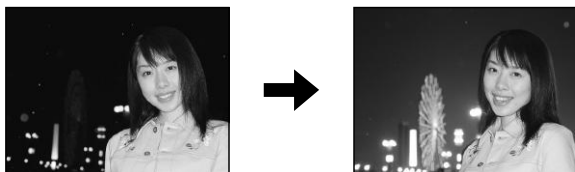
**Slow synchronization (2nd curtain) ⚡ SLOW2**

2nd curtain flash fires just before the shutter closes. Changing the flash timing can create interesting effects in your picture, such as expressing the movement of a car by showing the tail-lights streaming backwards. The slower the shutter speed, the better the effects turn out. The slowest possible shutter speed depends on the shooting mode.

P mode : 2 sec.

A/S/M mode (Bulb is also available) : 30 sec.

When the shutter speed is set to 2 sec.

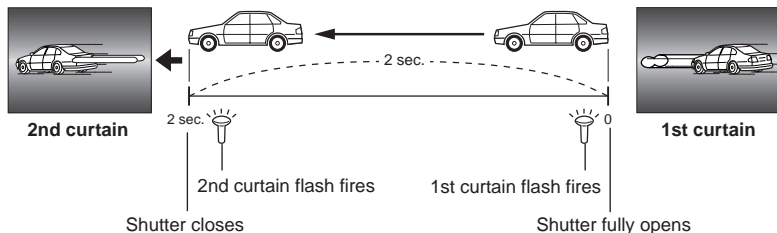
**Slow synchronization + Red-eye reduction flash 👁 ⚡ SLOW**

This mode is for when you want to use slow synchronization, yet also reduce the red-eye phenomenon. For instance, when shooting a person against a brightly lit night background. A normal flash might make the person's eyes red, but this mode lets you capture the background correctly and reduce the red-eye phenomenon at the same time. 2nd curtain flash with red-eye reduction is not available.

Fill-in flash ⚡

The flash fires regardless of the light conditions. This mode is useful for eliminating shadows on the subject's face (such as shadows from tree leaves), in a backlight situation, or for correcting the color shift produced by artificial lighting (especially fluorescent light).



4

Various shooting functions

! Note

- When the flash fires, the shutter speed is set to 1/180 sec. or less. When shooting a subject against a bright background with the flash, the background may be overexposed. In this case, use the optional FL-50/FL-36 external flash and set it to the Super FP flash mode.

















Fill-in flash + Red-eye reduction flash 👁⚡

This mode makes it possible to fire the flash regardless of the light conditions and also to reduce red-eye phenomenon.

Fill-in flash + Slow synchronization (2nd curtain) ⚡ SLOW2

The flash fires regardless of the light conditions at the timing of the 2nd curtain.

Flash modes available in the exposure mode

Exposure mode	Control panel screen	Flash mode	Flash timing	Conditions to fire the flash	Shutter speed restrictions	
P A     	AUTO	Auto-flash	1st curtain	Fires automatically in dark/backlit* conditions	1/30 - 1/180 with auto/ 	
		Auto-flash (Red-eye reduction)				Restricted to 2 - 1/180 sec.
		Slow synchronization (Red-eye reduction)				
		Slow synchronization	2nd curtain		Always fires	
		Slow synchronization (2nd curtain)	1st curtain			
		Fill-in flash	—			
		Flash off	—	—	—	
S M		Fill-in flash	1st curtain	Always fires	Restricted to 60 - 1/180 sec.	
		Fill-in flash (Red-eye reduction)	1st curtain			
		Fill-in flash (2nd curtain)	2nd curtain			
		Flash off	—	—	—	

* When the flash is set to the Super FP mode, it detects backlight before emitting light.

 "Super FP flash" (P. 63)

Setting the flash mode



Available modes



1 Press the ⚡ (flash) switch to raise the flash.

2 Press the ⚡ (flash mode) button.

- The current setting is displayed on the monitor.

3 Rotate the control dial until the desired setting is displayed.

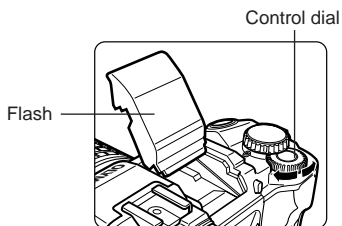

⚡ (flash mode) button

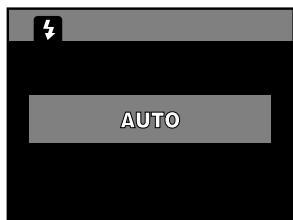
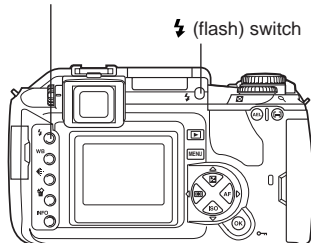

When the control panel screen is off

MANUAL FLASH

When MANUAL FLASH (⚡ P. 124) in the \mathcal{Y}_1 menu is set to ON, the flash emits a fixed amount of light.

Using the built-in flash

If you shoot a subject from as close as 1 m using a lens that is wider than 14 mm (equivalent to 28 mm on a 35 mm film camera), the light emitted by the flash may produce a vignette effect.

Available modes



- 1 Press the ⚡ (flash) switch to raise the flash.

⚡ (flash) switch

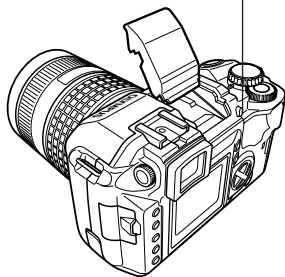

- 2 Press the shutter button halfway.

- The ⚡ (flash stand-by) mark lights when the flash is ready to fire. If the ⚡ mark is blinking, the flash is charging. Wait until charging is complete.

- 3 Press the shutter button all the way down (fully) to take the picture.

Viewfinder



Flash stand-by mark

Flash intensity control



This adjusts the amount of light emitted by the flash.

In some situations (e.g., when shooting small subjects, distant backgrounds, etc.), you may get better results by adjusting light emission. It is useful when you intend to increase the contrast (distinction between light and dark) of images to make the images more vivid.

Available modes



4

Various shooting functions

1 Menu → →

“How to use the menus” (P. 25)

2 Press .

- The setting screen is displayed.

3 To increase light emission:
Each time you press , light emission increases in steps of 1/3EV.
To decrease light emission:
Each time you press , light emission decreases in steps of 1/3EV.

- You can select EV steps from 1/3EV, 1/2EV or 1EV. “EV STEP” (P. 124)

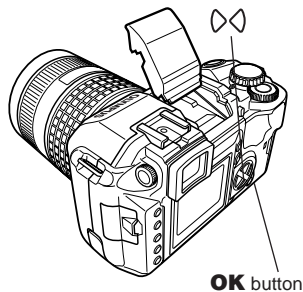

4 Press the **OK** button.

Note

- This does not work when the flash control mode on the electronic flash is set to MANUAL.
- If light emission is adjusted on the electronic flash, it will be combined with the camera's light emission setting.
- Flash intensity control is applicable to the flash you are using (built-in flash or external flash). When using both flashes simultaneously, flash intensity control is applicable to the amount of light emitted by both flashes.

Optional electronic flashes

In addition to this camera's built-in flash capabilities, you can take advantage of a variety of flash shooting techniques to suit different shooting conditions with the flash units specified for use with this camera — the Olympus FL-50, FL-36, and FL-20 electronic flashes.

These flashes communicate with the camera to make available various flash modes, such as auto-flash, red-eye reduction flash, slow synchronization, and controlled light emission. The flash can be mounted on the camera by attaching it to the camera's hot shoe.

Functions available with optional flash units

Optional flash	FL-50	FL-36	FL-20
Flash control mode	TTL-AUTO (Super FP flash), TTL-AUTO, AUTO, MANUAL, MANUAL (Super FP flash)	TTL-AUTO (Super FP flash), TTL-AUTO, AUTO, MANUAL, MANUAL (Super FP flash)	TTL-AUTO, AUTO, MANUAL
Using the external flash with the built-in flash	The external flash cannot be used with the built-in flash while the former is attached to the camera's hot shoe.	The external flash can be used with the built-in flash.	
GN (guide number) (ISO100)	GN 50 (85 mm*) GN 28 (24 mm*)	GN 36 (85 mm*) GN 26 (24 mm*)	GN 20 (35 mm*)

* Calculated based on 35mm film.

Using the electronic flash

The following instructions describe how to connect and use the FL-50 electronic flash (optional). Be sure to attach the flash to the camera before turning on the flash's power.

Available modes



4

Various shooting functions

1 Remove the hot shoe cover by sliding it in the direction indicated by the arrow in the illustration.

- Keep the shoe cover in a safe place to avoid losing it, and put it back on the camera after flash shooting.

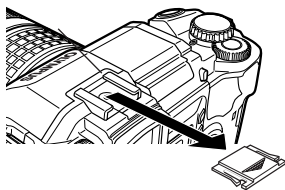

2 Attach the FL-50 electronic flash to the hot shoe on the camera.

- If the lock pin is protruding, turn the shoe lock dial as far as it will go in the direction opposite to ◀ LOCK. This will pull the lock pin back inside.
- For instructions on how to attach the flash, refer to the FL-50's manual.

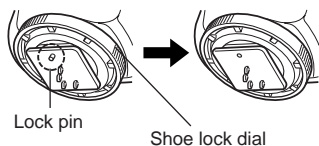

3 Turn on the flash.

- When the charge lamp on the flash lights up, charging is complete.
- The flash will be synchronized with the camera at a speed of 1/180 sec or less.

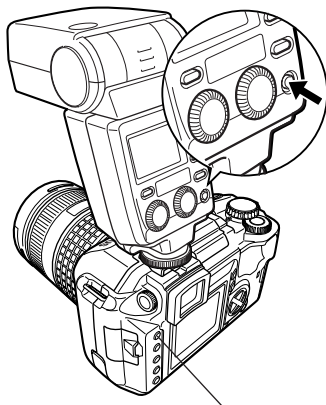

⚡ (flash mode) button

4 Select a flash mode.

- ☞ "Selecting the flash mode" (P. 58)

5 Select the desired flash control mode.**6** Press the shutter button on the camera halfway.

- Shooting information such as ISO sensitivity, aperture value, and shutter speed is communicated between the camera and flash.
- ⚡ lights up in the viewfinder.

7 Press the shutter button all the way.

Viewfinder



⚡ blinks:
The flash is
charging.



⚡ lights up:
Charging is
complete.

Note

- When shooting with the flash control mode set to TTL-AUTO, pre-flashes are emitted before firing the regular flash.
- When the flash control mode is set to TTL-AUTO, or when shooting a subject at a distance with ISO set to 400 or higher, flash control accuracy will decrease.

4

Various shooting functions

Super FP flash

Super FP flash is available with the FL-50/FL-36. Super FP flash timing is longer than standard flash timing. This means that pictures can be taken at a higher shutter speed than is possible with normal flashes.

Flash shooting with the aperture open such as in portrait shooting is also possible with Super FP flash. For details, refer to the FL-50 manual.

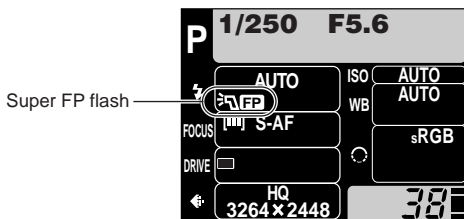

Using commercially available flashes

The amount of light emitted cannot be adjusted on commercially available flashes except for those specified. A small versatile flash can be synchronized with the camera at a shutter speed of 1/180 sec. or less, whereas a large flash (such as a studio flash) can be synchronized at 1/125 sec. or less. For details on non-specified commercial flashes, refer to the next page.

1 Remove the hot shoe cover to connect the flash unit to the camera.

2 Set the exposure mode to M mode, then set the aperture value and shutter speed.

 **“Manual shooting” (P. 49)**

- A slower shutter speed may produce blurred images.

3 Turn on the flash.

- Be sure to turn on the flash after attaching the flash unit to the camera.

4 Set the flash control mode on the flash to AUTO. Also set the ISO sensitivity and aperture value on the flash to match the camera’s settings.

- Refer to the manual for the flash to set its flash control mode.

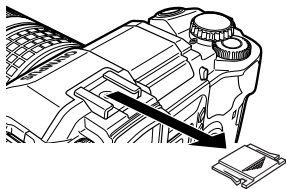

Note









- The camera's flash mode except 2nd curtain will have no effect on the non-specified commercial flashes.
- The flash fires each time the shutter is released. When you do not need to use the flash, turn off the flash's power.
- Check beforehand that the flash you are using is synchronized with the camera.

Non-specified commercial flashes

Before selecting a non-specified commercial flash, be sure to read the following information carefully to determine whether or not it can be used with this camera.

- (1) Exposures when using a flash require that adjustments be made on the flash. If a flash is used in the auto mode, match it with the F value and ISO sensitivity settings on the camera.
- (2) Even if the auto F value and ISO sensitivity of the flash are set to the same conditions as those on the camera, the correct exposure may not be obtained depending on the shooting conditions. In such a case, adjust the auto F value or ISO on the flash or calculate the distance in the manual mode. (Exposure compensation on the camera cannot be used when shooting with the flash.)
- (3) Use a flash with an illumination angle that matches the focal length of the lens. The focal length of the lens for 35 mm film is approximately twice as long as the focal length of the lenses designed for this camera.
- (4) **Do not use a flash unit or other accessory TTL flash that has additional communications functions other than the specified flashes, since it may not only fail to function normally, but may also cause damage to the camera's circuitry.**



The following drive modes are available with this camera.

- Single-frame shooting**  : Shoots 1 frame at a time when the shutter button is pressed. (Normal shooting mode, single-frame shooting)
- Sequential shooting**  : Shoots 4 frames or more at 2.5 frames/sec. (in SHQ, HQ or SQ) for as long as the shutter button pressed. Focus and exposure are locked at the first frame. (except C-AF shooting  P. 82)
- Auto-bracketing BKT** : Shoots multiple frames of the same scene at different exposures (AE bracketing) or white balance (WB bracketing).
 “Auto bracketing” (P. 68)
- Self-timer shooting**  : Triggers the shutter after a set time, either 12 sec. or 2 sec.  P. 72
- remote control shooting**  : Shoots using the optional remote control.
 P. 72

Sequential shooting

Available modes



- 1** Menu →  → DRIVE → 
 “How to use the menus” (P. 25)

Shutter button

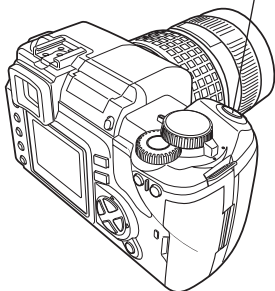

2 Start shooting.

- Press the shutter button fully and keep it pressed. The camera will take pictures in sequence until you release the button.

Note

- Sequential shooting is not possible when NOISE REDUCTION is set to ON.
- During sequential shooting, if the battery check blinks due to low battery, the camera stops shooting and starts saving the pictures you have taken on the card. The camera may not save all of the pictures depending on how much battery power remains.

Auto bracketing

BKT

Useful when you are not sure what exposure or white balance settings are appropriate and you don't have time to take several test shots at different settings.

AE bracketing

The camera automatically shoots a number of pictures at different exposure values for each frame. Even in conditions where correct exposure is difficult to obtain (such as a backlit subject or a scene at dusk), you can pick the picture you prefer from a selected number of frames with a variety of different exposure settings (exposure and compensation values). The pictures are taken in the following order: Picture with optimum exposure, picture adjusted in – direction, and picture adjusted in + direction.

Example:
When BKT
is set to 1.0



-1.0



±0



+1.0

Compensation value : 0.3, 0.7 or 1.0

The exposure compensation values depend on the EV step interval setting that can be changed in the menu. Exposure compensation value can be adjusted within a range of ± 1.0 . “EV STEP” (P. 124)

Number of frames : 3

Available modes



1 Menu → → DRIVE → BKT

“How to use the menus” (P. 25)

Shutter button

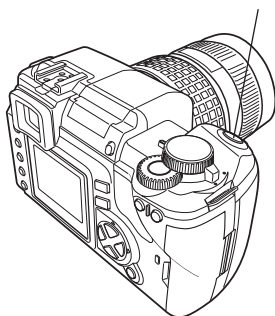

2 Press \blacktriangleleft .

- The BKT selection screen is displayed.

3 Press \blacktriangledown to select compensation value. Press the **OK** button.**4** Single-frame shooting :

Each time the shutter button is pressed fully, a picture is taken at a different exposure.

- The setting for the next shot is displayed in the viewfinder.

Sequential shooting :

Hold down the shutter button until the selected number of frames are taken.

The camera shoots each frame at a different exposure.

- Releasing the shutter button stops auto bracketing shooting.

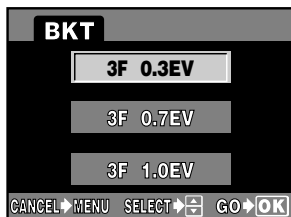

Viewfinder

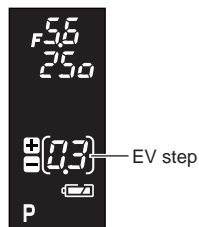

How AE bracketing compensates exposure in each exposure mode

Depending on the selected exposure mode, exposure is compensated in the following way:

- P mode** : Aperture value and shutter speed
- A mode** : Shutter speed
- S mode** : Aperture value
- M mode** : Shutter speed

TIPS

To apply AE bracketing to the exposure value you have compensated:

- Compensate the exposure value, then use the AE bracketing feature. AE bracketing is applied to the exposure value you have compensated.

Auto bracketing compensation range

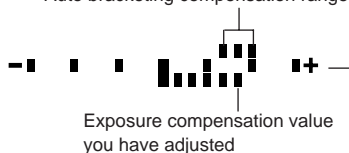

If the selected range is beyond the scale of the exposure level indicator, only the part within the scale is displayed.

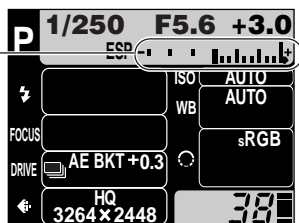
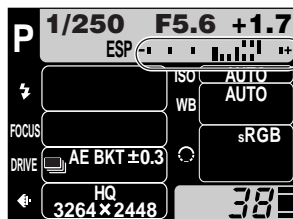
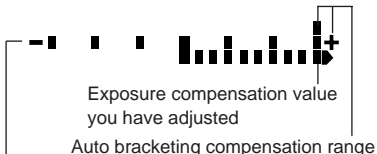

! Note

- Auto bracketing is not possible when the flash is on.
- During WB bracketing, the camera cannot shoot in sequence if there is not enough memory in the camera and card for storing more than the selected number of frames.
- During sequential shooting, if the battery check blinks due to low battery, the camera stops shooting and starts saving the pictures you have taken on the card. The camera may not save all of the pictures depending on how much battery power remains.

WB bracketing WB BKT

Three images with different white balances are automatically created from one shot. One is the image just taken with the specified white balance, one is the same image adjusted in the red direction, and the third the same image adjusted in the blue direction. All three images are saved on the card.

Available modes



- 1 Menu → → WB BKT → OFF,
3F 2STEP, 3F 4STEP, 3F 6STEP
 “How to use the menus” (P. 25)

2 Take the picture.

- When the shutter button is pressed down all the way, three images are automatically created.

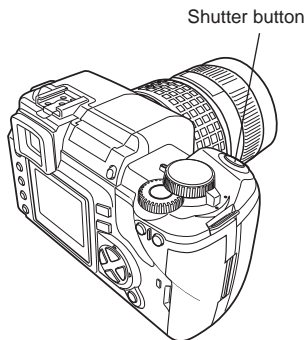

4

Various shooting functions

TIPS

To apply WB bracketing to white balance you have adjusted:

- Adjust white balance manually, then use the WB bracketing feature. WB bracketing is applied to your white balance adjustment.

Self-timer shooting / Remote control shooting (with optional remote control)

You can select self-timer shooting or remote control shooting.



Self-timer shooting :





This function lets you take pictures using the self-timer. You can set the camera to trigger the shutter after either 12 or 2 seconds. Fix the camera securely on a tripod for self-timer shooting.

Remote control shooting (with optional remote control) :









By using the optional remote control (RM-1), you can take a picture with yourself in it or a night scene without touching the camera. The camera can be set to trigger the shutter either right away or 2 seconds after the shutter button on the remote control is pressed.

Available modes          **SCENE**

Setting  or 

1 Menu →  → DRIVE →  or 
 “How to use the menus” (P. 25)

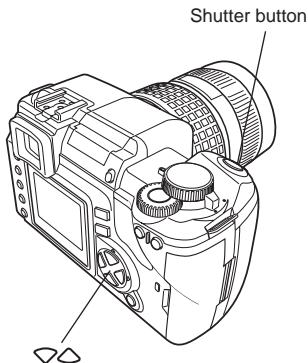

2 Press  .
 • The setting screen is displayed.

3 Press   to select a mode from the  or  settings.
 : 12-second self-timer
 : 2-second self-timer
 : Triggers the shutter button right away.
 : 2-second remote control timer



Using the self-timer

1 Press the shutter button all the way.

- A picture is taken.
- The focus and exposure are locked when the shutter button is pressed halfway.
- When  is selected: First, the self-timer lamp lights up for approximately 10 seconds, then it blinks for approximately 2 seconds and the picture is taken.
When  is selected: The self-timer lamp lights up for approximately 2 seconds, then the picture is taken.
- To cancel the activated self-timer, press the **MENU** button.



TIPS

To exit the self-timer mode.

- The self-timer mode is not canceled automatically after shooting. In the menu, switch from DRIVE to one of the other modes.

Eyepiece cover

When shooting without looking through the viewfinder, such as when using the self-timer, attach the eyepiece cover to the viewfinder so that the light does not enter the viewfinder.

To attach the eyepiece cover, remove the eyecup from the camera as illustrated.

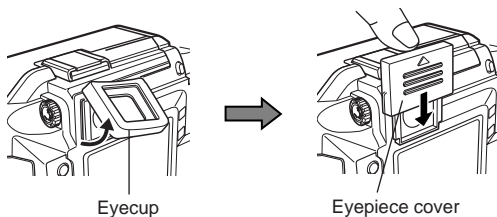

Eyecup

Eyepiece cover

! Note

Do not press the shutter button while standing in front of the camera; this could result in the subject being out of focus since focusing is performed when the shutter button is pressed halfway.

Using the remote control

1 Mount the camera on a tripod or place it on a stable, flat surface.

2 Point the remote control at the remote control receiver on the camera and press the shutter button on the remote control.

- When  is selected: The focus and exposure are locked, the remote control lamp blinks and the picture is taken.

- When  is selected: The focus and exposure are locked, the remote control lamp blinks and the picture is taken after approximately 2 seconds.

Remote control lamp
Remote control receiver

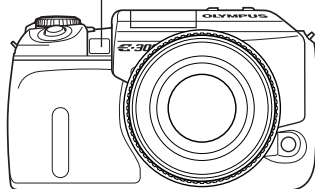

4

Various shooting functions

Transmitted signal effective area

Point the remote control at the remote control receiver of the camera within the effective area as shown below.

Powerful lighting such as direct sunlight, fluorescent light or devices emitting electrical or radio waves could narrow the effective area.

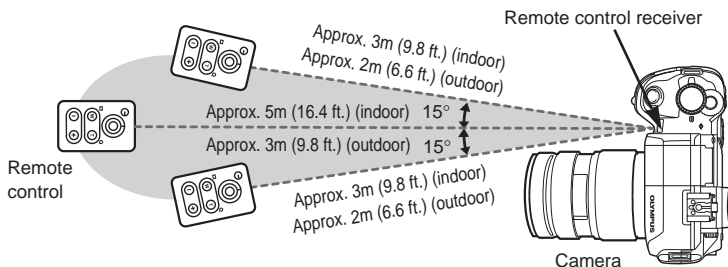

TIPS



The remote control lamp does not blink after the shutter button on the remote control is pressed.

- The transmitted signal may not be effective if the remote control receiver is exposed to powerful lighting. Move the remote control closer to the camera and press the shutter button on the remote control again.
- The transmitted signal may not be effective if the remote control is too far from the camera. Move the remote control closer to the camera and press the shutter button on the remote control again.
- There is signal interference. Change the channel as described in the remote control's instruction manual.

To cancel the remote control shooting mode:

- The remote control shooting mode will not be canceled after shooting. In the menu, switch from DRIVE to one of the other modes.

To use the shutter button on the camera in the remote control shooting mode:

- The shutter button on the camera still works even if  or  is displayed.

Note

- The shutter will not be released if the subject is not in focus.
- Under bright light conditions, the remote control lamp may be difficult to see, making it hard to determine whether or not the picture has been taken.
- Zoom is not available on the remote control.

MONOTONE shooting

This setting lets you add special effects to pictures.

BLACK & WHITE : Records pictures in black and white.

SEPIA : Records pictures in sepia.

Available modes



1 Menu →  → MONOTONE → OFF, BLACK & WHITE, SEPIA

 "How to use the menus" (P. 25)

4

Various shooting functions

5

Focusing functions

When you turn a focus ring to focus on a subject it's called manual focus. If you're a beginner, it usually takes some time to get used to this style of focusing. Fortunately, your digital camera provides not only manual focus, but also auto focus and various other focus modes — all easily accessible through simple button operations. These different modes will enhance your shooting flexibility. For example, if you want to capture a fast-moving subject without blur, choosing the right shutter speed is important. But you can also use focusing to achieve the same effect — when the focus mode is set to continuous AF mode, the camera focuses on the subject in anticipation of its movement.

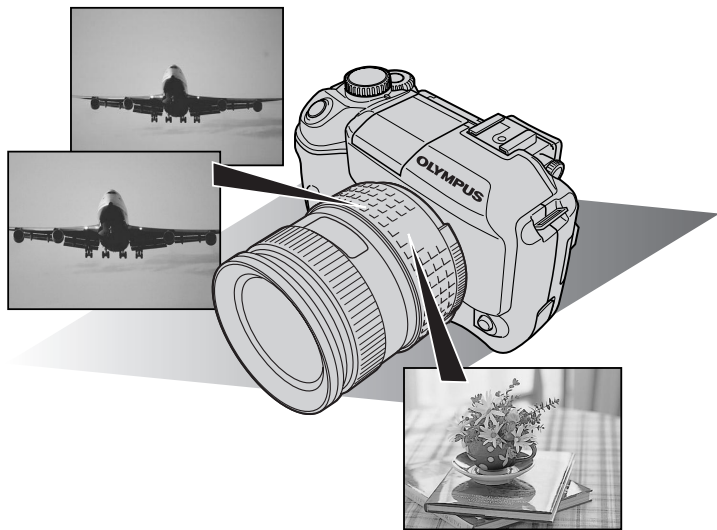

Normally, the camera measures the distance to the subject using the 3 AF frames in the viewfinder and selects the most appropriate point. This function allows you to select only one AF frame.

- (AUTO) : Focuses using the 3 AF frames. (Factory default setting)
- : Focuses using the left AF frame.
- : Focuses using the center AF frame.
- : Focuses using the right AF frame.

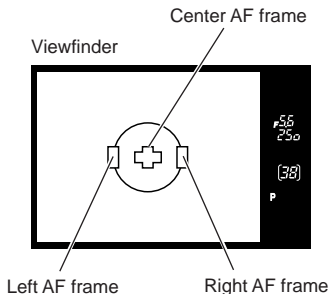

5

Focusing functions



1 Press the (AF frame selection) button.

- The current setting is displayed on the monitor.

2 Rotate the control dial until the desired setting is displayed.

3 Take the picture.

- The AF frame you have selected lights up.

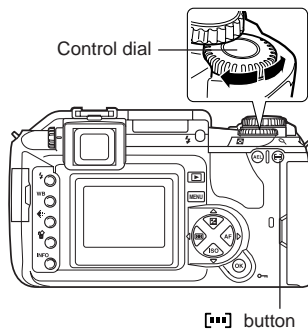

Monitor

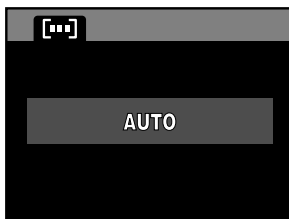

When the control panel screen is off

Focus mode

Three focus modes are available with this camera: S-AF (single AF), C-AF (continuous AF) and MF (manual focus).

Available modes



1 Press the **AF** (focus mode) button.

- The current setting is displayed on the monitor.

2 Rotate the control dial until the desired setting is displayed.

- ☞ “S-AF (single AF) shooting” (P. 80),
“Simultaneous use of S-AF mode and MF mode” (P. 81),
“C-AF (continuous AF) shooting” (P. 82),
“Manual focus (MF)” (P. 83)

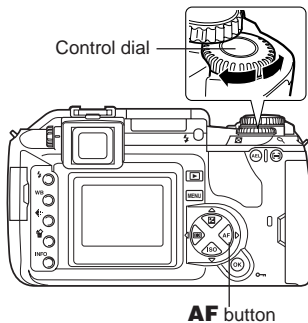

Monitor

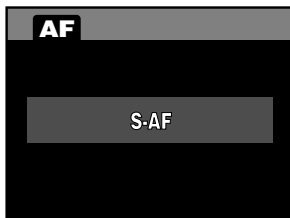

When the control panel screen is off

5

Focusing functions

S-AF (single AF) shooting

Focusing is performed once when the shutter button is pressed halfway. If focusing fails, release your finger from the shutter button and press it halfway again. This mode is suitable for taking pictures of non-moving subjects or subjects with limited movement.



Available modes



5

Focusing functions

1 Press the shutter button halfway.

- When the focus is locked, the AF confirmation mark lights up.
- A beep sound is output when the subject is in focus.

2 Press the shutter button all the way.

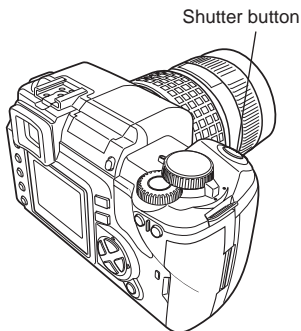

Viewfinder

AF confirmation mark

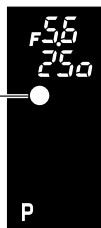

TIPS

To adjust focus manually while using AF:

- ☞ “Simultaneous use of S-AF mode and MF mode” (P. 81)

Simultaneous use of S-AF mode and MF mode

This function allows you to fine-adjust focus manually by turning the focus ring after AF is performed in the S-AF mode.

Available modes **P A S M**

- 1 Press the shutter button halfway to use AF.
 - When the focus is locked, the AF confirmation mark lights up.
- 2 Fine-adjust the focus using the focus ring, while keeping the shutter button pressed halfway.
- 3 Press the shutter button all the way to take the picture.

Shutter button

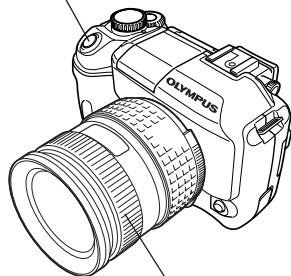

Focus ring

Viewfinder

AF confirmation mark



5

Focusing functions

! Note

If the shutter button is pressed again after fine-adjusting focus with the focus ring, the AF is activated and your adjustments are canceled.

C-AF (continuous AF) shooting

The camera repeats focusing. When the subject is in motion, the camera focuses on the subject in anticipation of its movement (Predictive AF). Even if the subject moves or you change the composition of the picture, the camera continues trying to focus.



5

Focusing functions

Available modes



1 Press the shutter button halfway and keep it in this position.

- When the subject is in focus and exposure is locked, the AF confirmation mark lights up.
- The AF frame does not light up, even when the subject is in focus.
- The camera repeats focusing. Even if the subject moves or even if you change the composition of the picture, focusing is tried continuously.
- A beep sound is output when the subject is in focus. The beep sound is not output after the third continuous AF operation, even when the subject is in focus.

Shutter button

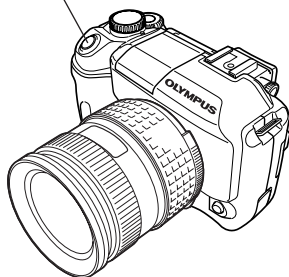

Viewfinder

AF confirmation mark



Manual focus (MF)

This function allows you to manually focus on any subject while looking through the viewfinder.



1 Adjust the focus using the focus ring. Shutter button

2 Take the picture.

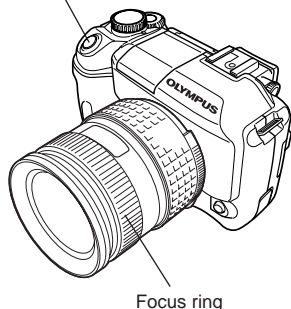

Rotational direction of the focus ring

You can select the rotational direction of the focus ring to suit your preference for how the lens adjusts to the focusing point. "FOCUS RING" (P. 126)

Focus aid

When you focus the lens on a subject manually (by turning the focus ring), the AF confirmation mark lights.

When 3 AF frames are selected, the camera performs focusing in the center AF frame.

AF ILLUMINATOR

When AF ILLUMINATOR is set to ON, the flash provides light if a subject is in a dark environment and auto focus does not work. To use this function, raise the flash.

Available modes



Setting the AF ILLUMINATOR

1 Menu → \mathcal{I} → AF ILLUMINATOR → ON, OFF

☞ “How to use the menus” (P. 25)

Using the flash as the AF illuminator

1 Raise the flash. ☞ P. 58

2 Take the picture.

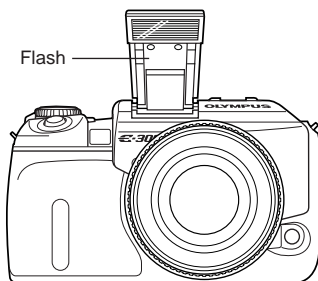

5

Focusing functions

6

Exposure, image and color

If you wish to go beyond simple shooting using only the shutter button, you will find various functions that can be used to modify image/brightness/exposure parameters to achieve remarkably better results.

For instance, if you want to shoot atmospheric pictures indoors, or if your subject would strongly reflect the flash light, shooting without the flash would typically result in a blurred or dark picture. To overcome this problem, try adjusting the ISO setting; use a lower ISO value with normal light, and a higher ISO value with dark subjects.

With exposure compensation you can adjust the image brightness and make a significant difference to how the picture turns out. Try adjusting toward “-” when you want to capture images with a dark background such as green leaves in shadow or crimson foliage on a mountainside. The red, green, and yellow of autumn leaves will be beautifully reproduced, standing out against the background.

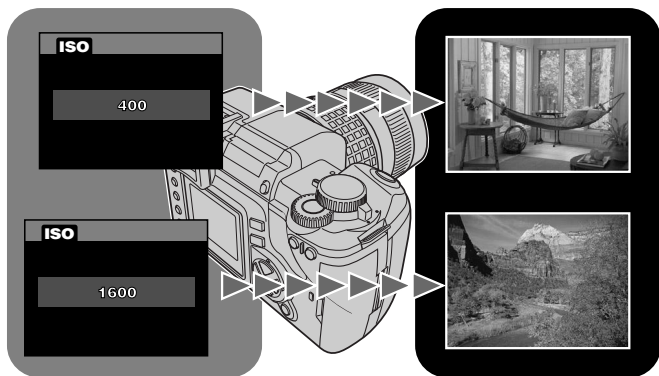

There are 3 ways of measuring the subject brightness: Digital ESP metering, Center weighted averaging metering and spot metering. Select the most suitable mode depending on the shooting condition.



- 1 Press the  (metering) button.**
 - The current setting is displayed on the monitor.

- 2 Rotate the control dial until the desired setting is displayed.**

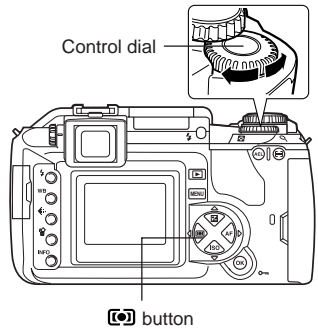

The selected metering mode is displayed in the viewfinder.

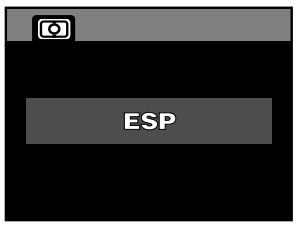

When the control panel screen is off

■ Digital ESP metering **ESP**

The camera meters and calculates the light levels or light level differences in the center and other areas of the image separately. Recommended for shooting under conditions where there is high contrast between the center of the screen and the area around it, such as when shooting backlit subjects or under excessively bright light.

■ Center weighted averaging metering

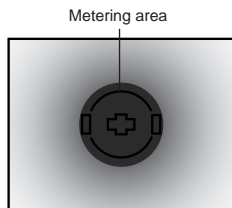

This metering mode provides the average metering between the subject and the background lighting, placing more weight on the subject at the center. Use this mode when you do not want the light level of background to affect the exposure value.

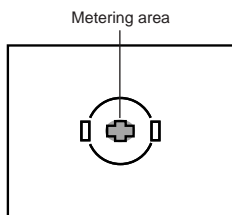

■ Spot metering

The camera meters a very small area around the center of the subject, defined by the spot metering area mark in the viewfinder. Use this mode for intensively backlit subjects, etc.



In some situations, you may get better results if you manually compensate (adjust) the exposure value set automatically by the camera. In many cases, bright subjects (such as snow) will turn out darker than their natural colors. Adjusting toward + makes these subjects closer to their real shades. For the same reason, adjust toward – when shooting dark subjects. The exposure can be adjusted in range of ± 5.0 EV. Center weighted averaging metering () or spot metering () is recommended for exposure compensation. The EV step interval can be selected from 1/3EV, 1/2EV or 1EV.  “EV STEP” (P. 124)

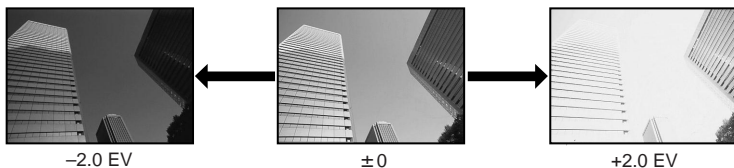

6

Exposure, image and color

Available modes



1 Press the (exposure compensation) button.

- The exposure compensation indicator appears on the monitor.

2 Rotate the control dial to make adjustment.

- Adjust toward +: up to +5.0 EV
- Adjust toward -: up to -5.0 EV

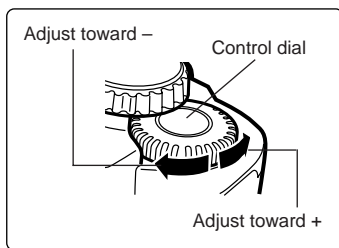

When the control panel screen is off

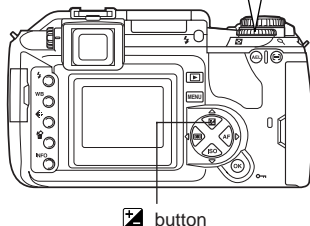

Example: When adjusting the exposure in $-1/3$ step

Press the  button.

Rotate the control dial to set the desired exposure compensation value.

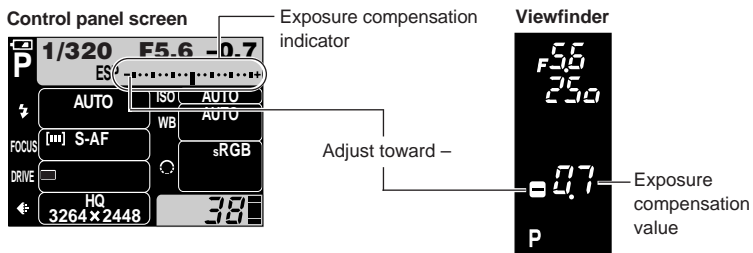

The exposure compensation indicator disappears if the exposure is compensated by 0.

TIPS**To change the EV step interval:**

→ In the menu, set the EV step interval to $1/3$ EV, $1/2$ EV or 1EV.

 "EV STEP" (P. 124)

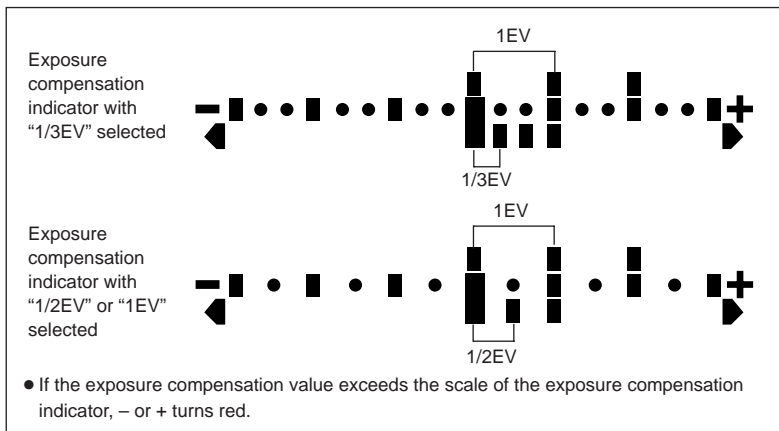
**Note**

Pressing the  button has no effect in the **M** or **SCENE** mode.

The metered exposure value can be locked with the **AEL** button (AE lock). Use AE lock when you want a different exposure setting from the one that would normally apply under the current shooting conditions.

Normally, pressing the shutter button halfway locks both AF (auto focus) and AE (automatic exposure), but you can lock the exposure alone by pressing **AEL**. When you lock the exposure, the metering mode (digital ESP metering, center weighted averaging metering or spot metering) selected in the menu is automatically applied.  “AEL METERING” (P. 124)

Available modes **P A S**      **SCENE**

1 Aim the camera toward the subject.

2 Hold down **AEL**.

- The exposure is locked.
- **AEL** is displayed in the viewfinder.

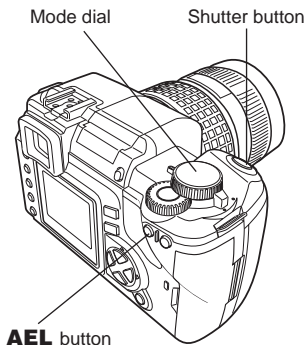
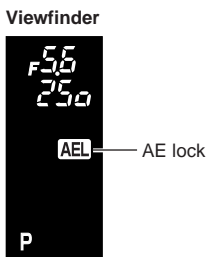

3 Compose your shot. While holding down **AEL**, hold down the shutter button halfway.

- The focus is locked.

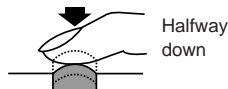

4 Press the shutter button all the way.

- Releasing **AEL** cancels AE lock.

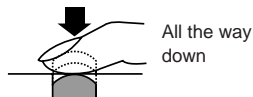

ISO sensitivity—Setting the desired sensitivity to light

The higher the ISO value, the greater the camera's light sensitivity and the better its ability to shoot in low light conditions. However, higher values may give pictures a grainy appearance.

Setting the ISO sensitivity to ISO BOOST using the menu beforehand allows you to select the high ISO sensitivity (800 or 1600).  "ISO BOOST" (P. 92)

AUTO, 100, 200, 400, 800, 1600

With a lower ISO setting, you can shoot clear, sharp images in daylight.

 The values can be selected when ISO is set to ISO BOOST.

Setting the ISO sensitivity

Available modes



1 Press the **ISO** button.

- The current setting is displayed on the monitor.

2 Rotate the control dial until the desired setting is displayed.

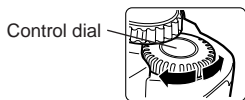

Control dial

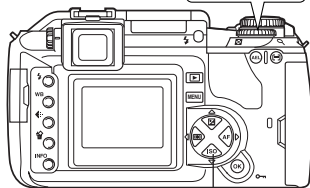

ISO button

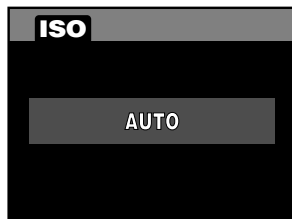

When the control panel screen is off

6

Exposure, image and color



Note

The ISO sensitivity when it is set to auto is usually ISO 100. If the subject is too far away for the flash illumination, the sensitivity is automatically increased.

ISO BOOST

This allows you to make ISO 800 and 1600 available for ISO setting.

Available modes **P A S M**     

1 Menu →  → ISO BOOST → ON.
 “How to use the menus” (P. 25)

2 Press the **OK** button.

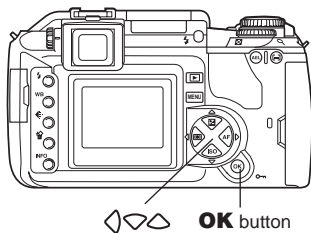

White balance—Adjusting the color tone

Color reproduction differs depending on the light conditions. For instance, when daylight or tungsten lighting is reflected on white paper, the shade of white produced will be slightly different for each.

With a film camera, you can adjust color balance using different films for different light conditions or by using filters. With a digital camera, on the other hand, white color can be adjusted to reproduce more natural white with a digital processor. This mechanism is called white balance. There are three options for setting the WB with this camera.

Auto white balance

This function enables the camera to automatically detect white in images and adjust the color balance accordingly. Auto WB is sufficient for most light conditions. If there is no near white color in the picture, the white balance of the image may not be correct. In such a case, use preset WB or one-touch WB to achieve the correct white balance.

Preset white balance

You can set the white balance by selecting the appropriate color temperature for the light source. For example, use preset WB when you want to reproduce more red in the picture of a sunset, or capture a warmer artistic effect under artificial lighting. You can enjoy creating different color tones by trying the different preset WB settings.

The color temperatures available for preset WB are as follows: 3000, 3300, 3600, 3900, 4000, 4300, 4500, 4800, 5300, 6000, 6600, or 7500.

You can also select one of 4 preset color temperatures in the menu and use it as a preset WB.  "CUSTOM WB" (P. 100)

One-touch white balance "Setting the one-touch white balance" (P. 97)

You can set the optimum white balance for the shooting conditions by pointing the camera at a white object like a sheet of white paper. The white balance achieved with this setting is saved as one of the preset WB settings.

Color temperature

The spectral balance of different white light sources is rated numerically by color temperature—a concept of physics, expressed using the Kelvin (K) temperature scale. The higher the color temperature, the richer the light in bluish tones and the poorer in reddish; the lower the color temperature, the richer the light in reddish tones and the poorer in bluish.

It follows, then, that the color temperatures of fluorescent lights make them unsuitable as artificial light sources. There are gaps in the hues from the color temperatures of fluorescent light. If these differences in hue are small, they can be calculated with color temperature and this is called correlated color temperature. The 4000K, 4500K and 6600K preset settings in this camera are correlated color temperatures, and should not be considered strictly as color temperatures. Use these settings for shooting conditions under fluorescent lights.

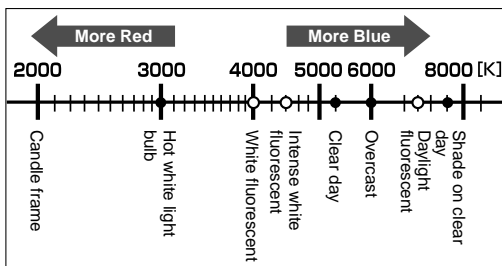

TIPS

White balance with a flash:

- Auto WB is recommended when taking pictures with the flash. If you intend to use preset WB, select the color temperature 6000K. When shooting with the flash, be sure to play back your pictures and check the color on the screen. Various conditions affect color temperature and how color is reproduced on the screen.

! Note

The color temperatures for each light source indicated in the above scale are approximate. They are not an accurate indication of color. For example, the actual sunlight is not exactly 5300K, nor fluorescent lights 4000K.

Setting the white balance

WB

You can adjust the white balance by selecting the appropriate color temperature for the light conditions.

Available modes



1 Press the **WB** (white balance) button.

- The current setting is displayed on the monitor.

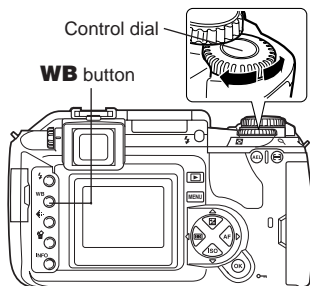
2 Rotate the control dial until the desired setting is displayed.

Viewfinder

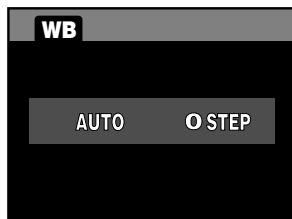
Displayed when any WB setting except AUTO is selected.



























When the control panel screen is off

6
Exposure, image and color

TIPS

When subjects with no white appear white in the image:

- In the auto WB setting, if there is no near-white color in the image framed in the screen, the white balance will not be correctly determined. In such a case, try preset WB or one-touch WB settings.

Monitor indications	Light conditions
 AUTO 	Used for most light conditions (when there is a white portion framed in the viewfinder)
 3000K 	For shooting under a tungsten light
 3600K 	For shooting under incandescent light to preserve the mood of the lighting
 4000K 	For shooting under white fluorescent lighting
 4500K 	For shooting under a neutral white fluorescent lamp
 6600K 	For shooting under a daylight fluorescent lamp
 5300K 	For shooting outdoors on a clear day, or to capture the reds in a sunset or the colors in a fireworks display
 6000K 	For shooting outdoors on a cloudy day (when using the flash)
 7500K 	For shooting outdoors in the shadows on a clear day
CWB1 	Color temperature set in custom white balance menu. When the value has not been adjusted, it is set to 2000K.  "CUSTOM WB" (P. 100)
CWB2 	Color temperature set in custom white balance menu. When the value has not been adjusted, it is set to 2500K.
CWB3 	Color temperature set in custom white balance menu. When the value has not been adjusted, it is set to 8000K.
CWB4 	Color temperature set in custom white balance menu. When the value has not been adjusted, it is set to 10000K.
	Color temperature set by one-touch WB. When the value has not been set, it is set to 5300K.  "Setting the one-touch white balance" (P. 97)

Setting the one-touch white balance



This function is useful when you need a more precise white balance than preset WB can provide. Point the camera at a sheet of white paper under the light source you want to use to determine the white balance. The optimum white balance for the current shooting conditions can be saved in the camera.

This is useful when shooting a subject under natural light, as well as under various light sources with different color temperatures.

Available modes



1 Menu → →

“How to use the menus” (P. 25)

2 Press .

- The screen appears.

3 With the screen displayed, point the camera at a sheet of white paper.

- Position the paper so that it fills the viewfinder. Make sure there are no shadows.

4 Set the aperture and shutter speed to obtain the optimum exposure.

5 Press the **OK** button.

- The white balance is registered.
- The registered white balance will be stored in the camera as a preset WB setting. Turning the power off does not reset the data.

“Setting the white balance” (P. 95)

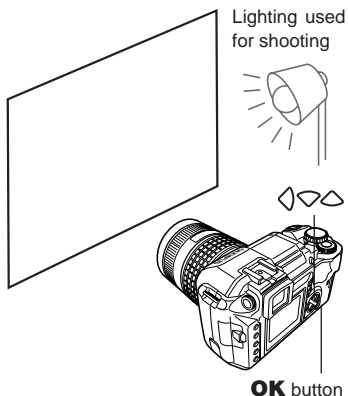

6

Exposure, image and color

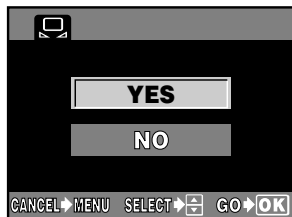

TIPS

After pressing **OK**, “WB NG RETRY” is displayed.

- When there is not enough white in the image, or when the image is too bright, too dark or the colors look unnatural, you cannot register the white balance.
Repeat the procedure from Step 1.

WB compensation



This function lets you make fine changes to the auto WB and preset WB settings.



1 Menu → \mathcal{I} 1 →
 “How to use the menus” (P. 25)

2 Press \triangleleft .
 • The screen is displayed.

3 Press \triangleleft \triangleright to select the white balance to adjust, then press \triangleleft .
 • The setting screen for WB compensation is displayed.

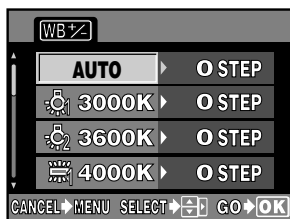
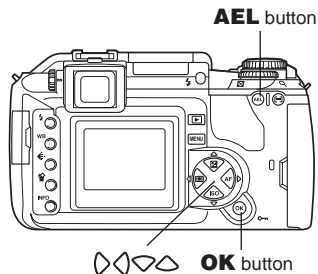

4 The color becomes bluer each time you press \blacktriangledown , and redder each time you press \blacktriangle , depending on the original WB conditions. Press the **OK** button to save your adjustment.

- The white balance can be adjusted in 7 increments in both the RED and BLUE directions.

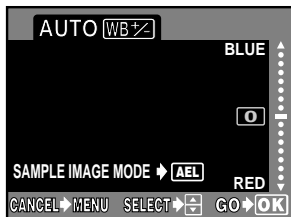

5 Point the camera at the subject to take test shots.

6 Press the **AEL** button.

- Sample images that have been taken with the current WB settings are displayed.
- The WB compensation indicator indicates the current WB compensation value.



7 After checking the sample images, press **OK**.

- Press **OK** again to complete WB compensation.

CUSTOM WB



You can reset the current custom white balance values to different color temperatures.



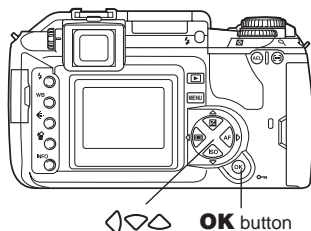

1 Menu →  → CUSTOM WB
 “How to use the menus” (P. 25)

2 Press  .
 • The CUSTOM WB SETTING screen appears.



3 Press   to select CWB1, CWB2, CWB3 or CWB4, then press  .

4 Press   to adjust the current white balance.

5 Press the **OK** button.
 • Select the other custom white balance items to set.

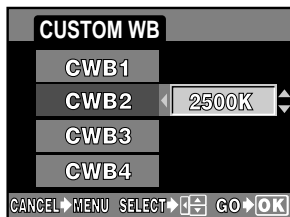

This function adjusts the sharpness of the image.

Available modes **P A S M**

1 Menu → → SHARPNESS
 “How to use the menus” (P. 25)

2 Press .
 • The setting screen is displayed.

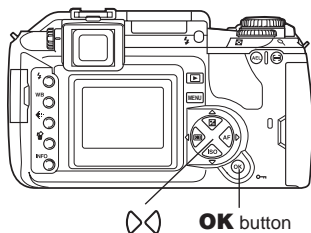

3 Press to move .
 To increase the sharpness (Hi):
 Press . The image contours are emphasized, making the image appear sharper and more vivid. Use this setting when you want to print pictures.
 To reduce the sharpness (Lo):
 Press . The image contours are softened. Use this setting when you want to edit images on a PC.

4 Press the **OK** button.
 • Your adjustment is saved.



Note

Adjusting the sharpness toward Hi may give the picture a grainy appearance.



This function adjusts the contrast (distinction between light and dark) of images. For example, you can make images with marked differences in light and shadow softer, and those with less differences more vivid.

Available modes **P A S M**

1 Menu → **C2** → **CONTRAST**
 “How to use the menus” (P. 25)

2 Press **◁**.
 • The setting screen is displayed.

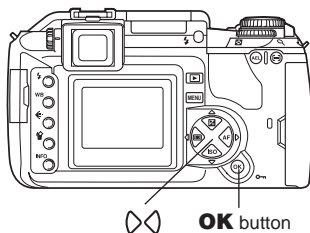

6 **3** Press **▷◁** to move **◆**.
To increase the contrast (Hi):
 Press **▷**. The light and dark areas are defined more clearly, making the image look crisper.
To reduce the contrast (Lo):
 Press **◁**. The light and dark areas become less defined, giving the image a softer impression. Use this setting when you want to edit images on a PC.



4 Press the **OK** button.
 • Your adjustment is saved.

This function sets the color depth of images.

Available modes **P A S M**

1 Menu → → SATURATION
 “How to use the menus” (P. 25)

2 Press .
 • The setting screen is displayed.

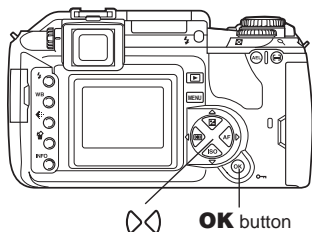

3 Press to move .
 To increase the saturation (Hi):
 Press . The color becomes more vivid.
 To reduce the saturation (Lo):
 Press . The color becomes more subdued.

4 Press the **OK** button.
 • Your adjustment is saved.





Lets you select the brightness of the entire image. Suitable when you want to produce a brighter image for a bright object and a darker image for a dark object.



HI KEY :

A brighter image is produced.

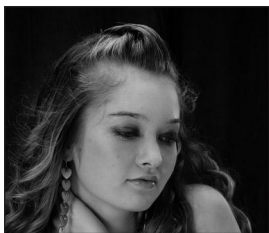

LOW KEY :

A shadowy image is produced.

6

Exposure, image and color

Available modes



- 1 Menu → → GRADATION → NORMAL, HI KEY, LOW KEY
 "How to use the menus" (P. 25)

- 2 Press the **OK** button.

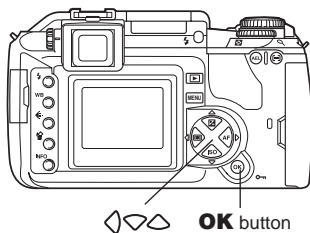

This function reduces the noise that is generated during long exposures. When shooting night scenes, shutter speeds are slower and noise tends to appear in images. When NOISE REDUCTION is set to ON, the camera automatically reduces noise to produce clearer images. However, shooting time is approximately twice as long as usual.

For more information about noise generated in images during long exposures, refer to “Noise in images” (P. 51).



NOISE REDUCTION: OFF



NOISE REDUCTION: ON

Available modes

P A S M

1 Menu → → NOISE REDUCTION → ON

“How to use the menus” (P. 25)

2 Press the **OK** button.

3 Take a picture.

- The noise-reduction process is activated after shooting.
- The card access lamp blinks during the noise-reduction process. You cannot take more pictures until the card access lamp goes out.
- Busy is displayed while noise reduction is operating.

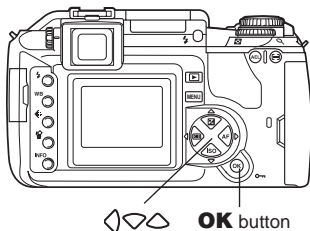

Note

- When , , , or mode is set, NOISE REDUCTION is fixed to ON.
- When NOISE REDUCTION is set to ON, sequential shooting is not available.
- This function may not work effectively with some shooting conditions or subjects.

This function lets you select how colors are reproduced on the monitor or printer. The first character in image file names indicates the current color space.

☞ “FILE NAME” (P. 129)

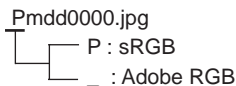

sRGB : Standardized color space for Windows

Adobe RGB : Color space that can be set by Adobe Photoshop

Available modes



1 Menu → \mathcal{I} 2 → COLOR SPACE → sRGB, Adobe RGB

☞ “How to use the menus” (P. 25)

2 Press the **OK** button.

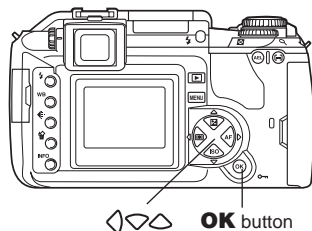

7

Playback

One of the big advantages of a digital camera is that as soon as you take a picture, you can see how it looks right away. That means that if the picture is out of focus or just hasn't turned out the way you want, you can erase it and try again. With a film camera, on the other hand, you won't know if there is a problem with the picture until you get the film developed. Because a digital camera lets you erase those unwanted images, you can keep more memory free to store images and take more shots. You can also protect images that you do not want to erase. Another benefit is that you can edit recorded images: change colors to black and white or sepia, trim images, change the resolution, etc. So take advantage of your digital camera's benefits and have fun taking great pictures.

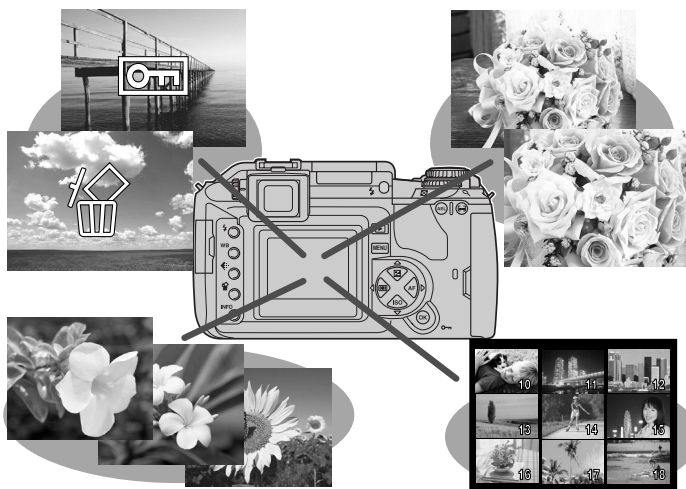

Viewing still images

There are several different ways to view and edit images. However, before using any of these functions, follow step 1 below.

Single-frame playback

1 Press the (playback mode) button.

- The monitor turns off after about 1 minute if no operations are performed. After about 1 hour without being used, the camera will turn off automatically. Turn on the camera again.

The last recorded image appears.

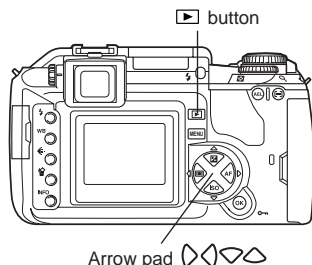

7

Playback

2 Use the arrow pad to select images you want to view.

 Displays the frame that is stored 10 frames back.

 Displays the previous frame.

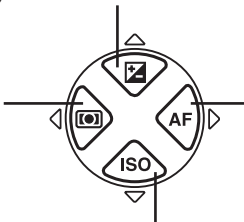

 Displays the next frame.

 Displays the frame that is stored 10 frames ahead.

- Pressing the shutter button halfway resumes the shooting mode.

Note

When the AC adapter is used, the camera does not turn off automatically.

Close-up playback



This function lets you enlarge images displayed on the monitor. It is useful when you want to check the details in an image. Each time you rotate the control dial toward , the image is enlarged in steps of 2x - 10x.

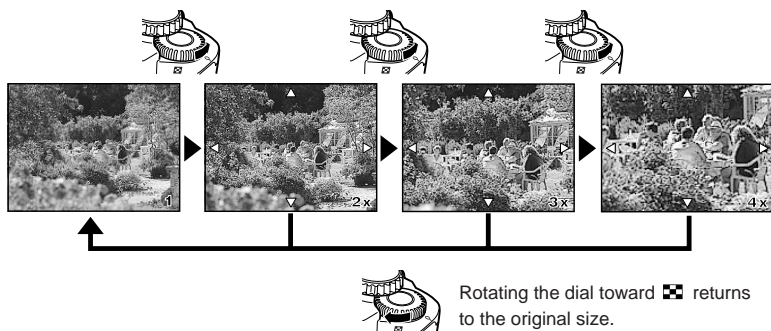
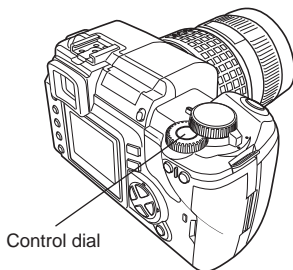

7

Playback

Displacing the image

During close-up playback, you can displace the image vertically and horizontally and display the adjusted image.

- 1** During close-up playback, press the arrow pad button that corresponds to the direction you want to move.

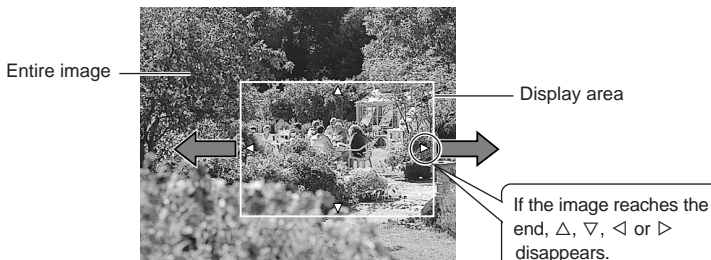

Viewing other images

During close-up playback, you can view other images.

1 Press the **OK** button.

2 Use the arrow pad to select images you want to view.

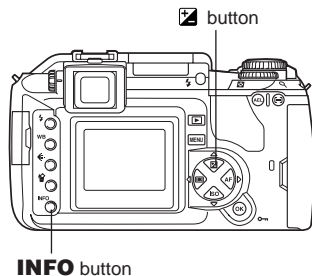

◁ Displays the frame that is stored 10 frames back.

◁ Displays the previous frame.

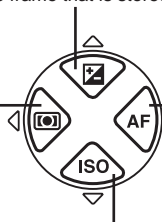

▷ Displays the next frame.

▷ Displays the frame that is stored 10 frames ahead.

3 To apply close-up to the image or return to the original size, press the **OK** button.

Displaying close-up position

You can check which part of the image is enlarged.

1 Press the **INFO** button during close-up playback.

- The part you have enlarged is displayed with a frame. When you release the button, the frame disappears.







Index display



This function lets you show several images on the monitor at the same time. It is useful when you want to quickly search a number of pictures to find a particular image.

Each time you rotate the control dial toward , the number of images shown changes from 4 to 9 to 16.

-  : Moves to the previous frame.
-  : Moves to the next frame.
-  : Displays the index previous to the top-left image in the currently displayed index.
-  : Displays the index proceeding the lower-right image in the currently displayed index.

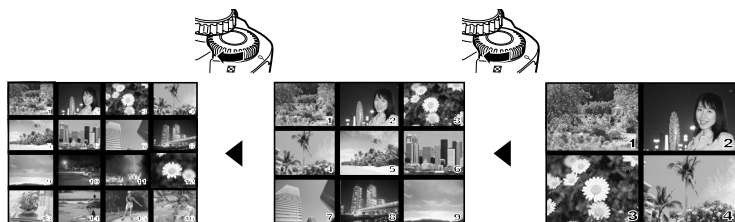
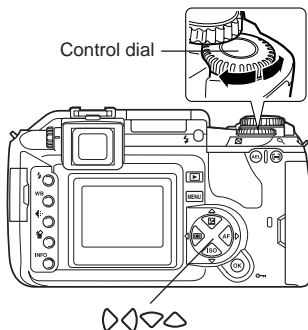

Rotating the control dial toward  returns to single-frame playback.

This allows you to display detailed information about the image. Luminance information can also be displayed with histogram and highlight graphs.

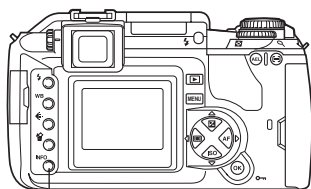
INFO button

1 Press the **INFO** button repeatedly until the desired information is displayed.

- This setting is stored and will be shown the next time the information display is called up.

Only image



Information 1



Information 2

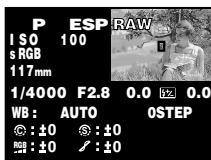

Shooting information



Highlight



Histogram

7

Playback

Information 1

Frame number, print reservation and protect.



Information 2

Print reservation, protect, record mode, number of pixels, compression, date and time and file number.

**Histogram**

Shows you the distribution of brightness in recorded images. Checking the histogram will enable more precise exposure control for subsequent shots.

Histogram



Dark

Distribution
of brightness

Bright

How to use the histogram display

The histogram display enables you to check the brightest highlights and darkest shadows which may result in a poor image. If the bars in the histogram are higher towards the right, the image may be too bright. If the bars are higher on the left, the image may be too dark. Compensate the exposure or shoot again.

Highlight

The overexposed parts of the recorded image blink.

Overexposed parts

**Shooting information**

Displays the exposure mode, metering mode, record mode, ISO sensitivity, color space, saturation and focal length, etc.

☞ "Monitor indications (only for playback)" (P. 201)





This function displays images stored on the card one after another in succession. Images are displayed one by one for about 5 seconds starting from the currently displayed image. Slideshow can be performed using index display. You can select the number of images displayed during slideshow from 1, 4, 9 or 16.

1 Menu → → → , , ,

“How to use the menus” (P. 25)

2 Press the **OK** button to start the slideshow.

3 Press **OK** to stop the slideshow.

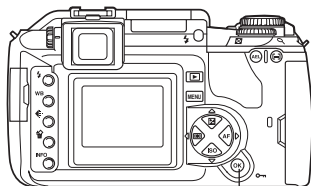

OK button



When selecting

! Note

If the camera is running on battery power during slideshow, the camera will turn off automatically in about 30 minutes.



This function lets you rotate images and display them vertically on the monitor. This is useful for viewing pictures that were taken with the camera held vertically.

1 Menu → → → ON
 “How to use the menus” (P. 25)

2 Press the (flash mode) button.

- Each press of the button turns the image 90 degrees clockwise.
- The rotated image will be recorded on the card.

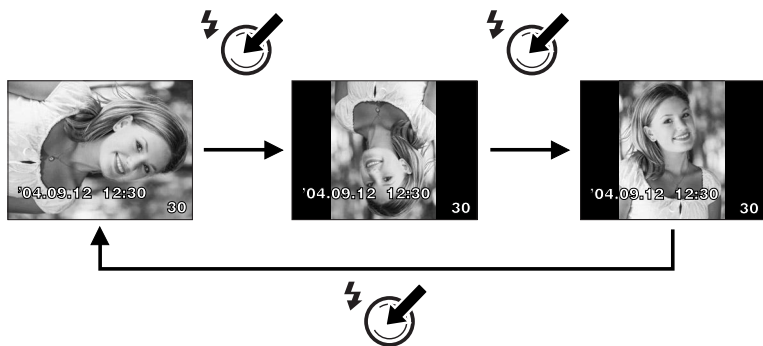
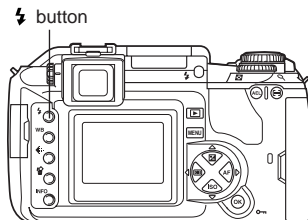

Playback on TV

Use the video cable provided with the camera to play back recorded images on your TV.

1 Turn the camera and TV off, and connect the video cable as illustrated.

2 Turn on the TV and set it to the video input mode. For details on switching to the video input mode, refer to the TV's instruction manual.

3 Turn the camera on and press the  (playback mode) button.

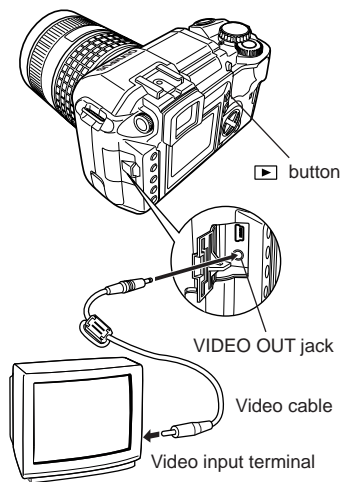

Note

- To connect the camera to a TV, use the provided video cable.
- Make sure that the camera's video output signal type is the same as the TV's video signal type.  "VIDEO OUT — Selecting the video signal type before TV connection" (P. 134)
- The camera's monitor turns off automatically when the video cable is connected to the camera.
- The image may appear off-center depending on the TV screen.

Editing still images

Recorded images can be edited and saved as new images. Available editing functions depend on the image format (image record mode).

Editing images recorded in RAW data format

This performs image processing (such as white balance and sharpness adjustment) on images in the RAW data format, then saves the data to a new file in the TIFF or JPEG format. While checking recorded images, you can edit them to your liking.

Image processing is performed based on the current camera settings. If you want to use different settings when editing, change the current camera settings beforehand.

Editing images recorded in JPEG/TIFF data format

BLACK & WHITE Creates black and white images.

SEPIA Creates sepia-toned images.

Resizing  Converts the image file size to 1280 x 960, 640 x 480 or 320 x 240.

1 Menu → → EDIT

- The image selection screen is displayed.
 "How to use the menus" (P. 25)

2 Press to select the image, then press the **OK** button.

- The camera recognizes the image data format.

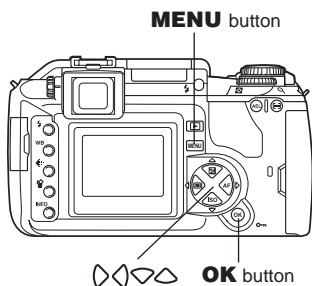
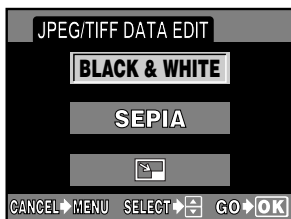

Image in RAW data format

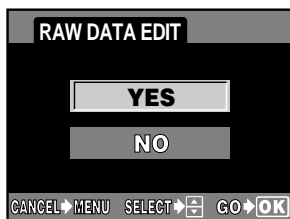

Image in JPEG/TIFF data format

- 3** Press \triangleleft \triangleright to select the item. Press the **OK** button.
 If you select \square for the JPEG/TIFF image, go to step 4.
 If you select any item except \square , go to step 5



When editing JPEG/TIFF image



When editing RAW image

- 4** When you select \square :
 Press \triangleleft \triangleright to select the pixel count. Press the **OK** button.

7

- 5** To edit another image, press \triangleleft \triangleright to select the desired image.
 • Press the **MENU** button to exit the menu.

Playback

! Note

The image recorded in TIFF is saved as an SHQ image.



Protect images you do not want to erase. Protected images cannot be erased by the selected frame/all-frame erase function.

1 Play back the image you want to protect. P. 108

2 Press the (protect) button.

- is displayed on the screen.

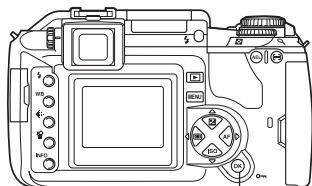

button

Protect mark



To cancel the protection

Display the images that are protected and press .

Note

- Formatting the card erases all image even if they have been protected.
- Protected images cannot be rotated.

Erasing images



Lets you erase recorded images. You can select either single-frame erase, which erases only the currently displayed image, or all-frame erase, which erases all the images stored on the card.

! Note

- Protected images cannot be erased. Cancel protected images, then erase them.
- Once erased, images cannot be restored. “Protecting images — Preventing accidental erasure” (P. 119)

Single-frame erase

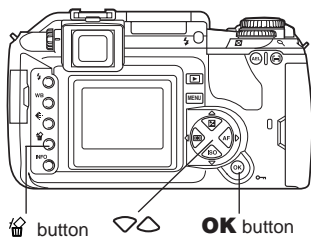

7
Playback

- 1 Play back the image you want to erase.
- 2 Press the  (erase) button.
 - The ERASE screen is displayed.
- 3 Press   to select YES, then press the **OK** button.



ERASE screen

ERASE SETTING

In the ERASE SETTING screens in the  menu, you can set the screen cursor setting to YES.  “ERASE SETTING” (P. 128)

All-frame erase



- 1 Menu → → **CARD SETUP**
 “How to use the menus” (P. 25)
- 2 Press .
 • The CARD SETUP screen is displayed.
- 3 Press to select **ALL ERASE**, then press the **OK** button.
 • The ALL ERASE screen is displayed.
- 4 Press to select **YES**, then press **OK**.
 • All frames will be erased.

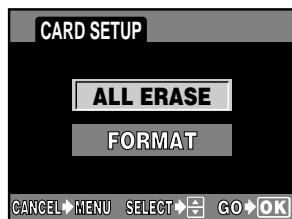
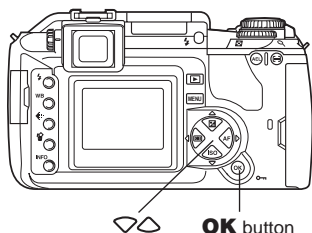

CARD SETUP screen

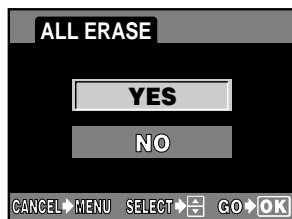

ALL ERASE screen

ERASE SETTING

In the ERASE SETTING screens in the menu, you can set the screen cursor setting to YES. “ERASE SETTING” (P. 128)

7

Playback

8

Customizing the settings/functions of your camera



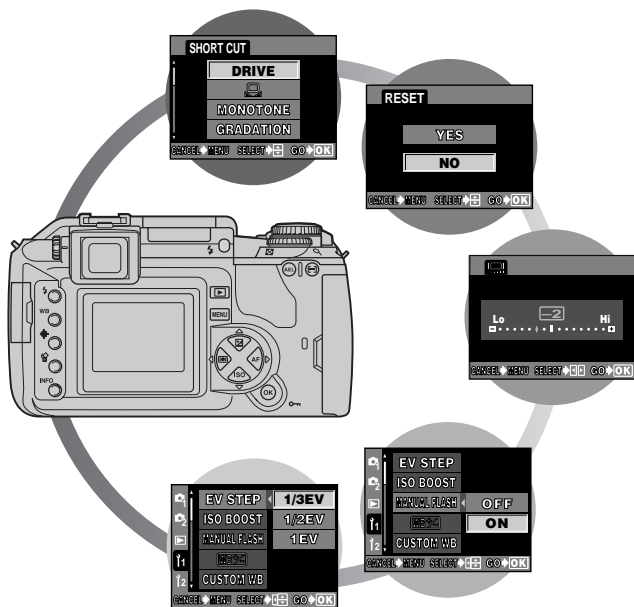

Thanks to digital technology you can effortlessly customize many of your camera's functions. For example, you can call up your favorite functions at the touch of a button, adjust EV step values, or set the amount of flash light. This chapter introduces all the functions that can be customized to suit preferences. Try these functions to find ways to use your camera even more effectively.



AEL METERING

Set the metering mode before using the **AEL** button to lock the exposure. This allows the camera to automatically apply the selected metering mode when the AEL lock function is used.

Available modes 

- 1 Menu →  → **AEL METERING** →
AUTO, ESP, , 
 “How to use the menus” (P. 25)

- 2 Press the **OK** button.

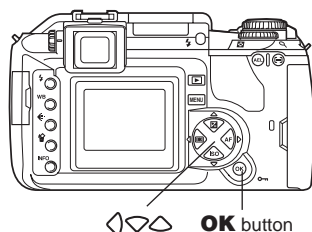

EV STEP

This allows you to change the EV step for exposure parameter setting, such as shutter speed, aperture value or exposure compensation value, etc.

Available modes 



- 1 Menu →  → **EV STEP** → 1/3EV, 1/2EV, 1EV
 “How to use the menus” (P. 25)

- 2 Press the **OK** button.

MANUAL FLASH

This allows the built-in flash to output a fixed amount of light. With MANUAL FLASH set to ON, you can set the amount of light to FULL, 1/4, 1/16, or 1/64 with the  (flash) button.

Available modes 

- 1 Menu →  → **MANUAL FLASH** → ON
 “How to use the menus” (P. 25)

- 2 Press the **OK** button.

CUSTOM OK

This lets you select a shooting function to register on the **OK** button. You will be able to call up the selected function's setting screen by pressing the **OK** button or use it to perform function setting.

- OFF** : The **OK** button is used for setting confirmation in the normal way.
- SHORTCUT** : Registers one of the shooting menus. This is useful when you want to go quickly to the setting screen of a function you use frequently.
- PREVIEW** : Registers the preview function. When you press the **OK** button, the viewfinder shows the actual depth of field (the distance from the nearest to the furthest point of perceived "sharp" focus) in a picture, with the selected aperture value.
- AF/MF** : Lets you switch between AF and MF. While holding down the **OK** button, you can adjust the focus manually in the S-AF mode or operate AF in the MF mode.

Available modes



- 1** Menu → $\bar{1}$ → **CUSTOM OK** → **OFF**,
SHORTCUT, **PREVIEW**, **AF/MF**

"How to use the menus" (P. 25)

- 2** Press the **OK** button.

When you have selected **SHORTCUT**

- 3** Press \diamond .

• The SHORT CUT screen appears.

Any of the following items can be registered with **SHORTCUT**:

DRIVE (P. 66), One-touch white balance (P. 97), MONOTONE (P. 75), GRADATION (P. 104), SATURATION (P. 103), CONTRAST (P. 102), SHARPNESS (P. 101), WB bracketing (P. 71)

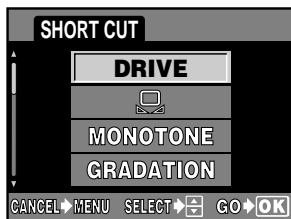
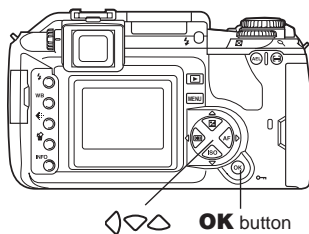

- 4** Press \diamond to select the item to set.
Press the **OK** button.

RESET LENS

This allows you to reset the focus of the lens (infinity) when the power is turned off.

Available modes **P A S M**      **SCENE**

1 Menu → \mathcal{I} 2 → RESET LENS → ON
 “How to use the menus” (P. 25)

2 Press the **OK** button.

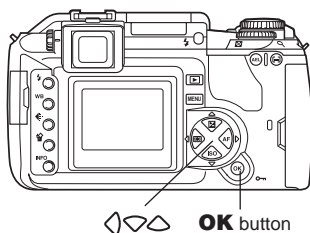

FOCUS RING

This allows you to customize how the lens adjusts to the focal point by selecting the rotational direction of the focus ring.

Available modes **P A S M**      **SCENE**

1 Menu → \mathcal{I} 2 → FOCUS RING → \curvearrowright , \curvearrowleft
 “How to use the menus” (P. 25)

2 Press the **OK** button.

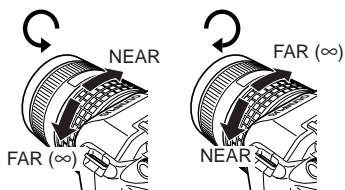



Date and time information is recorded on images. The file No. is also included with the date and time information.

Available modes



1 Menu → \mathcal{I} 2 → ⌚

“How to use the menus” (P. 25)

2 Press \triangleleft .

- The ⌚ screen is displayed.

3 Press \triangleleft to select one of the following date formats:

Y-M-D (Year/Month/Day),

M-D-Y (Month/Day/Year),

D-M-Y (Day/Month/Year).

Then press \triangleleft .

- The following steps show the procedure used when the date and time settings are set to Y-M-D.

4 Press \triangleleft to set the year, then press \triangleleft to move to the month setting.

- To return to the previous setting, press \triangleright .
- The first two digits of the year are fixed.

5 Repeat this procedure until the date and time are completely set.

- The time is displayed in the 24-hour format.
For example, 2 p.m. will be displayed as 14:00.

6 Press the **OK** button.

- For a more accurate setting, press **OK** when the time signal hits 00 seconds.
The clock starts when you press the button.

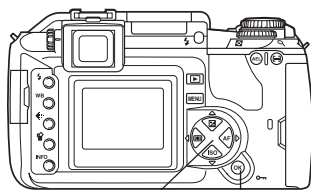

\triangleleft \triangleright \triangleleft \triangleright **OK** button

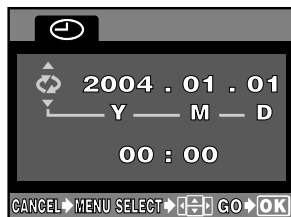



! Note

The date/time setting is saved for approximately 3 months using the built-in battery. Depending on how the camera is used, the date/time setting may be erased earlier. Date/time settings will also be lost if the camera is left for a long period with no battery loaded. The internal battery will be fully recharged in about one day with the camera's battery loaded.

RESET —Restoring the factory default setting

Normally, current camera settings (including any changes you have made) are retained when the power is turned off. If you prefer the original setting to be restored, you can use this function to restore the factory default settings after the power is turned off.

Available modes **P A S M**      **SCENE**

1 Menu →  → **RESET**
 “How to use the menus” (P. 25)

2 Press .
• The RESET screen is displayed.

3 Press   to select YES. Press the **OK** button.

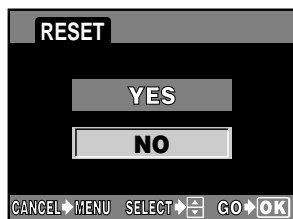
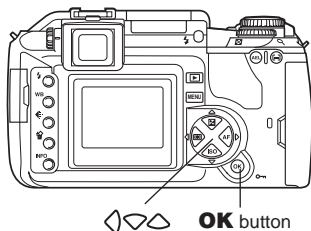

ERASE SETTING

This allows you to customize the cursor position (YES or NO) as the initial position on the ALL ERASE, ERASE or FORMAT screen.

Available modes **P A S M**      **SCENE**

1 Menu →  → **ERASE SETTING** → YES, NO
 “How to use the menus” (P. 25)

2 Press the **OK** button.

FILE NAME

When you take a picture, the camera assigns it a unique file name and saves it in a folder. The folder and file name can later be used for file handling on a computer. File names are assigned as shown in the illustration below.

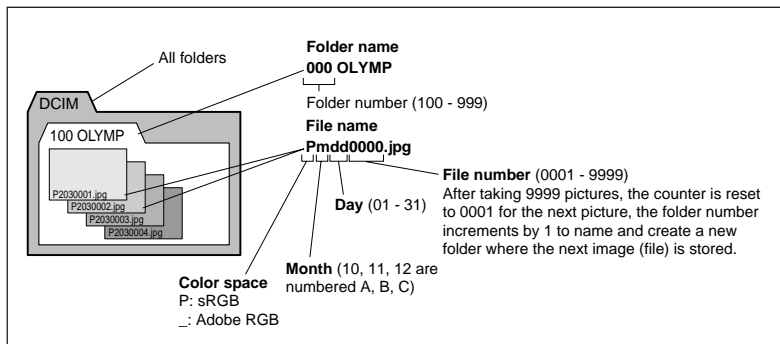

AUTO

Even when a new card is inserted, the folder numbers are retained from the previous card. If the new card contains an image file whose file number coincides with one saved on the previous card, the new card's file numbers start at the number following the highest number on the previous card.

RESET

When a new card is inserted, folder numbers start at 100 and file numbers start at 0001. If a card containing images is inserted, the file numbers start at the number following the highest file number on the card.

Available modes **P A S M**      **SCENE**

1 Menu → $\bar{1}$ 2 → FILE NAME → AUTO, RESET

 “How to use the menus” (P. 25)

2 Press the **OK** button.

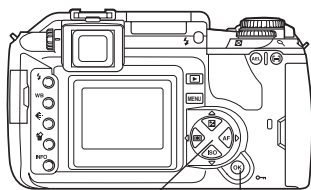

 **OK** button

Note

When both the Folder and File No. reach their respective maximum number (999/9999), it is not possible to store additional pictures even if the card is not full. No more pictures can be taken. Replace the card with a new one.

8

REC VIEW — Checking the picture immediately after shooting

This allows you to display the picture you have just taken on the monitor while it is being recorded to the card, and to select how long the picture is displayed. This is useful for making a brief check of the picture you have just taken. Pressing the shutter button halfway during REC VIEW lets you resume shooting immediately.

OFF : The picture being recorded to the card is not displayed.

5SEC : The picture being recorded to the card is displayed for 5 seconds.

20SEC: The picture being recorded to the card is displayed for 20 seconds.

Available modes **P A S M**      **SCENE**

1 Menu → $\bar{1}$ 2 → REC VIEW → OFF, 5SEC, 20SEC

 “How to use the menus” (P. 25)

2 Press the **OK** button.

Setting the warning tone



The camera beeps when buttons are pressed. It also beeps to alert you to warnings. You can turn the beep sound on or off with this function.

Available modes



1 Menu → 2 → → OFF, ON
 “How to use the menus” (P. 25)

2 Press the **OK** button.

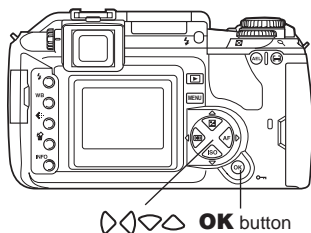

Monitor brightness adjustment



This allows you to adjust the brightness of the monitor for optimal viewing.

Available modes



1 Menu → 2 →
 “How to use the menus” (P. 25)

2 Press .
• The screen is displayed.

3 Press to adjust the brightness.
Press the **OK** button.



SLEEP

After a specified period of time elapses with no operations being performed, the camera enters the sleep mode (stand-by) to save battery power. SLEEP lets you select sleep timer. OFF cancels the sleep mode.

The camera activates again as soon as you touch any button (the shutter button, arrow pad etc.)

Available modes



1 Menu → **2** → SLEEP → OFF, 1min, 3min, 5min, 10min

☞ “How to use the menus” (P. 25)

2 Press the **OK** button.

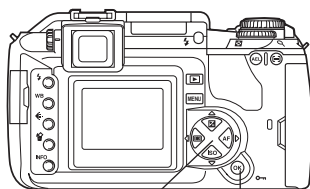

◀ ▶ ○ **OK** button

PC MODE

8

Customizing the settings/functions of your camera

You can connect the camera directly to a computer or printer with the provided USB cable. If you specify the device you are connecting to beforehand, you can skip the USB connection setting procedure normally required every time you connect the cable to the camera. For details on how to connect the camera to either device, refer to Chapter 9 “Printing” (☞ P. 137) and Chapter 10 “Connecting the camera to a computer” (☞ P. 163).

- AUTO** : You are required to select PC or PRINT in the USB connection menu every time you connect the cable to a computer or printer.
- STORAGE** : Allows USB connection to a PC and transfer of data to the PC. Also, select to use the OLYMPUS master software via PC connection.
- CONTROL** : Allows you to control the camera from a PC using the optional OLYMPUS Studio.
- PRINT** : Allows you to connect the camera to a PictBridge-compatible printer. Pictures can be printed directly without using a PC. ☞ “Connecting the camera to a printer” (P. 147)

Available modes **P A S M**      **SCENE**

1 Menu →  → PC MODE → AUTO, STORAGE, CONTROL, PRINT

 “How to use the menus” (P. 25)

2 Press the **OK** button.

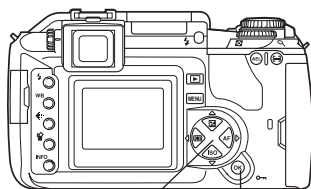



 **OK** button

Changing the display language



You can change the language used for the on-screen display and error messages from ENGLISH to another language.

Available modes **P A S M**      **SCENE**

1 Menu →  → 

 “How to use the menus” (P. 25)

2 Press .

• The language selection screen is displayed.

3 Press  to select the language you want to use. Press the **OK** button.

• You can add another language to your camera with the provided OLYMPUS Master software. For details, refer to Help.



VIDEO OUT —Selecting the video signal type before TV connection

This lets you select NTSC or PAL according to your TV's video signal type. Make sure the correct video signal type is selected before connecting the AV cable. If you use the wrong video signal type, recorded pictures will not play back properly on your TV.

Available modes **P** **A** **S** **M**      **SCENE**

1 Menu →  2 → VIDEO OUT → NTSC, PAL

 “How to use the menus” (P. 25)

2 Press the **OK** button.

TV video signal types & main regions

Check the video signal type before connecting the camera to your TV.

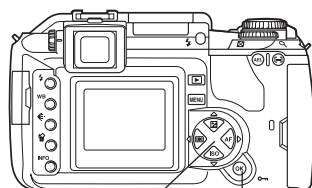

  **OK** button

NTSC	North America, Japan, Taiwan, Korea
PAL	European countries, China

CARD SETUP — Formatting the card

Lets you format a card. Formatting prepares cards to receive data.

Non-Olympus cards or cards formatted on a computer must be formatted with the camera before they can be used.

All data stored on the card, including protected images, is erased when the card is formatted. When formatting a used card, confirm there are no images that you still want to keep on the card.

Available modes



1 Menu → → **CARD SETUP**
 “How to use the menus” (P. 25)

2 Press .
• The CARD SETUP screen is displayed.

3 Press to select **FORMAT**. Press .
• The **FORMAT** screen is displayed.

4 Press to select **YES**. Press **OK**.
• **FORMAT** is performed.

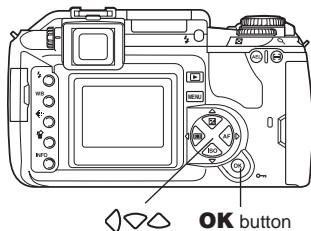

9 Printing

Turning the images you shot into prints is the next step in digital imaging. You can print your images at photo labs or on your own printer. If you print at photo labs, you'll find the print reservation function helpful. Print reservation allows you to save the number of prints and the date and time information on the card.

If you print on a printer, there are a number of different ways to do it. One method is to connect your digital camera to an exclusive printer and print out recorded pictures directly from the camera. The other is to transfer images to a computer and print them on a printer connected to the computer.

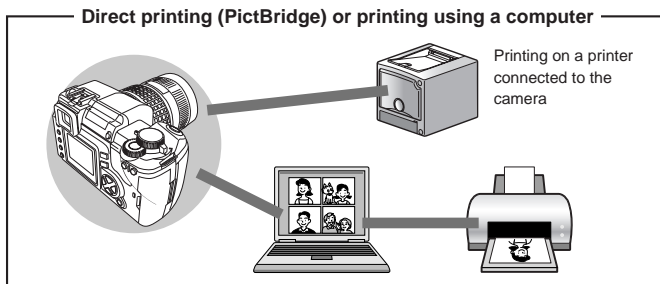
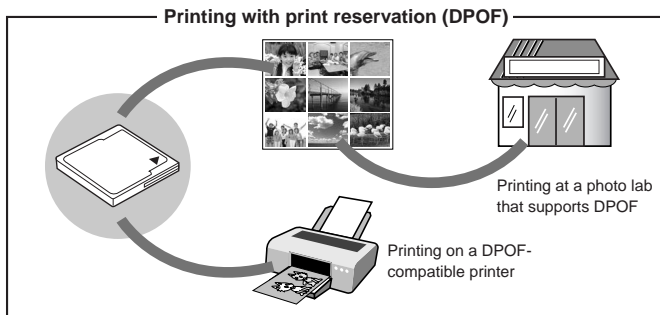



Print reservation allows you to save printing data (the number of prints and the date/time information) with the pictures stored on the card.

With print reservation, you can print out pictures easily either at home using a personal DPOF-compatible printer or at a photo lab that supports DPOF.

DPOF is a standard format used to record automatic print information from digital cameras. You can print out pictures automatically, at home or in a photo lab, by storing such data as which pictures you wish to print and the number of prints on a card.

Pictures set with print reservation can be printed using the following procedures.

Printing using a DPOF-compatible photo lab

You can print the pictures using the print reservation data.

Printing using a DPOF-compatible printer

Printing is possible directly from a card containing print reservation data without using a PC. For more details, refer to the printer's instruction manual.

A PC card adapter may also be necessary.

Picture size and printing



The resolution of a computer/printer is generally based on the number of dots (pixels) per square inch. This is called dpi (dots per inch). The higher the dpi value, the better the printed results. Keep in mind, however, that the dpi of the picture does not change. This means that when you print an image with a higher resolution, the size of the printed picture will be smaller. Although you can print magnified images, picture quality will decrease.





If you want to print large, high-quality pictures, set the record mode as high as possible when taking the pictures.  "Selecting the record mode" (P. 33)

Note

- DPOF reservations set by another device cannot be changed by this camera. Make changes using the original device.
- If a card contains DPOF reservations set by another device, entering reservations using this camera will erase the previous reservations.
- If there is not enough space in the card memory, CARD FULL will be displayed and you may not be able to enter the reservation data.
- You can make DPOF print reservations for up to 999 images per card.
- Not all functions may be available on all printers or at all photo labs.
- Print reservation may take considerable time when saving printing data to a card.

Flowchart for print reservation

You can select single-frame reservation  or all-frame reservation . Follow the operation guide on the camera's monitor.

Play back a still picture ( "Single-frame playback", P. 108) and select  →  in the menu. Press  to select the item you want.

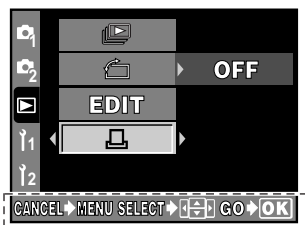

Follow the operation guide displayed here.

Select the print reservation mode.



Select whether to apply print reservation to selected pictures or apply print reservation to all the pictures stored on the card.  P. 142

Select frames you want to print (only for when you have selected ).



Select the picture to be printed and set the desired number of prints. You cannot perform this procedure with all-frame reservation, as the number of prints is fixed to one for each frame.  P. 142

Set the printing data.



Select whether to print the pictures without the date and time, print the pictures with the shooting date or with the shooting time. P. 143

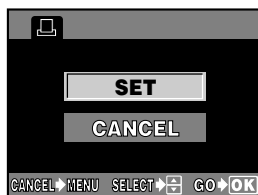

Confirm the print reservation you have set.





The print reservation you have made is stored on the card. P. 143

Selecting the print reservation mode

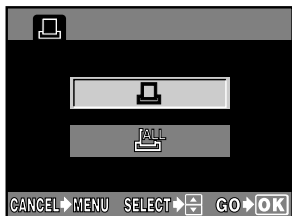

Two print reservation modes are available: single-frame reservation  and all-frame reservation .



 : Applies print reservation to selected pictures.

 : Applies print reservation to all the pictures stored in the card.

Pictures shot after performing all-frame reservation and stored on the same card will not be printed.

If print reservation data is already stored on the card

The RESET/KEEP selection screen appears, giving you the choice of resetting the data or keeping it.  "Resetting print reservation" (P. 144)

Selecting pictures you want to print

Lets you apply print reservation to selected pictures. Display the picture to be printed and select the desired number of prints. The number of prints can be set up to 10. If the number of prints is set to 0, print reservation will not be applied. If all-frame reservation is used after single-frame reservation, specifications for the number of prints will be overwritten and only one copy of each frame will be printed.



Setting printing data

You can print the shooting date and time on all the pictures selected for printing.



NO : The pictures are printed without the date and time.

DATE : All the selected pictures are printed with the shooting date.

TIME : All the selected pictures are printed with the shooting time.

Confirming your print setting



SET : Confirms the print reservation you have made.

CANCEL : Cancels the print reservation and the  menu is restored.

Resetting print reservation

Lets you reset print reservation data. You can reset all print reservation data or just the data for selected pictures.

1 Play back a still picture.

☞ “Single-frame playback” (P. 108)

2 Menu → →

☞ “How to use the menus” (P. 25)

3 Press .

- If print reservation data is already stored on the card, the RESET/KEEP selection screen appears, giving you the choice of resetting the data or keeping it.

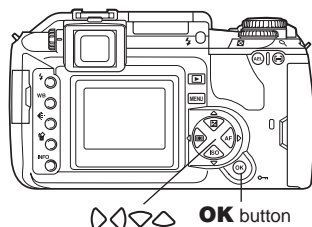

Resetting the print reservation data for all pictures

4 Press to select RESET, then press **OK**.

5 Press the **MENU** button.

- The  menu is restored.





Resetting the print reservation data for a selected picture

4 Select **KEEP**, then press **OK**.

5 Press to select , then press **OK**.



6 Press  to select the frame with print reservation data you want to reset, then press  to set the number of prints to 0.

- To reset print reservation data of other frames, repeat this step.

7 Press **OK** when you are finished.

- The  screen is displayed.



8 Press  to select NO, DATE or TIME. Press **OK**.

- This setting is applied to all frames with print reservation data.



9 Press  to select SET, then press **OK**.

- The setting is saved.
- The  menu is restored.

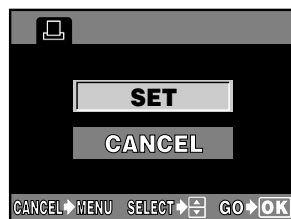

Direct printing (PictBridge)



By connecting the camera to a PictBridge-compatible printer with the USB cable, you can print out recorded pictures directly. With the camera connected to the printer, select the pictures you want to print and the number of prints on the camera's monitor. It is also possible to print out pictures using the print reservation data.  P. 138

To find out if your printer is compatible with PictBridge, refer to the printer's instruction manual.

PictBridge

It is the standard that enables digital cameras and printers made by different manufacturers to be connected, and also allows pictures to be printed directly from the camera.

STANDARD

All printers that support PictBridge have standard print settings. By selecting  STANDARD on the settings screens ( P. 148), you can print pictures according to these settings. For details on your printer's standard settings, refer to the printer's instruction manual or contact the printer manufacturer.

Printer accessories

For details on printing paper types, ink cassettes, etc., refer to the printer's instruction manual.

Note

- You are recommended to use the optional AC adapter when printing pictures.
If you use the battery, make sure that it is fully charged. If the camera stops operating while communicating with the printer, the printer may malfunction or image data may be lost.
- Images recorded in RAW data cannot be printed.
- The camera will not enter sleep mode while it is connected to the USB cable.

Connecting the camera to a printer

Use the USB cable provided to connect the camera to a PictBridge-compatible printer. The procedure described below is for when the PC mode is set to AUTO in the menu. If you set the PC mode to PRINT beforehand, you can skip this procedure.

1 Turn the printer on and plug the printer end of the USB cable into the printer's USB port.

- For details on how to turn the printer on and the position of the USB port, refer to the printer's instruction manual.

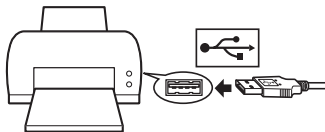

2 Plug the USB cable into the camera's USB connector and turn the camera on.

- The selection screen for the USB connection is displayed.

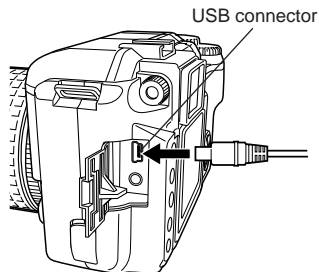

3 Select PRINT.

- ONE MOMENT is displayed and the camera and printer are connected. The PRINT MODE SELECT screen is displayed on the monitor.

4 Go to "Flowchart for printing" (P. 148).

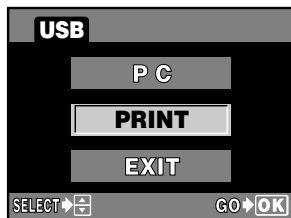

! Note

If the screen is not displayed after a few minutes, turn off the camera and start again from Step 2.

Flowchart for printing

When you have connected the camera to a printer successfully, you can apply print reservation to selected pictures or you can print a currently displayed picture. Follow the operation guide on the camera's monitor.

Press  to select the item you want.

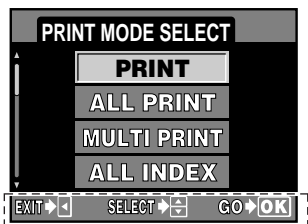

Follow the operation guide displayed here.

Select the print mode.

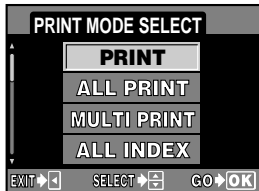

You can print selected pictures one by one or you can print multiple pictures on a single sheet of paper.  P. 150

Select the print paper setting.

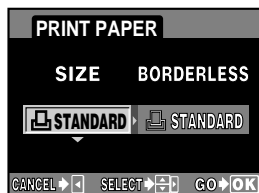

You can select the print paper setting according to your printer and you can select whether to print pictures with a blank frame or not.  P. 151

Select frames you want to print.

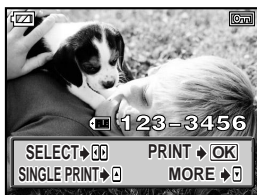

Display the picture you want to print. You can print the currently displayed picture immediately. If you have selected an image, you can also apply print reservation. [P. 151](#)

Set the printing data.



Set the number of prints, and select whether to print the date and time information or file name on the pictures. [P. 152](#)

Print pictures.



Print the pictures with print reservation. [P. 152](#)

Selecting the print mode

Select the type of printing (print mode). You can print pictures one by one or multiple pictures on a single sheet of paper.

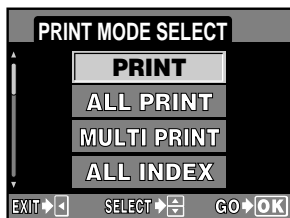

- PRINT** : Prints selected pictures.
- ALL PRINT** : Prints all the pictures stored in the card and makes one print for each picture.
- MULTI PRINT** : Prints multiple copies of one image in separate frames on a single sheet.
- ALL INDEX** : Prints an index of all the pictures stored in the card.
- PRINT ORDER** : Prints according to the print reservation you made. If there is no picture with print reservation, this is not available. P. 138

Print modes and settings

The available print modes and settings such as paper size vary depending on the type of printer. For details, refer to the printer's instructions.

Setting the print paper items

This setting varies depending on the type of printer. If only the printer's  STANDARD setting is available, you cannot change the setting.

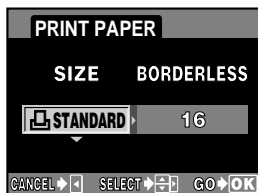



- SIZE** : Sets the paper size that the printer supports.
- BORDERLESS** : Selects whether the picture is printed on the entire page or inside a blank frame.
- PICS/SHEET** : Selects the number of pictures per sheet. Displayed when you have selected MULTI PRINT.

Selecting pictures you want to print

Select pictures you want to print. The selected pictures can be printed later (single-frame reservation) or the picture you are displaying can be printed right away.



PRINT [OK] : Prints the currently displayed picture. If there is a picture that SINGLE PRINT reservation has already been applied to, only the picture with SINGLE PRINT reservation will be printed.

SINGLE PRINT [] : Applies print reservation to the currently displayed picture. If you want to apply reservation to other pictures, press   to select them.

MORE [] : Sets the number of prints and other items for the currently displayed picture, and whether or not to print it.

 "Setting printing data" (P. 152)

Setting printing data

Select whether to print printing data such as the date and time or file name on the picture when printing.



- x** : Sets the number of prints.
- : Prints the date and time recorded on the picture.

FILE NAME: Prints the file name recorded on the picture.

Printing

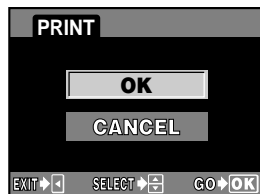

Print when you have set the pictures for printing and printing data.

- OK** : Transfers images you print to the printer.
- CANCEL** : Resets the settings. All print reservation data will be lost. If you want to keep the print reservation data and make other settings, press \triangleright . This returns you to the previous setting.

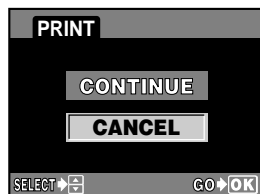







To stop and cancel printing, press the **OK** button.

- CONTINUE**: Continues printing.
- CANCEL** : Cancels printing. All print reservation data will be lost.

If an error code is displayed

- If an error code is displayed during direct printing setting or printing, see the following table.
- For more details on solutions, refer to the printer's instruction manual.
- If other codes are displayed, refer to "Error codes" (P. 174).

Monitor indication	Possible cause	Corrective action
 NO CONNECTION	The camera is not connected to the printer correctly.	Disconnect the camera and connect it again correctly.
 NO PAPER	There is no paper in the printer.	Load some paper in the printer.
 NO INK	The printer has run out of ink.	Replace the ink cartridge in the printer.
 JAMMED	The paper is jammed.	Remove the jammed paper.
SETTINGS CHANGED	The printer's paper cassette has been removed or the printer has been manipulated while making settings on the camera.	Do not manipulate the printer while making settings on the camera.
 PRINT ERROR	There is a problem with the printer and/or camera.	Turn off camera and printer. Check the printer and remedy any problems before turning the power on again.
 CANNOT PRINT	Pictures recorded on other cameras may not be printed on this camera.	Use a personal computer to print.

10

Transferring images to a computer

Transferring images to your computer is a great way to make the most of the potential of digital imaging. Not only can you print the images of your choice, you can also use image processing software to organize, edit, and manipulate images. There are so many things you can do. Sort images by date/time or other criteria. Trim, crop, colorize, or add special effects. And much more.

Once you've transferred images to your computer, you can email them to friends, post them on your website, create slideshows or HTML albums, you can even use them as wallpaper for your desktop.

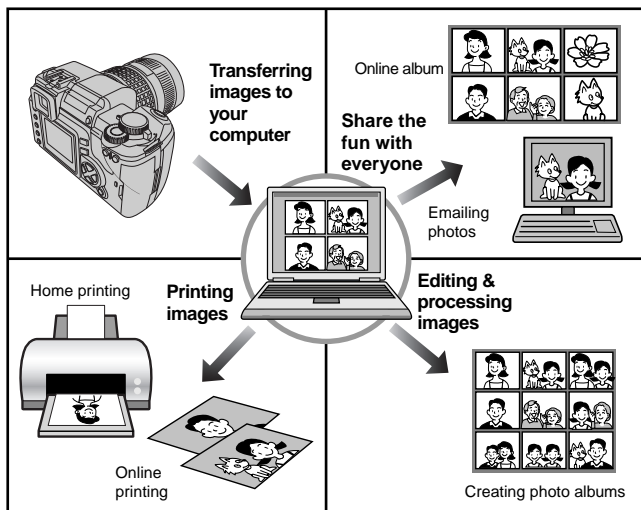

Just connect the camera to a computer with the USB cable and you can easily transfer images stored on the card to the computer with the provided OLYMPUS Master software.

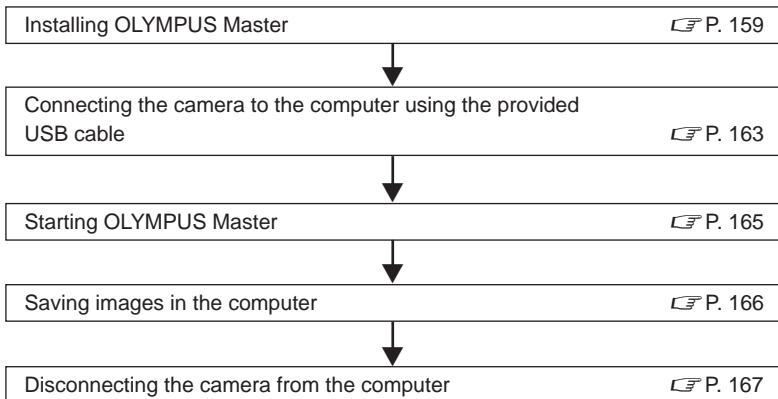

Note

- When connecting the camera to the computer, use the provided AC adapter whenever possible. When connected (transmitting) to the computer, the camera may stop operating if battery power runs low. This could cause the computer to malfunction, and any image data (file) being transmitted may be lost.
- Never open the camera's battery/card compartment cover or disconnect or connect the AC adapter while the card access lamp is blinking. Doing so may destroy the image files.
- If the camera is connected to the computer via a USB hub, operation may not be stable if there are any compatibility problems between the computer and the hub. In such cases, do not use the hub and connect the camera directly to the computer instead.

Viewing or processing images downloaded to the computer

If you want to process images using graphics applications, be sure to download them to your computer first. Depending on the software, image files may be destroyed if the images are processed (rotated, etc.) while they are on the card.

When your computer cannot read the camera's image data with the USB connection

Transferring images to the computer is possible with the use of the optional PC card adapter or other media adapters for the Compact Flash.

For details, see the Olympus web site.

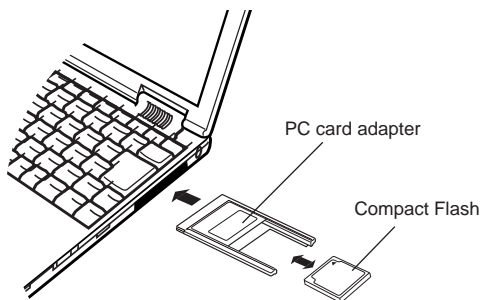

Using the provided OLYMPUS Master software

Install the OLYMPUS Master software from the provided CD-ROM to edit and manage images on your computer.

What is OLYMPUS Master?

OLYMPUS Master is an image management program with viewing and editing features for pictures taken with your digital camera. Once installed on your computer, you can take advantage of the following.

Viewing images and movies

You can also enjoy slideshows and sound playback.

Grouping and organizing images

You can organize images by displaying them in a calendar format. Using shooting date or key words, you can quickly find the particular images you want.

Transferring images from the camera or removable media to your computer

Editing images

You can rotate, trim or change the image size.

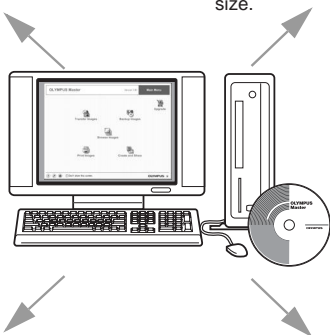

Correcting images using filter and correction functions

A variety of printing formats

You can print in a variety of formats including index prints, calendars, postcards, and more.

Creating panorama images

You can make a panorama from the photos you have taken using the panorama function.

For information about OLYMPUS Master's other features, as well as for details on how to use the software, refer to OLYMPUS Master Help or the OLYMPUS Master software user's guide.

Installing OLYMPUS Master

Identify the OS on your computer before installing the software.

For the latest information on compatible operating systems, visit the OLYMPUS web site (<http://www.olympus.com>).

System requirements

Windows

OS	Windows 98SE/Me/2000 Professional/XP
CPU	Pentium III 500 MHz or higher
RAM	128 MB or more (256 MB or more recommended)
HD space	300 MB or more
Interface	USB port
Monitor	1024 x 768 pixel or more, minimum 65,536 colors

Note

- Only pre-installed operating systems are supported.
- To install OLYMPUS Master on a computer running Windows 2000 Professional or Windows XP, login as a user with administrator privileges.
- QuickTime 6 and Internet Explorer or later must be installed on the computer beforehand.
- For Windows XP, Windows XP Professional/Home Edition is supported.
- For Windows 2000, only Windows 2000 Professional is supported.
- For Windows 98SE, a USB driver will be automatically installed.

Macintosh

OS	Mac OS X 10.2 or later
CPU	Power PC G3 500 MHz or higher
RAM	128 MB or more (256 MB or more recommended)
HD space	300 MB or more
Interface	USB port
Monitor	1024 x 768 pixel or more, minimum 32,000 colors

Note

- If your Macintosh has no built-in USB port, its functionality may not be guaranteed when the camera is connected to the computer via USB.
- Quick Time 6 or later and Safari 1.0 or later must be installed on your computer.
- Be sure to remove the card (drag and drop it onto the Trash icon) first before performing the following procedures. If you skip these procedures, the computer may not function properly, requiring you to restart it.
 - Unplug the cable connected between the camera and computer.
 - Turn off the camera.
 - Open the camera's card compartment cover.

How to install

Windows

1 Boot your computer and insert the OLYMPUS Master CD into your CD-ROM drive.

- The OLYMPUS Master Setup Menu will automatically launch.
- If the menu window does not appear, double-click the [My Computer] icon, and click the CD-ROM icon.

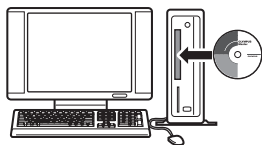

2 Click the [OLYMPUS Master] button.

- The QuickTime Setup program will automatically run.
- QuickTime is required to run OLYMPUS Master. If QuickTime 6 or later is preinstalled on your computer, the setup program will not run. In this case, go to step 4.



3 Click the [Next] button, then follow the on-screen prompts to continue installing the program.

- When the software license agreement window appears, read the license agreement text, then click [Agree].
- The OLYMPUS Master installation window appears.

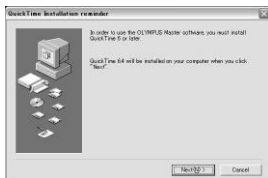

4 Follow the on-screen prompts to continue installing the program.

- When the software license agreement window appears, read the license agreement text, then click [Yes].
- When a dialog box prompting you for User Information appears, enter your name and the OLYMPUS Master serial number that is printed on the label on the CD-ROM package. Select your country, then click [Next]. Installation starts. When the DirectX license agreement window appears, read the message, then click [Yes] to continue installation.

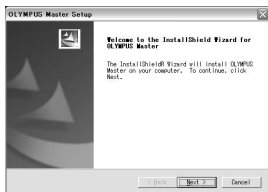
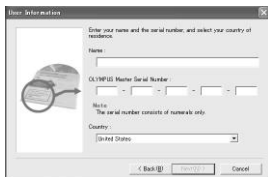

- A confirmation window appears, asking you if you want to install Adobe Reader. To view the OLYMPUS Master software user's guide, Adobe Reader must be installed. If Acrobat Reader is preinstalled on your computer, the confirmation window will not appear.

5 If you want to install Adobe Reader, click [OK].

- If you do not want to install the program, click [Cancel]. Go to step 7.
- The Adobe Reader installation window appears.

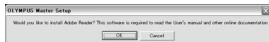

6 Follow the on-screen prompts to continue installing the program.

- A window appears to inform you when installation is complete.

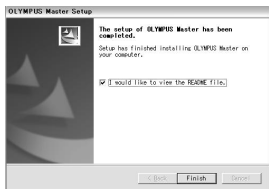

7 Click [Finish].

- The screen returns to the Olympus Software Setup Menu.

8 Select the option to restart immediately when the screen asking you if you wish to restart the computer is displayed and click [OK].

- The computer restarts.

9 Remove the CD, then click [Finish].

Macintosh

1 Insert the OLYMPUS Master software CD into your CD-ROM drive.

- The CD-ROM window automatically appears.
- If the screen does not appear, double-click the CD-ROM icon on your desktop.



2 Double-click the [Installer] icon.

- Follow the on-screen prompts to continue installing the program. OLYMPUS Master Installer will automatically launch.
- When the software license agreement window appears, read the license agreement text, then click [Continue] and [Agree].
- A window appears to inform you when installation is complete.



3 Click the [Quit] button.

4 Remove the CD, then click [Restart].

Connecting the camera to a computer

Connect the camera to your computer with the provided USB cable.

- 1** Insert the marked end of the provided USB cable into the USB port on your computer.

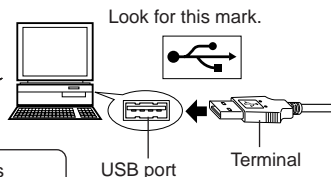

The location of the USB port varies depending on the computer. For details, refer to your computer's manual.

- 2** Insert the provided USB cable into the USB connector.

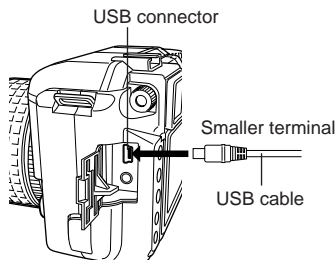

- 3** Set the camera's power switch to **ON**.

- 4** Press  to select PC. Press the **OK** button.

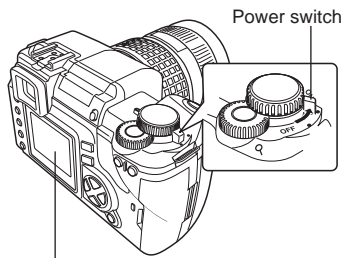

The selection screen for the USB connection is displayed.

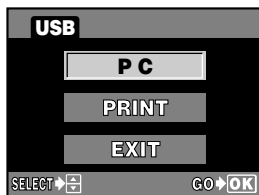

5 The computer recognizes the camera as a new device.

• Windows 98SE/Me/2000

When you connect the camera to the computer for the first time, the computer automatically recognizes the camera.

Click [OK] when the message saying that the installation is completed appears.

The computer recognizes the camera as a [Removable Disk ].

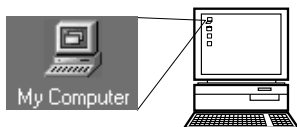

Removable
Disk (F:)

• Windows XP

You can download image files from the camera easily. To transfer images with OLYMPUS Master, click [Cancel].

• Mac OS X

iPhoto is the default image management application for Mac OS. When you connect your Olympus digital camera for the first time, iPhoto will start up automatically. Close iPhoto and start OLYMPUS Master.

Note

When the camera is connected to the computer, none of the camera buttons are functional.

Starting OLYMPUS Master

Windows

1 Double-click  (OLYMPUS Master) on the desktop.

- The OLYMPUS Master main menu appears.

Macintosh

1 Double-click  (OLYMPUS Master) in the [OLYMPUS Master] folder.

- The OLYMPUS Master main menu appears.
- The first time you start the program, a dialog box appears, prompting you for User Information. Enter your name and the OLYMPUS Master serial number that is printed on the affixed label, then select your country.

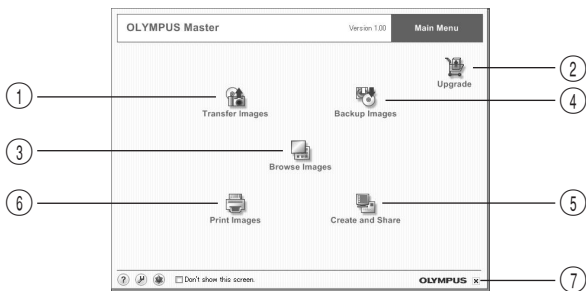

1 [Transfer Images] button

Transfers images from the camera or removable media.

2 [Upgrade] button

Displays the dialog box that allows upgrade to OLYMPUS Master PLUS.

3 [Browse Images] button

Displays the Browse window.

4 [Backup Images] button

Backs up images onto removable media.

5 [Create and Share] button

Displays menus to enjoy images.

6 [Print Images] button

Displays the print menu.

7 Close button

Closes the OLYMPUS Master program.

Closing OLYMPUS Master

1 Click  (Close) in the main menu.

- The OLYMPUS Master program is closed.

Downloading images to save on your computer

Save images downloaded from the camera on your computer.

1 Click  (**Transfer Images**) in the **OLYMPUS Master** main menu.

- The selection menu for the folders containing the files to be copied appears.

2 Click  (**From Camera**).

- The window containing the files to be copied appears. The thumbnails of all the images in the camera appear.

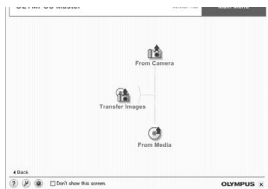

3 Select the image file you want to save on the computer, then click the **[Transfer Images]** button.

- A confirmation message appears.

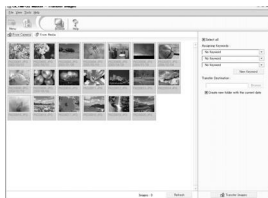

4 Click the **[Browse images now.]** button.

- The images downloaded to the Browse window appear.
- Clicking [Menu] in the Browse window returns to the main menu.
- Never open the camera's battery/card compartment cover or disconnect or connect the AC adapter while the card access lamp is blinking. Doing so may destroy the image files.

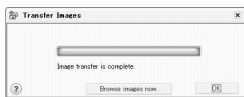

Disconnecting the camera from your computer

After downloading images from the camera to your computer, you can disconnect the camera from your computer.

- 1 Make sure that the card access lamp goes out.

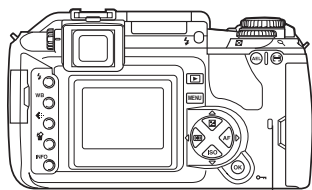

Card access lamp

2 Windows 98SE:

- 1 Double-click the [My Computer] icon and right-click the [Removable Disk] to display the menu.
- 2 Click [Eject] on the menu.



Windows Me/2000/XP:

- 1 In the System Tray, click the Remove Hardware icon .
- 2 Click on the pop-up message.
- 3 Click [OK] on the [Safe to Remove Hardware] window.

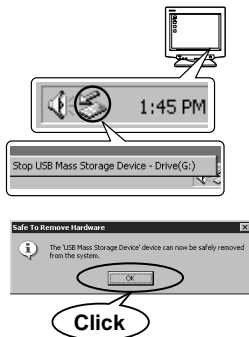

Macintosh:

- 1 Drag and drop the [untitled] (or [NO_NAME]) icon on the desktop to [Trash].

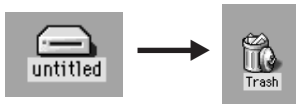

- 3 Unplug the USB cable from the camera.

Note

Windows Me/2000/XP: When you click [Unplug or Eject Hardware], the window may return the following message. In such case, make sure that no image data is being downloaded from the camera, and that there are no applications open that were accessing the camera image files. Close any such applications and click [Unplug or Eject Hardware] again and then remove the cable.

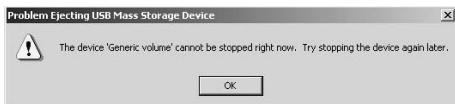

Viewing still images

- 1 Click  (Browse Images) in the OLYMPUS main menu.
 - The Browse window appears.

- 2 Double-click the thumbnail of the image you want to view.

Thumbnail

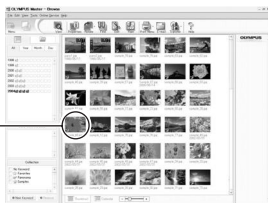

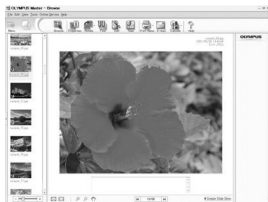

- The screen switches to the View mode, enlarging the image.
- Clicking the [Menu] in the Browse window returns to the main menu.



Printing images

The print menus include menus such as [Photo], [Index], [Postcard], [Calendar] etc. The examples in the instructions below are taken from the [Photo] menu.

- 1 Click  (Print Images) in the OLYMPUS Master main menu.**
 - The print menu appears.
- 2 Click  (Photo).**
 - The photo print window appears.
- 3 Click  (Settings) on the photo print window. The printer setting dialog box appears. Make printer settings as required.**
- 4 Select the layout and size of the image to print.**
 - To print images with the date or date and time, check off [Print Date], then select [Date] or [Date & Time].
- 5 Select the thumbnail of the image you want to print, then click the [Add] button.**
 - The selected image is previewed on the layout.
- 6 Set the number of images to print.**
- 7 Click the [Print] button.**
 - Clicking [Menu] in the photo print window returns to the main menu.

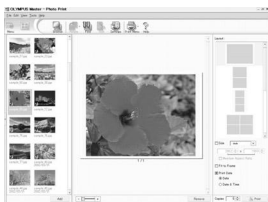
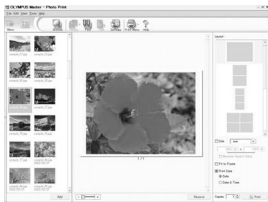
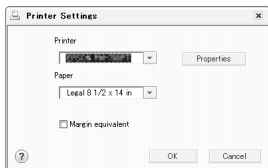
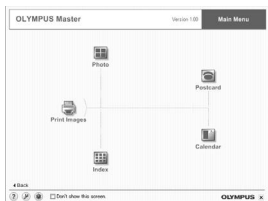

Your camera supports the USB Mass Storage Class. You can transfer images to a computer by connecting the camera to the computer with the provided USB cable. This can be done even without using OLYMPUS Master.

The following operating systems are compatible with the USB connection:

Windows : Windows 98SE/Me/2000 Professional/XP

Macintosh : Mac OS 9.0-9.2/X

Note

- Users running Windows 98SE need to install the USB driver. Before connecting the camera to your computer with the USB cable, double-click the file included in the following folder on the provided OLYMPUS Master CD-ROM. When you install OLYMPUS Master, the USB driver will be installed at the same time.
Your computer's drive name: \USB\INSTALL.EXE
- Even if your computer has a USB connector, data transfer may not function correctly if you are using one of the operating systems listed below or if you have an add-on USB connector (extension card, etc.).
 - Windows 95/98/NT 4.0
 - Windows 98SE upgrade from Windows 95/98
 - Mac OS 8.6 or lower
(except Mac OS 8.6 equipped with USB MASS Storage Support 1.3.5 installed at the factory)
 - Data transfer is not guaranteed on a home-built PC system or PCs with no factory installed OS.

11

Appendix

The appendix will assist in solving most problems you may encounter. Solutions to error messages, operational problems, blurry pictures, camera storage, basic terminology and more can easily be found in this section.

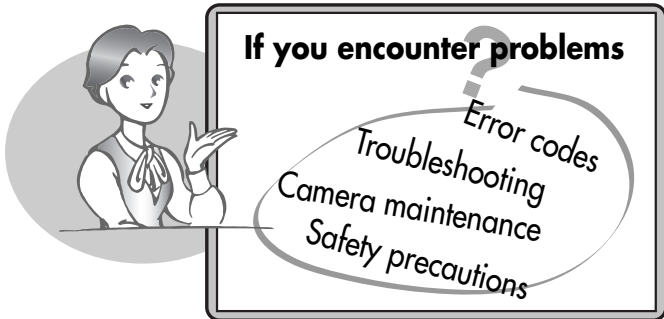

“Card” in this manual refers to a recording medium. This camera can use a Compact Flash or Microdrive (optional). An xD-Picture Card can also be used with a card adapter (optional).

Compact Flash

A Compact Flash is a large-capacity solid state flash memory card. You can use commercially available cards.

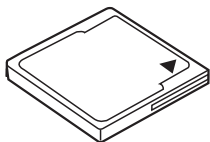

Microdrive

A Microdrive is a medium that uses a large-capacity compact hard disk drive. You can use a Microdrive that supports CF+Type II (Compact Flash extension standard).

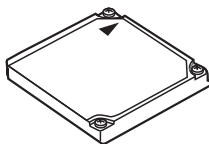

Precautions when using a Microdrive

A Microdrive is a medium that uses a compact hard disk drive. Because the disk drive rotates, a Microdrive is not as resistant to vibration or impact as other cards. Special care is needed when using a Microdrive (especially during recording and playback) to make sure the camera is not subjected to shock or vibrations. Be sure to read the following precautions before using a Microdrive. Also, refer to the manuals provided with your Microdrive.

- Be very careful when putting the camera down during recording. Place it gently on a firm surface.
- Be careful not to hit the camera against anything when carrying it by the strap.
- Do not use the camera in places subject to vibrations or excessive shock, such as at a construction site or in a car while driving along a bumpy road.
- Do not take a Microdrive close to areas where it may be exposed to strong magnetism.
- Microdrives confirmed for use with this camera (as of October, 2004):

Hitachi

DSCM-1100 (1 GB)

HMS360404D5CF00 (4GB)

DSCM-10512 (512 MB)

HMS360402D5CF00 (2GB)

DSCM-10340 (340 MB)

Select the lens that you want to shoot with.

Use a specified Four Thirds lens (Four Thirds mount*). When a non-specified lens is used, AF (auto focus) and light metering will not function correctly. In some cases, other functions may not work either.

*Four Thirds mount:

Standard developed by Olympus. Lens mount of Four Thirds system. Developed from the ground up, these all-new interchangeable lenses are based on optic engineering exclusively for digital cameras.

Four Thirds system interchangeable lens

Designed to withstand severe professional use. The Four Thirds system makes it possible for a fast lens to be compact and lightweight as well.

The Four Thirds system interchangeable lens lineup includes the following products:

ZUIKO DIGITAL 14mm-54mm f2.8-3.5:

Standard zoom lens equivalent to 28-108 mm on a 35 mm lens

ZUIKO DIGITAL ED 50mm-200mm f2.8-3.5:

Super telephoto zoom lens equivalent to 100-400 mm on a 35 mm lens







ZUIKO DIGITAL ED 40mm-150mm f3.5-4.5:







Telephoto zoom lens equivalent to 80-300 mm on a 35 mm lens

Note

- When you attach or remove the body cap and lens from the camera, keep the lens mount on the camera pointed downward. This helps prevent dust and other foreign matter from getting inside the camera.
- Do not remove the body cap or attach the lens in dusty places.
- Do not point the lens attached to the camera toward the sun. This may cause the camera to malfunction or even ignite due to the magnifying effect of sunlight focusing through the lens.
- Be careful not to lose the body cap and rear cap.
- Attach the body cap to the camera to prevent dust from getting inside when no lens is attached.

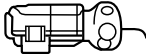
Error codes

Viewfinder indications	Monitor indications	Possible cause	Corrective action
Normal indication	 NO CARD	The card is not inserted, or it cannot be recognized.	Insert a card or insert a different card.
	 CARD ERROR	There is a problem with the card.	Insert the card again. If the problem persists, format the card. If the card cannot be formatted, it cannot be used.
	 WRITE PROTECT	Writing to the card is prohibited.	The card has been set to read-only setting with the computer. Reset the card with the computer.
No indication	 CARD FULL	The card is full. No more pictures can be taken or no more information such as print reservation can be recorded.	Replace the card or erase unwanted pictures. Before erasing, download important images to a PC.
No indication	 NO PICTURE	There are no pictures on the card.	The card contains no pictures. Record pictures.

Viewfinder indications	Monitor indications	Possible cause	Corrective action
No indication	 PICTURE ERROR	The selected picture cannot be displayed for playback due to a problem with this picture. Or the picture cannot be used for playback on this camera.	Use image processing software to view the picture on a PC. If that cannot be done, the image file is damaged.
	 CARD-COVER OPEN	The card cover is open.	Close the card cover.
	 CARD ERROR	The card is not formatted.	Format the card.
No indication	 BATTERY EMPTY	The battery is drained.	Charge the battery.
No indication	No indication	Camera interior has overheated.	Switch the camera off and allow it to cool, and then switch the camera on again.

Troubleshooting

Possible cause	Corrective action	Ref. Page
The camera does not turn on or function buttons do not respond.		
The power is off.	The camera automatically turns off if it is not operated for a certain period of time. Set the power switch to ON .	–
The camera enters the sleep mode.	Press the shutter button halfway.	P. 132
The battery is drained.	Charge the battery.	–
The battery is temporarily unable to function because of the cold.	Warm the battery by putting it in your pocket for a while.	–
The camera is connected to a PC.	The camera will not operate while it is connected to a PC. The optional OLYMPUS Studio software is required in the CONTROL mode.	P. 132
No picture is taken when the shutter button is pressed.		
The battery is drained.	Charge the battery.	–
Subjects are difficult to focus on (AF does not work properly).	Use manual focus or focus lock to focus on the subject and then shoot.	P. 30, 83
Pictures are being recorded to the card.	During sequential shooting, no pictures can be taken when the camera's memory is full.	P. 200
The flash has not finished charging.	Remove your finger from the shutter button, and wait until the ⚡ mark stops blinking. Press the shutter button again.	P. 59
The card is full.	Erase unwanted images or insert a new card. Before erasing, download important images to a PC.	P. 120, 166
The battery ran out of power during shooting or while the images were being written to the card. (The monitor turns off after BATTERY EMPTY is displayed.)	Charge the battery. (Wait until the card access lamp stops blinking.)	–
There is a problem with the card.	Refer to the "Error codes".	P. 174

Possible cause	Corrective action	Ref. Page
The viewfinder display is not clear.		
The diopter is not adjusted.	Adjust the diopter so that the AF frame is clearly visible.	–
Stray light enters through the lens.	Use a sunshade.	–
Stray light enters through the viewfinder.	Use the provided eyepiece cover.	P. 73
There is condensation* in the lens or viewfinder.	Turn off the camera's power and wait until the camera is dry. The camera will dry out as it gets accustomed to the environmental temperature.	–
The date recorded with the image data is wrong.		
The date/time is not set.	Set the date/time. The clock adjustment is not factory-preset.	P. 127
The camera was left for a long period with the battery removed.	If the camera is left for a long period with the battery removed, the stored date/time setting will be canceled. Set the date/time again.	P. 127
Turning the camera's power off does not reset the stored settings.		
This camera retains the saved settings after the camera's power is turned off.	Turning the camera's power off does not reset the saved settings. Set RESET to ON, then turn off the camera.	P. 128
The picture is out of focus.		
The subject is too close.	Move back to the closest focusing distance for the lens and take the picture.	–
Subjects are difficult to focus on (AF does not work properly).	Use manual focus or focus lock to focus on the subject and then shoot.	P. 30, 83
The subject is dark.	Set AF ILLUMINATOR to ON in the menu and raise the flash.	P.84
There is condensation* in the lens or viewfinder.	Turn off the camera's power and wait until the camera is dry.	–

*Condensation: When it is cold outside, the water vapor in the air is rapidly cooled and turns to droplets of water. Condensation occurs when the camera is suddenly taken from a cold place into a warm room.

Possible cause	Corrective action	Ref. Page
The picture is blurred.		
A subject unsuited to AF was taken	Use manual focus or focus lock to focus on the subject and then shoot.	P. 30, 83
The camera moved when the shutter button was pressed.	Camera vibrations will result in a blurred picture. Hold the camera correctly and press the shutter button gently. When a telephoto lens is used, special care is needed.	–
ISO is set to auto in a dark environment.	The camera is more likely to move with slower shutter speeds. Use the flash or set a higher ISO sensitivity. The use of a tripod is also recommended.	P. 54, 91
The lens was dirty.	Clean the lens. Use a commercially available blower brush and then wipe with a lens cleaner to remove dust. Mold may form on the lens surface if the lens is left dirty.	P. 181
The picture is too bright.		
There was something dark in the center of the image.	When there is something dark in the center of the image, the edges of the image will be brighter regardless of the metering system. Adjust the exposure toward –.	P. 88
The ISO setting is high.	Set ISO to auto or 100. If there is no improvement, use an ND filter.	P. 91
A low aperture value is set in the A (M) mode.	Increase the aperture value. Or set the exposure mode to the P mode.	P. 43, 45
A slow shutter speed is set in the S (M) mode.	Increase the shutter speed. Or set the exposure mode to the P mode.	P.43, 47

Possible cause	Corrective action	Ref. Page
The picture is too dark.		
The subject was too small and was backlit.	Set the metering system to spot metering. Or use the flash.	P. 54, 87
There was something bright in the center of the image.	When there is something bright in the center of the image, the whole image will be darker regardless of the metering system. Adjust the exposure toward +.	P. 88
A high aperture value is set in the A (M) mode.	Decrease the aperture value. Or set the exposure mode to the P mode.	P. 43, 45
A fast shutter speed is set in the S (M) mode.	Reduce the shutter speed. Or set the exposure mode to the P mode.	P. 43, 47
The colors of pictures taken indoors look unnatural.		
Indoor lighting affected the picture's colors.	Set the appropriate white balance for the lighting. More natural-looking colors can be reproduced with the one-touch white balance.	P. 93
The white balance setting is wrong.	Set the appropriate white balance for the lighting again.	P. 93
Halation produces unnatural colors in the picture.		
This may be caused by excessively bright ultraviolet light on the subject, such as sunlight shining through the leaves of trees, brightly lit windows at night, reflections off metal in direct sunlight, etc.	<ul style="list-style-type: none"> ● Use a UV filter. As this may upset the overall color balance, it should only be used under the conditions described on the left. ● Process the picture using a graphics application that supports JPEG (Paint Shop Pro, Photoshop, etc.). For example, after picking up unnatural colors with an eyedropper tool, etc., you can select color areas, and try color conversion or saturation adjustment. For details, refer to the manual for the graphics application you are using. 	—

Possible cause	Corrective action	Ref. Page
The top left part of the picture appears too bright.		
When shooting at slow shutter speeds, noise may be generated due to a rise in temperature in the CCD drive circuit.	Set NOISE REDUCTION to ON before taking pictures.	P. 105
Pictures cannot be played back on the monitor.		
Pictures are not stored on the card.	NO PICTURE appears on the monitor. Record pictures.	-
The card error occurs.	Refer to "Error codes".	P. 174
No picture is displayed on the TV when connected to the camera.		
The video cable is not connected correctly.	Connect the cable properly according to the instructions.	P. 116
The camera's video output signal is incorrect.	Set the video signal according to the region where used.	P. 134
The TV 's video signal is incorrect.	Set the TV to the video input mode.	-
The monitor is hard to see.		
The brightness is not adjusted properly.	Adjust the brightness of the monitor using the menu.	P. 131
The monitor is exposed to direct sunlight.	Block the sunlight with your hand.	-
The computer does not recognize the camera correctly.		
The camera's power is turned off.	Set the power switch to ON .	-
The USB driver was not successfully installed.	Install the OLYMPUS Master.	P. 158
The camera's PC MODE is set to CONTROL.	Set PC MODE to AUTO or STORAGE. When AUTO is set, the selection screen for USB connection is displayed every time you connect the USB cable to the camera.	P. 132

Cleaning and storing the camera

Cleaning the camera

Turn off the camera and remove the battery before cleaning the camera.

Exterior:

- Wipe gently with a soft cloth. If the camera is very dirty, soak the cloth in mild soapy water and wring well. Wipe the camera with the damp cloth and then dry it with a dry cloth. If you have used the camera at the beach, use a cloth soaked in clean water and well wrung.

Monitor and viewfinder:

- Wipe gently with a soft cloth.

Lens, mirror and focusing screen:

- Blow dust off the lens, mirror and focusing screen with a commercially available blower. For the lens, wipe gently with a lens cleaning paper. Do not use a high-pressure bottled blower. If high-pressure gas is sprayed onto the lens, mirror, or focusing screen by non-authorized service persons, the camera will be damaged.

Storage

- When storing the camera for extended periods, remove the battery and card. Store the camera in a cool, dry place that is well ventilated.
- Replace the battery periodically and test camera functions.

Cleaning and Checking the CCD

This camera incorporates a dust reduction function to keep dust from getting on the CCD and to remove any dust or dirt from the CCD surface with ultrasonic vibrations. Dust reduction works when the power switch is set to ON.

Since dust reduction is activated every time the camera's power is turned on, the camera should be held upright for the dust reduction function to be effective. The SSWF indicator blinks while dust reduction is working.

 "Names of parts" (P. 198)

Note

- Do not use strong solvents such as benzene or alcohol, or chemically treated cloth.
- Avoid storing the camera in places where chemicals are treated, in order to protect the camera from corrosion.
- Mold may form on the lens surface if the lens is left dirty.
- Check each part of the camera before use if it has not been used for a long time. Before taking important pictures, be sure to take a test shot and check that the camera works properly.

CLEANING MODE —Removing dust on the CCD

If dust or dirt gets on the CCD, black dots may appear in the picture. If this happens, contact your Olympus Authorized Service Center to have the CCD physically cleaned. The CCD is a precision device and is easily damaged. When cleaning the CCD yourself, be sure to follow the instructions below. When cleaning the CCD, the specified AC adapter should be used (P. 206). If a battery is used and power runs out during cleaning, the shutter will close, which may cause the shutter curtain and mirror to break.

- 1** Remove the lens from the camera.
- 2** Set the power switch to **ON**.
- 3** Menu → $\bar{I}2$ → **CLEANING MODE**
 ☞ “How to use the menus” (P. 25)
- 4** Press \triangleleft , then press the **OK** button.
 - The camera enters the cleaning mode.
- 5** Press the shutter button fully.
 - The mirror goes up and the shutter curtain opens.
- 6** Clean the CCD.
 - Carefully blow off any dust on the surface of the CCD by using a mechanical blower (commercially available).
- 7** Be careful not to catch the mechanical blower in the shutter curtain when turning the power off to finish cleaning.
 - If the camera turns off, the shutter curtain closes, causing the mirror to fall.

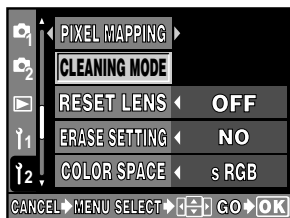
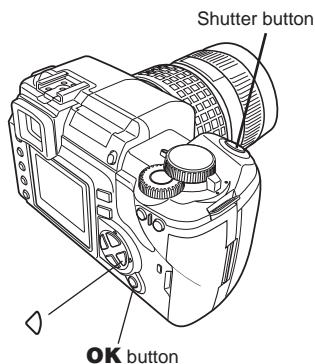

! Note

- Be careful to not let the mechanical blower (commercially available) touch the CCD. If the blower touches the CCD, the CCD will be damaged.
- Never put the mechanical blower behind the lens mount. If the power turns off, the shutter closes, breaking the shutter curtain.
- Do not use anything other than the mechanical blower. If high-pressure gas is sprayed onto the CCD, it will freeze on the CCD's surface, damaging the CCD.

PIXEL MAPPING — Checking the image processing functions

The PIXEL MAPPING feature allows the camera to check and adjust the CCD and image processing functions. It is not necessary to operate this function frequently. Approximately once a year is recommended. After using the monitor or taking continuous shots, wait for at least one minute before using the PIXEL MAPPING function to ensure that it operates correctly.

1 Menu → \mathcal{Y} 2 → PIXEL MAPPING

 “How to use the menus” (P. 25)

2 Press \triangleleft , then press the **OK** button.

- The busy bar is displayed during PIXEL MAPPING. When PIXEL MAPPING is finished, the menu is restored.

Note

- If you accidentally turn the camera off during PIXEL MAPPING, start again from Step 1.

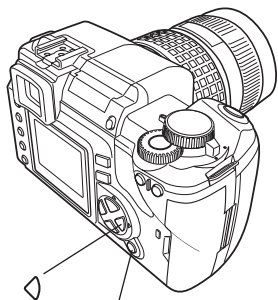

OK button

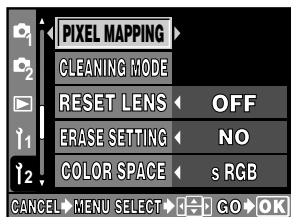

Safety precautions

Handling and storage precautions

- To protect the high-precision technology contained in this product, never leave the camera in the places listed below, no matter if in use or storage:
 - Places where temperatures and/or humidity are high or go through extreme changes. Direct sunlight, beaches, locked cars, or near other heat sources (stove, radiator, etc.) or humidifiers.
 - In sandy or dusty environments.
 - Near flammable items or explosives.
 - In wet places, such as bathrooms or in the rain.
 - In places prone to strong vibrations.
- Never drop the camera or subject it to severe shocks or vibrations.
- Do not leave the camera pointed directly at the sun. This may cause lens damage, color failure, ghosting on the CCD, or may possibly cause fires.
- Condensation may form inside the camera when there is a sudden extreme change in temperature (such as when moving from indoors to outdoors). Acclimatize the camera to the temperature (e.g. by putting the camera into the plastic bag) before use.
- If the camera has not been used for a long time, mold may form or the camera may malfunction. Before using the camera, check that the camera works properly.
- Do not touch electric contacts on cameras and interchangeable lenses. Remember to attach the cap when removing the lens.
- Do not place the camera near anything that could be affected by magnetism (e.g. credit card, floppy disk, etc.). Doing so may destroy the data on these items.

Battery handling precautions

- This camera uses a lithium ion battery specified by Olympus. Do not use any other type of battery. For safe and proper use, read the battery's instruction manual carefully before using it.
- If the battery's terminals get wet or greasy, camera contact failure may result. Wipe the battery well with a dry cloth before use.
- Always charge a battery when using it for the first time, or if it has not been used for a long period.
- When operating the camera with battery power at low temperatures, try to keep the camera and spare battery as warm as possible. A battery that has run down at low temperatures may be restored after it is warmed at room temperature.
- The number of pictures you can take may vary depending on the shooting conditions or battery.

- Before going on a long trip, and especially before traveling abroad, purchase extra batteries. Recommended batteries may be difficult to obtain while traveling.
- **Please recycle batteries to help save our planet's resources. When you throw away dead batteries, be sure to cover their terminals and always observe local laws and regulations.**

Battery charger

- Although battery charging is guaranteed when the air temperature is 0°C - 40°C/32°F - 104°F, for best results, we recommend an air temperature between 10°C - 30° C/50°F - 86°F.
- If the red charge indicator blinks, the battery may be broken or not inserted correctly.
- The battery may become warm while charging, but this is not a malfunction.
- There may be static on other electronic equipment (such as a radio or television) if the battery charger is plugged in to the same outlet. If this occurs, plug the battery charger into a different outlet.

LCD monitor

- Do not push the monitor forcibly; otherwise the image may become fuzzy, resulting in a playback mode failure or damage to the monitor. If the monitor is damaged, be careful not to get any of the liquid crystals from the monitor in your mouth. If liquid crystals get on your limbs or clothes, wash them off.
- A strip of light may appear on the top/bottom of the monitor, but this is not a malfunction.
- When a subject is viewed diagonally in the camera, the edges may appear zigzagged on the monitor. This is not a malfunction; It will be less noticeable in playback mode.
- In places subject to low temperatures, the LCD monitor may take a long time to turn on or its color may change temporarily. When using the camera in extremely cold places, it is a good idea to occasionally place it in a warm place. A LCD monitor exhibiting poor performance due to low temperatures will recover in normal temperatures.
- **The LCD monitor is made with high-precision technology. However, black spots or bright spots of light may appear on the LCD monitor. These spots may not be uniform in color and brightness depending on their characteristics or the angle at which you are viewing the monitor. This is not a malfunction.**

A (Aperture Priority) Mode

You set the aperture yourself and the camera automatically varies the shutter speed so that the picture is taken with the correct exposure.

AE (Automatic Exposure)

The camera's built-in exposure meter automatically sets the exposure. The 3 AE modes available on this camera are P mode, in which the camera selects both the aperture and shutter speed, A mode, in which the user selects the aperture and the camera sets the shutter speed, and S mode, in which the user selects the shutter speed and the camera sets the aperture. In M mode, the user selects both the aperture and the shutter speed.

Aperture

The adjustable lens opening which controls the amount of light that enters the camera. The larger the aperture, the shorter the depth of field and the fuzzier the background. The smaller the aperture, the greater the depth of field and the sharper the background. Aperture is measured in f/stops. Larger aperture values indicate smaller apertures, and smaller aperture values indicate larger apertures.

CCD (Charge-Coupled Device)

This converts light passing through the lens into electrical signals. On this camera, light is picked up and converted into RGB signals to build a single image.

Center weighted averaging metering

A light metering mode or technique that uses an average of the center and periphery of the image area but is biased toward the information at the center of the image area. This method is best used when the brightness of the center and periphery of the image area does not vary greatly. See also digital ESP metering and spot metering.

Color space

A model that describes colors using more than three coordinates. Color spaces such as sRGB, Adobe RGB are occasionally used for encoding/reproducing colors.

Color temperature

The spectral balance of different white light sources is rated numerically by color temperature — a concept of theoretical physics that, with incandescent lighting, corresponds roughly to the absolute lamp filament temperature, expressed on the Kelvin (K) temperature scale. The higher the color temperature, the richer the light in bluish tones and the poorer in reddish; the lower the color temperature, the richer the light in reddish tones and the poorer in bluish. You may encounter difficulties with color reproduction when shooting indoors under fluorescent lighting, or where sunlight and fluorescent lighting are both present. Your camera is provided with a white balance adjustment feature that you can use to compensate for the odd effects of combinations of color you may occasionally see in your pictures.

Compression rate

Compression is a method of reducing file size by abbreviating some contents of data, and compression rate denotes the amount of compression. The actual effect of the selected compression rate could vary with the content of the image. The numbers for the compression rate selected with this camera provide only a general scale for reference and are not precise measurements.

Conventional Photograph

This refers to recording images using silver halide (the method for recording images in conventional, non-digital photography). This system is in contrast to still video and digital photography.

DCF (Design rule for Camera File system)

A standard for image files by the Japan Electronics and Information Technology Industries Association (JEITA).

Depth of Field

Depth of Field refers to the distance from the nearest to the furthest point of perceived "sharp" focus in a picture.

Digital ESP (Electro-Selective Pattern) Light Metering

This determines the exposure by metering and calculating the light levels in the center and other areas of the image separately.

DPOF (Digital Print Order Format)

This is for saving desired print settings on digital cameras. By entering which images to print and the number of copies of each, the user can easily have the desired images printed by a printer or print lab that supports the DPOF format.

Eclipsing (Vignetting)

This refers to when an object obscures part of the field of view so that the whole subject is not photographed. Vignetting also refers to when the image seen through the viewfinder does not exactly match the image shot through the objective lens, so the photographed image includes objects not seen through the viewfinder. In addition, vignetting can occur when an incorrect lens hood is used, causing shadowing to appear in the corners of the image.

EV (Exposure Value)

A system for measuring exposure. EV0 is when the aperture is at F1 and the shutter speed is 1 second. The EV then increases by 1 each time the aperture increases by one F stop or the shutter speed increases by one increment. EV can also be used to indicate brightness and ISO settings.

Exposure

The amount of light used to capture an image. The exposure is determined by the length of time the shutter is open (shutter speed) and the amount of light that passes through the lens (aperture).

Flash Bracket

A mount used to attach an external flash to the camera. Shadows on the subject can be changed by detaching the flash. The flash is used in combination with the flash cable.

ISO

A method for indicating film speed by the International Organization for Standardization (ISO) (e.g. "ISO100"). Higher ISO values indicate greater sensitivity to light, so images can be exposed even in low-light conditions.

JPEG (Joint Photographic Experts Group)

A compression format for color still images. Photographs (images) shot using this camera are recorded onto the card in JPEG format when the Record mode is set to SHQ, HQ, SQ. By downloading these images to a personal computer, users can edit them using graphics application software or view the images using an Internet web browser.

M (Manual) Mode

The user sets both the aperture and shutter speed.

NTSC (National Television Systems Committee) / PAL (Phase Alternating Line)

Television formats. NTSC is mainly used in Japan, North America and Korea. PAL is mainly used in Europe and China.

Number of Pixels (PIXEL COUNT)

The number of dots (pixels) used to create an image denotes the image size. For instance, an image in 640 x 480 resolution is the same size as the computer screen if the monitor setting is also 640 x 480. If the monitor setting is 1024 x 768, the image only takes up part of the screen.

P (Program) Mode

Also called Program AE mode. The camera automatically sets the best shutter speed and aperture for the shot.

PictBridge

A standard that enables digital cameras and printers made by different manufacturers to be connected, and also allows pictures to be printed directly from the camera.

Pixels

A pixel is the smallest unit (dot) used to make up an image. Clear large-sized printed images require millions of pixels.

RAW

Refers to raw data, data which has not been enhanced with a camera option like white balance, sharpness, contrast, etc. This file format is for viewing and processing with our own software. You may not be able to open or process these files with other graphics software applications, and these files cannot be selected for DPOF printing. RAW files are assigned an orf file extension (*.orf).

S (Shutter Priority) Mode

Also called Shutter Priority AE mode. The user selects the shutter speed and the camera automatically varies the aperture so that the picture is taken with the best exposure.

Single-lens reflex camera

A camera with a shooting lens working also as the viewfinder lens. The image of the subject enters through the lens, reflects off of the mirror and into the pentaprism, where focus is adjusted, then through the viewfinder lens. Pictures are taken by framing the composition and adjusting the focus in the viewfinder lens.

Sleep Mode

A mode designed to save battery life. The camera automatically enters the sleep mode if you do not operate it for a certain time. To get out of the sleep mode, use any button on the camera (shutter button, menu button, etc.)

Spot metering

The meter reading is taken from a very small area around the center of the subject, defined by the spot metering area mark in the viewfinder. Spot metering is ideal for use in difficult light conditions, or when the important element of the picture (subject's face) is small. Use spot metering for backlit subjects, or sports and stage performers. See also digital ESP metering and center weighted averaging metering.

TIFF (Tagged Image File Format)

A format used for saving highly detailed black and white or color image data. TIFF image files can be handled by software programs for scanners and graphics applications. Non-compressed image data are stored in this format with this camera.

TFT (Thin-Film Transistor) Color Monitor

A color monitor constructed using thin-film technology.

TTL phase-contrast detection system

This is used to measure the distance to the subject. The camera determines if the image is focused by the detected phase contrast.

TTL (Through-The-Lens) System

To help adjust exposure, a light receptor built into the camera directly measures the light passing through the lens.

12 Information

This chapter covers all the camera's functions already described in Chapters 1 through 11.

You can refer to the names of the camera's buttons and parts, the names and meanings of the icons displayed on the monitor, and the menu lists as necessary.

Use the index when you want to find the pages describing the functions and items if these are not included in the table of contents. You can also use the "Names of parts" and "Menu directory" to search for the relevant pages.

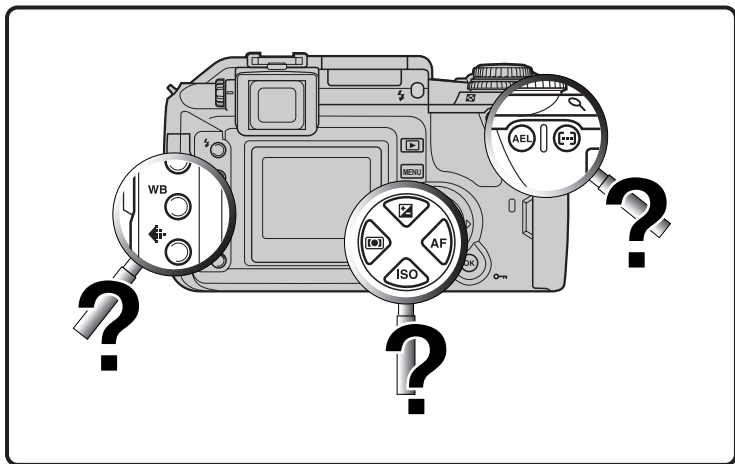

● Shooting Menu

Menu	Function	Setting	Ref. Page
		-5.0 - 0.0 - +5.0	P. 88
		RAW, TIFF, SHQ, HQ , SQ, RAW+SHQ, RAW+HQ, RAW+SQ	P. 36
		AUTO , , , SLOW, SLOW, SLOW2, ,	P. 58
	AF	S-AF, C-AF, MF, S-AF+MF	P. 79
	WB	AUTO , 3000K, 3600K, 4000K, 4500K, 6600K, 5300K, 6000K, 7500K, CWB1, CWB2, CWB3, CWB4,	P. 95
	ISO	AUTO , 100, 200, 400, 800, 1600	P. 91
		ESP, ,	P. 86
		AUTO , [] , [•] , []	P. 78

: Factory default setting

Menu	Function	Setting	Ref. Page	
2	CARD SETUP	ALL ERASE — YES, NO	P. 121	
		FORMAT — YES, NO	P. 135	
	DRIVE	<input type="checkbox"/>	P. 66	
			P. 66	
		BKT — 3F 0.3EV, 3F 0.7EV, 3F 1.0EV	P. 68	
			,	P. 72
			,	P. 72
		-2.0 - 0.0 - +2.0	P. 60	
		YES, NO	P. 97	
	MONOTONE	OFF, BLACK & WHITE, SEPIA	P. 75	
	GRADATION	HIGH KEY, NORMAL, LOW KEY	P. 104	
	SATURATION	-2.0 - 0.0 - +2.0	P. 103	
	CONTRAST	-2.0 - 0.0 - +2.0	P. 102	
	SHARPNESS	-2.0 - 0.0 - +2.0	P. 101	
	WB BKT	OFF, 3F 2STEP, 3F 4STEP, 3F 6STEP	P. 71	
	HQ	1/4, 1/8	P. 36	
	SQ	3200 x 2400	1/2.7, 1/4, 1/8	P. 36
		2560 x 1920		
		1600 x 1200		
		1280 x 960		
1024 x 768				
640 x 480				
NOISE REDUCTION	OFF, ON	P. 105		

: Factory default setting

● Playback Menu





Menu	Function	Setting	Ref. Page
▶		1, 4, 9, 16	P. 114
		OFF, ON	P. 115
	EDIT	JPEG/TIFF EDIT – BLACK & WHITE, SEPIA,	P. 117
		RAW DATA EDIT – YES, NO ,	P. 142

● Custom Menu

Menu	Function	Setting	Ref. Page	
1	EV STEP	1/3EV, 1/2EV, 1EV	P. 124	
	ISO BOOST	OFF, ON	P. 92	
	MANUAL FLASH	OFF, ON	P. 124	
		AUTO	BLUE7 - ±0	P. 98
			- RED7	
			3000K	
			3600K	
			4000K	
			4500K	
	CUSTOM WB	CWB1	2000K - 10000K	P. 100
CWB2				
CWB3				
CWB4				
AF ILLUMINATOR	OFF, ON	P. 84		
AEL METERING	AUTO, ESP, ,	P. 124		
CUSTOM OK	OFF	SHORTCUT	P. 125	
		PREVIEW		
		AF/MF		

: Factory default setting

● Setup Menu

Menu	Function	Setting	Ref. Page
12			P. 127
	RESET	YES, NO	P. 128
	FILE NAME	AUTO , RESET	P. 129
	REC VIEW	OFF, 5SEC , 20SEC	P. 130
		OFF, ON	P. 131
		-7 - 0 - +7	P. 131
	SLEEP	OFF, 1min , 3min, 5min, 10min	P. 132
	PC MODE	AUTO , STORAGE, CONTROL, PRINT	P. 132
		ENGLISH , FRANCAIS, DEUTSCH, ESPAÑOL, PORTUGUES*	P. 133
	VIDEO OUT	NTSC, PAL *	P. 134
	PIXEL MAPPING		P. 183
	CLEANING MODE		P. 182
	RESET LENS	OFF, ON	P. 126
	ERASE SETTING	YES, NO	P. 128
	COLOR SPACE	sRGB, Adobe RGB	P. 106
	FOCUS RING	Q , 	P. 126
	FIRMWARE		































* Settings differ depending on the region where the camera is sold.

 : Factory default setting

Available functions by shooting mode

Mode		P	A	S	M		SCENE							
Function														
Aperture value		—	✓	—	✓									
Shutter speed		—			✓									
Bulb shooting			—		✓									
			✓		—		✓							
					✓								✓ (Cannot be selected in / mode)	
Flash shooting					✓									
Flash mode	AUTO		✓		—		✓							
			✓		—		✓							
	SLOW		✓		—		✓							
	SLOW		✓		—		✓							
	SLOW		—		✓		—							
	SLOW2					✓								
						✓								
										✓				
AF mode					✓									
ISO					✓									
White balance					✓									
Metering					✓									
AF target mark										✓				
Preview					✓									
DRIVE					✓									
BKT					✓									
										✓				
										✓				
					✓									
					✓									
MONOTONE					✓									
GRADATION					✓									
SATURATION			✓											
CONTRAST			✓											
SHARPNESS			✓											
WB BKT					✓									

✓ : Available — : Not available

Function	Mode				    	SCENE							
	P	A	S	M		       	       						
HQ				✓		✓ (Cannot be selected in  /  mode)							
SQ				✓		✓ (Cannot be selected in  /  mode)							
NOISE REDUCTION				✓		—							
EV STEP				✓		—							
ISO BOOST				✓		—							
MANUAL FLASH				✓		—							
 WB				✓		—							
CUSTOM WB				✓		—							
AF ILLUMINATOR				✓		—							
AEL METERING				✓		—							
CUSTOM OK				✓		—							
						✓							
RESET						✓							
FILE NAME						✓							
REC VIEW						✓							
						✓ (Cannot be selected in  mode)							
						✓							
SLEEP						✓							
PC MODE						✓							
						✓							
VIDEO OUT						✓							
PIXEL MAPPING						✓							
CLEANING MODE						✓							
RESET LENS						✓							
ERASE SETTING						✓							
COLOR SPACE						✓							
FOCUS RING				✓		—							

✓ : Available — : Not available

Names of parts

Camera

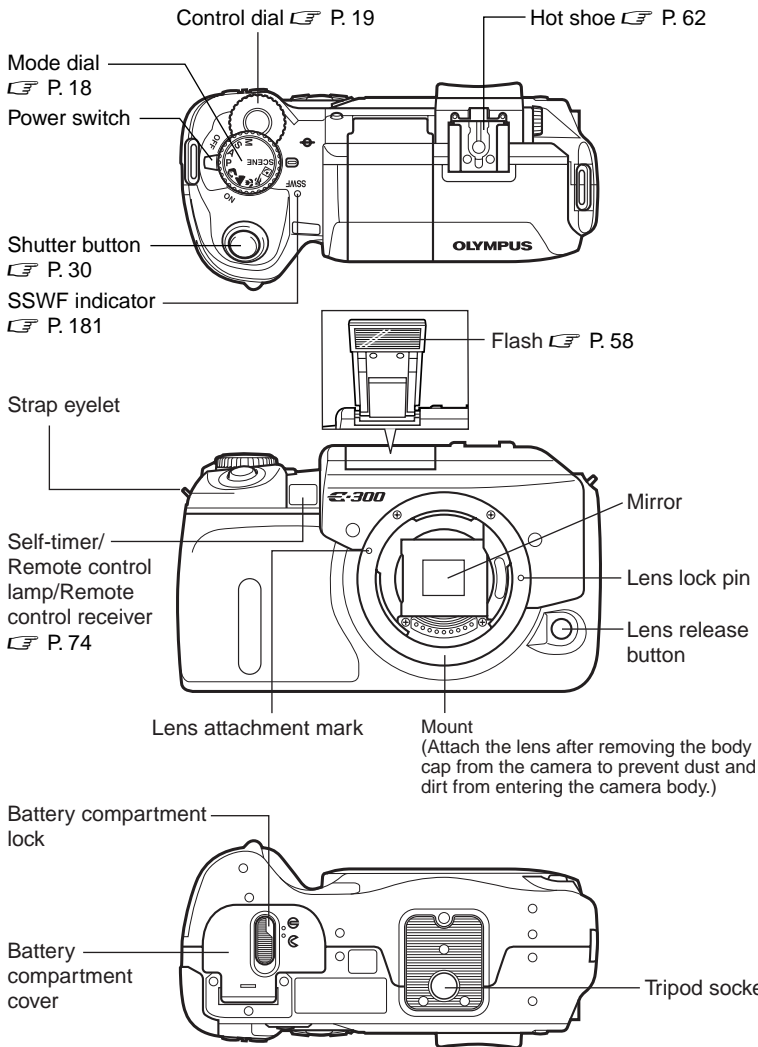

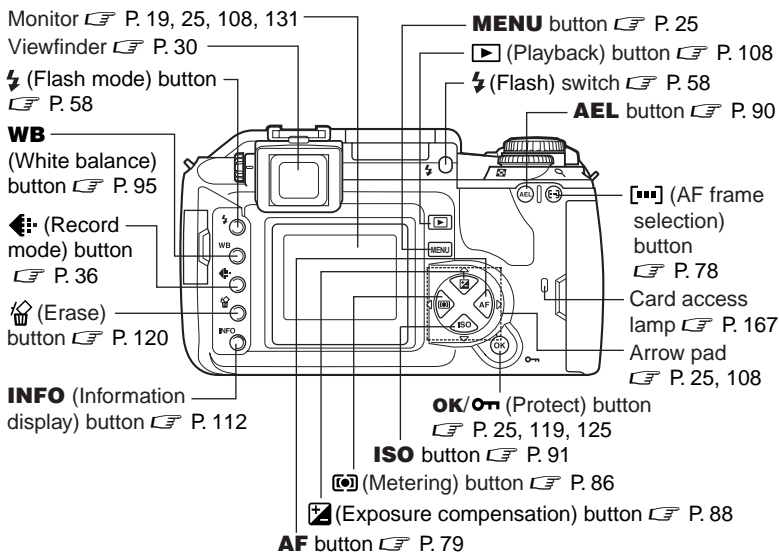



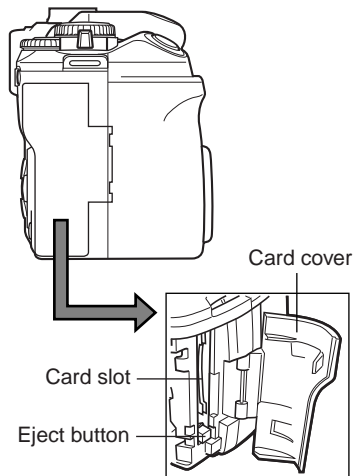
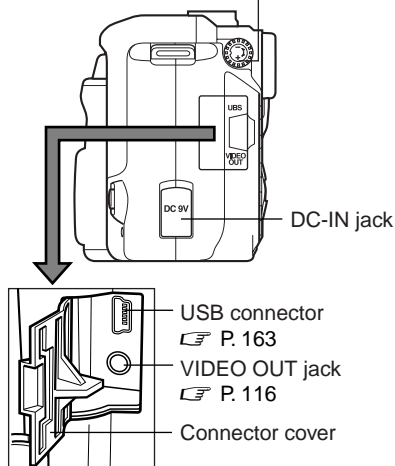

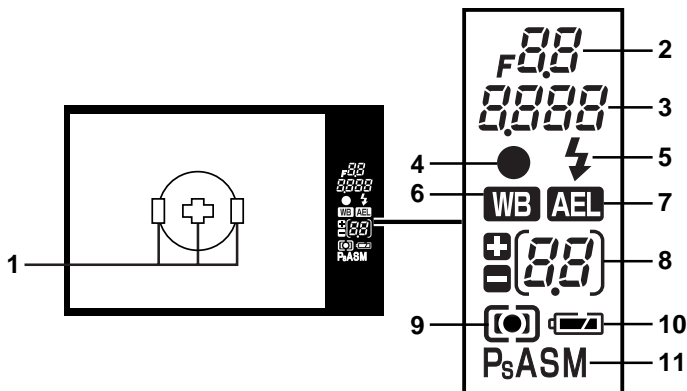

Diopter adjustment dial



Viewfinder indications



	Items	Indication examples	Ref. page
1	AF frame	□ ⊕ □	P. 78
2	Aperture value	F5.6	P. 45 - 50
3	Shutter speed Record mode (appears only when the  (record mode) button has been pressed)	250	P. 46 - 50
4	AF confirmation mark	●	P. 31
5	Flash		P. 59
6	White balance	WB	P. 95
7	AE lock	AEL	P. 90
8	Number of storable still pictures (appears during record mode setting) Exposure compensation value indication (appears during exposure compensation)	12 0.7	- P. 89
9	Metering mode	ESP,  , 	P. 86
10	Battery check	 ,  (blinks)	P. 203
11	Exposure mode	P, Ps, A, S, M	P. 43 - 51

Monitor indications (only for playback)

You can switch the monitor display using the **INFO** (information display) button.
 ☞ “Information display” (P. 112)

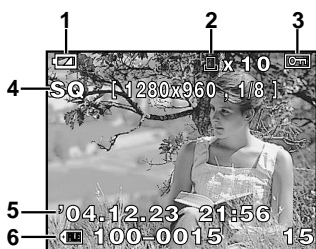

Single-frame playback information

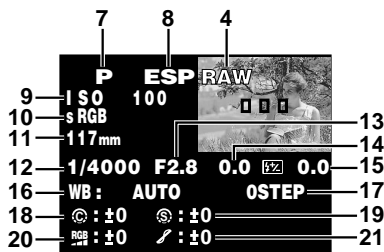

Shooting information

	Items	Indication examples	Ref. page
1	Battery check	,	P. 203
2	Print reservation, Number of prints	X10	P. 140
3	Protect		P. 119
4	Record mode	RAW, TIFF, SHQ, HQ, SQ	P. 35
5	Date and time	04. 12. 23. 21:56	P. 127
6	File number Frame number	100-0030 30	P. 113
7	Exposure mode	P, A, S, M, , , , , ,	P. 38
8	Metering mode	ESP, ,	P. 86
9	ISO	AUTO, ISO 100, ISO 200, ISO 400	P. 91
10	Color space	sRGB, Adobe RGB	P. 106
11	Focal length	117mm	-
12	Shutter speed	1/4000	P. 46 - 50
13	Aperture value	F2.8	P. 45 - 50
14	Exposure compensation	0.7	P. 88
15	Flash intensity control	0.5	P. 60
16	White balance	WB : 3300K	P. 96
17	White balance compensation	3 STEP	P. 98
18	Contrast	: +2	P. 102
19	Sharpness	: +2	P. 101
20	Saturation	: +2	P. 103
21	Gradation	H, L	P. 104

Control panel screen

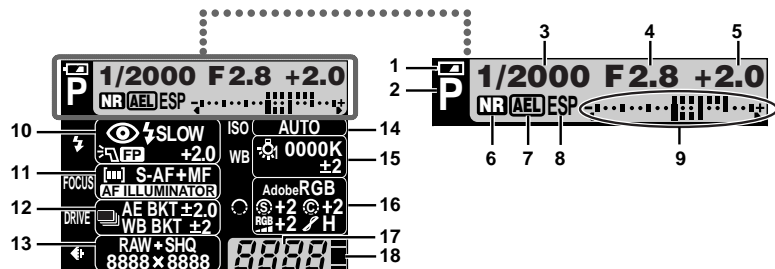

	Items	Indication examples	Ref. pag
1	Battery check		P. 203
2	Exposure mode	P, A, S, M,	P. 38
3	Shutter speed	1/2000	P. 46 - 50
4	Aperture value	F2.8	P. 45 - 50
5	Exposure compensation	+2.0	P. 88
6	Noise reduction	NR	P. 105
7	AE lock	AEL	P. 90
8	Metering mode	ESP,	P. 86
9	Exposure level indicator Exposure compensation indicator		P. 50 P. 89
10	Flash mode Super FP flash Flash intensity control	SLOW, +2.0	P. 57 P. 60
11	AF frame		P. 78
12	Drive mode Auto bracketing	 AE BKT ±2.0	P. 66 P. 68
13	Record mode Resolution	RAW+SHQ 1280×960	P. 35
14	ISO	AUTO, 100, 200, 400	P. 91
15	White balance	1 3000K, 5300K	P. 96
16	Color space Sharpness Contrast Saturation Gradation	sRGB, Adobe RGB +2 +2 +2 H, L	P. 106 P. 101 P. 102 P. 103 P. 104
17	Number of storable still pictures Error code	135 CARD ERROR, NO CARD	-
18	Memory gauge		P. 203

Memory gauge

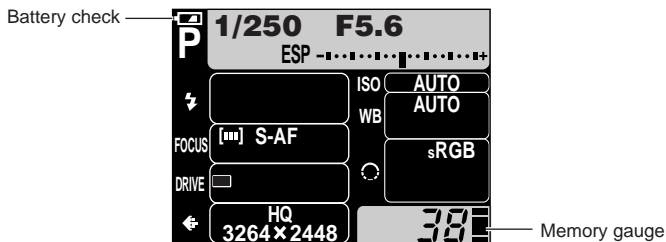

Each time you press the shutter button, the memory gauge lights on the control panel screen, indicating that the picture you have just taken is being recorded onto the card. The memory gauge changes according to how many pictures the camera is processing.

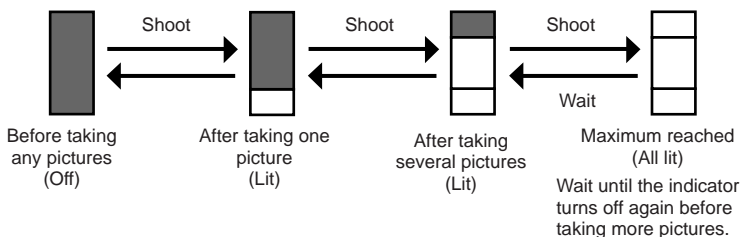

Battery check

When the camera is turned on or when remaining battery power is low, the battery check mark varies.



*1 Your digital camera's power consumption varies greatly depending on usage and operating conditions. Under some operating conditions, the camera may turn off without warning when the battery power is low. If this occurs, re-charge the battery.

*2 Blinks in the viewfinder.

Specifications —Camera

■ Product type

Product type	: Single-lens reflex digital camera with interchangeable lens system
Lens	: Zuiko Digital, Four Thirds System Lens
Lens mount	: Four Thirds Mount
Equivalent focal length on a 35 mm film camera	: Approx. twice the focal length of the lens

■ Image pickup element

Product type	: 4/3 type full frame transfer primary color CCD
Total no. of pixels	: Approx. 8,880,000 pixels
No. of effective pixels	: Approx. 8,000,000 pixels
Screen size	: 17.3 mm (H) x 13.0 mm (V) (0.9" x 0.5")
Aspect ratio	: 1.33 (4 : 3)

■ Viewfinder

Product type	: Eye-level single-lens reflex viewfinder
Field of view	: Approx. 94% (for field of view on recorded images)
Viewfinder magnification	: 1.0x (-1 m^{-1} , 50mm lens, infinity)
Eye point	: 20 mm (0.8") (-1 m^{-1})
Diopter adjustment range	: $-3.0 - +1.0 \text{ m}^{-1}$
Optical path fraction	: Quick return half mirror
Depth of field	: To be checked with the OK button (when PREVIEW registered)
Focusing screen	: Fixed
Eyecup	: Interchangeable

■ Monitor

Product type	: 1.8" TFT color LCD
Total no. of pixels	: Approx. 134,000 pixels

■ Shutter

Product type	: Computerized focal-plane shutter
Shutter	: 1/4000 - 30 sec. (1/3, 1/2, or 1 EV step) Manual mode: Bulb (Limit: 8 min.)

■ Autofocus

Product type	: TTL phase-contrast detection system
Focusing point	: 3-point multiple AF (left, center, right)
AF luminance range	: EV 0 - EV 19
Selection of focusing point	: Auto, Optional
AF illuminator	: The built-in flash provides light.

■ Exposure control

Metering system	: TTL full-aperture metering system (1) Digital ESP metering (2) Center weighted average metering (3) Spot metering (approx. 2% for the viewfinder screen)
Metering range	: (1) EV 2 - 20 (Digital ESP metering, Center weighted average metering) (2) EV 3 - 17 (Spot metering) (At normal temperature, 50 mm F2, ISO 100)
Exposure mode	: (1) P: Program AE (Program shift can be performed) (2) A: Aperture priority AE (3) S: Shutter priority AE (4) M: Manual
ISO sensitivity	: 100 - 400 (High ISO values (800 and 1600) are available)
Exposure compensation	: Exposure can be adjusted in 1/3, 1/2 or 1 EV step within a range of ± 5 EV.

■ White balance

Product type	: CCD
Mode setting	: Auto, Preset WB (8 settings), customized WB (4 settings can be registered), One-touch WB

■ Recording

Memory	: CF card (Compatible with Type I and II) Microdrive compatible (Compatible with FAT 32)
Recording system	: Digital recording, TIFF (non-compression), JPEG (in accordance with Design rule for Camera File system (DCF)), RAW Data
Applicable standards	: Exif 2.2, Digital Print Order Format (DPOF), PRINT Image Matching II, PictBridge

■ Playback

Playback mode	: Single-frame playback, Close-up playback, Index display, Image rotation, slideshow
Information display	: Information display, Histogram display

■ Drive

Drive mode	: Single-frame shooting, Sequential shooting, Self-timer, Remote control
Sequential shooting	: 2.5 frames/sec. (Max. no. of storable sequential pictures: 4 frames in RAW/TIFF)
Self-timer	: Operation time: 12 sec., 2 sec.
Optical remote control	: Operation time: 2 sec., 0 sec. (instantaneous shooting)

■ Flash

Synchronization	: Synchronized with the camera at 1/180 sec. or less
Flash control mode	: TTL-AUTO (TTL pre-flash mode), AUTO, MANUAL
External flash attachment	: Hot shoe

External connector

USB connector (mini-B), DC-IN jack, VIDEO OUT jack

Power supply

Battery : BLM-1 Lithium-ion Battery
 AC power supply : AC-1 AC adapter (optional)

Dimensions/weight

Dimensions : 146.5 mm (W) x 85 mm (H) x 64 mm (D) (5.8" x 3.3" x 2.5")
 (excluding protrusions)
 Weight : Approx. 580 g (1.3 lb.) (without battery)

Operating environment

Temperature : 0 - 40°C (operation)/-20 - 60°C (storage)
 Humidity : 30 - 90 % (operation)/10 - 90 % (storage)

Specifications — Provided accessories**BLM-1 Lithium ion battery**























Type : Lithium ion battery
 Standard voltage : DC 7.2 V
 Standard capacity : 1500 mAh
 Battery life : Approx. 500 full recharges
 *Varies depending on the battery temperature.
 Recommended temperature : 0°C – 40°C/32°F – 104°F (charging)
 -10°C – 60°C/14°F – 140°F (operation)
 -20°C – 35°C/-4°F – 95°F (storage)
 Dimensions : 55 mm (W) x 39 mm (D) x 21.5 mm (H) (2.2" x 1.5" x 0.8")
 Weight : Approx. 75 g/2.6 oz.

BCM-2 charger

Input voltage : AC100 - 240V, 50/60Hz
 Charging time : Approx. 5 hours
 *Varies depending on the battery temperature.
 Operating environment : 0 - 40°C (32 - 104°F)
 Storage environment : -20 - 60°C (14 - 140°F)
 Dimensions : 62 mm (W) x 83 mm (D) x 26 mm (H) (2.4" x 3.3" x 1.0")
 Weight : Approx. 72 g/2.5 oz. (excluding the power cable)

SPECIFICATIONS ARE SUBJECT TO CHANGE WITHOUT ANY NOTICE OR OBLIGATION ON THE PART OF THE MANUFACTURER.

- ⌂ (Custom) menu194
 - (Language setting)133
 - (Playback) menu194
 - ⌂ (Setup) menu195
 - ALL ERASE121
 - / (Shooting) menu192, 193
 - 1st curtain with red-eye reduction
 - SLOW**55
 - 2nd curtain **SLOW2**55
- A**
- Adobe RGB106
 - AE lock **AEL**90
 - AEL METERING124
 - AF frame78
 - AF mode79
 - All-frame reservation142
 - Aperture priority shooting **A**45
 - Auto bracketing **BKT**68
 - Auto flash54
- B**
- BEACH & SNOW42
 - Beep sound131
 - Bulb shooting51
- C**
- C-AF82
 - CANDLE42
 - CARD SETUP135
 - Card adapter157
 - Center weighted averaging
 - metering86
 - CLEANING MODE182
 - Close-up playback109
 - COLOR SPACE106
 - Compact Flash172
 - Compression34
 - CONTRAST102
- CONTROL132
- CUSTOM OK125
- CUSTOM WB100
- D**
- Date/time setting127
 - Digital ESP metering **ESP**86
 - DOCUMENTS41
 - DPOF138
 - Drive mode **DRIVE**66
- E**
- EDIT117
 - ERASE SETTING128
 - EV STEP124
 - Exposure compensation88
 - Exposure mode43
- F**
- FILE NAME129
 - Fill-in flash56
 - FIREWORKS40
 - Flash intensity control60
 - Flash mode54
 - FOCUS RING126
 - Focus lock30
 - FORMAT135
- G**
- GRADATION104
- H**
- HIGH KEY40
 - HQ36
- I**
- Image rotation115
 - Index display111
 - ISO BOOST92
- J**
- JPEG35

- L**
- LANDSCAPE 39
 - LANDSCAPE+PORTRAIT 39
- M**
- MACRO 41
 - MANUAL FLASH124
 - Manual focus **MF**83
 - Manual shooting **M**49
 - Menus25
 - MF83
 - Monitor brightness adjustment 131
 - MONOTONE75
 - MUSEUM 41
- N**
- NIGHT SCENE 39
 - NIGHT+PORTRAIT 39
 - NOISE REDUCTION105
 - NTSC134
 - Number of storable still pictures.....200
- O**
- One-touch white balance 97
- P**
- PAL134
 - PC MODE132
 - PictBridge.....146
 - PIXEL MAPPING183
 - PORTRAIT 40
 - Preset white balance93
 - PREVIEW52
 - Print reservation 138
 - Program shift **Ps**44
 - Program shooting **P**43
 - Protecting **On**119
- R**
- RAW.....35
 - RAW+HQ22
 - RAW+SHQ.....22
 - RAW+SQ22
 - REC VIEW130
 - Red-eye reduction flash 54
 - Remote control 72
 - RESET128
 - RESET LENS.....126
- S**
- S-AF.....80
 - S-AF+MF81
 - SATURATION 103
 - Self-timer shooting 72
 - Sequential shooting 66
 - SHARPNESS 101
 - SHQ35
 - Shutter priority shooting **S**47
 - Shutter speed.....46 – 50
 - Single-frame erase.....120
 - Single-frame reservation 142
 - SLEEP132
 - Slideshow 114
 - SPORT 41
 - Spot metering 86
 - SQ36
 - sRGB106
 - STORAGE132
 - SUNSET 40
 - Super FP flash63
- T**
- TIFF35
- V**
- VIDEO OUT134
- W**
- WB BKT71
 - White balance compensation 98
 - White balance **WB**93

OLYMPUS®

<http://www.olympus.com/>

OLYMPUS IMAGING CORP.

Shinjuku Monolith, 3-1 Nishi-Shinjuku 2-chome, Shinjuku-ku, Tokyo, Japan

OLYMPUS IMAGING AMERICA INC.

Two Corporate Center Drive, PO Box 9058, Melville, NY 11747-9058, U.S.A.
Tel. 1-631-844-5000

Technical Support (USA)

24/7 online automated help: <http://www.olympusamerica.com/E1>

Phone customer support: Tel. 1-800-260-1625 (Toll-free)

Our phone customer support is available from 8 am to 10 pm
(Monday to Friday) ET

E-Mail: e-slrpro@olympusamerica.com

Olympus software updates can be obtained at: <http://www.olympus.com/digital>

OLYMPUS EUROPA GMBH

Premises: Wendenstrasse 14-18, 20097 Hamburg, Germany

Tel. +49 40 - 23 77 3-0 / Fax +49 40 - 23 07 61

Goods delivery: Bredowstrasse 20, 22113 Hamburg, Germany

Letters: Postfach 10 49 08, 20034 Hamburg, Germany

European Technical Customer Support:

Please visit our homepage <http://www.olympus-europa.com>

or call our TOLL FREE NUMBER*: **00800 - 67 10 83 00**

for Austria, Belgium, Denmark, Finland, France, Germany, Italy, Luxemburg,
Netherlands, Norway, Portugal, Spain, Sweden, Switzerland, United Kingdom

* Please note some (mobile) phone services/provider do not permit access or
request an additional prefix to +800 numbers.

For all not listed European Countries and in case that you can't get connected to
the above mentioned number please make use of the following

CHARGED NUMBERS: **+49 180 5 - 67 10 83** or **+49 40 - 237 73 899**

Our Technical Customer Support is available from 9 am to 6 pm MET (Monday to
Friday)