

OLYMPUS®

DIGITAL CAMERA

E-510

INSTRUCTION
MANUAL

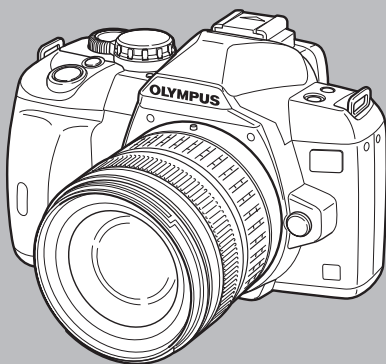

Basic guide

Mastering the E-510

Improving your shooting skills — Shooting guides

Shooting functions

Playback functions

Customizing the settings/functions of your camera

Printing

Using the OLYMPUS Master software

Getting to know your camera better

Information

Interchangeable lenses

Others

-
- We recommend that you take test shots to get accustomed to your camera before taking important photographs.
 - The screen and camera illustrations shown in this manual were produced during the development stages and may differ from the actual product.
 - The contents in this manual are based on firmware version 1.0 for this camera. If there are addition and/or modification of functions due to firmware update for the camera, the contents will differ. For the latest information, please visit the Olympus website.

Basic camera operation ➡ Basic guide

This section explains the preparations and settings for the camera, and basic camera operation from easy techniques for shooting to playback and erase functions.

Attaching the strap	3	Adjusting the viewfinder's diopter	7
Preparing the battery.....	3	Setting the date/time.....	8
Attaching a lens to the camera.....	5	Shooting	10
Loading the card	6	Playback/Erasing.....	12
Power on.....	7		

Mastering the E-510 ➡ P. 18

Read chapter 1 to master the basic camera operation before proceeding to use the various functions available on this camera.

Operating the camera  "Mastering the E-510" (P. 18)



Learn how to use the functions in the shooting guides  "Improving your shooting skills — Shooting guides" (P. 25)





Proceed to the pages on the various functions.

Locating the information you need

 "Shooting tips and information" (P. 97), "Menu directory" (P. 109), "Names of parts" (P. 115), "Index" (P. 136)

Indications used in this manual

	Important information on factors which may lead to a malfunction or operational problems. Also warns of operations that should be absolutely avoided.
 TIPS	Useful information and hints that will help you get the most out of your camera.
	Reference pages describing details or related information.

Attaching the strap

Thread the strap as indicated by the arrows (1, 2).
Lastly, pull the strap tight making sure that it is fastened securely (3).
Attach the other end of the strap to the other eyelet in the same way.

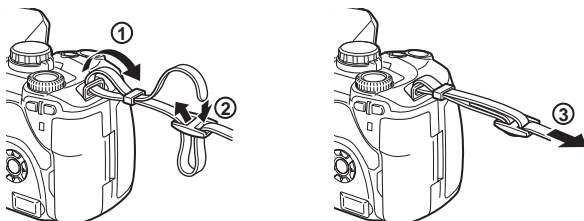

Preparing the battery

1 Charging the battery

Charging indicator
Red light: Charging in progress
Green light: Charging completed
(Charging time: Approx. 5 hours)

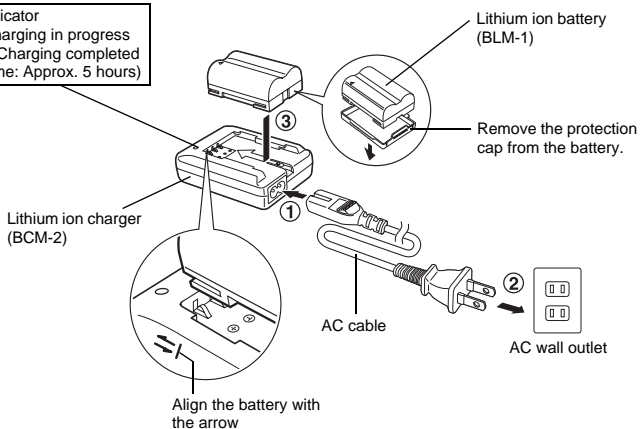

2 Loading the battery

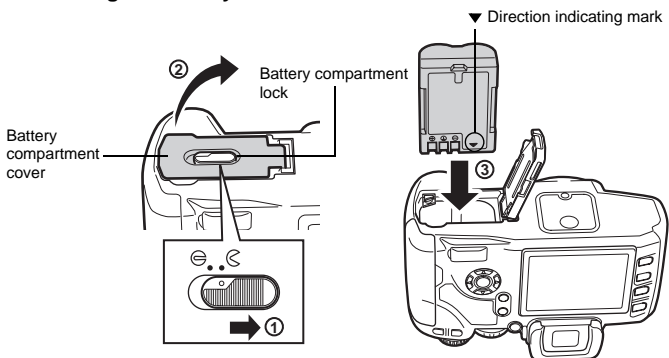

3 Close the battery compartment cover and slide the battery compartment lock in the direction of ⊖

Unloading the battery

Press the battery lock to unlock and remove the battery.

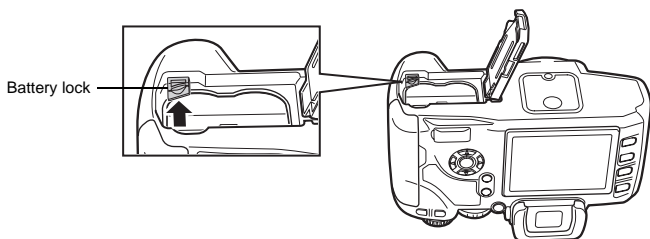

- It is recommended to set aside a backup battery for prolonged shooting in case the battery in use drains.

Attaching a lens to the camera

1 Remove the body cap from the camera and the rear cap from the lens

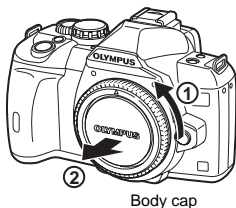
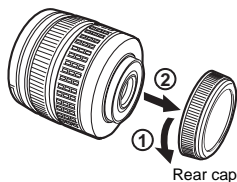

2 Attaching a lens to the camera

- Align the lens attachment mark (red) on the camera with the alignment mark (red) on the lens, then insert the lens into the camera's body (1). Rotate the lens in the direction indicated by the arrow until you hear it click (2).
- Do not press the lens release button.

3 Remove the lens cap (3, 4)

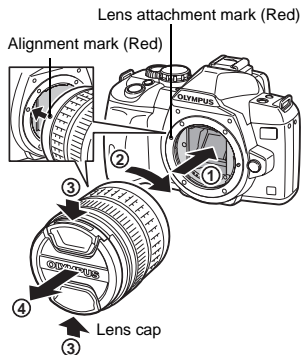

Removing the lens from the camera

While pressing the lens release button (1), rotate the lens in the direction of the arrow (2).

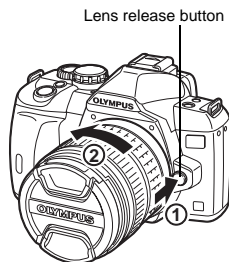

Loading the card

Open the card cover and insert the card.

CompactFlash/Microdrive

Insert the card's contact area into the slot as far as it can go.

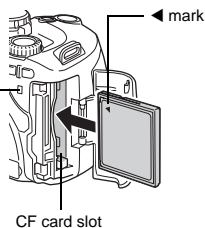

xD-Picture Card

Insert the card until it is locked into place.

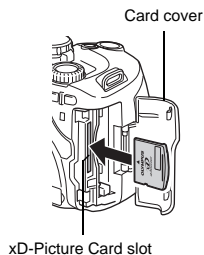

Removing the card

- Never open the card cover while the card access lamp is blinking.

CompactFlash/Microdrive

- Press the eject button all the way in and let it pop out, then press it all the way in again to eject the card.
- Pull out the card.

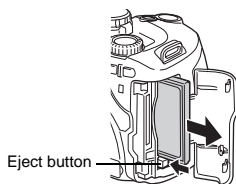

xD-Picture Card

- Press the inserted card lightly and it will be ejected.
- Pull out the card.

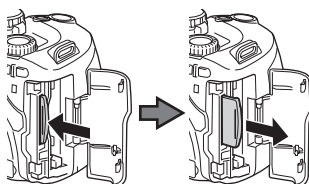

Power on

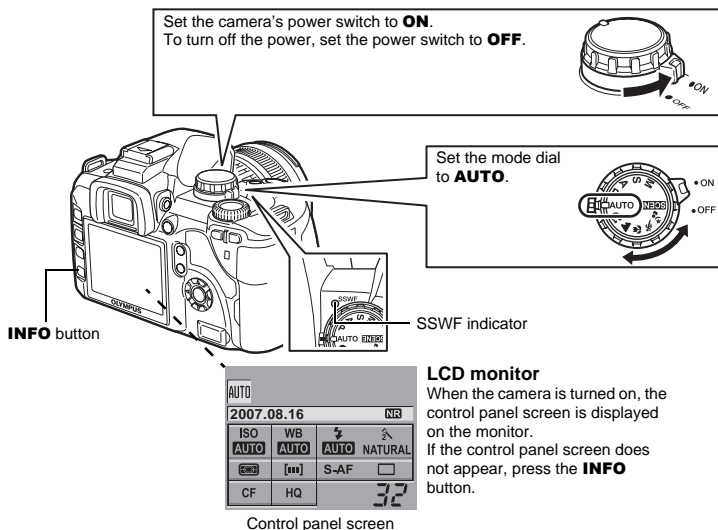

Dust reduction function operation

The dust reduction function is automatically activated when the camera is turned on. Ultrasonic vibrations are used to remove dust and dirt from the image pickup device's filter surface. The SSWF (Super Sonic Wave Filter) indicator blinks while dust reduction is working.

Adjusting the viewfinder's diopter

Adjust the viewfinder's diopter in accordance with your vision. While looking through the viewfinder, rotate the diopter adjustment dial little by little. When you can see the AF frame clearly, adjustment is complete.

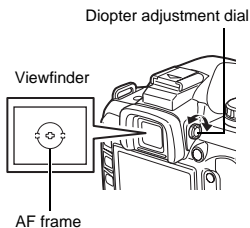

Setting the date/time

Date and time information is recorded on the card together with the images. The file name is also included with the date and time information. Be sure to set the correct date and time before using the camera.

1 Press the **MENU** button

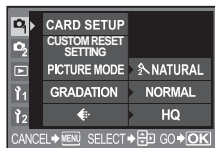
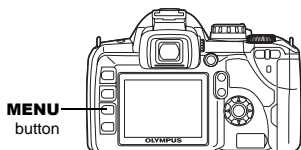

2 Use to select [{}], then press

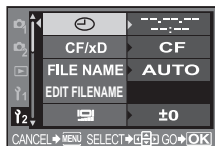
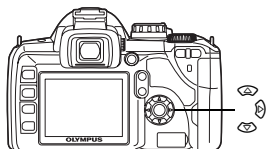

3 Use to select [{}], then press

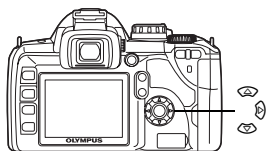

4 Use to select the year [Y], then press

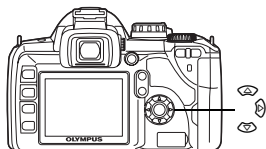

5 Repeat this procedure until the date and time are completely set

- The time is displayed in the 24-hour format.

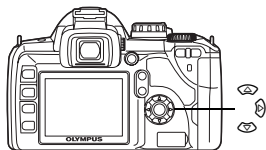

6 Use   to select the date format

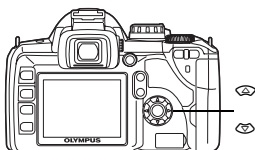

7 Press the  button

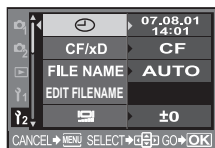
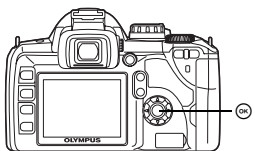

8 Press the **MENU** button to exit

1 Holding the camera

Keep your fingers and the strap away from the lens and the flash.



Horizontal grip



Vertical grip

2 Place the AF frame on the subject while viewing through the viewfinder

3 Adjust the focus

Press the shutter button gently (halfway).



Halfway down

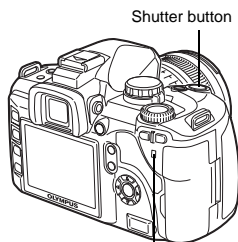
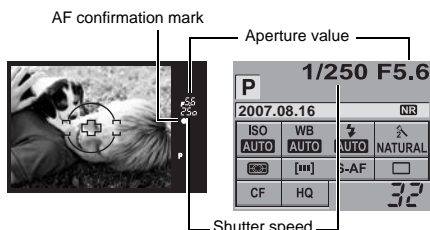

- The focus is locked when a beep tone is output. The AF confirmation mark and the AF focusing frame light up in the viewfinder.
- The shutter speed and aperture value that have been set automatically by the camera are displayed.
- The control panel screen is not displayed when the shutter button is pressed.

4 Release the shutter

Press the shutter button all the way (fully).

- The shutter sounds and the picture is taken.
- The card access lamp blinks and the camera starts recording the picture.
- Never remove the battery or card while the card access lamp mark is blinking. Doing so could destroy stored pictures and prevent storage of pictures you have just taken.



All the way down

Taking a picture while viewing the monitor

It is possible to use the LCD monitor as a viewfinder and check the subject's composition, or shoot while viewing an enlarged display on the LCD monitor.

 "Live view" (P. 23)

1 Press the (live view) button

- The subject is displayed on the LCD monitor.

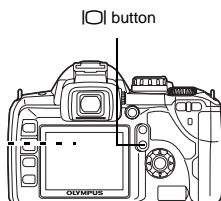

2 Press the shutter button all the way down

- The picture is taken with the focus adjusted.

When the camera stops operating

If no operations are performed for approximately 8 seconds while the camera is on, the monitor backlight turns off to save battery power. If no operations are performed for approximately one minute thereafter, the camera enters the sleep mode (stand-by) and stops operating. The camera activates again when you touch any button (the shutter button, arrow pad, etc.).  "Backlight timer" (P. 83), "Sleep timer" (P. 82)

Playback/Erasing

Playing back images

Pressing the  (playback) button displays the last picture taken.

Basic guide

 button

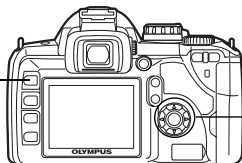

Displays the previous frame

Displays the frame that is stored 10 frames back

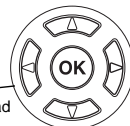

Displays the next frame

Arrow pad

Displays the frame that is stored 10 frames ahead



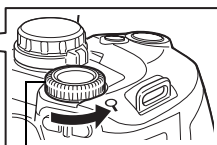
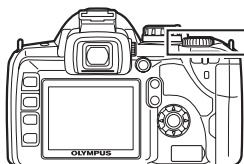

Close-up playback

Each time you rotate the control dial towards , the image is enlarged in steps of 2x - 14x.



Control dial

Erasing images

Playback the image you want to erase and press the  (erase) button. Use   to select [YES] and press the  button to erase.

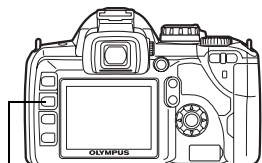

 button



Table of Contents

1	Mastering the E-510	18
	Describes the camera's functions and how to operate them.	
How to use the mode dial		18
Easy shooting modes.....		18
Advanced shooting modes.....		18
How to set the functions		19
How to make function settings		19
Setting functions using the control panel screen.....		19
Setting functions using direct buttons		20
Setting on the menu		21
Descriptions in this manual		22
Live view.....		23
Switching the information display.....		23
Enlarged display operation.....		24
Ruled lines display		24
2	Improving your shooting skills — Shooting guides.....	25
	Describes the shooting methods suitable for individual situation.	
Basic function guides.....		25
Focus: Operating the shutter button.....		25
Brightness: Exposure compensation.....		25
Color: White balance.....		26
A guide to functions for different subjects.....		26
Taking landscape pictures		26
Taking flower pictures		27
Taking night scene pictures		29
3	Shooting functions	30
	Categorizes and describes the shooting functions according to the shooting modes; shooting functions; focusing; exposure, color and image.	
Selecting the appropriate mode for shooting conditions		
Scene mode		30
P : Program shooting		31
A : Aperture priority shooting		32
S : Shutter priority shooting.....		33
M : Manual shooting.....		34
Preview function		35
Various shooting functions		
Shooting with the image stabilizer function		36
Checking the image stabilizer effect on the monitor		36
If correct focus cannot be obtained (Focus lock).....		37
AE bracketing		37
Flash shooting		39
Flash mode		39
Manual flash.....		40
Setting the flash mode		41
Using the built-in flash.....		42
Flash intensity control		42

Flash bracketing.....	43
External electronic flashes (optional)	43
Using the external electronic flash	43
Super FP flash	44
Using commercially available flashes	44
Non-specified commercial flashes	45
Sequential shooting/Self-timer/Remote control	45
Setting the functions	45
Sequential shooting	45
Using the self-timer	46
Using the remote control.....	46
Panorama shooting	48

Focusing functions

AF frame selection	49
Focus mode.....	49
Simultaneous use of S-AF mode and MF mode (S-AF+MF)	51
Simultaneous use of C-AF mode and MF mode (C-AF+MF).....	51
AF illuminator	51
Shutter release priority	51

Exposure, image and color

Selecting the record mode	52
Types of record modes	52
RAW data.....	52
How to select the record mode	53
Setting the number of pixels and compression rate.....	53
Metering mode — Changing the metering system.....	54
Exposure compensation — Varying the image brightness	55
AE lock — Locking the exposure	56
ISO — Setting the desired sensitivity to light	56
White balance — Adjusting the color tone	57
Setting the auto/preset/custom white balance	58
WB compensation.....	59
Setting the one-touch white balance.....	60
WB bracketing.....	60
Picture mode	61
Gradation.....	62
Shading compensation	62
Noise reduction	62
Noise filter	63
Color space	63
Anti-shock.....	63

4 Playback functions..... 64

Describes the functions used when playing back images that have been taken.

Single-frame/Close-up playback	64
Light box display.....	65
Index display/Calendar display.....	66
Information display	67
Slideshow	68
Rotating images	68
Playback on TV	69
Editing still images.....	69

Copying images.....	71
Single-frame copy.....	71
Copying selected frames.....	71
Copying all the frames.....	71
Protecting images — Preventing accidental erasure.....	72
Single-frame protect.....	72
Protecting selected frames.....	72
Canceling all protections.....	72
Erasing images.....	73
Single-frame erase.....	73
Erasing selected frames.....	74
All-frame erase.....	74

5 Customizing the settings/functions of your camera 75

Describes the other different types of functions. The settings or functions can be changed to suit the environment in which the camera is used.

Custom reset setting.....	75
AEL/AFL mode.....	77
Other function settings.....	78
AEL/AFL memo.....	78
AEL metering.....	78
EV step.....	78
ISO limit.....	78
Compensating all WB.....	78
Speed synchronization.....	78
Auto pop up.....	79
Fn FUNCTION.....	79
Live view boost.....	79
Customizing the control dial's function.....	79
My Mode setting.....	80
Reset lens.....	80
Focus ring.....	80
Priority setting.....	80
Quick erase.....	81
Erasing RAW and JPEG files.....	81
File name.....	81
Rename file.....	82
Rec view — Checking the picture immediately after shooting.....	82
Setting the beep sound.....	82
Monitor brightness adjustment.....	82
Sleep timer.....	82
Backlight timer.....	83
USB mode.....	83
Changing the display language.....	83
Video output.....	83
Button timer.....	84
Auto power off.....	84
⏪ (arrow pad) lock.....	84
AF-ON ⇌ Fn.....	84
Firmware.....	84

6 Printing 85

Describes how to print images that have been taken.

Print reservation (DPOF)	85
Print reservation	85
Single-frame reservation	85
All-frame reservation	86
Resetting the print reservation data	86
Direct printing (PictBridge)	87
Connecting the camera to a printer	88
Easy printing	88
Custom printing	89

7 Using the OLYMPUS Master software 91

Describes how to transfer and store the camera's images to your computer.

Flowchart	91
Using the provided OLYMPUS Master software	91
What is OLYMPUS Master?	91
Connecting the camera to a computer	92
Start up the OLYMPUS Master software	93
Displaying camera images on a computer	93
Downloading and saving images	93
Disconnecting the camera from your computer	94
Viewing still images	95
To increase the number of languages	95
Transferring images to your computer without using OLYMPUS Master	96

8 Getting to know your camera better 97

Reference for help or when you wish to know more about the camera.

Shooting tips and information	97
Tips before you start taking pictures	97
Shooting tips	97
Additional shooting tips and information	100
Playback tips	102
Viewing pictures on a computer	102
When error messages are displayed	103
Camera maintenance	105
Cleaning and storing the camera	105
Cleaning mode — Removing dust	106
Pixel mapping — Checking the image processing functions	106

9 Information 107

Describes how to handle the cards and rechargeable battery, and contains a directory of the camera's functions and displays.

Card basics	107
Usable cards	107
Formatting the card	107
Battery and charger	108
Using your charger abroad	108
Menu directory	109
Functions that can be set by shooting mode	112

List of record modes	114
Names of parts	115
Camera	115
Viewfinder indications	117
Control panel screen	118
LCD monitor indications (during live view)	120
LCD monitor indications (during playback)	121
Glossary	122
Specifications	125

10 Interchangeable lenses 128

Describes how to handle interchangeable lenses.

Lens	128
ZUIKO DIGITAL interchangeable lens	128

11 Others 130

Describes precautions regarding the use of the camera and accessories.

SAFETY PRECAUTIONS.....	130
Index.....	136

How to use the mode dial

The mode dial allows you to change the camera settings easily according to the subject.

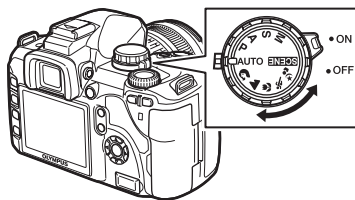

1

Mastering the E-510

Easy shooting modes

- Select according to the shooting scene. The camera sets the appropriate shooting conditions automatically.
- When rotating the mode dial or turning off the power in the easy shooting modes, functions with changes made to their settings are restored to the factory default settings.

AUTO	AUTO	Allows you to shoot using an optimum aperture and shutter speed that the camera sets. The built-in flash pops up automatically in low-light conditions.
	PORTRAIT	Suitable for shooting a portrait-style image of a person.
	LANDSCAPE	Suitable for shooting landscapes and other outdoor scenes.
	MACRO	Suitable for taking close-up pictures (macro shooting).
	SPORT	Suitable for capturing fast-moving action without blurring.
	NIGHT+PORTRAIT	Suitable for shooting both the main subject and background at night.
SCENE	Scene mode	18 different scene modes are available to suit a wide range of shooting situations. (P. 30)

Advanced shooting modes

- For more advanced shooting and greater creative control, you can set the aperture value and shutter speed.
- The settings made in the advanced shooting modes are retained even if the camera is turned off.

P	Program shooting	Allows you to shoot using an aperture and shutter speed that the camera sets. (P. 31)
A	Aperture priority shooting	Allows you to set the aperture manually. The camera sets the shutter speed automatically. (P. 32)
S	Shutter priority shooting	Allows you to set the shutter speed manually. The camera sets the aperture automatically. (P. 33)
M	Manual shooting	Allows you to set the aperture and shutter speed manually. (P. 34)

How to set the functions

How to make function settings

There are three basic ways to make function settings with this camera.

- Setting while looking at the control panel screen (See below)
- Setting using direct buttons (P. 20)
- Setting on the menu (P. 21)

Setting functions using the control panel screen

Select an item on the control panel screen and change the setting.

1 When the power switch is set to ON, the control panel screen (shooting information and setting screen) is displayed on the LCD monitor.

- The display changes each time the **INFO** button is pressed.
- You can also display the control panel screen by pressing the **OK** button and change the setting when using live view.

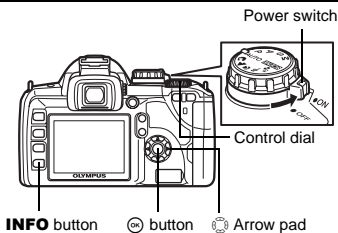

Control panel screen

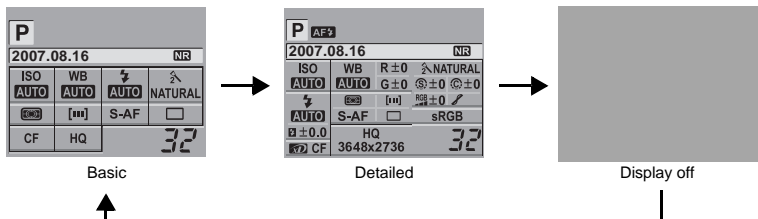

2 Press the **OK** button.

- The cursor (function being selected) on the control panel screen lights (1).

e.g.) When setting Sequential/Self-timer/Remote control shooting

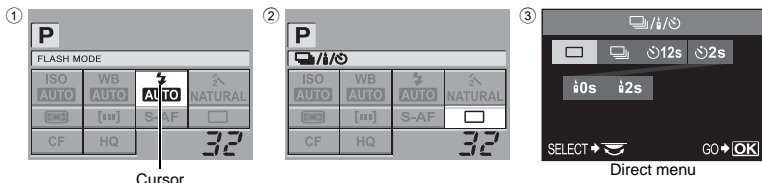

3 Use **OK** to move the cursor to the function you want to set (2).

4 Turn the control dial to change the setting.

- Pressing the **OK** button while the item is being selected displays the direct menu for that function. You can also use the direct menu to change the setting (3). After changing the setting, press the **OK** button to confirm your setting. Or if you do not operate the control dial within a few seconds, your setting will be confirmed and the control panel screen will be restored. P. 84

Functions on the control panel screen

The functions that can be set on the basic display and detailed display vary.

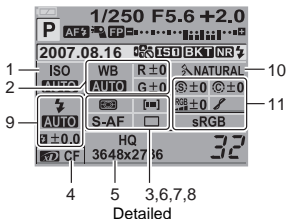
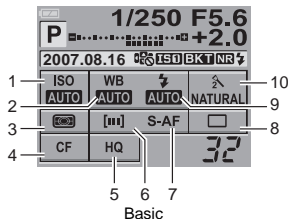

No.	Items	Basic	Detailed	Ref. page
1	ISO	✓	✓	P. 56
2	WB	✓	✓	P. 58
	White balance compensation	—	✓	P. 59
3	Metering mode	✓	✓	P. 54
4	Card	✓	✓	P. 107
5	Record mode	✓	✓	P. 52
6	AF frame	✓	✓	P. 49
7	Focus mode	✓	✓	P. 49
8	Sequential shooting/Self-timer/ Remote control	✓	✓	P. 45
9	Flash mode	✓	✓	P. 41
	Flash intensity control	—	✓	P. 42
10	Picture mode	✓	✓	P. 61
11	Color space	—	✓	P. 63
	Sharpness	—	✓	P. 61
	Contrast	—	✓	P. 61
	Saturation	—	✓	P. 61
	Gradation	—	✓	P. 62

✓: Can be set —: Cannot be set

Setting functions using direct buttons

This camera is equipped with direct buttons where functions have been assigned and can be set quickly.

1 Press the button for the function you want to set.

- The direct menu is displayed.

e.g.) Setting Sequential/Self-timer/
Remote control shooting

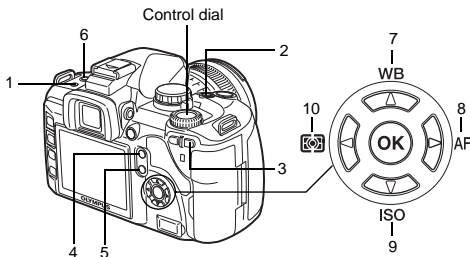
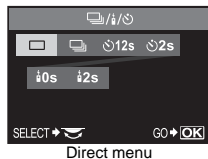

2 Turn the control dial to change the setting.

- Press the button to confirm your setting. Or if you do not operate the control dial within a few seconds, your setting will be confirmed and the previous screen will be restored.
 "Button timer" (P. 84)

List of direct buttons

The functions assigned to buttons are as shown below.

No.	Direct buttons	Function	Ref. page
1		Sequential shooting/Self-timer/Remote control button	Sequential shooting/Self-timer/Remote control P. 45
2		Exposure compensation button	Exposure compensation P. 55
3		AF frame button	AF frame selection P. 49
4	IS	Image stabilizer button	Sets image stabilizer P. 36
5		Live view button	Turns live view on or off P. 23
6		Flash button	Pops up the flash and sets flash mode P. 41
7	WB	White balance button	Sets white balance P. 57
8	AF	Focus mode button	Sets focus mode P. 49
9	ISO	ISO button	Sets ISO sensitivity P. 56
10		Metering button	Sets metering mode P. 54

Setting on the menu

1 Press the MENU button.

- The menu is displayed on the LCD monitor.

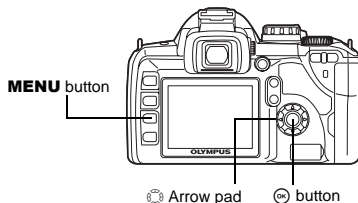
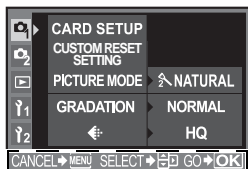

Operation guide is displayed at the bottom of the screen.

CANCEL → **MENU** : Press **MENU** to cancel the setting.

SELECT → : Press to select the item.

The illustration displayed corresponds to the arrow pad shown below.



GO → **OK** : Press to confirm your settings.

2 Use to set a function.

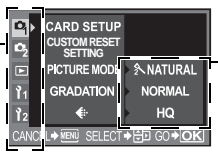

Tab The current setting is displayed

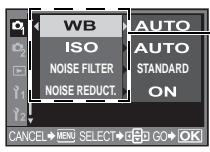

Function

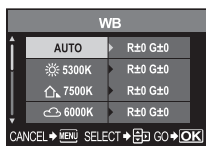



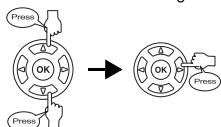

1

Mastering the E-510



Moves to the functions under the tab you have selected.

Types of tabs

-  Sets shooting functions.
-  Sets shooting functions.
-  Sets playback functions.
-  Customizes shooting functions.
-  Sets functions that allow you to use the camera efficiently.

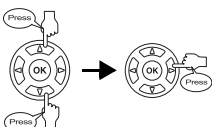

Select a function and go to the setting screen.



3 Press repeatedly until the menu disappears.

- The normal shooting screen is restored.
- For the menu lists, see "Menu directory" ( P. 109).

Descriptions in this manual

The operating instructions of the direct buttons, control panel screen and menu are described as follows in this manual.

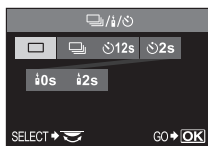

Direct buttons setting screen

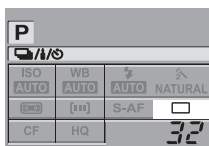

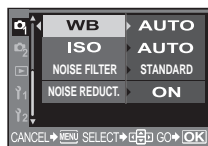

Control panel setting screen







Menu setting screen

Direct button

e.g.: When setting Sequential shooting/Self-timer/Remote control
   ▶ Control dial

Control panel screen

e.g.: When setting Sequential shooting/Self-timer/Remote control
 ▶   ▶ 

Menu

e.g.: When setting white balance
MENU ▶  ▶ **[WB]**

It is possible to use the LCD monitor as a viewfinder. You can view the exposure or white balance effect and the subject's composition while you take the picture.

1 Press the button.

- The subject is displayed on the LCD monitor.

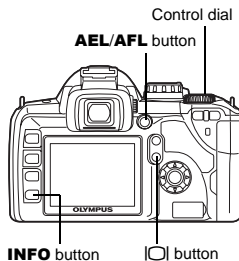

2 Press the shutter button all the way down to focus and shoot.

- To focus in advance, hold down the **AEL/AFL** button and press the shutter button. The focus is locked when the **AEL/AFL** button is pressed.
- The image display on the monitor freezes as the mirror goes down during focusing. The picture you just took is briefly displayed on the monitor so you can check the picture.

TIPS

To check the image stabilizer effect:

→ Press and hold the **IS** button.  "Checking the image stabilizer effect on the monitor" (P. 36)

To focus using MF:

→ Set **[AF MODE]** to **[MF]**.  "Focus mode" (P. 49)

- Turn the focus ring and focus on the subject. For MF shooting method, refer to "MF (manual focus)" (P. 50).
- You can also press the **AEL/AFL** button to activate auto focus.

Switching the information display

You can press the **INFO** button to switch the information displayed on the monitor.

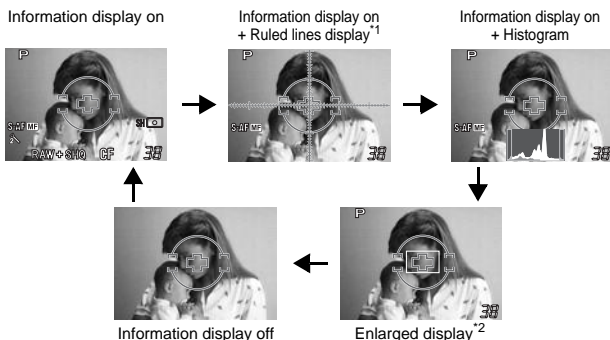

*1 Displayed when **[FRAME ASSIST]** is set.

*2 For operation in the enlarged display, refer to "Enlarged display operation" on the next page.

Enlarged display operation

It is possible to enlarge the subject 7 or 10 times for display. Enlarging the image during MF makes focus confirmation and adjustment easier.

1 Use to move the frame and press the button.

- Area inside the frame is enlarged and displayed.
- Press and hold the  button to return the shifted enlargement frame to the center.

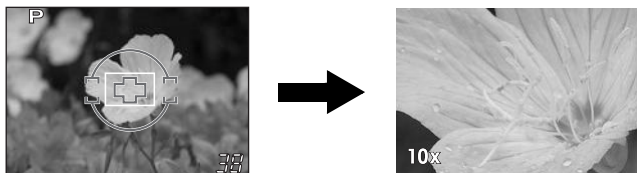

2 Turn the control dial to change the magnification (7x/10x).

- Pressing  cancels enlarged display operation.

Notes

- If there is a high-intensity light source within the screen, the image may be displayed darker but will be recorded normally.
- If the live view function is used over a long period, the temperature of the image pickup device rises causing images with high ISO sensitivity to appear noisy and unevenly colored. Either lower the ISO sensitivity or turn off the camera for some time.
- Replacing the lens will cause live view to stop.
- The following functions are not available during live view.
C-AF/AE lock/[AEL/AFL]

Ruled lines display

You can display the ruled lines on the LCD monitor as a guide when confirming the composition.

MENU ▸ [i] ▸ [FRAME ASSIST]
[OFF]/[GOLDEN SECTION]/[GRID]/[SCALE]

TIPS

Checking the subject on the monitor even in low light situations:

→ Refer to "Live view boost" ( P. 79)

Basic function guides

To familiarize yourself with the camera, you can start off by taking pictures of surrounding subjects, such as children, flowers and pets. If the pictures taken are not to your liking, try adjusting some of the settings below. You can take more satisfying pictures simply by familiarizing yourself with these basic camera functions.

Focus: Operating the shutter button

A picture can become out of focus when the focus in the picture is on the foreground, background, or other objects in the picture instead of on the subject. To prevent out-of-focus pictures, be sure to focus on the subject you are trying to capture. The shutter button can be pressed halfway down (half-press) and all the way down (full press). Once you are able to operate the shutter button effectively, you can focus accurately even on moving subjects.

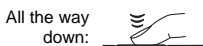

 "Shooting" (P. 10), "If correct focus cannot be obtained (Focus lock)" (P. 37)

Even when the subject is in focus, the picture can become blurred if you move the camera while the shutter button is being pressed. Make sure how to properly hold the camera. The camera is particularly subject to shaking when using live view to take pictures while viewing the subject on the monitor. You can reduce camera shake by using the image stabilizer.

 "Holding the camera" (P. 10), "Shooting with the image stabilizer function" (P. 36)

In addition to incorrect focusing and camera shake problems, movement of the subject can also cause blurring of the picture. In this case, use a shutter speed that matches the motion of the subject. You can confirm the actual shutter speed and aperture on the displays of the viewfinder and monitor by pressing the shutter button halfway.

 "How to use the mode dial" (P. 18), "Preview function" (P. 35), "Live view" (P. 23)

Brightness: Exposure compensation

The camera automatically determines the aperture value and shutter speed according to the brightness level. This is called auto exposure. However, you may not be able to capture the intended picture with auto exposure alone. In this case, you can increase or decrease the auto exposure setting. Increase the exposure to enhance the brightness of a summer beach or the whiteness of snow. Decrease the exposure when the area to be shot is brighter but smaller compared to its surrounding area. If you are unsure of how much exposure compensation is required, try taking several pictures at various settings and then compare the pictures.

 "Exposure compensation — Varying the image brightness" (P. 55), "AE bracketing" (P. 37)

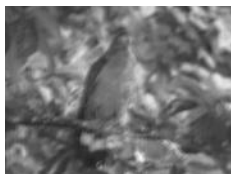

Color: White balance

Besides sunlight, there are other sources for illuminating the subject, such as tungsten and fluorescent lighting. These types of lighting contain particular colors; therefore, the same white object shot under different lighting has slightly different colors. Even under the same sunlight, the colors in the picture differ depending on the sky conditions, the shadows of trees or buildings, and other factors. White balance automatically corrects the effects from these types of lighting and enables shooting with the right colors. You can usually obtain the right colors with the white balance set to **[AUTO]**. Depending on the shooting conditions, however, you may not be able to obtain the intended colors. In this case, change the setting accordingly.

📖 "White balance — Adjusting the color tone" (P. 57)

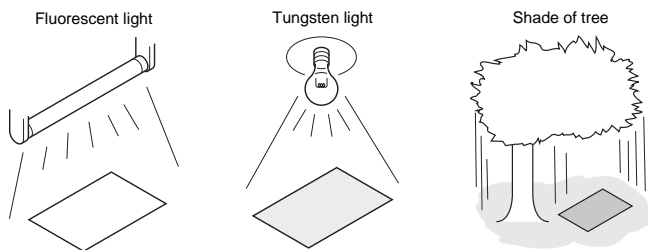

A guide to functions for different subjects

This section describes the functions suitable under different shooting conditions depending on the subject.

Taking landscape pictures

This section describes how to take outdoor scenery pictures of forests, lakes and beaches in daylight.

Changing shooting mode

The proper shooting method varies depending on whether you are trying to capture the silence of a still scene or the dynamism of a motion scene.

- To capture the depth of a forest, focus with a wider range of the image. Use **A** (aperture priority shooting) mode and close the aperture (increase the aperture value) as much as possible.
- To capture the waves crashing against the seashore, use **S** (shutter priority shooting) mode and select a fast shutter speed.
- To capture a flowing waterfall or river, shoot using a slow shutter speed.



Exposure compensation can be used even under different shooting modes. Check the image that you have shot and use + or - to adjust the exposure to obtain better results.

Using white balance

The color of water in pictures appears different depending on whether it is a lake reflecting nearby trees or a seashore surrounded by a coral reef. To capture the subtle difference in color, try changing the white balance setting. Change the setting for different situations, such as by using [☀️, 5300K] for sunny days and [☁️, 7500K] for outdoor shaded areas on sunny days.



Changing metering mode

Depending on the depth of the water and the direction of the sun, the brightness of the water can differ significantly in different areas of the same composition. There is also a difference in the brightness of forests depending on the way the trees overlap each other. If you know which areas you want to emphasize the compensation in the image composition, you can change the metering mode. When set to [☰] (Digital ESP metering), the camera automatically assesses the brightness in the composition and determines the exposure. To emphasize a specific partial exposure in the composition, change the metering mode to [⊙] (center weighted metering) or [●] (spot metering), adjust the AF frame to the locations that you want to adjust the exposure and then measure the exposure.



Changing saturation

There may be times when you cannot reproduce the desired color even when using white balance or exposure compensation. In this case, you can change the [SATURATION] setting to achieve the desired color. The [SATURATION] setting includes two levels of high and low settings. When the setting is high, a vivid color is used.

☞ “A: Aperture priority shooting” (P. 32), “S: Shutter priority shooting” (P. 33), “Metering mode — Changing the metering system” (P. 54), “Exposure compensation — Varying the image brightness” (P. 55), “White balance — Adjusting the color tone” (P. 57), “[SATURATION]: Vividness of the color” (P. 61)

Taking flower pictures

The proper method for taking pictures of flowers differs depending on whether you want to capture, for example, a single flower, a field of blooming flowers, a deep red rose, or the light color of a sweet pea.

Using white balance

There are many colors of flowers ranging from light to vivid ones. Depending on the colors of the flowers, subtle color shades may not be captured as seen. In this case, you can check the light conditions and change the white balance setting. At [AUTO], the camera automatically determines the type of light and shoots using the proper white balance. However, you can bring out subtle color shades more effectively by changing the setting according to shooting conditions, such as by using [☀️, 5300K] for sunny days and [☁️, 7500K] for outdoor shaded areas on sunny days.



Using exposure compensation

When shooting flowers against a background, select as simple a background as possible to bring out the shape and color of the flower. When shooting bright and whitish flowers, adjust the exposure compensation to – (minus) so that the flower stands out from the darker background.



2

Changing shooting mode

The proper shooting method when taking pictures of flowers differs depending on whether you want to emphasize a single flower or capture a field of flowers. To change the focus area, set the camera to **A** (aperture priority shooting) mode and select the aperture value.

- When you open the aperture (decrease the aperture value), the camera focuses within a shorter range (with a shallow depth of field), emphasizing the subject against a blurred background.
- When you close the aperture (increase the aperture value), the camera focuses over a wider range (with more depth of field), producing a picture with both the foreground and background in focus.

You can use the preview function to confirm the changes in the depth of field when the aperture is changed.



Using live view

When using a conventional digital single-lens reflex camera with interchangeable lens system, it was necessary to wait until after taking the picture to check the results of the exposure compensation and white balance settings. With the live view function of this camera, however, you can use the monitor to display and check the subject you want to capture.

Changing lenses

When the blooming flowers are few and sparse, take the picture using a telephoto lens. With a telephoto lens, you take pictures in which subjects at different distances appear closer together, giving the impression of a more densely blooming flower field. Using the telescopic feature of the zoom lens also achieves the same effect, but it is easier to achieve this effect when the focal distance of the lens is longer, such as 150 mm or 200 mm, rather than 54 mm.

 **A:** Aperture priority shooting" (P. 32), "Live view" (P. 23), "Preview function" (P. 35), "Exposure compensation — Varying the image brightness" (P. 55), "White balance — Adjusting the color tone" (P. 57)

Taking night scene pictures

There are different types of night scenes, from the afterglow of a sunset and city lights at night to special light displays and firework displays.

Using a tripod

Because a slow shutter speed is needed to capture night scenes, a tripod is required to prevent camera shake. If a tripod is not available, you should place the camera on a stable surface to prevent camera shake. Even if the camera is secured, camera shake may occur when pressing the shutter button. Therefore, it is recommended to use the remote control or self timer.

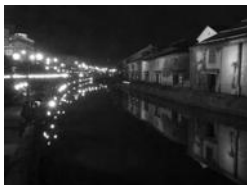

Changing shooting mode

Night scenes have different levels of brightness, and the balance of the brightness in the composition is not uniform. Start by using **A** (aperture priority shooting) mode to take the picture. Set the aperture to the medium setting (about F8 or F11) and allow the camera to automatically select the shutter speed. When shooting a night scene, because the camera sets the exposure to match the dark areas which occupy a majority of the composition and the image often turns out whitish (overexposed), adjust the exposure compensation to -1 or -1.5. Use **[REC VIEW]** to check the image and adjust the aperture and exposure compensation as necessary.

Image noise can easily occur when shooting at slow shutter speeds. In this case, set **[NOISE REDUCT.]** to **[ON]** to reduce noise.

Using manual focus

In cases where you cannot use AF (auto focus) to focus on the subject because the subject is too dark or you cannot focus in time to take pictures, such as during a fireworks display, set the focus mode to **[MF]** (manual focus) and focus manually. To take pictures of night scenes, turn the focus ring of the lens and check whether you can see the lights of the night scene clearly. To take pictures of a fireworks display, adjust the focus of the lens to infinite unless you are using a long focus lens. If you know the approximate distance to the subject, it is recommended that you focus on something that is at the same distance in advance.



☞ **"P":** Program shooting" (P. 31), **"A":** Aperture priority shooting" (P. 32), "Sequential shooting/Self-timer/Remote control" (P. 45), "Focus mode" (P. 49), "Noise reduction" (P. 62), "Rec view — Checking the picture immediately after shooting" (P. 82)

3 Shooting functions

Scene mode

When you select a mode to suit the shooting situation, the camera optimizes the settings for the shooting conditions. Unlike the mode dial's scene mode, most functions cannot be changed.

1 Set the mode dial to **SCENE**.

- The scene menu is displayed.

2 Use to select the scene mode.

- The sample image followed by a description of the selected mode is displayed.

3 Press the button.



















- The camera enters the shooting stand-by mode.
- To change the setting, press the  button again. The scene menu is displayed.



3

Shooting functions — Selecting the appropriate mode for shooting conditions

Types of scene modes

Icon	Mode	Icon	Mode
	1 PORTRAIT		10 DIS MODE
	2 LANDSCAPE		11 MACRO
	3 LANDSCAPE+PORTRAIT		12 NATURE MACRO
	4 NIGHT SCENE		13 CANDLE
	5 NIGHT+PORTRAIT		14 SUNSET
	6 CHILDREN		15 FIREWORKS
	7 SPORT		16 DOCUMENTS
	8 HIGH KEY		17 PANORAMA
	9 LOW KEY		18 BEACH & SNOW

P: Program shooting

The camera sets the optimum aperture value and shutter speed automatically according to the subject brightness.

Set the mode dial to P.

- When the shutter button is half-pressed, the shutter speed and aperture value are displayed on the viewfinder. Releasing the shutter button displays the shutter speed and aperture value on the control panel screen.

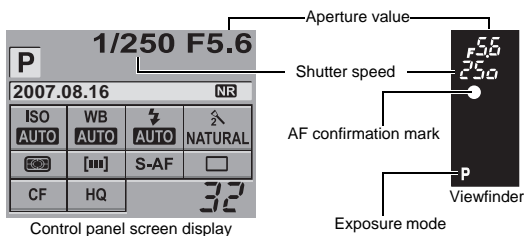

Aperture values and shutter speeds in the P mode

In the **P** mode, the camera is programmed such that the aperture value and shutter speed are automatically selected according to the subject's brightness as shown below. The program line diagram varies with the type of lens mounted.

— When using the 14 - 42 mm f3.5 - 5.6 zoom lens (focal length: 14 mm)

— Program shift

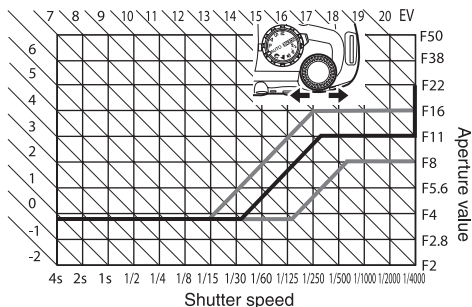

Program shift (Ps)

By turning the control dial in the **P** mode, you can change the combination of aperture and shutter speed as illustrated above while maintaining the optimum exposure.

The program shift setting will not be canceled after shooting. To cancel program shift setting, turn the control dial so that the viewfinder's or control panel screen's exposure mode indication **Ps** changes to **P** or turn off the power. Program shift is not available when you are using a flash.

A: Aperture priority shooting

The camera sets the optimum shutter speed automatically for the aperture value you have selected. When you open the aperture (decrease the aperture value), the camera will focus within a shorter range (shallow depth of field) and produce a picture with a blurred background. When you close the aperture (increase the aperture value), the camera will focus within a longer range. Use this mode when you wish to add changes to the background representation. Before shooting, you can use the preview function to check how the background will look in your picture.  "Preview function" (P. 35)

When the aperture value (f-number) is decreased



When the aperture value (f-number) is increased

3

Shooting functions — Selecting the appropriate mode for shooting conditions

Set the mode dial to A and turn the control dial to set the aperture value.

- The aperture value changes in 1/3 EV increments as the control dial is turned. You can also change the step with the customized settings.  "EV step" (P. 78)

Open the aperture (f-number is decreased)



Close the aperture (f-number is increased)

Display in the viewfinder when the shutter button is pressed halfway

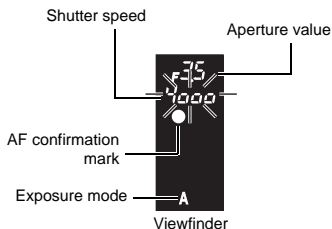

- Overexposed when the shutter speed indication is blinking. Increase the aperture value (f-number).
- Underexposed when the shutter speed indication is blinking. Decrease the aperture value (f-number).

TIPS

The shutter speed indication continues to blink after the aperture value is changed:

→ If the shutter speed indication is blinking when set to a high speed, set the ISO sensitivity to a lower value or use a commercially available ND filter (for adjusting the amount of light).

 "ISO — Setting the desired sensitivity to light" (P. 56)

→ If the shutter speed indication is blinking when set to a lower speed, set the ISO sensitivity to a higher value.  "ISO — Setting the desired sensitivity to light" (P. 56)

To check the depth of field with the selected aperture value:

→ Refer to "Preview function" (P. 35).

S: Shutter priority shooting

The camera sets the optimum aperture value automatically for the shutter speed you have selected. Set the shutter speed depending on the type of effect you want. A higher speed shutter allows you to capture a fast-moving subject without blur, and a slower shutter speed blurs a moving subject, creating a feeling of speed or motion.

A fast shutter speed can freeze a fast action scene without any blur.



A slow shutter speed will blur a fast action scene. This blurring will give the impression of dynamic motion.

Set the mode dial to S and turn the control dial to set the shutter speed.

- The shutter speed changes in 1/3 EV increments as the control dial is turned. You can also change the step with the customized settings. "EV step" (P. 78)

Slower shutter speed



Faster shutter speed

Display in the viewfinder when the shutter button is pressed halfway

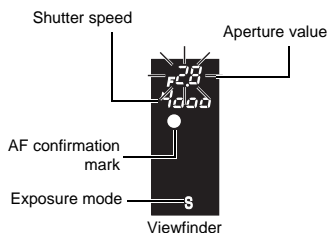

- If the aperture value indication at the minimum value is blinking*, the correct exposure has not been attained (underexposed). Lower the shutter speed.
- If the aperture value indication at the maximum value is blinking*, the correct exposure has not been attained (overexposed). Raise the shutter speed.

* The aperture value at the moment when its indication blinks varies with the lens type and focal length of the lens.

TIPS

The picture looks blurred:

→ The possibility of camera shake spoiling your picture increases greatly during macro or ultra-telephoto shooting. Raise the shutter speed or use a monopod or tripod to stabilize the camera.

The aperture value indication continues to blink after the shutter speed is changed:

→ If the aperture value indication at the maximum value is blinking, set the ISO sensitivity to a lower value or use a commercially available ND filter (for adjusting the amount of light). "ISO — Setting the desired sensitivity to light" (P. 56)

→ If the aperture value indication at the minimum value is blinking, set the ISO sensitivity to a higher value. "ISO — Setting the desired sensitivity to light" (P. 56)

M: Manual shooting

Allows you to set the aperture and shutter speed manually. You can check how much it differs from the appropriate exposure by using the exposure level indicator. This mode gives you more creative control, allowing you to make whatever settings you like, regardless of the correct exposure. Bulb shooting is also possible, allowing you to take astronomical or fireworks pictures.  “Bulb shooting” (P. 35)

Set the mode dial to M and turn the control dial to set the value.

- To set the shutter speed: Turn the control dial.
- To set the aperture value: Turn the control dial while holding down the  (exposure compensation) button.

Using the [DIAL] setting of the [1] menu allows you to change to the opposite settings.  “Customizing the control dial’s function” (P. 79)

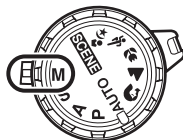

3

- The range of aperture values available varies with the lens type.
- The shutter speed can be set to 1/4000 - 60" (sec.) or [BULB].
- The aperture value and shutter speed change in 1/3 EV increments as the control dial is turned. You can also change the step with the customized settings.  “EV step” (P. 78)

Slower shutter speed

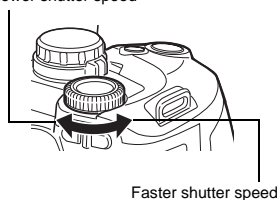

Open the aperture (f-number is decreased)

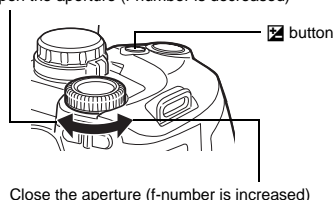

- The exposure level indicator appears on the control panel screen, showing the difference (ranging from -3 EV to +3 EV) between the exposure value calculated by the currently selected aperture and shutter speed compared to the exposure value considered optimum by the camera.

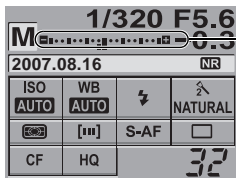

Exposure level indicator

Noise in images

During shooting at slow shutter speeds, noise may appear on-screen. These phenomena are caused when current is generated in those sections of the image pickup device that are not normally exposed to light, resulting in a rise in temperature in the image pickup device or image pickup device drive circuit. This can also occur when shooting with a high ISO setting in an environment exposed to heat. To reduce this noise, the camera activates the noise reduction function.

☞ “Noise reduction” (P. 62)

Bulb shooting

You can take a picture with a bulb exposure time in which the shutter stays open as long as you hold down the shutter button. Set the shutter speed to **[BULB]** in the **M** mode. Bulb shooting can also be done using an optional remote control (RM-1).

☞ “Bulb shooting on the remote control” (P. 47)

TIPS

The picture looks blurred:

→ The use of a monopod or tripod is recommended when taking a picture at slow shutter speed.

Preview function

The viewfinder shows the focused area (depth of field) with the selected aperture value. For the preview function to work by pressing the **Fn** button, it is necessary to set the function of the **Fn** button on the menu beforehand.

☞ “[Fn] FUNCTION” (P. 79)

Press the Fn button to use the preview function.

- When **[Fn] FUNCTION** is assigned to **[LIVE PREVIEW]**, pressing the **Fn** button automatically switches the camera to live view for a preview of the picture on the monitor.

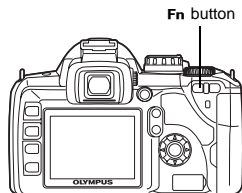

Shooting with the image stabilizer function

IS

You can reduce the amount of camera shake that easily occurs when shooting in low light situations or shooting with high magnification.

OFF Image stabilizer is off.

I.S. 1 Image stabilizer is on.

I.S. 2 This is used when panning in the horizontal direction to achieve a blurred background. The horizontal image stabilizer is turned off, and only the vertical image stabilizer is activated.

Direct button

IS ▶ Control dial



Viewfinder

Displayed when **[IMAGE STABILIZER]** is set to **[I.S. 1]** or **[I.S. 2]**.

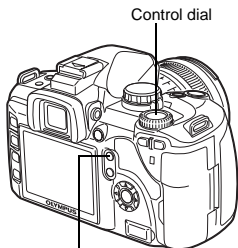

IS button

- When **[SCENE]** (Scene mode) is set to **[DIS MODE]** (DIS MODE), the image stabilizer automatically turns on (**[I.S. 1]**). "Scene mode" (P. 30)

Checking the image stabilizer effect on the monitor

You can hold down the **IS** button during live view to see the effect of the image stabilizer on the monitor. While in that position, you can press the shutter button fully to take a picture.

- When **[IMAGE STABILIZER]** is set to **[OFF]**, pressing and holding the **IS** button activates the image stabilizer (**[I.S. 1]**).
- Either releasing the **IS** button or holding down the **IS** button for several seconds turns off the image stabilizer.



Green: Image stabilizer active
Red : Image stabilizer failure

Notes

- The image stabilizer cannot correct excessive camera shake or camera shake that occurs when the shutter speed is set to the slowest speed. In these cases, it is recommended that you use a tripod.
- When using a tripod, set **[IMAGE STABILIZER]** to **[OFF]**.
- When using a lens with an image stabilization function, turn off the image stabilization function of either the lens or the camera.
- When you turn off the camera, it may initialize the image stabilizer function. The camera will vibrate for this operation, but this is not a malfunction.
- A red **[IS1]** displayed on the monitor indicates the failure of the image stabilizer function. If you take a picture as is, the composition may be off. Consult your Olympus Authorized Service Center.

3

If correct focus cannot be obtained (Focus lock)

The camera's auto focus may not be able to focus on the subject in situations such as when the subject is not in the center of the frame. If this happens, the easiest solution is to use focus lock.

1 Adjust the AF frame with the subject to be focused and press the shutter button halfway until the AF confirmation mark lights up.

- The focus is locked. The AF confirmation mark and the AF focusing frame light up in the viewfinder.
- If the AF confirmation mark blinks, press the shutter button halfway again.
- While the shutter button is being pressed, the control panel screen disappears.

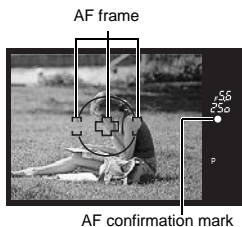
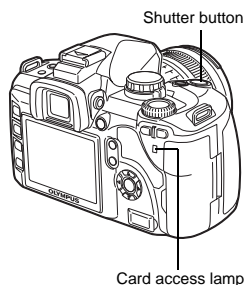

2 While pressing the shutter button halfway, move to the desired composition and press the button all the way.

- The card access lamp blinks while the picture is being stored on the card.



If the subject has lower contrast than its surroundings

If the contrast of the subject is weak, such as when the lighting is insufficient or the subject cannot be seen clearly because of fog, the focus may not be achieved. Focus (focus lock) on a high-contrast object the same distance away as the intended subject, recompose your shot and then take the picture.

AE bracketing

The camera automatically shoots a number of pictures at different exposure values for each frame. Even in conditions where correct exposure is difficult to obtain (such as a backlit subject or a scene at dusk), you can pick the picture you prefer from a selected number of frames with a variety of different exposure settings (exposure and compensation values). The pictures are taken in the following order: Picture with optimum exposure, picture adjusted in - direction, and picture adjusted in + direction.

e.g.) When BKT is set to [3F 1.0EV]



-1.0EV



±0



+1.0EV

Compensation value: 0.3, 0.7 or 1.0

The exposure compensation value will change if the EV step is changed. The EV step can be changed using the menu. Exposure compensation value can be adjusted within a range of ±1.0. "EV step" (P. 78)

Number of frames: 3

3

Menu

MENU **[C]** **[AE BKT]**
[OFF]/[3F 0.3EV]/[3F 0.7EV]/[3F 1.0EV]

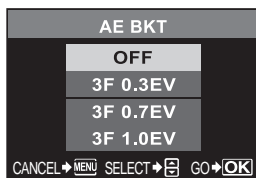

Start shooting.

- The shooting method varies depending on the setting of single-frame or sequential shooting. "Sequential shooting" (P. 45)

Single-frame shooting

Each time the shutter button is pressed fully, a picture is taken at a different exposure.

- The setting for the next shot is displayed in the viewfinder.

Sequential shooting

Hold down the shutter button until the selected number of frames are taken. The camera shoots each frame at a different exposure.

- Releasing the shutter button stops auto bracketing shooting. When it stops, **BKT** on the control panel is displayed in green.

How AE bracketing compensates exposure in each exposure mode

Depending on the selected exposure mode, exposure is compensated in the following way:

- P** mode : Aperture value and shutter speed
- A** mode : Shutter speed
- S** mode : Aperture value
- M** mode : Shutter speed

TIPS

To apply AE bracketing to the exposure value you have compensated:

- Compensate the exposure value, then use the AE bracketing feature. AE bracketing is applied to the exposure value you have compensated.



Viewfinder

Notes

- During sequential shooting, if the battery check blinks due to low battery, the camera stops shooting and starts saving the pictures you have taken on the card. The camera may not save all of the pictures depending on how much battery power remains.

Flash shooting

Flash mode

The camera sets the flash mode according to various factors such as firing pattern and flash timing. Available flash modes depend on the exposure mode. The flash modes are available to optional external flashes.

Auto flash **AUTO**

The flash fires automatically in low light or backlight conditions. To shoot a subject with backlighting, position the AF frame over the subject.

Red-eye reduction flash

In the red-eye reduction flash mode, a series of pre-flashes are emitted just before the regular flash fires. This helps accustom the subject's eyes to the bright light and minimizes the red-eye phenomenon.



The subject's eyes appear red

Notes

- After the pre-flashes, it takes about 1 second before the shutter is released. Hold the camera firmly to avoid camera shake.
- Effectiveness may be limited if the subject is not looking directly at pre-flashes, or if the shooting range is too far. Individual physical characteristics may also limit effectiveness.

Slow synchronization (1st curtain) **SLOW**

The slow synchronization flash is designed for slow shutter speeds. Normally, when shooting with a flash, shutter speeds cannot go below a certain level to prevent camera shake. But when shooting a subject against a night scene, fast shutter speeds can make the background too dark. Slow synchronization allows you to capture both the background and the subject. Since the shutter speed is slow, be sure to stabilize the camera by using a tripod so as not to cause the picture to be blurred.



1st curtain

Usually, the flash fires right after the shutter fully opens. This is called 1st curtain. Unless you change it, this is how the flash always fires.

Slow synchronization (2nd curtain) **SLOW2**

2nd curtain flash fires just before the shutter closes. Changing the flash timing can create interesting effects in your picture, such as expressing the movement of a car by showing the tail-lights streaming backwards. The slower the shutter speed, the better the effects turn out. The slowest possible shutter speed depends on the shooting mode.

When the shutter speed is set to 2 sec.

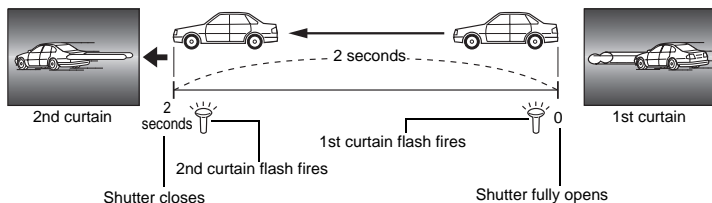

Slow synchronization (1st curtain)/Red-eye reduction flash SLOW

While using slow synchronization with flash shooting, you can also use this function to achieve red-eye reduction. When shooting a subject against a night scene, this function allows you to reduce the red-eye phenomenon. As the time from emitting pre-flashes to shooting is long in 2nd curtain synchronization, it is difficult to achieve red-eye reduction. Hence, only 1st curtain synchronization setting is available.

Fill-in flash

The flash fires regardless of the light conditions. This mode is useful for eliminating shadows on the subject's face (such as shadows from tree leaves), in a backlight situation, or for correcting the color shift produced by artificial lighting (especially fluorescent light).



Notes

- When the flash fires, the shutter speed is set to 1/180 sec. or less. When shooting a subject against a bright background with the fill-in flash, the background may be overexposed. In this case, use the optional FL-50 or FL-36 external flash and shoot in the Super FP flash mode. "Super FP flash" (P. 44)

Flash off

The flash does not fire.

Even in this mode, the flash can be used as an AF illuminator when it is raised. "AF illuminator" (P. 51)

Flash synchronization speed

Shutter speed can be changed when the built-in flash fires. "Speed synchronization" (P. 78)

Manual flash

This allows the built-in flash to output a fixed amount of light. To shoot with manual flash, set the f-number on the lens based on the distance to the subject.

Ratio of amount of light	GN: Guide number (Equivalent to ISO 100)
FULL (1/1)	12
1/4	6
1/16	3
1/64	1.5

Calculate the f-number on the lens using the following formula.

$$\text{Aperture (f-number)} = \frac{\text{GN} \times \text{ISO sensitivity}}{\text{Distance to the subject (m)}}$$

ISO sensitivity

ISO value	100	200	400	800	1600
ISO sensitivity	1.0	1.4	2.0	2.8	4.0

Flash modes available in different exposure modes

Exposure mode	Control panel screen display	Flash mode	Conditions to timing	Conditions to fire the flash	Shutter speed restrictions
AUTO	AUTO	Auto flash	1st curtain	Fires automatically in dark/backlit ^{*1} conditions	1/30 sec. - 1/180 sec.
		Auto flash (red-eye reduction)			
	P		Fill-in flash	Always fires	60 sec. - 1/180 sec.
	A		Flash off	—	—
S		Slow synchronization (red-eye reduction)	1st curtain	Fires automatically in dark/backlit ^{*1} conditions	1/30 sec. - 1/180 sec.
		Slow synchronization (1st curtain)			
		Slow synchronization (2nd curtain)	2nd curtain		
		Manual flash (FULL)	1st curtain		
M		Manual flash (1/4)		Always fires	60 sec. - 1/180 sec.
		Manual flash (1/16)			
		Manual flash (1/64)			
		Manual flash (1/64)			
S		Fill-in flash	2nd curtain	Always fires	60 sec. - 1/180 sec.
		Fill-in flash (red-eye reduction)			
		Flash off	—		
		Fill-in flash/Slow synchronization (2nd curtain)	1st curtain		
		Manual flash (FULL)			
		Manual flash (1/4)			
	Manual flash (1/16)				
	Manual flash (1/64)				

^{*1} When the flash is set to the Super FP mode, it detects backlight with longer duration than for normal flash before emitting light. "Super FP flash" (P. 44)

^{*2} **AUTO**, , cannot be set in mode.

Setting the flash mode



Direct button

▶ Control dial

Control panel screen

▶ : FLASH MODE ▶

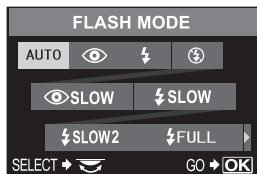

3

Shooting functions — Various shooting functions

Using the built-in flash

If you shoot a subject using a lens that is wider than 14 mm (equivalent to 28 mm on a 35 mm film camera), the light emitted by the flash may produce a vignette effect. Whether or not vignetting occurs also depends on lens type and shooting conditions (such as distance to the subject).

1 Press the button to raise the built-in flash.

- The built-in flash will pop up automatically and fire in low light conditions under the following modes.

AUTO         

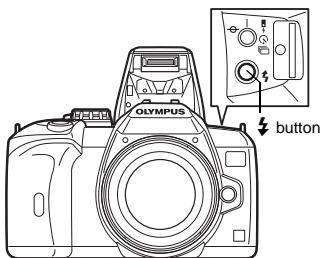

2 Press the shutter button halfway.

- The  (flash stand-by) mark lights when the flash is ready to fire. If the mark is blinking, the flash is charging. Wait until charging is complete.

3 Press the shutter button all the way.

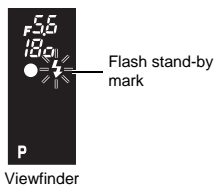

TIPS



When you do not want the flash to pop up automatically:

→ Set [AUTO POP UP] on the [1] menu to [OFF].  “Auto pop up” (P. 79)

Flash intensity control

This adjusts the amount of light emitted by the flash.



In some situations (e.g., when shooting small subjects, distant backgrounds, etc.), you may get better results by adjusting light emission. It is useful when you intend to increase the contrast (distinction between light and dark) of images to make the images more vivid.

MENU >  > 

Use  to set the compensation value.



TIPS

To call up the flash compensation screen quickly:

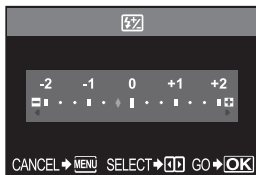
→ Hold down the  button and the  (exposure compensation) button at the same time until the  screen appears. Use the control dial to set.



Notes

- This does not work when the flash control mode on the electronic flash is set to MANUAL.
- If light emission is adjusted on the electronic flash, it will be combined with the camera's light emission setting.
- When + on the [1] menu is set to [ON], it will be added to the exposure compensation value.

Flash bracketing

The camera shoots multiple frames, changing the amount of light emitted by the flash for each shot.

MENU ▶ [C2] ▶ [FL BKT]

[OFF]/[3F 0.3EV]/[3F 0.7EV]/[3F 1.0EV]

- You can change the EV step interval in the custom menu. See “EV step” (P. 78)
- In sequential shooting, when the shutter button is pressed, the camera shoots 3 frames at a time in the following order: frame with optimum amount of light emission, frame adjusted in – direction and frame adjusted in + direction. In single-frame shooting, the amount of light emitted by the flash changes every time the shutter button is pressed.

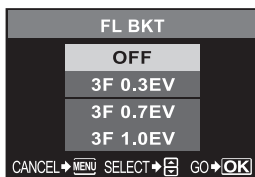

External electronic flashes (optional)

In addition to the camera's built-in flash capabilities, you can use any of the external flash units specified for use with this camera. This enables you to take advantage of a wider variety of flash shooting techniques to suit different shooting conditions.

The external flashes communicate with the camera, allowing you to control the camera's flash modes with various available flash control modes, such as TTL-AUTO and Super FP flash. The flash can be mounted on the camera by attaching it to the camera's hot shoe. Refer to the external flash's manual as well.

Functions available with external flash units

Optional flash	FL-50	FL-36	FL-20	RF-11	TF-22
Flash control mode	TTL-AUTO, AUTO, MANUAL, FP TTL AUTO, FP MANUAL		TTL-AUTO, AUTO, MANUAL	TTL-AUTO, MANUAL	
GN (Guide number) (ISO100)	GN50 (85 mm [*]) GN28 (24 mm [*])	GN36 (85 mm [*]) GN26 (24 mm [*])	GN20 (35 mm [*])	GN11	GN22

* The focal length of the lens that can be covered (Calculated based on 35 mm film camera)

Notes

- The FL-40 optional flash cannot be used.

Using the external electronic flash

Be sure to attach the flash to the camera before turning on the flash's power.

1 Remove the hot shoe cover by sliding it in the direction indicated by the arrow in the illustration.

- Keep the shoe cover in a safe place to avoid losing it, and put it back on the camera after flash shooting.

2 Attach the electronic flash to the hot shoe on the camera.

- If the lock pin is protruding, turn the shoe lock ring as far as it will go in the direction opposite to LOCK. This will pull the lock pin back inside.

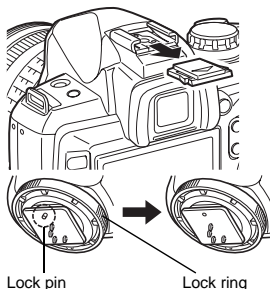

3 Turn on the flash.

- When the charge lamp on the flash lights up, charging is complete.
- The flash will be synchronized with the camera at a speed of 1/180 sec. or less.

4 Select a flash mode.

5 Select the flash control mode.

- TTL-AUTO is recommended for normal use.

6 Press the shutter button halfway.

- Shooting information such as ISO sensitivity, aperture value, and shutter speed is communicated between the camera and flash.

7 Press the shutter button all the way.

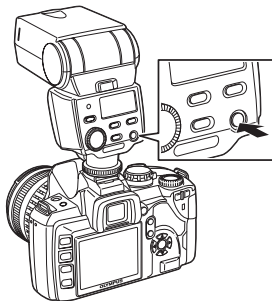

3

Notes

- The built-in flash cannot be used when an external flash is attached to the hot shoe.

Super FP flash

Super FP flash is available with the FL-50 or FL-36. Use the Super FP flash where normal flashes cannot be used with high shutter speed.

Fill-in flash shooting with the aperture open (such as in outdoor portrait shooting) is also possible with Super FP flash. For details, refer to the external flash's manual.

Super FP flash

P	FP		
2007.08.16		NR	
ISO	WB	R ±0	NATURAL
AUTO	AUTO	G ±0	S ±0 C ±0
Flash	S-AF	[M]	RGB ±0
AUTO	S-AF		sRGB
±0.0	HQ		32
CF	3648x2736		

Detailed display on the control panel

Using commercially available flashes

Use the **M** shooting mode on the camera when using any commercially available flash except for the flashes specified for this camera. For details on non-specified commercial flashes, see "Non-specified commercial flashes" (P. 45).

1 Remove the hot shoe cover to connect the flash unit to the camera.

2 Set the shooting mode to **M** mode, then set the aperture value and shutter speed.

- Set the shutter speed to 1/180 sec. or slower. If the shutter speed is faster than this, commercially available flashes cannot be used.
- A slower shutter speed may produce blurred images.

3 Turn on the flash.

- Be sure to turn on the flash after attaching the flash unit to the camera.

4 Set the ISO value and aperture value on the camera to match the flash control mode on the flash.

- Refer to the flash's manual for instructions on how to set its flash control mode.

Notes

- The flash fires each time the shutter is released. When you do not need to use the flash, turn off the flash's power.
- Check beforehand that the flash you are using is synchronized with the camera.

Non-specified commercial flashes

- 1) Exposures when using a flash require that adjustments be made on the flash. If a flash is used in the auto mode, match it with the f-number and ISO sensitivity settings on the camera.
- 2) Even if the flash auto f-number and ISO sensitivity are set the same as on the camera, the correct exposure may not be obtained depending on the shooting conditions. In such a case, adjust the auto f-number or ISO on the flash or calculate the distance in the manual mode.
- 3) Use a flash with an illumination angle that matches the focal length of the lens. The focal length of the lens for 35 mm film is approximately twice as long as the focal length of the lenses designed for this camera.
- 4) Do not use a flash unit or other accessory TTL flash that has additional communication functions other than the specified flashes, since it may not only fail to function normally, but may also cause damage to the camera's circuitry.

3

Shooting functions — Various shooting functions

Sequential shooting/Self-timer/Remote control



Setting the functions

Direct button

Control dial

- When settings are made with the button, the information is also displayed on the viewfinder.

Sequential shooting



1-d:
Single-frame shooting
2-d:
Sequential shooting

Self-timer



12 SELF:
12-second self-timer
2 SELF:
2-second self-timer

Remote control



0 r-c-d:
0 second
2 r-c-d:
2 seconds

button Control dial

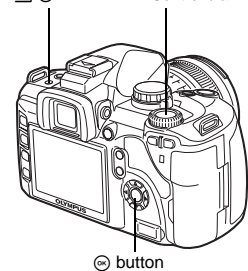

button

Control panel screen



Sequential shooting

Single-frame shooting

Shoots 1 frame at a time when the shutter button is pressed (normal shooting mode).

Sequential shooting

Shoots 12 frames or more at 3 frames/sec. for as long as the shutter button is pressed (during JPEG). Focus, exposure, and white balance are locked at the first frame (during S-AF, MF).

- Press the shutter button fully and keep it pressed. The camera will take pictures in sequence until you release the button.

Notes

- During sequential shooting, if the battery check blinks due to low battery, the camera stops shooting and starts saving the pictures you have taken on the card. The camera may not save all of the pictures depending on how much battery power remains.

Using the self-timer

This function lets you take pictures using the self-timer. You can set the camera to release the shutter after either 12 or 2 seconds. Fix the camera securely on a tripod for self-timer shooting.

Press the shutter button all the way.

- A picture is taken.
- When **12s** is selected:
First, the self-timer lamp lights up for approximately 10 seconds, then it blinks for approximately 2 seconds and the picture is taken.
- When **2s** is selected:
The self-timer lamp blinks for approximately 2 seconds, then the picture is taken.
- To cancel the activated self-timer, press the  button.

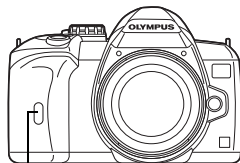

Self-timer lamp

Notes

- Do not press the shutter button while standing in front of the camera; this could result in the subject being out of focus since focusing is performed when the shutter button is pressed halfway.

Eyepiece cover

When shooting without looking through the viewfinder, attach the eyepiece cover to the viewfinder so that light does not enter the viewfinder. Attach the eyepiece cover after removing the eyecup as illustrated. The same applies when replacing with an optional eyecup.

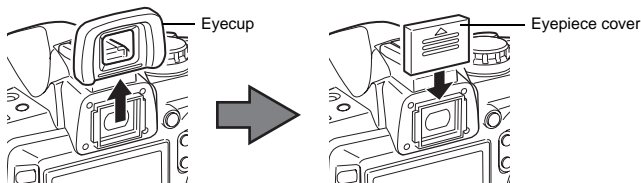

Using the remote control

By using the optional remote control (RM-1), you can take a picture with yourself in it or a night scene without touching the camera. The camera can be set to release the shutter either right away or 2 seconds after the shutter button on the remote control is pressed. Bulb shooting is also possible when using the optional remote control.

Mount the camera securely on a tripod, point the remote control at the remote control receiver on the camera and press the shutter button on the remote control.

- When **0s** is selected:
The focus and exposure are locked, the remote control lamp blinks and the picture is taken.
- When **2s** is selected:
The focus and exposure are locked, the remote control lamp blinks, then after approximately 2 seconds the picture is taken.

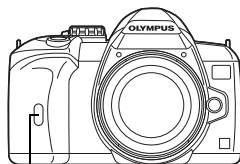

Remote control lamp
Remote control receiver

Transmitted signal effective area

Point the remote control at the remote control receiver of the camera within the effective area as shown below.

When powerful lighting such as direct sunlight is shining on the remote control receiver, or when fluorescent light or devices emitting electrical or radio waves are nearby, it could narrow the effective area.

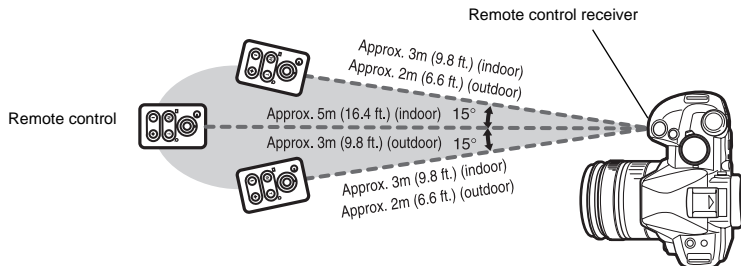

TIPS

The remote control lamp does not blink after the shutter button on the remote control is pressed:

- The transmitted signal may not be effective if the remote control receiver is exposed to powerful lighting. Move the remote control closer to the camera and press the shutter button on the remote control again.
- The transmitted signal may not be effective if the remote control is too far from the camera. Move the remote control closer to the camera and press the shutter button on the remote control again.
- There is signal interference. Change the channel as described in the remote control's manual.

To cancel the remote control shooting mode:

- The remote control shooting mode will not be canceled after shooting. Press the  button to set to [□] (single-frame shooting), etc.

To use the shutter button on the camera in the remote control shooting mode:

- The shutter button on the camera still works even in the remote control shooting mode.

Notes

- The shutter will not be released if the subject is not in focus.
- Under bright light conditions, the remote control lamp may be difficult to see, making it hard to determine whether or not the picture has been taken.
- Zoom is not available on the remote control.

Bulb shooting on the remote control

Set the mode dial to **M**, then set the shutter speed to **[BULB]**.

Press the **W** button on the remote control to open the shutter.

If 8 minutes elapse after pressing the **W** button, the shutter closes automatically.

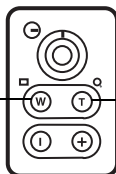

Press the **T** button to close the shutter.

Panorama shooting

You can enjoy panorama shooting easily using the OLYMPUS xD-Picture Card. Using OLYMPUS Master (provided CD-ROM) to join a few images shot where the subject's edges overlap, you can create a single panorama composite image. Panorama shooting is possible up to a maximum of 10 images.







3



- Try your best to include the common parts of the overlapping images when shooting the subject.

1 Set the mode. “Scene mode” (P. 30)

- Live view is activated.

2 Use to specify the direction for joining, then shoot the subject with the edges overlapping.

-  : Joins the next image to the right.
-  : Joins the next image to the left.
-  : Joins the next image to the top.
-  : Joins the next image to the bottom.

- Shoot while changing the composition such that the subject overlaps.
- The focus, exposure, etc. will be determined in the first image.
- The  (warning) mark will be displayed after you have finished taking 10 shots.
- Pressing the  button before shooting the first frame returns to the scene mode selection menu.
- Pressing the  button in the midst of shooting ends the sequence of panorama shooting, and allows you to continue with the next one.

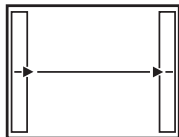

Notes

- Panorama shooting cannot be done if the OLYMPUS xD-Picture Card is not loaded in the camera.
- During panorama shooting, the image previously taken for position alignment will not be retained. With the frames or other markers for display in the images as a guide, set the composition such that the edges of the overlapping images overlap within the frames.

AF frame selection



Normally, the camera measures the distance to the subject using the 3 AF frames in the viewfinder and selects the most appropriate point. This function allows you to select only one AF frame.

[AUTO] or [•••] ([AUTO])

Focuses using the 3 AF frames.

[] Focuses using the left AF frame.

[•] Focuses using the center AF frame.

[] Focuses using the right AF frame.

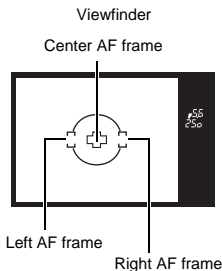

3

Shooting functions — Focusing functions

Direct button

[•••] > Control dial

Control panel screen

☺ > ☺: AF AREA > ☺

Menu

MENU > [•] > [•••]

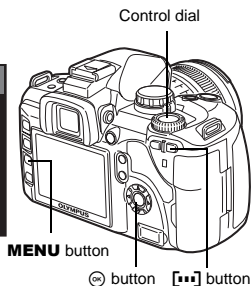
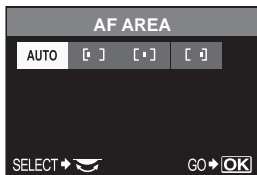

Focus mode

AF

The following three focus modes are available with this camera.

You can take pictures by combining S-AF or C-AF mode with MF mode. “Simultaneous use of S-AF mode and MF mode (S-AF+MF)” (P. 51), “Simultaneous use of C-AF mode and MF mode (C-AF+MF)” (P. 51)

S-AF (single AF)

Focusing is performed once when the shutter button is pressed halfway.

If focusing fails, release your finger from the shutter button and press it halfway again. This mode is suitable for taking pictures of still subjects or subjects with limited movement.

Press the shutter button halfway.

- When the focus is locked, the AF confirmation mark lights up.
- A beep sound is output when the subject is in focus.

C-AF (continuous AF)

The camera repeats focusing while the shutter button remains pressed halfway. When the subject is in motion, the camera focuses on the subject in anticipation of its movement (Predictive AF). Even if the subject moves or you change the composition of the picture, the camera continues trying to focus.

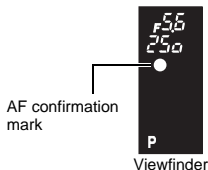

Press the shutter button halfway and keep it in this position.

- When the subject is in focus and locked, the AF confirmation mark lights up.
- The AF frame does not light up, even when the subject is in focus.
- The camera repeats focusing. Even if the subject moves or even if you change the composition of the picture, focusing is tried continuously.
- A beep sound is output when the subject is in focus. The beep sound is not output after the third continuous AF operation, even when the subject is in focus.

MF (manual focus)

This function allows you to manually focus on any subject while looking through the viewfinder.

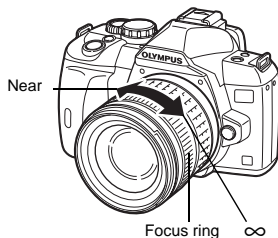
Adjust the focus using the focus ring.**Rotational direction of the focus ring**

You can select the rotational direction of the focus ring to suit your preference for how the lens adjusts to the focusing point. "Focus ring" (P. 80)

Focus aid

When you focus the lens on a subject manually (by turning the focus ring), the AF confirmation mark lights. When is selected, the camera performs focusing in the center AF frame.

Direct button

AF ▶ Control dial

Control panel screen

▶ : **AF MODE** ▶
[S-AF]/[C-AF]/[MF]/[S-AF+MF]/[C-AF+MF]

Menu

MENU ▶ ▶ **[AF MODE]**

- You can check the settings in the viewfinder while using the **AF** button to make the settings.

	: S-AF
	: C-AF
	: MF
	: S-AF+MF
	: C-AF+MF

Viewfinder

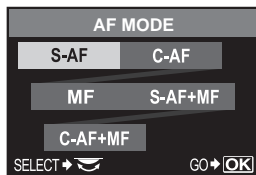
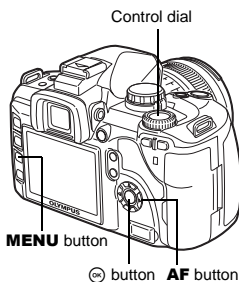

Simultaneous use of S-AF mode and MF mode (S-AF+MF)

This function allows you to fine-adjust focus manually by turning the focus ring after AF is performed in the S-AF mode. When the shutter button is not pressed, MF operation is available.

- You can fine-adjust the focus with the focus ring if you have pressed the shutter button halfway and AF is confirmed. You can also fine-adjust the focus with the focus ring when the shutter button is not pressed halfway.

Notes

- If the shutter button is pressed again after fine-adjusting focus with the focus ring, the AF is activated and your adjustments are canceled.

Simultaneous use of C-AF mode and MF mode (C-AF+MF)

Focus with the focus ring and press the shutter button halfway to activate C-AF mode.

- While the shutter button is kept pressed, MF mode is not activated.
- When the shutter button is not pressed, MF mode is available.

TIPS

Another way to adjust focus manually in C-AF mode:

→ You can set the **AEL/AFL** button to operate C-AF with the AEL/AFL mode settings.

 "AEL/AFL mode" (P. 77)

Notes

- If the shutter button is pressed again after fine-adjusting focus with the focus ring, the AF is activated and your adjustments are canceled.

AF illuminator

The built-in flash can function as an AF illuminator. This helps with focusing in low-light conditions in the AF mode. To use this function, raise the flash.

MENU ▸ [F1] ▸ [AF ILLUMINAT.]
[OFF]/[ON]

Shutter release priority

Normally, this camera does not release the shutter while the AF is operating or the flash is charging. If you want to release the shutter without waiting until these operations have completed, use the setting below. You can set the release priority individually in focus mode.

RELEASE PRIORITY S Sets release priority for S-AF mode ( P. 49).

RELEASE PRIORITY C Sets release priority for C-AF mode ( P. 49).

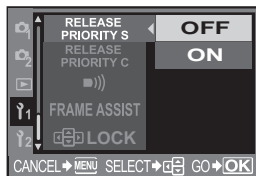

MENU ▸ [F1] ▸ [RELEASE PRIORITY S]/[RELEASE PRIORITY C]
[OFF]/[ON]

Notes

- When [RELEASE PRIORITY C] is set to [ON], Predictive AF is not available for the first shot.

Selecting the record mode

You can select a record mode in which to take pictures. Choose the record mode that's best for your purpose (printing, editing on a PC, website editing, etc.). For details about record modes and number of pixels, refer to the table on "List of record modes" (P. 114).

Types of record modes

Record mode allows you to select a combination of pixel count and compression rate for the images you record. An image consists of pixels (dots). When you enlarge an image with a low pixel count, it will be displayed as a mosaic. If an image has a high pixel count, the file size (amount of data) will be larger and the number of storable still pictures will be lower. The higher the compression, the smaller the file size. However, the image will have less clarity when played back.

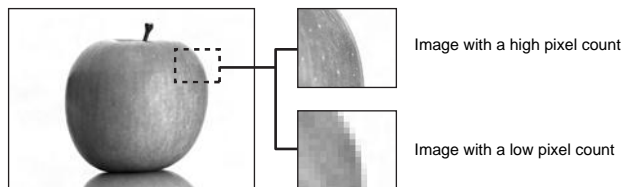

Image becomes clearer



Application	Number of pixels	Quality (Compression)			
		Low compression 1/2.7	High compression 1/4	High compression 1/8	High compression 1/12
Select for the print size	3648 × 2736	SHQ	HQ		
	3200 × 2400	SQ			
	2560 × 1920				
	1600 × 1200				
	1280 × 960				
1024 × 768					
For small-sized print and website	640 × 480	SQ			

RAW data

This is unprocessed data that has not undergone changes in white balance, sharpness, contrast or color. To display as an image on the computer, use OLYMPUS Master. RAW data cannot be displayed on a different camera or by using common software, and it cannot be selected for print reservation.

It is possible to edit images taken with the record mode set to RAW data using this camera.

☞ "Editing still images" (P. 69)

3

Shooting functions — Exposure, Image and color

Number of pixels increases



How to select the record mode

Control panel screen



Menu

MENU ▶ [P] ▶ [↩] ▶
[HQ]/[SQ]/[RAW+SHQ]/[RAW+HQ]/
[RAW+SQ]/[RAW]/[SHQ]

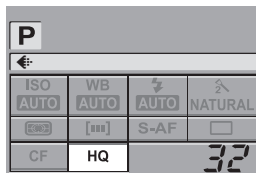

Setting the number of pixels and compression rate

You can change the number of pixels and compression rate of [HQ] and [SQ]. This setting is reflected in the [↩] setting.

Menu

MENU ▶ [i] ▶ [HQ]

- 1) Use [↩] to set the compression rate.
[1/4]/[1/8]/[1/12]

MENU ▶ [i] ▶ [SQ]

- 1) Use [↩] to set the number of pixels.
[3200 × 2400]/[2560 × 1920]/[1600 × 1200]/
[1280 × 960]/[1024 × 768]/[640 × 480]
- 2) Use [↩] to set the compression rate.
[1/2.7]/[1/4]/[1/8]/[1/12]

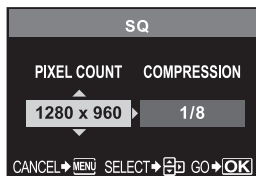

3

Shooting functions — Exposure, image and color

Metering mode — Changing the metering system



There are 5 ways to measure the subject brightness: Digital ESP metering, Center weighted averaging metering, and three types of spot metering. Select the most suitable mode for the shooting conditions.

Direct button

▶ Control dial

Control panel screen

▶ : METERING ▶
 / / / /

Menu

MENU ▶ ▶ [METERING]

- You can check the settings in the viewfinder while using the button to make the settings.



Viewfinder

ESP : Digital ESP metering
 : Center weighted averaging metering
 : Spot metering
H : Spot metering Highlight control
S : Spot metering Shadow control

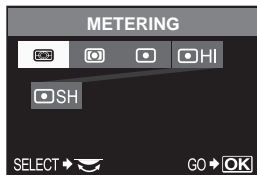
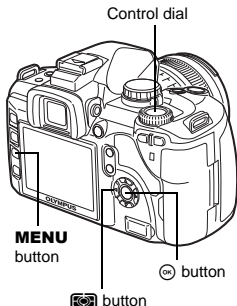

Digital ESP metering

The camera measures the light levels and calculates the light level differences in 49 separate areas of the image. This mode is recommended for general use. Setting the AF synchronized function to **[ESP+AF]** operates the metering area with the frame in focused in AF as the center.

Center weighted averaging metering

This metering mode provides the average metering between the subject and the background lighting, placing more weight on the subject at the center. Use this mode when you do not want the light level of the background to affect the exposure value.

Spot metering

The camera meters a very small area around the center of the subject, defined by the spot metering area mark in the viewfinder. Use this mode when there is very strong backlight.

HI Spot metering - highlight control

When the overall background is bright, white areas of the image will come out gray if you use the camera's automatic exposure. Using this mode enables the camera to shift to over-exposure, allowing accurate white reproduction.

Metering area is the same as spot metering.

SH Spot metering - shadow control

When the overall background is dark, black areas of the image will come out gray if you use the camera's automatic exposure. Using this mode enables the camera to shift to under-exposure, allowing accurate black reproduction.

Metering area is the same as spot metering.



Metering area

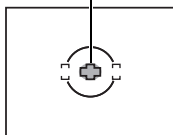

Exposure compensation — Varying the image brightness



In some situations, you may get better results if you manually compensate (adjust) the exposure value set automatically by the camera. In many cases, bright subjects (such as snow) will turn out darker than their natural colors. Adjusting toward + makes these subjects closer to their real shades. For the same reason, adjust toward – when shooting dark subjects. The exposure can be adjusted in range of ± 5.0 EV.

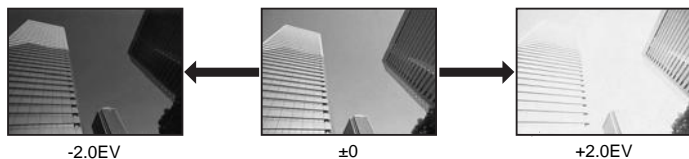

While holding down the (exposure compensation) button, use the control dial to set the compensation value.

- The EV step interval can be selected from 1/3 EV, 1/2 EV or 1 EV. “EV step” (P. 78)
- In **P** mode, you can change the control dial's functionality so that exposure compensation can be set using the control dial only. “Customizing the control dial's function” (P. 79)

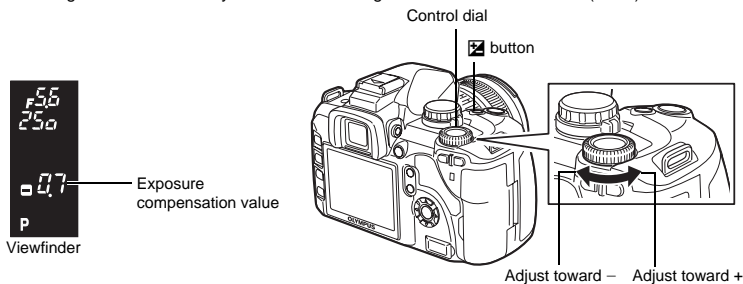

Exposure compensation value

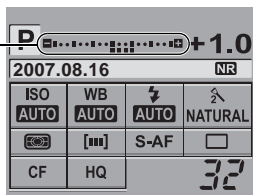
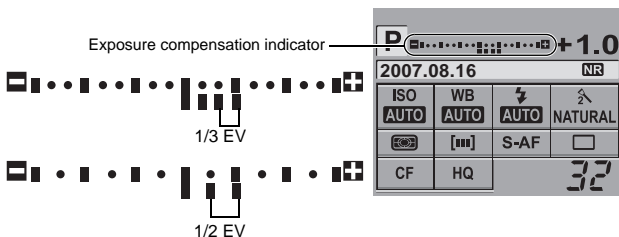

- If the exposure compensation value exceeds the scale of the exposure compensation indicator, red will be displayed on the left and right edges of the indicator.
- The exposure compensation indicator will not be displayed when the exposure is compensated by 0.

Notes

- Exposure compensation is not possible in **M** and **SCENE** modes.

AE lock — Locking the exposure

AEL

The metered exposure value can be locked with the **AEL/AFL** button (AE lock). Use AE lock when you want a different exposure setting from the one that would normally apply under the current shooting conditions.

Normally, pressing the shutter button halfway locks both AF (auto focus) and AE (automatic exposure), but you can lock the exposure alone by pressing the **AEL/AFL** button.

Press the AEL/AFL button at the position where you wish to lock the metering values and the exposure will be locked. As the exposure will be locked while the AEL/AFL button is being pressed, press the shutter button.

- Releasing the **AEL/AFL** button cancels AE lock.
- Using the custom menu, you can set AE lock so that it is not canceled when the **AEL/AFL** button is released.  "AEL/AFL memo" (P. 78)

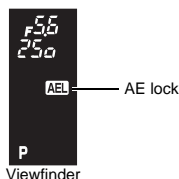
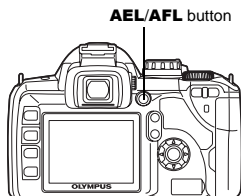

ISO — Setting the desired sensitivity to light

ISO



The higher the ISO value, the greater the camera's light sensitivity and the better its ability to shoot in low light conditions. However, higher values may give pictures a grainy appearance. For **[AUTO]**, sensitivity is set automatically according to the shooting conditions. You can set the maximum sensitivity that is set automatically.  "ISO limit" (P. 78)

However, sensitivity is fixed to ISO100, regardless of this setting, when the flash is not fired in **S** or **M** mode.

Direct button

ISO ▶ Control dial

Control panel screen

 ▶  : ISO ▶ 
[AUTO], [100] - [1600]

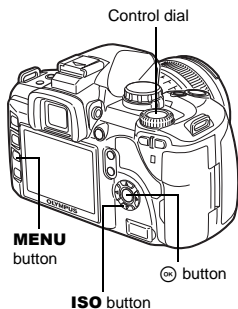
**3**

Shooting functions — Exposure, Image and color

Menu

MENU ▶ [Q] ▶ [ISO]

- You can check the settings in the viewfinder while using the **ISO** button to make the settings.

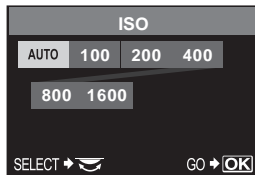
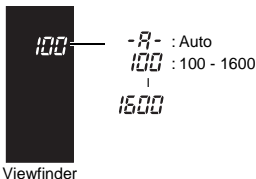

White balance — Adjusting the color tone

3

Color reproduction differs depending on the light conditions. For instance, when daylight or tungsten lighting is reflected on white paper, the shade of white produced will be slightly different for each. With a digital camera, white color can be adjusted to reproduce more natural white with a digital processor. This mechanism is called white balance. There are 4 options for setting the WB with this camera.

Auto white balance

This function enables the camera to automatically detect white in images and adjust the color balance accordingly.

Use this mode for general use.

Preset white balance

Seven different color temperatures are programmed on this camera covering a variety of indoor and outdoor lighting including fluorescent lights and light bulbs. For example, use preset WB when you want to reproduce more red in the picture of a sunset, or capture a warmer artistic effect under artificial lighting.

Custom white balance

You can change the color temperature of one of the preset WB settings to your liking.

☞ "Setting the auto/preset/custom white balance" (P. 58)

One-touch white balance

You can set the optimum white balance for the shooting conditions by pointing the camera at a white object like a sheet of white paper. The white balance achieved with this setting is saved as one of the preset WB settings.

☞ "Setting the one-touch white balance" (P. 60)

Color temperature

The spectral balance of different white light sources is rated numerically by color temperature — concept of physics, expressed using the Kelvin (K) temperature scale. The higher the color temperature, the richer the light in bluish tones and the poorer in reddish; the lower the color temperature, the richer the light in reddish tones and the poorer in bluish.

It follows, then, that the color temperatures of fluorescent lights make them unsuitable as artificial light sources. There are gaps in the hues from the color temperatures of fluorescent light. If these differences in hue are small, they can be calculated with color temperature and this is called correlated color temperature.

The 4000K, 4500K and 6600K preset settings in this camera are correlated color temperatures, and should not be considered strictly as color temperatures. Use these settings for shooting conditions under fluorescent lights.

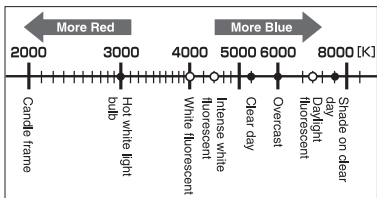

- The color temperatures for each light source indicated in the above scale are approximate.

Setting the auto/preset/custom white balance

WB

You can adjust the white balance by selecting the appropriate color temperature for the light conditions.

Direct button

WB ▸ Control dial

Control panel screen

☺ ▸ ⚙ : **WB** ▸ ☺

[AUTO]/[☺]/[☺]/[☺]/[☺]/[☺]/[☺]/[☺]/[☺]/[☺]/[☺]/[☺]/[☺]/[☺]/[☺]





- CWB (custom white balance) is set by selecting [CWB] and turn the control dial while pressing down the  button (exposure compensation) button.

Menu

MENU ▸ [WB] ▸ [WB]

- You can check the settings in the viewfinder while using the **WB** button to make the settings.

Viewfinder

--  : Auto white balance
 -- 
 C  : Custom white balance
 -  : One-touch white balance

Viewfinder

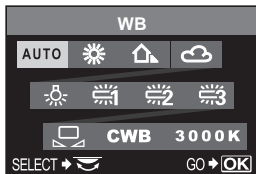
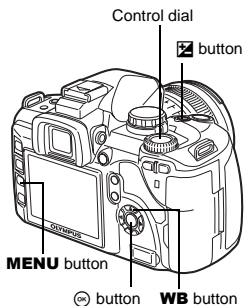

WB mode	Light conditions
AUTO	Used for most light conditions (when there is a white portion framed in the viewfinder). Use this mode for general use.
5300K	For shooting outdoors on a clear day, or to capture the reds in a sunset or the colors in a fireworks display
7500K	For shooting outdoors in the shadows on a clear day
6000K	For shooting outdoors on a cloudy day
3000K	For shooting under a tungsten light
4000K	For shooting under white fluorescent lighting
4500K	For shooting under a neutral white fluorescent lamp
6600K	For shooting under a daylight fluorescent lamp
	Color temperature set by one-touch WB. "Setting the one-touch white balance" (P. 60)
CWB	Color temperature set in custom white balance menu. When the value has not been set, it is set to 3000K. The color temperature display changes according to your CWB setting.

TIPS

When subjects that are not white appear white:

→ In the auto WB setting, if there is no near-white color in the image framed in the screen, the white balance will not be correctly determined. In such a case, try preset WB or one-touch WB settings.

WB compensation

This function lets you make fine changes to the auto WB and preset WB settings.

- 1 MENU** ▸ [OK] ▸ [WB]
- Use to select the white balance to adjust.

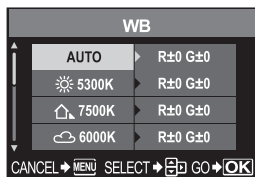

- 3 Use to select the color direction.**

R-B Red—Blue
G-M Green—Magenta

- You can set both color directions.

Adjusting the white balance in the R-B direction

Depending on the original WB conditions, the image will become redder each time you press , and bluer each time you press .

Adjusting the white balance in the G-M direction

Depending on the original WB conditions, the image will become greener each time you press , and more magenta each time you press .

- The white balance can be adjusted in 7 increments in each direction (R, B, G and M).

- 4 Press the button.**

- Your adjustment is saved.

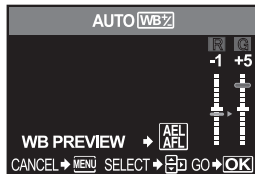

TIPS

Checking the white balance you have adjusted:

→ After performing Step 3, point the camera at the subject to take test shots. When the **AEL/AFL** button is pressed, sample images that have been taken with the current WB settings are displayed.

Adjusting all WB mode settings at once:

→ Refer to "Compensating all WB" (P. 78).

Setting the one-touch white balance

This function is useful when you need a more precise white balance than preset WB can provide. Point the camera at a sheet of white paper under the light source you want to use to determine the white balance. The optimum white balance for the current shooting conditions can be saved in the camera. This is useful when shooting a subject under natural light, as well as under various light sources with different color temperatures.

Set **[Fn FUNCTION]** to **[WB]** beforehand. (P. 79)

1 Point the camera at a sheet of white paper.

- Position the paper so that it fills the viewfinder. Make sure there are no shadows.

2 While holding down the Fn button, press the shutter button.

- The one-touch white balance screen appears.

3 Select [YES] and press the **OK** button.

- The white balance is registered.
- The registered white balance will be stored in the camera as a preset WB setting. Turning the power off does not erase the data.

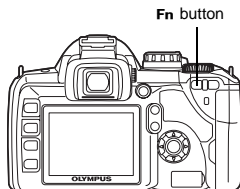

TIPS

After pressing the shutter button, [WB NG RETRY] is displayed:

→ When there is not enough white in the image, or when the image is too bright, too dark or the colors look unnatural, you cannot register the white balance. Change the aperture and shutter speed settings, then repeat the procedure from Step 1.

WB bracketing

Three images with different white balances (adjusted in specified color directions) are automatically created from one shot. One image has the specified white balance, while the others are the same image adjusted in different color directions.

1 MENU ▸ [WB] ▸ [WB BKT]

2 Use **OK** to select the color direction.

R-B Red—Blue

G-M Green—Magenta

- You can set both color directions.

3 Use **OK** to set the EV steps.

[OFF]/[3F 2STEP]/[3F 4STEP]/[3F 6STEP]

4 Start shooting.

- When the shutter button is pressed down all the way, 3 images adjusted in specified color directions are automatically created.

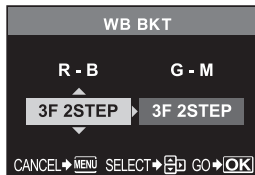

TIPS

To apply WB bracketing to the white balance you have adjusted:

→ Adjust white balance manually, then use the WB bracketing feature. WB bracketing is applied to the white balance you have adjusted.

Notes

- During WB bracketing, the camera cannot shoot in sequence if there is not enough memory in the camera and card for storing more than the selected number of frames.

Picture mode

You can select image tone to create unique image effects. You can also fine-adjust image parameters such as contrast and sharpness for each mode.

MENU ▶ [Q1] ▶ [PICTURE MODE]

The adjustable parameters are classified according to the condition of the picture.

• Contrast/Sharpness/Saturation

- [VIVID] : Produces vivid colors.
- [NATURAL] : Produces natural colors.
- [MUTED] : Produces flat tones.

• Contrast/Sharpness/B&W Filter/Picture tone

- [MONOTONE] : Produces black and white tone.

The individual parameters are as follows.

- [CONTRAST] : Distinction between light and dark
- [SHARPNESS] : Sharpness of the image
- [SATURATION] : Vividness of the color
- [B&W FILTER] : Creates a black and white image. The filter color is brightened and the complementary color is darkened.
 - [N: NEUTRAL] : Creates a normal black and white image.
 - [Ye: YELLOW] : Reproduces clearly defined white cloud with natural blue sky.
 - [Or: ORANGE] : Slightly emphasizes colors in blue skies and sunsets.
 - [R: RED] : Strongly emphasizes colors in blue skies and brightness of crimson foliage.
 - [G: GREEN] : Strongly emphasizes colors in red lips and green leaves.

[PICT. TONE] : Colors the black and white image.

- [N: NEUTRAL] : Creates a normal black and white image.
- [S: SEPIA] : Sepia
- [B: BLUE] : Bluish
- [P: PURPLE] : Purplish
- [G: GREEN] : Greenish

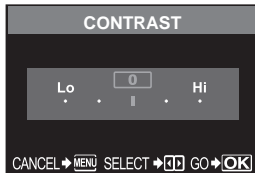
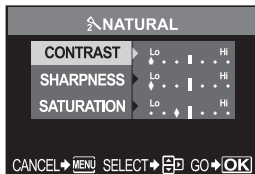
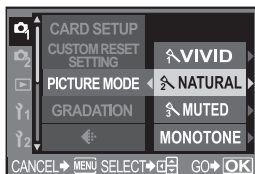

3

Shooting functions — Exposure, image and color

The adjusted parameters are recorded in each picture effect mode. You can select the picture effect modes on the control panel.

Gradation

In addition to the **[NORMAL]** gradation setting, you can select from 2 other gradation settings.

- HIGH KEY (H) : Extended bright gradations.
- LOW KEY (L) : Extended dark gradations.
- NORMAL : Use **[NORMAL]** mode for general uses.



HIGH KEY
Suitable for a subject that is mostly highlighted.



LOW KEY
Suitable for a subject that is mostly shadowed.

3

Shooting functions — Exposure, Image and color

MENU ▸ **[Fn]** ▸ **[GRADATION]**

Notes

- Contrast adjustment does not work when set to **[HIGH KEY]** or **[LOW KEY]**.

Shading compensation

In some cases, the edges of the image may be shadowed due to the properties of the lens. The shading compensation function compensates by increasing brightness at the dark edge of the image. This function is especially useful when a wide-angle lens is used.

MENU ▸ **[Fn2]** ▸ **[SHADING COMP.]**
[OFF]/[ON]

Notes

- This function is not available when a teleconverter or an extension tube is attached to the camera.
- At higher ISO settings, noise in image edges may be conspicuous.

Noise reduction

This function reduces the noise that is generated during long exposures. When shooting night scenes, shutter speeds are slower and noise tends to appear in images. When the shutter speed is slow, noise reduction is activated and the camera automatically reduces noise to produce clearer images. However, shooting time is approximately twice as long as usual.



OFF



ON

MENU ▸ [Fn] ▸ [NOISE REDUCT.] [OFF]/[ON]

- The noise-reduction process is activated after shooting.
- The card access lamp blinks during the noise-reduction process. You cannot take more pictures until the card access lamp goes out.
- **[busy]** is displayed on the viewfinder while noise reduction is operating.

! Notes

- When the **SCENE** mode is set to , **[NOISE REDUCT.]** is fixed to **[ON]**.
- When **[S]** (Sequential shooting) is set, **[NOISE REDUCT.]** is **[OFF]** automatically.
- This function may not work effectively with some shooting conditions or subjects.

Noise filter

You can select the noise processing level. Use **[STANDARD]** for general use. **[HIGH]** is recommended during high sensitivity shooting.

MENU ▸ [Fn] ▸ [NOISE FILTER] [OFF]/[LOW]/[STANDARD]/[HIGH]

Color space

This function lets you select how colors are reproduced on the monitor or printer. The first character in image file names indicates the current color space.  "File name" (P. 81)

P	[sRGB]	Standardized color space for Windows.
— P	[Adobe RGB]	Color space that can be set by Adobe Photoshop.
— _	Adobe RGB	

MENU ▸ [Fn2] ▸ [COLOR SPACE]

Anti-shock

This diminishes camera shake caused by vibrations when the mirror moves. You can select the interval from the time the mirror is raised until the shutter is released. This feature can be useful in astrophotography and microscope photography or other photographic situations where a very slow shutter speed is used, and camera vibration needs to be kept to a minimum.

MENU ▸ [Fn2] ▸ [ANTI-SHOCK] [OFF]/[1SEC] - [30SEC]

4 Playback functions

Single-frame/Close-up playback



The basic procedure for viewing pictures are as shown below.
However, before using any of these functions, follow Step 1 below.

1 Press the (playback) button (Single-frame playback).

- The last recorded image appears.
- The LCD monitor turns off after more than 1 minute if no operations are performed. The camera will turn off automatically if there is no operation after 4 hours (factory default setting). Turn on the camera again.

2 Use to select images you want to view. You can also turn the control dial to switch to for close-up playback.

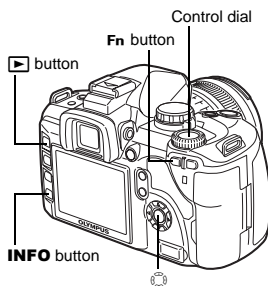

4

Playback functions

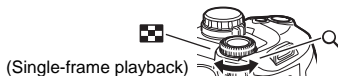

(Single-frame playback)



- : Displays the frame that is stored 10 frames back
- : Displays the frame that is stored 10 frames ahead
- : Displays the next frame
- : Displays the previous frame

Press the **Fn** button

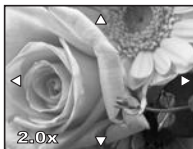

(Close-up playback)

Press to change the close-up position.

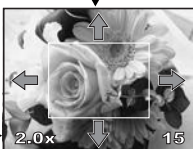

Press the **INFO** button

(Close-up position playback)

Press to move the display of the close-up position.

Press the **INFO** button

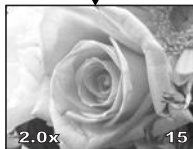

(Close-up playback)

Press to view frame-by-frame close-ups.

- To exit the playback mode, press the button.
- Pressing the shutter button halfway resumes the shooting mode.

Light box display

You can view the playback image and another image together on the left and right sides of the monitor. This is useful if you want to compare images you recorded using bracketing.

1 Press the [••] button while viewing an image.

- The frame being viewed is displayed on the left side of the monitor, and the next frame is displayed on the right side. The image is displayed at the same magnification of the image being viewed.
- The image on the left is the benchmark image.

2 Use to select an image.

- You can protect, erase or copy the image on the right.

3 Press the [••] button.

- The camera returns to single-frame playback of the image on the left at the magnification being viewed.

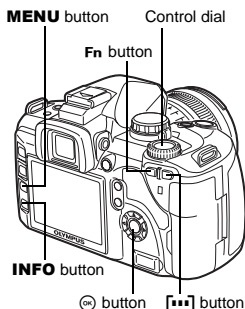

Benchmark image

Operations during light box display

- Pressing the ◀ button replaces the image on the left with the image on the right and becomes the new benchmark image.
- You can use the control dial to change the magnification of both images at the same time.
- Pressing the Fn button or INFO button allows you to move the position of the image on the right with the ◀ button. Pressing the Fn button or INFO button again allows you to move the positions of both images with the ◀ button.

◀ : Selects the right image



◀ : Scrolls the right image



◀ : Scrolls both images in synchronization

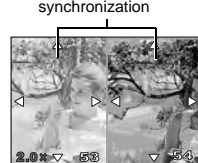





* You can also use the INFO button in the same way for this procedure.

Index display/Calendar display



This function lets you show several images on the monitor at the same time. This is useful when you want to quickly search a number of pictures to find a particular image.

During single-frame playback, each time you turn the control dial toward , the number of images shown changes from 4 to 9 to 16 to 25.

-  : Moves to the previous frame
-  : Moves to the next frame
-  : Moves to the upper frame
-  : Moves to the lower frame

- To return to single-frame playback, turn the control dial to .

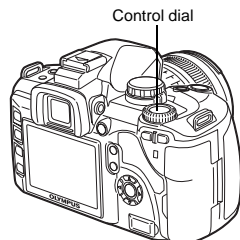

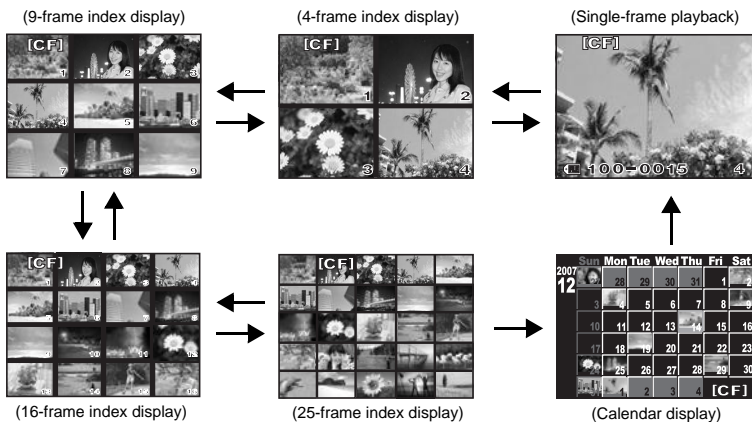

4

Playback functions



Calendar display

With the calendar, you can display images recorded on the card by date. If more than one image was taken on a single date, the image shot first on that date is displayed.

Use  to select a date and press the  button to play back images for the selected date in single-frame display.

This allows you to display detailed information about the image.

Luminance information can also be displayed with histogram and highlight graphs.

Press the INFO button repeatedly until the desired information is displayed.

- This setting is stored and will be shown the next time the information display is called up.

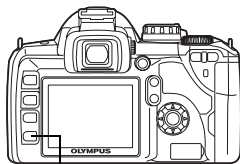

INFO button

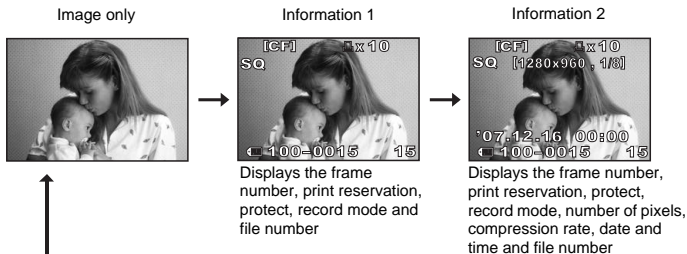

*Histogram

If the bars in the histogram are higher on the right, the image may be too bright. If the bars are higher on the left, the image may be too dark. Compensate the exposure or shoot again.

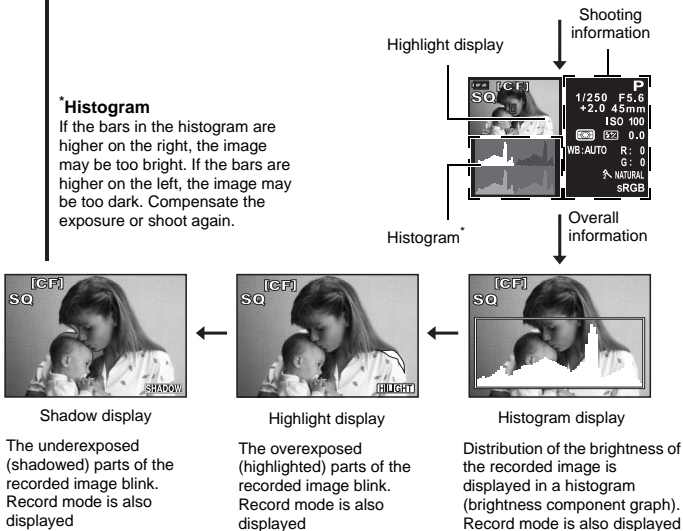

Slideshow

This function displays images stored on the card one after another. Images are displayed one by one for about 5 seconds starting from the currently displayed image. Slideshow can be performed using index display. You can select the number of frames displayed during slideshow from 1, 4, 9, 16 or 25.

1 **MENU** ▸ [▶] ▸ [🖼️]

2 Use  to set.

[🖼️1] (1-frame display)/[🖼️4] (4-frame display)/[🖼️9] (9-frame display)/[🖼️16] (16-frame display)/[🖼️25] (25-frame display)

3 Press the  button to start the slideshow.

4 Press the  button to stop the slideshow.



When selecting [🖼️4]

4

Notes

- If the slideshow is left running for about 30 minutes, the camera will turn off automatically.

Rotating images

This function lets you rotate images and display them vertically on the monitor during single-frame playback. This is useful when taking pictures with the camera held vertically. The images will automatically be displayed in the correct direction even if the camera is rotated.

MENU ▸ [▶] ▸ [🖼️]
[OFF]/[ON]

- When set to [ON], images shot vertically will be automatically rotated and displayed during playback. You can also press the  button to rotate and display the image.
- The rotated image will be recorded on the card in that position.

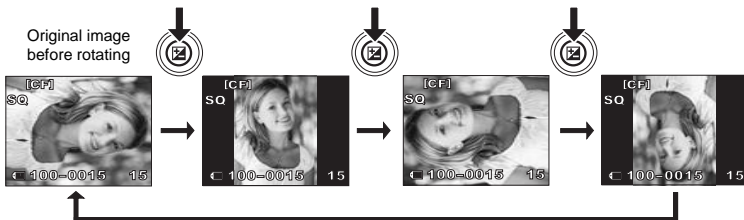
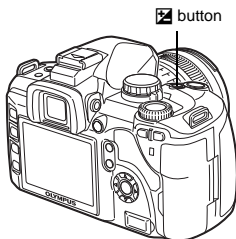

Playback on TV

Use the video cable provided with the camera to play back recorded images on your TV.

- 1 Turn the camera and TV off, and connect the video cable as illustrated.
- 2 Turn on the TV and set it to the video input mode. For details on switching to the video input mode, refer to the TV's manual.
- 3 Turn the camera on and press the  (playback) button.

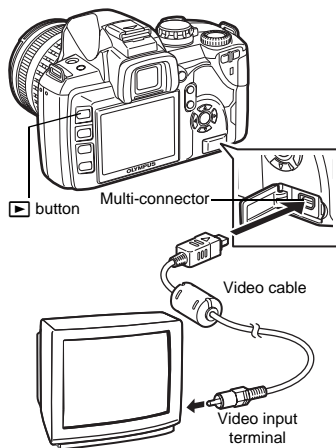

Notes

- To connect the camera to a TV, use the provided video cable.
- Make sure that the camera's video output signal type is the same as the TV's video signal type.  "Video output" (P. 83)
- The camera's monitor turns off automatically when the video cable is connected to the camera.
- The image may appear off-center depending on the TV screen.

Editing still images

Recorded images can be edited and saved as new images. Available editing functions depend on the image format (image record mode). A JPEG file can be printed as is without modification. A RAW file, on the other hand cannot be printed as is. To print a RAW file, use the RAW edit function to convert the RAW data format to JPEG.

Editing images recorded in RAW data format

The camera performs image processing (such as white balance and sharpness adjustment) on images in the RAW data format, then saves the data to a new file in the JPEG format. While checking recorded images, you can edit them to your liking.

Image processing is performed based on the current camera settings. Change the camera settings to suit your preferences before editing.

Editing images recorded in JPEG data format

- | | |
|--|---|
| [BLACK & WHITE] | Creates black and white images. |
| [SEPIA] | Creates sepia-toned images. |
| [REDEYE FIX] | Reduces red-eye phenomenon during flash shooting. |
| [SATURATION] | Sets the color depth. |
|  | Converts the image file size to 1280 x 960, 640 x 480 or 320 x 240. |

1 MENU ▸ [▶] ▸ [EDIT]

2 Use to select images you want to view. Press the button.

- The camera recognizes the image data format.
- When editing other images, use  to select the image.
- For images recorded in RAW+JPEG, a selection screen will appear, asking you to edit the appropriate data.
- To exit the edit mode, press the **MENU** button.

3 The setting screen varies with the image data format. Select the data you want to edit and do the following steps depending on the image data format.

Confirm the data format from here. RAW or SHQ, HQ, SQ (=JPEG)

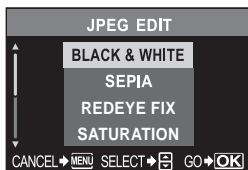
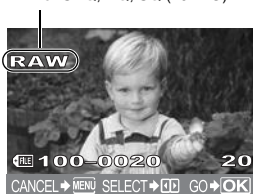

When editing JPEG image

[BLACK & WHITE]/[SEPIA]/[REDEYE FIX]/
[SATURATION]/[

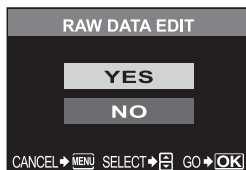

When editing RAW image

RAW editing is based on the camera's current settings. Set the camera to suit your preferences before editing.

- The edited image is saved as another image, apart from the original image.

Notes

- Red-eye correction may not work depending on the image. Red-eye correction may affect other parts of the image, as well as the eyes.
- Resizing is not possible in the following cases:
When an image is recorded in RAW, when an image is processed on a PC, when there is not enough space in the card memory, when an image is recorded on another camera
- When resizing () an image, you cannot select a larger number of pixels than was originally recorded.

This function lets you copy images to and from the xD-Picture Card and CompactFlash or Microdrive. This menu can be selected if both cards are inserted. The selected card is the copying source.

[CF/xD] (P. 108)

Single-frame copy

- 1 Select the desired frame and press the **COPY/** button.
- 2 Use to select [YES], then press .

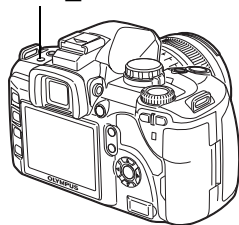

Copying selected frames

This function lets you copy all selected images during single-frame playback or index display.

- 1 Display the images you want to copy and press the button.
 - The selected images will be shown with red frames.
 - To cancel your selection, press the button again.
- 2 Press to display the next images you want to copy and press the button.
- 3 After you have selected the images to copy, press the **COPY/** (copy) button.
- 4 Use to select [YES], then press .
 - It is possible to copy selected frames during index display.

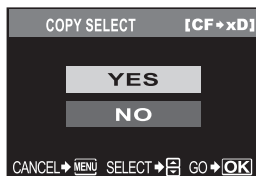

Copying all the frames

- 1 **MENU** ▸ ▸ [COPY ALL]
- 2 Press .
- 3 Use to select [YES].
- 4 Press .

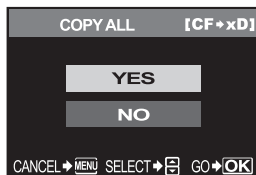

Protecting images — Preventing accidental erasure



Protect images you do not want to erase. Protected images cannot be erased by the single-frame or all-frame erase function.

Single-frame protect

Play back the image you want to protect and press the  (protect) button.

-  (protect mark) is displayed on the top right corner of the screen.

To cancel the protection

Display the images that are protected and press the  button.

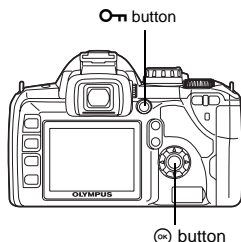



4

Protecting selected frames

This function lets you protect selected images at one time during single-frame playback or index display.

1 Display the images you want to protect and press the  button.

- The selected images will be shown with red frames.
- To cancel your selection, press the  button again.
- During index display, press  to select the images you want to protect and press the  button.

2 Press  to display the next images you want to protect and press the  button.

3 After you have selected the images to protect, press the  (protect) button.



Canceling all protections

This function lets you cancel the protection of several images at one time.

1 MENU ▸ [▶] ▸ [RESET PROTECT]

2 Use   to select [YES], then press .

Notes

- Formatting the card erases all images even if they have been protected.  "Formatting the card" (P. 107)
- Protected images cannot be rotated even when the  button is pressed.

Erasing images



Lets you erase recorded images. You can select single-frame erase, which erases only the currently displayed image; all-frame erase, which erases all the images stored on the card; or selected frame erase, which erases only the frames selected.

Notes

- When you perform all-frame or selected frame erase on images recorded using RAW+JPEG, both the RAW and JPEG images are erased. When using single-frame erase, you can select whether to erase the JPEG, RAW, or both RAW and JPEG images. "Erasing RAW and JPEG files" (P. 81)
- Protected images cannot be erased. Cancel protected images, then erase them.
- Once erased, images cannot be restored. "Protecting images — Preventing accidental erasure" (P. 72)

Single-frame erase

- 1 Play back the image you want to erase.
- 2 Press the (erase) button.
- 3 Use to select [YES], then press .

TIPS

To erase immediately:

→ If you have set [QUICK ERASE] (P. 81) to [ON], pressing the button will erase an image immediately.

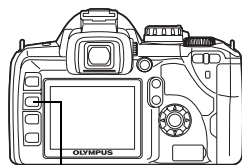

button



4

Playback functions

Erasing selected frames

This function lets you erase selected images at one time during single-frame playback or index display.

- 1 Display the images you want to erase and press the **OK** button.
 - The selected images will be shown with red frames.
 - To cancel your selection, press the **DISP** button again.
 - During index display, press **DISP** to select the images you want to erase and press the **OK** button.
- 2 Press **DISP** to display the next images you want to erase and press the **OK** button.
- 3 After you have selected the images to erase, press the **ERASE** (eraser) button.
- 4 Use **UP**/**DOWN** to select [YES], then press **OK**.

Priority setting

In the [12] menu, [PRIORITY SET] (P. 80) allows you to set the initial position of the cursor to [YES].

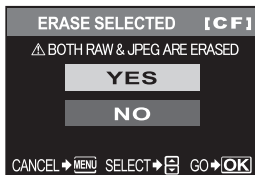

4

Playback functions

All-frame erase

- 1 MENU → [1] → [CARD SETUP]
- 2 Use **UP**/**DOWN** to select [ALL ERASE], then press **OK**.
- 3 Use **UP**/**DOWN** to select [YES], then press **OK**.
 - All frames will be erased.

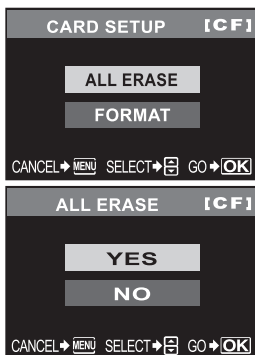

Custom reset setting

Normally, current camera settings (including any changes you have made) are retained when the power is turned off. However, this camera features **[RESET]** that restores the factory default settings and **[RESET1]** and **[RESET2]** that restores settings registered in advance. The camera settings at that time are registered in **[RESET1]** and **[RESET2]**.

MENU ▶ **[OK]** ▶ **[CUSTOM RESET SETTING]**
[RESET]/[RESET1]/[RESET2]

- If settings have already been registered, **[SET]** is displayed next to the **[RESET1]/[RESET2]** option.

Registering reset settings

- 1 Select either **[RESET1]/[RESET2]** to register and press the **[REVERSE]** button.
- 2 Select **[SET]** and press the **[OK]** button.
 - To cancel the registration, select **[RESET]**.

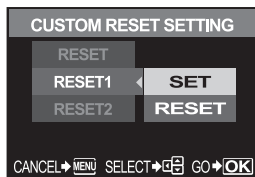

Using reset settings

You can reset the camera to **[RESET1]** or **[RESET2]** setting or restore the factory default settings.

[RESET]: Resets to the factory default settings. For the factory default settings, see "Menu directory" (P. 109).

[RESET1]/[RESET2]: Resets to the registered settings.

- 1 Select either **[RESET]/[RESET1]/[RESET2]** and press the **[OK]** button.
- 2 Use **[UP]** **[DOWN]** to select **[YES]**, then press **[OK]**.



Functions that can be registered

Function	Custom reset setting registration	My Mode registration	Function	Custom reset setting registration	My Mode registration
PICTURE MODE	✓	✓	RAW+JPEG ERASE	✓	—
GRADATION	✓	✓	FUNCTION	✓	—
	✓	✓	MY MODE SETUP	✓	—
	✓	✓	FOCUS RING	✓	—
NOISE FILTER	✓	✓	AF ILLUMINAT.	✓	✓
NOISE REDUCT.	✓	—	RESET LENS	—	—
WB	✓	✓	LIVE VIEW BOOST	✓	✓
ISO	✓	✓	RELEASE PRIORITY S	✓	✓
METERING	✓	✓	RELEASE PRIORITY C	✓	✓
FLASH MODE	✓	✓		✓	—
	✓	✓	FRAME ASSIST	✓	—
	✓	✓	LOCK	✓	—
IMAGE STABILIZER	✓	—		—	—
AF MODE	✓	✓	CF/xD	—	—
	✓	✓	FILE NAME	—	—
AE BKT	✓	✓	EDIT FILENAME	—	—
WB BKT	✓	✓		✓	—
FL BKT	✓	✓		—	—
ANTI-SHOCK	✓	—	VIDEO OUT	—	—
ISO LIMIT	✓	—	REC VIEW	✓	—
EV STEP	✓	—	SLEEP	✓	—
ALL	—	—	BACKLIT LCD	✓	—
HQ	✓	—	4 h TIMER	—	—
SQ	✓	—	BUTTON TIMER	—	—
	✓	—	PRIORITY SET	—	—
X-SYNC	✓	✓	USB MODE	—	—
AUTO POP UP	✓	—	COLOR SPACE	✓	✓
DIAL	✓	—		—	—
AEL/AFL	✓	—	SHADING COMP.	✓	✓
AEL/AFL MEMO	✓	—	PIXEL MAPPING	—	—
AELMetering	✓	—	CLEANING MODE	—	—
QUICK ERASE	✓	—	FIRMWARE	—	—

✓ : Can be registered. — : Cannot be registered.

AEL/AFL mode

You can use the **AEL/AFL** button to perform AF or metering operations instead of using the shutter button. You can use the button in the following ways.

- When you want to focus on a subject and then change the composition of the photo.
- When you want to set the exposure by metering an area different from where the camera is focused.

Select the function of the button to match the operation when the shutter button is pressed. Select **[mode1]** to **[mode4]** in each focus mode. (You can only select **[mode4]** in C-AF mode.)

MENU ▸ [*i*] ▸ **[AEL/AFL]**
[S-AF]/[C-AF]/[MF]

Modes available in the S-AF mode

Mode	Shutter button function				AEL/AFL button function	
	Half-press		Full press		When holding down AEL/AFL	
	Focus	Exposure	Focus	Exposure	Focus	Exposure
mode1	Locked	Locked	—	—	—	Locked
mode2	Locked	—	—	Locked	—	Locked
mode3	—	Locked	—	—	Locked	—

Modes available in the C-AF mode

Mode	Shutter button function				AEL/AFL button function	
	Half-press		Full press		When holding down AEL/AFL	
	Focus	Exposure	Focus	Exposure	Focus	Exposure
mode1	Focusing starts	Locked	Locked	—	—	Locked
mode2	Focusing starts	—	Locked	Locked	—	Locked
mode3	—	Locked	Locked	—	Focusing starts	—
mode4	—	—	Locked	Locked	Focusing starts	—

Modes available in the MF mode

Mode	Shutter button function				AEL/AFL button function	
	Half-press		Full press		When holding down AEL/AFL	
	Focus	Exposure	Focus	Exposure	Focus	Exposure
mode1	—	Locked	—	—	—	Locked
mode2	—	—	—	Locked	—	Locked
mode3	—	Locked	—	—	S-AF	—

Other function settings

AEL/AFL memo

You can lock and maintain the exposure by pressing the **AEL/AFL** (AE lock) button.

MENU ▸ [i] ▸ [AEL/AFL MEMO]

[ON] : Press the **AEL/AFL** button to lock and maintain the exposure. Press again to cancel the maintaining of the exposure.

[OFF] : The exposure will be locked only while the **AEL/AFL** button is pressed.

AEL metering

Sets the metering mode for when pressing the **AEL/AFL** (AE lock) button to lock the exposure.

MENU ▸ [i] ▸ [AELMetering]

[AUTO]/**[☉]**/**[□]**/**[□]HI**/**[□]SH**

- **[AUTO]** performs metering in the mode selected under **[METERING]** mode.

EV step

This allows you to change the EV step for exposure parameter setting, such as shutter speed, aperture value, exposure compensation value, etc.

MENU ▸ [i] ▸ [EV STEP]

[1/3EV]/**[1/2EV]**/**[1EV]**

ISO limit

When **[ISO]** is set to **[AUTO]**, you can set the maximum ISO that is set automatically.

MENU ▸ [i] ▸ [ISO LIMIT]

[100]/**[200]**/**[400]**

Compensating all WB



This lets you apply the same compensation value to all the white balance modes at once.

MENU ▸ [i] ▸ [ALL **WB** %]

[ALL SET] : The same compensation value applies to all WB modes.

[ALL RESET] : The WB compensation value settings applied to each WB mode are all cleared at once.

If you select [ALL SET]

- 1) Use  to select the color direction.
R-B Red—Blue/G-M Green—Magenta
- 2) Use  to set compensate value.  “WB compensation” (P. 59)
 - You can check the white balance you have adjusted.

If you select [ALL RESET]

- 1) Use  to select **[YES]**.

Speed synchronization

You can set the shutter speed that will be used when the built-in flash fires. The speed can be set from 1/60 to 1/180.

MENU ▸ [i] ▸ [X-SYNC]

[1/60] - **[1/180]**

- For details on the synchronization speed of commercially available flashes, refer to their manuals.

Auto pop up

The built-in flash pops up automatically in low light or backlight conditions while in the **AUTO** or scene mode.

This allows you to stop the built-in flash from popping up automatically.

MENU ▶ [] ▶ [AUTO POP UP]

[ON] : The built-in flash pops up automatically.

[OFF] : The built-in flash will not pop up automatically.

Fn FUNCTION

This lets you assign a function to the **Fn** button.

MENU ▶ [] ▶ [Fn FUNCTION]

[OFF]

Does not allow function allocation.



Press the **Fn** button to acquire the WB value.

☞ "Setting the one-touch white balance" (P. 60)

[TEST PICTURE]

Pressing the shutter button while pressing the **Fn** button enables you to check the picture you have just taken on the monitor without having to record the picture to the card. This is useful when you want to see how a picture turned out without saving it.

[MY MODE]

While holding down the **Fn** button, you can take pictures using the camera settings registered in the **[MY MODE SETUP]**. ☞ "My Mode setting" (P. 80)

[PREVIEW]/[LIVE PREVIEW] (electronic)

While holding down the **Fn** button, you can use the preview function.

☞ "Preview function" (P. 35)

Live view boost

During live view shooting, you can brighten the monitor for easier confirmation on the subject.

MENU ▶ [] ▶ [LIVE VIEW BOOST]

[OFF]

The subject is displayed on the monitor with the brightness level that is adjusted according to the exposure being set. You can shoot while confirming through the monitor in advance to get a picture that is to your liking.

[ON]

The camera automatically adjusts the brightness level and displays the subject on the monitor for easier confirmation. The effect of the exposure compensation adjustments will not be reflected on the monitor.

Customizing the control dial's function

You can set the control dial's operation to settings the opposite from the factory default setting. The control dial can be used to operate the exposure compensation setting instead of the program shift setting in **P** mode, and the aperture value setting instead of the shutter speed setting in **M** mode.

MENU ▶ [] ▶ [DIAL] [P]/[M]

If you select [P]: P mode

Setting	Set using the control dial	Set using the control dial while pressing the button
Ps (factory default setting)	Program shift (Ps)	Exposure compensation
	Exposure compensation	Program shift (Ps)

If you select [M]: M mode

Setting	Set using the control dial	Set using the control dial while pressing the  button
SHUTTER (factory default setting)	Shutter speed	Aperture value
FNo.	Aperture value	Shutter speed

My Mode setting

This allows you to register 2 different combinations of camera settings. It is useful when you want to temporarily change the settings during memo shooting. You can set either of the **[MY MODE SETUP]** in the menu in advance. For My Mode, set **[Fn] FUNCTION** to **[MY MODE]** and when using it, shoot while pressing the **Fn** button.  "Fn FUNCTION" (P. 79)

MENU ▶ [1] ▶ [MY MODE SETUP]

[MY MODE1]/[MY MODE2]

- If menu settings have already been registered, **[SET]** is displayed next to the corresponding reset option.

Registering

Select **[SET]** and press the  button.

- The current settings are registered in the camera. For details on the functions that can be registered to My Mode, refer to "Functions that can be registered" ( P. 76).
- To cancel the registration, select **[RESET]**.

Executing

Select **[MY MODE1]** or **[MY MODE2]** and press the  button.

- Select **[YES]** and press the  button to set to the available My Mode.

Reset lens

This allows you to reset the focus of the lens (infinity) when the power is turned off.

MENU ▶ [1] ▶ [RESET LENS]

[OFF]/[ON]

Focus ring

This allows you to customize how the lens adjusts to the focal point by selecting the rotational direction of the focus ring.

MENU ▶ [1] ▶ [FOCUS RING]

[C]/[Q]

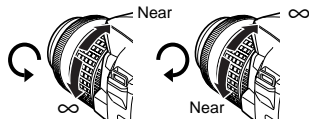

Priority setting

This allows you to customize the initial position of the cursor (**[YES]** or **[NO]**) on the **[ALL ERASE]** or **[FORMAT]** screen.



MENU ▶ [2] ▶ [PRIORITY SET]

[YES]/[NO]

Quick erase

This lets you erase the picture you have just taken immediately using the  (erase) button.

MENU ▸ [1] ▸ [QUICK ERASE]

- [OFF] When the  (erase) button is pressed, the confirmation screen appears, asking you if you want to erase the picture.
- [ON] Pressing the  (erase) button erases the picture immediately.

Erasing RAW and JPEG files

This lets you select the method to erase images recorded in RAW+JPEG. It is a function effective only when deleting one frame.

MENU ▸ [1] ▸ [RAW+JPEG ERASE]

- [JPEG] Erases all JPEG image files, leaving only the RAW image files.
- [RAW] Erases all RAW image files, leaving only the JPEG image files.
- [RAW+JPEG] Erases both image file types.

Notes

- This function is effective only if deleting one frame. For all-frame erase or erasing selected frames, both RAW and JPEG will be erased regardless of this setting.

File name

When you take a picture, the camera assigns it a unique file name and saves it in a folder. The folder and file name can later be used for file handling on a computer. File names are assigned as shown in the illustration below.

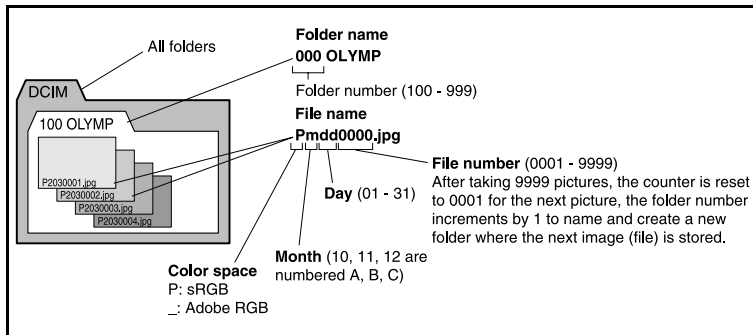

MENU ▸ [2] ▸ [FILE NAME]

[AUTO]

Even when a new card is inserted, the folder numbers are retained from the previous card. If the new card contains an image file whose file number coincides with one saved on the previous card, the new card's file numbers start at the number following the highest number on the previous card.

[RESET]

When a new card is inserted, folder numbers start at 100 and file numbers start at 0001. If a card containing images is inserted, the file numbers start at the number following the highest file number on the card.

- When both the Folder and File No. reach their respective maximum number (999/9999), it is not possible to store additional pictures even if the card is not full. No more pictures can be taken. Replace the card with a new one.

Rename file

You can rename image files to make them easier to identify and organize.

Select [sRGB] or [Adobe RGB].

"Color space" (P. 63)

MENU ▶ [1/2] ▶ [EDIT FILENAME]

Use to enter the first character. Press to move to the next setting, then use to enter the second character.

sRGB : Pmdd0000.jpg AdobeRGB : _mdd0000.jpg

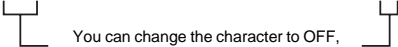

You can change the character to OFF,
A - Z or 0 - 9.

Rec view — Checking the picture immediately after shooting

This allows you to display the picture you have just taken on the monitor while it is being recorded to the card, and to select how long the picture is displayed. This is useful for making a brief check of the picture you have just taken. Pressing the shutter button halfway while checking the picture lets you resume shooting immediately.

MENU ▶ [1/2] ▶ [REC VIEW]

[OFF] The picture being recorded to the card is not displayed.
[1SEC] - [20SEC] Selects the number of seconds to display each picture. Can be set in units of 1 second.

Setting the beep sound

You can turn off the beep sound that is emitted when the focus locks by pressing the shutter button.

MENU ▶ [1/1] ▶ [●/)]]
[OFF]/[ON]

Monitor brightness adjustment

This allows you to adjust the brightness of the monitor for optimal viewing.

MENU ▶ [1/2] ▶ [☰/☷]
Use to adjust the brightness.

Sleep timer

After a specified period of time elapses with no operations being performed, the camera enters the sleep mode (stand-by) to save battery power. After the control panel is displayed for a specified period of time, the backlight turns off. After a specific period of time has further passed, the camera enters sleep mode. [SLEEP] lets you select sleep timer. [OFF] cancels the sleep mode. The camera activates again as soon as you touch any button (the shutter button, arrow pad, etc.).

MENU ▶ [1/2] ▶ [SLEEP]
[OFF]/[1MIN]/[3MIN]/[5MIN]/[10MIN]

Backlight timer

To save battery power, after the control panel is displayed for a specified period of time, the monitor backlight turns off and the monitor darkens. **[HOLD]** sets the backlight to stay on. The monitor backlight turns on again as soon as you touch any button (the shutter button, arrow pad, etc.).

MENU ▸ **[1/2]** ▸ **[BACKLIT LCD]**
[8SEC]/[30SEC]/[1MIN]/[HOLD]

USB mode

You can connect the camera directly to a computer or printer with the provided USB cable. If you specify the device you are connecting to beforehand, you can skip the USB connection setting procedure normally required every time you connect the cable to the camera. For details on how to connect the camera to either device, refer to "Connecting the camera to a printer" (P. 88) and "Connecting the camera to a computer" (P. 92).

MENU ▸ **[1/2]** ▸ **[USB MODE]**
[AUTO]

The selection screen for the USB connection will be displayed every time you connect the cable to a computer or printer.

[STORAGE]

Allows you to transfer images to a computer. Also, select to use the OLYMPUS Master software via PC connection.

[MTP]

Allows you to transfer images to a computer running Windows Vista without using the OLYMPUS Master software.

[CONTROL]

Allows you to control the camera from a PC using the optional OLYMPUS Studio.

[EASY]

Can be set when connecting the camera to a PictBridge-compatible printer. Pictures can be printed directly without using a PC.

☞ "Connecting the camera to a printer" (P. 88)

[CUSTOM]

Can be set when connecting the camera to a PictBridge-compatible printer. You can print out pictures with set number of prints, print paper and other settings.

☞ "Connecting the camera to a printer" (P. 88)

Changing the display language

You can change the language used for the on-screen display and error messages from ENGLISH to another language.

MENU ▸ **[1/2]** ▸ **[Language]**

Use **[Left]** **[Right]** to select the language you want to use.

- You can add another language to your camera with the provided OLYMPUS Master software. For details, refer to Help in OLYMPUS Master software. ☞ "Using the OLYMPUS Master software" (P. 91)

Video output

This lets you select NTSC or PAL according to your TV's video signal type.

You will need to set this when you want to connect the camera to a TV and play back images in a foreign country. Make sure the correct video signal type is selected before connecting the video cable. If you use the wrong video signal type, recorded pictures will not play back properly on your TV.

MENU ▸ **[1/2]** ▸ **[VIDEO OUT]**
[NTSC]/[PAL]

TV video signal types in major countries and regions

Check the video signal type before connecting the camera to your TV.

NTSC	North America, Japan, Taiwan, Korea
PAL	European countries, China

Button timer

When functions are set with the direct buttons, this function allows you to set the duration from when you stop operating the buttons to when the menu disappears.

MENU ▸ [**2**] ▸ [**BUTTON TIMER**]

[**HOLD**]

You can take as long as you like to complete function setting. The current screen will remain until you press the button again.

[**3SEC**]/[**5SEC**]/[**8SEC**] You can change the setting during the number of seconds indicated.

Auto power off

You can set the camera to turn off automatically if not operated for a long time. It will not turn off if this is set to [**OFF**].

MENU ▸ [**2**] ▸ [**4 h TIMER**]

[**OFF**]/[**4 h**]

(arrow pad) lock

To prevent any unwanted operations, you can lock the arrow pad so that the functions assigned to the arrow pad buttons are not activated when pressed.  "Setting functions using direct buttons" (P. 20)

MENU ▸ [**1**] ▸ [**LOCK**]

[**OFF**]/[**ON**]



You can switch the functions of the **AEL/AFL** button and the **Fn** button. When you select [**ON**], the **AEL/AFL** button will function as the **Fn** button, and the **Fn** button will function as the **AEL/AFL** button.

MENU ▸ [**2**] ▸ []



[**OFF**]/[**ON**]

Firmware

Your product's firmware version will be displayed.

When you make inquiries about your camera or accessories or when you want to download software, you will need to state which version of each of the products you are using.

MENU ▸ [**2**] ▸ [**FIRMWARE**]

Press . Your product's firmware version will be displayed. Press the  button to return to the previous screen.

6 Printing

Print reservation (DPOF)



Print reservation

Print reservation allows you to save printing data (the number of prints and the date/time information) with the pictures stored on the card.

Insert the card that contains the recorded pictures into the camera.

Pictures set with print reservation can be printed using the following methods.

Printing using a DPOF-compatible photo lab

You can print the pictures using the print reservation data.

Printing using a DPOF-compatible printer

Pictures can be printed directly from a dedicated printer without using a PC. For more details, refer to the printer's manual. A PC card adapter may also be necessary.

Notes

- DPOF reservations set by another device cannot be changed by this camera. Make changes using the original device. Moreover, setting new DPOF reservations using this camera will erase the previous reservations set by another device.
- Not all functions may be available on all printers or at all photo labs.
- RAW data are not printable.

Single-frame reservation

Follow the operation guide to set print reservation for a picture.

1 MENU ▸ [▶] ▸ [📄]

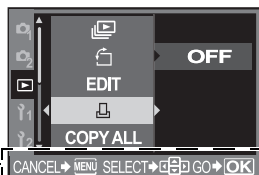

2 Select [📄] and press the **OK** button.



3 Press [👁] to select the frame that you want to set as print reservation, then press [👁] to set the number of prints.

- To set print reservation for several pictures, repeat this step.



4 Press the **OK** button when you have finished.

- The menu screen for single-frame reservation appears.

5 Use **OK** to select the date and time format.

- [NO] The pictures are printed without the date and time.
[DATE] The pictures are printed with the shooting date.
[TIME] The pictures are printed with the shooting time.

6 Select [SET] and press the **OK** button.

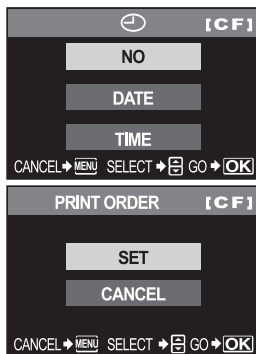

All-frame reservation

Applies print reservation to all the pictures stored in the card. The number of prints is fixed at 1.

1 **MENU** > [▶] > [📄]

2 Select [ALL] and press the **OK** button.

3 Use **OK** to select the date and time format.

- [NO] The pictures are printed without the date and time.
[DATE] The pictures are printed with the shooting date.
[TIME] The pictures are printed with the shooting time.

4 Select [SET] and press the **OK** button.

Resetting the print reservation data

You can reset all print reservation data or just the data for selected pictures.

1 **MENU** > [▶] > [📄]









Resetting the print reservation data for all pictures

2 Select [📄] or [ALL] and press the **OK** button.

3 Select [RESET] and press the **OK** button.



Resetting the print reservation data for a selected picture

- 2 Select [] and press the  button.
- 3 Select [KEEP] and press the  button.
- 4 Use   to select the frame with print reservation data you want to reset, then press  to set the number of prints to 0.
- 5 Press the  button when you have finished.
- 6 Use  to select the date and time format.
 - This setting is applied to all frames with print reservation data.
- 7 Select [SET] and press the  button.

Direct printing (PictBridge)



By connecting the camera to a PictBridge-compatible printer with the USB cable, you can print out recorded pictures directly. To find out if your printer is compatible with PictBridge, refer to the printer's manual.

PictBridge

The standard that enables digital cameras and printers made by different manufacturers to be connected, and also allows pictures to be printed directly from the camera.

STANDARD

All printers that support PictBridge have standard print settings. By selecting [STANDARD] on the settings screens ( P. 89), you can print pictures according to these settings. For details on your printer's standard settings, refer to the printer's manual or contact the printer manufacturer.

- The available print modes and settings such as paper size vary with the type of printer. For details, refer to the printer's manual.
- For details on printing paper types, ink cassettes, etc., refer to the printer's manual.

Notes

- Use a fully charged battery for printing.
- Images recorded in RAW data cannot be printed.
- The camera will not enter sleep mode while it is connected to the USB cable.

Connecting the camera to a printer

Use the provided USB cable to connect the camera to a PictBridge-compatible printer.

1 Turn the printer on and connect the camera's multi-connector to the printer's USB port with the USB cable

- For details on how to turn the printer on and the position of the USB port, refer to the printer's manual.

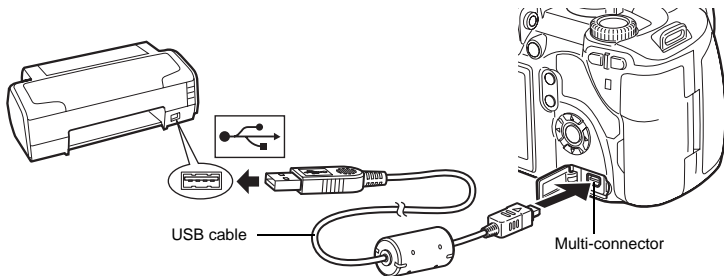

2 Turn on the camera.

- The selection screen for the USB connection is displayed.

3 Use to select [EASY PRINT] or [CUSTOM PRINT].

If you select [EASY PRINT]

- Go to "Easy printing" (P. 88).

If you select [CUSTOM PRINT]

- [ONE MOMENT] is displayed and the camera and printer are connected.
Go to "Custom printing" (P. 89).

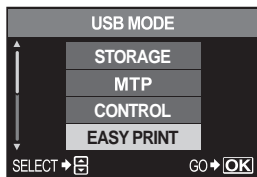

Notes



- If the screen is not displayed after a few minutes, disconnect the USB Cable and start again from Step 1.

Easy printing

1 Use to display the pictures you want to print on the camera.

- Display the image you want to print on the camera and connect the camera with a printer using a USB cable.
The screen on the right appears shortly.

2 Press the (print) button.

- The picture selection screen appears when printing is completed. To print another picture, use  to select the image and press the  button.
- To exit, unplug the USB cable from the camera while the picture selection screen is displayed.



1 Follow the operation guide to set a print option.

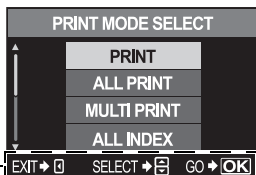

Follow the operation guide displayed here.

Selecting the print mode

Select the type of printing (print mode). The available print modes are as shown below.

[PRINT]	Prints selected pictures.
[ALL PRINT]	Prints all the pictures stored in the card and makes one print for each picture.
[MULTI PRINT]	Prints multiple copies of one image in separate frames on a single sheet.
[ALL INDEX]	Prints an index of all the pictures stored in the card.
[PRINT ORDER]	Prints according to the print reservation you made. If there is no picture with print reservation, this is not available. (P. 85)

Setting the print paper items

This setting varies with the type of printer. If only the printer's STANDARD setting is available, you cannot change the setting.

[SIZE]	Sets the paper size that the printer supports.
[BORDERLESS]	Selects whether the picture is printed on the entire page or inside a blank frame.
[PICS/SHEET]	Selects the number of pictures per sheet. Displayed when you have selected [MULTI PRINT].

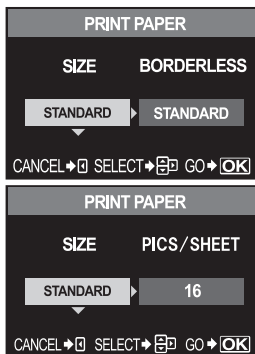

Selecting pictures you want to print

Select pictures you want to print. The selected pictures can be printed later (single-frame reservation) or the picture you are displaying can be printed right away.

[PRINT] (OK)

Prints the currently displayed picture. If there is a picture that [SINGLE PRINT] reservation has already been applied to, only that reserved picture will be printed.

[SINGLE PRINT] (A)

Applies print reservation to the currently displayed picture. If you want to apply reservation to other pictures after applying [SINGLE PRINT], use (3) to select them.

[MORE] (V)

Sets the number of prints and other items for the currently displayed picture, and whether or not to print it. (P. 90) "Setting printing data" (P. 90)



Setting printing data

Select whether to print printing data such as the date and time or file name on the picture when printing.

[]x

Sets the number of prints.

[DATE]

Prints the date and time recorded on the picture.

[FILE NAME]

Prints the file name recorded on the picture.

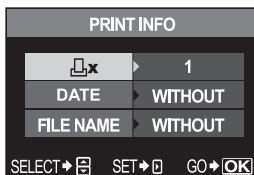

6

Printing

2 Once you have set the pictures for printing and printing data, select [PRINT], then press the (OK) button.

[PRINT]

Transfers images you print to the printer.

[CANCEL]

Resets the settings. All print reservation data will be lost. If you want to keep the print reservation data and make other settings, press (3). This returns you to the previous setting.

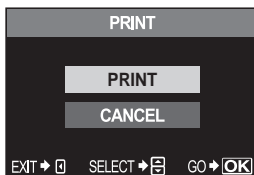

- To stop and cancel printing, press the (C) button.

[CONTINUE]

Continues printing.

[CANCEL]

Cancels printing. All print reservation data will be lost.

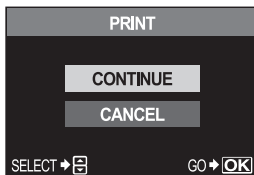

7 Using the OLYMPUS Master software

Flowchart

Just connect the camera to a computer with the USB cable and you can easily transfer images stored on the card to the computer with the provided OLYMPUS Master software.

Things to prepare

- OLYMPUS Master 2 CD-ROM
- USB cable
- Computer equipped with USB port

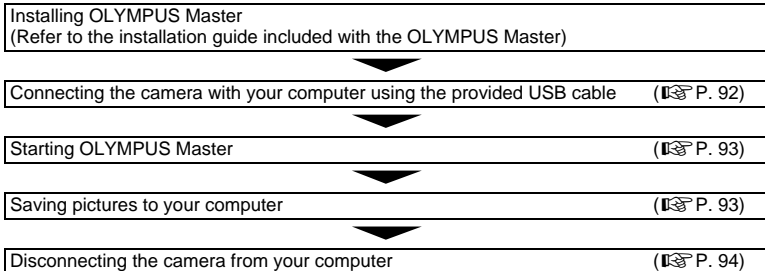

Using the provided OLYMPUS Master software

What is OLYMPUS Master?

OLYMPUS Master is an image management program with viewing and editing features for pictures taken with your digital camera. Once installed on your computer, you can take advantage of the following.

- **Transferring images from the camera or removable media to your computer**
- **Viewing images**
You can also enjoy slideshows and sound playback.
- **Grouping and organizing images**
You can organize images into albums or folders. Transferred images are automatically organized by shooting date, allowing you to quickly find the particular images you want.
- **Correcting images using filter and correction functions**
- **Editing images**
You can rotate, trim or change the image size.
- **A variety of printing formats**
You can easily make prints of your pictures.
- **Creating panorama images**
You can make a panorama from the photos you have taken using the panorama function.
- **Updating the camera firmware**

For information about OLYMPUS Master's other features, as well as for details on how to use the software, refer to "Help" in OLYMPUS Master software.

Connecting the camera to a computer

Connect the camera to your computer with the provided USB cable.

1 Use the provided USB cable to connect the computer's USB port to the camera's multi-connector.

- The location of the USB port varies with the computer. For details, refer to your computer's manual.

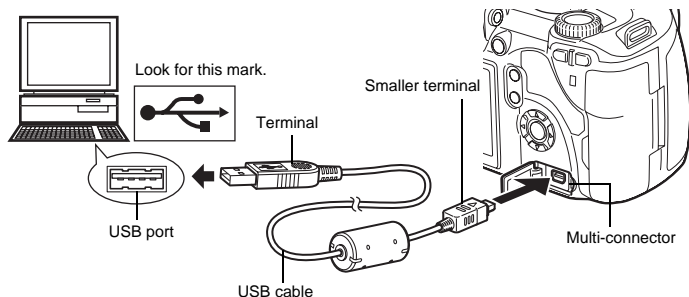

2 Set the camera's power switch to **ON**.

- The selection screen for the USB connection is displayed.

3 Press to select [STORAGE]. Press the button.

4 The computer recognizes the camera as a new device.

- Windows
When you connect the camera to the computer for the first time, the computer automatically recognizes the camera. Click "OK" when the message saying that the installation is completed appears.
The computer recognizes the camera as a "Removable Disk ".
- Macintosh
iPhoto is the default image management application for Mac OS. When you connect your Olympus digital camera for the first time, iPhoto will start up automatically. Close iPhoto and start OLYMPUS Master.

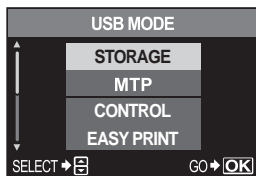

Notes

- When the camera is connected to the computer, none of the camera buttons are functional.

7

Using the OLYMPUS Master software

Start up the OLYMPUS Master software

■ Windows

1 Double-click the “OLYMPUS Master 2” icon  on the desktop.

■ Macintosh

1 Double-click the “OLYMPUS Master 2” icon  in the “OLYMPUS Master 2” folder.

- The browse window is displayed.
- When OLYMPUS Master is started up for the first time after installation, the OLYMPUS Master initial setting screen and user registration screen are displayed before the browse window. Follow the on-screen instructions.

To exit OLYMPUS Master

1 Click “Exit”  on any window.

- OLYMPUS Master is exited.

Displaying camera images on a computer

Downloading and saving images

1 Click “Transfer Images”  on the browse window, and then click “From Camera” .

- The window for selecting the pictures you want to transfer from the camera is displayed. All the images in the camera are displayed.

2 Select “New Album” and enter an album name.

3 Select the image files and click “Transfer Images”.

- A window indicating that the download is complete is displayed.

4 Click “Browse images now”.

- The downloaded images are displayed in the browse window.



7

Using the OLYMPUS Master software

Disconnecting the camera from your computer

- 1 Make sure that the card access lamp has stopped blinking.

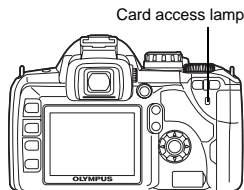

- 2 Prepare to remove the USB cable.

■ Windows

- 1) In the system tray, click the "Unplug or Eject Hardware" icon .
- 2) Click on the pop-up message.
- 3) Click "OK" on the "Safe to Remove Hardware" window.



■ Macintosh

- 1) The trash icon changes to the eject icon when the "Untitled" or "NO_NAME" icon on the desktop is dragged. Drag and drop it on the eject icon.



7

- 3 Unplug the USB cable from the camera.

! Notes

- For Windows users:
When you click "Unplug or Eject Hardware", a warning message may be displayed. In such case, make sure that no image data is being downloaded from the camera, and that there are no applications open that were accessing the camera image files. Close any such applications and click "Unplug or Eject Hardware" again and then remove the cable.

Viewing still images

1 Click the “Album” tab on the browse window and select the album that you want to view.

- The selected album image is displayed in the thumbnail area.

2 Double-click the still picture thumbnail that you want to view.

- OLYMPUS Master switches to the image edit window and the picture is enlarged.
- Click “Back”  to return to the browse window.



To increase the number of languages

Please take care that your battery is fully charged!

1 Make sure that your computer is connected to the Internet.

2 Plug the USB cable into the USB port on the computer.

3 Plug the other end of the USB cable into the camera’s USB connector.

- The camera turns on automatically.
- The monitor turns on and the selection screen for the USB connection is displayed.

4 Select [STORAGE], and press .

5 In the browse window, select “Camera”, then “Update Camera/Add Display Language”.

- The confirmation window for updating is displayed.

6 Click “OK”.

- The updating the camera window is displayed.

7 Click “Add Language” in the updating camera display.

- The “Add Display Language of Camera” window is displayed.



8 Click and select a language.

9 Click “Add”.

- The new language is downloaded to your camera. Please do not remove any cable or the battery while the camera is processing.



10 After the download procedure the camera display will show “OK”. You can remove the cables and turn power off. After restarting the camera you will be able to choose the new language from [🌐📄].

Transferring images to your computer without using OLYMPUS Master

Your camera supports the USB Mass Storage Class. You can transfer images to a computer by connecting the camera to the computer with the provided USB cable. This can be done even without using OLYMPUS Master. The following operating systems are compatible with the USB connection:

Windows : Windows 98SE/Me/2000 Professional/XP Home Edition/XP Professional/Vista
Macintosh : Mac OS 9.0 - 9.2/X

! Notes

- If your computer is running Windows 98SE, you will need to install the USB driver. Before connecting the camera to your computer with the USB cable, double-click the files from the following folders on the provided OLYMPUS Master CD-ROM.
(Drive name): \win98usb\INSTALL.EXE
- If your computer is running Windows Vista, select **[MTP]** in Step 3 on page 92 to use Windows Photo Gallery.
- Data transfer is not guaranteed in the following environments, even if your computer is equipped with a USB port.
 - Windows 95/98/NT 4.0
 - Windows 98SE upgrades from Windows 95/98
 - Mac OS 8.6 or earlier
 - Computers with a USB port added by means of an extension card, etc.
 - Computers without a factory-installed OS and home-built computers

8 Getting to know your camera better

Shooting tips and information

Tips before you start taking pictures

The camera does not turn on even when a battery is loaded

The battery is not fully charged

- Charge the battery with the charger.

The battery is temporarily unable to function because of the cold

- Battery performance declines in low temperatures, and the charge may not be sufficient to turn on the camera. Remove the battery and warm it by putting it in your pocket for a while.

No picture is taken when the shutter button is pressed

The camera has turned off automatically

- To save battery power, if there is no operation even while the camera is on (monitor is lit), the camera goes into sleep mode after a fixed period of time and the camera stops operating. When this happens, the LCD monitor's light will go off. The camera will turn off automatically if there is no further operation for 4 hours. The camera will not work until it is turned back on.  "Sleep timer" (P. 82), "Auto power off" (P. 84)

The flash is charging

- When the flash is activated and the  symbol in the control panel or the viewfinder is blinking, this indicates that the flash is charging. Wait for the blinking to stop, then press the shutter button.

Unable to focus

- When the AF confirmation mark in the viewfinder is blinking, it indicates that the camera is unable to focus using AF. Press the shutter button again.

Noise reduction is activated

- When shooting night scenes, shutter speeds are slower and noise tends to appear in images. The camera activates the noise-reduction process after shooting at slow shutter speeds. During which, shooting is not allowed. You can set [NOISE REDUCT.] to [OFF].  "Noise reduction" (P. 82)

The date and time has not been set

The camera is used with the settings at the time of purchase

- The date and time of the camera is not set when purchased. Set the date and time before using the camera.  "Setting the date/time" (P. 8)

The battery has been removed from the camera

- The date and time settings will be returned to the factory default settings if the camera is left without the battery for approximately 1 day. The settings will be canceled more quickly if the battery was only loaded in the camera for a short time before being removed. Before taking important pictures, check that the date and time settings are correct.

Shooting tips

Focusing on the subject

There are several ways to focus, depending on the subject.

AF frame is not focused on the subject

- Use focus lock to focus the AF frame on the subject.  "If correct focus cannot be obtained (Focus lock)" (P. 37)

Other things instead of the subject are focused on the respective AF frames

- Set [AF-ON] (AF frame selection) to [] and focus on the center of the image.
☞ "AF frame selection" (P. 49)

The subject is moving quickly

- Focus the camera on a point roughly the same distance away as the subject you want to shoot (by pressing the shutter button halfway), and then recompose your picture and wait for the subject to enter the frame.

Close up on the subject using macro lens

- When using macro lens to close up on the subject, it is difficult to focus with AF when the enlargement ratio of the subject is bigger. Set to manual focus (MF), rotate the focus ring and focus manually. ☞ "MF (manual focus)" (P. 50)

Taking pictures in low light conditions

- The built-in flash can be set to function as an AF illuminator. The flash helps to focus in low-light conditions in the AF mode when raised. ☞ "Using the built-in flash" (P. 42), "AF illuminator" (P. 51)

Subjects that are difficult to focus on

It may be difficult to focus with auto focus in the following situations.

AF confirmation mark is blinking.
These subjects are not focused.

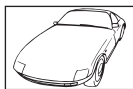

Subject with low contrast



Excessively bright light in center of frame

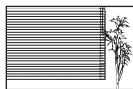

Subject with repeated patterns

AF confirmation mark lights up but the subject is not focused.



Subjects at different distances

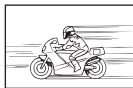

Fast-moving subject



Subject not inside AF frame

8

In any situation, focus on something with high contrast that is at the same distance as the subject, determine the composition and shoot the picture.

Taking pictures without blurring

There are several factors that can cause the picture to blur.

The subject is too dark

- Change the shutter speed to match the brightness of the subject. If the shutter speed is set low to shoot a dark subject, blurring is likely to occur if the subject moves. In addition, when the flash is turned on in **SCENE** (Scene mode), the shutter speed becomes slower. Mount the camera on a tripod. Using the remote control (optional) to close the shutter is also effective for reducing blurring.

There are also ways to shoot with [DIS] (DIS MODE) under **SCENE** (Scene mode). As the ISO sensitivity increases automatically, you can hand hold the camera and take pictures in low light situations with the flash off.

The camera or your hand moves when pressing the shutter button.

- Press the shutter button gently or hold the camera securely with both hands.
- Use the image stabilizer function. ☞ "Shooting with the image stabilizer function" (P. 36)

Taking pictures with less flash

The flash will light up automatically when it is not bright enough. If the subject is too far away, the flash may have no effect. Here is how to take pictures without the flash in this type of situation.

Setting the image stabilizer function

- This function reduces camera shake, enabling you to hold the camera and take pictures in low light situations with the flash off.  "Shooting with the image stabilizer function" (P. 36)

Set **SCENE** (Scene mode) to (**DIS MODE**)

- As the image stabilizer (**I.S. 1**) is automatically activated, the ISO sensitivity also increases automatically. You can hand-hold the camera and take pictures in low light situations with the flash off.

Increase the **[ISO]** setting

- Increase the value of the **[ISO]** setting. The image may become grainy.  "ISO — Setting the desired sensitivity to light" (P. 56)

The picture is too grainy

There are several factors that can cause the picture to appear grainy.

Increasing the ISO sensitivity



- When you increase the **[ISO]** setting, "noise", which appears as spots of unwanted color or unevenness in the color, can be introduced and give the picture a grainy appearance. This camera is equipped with a function to allow shooting at high sensitivity while suppressing noise; however, increasing the ISO sensitivity creates grainier pictures than when using a lower sensitivity.  "ISO — Setting the desired sensitivity to light" (P. 56)

Image taken appears whitish

This may occur when the picture is taken in backlight or semi-backlight conditions. This is due to a phenomenon called flare or ghost. As far as possible, consider a composition where strong light source is not taken in the picture. Flare may occur even when a light source is not present in the picture. Use a lens hood to shade the lens from the light source. If a lens hood does not have effect, use your hand to shade the lens from the light.







Taking pictures with the correct color

The reason why there are differences between the colors in a picture and the actual colors taken and the actual color is the light source illuminating the subject. **[WB]** is the function that allows the camera to determine the correct colors. Normally, the **[AUTO]** setting provides the optimal white balance, but depending on the subject, it may be better to experiment with changing the **[WB]** setting.

- When the subject is in the shade on a sunny day
- When the subject is illuminated by both natural light and indoor lighting, such as when near a window
- When there is no white in the frame  "White balance — Adjusting the color tone" (P. 57)

Taking pictures of a white beach or snow scene

In normal cases, white subjects such as snow will appear darker than usual when the picture is taken. There are several ways to capture the whiteness.

- Adjust the exposure compensation toward **[+]**.  "Exposure compensation — Varying the image brightness" (P. 55)
- Use  (**BEACH & SNOW**) in **SCENE** (Scene mode) to take the picture. It is most suitable for taking pictures of the sea in a sunny day or snow-capped mountains.  "Scene mode" (P. 30)
- Use  **[HI]** (Highlight control). Press the shutter button halfway at the center of the viewfinder where you wish to highlight the whiteness. The metered part at the center will be set to appear whiter.  "Metering mode — Changing the metering system" (P. 54)
- Use the auto bracketing function to take the picture. If you do not know the amount of exposure compensation, try using auto bracketing. The compensation value changes a little every time you press the shutter button. If you set a larger exposure compensation, you can change the compensation value either upwards or downwards based on that value and shoot the picture.  "AE bracketing" (P. 37)

Taking pictures of a subject against backlight

If the background is too bright compared to the subject, the exposure will be affected at the bright parts and the subject will appear darker. This is because the camera determines the exposure from the brightness of the whole screen.

- Set **[METERING]** to **[☐]** (spot metering) to measure the exposure of the subject in the center of the picture. To change the composition, place the subject in the center of the picture. While holding down the **AEL/AFL** button, change the composition and press the shutter button.
🔍 “Metering mode — Changing the metering system” (P. 54)
- Activate the flash, set the flash mode to **[⚡]** (fill-in flash) and shoot the picture. You can shoot a subject against backlight without the face of the subject appearing dark. **[⚡]** (fill-in flash) is used for shooting against backlight and under fluorescent and other artificial lighting.
🔍 “Setting the flash mode” (P. 41)

Image turns out too bright or too dark

When taking pictures in **S** mode or **A** mode, the shutter speed or aperture setting displayed in the control panel screen or viewfinder may blink. A red display means that the correct exposure cannot be obtained. If you take the picture as is, the picture will appear too bright or too dark. If that happens, change the aperture setting or shutter speed.

🔍 “**A**: Aperture priority shooting” (P. 32), “**S**: Shutter priority shooting” (P. 33)

Unknown bright dot(s) appear on the subject in the picture taken

This may be due to stuck pixel(s) on the image pickup device. Perform **[PIXEL MAPPING]**. If the problem persists, repeat pixel mapping a few times. 🔍 “Pixel mapping — Checking the image processing functions” (P. 106)

Additional shooting tips and information

Increasing the number of pictures that can be taken

The captured image will be recorded on the card. The following ways describe how to record more images.

- Change the record mode.
The size of an image varies with the record mode. When you are not sure of the available card capacity, change the image mode and shoot the picture. The smaller the **[PIXEL COUNT]** and the bigger the **[COMPRESSION]**, the smaller the size of the image becomes. You can select both in **[SQ]** of the record mode. 🔍 “Selecting the record mode” (P. 52)
- Use a card with large capacity.
The number of recordable images varies with the capacity of the card. Use a card with large capacity.

Using a new card

If you use a non-Olympus card or a card used for another application, such as for a computer, the message **[CARD ERROR]** is displayed. To use this card with this camera, use the **[FORMAT]** function to format the card. 🔍 “Formatting the card” (P. 107)

Extending the useful life of the battery

Performing any of the following operations when not actually taking pictures can deplete the battery power.

- Repeatedly pressing the shutter button halfway
- Repeatedly playing back the captured images over a long period of time
- Using the live view function over a long period

To save battery power, turn off the camera whenever it is not in use.

Functions that cannot be selected from menus

Some items may not be selectable from the menus when using the arrow pad.

- Items that cannot be set with the current shooting mode
- Items that cannot be set because of an item that has already been set:
Combination of [] and [NOISE REDUCT.], etc.

Selecting the optimal record mode

Record modes are divided into 2 main types: RAW and JPEG. RAW records without reflecting the settings for exposure compensation, white balance, etc. on the images themselves. JPEG records as images that reflect these settings. JPEG also compresses images to reduce the file size when recording them. JPEG is divided into [SHQ], [HQ] and [SQ] types based on the image size (pixel count) or compression rate. The higher the compression rate, the grainier the image will appear when enlarged during display. A rough guide for selection is shown below.

Make fine-adjustments of the shooting settings on the computer

- [RAW]

To print large images on A3/A4 paper/To edit and process images on a computer

- [SHQ][HQ] with a large pixel count

To print postcard-size images

- [SQ] with a large pixel count

To send as an e-mail attachment or post on a web site

- [SQ] with a small pixel count

☞ "List of record modes" (P. 114)

To restore functions to their settings at the time of purchase

- The settings are saved even when the power is switched off. (When power is switched on in "Easy shooting modes" (P. 18), it changes to specific settings.)
- To return to the factory default settings, set [RESET] under [CUSTOM RESET SETTING]. You can register up to two types of settings to be reset. Set various functions of the camera and register using [RESET1] or [RESET2] under [CUSTOM RESET SETTING].
☞ "Custom reset setting" (P. 75)

Confirming the exposure when it is difficult to view the monitor outdoors

The monitor may be difficult to view and the exposure difficult to confirm when shooting outdoors.

During live view, press the **INFO** button repeatedly to display the histogram.

The following shows you how to read the histogram display easily.

How to read the histogram

- ① If the graph has many peaks around here, the image will appear mostly black.
- ② If the graph has many peaks around here, the image will appear mostly white.
- ③ The part indicated in green in the histogram shows the luminance distribution within the center AF frame.

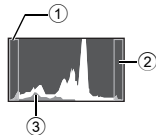

☞ "Live view" (P. 23)

Leaving set functions in the camera so that they can be used later

You can register up to two current camera settings in **[MY MODE SETUP]**. To call up and use My Mode settings, **[Fn FUNCTION]** must be set to **[MY MODE]**. If you press down the **Fn** button while taking the picture, the picture can be taken with the registered settings.

 **[Fn FUNCTION]** (P. 79), "My Mode setting" (P. 80)

Playback tips

Understanding the settings and other information of pictures taken

Play back a picture, and press the **INFO** button. Press the button repeatedly to change the amount of information displayed.  "Information display" (P. 67)

Viewing pictures on a computer

Viewing the entire picture on a computer screen

The size of the picture displayed on a computer screen changes depending on the computer settings. When the monitor setting is 1024 × 768 and you are using Internet Explorer to view a picture with an image size of 2048 × 1536 at 100%, the entire picture cannot be viewed without scrolling. There are several ways you can view the entire picture on the computer screen.

View the picture using image browsing software

- Install the OLYMPUS Master software from the provided CD-ROM.











Change the monitor setting









- The icons on the computer desktop may be rearranged. For details of changing the settings on your computer, refer to the computer's manual.

To view recorded images in RAW

Install the OLYMPUS Master software from the provided CD-ROM. You can use the RAW development function in OLYMPUS Master to develop the RAW image in the camera setting used during shooting, as well as change detailed settings of exposure compensation and white balance.

When error messages are displayed

Viewfinder indications	Monitor indication	Possible cause	Corrective action
Normal indication	 NO CARD	The card is not inserted, or it cannot be recognized.	Insert a card or insert a different card.
	 CARD ERROR	There is a problem with the card.	Insert the card again. If the problem persists, format the card. If the card cannot be formatted, it cannot be used.
	 WRITE PROTECT	Writing to the card is prohibited.	The card has been set to read-only setting with the computer. Reset the card with the computer.
No indication	 CARD FULL	The card is full. No more pictures can be taken or no more information such as print reservation can be recorded.	Replace the card or erase unwanted pictures. Before erasing, download important images to a PC.
No indication	 NO PICTURE	There are no pictures on the card.	The card contains no pictures. Record pictures and play back.
No indication	 PICTURE ERROR	The selected picture cannot be displayed for playback due to a problem with this picture. Or the picture cannot be used for playback on this camera.	Use image processing software to view the picture on a PC. If that cannot be done, the image file is damaged.
No indication	 THE IMAGE CANNOT BE EDITED	Pictures taken with another camera cannot be edited on this camera.	Use image processing software to edit the picture.
No indication	 Internal camera temperature is too high. Please wait for cooling before camera use.	Extended use of live view or sequential shooting has increased the internal temperature of the camera.	Wait a moment for the camera to turn off automatically. Allow the internal temperature of the camera to cool before resuming operations.

Viewfinder indications	Monitor indication	Possible cause	Corrective action
	 CARD-COVER OPEN	The card cover is open.	Close the card cover.
No indication	 BATTERY EMPTY	The battery is drained.	Charge the battery.
No indication	 NO CONNECTION	The camera is not connected to the computer or printer correctly.	Disconnect the camera and connect it again correctly.
No indication	 NO PAPER	There is no paper in the printer.	Load some paper in the printer.
No indication	 NO INK	The printer has run out of ink.	Replace the ink cartridge in the printer.
No indication	 JAMMED	The paper is jammed.	Remove the jammed paper.
No indication	SETTINGS CHANGED	The printer's paper cassette has been removed or the printer has been manipulated while making settings on the camera.	Do not manipulate the printer while making settings on the camera.
No indication	 PRINT ERROR	There is a problem with the printer and/or camera.	Turn off camera and printer. Check the printer and remedy any problems before turning the power on again.
No indication	 CANNOT PRINT	Pictures recorded on other cameras may not be printed on this camera.	Use a personal computer to print.

Camera maintenance

Cleaning and storing the camera

■ Cleaning the camera

Turn off the camera and remove the battery before cleaning the camera.

Exterior:

→ Wipe gently with a soft cloth. If the camera is very dirty, soak the cloth in mild soapy water and wring well. Wipe the camera with the damp cloth and then dry it with a dry cloth. If you have used the camera at the beach, use a cloth soaked in clean water and well wrung.

Monitor and viewfinder:

→ Wipe gently with a soft cloth.

Lens, mirror and focusing screen:

→ Blow dust off the lens, mirror and focusing screen with a commercially available blower. For the lens, wipe gently with a lens cleaning paper.

■ Storage

- When not using the camera for a prolonged period, remove the battery and card. Store the camera in a cool, dry place that is well ventilated.
- Insert the battery periodically and test the camera's functions.

Cleaning and checking the image pickup device

This camera incorporates a dust reduction function to keep dust from getting on the image pickup device and to remove any dust or dirt from the image pickup device surface with ultrasonic vibrations. Dust reduction works when the power switch is set to ON. The dust reduction function operates at the same time as the pixel mapping, which checks the image pickup device and image processing circuitry. Since dust reduction is activated every time the camera's power is turned on, the camera should be held upright for the dust reduction function to be effective. The SSWF indicator blinks while dust reduction is working.

 "SSWF indicator" (P. 7)

Notes

- Do not use strong solvents such as benzene or alcohol, or a chemically treated cloth.
- Avoid storing the camera in places where chemicals are treated, in order to protect the camera from corrosion.
- Mold may form on the lens surface if the lens is left dirty.
- Check each part of the camera before use if it has not been used for a long time. Before taking important pictures, be sure to take a test shot and check that the camera works properly.

Cleaning mode — Removing dust

If dust or dirt gets on the image pickup device, black dots may appear in the picture. Contact your Olympus Authorized Service Center to have the image pickup device physically cleaned. The image pickup device is a precision device and is easily damaged. When cleaning the image pickup device yourself, be sure to follow the instructions below. If power runs out during cleaning, the shutter will close, which may cause the shutter curtain and mirror to break. Keep an eye on the remaining battery power.

1 Remove the lens from the camera, and set the power switch to ON.

2 MENU ▸ [F2] ▸ [CLEANING MODE]

3 Press **[Z]**, then press the **[OK]** button.

- The camera enters the cleaning mode.

4 Press the shutter button all the way.

- The mirror goes up and the shutter curtain opens.

5 Clean the image pickup device.

- Carefully blow off any dust on the surface of the image pickup device by using a mechanical blower (commercially available).

6 Be careful not to catch the mechanical blower in the shutter curtain when turning the power off to finish cleaning.

- If the camera turns off, the shutter curtain closes, causing the mirror to fall.

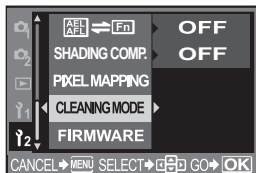

Notes

- Be careful not to let the mechanical blower (commercially available) touch the image pickup device. If the blower touches the image pickup device, the image pickup device will be damaged.
- Never put the mechanical blower behind the lens mount. If the power turns off, the shutter closes, breaking the shutter curtain.
- Do not use anything other than the mechanical blower. If high-pressure gas is sprayed onto the image pickup device, it will freeze on the image pickup device's surface, damaging the image pickup device.

8

Getting to know your camera better

Pixel mapping — Checking the image processing functions

The pixel mapping feature allows the camera to check and adjust the image pickup device and image processing functions. After using the monitor or taking continuous shots, wait for at least one minute before using the pixel mapping function to ensure that it operates correctly.

1 MENU ▸ [F2] ▸ [PIXEL MAPPING]

2 Press **[Z]**, then press the **[OK]** button.

- The **[BUSY]** bar is displayed when pixel mapping is in progress. When pixel mapping is finished, the menu is restored.

Notes

- If you accidentally turn the camera off during pixel mapping, start again from Step 1.

Card basics

Usable cards

"Card" in this manual refers to a recording medium. This camera can use CompactFlash, Microdrive or xD-Picture Card (optional).

CompactFlash

A CompactFlash is a large-capacity solid state flash memory card. You can use commercially available cards.

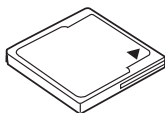

Microdrive

A Microdrive is a medium that uses a large-capacity compact hard disk drive. You can use a Microdrive that supports CF+Type II (CompactFlash extension standard).

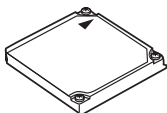

xD-Picture Card

An xD-Picture Card is a recording medium used mainly in compact cameras.



Precautions when using a Microdrive

A Microdrive is a medium that uses a compact hard disk drive. Because the disk drive rotates, a Microdrive is not as resistant to vibration or impact as other cards. Special care is needed when using a Microdrive (especially during recording and playback) to make sure the camera is not subjected to shock or vibrations. Be sure to read the following precautions before using a Microdrive. Also, refer to the manuals provided with your Microdrive.

- Be very careful when putting the camera down during recording. Place it gently on a firm surface.
- Do not use the camera in places subject to vibrations or excessive shock, such as at a construction site or in a car while driving along a bumpy road.
- Do not take a Microdrive close to areas where it may be exposed to strong magnetism.

Notes

- The data in the card will not be erased completely even after formatting the card or deleting the data. When discarding, destroy the card to prevent leakage of personal information.

Formatting the card

Non-Olympus cards or cards formatted on a computer must be formatted with the camera before they can be used.

All data stored on the card, including protected images, is erased when the card is formatted. When formatting a used card, confirm there are no images that you still want to keep on the card.

- 1 MENU ▸ [M] ▸ [CARD SETUP]
- 2 Use to select [FORMAT], then press the button.
- 3 Use to select [YES], then press the button.
 - Formatting is performed.

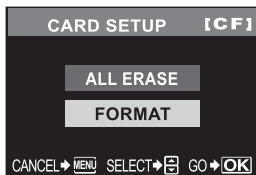

TIPS

When inserting cards into the two card slots:

→ Select the card to be used in [CF/xD].

Control panel screen



Menu

MENU ▶ [12] ▶ [CF/xD]

Battery and charger

- Use the single Olympus lithium-ion battery (BLM-1). Other batteries cannot be used.
- The camera's power consumption varies widely with usage and other conditions.
- As the following consume a lot of power even without shooting, the battery will be drained quickly.
 - Pressing the shutter button halfway in shooting mode, performing auto focus repeatedly.
 - Using live view.
 - Displaying images on the LCD monitor for a prolonged period.
 - When connected to a computer or printer.
- When using a drained battery, the camera may turn off without the low battery warning being displayed.
- The battery will not be fully charged at the time of purchase. Charge the battery using the designated charger (BCM-2) before use.
- The normal charging time of the provided charger is approximately 5 hours (estimated).
- Do not use chargers other than the one designated.

Using your charger abroad

- The charger can be used in most home electrical sources within the range of 100 V to 240 V AC (50/60Hz) around the world. However, depending on the country or area you are in, the AC wall outlet may be shaped differently and the charger may require a plug adapter to match the wall outlet. For details, ask at your local electrical shop or travel agent.
- Do not use commercially available travel adaptors as the charger may malfunction.

Menu directory

Shooting Menu

Tab	Function	Setting	Ref. page	
1	CARD SETUP	ALL ERASE/FORMAT	P. 74 P. 107	
	CUSTOM RESET SETTING	RESET		P. 75
		RESET1	SET/RESET	
		RESET2	SET/RESET	
	PICTURE MODE	↕ VIVID/↔ NATURAL * / 1/3 \ MUTED/MONOTONE	P. 61	
	GRADATION	HIGH KEY/NORMAL * /LOW KEY	P. 62	
		RAW/SHQ/HQ * /SQ/RAW+SHQ/RAW+HQ/RAW+SQ	P. 52	
	WB	AUTO *	R-7 - +7, G-7 - +7	P. 58
		5300K	R-7 - +7, G-7 - +7	
		7500K	R-7 - +7, G-7 - +7	
		6000K	R-7 - +7, G-7 - +7	
		3000K	R-7 - +7, G-7 - +7	
		4000K	R-7 - +7, G-7 - +7	
		4500K	R-7 - +7, G-7 - +7	
6600K		R-7 - +7, G-7 - +7		
		R-7 - +7, G-7 - +7		
CWB	2000K - 14000K			
ISO	AUTO * /100 - 1600	P. 56		
NOISE FILTER	OFF/LOW/STANDARD * /HIGH	P. 63		
NOISE REDUCT.	OFF/ON *	P. 62		
2	METERING	* ESP + AF * /ESP	P. 54	
		HI		
		SH		
		-2.0 - 0.0 * - +2.0	P. 42	
	AF MODE	S-AF * /C-AF/MF/S-AF+MF/C-AF+MF	P. 49	
		AUTO * / [] [.] []	P. 49	
	AE BKT	OFF * /3F 0.3EV/3F 0.7EV/3F 1.0EV	P. 37	
	WB BKT	R-B	OFF * /3F 2STEP/3F 4STEP/ 3F 6STEP	P. 60
		G-M		
FL BKT	OFF * /3F 0.3EV/3F 0.7EV/3F 1.0EV	P. 43		
ANTI-SHOCK	OFF * /1SEC - 30SEC	P. 63		

* Factory default setting



Playback menu

Tab	Function	Setting	Ref. page	
▶		* / / / /	P. 68	
		OFF/ON*	P. 68	
	EDIT	RAW DATA EDIT		P. 69
		JPEG EDIT	BLACK & WHITE/SEPIA/ REDEYE FIX/SATURATION/	
		/		P. 85
	COPY ALL	YES/NO		P. 71
	RESET PROTECT	YES/NO		P. 72

* Factory default setting







Custom menu

Tab	Function	Setting	Ref. page	
11	ISO LIMIT	100/200/400*	P. 78	
	EV STEP	1/3EV ⁺ /1/2EV/1EV	P. 78	
	ALL	ALL SET	R-7 - +7 G-7 - +7	P. 78
		ALL RESET	YES/NO	
	HQ	1/4 / 1/8 ⁺ / 1/12		P. 53
	SQ	PIXEL COUNT	3200×2400/2560×1920/ 1600×1200/1280×960 ⁺ /1024×768/ 640×480	P. 53
		COMPRESSION	1/2.7, 1/4, 1/8 ⁺ , 1/12	
		OFF/ON*		P. 42
		1/60 - 1/180*		P. 78
	AUTO POP UP	OFF/ON*		P. 79
	DIAL	P	Ps ⁺ /	P. 79
		M	SHUTTER ⁺ / FNo.	
	AEL/AFL	S-AF ⁺	mode1 ⁺ /mode2/mode3	P. 77
		C-AF	mode1/mode2 ⁺ /mode3/mode4	
		MF	mode1 ⁺ /mode2/mode3	
	AEL/AFL MEMO	OFF ⁺ /ON		P. 78
	AEL Metering	AUTO / / / HI / SH		P. 78
	QUICK ERASE	OFF ⁺ /ON		P. 81
	RAW+JPEG ERASE	JPEG/RAW/RAW+JPEG ⁺		P. 81
	FUNCTION	OFF / / TEST PICTURE/MY MODE/PREVIEW ⁺ / LIVE PREVIEW		P. 79
MY MODE SETUP	MY MODE1/ MY MODE2		P. 80	
FOCUS RING	/		P. 80	
AF ILLUMINAT.	OFF/ON*		P. 51	

Tab	Function	Setting	Ref. page
11	RESET LENS	OFF*/ON*	P. 80
	LIVE VIEW BOOST	OFF*/ON	P. 79
	RELEASE PRIORITY S	OFF*/ON	P. 51
	RELEASE PRIORITY C	OFF*/ON*	P. 51
		OFF*/ON*	P. 82
	FRAME ASSIST	OFF*/GOLDEN SECTION/GRID/SCALE	P. 24
	 LOCK	OFF*/ON	P. 84

* Factory default setting

Setup menu

Tab	Function	Setting	Ref. page	
12		—	P. 8	
	CF/xD	CF*/xD	P. 108	
	FILE NAME	AUTO*/RESET	P. 81	
	EDIT FILENAME	Adobe RGB	OFF*/A - Z/0 - 9	P. 82
		sRGB		
		Lo -7 - 0* - Hi +7	P. 82	
		*1	P. 83	
	VIDEO OUT	*1	P. 83	
	REC VIEW	OFF/1SEC - 20SEC (5 seconds*)	P. 82	
	SLEEP	OFF/1MIN*/3MIN/5MIN/10MIN	P. 82	
	BACKLIT LCD	8SEC*/30SEC/1MIN/HOLD	P. 83	
	4 h TIMER	OFF/4 h*	P. 84	
	BUTTON TIMER	3SEC*/5SEC/8SEC*/HOLD	P. 84	
	PRIORITY SET	YES/NO*	P. 80	
	USB MODE	AUTO*/STORAGE/MTP/CONTROL/  EASY/  CUSTOM	P. 83	
	COLOR SPACE	sRGB*/Adobe RGB	P. 63	
		OFF*/ON	P. 84	
	SHADING COMP.	OFF*/ON	P. 62	
	PIXEL MAPPING	—	P. 106	
	CLEANING MODE	—	P. 106	
FIRMWARE	—	P. 84		

* Factory default setting

*1 Settings differ depending on the region where the camera is purchased.

Functions that can be set by shooting mode

Function		AUTO	P	A	S	M		SCENE
Aperture value		—	✓	—	✓			—
Shutter speed		—			✓			—
Bulb shooting		—				✓		—
			✓			—		—
							✓	—
Flash shooting						✓		—
Flash mode	AUTO	✓			—		✓	—
		✓			—		(Cannot be selected in)	—
	SLOW	✓			—		✓	—
	SLOW	✓			—		✓	—
		—			✓			—
	SLOW2					✓		—
						✓ (Cannot be selected in)		—
						✓		—
CUSTOM RESET SETTING		—		✓				—
PICTURE MODE				✓				—
GRADATION						✓		—
NOISE REDUCT.						✓		✓ (Cannot be selected in)
NOISE FILTER						✓		—
						✓		—
ISO						✓		—
WB						✓		—
						✓		—
METERING						✓		—
(Sequential Shooting)						✓		— ^{*1}
(Self-timer)							✓	—
(Remote control)							✓	—
AF MODE						✓		—
						✓		✓ (Cannot be selected in)
AE BKT						✓		—
WB BKT						✓		—
FL BKT						✓		—
ANTI-SHOCK						✓		—
ISO LIMIT						✓		—
EV STEP						✓		—
ALL						✓		—

✓: Can be set —: Cannot be set

*1: , , can be set

Function	AUTO	P	A	S	M		SCENE
HQ						✓	
SQ						✓	
+					✓		—
X-SYNC					✓		—
AUTO POP UP						✓	
DIAL						✓	
AEL/AFL					✓		—
AEL/AFL MEMO					✓		—
AEL Metering					✓		—
QUICK ERASE						✓	
RAW+JPEG ERASE						✓	
FUNCTION					✓		—
MY MODE SETUP	—		✓				—
FOCUS RING						✓	
RESET LENS						✓	
RELEASE PRIORITY S					✓		—
RELEASE PRIORITY C					✓		—
FRAME ASSIST					✓		✓ (Cannot be selected in mode)
LOCK						✓	
						✓	
CF/xD						✓	
FILE NAME						✓	
EDIT FILENAME						✓	
						✓	
						✓	
VIDEO OUT						✓	
						✓	
REC VIEW						✓	
SLEEP						✓	
BACKLIT LCD						✓	
4 h TIMER						✓	
BUTTON TIMER						✓	
PRIORITY SET						✓	
USB MODE						✓	
COLOR SPACE					✓		—
AF ILLUMINAT.					✓		—
LIVE VIEW BOOST						✓	
					✓		—
SHADING COMP.					✓		—
PIXEL MAPPING						✓	
CLEANING MODE						✓	

✓: Can be set —: Cannot be set

List of record modes

The file size in the table is approximate.

Record mode	Number of pixels	Compression	File format	File size (MB)
RAW	3648 × 2736	Loss-less compression	ORF	Approx. 11
SHQ		1/2.7		Approx. 6.8
HQ		1/4		Approx. 4.7
		1/8		Approx. 2.2
		1/12		Approx. 1.5
SQ	3200 × 2400	1/2.7	JPEG	Approx. 5.3
		1/4		Approx. 3.7
		1/8		Approx. 1.7
		1/12		Approx. 1.1
		2560 × 1920		1/2.7
	1/4			Approx. 2.2
	1/8			Approx. 1.1
	1/12			Approx. 0.7
	1600 × 1200	1/2.7		Approx. 1.3
		1/4		Approx. 0.8
		1/8		Approx. 0.5
		1/12		Approx. 0.3
	1280 × 960	1/2.7		Approx. 0.8
		1/4		Approx. 0.5
		1/8		Approx. 0.3
		1/12		Approx. 0.2
	1024 × 768	1/2.7		Approx. 0.5
		1/4		Approx. 0.4
		1/8		Approx. 0.2
		1/12		Approx. 0.1
	640 × 480	1/2.7		Approx. 0.2
		1/4		Approx. 0.2
		1/8		Approx. 0.1
		1/12		Approx. 0.1

Notes

- The number of remaining pictures may change according to the subject or factors like whether print reservations have been made or not. In certain instances, the number of remaining pictures displayed on the viewfinder or the LCD monitor does not change even when you take pictures or stored images are erased.
- The actual file size varies according to the subject.

Names of parts

Camera

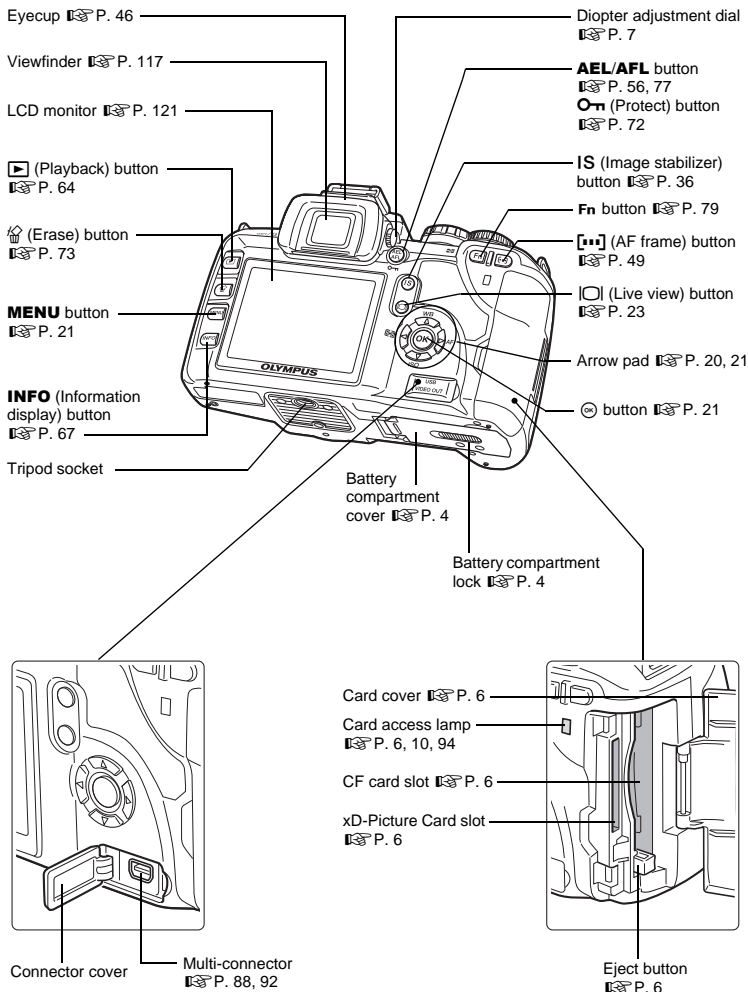

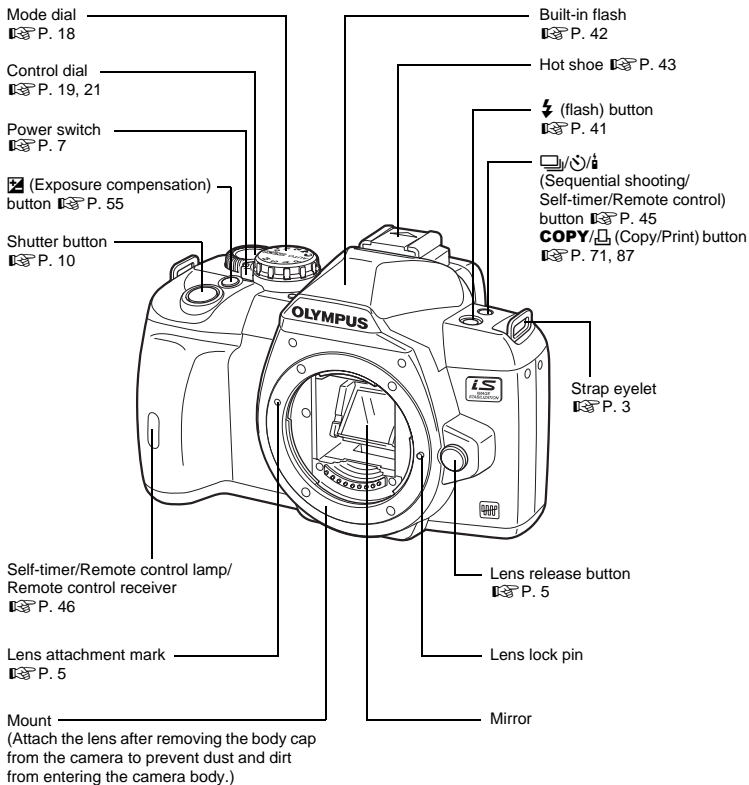

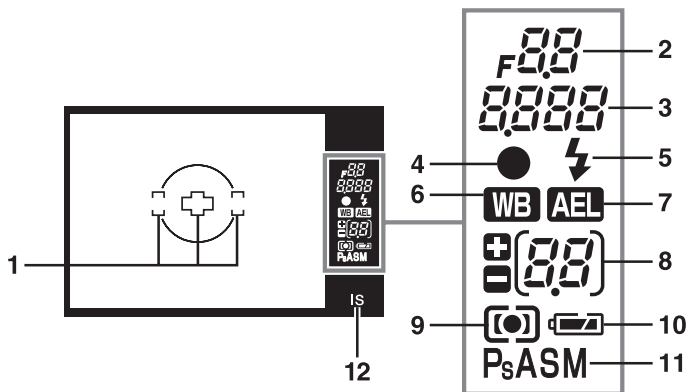

No.	Items	Indication examples	Ref. page
1	AF frame		P. 37, 49
2	Aperture value		P. 31 - 34
3	Shutter speed		P. 31 - 34
4	AF confirmation mark		P. 37
5	Flash	(blinks: charging in progress, lights up: charging completed)	P. 42
6	White balance	(when set to a setting other than [AUTO])	P. 58
7	AE lock		P. 56
8	Exposure compensation value		P. 55
9	Metering mode	(center weighted averaging metering), (spot metering)	P. 54
10	Battery check	(ready for use), (charging required)	—
11	Exposure mode	P, Ps, A, S, M	P. 31 - 34
12	Image stabilizer	IS	P. 36

Control panel screen

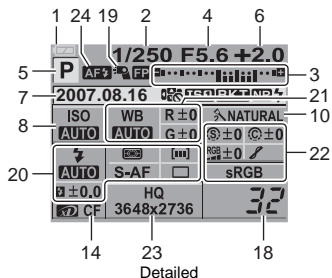
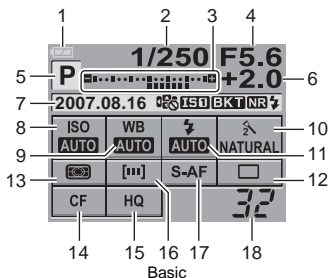

No.	Items	Indication examples	Ref. page
1	Battery check	(ready for use), (charging required)	—
2	Shutter speed	1/250	P. 31 - 34
3	Exposure compensation indicator Exposure level indicator Flash intensity level indicator		P. 55 P. 34 P. 42
4	Aperture value	F5.6	P. 31 - 34
5	Exposure mode	P, A, S, M,	P. 18, P. 30 - 34
6	Exposure compensation value	+2.0	P. 55
7	Date Arrow pad lock Image stabilizer Auto bracketing Noise reduction Flash Internal temperature warning	2007.08.16 BKT NR (blinks: charging in progress, lights up: charging completed) °C/F	P. 8 P. 84 P. 36 P. 37 P. 62 P. 42 P. 103
8	ISO	AUTO, 100, 200, 400	P. 56
9	White balance		P. 58
10	Picture mode	NATURAL	P. 61
11	Flash mode		P. 41
12	Sequential shooting/Self-timer/ Remote control	2s, 0s	P. 45
13	Metering mode	HI, SH	P. 54
14	Card	CF	P. 107
15	Record mode	HQ	P. 53
16	AF frame	[...]	P. 49
17	AF mode	S-AF	P. 49
18	Number of storable still pictures	32	—
19	Super FP flash	FP	P. 44

No.	Items	Indication examples	Ref. page
20	Flash mode		P. 41
	Flash intensity control	+2.0	P. 42
	Metering mode	, ,	P. 54
	AF mode	S-AF	P. 49
	AF frame		P. 49
	Sequential shooting/Self-timer/ Remote control	, 2s, 0s	P. 45
21	White balance		P. 58
	White balance compensation	R+3, G-2	P. 59
22	Color space	sRGB, Adobe RGB	P. 63
	Sharpness	+2	P. 61
	Contrast	+2	P. 61
	Saturation	+2	P. 61
	Gradation	, H, L	P. 62
23	Record mode	HQ	P. 53
	Pixel count	3648 x 2736	
24	AF illuminator		P. 51

LCD monitor indications (during live view)



No.	Items	Indication examples	Ref. page
1	Battery check	(ready for use), (charging required)	—
2	Exposure mode	P, A, S, M, 	P. 18, P. 30 - 34
3	Shutter speed	1/250	P. 31 - 34
4	Aperture value	F5.6	P. 31 - 34
5	Exposure compensation value	+2.0	P. 55
6	Flash	(blinks: charging in progress, lights up: charging completed)	P. 42
7	AF confirmation mark		—
8	Flash mode		P. 41
9	White balance		P. 58
10	Metering mode	HI SH	P. 54
11	Number of storable still pictures	38	—
12	Card	CF	P. 107
13	AF frame	—	P. 49
14	Record mode	RAW+SHQ	P. 53
15	Image stabilizer	IS1 , IS2	P. 36
16	Picture mode		P. 61
17	AF mode	S-AF MF	P. 49
18	Sequential shooting		P. 45
19	ISO	ISO AUTO, ISO100, ISO200, ISO400	P. 56
20	Internal temperature warning	°C/°F	P. 103

LCD monitor indications (during playback)

You can switch the monitor display using the **INFO** (information display) button.







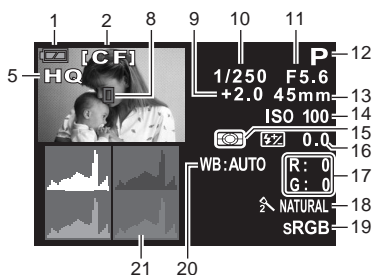













 "Information display" (P. 67)



Single-frame playback information



Shooting information

No.	Items	Indication examples	Ref. page
1	Battery check	 (ready for use),  (charging required)	—
2	Card	[CF], [xD]	P. 107
3	Print reservation Number of prints	 x10	P. 85
4	Protect		P. 72
5	Record mode	RAW, SHQ, HQ, SQ	P. 53
6	Date and time	'07.08.16 21:56	P. 8
7	File number Frame number	 100-0015 15	P. 67
8	AF frame		P. 49
9	Exposure compensation	+2.0	P. 55
10	Shutter speed	1/250	P. 31 - 34
11	Aperture value	F5.6	P. 31 - 34
12	Exposure mode	P, A, S, M ,  ,  ,  ,  ,  ,  , 	P. 18, P. 30 - 34
13	Focal distance*	45 mm	P. 129
14	ISO	ISO 100, ISO 200, ISO 400	P. 56
15	Metering mode	 ,  ,  ,  , 	P. 54
16	Flash intensity control	 0.0	P. 42
17	White balance compensation	R: 0, G: 0	P. 59
18	Picture mode	 NATURAL	P. 61
19	Color space	sRGB, Adobe RGB	P. 63
20	White balance	WB:AUTO	P. 58
21	Histogram	—	P. 67

* The focal distance is displayed in 1 mm units.

A (Aperture Priority) Mode

You set the aperture yourself and the camera automatically varies the shutter speed so that the picture is taken with the correct exposure.

AE (Automatic Exposure)

The camera's built-in exposure meter automatically sets the exposure. The 3 AE modes available on this camera are **P** mode, in which the camera selects both the aperture and shutter speed, **A** mode, in which the user selects the aperture and the camera sets the shutter speed, and **S** mode, in which the user selects the shutter speed and the camera sets the aperture.

In **M** mode, the user selects both the aperture and the shutter speed.

Aperture

The adjustable lens opening which controls the amount of light that enters the camera. The larger the aperture, the shorter the depth of field and the fuzzier the background. The smaller the aperture, the greater the depth of field and the sharper the background. Aperture is measured in f/stops. Larger aperture values indicate smaller apertures, and smaller aperture values indicate larger apertures.

AUTO mode

Program AE mode (see "**P** (Program) Mode"). In addition, this mode features automatic flash pop up when shooting in low-light conditions.

Center weighted averaging metering

A light metering mode or technique that uses an average of the center and periphery of the image area but is biased toward the information at the center of the image area. This method is best used when the brightness of the center and periphery of the image area does not vary greatly. See also digital ESP metering and spot metering.

Color space

A model that describes colors using more than three coordinates. Color spaces such as sRGB, Adobe RGB are occasionally used for encoding/reproducing colors.

Color temperature

The spectral balance of different white light sources is rated numerically by color temperature — a concept of theoretical physics that, with incandescent lighting, corresponds roughly to the absolute lamp filament temperature, expressed on the Kelvin (K) temperature scale. The higher the color temperature, the richer the light in bluish tones and the poorer in reddish; the lower the color temperature, the richer the light in reddish tones and the poorer in bluish. You may encounter difficulties with color reproduction when shooting indoors under fluorescent lighting, or where sunlight and fluorescent lighting are both present. Your camera is provided with a white balance adjustment feature that you can use to compensate for the odd effects of combinations of color you may occasionally see in your pictures.

Compression rate

Compression is a method of reducing file size by abbreviating some contents of data, and compression rate denotes the amount of compression. The actual effect of the selected compression rate could vary with the content of the image. The numbers for the compression rate selected with this camera provide only a general scale for reference and are not precise measurements.

DCF (Design rule for Camera File system)

A standard for image files by the Japan Electronics and Information Technology Industries Association (JEITA).

Depth of Field

Depth of Field refers to the distance from the nearest to the furthest point of perceived "sharp" focus in a picture.

Digital ESP (Electro-Selective Pattern) Light Metering

This determines the exposure by splitting the image into 49 areas and metering and calculating the light levels in each area.

DPOF (Digital Print Order Format)

This is for saving desired print settings on digital cameras. By entering which images to print and the number of copies of each, the user can easily have the desired images printed by a printer or print lab that supports the DPOF format.

Eclipsing (Vignetting)

This refers to when an object obscures part of the field of view so that the whole subject is not photographed. Vignetting also refers to when the image seen through the viewfinder does not exactly match the image shot through the objective lens, so the photographed image includes objects not seen through the viewfinder. In addition, vignetting can occur when an incorrect lens hood is used, causing shadowing to appear in the corners of the image.

EV (Exposure Value)

A system for measuring exposure. EV0 is when the aperture is at F1 and the shutter speed is 1 second. The EV then increases by 1 each time the aperture increases by one F stop or the shutter speed increases by one increment. EV can also be used to indicate brightness and ISO settings.

Exposure

The amount of light used to capture an image. The exposure is determined by the length of time the shutter is open (shutter speed) and the amount of light that passes through the lens (aperture).

Image pickup device

This converts light passing through the lens into electrical signals. On this camera, light is picked up and converted into RGB signals to build a single image.

ISO

International abbreviation for International Organization for Standardization. The sensitivity setting used in digital cameras is based on the same ISO standard used for film sensitivity. The sensitivity is denoted as shown in "ISO 100". Higher ISO values indicate greater sensitivity to light, so images can be exposed even in low-light conditions.

JPEG (Joint Photographic Experts Group)

A compression format for color still images. Photographs (images) shot using this camera are recorded onto the card in JPEG format when the Record mode is set to SHQ, HQ, SQ. By downloading these images to a personal computer, users can edit them using graphics application software or view the images using an Internet web browser.

M (Manual) Mode

The user sets both the aperture and shutter speed.

NTSC (National Television Systems Committee) / PAL (Phase Alternating Line)

Television formats. NTSC is mainly used in Japan, North America and Korea.

PAL is mainly used in Europe and China.

Number of Pixels (PIXEL COUNT)

The number of dots (pixels) used to create an image denotes the image size.

For instance, an image in 640 × 480 pixel count is the same size as the computer screen if the monitor setting is also 640 × 480. If the monitor setting is 1024 × 768, the image only takes up part of the screen.

P (Program) Mode

Also called Program AE mode. The camera automatically sets the best shutter speed and aperture for the shot.

PictBridge

A standard that enables digital cameras and printers made by different manufacturers to be connected, and also allows pictures to be printed directly from the camera.

Pixels

A pixel is the smallest unit (dot) used to make up an image. Clear large-sized printed images require millions of pixels.

RAW

Refers to raw data, data which has not been enhanced with a camera option like white balance, sharpness, contrast, etc. This file format is for viewing and processing with our own software. You may not be able to open or process these files with other graphics software applications, and these files cannot be selected for DPOF printing. RAW files are assigned an orf file extension (*.orf).

S (Shutter Priority) Mode

Also called Shutter Priority AE mode. The user selects the shutter speed and the camera automatically varies the aperture so that the picture is taken with the best exposure.

Single-lens reflex camera

A camera that uses the reflective mirror to bend the light entering from the shooting lens and uses the viewfinder to check. There is no difference between the composition to be captured and the composition viewed on the viewfinder.

Sleep Mode

A mode designed to save battery life. The camera automatically enters the sleep mode if you do not operate it for a certain time. To get out of the sleep mode, use any button on the camera (shutter button, menu button, etc.).

Spot metering

The meter reading is taken from a very small area around the center of the subject, defined by the spot metering area mark in the viewfinder. Spot metering is ideal for use in difficult light conditions, or when the important element of the picture (subject's face) is small. Use spot metering for backlit subjects, or sports and stage performers. See also digital ESP metering and center weighted averaging metering.

TFT (Thin-Film Transistor) Color Monitor

A color monitor constructed using thin-film technology.

TTL phase-contrast detection system

This is used to measure the distance to the subject. The camera determines if the image is focused by the detected phase contrast.

TTL (Through-The-Lens) System

To help adjust exposure, a light receptor built into the camera directly measures the light passing through the lens.

Specifications

Camera specifications

■ Product type

Product type	: Single-lens reflex digital camera with interchangeable lens system
Lens	: Zuiko Digital, Four Thirds System Lens
Lens mount	: Four Thirds mount
Equivalent focal length on a 35 mm film camera	: Approx. twice the focal length of the lens

■ Image pickup device

Product type	: 4/3" Live MOS sensor
No. of total pixels	: Approx. 11,800,000 pixels
No. of effective pixels	: Approx. 10,000,000 pixels
Screen size	: 17.3 mm (H) × 13.0 mm (V) (0.7" × 0.5")
Aspect ratio	: 1.33 (4:3)

■ Viewfinder

Product type	: Eye-level single-lens reflex viewfinder
Field of view	: Approx. 95 % (for field of view on recorded images)
Viewfinder magnification	: Approx. 0.92× (-1 m ⁻¹ , 50 mm lens, infinity)
Eye point	: 14 mm (0.6") from the cover glass (-1 m ⁻¹)
Diopter adjustment range	: -3.0 - +1.0 m ⁻¹
Optical path fraction	: Quick return half mirror
Depth of field	: Can be checked with the Fn button (when PREVIEW registered)
Focusing screen	: Fixed
Eyecup	: Interchangeable

■ Live view

	: Uses Live MOS sensor for shooting
	: Field of view of 100%

■ LCD monitor

Product type	: 2.5" TFT color LCD (HyperCrystal LCD)
Total no. of pixels	: Approx. 230,000 pixels

■ Shutter

Product type	: Computerized focal-plane shutter
Shutter	: 1/4000 - 60 sec., Bulb shooting

■ Auto focus

Product type	: TTL phase-contrast detection system
Focusing point	: 3-point multiple AF (left, center, right)
AF luminance range	: EV 0 - EV 19
Selection of focusing point	: Auto, Optional
AF illuminator	: The built-in flash provides light.

■ Exposure control

Metering system	: TTL full-aperture metering system (1) Digital ESP metering (2) Center weighted averaging metering (3) Spot metering (approx. 2% for the viewfinder screen)
Metering range	: EV 1 - 20 (Digital ESP metering, Center weighted average metering, Spot metering) (At normal temperature, 50 mm F2, ISO 100)
Exposure mode	: (1) AUTO : Fully automatic (2) P : Program AE (Program shift can be performed) (3) A : Aperture priority AE (4) S : Shutter priority AE (5) M : Manual
ISO sensitivity	: 100 - 1600
Exposure compensation	: ± 5 EV (1/3, 1/2, 1 EV step)

■ White balance

Product type	: Image pickup device
Mode setting	: Auto, Preset WB (7 settings), Customized WB, One-touch WB

■ Recording

Memory	: CF card (Compatible with Type I and II) Microdrive (Compatible with FAT 16/32) xD-Picture Card
Recording system	: Digital recording, JPEG (in accordance with Design rule for Camera File system (DCF)), RAW Data
Applicable standards	: Exif 2.2, Digital Print Order Format (DPOF), PRINT Image Matching III, PictBridge

■ Playback

Playback mode	: Single-frame playback, Close-up playback, Index display, Image rotation, Slideshow, Light box display, Calendar display
Information display	: Information display, Histogram display

■ Drive

Drive mode	: Single-frame shooting, Sequential shooting, Self-timer, Remote control
Sequential shooting	: 3 frames/sec. (Max. no. of storable sequential pictures: 8 frames in RAW)
Self-timer	: Operation time: 12 sec., 2 sec.
Optical remote control	: Operation time: 2 sec., 0 sec. (instantaneous shooting) (RM-1 Remote Control (optional))

■ Flash

Synchronization	: Synchronized with the camera at 1/180 sec. or less
Flash control mode	: TTL-AUTO (TTL pre-flash mode), AUTO, MANUAL
External flash attachment	: Hot shoe

■ External connector

USB connector/VIDEO OUT connector (Multi-connector)	
---	--

■ Power supply

Battery	: Li-ion Battery (BLM-1) × 1
---------	------------------------------

■ Dimensions/weight

Dimensions	: 136 mm (W) × 91.5 mm (H) × 68 mm (D) (5.4" × 3.6" × 2.7") (excluding protrusions)
Weight	: Approx. 460 g (1.0 lb.) (without battery)

■ Operating environment

Temperature	: 0°C - 40°C (32°F - 104°F) (operation)/ -20°C - 60°C (-4°F - 140°F) (storage)
Humidity	: 30 - 90% (operation)/10 - 90% (storage)

Battery/charger specifications

BLM-1 Lithium ion battery

MODEL NO.	: PS-BLM1
Product type	: Rechargeable Lithium ion battery
Nominal voltage	: DC 7.2 V
Nominal capacity	: 1500 mAh
No. of charge and discharge times	: Approx. 500 times (vary with usage conditions)
Ambient temperature	: 0°C - 40°C (32°F - 104°F) (charging) -10°C - 60°C (14°F - 140°F) (operation) -20°C - 35°C (-4°F - 95°F) (storage)
Dimensions	: Approx. 39 mm (W) × 55 mm (D) × 21.5 mm (H) (1.5" × 2.2" × 0.8")
Weight	: Approx. 75 g (0.2 lb.) (without protection cap)

BCM-2 Lithium ion charger

MODEL NO.	: PS-BCM2
Rated input	: AC 100 V - 240 V (50/60 Hz)
Rated output	: DC 8.35 V, 400 mA
Charging time	: Approx. 5 hours (room temperature: if using BLM-1)
Ambient temperature	: 0°C - 40°C (32°F - 104°F) (operation)/ -20°C - 60°C (-4°F - 140°F) (storage)
Dimensions	: Approx. 62 mm (W) × 83 mm (D) × 26 mm (H) (2.4" × 3.3" × 1.0")
Weight	: Approx. 72 g (0.2 lb.) (without AC cable)

SPECIFICATIONS ARE SUBJECT TO CHANGE WITHOUT ANY NOTICE OR OBLIGATION ON THE PART OF THE MANUFACTURER.

10 Interchangeable lenses

Lens

Usable lenses

Select the lens that you want to shoot with.

Use a specified Four Thirds lens (Four Thirds mount). When a non-specified lens is used, AF (auto focus) and light metering will not function correctly. In some cases, other functions may not work either.

Four Thirds mount

Developed by Olympus as the lens mount standard for the Four Thirds system. These all-new interchangeable lenses featuring the Four Thirds mount were developed from the ground up based on optic engineering exclusively for digital cameras.

ZUIKO DIGITAL interchangeable lens

Four Thirds system interchangeable lens designed to withstand rigorous professional use. The Four Thirds system makes it possible for a fast lens to be compact and lightweight as well.

Notes

- When you attach or remove the body cap and lens from the camera, keep the lens mount on the camera pointed downward. This helps prevent dust and other foreign matter from getting inside the camera.
- Do not remove the body cap or attach the lens in dusty places.
- Do not point the lens attached to the camera toward the sun. This may cause the camera to malfunction or even ignite due to the magnifying effect of sunlight focusing through the lens.
- Be careful not to lose the body cap and rear cap.
- Attach the body cap to the camera to prevent dust from getting inside when no lens is attached.

ZUIKO DIGITAL interchangeable lens

Names of parts

- 1 Hood mount section
- 2 Filter mount thread
- 3 Zoom ring
- 4 Focus ring
- 5 Mount index
- 6 Electrical contacts
- 7 Front cap
- 8 Rear cap
- 9 Lens hood

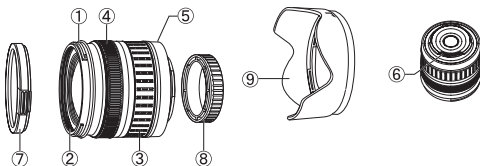

Attaching the hood

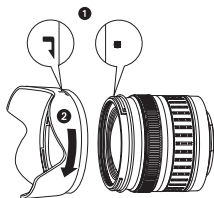

Storing the hood

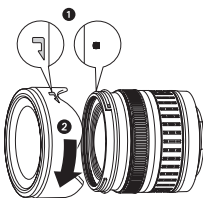

- Use the hood when shooting a backlit subject.
- For 17.5-45 mm lens, the lens hood is not provided.

■ Main Specifications

Items	17.5-45 mm	14-42 mm	40-150 mm
Mount	FOUR THIRDS mount		
Focal distance	17.5 - 45 mm	14 - 42 mm	40 - 150 mm
Max. aperture	f3.5 - 5.6	f3.5 - 5.6	f4 - 5.6
Image angle	63° - 27°	75° - 29°	30° - 8.2°
Lens configuration	7 groups, 7 lenses	8 groups, 10 lenses	9 groups, 12 lenses
	Multilayer film coating (partially single layered)		
Iris control	f3.5 - 22	f3.5 - 22	f4 - 22
Shooting range	0.28 m - ∞	0.25 m - ∞	0.9 m - ∞
Focus adjustment	AF/MF switching		
Weight (excluding hood and cap)	210 g	190 g	220 g
Dimensions (Max. diameter x overall length)	ø71 x 70 mm	ø65.5 x 61 mm	ø65.5 x 72 mm
Lens hood mount	—	Bayonet	
Filter mount thread diameter	52 mm	58 mm	

Can be used with the optional EX-25 extension tube under the following conditions.
The focus adjustment when EX-25 is used will be MF.

Lens, focal distance		Shooting range	Magnification (): Calculated based on 35 mm film camera
17.5-45 mm	17.5 mm	Shooting is not possible since subjects cannot be brought into focus at this focal length.	
	28 mm	15.1 cm - 15.9 cm	0.89 - 1.16x (1.78 - 2.32x)
	45 mm	18.4 cm - 22.4 cm	0.57 - 0.91x (1.14 - 1.82x)
14-42 mm	14 mm	Shooting is not possible since subjects cannot be brought into focus at this focal length.	
	25 mm	13.3 cm	1.02x (2.04x)
	42 mm	16.2 cm - 17.3 cm	0.61 - 0.69x (1.22 - 1.38x)
40-150 mm	40 mm	19.0 cm - 20.4 cm	0.61 - 0.70x (1.22 - 1.40x)
	80 mm	28.0 cm - 40.6 cm	0.32 - 0.48x (0.64 - 0.96x)
	150 mm	48.0 cm - 118.8 cm	0.17 - 0.39x (0.34 - 0.78x)

■ Storage Precautions

- Clean the lens after use. Remove dust and dirt on the surface of the lens with a blower brush or brush. Use commercially available lens cleaning paper to remove the dirt on the lens.
- Always cap the lens and store it when it is not used.
- Do not use organic solvents.

! Notes on Shooting

- Edges of pictures may be cut off if more than one filter is used or if a thick filter is used.

10

Interchangeable lenses

SAFETY PRECAUTIONS



CAUTION

RISK OF ELECTRIC SHOCK
DO NOT OPEN

CAUTION: TO REDUCE THE RISK OF ELECTRICAL SHOCK, DO NOT REMOVE COVER (OR BACK). NO USER-SERVICEABLE PARTS INSIDE. REFER SERVICING TO QUALIFIED OLYMPUS SERVICE PERSONNEL.



An exclamation mark enclosed in a triangle alerts you to important operating and maintenance instructions in the documentation provided with the product.



DANGER

If the product is used without observing the information given under this symbol, serious injury or death may result.



WARNING

If the product is used without observing the information given under this symbol, injury or death may result.



CAUTION

If the product is used without observing the information given under this symbol, minor personal injury, damage to the equipment, or loss of valuable data may result.

WARNING!

TO AVOID THE RISK OF FIRE OR ELECTRICAL SHOCK, NEVER DISASSEMBLE, EXPOSE THIS PRODUCT TO WATER OR OPERATE IN A HIGH HUMIDITY ENVIRONMENT.

General Precautions

Read All Instructions — Before you use the product, read all operating instructions. Save all manuals and documentation for future reference.

Cleaning — Always unplug this product from the wall outlet before cleaning. Use only a damp cloth for cleaning. Never use any type of liquid or aerosol cleaner, or any type of organic solvent to clean this product.

Attachments — For your safety, and to avoid damaging the product, use only accessories recommended by Olympus.

Water and Moisture — For precautions on products with weatherproof designs, read the weatherproofing sections.

Location — To avoid damage to the product, mount the product securely on a stable tripod, stand, or bracket.

Power Source — Connect this product only to the power source described on the product label.

Foreign Objects — To avoid personal injury, never insert a metal object into the product.

Heat — Never use or store this product near any heat source such as a radiator, heat register, stove, or any type of equipment or appliance that generates heat, including stereo amplifiers.

Product Handling Precautions



WARNING

- Do not use the camera near flammable or explosive gases.
- Do not use the flash and LED on people (infants, small children, etc.) at close range.
 - You must be at least 1 m (3 ft.) away from the faces of your subjects. Firing the flash too close to the subject's eyes could cause a momentary loss of vision.
- Keep young children and infants away from the camera.
 - Always use and store the camera out of the reach of young children and infants to prevent the following dangerous situations which could cause serious injury:
 - Becoming entangled in the camera strap, causing strangulation.
 - Accidentally swallowing the battery, cards or other small parts.
 - Accidentally firing the flash into their own eyes or those of another child.
 - Accidentally being injured by the moving parts of the camera.
- Do not look at the sun or strong lights with the camera.
- Do not use or store the camera in dusty or humid places.
- Do not cover the flash with a hand while firing.



CAUTION

- Stop using the camera immediately if you notice any unusual odors, noise, or smoke around it.
 - Never remove the batteries with bare hands, which may cause a fire or burn your hands.
- Never hold or operate the camera with wet hands.
- Do not leave the camera in places where it may be subject to extremely high temperatures.
 - Doing so may cause parts to deteriorate and, in some circumstances, cause the camera to catch fire. Do not use the charger if it is covered (such as a blanket). This could cause overheating, resulting in fire.
- Handle the camera with care to avoid getting a low-temperature burn.
 - When the camera contains metal parts, overheating can result in a low-temperature burn. Pay attention to the following:
 - When used for a long period, the camera will get hot. If you hold on to the camera in this state, a low-temperature burn may be caused.
 - In places subject to extremely cold temperatures, the temperature of the camera's body may be lower than the environmental temperature. If possible, wear gloves when handling the camera in cold temperatures.
- Be careful with the strap.
 - Be careful with the strap when you carry the camera. It could easily catch on stray objects - and cause serious damage.

Battery Handling Precautions

Follow these important guidelines to prevent batteries from leaking, overheating, burning, exploding, or causing electrical shocks or burns.



DANGER

- The camera uses a lithium ion battery specified by Olympus. Charge the battery with the specified charger. Do not use any other chargers.
- Never heat or incinerate batteries.
- Take precautions when carrying or storing batteries to prevent them from coming into contact with any metal objects such as jewelry, pins, fasteners, etc.
- Never store batteries where they will be exposed to direct sunlight, or subjected to high temperatures in a hot vehicle, near a heat source, etc.
- To prevent causing battery leaks or damaging their terminals, carefully follow all instructions regarding the use of batteries. Never attempt to disassemble a battery or modify it in any way, by soldering, etc.
- If battery fluid gets into your eyes, flush your eyes immediately with clear, cold running water and seek medical attention immediately.
- Always store batteries out of the reach of small children. If a child accidentally swallows a battery, seek medical attention immediately.



WARNING

- Keep batteries dry at all times.
- To prevent batteries from leaking, overheating, or causing a fire or explosion, use only batteries recommended for use with this product.
- Insert the battery carefully as described in the operating instructions.

- If rechargeable batteries have not been recharged within the specified time, stop charging them and do not use them.
- Do not use a battery if it is cracked or broken.
- If a battery leaks, becomes discolored or deformed, or becomes abnormal in any other way during operation, stop using the camera.
- If a battery leaks fluid onto your clothing or skin, remove the clothing and flush the affected area with clean, running cold water immediately. If the fluid burns your skin, seek medical attention immediately.
- Never subject batteries to strong shocks or continuous vibration.



CAUTION

- Before loading, always inspect the battery carefully for leaks, discoloration, warping, or any other abnormality.
- The battery may become hot during prolonged use. To avoid minor burns, do not remove it immediately after using the camera.
- Always unload the battery from the camera before storing the camera for a long period.
- This camera uses a lithium ion battery specified by Olympus. Do not use any other type of battery. For safe and proper use, read the battery's instruction manual carefully before using it.
- If the battery's terminals get wet or greasy, camera contact failure may result. Wipe the battery well with a dry cloth before use.
- Always charge a battery when using it for the first time, or if it has not been used for a long period.
- When operating the camera with battery power at low temperatures, try to keep the camera and spare battery as warm as possible. A battery that has run down at low temperatures may be restored after it is warmed at room temperature.
- The number of pictures you can take may vary depending on the shooting conditions or battery.
- Before going on a long trip, and especially before traveling abroad, purchase extra batteries. A recommended battery may be difficult to obtain while traveling.
- Please recycle batteries to help save our planet's resources. When you throw away dead batteries, be sure to cover their terminals and always observe local laws and regulations.

Caution for Usage Environment

- To protect the high-precision technology contained in this product, never leave the camera in the places listed below, no matter if in use or storage:
 - Places where temperatures and/or humidity are high or go through extreme changes. Direct sunlight, beaches, locked cars, or near other heat sources (stove, radiator, etc.) or humidifiers.
 - In sandy or dusty environments.
 - Near flammable items or explosives.
 - In wet places, such as bathrooms or in the rain. When using products with weatherproof designs, read their manuals as well.
 - In places prone to strong vibrations.
- Never drop the camera or subject it to severe shocks or vibrations.
- When mounted on a tripod, adjust the position of the camera with the tripod head. Do not twist the camera.
- Do not leave the camera pointed directly at the sun. This may cause lens or shutter curtain damage, color failure, ghosting on the image pickup device, or may possibly cause fires.
- Do not touch electric contacts on cameras and interchangeable lenses. Remember to attach the body cap when removing the lens.
- Before storing the camera for a long period, remove the battery. Select a cool, dry location for storage to prevent condensation or mold from forming inside the camera. After storage, test the camera by turning it on and pressing the shutter release button to make sure that it is operating normally.
- Always observe the operating environment restrictions described in the camera's manual.

LCD Monitor

- Do not push the monitor forcibly; otherwise the image may become vague, resulting in a playback mode failure or damage to the monitor.
- A strip of light may appear on the top/bottom of the monitor, but this is not a malfunction.
- When a subject is viewed diagonally in the camera, the edges may appear zigzagged on the monitor. This is not a malfunction; it will be less noticeable in playback mode.
- In places subject to low temperatures, the LCD monitor may take a long time to turn on or its color may change temporarily. When using the camera in extremely cold places, it is a good idea to occasionally place it in a warm place. An LCD monitor exhibiting poor performance due to low temperatures will recover in normal temperatures.
- The LCD used for the monitor is made with high-precision technology. However, black spots or bright spots of light may appear constantly on the LCD Monitor. Due to its characteristics or the angle at which you are viewing the monitor, the spot may not be uniform in color and brightness. This is not a malfunction.

Lens

- Do not immerse in water or splash with water.
- Do not drop or exert strong force on the lens.
- Do not hold at the moving part of the lens.
- Do not touch the lens surface directly.
- Do not touch the contact points directly.
- Do not subject to abrupt temperature changes.
- Do observe the operating temperature limit.

Legal and Other Notices

- Olympus makes no representations or warranties regarding any damages, or benefit expected by using this unit lawfully, or any request from a third person, which are caused by the inappropriate use of this product.
- Olympus makes no representations or warranties regarding any damages or any benefit expected by using this unit lawfully which are caused by erasing picture data.

Disclaimer of Warranty

- Olympus makes no representations or warranties, either expressed or implied, by or concerning any content of these written materials or software, and in no event shall be liable for any implied warranty of merchantability or fitness for any particular purpose or for any consequential, incidental or indirect damages (including but not limited to damages for loss of business profits, business interruption and loss of business information) arising from the use or inability to use these written materials or software or equipment. Some countries do not allow the exclusion or limitation of liability for consequential or incidental damages, so the above limitations may not apply to you.
- Olympus reserves all rights to this manual.

Warning

Unauthorized photographing or use of copyrighted material may violate applicable copyright laws. Olympus assumes no responsibility for unauthorized photographing, use or other acts that infringe upon the rights of copyright owners.

Copyright Notice

All rights reserved. No part of these written materials or this software may be reproduced or used in any form or by any means, electronic or mechanical, including photocopying and recording or the use of any type of information storage and retrieval system, without the prior written permission of Olympus. No liability is assumed with respect to the use of the information contained in these written materials or software, or for damages resulting from the use of the information contained therein. Olympus reserves the right to alter the features and contents of this publication or software without obligation or advance notice.

FCC Notice

- Radio and Television Interference
Changes or modifications not expressly approved by the manufacturer may void the user's authority to operate this equipment. This equipment has been tested and found to comply with the limits for a Class B digital device, pursuant to Part 15 of the FCC Rules. These limits are designed to provide reasonable protection against harmful interference in a residential installation. This equipment generates, uses, and can radiate radio frequency energy and, if not installed and used in accordance with the instructions, may cause harmful interference to radio communications. However, there is no guarantee that interference will not occur in a particular installation. If this equipment does cause harmful interference to radio or television reception, which can be determined by turning the equipment off and on, the user is encouraged to try to correct the interference by one or more of the following measures:
 - Adjust or relocate the receiving antenna.
 - Increase the distance between the camera and receiver.
 - Connect the equipment to an outlet on a circuit different from that to which the receiver is connected.
 - Consult your dealer or an experienced radio/TV technician for help. Only the OLYMPUS-supplied USB cable should be used to connect the camera to USB enabled personal computers (PC).

Any unauthorized changes or modifications to this equipment would void the user's authority to operate it.

For customers in North and South America

For customers in USA

Declaration of Conformity

Model Number : E-510

Trade Name : OLYMPUS

Responsible Party : **OLYMPUS IMAGING AMERICA INC.**

Address : 3500 Corporate Parkway, P.O. Box 610, Center Valley,
PA 18034-0610, U.S.A.

Telephone Number : 484-896-5000

Tested To Comply With FCC Standards
FOR HOME OR OFFICE USE

This device complies with Part 15 of the FCC rules. Operation is subject to the following two conditions:

- (1) This device may not cause harmful interference.
- (2) This device must accept any interference received, including interference that may cause undesired operation.

For customers in Canada

This Class B digital apparatus meets all requirements of the Canadian Interference-Causing Equipment Regulations.

For customers in Europe



"CE" mark indicates that this product complies with the European requirements for safety, health, environment and customer protection. "CE" mark cameras are intended for sales in Europe.



This symbol [crossed-out wheeled bin WEEE Annex IV] indicates separate collection of waste electrical and electronic equipment in the EU countries. Please do not throw the equipment into the domestic refuse. Please use the return and collection systems available in your country for the disposal of this product.

Use Only Dedicated Rechargeable Battery and Battery Charger

We strongly recommend that you use only the genuine Olympus dedicated rechargeable battery and battery charger with this camera.

Using a non-genuine rechargeable battery and/or battery charger may result in fire or personal injury due to leakage, heating, ignition or damage to the battery. Olympus does not assume any liability for accidents or damage that may result from the use of a battery and/or battery charger that are not genuine Olympus accessories.

Provisions of warranty

1. If this product proves to be defective, although it has been used properly (in accordance with the written Handling Care and Operating instructions supplied with it), during a period of two years from the date of purchase from an authorized Olympus distributor within the business area of Olympus Imaging Europa GmbH as stipulated on the website: <http://www.olympus.com> this product will be repaired, or at Olympus's option replaced, free of charge. To claim under this warranty the customer must take the product and this Warranty Certificate before the end of the two year warranty period to the dealer where the product was purchased or any other Olympus service station within the business area of Olympus Imaging Europa GmbH as stipulated on the website: <http://www.olympus.com>. During the one year period of the World Wide Warranty the customer may turn the product in at any Olympus service station. Please notice that not in all countries such Olympus service station exists.
2. The customer shall transport the product to the dealer or Olympus authorized service station at his own risk and shall be responsible for any costs incurred in transporting the product.
3. This warranty does not cover the following and the customer will be required to pay repair charge, even for defects occurring within the warranty period referred to above.

- (a) Any defect that occurs due to mishandling (such as an operation performed that is not mentioned in the Handling Care or other sections of the instructions, etc.)
 - (b) Any defect that occurs due to repair, modification, cleaning, etc. performed by anyone other than Olympus or an Olympus authorized service station.
 - (c) Any defect or damage that occurs due to transport, a fall, shock, etc. after purchase of the product.
 - (d) Any defect or damage that occurs due to fire, earthquake, flood damage, thunderbolt, other natural disasters, environmental pollution and irregular voltage sources.
 - (e) Any defect that occurs due to careless or improper storage (such as keeping the product under conditions of high temperature and humidity, near insect repellents such as naphthalene or harmful drugs, etc.), improper maintenance, etc.
 - (f) Any defect that occurs due to exhausted batteries, etc.
 - (g) Any defect that occurs due to sand, mud, etc. entering the inside of the product casing.
 - (h) When this Warranty Certificate is not returned with the product.
 - (i) When any alterations whatsoever are made to the Warranty Certificate regarding the year, month and date of purchase, the customer's name, the dealer's name, and the serial number.
 - (j) When proof of purchase is not presented with this Warranty Certificate.
4. This Warranty applies to the product only; the Warranty does not apply to any other accessory equipment, such as the case, strap, lens cap and batteries.
 5. Olympus's sole liability under this warranty shall be limited to repairing or replacing the product. Any liability for indirect or consequential loss or damage of any kind incurred or suffered by the customer due to a defect of the product, and in particular any loss or damage caused to any lenses, films, other equipment or accessories used with the product or for any loss resulting from a delay in repair or loss of data, is excluded. Compelling regulations by law remain unaffected by this.

Notes regarding warranty maintenance

1. This warranty will only be valid if the Warranty Certificate is duly completed by Olympus or an authorized dealer or other documents contain sufficient proof. Therefore, please make sure that your name, the name of the dealer, the serial number and the year, month and date of purchase are all completed or the original invoice or the sales receipt (indicating the dealer's name, the date of purchase and product type) is attached to this Warranty Certificate. Olympus reserves the right to refuse free-of-charge service if neither Warranty Certificate is completed nor the above document is attached or if the information contained in it is incomplete or illegible.
 2. Since this Warranty Certificate will not be re-issued, keep it in a safe place.
- Please refer to the list on the web site: <http://www.olympus.com> for the authorized international Olympus service network.

Trademarks

- IBM is a registered trademark of International Business Machines Corporation.
- Microsoft and Windows are registered trademarks of Microsoft Corporation.
- Macintosh is a trademark of Apple Inc.
- xD-Picture Card™ is a trademark.
- All other company and product names are registered trademarks and/or trademarks of their respective owners.
- The standards for camera file systems referred to in this manual are the "Design Rule for Camera File System/DCF" standards stipulated by the Japan Electronics and Information Technology Industries Association (JEITA).

Index

Symbols

(Language selection)	83
IS (Image stabilizer)	36
BEEP sound	82
CUSTOM	83
Custom menu	110
EASY	83
FUNCTION	79
LOCK	84
MUTED	61
NATURAL	61
Playback menu	110
Setup menu	111
Shooting Menu	109
SLOW	39
VIVID	61
X-SYNC	78
4 h TIMER	84

A

Adobe RGB	63
AE (Automatic Exposure)	122
AE BKT	38
AE lock	56
AEL/AFL	77
AEL/AFL MEMO	78
AELMetering	78
AF frame [■■■]	49
AF ILLUMINAT.	51
AF MODE AF	49
ALL 	78
ALL ERASE	74
ANTI-SHOCK	63
Aperture priority shooting A	32
Aperture value	31
Auto flash	39
Auto focus	37, 98
AUTO POP UP	42, 79
Auto white balance	57, 58

B

B&W FILTER	61
Backlight timer	11, 83
BACKLIT LCD	83
Battery	3, 108
BEACH&SNOW 	30
BLACK & WHITE	69
Bulb shooting	35, 47
BUTTON TIMER	84

C

C-AF (continuous AF)	49
C-AF+MF	51
Calendar display	66
CANDLE 	30
CARD SETUP	74, 107
Cards	6, 107
Center weighted averaging metering 	54
CF/xD	108

CHILDREN 	30
CLEANING MODE	106
Close-up playback 	64
COLOR SPACE	63
Color temperature	58, 122
CompactFlash	6, 107
Compression rate	53, 122
Continuous AF (C-AF)	49
CONTRAST	61
Control panel	19, 118
COPY ALL	71
Custom printing	89
CUSTOM RESET SETTING	75
Custom white balance CWB	57

D

Date/time setting 	8
DIAL	79
Digital ESP metering 	54
Diopter adjustment	7
Direct buttons	20
Direct print	87
DIS MODE 	30
DOCUMENTS 	30
DPOF	85
Dust reduction	7, 105

E

Easy printing	88
Easy shooting modes	18
EDIT FILENAME	82
EV STEP	78
Exposure compensation 	55
Eyepiece cover	46

F

FILE NAME	81
Fill-in flash 	40
FIREWORKS 	30
FIRMWARE	84
FL BKT	43
Flash bracketing	43
Flash intensity control 	42
Flash mode 	39
Flash off 	40
Flash synchronization speed	40, 78
Focus aid	50
Focus lock	37
FOCUS RING	80
FORMAT	107
FRAME ASSIST	24

G

GRADATION	62
-----------------	----

H

HIGH KEY	62
HIGH KEY 	30
Histogram	67, 101
How to use the mode dial	18
HQ	52, 53, 101

I	
IMAGE STABILIZER IS	36
Index display	66
Information display	23, 67
ISO ISO	56
ISO LIMIT	78

J	
JPEG EDIT	69

L	
LANDSCAPE	30
LANDSCAPE+PORTRAIT	30
Lens	5, 128
Light box display	65
Lithium ion battery	3, 108
Lithium ion charger	3, 108
LIVE PREVIEW	35, 79
Live view	23
LIVE VIEW BOOST	79
LOW KEY	62
LOW KEY	30

M	
MACRO	30
Manual flash	40
Manual focus (MF)	50
Manual shooting M	34
Menu	21
METERING	54
MF (manual focus)	50
Microdrive	6, 107
Monitor adjustment	82
MONOTONE	61
MTP	83, 96
MY MODE SETUP	80

N	
NATURE MACRO	30
NIGHT SCENE	30
NIGHT+PORTRAIT	30
NOISE FILTER	63
NOISE REDUCT.	63
NTSC	84
Number of pixels	53, 123

O	
OLYMPUS Master	91
One-touch white balance	57, 60

P	
PAL	84
PANORAMA	48
PICT. TONE	61
PictBridge	87
PICTURE MODE	61
PIXEL MAPPING	106
PORTRAIT	30
Preset white balance	57
Preventing accidental erasure O-m	72
PREVIEW	79
Preview function	35
Print mode	89

Print reservation	85
PRIORITY SET	74, 80
Program shift Ps	31
Program shooting P	31

Q	
QUICK ERASE	81

R	
RAW	52
RAW DATA EDIT	69
RAW+JPEG ERASE	81
REC VIEW	82
Record mode	52, 53, 114
REDEYE FIX	69
Red-eye reduction flash	39
RELEASE PRIORITY C	51
RELEASE PRIORITY S	51
Remote control	46
RESET LENS	80
RESET PROTECT	72
Resizing	69
Rotating images	68

S	
S-AF (single AF)	49
S-AF+MF	51
SATURATION	61, 69
Scene mode SCENE	30
Self-timer	46
SEPIA	69
Sequential shooting	45
SHADING COMP.	62
SHARPNESS	61
SHQ	52, 101
Shutter priority shooting S	33
Shutter speed	31
Single AF (S-AF)	49
Single-frame copy	71
Single-frame erase	73
Single-frame playback	64
Single-frame protect	72
Single-frame shooting	45
Sleep timer	11, 82
Slideshow	68
SPORT	30
Spot metering	54
Spot metering - highlight control HI	54
Spot metering - shadow control SH	54
SQ	52, 53, 101
sRGB	63
STORAGE	83, 92
Strap	3
SUNSET	30
Super FP flash FP	44

T	
TEST PICTURE	79

U	
USB MODE	83

V

VIDEO OUT	83
Viewfinder	7, 117

W

WB	58
WB BKT	60
WB Compensation	59
White balance bracketing	60
White balance WB	57

X

xD-Picture Card	6, 107
-----------------------	--------

Z

ZUIKO DIGITAL interchangeable lens	128
--	-----

OLYMPUS®

<http://www.olympus.com/>

OLYMPUS IMAGING CORP.

Shinjuku Monolith, 3-1 Nishi-Shinjuku 2-chome, Shinjuku-ku, Tokyo, Japan

OLYMPUS IMAGING AMERICA INC.

3500 Corporate Parkway, P.O. Box 610, Center Valley, PA 18034-0610, U.S.A. Tel. 484-896-5000

Technical Support (USA)

24/7 online automated help: <http://www.olympusamerica.com/E1>

Phone customer support: Tel. 1-800-260-1625 (Toll-free)

Our phone customer support is available from 8 am to 10 pm
(Monday to Friday) ET

E-Mail: e-slrpro@olympusamerica.com

Olympus software updates can be obtained at: <http://www.olympusamerica.com/digital>

Authorized Distributors

U.S.A.:

California

Olympus Imaging America Inc.
10805 Holder Street Suite 170
Cypress, CA 90630-5145
Tel: (800) 260-1625
FAX: (714) 229-1652

New York

Olympus Imaging America Inc.
400 Rabro Drive
Hauppauge, NY 11788-4258
Tel: (800) 260-1625
FAX: (631) 881-6510

Canada:

Olympus Canada Inc.
Consumer Products Group
151 Telson Road
Markham, Ontario Canada L3R 1E7
Tel. 1-866-267-3039

OLYMPUS IMAGING EUROPA GMBH

Premises: Wendenstrasse 14-18, 20097 Hamburg, Germany

Tel: +49 40-23 77 3-0 / Fax: +49 40-23 07 61

Goods delivery: Bredowstrasse 20, 22113 Hamburg, Germany

Letters: Postfach 10 49 08, 20034 Hamburg, Germany

European Technical Customer Support:

Please visit our homepage <http://www.olympus-europa.com>

or call our TOLL FREE NUMBER* : **00800 - 67 10 83 00**

for Austria, Belgium, Denmark, Finland, France, Germany, Italy, Luxemburg, Netherlands,
Norway, Portugal, Spain, Sweden, Switzerland, United Kingdom

* Please note some (mobile) phone services providers do not permit access or request an
additional prefix to +800 numbers.

For all European Countries not listed and in case that you can't get connected

to the above mentioned number, please make use of the following

CHARGED NUMBERS: **+49 180 5 - 67 10 83** or **+49 40 - 237 73 4899**

Our Technical Customer Support is available from 9 am to 6 pm MET (Monday to Friday)