

# OLYMPUS

## DIGITAL CAMERA TG-6 Instruction Manual

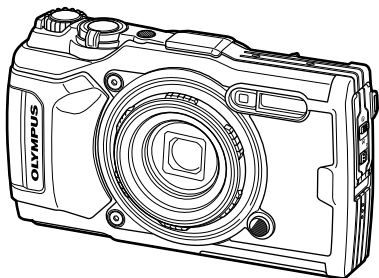

**Before You Begin**

**Table of Contents**

**Quick Task Index**

- 1. Preparation**
- 2. Shooting**
- 3. Playback**
- 4. Menu Functions**
- 5. Connecting the camera to a smartphone**
- 6. Using Field Sensor Data**
- 7. Connecting to a Computer**
- 8. Cautions**
- 9. Troubleshooting**
- 10. Information**
- 11. SAFETY PRECAUTIONS**



Model No. : IM015

- Thank you for your purchase of an Olympus digital camera. Consult this manual while operating the camera to ensure that you are using the product safely and correctly.
- Be sure you have read and understood the contents of "11. SAFETY PRECAUTIONS", before using this product. Keep these instructions available for future reference.
- We recommend that you take test shots to get accustomed to your camera before taking important photographs.
- The screen and camera illustrations shown in this manual were produced during the development stages and may differ from the actual product.
- If there are additions and/or modifications of functions due to firmware update for the camera, the contents will differ. For the latest information, please visit the Olympus website.

# Before You Begin

## **Read and Follow Safety Precautions**

To prevent incorrect operation resulting in fire or other damage to property or harm to yourself or to others, read "11. SAFETY PRECAUTIONS" (P. 148) in its entirety before using the camera.

While using the camera, consult this manual to ensure safe and correct operation. Be sure to keep the manual in a safe place once it is read.

Olympus will not be held liable for violations of local regulations arising from use of this product outside the country or region of purchase.

## **Wireless LAN and GPS**

The camera features built-in wireless LAN and GPS. Use of these features outside the country or region of purchase may violate local wireless regulations; be sure to check with local authorities before use. Olympus will not be held liable for the user's failure to comply with local regulations.

Disable wireless LAN and GPS in areas where their use is prohibited.

 "5. Connecting the camera to a smartphone" (P. 106), "6. Using Field Sensor Data" (P. 111)

## **User Registration**

Visit the OLYMPUS website for information on registering your OLYMPUS products.

## Product Manuals

In addition to the “Instruction Manual” (this pdf), the documentation available for this product includes “Maintaining Water Resistance” (supplied). Consult these manuals when using the product.



### Instruction Manual (this pdf)

A how-to guide to the camera and its features. The Instruction Manual can be downloaded from the OLYMPUS website or directly using the “OLYMPUS Image Share” (OI.Share) smartphone app.





### Maintaining Water Resistance

This document lists precautions regarding water resistance. Read these instructions together with “Important Information about Water and Shock Resistant Features” (P. 123).





## Indications used in this manual







The following symbols are used throughout this manual.

 Notes	Points to note when using the camera.
	Reference pages describing details or related information.

# Table of Contents

<b>Before You Begin</b>	<b>2</b>	<b>Matching Settings to the Scene (SCN mode)</b> .....28
<b>Quick Task Index</b>	<b>8</b>	[Live Composite]: Live composite photography.....31
<b>Names of parts</b>	<b>10</b>	Panorama.....32
<b>1. Preparation</b>	<b>12</b>	<b>Shooting at Very Close Range (Δ mode)</b> .....33
Unpacking the Box Contents ....12		<b>Matching Settings to Underwater Scenes (🐟 mode)</b> .....34
Inserting and Removing the Battery and Card .....13		<b>Letting the Camera Select Aperture and Shutter Speed (P mode)</b> .....35
Removing the battery .....14		<b>Selecting Aperture (A mode)</b> ....36
Removing the card .....15		<b>Custom Modes (Custom mode C1/C2)</b> .....37
Usable cards.....15		Saving settings .....37
Charging the Battery.....16		Recalling settings .....37
Turning the Camera On.....17		<b>Recording Movies</b> .....38
Initial Setup.....18		<b>Recording Movies in Photo Shooting Modes</b> .....38
Camera Displays Unreadable/ not in the Selected Language ...20		<b>Recording Movies in Movie Mode (🎬 mode)</b> .....39
Formatting the Card.....21		<b>Using Various Settings</b> .....40
<b>2. Shooting</b>	<b>22</b>	<b>Settings Accessible via Direct Buttons</b> .....41
Information Displays while Shooting.....22		Controlling exposure (Exposure  ).....41
Switching the information display .....24		Zoom (Digital teleconverter) .....42
Basic Photography.....25		Performing the sequential/self-timer shooting .....42
Taking photographs (AUTO mode) .....25		Pro Capture .....44
Using the zoom.....26		Using a flash (Flash photography) .....45
Selecting a Shooting Mode .....27		Focus lock .....46
Types of shooting modes.....27		Using the LED illuminator .....47

<b>Settings Accessible via Live Controls</b> .....	<b>48</b>
Processing options (Picture mode).....	50
Changing ISO sensitivity (ISO).....	52
Adjusting color (White balance).....	53
Selecting a focus mode (AF mode).....	55
Setting the image aspect.....	55
Selecting image quality (Still image quality).....	56
Selecting image quality (Movie quality).....	57
Reducing camera shake (Image stabilizer).....	59
Adjusting flash output (Flash intensity control).....	59
Selecting how the camera measures brightness (Metering).....	60
Automatic face detection (Face priority).....	60
Using optional accessories (Accessory).....	61
<b>3. Playback</b> .....	<b>62</b>
<b>Information Display during Playback</b> .....	<b>62</b>
Playback image information.....	62
Switching the information display.....	63
<b>Viewing Photographs and Movies</b> .....	<b>64</b>
Index display/Calendar display.....	65
Close-up playback.....	65
Movie playback.....	66
Erasing images during playback.....	66
<b>Using the Playback Menu</b> .....	<b>67</b>
Play.....	67
RAW Data Edit/JPEG Edit.....	68
Play Movie.....	69
Movie Edit.....	69
Share Order.....	71
 .....	71
 .....	72
Rotate.....	72
 .....	73
Image Overlay.....	74
 .....	75
Erase.....	75
<b>Selecting images (On, Erase Selected, Share Order Selected)</b> .....	<b>76</b>
<b>Scrolling Panoramas</b> .....	<b>77</b>
<b>4. Menu Functions</b> .....	<b>78</b>
<b>Basic menu operations</b> .....	<b>78</b>
<b>Using Shooting Menu 1/ Shooting Menu 2</b> .....	<b>80</b>
Restoring default settings/saving settings (Reset/Assign Custom Modes).....	80
Processing options (Picture Mode).....	81
Selecting the focusing area (AF Area).....	82
Shooting automatically with a fixed interval (Intrvl. Sh./Time Lapse).....	84
Varying focus little-by-little over a series of pictures (Focus BKT).....	85
Increasing depth of field (Focus Stacking Settings).....	86
Date stamps (Date Stamp).....	86

■ Using the Video Menu.....	87
■ Using the Playback Menu.....	88
Displaying images rotated (  ).....	88
Retouching pictures (Edit).....	88
Creating movie stills (In-Movie Image Capture).....	92
Trimming movies (Movie Trimming).....	93
Canceling all protections.....	93
■ Using the Setup Menu.....	94
Deleting all images (Card Setup).....	95
Selecting a language (  ).....	95
■ Using the Custom Menus.....	96
<b>A</b> AF/MF.....	96
<b>B</b> Disp/(  )/PC.....	96
<b>C</b> Exp/ISO.....	97
<b>D</b>  Custom.....	98
<b>E</b>  /WB/Color.....	98
<b>F</b> Record.....	99
<b>G</b> Field Sensor.....	100
<b>H</b>  Utility.....	100
Improving focus in dark surroundings (AF Illuminator).....	101
MF Assist.....	101
Adding information displays.....	102
Viewing camera images on TV.....	104
Combinations of JPEG image sizes and compression rates.....	105

## 5. Connecting the camera to a smartphone 106

■ Adjusting Settings for Connection to a Smartphone.....	107
■ Transferring Images to a Smartphone.....	108
■ Shooting Remotely with a Smartphone.....	108
■ Changing Connection Method.....	109
■ Resetting Wireless LAN Settings.....	109
■ Changing the Password.....	110
■ Cancelling a Share Order.....	110

## 6. Using Field Sensor Data 111

GPS: Precautions for use.....	111
Before using GPS function (A-GPS data).....	111
Using GPS.....	112
Displaying tracked movement of GPS logs.....	112
■ Recording and Saving Logs.....	113
■ Using Buffered and Saved Logs.....	114
■ Viewing Location Data.....	115
Location data displays.....	115

<b>7. Connecting to a Computer</b>	<b>116</b>	<b>10. Information</b>	<b>136</b>
■ Connecting the Camera to a Computer .....	116	■ List of Settings Available in each Shooting Mode .....	136
■ Copying Pictures to a Computer .....	117	■ Default/Custom Settings.....	140
■ Installing the PC Software .....	117	■ Specifications .....	145
<b>8. Cautions</b>	<b>118</b>	<b>11. SAFETY PRECAUTIONS</b>	<b>148</b>
■ Batteries .....	118	■ SAFETY PRECAUTIONS .....	148
■ Using Your Charger Abroad ....	118	<b>Index</b>	<b>161</b>
■ Number of Images (Stills)/ Length of Footage (Movies) per Card.....	119		
■ Cleaning and Storing the Camera .....	121		
Cleaning the camera .....	121		
Storage .....	122		
Pixel Mapping - Checking the image processing functions ....	122		
■ Important Information about Water and Shock Resistant Features .....	123		
■ Using Separately Sold Accessories .....	125		
Attaching optional silicone jackets .....	125		
Taking pictures with the Olympus Wireless RC Flash System.....	125		
■ Optional Accessories.....	126		
<b>9. Troubleshooting</b>	<b>130</b>		
■ Some Common Issues and Their Solutions .....	130		

# Quick Task Index

## Shooting



Just shoot without making any difficult settings	▶ AUTO mode (AUTO)	25
Photographing light trails (lighten blending)	▶ Live Composite (SCN)	31
Taking close-ups of small objects/ macro (close range) photography	▶ Microscope mode (Δ)	33
Keeping both foreground and background in focus	▶ Focus Stacking	33
Taking stylish pictures/ taking monotone pictures	▶ ART (Picture mode)	50
Adjusting settings for underwater photography	▶ Underwater mode (🐟)	34
Adjusting the brightness of highlights and shadows	▶ Exposure compensation	41
Recording GPS location data, air and water temperature, altitude (depth), and heading	▶ Field sensors	111
Taking pictures with colors at the same shade as they appear	▶ White balance	53
Changing an aspect ratio	▶ Aspect ratio	55
When the camera will not focus on your subject/Focusing on one area	▶ AF target settings	82
Keeping a moving subject in focus	▶ Tracking	83
Taking photos in the dark/ taking photos under low light conditions	▶ LED illuminator ▶ AF Illuminator	47 101
Capturing fleeting moments	▶ Pro Capture	44
Checking horizontal or vertical orientation before shooting	▶ Level Gauge	24, 102
Shooting with deliberate composition	▶ Displayed Grid	96
Optimizing the monitor/ adjusting monitor hue	▶ Monitor brightness adjustment	94
Increasing the number of pictures that can be taken	▶ Still image quality mode	56
Using a remote control	▶ Shooting remotely with a smartphone	108



## Playback/Retouch



Viewing images on a TV/ viewing images with high picture quality on a highdefinition TV	▶ HDMI	97
	▶ Viewing camera images on TV	104
Brightening shadows	▶ Shadow Adj (JPEG Edit)	68, 90
Dealing with red-eye	▶ Redeye Fix (JPEG Edit)	68, 90
Printing made easy	▶ Creating a print order	75
Erasing the sound recorded to a still image	▶	72
Changing the number of frames or adding frames to the index playback display	▶ /Info Settings	102

## Camera Settings



Synchronizing the date and time	▶ Setting the date/time	18, 94
Restoring default settings	▶ Reset	80
Changing the menu display language	▶	95
Turning off the auto focus sound	▶  (Beep sound)	97
Saving settings	▶ Custom mode (C1/C2)	37
Putting date stamps on photos	▶ Date Stamp	86
Hiding menu guides	▶ Basic menu operations	78

# Names of parts

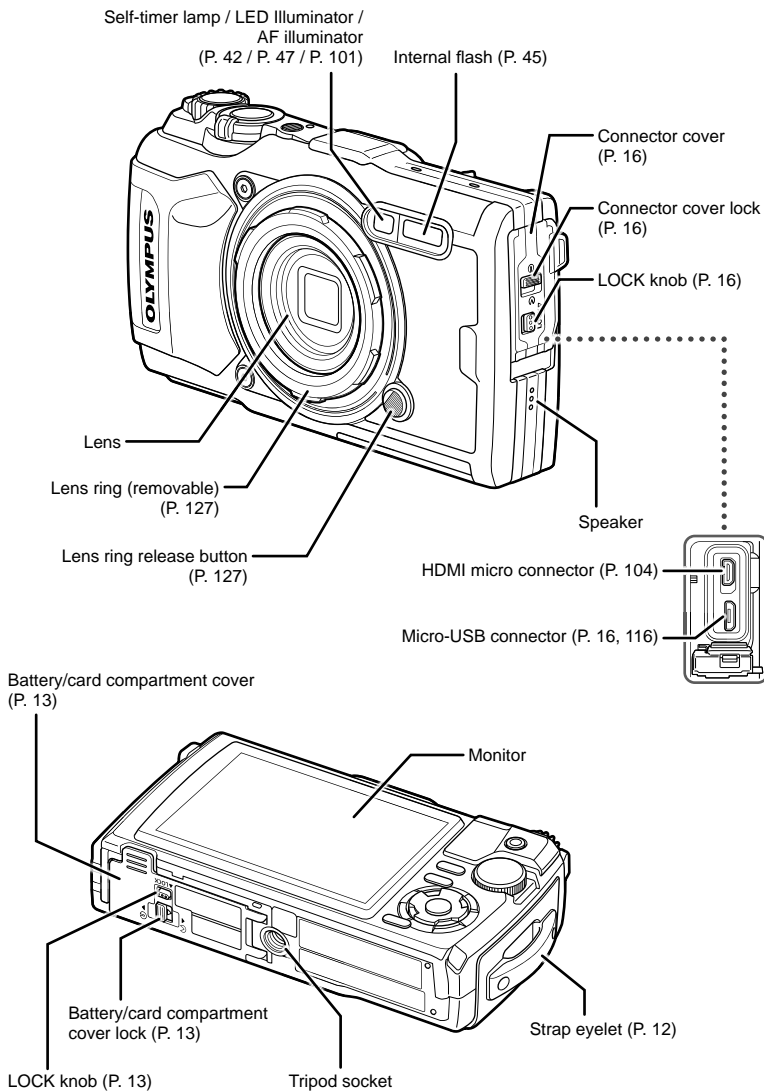

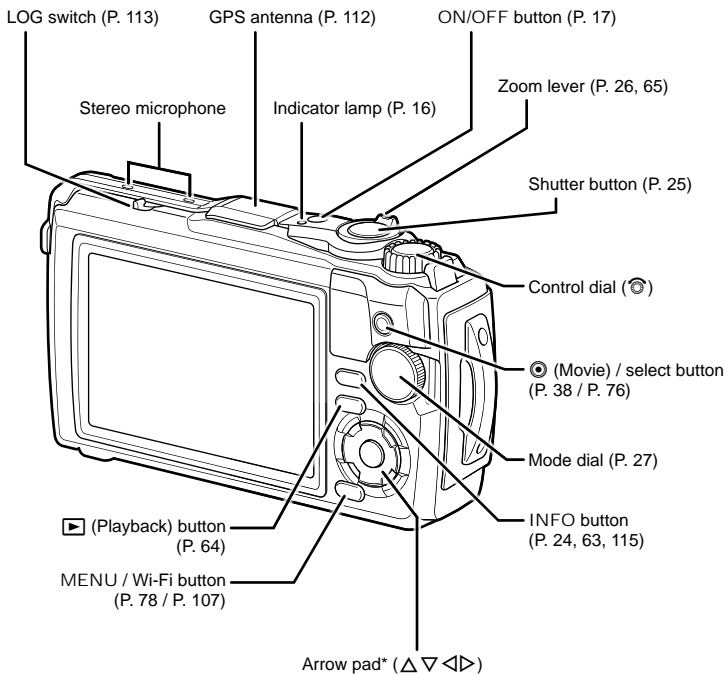

$\Delta$  (Up) /  $\square$  (Exposure compensation) button (P. 41)

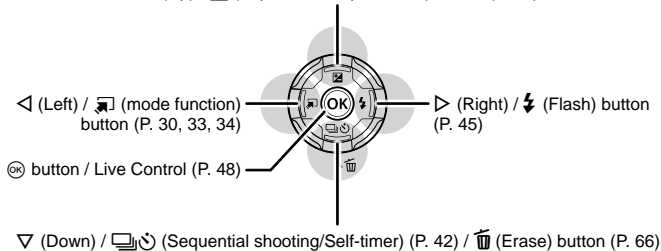

\* In this manual, the  $\Delta$   $\nabla$   $\triangleleft$   $\triangleright$  icons represent operations performed using the arrow pad.

# 1 Preparation

1

Preparation

## Unpacking the Box Contents

The following items are included with the camera. If anything is missing or damaged, contact the dealer from whom you purchased the camera.

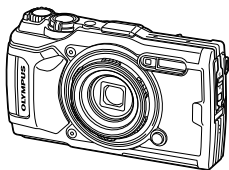

Camera  
(with removable lens ring)

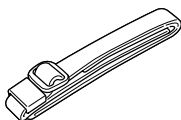

Strap

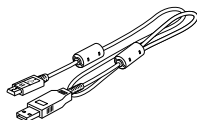

USB cable CB-USB12

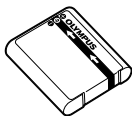

Lithium-ion battery LI-92B

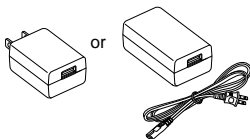

USB-AC adapter F-5AC

- Basic Manual
- Maintaining Water Resistance
- Warranty card

Contents may vary depending on purchase location.

### Attaching the strap

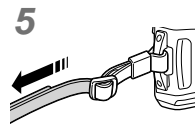
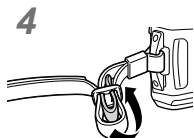
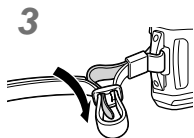
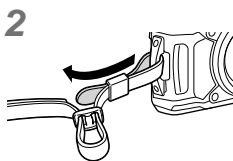
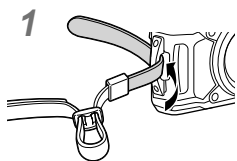

- Lastly, pull the strap firmly, making sure that it is fastened securely.

## Inserting and Removing the Battery and Card

Turn off the camera before opening the battery/card compartment cover.

In this manual, all storage devices are referred to as “cards.”

The following types of SD card (commercially available) can be used with this camera: SD, SDHC, and SDXC.

Cards must be formatted with this camera before first use or after being used with other cameras or computers.  “Formatting the Card” (P. 21)

### 1 Opening the battery/card compartment cover.

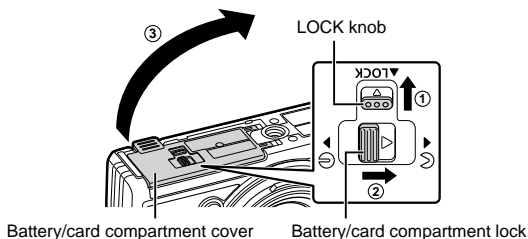

### 2 Loading the battery.

- Use only LI-92B batteries (P. 12, 147).
- Insert the battery as illustrated with the mark toward the battery lock knob. 
- If you insert the battery in the wrong direction, the camera is not turned on. Be sure to insert it in the correct direction.

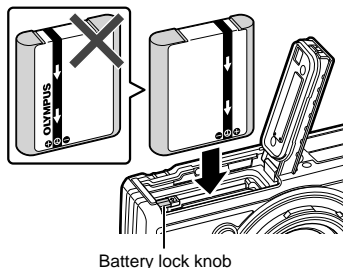

### 3 Loading the card.

- Slide the card in until it is locked into place.  “Usable cards” (P. 15)

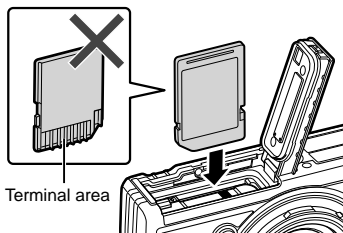

- Do not forcibly insert a damaged or deformed card. Doing so may damage the card slot.

#### 4 Closing the battery/card compartment cover.

- When using the camera, be sure to close the battery/card compartment cover.

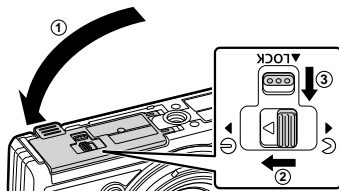

### Removing the battery

To remove the battery, first push the battery lock knob in the direction of the arrow and then remove.

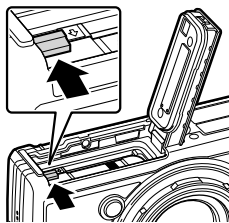

- Do not remove the battery while the card write indicator is displayed.

Card write indicator



- Contact an authorized distributor or service center if you are unable to remove the battery. Do not use force.

#### Notes

- It is recommended to set aside a backup battery for prolonged shooting in case the battery in use drains.
- Also read "Batteries" (P. 118).

## Removing the card

Press the inserted card lightly and it will be ejected. Pull out the card.

- Do not remove the card while the card write indicator is displayed (P. 14).

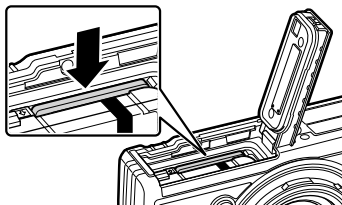

## Usable cards

In this manual, all storage devices are referred to as "cards." The following types of SD card (commercially available) can be used with this camera: SD, SDHC, and SDXC. For the latest information, please visit the Olympus website.



### SD card write protect switch

The SD card body has a write protect switch. Setting the switch to "LOCK" prevents data being written to the card. Return the switch to the unlock position enable writing.



- Cards must be formatted with this camera before first use or after being used with other cameras or computers. "Formatting the Card" (P. 21)
- The data in the card will not be erased completely even after formatting the card or deleting the data. When discarding, destroy the card to prevent leakage of personal information.

## File storage locations

Data on the card are stored in the following folders:

Folder name	Folder name: Data type
DCIM	100OLYMP: Images
GPSLOG: GPS logs	999OLYMP: Images
SNSLOG: Sensor logs	Automatic file numbering

## Charging the Battery

The battery is not fully charged at shipment. Charge the battery before use, not stopping until the indicator lamp has turned off to show that the battery is fully charged.

- 1 Check that the battery is in the camera, and connect the USB cable and USB-AC adapter.

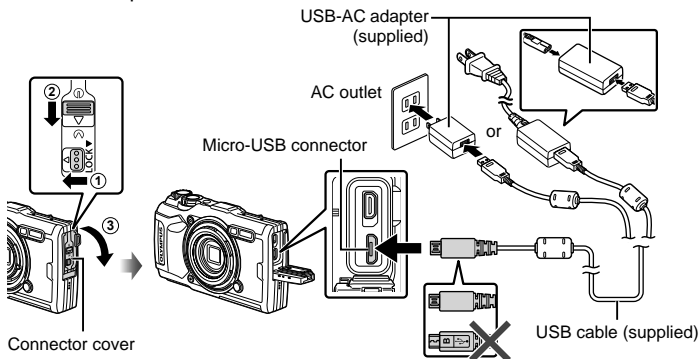

- 2 Highlight [Charge] using the  $\Delta$   $\nabla$  buttons on the arrow pad and press the  $\odot$  button.

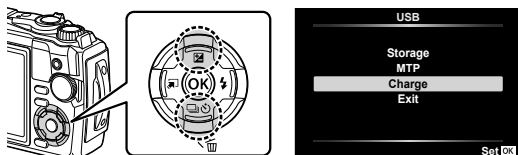

- The indicator lamp will light and charging will begin.
- The indicator lamp turns off when charging is complete.
- Charging takes about 3 hours. Charging times may increase at high ambient temperatures.

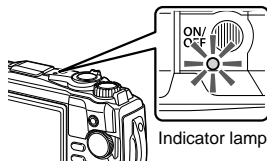

- Be sure to unplug the power plug of the USB-AC adapter from the wall outlet when the charging is complete.
- For charging the battery abroad, see "Using Your Charger Abroad" (P. 118).
- Never use any cable other than supplied or Olympus-designated USB cable. This may cause smoking or burning.
- The included F-5AC USB-AC adapter (hereafter referred to as USB-AC adapter) differs depending on the region where you purchased the camera. If you received a plug-in type USB-AC adapter, plug it directly into AC outlet.
- For details on the battery, see "SAFETY PRECAUTIONS" (P. 148). For details on the USB-AC adapter, see "SAFETY PRECAUTIONS" (P. 148).



- If the indicator lamp does not light, reconnect the USB cable and USB-AC adapter to the camera.
- If the message “No Connection” is displayed in the monitor, disconnect and reconnect the cable.
- A charger (UC-92: sold separately) can be used to charge the battery.

### When to charge the batteries

If the camera displays the message shown in the illustration, charge the battery.

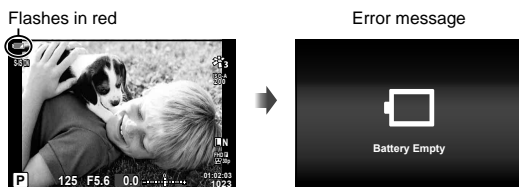

## Turning the Camera On

- 1 Press the ON/OFF button to turn on the camera.
  - The camera will turn on and the indicator lamp and monitor will light.

ON/OFF button

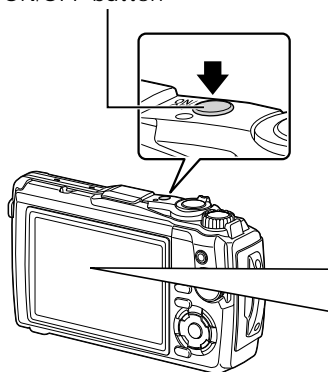

Monitor

### Battery level

The battery level icon will be displayed.

- (green): The camera is ready to shoot.
- (green): The battery is not full.
- (blinks red): Charge the battery.



### Camera sleep operation

If no operations are performed for a minute, the camera enters “sleep” (stand-by) mode to turn off the monitor and to cancel all actions. The camera activates again when you touch any button (the shutter button, button, etc.). The camera will turn off automatically if left in sleep mode for 5 minutes. Turn the camera on again before use. You can select how long the camera remains idle before entering sleep mode. [Sleep] (P. 100)

## Initial Setup

After turning the camera on for the first time, perform the initial setup by selecting a language and setting the camera clock.

- Date and time information is recorded on the card together with the images.
- The file name is also included with the date and time information. Be sure to set the correct date and time before using the camera. Some functions cannot be used if the date and time have not been set.

- 1 Press the **OK** button when the initial setup dialog is displaying prompting you to select a language.

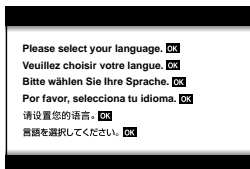

- 2 Highlight the desired language using the control dial or the **△ ▽ ◀ ▶** buttons on the arrow pad.

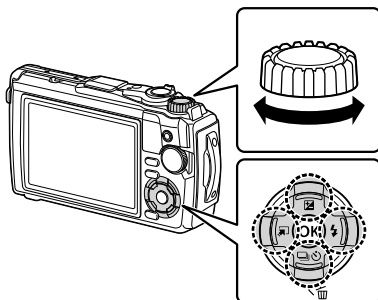

- The language-selection dialog has two pages of options. Use the control dial or the **△ ▽ ◀ ▶** buttons on the arrow pad to move the cursor between pages.

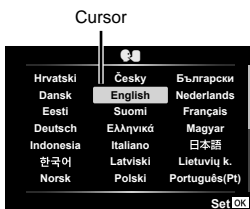

### 3 Press the **OK** button when the desired language is highlighted.

- If you press the shutter button before pressing the **OK** button, the camera will exit to shooting mode and no language will be selected. You can perform the initial setup by turning the camera off and then on again to display the initial setup dialog and repeating the process from Step 1.
- The language can be changed at any time from the **Y** setup menu. **INFO** "Selecting a language (**INFO**)" (P. 95)



### 4 Set the date, time, and date format.

- Use the **<|>** buttons on the arrow pad to highlight items.
- Edit the highlighted item using the control dial or the **Δ** **∇** buttons on the arrow pad.
- Press the **OK** button to set the clock.
- The clock can be adjusted at any time from the **Y** setup menu. **INFO** [Clock Settings] (P. 94)

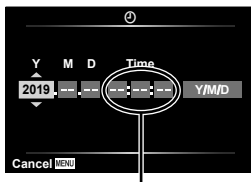

The time is displayed using a 24-hour clock.

### 5 Highlight a time zone using the control dial or the **Δ** **∇** buttons on the arrow pad and press the **OK** button.

- Daylight saving time can be turned on or off using the **INFO** button.



- If the battery is removed from the camera and the camera is left for a while, the date and time may be reset to the factory default setting.
- You may also need to adjust the frame rate before shooting movies. **INFO** [Video Frame Rate] (P. 87)

## Camera Displays Unreadable/not in the Selected Language

If the camera displays are in an unfamiliar language or use characters you are unable to read, you may have accidentally selected the wrong language in the language-selection dialog. Follow the steps below to change languages.

1

Preparation

- 1 Press the MENU button to display the menus.

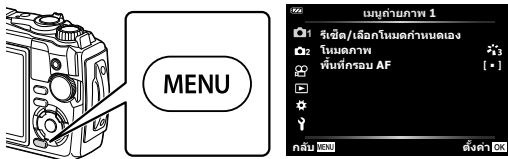

- 2 Highlight the ȳ tab using the  $\Delta$   $\nabla$   $\triangleleft$  buttons on the arrow pad and press the  $\text{OK}$  button.

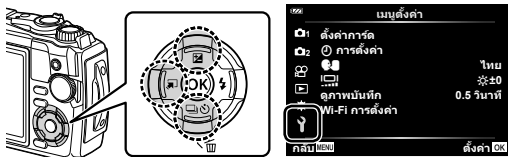

- 3 Highlight [ȳ] using the  $\Delta$   $\nabla$  buttons on the arrow pad and press the  $\text{OK}$  button.



- 4 Highlight the desired language using the  $\Delta$   $\nabla$   $\triangleleft$   $\triangleright$  buttons on the arrow pad and press the  $\text{OK}$  button.



## Formatting the Card



Cards must be formatted with this camera before first use or after being used with other cameras or computers.

All data stored on the card, including protected images, is erased when the card is formatted.

When formatting a used card, confirm there are no images that you still want to keep on the card.  "Usable cards" (P. 15)

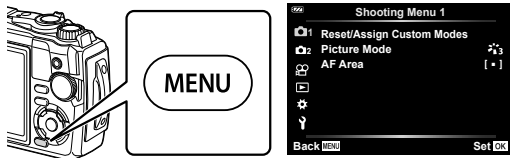
- 1 Press the MENU button to display the menus.



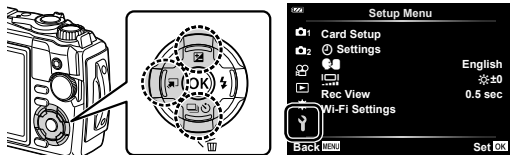

- 2 Highlight the  tab using the  $\Delta$   $\nabla$   $\triangleleft$  buttons on the arrow pad and press the  button.

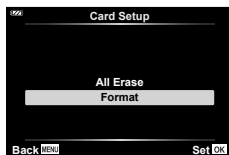

- 3 Highlight [Card Setup] using the  $\Delta$   $\nabla$  buttons on the arrow pad and press the  button.

- If there is data on the card, menu items appear.  
Highlight [Format] and press the  button.



- 4 Highlight [Yes] and press the  button.

- Formatting is performed.

# 2 Shooting

## Information Displays while Shooting

### Monitor display during still photography

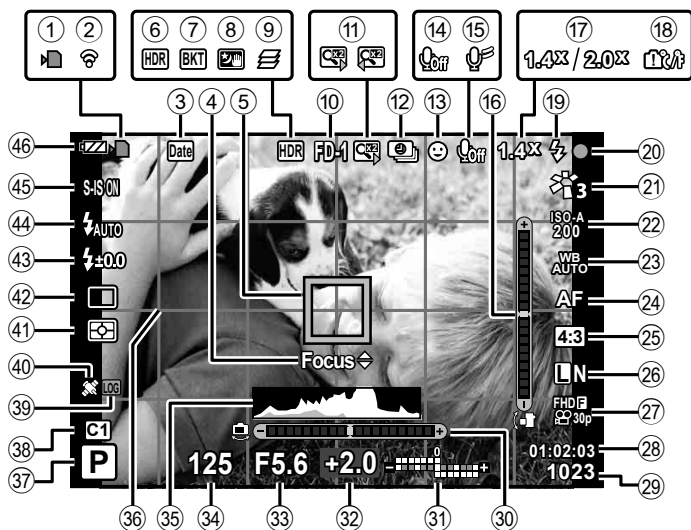

### Monitor display during movie mode

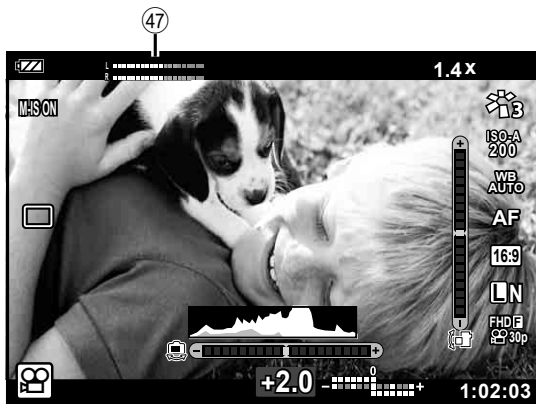

- ① Card write indicator.....P. 14
- ② Wireless LAN connection status  
.....P. 106–110
- ③ Date stamp .....P. 86
- ④ AF fine-tuning guide.....P. 46, 55
- ⑤ Af target .....P. 25, 82
- ⑥ HDR.....P. 29, 34
- ⑦ Bracketing icon .....P. 33, 85
- ⑧ Handheld starlight.....P. 28
- ⑨ Focus stacking.....P. 33
- ⑩ Accessory .....P. 61, 126
- ⑪ Digital teleconverter\*1 .....P. 42
- ⑫ Time lapse shooting.....P. 84
- ⑬ Face priority .....P. 60
- ⑭ Movie sound .....P. 38, 72, 87
- ⑮ Wind noise reduction .....P. 87
- ⑯ Level gauge (tilt) .....P. 24, 102
- ⑰ Optical zoom ratio/  
magnification\*1 .....P. 26, 33
- ⑱ Internal temperature warning.....P. 134
- ⑲ Flash .....P. 45  
(blinks: charging in progress, lights up:  
charging completed)
- ⑳ AF confirmation mark.....P. 25
- ㉑ Picture mode.....P. 50, 81
- ㉒ ISO sensitivity .....P. 52
- ㉓ White balance .....P. 53
- ㉔ AF mode .....P. 55
- ㉕ Aspect ratio.....P. 55
- ㉖ Image quality (still images) .....P. 56
- ㉗ Record mode (movies) .....P. 57
- ㉘ Available recording time .....P. 119
- ㉙ Number of storable still pictures ...P. 119
- ㉚ Level gauge (horizon).....P. 24, 102
- ㉛ Top: Flash intensity control .....P. 59  
Bottom: Exposure compensation....P. 41
- ㉜ Exposure compensation value.....P. 41
- ㉝ Aperture value .....P. 36
- ㉞ Shutter speed .....P. 35
- ㉟ Histogram .....P. 24
- ㊱ Grid guide .....P. 96
- ㊲ Shooting mode.....P. 27–39
- ㊳ Custom mode .....P. 37
- ㊴ LOG icon/warning.....P. 113
- ㊵ GPS icon.....P. 111
- ㊶ Metering mode.....P. 60
- ㊷ Sequential shooting/Self-timer.....P. 42  
Pro Capture shooting.....P. 44
- ㊸ Flash intensity control.....P. 59
- ㊹ Flash mode .....P. 45
- ㊺ Image stabilizer.....P. 59
- ㊻ Battery level.....P. 17
- ㊼ Recording level meter.....P. 39

\*1 Displayed at all times if [  Microscope Control ] (P. 33) is in use.

## Switching the information display

You can switch the information displayed in the monitor during shooting using the INFO button.

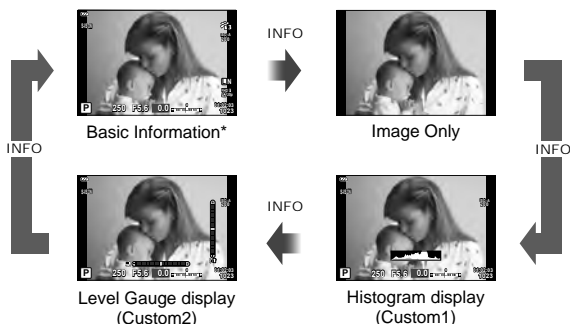
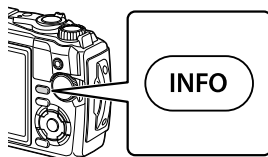

\* Not displayed in mode (movie mode) unless recording is in progress.

- You can change Custom1 and Custom2 settings. [Info Settings] > [LV-Info] (P. 102)
- The information display screens can be switched in either direction by rotating the control dial while pressing the INFO button.

### Histogram display

A histogram showing the distribution of brightness in the image is displayed. The horizontal axis gives the brightness, the vertical axis the number of pixels of each brightness in the image. During shooting, overexposure is indicated in red, underexposure in blue, and the range metered using spot metering in green.

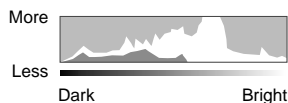

### Level gauge display

The orientation of the camera is indicated. The “tilt” direction is indicated on the vertical bar and the “horizon” direction on the horizontal bar. The camera is level and plumb when the bars turn green.

- Use the indicators on the level gauge as a guide.
- Error in the display can be corrected via calibration (P. 100).



## Basic Photography

Just press the shutter button and let the camera adjust settings to suit the scene.

### Taking photographs (AUTO mode)

- 1 Rotate the mode dial to **AUTO**.

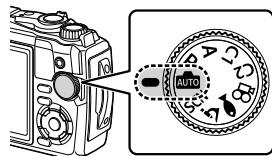

- 2 Frame the shot.

- Be careful that your fingers or the camera strap do not obstruct the lens or AF illuminator.

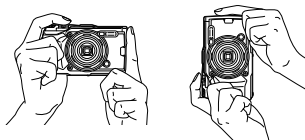

Landscape position

Portrait position

- 3 Adjust the focus.

- Display the subject in the center of the monitor, and lightly press the shutter button down to the first position (press the shutter button halfway).  
The AF confirmation mark (●) will be displayed, and a green frame (AF target) will be displayed in the focus location.

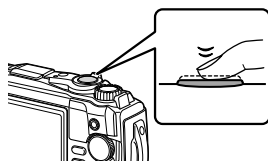

Press the shutter button halfway.



AF confirmation mark

AF target

- If the AF confirmation mark blinks, the subject is not in focus. (P. 131)

#### 4 Release the shutter.

- Press the shutter button all the way (fully).
- The camera will release the shutter and take a picture.
- The shot image will be displayed on the monitor.

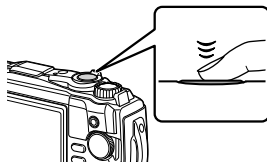

Press the shutter button all the way.



#### Notes

- To exit to shooting mode from menus or playback, press the shutter button halfway.

### Using the zoom

Zoom in to photograph distant objects or zoom out to increase the area visible in the frame. Zoom can be adjusted using the zoom lever.

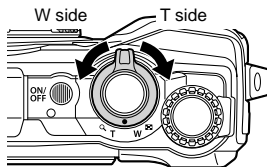



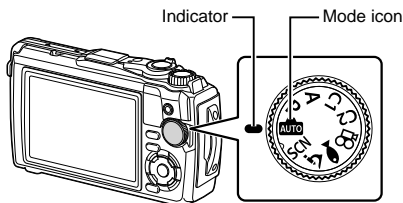

## Selecting a Shooting Mode

Use the mode dial to select the shooting mode, and then shoot the image.



### Types of shooting modes

For how to use the various shooting modes, see the following.

Shooting mode	Description	☞
	The camera automatically selects the most appropriate shooting mode.	25
SCN	The camera automatically optimizes settings for the subject or scene.	28
	Images can be taken from up to 1 cm away from the subject. In this mode you can shoot images with a large depth of field, and perform focus bracket shooting of a set number of images.	33
	Only by selecting a sub mode according to the subject or the scene, you can shoot underwater photographs with a proper setting.	34
<b>P</b>	The camera meters subject brightness and automatically adjusts shutter speed and aperture for optimal results.	35
<b>A</b>	You select the aperture and the camera automatically adjusts shutter speed for optimal results.	36
C1	Use custom modes to save and recall settings. <ul style="list-style-type: none"><li>• Different settings can be stored in each of the two custom modes (C1 and C2).</li></ul>	37
	Shoot movies.	39

#### Functions that cannot be selected from menus











Some items may not be selectable from the menus when using the arrow pad.













- Items that cannot be set with the current shooting mode. ☞ “List of Settings Available in each Shooting Mode” (P. 136)
- Items that cannot be set because of an item that has already been set:  
Settings such as picture mode are unavailable when the mode dial is rotated to .

## Matching Settings to the Scene (SCN mode)

Just rotate the mode dial to SCN and select the scene mode of your choice to shoot with the camera settings optimized by the subject or scene.

- The procedures for using [Live Composite] and [Panorama] differ from the other scene modes; for more information, see "[Live Composite]: Live composite photography" (P. 31) and "Panorama" (P. 32).

Subject type	Scene mode	Description
People	 Portrait	Suitable for portrait shooting. Brings out skin texture.
	 e-Portrait	Smooths out skin tones and texture. This mode is suitable when viewing images on a high-definition TV. The camera records two pictures: one with the effect applied and one without.
	 Portrait + Landscape	Suitable for portraits featuring a landscape in the background. Blues, greens, and skin tones are captured beautifully.
	 Portrait + Nightscape	Suitable for portrait shooting against a background of night view. Use of a tripod and remote control via OI.Share is recommended (P. 107, 108).
	 Children	Suitable for photographs of children and other active subjects.
Nightsapes	 Nightscape	Suitable for tripod shooting of night scenes. Use of a tripod and remote control via OI.Share is recommended (P. 107, 108).
	 Portrait + Nightscape	Suitable for portrait shooting against a background of night view. Use of a tripod and remote control via OI.Share is recommended (P. 107, 108).
	 Handheld Starlight	Suitable for shooting night scenes without a tripod. Reduces blur when shooting low light/illuminated scenes. The camera makes eight exposures and combines them into a single photograph.
	 Fireworks	Suitable for shooting fireworks at night. Use of a tripod and remote control via OI.Share is recommended (P. 107, 108).
	 Live Composite	The camera automatically shoots multiple images, takes newly bright areas only, and composites them into a single image. With normal long exposure, an image of light trace such as star trails with bright buildings tends to get too bright. You can capture them without over exposure while checking the progress. <ul style="list-style-type: none"> <li>For information on taking photos using this feature, see "[Live Composite]: Live composite photography" (P. 31).</li> </ul>

Subject type	Scene mode	Description
Motion	 Sport	Suitable for fast action shooting. The camera will take photos while the shutter button is pressed.
	 Children	Suitable for photographs of children and other active subjects.
Scenery	 Landscape	Suitable for landscape shooting.
	 Sunset	Suitable for shooting the sunset.
	 Beach & Snow	Suitable for shooting at snow-capped mountains, seascapes in the sun, and other whitish scenes.
	 Panorama	Shoot a series of images that combine to create a panorama. • For information on taking photos using this feature, see "Panorama" (P. 32).
	 Backlight HDR	Suitable for high-contrast scenes. Each time the shutter button is pressed, the camera takes four shots and subsequently merges them into one, correctly exposed image.
Indoors	 Candlelight	Suitable for shots of candlelit scenes. Warm colors are preserved.
	 Portrait	Suitable for portrait shooting. Brings out skin texture.
	 e-Portrait	Smooths out skin tones and texture. This mode is suitable when viewing images on a high-definition TV. The camera records two pictures: one with the effect applied and one without.
	 Children	Suitable for photographs of children and other active subjects.
	 Backlight HDR	Suitable for high-contrast scenes. Each time the shutter button is pressed, the camera takes four shots and subsequently merges them into one, correctly exposed image.

- To maximize the benefits of the scene modes, some of the shooting function settings are disabled.
- Some time may be needed to record pictures taken using [e-Portrait]. In addition, when the image quality mode is [RAW], the image is recorded in RAW+JPEG.
- [Handheld Starlight] pictures taken with [RAW] selected for image quality will be recorded in RAW+JPEG format, with the first frame recorded as a RAW image and the final composite as a JPEG image.
- [Backlight HDR] records HDR-processed images in JPEG format. When the image quality mode is set to [RAW], the image is recorded in RAW+JPEG.
  - Noise may be more noticeable in photos taken in conditions associated with slow shutter speeds.
  - For best results, secure the camera by, for example, mounting it on a tripod.
  - The image displayed on the monitor while shooting will differ from the HDR-processed image.
  - The picture mode is fixed to [Natural] and the color space is fixed to [sRGB].

**1** Rotate the mode dial to SCN.

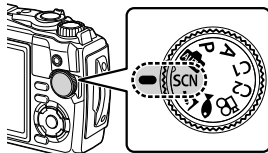

**2** Highlight the desired subject type using  $\Delta$   $\nabla$   $\langle$   $\rangle$  or the control dial and press the  $\odot$  button.



**3** Highlight the desired scene mode using  $\langle$   $\rangle$  or the control dial and press the  $\odot$  button.

- To return to the previous display, press the MENU button without pressing the  $\odot$  button to select a scene mode.
- To select a different scene mode, press the  $\square$  ( $\langle$ ) button.

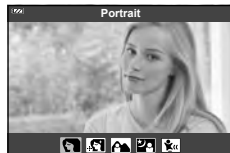

**4** Shoot.

## [Live Composite]: Live composite photography

---

- 1 Rotate the mode dial to SCN.
- 2 Highlight [Nightscapes] using  $\Delta \nabla \triangleleft \triangleright$  or the control dial and press the  $\text{OK}$  button.
- 3 Highlight [Live Composite] using  $\triangleleft \triangleright$  or the control dial and press the  $\text{OK}$  button.
- 4 Press the shutter button halfway down to focus.
  - To reduce blur caused by camera shake, fix the camera securely to a tripod and use a remote shutter release controlled via OI.Share (P. 108) in wireless remote mode.
  - If the focus indicator blinks, the camera is not in focus.
- 5 Press the shutter button all the way down to shoot.
  - The camera configures the proper settings automatically and starts shooting.
  - After pressing the shutter button, there is a time lag until shooting starts.
  - The composite image will be displayed at regular intervals.
- 6 Press the shutter button again to stop shooting.
  - View the changing result in the monitor and press the shutter button to end shooting once the desired result is achieved.
  - The recording length in one shooting is up to 3 hours.

## Panorama

- 1 Rotate the mode dial to SCN.
- 2 Highlight [Scenery] using  $\Delta$   $\nabla$   $\triangleleft$   $\triangleright$  or the control dial and press the  $\odot$  button.
- 3 Highlight [Panorama] using  $\triangleleft$   $\triangleright$  or the control dial and press the  $\odot$  button.
- 4 Press the shutter button to take the first frame.
- 5 Pan the camera slowly to frame the second shot.
  - A target mark will be displayed.
- 6 Move the camera slowly so that the pointer and the target mark overlap. The camera releases the shutter automatically when the pointer and the target overlap.
  - To combine only two frames, press the  $\odot$  button.
- 7 Repeat step 5 to take a third frame. The camera automatically combines the frames into a single panorama image.
  - To cancel the panorama function, press the MENU button.

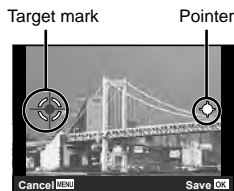

Screen when combining images from left to right







### Notes

- Focus, exposure, and the like are fixed at the values in effect at the start of shooting.
- If you press the  $\odot$  button or press the shutter button again before panning the camera to move the target over the pointer, shooting will end and a panorama will be created from the frames shot to that point.



## Shooting at Very Close Range ( $\Delta$ mode)

Images can be taken from up to 1 cm away from the subject. In this mode you can shoot images with a large depth of field, and perform focus bracket shooting of a set number of images.

Sub mode	Application
 Microscope	Images can be taken from up to 1 cm away from the subject.
 Focus Stacking* <sup>1</sup>	The camera shoots a number of images, automatically shifting the focus in each image. These can then be combined into a composite image with a large depth of field. Two images are recorded, the first frame and the composite image. The number of shots and the length of time the camera waits before shooting starts can be selected using [Focus Stacking Settings] (P. 86).
 Focus Bracketing	In this mode, the camera shoots a number of images, automatically shifting the focus in each image. The number of images and shooting steps are set in [Focus BKT] (P. 85).
 Microscope Control	Optimized for close-ups with the subject magnified in the monitor. The magnification level when the shooting distance is 1 cm is displayed on the monitor. Press $\triangleright$ to zoom in on the view through the lens (2x zoom). Press again for 4x zoom. Pressing $\triangleleft$ when 4x zoom is selected cancels zoom. At high magnification levels, the image may be grainy.

\*1 There may be situations in which it is not possible to create composite image due to camera shake.

1 Rotate the mode dial to  $\Delta$ .

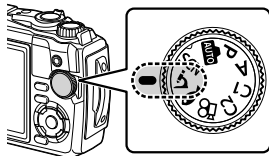

2 Highlight a secondary ("sub") mode using  $\triangleleft/\triangleright$  or the control dial and press the  $\odot$  button.



3 Shoot.





- To take a series of shots at the same focus distance, use focus lock (P. 46) or MF (P. 55).

 Notes

- When the mode dial is  $\Delta$ , the secondary ("sub") mode selection screen is displayed by pressing the  $\text{Fn}$  ( $\triangleleft$ ) button.



## Matching Settings to Underwater Scenes (🐟 mode)

Only by selecting a sub mode according to the subject or the scene, you can shoot underwater photographs with a proper setting.

Sub mode	Application
 Underwater Snapshot	Optimized for underwater photography that uses natural light.
 Underwater Wide	Suitable for shooting underwater.
 Underwater Macro	Suitable for shooting close-up view underwater.
 Underwater Microscope	Suitable for shooting subjects under water from distances as close as 1 cm.
 Underwater HDR	Suitable for contrasting underwater scenes. This mode captures multiple images and merges them into one, properly exposed image. This mode may not function well for shooting a fast-moving subject.

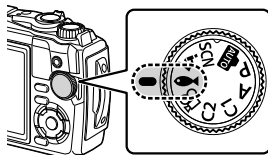
- 1 Rotate the mode dial to 🐟.



- 2 Highlight a secondary ("sub") mode using   or the control dial and press the  button.

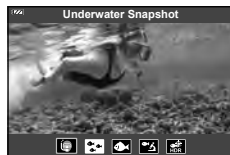

- 3 Shoot.

- To take a series of shots at the same focus distance, use focus lock (P. 46) or MF (P. 55).

### Notes

- When the mode dial is 🐟, the secondary ("sub") mode selection screen is displayed by pressing the  (<) button.

## Letting the Camera Select Aperture and Shutter Speed (P mode)

In **P** mode, the camera selects the optimal aperture, shutter speed, and ISO sensitivity according to subject brightness. Set the mode dial to **P**.

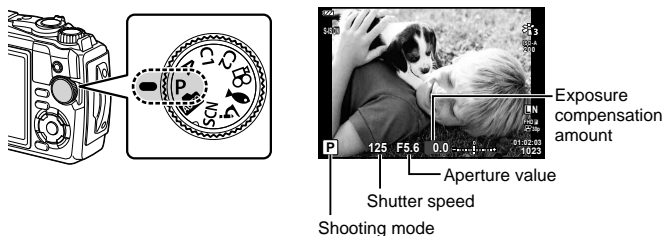

- The shutter speed and aperture selected by the camera are displayed.
- Exposure compensation (P. 41) can be adjusted by rotating the control dial or by pressing the  ( $\Delta$ ) button and then using  $\triangleleft$ / $\triangleright$ .

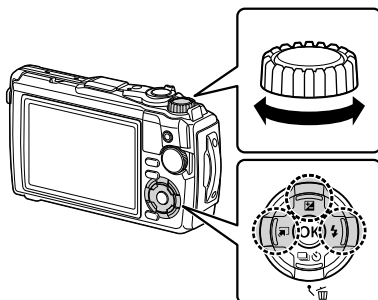



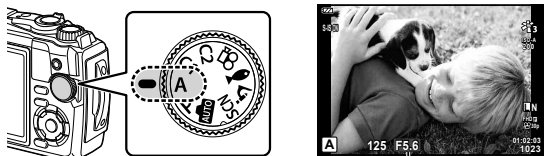

- The shutter speed and aperture value displays will blink if the camera is unable to achieve correct exposure.

## Selecting Aperture (A mode)





**A** mode is a shooting mode where you select the aperture and let the camera automatically adjust to the appropriate shutter speed. Rotate the mode dial to **A** and then use the control dial to select an aperture value.

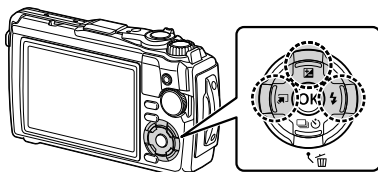

Aperture value

- After pressing the  () button, you can also use   to select the aperture.



- After pressing the  () button, you can adjust exposure compensation (P. 41) by using the control dial or  .

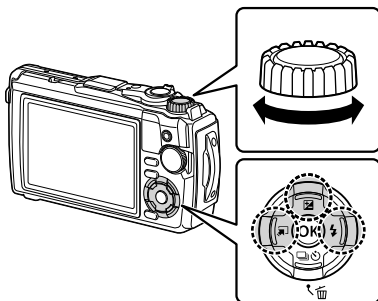







- The shutter speed display will blink if the camera is unable to achieve correct exposure.

## Custom Modes (Custom mode C1/C2)

Use custom modes to save and recall settings.

- Different settings can be stored in each of the two custom modes (C1 and C2).

### Saving settings

- 1 Adjust settings in order to save.
  - Rotate the mode dial to a position other than  (movie mode).
- 2 Press the MENU button to display the menus.
- 3 Highlight the  tab using  $\Delta$   $\nabla$   $\triangleleft$  and press the  button.
- 4 Highlight [Reset/Assign Custom Modes] and press the  button.
- 5 Highlight [Custom Mode C1] or [Custom Mode C2] and press the  button.
- 6 Highlight [Set] and press the  button.
  - Any existing settings are overwritten.
  - To cancel the registration, select [Reset].

### Recalling settings

- 1 Rotate the mode dial to C1 or C2.
  - The settings saved using [Reset/Assign Custom Modes] > [Custom Mode C1] or [Custom Mode C2] in  Shooting Menu 1 will be recalled.
- 2 Shoot.

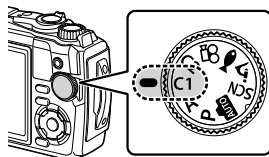

## Recording Movies

You can film movies using the camera's dedicated  (movie) mode or perform basic recording operations without ending still photography.

Movies are recorded using the  (movie) button.

Movie-related options and indicators can be displayed by rotating the mode dial to select  (movie) mode.

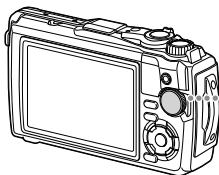

### (movie) mode

Select this mode if you will primarily be filming movies.

### Still photography modes

Select these modes to film movies during still photography.

- CMOS image sensors of the type used in the camera generate a so-called “rolling shutter” effect that can cause distortion in pictures of moving objects. This distortion is a physical phenomenon that occurs in pictures of fast-moving subjects or if the camera is moved during shooting. It is particularly noticeable in pictures taken at long focal lengths.
- The  button cannot be used to record movies in the following instances:
  - while shutter the button is pressed halfway or sequential, interval timer, live composite, or panorama photography is in progress
- A beep does not sound when the camera focuses in movie mode.

## Recording Movies in Photo Shooting Modes

- 1 Press the  button to begin recording.
  - Movie you are recording will be displayed on the monitor.

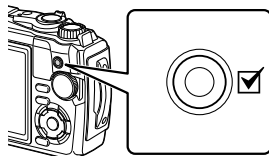

- 2 Press the  button again to end recording.

## Recording Movies in Movie Mode (🎥 mode)

- 1 Rotate the mode dial to 🎥.

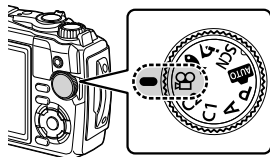

- 2 Press the **OK** button to display live controls and then use **△**/**▽** highlight 🎥 movie quality (P. 57).



🎥 Movie quality

- 3 Highlight the desired option using **◀**/**▶** and press the **OK** button.
- 4 Press the **⊙** button to begin recording.
- Press the **⊙** button again to end recording.

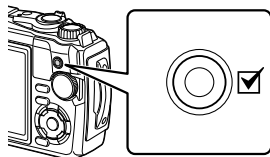

Recording level meter

- The sound level during recording is shown by the recording level meter. The more the meter extends into the red, the higher the recording level.
- The recording level can be adjusted from the 🎥 video menu. **🔊** [Recording Volume] (P. 87)



### 📝 Notes

- A beep does not sound when the camera focuses in movie mode.

## Using Various Settings

Shooting settings can be adjusted using any of the following:

### Direct Buttons (P. 41)

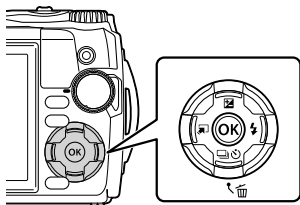

Frequently used functions are assigned to  $\Delta$   $\nabla$   $\triangleleft$   $\triangleright$ . Just by pressing the button, you can select the assigned function directly. Some features may be unavailable depending on the shooting mode and camera settings. "List of Settings Available in each Shooting Mode" (P. 136)

### Live Controls (P. 48)



Adjust settings while previewing the results in the display. Some functions are not available in some shooting modes. "List of Settings Available in each Shooting Mode" (P. 136)

### Menus (P. 78)

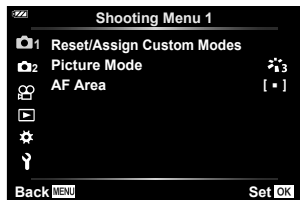

Access a wide variety of functions, including shooting, playback, time and date, and display settings.



## Settings Accessible via Direct Buttons

Frequently used functions are assigned to  $\Delta \nabla \triangleleft \triangleright$ . Just by pressing the button, you can select the assigned function directly.





Some features may be unavailable depending on the shooting mode and camera settings. "List of Settings Available in each Shooting Mode" (P. 136)

### Controlling exposure (Exposure )

Select positive ("+") values to make pictures brighter, negative ("-") values to make pictures darker. Exposure can be adjusted by  $\pm 2.0$  EV.





The method used varies with the shooting mode.

Shooting mode	Method
<b>P</b> mode/custom mode/movie mode/  mode/  mode	Rotate the control dial. or Press the  ( $\Delta$ ) button and then press $\triangleleft \triangleright$ .
<b>A</b> mode	Press the  ( $\Delta$ ) button and then rotate the control dial. or Press the  ( $\Delta$ ) button and then press $\triangleleft \triangleright$ .

- Exposure compensation is not available in  or SCN mode.

## Zoom (Digital teleconverter)

Zoom in on and record the center of the frame. In **P**, **A**, and  modes, the zoom ratio increases by about 2x, while when  (Microscope Control) is selected in **Δ** mode, you have a choice of 2x and 4x zoom.



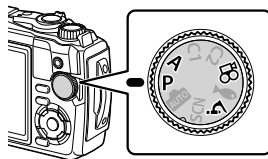

1 Rotate the mode dial to **P**, **A**,  or **Δ**.

- If the mode dial is rotated to **Δ**, select  (Microscope Control).



2 If the mode dial is rotated to **P**, **A**, or , press .

If the mode dial is rotated to **Δ**, press .

- The zoom ratio increases by 2x and a  icon is displayed. To cancel zoom, press .
- If the mode dial is rotated to **Δ**, pressing  increases zoom by 2x. Press  again for 4x zoom, and a third time to cancel zoom.
- JPEG images are recorded at the selected zoom ratio. In the case of RAW images, a frame showing the zoom crop is displayed on the image during playback.
- In the case of 4K and high-speed movies, the digital teleconverter is automatically disabled when recording starts.
- [AF Area] is fixed at [ [ ■ ] ] (single target).

Digital teleconverter









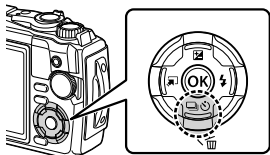



## Performing the sequential/self-timer shooting

You can take a series of pictures by keeping the shutter button pressed all the way down. Alternatively, you can take pictures using the self-timer.



1 Press the  (  ) button.



## 2 Highlight an option using $\triangleleft$ $\triangleright$ or the control dial.

	<b>Single</b>	1 frame is taken at a time when the shutter button is pressed.
	<b>Sequential High</b>	Hold the shutter-release button all the way down to take a series of photographs. <ul style="list-style-type: none"> <li>To select a frame advance rate, highlight [Sequential High] and press the INFO button before you press the <math>\odot</math> button. Select from frame advance rates of approximately 10 frames per second (10 fps) or 20 frames per second (20 fps). Use <math>\triangle</math> <math>\nabla</math> <math>\triangleleft</math><math>\triangleright</math> or the control dial to highlight a frame advance rate and press the <math>\odot</math> button to select.</li> <li>The flash is disabled.</li> </ul>
	<b>Sequential Low</b>	Pictures will be taken at about 5 fps while the shutter button is pressed all the way down.
	 <b>12 sec</b>	Press the shutter button halfway to focus, all the way down to start the timer. First, the self-timer lamp lights up for approximately 10 seconds, then it blinks for approximately 2 seconds and the picture is taken.
	 <b>2 sec</b>	Press the shutter button halfway to focus, all the way down to start the timer. The self-timer lamp blinks for approximately 2 seconds, and then the picture is taken.
	<b>Custom Self-timer</b>	Press the INFO button to set [ $\odot$ Timer], [Number of Frames], and [Interval Length]. Use $\triangleleft$ $\triangleright$ to highlight items and $\triangle$ $\nabla$ to select a value. Focus, exposure, and white balance are fixed at the values for the first shot in each series.
	<b>Pro Capture</b>	Sequential shooting begins when you press the shutter button halfway. Press the shutter button all the way down to begin recording captured images to the card, including those for a halfway press. Focus, exposure, and white balance are fixed at the values for the first shot in each series.  "Pro Capture" (P. 44) <ul style="list-style-type: none"> <li>The flash is disabled.</li> </ul>

## 3 Press the $\odot$ button.

- Fix the camera securely on a tripod for self-timer shooting.
- If you stand in front of the camera to press the shutter button when using the self-timer, the picture may be out of focus.
- When you are using , live view is displayed. In , the display shows the last photograph taken during the sequential shooting.
- During sequential shooting, if the battery level icon blinks due to low battery, the camera stops shooting and starts saving the pictures you have taken on the card. The camera may not save all of the pictures depending on how much battery power remains.

### Notes

- To cancel the activated self-timer, press the MENU button.
- Self timer is not canceled automatically after shooting.

## Pro Capture

In Pro Capture mode, the camera records pictures at a rate of about 10 frames per second, starting approximately 0.5 seconds before the shutter button is pressed all the way down. Use this mode to capture moments you might otherwise miss due to shutter lag.

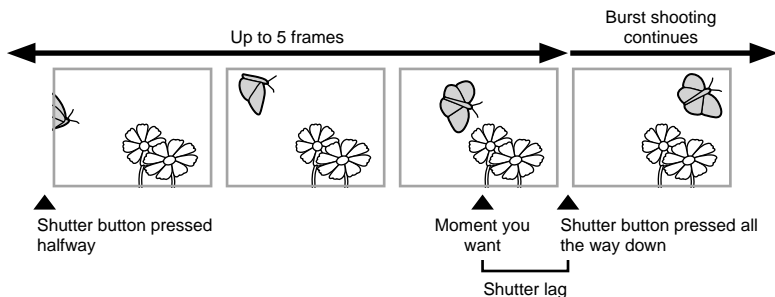

To eliminate the lag between the shutter button being pressed all the way down and the start of recording, the camera starts shooting a series of pictures using the electronic shutter when the shutter button is pressed halfway, and begins recording the pictures—including those taken when the shutter button was pressed halfway (up to 5)—to the card when the shutter button is pressed all the way down.

- 1 Press the (▼) button.

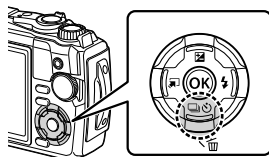





- 2 Highlight **Pro Cap** (Pro Capture) using or the control dial and press the button.
- 3 Press the shutter button halfway to start shooting.
- 4 Press the shutter button all the way down to start recording to the card.
  - The camera will continue shooting for up to a minute while the shutter button is pressed halfway. To resume shooting, press the button halfway again.
  - Flickering occurred by fluorescent lights or the large movement of the subject, etc. may cause distortions in images.
  - The monitor will not be blacked out and the shutter sound will not be emitted while bracketing.
  - The slowest shutter speed is limited.



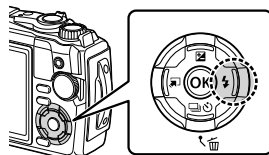









## Using a flash (Flash photography)





You can use a flash when shooting.

- 1 Press the  () button.



- 2 Highlight a flash mode using   or the control dial and press the  button.

	<b>Flash Auto</b>	The flash fires automatically in low light or backlight conditions.
	<b>Fill In</b>	The flash fires regardless of the light conditions.
	<b>Redeye</b>	The flash fires so that the red-eye phenomenon is reduced.
	<b>Flash Off</b>	The flash does not fire.
	<b>Red-Eye Slow Slow synchronization (1st curtain/Red-eye reduction flash)</b>	The slow synchronization is combined with the red-eye reduction flash.
	<b>Slow Slow synchronization (1st curtain)</b>	The flash fires with slow shutter speeds to brighten dimly-lit backgrounds.
	<b>Manual Value</b>	Control flash output manually. If you highlight [Manual Value] and press the INFO button before pressing the  button, you can adjust flash output using    or the control dial.
	<b>Remote Control</b>	The dedicated underwater strobe or the Olympus wireless RC flash is used to take pictures. For details, see "Taking pictures with the Olympus Wireless RC Flash System" (P. 125).
	<b>LED On</b>	The LED turns on when a picture is taken. This is effective for taking close up pictures.





- In [ (Redeye)], after the pre-flashes, it takes about 1 second before the shutter is released. Do not move the camera until shooting is complete.
- [ (Redeye)] may not work effectively under some shooting conditions.
- The shutter speed becomes slower in [ (Slow)]. Use a tripod and secure the camera.
- Some features may be unavailable depending on the shooting mode and camera settings.  "List of Settings Available in each Shooting Mode" (P. 136)

## Focus lock

You can lock focus at the desired position.

- 1 Press the shutter button halfway to focus.
- 2 While keeping the position of the camera, press the  button.
  - The camera focuses and locks the position.



- While focus lock is in effect, the focus distance can be fine-tuned using  $\Delta$   $\nabla$  or the control dial.
- Pressing the , zooming operation, pressing the MENU button, and the other operations also release the focus lock.
- If the focus indicator blinks when the shutter button is pressed halfway with  [Live Composite] (P. 28, 31) selected for SCN mode, you can set focus to infinity by pressing the  button.
- Focus lock is not available in  mode and some SCN modes.

## Using the LED illuminator

Unlike the flash, which lights only briefly, the LED illuminator stays lit for longer periods. It can also serve as a flashlight.

- 1 Press and hold the INFO button.

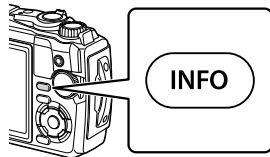

- 2 Release the button when the LED illuminator lights.

- The illuminator will light even if the camera is off.

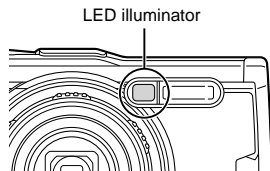

### ■ If the camera is on

The LED illuminator will remain lit for up to around 90 seconds while camera controls are in use, or up to 30 seconds if no operations are performed.

- The LED illuminator can be used during movie recording. It cannot, however, be used to film 4K movies.

### ■ If the camera is off

The LED illuminator will remain lit for up to around 30 seconds, whether or not you attempt to operate camera controls.

- The LED illuminator turns off automatically if you:
  - press the ON/OFF button,
  - use the LOG switch,
  - display the menus,
  - connect or disconnect a USB cable, or
  - connect to a Wi-Fi network.

### To turn the LED illuminator off

Press and hold the INFO button down until the LED illuminator turns off.





## Settings Accessible via Live Controls

You can use live control to select the shooting function while checking the effect on the screen.

- The selected settings apply in all of **P**, **A**, and  modes.





### Available settings



Picture mode .....	P. 50	 Image stabilizer*3 .....	P. 59
Scene mode*1 .....	P. 28	 Image stabilizer*2 .....	P. 59
ISO sensitivity .....	P. 52	Flash*3*4 .....	P. 45
White balance .....	P. 53	Flash compensation*3 .....	P. 59
AF mode .....	P. 55	Sequential shooting/Self-timer .....	P. 42
Aspect ratio .....	P. 55	Metering mode*3 .....	P. 60
 Still image quality .....	P. 56	Face priority .....	P. 60
 Movie quality .....	P. 57	Accessory .....	P. 61

\*1 Displayed only in scene modes.

\*2 Displayed only in movie mode.

\*3 Not displayed in movie mode.

\*4 The camera stores the settings for **P**, **A**,  (underwater mode), and  (microscope mode) separately and restores them the next time the mode is selected, even after the camera has been turned off.

- Press the  button to display the live control.
  - To hide the live control, press the  button again.

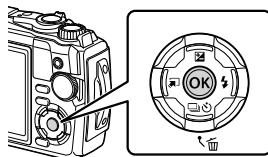



2 Use  $\Delta$   $\nabla$  to highlight the desired function and  $\triangleleft$   $\triangleright$  to highlight a setting, and then press the  $\text{OK}$  button.

- You can use the control dial to select a setting.
- The selected settings take effect automatically if no operations are performed for about 8 seconds.

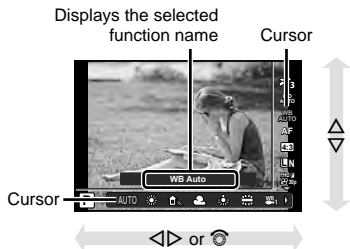

- Some items are not available in some shooting modes.  $\text{INFO}$  "List of Settings Available in each Shooting Mode" (P. 136)

#### Notes

- For the default settings of each option, refer to "Default/Custom Settings" (P. 140).

## Processing options (Picture mode)

You can select a picture mode and make individual adjustments to contrast, sharpness, and other parameters (P. 81). Changes to each picture mode are stored separately.



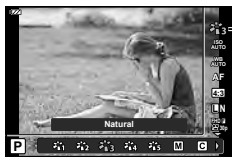















- 1 Press the **OK** button and use **Δ** **▽** to highlight Picture Mode.
- 2 Highlight an option using **◀** **▶** and press the **OK** button.



Picture mode

### ■ Picture mode options

	<b>i-Enhance</b>	Produces more impressive-looking results suited to the scene.
	<b>Vivid</b>	Produces vivid colors.
	<b>Natural</b>	Produces natural colors.
	<b>Muted</b>	Produces flat tones.
	<b>Portrait</b>	Produces beautiful skin tones.
	<b>Monochrome</b>	Produces black and white tone.
	<b>Custom</b>	Select an existing picture mode, edit its parameters, and save it as a custom picture mode.
	<b>e-Portrait</b>	Produces smooth skin textures. This mode cannot be used with bracket photography or when shooting movies.
	<b>Underwater</b>	Process pictures to preserve the vivid colors seen under water. • We recommend selecting [Off] for [ <b>⚡</b> +WB] (P. 98) when this option is in effect.
	<b>Pop Art</b>	Enhances the color and atmosphere of an image more brightly and vividly.
	<b>Soft Focus</b>	Expresses an ethereal atmosphere with a soft tone and makes an image dreamy.
	<b>Pale&amp;Light Color</b>	Expresses a comfortable floating feeling by making an image more pale and light.
	<b>Light Tone</b>	Creates a high-quality image by softening both shadows and highlights.
	<b>Grainy Film</b>	Expresses the strength and roughness of black and white.
	<b>Pin Hole</b>	Expresses the tunnel effect like that obtained from an old fashioned camera or a toy camera by reducing the peripheral brightness.

ART 7  / ART* 7 	<b>Diorama</b>	Expresses an image shooting a surreal miniature world with enhancing the saturation and contrast and blurring an out-of-focus area of an image.
ART 8  / ART* 8 	<b>Cross Process</b>	Creates an image that expresses a surreal atmosphere.
ART 9	<b>Gentle Sepia</b>	Creates a high-quality image by drawing out shadows and softening the overall image.
ART 10  / ART* 10 	<b>Dramatic Tone</b>	Enhances the local contrast of an image and provide an image that a difference of brightness and darkness is emphasized.
ART 11  / ART* 11 	<b>Key Line</b>	Creates an image that emphasizes edges and adds an illustrative style.
ART 12  / ART* 12 	<b>Watercolor</b>	Creates a soft, bright image by removing dark areas, blending pale colors on a white canvas, and further softening contours.
ART 13  / ART / ART* 13  / 13 	<b>Vintage</b>	Expresses an everyday shot in a nostalgic, vintage tone using printed film discoloration and fading.
ART 14  / ART / ART* 14  / 14 	<b>Partial Color</b>	Impressively expresses a subject by extracting colors you want to emphasize and keeping everything else monotone.
ART 15  / ART* 15 	<b>Bleach Bypass</b>	The “bleach bypass” effect, which you may recognize from motion pictures and the like, can be used to great effect in shots of streetscapes or metal objects.
ART 16	<b>Instant Film</b>	A contemporary take on the skin tones and shadow gradations typical of film.

\* II and III are altered versions of the original (I).

- When [ART] is selected for picture mode, [Color Space] (P. 98) will be locked at [sRGB].

### ■ Using [Partial Color]

Record only selected hues in color.

- 1 Press the **OK** button and use **Δ** **▽** to highlight the picture mode.
- 2 Highlight [Partial Color I/II/III] using **◀▶**.
- 3 Press the INFO button.
  - A color ring appears in the display.



Color ring

- 4 Select a color using **◀▶** or the control dial.
  - The effect is visible in the display.
- 5 Shoot.

## Changing ISO sensitivity (ISO)

Increasing ISO sensitivity increases noise (graininess) but allows photographs to be taken when lighting is poor.

- 1 Press the **OK** button and then highlight ISO sensitivity using **Δ** **▽**.
- 2 Highlight an option using **◀▶** and press the **OK** button.

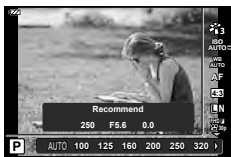

ISO

<b>AUTO</b>	The sensitivity is set automatically according to the shooting conditions. The maximum ISO sensitivity value and other auto ISO settings can be adjusted using the [ISO-Auto Set] option in custom menus (P. 97).
<b>100–12800</b>	The sensitivity is set to the selected value.

## Adjusting color (White balance)

White balance (WB) ensures that white objects in images recorded by the camera appear white. [WB AUTO] is suitable in most circumstances, but other values can be selected according to the light source when [WB AUTO] fails to produce the desired results or you wish to introduce a deliberate color cast into your images.

- 1 Press the **OK** button and use **Δ**/**▽** to highlight White Balance.
- 2 Highlight an option using **◀**/**▶** and press the **OK** button.



White balance

WB mode		Color temperature	Light conditions
WB AUTO	<b>Auto white balance</b>	—	For most light conditions (when there is a white portion framed on the monitor). Use this mode for general use.
	<b>Preset white balance</b>	5300 K	For shooting outdoors on a clear day, or to capture the reds in a sunset or the colors in a fireworks display
		7500 K	For shooting outdoors in the shadows on a clear day
		6000 K	For shooting outdoors on a cloudy day
		3000 K	For shooting under a tungsten light
		4000 K	For shooting under a fluorescent light
WB 1 *		—	For pictures taken in shallow waters (approximately 3 m (9.8 ft.) or less)
WB 2 *		—	For pictures taken underwater at depths of from 3 to 15 m (9.8 to 49.2 ft.)
WB 3 *		—	For pictures taken underwater at below 15 m (49.2 ft.) • Use a underwater case at depths below 15 m (49.2 ft.).
WB 4 *		—	—
WB 5 *	—	5500 K	For flash shooting
/ / /	<b>One-touch white balance</b>	Color temperature set by one-touch WB	Press the INFO button to measure white balance using a white or gray target when using a flash or other light source of an unknown type or when shooting under mixed lighting.  “One-touch white balance” (P. 54)
CWB 2000 - CWB 14000	<b>Custom white balance</b>	2000 K–14000 K	After pressing the INFO button, use <b>Δ</b> / <b>▽</b> / <b>◀</b> / <b>▶</b> to select a color temperature and then press the <b>OK</b> button.

\* Depends on weather and sea conditions, etc.

### One-touch white balance

Measure white balance by framing a piece of paper or other white object under the lighting that will be used in the final photograph. This is useful when shooting a subject under natural light, as well as under various light sources with different color temperatures.

- 1 Highlight [W1], [W2], [W3], or [W4] (one-touch white balance 1, 2, 3, or 4) and press the INFO button.

- The one-touch white balance screen appears.

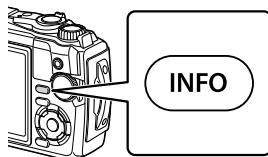

- 2 Photograph a piece of colorless (white or gray) paper.
  - Frame the paper so that it fills the display and no shadows fall it.
- 3 Highlight [Yes] and press the **OK** button.
  - The new value is saved as a preset white balance option.
  - The new value is stored until one-touch white balance is measured again. Turning the power off does not erase the data.

## Selecting a focus mode (AF mode)

You can select a focusing method (focus mode). You can select separate focusing methods for still photography mode and movie mode.

- 1 Press the **OK** button and use  $\Delta$   $\nabla$  to highlight AF mode.



AF mode

- 2 Highlight an option using  $\triangleleft$   $\triangleright$  and press the **OK** button.

<b>AF</b> (Auto focus)	The camera focuses automatically when the shutter button is pressed halfway. You can select the focus area in the shooting menu. <ul style="list-style-type: none"> <li>• The camera adjusts focus continuously during movie recording.</li> </ul>
<b>MF</b> (Manual focus)	Use $\Delta$ $\nabla$ or the control dial to focus manually on a subject anywhere in the frame. Manual focus can be enabled by pressing and holding the <b>OK</b> button during shooting.
(Super macro AF)	Focus at short distances using auto focus.
(Super macro MF)	Focus at short distances using manual focus.

- The camera may be unable to focus if the subject is poorly lit, obscured by mist or smoke, or lacks contrast.
- [] and [] are available only in **P**, **A**, and modes.

## Setting the image aspect

You can change the aspect ratio (horizontal-to-vertical ratio) when taking pictures. Depending on your preference, you can set the aspect ratio to [4:3] (standard), [16:9], [3:2], [1:1], or [3:4].

- 1 Press the **OK** button and use  $\Delta$   $\nabla$  to highlight Image Aspect.
- 2 Use  $\triangleleft$   $\triangleright$  to select a value and press the **OK** button.



Image aspect

- Image aspect can only be set for still images.
- JPEG images cropped to the selected aspect ratio are saved. RAW images are not cropped and are saved with the selected aspect ratio information.
- When RAW images are played back, the selected aspect ratio is shown by a frame.

## Selecting image quality (Still image quality)

You can set an image quality mode for still images. Select a quality suitable for the application (such as for processing on PC, use on website etc.).

- 1 Press the **OK** button and use **Δ** **∇** to highlight (Still image quality).



Still image quality

- 2 Highlight an option using **◀▶** and press the **OK** button.

- You have a choice of JPEG (**L**F, **L**N, **M**N, and **S**N) and RAW\*1 modes. Select a JPEG+RAW option to record both a JPEG and a RAW image with each shot.\*2 JPEG modes combine image size (**L**, **M**, and **S**) and compression ratio (SF, F, and N).

Image size		Compression rate			Application
Name	Pixel Count	SF (Super Fine)	F (Fine)	N (Normal)	
<b>L</b> (Large)	4000x3000	<b>L</b> SF	<b>L</b> F	<b>L</b> N	Select for the print size
<b>M</b> (Middle)	3200x2400	<b>M</b> SF	<b>M</b> F	<b>M</b> N	
<b>S</b> (Small)	1280x960	<b>S</b> SF	<b>S</b> F	<b>S</b> N	For small prints and use on a website

- When you want to select a combination other than **L**F, **L**N, **M**N, and **S**N, change the [**Set**] (P. 98) settings in Custom Menu.

\*1 Pictures taken at an image quality setting of RAW are automatically recorded as JPEG+RAW in the following modes:

[**RAW**], [**SF**], [**F**], [**N**], [**RAW**].

\*2 The individual JPEG and RAW files recorded each time a photo is taken at a setting of JPEG+RAW can not be deleted separately. Deleting one automatically deletes the other (if you delete the JPEG copy on a computer and then copy the RAW image back to the camera, you will be able to edit the image (P. 68, 88) but not select it for printing (P. 75)).

### RAW image data

This format (extension ".ORF") stores unprocessed image data for later processing. RAW image data cannot be viewed using other cameras or software, and RAW images cannot be selected for printing. JPEG copies of RAW images can be created using this camera.

[**RAW**] "RAW Data Edit/JPEG Edit" (P. 68), "Retouching RAW pictures (RAW Data Edit)" (P. 88)





**Record mode: 4K**

Record 4K movies.



- ① Frame size  
4K : 3840×2160
- ② Frame rate  
30p, 25p

**Record mode: FHD/HD**

Record standard movies.

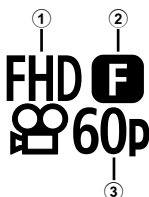

- ① Frame size  
FHD : 1920×1080  
HD : 1280×720
- ② Bit rate (compression ratio)  
SF (Super Fine), F (Fine), N (Normal)
- ③ Frame rate  
60p (30p), 50p (25p)

**Record mode: HS (High-speed)**

Record slow-motion movies. Footage shot at a high frame rate plays back at approximately 30 fps.



- ① Frame size
- ② Frame rate  
FHD : 1920×1080 120 fps  
HD : 1280×720 240 fps  
SD : 640×360 480 fps

- Focus and exposure are fixed at the start of recording.
- Recording can continue for up to 20 seconds.
- Sound will not be recorded.
- [FHD HS]<sub>120fps</sub>, [FHD HS]<sub>240fps</sub>, and [SD HS]<sub>480fps</sub> are not available in  or SCN mode.

## Reducing camera shake (Image stabilizer)

You can reduce the amount of camera shake that can occur when shooting in low light situations or shooting with high magnification.

The image stabilizer starts when you press the shutter button halfway.

- 1 Press the **OK** button and use **Δ**/**▽** to highlight the image stabilizer item.
- 2 Highlight an option using **◀**/**▶** and press the **OK** button.

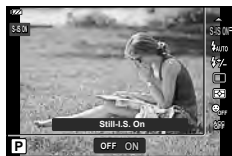

Image stabilizer

Still picture	S-IS Off	Image stabilizer is off.
	S-IS On	The camera detects the panning direction and applies the appropriate image stabilization.
Movie	M-IS Off	Image stabilizer is off.
	M-IS On	Image stabilizer enabled.

- Image stabilizer may be unable to fully compensate for the effects of camera movement on photographs if the movement is very large or the shutter speed very slow. In these cases, it is recommended that you use a tripod.
- The edges of the frame are cropped out when [M-IS On] is selected, reducing the area recorded.
- Image stabilizer is set to [M-IS Off] when **[FHD H5]** (120fps), **[HD H5]** (240fps), and **[SD H5]** (480fps) is selected for movie quality.
- When using a tripod, set [Image Stabilizer] to [S-IS Off]/[M-IS Off].
- You may notice an operating sound or vibration when the image stabilizer is activated.

## Adjusting flash output (Flash intensity control)

Flash output can be adjusted if you find that your subject appears overexposed, or is underexposed even though the exposure in the rest of the frame is just right.

- 1 Press the **OK** button and use **Δ**/**▽** to highlight the flash intensity control item.
- 2 Use **◀**/**▶** to select a value and press the **OK** button.



Flash intensity control

- Flash brightness can be reduced by selecting negative values (the lower the value, the dimmer the flash) or increased by selecting positive values (the higher the value, the brighter the flash).
- Not available in **AUTO** mode, when **[Underwater HDR]** is selected in **🐟** mode, or in **SCN** mode.

## Selecting how the camera measures brightness (Metering)

You can select how the camera meters subject brightness.

- 1 Press the **OK** button and use **Δ**/**∇** to highlight metering.

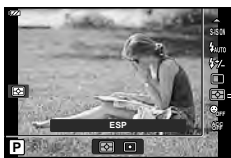

Metering

- 2 Highlight an option using **◀**/**▶** and press the **OK** button.

	<b>ESP</b>	Shoots to obtain a balanced brightness over the entire screen (Meters the brightness at the center and surrounding areas of the screen separately). When set to [ESP], the center may appear dark when shooting against strong backlighting.
	<b>Spot</b>	Shoots the subject at the center during backlighting (Meters the brightness at the center of the screen).

## Automatic face detection (Face priority)

The camera detects faces and adjusts focus and digital ESP.

- 1 Press the **OK** button and use **Δ**/**∇** to highlight the face priority item.
- 2 Use **◀**/**▶** to select an option and press the **OK** button.

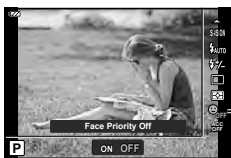

Face priority

<b>ON</b>	<b>Face Priority On</b>	Face priority is on.
<b>OFF</b>	<b>Face Priority Off</b>	Face priority is off.

## Using optional accessories (Accessory)

Use this option when optional accessories are attached.

- 1 Press the **OK** button and use **△**/**▽** to highlight the accessory item.
- 2 Use **◀**/**▶** to select an option and press the **OK** button.



Accessory

OFF	Accessory Off	Take pictures using the camera alone.
	PTWC-01	Select according to the optional accessory attached.
	TCON-T01	
	FCON-T01	
	FCON-T02	
FD-1	FD-1	

"Optional Accessories" (P. 126)

# 3 Playback

## Information Display during Playback

### Playback image information

#### Simplified display

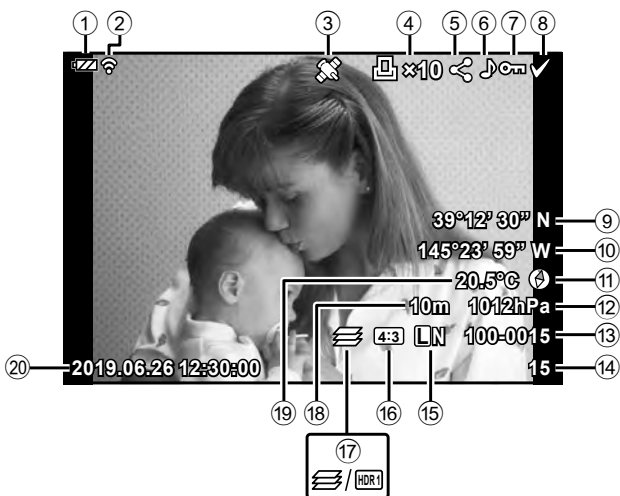

#### Overall display

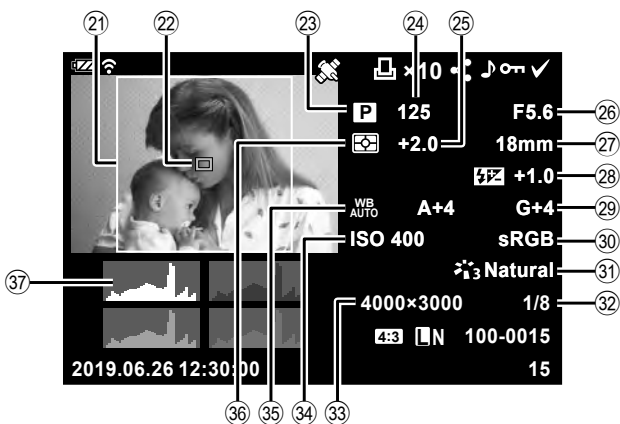

- |   |   |
|---|---|
| ① Battery level.....P. 17                           | ⑱ Altitude/Water depth .....P. 115            |
| ② Wireless LAN connection status<br>.....P. 106–110 | ⑲ Temperature (water temperature) .....P. 115 |
| ③ Including GPS information .....P. 112             | ⑳ Date and time .....P. 18                    |
| ④ Print order<br>Number of prints .....P. 75        | ㉑ Aspect border *1 .....P. 55                 |
| ⑤ Share order.....P. 71                             | ㉒ AF area pointer .....P. 25                  |
| ⑥ Sound record .....P. 72, 87                       | ㉓ Shooting mode.....P. 27–39                  |
| ⑦ Protect .....P. 71                                | ㉔ Shutter speed .....P. 35                    |
| ⑧ Image selected .....P. 76                         | ㉕ Exposure compensation .....P. 41            |
| ⑨ Latitude .....P. 115                              | ㉖ Aperture value .....P. 36                   |
| ⑩ Longitude.....P. 115                              | ㉗ Focal length                                |
| ⑪ Direction information.....P. 115                  | ㉘ Flash intensity control.....P. 59           |
| ⑫ Atmospheric.....P. 115                            | ㉙ White balance compensation.....P. 98        |
| ⑬ File number.....P. 99                             | ㉚ Color space.....P. 98                       |
| ⑭ Frame number                                      | ㉛ Picture mode.....P. 50, 81                  |
| ⑮ Image quality .....P. 56                          | ㉜ Compression rate .....P. 105, 119           |
| ⑯ Aspect ratio.....P. 55                            | ㉝ Pixel count .....P. 105, 119                |
| ⑰ Focus Stacking/HDR image<br>.....P. 33/P. 29, 34  | ㉞ ISO sensitivity.....P. 52                   |
|   | ㉟ White balance.....P. 53                     |
|   | ㊱ Metering mode.....P. 60                     |
|   | ㊲ Histogram .....P. 102                       |

\*1 Displayed only if an aspect ratio other than 4:3 is selected with a RAW image quality option.

## Switching the information display

You can switch the information displayed during playback by pressing the INFO button.

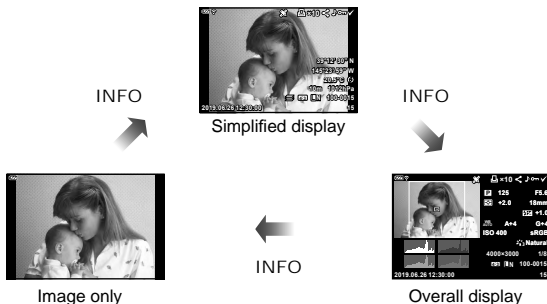
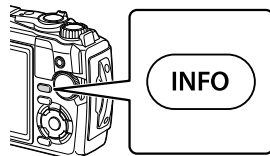









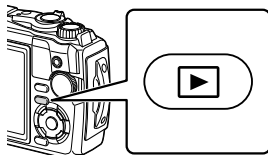













- You can add histogram and highlight & shadow to the information displayed during playback. [Info] (P. 102)

## Viewing Photographs and Movies

### 1 Press the button.

- A photograph or movie will be displayed.
- Select the desired photograph or movie using the control dial or arrow pad.
- To return to shooting mode, press the shutter button halfway or press the  button.









<b>Control dial</b>	Single-frame playback: Previous (  ) / Next (  ) Close-up playback: You can display the next frame or the previous frame during close-up playback. Index/calendar playback: Highlight image
<b>Arrow pad (   )</b>	Single-frame playback: display the next frame (  ) / display the previous frame (  ) Close-up playback: Changing the close-up position You can display the next frame (  ) or the previous frame (  ) during close-up playback by pressing the INFO button. Press the INFO button again to display a zoom frame and use     to change its position. Index/calendar playback: Highlight image
<b>Zoom lever</b>	Rotate the zoom lever counterclockwise for index or calendar playback. Rotate the zoom lever clockwise for close-up playback.
<b>INFO button</b>	View image info
<b> () button</b>	Delete picture
<b> button</b>	Display the menus (or exit to single-frame playback from close-up playback or calendar playback).
<b> () button</b>	You can select multiple images for [  , [Erase Selected] or [Share Order Selected].  "Selecting images (  , Erase Selected, Share Order Selected)" (P. 76)

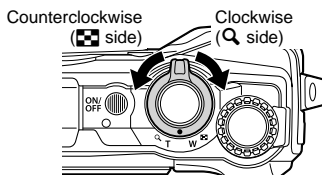



## Index display/Calendar display

Rotating the zoom lever counterclockwise (toward ) during single-frame playback initiates index playback. Repeating the process will increase the number of images displayed, ending in a calendar display.





- Use    or the control dial to move the cursor.
- Rotate the zoom lever clockwise () to proceed in turn from calendar to index to single-frame playback.
- To exit from calendar to single-frame playback, press the  button.





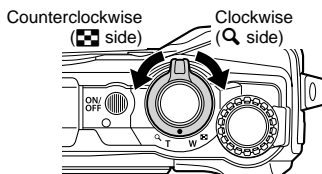

- You can change the number of frames for index display.   [Settings] (P. 103)

## Close-up playback

To zoom in on the current picture during single-frame playback, rotate the zoom lever clockwise (toward ) for zoom ratios of from 2x to 14x and counterclockwise (toward ) to zoom out. Press the  button to return to single-frame playback.



- Press    to scroll an image to the direction of the button you pressed.
- To view other images at the same zoom ratio, press the INFO button and then press . Press the INFO button again to re-enable scrolling. You can also view other images using the control dial.

## Movie playback

Select a movie and press the **OK** button to display the playback menu. Highlight [Play Movie] and press the **OK** button to begin playback.



### Operations during playback

<b>Pause</b>	Press the <b>OK</b> button to pause playback. To resume playback, press the <b>OK</b> button again.
<b>Fast forward</b>	Press <b>▶</b> to fast forward. Press <b>▶</b> again to increase the fast forward speed.
<b>Rewind</b>	Press <b>◀</b> to rewind. Press <b>◀</b> again to increase the rewind speed.
<b>Adjusting the volume</b>	Use <b>Δ</b> <b>∇</b> to adjust the volume.

### Operations while playback is paused

<b>Cueing</b>	Use <b>Δ</b> to display the first frame and press <b>∇</b> to display the last frame.
<b>Advancing and rewinding one frame at a time</b>	Use <b>◀▶</b> or the control dial to advance or rewind one frame at a time. Keep <b>◀▶</b> pressed for continuous advance or rewind.
<b>Resuming playback</b>	Press the <b>OK</b> button to resume playback.

### To stop movie playback

Press the MENU button.

## Erasing images during playback

Display an image you want to delete and press the **Trash** (**🗑**) button. Highlight [Yes] and press the **OK** button.

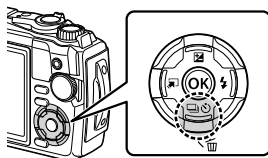

## Using the Playback Menu

The playback menu can be displayed by pressing the **OK** button during playback. Highlight the desired option and select it by pressing the **OK** button. The options displayed vary with the type of image selected.

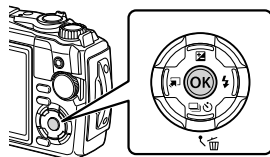

	RAW	JPEG	RAW+JPEG	Movies
Play	✓	✓	✓	—
RAW Data Edit	✓	—	✓	—
JPEG Edit	—	✓	✓	—
Play Movie	—	—	—	✓
Movie Edit	—	—	—	✓
Share Order	—	✓	✓	✓
	✓	✓	✓	✓
	✓	✓	✓	—
Rotate	✓	✓	✓	—
	✓	✓	✓	✓
Image Overlay	✓	—	✓	—
	—	✓	✓	—
Erase	✓	✓	✓	✓

### Play

Voice memos (P. 72) are played back when the associated image is displayed.

- 1 Select a photo with audio and press the **OK** button.
- 2 Highlight [Play ] and press the **OK** button.
  - Audio playback will start.
  - To end audio playback, press the **OK** or MENU button.
  - Use **Δ**/**∇** to adjust volume during playback.













## RAW Data Edit/JPEG Edit





Recorded images can be edited and saved as separate images.

**1** During playback, display the photo you want to retouch and press the  button.

- [RAW Data Edit] is displayed if a RAW image is selected, and [JPEG Edit] if a JPEG image is selected. For images recorded in RAW+JPEG format, both [RAW Data Edit] and [JPEG Edit] are displayed. Select the desired option from them.

**2** Highlight [RAW Data Edit] or [JPEG Edit] and press the  button.

RAW Data Edit	Current	The JPEG copy is processed using the current camera settings. Adjust the camera settings before selecting this option. Some settings such as exposure compensation are not applied.
	ART BKT	The image is edited using settings for the selected art filter. <ul style="list-style-type: none"> <li>• Pressing  displays a menu of the art filters that can be applied to the image. Highlight art filters and press the  button to select or deselect; selected filters are marked with a . After selecting the desired filters, press the MENU button to return to the previous display. Highlight [ART BKT] and press the  button to record the modified copy to the card.</li> </ul> To create additional copies from the same original, highlight [Reset] and press the  button. To exit without creating more copies, highlight [No] and press the  button.
	No	Exit without editing the image.
JPEG Edit	Shadow Adj	Brightens a dark backlit subject.
	Redeye Fix	Reduces the red-eye phenomenon due to flash shooting.
		Trims an image. Use the control dial to select the size of the crop and   to specify the crop position.
	Aspect	Changes the aspect ratio of images from 4:3 (standard) to [3:2], [16:9], [1:1], or [3:4]. After changing the aspect ratio, use   to specify the trimming position.
	Black & White	Creates black and white images.
	Sepia	Creates sepia-toned images.
	Saturation	Increases the vividness of images. Adjust the color saturation checking the image on the screen.
		Converts the image size to 1280 x 960, 640 x 480, or 320 x 240. Images with an aspect ratio other than 4:3 (standard) are converted to the closest image size.
	e-Portrait	Compensates the skin look for smoothness. Compensation cannot be applied in such a case that a face cannot be detected.

- 3** When the settings are complete, press the  button.
  - The settings are applied to the image.
- 4** Highlight [Yes] and press the  button.
  - The edited image is stored in the card.
  - Red-eye correction may not work depending on the image.
  - Editing of a JPEG image is not possible in the following cases:
    - When an image is processed on a PC, when there is not enough space in the card memory, or when an image is recorded on another camera.
  - The image cannot be resized () to the larger size than the original size.
  - Some images can not be resized.
  - [] (trimming) and [Aspect] can only be used to edit images with an aspect ratio of 4:3 (standard).

## Play Movie

---

View the current movie.  "Movie playback" (P. 66)











## Movie Edit

---

Edit movies.

### ■ Creating movie stills (In-Movie Image Capture)

Save a still copy (aspect ratio 16:9) of a frame selected from a 4K movie recorded with the camera.

- 1** Display the movie to which you want to edit and press the  button.
- 2** Highlight [Movie Edit] and press the  button.
- 3** Use   to highlight [In-Movie Image Capture] and press the  button.
- 4** Use   to select a frame to be saved as a still image and press the  button.
  - Use   or to skip multiple frames.
  - Press the MENU button to return to single-frame playback.
- The date of recording of the still may differ from that of the original movie.

### ■ Trimming movies (Movie Trimming)

Trim selected footage from movies recorded with the camera and either overwrite the original with the edited footage or save the edited copy separately.

- 1 Display the movie to which you want to edit and press the **OK** button.
- 2 Highlight [Movie Edit] and press the **OK** button.
- 3 Use **△▽** to highlight [Movie Trimming] and press the **OK** button.
- 4 Highlight [Overwrite] or [New File] and press the **OK** button.
  - If the image is protected, you cannot select [Overwrite].
- 5 Select whether the section to be deleted begins with the first frame or ends with the last frame, using **<▷** to highlight the desired option and pressing the **OK** button to select.
  - To jump to the first or last frame, rotate the control dial.
- 6 Use **<▷** to select the section to be deleted.
  - The section to be deleted is shown in red.
- 7 Press the **OK** button.
- 8 Highlight [Yes] and press the **OK** button.
  - The date of recording of the still may differ from that of the original movie.

## Share Order

You can select images you want to transfer to a smartphone in advance. You can also use OI.Share to browse the images included in the share order. When playing back images you want to transfer, press the **OK** button to display the playback menu. After selecting [Share Order] and pressing the **OK** button, press  $\Delta$  or  $\nabla$  to set a share order on an image and display  $\leftarrow$ . To cancel a share order, press  $\Delta$  or  $\nabla$ .

You can select images you want to transfer in advance and set a share order all at once. "Selecting images (**On**, Erase Selected, Share Order Selected)" (P. 76)

- Share orders cannot include RAW images.

### Notes

- Share marking can be removed from all images via the  $\uparrow$  setup menu. "Cancelling a Share Order" (P. 110)

## **On**

Protect images from accidental deletion. Display an image you wish to protect and press the **OK** button to display the playback menu. Highlight [**On**] and press the **OK** button, and then press  $\Delta$  or  $\nabla$  to protect the image. Protected images are shown by a **On** (protect) icon. Press  $\Delta$  or  $\nabla$  to remove protection.

You can also protect multiple selected images.

"Selecting images (**On**, Erase Selected, Share Order Selected)" (P. 76)

- Formatting the card erases all data including protected images.





Audio can be added to still images (up to 30 sec. long).

- 1 Display the image to which you want to add audio and press the **OK** button.
  - Audio recording is not available with protected images.
- 2 Highlight **[🎤]** and press the **OK** button.
  - To exit without adding audio, select **[No]**.



- 3 Highlight **[🎤 Start]** and press the **OK** button to begin recording.
- 4 Press the **OK** button to end recording.
  - Images recorded with audio are indicated by a 🎵 icon.

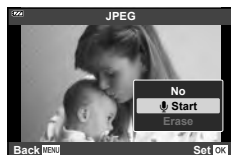

- To delete recorded audio, select **[Erase]** in Step 3.



#### Notes

- Audio recording is also available in the **[▶]** Playback Menu (P. 88).
- The recorded audio can be played back using **[Play 🎵]** (P. 67).

## Rotate

Select whether to rotate photographs.

- 1 Play the photograph back and press the **OK** button.
- 2 Highlight **[Rotate]** and press the **OK** button.
- 3 Press **△** to rotate the image counterclockwise, **▽** to rotate it clockwise; the image rotates each time the button is pressed.
  - Press the **OK** button to save settings and exit.
  - The rotated image is saved in its current orientation.
  - Movies and protected images cannot be rotated.





This function displays images stored on the card one after another.

- 1 Press the **OK** button in the playback display.
- 2 Highlight **[Start]** and press the **OK** button.



- 3 Adjust settings.

<b>Start</b>	Start the slideshow. Images are displayed in order, starting with the current image.
<b>BGM</b>	Set [Party Time] or [Off].
<b>Slide</b>	Set the type of data to be played back.
<b>Slide Interval</b>	Select the length of time each slide is displayed from 2 to 10 seconds.
<b>Movie Interval</b>	Select [Full] to play back full length of each movie clip in the slideshow or [Short] to play back only the opening portion of each movie clip.

- 4 Highlight [Start] and press the **OK** button.

- The slideshow will start.
- Press  $\Delta$   $\nabla$  during the slideshow to adjust the overall volume of the camera speaker. Press  $\triangleleft$   $\triangleright$  while the volume adjustment indicator is displayed to adjust the balance between the sound recorded with the image or movie and background music.
- Press the **OK** button to stop the slideshow.

#### **BGM other than [Party Time]**

To use BGM other than [Party Time], record data that you have downloaded from the Olympus website onto the card and select it as [BGM] in Step 3. Visit the following website for the download.

<http://support.olympus-imaging.com/bgmdownload/>

## Image Overlay

Up to 3 frames of RAW images taken with the camera can be overlaid and saved as a separate image.

The image is saved with the record mode set at the time the image is saved. (If [RAW] is selected, the copy will be saved in [L/N+RAW] format.)

- 1 Play the picture back and press the **OK** button.
- 2 Highlight [Image Overlay] and press the **OK** button.
- 3 Select the number of images to be overlaid and press the **OK** button.
- 4 Use **Δ** **∇** **◀▶** to select the RAW images and press the **OK** button to add them to the overlay.
  - The overlaid image will be displayed if images of the number specified in step 3 are selected.
- 5 Adjust gain (brightness) for the pictures in the overlay.
  - Use **◀▶** to select an image and **Δ** **∇** to adjust gain.
  - Gain can be adjusted in the range 0.1–2.0. Check the results in the monitor.
- 6 Press the **OK** button to display the confirmation dialog. Highlight [Yes] and press the **OK** button.

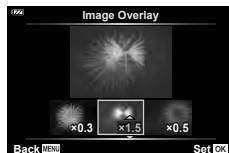
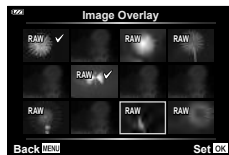

### Notes

- To overlay 4 or more frames, save the overlay image as a RAW file and use [Image Overlay] repeatedly.



You can save digital “print orders” to the card listing the pictures to be printed and the number of copies of each print. The pictures can be printed at print shops that the Digital Print Order Format (DPOF). A card is required when creating a print order.

- 1 Play the photograph back and press the **OK** button.
- 2 Highlight [**Print**] and press the **OK** button.
- 3 Highlight [**Print**] or [**Print ALL**] and press the **OK** button.

### Individual picture

Press **<**/**>** to select the frame that you want to set as print reservation, then press **△**/**▽** to set the number of prints.

- To set print reservation for several pictures, repeat this step. Press the **OK** button when all the desired pictures have been selected.

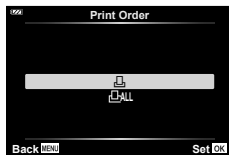

### All pictures

Highlight [**Print ALL**] and press the **OK** button.

- 4 Select the date and time format and press the **OK** button.

<b>No</b>	The pictures are printed without the date and time.
<b>Date</b>	The pictures are printed with the shooting date.
<b>Time</b>	The pictures are printed with the shooting time.



- When printing images, the setting cannot be changed between the images.

- 5 Highlight [**Set**] and press the **OK** button.

- The camera cannot be used to modify print orders created with other devices. Creating a new print order deletes any existing print orders created with other devices.
- Print orders cannot include RAW images or movies.

## Erase

Delete the current image.

- 1 Play back the picture you want to delete and press the **OK** button.
- 2 Highlight [**Erase**] and press the **OK** button.
- 3 Highlight [**Yes**] and press the **OK** button.
  - The image will be deleted.

## Selecting images (OK, Erase Selected, Share Order Selected)

You can select multiple images for [OK], [Erase Selected] or [Share Order Selected].

- 1 Display the image to which you want to select in single-frame playback or highlight it during index playback (P. 65).
- 2 Press the  button.

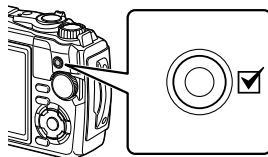

- Selected images are indicated by a  icon. Press the button again to deselect the image.



- 3 Press the OK button to display a menu.
- 4 Highlight [Share Order Selected], [OK], or [Erase Selected] and press the OK button.

## Scrolling Panoramas

Panoramas made up of multiple images joined together can be viewed in a scrolling display.

- 1 Select a panorama in single-frame playback.
- 2 Rotate the zoom lever clockwise.
  - Press  $\Delta \nabla \triangleleft \triangleright$  to scroll the image in the direction of the pressed button.

Clockwise (Q side)

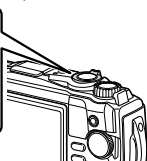
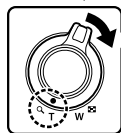

Viewing area



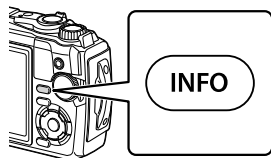

- During playback, you can rotate the zoom lever clockwise to zoom in from 2x to 14x or counterclockwise to zoom out. Press the  $\text{Q}$  button to return to single-frame playback.
- To view other images at zoom ratios above 2x, press the INFO button and then press  $\triangleleft \triangleright$ . Press the INFO button again to re-enable scrolling. You can also view other images using the control dial.



# 4 Menu Functions



## Basic menu operations

The menus can be used to customize the camera for ease of use and include shooting and playback options not displayed in the live control screen or the like.

	Shooting setup and shooting settings (P. 80)
	Movie mode settings (P. 87)
	Playback and retouch options (P. 88)
	Customizing camera settings (P. 96)
	Camera setup (e.g., date and language) (P. 94)

### Functions that cannot be selected from menus

Some items may not be selectable from the menu when using the arrow pad.

- Items that cannot be set with the current shooting mode.  "List of Settings Available in each Shooting Mode" (P. 136)
- Items that cannot be set because of an item that has already been set:  
Settings such as picture mode are unavailable when the mode dial is rotated to .

### 1 Press the MENU button to display the menus.

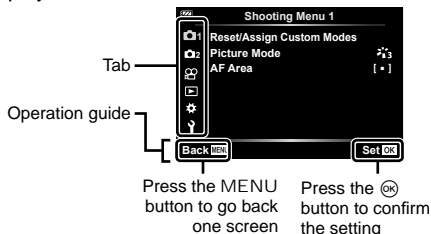
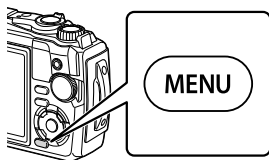

- A guide is displayed in 2 seconds after you select an option.
- Press the INFO button to view or hide guides.

**2** Use  $\Delta$ / $\nabla$  to select a tab and press the  $\odot$  button.

- The menu group tab appears when the  $\star$  Custom Menu is selected. Use  $\Delta$ / $\nabla$  to select the menu group and press the  $\odot$  button.

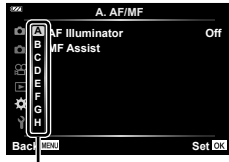
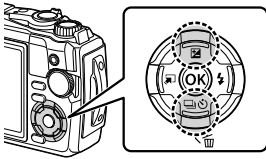

Menu group

**3** Select an item using  $\Delta$ / $\nabla$  and press the  $\odot$  button to display options for the selected item.

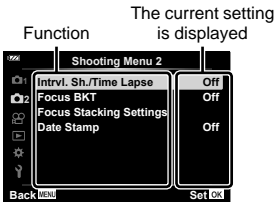

**4** Use  $\Delta$ / $\nabla$  to highlight an option and press the  $\odot$  button to select.

- Press the MENU button repeatedly to exit the menu.

 Notes

- For the default settings of each option, refer to "Default/Custom Settings" (P. 140).

## Using Shooting Menu 1/Shooting Menu 2

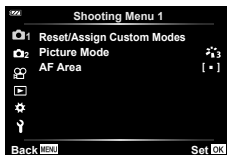

### Shooting Menu 1

- 1 Reset/Assign Custom Modes  
Picture Mode (P. 50, 81)  
AF Area (P. 82)

### Shooting Menu 2

- 2 Intrvl. Sh./Time Lapse (P. 84)  
Focus BKT (P. 85)  
Focus Stacking Settings (P. 86)  
Date Stamp (P. 86)

4

Menu functions (Shooting menu)

## Restoring default settings/saving settings (Reset/Assign Custom Modes)

### ■ Returning to default settings (Reset)

Camera settings can be easily restored to default settings. "Default/Custom Settings" (P. 140)

- 1 Highlight [Reset/Assign Custom Modes] in Shooting Menu 1 and press the button.
- 2 Highlight [Reset] and press the button.
- 3 Highlight a reset option ([Full] or [Basic]) and press the button.







<b>Full</b>	Reset all settings with a few exceptions, such as date/time setting and display.
<b>Basic</b>	Reset basic photography-related settings.

- 4 Highlight [Yes] and press the button.





## ■ Saving Settings

Current settings can be saved to either of two Custom Modes.





- 1 Adjust settings in order to save.
    - Rotate the mode dial to a position other than  (movie mode).
  - 2 Highlight [Reset/Assign Custom Modes] in  Shooting Menu 1 and press the  button.
  - 3 Highlight [Custom Mode C1] or [Custom Mode C2] and press the  button.
  - 4 Highlight [Set] and press the  button.
    - Any existing settings are overwritten.
    - To cancel the registration, select [Reset].
- Saved settings can be quickly recalled by rotating the mode dial to C1 or C2.
    -  “Custom Modes (Custom mode C1/C2)” (P. 37)

## Processing options (Picture Mode)

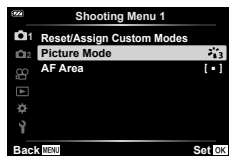
You can make individual adjustments to contrast, sharpness and other parameters in [Picture Mode] (P. 50) settings. Changes to parameters are stored for each picture mode separately.

- 1 Highlight [Picture Mode] in  Shooting Menu 1 and press the  button.
  - The camera will display the picture mode available in the current shooting mode.



- 2 Select an option with   and press the  button.
  - Press  to set the detailed options for the selected picture mode. Detailed options are not available for some picture modes.
  - Changes to contrast have no effect at settings other than [Normal].











## Selecting the focusing area (AF Area)

You can select the position and size of the focus area for auto focus.

 (All Targets)	The camera automatically selects from the full set of focus targets.
[ ■ ] (Single Target)	You can select a single AF target.
Tracking	The camera tracks the subject movement automatically to focus on it continuously.







### ■ Setting the AF target (Area)

You can select the position of the AF target manually.

- 1 Highlight [AF Area] in  Shooting Menu 1 and press the  button.
- 2 Highlight [[ ■ ]] and press the  button.
- 3 Use     to select the position of AF target and press the  button.
  - Pressing and holding the  button before setting the position returns the AF target to the center.
  - To reposition the AF target when the camera is ready to shoot, press and hold the  button.
  - The number and size of the AF targets changes with the aspect ratio (P. 55).
  - The position of the AF target cannot be changed while the digital teleconverter is in use.



## ■ Tracking focus on moving subjects (Tracking)

The camera tracks the subject movement automatically to focus on it continuously.

- 1** Highlight [AF Area] in  Shooting Menu 1 and press the  button.
  - 2** Highlight [Tracking] and press the  button.
  - 3** Press the MENU button to return to the shooting display.
  - 4** Place the AF target over your subject and press the  button, keeping the shutter button pressed halfway.
  - 5** When the camera recognizes the subject, the AF target automatically tracks the subject movement to focus on it continuously.
    - To cancel the tracking, press the  button.
- Depending on the subjects or the shooting conditions, the camera may be unable to lock the focus or fail to track the subject movement.
  - When the camera fails to track the subject movement, the AF target changes to red.
  - [] (single target) is selected automatically when the digital teleconverter is in use.

## Shooting automatically with a fixed interval (Intrvl. Sh./Time Lapse)

You can set the camera to shoot automatically with a set time lapse. The shot frames can also be recorded as into a single movie.

- 1 Highlight [Intrvl. Sh./Time Lapse] in  Shooting Menu 2 and press the  button.



- 2 Highlight [On] and press the .

- 3 Adjust the following settings:

<b>Number of Frames</b>	2 to 299 (frames)	Sets the number of frames to be shot.
<b>Start Waiting Time</b>	00:00:00 to 24:00:00 (minutes)	Sets waiting time before starting to shoot.
<b>Interval Length</b>	00:00:00 to 24:00:00 (minutes)	Sets interval between shots after shooting starts.
<b>Time Lapse Movie</b>	Off	Sets recording format of frame sequence. [Off]: Records each frame as a still picture. [On]: Records each frame as a still picture and generates a single movie from the frame sequence.
	On	
<b>Movie Settings</b>	Movie Resolution	[Movie Resolution]: Select a size for time lapse movies.
	Frame Rate	[Frame Rate]: Select a frame rate for time lapse movies.

- The starting and ending times shown in the display are intended as a guide only. The actual times may vary with shooting conditions.
- Highlight items and press the  to select.

- 4 Press the  button when settings are complete.

- 5 The [Off]/[On] options will be displayed once more; confirm that [On] is highlighted and press the  button again.





- 6 Shoot.

- [Rec View] (P. 94) operates for 0.5 seconds.
- If either of the time before shooting, or shooting interval is set to 1 minute 31 seconds or longer, the monitor and camera power will turn off after 1 minute. 10 seconds before shooting, the power will automatically turn on again. When the monitor is off, press the ON/OFF button to turn it on again.



- If any of still pictures are not recorded correctly, the time lapse movie will not be generated.
- If there is insufficient space on the card, the time lapse movie will not be recorded.
- Using any of the controls or performing any of the operations listed below ends time-lapse shooting:
  - the mode dial, MENU button, the  button, connecting a USB cable, turning the camera off
- Interval-timer photography will end if the battery runs low. Check that the battery is charged before shooting; if you will be shooting for an extended period, use the USB-AC adapter. If you are using the USB-AC adapter, insert the battery in the camera and select [Charge] in the dialog displayed after the USB cable is connected. Once the monitor has turned off, you can press the ON/OFF button to turn the monitor on again and continue to take pictures while charging is in progress.
- Movies recorded with [4K] selected for [Movie Settings] > [Movie Resolution] may not display on some computer systems. More information is available on the OLYMPUS website.

## Varying focus little-by-little over a series of pictures (Focus BKT)

Each time the shutter button is pressed, the camera will automatically vary focus over a series of 10, 20, or 30 shots.



- 1 Highlight [Focus BKT] in  Shooting Menu 2 and press the  button.
- 2 Highlight [On] and press the .
- 3 Adjust the following settings and press the  button.

<b>Start Waiting Time</b>	0 to 30 sec	Select the length of time the camera waits before shooting starts.
<b>Set number of shots</b>	10/20/30	Select the number of frames in the bracketing sequence.
<b>Set focus differential</b>	Narrow/Normal/ Wide	Select the amount focus changes with each shot.



- 4 Press the shutter button halfway down to focus.
  - If the focus indicator blinks, the camera is not in focus.
- 5 Press the shutter button all the way down to shoot.
  - The camera takes the number of shots selected for [Set number of shots] while varying focus with each shot. The camera will take pictures at, and at distances in front of and behind, the focus distance selected when the shutter button is pressed halfway.
  - The  indicator turns green during bracketing.
  - Shooting ends when focus reaches  $\infty$  (infinity).
  - AF target selection is fixed at [] (single target).
  - Exposure and white balance are fixed at the values for the first shot in each series.

## Increasing depth of field (Focus Stacking Settings)

Vary focus over the selected number of shots and combine the resulting pictures to form a single image. The camera records two pictures: the first shot taken and the composite image.

- 1 Highlight [Focus Stacking Settings] in  Shooting Menu 2 and press the  button.
- 2 Adjust the following settings and press the  button.





<b>Start Waiting Time</b>	Select the length of time the camera waits before shooting starts.
<b>Set number of shots</b>	Select the number of shots that will be taken and combined to create the final picture. <ul style="list-style-type: none"> <li>• The first shot is not included.</li> </ul>

- 3 Rotate the mode dial to .
- 4 Highlight [Focus Stacking] using  and press the  button.
- 5 Press the shutter button halfway to focus.
  - If the focus indicator blinks, the camera is not in focus.
  - Use focus lock (P. 46) or manual focus (P. 55) to lock focus before shooting.
- 6 Press the shutter button all the way down to start shooting.
  - AF target selection is fixed at [ [ ] ].
  - Exposure and white balance are fixed at the values for the first shot in each series.

## Date stamps (Date Stamp)

Stamp photos with the date and/or time of recording.

<b>Off</b>	Do not place date and time stamps on photos.
<b>Date</b>	Stamp photos with the date of recording.
<b>Time</b>	Stamp photos with the time of recording.
<b>Date + Time</b>	Stamp photos with the date and time of recording.

- Date/time stamps cannot be removed.
- This option will not be available if the date and time have not been set.  "Initial Setup" (P. 18)
- This option is not available with:
  - RAW pictures (including pictures shot using JPEG+RAW); movies; pictures recorded using [e-Portrait], [Handheld Starlight], [Live Composite], [Panorama], or [Backlight HDR] in SCN mode; pictures taken using [Focus Stacking] or [Focus Bracketing] in  mode; pictures taken using [Underwater HDR] in  mode; photos taken with [ART] selected for picture mode; photos taken with the mode dial rotated to ; pictures taken in burst mode; or photos created using the [Edit] option in the playback menu.
- A  icon is displayed when [Date Stamp] is enabled.

## Using the Video Menu

Movie recording functions are set in the Video Menu.

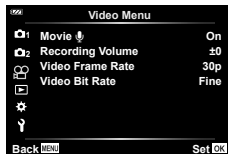

Option	Description	
<b>Movie</b>	[Off]: Record movies without sound. [On]: Record movies with sound. [On ]: Record movies with sound; wind noise reduction enabled.	38
<b>Recording Volume</b>	Adjust the sensitivity of the built-in microphone. Adjust the sensitivity using $\Delta$ $\nabla$ while checking the peak sound level picked up by the microphone over the previous few seconds.	—
<b>Video Frame Rate</b>	Select the frame rate for movie recording. <ul style="list-style-type: none"> <li>When shooting movies that will be viewed on a television, select a frame rate that matches the video standard used in the device, as otherwise the movie may not play back smoothly. Video standards vary by country or region: some use NTSC, others PAL.               <ul style="list-style-type: none"> <li>When shooting for display on NTSC devices, select 60p (30p)</li> <li>When shooting for display on PAL devices, select 50p (25p)</li> </ul> </li> </ul>	57
<b>Video Bit Rate</b>	Select the compression ratio for movie recording.	57

- Operation sounds of the lens and camera may be recorded in a movie. To prevent it from recording, reduce the operation sounds by minimizing the button operations of the camera.
- Sound is not recorded with high-speed movies or movies shot with <sup>ART</sup> (Diorama) selected for picture mode.
- When [Movie ] is set to [Off], is displayed.

## Using the Playback Menu

### Playback Menu

 (P. 73)



Edit

Print Order (P. 75)

Reset Protect (P. 93)

Connection to Smartphone (P. 107)



### Displaying images rotated ()









If set to [On], images in portrait orientation are automatically rotated to be displayed in the correct orientation on the playback display.

### Retouching pictures (Edit)

Create retouched copies of pictures. In the case of RAW pictures, you can adjust the settings in effect at the time the picture was taken, such as white balance and picture mode (art filters included). With JPEG pictures, you can make simple edits such as cropping and resizing.

<b>RAW Data Edit</b>	Creates a JPEG copy of a RAW image according to the selected settings.
<b>JPEG Edit</b>	Retouch JPEG pictures and save the resulting copies in JPEG format (P. 90).

#### ■ Retouching RAW pictures (RAW Data Edit)



- 1 Highlight [Edit] in the  Playback Menu and press the  button.
- 2 Use   to highlight [Sel. Image] and press the  button.
- 3 Use   to select the image to be edited and press the  button.
  - Retouch options will be displayed.
  - If the current picture is not a RAW image, [RAW Data Edit] will not be displayed. Select a different image.









- 4 Highlight [RAW Data Edit] and press the **OK** button.
  - Edit options will be displayed.
- 5 Highlight an option ([Current] or [ART BKT]) and press the **OK** button.
  - Your next steps vary with the option selected.
    - Current:** The image is processed to reflect current camera settings. Adjust settings before selecting this option. Exposure compensation and some other settings are not applied.
      - 1) Press the **OK** button.
        - Current camera settings will be applied.
      - 2) Highlight [Yes] and press the **OK** button.
        - The edited image will be saved to the card.
    - ART BKT:** Apply selected art filters.
      - 1) Press **▷**.
        - The camera will display a menu of available art filters.
      - 2) Highlight art filters and press the **OK** button to select or deselect.
        - Selected filters are marked with a **✓**.
      - 3) Press the MENU button to return to the previous display.
      - 4) Highlight [ART BKT] and press the **OK** button.
        - The modified copy will be recorded to the card.
- 6 To create additional copies from the same original, highlight [Reset] and press the **OK** button. To exit without creating more copies, highlight [No] and press the **OK** button.
  - Selecting [Reset] displays the retouch menu. Repeat the process from Step 4.
- [Color Space] is fixed at [sRGB] when an art filter is selected for picture mode.
- RAW pictures cannot be retouched if:
  - When there is not enough space in the card memory, or when an image is recorded on another camera.
- You can also edit selected pictures during playback. **👉** "RAW Data Edit/JPEG Edit" (P. 68)

## ■ Retouching JPEG pictures (JPEG Edit)

The [JPEG Edit] menu contains the following options.

<b>Shadow Adj</b>	Brightens a dark backlit subject.
<b>Redeye Fix</b>	Reduces the red-eye phenomenon due to flash shooting.
	Trims an image. Use the control dial to select the size of the crop and $\Delta \nabla \langle \rangle$ to specify the crop position.
<b>Aspect</b>	Changes the aspect ratio of images from 4:3 (standard) to [3:2], [16:9], [1:1], or [3:4]. After changing the aspect ratio, use $\Delta \nabla \langle \rangle$ to specify the trimming position.
<b>Black &amp; White</b>	Creates black and white images.
<b>Sepia</b>	Creates sepia-toned images.
<b>Saturation</b>	Increases the vividness of images. Adjust the color saturation checking the image on the screen.
	Converts the image size to 1280 x 960, 640 x 480, or 320 x 240. Images with an aspect ratio other than 4:3 (standard) are converted to the closest image size.
<b>e-Portrait</b>	Compensates the skin look for smoothness. Compensation cannot be applied in such a case that a face cannot be detected.

- Red-eye correction may not work depending on the image.
- Editing of a JPEG image is not possible in the following cases:
  - When an image is processed on a PC, when there is not enough space in the card memory, or when an image is recorded on another camera.
- The image cannot be resized () to the larger size than the original size.
- Some images can not be resized.
- [] (trimming) and [Aspect] can only be used to edit images with an aspect ratio of 4:3 (standard).

- 1** Highlight [Edit] in the  Playback Menu and press the  button.
- 2** Use  $\Delta \nabla$  to highlight [Sel. Image] and press the  button.
- 3** Use  $\langle \rangle$  to select the image to be edited and press the  button.
  - Edit options will be displayed.
  - If the current picture is not a JPEG image, [JPEG Edit] will not be displayed. Select a different image.
- 4** Highlight [JPEG Edit] and press the  button.
  - An edit menu will be displayed.

- 5 Select an option with  $\Delta \nabla$  and press the  $\text{OK}$  button.
  - The effect can be previewed in the monitor. If multiple options are listed for the selected item, use the  $\Delta \nabla$  to select the desired option.
  - When [Crop] is selected, you can size the crop using the control dial and position it using  $\Delta \nabla \langle \triangleright \rangle$ .
  - When [Aspect] is selected, you can position the crop using  $\Delta \nabla \langle \triangleright \rangle$ .
- 6 Highlight [Yes] and press the  $\text{OK}$  button.
  - The edited image will be saved to the card.

#### ■ Audio recording

Audio can be added to still images (up to 30sec. long).  
This is the same function as [M] during playback (P. 72).

#### ■ Image Overlay

Up to 3 frames of RAW images taken with the camera can be overlaid and saved as a separate image.

The image is saved with the record mode set at the time the image is saved. (If [RAW] is selected, the copy will be saved in [L+N+RAW] format.)

- 1 Highlight [Edit] in the  $\text{▶}$  Playback Menu and press the  $\text{OK}$  button.
- 2 Use  $\Delta \nabla$  to highlight [Image Overlay] and press the  $\text{OK}$  button.
- 3 Select the number of images to be overlaid and press the  $\text{OK}$  button.
- 4 Use  $\Delta \nabla \langle \triangleright \rangle$  to select the RAW images and press the  $\text{OK}$  button to add them to the overlay.
  - The overlaid image will be displayed if images of the number specified in step 3 are selected.
- 5 Adjust gain (brightness) for the pictures in the overlay.
  - Use  $\langle \triangleright \rangle$  to select an image and  $\Delta \nabla$  to adjust gain.
  - Gain can be adjusted in the range 0.1–2.0. Check the results in the monitor.
- 6 Press the  $\text{OK}$  button to display the confirmation dialog. Highlight [Yes] and press the  $\text{OK}$  button.

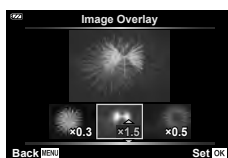
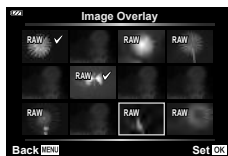

















#### Notes

- To overlay 4 or more frames, save the overlay image as a RAW file and use [Image Overlay] repeatedly.





















## Creating movie stills (In-Movie Image Capture)

Save a still copy (aspect ratio 16:9) of a frame selected from a 4K movie recorded with the camera.

- 1 Highlight [Edit] in the  Playback Menu and press the  button.
  - 2 Use   to highlight [Sel. Image] and press the  button.
  - 3 Use   to select a movie and press the  button.
  - 4 Highlight [Movie Edit] and press the  button.
  - 5 Use   to highlight [In-Movie Image Capture] and press the  button.
  - 6 Use   to select a frame to be saved as a still image and press the  button.
    - Use   or to skip multiple frames.
    - Press the MENU button to return to single-frame playback.
- The date of recording of the still may differ from that of the original movie.

## Trimming movies (Movie Trimming)

Cut selected footage from movies recorded with the camera and either overwrite the original with the edited footage or save the edited copy separately.

- 1 Highlight [Edit] in the  Playback Menu and press the  button.
- 2 Use   to highlight [Sel. Image] and press the  button.
- 3 Use   to select a movie and press the  button.
- 4 Highlight [Movie Edit] and press the  button.
- 5 Use   to highlight [Movie Trimming] and press the  button.
- 6 Highlight [Overwrite] or [New File] and press the  button.
  - If the image is protected, you cannot select [Overwrite].
- 7 Select whether the section to be deleted begins with the first frame or ends with the last frame, using   to highlight the desired option and pressing the  button to select.
  - To jump to the first or last frame, rotate the control dial.
- 8 Use   to select the section to be deleted.
  - The section to be deleted is shown in red.
- 9 Press the  button.
- 10 Highlight [Yes] and press the  button.
  - The date of recording of the still may differ from that of the original movie.

## Canceling all protections





Protections of multiple images can be canceled at a time.

- 1 Highlight [Reset Protect] in the  Playback Menu and press the  button.
- 2 Highlight [Yes] and press the  button.

## Using the Setup Menu

Use the  $\downarrow$  Setup Menu to set the basic camera functions.



Option	Description	
<b>Card Setup</b>	Format the card and delete all images.	21, 95
<b>Settings</b> (Date/time setting)	Set the camera clock.	18
 (Changing the display language)	Select a different language for the menus and messages displayed in the monitor.	95
 (Monitor brightness adjustment)	Adjust monitor brightness. Use $\Delta$ $\nabla$ to select an option.	—
<b>Rec View</b>	Sets whether to display the captured image on the monitor after shooting, and the length of time for the display. This is useful for a brief check of the picture you have taken. You can shoot the next shot by pressing the shutter button halfway even while the captured image is displayed on the monitor. [0.3sec]–[20sec]: Sets the length of time (seconds) to display the captured image on the monitor. [Off]: The captured image is not displayed on the monitor. [Auto  ]: Displays the captured image, and then switches to playback mode. This is useful for erasing a picture after checking it.	—
<b>Wi-Fi Settings</b>	Adjust settings for connection to Wi-Fi-compatible smartphones using the camera's wireless function.	109, 110

## Deleting all images (Card Setup)

All images on a card can be deleted at a time. Protected images are not deleted.

- 1 Highlight [Card Setup] in the  $\uparrow$  Setup Menu and press the  $\text{OK}$  button.
- 2 Highlight [All Erase] and press the  $\text{OK}$  button.
- 3 Highlight [Yes] and press the  $\text{OK}$  button.
  - All images are deleted.

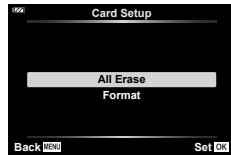

## Selecting a language (🗨️)

Select a different language for the menus and messages displayed in the monitor.





- 1 Highlight [🗨️] in the  $\uparrow$  Setup Menu and press the  $\text{OK}$  button.
- 2 Highlight the desired language using  $\Delta$   $\nabla$   $\triangleleft$   $\triangleright$  or the control dial.
  - The language-selection dialog has two pages of options. Use the control dial or the  $\Delta$   $\nabla$   $\triangleleft$   $\triangleright$  buttons on the arrow pad to move the cursor between pages.
- 3 Press the  $\text{OK}$  button when the desired language is highlighted.



## Using the Custom Menus

Camera settings can be customized using the  Custom Menu.

### Custom Menu

- A** AF/MF
- B** Disp.//PC
- C** Exp/ISO (P. 97)
- D**  Custom (P. 98)
- E** WB/Color (P. 98)
- F** Record (P. 99)
- G** Field Sensor (P. 100)
- H**  Utility (P. 100)

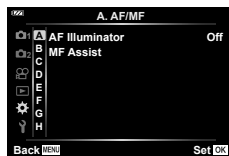





### **A** AF/MF

MENU →  → **A**

Option	Description	
<b>AF Illuminator</b>	Enable the AF illuminator to assist focus when lighting is poor.	101
<b>MF Assist</b>	Enable MF assist to assist focusing during focus lock or manual focus.	101

### **B** Disp.//PC

MENU →  → **B**

Option	Description	
 /Info Settings	Select the information displayed when the INFO button is pressed. [Info]: Select the information displayed in full frame playback. [LV-Info]: Select the information displayed when the camera is in shooting mode. [Settings]: Select the information shown in the index and calendar displays.	102, 103
<b>Live View Boost</b>	[Off]: Changes to settings such as exposure compensation are reflected in the display in the monitor. [On]: Changes to settings such as exposure compensation are not reflected in the display in the monitor; instead, brightness is adjusted to bring the display as close as possible to optimal exposure.	—
<b>Flicker Reduction</b>	Reduce the effects of flicker under some kinds of lighting, including fluorescent lamps. When flicker is not reduced by the [Auto] setting, set to [50Hz] or [60Hz] in accordance with the commercial power frequency of the region where the camera is used.	—
<b>Displayed Grid</b>	Select  or  to display a grid on the monitor.	—
<b>Peaking Color</b>	Select the color of the outlines (red, yellow, white, or black) in the focus peaking display.	101



Option	Description	
■))) (Beep sound)	Use $\Delta$ $\nabla$ to adjust the volume of the sounds made in response to camera controls. Select "0" to disable sounds such as those made when the camera focuses or the shutter is released.	—
HDMI	[Output Size]: Selecting the digital video signal format for connecting to a TV via an HDMI cable. [HDMI Control]: Select [On] to allow the camera to be operated using remotes for TVs that support HDMI control. This option takes effect when pictures are displayed on a TV.	104

## Exp/ISO

MENU  $\rightarrow$   $\rightarrow$

Option	Description	
Exposure Shift	Adjust correct exposure separately for each metering mode. <ul style="list-style-type: none"> <li>The effects are not visible in the monitor. To make normal adjustments to the exposure, perform exposure compensation (P. 41).</li> </ul>	—
ISO-Auto Set	[Upper Limit / Default]: Select the upper limit and default value used for ISO sensitivity when [Auto] is selected for ISO. [Upper Limit]: Select the upper limit for auto ISO sensitivity selection. [Default]: Select the default value for auto ISO sensitivity selection. [Lowest S/S Setting]: Select the shutter speed below which the camera will automatically raise ISO sensitivity in modes <b>P</b> and <b>A</b> . If set to [Auto], the camera automatically sets the shutter speed.	—
Noise Filter	Select the amount of noise reduction performed at high ISO sensitivities.	—
Noise Reduct.	This function reduces the noise that is generated during long exposures. [Auto]: Noise reduction is performed at slow shutter speeds, or when the internal temperature of the camera has risen. [On]: Noise reduction is performed with every shot. [Off]: Noise reduction off. <ul style="list-style-type: none"> <li>The time required for noise reduction is shown in the display.</li> <li>[Off] is selected automatically during sequential shooting.</li> <li>This function may not work effectively with some shooting conditions or subjects.</li> </ul>	—

### Noise in images

While shooting at slow shutter speeds, noise may appear on screen. These phenomena occur when the temperature rises in the image pickup device or image pickup device internal drive circuit, causing current to be generated in those sections of the image pickup device that are not normally exposed to light. This can also occur when shooting with a high ISO setting in a high-temperature environment. To reduce this noise, the camera activates the noise reduction function.

Option	Description	Page
+	When set to [On], the exposure compensation value is added to the flash compensation value.	41, 59
+ WB	Adjust white balance for use with a flash. [Off]: The camera uses the value currently selected for white balance. [AUTO]: The camera uses auto white balance ([AUTO]). [WB ]: The camera uses flash white balance ([WB ]).	—

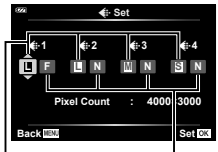
Option	Description	Page
Set	You can select the JPEG image quality mode from combinations of 3 image sizes and 3 compression rates.  <ol style="list-style-type: none"> <li>Use   to select a combination ([-1] – [-4]) and use   to change.</li> <li>Press the  button.</li> </ol>  Image size      Compression rate	56, 105
WB	Set the white balance. You can also fine-tune the white balance for each mode.  <ol style="list-style-type: none"> <li>Highlight the white balance option you wish to fine-tune and press .</li> <li>Highlight the A (amber–blue) or G (green–magenta) axis and use   to select a value.                             <ul style="list-style-type: none"> <li>Higher values on the A (amber–blue) axis give images a red cast, lower values a blue cast.</li> <li>Higher values on the G (green–magenta) axis heighten greens, while lower values give images a magenta cast.</li> </ul> </li> </ol>	53
AUTO Keep Warm Color	Select [On] to preserve “warm” colors in pictures taken under incandescent lighting.	—
Color Space	You can select a format to ensure that colors are correctly reproduced when shot images are regenerated on a monitor or using a printer. [sRGB]: This is the RGB color space standard stipulated by the International Electrotechnical Commission (IEC). Normally, use [sRGB] as the standard setting. [AdobeRGB]: This is a standard provided by Adobe Systems. Compatible software and hardware such as a display, printer etc. are required for a correct output of images.	—

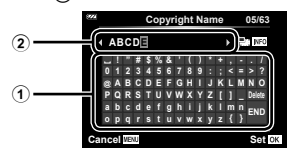
Option	Description	☞
<p><b>File Name</b></p>	<p>[Auto]: Even when a new card is inserted, the file numbers are retained from the previous card. File numbering continues from the last number used or from the highest number available on the card.</p> <p>[Reset]: When you insert a new card, the folder numbers starts at 100 and the file name starts at 0001. If a card containing images is inserted, the file numbers start at the number following the highest file number on the card.</p>	<p>—</p>
<p><b>Edit Filename</b></p>	<p>Select how image files are named by editing the portion of the filename highlighted below in gray.</p> <p>sRGB: Pmdd0000.jpg _____ Pmdd                      Adobe RGB: _mdd0000.jpg _____ mdd</p> <div style="border: 1px solid gray; padding: 5px;"> <ol style="list-style-type: none"> <li>1) Highlight [sRGB] or [AdobeRGB] and press ▷.</li> <li>2) Use &lt; &gt; to move the cursor and △ ▽ to edit the highlighted character.</li> <li>3) Repeat Step 2 as necessary to create the desired filename and then press the <b>OK</b> button.</li> </ol> </div>	<p>—</p>
<p><b>Copyright Settings*</b></p>	<p>Add the names of the photographer and copyright holder to new photographs. Names can be up to 63 characters long.</p> <p>[Copyright Info.]: Select [On] to include the names of the photographer and copyright holder in the Exif data for new photographs.</p> <p>[Artist Name]: Enter the name of the photographer.</p> <p>[Copyright Name]: Enter the name of the copyright holder.</p> <div style="border: 1px solid gray; padding: 5px;"> <ol style="list-style-type: none"> <li>1) Select characters from ① and press the <b>OK</b> button. The selected characters appear in ②.</li> <li>2) Repeat Step 1 to complete the name, then highlight [END] and press the <b>OK</b> button.                             <ul style="list-style-type: none"> <li>• To delete previously-entered characters, press the INFO button to position the cursor in the text display area (②) and then highlight the character you wish to delete. After pressing the INFO button again to return to the keyboard area (①), highlight [Delete] and press the <b>OK</b> button.</li> </ul> </li> </ol> </div> <div style="text-align: center; margin-top: 10px;">  </div> <p>* OLYMPUS does not accept liability for damages arising from disputes involving the use of [Copyright Settings]. Use at your own risk.</p>	<p>—</p>

## G Field Sensor

MENU → ⚙ → G

Option	Description	
<b>Record GPS location</b>	Select [On] to record location data with pictures as they are taken.	—
<b>GPS Priority</b>	Select the GPS mode. [GPS accuracy]: Prioritize the accuracy of GPS data over battery endurance. [Battery power]: Prioritize battery endurance over data accuracy.	—
<b>Elevation/ Temperature</b>	Select the units used for temperature and altitude in the sensor data display. You can also calibrate altitude. [Calibrate Elevation]: Calibrate altitude when the current altitude and the value shown by the camera do not match. [m/ft]: Select whether altitude is shown in meters (m) or feet (ft). [°C/°F]: Select whether the temperature is displayed in degrees Celsius (°C) or degrees Fahrenheit (°F). <div style="border: 1px solid gray; padding: 5px; margin-top: 10px;"><ol style="list-style-type: none"><li>1) Highlight the desired item using <math>\Delta \nabla</math>.</li><li>2) Press <math>\triangleright</math>.</li><li>3) Highlight items using <math>\Delta \nabla</math> and press the <math>\text{OK}</math> button to select.</li></ol></div>	—

## H Utility

MENU → ⚙ → H

Option	Description	
<b>Pixel Mapping</b>	The pixel mapping feature allows the camera to check and adjust the image pickup device and image processing functions.	122
<b>Level Adjust</b>	You can calibrate the angle of the level gauge. [Reset]: Resets adjusted values to the default settings. [Adjust]: Sets the current camera orientation as the 0 position.	—
<b>Sleep</b>	The camera will enter sleep (energy saving) mode if no operations are performed for the selected period. The camera can be reactivated by pressing the shutter button halfway.	—
<b>Certification</b>	Display certification icons.	—

## Improving focus in dark surroundings (AF Illuminator)

MENU →  →  → [AF Illuminator]

The AF illuminator (AF assist lamp) lights to assist the focus operation in dark environments. Select [Off] to disable AF illuminator.

## MF Assist

MENU →  →  → [MF Assist]

This feature is used to assist manual focus. If the focus position changes during focus lock or manual focus, the camera will enhance outlines or zoom the display in on an area of the frame.

<b>Magnify</b>	Magnifies a portion of the screen. <ul style="list-style-type: none"><li>• The subject in the center of the frame is displayed at a higher magnification. If you are using focus lock (P. 46), the location on which focus is locked will be displayed at a higher magnification.</li></ul>
<b>Peaking</b>	Displays clearly defined outlines with edge enhancement. You can select the color of the outlines.  [Peaking Color] (P. 96)

- When Peaking is in use, the edges of small subjects tend to be enhanced more strongly. This is no guarantee of accurate focusing.
- Depending on the subject, outlines may be hard to see when [On] is selected for both [Magnify] and [Peaking].

## Adding information displays

MENU → ⚙ → B → [Info/Info Settings]

### ■ [Info] Info (Playback information displays)

Use [Info] to add the following playback information displays. The added displays are displayed by repeatedly pressing the INFO button during playback. You can also opt to not show displays that appear at the default setting.

👉 “Switching the information display” (P. 63)



### Histogram display

A histogram showing the distribution of brightness in the image is displayed. The horizontal axis gives the brightness, the vertical axis the number of pixels of each brightness in the image.

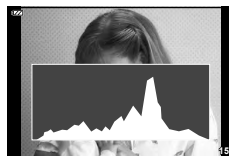

Histogram display

### Highlight & Shadow display

The Highlight & Shadow display shows overexposed areas in red, underexposed areas in blue.



Highlight & Shadow display

### ■ LV-Info (Shooting information displays)

The histogram, Highlight & Shadow, and level gauge displays can be added to [LV-Info]. Select [Custom 1] or [Custom 2] and select the displays you wish to add. The added displays are displayed by repeatedly pressing the INFO button during shooting. You can also opt to not show displays that appear at the default setting. 👉 “Switching the information display” (P. 24)



### Level gauge display

The orientation of the camera is indicated. The “tilt” direction is indicated on the vertical bar and the “horizon” direction on the horizontal bar. The camera is level and plumb when the bars turn green.

- Use the indicators on the level gauge as a guide.
- Error in the display can be corrected via calibration (P. 100).

## ■ [Settings] (Index/calendar display)

You can change the number of frames to be displayed on the index display and set to not display the screens that are set to be displayed by default with [Settings]. The displays marked with a check can be viewed by rotating the zoom lever.

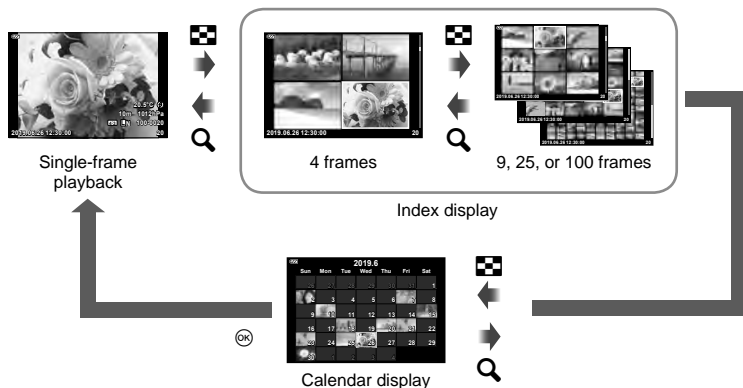
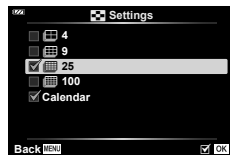
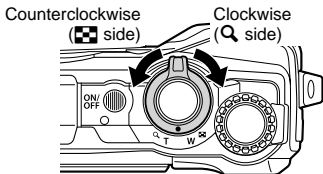

## Viewing camera images on TV

**MENU** → **⚙** → **Ⓑ** → [HDMI]

Use the separately sold cable with the camera to playback recorded images on your TV. This function is available during shooting. Connecting the camera to a high-definition TV allows you to view pictures in high resolution.

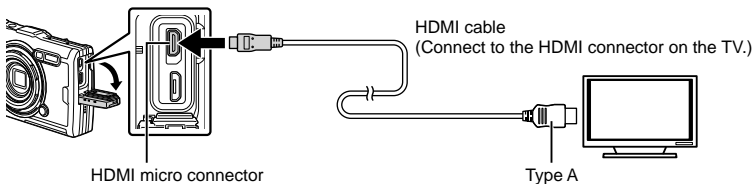

Connect the TV and camera and switch the input source of the TV.

- The camera monitor turns off when an HDMI cable is connected.
- For details on changing the input source of the TV, refer to the TV's instruction manual.
- Depending on the TV's settings, the displayed images and information may become cropped.
- If the camera is connected via an HDMI cable, you will be able to select the digital video signal type. Select a format that matches the input format selected with the TV.

<b>4K</b>	Priority is given to 4K HDMI output.
<b>1080p</b>	Priority is given to 1080p HDMI output.
<b>720p</b>	Priority is given to 720p HDMI output.
<b>480p/576p</b>	480p/576p HDMI output.

- Do not connect the camera to other HDMI output devices. Doing so may damage the camera.
- HDMI output is not performed while connected via USB to a computer.
- When [4K] is selected, video output in shooting mode is [1080p].

### Using the TV remote control

The camera can be operated by a TV remote control when connected to a TV that supports HDMI control. Select [On] for [HDMI Control]. When [On] is selected, camera controls can be used for playback only.

- You can operate the camera by following the operation guide displayed on the TV.
- During single-frame playback, you can display or hide the information display by pressing the “Red” button, and display or hide the index display by pressing the “Green” button.
- Some televisions may not support all features.



## Combinations of JPEG image sizes and compression rates

MENU → ⚙ → **E** → [←⋮ Set]

You can set the JPEG image quality by combining image size and compression rate.

Image size		Compression rate			Application
Name	Pixel Count	SF (Super Fine)	F (Fine)	N (Normal)	
<b>L</b> (Large)	4000×3000	<b>L</b> SF	<b>L</b> F	<b>L</b> N	Select for the print size
<b>M</b> (Middle)	3200×2400	<b>M</b> SF	<b>M</b> F	<b>M</b> N	
<b>S</b> (Small)	1280×960	<b>S</b> SF	<b>S</b> F	<b>S</b> N	For small prints and use on a website

Use the camera's wireless LAN (Wi-Fi) features to connect to a smartphone, where you can use the dedicated app to enhance your enjoyment of the camera both before and after shooting.

- Operation is not guaranteed on all smartphones.

#### **OLYMPUS Image Share (OI.Share)**

Use a smartphone to control the camera remotely and download pictures.

For more information, visit:

<http://app.olympus-imaging.com/oishare/>

#### **OLYMPUS Image Track (OI.Track)**

View and manage field sensor logs recorded with the camera.

For more information, visit:

<http://app.olympus-imaging.com/oitrack/>

#### **OLYMPUS Image Palette (OI.Palette)**

Retouch or crop pictures using tools such as art filters or the Color Creator.



For more information, visit:

<http://app.olympus-imaging.com/oipalette/>

- **Before using the wireless LAN function, read “Using the wireless LAN function” (P. 152).**
- As with any wireless communication, there is always a risk of interception by a third party.
- The wireless LAN function on the camera cannot be used to connect to a home or public access point.
- The transceiver antenna is located inside the grip. Keep the antenna away from metal objects whenever possible.
- During wireless LAN connection, the battery will run down faster. If the battery is running low, the connection may be lost during a transfer.
- Connection may be difficult or slow in proximity to devices that generate magnetic fields, static electricity or radio waves, such as near microwaves, cordless telephone.
- If Wi-Fi seems sluggish, try using Wi-Fi with Bluetooth disabled on the smartphone.

## Adjusting Settings for Connection to a Smartphone

Start the OI.Share App installed on your smartphone.

- 1 Highlight [Connection to Smartphone] in the  Playback Menu and press the  button.
  - You can also launch [Connection to Smartphone] by pressing and holding the MENU button when the camera is ready to shoot.
- 2 Follow the on-screen guide to adjust Wi-Fi settings.
  - The SSID, password and QR code are displayed on the monitor.



- 3 Tap the camera icon at the bottom of the OI.Share display.
- 4 Follow the on-screen instructions in OI.Share to scan the QR code and adjust connection settings.
  - Some smartphones will need to be configured manually after reading the QR code.
  - If you are unable to scan the QR code, follow the on-screen instructions in OI.Share to adjust settings manually.
  - To connect, enter the SSID and password displayed in the camera monitor into the smartphone Wi-Fi settings dialog. For information on how to access Wi-Fi settings on your smartphone, see the documentation provided with the device.
  - If the smartphone is currently connected via Wi-Fi to another network or device, you will need to select the camera in the Wi-Fi connection section of the smartphone settings app.
  -  1 will be displayed when pairing is complete.
- 5 To end the connection, press the MENU button of the camera.
  - You can also turn the camera off and end the connection from OI.Share.

## Transferring Images to a Smartphone

You can select images in the camera and load them to a smartphone. You can also use the camera to select images you want to share in advance.  “Share Order” (P. 71)

- 1 Connect the camera to a smartphone (P. 107).
- 2 Launch OI.Share and tap the Image Transfer button.
  - The images in the camera are displayed in a list.
- 3 Select the pictures you want to transfer and tap the [Save] button.
  - When transfer is complete, you can turn off the camera from the smartphone.

## Shooting Remotely with a Smartphone

You can shoot remotely by operating the camera with a smartphone.

- 1 Connect the camera to a smartphone (P. 107).
  - 2 Launch OI.Share and tap the Remote button.
  - 3 Tap the shutter button to shoot.
    - The image taken is saved to the card inserted in the camera.
- Available shooting options are partially limited.

## Changing Connection Method

There are two ways to connect the camera to a smartphone: [Private], by which you use the same setting every time, and [One-Time], by which you use different setting every time. It is recommended to use [Private] when connecting to your smartphone, and to use [One-Time] when transferring images to another smartphone. The default setting is [Private].

- 1 Highlight [Wi-Fi Settings] in the  $\Psi$  Setup Menu and press the  $\text{\textcircled{OK}}$  button.
- 2 Highlight [Wi-Fi Connect Settings] and press  $\blacktriangleright$ .
- 3 Select the wireless LAN connection method and press the  $\text{\textcircled{OK}}$  button.
  - [Private]: Connect to one smartphone (connects automatically using the settings after the initial connection). All OI.Share functions are available.
  - [One-Time]: Connect to multiple smartphones (connects using different connection settings each time). Only OI.Share's image transfer function is available. You can view only images that are set for share order using the camera.
  - [Select]: Select which method to use each time.
  - [Off]: The Wi-Fi function is turned off.

## Resetting Wireless LAN Settings

To restore [Wi-Fi Settings] to default values:

- 1 Highlight [Wi-Fi Settings] in the  $\Psi$  Setup Menu and press the  $\text{\textcircled{OK}}$  button.
- 2 Highlight [Reset Wi-Fi Settings] and press  $\blacktriangleright$ .
- 3 Highlight [Yes] and press the  $\text{\textcircled{OK}}$  button.
  - The following settings will be reset:

Option	Default
Wi-Fi Connect Settings	Private
Private Password	— (generated randomly) *

\* The connection to the smartphone will also be reset (deactivated).

## Changing the Password

Change the password used for [Private].

- 1 Highlight [Wi-Fi Settings] in the **Y** Setup Menu and press the **OK** button.
- 2 Highlight [Private Password] and press **▷**.
- 3 Follow the operation guide and press the **OK** button.
  - A new password will be set.
  - Reconnect to the smartphone after changing passwords.  "Adjusting Settings for Connection to a Smartphone" (P. 107)

## Cancelling a Share Order

Cancel share orders that are set on images.

- 1 Highlight [Wi-Fi Settings] in the **Y** Setup Menu and press the **OK** button.
- 2 Highlight [Reset share Order] and press **▷**.
- 3 Highlight [Yes] and press the **OK** button.

# 6 Using Field Sensor Data

The camera can log data on position, altitude, and heading acquired via GPS, as well as data from temperature and pressure sensors. These data can also be recorded with photographs. Logs can be viewed using the “OLYMPUS Image Track” (OI.Track) smartphone app.

For more information on OI.Track, visit:

<http://app.olympus-imaging.com/oitrack/>

- The camera also supports the Quazi-Zenith Satellite System (QZSS) and GLONASS.
- Latitude and longitude are displayed on images to which position information has been added.
- The camera is not equipped for GPS navigation.
- Be sure to use the latest version of the app.

## **GPS and other data displays**

These displays are not intended for applications that require a high degree of precision, and the accuracy of the data (latitude and longitude, heading, altitude, temperature, and the like) they provide is not guaranteed. The accuracy of these displays may be also affected by factors not under the control of the manufacturer.

## **GPS: Precautions for use**

- Before using the GPS function, read “GPS function, electronic compass” (P. 152).
- In certain countries and regions it may be illegal to acquire position information without prior application to the government. Because of this, in certain sales regions, the camera may be set up not to display position information.  
When taking the camera abroad, be aware that some regions or countries may have laws regulating the use of this function. Be sure to abide by all local laws.
- Before boarding an aircraft or entering other locations where the use of GPS devices is prohibited, be sure to rotate the LOG switch to OFF and select [Off] for both [Record GPS location] (P. 100) and [⊙ Settings] > [Auto Time Adjust] (P. 94).

## **Before using GPS function (A-GPS data)**

Depending on the status of the camera and communication, it may take time to acquire the position information. When the A-GPS is used, the position determination time can be shortened from a few seconds to a few tens of seconds. The A-GPS data can be updated using the smartphone app “OLYMPUS Image Track” (OI.Track) or the PC software “OLYMPUS A-GPS Utility”.

Make sure that the camera date is set correctly.

- Set camera Wi-Fi connection settings to [Private] (P. 109).
- A-GPS data must be updated every 4 weeks.  
The position information may have changed when time has elapsed after updating the data. Use as new A-GPS data as possible.
- The provision of A-GPS data may be terminated without prior notice.

### ■ Updating the A-GPS data using a smartphone

Before update, install the smartphone app "OLYMPUS Image Track" (OI.Track) on your smartphone. Refer to the URL below for details on how to update the A-GPS data.

<http://app.olympus-imaging.com/oitrack/>

Connect the camera and the smartphone, following the procedure described in "Adjusting Settings for Connection to a Smartphone" (P. 107). Select [Update GPS Assist Data] in the OI.Track settings dialog.

- If a connection error is displayed, you will need to re-establish the connection between the camera and smartphone.

### ■ Updating the A-GPS data using a PC

Download the OLYMPUS A-GPS Utility software from the URL below, and install it on your PC.

<http://sdl.olympus-imaging.com/agps/>

Refer to "OLYMPUS A-GPS Utility Instruction Manual" on the website with above URL for details on how to update the data.

- If you are using the GPS function for the first time and the A-GPS has not been updated, or if the function has not been used for a long time, it may take a few minutes for the position measurement to end.

## Using GPS

---

Any of the following enable GPS:

rotating the LOG switch to LOG (P. 113), selecting [On] for [Record GPS location] (P. 100), or selecting [On] for [⊙ Settings] > [Auto Time Adjust] (P. 94).

- Do not cover the GPS antenna with your hands or metal objects.
- If you are using the GPS function for the first time and the A-GPS has not been updated, or if the function has not been used for a long time, it may take a few minutes for the position measurement to end.
- Enabling GPS increases the drain on the battery. To reduce the drain on the battery when GPS is enabled, select [Battery power] for [GPS Priority] (P. 100).

## Displaying tracked movement of GPS logs

---

After the GPS track logs are recorded, the tracked movement of the logs can be displayed using the OI.Track.

- The tracked movement cannot be displayed on the camera.



## Recording and Saving Logs

While the LOG switch is in the LOG position, the camera will log GPS and other sensor data (P. 111). Logs can be downloaded for use with the OLYMPUS Image Track (Ol.Track) smartphone app.

Rotate the LOG switch to LOG.

- Logging will start. The indicator lamp will blink while logging is in progress.

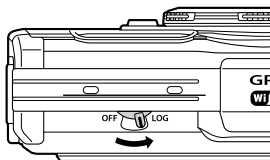

- Logging ends automatically when the battery runs low (P. 134).
- In LOG mode, the camera draws on the battery continuously to acquire location data.
- No data can be added to the log once the memory allocated to temporary log storage is full, in which case you will need to rotate the LOG switch to OFF to save the log to the card (P. 134).

### Saving logs

The current log is saved to the card when the LOG switch is rotated to OFF.

- A message is displayed in the monitor while the log is being saved. Do not remove the card until the message has cleared from the display. Removing the card while the log is being saved could cause loss of the log file or camera or card malfunction.
- The camera may not begin saving the log to the card when the LOG switch is rotated to OFF if, for example, wireless data transfer is in progress or the card is full or write-protected, in which case you should terminate wireless data transfer, delete unwanted data from the card, or otherwise enable the log to be saved. Do not remove the battery from the camera until the log has been saved.
- The log will not be saved if no card is inserted.
- Logs will not be saved if the battery is low. Charge the battery.
- Each card can store up to 199 log files. An error message will be displayed when the log file count approaches this number (P. 134). Should this occur, insert another card or delete log files after copying them to a computer.
- Log files are recorded to the "GPSLOG" and "SNSLOG" folders on the card (P. 15).

## Using Buffered and Saved Logs

To access logs stored in the camera's temporary buffer or saved to the card, launch the OLYMPUS Image Track (OI.Track) smartphone app and connect to the smartphone using the camera wireless LAN function (P. 107).

### Things you can do with the specified app, OLYMPUS Image Track (OI.Track)

- Viewing the current log and images  
The current log and images can be viewed on the smartphone.
- Downloading the current log and images  
The current log and images can be copied to and browsed on the smartphone.
- Viewing tracks  
Logs stored on the card can be copied to the smartphone and viewed as tracks.
- Linking images to a log  
Images shot while log recording was enabled can be linked to the log for viewing or file management.
- OI.Track can be used to update GPS assist data (P. 111).

For details, visit the address below:

<http://app.olympus-imaging.com/oitrack/>

## Viewing Location Data

Pressing the INFO button when the camera is off displays location data in the monitor.

- The accuracy of the data displayed varies with weather conditions and the like. Use as a rough guide only.

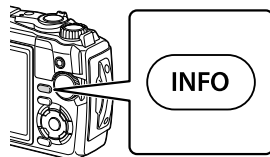

## Location data displays



- |                                   |                    |
|-----------------------------------|--------------------|
| ① Time                            | ⑥ Altitude (depth) |
| ② Log recording in progress       | ⑦ GPS icon         |
| ③ Direction information           | ⑧ Latitude         |
| ④ Temperature (water temperature) | ⑨ Longitude        |
| ⑤ Atmospheric pressure            |                    |

### ■ Latitude and longitude

If the GPS icon blinks or is not displayed, the camera is unable to determine the current position.

## GPS and other data displays

- These displays are not intended for applications that require a high degree of precision, and the accuracy of the data (latitude and longitude, heading, depth, temperature, and the like) they provide is not guaranteed. The accuracy of these displays may be also affected by factors not under the control of the manufacturer.

# 7 Connecting to a Computer

## Connecting the Camera to a Computer

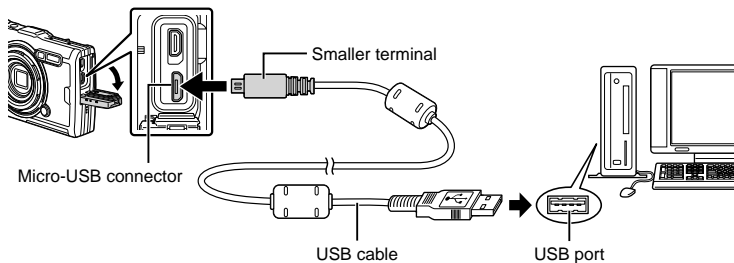

- When the camera is connected to a computer via USB, a dialog should be displayed in the monitor prompting you to select a host.
- If nothing is displayed on the camera screen even after connecting the camera to the computer, the battery may be exhausted. Use a full-charged battery.
- If the camera cannot connect to PC, disconnect and reconnect the cable.
- The battery can be charged while the camera is connected to the computer via USB. The charging time varies depending on the performance of the computer. (There may be cases in which it takes approx. 10 hours.)

## Copying Pictures to a Computer

The following operating systems are compatible with the USB connection:

**Windows:** Windows 7 SP1/Windows 8/Windows 8.1/Windows 10

**Mac:** OS X v10.9 – v10.11/macOS v10.12 – v10.14

- 1 Turn the camera off and connect it to the computer.
  - The location of the USB port varies with the computer. For details, refer to your computer's manual.
  - The selection screen for the USB connection is displayed.

- 2 Highlight [Storage] or [MTP] using  $\Delta$   $\nabla$ . Press the  $\text{OK}$  button.

<b>Storage</b>	Connect camera as a card reader.
<b>MTP</b>	Treat the camera as a portable device.

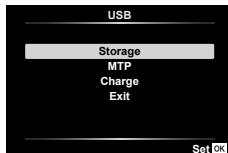

- 3 The computer recognizes the camera as a new device.
  - Data transfer is not guaranteed in the following environments, even if your computer is equipped with a USB port.
    - Computers with a USB port added by means of an extension card, etc., computers without a factory-installed OS, or home-built computers
  - Camera controls cannot be used while the camera is connected to a computer.
  - If the computer does not detect the camera, disconnect the USB cable and then reconnect it to the computer.

## Installing the PC Software

Install the following software to access the camera while it is connected directly to the computer via USB.

### Olympus Workspace

This computer application is used to download, view, and manage photos and movies recorded with the camera. It can also be used to update the camera firmware. The software can be downloaded from the website below. Be prepared to provide the camera serial number when downloading the software.

<https://support.olympus-imaging.com/owdownload/>

# 8 Cautions

## Batteries

- The camera uses a single Olympus lithium-ion battery. Never use any battery other than genuine OLYMPUS batteries.
- The camera's power consumption varies widely with usage and other conditions.
- As the following consume a lot of power even without shooting, the battery will be drained quickly.
  - The zoom is used repeatedly.
  - Performing auto focus repeatedly by pressing the shutter button halfway in shooting mode.
  - Displaying images on the monitor for a prolonged period.
  - When connected to a computer.
  - Leaving wireless LAN enabled.
- When using a drained battery, the camera may turn off without the low battery warning being displayed.
- The battery will not be fully charged at the time of purchase. Charge the battery using the supplied USB-AC adapter before use.
- Remove the batteries before putting the camera into storage for periods of a month or more. Leaving the batteries in the camera for extended periods shortens their lives, potentially rendering them unusable.
- Fully charging the battery using the supplied USB-AC adapter takes about 3 hours. Charging times may increase at high ambient temperatures.
- Do not use USB-AC adapters or chargers not specifically designated for use with batteries of the supplied type. Similarly, do not use the supplied USB-AC adapter with batteries other than those of the designated type.
- There is a risk of explosion if the battery is replaced with the incorrect battery type.
- Dispose of the used battery following the instructions "CAUTION" (P. 150) in the instruction manual.
- To ensure reliable operation, be sure the battery is inserted when using the USB-AC adapter.

## Using Your Charger Abroad

- The charger and USB-AC adapter can be used with most household AC power supplies of 100–240 V (50/60 Hz) worldwide. However, depending on the country or area you are in, the AC wall outlet may be shaped differently and the charger may require a plug adapter to match the wall outlet.
- Do not use travel voltage converters as they could damage your charger and USB-AC adapter.

## Number of Images (Stills)/Length of Footage (Movies) per Card

- The figures for the number of storable still pictures and recording length are approximate. The actual capacity varies with shooting conditions and the card used.
- The table below shows the approximate number of storable still pictures and recording length that can be stored on a 4 GB card.























### ■ Still pictures

Examples of image size when the aspect ratio is 4:3.

Record mode	Image size (Pixel Count)	Compression	File format	Number of storable still pictures
RAW	4000×3000	Loss-less compression	ORF	270
L <sup>S</sup> F		1/2.7	JPEG	436
L <sup>F</sup>		1/4		638
L <sup>N</sup>		1/8		1231
M <sup>S</sup> F	1/2.7	673		
M <sup>F</sup>	1/4	975		
M <sup>N</sup>	1/8	1846		
S <sup>S</sup> F	1280×960	1/2.7		3385
S <sup>F</sup>		1/4		4514
S <sup>N</sup>		1/8		7170

- The number of storable still pictures may change according to the subject, whether or not print reservations have been made, and other factors. In certain instances, the number of storable still pictures displayed on the monitor will not change even when you take pictures or erase stored images.
- The actual file size varies according to the subject.
- The maximum number of storable still pictures displayed on the monitor is 9999.

## ■ Movies

Image size/bit rate/frame rate		Recording length
 3840×2160 30p	3840×2160 25p	5 min.
 3840×2160 25p		
 1920×1080 Super Fine 60p	1920×1080 Super Fine 25p	10 min.
 1920×1080 Super Fine 50p		
 1920×1080 Super Fine 30p		
 1920×1080 Super Fine 25p		
 1920×1080 Fine 60p	1920×1080 Fine 25p	17 min.
 1920×1080 Fine 50p		
 1920×1080 Fine 30p		
 1920×1080 Fine 25p		
 1920×1080 Normal 60p	1920×1080 Normal 25p	29 min.
 1920×1080 Normal 50p		
 1920×1080 Normal 30p		
 1920×1080 Normal 25p		
 1280×720 Super Fine 30p	1280×720 Super Fine 25p	20 min.
 1280×720 Super Fine 25p		
 1280×720 Fine 30p	1280×720 Normal 25p	29 min.
 1280×720 Fine 25p		
 1280×720 Normal 30p		
 1280×720 Normal 25p		
 1920×1080 HighSpeed 120fps	640×360 HighSpeed 480fps	20 sec.
 1280×720 HighSpeed 240fps		
 640×360 HighSpeed 480fps		

- At movie quality settings of [FHD HS 120fps], [HD HS 240fps], or [SD HS 480fps], a maximum of 20 seconds of footage can be recorded per shot.
- The maximum file size of a single movie is 4GB, regardless of the capacity of the card.

### Increasing the number of pictures that can be taken

Delete unwanted images or connect the camera to a computer or other device and transfer the images to long-term storage before deleting them from the card.

 [Erase] (P. 66), [Erase Selected] (P. 76), [All Erase] (P. 95), [Format] (P. 21)



## Cleaning and Storing the Camera

For information on the precautions that must be observed when the camera is used underwater, see "Important Information about Water and Shock Resistant Features" (P. 123).

### Cleaning the camera

Turn off the camera and remove the battery before cleaning the camera.

- Do not use strong solvents such as benzene or alcohol, or a chemically treated cloth.

#### Exterior:

- Wipe gently with a soft cloth. If the camera is very dirty, soak the cloth in mild soapy water and wring well. Wipe the camera with the damp cloth and then dry it with a dry cloth. If you have used the camera at the beach, use a cloth soaked in clean water and well wrung.
- Foreign materials may be attached to the camera when using the camera in conditions with foreign materials such as dirt, dust or sand. If you continue to use the camera in such conditions, it could cause damage to the camera.

To avoid such damage, wash the camera using the following method.

- 1** Close and lock the battery/card compartment cover and connector cover firmly (P. 10).
- 2** Fill a bucket or other container with fresh water, immerse the camera facing downward in the bucket and shake the camera thoroughly. And rinse the camera by placing it directly under a strong stream of tap water with pressing the button.

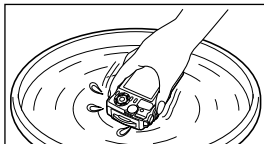

#### Monitor:

- Wipe gently with a soft cloth.

#### Lens:

- Cloths may scratch the lens if used without first removing sand, dust, or other foreign matter. Remove dust from the lens with a third-party blower and then gently clean it with lens cleaning paper.
- Mold may form on the lens surface if the lens is left dirty.

#### Battery/USB-AC adapter:

- Wipe gently with a soft, dry cloth.

## Storage

---

- When not using the camera for a prolonged period, remove the battery and card. Store the camera in a cool, dry place that is well ventilated.
- Insert the battery periodically and test the camera's functions.
- Clean the camera after use.
- Do not store with insect repellent.
- Avoid storing the camera in places where chemicals are treated, in order to protect the camera from corrosion.
- Mold may form on the lens surface if the lens is left dirty.
- Check each part of the camera before use if it has not been used for a long time. Before taking important pictures, be sure to take a test shot and check that the camera works properly.

## Pixel Mapping - Checking the image processing functions

---

The pixel mapping feature allows the camera to check and adjust the image pickup device and image processing functions. Before using the pixel mapping function to ensure that it operates correctly, wait for 1 minute or longer immediately after shooting or playback.

- 1** In Custom Menu **[H]**, select [Pixel Mapping] (P. 100).
  - 2** Press the **[OK]** button when [Start] (Submenu 2) is displayed.
    - The [Busy] bar is displayed when pixel mapping is in progress. When pixel mapping is finished, the menu is restored.
- If you accidentally turn the camera off during pixel mapping, start again from Step 1.

## Important Information about Water and Shock Resistant Features

**Water resistance:** The waterproof feature is warranted\*1 to operate at depths up to 15 m (49.2 feet) for up to one hour.

The waterproof feature may be compromised if the camera is subject to substantial or excessive impact.

**Shock resistance:** The anti-shock feature warrants\*2 the operation of the camera against accidental impact incurred from everyday use of your digital compact camera. The anti-shock feature does not unconditionally warrant all defective operation or cosmetic damage. Cosmetic damage, such as scratches and dents, are not covered under the warranty.

As with any electronic device, proper care and maintenance are required to preserve the integrity and operation of your camera. To maintain camera performance, please take your camera to the nearest Olympus Authorized Service Center to have it inspected after any major impact. In the event the camera is damaged as a result of negligence or misuse, the warranty will not cover costs associated with the service or repair of your camera. For additional information on our warranty, please visit to the Olympus website for your local area.

Please observe the following care instructions for your camera.

\*1 As determined by Olympus in-house tests performed in accordance with IEC Standard Publication 60529 IPX8 - This means that the camera can be used normally under water at a specified water pressure.

\*2 This anti-shock performance is confirmed by Olympus' testing conditions in accordance with MIL-STD-810F, Method 516.5, Procedure IV (Transit Drop Test). For more details of Olympus' testing conditions, please refer to the Olympus website for your local area.

### Before use:

- Check the camera for foreign material including dirt, dust or sand.
- Firmly close the battery/card compartment cover lock, connector cover lock and LOCK knob.
- Do not open the battery/card compartment cover and connector cover with wet hands, while under water, or in a damp or dusty environment (e.g. beach).

### After use:

- Be sure to wipe off any excess water or debris after using the camera under water.
- **After the camera is used under seawater, immerse the camera in a bucket containing fresh water for about 10 minutes (with the battery/card compartment cover and connector cover firmly closed, the lock in place and the lens ring removed). After that, let the camera dry in a shaded location with good ventilation.**
- **When opening the battery/card compartment cover or connector cover, open slowly with the camera orientated as shown in the following illustration to prevent water drops entering the camera. If any water drops are found on the inner side of the cover, be sure to wipe them off before using the camera.**

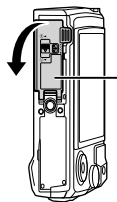

Battery/card compartment cover

## Storage and maintenance

- Do not use chemicals for cleaning, rust prevention, anti-fogging, repairing, etc. Failure to do so may break down water resistance.
- **Do not leave the camera in water for a long time. Prolonged exposure to water will cause damage to the camera's appearance and/or deteriorate water resistance.**
- **In order to preserve the water resistant feature, as with any underwater housing, it is recommended that the waterproof packing (and seals) are replaced annually. For the Olympus distributors or service stations where the waterproof packing can be replaced, visit Olympus website for your local area.**
- The included accessories (e.g. USB-AC adapter) do not offer shock or water resistance.

## Using Separately Sold Accessories

### Attaching optional silicone jackets

Attach the jacket as shown. Reverse the steps to remove the jacket.

- Do not use excessive force. Failure to observe this precaution could damage the jacket.

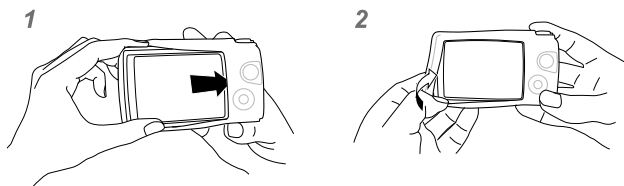

### Taking pictures with the Olympus Wireless RC Flash System

You can take pictures and underwater pictures with a wireless flash when using a flash compatible with the Olympus Wireless RC Flash System.

The guideline of the setup range in wireless flash shooting is from 1 to 2 m, however note that it varies depending on the ambient environment.

- The camera's built-in flash is used for communication between the camera and flash.
- To use a dedicated underwater strobe, prepare an underwater case, a fiber-optic cable and so on.
- For details about operation of a wireless flash and an underwater strobe, refer to the instruction manual for a special external flash or an underwater case.

**1** Turn on the dedicated strobe.

**2** Set the flash mode of the dedicated strobe to RC mode.

- When you have to set a channel and a group, select CH1 for the channel, A for the group.

**3** Highlight flash settings in live controls and select [**RC**] (remote control).

- "Using a flash (Flash photography)" (P. 45)

**4** Take a test shot to check the operation of the flash and the resulting image.

- Be sure to check the charge level of the camera and wireless flash before taking pictures.
- When the camera flash is set to [**RC**], the camera built-in flash is used for communication with the wireless flash. It cannot be used for taking pictures.
- To take pictures with a wireless flash, point the remote sensor of the special external flash toward the camera, and point the flash in the direction of the subject.

## Optional Accessories

Optional accessories can expand your photographic horizons. Before mounting accessories on the camera, remove the supplied lens ring.

LED light guide (LG-1)	An accessory for $\Delta$ (microscope mode) mode and macro photography that ensures that the macro LED light provides even lighting. <ul style="list-style-type: none"><li>• Do not use the flash.</li><li>• The LG-1 cannot be used underwater.</li></ul>
Flash diffuser (FD-1)	An accessory for $\Delta$ (microscope mode) mode and macro photography that allows the flash to be used at close ranges.
Lens barrier (LB-T01)	Protects the lens from dirt and scratches during shooting and transport. <ul style="list-style-type: none"><li>• The LB-T01 cannot be used with silicone jackets.</li></ul>
Fisheye converter (FCON-T01) *	Capture more of a scene.
Circular fisheye converter (FCON-T02) *	Switch from circular to full-frame fish-eye just by adjusting zoom.
Teleconverter (TCON-T01) *	Shoot more distant scenes.
Protective filter (PRF-D40.5 PRO) *	Protects the lens from dirt and scratches during shooting and transport.

\* Requires that a CLA-T01 converter adapter be mounted on the camera.

- When using optional accessories, select the corresponding accessory option via live controls.  "Using optional accessories (Accessory)" (P. 61)
- Rinse the product with fresh water after underwater use.
- For details, please visit the Olympus website for your local area.

## ■ Removing and attaching the lens ring

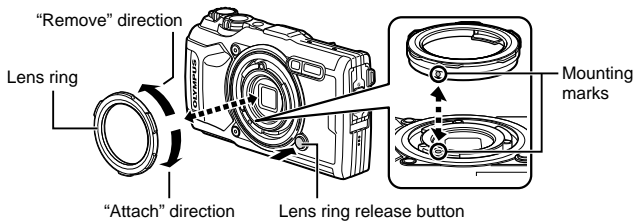

### Removing the lens ring

Keeping the lens ring release button pressed, rotate the ring in the "remove" direction.

### Attaching the lens ring

Align the mounting marks and rotate the ring in the "attach" direction until it clicks into place.

## ■ Attaching and removing LED light guides

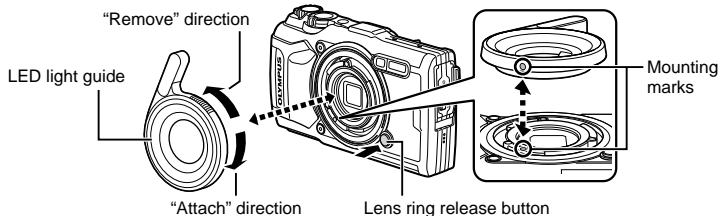

### Attaching light guides

Align the mounting marks and rotate the guide in the "attach" direction until it clicks into place.

### Removing light guides

Keeping the lens ring release button pressed, rotate the guide in the "remove" direction.

## ■ Attaching and removing flash diffusers

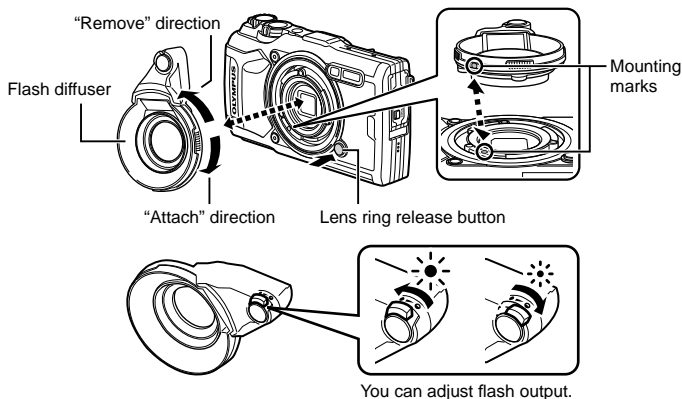

### Attaching flash diffusers

Align the mounting marks and rotate the diffuser in the “attach” direction until it clicks into place.

### Removing flash diffusers

Keeping the lens ring release button pressed, rotate the diffuser in the “remove” direction.

## ■ Attaching and removing lens barriers

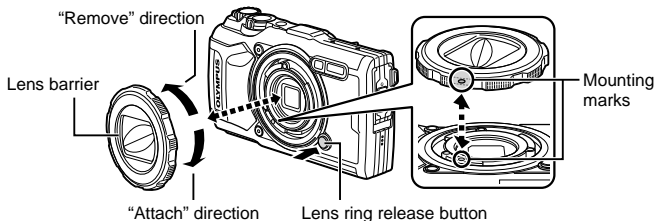

### Attaching lens barriers

Align the mounting marks and rotate the barrier in the “attach” direction until it clicks into place.

- The lens barrier mounting mark can be found on the back of the barrier.

### Removing lens barriers

Keeping the lens ring release button pressed, rotate the barrier in the “remove” direction.



## ■ Attaching and removing converter lenses and protective filters

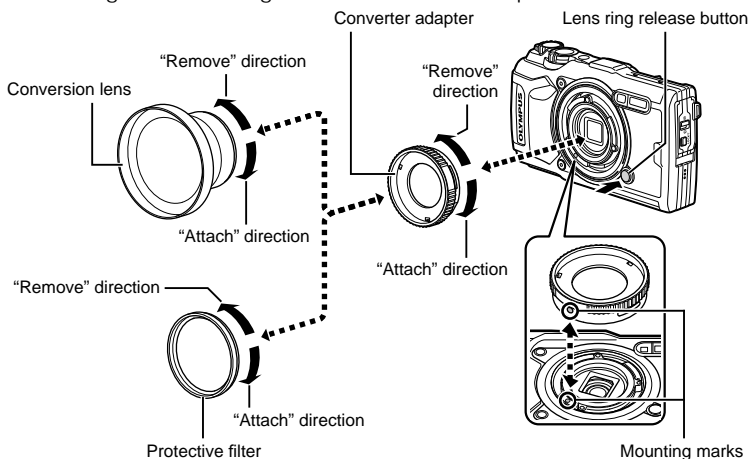

### Attaching converter lenses and filters

- 1) Attach a converter adapter.
  - Align the mounting marks and rotate the adapter in the "attach" direction until it clicks into place.
- 2) Rotate the lens or filter in the "attach" direction to screw it onto the adapter.

### Removing converter lenses and filters

- 1) Rotate the lens or filter in the "remove" direction.
- 2) Remove the converter adapter.
  - Keeping the lens ring release button pressed, rotate the adapter in the "remove" direction.

# 9 Troubleshooting

## Some Common Issues and Their Solutions

### The camera does not turn on even when a battery is loaded

#### The battery is not fully charged

- Charge the battery with the charger.

#### The battery is temporarily unable to function because of the cold

- Battery performance drops at low temperatures. Remove the battery and warm it by putting it in your pocket for a while.

### A language-selection prompt is displayed

The dialog shown in the illustration will be displayed in the following circumstances:

- The camera is turned on for the first time
- You previously ended initial setup without selecting a language

Select a language as described in "Initial Setup" (P. 18).

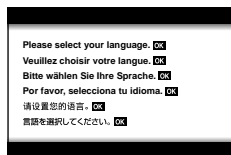

### No picture is taken when the shutter button is pressed

#### The camera has turned off automatically

- The camera automatically enters sleep mode to reduce the drain on the battery if no operations are performed for a set period of time.  [Sleep] (P. 100)  
Press the shutter button halfway to exit the sleep mode.  
The camera will turn off automatically if left in sleep mode for 5 minutes.

#### The flash is charging

- On the monitor, the  mark blinks when charging is in progress. Wait for the blinking to stop, then press the shutter button.

#### The camera temperature is elevated

- The camera may shut down if its internal temperature rises after extended use. Remove the battery and wait until the internal temperature has dropped enough for the camera to be used again. The camera may also become warm to the touch during use, but this does not indicate a malfunction.

## Unable to focus

- The camera cannot focus on subjects that are too close to the camera or that are not suited to auto focus (the AF confirmation mark will blink in the monitor). Increase the distance to the subject or focus on a high contrast object at the same distance from the camera as your main subject, compose the shot, and shoot.

### Subjects that are difficult to focus on

It may be difficult to focus with auto focus in the following situations.

AF confirmation mark is blinking. These subjects are not focused.



Subject with low contrast



Excessively bright light in center of frame

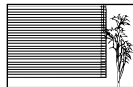

Subject containing no vertical lines\*1

AF confirmation mark lights up but the subject is not focused.



Subjects at different distances

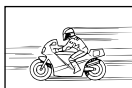

Fast-moving subject



Subject not inside AF area

\*1 It is also effective to compose the shot by holding the camera vertically to focus, and then returning to the horizontal position to take the picture.

### Noise reduction is activated

- When shooting night scenes, shutter speeds are slower and noise tends to appear in images. The camera activates the noise-reduction process after shooting at slow shutter speeds. During which, shooting is not allowed. You can set [Noise Reduct.] to [Off].  
 [Noise Reduct.] (P. 97)

## The date and time has not been set

### The camera is used with the settings at the time of purchase

- The date and time of the camera is not set when purchased. Set the date and time before using the camera.  "Initial Setup" (P. 18)

### The battery has been removed from the camera

- The date and time settings will be returned to the factory default settings if the camera is left without the battery for approximately 1 day. The settings will be canceled more quickly if the battery was only loaded in the camera for a short time before being removed. Before taking important pictures, check that the date and time settings are correct.

## Set functions are restored to their factory default settings

When you rotate the mode dial or turn off the power in a shooting mode other than **P**, **A**, or **M**, any settings you have altered will be reset to default values.

## Some settings are unavailable

Some features may be unavailable depending on the shooting mode and camera settings.

 "List of Settings Available in each Shooting Mode" (P. 136)

## Pictures are grainy



Select a larger image size or set compression to SF or F.  "Selecting image quality (Still image quality)" (P. 56)

Image "noise" mottling can sometimes be reduced by lowering ISO sensitivity.

 "Changing ISO sensitivity (ISO)" (P. 52)

## Image taken appears whitish

This may occur when the picture is taken in backlight or semi-backlight conditions. This is due to a phenomenon called flare or ghosting. As far as possible, consider a composition where strong light source is not taken in the picture. Flare may occur even when a light source is not present in the picture. If this does not have the desired effect, try shading the lens with your hand or other objects.

## The light is caught in the picture.

Shooting with flash in dark situations results in an image with many flash reflections on dust in the air.

## Unknown bright dot(s) appear on the subject in the picture taken

This may be due to stuck pixel(s) on the image pickup device. Perform [Pixel Mapping]. If the problem persists, repeat pixel mapping a few times.  "Pixel Mapping - Checking the image processing functions" (P. 122)

## The lens is cloudy or the monitor is hard to read

For rapid temperature change, lens fogging (condensation) may occur.

Turn off the power, and wait for the camera body to become acclimated to the surrounding temperature and dry out before taking pictures.









## Movies do not play back smoothly when viewed on a TV







The movie frame rate may not match the video standard used in the TV. View the movie on a computer instead. Before recording movies for display on a TV, select a frame rate that matches the video standard used in the device.  [Video Frame Rate] (P. 87)



## The heading is not correct

The compass does not function as expected in the vicinity of strong electromagnetic fields, such as from televisions, microwaves, large electric motors, radio transmitters, and high-voltage power lines. Normal function can sometimes be restored by moving the camera in a figure eight while rotating your wrist.

## Warnings (error codes) are displayed in the monitor

Monitor indication	Possible cause	Corrective action
 No Card	The card is not inserted, or it cannot be recognized.	Insert a card or insert a different card.
 Card Error	There is a problem with the card.	Insert the card again. If the problem persists, format the card. If the card cannot be formatted, it cannot be used.
 Write Protect	Writing to the card is prohibited.	The card write-protect switch is set to the "LOCK" side. Release the switch. (P. 15)
 Card Full	The card is full. No more pictures can be taken or no more information such as print reservation can be recorded.	Replace the card or erase unwanted pictures. Before erasing, download important images to a PC.
	There is no space in the card and print reservation or new images cannot be recorded.	
 No Picture	There are no pictures on the card.	The card contains no pictures. Record pictures and play back.
 Picture Error	The selected picture cannot be displayed for playback due to a problem with this picture. Or the picture cannot be used for playback on this camera.	Use image processing software to view the picture on a PC. If that cannot be done, the image file is damaged.
 The Image Cannot Be Edited	Pictures taken with another camera cannot be edited on this camera.	Use image processing software to edit the picture.
 Y/M/D	The clock is not set.	Set the clock (P. 18).

Monitor indication	Possible cause	Corrective action
		Turn off the camera and wait for the internal temperature to cool.
 Internal camera temperature is too high. Please wait for cooling before camera use.	The internal temperature of the camera has risen due to sequential shooting.	Wait a moment for the camera to turn off automatically. Allow the internal temperature of the camera to cool before resuming operations.
 Battery Empty	The battery is drained.	Charge the battery.
 No Connection	The camera is not correctly connected to a computer, HDMI display, or other device.	Reconnect the camera.
 Logging function cannot be used at this time.	The area of camera memory used for temporary storage of the log file is full.	Insert a card or confirm that the current card is correctly inserted and transfer to log file to the card.
	The battery is exhausted.	Charge the battery.
	The camera is connected to a television or other device via an HDMI cable.	Disconnect the HDMI cable.
	Wireless data transfer is in progress.	End transfer.
	The USB-AC adapter is being used to supply power to the camera from an electrical outlet while the battery is removed.	Insert the battery and unplug the USB-AC adapter from the outlet.
 Card log capacity is full. Cannot record new log files.	The current log cannot be saved to the card. • Each card can store up to 199 log files.	Copy log files to a computer and delete them from the card.

Monitor indication	Possible cause	Corrective action
 (blinks)	The current log has not been saved to the card.	Insert the card correctly and save the log to the card.
	The current log cannot be saved to the card. <ul style="list-style-type: none"> <li>Each card can store up to 199 log files.</li> </ul>	Copy log files to a computer and delete them from the card.
	There is a problem with the card.	Insert a new card.
	Writing to the card is prohibited.	The card write-protect switch is set to the "LOCK" side. Release the switch. (P. 15)
	There is no space in the card and print reservation or new images cannot be recorded.	Replace the card or erase unwanted pictures. Before erasing, download important images to a PC.
 (steady)	The area of camera memory used for temporary storage of the log file is full.	Insert a card or confirm that the current card is correctly inserted and transfer to log file to the card.
	The battery is exhausted.	Charge the battery.
	The camera is connected to a television or other device via an HDMI cable.	Disconnect the HDMI cable.
	Wireless data transfer is in progress.	End transfer.
	The USB-AC adapter is being used to supply power to the camera from an electrical outlet while the battery is removed.	Insert the battery and unplug the USB-AC adapter from the outlet.
The clock is not set.	Set the clock and select a time zone.	
 (red)	GPS malfunction.	Turn the camera off and then on again; if the message does not clear from the display, contact an OLYMPUS service representative.





## List of Settings Available in each Shooting Mode

■       mode

		P	A				
						FOCUS BKT	
Exposure compensation	—	✓	✓	✓	✓	✓	✓
Picture mode	—	✓	✓	*1	*1	*1	*1
ISO	—	✓	✓	✓	✓	✓	✓
White balance	—	✓	✓	✓	✓	✓	✓
AF mode	—	✓	✓	*1	*1	*1	*1
Aspect ratio	✓	✓	✓	✓	✓	✓	—
 Still image quality	✓	✓	✓	✓	*1	✓	✓
 Movie quality	✓	✓	✓	✓	✓	✓	✓
 Image stabilizer	—	✓	✓	✓	✓	✓	✓
 Image stabilizer	—	—	—	—	—	—	—
Flash	*1	✓	✓	*1	*1	*1	*1
Flash compensation	—	✓	✓	✓	✓	✓	✓
Sequential shooting/Self-timer	*1	✓	✓	✓	*1	*1	✓
Metering mode	—	✓	✓	✓	✓	✓	✓
Face priority	—	✓	✓	—	—	—	—
Accessory	*1	✓	✓	*1	*1	*1	*1
Reset/Assign Custom Modes	✓	✓	✓	✓	✓	✓	✓
AF Area	✓	✓	✓	—	—	—	—
Intrvl. Sh./Time Lapse	—	✓	✓	✓	—	—	✓
Focus BKT	—	✓	✓	—	—	✓	—
Focus Stacking Settings	✓	✓	✓	✓	✓	✓	✓
Date Stamp	✓	✓	✓	✓	—	—	✓
Movie 	✓	✓	✓	✓	✓	✓	✓
Recording Volume	✓	✓	✓	✓	✓	✓	✓
Video Frame Rate	✓	✓	✓	✓	✓	✓	✓
Video Bit Rate	✓	✓	✓	✓	✓	✓	✓

\*1 Some functions cannot be set.



						
						
Exposure compensation	✓	✓	✓	✓	✓	✓
Picture mode	—	—	—	—	—	*1
ISO	—	—	—	—	—	—
White balance	✓	✓	✓	✓	✓	✓
AF mode	*1	*1	*1	*1	*1	✓
Aspect ratio	✓	✓	✓	✓	✓	—
 Still image quality	✓	✓	✓	✓	*1	✓
 Movie quality	✓	✓	✓	✓	✓	✓
 Image stabilizer	✓	✓	✓	✓	✓	—
 Image stabilizer	—	—	—	—	—	*1
Flash	*1	*1	*1	*1	—	—
Flash compensation	✓	✓	✓	✓	—	—
Sequential shooting/Self-timer	*1	*1	*1	*1	—	*1
Metering mode	—	—	—	—	—	—
Face priority	—	—	—	—	—	*1
Accessory	*1	*1	*1	*1	*1	*1
Reset/Assign Custom Modes	✓	✓	✓	✓	✓	*1
AF Area	✓	✓	✓	—	✓	✓
Intrvl. Sh./Time Lapse	—	—	—	—	—	—
Focus BKT	—	—	—	—	—	—
Focus Stacking Settings	✓	✓	✓	✓	✓	✓
Date Stamp	✓	✓	✓	✓	—	—
Movie 	✓	✓	✓	✓	✓	*1
Recording Volume	✓	✓	✓	✓	✓	*1
Video Frame Rate	✓	✓	✓	✓	✓	*1
Video Bit Rate	✓	✓	✓	✓	✓	*1

\*1 Some functions cannot be set.

■ SCN mode

Exposure compensation	—	✓	—	—	—	—	—	—
Picture mode	—	—	—	—	—	—	—	—
ISO	—	—	—	—	—	—	—	—
White balance	—	—	—	—	—	—	—	—
AF mode	—	—	—	—	—	—	—	—
Aspect ratio	✓	✓	✓	✓	✓	✓	✓	✓
Still image quality	✓	*1	✓	✓	✓	✓	*1	✓
Movie quality	✓	✓	✓	✓	✓	✓	✓	✓
Image stabilizer	✓	✓	✓	✓	✓	✓	✓	✓
Image stabilizer	—	—	—	—	—	—	—	—
Flash	*1	*1	*1	*1	*1	—	—	—
Flash compensation	—	—	—	—	—	—	—	—
Sequential shooting/Self-timer	*1	*1	*1	*1	*1	*1	—	*1
Metering mode	—	—	—	—	—	—	—	—
Face priority	—	—	—	—	—	—	—	—
Accessory	*1	*1	*1	*1	*1	*1	*1	*1
Reset/Assign Custom Modes	✓	✓	✓	✓	✓	✓	✓	✓
AF Area	✓	✓	✓	✓	✓	✓	✓	✓
Intrvl. Sh./Time Lapse	—	—	—	—	—	—	—	—
Focus BKT	—	—	—	—	—	—	—	—
Focus Stacking Settings	✓	✓	✓	✓	✓	✓	✓	✓
Date Stamp	✓	—	✓	✓	✓	✓	—	✓
Movie	✓	—	✓	✓	✓	✓	—	✓
Recording Volume	✓	—	✓	✓	✓	✓	—	✓
Video Frame Rate	✓	✓	✓	✓	✓	✓	✓	✓
Video Bit Rate	✓	✓	✓	✓	✓	✓	✓	✓

\*1 Some functions cannot be set.

Exposure compensation	—	—	—	—	—	✓	—	—
Picture mode	—	—	—	—	—	—	—	—
ISO	—	—	—	—	—	—	—	—
White balance	—	—	—	—	—	✓	—	—
AF mode	—	—	—	—	—	—	—	—
Aspect ratio	✓	✓	✓	✓	✓	—	✓	✓
Still image quality	✓	✓	✓	✓	✓	—	*1	✓
Movie quality	✓	✓	✓	✓	✓	✓	✓	✓
Image stabilizer	—	✓	✓	✓	✓	✓	✓	✓
Image stabilizer	—	—	—	—	—	—	—	—
Flash	—	*1	*1	—	*1	—	—	—
Flash compensation	—	—	—	—	—	—	—	—
Sequential shooting/Self-timer	—	*1	*1	*1	*1	—	—	*1
Metering mode	—	—	—	—	—	—	—	—
Face priority	—	—	—	—	—	—	—	—
Accessory	*1	*1	*1	*1	*1	*1	*1	*1
Reset/Assign Custom Modes	✓	✓	✓	✓	✓	✓	✓	✓
AF Area	✓	✓	✓	✓	✓	*1	✓	✓
Intrvl. Sh./Time Lapse	—	—	—	—	—	—	—	—
Focus BKT	—	—	—	—	—	—	—	—
Focus Stacking Settings	✓	✓	✓	✓	✓	✓	✓	✓
Date Stamp	—	✓	✓	✓	✓	—	—	✓
Movie	—	✓	✓	✓	✓	—	—	✓
Recording Volume	—	✓	✓	✓	✓	—	—	✓
Video Frame Rate	✓	✓	✓	✓	✓	✓	✓	✓
Video Bit Rate	✓	✓	✓	✓	✓	✓	✓	✓

\*1 Some functions cannot be set.

## Default/Custom Settings

\*1: Items that can be stored in [Custom Mode C1] or [Custom Mode C2].

\*2: Default can be restored by selecting [Full] for [Reset].

\*3: Default can be restored by selecting [Basic] for [Reset].

### Direct buttons

Function	Default	*1	*2	*3		
Exposure compensation	±0.0	✓	✓	✓	35, 36, 41	
Flash	(Δ mode); ; ; (🐟 mode)		✓	✓	✓	45
	; ; (Δ mode)		✓	✓	✓	
	Other modes	AUTO	✓	✓	✓	
Sequential shooting/Self-timer	<input type="checkbox"/>	✓	✓	✓	42	

### Live Control

Function	Default	*1	*2	*3		
Picture mode	Natural	✓	✓	✓	50	
ISO	AUTO	✓	✓	✓	52	
White balance	AUTO	✓	✓	✓	53	
AF mode	AF	✓	✓	✓	55	
Aspect ratio	4:3	✓	✓	✓	55	
Still image quality	L/N	✓	✓	✓	56	
Movie quality	1920x1080 Fine 30p	✓	✓	✓	57	
Image stabilizer	ON	✓	✓	✓	59	
Image stabilizer	ON	✓	✓	✓	59	
Flash	(Δ mode); ; ; (🐟 mode)		✓	✓	✓	45
	; ; (Δ mode)		✓	✓	✓	
	Other modes	AUTO	✓	✓	✓	
Flash compensation	±0.0	✓	✓	✓	45	
Sequential shooting/Self-timer	<input type="checkbox"/>	✓	✓	✓	42	
Metering mode		✓	✓	✓	60	
Face priority	OFF	✓	✓	✓	60	
Accessory	OFF	✓	✓	✓	61	

## 📷 Shooting Menu

Tab	Function	Default	*1	*2	*3	👉	
📷 1	Reset/Assign Custom Modes	Reset	Basic	—	—	—	80
		Custom Mode C1	—	—	—	—	81
		Custom Mode C2	—	—	—	—	
	Picture Mode	Natural	✓	✓	—	81	
	AF Area	[ ■ ]	✓	✓	✓	82	
📷 2	Intrvl. Sh./Time Lapse	Off	—	✓	✓	84	
	Number of Frames	99	—	✓	✓		
	Start Waiting Time	00:00:01	—	✓	✓		
	Interval Length	00:00:01	—	✓	✓		
	Time Lapse Movie	Off	—	✓	✓		
	Movie Settings	Movie Resolution	FullHD	—	✓		✓
		Frame Rate	10fps	—	✓	✓	
	Focus BKT	Off	✓	✓	✓	85	
	Start Waiting Time	0 sec	✓	✓	✓		
	Set number of shots	30	✓	✓	✓		
	Set focus differential	Normal	✓	✓	✓		
	Focus Stacking Settings	Start Waiting Time	0 sec	✓	✓	✓	86
		Set number of shots	8	✓	✓	✓	
	Date Stamp	Off	✓	✓	✓	86	

## 📷 Video Menu

Tab	Function	Default	*1	*2	*3	👉
📷 3	Movie 🎤	On	—	✓	—	87
	Recording Volume	±0	—	✓	—	87
	Video Frame Rate	30p	—	✓	—	57, 87
	Video Bit Rate	Fine	—	✓	—	57, 87

## ▶ Playback Menu





Tab	Function		Default	*1	*2	*3	☞	
▶	▶	Start	—	—	—	—	73	
		BGM	Party Time	—	✓	✓		
		Slide	All	—	✓	✓		
		Slide Interval	3 sec	—	✓	—		
		Movie Interval	Short	—	✓	—		
	📁		On	—	✓	✓	88	
	Edit	Sel. Image	RAW Data Edit	—	✓	✓	✓	88
			JPEG Edit	—	—	—	—	88
			Movie Edit	—	—	—	—	92, 93
		🎤		—	—	—	—	91
		Image Overlay	—	—	—	—	91	
		Print Order	—	—	—	—	75	
		Reset Protect	—	—	—	—	93	
		Connection to Smartphone	—	—	✓	—	107	

## ⚙ Custom Menu

Tab	Function		Default	*1	*2	*3	☞	
⚙	AF/MF							
	A	AF Illuminator	Off	✓	✓	✓	96, 101	
		MF Assist	Magnify	Off	✓	✓	—	96, 101
			Peaking	Off	✓	✓	—	
	Disp/☞/PC							
	B	▶/Info Settings	▶ Info	Image Only, Overall	✓	✓	✓	96, 102
			LV-Info	Custom1 (📊), Custom2 (Level Gauge)	✓	✓	✓	
			☑ Settings	25, Calendar	✓	✓	—	
			Live View Boost	Off	✓	✓	✓	96
			Flicker Reduction	Auto	✓	✓	—	96
			Displayed Grid	Off	✓	✓	—	96
			Peaking Color	White	✓	✓	—	96, 101
			☞/))	3	✓	✓	✓	97
		HDMI	Output Size	1080p	—	✓	—	97, 104
HDMI Control			Off	—	✓	—		

Tab	Function	Default	*1	*2	*3			
	Exp/ISO							
	<b>C</b>	Exposure Shift	±0	✓	✓	—	97	
		ISO-Auto Set	Upper Limit / Default	Upper Limit 1600 Default 100	✓	✓	✓	97
	Lowest S/S Setting		Auto	✓	✓	✓		
	Noise Filter		Standard	✓	✓	✓	97	
	Noise Reduct.		Auto	✓	✓	✓	97	
	Custom							
	<b>D</b>		Off	✓	✓	✓	41, 59, 98	
		+WB	<sup>WB</sup> AUTO	✓	✓	—	98	
	/WB/Color							
	<b>E</b>	Set	-1 <b>F</b> , -2 <b>N</b> , -3 <b>M</b> , -4 <b>S</b>	✓	✓	✓	98, 105	
		WB	Auto   A±0, G±0	✓	✓	—	53, 98	
		<sup>WB</sup> AUTO Keep Warm Color	On	✓	✓	✓	98	
		Color Space	sRGB	✓	✓	✓	98	
	Record							
	<b>F</b>	File Name	Reset	—	✓	—	99	
		Edit Filename	—	—	✓	—	99	
		Copyright Settings	Copyright Info.	Off	—	✓	—	99
			Artist Name	—	—	—	—	
	Copyright Name	—	—	—	—	—		
Field Sensor								
<b>G</b>	Record GPS location	Off	—	✓	—	100		
	GPS Priority	GPS accuracy	—	✓	✓	100		
	Elevation/ Temperature	Calibrate Elevation	—	—	✓	—	100	
		m/ft	m	—	✓	—		
°C/°F	°C	—	✓	—	—			
Utility								
<b>H</b>	Pixel Mapping	—	—	—	—	100, 122		
	Level Adjust	—	—	✓	—	100		
	Sleep	1 min	—	✓	✓	17, 100		
	Certification	—	—	—	—	100		



## ⌵ Setup Menu

Tab	Function	Default	*1	*2	*3		
⌵	Card Setup	—	—	—	—	21, 95	
	 Settings	—	—	—	—	19	
		English	—	—	—	95	
		±0	—	✓	—	94	
	Rec View	0.5 sec	✓	✓	—	94	
	Wi-Fi Settings	Wi-Fi Connect Settings	Private	—	✓	—	109
		Private Password	—	—	—	—	110
		Reset share Order	—	—	—	—	110
		Reset Wi-Fi Settings	—	—	—	—	109



## Specifications

### ■ Camera

<b>Product type</b>	
	Digital camera (for shooting and displaying)
<b>Recording system</b>	
Still pictures	Digital recording, JPEG (in accordance with Design rule for Camera File system (DCF))
Applicable standards	Exif 2.3, Digital Print Order Format (DPOF)
Sound with still pictures	Wave format
Movie	MOV H.264 linear PCM (HS120fps or HS240fps for time lapse movie)
<b>Memory</b>	
	SD/SDHC/SDXC (supports UHS-I)
<b>Total no. of pixels</b>	
	Approx. 12.71 million
<b>No. of effective pixels</b>	
	12 million
<b>Image pickup device</b>	
	1/2.3" CMOS (primary color filter)
<b>Lens</b>	
	Olympus lens 4.5 mm to 18.0 mm, f2.0 to f4.9 (Equivalent to 25 mm to 100 mm on a 35 mm film)
<b>Photometric system</b>	
	Digital ESP metering, spot metering system
<b>Shutter speed</b>	
	1/2–1/2000 sec. (slowest shutter speed available increases to 4 sec. in <b>A</b> mode or when  is selected in SCN mode and to 15 sec. when  is selected in SCN mode)
<b>Shooting range</b>	
Normal	0.1 m (0.3 ft.) to ∞ (W/T)
Super macro	0.01 m (0.03 ft.) to 0.3 m (1.0 ft.) (f=5.4 mm to 18.0 mm)
Microscope mode	0.01 m (0.03 ft.) to 0.3 m (1.0 ft.) (f=5.4 mm to 18.0 mm)
<b>Monitor</b>	
	3.0" TFT color LCD display, Approx. 1.04 million dots
<b>Connector</b>	
	Micro-USB connector/HDMI micro connector (type D)
<b>Automatic calendar system</b>	
	2000 up to 2099

<b>Water resistance</b>	
Type	IEC 60529 IPX8 (under OLYMPUS test conditions), available in 15 m (49.2 ft.) deep water
Meaning	Camera can normally be used under water at a specified water pressure.
<b>Dust resistance</b>	
	IEC 60529 IP6X
<b>Wi-Fi standard</b>	
	IEEE802.11b/g/n
<b>GPS</b>	
Reception frequency	1575.42 MHz (GPS/ Quasi-Zenith Satellites System) 1598.0625 MHz to 1605.3750 MHz (GLONASS)
Geodetic system	WGS84
<b>Operating environment</b>	
Temperature	-10 °C to 40 °C (14 °F to 104 °F) (operation)/ -20 °C to 60 °C (-4 °F to 140 °F) (storage)
Humidity	30% – 90% (operation)/10% – 90% (storage)
<b>Power supply</b>	
	One Olympus lithium ion battery (LI-92B) or USB-AC adapter (F-5AC)
<b>Dimensions</b>	
	113.0 mm (W) × 66.0 mm (H) × 32.4 mm (D) (4.5 × 2.6 × 1.3 in.) (excluding protrusions)
<b>Weight</b>	
	253 g (8.9 oz) (including battery and card)

■ Lithium ion battery (LI-92B)

<b>Product type</b>	
	Lithium ion rechargeable battery
<b>Model No.</b>	
	LI-92B
<b>Standard voltage</b>	
	DC 3.6 V
<b>Standard capacity</b>	
	1350 mAh
<b>Battery life</b>	
	Approx. 300 full charges (varies on usage)
<b>Operating environment</b>	
Temperature	0 °C to 40 °C (32 °F to 104 °F) (charging)

■ USB-AC adapter (F-5AC)

<b>Model No.</b>	
	F-5AC-1/F-5AC-2
<b>Power requirements</b>	
	AC 100 to 240 V (50/60 Hz)
<b>Output</b>	
	DC 5 V, 1500 mA
<b>Operating environment</b>	
Temperature	0 °C to 40 °C (32 °F to 104 °F) (operation)/ -20 °C to 60 °C (-4 °F to 140 °F) (storage)

- SPECIFICATIONS ARE SUBJECT TO CHANGE WITHOUT ANY NOTICE OR OBLIGATION ON THE PART OF THE MANUFACTURER.
- Visit our website for the latest specifications.

The terms HDMI and HDMI High-Definition Multimedia Interface, and the HDMI Logo are trademarks or registered trademarks of HDMI Licensing Administrator, Inc. in the United States and other countries.



## SAFETY PRECAUTIONS



## CAUTION

RISK OF ELECTRIC SHOCK  
DO NOT OPEN



CAUTION: TO REDUCE THE RISK OF ELECTRICAL SHOCK,  
DO NOT REMOVE COVER (OR BACK).  
NO USER-SERVICEABLE PARTS INSIDE.  
REFER SERVICING TO QUALIFIED OLYMPUS SERVICE PERSONNEL.



An exclamation mark enclosed in a triangle alerts you to important operating and maintenance instructions in the documentation provided with the product.



## WARNING

If the product is used without observing the information given under this symbol, serious injury or death may result.



## CAUTION

If the product is used without observing the information given under this symbol, injury may result.



## NOTICE

If the product is used without observing the information given under this symbol, damage to the equipment may result.

## WARNING!

TO AVOID THE RISK OF FIRE OR ELECTRICAL SHOCK, NEVER DISASSEMBLE THIS PRODUCT.

## General Precautions

**Read All Instructions** — Before you use the product, read all operating instructions. Store all manuals and documentation for future reference.

**Water and Moisture** — For precautions on products with weatherproof designs, read the weatherproofing sections.

**Power Source** — Connect this product only to the power source described on the product label.

**Foreign Objects** — To avoid personal injury, never insert a metal object into the product.

**Cleaning** — Always unplug this product from the wall outlet before cleaning. Use only a damp cloth for cleaning. Never use any type of liquid or aerosol cleaner, or any type of organic solvent to clean this product.

**Heat** — Never use or store this product near any heat source such as a radiator, heat register, stove, or any type of equipment or appliance that generates heat, including stereo amplifiers.

**Lightning** — If a lightning storm occurs while using a USB-AC adapter, remove it from the wall outlet immediately.

**Attachments** — For your safety, and to avoid damaging the product, use only accessories recommended by Olympus.

**Location** — To avoid damage to the product, mount the product securely on a stable tripod, stand, or bracket.

## WARNING

- **Do not use the camera near flammable or explosive gases.**
- **Do not use the flash and LED (including AF illuminator) on people (infants, small children, etc.) at close range.**
  - You must be at least 1 m (3 ft.) away from the faces of your subjects. Firing the flash too close to the subject's eyes could cause a momentary loss of vision.
- **Do not look at the sun or strong lights with the camera.**
- **Keep young children and infants away from the camera.**
  - Always use and store the camera out of the reach of young children and infants to prevent the following dangerous situations which could cause serious injury:
    - Becoming entangled in the camera strap, causing strangulation.
    - Accidentally swallowing the battery, cards or other small parts.
    - Accidentally firing the flash into their own eyes or those of another child.
    - Accidentally being injured by the moving parts of the camera.
- **If you find that the USB-AC adapter is extremely hot or notice any unusual odors, noise, or smoke around it, unplug the power plug from wall outlet immediately and stop using it. Then, contact an authorized distributor or service center.**
- **Stop using the camera immediately if you notice any unusual odors, noise, or smoke around it.**
  - Never remove the batteries with bare hands, which may cause a fire or burn your hands.
- **Do not leave the camera in places where it may be subject to extremely high temperatures.**
  - Doing so may cause parts to deteriorate and, in some circumstances, cause the camera to catch fire. Do not use the charger or USB-AC adapter if it is covered (such as a blanket). This could cause overheating, resulting in fire.
- **Handle the camera with care to avoid getting a low-temperature burn.**
  - When the camera contains metal parts, overheating can result in a low-temperature burn. Pay attention to the following:
    - When used for a long period, the camera will get hot. If you hold on to the camera in this state, a low-temperature burn may be caused.
    - In places subject to extremely cold temperatures, the temperature of the camera's body may be lower than the environmental temperature. If possible, wear gloves when handling the camera in cold temperatures.
- To protect the high-precision technology contained in this product, never leave the camera in the places listed below, no matter if in use or storage:
  - Places where temperatures and/or humidity are high or go through extreme changes. Direct sunlight, beaches, locked cars, or near other heat sources (stove, radiator, etc.) or humidifiers.
  - In sandy or dusty environments.
  - Near flammable items or explosives.
  - In wet places, such as bathrooms or in the rain. When using products with weatherproof designs, read their manuals as well.
  - In places prone to strong vibrations.
- **The camera uses a lithium ion battery specified by Olympus.**

Charge the battery with the specified USB-AC adapter or charger. Do not use any other USB-AC adapters or chargers.
- **Never incinerate or heat batteries in microwaves, on hot plates, or in pressure vessels, etc.**
- **Never leave the camera on or near electromagnetic devices.**

This may cause overheating, burning, or exploding.
- **Do not connect terminals with any metallic objects.**
  - Take precautions when carrying or storing batteries to prevent them from coming into contact with any metal objects such as jewelry, pins, fasteners, keys, etc.

The short circuit may cause overheating, exploding, or burning, which burn or damage you.
- **To prevent causing battery leaks or damaging their terminals, carefully follow all instructions regarding the use of batteries. Never attempt to disassemble a battery or modify it in any way, solder, etc.**

- If battery fluid gets into your eyes, flush your eyes immediately with clear, cold running water and seek medical attention immediately.
- If you cannot remove the battery from the camera, contact an authorized distributor or service center.  
Do not try to remove the battery by force.  
Damage to the battery exterior (scratches, etc.) may produce heat or an explosion.
- **Always store batteries out of the reach of small children and pets. If they accidentally swallow a battery, seek medical attention immediately.**
- To prevent batteries from leaking, overheating, or causing a fire or explosion, use only batteries recommended for use with this product.
- If rechargeable batteries have not been recharged within the specified time, stop charging them and do not use them.
- Do not use batteries with scratches or damage to the casing, and do not scratch the battery.
- Never subject batteries to strong shocks or continuous vibration by dropping or hitting.  
This may cause exploding, overheating, or burning.
- If a battery leaks, has unusual odor, becomes discolored or deformed, or becomes abnormal in any other way during operation, stop using the camera, and keep away from fire immediately.
- If a battery leaks fluid onto your clothing or skin, remove the clothing and flush the affected area with clean, running cold water immediately. If the fluid burns your skin, seek medical attention immediately.
- The Olympus lithium ion battery is designed to be used only for the Olympus digital camera. Do not use the battery to other devices.
- **Do not allow children or animals/pets to handle or transport batteries (prevent dangerous behaviour such as licking, putting in mouth or chewing).**

## Use Only Dedicated Rechargeable Battery, Battery Charger and USB-AC adapter

We strongly recommend that you use only the genuine Olympus dedicated rechargeable battery, battery charger and USB-AC adapter with this camera. Using a non-genuine rechargeable battery, battery charger and/or USB-AC adapter may result in fire or personal injury due to leakage, heating, ignition or damage to the battery. Olympus does not assume any liability for accidents or damage that may result from the use of a battery, battery charger and/or USB-AC adapter that are not genuine Olympus accessories.

### CAUTION

- The included USB-AC adapter F-5AC is designed to be used only with this camera. Other cameras cannot be charged with this USB-AC adapter.
- Do not connect the included USB-AC adapter F-5AC to equipment other than this camera.
- **Never store batteries where they will be exposed to direct sunlight, or subjected to high temperatures in a hot vehicle, near a heat source, etc.**
- Keep batteries dry at all times.
- The battery may become hot during prolonged use. To avoid minor burns, do not remove it immediately after using the camera.
- This camera uses one Olympus lithium ion battery. Use the specified genuine battery.  
There is a risk of explosion if the battery is replaced with the incorrect battery type.
- Please recycle batteries to help save our planet's resources. When you throw away dead batteries, be sure to cover their terminals and always observe local laws and regulations.
- **Do not cover the flash with a hand while firing.**

## NOTICE

- **Do not use or store the camera in dusty or humid places.**
- **Use SD/SDHC/SDXC cards only. Never use other types of cards.**

If you accidentally insert another type of card into the camera, contact an authorized distributor or service center. Do not try to remove the card by force.

- Regularly back up important data to a computer or other storage device to prevent accidental loss.
- OLYMPUS accepts no liability for any loss of data associated with this device.
- Be careful with the strap when you carry the camera. It could easily catch on stray objects and cause serious damage.
- Never drop the camera or subject it to severe shocks or vibrations.
- When attaching the camera to or removing it from a tripod, rotate the tripod screw, not the camera.
- Before transporting the camera, remove a tripod and all other non-OLYMPUS accessories.
- Do not touch electric contacts on cameras.
- Do not leave the camera pointed directly at the sun. This may cause lens or shutter curtain damage, color failure, ghosting on the image pickup device, or may possibly cause fires.
- Do not push or pull severely on the lens.
- Before storing the camera for a long period, remove the batteries. Select a cool, dry location for storage to prevent condensation or mold from forming inside the camera. After storage, test the camera by turning it on and pressing the shutter button to make sure that it is operating normally.
- The camera may malfunction if it is used in a location where it is subject to a magnetic/electromagnetic field, radio waves, or high voltage, such as near a TV set, microwave, video game, loud speakers, large monitor unit, TV/radio tower, or transmission towers. In such cases, turn the camera off and on again before further operation.
- Always observe the operating environment restrictions described in the camera's manual.
- Insert the battery carefully as described in the operating instructions.
- Before loading, always inspect the battery carefully for leaks, discoloration, warping, or any other abnormality.
- Always unload the battery from the camera before storing the camera for a long period.
- When storing the battery for a long period, select a cool location for storage.
- Power consumption by the camera varies depending on which functions are used.
- During the conditions described below, power is consumed continuously and the battery becomes exhausted quickly.
  - The zoom is used repeatedly.
  - The shutter button is pressed halfway repeatedly in shooting mode, activating the auto focus.
  - A picture is displayed on the monitor for an extended period of time.
  - GPS is used.
- Using an exhausted battery may cause the camera to turn off without displaying the battery level warning.
- If the battery's terminals get wet or greasy, camera contact failure may result. Wipe the battery well with a dry cloth before use.
- Always charge a battery when using it for the first time, or if it has not been used for a long period.
- When operating the camera with battery power at low temperatures, try to keep the camera and spare battery as warm as possible. A battery that has run down at low temperatures may be restored after it is warmed at room temperature.
- Before going on a long trip, and especially before traveling abroad, purchase extra batteries. A recommended battery may be difficult to obtain while traveling.
- For plug-in type USB-AC adapter:
  - Connect the plug-in type USB-AC adapter F-5AC correctly by plugging it vertically into the wall outlet.

## Using the wireless LAN function

- **Turn off the camera in hospitals and other locations where medical equipment is present.**

The radio waves from the camera may adversely affect medical equipment, causing a malfunction that results in an accident.

- **Turn off the camera when onboard aircraft.**

Using wireless devices onboard may hinder safe operation of the aircraft.

## Precautions when using the wireless LAN function

If using the wireless LAN function in a country outside the region where the camera was purchased, there is a risk that the camera will not conform to the wireless communication regulations of that country. Olympus will not be held responsible for any failure to meet such regulations.

## GPS function, electronic compass

- In a location not open to the sky (inside, underground, underwater, in a forest, near high buildings) or in a location subject to strong magnetic or electric fields (near new high-voltage power lines, magnets or electrical goods, 1.5GHz mobile telephones), it may not be possible to determine measurements or generate errors.
- The altitude displayed on the measurement information screen or picture playback screen etc. is displayed/recorded based on information from pressure sensors built into camera body. Be careful since the displayed altitude is not based on GPS position measurements.
- Electronic compass errors may be caused by the effects of strong magnetic or electrical fields (such as televisions, microwaves, large motors, radio towers and high-voltage lines). To restore the electronic compass function, hold the camera firmly and move in a figure of 8 while turning your wrist over.
- Since the GPS function and electronic compass function are not required to be accurate, there is no guarantee that the measured values (latitude, longitude, compass direction etc.) are accurate.

## Monitor

- Do not push the monitor forcibly; otherwise the image may become vague, resulting in a playback mode failure or damage to the monitor.
- A strip of light may appear on the top/bottom of the monitor, but this is not a malfunction.
- When a subject is viewed diagonally in the camera, the edges may appear zigzagged on the monitor. This is not a malfunction; it will be less noticeable in playback mode.
- In places subject to low temperatures, the monitor may take a long time to turn on or its color may change temporarily. When using the camera in extremely cold places, it is a good idea to occasionally place it in a warm place. The monitor exhibiting poor performance due to low temperatures will recover in normal temperatures.
- The monitor of this product is manufactured with high-quality accuracy, however, there may be a stuck or dead pixel on the monitor. These pixels do not have any influence on the image to be saved. Because of the characteristics, the unevenness of the color or brightness may also be found depending on the angle, but this is due to the structure of the monitor. This is not a malfunction.

## Legal and Other Notices

- Olympus makes no representations or warranties regarding any damages, or benefit expected by using this unit lawfully, or any request from a third person, which are caused by the inappropriate use of this product.
- Olympus makes no representations or warranties regarding any damages or any benefit expected by using this unit lawfully which are caused by erasing picture data.

## Disclaimer of Warranty

- Olympus makes no representations or warranties, either expressed or implied, by or concerning any content of these written materials or software, and in no event shall be liable for any implied warranty of merchantability or fitness for any particular purpose or for any consequential, incidental or indirect damages (including but not limited to damages for loss of business profits, business interruption and loss of business information) arising from the use or inability to use these written materials or software or equipment. Some countries do not allow the exclusion or limitation of liability for consequential or incidental damages or of the implied warranty, so the above limitations may not apply to you.
- Olympus reserves all rights to this manual.



## Warning

Unauthorized photographing or use of copyrighted material may violate applicable copyright laws. Olympus assumes no responsibility for unauthorized photographing, use or other acts that infringe upon the rights of copyright owners.

## Copyright Notice

All rights reserved. No part of these written materials or this software may be reproduced or used in any form or by any means, electronic or mechanical, including photocopying and recording or the use of any type of information storage and retrieval system, without the prior written permission of Olympus. No liability is assumed with respect to the use of the information contained in these written materials or software, or for damages resulting from the use of the information contained therein. Olympus reserves the right to alter the features and contents of this publication or software without obligation or advance notice.

## FCC Notice

This equipment has been tested and found to comply with the limits for a Class B digital device, pursuant to part 15 of the FCC Rules. These limits are designed to provide reasonable protection against harmful interference in a residential installation. This equipment generates, uses and can radiate radio frequency energy and, if not installed and used in accordance with the instructions, may cause harmful interference to radio communications. However, there is no guarantee that interference will not occur in a particular installation. If this equipment does cause harmful interference to radio or television reception, which can be determined by turning the equipment off and on, the user is encouraged to try to correct the interference by one or more of the following measures:

- Reorient or relocate the receiving antenna.
- Increase the separation between the equipment and receiver.
- Connect the equipment into an outlet on a circuit different from that to which the receiver is connected.
- Consult the dealer or an experienced radio/TV technician for help.
- Only the OLYMPUS-supplied USB cable should be used to connect the camera to USB enabled personal computers.

## FCC/ISED Caution

Changes or modifications not expressly approved by the party responsible for compliance could void the user's authority to operate the equipment.

This transmitter must not be co-located or operated in conjunction with any other antenna or transmitter.

This equipment complies with FCC radiation exposure limits set forth for an uncontrolled environment and meets the FCC radio frequency (RF) Exposure Guidelines as this equipment has very low levels of RF energy. The available scientific evidence does not show that any health problems are associated with using low power wireless devices. There is no proof, however, that these low power wireless devices are absolutely safe. Low power Wireless devices emit low levels of radio frequency energy (RF) in the microwave range while being used. Whereas high levels of RF can produce health effects (by heating tissue), exposure of low-level RF that does not produce heating effects causes no known adverse health effects. Many studies of low-level RF exposures have not found any biological effects. Some studies have suggested that some biological effects might occur, but such findings have not been confirmed by additional research. IM015 has been tested and found to comply with ISED radiation exposure limits set forth for an uncontrolled environment and meets RSS-102 of the ISED radio frequency (RF) Exposure rules.

## For customers in North America, Central America, South America and the Caribbean

### Declaration of Conformity

Model Number : IM015

Trade Name : OLYMPUS

Responsible Party : **OLYMPUS AMERICA INC.**

Address : 3500 Corporate Parkway, P.O. Box 610, Center Valley, PA 18034-0610, U.S.A.

Telephone Number : 484-896-5000

Tested To Comply With FCC Standards

FOR HOME OR OFFICE USE

This device complies with part 15 of FCC Rules and Innovation, Science and Economic Development Canada's licence-exempt RSS(s). Operation is subject to the following two conditions: (1) this device may not cause harmful interference, and (2) this device must accept any interference received, including interference that may cause undesired operation.

This Class B digital apparatus complies with Canadian ICES-003. CAN ICES-3(B)/NMB-3(B)

### OLYMPUS AMERICAS LIMITED WARRANTY - OLYMPUS AMERICA INC. PRODUCTS

Olympus warrants that the enclosed Olympus® imaging product(s) and related Olympus® accessories (individually a "Product" and collectively the "Products") will be free from defects in materials and workmanship under normal use and service for a period of one (1) year from the date of purchase.

If any Product proves to be defective within the one-year warranty period, the customer must return the defective Product to the authorized Olympus Repair Service Center designated by Olympus, following the procedure set forth below (See "WHAT TO DO WHEN SERVICE IS NEEDED").

Olympus, at its sole discretion, will repair, replace, or adjust the defective Product at Olympus's cost, provided that an Olympus investigation and factory inspection disclose that (a) such defect developed under normal and proper use and (b) the Product is covered under this limited warranty.

Repair, replacement, or adjustment of defective Products shall be Olympus's sole obligation and the customer's sole remedy hereunder.

Repair or replacement of a Product shall not extend the warranty period provided herein, unless required by law. Except where prohibited by law, the customer is liable and shall pay for shipment of the Products to the designated Olympus Repair Service Center.

Olympus shall not be obligated to perform preventive maintenance, installation, deinstallation, or maintenance.

Olympus reserves the right to (i) use reconditioned, refurbished, and/or serviceable used parts (that meet Olympus's quality assurance standards) for warranty or any other repairs and (ii) make any internal or external design and/or feature changes on or to its products without any liability to incorporate such changes on or to the Products.

### WHAT IS NOT COVERED BY THIS LIMITED WARRANTY

Excluded from this limited warranty and not warranted by Olympus in any fashion, either express, implied, or by statute, are:

- products and accessories not manufactured by Olympus and/or not bearing the "OLYMPUS" brand label (the warranty coverage for products and accessories of other manufacturers, which may be distributed by Olympus, is the responsibility of the respective manufacturer of such products and accessories in accordance with the terms and duration of such manufacturers' warranties);
- any Product which has been disassembled, repaired, tampered with, altered, changed, or modified by persons other than Olympus's own authorized service personnel unless repair by others is made with the written consent of Olympus;
- defects or damage to the Products resulting from wear, tear, misuse, abuse, negligence, sand, liquids, impact, improper storage, nonperformance of scheduled operator and maintenance items, battery leakage, use of non-"OLYMPUS" brand accessories, consumables, or supplies, or use of the Products in combination with non-compatible devices;
- software programs;
- supplies and consumables (including but not limited to lamps, ink, paper, film, prints, negatives, cables and batteries); and/or
- Products which do not contain a validly placed and recorded Olympus serial number, unless they are a model on which Olympus does not place and record serial numbers.

- (g) Products shipped, delivered, purchased, or sold from dealers located outside of North America, Central America, South America and the Caribbean; and/or
- (h) Products that are not intended or authorized to be sold in North America, South America, Central America, or the Caribbean (ie. Gray Market Goods).

**WARRANTY DISCLAIMER; LIMITATION OF DAMAGES; AFFIRMATION OF ENTIRE WARRANTY AGREEMENT; INTENDED BENEFICIARY**

EXCEPT FOR THE LIMITED WARRANTY SET FORTH ABOVE, OLYMPUS MAKES NO AND DISCLAIMS ALL OTHER REPRESENTATIONS, GUARANTIES, CONDITIONS, AND WARRANTIES CONCERNING THE PRODUCTS, WHETHER DIRECT OR INDIRECT, EXPRESS OR IMPLIED, OR ARISING UNDER ANY STATUTE, ORDINANCE, COMMERCIAL USAGE OR OTHERWISE, INCLUDING BUT NOT LIMITED TO ANY WARRANTY OR REPRESENTATION AS TO THE SUITABILITY, DURABILITY, DESIGN, OPERATION, OR CONDITON OF THE PRODUCTS (OR ANY PART THEREOF) OR THE MERCHANTABILITY OF THE PRODUCTS OR THEIR FITNESS FOR A PARTICULAR PURPOSE, OR RELATING TO THE INFRINGEMENT OF ANY PATENT, COPYRIGHT, OR OTHER PROPRIETARY RIGHT USED OR INCLUDED THEREIN.

IF ANY IMPLIED WARRANTIES APPLY AS A MATTER OF LAW, THEY ARE LIMITED IN DURATION TO THE LENGTH OF THIS LIMITED WARRANTY.

SOME STATES MAY NOT RECOGNIZE A DISCLAIMER OR LIMITATION OF WARRANTIES AND/OR LIMITATION OF LIABILITY SO THE ABOVE DISCLAIMERS AND EXCLUSIONS MAY NOT APPLY. THE CUSTOMER MAY ALSO HAVE DIFFERENT AND/OR ADDITIONAL RIGHTS AND REMEDIES THAT VARY FROM STATE TO STATE.

THE CUSTOMER ACKNOWLEDGES AND AGREES THAT OLYMPUS SHALL NOT BE RESPONSIBLE FOR ANY DAMAGES THAT THE CUSTOMER MAY INCUR FROM DELAYED SHIPMENT, PRODUCT FAILURE, PRODUCT DESIGN, SELECTION, OR PRODUCTION, IMAGE OR DATA LOSS OR IMPAIRMENT OR FROM ANY OTHER CAUSE, WHETHER LIABILITY IS ASSERTED IN CONTRACT, TORT (INCLUDING NEGLIGENCE AND STRICT PRODUCT LIABILITY) OR OTHERWISE. IN NO EVENT SHALL OLYMPUS BE LIABLE FOR ANY INDIRECT, INCIDENTAL, CONSEQUENTIAL OR SPECIAL DAMAGES OF ANY KIND (INCLUDING WITHOUT LIMITATION LOSS OF PROFITS OR LOSS OF USE), WHETHER OR NOT OLYMPUS SHALL BE OR SHOULD BE AWARE OF THE POSSIBILITY OF SUCH POTENTIAL LOSS OR DAMAGE.

Representations and warranties made by any person, including but not limited to dealers, representatives, salespersons, or agents of Olympus, which are inconsistent or in conflict with or in addition to the terms of this limited warranty, shall not be binding upon Olympus unless reduced to writing and approved by an expressly authorized officer of Olympus.

This limited warranty is the complete and exclusive statement of warranty which Olympus agrees to provide with respect to the Products and it shall supersede all prior and contemporaneous oral or written agreements, understandings, proposals, and communications pertaining to the subject matter hereof.

This limited warranty is exclusively for the benefit of the original customer and cannot be transferred or assigned.

**WHAT TO DO WHEN SERVICE IS NEEDED**

The customer must contact the designated Olympus Consumer Support Team for your region to coordinate the submission of your Product for repair service. To contact your Olympus Consumer Support Team in your region please visit or call the following:

Canada:

[www.olympuscanada.com/repair](http://www.olympuscanada.com/repair) / 1-800-622- 6372

United States:

[www.olympusamerica.com/repair](http://www.olympusamerica.com/repair) / 1-800-622- 6372

Latin America:

[www.olympusamericalatina.com](http://www.olympusamericalatina.com)

The customer must copy or transfer any image or other data saved on a Product to another image or data storage medium prior to sending the Product to Olympus for repair service.

IN NO EVENT SHALL OLYMPUS BE RESPONSIBLE FOR SAVING, KEEPING OR MAINTAINING ANY IMAGE OR DATA SAVED ON A PRODUCT RECEIVED BY IT FOR SERVICE, OR ON ANY FILM CONTAINED WITHIN A PRODUCT RECEIVED BY IT FOR SERVICE, NOR SHALL OLYMPUS BE RESPONSIBLE FOR ANY DAMAGES IN THE EVENT ANY IMAGE OR DATA IS LOST OR IMPAIRED WHILE SERVICE IS BEING PERFORMED (INCLUDING, WITHOUT LIMITATION, DIRECT, INDIRECT, INCIDENTAL, CONSEQUENTIAL OR SPECIAL DAMAGES, LOSS OF PROFITS OR LOSS OF USE), WHETHER OR NOT OLYMPUS SHALL BE OR SHOULD BE AWARE OF THE POSSIBILITY OF SUCH POTENTIAL LOSS OR IMPAIRMENT.

The customer should package the Product carefully using ample padding material to prevent damage in transit. Once the Product is properly packaged, ship the package to Olympus or the Olympus Authorized Repair Service Center location as instructed by the respective Olympus Consumer Support Team.

When sending Products for repair service, your package should include the following:

- 1) Sales receipt showing date and place of purchase. Handwritten receipts will not be accepted;
- 2) Copy of this limited warranty **bearing the Product serial number corresponding to the serial number on the Product** (unless it is a model on which Olympus does not place and record serial numbers);
- 3) A detailed description of the problem; and
- 4) Sample prints, negatives, digital prints (or files on disk) if available and related to the problem.

**KEEP COPIES OF ALL DOCUMENTS.** Neither Olympus nor an Olympus Authorized Repair Service Center will be responsible for documents that are lost or destroyed in transit.

When service is completed, the Product will be returned to you postage prepaid.

#### PRIVACY

Any information provided by you to process your warranty claim shall be kept confidential and will only be used and disclosed for the purposes of processing and performing warranty repair services.

## For customers in Mexico

The operation of this equipment is subject to the following two conditions:

- (1) it is possible that this equipment or device may not cause harmful interference, and (2) this equipment or device must accept any interference, including interference that may cause undesired operation.

## For customers in Europe

#### Simple Declaration of Conformity

Hereby, OLYMPUS CORPORATION declares that the radio equipment type IM015 is in compliance with Directive 2014/53/EU.

The full text of the EU declaration of conformity is available at the following internet address:

<http://www.olympus-europa.com/>



This symbol [crossed-out wheeled bin WEEE Annex IV] indicates separate collection of waste electrical and electronic equipment in the EU countries.

Please do not throw the equipment into the domestic refuse.

Please use the return and collection systems available in your country for the disposal of this product.



This symbol [crossed-out wheeled bin Directive 2006/66/EC Annex II] indicates separate collection of waste batteries in the EU countries.

Please do not throw the batteries into the domestic refuse.

Please use the return and collection systems available in your country for the disposal of the waste batteries.

### Provisions of warranty

In the unlikely event that your product proves to be defective, although it has been used properly (in accordance with the written Instruction Manual supplied with it), during the applicable national warranty period and has been purchased from an authorized Olympus distributor within the business area of OLYMPUS EUROPA SE & Co. KG as stipulated on the website: <http://www.olympus-europa.com>, it will be repaired, or at Olympus's option replaced, free of charge. In order to enable Olympus to provide you with the requested warranty services to your full satisfaction and as fast as possible, please note the information and instructions listed below:

1. To claim under this warranty please follow the instructions on <http://consumer-service.olympus-europa.com> for registration and tracking (this service is not available in all countries) or take the product, the corresponding original invoice or purchase receipt and the completed Warranty Certificate to the dealer where it was purchased or any other Olympus service station within the business area of OLYMPUS EUROPA SE & Co. KG as stipulated on the website: <http://www.olympus-europa.com>, before the end of the applicable national warranty period.
2. Please make sure your Warranty Certificate is duly completed by Olympus or an authorized dealer or Service center. Therefore, please make sure that your name, the name of the dealer, the serial number and the year, month and date of purchase are all completed or the original invoice or the sales receipt (indicating the dealer's name, the date of purchase and product type) is attached to your Warranty Certificate.
3. Since this Warranty Certificate will not be re-issued, keep it in a safe place.
4. Please note that Olympus will not assume any risks or bear any costs incurred in transporting the product to the dealer or Olympus authorized service station.
5. This Warranty does not cover the following and you will be required to pay a repair charge, even for defects occurring within the warranty period referred to above.
  - a. Any defect that occurs due to mishandling (such as an operation performed that is not mentioned in the Instruction Manual, etc.)
  - b. Any defect that occurs due to repair, modification, cleaning, etc. performed by anyone other than Olympus or an Olympus authorized service station.
  - c. Any defect or damage that occurs due to transport, a fall, shock, etc. after purchase of the product.
  - d. Any defect or damage that occurs due to fire, earthquake, flood damage, thunderbolt, other natural disasters, environmental pollution and irregular voltage sources.
  - e. Any defect that occurs due to careless or improper storage (such as keeping the product under conditions of high temperature and humidity, near insect repellents such as naphthalene or harmful drugs, etc.), improper maintenance, etc.
  - f. Any defect that occurs due to exhausted batteries, etc.
  - g. Any defect that occurs due to sand, mud, water etc. entering the inside of the product casing.
6. Olympus's sole liability under this Warranty shall be limited to repairing or replacing the product. Any liability under the Warranty for indirect or consequential loss or damage of any kind incurred or suffered by the customer due to a defect of the product, and in particular any loss or damage caused to any lenses, films, other equipment or accessories used with the product or for any loss resulting from a delay in repair or loss of data, is excluded. Compelling regulations by law remain unaffected by this.

## For customers in Asia

### Provisions of warranty

1. If this product proves to be defective, although it has been used properly (in accordance with the written Handling Care and Operating instructions supplied with it), during a period of up to one year from the date of purchase this product will be repaired, or at Olympus's option replaced, free of charge. To claim under warranty the customer must take the product and this Warranty certificate before the end of the one year warranty period to the dealer where the product was purchased or any Olympus authorized service station listed in the instructions and request the necessary repairs.
2. The customer shall transport the product to the dealer or Olympus authorized service station at his own risk and shall be responsible for any costs incurred in transporting the product.
3. This warranty does not cover the following and the customer will be required to pay repair charge, even for defects occurring within the one year period referred to above.
  - a. Any defect that occurs due to mishandling (such as an operation performed that is not mentioned in the Handling Care or other sections of the instructions, etc.)
  - b. Any defect that occurs due to repair, modification, cleaning, etc. performed by anyone other than Olympus or an Olympus authorized service station.
  - c. Any defect or damage that occurs due to transport, a fall, shock, etc. after purchase of the product.
  - d. Any defect or damage that occurs due to fire, earthquake, flood damage, thunderbolt, other natural disasters, environmental pollution and irregular voltage sources.
  - e. Any defect that occurs due to careless or improper storage (such as keeping the product under conditions of high temperature and humidity, near insect repellents such as naphthalene or harmful drugs, etc.), improper maintenance, etc.
  - f. Any defect that occurs due to exhausted batteries, etc.
  - g. Any defect that occurs due to sand, mud, etc. entering the inside of the product casing.
  - h. When this Warranty Certificate is not returned with the product.
  - i. When any alterations whatsoever are made to the Warranty Certificate regarding the year, month and date of purchase, the customer's name, the dealer's name, and the serial number.
  - j. When proof of purchase is not presented with this Warranty Certificate.
4. This Warranty applies to the product only; the Warranty does not apply to any other accessory equipment, such as the case, strap, lens cap, batteries and battery chargers.
5. Olympus' sole liability under this warranty shall be limited to repairing or replacing the product and any liability for indirect or consequential loss or damage of any kind incurred or suffered by the customer due to a defect in the product, and in particular any loss or damage caused to any film or lenses or other equipment or accessories used with the product or for any loss resulting from delay in repair, is excluded.

### For customer in Singapore

Complies with IMDA Standards DB104634
---

#### Notes;

1. This Warranty is in addition to and does not affect the customer's statutory right.
2. If you have any queries regarding this Warranty, call any of the Olympus authorized service stations listed in the instructions.

### Notes regarding warranty maintenance

1. This Warranty will only be valid if the Warranty Certificate is duly completed by Olympus or the dealer. Make sure that your name, the name of the dealer, the serial number and the year, month and date of purchase are all completed.
2. Since this Warranty Certificate will not be re-issued, keep it in a safe place.
3. Any request for repair by a customer in same country where the product was purchased shall be subject to the terms of the warranty issued by the Olympus distributor in that country. Where the local Olympus distributor does not issue a separate warranty or where the customer is not in the country where the product was purchased the terms of this worldwide warranty shall apply.
4. Where applicable, this Warranty is valid only in the country the product was purchased. The Olympus authorized service stations listed in this Warranty will gladly honor it.
  - \* Please refer to the appended list for the authorized international Olympus service network.

### Disclaimer of Warranty

Olympus makes no representations or warranties, either expressed or implied, by or concerning any content if these written materials or software, and in no event shall be liable for any implied warranty of merchantability or fitness for any particular purpose or for any consequential, incidental or indirect damages (including but not limited to damages for loss of business profits, business interruption and loss of business information) arising from the use of inability to use these written materials or software. Some states do not allow the exclusion or limitation of liability for consequential or incidental damages, so the above limitations may not apply to you.

### Trademarks

- Microsoft and Windows are registered trademarks of Microsoft Corporation.
- Mac is a trademark of Apple Inc.
- SDXC logo is a trademark of SD-3C, LLC.
- Apical logo is a registered trademark of Apical Limited.
- Wi-Fi is a registered trademark of the Wi-Fi Alliance.
- The Wi-Fi CERTIFIED logo is a certification mark of the Wi-Fi Alliance.



- All other company and product names are registered trademarks and/or trademarks of their respective owners.

THIS PRODUCT IS LICENSED UNDER THE AVC PATENT PORTFOLIO LICENSE FOR THE PERSONAL AND NONCOMMERCIAL USE OF A CONSUMER TO (i) ENCODE VIDEO IN COMPLIANCE WITH THE AVC STANDARD ("AVC VIDEO") AND/OR (ii) DECODE AVC VIDEO THAT WAS ENCODED BY A CONSUMER ENGAGED IN A PERSONAL AND NON-COMMERCIAL ACTIVITY AND/OR WAS OBTAINED FROM A VIDEO PROVIDER LICENSED TO PROVIDE AVC VIDEO. NO LICENSE IS GRANTED OR SHALL BE IMPLIED FOR ANY OTHER USE. ADDITIONAL INFORMATION MAY BE OBTAINED FROM MPEG LA, L.L.C. SEE [HTTP://WWW.MPEGLA.COM](http://www.mpegla.com)

The software in this camera may include third party software. Any third party software is subject to the terms and conditions, imposed by the owners or licensors of that software, under which software is provided to you.

Those terms and other third party software notices, if any, may be found in the software notice PDF file stored at

<http://www.olympus.co.jp/en/support/img/digicamera/download/notice/notice.cfm>

- The standards for camera file systems referred to in this manual are the "Design rule for Camera File system/DCF" standards stipulated by the Japan Electronics and Information Technology Industries Association (JEITA).



# Index

## Symbols

RC Mode.....	125
(Language).....	94
(Face priority AF).....	60
(Sequential Low).....	43
(Sequential High).....	43
/Info Settings.....	96, 102
Info.....	96, 102
Settings.....	96, 103
	42
	98
+WB.....	98
(Index display).....	65, 103
(Close-up playback).....	65
(Single-frame erase).....	75
(Image selection).....	76
	30, 33, 34
(Movie) button.....	38
(Share Order).....	71
(Beep sound).....	97
(Protect).....	71
(Monitor brightness adjustment).....	94
(One-touch white balance).....	54
(Image rotation).....	88
Keep Warm Color.....	98
(Audio recording).....	72
(Print Order).....	75
Set.....	98, 105

## A

<b>A</b> (Aperture priority mode).....	36
AdobeRGB.....	98
AF Area.....	82
AF illuminator.....	25, 101
AF mode.....	55
Aspect ratio.....	55
Audio recording	
Still image.....	72
AUTO mode ().....	25

## B

Backlight HDR.....	29
Battery charge.....	16
Computer.....	116
Battery level.....	17
Beep sound.....	97
BGM.....	73

## C

Calendar display.....	65, 103
Card.....	13, 15
Card Setup.....	21, 95
Certification.....	100
Close-up playback.....	65
Close-ups.....	33, 55
Color Space.....	98
Compression rate.....	56, 105, 119
Connection	
Computer.....	116
Smartphone.....	106
Conversion lens.....	129
Copyright Settings.....	99
Custom Menu.....	96, 142

## D

Data logger function.....	111, 113
Date Stamp.....	86
Date/time setting ().....	18
Digital Tele-converter.....	42
Displayed Grid.....	96
DPOF.....	75

## E

Edit.....	88
Edit Filename.....	99
Edit images.....	68, 88, 90
Erase	
All images.....	95
Selected images.....	76
Single-frame.....	75
Exif data.....	99

Exposure compensation .....	41
Exposure Shift .....	97
External flash units .....	125

## F

Face priority AF .....	60
File format.....	119
File Name .....	99
Flash.....	45
Flash intensity control.....	59
Flicker Reduction.....	96
Focus BKT.....	33, 85
Focus lock .....	46
Focus mode.....	55
Focus Stacking.....	33
Focus Stacking Settings.....	86
Format .....	21
Frame rate.....	57

## G

GPS log .....	113
GPS Priority.....	100

## H

HDMI .....	97, 104
HDMI output .....	104
High-speed movie.....	58
Histogram display.....	24, 102

## I

Image aspect.....	55
Image Overlay .....	74, 91
Image quality	
Movie .....	57
Still image .....	56
Image quality settings.....	98, 105
Image selection .....	76
Image size .....	119
Movie .....	57
Still image .....	56, 105
Image stabilizer .....	59
Image transfer to smartphone .....	108
Index display.....	65, 103
INFO button.....	24, 63, 78

Information display .....	22
Playback .....	62
In-Movie Image Capture.....	69, 92
Installation .....	117
Intrvl. Sh./Time Lapse.....	84
ISO-Auto Set .....	97
ISO sensitivity.....	52

## J

JPEG Edit.....	68, 88, 90
----------------	------------

## L

Language setting (  ).....	94
LED illuminator .....	47
LED light guide .....	127
Lens barrier .....	128
Level Adjust .....	100
Level Gauge .....	24, 102
Lighten blending.....	31
List of settings.....	136, 138
Live composite photography.....	31
Live control .....	48
Live View Boost .....	96
Location data .....	100, 115
LOG.....	111, 113
LV-Info .....	96, 102

## M

Macro photography.....	33, 55
Manual focus .....	55
Menu.....	78, 140
Metering.....	60
MF Assist.....	96, 101
MF (Manual focus).....	55
Microscope .....	33
Mode dial .....	27
Monitor brightness adjustment .....	94
Movie  .....	87
Movie edit.....	69, 92, 93
Movie mode.....	39
Movie playback.....	66
Movie recording.....	38

## N

Noise Filter .....	97
Noise Reduct .....	97
Number of storable still pictures .....	119

## O

Ol.Palette.....	106
Ol.Share .....	106
Ol.Track.....	106
Olympus Workspace .....	117
One-touch white balance (  ) .....	54

## P

<b>P</b> (Program mode) .....	35
Panorama .....	32
Partial Color .....	52
PC.....	116
PC software .....	117
Peaking.....	101
Peaking Color .....	96
Picture Mode .....	50, 81
Pixel Count .....	56, 105, 119
Pixel Mapping .....	100, 122
Playback	
Movie .....	64, 66
Still image .....	64, 65
Playback Menu .....	88, 142
Position information .....	100
Print Order .....	75
Pro Capture .....	44
Protect .....	71

## R

RAW Data Edit .....	68, 88
RAW image .....	56
RC Mode (  RC Mode ) .....	125
Record GPS location .....	100
Recording Volume .....	87
Rec View .....	94
Remote shooting .....	108
Reset/Assign Custom Modes .....	80
Reset Protect.....	93
Rotate .....	72



## S

Scene mode .....	28
SCN (Scene mode).....	28
SD card.....	15
Formatting the card.....	21
Self-timer .....	42
Sequential shooting.....	42
Setup Menu .....	94, 144
Share Order.....	71
Shooting	
Movie .....	38
Still image .....	27
Shooting Menu .....	80, 141
Shooting Menu 1.....	80
Shooting Menu 2.....	80
Shooting modes.....	27
Silicone jacket.....	125
Sleep .....	17, 100
Slideshow .....	73
Slow-motion movie .....	58
sRGB .....	98
Storage.....	117
Super macro .....	55

## T

Telephoto (Zoom) .....	26
Time Lapse Movie .....	84
Tracking.....	83
Trimming	
JPEG image.....	68, 90
Movie .....	70, 93
TV .....	104

## U

Underwater mode (  ) .....	34
Underwater photography (  ) .....	34
Underwater strobe .....	125
USB connection.....	116
User registration .....	2

## V

Video Bit Rate.....	57, 87
Video Frame Rate .....	57, 87
Video Menu .....	87, 141

Volume adjustment ..... 66

## **W**

---

WB ..... 98

White balance ..... 53

White balance compensation ..... 98

Wide (Zoom) ..... 26

Wi-Fi Settings ..... 94, 109, 110

Wireless LAN ..... 106

Wireless Remote Control Flash ..... 125

## **Z**

---

Zoom ..... 26

**OLYMPUS KOREA CO., LTD.**

2F-3F Majestar City 1, 12, Seocho-daero 38-gil, Seocho-gu, Seoul,  
06655, Republic of Korea  
Tel. 1544-3200  
E-mail: [hotline.okr@olympus-ap.com](mailto:hotline.okr@olympus-ap.com)  
<http://www.olympus.co.kr>

**OLYMPUS (MALAYSIA) Sdn Bhd**

512, 5th Floor, Block D, Kelana Square 17, Jalan SS 7/26, Kelana Jaya,  
47301 Petaling Jaya, Selangor, Malaysia  
Tel: (603) 7806 2173  
Fax: (603) 7803 7164  
E-mail: [service.oml@olympus-ap.com](mailto:service.oml@olympus-ap.com)  
<http://www.olympus.com.my>

**OLYMPUS (Thailand) CO., LTD.**

23/112 Sorachai Building, 27th Floor, Soi Sukhumvit 63 (Ekamai)  
Sukhumvit road Klongton Nua, Wattana, Bangkok 10110 Thailand  
Tel: (66) 2-000-7700  
E-mail: [imaging.oth@olympus-ap.com](mailto:imaging.oth@olympus-ap.com)

## **OLYMPUS AMERICA INC.**

3500 Corporate Parkway, P.O. Box 610, Center Valley, PA 18034-0610, U.S.A. Tel. 484-896-5000

### **Technical Support (U.S.A. / Canada)**

24/7 online automated help:  
<http://www.olympusamerica.com/support>  
Phone customer support:  
Tel. 1-800-260-1625 (Toll-free)

Our phone customer support is available from  
9 am to 9 pm (Monday to Friday) ET  
<http://olympusamerica.com/contactus>  
Olympus software updates can be obtained at:  
<http://www.olympusamerica.com/digital>

## **OLYMPUS EUROPA SE & CO. KG**

Premises: Consumer Product Division  
Wendenstrasse 14-18, 20097  
Hamburg, Germany  
Tel: +49 40-23 77 3-0 / Fax: +49 40-23 07 61

Goods delivery: Modul H, Willi-Bleicher Str. 36,  
52353 Düren, Germany  
Mailing address: Postfach 10 49 08,  
20034 Hamburg, Germany

### **European Technical Customer Support:**

Please visit our homepage <http://www.olympus-europa.com> or call our TOLL FREE NUMBER\* :  
**00800 - 67 10 83 00**

for Austria, Belgium, Denmark, Finland, France, Germany, Luxemburg, Netherlands, Norway,  
Poland, Portugal, Spain, Sweden, Switzerland, United Kingdom.  
810-800 67 10 83 00 for Russia  
800 167 777 for Czech Republic

\* Please note some phone service providers do not permit access to 00800 numbers or require  
an additional prefix. Charges may apply here. Please contact your service provider directly for  
more details.

For all not listed European Countries and in case that you can't get connected to the above mentioned number,  
please make use of the following CHARGED NUMBERS **+49 40 - 237 73 899**

## **OLYMPUS (BEIJING) SALES & SERVICE CO.,LTD**

Customer Support: 400-650-0303 Homepage: <http://olympus-imaging.cn>

### **Customer Service Center:**

10F, K, Wah Centre, 1010 Huaihai Road(M), Xuhui District, Shanghai  
Zip: 200031

## **OLYMPUS HONG KONG AND CHINA LIMITED**

Digital Camera Repair Centre  
L4207, Office Tower, Langham Place, 8 Argyle Street, Mongkok, Kowloon, Hong Kong  
Customer Hotline: +852-2376-2150 Fax: +852-2375-0630  
E-mail: [cs.ohc@olympus-ap.com](mailto:cs.ohc@olympus-ap.com)  
<http://www.olympus.com.hk>