

Quick Reference Guide

IP Proprietary Telephone

Model No. **KX-NT343/KX-NT346/KX-NT366**

Thank you for purchasing an IP Proprietary Telephone (IP-PT). Please read this manual carefully before using this product and save this manual for future use. For more details, please refer to the manuals of the PBX.

This unit supports the following optional devices and features:

	KX-NT343	KX-NT346	KX-NT366*1
Display	3-Line	6-Line	6-Line
CO keys	24	24	48 (12×4)
Self Labeling			✓
KX-NT303 Add-on 12 key module	✓	✓	
KX-NT305 Add-on 60 key module*2	✓	✓	
KX-NT307(PSLP1528) Bluetooth® Module	✓	✓	✓
KX-A239 Optional AC Adaptor	✓	✓	✓
CODEC	G.729A, G.711, G.722*3		

✓: Available

*1 KX-NT366 is only available for KX-TDE100/KX-TDE200.

*2 KX-NT305 is only available for KX-TDE100/KX-TDE200.

*3 G.722 is only available for KX-TDE100/KX-TDE200.

- For information on connecting the KX-NT307, refer to the KX-NT307 Bluetooth Module Installation Instructions.

This model supports the following PBX versions:

KX-TDA30: PSMR Version 4.0000 or later

KX-TDE100/KX-TDE200: PMMPR Software File version 1.0000 or later

Trademark:

The Bluetooth word mark and logos are owned by the Bluetooth SIG, Inc. and any use of such marks by Matsushita Electric Industrial Co., Ltd. is under license.

Location of Controls

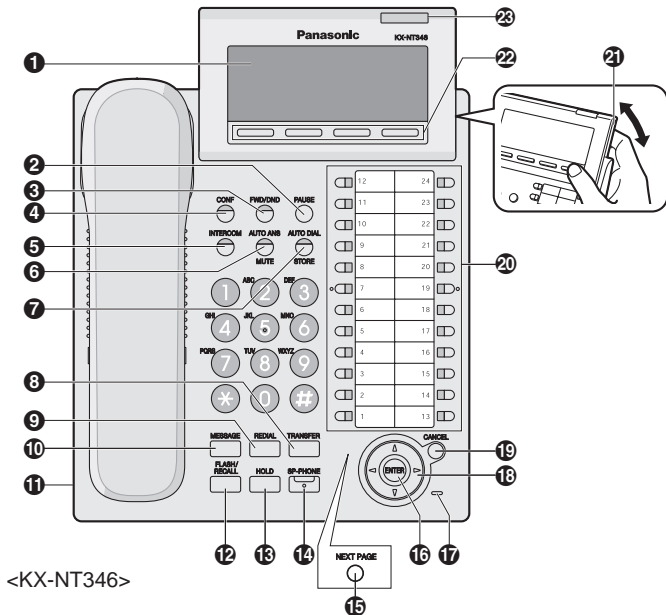

<KX-NT346>

- 1 LCD (Liquid Crystal Display)**
- 2 PAUSE:** Used to insert a pause when storing a telephone number. This button is also used for programming this unit.
- 3 FWD/DND (Call Forwarding/Do Not Disturb):** Used to set Call Forwarding or Do Not Disturb on your extension.
- 4 CONF (Conference):** Used to establish a multiple party conversation.
- 5 INTERCOM:** Used to make or receive intercom calls.
- 6 AUTO ANS (Auto Answer)/MUTE:** Used to receive an incoming call in hands-free mode or mute the microphone/handset during a conversation.





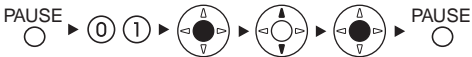
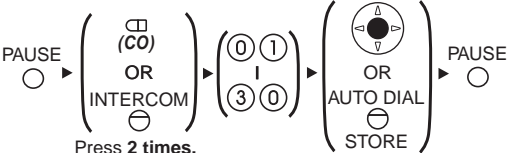
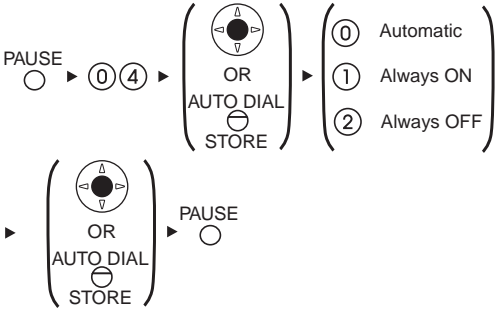

- 7 AUTO DIAL/STORE:** Used for System/Personal Speed Dialing or storing program changes.
- 8 TRANSFER:** Used to transfer a call to another party.
- 9 REDIAL:** Used to redial the last dialed number.
- 10 MESSAGE:** Used to leave a message waiting indication or call back the party who left the message waiting indication.
- 11 Headset Jack**
- 12 FLASH/RECALL:** Used to disconnect the current call and make another call without hanging up.
- 13 HOLD:** Used to place a call on hold.
- 14 SP-PHONE (Speakerphone):** Used for performing hands-free operations.
- 15 NEXT PAGE Key:** Used to switch the page for the Self Labeling feature. (KX-NT366 only)
- 16 ENTER:** Used to assign the selected item.
- 17 Microphone:** Used for hands free conversations.
- 18 Navigator Key:** Used to adjust the volume and the display contrast or select desired items.
- 19 CANCEL:** Used to cancel the selected item.
- 20 Flexible Outside (CO) Line Buttons:** Used to seize an outside line or perform a feature that has been assigned to the key.
- 21 LCD Panel:** Can be adjusted to the desired angle.
- 22 Soft Buttons (S1-S4):** S1-S4 (located from left to right) are used to select the item displayed on the bottom line of the display.
- 23 Message/Ringer Lamp:** When you receive an intercom call, the lamp flashes green, and on an outside call, the lamp flashes red. When someone has left you a message, the lamp stays on red.

Settings



















Speaker volume	<i>While in a hands-free conversation</i>	 <p>Press Up to increase or Down to decrease the volume.</p>
Handset/Headset volume*	<i>While using the handset or headset</i>	
Ringer volume	<i>While on-hook or receiving a call</i>	
LCD Contrast (for the main display)	<i>While on-hook</i>	
Ring Tone		 <p>Press 2 times.</p>
LCD Backlight	<i>While on-hook</i>	

* If you hear your own voice through the handset or headset, decrease the volume.

Icon Meanings

 = Outside (CO) Line button
  = Off-hook
  = On-hook
 = Feature number
  = Talk
 C.  Tone = Confirmation Tone

Making Calls

Calling	
To an extension  ► <input data-bbox="150 393 315 429" type="text" value="extension no."/> ► 	To an outside party  ►  ► <input data-bbox="621 393 833 429" type="text" value="outside phone no."/> ► 
Redial	
 ► REDIAL ► <input data-bbox="160 516 212 553" type="text" value=""/> ► 	
Quick Dialing	
 ► <input data-bbox="150 633 315 669" type="text" value="quick dial no."/> ► 	
One-touch Dialing	
To store (KX-NT343/KX-NT346) For storing on a KX-NT366, refer to page 12. PAUSE ►  ► ② ► <input data-bbox="341 793 657 829" type="text" value="desired no.* (max. 32 digits)"/> ►  ► STORE ► PAUSE <small>* Enter outside line access number before outside phone number.</small>	
To dial  ► <input data-bbox="160 939 191 968" type="checkbox"/> assigned as a One-touch Dialing button ► 	
Personal Speed Dialing	
To store  ► * ③ ① ► <input data-bbox="305 1084 481 1135" type="text" value="personal speed dial no. (2 digits)"/> ► <input data-bbox="523 1084 699 1135" type="text" value="desired no.* (max. 32 digits)"/> ► # C.   <small>* Enter outside line access number before outside phone number.</small>	
To dial  ►  ► STORE ► * ► <input data-bbox="378 1288 751 1324" type="text" value="personal speed dial no. (2 digits)"/> ► 	

Features List

System Speed Dialing

To dial

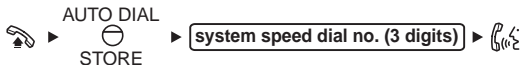

Doorphone Call



During a Conversation

Call Hold

To hold

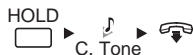

To retrieve a call at the holding extension



To retrieve an outside call from another extension



Call Transfer

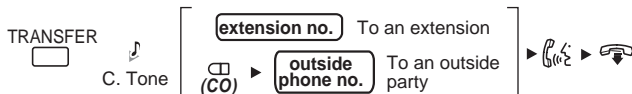

Useful Features

Multiple Party Conversation

To add other parties during a conversation (i.e., conference)



To leave a conference

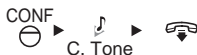

Setting the Telephone According to Your Needs

Do Not Disturb

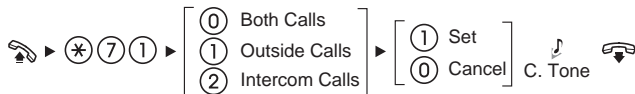

Timed Reminder

To set

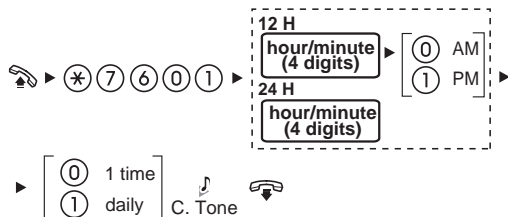

To cancel



To stop or answer the ring back



Before Leaving Your Desk

Call Forwarding

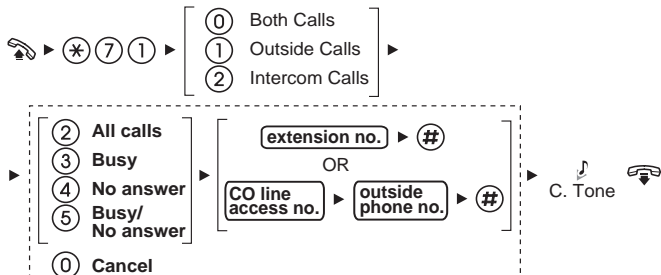

Features List

Making Use of the Voice Mail Service

Listening to a message

From your own extension

 ▶ **VPS extension no.** ▶

▶ **Mailbox Password*** (#)

* If you have no password, you can skip the last step.

KX-TVA series

- ① Listen to Message
- ② Deliver Message
- ③ Mailbox Management
- ▶ ④ Automated Attendant
- ⑤ Message Notification
- ⑥ Other Features
- ⊛ End Call

From someone else's extension

 ▶ **VPS extension no.** ▶

▶ (#) 6 ▶ ⊛ ▶

▶ **mailbox no.** ▶

▶ **Mailbox Password*** (#)

* If you have no password, you can skip the last step.

KX-TVS series

- ① Listen to Message
- ② Deliver Message
- ③ Check Mailbox Distribution
- ▶ ④ Automated Attendant
- ⑤ Mailbox Management
- ⑥ Other Features
- ⊛ End Call

Leaving a message

 ▶ **VPS extension no.** ▶

From your own extension

Mailbox Password* (#)

From someone else's extension

(#) 6 ▶ ⊛ ▶ **mailbox no.** ▶ **Mailbox Password*** (#) ▶

* If you have no password, you can skip the last step.

▶ ② ▶ Enter the desired mailbox number ▶ ② ① ▶ Leave a message ▶ ① ② ▶

To send the message immediately

① ② (KX-TVA series)

② (KX-TVS series)

To set the delivery time

OR ① ① ▶ Follow the guidance

During playback

- | | |
|-------------------------|--------|
| ① Repeat Voice Guidance | * Exit |
|-------------------------|--------|

- Consult your dealer for more details regarding feature numbers.
- It is possible to assign flexible CO buttons as feature buttons.
- Control panel/button names and descriptions can be found in "Location of Controls" on page 2.

Accessing Features Using the Display

Using the LCD Display

It is possible to access the following directories, logs, and menus by pressing left or right on the Navigator Key while this unit is idle:

- Extension Number Directory**
- System Speed Dialing Directory**
- Personal Speed Dialing Directory**
- Outgoing Call Log**
- Incoming Call Log**

Entering Characters

You can enter alphabetic characters and digits using the dialing buttons. Pressing a dialing button repeatedly displays different characters, as shown in the following tables. While entering characters, you can move the cursor with the left and right Navigator keys and delete characters with the TRANSFER button. To toggle between Table 1 and Table 2, press the Soft button (S1) at any time while entering characters. For a list of available characters, refer to the next page.

Accessing Features Using the Display

Table 1 (Standard mode)

Times Buttons	1	2	3	4	5	6	7	8	9
①	!	?	"	l					
②	A	B	C	a	b	c	2		
③	D	E	F	d	e	f	3		
④	G	H	I	g	h	i	4		
⑤	J	K	L	j	k	l	5		
⑥	M	N	O	m	n	o	6		
⑦	P	Q	R	S	p	q	r	s	7
⑧	T	U	V	t	u	v	8		
⑨	W	X	Y	Z	w	x	y	z	9
⑩	space	.	,	'	:	;	0		
*	/	+	-	=	<	>	*		
#	\$	%	&	@	()	€	£	#

Table 2 (Option mode)

Times Buttons	1	2	3	4	5	6	7	8	9	10	11	12	13	14	15
①	!	?	"	ä	ö	ü	l								
②	A	B	C	a	b	c	À	Á	Â	Ã	Ä	Å	Æ	Ç	2
③	D	E	F	d	e	f	Ð	È	É	Ê	Ë	3			
④	G	H	I	g	h	i	Ì	Í	Î	Ï	4				
⑤	J	K	L	j	k	l	5								
⑥	M	N	O	m	n	o	Ñ	Ò	Ó	Ô	Õ	Ö	Ø	Œ	6
⑦	P	Q	R	S	p	q	r	s	Š	ß	7				
⑧	T	U	V	t	u	v	Ù	Ú	Û	Ü	8				
⑨	W	X	Y	Z	w	x	y	z	Ý	Ž	9				
⑩	space	.	,	'	:	;	0								
*	/	+	-	=	<	>	*								
#	\$	%	&	@	()	€	£	#						

Self Labeling (KX-NT366 only)

The KX-NT366 IP-PT features 12 flexible buttons, with an LCD screen next to the buttons. Each item can be named on the LCD screen through personal or system programming to reflect the function of its corresponding flexible button. Additionally, the flexible buttons can be organized into 4 “pages”, allowing you to assign a total of 48 items to the 12 flexible buttons. You can toggle between pages by pressing the NEXT PAGE key, as follows:

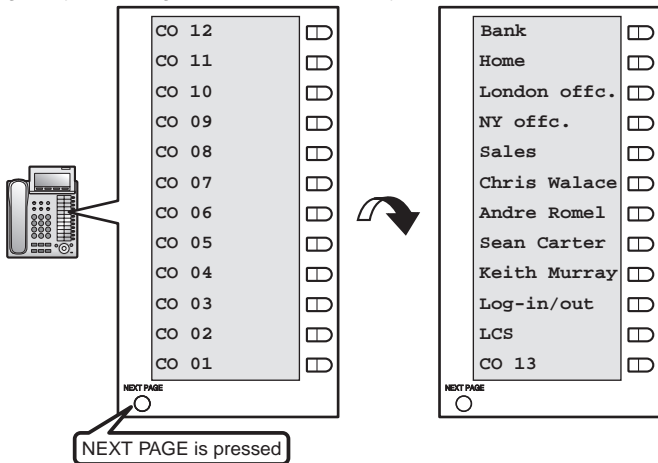

- This feature is only available for the KX-TDE100/KX-TDE200.

Self Labeling (KX-NT366 only)

Storing a One-touch Dialing button, and setting the displayed text for the Self Labeling LCD Display

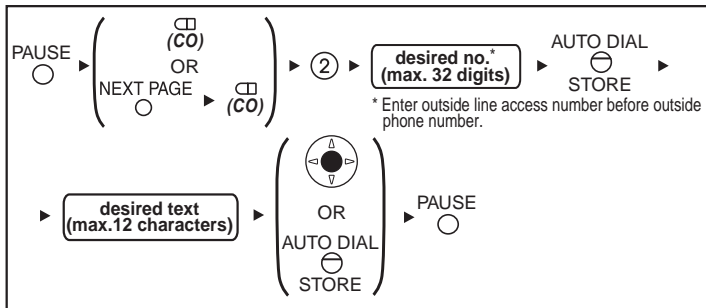

- Similar to the above procedure, when storing other types of buttons (CO buttons, feature buttons, etc.), the displayed text for the Self Labeling LCD Display can be assigned.

Setting the Self Labeling LCD Display contrast levels

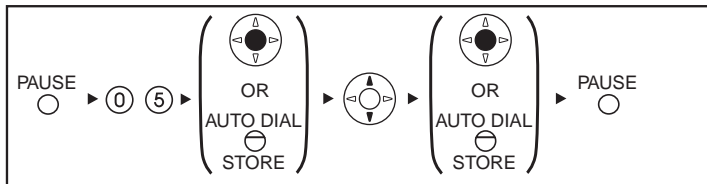

Operation Board Angle Adjustment

The angle of the operation board can be set to one of eight angles (level 1 = 0°, level 8 = 45°).

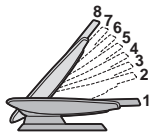

CAUTION:

Hold the operation board until the operation board is secured at the desired angle. Make sure you do not pinch your fingers when raising or lowering the operation board.

To raise:

Gently lift the operation board one level at a time.

To lower:

Raise the operation board to level 8. Next, with one hand on the base of the unit, lift the operation board again to release the latch, then slowly push the operation board down to level 1. If the operation board cannot be lowered to level 1, repeat this step.

- When a KX-NT305 is attached to this unit, first lift the unit's handset cradle to release the latch (1), then with one hand on the base of the KX-NT305, similarly lift its operation board to release its latch (2).

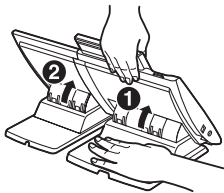

Locking the Handset Hook

Pull down the handset hook until it locks to prevent the handset from falling off the handset cradle when the unit is mounted to a wall or set at a high angle. To temporarily place the handset down during a conversation, hook it over the top edge of the unit as shown.



Connection

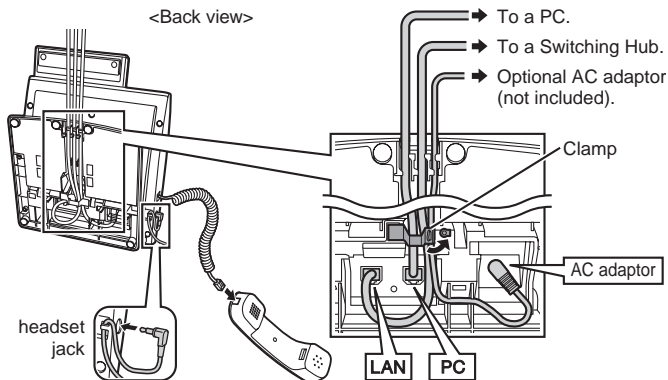

PC connection

- Use a straight CAT 5 (or higher) Ethernet cable (not included) that is 6.5 mm (1/4 in) in diameter or less.
- For further information on the connection to a PC, refer to the documentation provided for the PBX.

Switching Hub connection

- Use a straight CAT 5 (or higher) Ethernet cable (not included) that is 6.5 mm (1/4 in) in diameter or less.

AC adaptor

- Use a Panasonic AC adaptor KX-A239 (PQLV206).
- The AC adaptor is used as the main disconnect device. Ensure that the AC outlet is located near the unit and is easily accessible.

Headset jack

Recommended: KX-TCA86, KX-TCA91, KX-TCA92

Do not use a KX-7090 headset.

- For extra orders for the accessories, call toll-free: 1-800-332-5368

CAUTION:

When selecting Ethernet cables

Use flexible, high-quality, snagless (without strain relief) cables. Do not use cables with coating that may tear or crack when bent.

To prevent damage to the cables, use cables* that do not protrude from the bottom of the base when the operation board is set to level 1. (For information on adjusting the angle of the operation board, refer to page 13.)

* Use cables as shown.

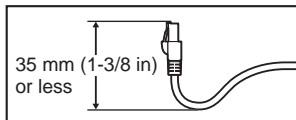
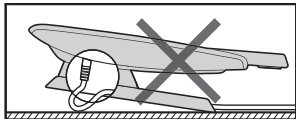
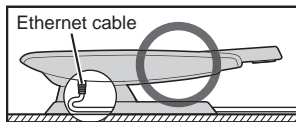

When connecting cables

Ensure that the Ethernet cables and the AC adaptor cord are inserted in the grooves, and are clamped to prevent damage to the connectors. Leave some slack in the AC adaptor cord and the Ethernet cable connected to the hub.

When connecting headset jack

Ensure that the headset cord is wound around the hook to prevent damage to the connector.

ConnectionWall Mounting

1. Remove the wall mounting adaptor from the unit as shown.

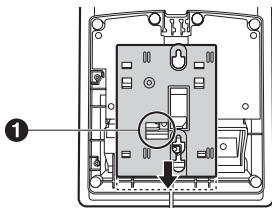

2. Set the operation board to level 1, then connect and secure the cables. Next, attach the wall mounting adaptor as shown.

- The cables can also be run from the top of the unit (page 14).
- Make sure the cables are not pinched by the wall mounting adaptor. When running the cables from the top of the unit, look through the opening in the wall mounting adaptor (1) to confirm that the cables are not being pinched.

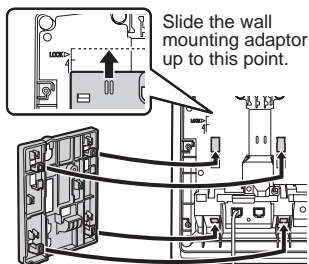

3. Drive the screws (included) into the wall, and mount the unit on the wall as shown below.

- Mount the unit in such a way that its weight (1.5 kg [33.07 lb]) can be supported.
- Make sure the cables are securely fastened to the wall.
- You can find a measurement guide for wall mounting on the last page of this manual.

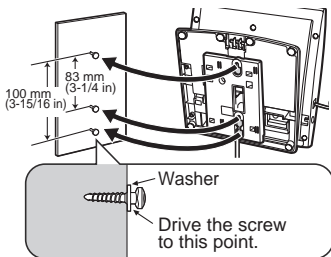

- For information on locking the handset hook, refer to page 13.

Installing the KX-NT303/KX-NT305

The KX-NT303/KX-NT305 allow 12/60 additional CO buttons to be connected to this unit. These buttons are used to seize an outside line, make a call using One-touch Dialing, or perform a feature that has been assigned to the key.



<with a KX-NT346>

To prevent damage to the telephone, be sure to unplug the extension line before you install or uninstall the Add-on Key Module.

KX-NT303 (For KX-NT343/KX-NT346)

1. Open the cover.
2. Attach the KX-NT303 to your unit with the screws (include).

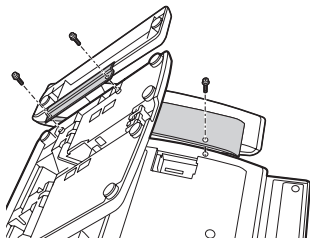
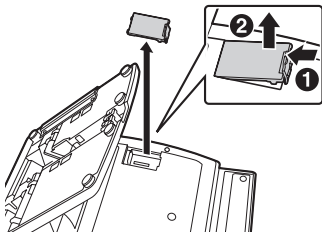

3. Plug the flat cable into the connector (1), then bend the cable slightly as shown (2).

4. Close the cover.

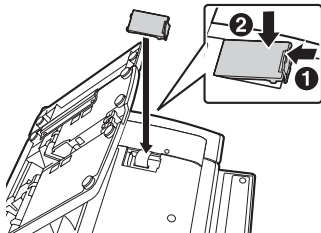
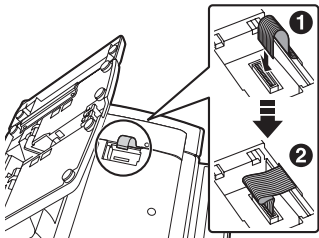

Installing the KX-NT303/KX-NT305

KX-NT305 (For KX-NT343/KX-NT346)

1. Open the cover.
2. Attach the KX-NT305 to your unit with the screws.

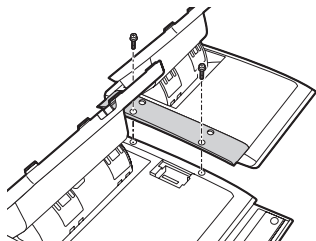
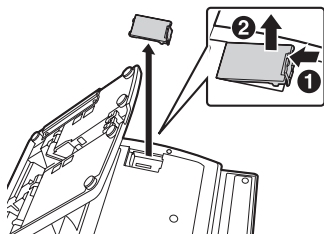

3. Plug the flat cable into the connector (1), then bend the cable slightly as shown (2).

4. Close the cover.

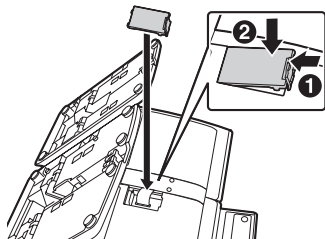
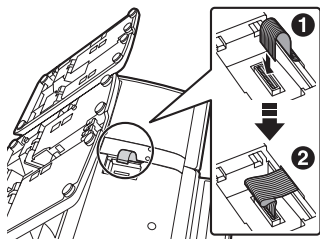

When using KX-NT300 series IP-PTs, keep the following conditions in mind.

- If the unit does not operate properly, disconnect the unit from the Ethernet cable and then connect again.
- If you are having problems making calls, disconnect the Ethernet cable and connect a known working IP-PT. If the known working IP-PT operates properly, have the defective IP-PT repaired by an authorised Panasonic factory service center. If the known working IP-PT does not operate properly, check the PBX and the Ethernet cable.
- Wipe the unit with a soft cloth. Do not clean the unit with abrasive powders or with chemical agents such as benzene or thinner.
- Use only the correct Panasonic handset.
- Do not disassemble this unit. Dangerous electrical shock could result. The unit must only be disassembled and repaired by qualified service technicians.
- If damage to the unit exposes any internal parts, immediately disconnect the cable or cord. If the power is supplied from the network to the IP-PT [Power-over-Ethernet], disconnect the Ethernet cable. Otherwise, disconnect the AC adaptor cord. Then return this unit to a service center.
- Never attempt to insert wires, pins, etc. into the vents or other holes of this unit.

Take special care to follow the safety suggestions listed below.

Safety

- 1) The unit should only be connected to a power supply of the type described in the Quick Reference Guide or as shown on the label on the unit.
- 2) When left unused for a long period of time, the optional AC adaptor should be unplugged from the AC outlet, if you are using Power-over-Ethernet, disconnect the Ethernet cable.

Installation

Environment

- 1) Do not use this unit near water, for example, near a bathtub, washbowl or sink. Damp basements should also be avoided.
- 2) Keep the unit away from heating appliances and devices that generate electrical noise, such as fluorescent lamps, motors and televisions. These noise sources can interfere with the performance of the unit. It also should not be placed in rooms where the temperature is less than 5 °C (41 °F) or greater than 40 °C (104 °F). Allow 10 cm (3-15/16 in) clearance around the unit for proper ventilation.

Important Information

Placement

- 1) Do not place heavy objects on top of this unit.
- 2) Care should be taken so that objects do not fall onto, and liquids are not spilled into, the unit. Do not subject this unit to excessive smoke, dust, moisture, mechanical vibration, shock or direct sunlight.
- 3) Place the unit on a flat surface.

WARNING:

TO PREVENT POSSIBLE FIRE OR ELECTRIC SHOCK, DO NOT EXPOSE THIS UNIT TO RAIN OR MOISTURE.

THIS HANDSET EARPIECE IS MAGNETISED AND MAY RETAIN SMALL FERROUS OBJECTS.

DISCONNECT THIS UNIT FROM POWER OUTLET/THE ETHERNET CABLE IF IT EMITS SMOKE, AN ABNORMAL SMELL OR MAKES UNUSUAL NOISE. THESE CONDITIONS CAN CAUSE FIRE OR ELECTRIC SHOCK. CONFIRM THAT SMOKE HAS STOPPED AND CONTACT AN AUTHORISED SERVICE CENTER.

IMPORTANT NOTICE:

- Under power failure conditions, the IP-PT may not operate. Please ensure that a separate telephone, not dependent on local power, is available for use in remote sites in case of emergency.
- For information regarding network setup of the IP-PT such as IP addresses, please refer to the Installation Manual for the Panasonic PBX.
- If an error message is shown on your display, consult the network administrator.
- The firmware of the KX-NT343, KX-NT346, and KX-NT366 are protected by copyright laws and international treaty provisions, and all other applicable laws. It cannot be reverse engineered, decompiled or disassembled.

When you ship the product:

Carefully pack and send it prepaid, adequately insured and preferably in the original carton. Attach a postage-paid letter, detailing the symptom to the outside of the carton.

DO NOT send the product to the Executive or Regional Sales offices. They are NOT equipped to make repairs.

Product service:

Panasonic factory service centers for this product are listed in the service center directory.

Consult your authorized Panasonic dealer for detailed instructions.

Important Safety Instructions

When using this unit, basic safety precautions, including those below, should always be followed to reduce the risk of fire, electric shock and injury to persons.

1. Read and understand all instructions.
2. Follow all warnings and instructions marked on this unit.
3. Unplug this unit from the AC outlet before cleaning. Do not use liquid or aerosol cleaners. Clean with a damp cloth.
4. Do not use the unit near water, for example, near a bathtub, kitchen sink, or laundry tub, in a wet basement, or near a swimming pool.
5. Place this unit on a flat surface. Serious damage and/or injury may result if the unit falls.
6. The unit should never be placed near or over a radiator or other heat source.
7. This unit should be operated only from the type of power source indicated on the unit label. If you are not sure of the type of power supply to your home, consult your dealer or local power company.
8. Do not allow anything to rest on the power cord. Do not locate this unit where the cord may be stepped on or tripped on.
9. To reduce the risk of fire or electric shock, do not overload AC outlets and extension cords.
10. Do not insert objects of any kind into this unit through openings, as they may touch dangerous voltage points or short out parts that could result in a risk of fire or electric shock. Never spill liquid of any kind on the unit.
11. To reduce the risk of electric shock, do not disassemble this unit. Only qualified personnel should service this unit. Opening or removing covers may expose you to dangerous voltages or other risks. Incorrect reassembly can cause electric shock.
12. Unplug this unit from the AC outlet and have the unit serviced by qualified service personnel in the following cases:
 - A. When the power supply cord or plug is damaged or frayed.
 - B. If liquid has been spilled on the unit.
 - C. If the unit has been exposed to rain or water.
 - D. If the unit does not work normally by following the manual. Adjust only controls covered by the manual. Improper adjustment may require repair by an authorized service center.
 - E. If the unit has been dropped, or damaged.
 - F. If the unit's performance deteriorates.
13. Avoid using a telephone (other than a cordless type) during an electrical storm. There is a remote risk of electric shock from lightning.

Important Information

14. Do not use the telephone in the vicinity of a gas leak to report the leak.

SAVE THESE INSTRUCTIONS

FCC Information

F.C.C. REQUIREMENTS AND RELEVANT INFORMATION

This equipment has been tested and found to comply with the limits for a Class B digital device, pursuant to Part 15 of the FCC Rules. These limits are designed to provide reasonable protection against harmful interference in a residential installation.

This equipment generates, uses, and can radiate radio frequency energy and, if not installed and used in accordance with the instructions, may cause harmful interference to radio communications. However, there is no guarantee that interference will not occur in a particular installation. If this equipment does cause harmful interference to radio or television reception, which can be determined by turning the equipment off and on, the user is encouraged to try to correct the interference by one or more of the following measures:

- Reorient or relocate the receiving antenna.
- Increase the separation between the equipment and receiver.
- Connect the equipment into an outlet on a circuit different from that to which the receiver is connected.
- Consult the dealer or an experienced radio/TV technician for help.

CAUTION:

To assure continued compliance with FCC rules, do not make any unauthorized changes or modifications to this equipment would void the user's authority to operate this device.

When programming emergency numbers and/or making test calls to emergency numbers:

- 1) Remain on the line and briefly explain to the dispatcher the reason for the call before hanging up.
- 2) Perform such activities in the off peak hours, such as early morning hours or late evenings.

Customer Information

This equipment complies with Part 68 of the FCC rules and the requirements adopted by the ACTA. On the bottom of the cabinet of this equipment is a label that contains, among other information, a product identifier in the format US: AAAEQ##Txxxx. If requested, this number must be provided to the telephone company.

If trouble is experienced with this equipment KX-NT343, KX-NT346, and KX-NT366, for repair or warranty information, please contact:

Panasonic Service and Technology Company
BTS Center
1225 Northbrook Parkway Suite
1-216 Suwanee
GA 30024

If the equipment is causing harm to the telephone network, the telephone company may request that you disconnect the equipment until the problem is resolved.

Hearing Aid Compatibility:

This telephone provides magnetic coupling for hearing aids.

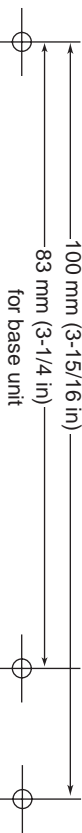

**Panasonic Consumer Electronics Company,
Division of Panasonic Corporation of North America**
One Panasonic Way, Secaucus, New Jersey 07094

Panasonic Puerto Rico, Inc.

San Gabriel Industrial Park, Ave. 65 de Infantería, Km. 9.5,
Carolina, Puerto Rico 00985

<http://www.panasonic.com/csd>

Copyright:

This material is copyrighted by Panasonic Communications Co., Ltd., and may be reproduced for internal use only. All other reproduction, in whole or in part, is prohibited without the written consent of Panasonic Communications Co., Ltd.

© 2007 Panasonic Communications Co., Ltd. All Rights Reserved.