

Panasonic Telephone Systems

Panasonic KX-TA824, KXTA824, KX TA824, TA824



www.voicesonic.com

Phone: 877-289-2829



Advanced Hybrid System Feature Manual

Model No. **KX-TA824**



Thank you for purchasing a Panasonic Advanced Hybrid System.

Please read this manual carefully before using this product and save this manual for future use.

Introduction

About this Feature Manual

The Feature Manual is designed to serve as an overall reference describing the features of the Panasonic Advanced Hybrid System.

It explains what the PBX can do, as well as how to obtain the most of its many features and facilities.

The Feature Manual is divided into the following sections:

Section 1, General Features

Describes all the basic, optional and programmable features in alphabetical order.

Section 2, Appendix

Provides tables that describe the resource capacity of the PBX, as well as its different tones and ring tones.

Index

References Found in the Feature Manual

Installation Manual References

The Installation Manual provides instructions detailing the installation and maintenance of the PBX.

Sections from the Installation Manual are listed throughout the Feature Manual for your reference.

Programming Manual References

Commonly used settings can be programmed using a display proprietary telephone (PT) (→ 1.1.103 PT Programming) or the KX-TA Maintenance Console software (→ 1.1.99 PC Programming). These PT/PC programming items are noted throughout the Programming Manual for your reference. For programming details, you can also refer to the on-line help that is installed along with KX-TA Maintenance Console (→ 3.2.1 Installing and Starting KX-TA Maintenance Console).

Feature Manual References

Related sections of the Feature Manual are listed for your reference.

Operating Manual References

The Operating Manual describes how users can access commonly used PBX features and functions with their PTs, single line telephones (SLTs), and Direct Station Selection (DSS) Consoles. Sections from the Operating Manual are listed throughout the Feature Manual for your reference.

Links to Other Pages and Manuals

If you are viewing this Feature Manual with a PC, certain items are linked to different sections of the Feature Manual and other PBX manuals. Click on a link to jump to that section.

Linked items include:

- [Installation Manual References](#)
- [Programming Manual References](#)
- [Feature Manual References](#)
- [Operating Manual References](#)

List of Abbreviations

| | | | |
|----------|------|---|-----------------------------------|
| A | AA | → | Automated Attendant |
| | APT | → | Analog Proprietary Telephone |
| B | BGM | → | Background Music |
| | BSS | → | Busy Station Signaling |
| | BV | → | Built-in Voice Message |
| C | COS | → | Class of Service |
| | CPC | → | Calling Party Control |
| D | DIL | → | Direct In Line |
| | DISA | → | Direct Inward System Access |
| | DND | → | Do Not Disturb |
| | DSS | → | Direct Station Selection |
| | DTMF | → | Dual Tone Multi-Frequency |
| E | EFA | → | External Feature Access |
| F | FWD | → | Call Forwarding |
| G | G-CO | → | Group-CO |
| I | IRNA | → | Intercept Routing—No Answer |
| L | LCS | → | Live Call Screening |
| | LED | → | Light Emitting Diode |
| O | O-CO | → | Other-CO |
| | OGM | → | Outgoing Message |
| P | PF | → | Programmable Feature |
| | PSTN | → | Public Switched Telephone Network |
| | PT | → | Proprietary Telephone |
| S | S-CO | → | Single-CO |
| | SLT | → | Single Line Telephone |
| | SMDR | → | Station Message Detail Recording |
| T | TAM | → | Telephone Answering Machine |
| | TRS | → | Toll Restriction |
| V | VM | → | Voice Mail |
| | VPS | → | Voice Processing System |

Feature Highlights

Built-in Voice Message (BV) (Optional voice message card required)

Built-in Voice Message (BV) allows a caller to leave a voice message in a user's personal message area or the PBX's common message area (→ 1.1.8 Built-in Voice Message (BV)).

Caller ID Display on SLT

The PBX can receive Caller ID information (telephone numbers and callers' names) from calls received on outside (CO) lines. This information can be shown on the displays of SLTs that support Caller ID as well as proprietary telephones (PTs) when receiving calls (→ 1.1.30 Caller ID).

3-level Automated Attendant (AA)

3-level Automated Attendant (AA) service allows a caller to dial a single-digit number (Direct Inward System Access [DISA] AA number) following the guidance of 3-level DISA outgoing messages (OGMs), and be connected to the desired party automatically (→ 1.1.41 Direct Inward System Access (DISA)).

PC Programming

System programming settings can be accessed using a PC and the Panasonic KX-TA Maintenance Console software as well as by using a PT (→ 1.1.99 PC Programming).

The PBX software can be upgraded via the Serial Interface (RS-232C port) or USB port, using the KX-TA Maintenance Console software (→ 1.1.58 Firmware Upgrade).

Automatic Configuration for Outside (CO) Line Type

The dialing mode of connected outside (CO) lines is automatically configured the first time the PBX is accessed with a PC using the KX-TA Maintenance Console software, or after the PBX data has been cleared (→ 1.1.5 Automatic Configuration for Outside (CO) Line Type).

Call Waiting Caller ID

Call Waiting Caller ID allows the user to see the name or telephone number of a second caller during a conversation (→ 1.1.28 Call Waiting Caller ID).

Local Carrier-based Voice Mail Service

Local carrier-based voice mail service allows the user to receive remote voice mail service from the telephone company to record caller messages when calls cannot be answered (→ 1.1.78 Local Carrier-based Voice Mail Service).

Wireless Proprietary Telephones (PTs)

Wireless PTs such as the KX-T7885 and the KX-TD7895 give a user the freedom to move around and still have the powerful features of Panasonic PTs. Some examples of the advantages of wireless PTs over wireless SLTs are:

- a) Caller ID
- b) Seizure of outside (CO) lines by a one-touch operation
- c) Carrier-based voice mail service

Refer to the Operating Instructions of the wireless PT for additional information.

Advanced Hybrid System

This PBX supports the connection of PTs*¹, wireless PTs, Direct Station Selection (DSS) Consoles, and single line devices such as SLTs, fax machines, wireless SLTs, and data terminals.

*¹ In this manual, "proprietary telephone" ("PT") means an analog proprietary telephone (APT).

Table of Contents

| | | |
|----------|--|----------|
| 1 | General Features | 9 |
| 1.1 | General Features..... | 10 |
| 1.1.1 | Absent Message | 10 |
| 1.1.2 | Account Code Entry | 10 |
| 1.1.3 | Answering, Direct Outside (CO) Line | 12 |
| 1.1.4 | Automatic Callback Busy (Camp-on) | 12 |
| 1.1.5 | Automatic Configuration for Outside (CO) Line Type | 13 |
| 1.1.6 | Automatic Time Adjustment | 14 |
| 1.1.7 | Background Music (BGM) | 14 |
| 1.1.8 | Built-in Voice Message (BV)..... | 15 |
| 1.1.9 | Busy Station Signaling (BSS)..... | 21 |
| 1.1.10 | Call Forwarding (FWD)—SUMMARY | 21 |
| 1.1.11 | Call Forwarding (FWD)—All Calls | 23 |
| 1.1.12 | Call Forwarding (FWD)—Busy/No Answer..... | 24 |
| 1.1.13 | Call Forwarding (FWD)—Follow Me..... | 26 |
| 1.1.14 | Call Forwarding (FWD)—To Outside (CO) Line | 27 |
| 1.1.15 | Call Hold..... | 28 |
| 1.1.16 | Call Hold, Exclusive | 30 |
| 1.1.17 | Call Hold Retrieve | 30 |
| 1.1.18 | Call Log, Incoming | 31 |
| 1.1.19 | Call Park..... | 34 |
| 1.1.20 | Call Pickup, Directed | 35 |
| 1.1.21 | Call Pickup, Group | 36 |
| 1.1.22 | Call Pickup Deny | 36 |
| 1.1.23 | Call Retrieving from a TAM (Telephone Answering Machine) | 37 |
| 1.1.24 | Call Splitting | 37 |
| 1.1.25 | Call Transfer—To Extension | 38 |
| 1.1.26 | Call Transfer—To Outside (CO) Line | 39 |
| 1.1.27 | Call Waiting | 40 |
| 1.1.28 | Call Waiting Caller ID | 41 |
| 1.1.29 | Call Waiting from the Telephone Company | 42 |
| 1.1.30 | Caller ID | 43 |
| 1.1.31 | Calling Party Control (CPC) Signal Detection | 47 |
| 1.1.32 | Class of Service (COS)..... | 48 |
| 1.1.33 | Conference..... | 49 |
| 1.1.34 | Conference, Unattended | 50 |
| 1.1.35 | Confirmation Tone | 51 |
| 1.1.36 | Consultation Hold..... | 52 |
| 1.1.37 | Data Line Security..... | 52 |
| 1.1.38 | Dial Tone | 52 |
| 1.1.39 | Dial Type Selection..... | 53 |
| 1.1.40 | Direct In Line (DIL)..... | 54 |
| 1.1.41 | Direct Inward System Access (DISA)..... | 56 |
| 1.1.42 | Direct Inward System Access (DISA) Ring | 64 |
| 1.1.43 | Display Information..... | 65 |
| 1.1.44 | Do Not Disturb (DND) | 67 |
| 1.1.45 | Do Not Disturb (DND) Override..... | 68 |

| | | |
|--------|---|-----|
| 1.1.46 | Door Open | 68 |
| 1.1.47 | Doorbell/Door Chime | 69 |
| 1.1.48 | Doorphone Call..... | 71 |
| 1.1.49 | Emergency Call..... | 72 |
| 1.1.50 | Executive Busy Override—Extension | 73 |
| 1.1.51 | Executive Busy Override—Outside (CO) Line | 74 |
| 1.1.52 | Extension Feature Clear | 75 |
| 1.1.53 | Extension Group | 75 |
| 1.1.54 | Extension Jack Configuration..... | 77 |
| 1.1.55 | Extension Lock..... | 77 |
| 1.1.56 | External Feature Access (EFA)..... | 78 |
| 1.1.57 | Feature Numbering..... | 79 |
| 1.1.58 | Firmware Upgrade | 83 |
| 1.1.59 | Fixed Buttons | 84 |
| 1.1.60 | Flash/Recall | 86 |
| 1.1.61 | Flexible Buttons..... | 87 |
| 1.1.62 | Hands-free Answerback..... | 89 |
| 1.1.63 | Hands-free Operation | 90 |
| 1.1.64 | Headset Operation..... | 90 |
| 1.1.65 | Host PBX Access Code (Access Code to the Telephone Company from a Host PBX) ... | 91 |
| 1.1.66 | Hot Line..... | 92 |
| 1.1.67 | Idle Extension Hunting | 93 |
| 1.1.68 | Intercept Routing..... | 94 |
| 1.1.69 | Intercom Call..... | 95 |
| 1.1.70 | LED Indication..... | 96 |
| 1.1.71 | Line Access, Outside (CO) Line—SUMMARY | 98 |
| 1.1.72 | Line Access, Automatic..... | 100 |
| 1.1.73 | Line Access, Outside (CO) Line Group..... | 101 |
| 1.1.74 | Line Access, S-CO Line | 102 |
| 1.1.75 | Line Preference—Incoming | 103 |
| 1.1.76 | Line Preference—Outgoing | 104 |
| 1.1.77 | Live Call Screening (LCS) (Voice Mail APT Integration only) | 105 |
| 1.1.78 | Local Carrier-based Voice Mail Service | 106 |
| 1.1.79 | Lockout | 108 |
| 1.1.80 | Log-in/Log-out..... | 108 |
| 1.1.81 | Memory Dialing..... | 109 |
| 1.1.82 | Message Waiting..... | 111 |
| 1.1.83 | Message Waiting for Another Extension | 112 |
| 1.1.84 | Microphone Mute | 114 |
| 1.1.85 | Music on Hold | 114 |
| 1.1.86 | One-touch Dialing | 115 |
| 1.1.87 | Operator/Manager Features..... | 116 |
| 1.1.88 | Outgoing Message (OGM) for DISA | 118 |
| 1.1.89 | Outside (CO) Line Group | 119 |
| 1.1.90 | Outside (CO) Line Ringing Selection | 120 |
| 1.1.91 | Outside-to-Outside (CO-to-CO) Line Call Duration..... | 120 |
| 1.1.92 | Paging—SUMMARY | 121 |
| 1.1.93 | Paging—All Extensions..... | 122 |
| 1.1.94 | Paging—All Extensions & External | 122 |
| 1.1.95 | Paging—External | 123 |

| | | |
|--------------|---|------------|
| 1.1.96 | Paging—Group..... | 124 |
| 1.1.97 | Paralleled Telephone..... | 124 |
| 1.1.98 | Pause Insertion | 125 |
| 1.1.99 | PC Programming..... | 126 |
| 1.1.100 | Personal Speed Dialing..... | 128 |
| 1.1.101 | Power Failure Restart..... | 129 |
| 1.1.102 | Power Failure Transfer..... | 129 |
| 1.1.103 | PT Programming | 130 |
| 1.1.104 | Pulse to Tone Conversion | 131 |
| 1.1.105 | Redial, Last Number | 132 |
| 1.1.106 | Redial, Saved Number | 132 |
| 1.1.107 | Remote Extension Lock | 133 |
| 1.1.108 | Ring Tone Pattern Selection..... | 134 |
| 1.1.109 | Ringing, Delayed..... | 135 |
| 1.1.110 | Room Monitor..... | 136 |
| 1.1.111 | Secret Dialing..... | 137 |
| 1.1.112 | Station Message Detail Recording (SMDR)..... | 137 |
| 1.1.113 | System Speed Dialing..... | 142 |
| 1.1.114 | Time Service | 143 |
| 1.1.115 | Timed Reminder..... | 146 |
| 1.1.116 | Timed Reminder, Remote | 147 |
| 1.1.117 | Toll Restriction (TRS) | 147 |
| 1.1.118 | Toll Restriction (TRS) Override by Account Code | 151 |
| 1.1.119 | Two-way Recording into the VPS (Voice Mail APT Integration only)..... | 153 |
| 1.1.120 | Voice Mail APT Integration | 154 |
| 1.1.121 | Voice Mail Inband (DTMF) Integration..... | 159 |
| 1.1.122 | Walking COS..... | 162 |
| 2 | Appendix | 165 |
| 2.1 | Capacity of System Resources..... | 166 |
| 2.1.1 | Capacity of System Resources | 166 |
| 2.2 | Tones/Ring Tones..... | 168 |
| 2.2.1 | Tones/Ring Tones..... | 168 |
| Index | | 173 |

Section 1

General Features

1.1 General Features

1.1.1 Absent Message

Description

Extension users can prepare a brief text message (Absent Message) that will be displayed to other extension users when they are called. This message can explain the reason for their absence, and can be used by any extension user.

The following Absent Messages may be programmed:

| Message No. | Message |
|-------------|---------------------------------------|
| 1 | Will Return Soon |
| 2 | Gone Home |
| 3 | At Ext %%% (Extension Number) |
| 4 | Back at %:%% (Hour:Minute) AM (or PM) |
| 5 | Out Until %%/%% (Month/Day) |
| 6 | In a Meeting |

Note

The "%" shown above indicates a parameter to be entered when assigning a message at an individual extension.

Conditions

- An extension user can select only one Absent Message at a time. The selected message is displayed at the extension every time the user goes off-hook.
- The caller must be using a display proprietary telephone (PT) to see the Absent Message.

Operating Manual References

1.3.1 Absent Message

1.1.2 Account Code Entry

Description

An account code is used to identify outgoing outside (CO) line calls for accounting and billing purposes. Account codes are appended to SMDR call records (→ 1.1.112 Station Message Detail Recording (SMDR)), and have several uses. For example, a firm can use an account code for each client to determine which calls were made for which client, and can submit a bill to the client according to the client's account code as shown on the SMDR call record.

There are 4 methods of entering account codes, explained below. One method is assigned to each extension through system programming (→ [605] Account Code Mode).

| Mode | Description |
|--------------------|---|
| Option | An extension user can (but is not required to) enter a 4-digit account code during a conversation or within 30 seconds after a conversation ends when a record is needed. |
| Forced | An extension user must always enter a 4-digit account code within 5 seconds after seizing an outside (CO) line. This method ensures that extension users will not forget to enter account codes. |
| Verify-All | An extension user must always enter a preprogrammed account code (→ [310] Account Code) within 5 seconds after seizing an outside (CO) line. If the entered code does not match any preprogrammed code, the user will hear a reorder tone. |
| Verify-Toll | An extension user can enter a preprogrammed account code (→ [310] Account Code) within 5 seconds after seizing an outside (CO) line to override TRS (→ 1.1.118 Toll Restriction (TRS) Override by Account Code). Classes of service (COSs) 3 through 5 will be changed temporarily to COS 2. COSs 1 and 2 will not be affected. If the entered account code is also registered as an extension password, the extension password feature will be given priority. The COS of the corresponding extension will be applied. |

Conditions

- An account code can be stored in Memory Dialing (One-touch Dialing, Hot Line, Personal Speed Dialing, System Speed Dialing, Call Forwarding (FWD) to Outside (CO) Line, etc.). In this case, the Account Code feature number and specified account code must be entered after the Outside (CO) Line Access number.
- An extension user does not need to enter an account code for incoming outside (CO) line calls.
- Even in Forced/Verify-All/Verify-Toll mode, emergency calls can be made without an account code (→ 1.1.49 Emergency Call).

Programming Manual References

[PT Programming]

[310] Account Code

[601-603] TRS-COS—Day/Night/Lunch

[605] Account Code Mode

[805] SMDR Account Code

[PC Programming]

9.1.6 Account Codes [1-5]

9.1.8 SMDR [1-7]—Selection for Printing—Account Code

9.2.1 Main [2-1]—Account Code Mode

9.5.1 Class of Service (COS) [5-1]—Day, Night, Lunch

Feature Manual References

1.1.49 Emergency Call

1.1.81 Memory Dialing

- 1.1.112 Station Message Detail Recording (SMDR)
- 1.1.118 Toll Restriction (TRS) Override by Account Code

Operating Manual References

- 1.3.2 Account Code Entry

1.1.3 Answering, Direct Outside (CO) Line

Description

A proprietary telephone (PT) user can answer incoming calls simply by pressing the flashing CO button.

Conditions

- This feature allows the user to specify which line to answer when multiple incoming outside (CO) lines are ringing.

Operating Manual References

- 1.3.4 Answering, Direct Outside (CO) Line

1.1.4 Automatic Callback Busy (Camp-on)

Description

If the dialed extension or outside (CO) line is busy when a call is made, the caller can choose to be informed by a callback ring (Camp-on Recall) when the extension or outside (CO) line becomes free. When the user answers the callback ring:

For an intercom call: The called extension starts ringing without the user having to redial.

For an outside (CO) line call: The line is seized.

Conditions

- If the callback ring is not answered within 10 seconds (4 rings), the callback is canceled.
- More than one extension user can set this feature to monitor the same destination extension or outside (CO) line at the same time.

Operating Manual References

- 1.3.5 Automatic Callback Busy (Camp-on)

1.1.5 Automatic Configuration for Outside (CO) Line Type

Description

The dialing mode (DTMF [Dual Tone Multi-Frequency]/Pulse) of connected outside (CO) lines is automatically assigned after restarting the PBX using the System Clear Switch or through system programming (→ [999] System Data Clear). No system programming in [401] Dial Mode and [402] Pulse Speed is required unless the dialing mode of the connected outside (CO) line is Call Blocking. Automatic Configuration for Outside (CO) Line Type can also be programmed the first time the PBX is accessed with a PC using the KX-TA Maintenance Console software (Quick Setup). For more information about Quick Setup, refer to the Installation Manual (→ 3.1.1 Installing KX-TA Maintenance Console on a PC).

Conditions

- If no outside (CO) lines are connected to the outside (CO) line ports of the PBX, the default values are assigned automatically.
- It takes a maximum of 4 minutes to complete checking the dialing mode, unless the outside (CO) line is in use. In this case, the PBX will start checking it after the outside (CO) line becomes idle.
- This feature will not function properly when:
 - It takes 3 seconds or more to detect the dialing mode of your telephone company.
 - The cable from the outside (CO) line is disconnected while the PBX is checking the dialing mode.
- If your telephone company or a host PBX can receive both DTMF and Pulse signals, the PBX selects an outside (CO) line type according to the following priority:
DTMF → Pulse (High) → Pulse (Low)

Installation Manual References

- 3.1.1 Installing KX-TA Maintenance Console on a PC
- 4.1.5 System Reset with System Data Clear

Programming Manual References

[PT Programming]

- [401] Dial Mode
- [402] Pulse Speed
- [999] System Data Clear

[PC Programming]

- 8.4 System Data Clear
- 9.3.3 Detail [3-3]—Dial Mode, Pulse Speed

Feature Manual References

- 1.1.39 Dial Type Selection

1.1.6 Automatic Time Adjustment

Description

The PBX clock can be adjusted automatically according to the time information received from your telephone company. Time information can be received when an incoming call with Caller ID that includes time information is received.

The PBX clock will be adjusted every day with the first call after 3:05 A.M., if enabled through system programming (→ [152] Automatic Time Adjustment).

Note

Since the PBX clock is put ahead by one hour on the Daylight Saving Time start date, a timed reminder set within one hour of the Automatic Time Adjustment feature will not ring.

Since the PBX clock is put back by one hour on the Daylight Saving Time end date, a timed reminder set within one hour before the Automatic Time Adjustment feature will ring 2 times.

Conditions

- SMDR will log call information using the PBX clock so that the logging time will be overlapped at the end of Daylight Saving Time (→ 1.1.112 Station Message Detail Recording (SMDR)).

Programming Manual References

[PT Programming]

[152] Automatic Time Adjustment

[PC Programming]

9.1.2 Main [1-2]—Time—Automatic Time Adjustment

Feature Manual References

1.1.112 Station Message Detail Recording (SMDR)

1.1.115 Timed Reminder

1.1.7 Background Music (BGM)

Description

A proprietary telephone (PT) user can listen to background music (BGM) through the built-in speaker while on-hook and idle.

Conditions

- **Hardware requirement:** A user-supplied external audio device, such as a CD player or radio for External audio source.
- The music heard through the PT is interrupted when going off-hook, receiving a call, or receiving a paging announcement.
- The audio can be selected through system programming (→ [111] Music on Hold).

- This feature can be turned on and off by dialing "1" while the extension is on-hook and idle, if BGM is enabled through system programming (→ [626] BGM Control for APT).

Installation Manual References

2.8.1 Connecting Peripherals

Programming Manual References

[PT Programming]

[111] Music on Hold

[626] BGM Control for APT

[PC Programming]

9.1.2 Main [1-2]—Music on Hold

9.2.1 Main [2-1]—BGM Control for APT

Feature Manual References

1.1.85 Music on Hold

Operating Manual References

1.3.6 Background Music (BGM)

1.1.8 Built-in Voice Message (BV)

Description

If an optional voice message card is installed in the PBX, a caller can leave a voice message in a user's personal message area or the PBX's common message area. Information on the recorded messages is automatically logged in the Incoming Call Log of the extension, where it can be viewed later or used to play back the original message (→ 1.1.18 Call Log, Incoming).

The optional voice message card has 2 voice message resources (Built-in Voice Message [BV] resource 1 and BV resource 2), and every extension must belong to one of these resources based on system programming (→ [621] BV Resource).

Extension users other than the operator or manager can access the following options:

- Personal BV outgoing messages (OGMs)
- Personal voice messages (left by callers via Call Forwarding [FWD] or Direct Message)

Messages can be recorded, played, and erased by that extension's user.

The operator or manager can access the following options:

- Personal BV OGMs for the operator or manager
- Personal voice messages (left by callers via FWD or Direct Message for the operator or manager)
- Common BV OGMs for the company
- Common voice messages (left by callers for the company)

Messages can be recorded, played, and erased by the operator or manager only.

Up to 125 voice messages with a total recording time of 60 minutes (→ [807] BV Total Recording Time) can be logged per BV resource. All personal/common message areas within each BV resource share the total space of the resource. For example, in BV resource 1, if the common message area currently has 10

messages, totaling 10 minutes, the personal and common message areas can jointly store up to 115 messages or 50 minutes.

[Example: Pattern A]

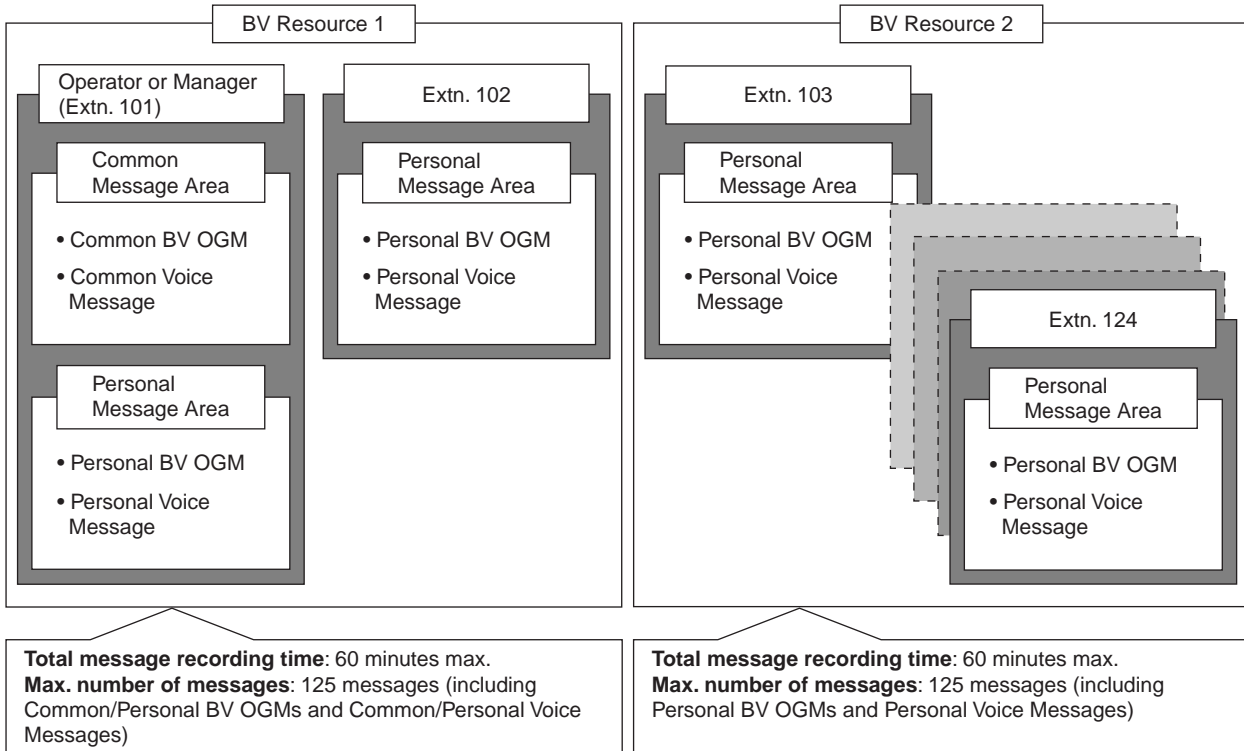

[Example: Pattern B]

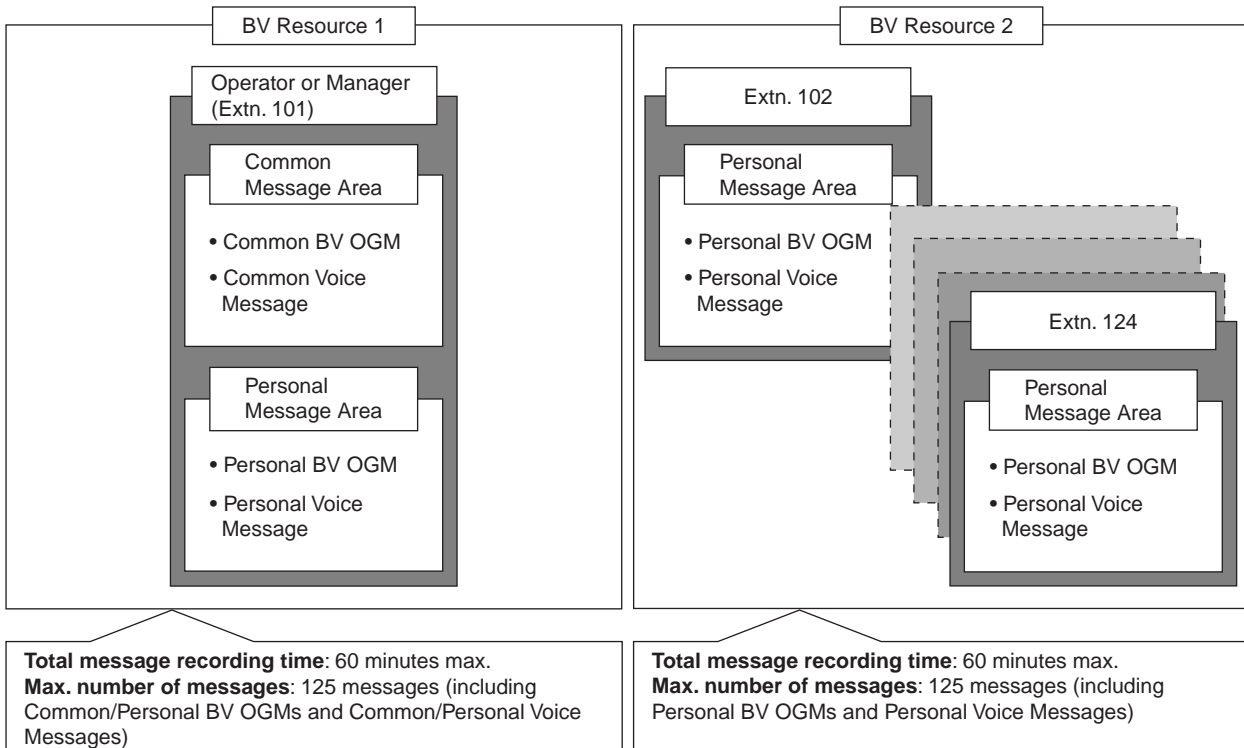

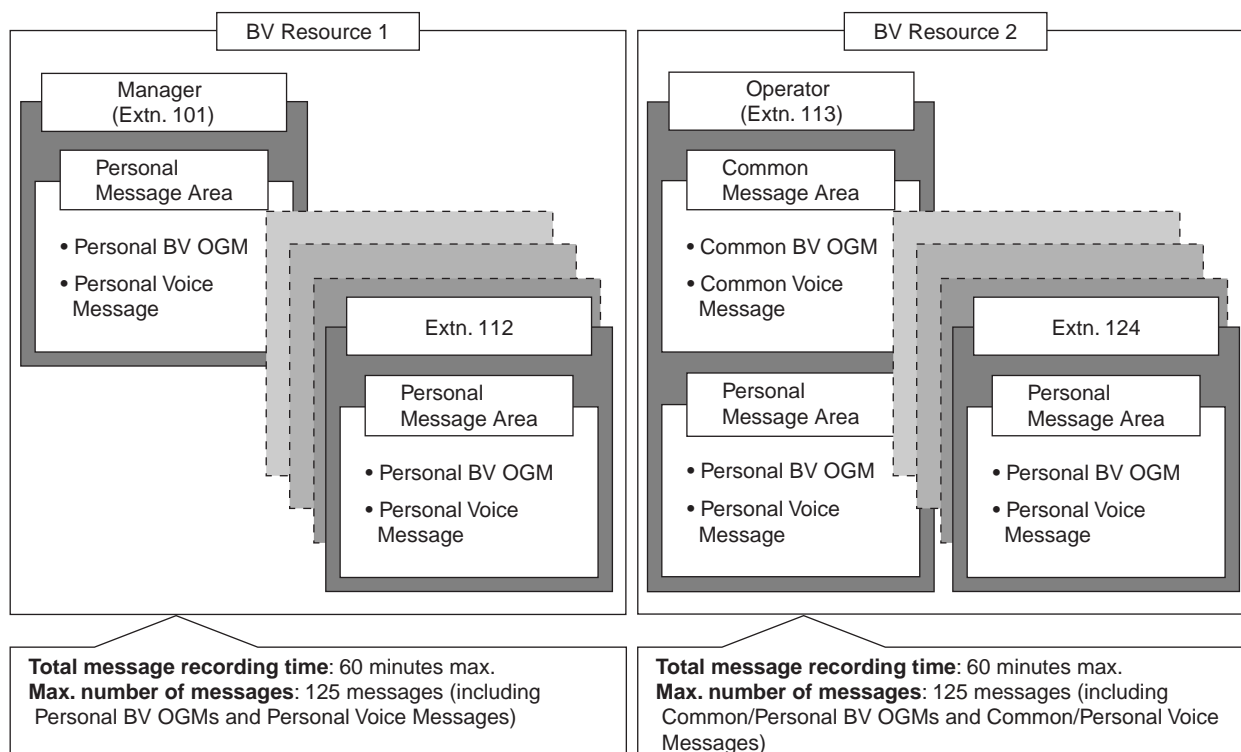
[Example: Pattern C]

If there are new voice messages in a user's personal message area or the common message area (if accessible), the user will hear a special dial tone (dial tone 4) when going off-hook. In addition, if that user's telephone has a MESSAGE button or Message/Ringer Lamp, the corresponding button or lamp will light when a message has been left. A MESSAGE button can be used to listen to the message after the user goes off-hook. Pressing the lit MESSAGE button on a display proprietary telephone (PT) while on-hook shows voice message information.

The BV feature allows users to also perform the following operations:

- If outside (CO) line calls are preprogrammed to be automatically directed to a common message area (→ [414-416] CO Line Mode—Day/Night/Lunch), or if Direct Inward System Access (DISA) calls are preprogrammed to be redirected to a common message area via Intercept Routing (→ [438-440] DISA IRNA to BV—Day/Night/Lunch), the caller will hear a common BV OGM and can leave a voice message directly in the common message area.

[Programming Example]

| Outside (CO) Line No. | Distribution method*1 | | | DISA IRNA to BV*2 | | |
|--------------------------|-----------------------|--------------|--------|-------------------|------------|------------|
| | Day | Night | Lunch | Day | Night | Lunch |
| 1 | BV01*3 | BV02*3 | BV02*3 | Not Stored | Not Stored | Not Stored |
| 2 | DISA OGM3 | DISA OGM4 | Normal | BV20*3 | BV21*3 | Not Stored |
| (Cont.) : | : | : | : | : | : | : |
| : | : | : | : | : | : | : |
| 8 | Normal | Normal | Normal | Not Stored | Not Stored | Not Stored |

*1 → [414-416] CO Line Mode—Day/Night/Lunch

*2 → [438-440] DISA IRNA to BV—Day/Night/Lunch

Note

This feature functions only when "DISA" is selected as the distribution method for the corresponding outside (CO) line port.

*3 BVxx (xx=01–24): Common BV OGM number followed by the Common BV OGM feature number "722"

In this example:

If an outside (CO) line call is received on outside (CO) line 1:

- a) In day mode: The common BV OGM to be played ("BV01") for BV distribution is assigned. The caller hears the specified common BV OGM and leaves a voice message in the common message area.
- b) In night/lunch mode: The common BV OGM to be played ("BV02") for BV distribution is assigned. The caller hears the specified common BV OGM and leaves a voice message in the common message area.

If an outside (CO) line call is received on outside (CO) line 2:

- a) In day mode: The DISA OGM to be played ("DISA OGM3") for DISA distribution and the common BV OGM to be played ("BV20") for DISA IRNA to BV are assigned. The call arrives on a DISA line and the caller hears the specified DISA OGM. When the destination does not answer the DISA call, the call is redirected to the common message area via Intercept Routing. The caller hears the specified common BV OGM and leaves a voice message in the common message area.
 - b) In night mode: The DISA OGM to be played ("DISA OGM4") for DISA distribution and the common BV OGM to be played ("BV21") for DISA IRNA to BV are assigned. The call arrives on a DISA line and the caller hears the specified DISA OGM. When the destination does not answer the DISA call, the call is redirected to the common message area via Intercept Routing. The caller hears the specified common BV OGM and leaves a voice message in the common message area.
- An extension user can set incoming calls to be forwarded to his or her personal message area, when he or she cannot answer them. If an incoming call, direct to the user's extension, or a call using the DISA AA service (→ [414-416] CO Line Mode—Day/Night/Lunch), is forwarded to the user's personal message area, the caller will hear a personal BV OGM and can leave a voice message.
 - **Direct Message feature**
An extension user can leave a voice message directly in the personal message area of another extension, even if the extension has not been set to forward incoming calls to its personal message area, or even if no personal/common BV OGM has been recorded. When a caller leaves a voice message using this feature, the voice message is automatically linked to the caller information (including the extension number and name [if stored]) in the Incoming Call Log.
 - An extension user can play and/or erase voice messages from the user's extension. In addition, a user or the operator/manager can remotely play and/or erase voice messages through an outside (CO) line. The relevant voice message area is accessed by entering a preprogrammed voice message access code (→ [625] BV Access Code through CO Line) while hearing a personal/common BV OGM or DISA OGM.

Note

If the Voice Mail Integration feature has been set, the BV feature will not function.

Conditions

- **Hardware Requirement:** An optional voice message card.
- The BV feature does not use OGMs for DISA on either the preinstalled DISA OGM card or the optional message expansion card for DISA OGMs (if present) (→ 1.1.88 Outgoing Message (OGM) for DISA).
- When an extension that belongs to BV resource 1 or BV resource 2 is reassigned to the other resource, the voice messages that were recorded prior to reassignment are erased, but the personal/common BV OGMs are not erased.
- Each resource can only be accessed by one extension at a time. When the resource an extension is assigned to is being used by another extension, the extension cannot use that resource, even if the other resource is available.
- The PBX can record a maximum of 125 voice messages per resource. The maximum recording time of each voice message (→ [214] BV Recording Time) and the total recording time of the PBX (→ [807] BV Total Recording Time) are programmable. The maximum recording time of each personal/common BV OGM (→ [215] Common/Personal BV OGM Recording Time) is also programmable.
- System programming determines the extension users that can use this feature (→ [622] BV for Extension).
- If a voice message channel (resource) is in use when an outside caller tries to leave a voice message, he or she will hear a ringback tone. The caller will hear a personal/common BV OGM as soon as a channel becomes available. Up to 8 outside (CO) line calls can be placed in a queue as they arrive.
- If a user performs System Data Clear by selecting "All para" through system programming (→ [999] System Data Clear), all voice messages except for personal/common BV OGMs are erased. To erase all voice messages and personal/common BV OGMs at once, initialize the voice message card through system programming (→ [808] BV Card Initialization).
- Even if no flexible CO button is assigned as a Caller ID Indication—Personal button or a Caller ID Indication—Common button, a caller can leave a voice message in that personal/common message area and the Caller ID information, including associated voice messages will be logged.
- When the remaining recording time for the PBX is less than 5 minutes, the display informs both the extension users within the same resource and the manager that the voice message resource is full, and the users will hear a special dial tone (dial tone 5) when going off-hook. If the remaining recording time goes back to being 5 minutes or more, for example, when messages are erased, the display returns to the idle status display and the users will hear another dial tone instead of dial tone 5 when going off-hook.
- If the FWD feature is enabled for an extension whose FWD destination is the BV feature number (→ [963] Call Forwarding Selection) and the extension has been assigned as "Normal" (→ [414-416] CO Line Mode—Day/Night/Lunch), outside (CO) line calls arriving at the extension will not be forwarded and the extension will not ring, even if the user has set the FWD feature. If FWD is disabled, outside (CO) line calls arriving at the extension will not be forwarded and the extension will ring.
- Only the operator or the manager can access the common message area (including common BV OGM). The operator has higher priority than the manager as follows:
 - When the operator extension is reassigned, the common voice messages (except for the personal BV OGM of the operator) that were recorded prior to reassignment are erased. The new operator can record, play back, and erase the common BV OGM.
 - When the operator, who does not share an extension number with the manager, is newly assigned, the common voice messages (except for the personal BV OGM of the manager) that were recorded prior to reassignment are erased. The operator can record, play back, and erase the common BV OGM.
 - When the operator, who does not share an extension number with the manager, is deleted, the common voice messages (except for the personal BV OGM of the operator) that were recorded prior to reassignment are erased. In this case, the manager can record, play back, and erase the common BV OGM.

- A voice message area cannot be included as a member of a conference call.
- Even if a caller does not leave a voice message in either the personal or common message area, for example, by going on-hook while hearing a personal/common BV OGM, the information is still logged in the corresponding Incoming Call Log (common or personal area) and displayed by SMDR (→ 1.1.112 Station Message Detail Recording (SMDR)).
- A PT user can listen to voice messages by entering the Message Waiting Answer feature number.

Installation Manual References

2.3.8 2-Channel Voice Message Card (KX-TA82492)

Programming Manual References

[PT Programming]

[214] BV Recording Time
[215] Common/Personal BV OGM Recording Time
[414-416] CO Line Mode—Day/Night/Lunch
[438-440] DISA IRNA to BV—Day/Night/Lunch
[621] BV Resource
[622] BV for Extension
[625] BV Access Code through CO Line
[807] BV Total Recording Time
[808] BV Card Initialization
[963] Call Forwarding Selection
[999] System Data Clear

[PC Programming]

8.4 System Data Clear
8.6 BV Card Initialization
9.2.1 Main [2-1]—FWD Selection
9.2.2 Feature settings [2-2]—FWD/DND
9.3.1 Line Mode [3-1]—Mode of incoming CO calls—Day, Night, Lunch
9.8 BV [8]

Feature Manual References

1.1.18 Call Log, Incoming
1.1.41 Direct Inward System Access (DISA)
1.1.59 Fixed Buttons
1.1.61 Flexible Buttons
1.1.88 Outgoing Message (OGM) for DISA
1.1.112 Station Message Detail Recording (SMDR)
2.2.1 Tones/Ring Tones

Operating Manual References

1.3.7 Built-in Voice Message (BV)
2.1.3 Common BV Outgoing Messages

3.1.3 Flexible Button Assignment—FWD/DND, Message, or Caller ID Indication—Personal/Common button

1.1.9 Busy Station Signaling (BSS)

Description

When an extension user attempts to call a busy extension (i.e., an extension that is ringing or having a conversation), a call waiting tone will be sent to the called extension to indicate another call is waiting.

Conditions

- This feature functions only if the called extension has activated Call Waiting. If it is activated, the calling extension user will hear a ringback tone.
- One of 2 call waiting tones can be selected through personal programming (Call Waiting Tone Type Selection).

Feature Manual References

1.1.27 Call Waiting

2.2.1 Tones/Ring Tones

Operating Manual References

1.3.8 Busy Station Signaling (BSS)

3.1.2 Personal Feature Assignment—Call Waiting Tone Type Selection

1.1.10 Call Forwarding (FWD)—SUMMARY

Description

Extension users can forward their calls to preset destinations. There are 4 Call Forwarding (FWD) modes, described below.

| Mode | Description |
|-----------------------------|--|
| All Calls | All calls are forwarded to another extension. |
| Busy/No Answer | All calls are forwarded to another extension when the extension user's line is busy, or when the user does not answer within a preprogrammed time period (→ [202] Call Forwarding Start Time). |
| Follow Me | When an extension user fails to set this feature before leaving his or her desk, this feature can be set from the destination extension. |
| To Outside (CO) Line | All calls are forwarded to an outside party, provided this feature is enabled for each extension through system programming (→ [607] Call Forwarding to CO Line). |

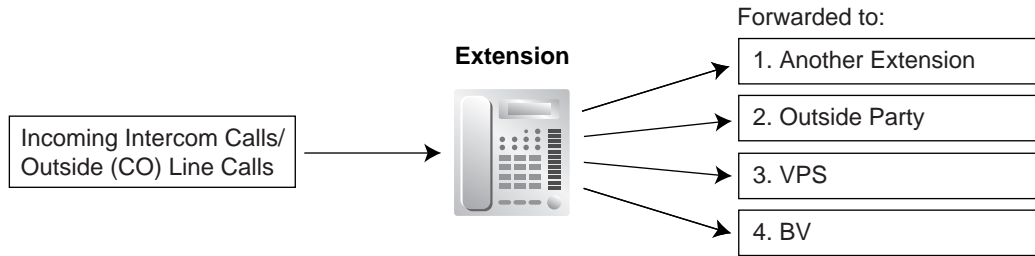

[Available Destinations]

| Destination | Availability |
|--|--|
| Extension (proprietary telephone [PT]/single line telephone [SLT]) | – |
| Automatic Line Access no. + Phone no. | Only available when FWD to Outside (CO) Line is enabled for the extension through system programming (→ [607] Call Forwarding to CO Line). |
| Outside (CO) Line Group Access no. + Outside (CO) Line Group no. + Phone no. | Only available when FWD to Outside (CO) Line is enabled for the extension through system programming (→ [607] Call Forwarding to CO Line). |
| Voice Processing System (VPS) | – |
| Built-in Voice Message (BV) feature no. | Only available when the BV feature is enabled for the extension through system programming (→ [622] BV for Extension). |

Conditions

- **FWD/DND Button**
If a proprietary telephone (PT) does not have an FWD/DND button, a flexible CO button can be customized as an FWD/DND button.

[Button Status]

The FWD/DND button shows the current status as follows:

| Light Pattern | Status |
|-------------------|-------------|
| Red on | DND on |
| Slow red flashing | FWD on |
| Off | FWD/DND off |

- Setting a new FWD mode, such as All Calls or Busy/No Answer, or the DND feature, clears the status of the previous FWD mode or DND feature.

Programming Manual References

[PT Programming]

- [202] Call Forwarding Start Time
- [607] Call Forwarding to CO Line
- [622] BV for Extension

[PC Programming]

9.1.7 Timers [1-6]—Start Time—Call Forwarding

9.2.1 Main [2-1]—Call Forward to CO

9.2.2 Feature settings [2-2]—FWD/DND

9.8.1 Main [8-1]—BV for Extension

Feature Manual References

1.1.59 Fixed Buttons

1.1.61 Flexible Buttons

Operating Manual References

1.3.7 Built-in Voice Message (BV)

1.3.9 Call Forwarding (FWD)—SUMMARY

1.3.88 Voice Mail Integration

3.1.3 Flexible Button Assignment—FWD/DND button

1.1.11 Call Forwarding (FWD)—All Calls**Description**

All calls are forwarded to another extension.

Conditions

- This feature does not apply to calls from Hold Recall and Camp-on Recall.
- The types of calls that are forwarded by this feature are:

| Call Type | |
|-------------------------|--|
| Outside (CO) line calls | Normal, Direct In Line (DIL), Direct Inward System Access (DISA) |
| Intercom calls | Extension, Transfer |

- When a call is forwarded, the corresponding message waiting indication is not forwarded. The MESSAGE button light or Message/Ringer Lamp turns on only at the originally called extension (→ 1.1.82 Message Waiting).
- It is programmable whether the calls received on outside (CO) lines programmed as "Normal" (→ [414-416] CO Line Mode—Day/Night/Lunch) are forwarded for each extension or not (→ [963] Call Forwarding Selection). If FWD is enabled for an extension whose FWD destination is a VPS or Telephone Answering Machine (TAM) and the extension has been assigned to ring with other extensions, the VPS or TAM may answer the call before other extensions can answer it. To prevent this, disable FWD.
- A call can only be automatically forwarded one time. In the example below, extension A's calls are being forwarded to extension B. If extension B tries to set FWD to extension C, the extension B user hears a reorder tone and the setting is denied. If extension B has already set FWD to extension C, and extension A tries to set FWD to extension B, the setting is also denied.

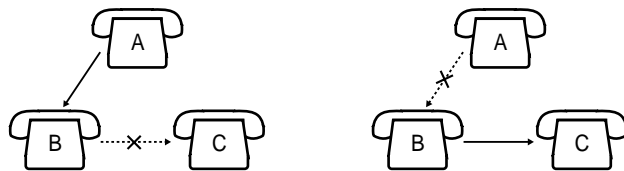

- The destination of an extension's forwarded calls can call or transfer calls to the original extension.

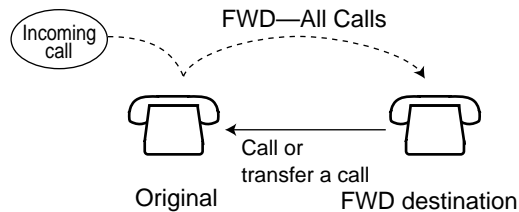

Programming Manual References

[PT Programming]

[414-416] CO Line Mode—Day/Night/Lunch

[963] Call Forwarding Selection

[PC Programming]

9.2.1 Main [2-1]—FWD Selection

9.3.1 Line Mode [3-1]—Mode of incoming CO calls—Day, Night, Lunch

Feature Manual References

1.1.82 Message Waiting

Operating Manual References

1.3.10 Call Forwarding (FWD)—All Calls

1.1.12 Call Forwarding (FWD)—Busy/No Answer

Description

All calls are forwarded to another extension when the extension user's line is busy, or when the user does not answer within a preprogrammed time period (→ [202] Call Forwarding Start Time).

Conditions

- This feature does not apply to calls from Hold Recall and Camp-on Recall.
- The types of calls that are forwarded by this feature are:

| Call Type | |
|-------------------------|--|
| Outside (CO) line calls | Normal, Direct In Line (DIL), Direct Inward System Access (DISA) |
| Intercom calls | Extension, Transfer |

- When a call is forwarded, the corresponding message waiting indication is not forwarded. The MESSAGE button light or Message/Ringer Lamp turns on only at the originally called extension (→ 1.1.82 Message Waiting).
- It is programmable whether the calls received on outside (CO) lines programmed as "Normal" (→ [414-416] CO Line Mode—Day/Night/Lunch) are forwarded for each extension or not (→ [963] Call Forwarding Selection). If FWD is enabled for an extension whose FWD destination is a VPS or Telephone Answering Machine (TAM) and the extension has been assigned to ring with other extensions, the VPS or TAM may answer the call before other extensions can answer it. To prevent this, disable FWD.
- A call can only be automatically forwarded one time. In the example below, extension A's calls are being forwarded to extension B. If extension B tries to set FWD to extension C, the extension B user hears a reorder tone and the setting is denied. If extension B has already set FWD to extension C, and extension A tries to set FWD to extension B, the setting is also denied.

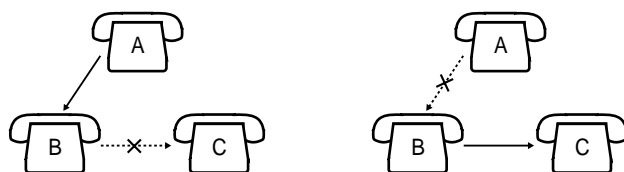

- The destination of an extension's forwarded calls can call or transfer calls to the original extension.

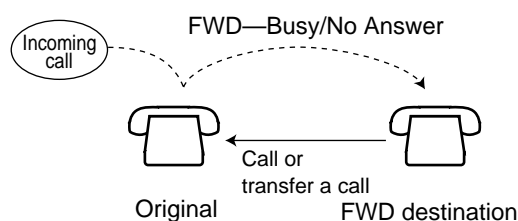

- **No Answer Time**
The length of time before calls are forwarded is programmable (→ [202] Call Forwarding Start Time).

Programming Manual References

[PT Programming]

[202] Call Forwarding Start Time

[414-416] CO Line Mode—Day/Night/Lunch

[963] Call Forwarding Selection

[PC Programming]

9.1.7 Timers [1-6]—Start Time—Call Forwarding

9.2.1 Main [2-1]—FWD Selection

9.3.1 Line Mode [3-1]—Mode of incoming CO calls—Day, Night, Lunch

Feature Manual References

1.1.82 Message Waiting

Operating Manual References

1.3.11 Call Forwarding (FWD)—Busy/No Answer

1.1.13 Call Forwarding (FWD)—Follow Me

Description

When an extension user fails to set this feature before leaving his or her desk, this feature can be set from the destination extension.

Conditions

- This feature does not apply to calls from Hold Recall and Camp-on Recall.
- The types of calls that are forwarded by this feature are:

| Call Type | |
|-------------------------|--|
| Outside (CO) line calls | Normal, Direct In Line (DIL), Direct Inward System Access (DISA) |
| Intercom calls | Extension, Transfer |

- When a call is forwarded, the corresponding message waiting indication is not forwarded. The MESSAGE button light or Message/Ringer Lamp turns on only at the originally called extension (→ 1.1.82 Message Waiting).
- It is programmable whether the calls received on outside (CO) lines programmed as "Normal" (→ [414-416] CO Line Mode—Day/Night/Lunch) are forwarded for each extension or not (→ [963] Call Forwarding Selection). If FWD is enabled for an extension whose FWD destination is a VPS or Telephone Answering Machine (TAM) and the extension has been assigned to ring with other extensions, the VPS or TAM may answer the call before other extensions can answer it. To prevent this, disable FWD.
- A call can only be automatically forwarded one time. In the example below, extension A's calls are being forwarded to extension B. If extension B tries to set FWD to extension C, the extension B user hears a reorder tone and the setting is denied. If extension B has already set FWD to extension C, and extension A tries to set FWD to extension B, the setting is also denied.

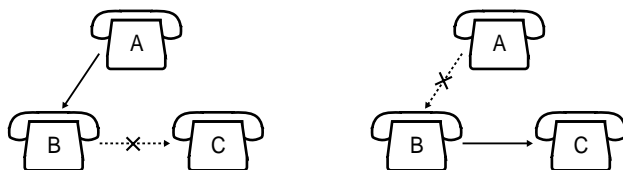

- The destination of an extension's forwarded calls can call or transfer calls to the original extension.

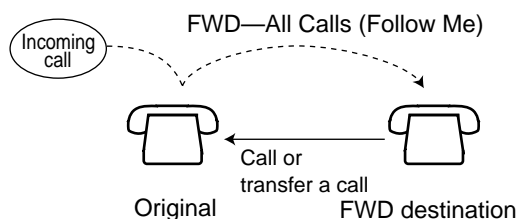

Programming Manual References

[PT Programming]

[414-416] CO Line Mode—Day/Night/Lunch

[963] Call Forwarding Selection

[PC Programming]

9.2.1 Main [2-1]—FWD Selection

9.3.1 Line Mode [3-1]—Mode of incoming CO calls—Day, Night, Lunch

Feature Manual References

1.1.11 Call Forwarding (FWD)—All Calls

1.1.82 Message Waiting

Operating Manual References

1.3.12 Call Forwarding (FWD)—Follow Me

1.1.14 Call Forwarding (FWD)—To Outside (CO) Line**Description**

All calls are forwarded to an outside party, provided this feature is enabled for each extension through system programming (→ [607] Call Forwarding to CO Line).

Conditions

- This feature does not apply to calls from Hold Recall and Camp-on Recall.
- The types of calls that are forwarded by this feature are:

| Call Type | |
|-------------------------|--|
| Outside (CO) line calls | Direct In Line (DIL), Direct Inward System Access (DISA) |
| Intercom calls | Extension, Transfer |

- A call can only be automatically forwarded one time.

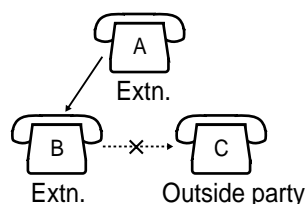

- System programming determines the extensions that can forward all intercom calls and certain outside (CO) line calls to an outside party (→ [607] Call Forwarding to CO Line). These outside (CO) line calls must arrive on outside (CO) lines whose programming (→ [414-416] CO Line Mode—Day/Night/Lunch) is one of the following:
 - a) DIL
 - b) DISA (only when the call is directly sent to an extension, not intercepted)
- **Outside (CO) Line Call Duration**
If a call between 2 outside parties is established, the call duration will be restricted by a system timer (→ [205] CO-to-CO Line Call Duration). Both parties will hear a warning tone 15 seconds before the timer expires. When the timer expires, the call is disconnected (→ 1.1.91 Outside-to-Outside (CO-to-CO) Line Call Duration).

- If a CPC (Calling Party Control) signal is received from an outside (CO) line, the corresponding call between 2 outside parties will be disconnected.

Programming Manual References

[PT Programming]

[205] CO-to-CO Line Call Duration

[414-416] CO Line Mode—Day/Night/Lunch

[605] Account Code Mode

[607] Call Forwarding to CO Line

[PC Programming]

9.1.7 Timers [1-6]—Call Duration—CO-to-CO Duration Limit

9.2.1 Main [2-1]—Account Code Mode, Call Forward to CO

9.3.1 Line Mode [3-1]—Mode of incoming CO calls—Day, Night, Lunch

Feature Manual References

1.1.91 Outside-to-Outside (CO-to-CO) Line Call Duration

Operating Manual References

1.3.13 Call Forwarding (FWD)—To Outside (CO) Line

1.1.15 Call Hold

Description

An extension user can put a call on hold. Any extension user can retrieve a held call.

Conditions

- Using the Call Hold feature, a proprietary telephone (PT) user can have one intercom call and multiple outside (CO) line calls on hold at the same time. To hold multiple intercom calls, the user should use the Call Park feature (→ 1.1.19 Call Park). Using the Call Hold feature, a single line telephone (SLT) user can have either one intercom call or one outside (CO) line call on hold. To hold multiple calls, the user should use the Call Park feature.
- If an outside party is placed on hold and the call is not retrieved within 30 minutes, the call is automatically disconnected.
- **Music on Hold**
Music, if available, is sent to the outside party on hold (→ 1.1.85 Music on Hold). An external audio source or tone can be selected as the Music on Hold through system programming (→ [111] Music on Hold).
- Doorphone calls cannot be put on hold.
- **Hold Recall**
If a call on hold is not retrieved within a preprogrammed time period (→ [200] Hold Recall Time), a ring tone will be heard at the extension that put the call on hold. If the extension is engaged in a call when the timer expires, an alarm tone will be heard. If the hold recall time is set to "Disable", no tone will be heard. Going off-hook after the hold recall time has expired automatically re-establishes the conversation with the call on hold.

- **SLT Hold Mode**

It is possible to specify how calls are held and transferred with an SLT when the Recall/hookswitch is pressed for less than 1000 ms.

The following methods (→ [104] SLT Hold Mode) are available:

| Mode | Hold | Transfer to Extension |
|---------------|--|--|
| Hold-1 | Pressing the Recall/hookswitch + Going on-hook | Pressing the Recall/hookswitch + Extension No. |
| Hold-2 | Pressing the Recall/hookswitch + Call Hold Feature No. + Going on-hook | Pressing the Recall/hookswitch + Extension No. |
| Hold-3 | Pressing the Recall/hookswitch + Call Hold Feature No. + Going on-hook | Pressing the Recall/hookswitch + Call Hold Feature No. + Extension No. |

In some cases, a call is not disconnected when an SLT user goes on-hook. Instead, the call is mistakenly placed on hold. After a specified time expires, the Hold Recall tone is heard. When the SLT user answers this, the user hears a cyclic tone (like a reorder tone). To avoid this problem, select "Hold-2" or "Hold-3". In either of these modes, all calls are disconnected when going on-hook, unless the Call Hold feature number is entered after pressing the Recall/hookswitch.

- Pressing the HOLD button multiple times alternates between General and Exclusive Call Hold.

Programming Manual References

[PT Programming]

[104] SLT Hold Mode

[111] Music on Hold

[200] Hold Recall Time

[PC Programming]

9.1.2 Main [1-2]—Music on Hold

9.1.7 Timers [1-6]—Recall Time—Call Hold

9.1.11 Detail [1-10]—Single Line Telephone—Hold Mode

Feature Manual References

1.1.19 Call Park

1.1.85 Music on Hold

2.2.1 Tones/Ring Tones

Operating Manual References

1.3.15 Call Hold

1.1.16 Call Hold, Exclusive

Description

A proprietary telephone (PT) user can put a call on hold. Only the PT user who held the call can retrieve it.

Conditions

- This feature is not available on single line telephones (SLTs).
- If an outside party is placed on hold and the call is not retrieved within 30 minutes, the call is automatically disconnected.
- **Music on Hold**
Music, if available, is sent to the outside party on hold (→ 1.1.85 Music on Hold). An external audio source or tone can be selected as the Music on Hold through system programming (→ [111] Music on Hold).
- **Hold Recall**
If a call on hold is not retrieved within a preprogrammed time period (→ [200] Hold Recall Time), a ring tone will be heard at the extension that put the call on hold. If the extension is engaged in a call when the timer expires, an alarm tone will be heard. If the hold recall time is set to "Disable", no tone will be heard. Going off-hook after the hold recall time has expired automatically re-establishes the conversation with the call on hold.
- Pressing the HOLD button multiple times alternates between General and Exclusive Call Hold.

Programming Manual References

[PT Programming]

[111] Music on Hold

[200] Hold Recall Time

[PC Programming]

9.1.2 Main [1-2]—Music on Hold

9.1.7 Timers [1-6]—Recall Time—Call Hold

Feature Manual References

1.1.85 Music on Hold

2.2.1 Tones/Ring Tones

Operating Manual References

1.3.16 Call Hold, Exclusive

1.1.17 Call Hold Retrieve

Description

An extension user can retrieve a call that has been put on hold at the holding extension or by another extension user.

Feature Manual References

- 1.1.15 Call Hold
- 2.2.1 Tones/Ring Tones

Operating Manual References

- 1.3.17 Call Hold Retrieve

1.1.18 Call Log, Incoming

Description

When a call containing Caller ID information is received by an extension, the information is shown on the telephone display, notifying the extension user of the caller's identity.

This information is also automatically logged in the Incoming Call Log of the extension, and can be viewed later or used to call that caller back.

There are 2 types of call log areas available in the PBX. One is the personal area, which stores logs of calls received by each extension when a call arrives at a certain proprietary telephone (PT).

The other is the common area, which stores a log of calls arriving at multiple PTs or via the Intercept Routing feature. Caller ID information can be logged by the following methods:

- Logged automatically when no one answers calls.
- Logged automatically if an extension user presets logging of the caller's information when answering calls.
- Logged manually by pressing the Caller ID Indication button during a conversation.
- Logged automatically when a caller leaves a voice message (→ 1.1.8 Built-in Voice Message (BV))

[Example]

If the information is stored in record "002"*1,

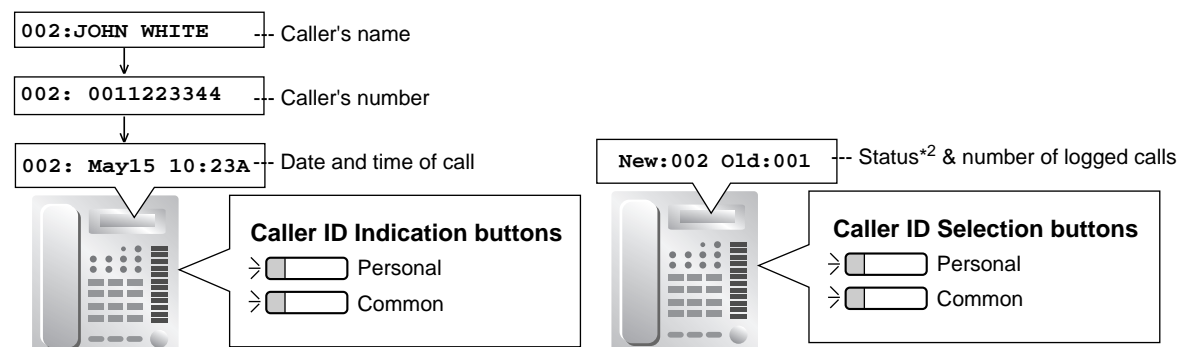

*1 If the Call Waiting Caller ID feature is enabled for one or more outside (CO) lines (→ [913] Call Waiting Caller ID Assignment), the sequence number such as "002:" will be deleted and subsequent information (Caller's number, etc.) will be moved to the left side of the display.

*2 "New" is displayed for call records that have not previously been viewed;
 "Old" is displayed for call records that have previously been viewed.
 Both new and old call records are stored in each personal and common area.

Conditions

- **Hardware Requirement:** An optional Caller ID card for outside (CO) lines 4–8.
- **Caller ID Indication—Personal/Common Button**
A flexible CO button can be customized as a Caller ID Indication—Personal/Common button, and will indicate the status of the Incoming Call Log for the extension, as shown below.

| Light pattern | Status of the corresponding call log |
|---------------|---|
| Red on | There are new call records since the last time the call log was viewed. |
| Off | There are no new call records in the call log, or the call log has been already viewed. |

The Caller ID Indication—Personal/Common button will alert an extension user to any missed (unanswered) calls.

The Caller ID Indication—Personal/Common button is also used to store the information of an incoming call during a conversation, and to view caller information while on-hook and then call back a caller. If a Caller ID Indication—Common button is not assigned to any PT, the calls will be logged in the personal area of the PT that is connected to the lowest-numbered jack, and its Caller ID Indication—Personal button light will turn red.

- **Caller ID Selection—Personal/Common Button**
A flexible CO button can be customized as a Caller ID Selection—Personal/Common button. The Caller ID Selection—Personal/Common button is used to display the number of logged calls while on-hook, to display and cycle through the information of an incoming call during a conversation, while receiving a call, or while viewing caller information, and to inform an extension user that the personal or common area call log is full. The user may also change the displayed information by pressing the "#" key instead of the Caller ID Selection—Personal/Common button while receiving a call, or while viewing caller information.
- It is programmable whether the user can view call logs stored in the common area or not (→ [909] Common Area Call Log Check). If this program is enabled, the Caller ID Indication—Common button and Caller ID Selection—Common button can be assigned.
- **Incoming Call Log Memory**
The total number of incoming calls that can be logged by the PBX is limited (→ 2.1.1 Capacity of System Resources). When a call log is full (personal area: 20 calls, common area: 300 calls), the Caller ID Selection—Personal/Common button light will turn red. When a caller leaves a voice message, it is automatically linked to the Caller ID information in the Incoming Call Log. Up to 125 voice messages per BV resource are stored separately from the Incoming Call Logs mentioned above.
It is possible for an extension user (or the operator/manager) to select whether the oldest call in the personal area (or common area) will be replaced each time a call is received, or whether the new call information will be discarded, by entering the 21st Incoming Call Logged in the Personal Area (or 301st Incoming Call Logged in the Common Area) feature number.
Caller records for all call logs of an extension are numbered sequentially as they are received, regardless of which call log the information is stored in. For example, information on the first call received will be stored as record "001" (e.g., 001, logged in the personal area) and information on the second call received will be stored as record "002" (e.g., 002, logged in the common area), whether it is logged in the personal area, common area, or BV.
If the call log in the personal area becomes full when the 21st call (e.g., 110, logged in the personal area) has been set to overwrite the oldest call (001, logged in the personal area),
 - The oldest call will be deleted and subsequent records will be moved one number down, if the 21st call is unanswered or if it is answered but has different information from the 20th call.
 - The 21st call will be discarded and the previous call information will stay as it is, if the 21st call is answered and has the same information as the 20th call.

Common area call logs function in the same way.

- If a transferred call (unscreened) is not answered, the information is logged in the personal area of the final destination.
- Regardless of the telephone type being used, the recorded voice message is associated with the caller's information.
- Even if no flexible CO button is assigned as a Caller ID Indication—Personal button or a Caller ID Indication—Common button, a caller can leave a voice message in that personal/common message area and the Caller ID information, including associated voice messages will be logged.
- **Call Log Display Lock, Incoming**
An extension user can lock the Incoming Call Log (including associated voice messages) stored in his or her personal area, preventing other users from viewing its contents (→ 1.1.55 Extension Lock). The operator or manager can cancel the lock in the case that the extension user forgets the lock code (Extension Lock—CANCEL ALL).
The Incoming Call Log for the common area can only be locked or unlocked by the operator or manager.
- **Automatic Caller ID Number Modification**
If the PBX is programmed to automatically modify incoming telephone numbers, the modified numbers will be displayed when Caller ID information is checked. Extension users can also modify the incoming telephone numbers manually.
- **Initial Display Selection**
If the Caller ID service provides both the number and name, the user can select which is shown first on the display of the PT through system programming (→ [904] Caller ID Log Priority).
- While a user is viewing his or her extension's Incoming Call Log, if the caller whose information is being viewed also left a voice message, the Message/Ringer Lamp or the MESSAGE button light will turn on. The associated voice messages in that personal/common message area can be played or erased with the MESSAGE button or the TRANSFER button respectively.
- Even if there are message waiting indications left at a user's extension, the Message/Ringer Lamp or the MESSAGE button light that displays notifications from the Message Waiting feature (→ 1.1.82 Message Waiting) turns off while the user is viewing his or her extension's Incoming Call Log with the Caller ID Indication—Personal/Common button.
- If a user erases voice messages by any method (for example, by using BV or performing System Data Clear), the caller's information is erased from the extension's Incoming Call Log simultaneously.
- Even if a caller does not leave a voice message, for example, by going on-hook while hearing a personal/common BV outgoing message (OGM), the information is logged in the corresponding Incoming Call Log (common or personal area).
- During a conversation with an extension or outside party, an extension user can transfer the call to another extension that has set incoming calls to be forwarded to that extension's personal message area, or can transfer the call to the personal message area using the Direct Message feature of BV. If the transferring user performs Call Transfer with Announcement, there is a chance that both parties may be recorded in the same message. In this case, the information of the last extension or outside party that recorded the message is logged in the corresponding Incoming Call Log (personal area).

Installation Manual References

2.3.5 3-Port Caller ID Card (KX-TA82493)

Programming Manual References

[PT Programming]

[900] Caller ID

[901] Caller ID Area Code

[902] Caller ID Modification for Local Calls

[903] Caller ID Modification for Long-distance Calls

[904] Caller ID Log Priority
[906] Caller ID SMDR Format
[907] Caller ID SMDR Printout
[909] Common Area Call Log Check
[913] Call Waiting Caller ID Assignment

[PC Programming]

9.9.1 Main [9-1]—CO Line Settings—Caller ID, CO Line Settings—Call Waiting Caller ID, Caller ID Modification—Local Area Code (for Local Call 1–5), Caller ID Modification—Removed Digits, Caller ID Modification—Added Number, Caller ID SMDR Format, Caller ID SMDR Printout

9.9.3 Call Log [9-3]

Feature Manual References

1.1.8 Built-in Voice Message (BV)
1.1.30 Caller ID
1.1.55 Extension Lock
1.1.61 Flexible Buttons
1.1.82 Message Waiting
2.1.1 Capacity of System Resources

Operating Manual References

1.3.18 Call Log, Incoming
1.3.19 Call Log Display Lock, Incoming in the Personal Area
2.1.1 Call Log, Incoming in the Common Area—CLEAR ALL
2.1.2 Call Log Display Lock, Incoming in the Common Area
2.1.6 Remote Extension Lock
2.1.7 System Feature Assignment—Extension Lock—CANCEL ALL
2.1.8 The 301st Call Log, Incoming in the Common Area Treatment
3.1.3 Flexible Button Assignment—Caller ID Indication—Personal/Common or Caller ID Selection—Personal/Common button

1.1.19 Call Park

Description

An extension user can hold a call by placing it into a common parking zone of the PBX. A parked call can be retrieved by any extension user. This feature is useful when an extension user wants to hold more than one intercom call with a proprietary telephone (PT), or more than one intercom call or outside (CO) line call with a single line telephone (SLT).

Conditions

- **Call Park Recall**
If a parked call is not retrieved within a preprogrammed time period (→ [200] Hold Recall Time), a ring tone will be heard at the extension that parked the call. If the destination is engaged in a call when the timer expires, an alarm tone will be heard.

- If a parked call is not retrieved within 30 minutes, it is automatically disconnected.
- **Retry**
If the specified parking zone is occupied, the extension user will hear a busy tone. While hearing a busy tone, the user can retry by selecting another parking zone.

Programming Manual References

[PT Programming]

[200] Hold Recall Time

[PC Programming]

9.1.7 Timers [1-6]—Recall Time—Call Hold

Operating Manual References

1.3.20 Call Park

1.1.20 Call Pickup, Directed

Description

An extension user can answer a call ringing at a specific other extension by entering the Directed Call Pickup feature number.

Conditions

- **Call Pickup applies to:**
Intercom calls, outside (CO) line calls, and doorphone calls.
- Calls from Hold Recall and Camp-on Recall cannot be picked up with this feature.
- An extension user will hear a confirmation tone when he or she picks up the call with this feature. It is possible to eliminate the tone through system programming (→ [117] Call Pickup Tone).

Programming Manual References

[PT Programming]

[117] Call Pickup Tone

[PC Programming]

9.1.11 Detail [1-10]—Extension—Call Pickup Tone

Operating Manual References

1.3.21 Call Pickup, Directed

1.1.21 Call Pickup, Group

Description

An extension user can answer a call to an extension in the same extension group (→ [600] Extension Group) ringing at another extension by entering the Group Call Pickup feature number.

Conditions

- **Call Pickup applies to:**
Intercom calls, outside (CO) line calls, and doorphone calls.
- Calls from Hold Recall and Camp-on Recall cannot be picked up with this feature.
- An extension user will hear a confirmation tone when he or she picks up the call with this feature. It is possible to eliminate the tone through system programming (→ [117] Call Pickup Tone).

Programming Manual References

[PT Programming]

[117] Call Pickup Tone

[600] Extension Group

[PC Programming]

9.1.11 Detail [1-10]—Extension—Call Pickup Tone

9.2.11 Extension Group [2-6]—Group No.

Operating Manual References

1.3.22 Call Pickup, Group

1.1.22 Call Pickup Deny

Description

An extension user can prevent other extensions from picking up calls ringing at his or her own extension. If this feature is enabled, other users will hear a reorder tone when trying to pick up calls.

Programming Manual References

[PC Programming]

9.2.2 Feature settings [2-2]—Call Pickup Deny

Feature Manual References

1.1.20 Call Pickup, Directed

1.1.21 Call Pickup, Group

Operating Manual References

1.3.23 Call Pickup Deny

1.1.23 Call Retrieving from a TAM (Telephone Answering Machine)

Description

An extension user can answer a call received by a preprogrammed Telephone Answering Machine (TAM) extension (→ [611] TAM Extension).

Programming Manual References

[PT Programming]

[611] TAM Extension

[PC Programming]

9.2.1 Main [2-1]—TAM Connection

Operating Manual References

1.3.24 Call Retrieving from a TAM (Telephone Answering Machine)

1.1.24 Call Splitting

Description

An extension user can speak alternately with 2 parties. Placing the current call on hold allows the user to speak with the other party.

Conditions

- This feature does not apply to calls from doorphones or paging announcements.
- **Consultation Hold**
When the extension user presses the HOLD button on a proprietary telephone (PT) or the Recall/ hookswitch on a single line telephone (SLT), the held party is automatically placed on consultation hold (→ 1.1.36 Consultation Hold).

Feature Manual References

1.1.36 Consultation Hold

Operating Manual References

1.3.25 Call Splitting

1.1.25 Call Transfer—To Extension

Description

An extension user can transfer a call to another extension.
The following features are available:

| Feature | Transferring method |
|-----------------------------|--|
| With Announcement | Transfer is completed after announcing the transfer to the destination extension party. |
| Without Announcement | Transfer is completed without an announcement. After dialing the destination extension number and hearing a ringback tone or busy tone, the originator can replace the handset. |

Call Transfer with Announcement is also known as Call Transfer—Screened.

Call Transfer without Announcement is also known as Call Transfer—Unscreened.

One-touch Transfer

Direct Station Selection (DSS) Console users and proprietary telephone (PT) users can hold an outside (CO) line call and quickly transfer it to an extension by pressing the DSS button directly (→ [005] One-touch Transfer Using a DSS Button).

A flexible CO/DSS/MESSAGE button can also be customized as a DSS button.

Conditions

- Transfer Recall for Call Transfer without Announcement**
 If the transfer destination extension does not answer within a preprogrammed time period (→ [201] Transfer Recall Time), the call will return to the extension that transferred the call. If there is no answer for 30 minutes after Transfer Recall starts, the call will be disconnected.
- Camp-on Transfer for Call Transfer without Announcement**
 Call Transfer without Announcement is possible while hearing a busy tone, or while hearing a ringback tone after executing Busy Station Signaling (BSS). When the destination extension becomes idle, the transferred call starts ringing automatically at that extension. This is called Camp-on Transfer.
- Music, if available, is sent to the held outside party while the call is being transferred (→ 1.1.85 Music on Hold). An external audio source or tone can be selected as the Music on Hold through system programming (→ [111] Music on Hold).
- Consultation Hold**
 When a transferring party presses the TRANSFER button on a PT or the Recall/hookswitch on a single line telephone (SLT), the transferred party is automatically placed on consultation hold (→ 1.1.36 Consultation Hold).

Programming Manual References

[PT Programming]

[005] One-touch Transfer Using a DSS Button

[104] SLT Hold Mode

[111] Music on Hold

[201] Transfer Recall Time

[PC Programming]

9.1.2 Main [1-2]—Music on Hold

9.1.7 Timers [1-6]—Recall Time—Call Transfer

9.1.11 Detail [1-10]—Single Line Telephone—Hold Mode, DSS—One-touch Transfer Using a DSS Button

Feature Manual References

1.1.36 Consultation Hold

1.1.61 Flexible Buttons

1.1.85 Music on Hold

Operating Manual References

1.3.26 Call Transfer—To Extension

3.1.3 Flexible Button Assignment—DSS button

1.1.26 Call Transfer—To Outside (CO) Line**Description**

A proprietary telephone (PT) user can transfer a call to an outside party. The following feature is available:

| Feature | Transferring method |
|--------------------------|---|
| With Announcement | Transfer is completed after announcing the transfer to the destination outside party. |

Call Transfer with Announcement is also known as Call Transfer—Screened.

Conditions

- System programming determines the extensions that are able to transfer calls to an outside party (→ [606] Call Transfer to CO Line). Single line telephone (SLT) users cannot transfer calls to an outside party.
- Music, if available, is sent to the held outside party while the call is being transferred (→ 1.1.85 Music on Hold). An external audio source or tone can be selected as the Music on Hold through system programming (→ [111] Music on Hold).
- **Outside (CO) Line Call Duration**
If an outside (CO) line call is transferred to an outside party, the call duration will be restricted by a system timer (→ [205] CO-to-CO Line Call Duration). Both parties will hear a warning tone 15 seconds before the timer expires (→ 1.1.91 Outside-to-Outside (CO-to-CO) Line Call Duration). The extension that transferred the call will also hear a ring tone or an alarm tone 50 seconds before the timer expires (→ 1.1.15 Call Hold). When the timer expires, the call is disconnected unless the extension joins the conversation again.
- If a CPC (Calling Party Control) signal is received from an outside (CO) line, the corresponding call between 2 outside parties will be disconnected.
- **Consultation Hold**
When a transferring party presses the TRANSFER button on a PT, the transferred party is automatically placed on consultation hold (→ 1.1.36 Consultation Hold).

Programming Manual References

[PT Programming]

[111] Music on Hold

[205] CO-to-CO Line Call Duration

[420] CPC Signal Detection—Incoming

[606] Call Transfer to CO Line

[PC Programming]

9.1.2 Main [1-2]—Music on Hold

9.1.7 Timers [1-6]—Call Duration—CO-to-CO Duration Limit

9.2.1 Main [2-1]—Transfer to CO

9.3.3 Detail [3-3]—CPC Signal Detection—Incoming

Feature Manual References

1.1.15 Call Hold

1.1.36 Consultation Hold

1.1.85 Music on Hold

1.1.91 Outside-to-Outside (CO-to-CO) Line Call Duration

Operating Manual References

1.3.27 Call Transfer—To Outside (CO) Line

1.1.27 Call Waiting

Description

A busy extension user can be alerted to a new call by Call Waiting. The busy extension user can then answer the second call either by disconnecting the current call or placing it on hold.

If Call Waiting is enabled, a call waiting tone will be sent to the user under the following conditions:

- a) When an outside (CO) line call or a doorphone call is received, or
- b) When another extension executes the Busy Station Signaling (BSS) feature.

If disabled, a reorder tone will be sent to the extension that executed the BSS feature.

Conditions

- **Data Line Security**

When an extension user activates Data Line Security, Call Waiting is turned off (→ 1.1.37 Data Line Security).

- **Call Waiting Tone**

A proprietary telephone (PT) user can select the preferred call waiting tone (Tone 1 or Tone 2) through personal programming (Call Waiting Tone Type Selection). For doorphone calls, Tone 1 is used as a call waiting tone (not changeable). Tone 2 depends on the assignments in [423] CO Line Ring Tone Pattern for outside (CO) line calls and [115] Extension Ring Tone Pattern for intercom calls.

Programming Manual References

[PT Programming]

- [104] SLT Hold Mode
- [115] Extension Ring Tone Pattern
- [423] CO Line Ring Tone Pattern

[PC Programming]

- 9.1.11 Detail [1-10]—Extension—Ring Tone Pattern, Single Line Telephone—Hold Mode
- 9.2.2 Feature settings [2-2]—Call Waiting—intercom calls, Call Waiting—outside calls
- 9.2.3 PT personal settings [2-3]—Call Waiting Tone Type
- 9.3.3 Detail [3-3]—Ring Tone Pattern

Feature Manual References

- 1.1.9 Busy Station Signaling (BSS)
- 1.1.37 Data Line Security
- 2.2.1 Tones/Ring Tones

Operating Manual References

- 1.3.28 Call Waiting
- 3.1.2 Personal Feature Assignment—Call Waiting Tone Type Selection

1.1.28 Call Waiting Caller ID

Description

While a proprietary telephone (PT) user hears the call waiting tone supplied by the telephone company, the Caller ID information will flash on the display for a preprogrammed time period (→ [908] Call Waiting Caller ID Time), if this feature is enabled for the outside (CO) line (→ [913] Call Waiting Caller ID Assignment). The user can answer the second call by disconnecting the current call or placing it on hold. This feature is also known as Visual Caller ID.

Conditions

- **Hardware Requirement:** An optional Caller ID card for outside (CO) lines 4–8.
- If the PT user does not press the FLASH/RECALL button while the information is displayed (flashing), the Caller ID information is automatically recorded in the user's personal area and the user's Caller ID Indication—Personal button lights if the call has been directed to the user (→ 1.1.18 Call Log, Incoming). A call via an outside (CO) line programmed as "Normal" (→ [414-416] CO Line Mode—Day/Night/Lunch) is automatically recorded in the common area and all corresponding user's Caller ID Indication—Common buttons light. However in this case, if a Caller ID Indication—Common button is not assigned to any PT,
 - The call will be logged in the personal area of the PT that hears the call waiting tone, if a Caller ID Indication—Personal button is assigned to that PT.
 - If the PT that hears the call waiting tone does not have a Caller ID Indication—Personal button assigned to it, the call will be logged in the personal area of the PT of the lowest-numbered jack, and its Caller ID Indication—Personal button light will turn red.
- This feature will not function when the extension:

- a) Is on a conference call
- b) Has a call on consultation hold
- c) Is using Live Call Screening (LCS) or 2-way Record
- d) Is on an outside-to-outside (CO-to-CO) line call
- e) Is hearing an outgoing message (OGM) used by Direct Inward System Access (DISA) or Built-in Voice Message (BV)

Installation Manual References

2.3.5 3-Port Caller ID Card (KX-TA82493)

Programming Manual References

[PT Programming]

[414-416] CO Line Mode—Day/Night/Lunch

[900] Caller ID

[908] Call Waiting Caller ID Time

[913] Call Waiting Caller ID Assignment

[914] Call Waiting Caller ID CAS Receive Time

[915] Caller ID Checksum

[968] KX-T7700 Series Incoming Lamp Control

[PC Programming]

9.1.11 Detail [1-10]—Proprietary Telephone—KX-T7700 Series Incoming Lamp Control

9.3.1 Line Mode [3-1]—Mode of incoming CO calls—Day, Night, Lunch

9.9.1 Main [9-1]—CO Line Settings—Caller ID, CO Line Settings—Call Waiting Caller ID, Call Waiting Caller ID Time, Call Waiting Caller ID CAS Receive Time, Caller ID Checksum

Feature Manual References

1.1.18 Call Log, Incoming

1.1.29 Call Waiting from the Telephone Company

1.1.30 Caller ID

Operating Manual References

1.3.18 Call Log, Incoming

1.3.29 Call Waiting Caller ID

1.1.29 Call Waiting from the Telephone Company

Description

Besides the Call Waiting feature provided by the PBX, you can also subscribe to your telephone company's Call Waiting service and receive call waiting tones through the telephone company's lines. This feature is available when an extension is in a conversation with an outside party, and a call is received from another outside party on the same outside (CO) line. The external call waiting tone will alert an extension user of

the incoming outside (CO) line call that is waiting. The user can answer the second call by disconnecting the current call or placing it on hold.

Conditions

- If a call waiting tone is heard but the corresponding CO button does not flash, this tone is an external call waiting tone from the telephone company. For details, consult your telephone company.

Programming Manual References

[PT Programming]

[110] Flash/Recall Key Mode

[418] Flash/Recall Time

[PC Programming]

9.1.11 Detail [1-10]—Proprietary Telephone—Flash/Recall Key Mode

9.3.3 Detail [3-3]—Flash/Recall Time

Feature Manual References

1.1.27 Call Waiting

Operating Manual References

1.3.30 Call Waiting from the Telephone Company

1.1.30 Caller ID

Description

The PBX can receive Caller ID information (telephone numbers and callers' names) from calls received on outside (CO) lines. This information can be shown on the displays of proprietary telephones (PTs) as well as some single line telephones (SLTs) when receiving calls. Additionally, Caller ID information is logged in the Incoming Call Log of the extension that received the call, allowing the caller to view a record of incoming calls or make a call to a person in the call log later.

The PBX can be programmed to modify a caller's telephone number when it is received by, for example, adding an Outside (CO) Line Access number or adding/deleting certain digits of incoming telephone numbers automatically. This allows an extension user to make a call later to a telephone number logged in his or her call log without worrying about Outside (CO) Line Access numbers, area codes, etc.

Notes

- The term "Caller ID" used in this Feature Manual refers to features that can receive caller information sent from the telephone company and received on outside (CO) lines. Your network provider may use a different name for this type of service.
- To receive Caller ID information, you must subscribe to the telephone company's Caller ID service and enable Caller ID for the appropriate outside (CO) lines through system programming (→ [900] Caller ID).

Caller ID Display on SLT

This feature is available only for SLTs compatible with either FSK-type Caller ID or DTMF (Dual Tone Multi-Frequency)-type Caller ID.

Notes

- This feature complies with ETSI (European Telecommunications Standards Institute)-type FSK and Bellcore-type FSK.
- This feature does not comply with methods using DT-AS signal or line reversal signal.

1. Caller ID-Related Feature

| Feature | Description | Details in |
|---------------------------|---|-----------------------------|
| Call Log, Incoming | Caller ID information is automatically recorded in the call log of the extension that received the call. This information can be used to view a record of incoming calls or make calls to any number in the call log. | • 1.1.18 Call Log, Incoming |

2. Automatic Caller ID Number Modification

When Caller ID information is checked, the PBX can automatically modify the caller's telephone number according to a preprogrammed set of rules (Caller ID Modification Table). This modified number allows the extension user to make a call to this number later without worrying about Outside (CO) Line Access numbers, area codes, etc.

[Programming Example: Caller ID Modification Table]

| Call Type | Code No. | Area Code*1 | Removed No. of Digits | Added No. |
|----------------------|--------------------|-------------|-----------------------|------------|
| Local Call*2 | 1 | 212 | 3 | Not Stored |
| | 2 | 011 | 3 | 001 |
| | : | : | : | : |
| | 5 | | | |
| Long-distance Call*3 | [Not programmable] | | 0 | 1 |

*1 → [901] Caller ID Area Code

*2 → [902] Caller ID Modification for Local Calls

*3 → [903] Caller ID Modification for Long-distance Calls

<Modification Flowchart>

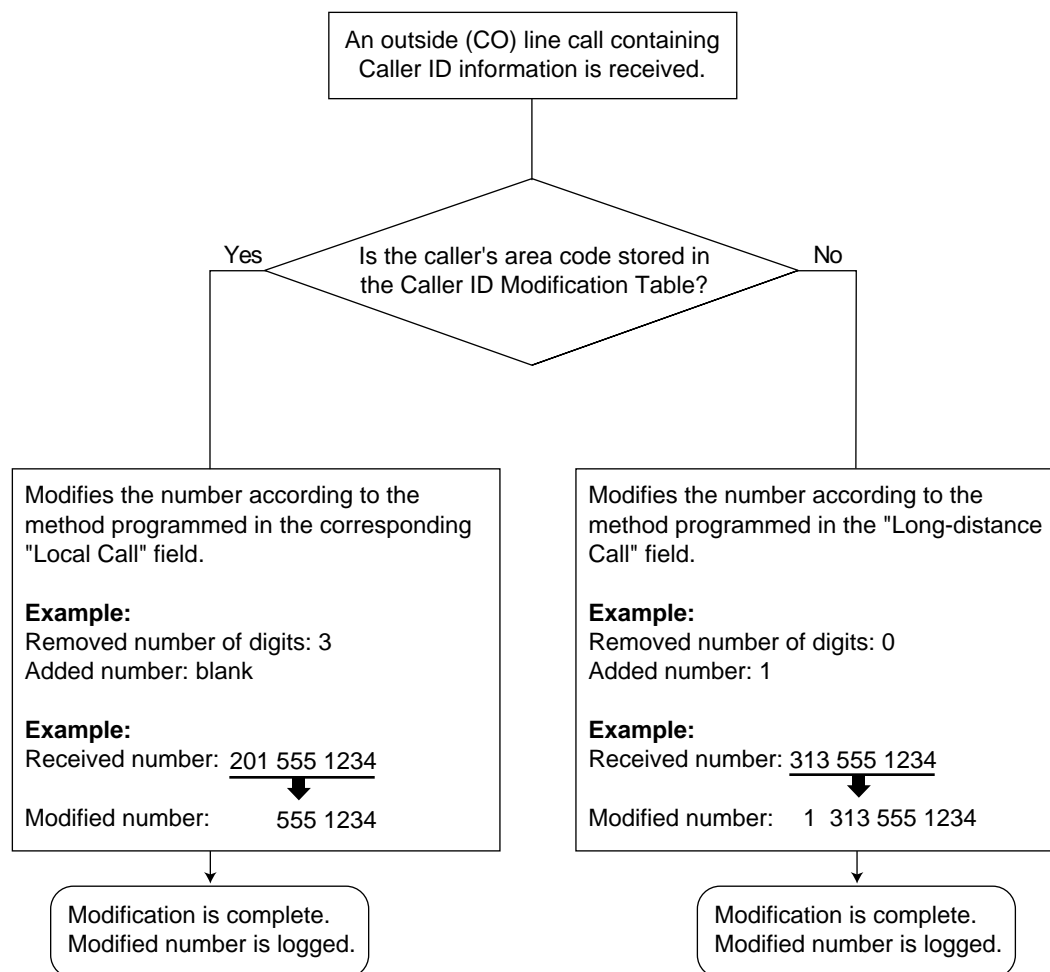
**3. Displaying the Caller's Name**

When a call containing Caller ID information is received, the PBX will search for the caller's name in the following order, then show that name on the display.

- 1) The System Speed Dialing Table
- 2) The Caller ID information received from the telephone company

If a caller's name is not stored in the PBX or sent from the telephone company, it will not be displayed.

Conditions**[General]**

- **Hardware Requirement:** An optional Caller ID card for outside (CO) lines 4–8.

[Caller ID Display on SLT]

- **Caller ID Display on SLT feature applies to:**
Intercom calls and outside (CO) line calls.
Intercom calls include forwarded calls, calls from Transfer Recall and Hold Recall.
Outside (CO) line calls include calls directed to Direct Inward System Access (DISA) ring groups,

forwarded calls, intercepted calls, or calls from extensions that placed outside (CO) line calls on consultation hold.

- SLT Caller ID signaling type can be selected through system programming (→ [150] SLT Caller ID Signaling Type).
- Each SLT (including an SLT connected in parallel with a PT) can be programmed to receive Caller ID information through system programming (→ [628] SLT Caller ID).
- When the caller's telephone number is sent to an SLT, an Outside (CO) Line Access number can be automatically added to the telephone number through system programming (→ [151] SLT Caller ID Line Access Number), to be used when calling the caller back.
- If a call is transferred, forwarded, or intercepted via Intercept Routing to an SLT, the original caller's information will be shown on the SLT.
- During a conversation, Caller ID information will not be shown on the SLT.
- When FSK-type Caller ID information is received, the caller's telephone number (max. 20 digits), name (max. 16 characters), date and time, or the reason for nondisplay of Caller ID information such as "Private", "Out of Area", or "Long Distance" will be shown on the SLT. If the caller's telephone number exceeds 20 digits, the SLT receives only the first 20 digits. If the caller's name exceeds 16 characters, the SLT receives only the first 16 characters.
- When DTMF-type Caller ID information is received, the caller's telephone number (max. 16 digits) or the reason for nondisplay of Caller ID information will be shown on the SLT. If the caller's telephone number exceeds 16 digits, the SLT receives only the first 16 digits. However, when a value less than "1500 ms" is set through system programming (→ [143] SLT Ring Bell-on Time), the SLT receives only the first 10 digits.
- Depending on the type of SLT being used, caller names and the dates and times that calls were received may not be able to be shown on the SLT.
- If an outside caller disconnects a call to an SLT on which the call's Caller ID information is displayed, and the SLT receives another outside (CO) line call directly after, the SLT will wait until a preprogrammed time has passed (→ [627] SLT Ring Wait Time for New Call) before it starts to ring, and the new caller's Caller ID information will be shown on the SLT. A certain amount of time may be required between calls for an SLT to receive Caller ID information correctly.
- To enable the Caller ID feature, it may be necessary to set the same ring tone pattern (→ [629] SLT Fixed Bell Pattern) as used by the telephone company.
- When an SLT is programmed to receive Caller ID information, the ringing of calls with Caller ID on that SLT is delayed for a few seconds. Therefore, the length of time before calls are forwarded or intercepted, and the length of time that intercepted calls ring at the destination SLT, may be slightly shorter than the duration specified through system programming.
- This feature will not function when the SLT uses the call waiting tone supplied by the telephone company (Call Waiting Caller ID).

Installation Manual References

2.3.5 3-Port Caller ID Card (KX-TA82493)

Programming Manual References

[PT Programming]

[142] SLT Ring/Silence Ratio

[143] SLT Ring Bell-on Time

[150] SLT Caller ID Signaling Type

[151] SLT Caller ID Line Access Number

[627] SLT Ring Wait Time for New Call

[628] SLT Caller ID
 [629] SLT Fixed Bell Pattern
 [900] Caller ID
 [901] Caller ID Area Code
 [902] Caller ID Modification for Local Calls
 [903] Caller ID Modification for Long-distance Calls
 [904] Caller ID Log Priority
 [906] Caller ID SMDR Format
 [907] Caller ID SMDR Printout

[PC Programming]

9.9.1 Main [9-1]—CO Line Settings—Caller ID, Caller ID Modification—Local Area Code (for Local Call 1–5), Caller ID Modification—Removed Digits, Caller ID Modification—Added Number, Caller ID SMDR Format, Caller ID SMDR Printout

9.9.2 SLT Caller ID [9-2]

9.9.3 Call Log [9-3]—Caller ID Log Priority

Feature Manual References

1.1.18 Call Log, Incoming
 1.1.113 System Speed Dialing
 2.2.1 Tones/Ring Tones

Operating Manual References

1.3.18 Call Log, Incoming

1.1.31 Calling Party Control (CPC) Signal Detection

Description

A CPC (Calling Party Control) signal is an on-hook indication (disconnect signal) sent from an outside (CO) line when the other party hangs up. To maintain efficient utilization of outside (CO) lines, the PBX monitors each line's status and when a CPC signal is detected on a line, the PBX disconnects the line and alerts the extension with a reorder tone.

Conditions

- CPC Signal Detection is programmable for incoming outside (CO) line calls (→ [420] CPC Signal Detection—Incoming) and for outgoing outside (CO) line calls (→ [421] CPC Signal Detection—Outgoing).
- If a CPC signal is detected during a call between a caller using the DISA feature (→ 1.1.41 Direct Inward System Access (DISA)) and an extension or an outside party, the call will be disconnected.
- Generally, CPC Signal Detection functions for incoming outside (CO) line calls and does not function for outgoing outside (CO) line calls. If an extension user remains off-hook after an outgoing outside (CO) line call is completed, the PBX will not release all the switches used to establish the connection. The connected outside (CO) line will continue to be in use. To prevent this, CPC Signal Detection can be programmed to function for outgoing outside (CO) line calls.

- If a CPC signal is detected on a line during a conference call, that outside party will be disconnected but the remaining 2 parties can continue their call.

Programming Manual References

[PT Programming]

[420] CPC Signal Detection—Incoming

[421] CPC Signal Detection—Outgoing

[PC Programming]

9.3.3 Detail [3-3]—CPC Signal Detection—Incoming, CPC Signal Detection—Outgoing

Feature Manual References

1.1.41 Direct Inward System Access (DISA)

1.1.32 Class of Service (COS)

Description

Each extension is assigned a class of service (COS) number (→ [601-603] TRS-COS—Day/Night/Lunch). The following features operate differently depending on an extension's COS.

- a) TRS (→ 1.1.117 Toll Restriction (TRS))
- b) Walking COS (→ 1.1.122 Walking COS)

Conditions

- **Walking COS**
An extension user can make a call from an extension with a lower COS by using his or her own COS temporarily.

Programming Manual References

[PT Programming]

[601-603] TRS-COS—Day/Night/Lunch

[PC Programming]

9.5.1 Class of Service (COS) [5-1]—Day, Night, Lunch

Feature Manual References

1.1.117 Toll Restriction (TRS)

1.1.122 Walking COS

Operating Manual References

1.3.85 Toll Restriction (TRS)

1.3.90 Walking COS

1.1.33 Conference

Description

During a 2-party conversation, an extension user can add a third party to the conversation, thereby establishing a 3-party conference call.

Conditions

- **Conference call arrangement**
The following configurations of 3-party conference calls are possible:
 - One extension and 2 outside parties
 - 2 extensions and one outside party
 - 3 extensions
- **Conference Button**
On a proprietary telephone (PT) that does not have a CONF (Conference) button, a flexible CO button can be customized as a Conference button.
- **Consultation Hold**
When an extension user tries to establish a conference call, the current call is automatically placed on consultation hold until the conference is established (→ 1.1.36 Consultation Hold).
- A confirmation tone will be sent to all parties when a 2-party conference call is changed to a 3-party conference call. It is possible to eliminate the tone through system programming (→ [105] Conference Tone).
- A 3-party conference call can also be established by Executive Busy Override.

Programming Manual References

[PT Programming]

[104] SLT Hold Mode

[105] Conference Tone

[PC Programming]

9.1.11 Detail [1-10]—Single Line Telephone—Hold Mode, Conference—Conference Tone

Feature Manual References

1.1.34 Conference, Unattended

1.1.36 Consultation Hold

1.1.59 Fixed Buttons

1.1.61 Flexible Buttons

Operating Manual References

1.3.31 Conference

3.1.3 Flexible Button Assignment—Conference button

1.1.34 Conference, Unattended

Description

The proprietary telephone (PT) user who originated a conference with 2 outside parties can leave the conference and allow the other parties to continue the conversation. The user may return to the conference at any time, if he or she desires.

Conditions

- **Conference Button**
On a PT that does not have a CONF (Conference) button, a flexible CO button can be customized as a Conference button.
- **Consultation Hold**
When an extension user tries to establish a conference call, the current call is automatically placed on consultation hold until the conference is established (→ 1.1.36 Consultation Hold).
- **Unattended Conference Recall**
The duration of unattended conferences is restricted by a system timer (→ [205] CO-to-CO Line Call Duration).
A ring tone or an alarm tone is heard at the conference originator's extension 50 seconds before the timer expires.
A warning tone starts to be heard by parties in the unattended conference 15 seconds before the timer expires.
If the originator returns to the conference before the unattended conference call is disconnected, the timer will be canceled. If not, the ring tone or alarm tone and the warning tone will continue to be heard until the unattended conference call is disconnected (→ 1.1.91 Outside-to-Outside (CO-to-CO) Line Call Duration).
- An unattended conference cannot be established unless the extension is allowed to transfer a call to an outside party through system programming (→ [606] Call Transfer to CO Line).

Programming Manual References

[PT Programming]

[205] CO-to-CO Line Call Duration

[606] Call Transfer to CO Line

[PC Programming]

9.1.7 Timers [1-6]—Call Duration—CO-to-CO Duration Limit

9.2.1 Main [2-1]—Transfer to CO

Feature Manual References

1.1.33 Conference

1.1.36 Consultation Hold

1.1.59 Fixed Buttons

1.1.61 Flexible Buttons

1.1.91 Outside-to-Outside (CO-to-CO) Line Call Duration

Operating Manual References

- 1.3.32 Conference, Unattended
- 3.1.3 Flexible Button Assignment—Conference button

1.1.35 Confirmation Tone

Description

At the end of a feature operation, the PBX confirms the success of the operation by sending a confirmation tone to the extension user.

| Type | Description |
|---------------|--|
| Tone 1 | Sent when the setting is accepted, or sent when the Extension Lock feature is set or canceled. |
| Tone 2 | Sent when the new setting is identical to the previous one, or sent when certain features are successfully performed or accessed (e.g., Call Hold, Automatic Callback Busy). |
| Tone 3 | Sent before a conversation is established when accessing the following features: <ul style="list-style-type: none"> • Call Pickup • Call Hold Retrieve with the Feature Number • Conference • Paging/Paging Answer |

Conditions

- It is possible to eliminate confirmation tone 3 (except for Call Hold Retrieve with the Feature Number) through system programming (→ [117] Call Pickup Tone, [105] Conference Tone, [106] External Pager Access Tone).

Programming Manual References

[PT Programming]

- [105] Conference Tone
- [106] External Pager Access Tone
- [117] Call Pickup Tone

[PC Programming]

- 9.1.11 Detail [1-10]—Extension—External Pager Access Tone, Extension—Call Pickup Tone, Conference—Conference Tone

Feature Manual References

- 2.2.1 Tones/Ring Tones

1.1.36 Consultation Hold

Description

When an extension user is on a call and performs Call Transfer (→ 1.1.25 Call Transfer—To Extension, 1.1.26 Call Transfer—To Outside (CO) Line), Call Splitting (→ 1.1.24 Call Splitting), or tries to establish a conference call (→ 1.1.33 Conference, 1.1.34 Conference, Unattended), the call is automatically placed on consultation hold. When the operation is completed or canceled, the consultation hold is released.

Feature Manual References

- 1.1.24 Call Splitting
- 1.1.25 Call Transfer—To Extension
- 1.1.26 Call Transfer—To Outside (CO) Line
- 1.1.33 Conference
- 1.1.34 Conference, Unattended

1.1.37 Data Line Security

Description

Once Data Line Security is set on an extension, communication between the extension and the other party is protected from signals such as Call Waiting, Hold Recall, and Executive Busy Override. Extensions that have devices such as modems, fax machines, or Voice Processing Systems (VPSs) connected to them may set this feature to maintain secure data transmission, by blocking tones or other interruptions during communication.

Programming Manual References

- [PC Programming]
- 9.2.2 Feature settings [2-2]—Data Line Security

Feature Manual References

- 1.1.27 Call Waiting
- 1.1.50 Executive Busy Override—Extension
- 1.1.51 Executive Busy Override—Outside (CO) Line

Operating Manual References

- 1.3.33 Data Line Security

1.1.38 Dial Tone

Description

The following dial tones inform extension users about features activated on their extensions:

| Type | Description |
|---------------|---|
| Tone 1 | A normal dial tone is heard when none of the features listed for dial tones 2 through 5 have been set. |
| Tone 2 | <p>Heard when any of the following features is set.</p> <ul style="list-style-type: none"> • Absent Message • Background Music (BGM) (for proprietary telephones [PTs] only) • Call Forwarding (FWD) • Call Pickup Deny • Data Line Security • Do Not Disturb (DND) • Extension Lock • Hot Line (for single line telephones [SLTs] only) • Message Waiting (for PTs only) • Remote Extension Lock • Timed Reminder |
| Tone 3 | <p>Heard when any of the following features is performed.</p> <ul style="list-style-type: none"> • Account Code Entry • Answering a call from Timed Reminder • Going off-hook with an SLT that has messages waiting |
| Tone 4 | Heard when going off-hook if new voice messages have been recorded (Built-in Voice Message [BV]). |
| Tone 5 | Heard when going off-hook if the remaining voice message recording time is less than 5 minutes or if 125 voice messages have been recorded (Built-in Voice Message [BV]). |

Feature Manual References

2.2.1 Tones/Ring Tones

1.1.39 Dial Type Selection

Description

The dialing mode can be selected for each outside (CO) line through system programming (→ [401] Dial Mode) regardless of the originating extension (dependent on the contract with the telephone company).

| Mode | Description |
|---|---|
| DTMF (Dual Tone Multi-Frequency) | Numbers dialed by an extension user are transmitted to the outside (CO) line using tones. If this PBX is installed behind an existing host PBX, select this mode as necessary. If your telephone company or a host PBX can receive both DTMF and Pulse signals but the contract specifies DTMF lines, select this mode. |
| Pulse (Rotary) | Numbers dialed by an extension user are transmitted to the outside (CO) line using pulses. |

| Mode | Description |
|----------------------|---|
| Call Blocking | If your telephone company or a host PBX can receive both DTMF and Pulse signals but the contract specifies Pulse lines, select this mode. When dialing with a touch-tone telephone, only Pulse signals will be sent to the telephone company. |

Conditions

- Automatic Configuration for Outside (CO) Line Type**

The dialing mode of connected outside (CO) lines is automatically assigned after restarting the PBX using the System Clear Switch or through system programming (→ [999] System Data Clear). No system programming in [401] Dial Mode and [402] Pulse Speed is required unless the dialing mode of the connected outside (CO) lines is Call Blocking. If your telephone company can receive both DTMF and Pulse signals, the PBX selects an outside (CO) line type according to the following priority: DTMF → Pulse (High) → Pulse (Low)
- The pulse rate for outside (CO) lines that have been set to "Pulse" or "Call Block" mode (→ [402] Pulse Speed) should be selected depending on your telephone company or a host PBX. There are 2 pulse rates: Low (10 pps) and High (20 pps).

Programming Manual References

[PT Programming]

[119] Redialing after Pulse to Tone Conversion

[401] Dial Mode

[402] Pulse Speed

[999] System Data Clear

[PC Programming]

8.4 System Data Clear

9.1.11 Detail [1-10]—CO—Redialing after Pulse to Tone Conversion

9.3.3 Detail [3-3]—Dial Mode, Pulse Speed

Feature Manual References

1.1.5 Automatic Configuration for Outside (CO) Line Type

1.1.104 Pulse to Tone Conversion

1.1.40 Direct In Line (DIL)

Description

Directs incoming outside (CO) line calls to a preprogrammed destination based on the outside (CO) line carrying the call. Each outside (CO) line can have a different destination for each time service mode.

[Programming Example]

The table can be programmed for each outside (CO) line.

| Outside (CO) Line No. | Distribution method and destination* | | | | | |
|-----------------------|--------------------------------------|-----|--------|-----|--------|-----|
| | Day | | Lunch | | Night | |
| 1 | DIL | 101 | DIL | 102 | DIL | 102 |
| 2 | DIL | 103 | DIL | 103 | DIL | 103 |
| (Cont.) : | : | : | : | : | : | : |
| : | : | : | : | : | : | : |
| 8 | Normal | — | Normal | — | Normal | — |

* → [414-416] CO Line Mode—Day/Night/Lunch

In this example:

If an outside (CO) line call is received on outside (CO) line 1:

- a) In day mode: Direct In Line (DIL) distribution is assigned. The call is routed to its DIL destination, extension 101.
- b) In lunch/night mode: DIL distribution is assigned. The call is routed to its DIL destination, extension 102.

Conditions

- To use this feature, "DIL" must be selected as the distribution method for the desired outside (CO) line port. When "Normal" is selected, an incoming outside (CO) line call is received at the extensions assigned in [408-410] Flexible Ringing—Day/Night/Lunch.
- This outside (CO) line can be used by multiple extension users to make calls, but can only be used by a single extension to receive calls.
- If a DIL destination is an extension within an extension group that has enabled the Idle Extension Hunting feature and it is busy, the Idle Extension Hunting feature becomes active (→ 1.1.67 Idle Extension Hunting).

Programming Manual References

[PT Programming]

[408-410] Flexible Ringing—Day/Night/Lunch

[414-416] CO Line Mode—Day/Night/Lunch

[PC Programming]

9.3.1 Line Mode [3-1]—Mode of incoming CO calls—Day, Night, Lunch

9.3.2 Incoming / Outgoing [3-2]—Ringling for incoming CO calls—Day, Night, Lunch

Feature Manual References

1.1.67 Idle Extension Hunting

1.1.114 Time Service

1.1.41 Direct Inward System Access (DISA)

Description

Direct Inward System Access (DISA) allows outside callers to be connected to their desired PBX destinations without the use of the operator. Callers can listen to a DISA outgoing message (OGM) instructing them as to which numbers to dial to be connected to the person or department they would like to speak with. DISA can also give PBX users access to PBX features, such as making outside (CO) line calls, when they are outside the office.

This DISA OGM can guide callers and allow them to:

- Call an extension by dialing the extension number.
- Call another outside party via the outside (CO) lines of the PBX.
- Access the desired extension simply by dialing a single-digit number (DISA Automated Attendant [AA] number) using DISA AA service.

DISA OGM

When a call arrives on a DISA line, callers will hear a DISA OGM or a short beep. When the DISA AA service is active, this DISA OGM will direct callers to dial the appropriate digit (DISA AA number) to be connected to a specified destination. To access other PBX features, such as making intercom or outside (CO) line calls, the caller may dial the appropriate numbers while the DISA OGM is playing.

An extension assigned as the operator or manager extension can record a DISA OGM (→ 1.1.88 Outgoing Message (OGM) for DISA).

DISA AA Service

DISA AA service allows a caller to dial a single-digit number (DISA AA number) and be connected to the desired party automatically. The PBX can store up to 10 destinations that can be called by dialing a DISA AA number (0–9) for each DISA OGM (→ [501] DISA Built-in AA). These destinations can be an extension number (→ [009] Extension Number), an extension group number (→ [600] Extension Group), or the DISA AA number of a 3-level DISA OGM (→ [540-549] 3-level AA Assignment).

During or after the DISA OGM announcement (→ [505] DISA Wait Time after OGM), or after a short beep (→ [515] Intercept Time for Internal DISA), the caller may dial a DISA AA number as directed by the DISA OGM (e.g., "Press 1 to speak to Sales. Press 2 to speak to Support.").

Each DISA AA number directs the call to a preprogrammed location.

Since DISA AA numbers are single digits, if the caller dials a second digit within a preprogrammed time period (→ [517] DISA AA Wait Time), DISA AA service will be bypassed because the PBX will assume the caller is trying to access a specific feature.

When the DISA AA service is used, Incoming Dial Mode must be set to "With AA" through system programming (→ [500] DISA Incoming Call Dial Mode). When "With AA" is selected, the PBX regards caller-dialed digits "0" through "9" as DISA AA numbers. If no destination is assigned to "9" or "0", the PBX regards the number (9/0) as the Automatic Line Access number or Operator Call number.

[Programming Example: 1-level (DISA) AA Table]

In order for a caller to be able to access Mike Smith (extension 102) using 1-level (DISA) AA, program as follows:

| Outside (CO) Line No. | Distribution method*1 | | |
|-----------------------|-----------------------|-----------|-----------|
| | Day | Lunch | Night |
| 1, 2 | DISA OGM1 | DISA OGM1 | DISA OGM1 |
| 3–8 | Normal | Normal | Normal |

| DISA AA No. for 1-level AA*2 | | | | | | | | | |
|------------------------------|------------------|-----------|-----------|-----------|-----------|-----------|-----------|---------------|---|
| 0 | 1 | 2 | 3 | 4 | 5 | 6 | 7 | 8 | 9 |
| – | Mike Smith (102) | Extn. 103 | Extn. 104 | Extn. 105 | Extn. 106 | Extn. 107 | Extn. 108 | Extn. Group 1 | – |

*1 → [414-416] CO Line Mode—Day/Night/Lunch

*2 → [501] DISA Built-in AA

[Programming Example: 3-level AA Table]

In order for a caller to be able to access Mike Smith of the Software Support Team (extension 102) using 3-level AA, program as follows:

| Outside (CO) Line No. | Distribution method*1 | | |
|-----------------------|-----------------------|-----------|-----------|
| | Day | Lunch | Night |
| 1–4 | DISA OGM1 | DISA OGM2 | DISA OGM3 |
| 5–8 | Normal | Normal | Normal |

1-level AA

| DISA AA No.*2 | | | | | | | | | |
|---------------|---------------|---------------|--------------|---|---|---|---|---|---|
| 0 | 1 | 2 | 3 | 4 | 5 | 6 | 7 | 8 | 9 |
| - | Extn. Group 1 | Extn. Group 2 | 2-level AA*3 | - | - | - | - | - | - |

2-level AA

| DISA AA No.*4 | | | | | | |
|---------------|---------------|--------------|---------------|---|---|---|
| 0 | 1 | 2 | 3 | 4 | 5 | 6 |
| - | Extn. Group 3 | 3-level AA*5 | Extn. Group 4 | - | - | - |

3-level AA

| DISA AA No.*4 | | | | | | |
|---------------|--------------------|---|---|---|---|---|
| 0 | 1 | 2 | 3 | 4 | 5 | 6 |
| Extn. 101 | Mike Smith (102)*6 | - | - | - | - | - |

*1 → [414-416] CO Line Mode—Day/Night/Lunch

*2 → [501] DISA Built-in AA

*3 2-level AA: Select "3-level AA" for AA number "3" in [501] DISA Built-in AA

*4 → [540-549] 3-level AA Assignment

*5 3-level AA: Select "3-level AA" for "second AA number 2" and for "third AA number ×" in the [543] of [540-549] 3-level AA Assignment

*6 Mike Smith (102): Select "Jack 02" for "second AA number 2" and for "third AA number 1" in the [543] of [540-549] 3-level AA Assignment

In this example:

- 1) After or while listening to the AA first-level DISA OGM (e.g., "Press 1 to speak to Sales. Press 2 to speak to Service. Press 3 to speak to Support."), caller dials a DISA AA number, "3", as directed by the DISA OGM.
- 2) Next, the AA second-level DISA OGM (e.g., "Press 1 to speak to Hardware Team. Press 2 to speak to Software Team.") directs the caller to dial another DISA AA number. The caller dials "2".
- 3) Finally, the AA third-level DISA OGM (e.g., "Press 1 to speak to Mike Smith. Press 0 to speak to the Operator.") directs the caller to dial a DISA AA number, "1", to be connected to a specified destination, extension 102.

Note

When the type of a destination from 2-level AA or 3-level AA to another setting is changed, any associated DISA OGM will also be cleared. In addition, any items within the AA menu being removed will also be removed.

DISA Busy Mode

If the destination of a DISA call is busy, the call will be redirected to an idle extension (→ [100] Hunting Group Set) in the destination's idle extension hunting group (→ 1.1.67 Idle Extension Hunting). If no extension in the group is available, or if the destination of the DISA call is not a member of an idle extension hunting group, the call will be handled in one of the following ways, according to system programming (→ [506] DISA Busy Mode):

- a) **Disconnect:** The caller hears a busy tone and the call is disconnected.
- b) **Call Waiting:** The called extension hears a call waiting tone if the extension has set Call Waiting.
- c) **DISA:** The following procedure is performed:
 - 1) If the assigned DISA OGM (busy message) has been recorded, the caller hears the DISA OGM (e.g., "The party you called is unavailable..."). If the assigned DISA OGM has not been recorded, the caller hears a busy tone and the call is disconnected.
 - 2) After the busy message has been played, the DISA OGM that was sent before the busy message is sent to the caller again.
 - 3) The PBX waits for the caller to enter a new destination. In this case, the PBX does not accept any Outside Line Access number regardless of the security type.

If the destination is a member of a DISA ring group, DISA Busy Mode will not function for the call. The PBX regards it as unanswered.

DISA Intercept Mode

If the destination of a DISA call does not answer the call within a preprogrammed time period (→ [508] DISA Ring Time before Intercept), the call will be handled in one of the following ways, according to system programming (→ [507] DISA Intercept Mode):

- a) **Disconnect:** The call is disconnected.
- b) **Intercept:** The call is redirected to preprogrammed intercept destinations in the following priority: [438-440] DISA IRNA to BV—Day/Night/Lunch → [408-410] Flexible Ringing—Day/Night/Lunch. This is useful for business calls. For example, the call can be forwarded to the operator, a Voice Processing System (VPS) or Built-in Voice Message (BV) automatically.

DISA No Dial Mode

If the PBX does not receive either DTMF (Dual Tone Multi-Frequency) signals or a fax (CNG) tone within a preprogrammed time period (→ [505] DISA Wait Time after OGM), or if the PBX does not receive DTMF signals within a preprogrammed time period (→ [515] Intercept Time for Internal DISA), the call will be handled in one of the following ways, according to system programming (→ [510] DISA No Dial Mode):

- a) **Disconnect:** The call is disconnected.
- b) **Intercept:** The call is redirected to preprogrammed intercept destinations in the following priority: [438-440] DISA IRNA to BV—Day/Night/Lunch → [408-410] Flexible Ringing—Day/Night/Lunch

DISA Security Mode

Security can be enabled for the PBX to control the types of calls that can be made by callers using DISA. When the DISA security mode is set to "All Security" or "Trunk Security" (→ [511] DISA Security Mode), a caller is required to enter a DISA security code (→ [512] DISA Security Code) before making intercom and outside (CO) line calls, or outside (CO) line calls only, respectively. The DISA security code and the number of digits required for the DISA security code (→ [530] DISA Security Code Digits) can be assigned by the manager. After entering a DISA security code, if the code is the same as one of the preprogrammed security codes, the caller will hear a short beep. It is possible to eliminate the tone through system programming (→ [518] DISA Tone after Security Code).

If the DISA security code is entered incorrectly 3 times when using DISA, a reorder tone will be sent to the caller and the call will be disconnected.

| Security Mode | Intercom Calls | Outside (CO) Line Calls |
|----------------|----------------|-------------------------|
| All Security | | |
| Trunk Security | ✓ | |
| No Security | ✓ | ✓ |

✓ Permitted

Outside-to-Outside (CO-to-CO) Line Calls through DISA

DISA callers can use DISA to make outside (CO) line calls when allowed by the DISA security mode. If a call between 2 outside parties is established via DISA, the length of the call can be limited to a preprogrammed duration (→ [205] CO-to-CO Line Call Duration). A timer will activate when the call is connected, and a warning tone will be heard 15 seconds before the timer expires. When the timer expires, the call is disconnected (→ 1.1.91 Outside-to-Outside (CO-to-CO) Line Call Duration). To detect the end of an outside-to-outside (CO-to-CO) line call, Calling Party Control (CPC) Signal Detection can be assigned through system programming (→ [420] CPC Signal Detection—Incoming, [421] CPC Signal Detection—Outgoing).

[Flowchart]

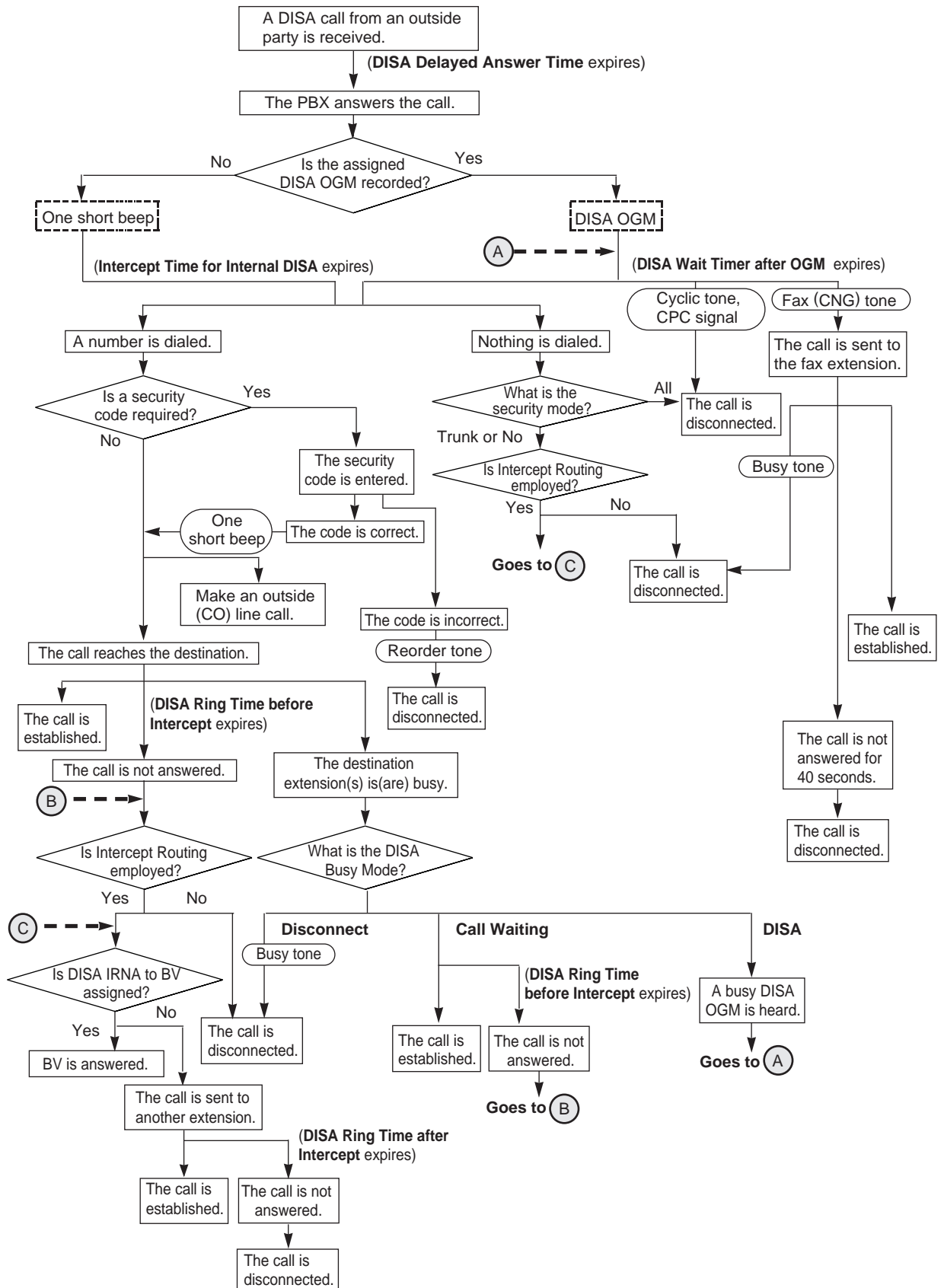

Conditions

WARNING

There is a risk that fraudulent telephone calls will be made using the Outside-to-Outside (CO-to-CO) Line Call feature of DISA.

The cost of such calls will be billed to the owner/renter of the PBX.

To protect the PBX from this kind of fraudulent use, we strongly recommend:

- a) **Enabling DISA security (Trunk Security or All Security).**
- b) **Maintaining the secrecy of passwords.**
- c) **Selecting passwords that are complex and random, so that they cannot be easily guessed.**
- d) **Changing passwords regularly.**

- The maximum recording time of each message is 3 minutes.
- The preinstalled DISA OGM card can play only one message at a time and the total recording time of the PBX for DISA OGMs is 3 minutes. When an optional message expansion card for DISA OGMs is added, up to 2 messages can be played simultaneously for callers, and the total recording time of the PBX is increased to 6 minutes.
- To use this feature, "DISA" must be selected as the distribution method for the desired outside (CO) line port (→ [414-416] CO Line Mode—Day/Night/Lunch).
- **DISA Delayed Answer Time**
It is possible to set the DISA Delayed Answer time (→ [504] DISA Delayed Answer Time) so that the caller will hear a ringback tone for a preprogrammed length of time before hearing a DISA OGM or a short beep.
- **Call Forwarding (FWD) to Outside (CO) Line**
When a DISA call is forwarded to an outside party, the caller is not required to enter a DISA security code regardless of the security mode.
- **SMDR**
The following are logged by SMDR for DISA calls (→ 1.1.112 Station Message Detail Recording (SMDR)):
 - The destination of the DISA call
 - DISA security code status
- **Call Deny**
System programming determines which extensions can receive DISA calls (→ [516] DISA Incoming Assignment). If a DISA call is received at an extension that has Call Deny set, the caller will hear a reorder tone and the call will be disconnected automatically. If a DISA call is received by a DISA ring group, this program does not function for extensions in that DISA ring group and these extensions will still ring.
- **Cyclic Tone Detection**
It is possible to select the number of times a cyclic tone must be detected while the DISA OGM is sent (→ [513] Cyclic Tone Detection). Cyclic Tone Detection can be used to disconnect an outside-to-outside (CO-to-CO) line call via DISA.
- **Fax Connection**
System programming determines the extensions that are able to receive fax data when the PBX receives a fax (CNG) tone via the DISA feature (→ [503] FAX Connection). The preprogrammed extension will automatically have the Data Line Security feature set (→ 1.1.37 Data Line Security).
- **Fax Tone Detection**
It is possible to select the number of times the fax (CNG) tone must be detected while the DISA OGM is sent before the PBX recognizes the incoming signal as fax data (→ [514] FAX Tone Detection). If the DISA OGM is short (0–5 s), in some cases the fax (CNG) tone may not be detected. In this case, it is recommended to set the length of time the PBX continues to search for a fax (CNG) tone after completing a DISA OGM to "10 s" or "15 s" through system programming (→ [505] DISA Wait Time

after OGM). If the assigned DISA OGM has not been recorded, it is recommended to set the length of time to "6 s" or "9 s" through system programming (→ [515] Intercept Time for Internal DISA).

- It is programmable whether a ringback tone (→ [128] Ringback Tone Pattern) or Music on Hold (→ [111] Music on Hold) is sent to the caller when a DISA call is received (→ [531] DISA Ringback Tone).

Installation Manual References

2.3.7 Message Expansion Card for DISA OGMs (KX-TA82491)

Programming Manual References

[PT Programming]

[009] Extension Number
 [100] Hunting Group Set
 [111] Music on Hold
 [128] Ringback Tone Pattern
 [205] CO-to-CO Line Call Duration
 [408-410] Flexible Ringing—Day/Night/Lunch
 [414-416] CO Line Mode—Day/Night/Lunch
 [420] CPC Signal Detection—Incoming
 [421] CPC Signal Detection—Outgoing
 [438-440] DISA IRNA to BV—Day/Night/Lunch
 [500] DISA Incoming Call Dial Mode
 [501] DISA Built-in AA
 [503] FAX Connection
 [504] DISA Delayed Answer Time
 [505] DISA Wait Time after OGM
 [506] DISA Busy Mode
 [507] DISA Intercept Mode
 [508] DISA Ring Time before Intercept
 [509] DISA Ring Time after Intercept
 [510] DISA No Dial Mode
 [511] DISA Security Mode
 [512] DISA Security Code
 [513] Cyclic Tone Detection
 [514] FAX Tone Detection
 [515] Intercept Time for Internal DISA
 [516] DISA Incoming Assignment
 [517] DISA AA Wait Time
 [518] DISA Tone after Security Code
 [530] DISA Security Code Digits
 [531] DISA Ringback Tone
 [540-549] 3-level AA Assignment
 [600] Extension Group

[PC Programming]

9.1.2 Main [1-2]—Music on Hold

- 9.1.3 Numbering Plan [1-3]—Ext. no.
- 9.1.7 Timers [1-6]—Call Duration—CO-to-CO Duration Limit
- 9.1.11 Detail [1-10]—Extension—Ringback Tone Pattern
- 9.2.11 Extension Group [2-6]—Group No., Extension Hunting—Extension Hunting
- 9.3.1 Line Mode [3-1]—Mode of incoming CO calls—Day, Night, Lunch
- 9.3.2 Incoming / Outgoing [3-2]—Ringing for incoming CO calls—Day, Night, Lunch
- 9.3.3 Detail [3-3]—CPC Signal Detection—Incoming, CPC Signal Detection—Outgoing
- 9.6 DISA [6]
- 9.8.2 Others [8-2]—DISA IRNA to BV—Day, Night, Lunch

Feature Manual References

- 1.1.8 Built-in Voice Message (BV)
- 1.1.37 Data Line Security
- 1.1.67 Idle Extension Hunting
- 1.1.68 Intercept Routing
- 1.1.88 Outgoing Message (OGM) for DISA
- 1.1.91 Outside-to-Outside (CO-to-CO) Line Call Duration
- 1.1.112 Station Message Detail Recording (SMDR)

Operating Manual References

- 1.3.34 Direct Inward System Access (DISA)
- 3.2.1 Programming Information

1.1.42 Direct Inward System Access (DISA) Ring

Description

A Direct Inward System Access (DISA) ring group is a specific extension group that receives DISA calls directed to the group. All extensions in the DISA ring group assigned as an Automated Attendant (AA) destination (→ [501] DISA Built-in AA) ring simultaneously.

Conditions

- To use this feature, "DISA" must be selected as the distribution method for the desired outside (CO) line port (→ [414-416] CO Line Mode—Day/Night/Lunch), and DISA AA service must be assigned as the destination of incoming outside (CO) line calls via the DISA feature (→ [500] DISA Incoming Call Dial Mode).
- The Log-in or Log-out status can be set for each extension (→ 1.1.80 Log-in/Log-out). The last member of a group cannot log out.

Programming Manual References

[PT Programming]

- [411-413] Delayed Ringing—Day/Night/Lunch
- [414-416] CO Line Mode—Day/Night/Lunch

[500] DISA Incoming Call Dial Mode

[501] DISA Built-in AA

[600] Extension Group

[PC Programming]

9.2.11 Extension Group [2-6]—Group No.

9.3.1 Line Mode [3-1]—Mode of incoming CO calls—Day, Night, Lunch

9.3.2 Incoming / Outgoing [3-2]—Ringing for incoming CO calls—Day, Night, Lunch

9.6.1 Automated Attendant [6-1]—DISA Incoming Call Dial Mode, AA table

Feature Manual References

1.1.41 Direct Inward System Access (DISA)

1.1.53 Extension Group

1.1.80 Log-in/Log-out

1.1.109 Ringing, Delayed

1.1.43 Display Information

Description

A display proprietary telephone (PT) can relay the following information to the user while making or receiving calls:

| Display Item | Display Example | Condition |
|--|--|---|
| The extension number and name of the calling or called extension | 123: Tom Smith | Extension numbers and names are programmable (→ [009] Extension Number, [604] Extension Name). If an extension name is not stored, only the extension number will be displayed. |
| The status of the called extension | 123: Busy | — |
| The name and number of the doorphone | DoorPhone 1 | — |
| The telephone number dialed | 1234567890 | — |
| The extension number and name of the calling extension after the call is forwarded | → 102:Mike | — |
| The received call information a) Caller's name b) Caller's number c) Outside (CO) line number | ABC Company 12345678 Call on CO 1 | The first line message can be either (a) or (b) at each extension through system programming (→ [904] Caller ID Log Priority). |

| Display Item | Display Example | Condition |
|--|-----------------|--|
| Duration of the current outside (CO) line call | CO 1 0:01'15 | The display remains for 5 seconds after the call is finished. The outgoing outside (CO) line call duration starts when the specified time expires (→ [204] Call Duration Counter Start). The display does not show the duration of intercom calls. |

Conditions

- Multilingual Display**
 Each extension can select its display language through system programming (→ [615] LCD Language). The selected language is shown on the display during operation and personal programming, but not during system programming.
- Display Contrast**
 The display contrast can be adjusted with the Navigator key or the CONTRAST selector. This is available only for PTs.
- Ringer Volume**
 The volume of the ringer can be adjusted with the RINGER Volume selector.
- Self-extension Number**
 A display PT user can confirm his or her own jack number and extension number on the display. Every time the "*" key is pressed, the display switches between "date (month, day) and time", "date (month, day, year, day of the week)", and "extension number (and extension name if stored)".
- Date and Time Set**
 The current date and time are set through system programming (→ [000] Date & Time) or the operator/manager service features. The time format shown on the display PTs while on-hook, "12 h" or "24 h", can also be selected through system programming (→ [010] LCD Time Display).
- Characters (name) or digits (number) exceeding the maximum length of the display are not displayed. Although in this case information may not be displayed properly, the received information is not altered. When the information displayed by pressing specific buttons (One-touch Dialing, REDIAL, Save) while on-hook exceeds 17 characters, the "&" mark will be shown on the right side of the display.

Programming Manual References

[PT Programming]

- [000] Date & Time
- [009] Extension Number
- [010] LCD Time Display
- [204] Call Duration Counter Start
- [604] Extension Name
- [615] LCD Language
- [904] Caller ID Log Priority

[PC Programming]

- 9.1.1 Date & Time [1-1]
- 9.1.2 Main [1-2]—Time—Time Display
- 9.1.3 Numbering Plan [1-3]
- 9.1.7 Timers [1-6]—Call Duration—Call Duration Counter Start Time

- 9.2.1 Main [2-1]—Display Language
- 9.9.3 Call Log [9-3]—Caller ID Log Priority

Feature Manual References

- 1.1.30 Caller ID

Operating Manual References

- 2.1.7 System Feature Assignment—Date & Time Set
- 3.1.2 Personal Feature Assignment—Self-extension Number Confirmation

1.1.44 Do Not Disturb (DND)

Description

Extension users can use this feature to prevent calls from ringing at their extension. The calling extension will hear a Do Not Disturb (DND) tone.

Conditions

- **DND Override**
An extension in DND mode can be called by extensions that are allowed to override DND through system programming (→ [609] DND Override).
- **FWD/DND Button**
If a proprietary telephone (PT) does not have an FWD/DND button, a flexible CO button can be customized as an FWD/DND button.

[Button Status]

The FWD/DND button shows the current status as follows:

| Light Pattern | Status |
|-------------------|-------------|
| Red on | DND on |
| Slow red flashing | FWD on |
| Off | FWD/DND off |

- Setting a new FWD mode, such as All Calls or Busy/No Answer, or the DND feature, clears the status of the previous FWD mode or DND feature.
- This feature does not apply to calls from Hold Recall and Timed Reminder.
- Calls from outside (CO) lines programmed as "Normal" or "DIL" (→ [414-416] CO Line Mode—Day/Night/Lunch) can be received at a user's extension, but the telephone will not ring. The corresponding CO button will flash when an outside (CO) line call is received, and the user can answer the call by pressing this button.

Programming Manual References

[PT Programming]

- [414-416] CO Line Mode—Day/Night/Lunch
- [609] DND Override

[PC Programming]

9.2.1 Main [2-1]—DND Override

9.2.2 Feature settings [2-2]—FWD/DND

9.3.1 Line Mode [3-1]—Mode of incoming CO calls—Day, Night, Lunch

Feature Manual References

1.1.45 Do Not Disturb (DND) Override

1.1.59 Fixed Buttons

1.1.61 Flexible Buttons

Operating Manual References

1.3.35 Do Not Disturb (DND)

3.1.3 Flexible Button Assignment—FWD/DND button

1.1.45 Do Not Disturb (DND) Override

Description

Extension users can call users who have set the Do Not Disturb (DND) feature, if the extension is allowed to override DND through system programming (→ [609] DND Override).

Programming Manual References

[PT Programming]

[609] DND Override

[PC Programming]

9.2.1 Main [2-1]—DND Override

Feature Manual References

1.1.44 Do Not Disturb (DND)

Operating Manual References

1.3.36 Do Not Disturb (DND) Override

1.1.46 Door Open

Description

Using an extension telephone, an extension user can unlock a door for a visitor.

The door can be unlocked by extension users who are allowed through system programming to unlock the door for each time service mode (→ [703-705] Door Opener—Day/Night/Lunch). While on a doorphone call, any extension user can unlock a door to let a visitor in (→ 1.1.48 Doorphone Call).

Conditions

- **Hardware Requirement:** A user-supplied door opener installed on each door, optional doorphone, and doorphone card.
- A door opener can unlock a door even if no doorphone is installed.
- **Door Open Duration**
An opened door will remain unlocked for a preprogrammed length of time (→ [709] Door Open Duration).

Installation Manual References

- 2.3.6 4-Port Doorphone Card (KX-TA82461)
- 2.6 Connecting Doorphones and Door Openers

Programming Manual References

[PT Programming]

- [703-705] Door Opener—Day/Night/Lunch
- [709] Door Open Duration

[PC Programming]

- 9.7.1 Ringing & Door Opener [7-1]—Door Opener 1–4—Day, Night, Lunch
- 9.7.2 Others [7-2]—Door Open Duration—Door 1–4

Feature Manual References

- 1.1.47 Doorbell/Door Chime
- 1.1.48 Doorphone Call

Operating Manual References

- 1.3.37 Door Open

1.1.47 Doorbell/Door Chime

Description

Extension users can choose how their telephones receive doorphone calls, by selecting to hear ringing, a chime, or both, provided a doorbell/door chime connected to a door opener is connected to the PBX. They can recognize which doorphone is ringing by selecting a different doorphone chime pattern for each doorphone.

[Programming Example]

In order for an extension connected to extension jack 01 (extension 101) to be able to receive a doorphone call from a doorbell/door chime connected to Relay 4, program as follows:

| Programming | Doorphone | | | |
|--------------------------------------|--------------------|--------------------|--------------------|--------------------|
| | 1 | 2 | 3 | 4 |
| Doorphone Ringing *1 | Enable (extn. 101) | Enable (extn. 101) | Enable (extn. 101) | Enable (extn. 101) |
| Doorphone Ring/Chime *2 | Chime | Chime | Chime | Chime |
| Doorphone Chime Assignment *3 | Relay 4 | Relay 4 | Relay 4 | Relay 4 |
| Doorphone Chime Pattern *4 | Pattern 1 | Pattern 2 | Pattern 3 | Pattern 4 |

*1 → [700-702] Doorphone Ringing—Day/Night/Lunch

*2 → [710] Doorphone Ring/Chime

*3 → [711] Doorphone Chime Assignment

*4 → [712] Doorphone Chime Pattern

In this example

When a visitor presses the Call button of Doorphone 2:

- A doorbell/door chime, connected to Relay 4, chimes with Pattern 2.
- Because Doorphone Ring/Chime is set to "Chime", extension 101 does not ring.
- The extension user who is allowed to receive a call from Doorphone 2 can answer the doorphone call by going off-hook within a preprogrammed time period (→ [708] Doorphone Ring Time). If the user is allowed to unlock the door (→ [703-705] Door Opener—Day/Night/Lunch), he or she can then unlock the door by entering the Door Open feature number.
- If the called extension is busy and has set Call Waiting, the extension user hears a call waiting tone and the call information flashes on the display.

Conditions

- **Hardware Requirement:** A user-supplied doorbell/door chime connected to each door opener.

Installation Manual References

2.7 Connecting Doorbell or Door Chime

Programming Manual References

[PT Programming]

[700-702] Doorphone Ringing—Day/Night/Lunch

[703-705] Door Opener—Day/Night/Lunch

[708] Doorphone Ring Time

[710] Doorphone Ring/Chime

[711] Doorphone Chime Assignment

[712] Doorphone Chime Pattern

[PC Programming]

9.7.1 Ringing & Door Opener [7-1]

9.7.2 Others [7-2]—Doorphone Ring Time—Door 1–4, Doorphone Ring / Chime—Door 1–4, Doorphone Chime Assignment—Door 1–4, Doorphone Chime Pattern—Door 1–4

Feature Manual References

- 1.1.46 Door Open
- 1.1.48 Doorphone Call
- 2.2.1 Tones/Ring Tones

Operating Manual References

- 1.3.28 Call Waiting
- 1.3.37 Door Open
- 1.3.38 Doorphone Call

1.1.48 Doorphone Call

Description

A visitor can use a doorphone to call its preprogrammed destination. Extension users can call a doorphone. Doorphones can also be used for the Room Monitor feature (→ 1.1.110 Room Monitor).

Conditions

- **Hardware Requirement:** An optional doorphone, and doorphone card.
- Doorphones 1 and 2 (or doorphones 3 and 4) cannot be used at the same time. When one is in use, the user cannot have a conversation with the other.
- A doorphone access tone will be sent to a monitored doorphone before monitoring starts. If an extension user wants to monitor a doorphone without informing the other party, it is possible to eliminate the tone through system programming (→ [707] Doorphone Access Tone).
- **Ring Duration**
If an incoming doorphone call is not answered within a preprogrammed time period (→ [708] Doorphone Ring Time), ringing stops and the call is canceled.
An extension user can choose the preferred ring tone pattern for doorphone calls through system programming (→ [706] Doorphone Ring Tone Pattern).
- **Call Destination**
System programming determines the extensions that can receive calls from each doorphone for each time service mode (→ [700-702] Doorphone Ringing—Day/Night/Lunch).
- **Door Open**
While on a doorphone call, an extension user can unlock the door to let the visitor in (→ 1.1.46 Door Open).
- When a doorphone call is received at a proprietary telephone (PT), a tone is heard instead of ringing.

Installation Manual References

- 2.3.6 4-Port Doorphone Card (KX-TA82461)
- 2.6 Connecting Doorphones and Door Openers
- 2.7 Connecting Doorbell or Door Chime

Programming Manual References

[PT Programming]

[700-702] Doorphone Ringing—Day/Night/Lunch

[706] Doorphone Ring Tone Pattern

[707] Doorphone Access Tone

[708] Doorphone Ring Time

[710] Doorphone Ring/Chime

[711] Doorphone Chime Assignment

[712] Doorphone Chime Pattern

[PC Programming]

9.7.1 Ringing & Door Opener [7-1]—Doorphone 1–4—Day, Night, Lunch

9.7.2 Others [7-2]—Doorphone Ring Tone Pattern—Door 1–4, Doorphone Access Tone—Door 1–4, Doorphone Ring Time—Door 1–4, Doorphone Ring / Chime—Door 1–4, Doorphone Chime Assignment—Door 1–4, Doorphone Chime Pattern—Door 1–4

Feature Manual References

1.1.46 Door Open

1.1.110 Room Monitor

2.2.1 Tones/Ring Tones

Operating Manual References

1.3.38 Doorphone Call

1.3.80 Room Monitor

1.1.49 Emergency Call

Description

An extension user can dial preprogrammed emergency numbers (→ [309] Emergency Number) after seizing an outside (CO) line regardless of the restrictions imposed on the extension.

Conditions

- If the PBX is installed behind an existing host PBX, an extension user must dial the Host PBX Access code after the Outside (CO) Line Access number.
- This feature will function even when:
 - In Account Code—Verify-All/Verify-Toll/Forced mode (→ 1.1.2 Account Code Entry)
 - Restricted by the current class of service (COS) (→ 1.1.117 Toll Restriction (TRS))
 - In Extension Lock (→ 1.1.55 Extension Lock, 1.1.107 Remote Extension Lock)

Programming Manual References

[PT Programming]

[309] Emergency Number

[403] Host PBX Access Code

[PC Programming]

9.3.3 Detail [3-3]—Host PBX Access Codes

9.5.4 Emergency Number & Others [5-4]—Emergency Number

Feature Manual References

1.1.2 Account Code Entry

1.1.55 Extension Lock

1.1.107 Remote Extension Lock

1.1.117 Toll Restriction (TRS)

Operating Manual References

1.3.39 Emergency Call

1.1.50 Executive Busy Override—Extension

Description

An extension user can interrupt an existing intercom call to establish a 3-party conference call.

Conditions

- **Executive Busy Override Deny**
It is possible for extension users to prevent their calls from being interrupted by another extension user.
- System programming determines extension users who can use Executive Busy Override—Extension (→ [608] Executive Busy Override).
- This feature will not function when the busy extension has set Executive Busy Override Deny or Data Line Security (→ 1.1.37 Data Line Security).
- When a 2-party conversation is changed to a 3-party conference call, a confirmation tone will be sent to all parties (→ 1.1.33 Conference). It is possible to eliminate the tone through system programming (→ [105] Conference Tone).

Programming Manual References

[PT Programming]

[105] Conference Tone

[608] Executive Busy Override

[PC Programming]

9.1.11 Detail [1-10]—Conference—Conference Tone

9.2.1 Main [2-1]—Busy Override

9.2.2 Feature settings [2-2]—Busy Override Deny

Feature Manual References

1.1.33 Conference

1.1.37 Data Line Security

Operating Manual References

1.3.40 Executive Busy Override—Extension

1.3.42 Executive Busy Override Deny

1.1.51 Executive Busy Override—Outside (CO) Line

Description

A proprietary telephone (PT) user can interrupt an existing outside (CO) line call to establish a 3-party conference call.

Conditions

- **Executive Busy Override Deny**
It is possible for extension users to prevent their calls from being interrupted by another extension user.
- System programming determines extension users who can use Executive Busy Override—Outside (CO) Line (→ [608] Executive Busy Override).
- This feature will not function when the busy extension has set Executive Busy Override Deny or Data Line Security (→ 1.1.37 Data Line Security).
- When a 2-party conversation is changed to a 3-party conference call, a confirmation tone will be sent to all parties (→ 1.1.33 Conference). It is possible to eliminate the tone through system programming (→ [105] Conference Tone).

Programming Manual References

[PT Programming]

[105] Conference Tone

[608] Executive Busy Override

[PC Programming]

9.1.11 Detail [1-10]—Conference—Conference Tone

9.2.1 Main [2-1]—Busy Override

9.2.2 Feature settings [2-2]—Busy Override Deny

Feature Manual References

1.1.33 Conference

1.1.37 Data Line Security

Operating Manual References

1.3.41 Executive Busy Override—Outside (CO) Line

1.3.42 Executive Busy Override Deny

1.1.52 Extension Feature Clear

Description

Extension users can simultaneously clear all of the following features set on their own telephone:

| Feature | Value after Extension Feature Clear |
|------------------------------|--|
| Absent Message | Off |
| Automatic Callback Busy | Off |
| Background Music (BGM) | Off |
| Call Forwarding (FWD) | Off |
| Call Pickup Deny | Allow |
| Call Waiting | Disable |
| Data Line Security | Off |
| Do Not Disturb (DND) | Off |
| Executive Busy Override Deny | Allow |
| Hot Line | The stored telephone numbers will be cleared. |
| Log-in/Log-out | Log-in |
| Message Waiting | All messages left by other extensions will be cleared. |
| Paging Deny | Allow |
| Room Monitor | Off |
| Timed Reminder | Cleared |
| Voice Mail Integration | Off |

This feature is also known as Station Feature Clear or Station Program Clear.

Operating Manual References

1.3.43 Extension Feature Clear

1.1.53 Extension Group

Description

This PBX supports various types of extension groups. Extensions can be grouped into 8 extension groups (→ [600] Extension Group). Each extension group can have the following attribute set:

- a) Call Pickup, Group
- b) Paging—Group
- c) Idle Extension Hunting Group
- d) Direct Inward System Access (DISA) Ring Group

Every extension must belong to one extension group and cannot belong to more than one extension group.

Assignable Extensions: Proprietary telephones (PTs)/single line telephones (SLTs)

[Example]

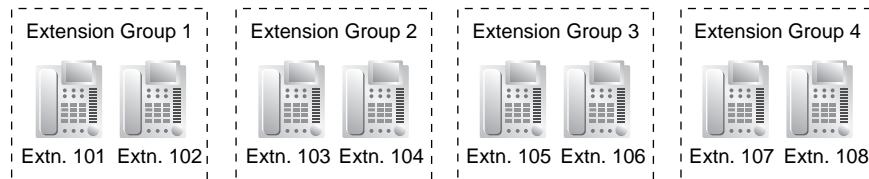

2.1. Call Pickup, Group

Using the Call Pickup feature, extensions can answer any calls within the call pickup group to which they belong.

2.2. Paging—Group

Using the Paging feature, extensions can make a page to any paging group, or answer a page made to any group.

2.3. Idle Extension Hunting Group

If a called extension is busy, Idle Extension Hunting redirects the incoming call to an idle member of the same extension group (→ [100] Hunting Group Set). When calls are received, idle extensions are automatically searched for according to a preprogrammed hunting type (→ [101] Hunting Type): Circular Hunting or Terminated Hunting.

2.4. Direct Inward System Access (DISA) Ring Group

A DISA ring group is a specific extension group that receives DISA calls directed to the group. All extensions in the group assigned as an Automated Attendant (AA) destination (→ [501] DISA Built-in AA) ring simultaneously. To use this feature, "DISA" must be selected as the distribution method for the desired outside (CO) line port (→ [414-416] CO Line Mode—Day/Night/Lunch) and "With AA" must be selected as the destination of incoming outside (CO) line calls via the DISA feature (→ [500] DISA Incoming Call Dial Mode).

Programming Manual References

[PT Programming]

[100] Hunting Group Set

[101] Hunting Type

[414-416] CO Line Mode—Day/Night/Lunch

[500] DISA Incoming Call Dial Mode

[501] DISA Built-in AA

[600] Extension Group

[PC Programming]

9.2.11 Extension Group [2-6]

9.3.1 Line Mode [3-1]—Mode of incoming CO calls—Day, Night, Lunch

9.6.1 Automated Attendant [6-1]—DISA Incoming Call Dial Mode, AA table

Feature Manual References

- 1.1.21 Call Pickup, Group
- 1.1.42 Direct Inward System Access (DISA) Ring
- 1.1.67 Idle Extension Hunting
- 1.1.96 Paging—Group

1.1.54 Extension Jack Configuration

Description

Extension jacks are used to connect proprietary telephones (PTs), single line telephones (SLTs), Direct Station Selection (DSS) Consoles, and Voice Processing Systems (VPSs) to the PBX.

Conditions

- **PT and SLT in Parallel Mode**
A PT and an SLT can be connected to an extension jack and used in parallel mode.
- **DSS Console and Paired Telephone Assignment**
When a DSS Console is connected, a PT must be paired with the DSS Console through system programming (→ [003] DSS Console Jack Assignment, [004] Console Paired Telephone). Each extension jack number should be unique.
- **Automatic Detection**
A PT and an SLT can be connected to an extension jack with no programming required.

Programming Manual References

[PT Programming]

[003] DSS Console Jack Assignment

[004] Console Paired Telephone

[PC Programming]

9.2.8 DSS Console [2-5]

1.1.55 Extension Lock

Description

Extension users can lock their telephones to prevent unauthorized use. This is useful for situations when extension users must leave their desks temporarily. Any 4-digit code can be used to lock and unlock an extension.

This feature is also known as Electronic Station Lockout.

Conditions

- **Remote Extension Lock**
When the operator or manager locks an extension remotely, the extension's user cannot unlock it. When a user locks an extension, the operator or manager extension can override the lock and unlock the extension.

- **TRS—Extension Lock Class**
The class of service (COS) of extensions locked by the Extension Lock or Remote Extension Lock feature can be assigned (→ [312] TRS—Extension Lock Class) so that even a locked extension can make outside (CO) line calls. The higher COS number will take precedence. If, for example, COS 3 is assigned to an extension (→ [601-603] TRS-COS—Day/Night/Lunch) and the COS of locked extensions is assigned as "4", when the extension is locked, the PBX allows the extension user to make outside (CO) line calls using COS 4.
- **Extension Lock—CANCEL ALL**
The operator or manager can cancel this feature for all extensions simultaneously.
- This feature also functions as Call Log Display Lock, Incoming (→ 1.1.18 Call Log, Incoming).
The Incoming Call Log for the common area can only be locked or unlocked by the operator or manager (Call Log Display Lock, Incoming in the Common Area).
- This feature will not block Emergency Calls (→ 1.1.49 Emergency Call).

Programming Manual References

[PT Programming]

[108] Flash/Recall Mode for a Locked Extension

[312] TRS—Extension Lock Class

[601-603] TRS-COS—Day/Night/Lunch

[PC Programming]

9.1.11 Detail [1-10]—Extension—Flash/Recall Mode for a Locked Extension

9.5.1 Class of Service (COS) [5-1]—Day, Night, Lunch

9.5.4 Emergency Number & Others [5-4]—Extension Lock Class

Feature Manual References

1.1.18 Call Log, Incoming

1.1.49 Emergency Call

1.1.107 Remote Extension Lock

1.1.117 Toll Restriction (TRS)

Operating Manual References

1.3.44 Extension Lock

2.1.7 System Feature Assignment—Extension Lock—CANCEL ALL

1.1.56 External Feature Access (EFA)

Description

An extension user can access features of a host PBX or the telephone company, such as Call Waiting. An EFA (External Feature Access) signal is sent to the host PBX or the telephone company. This feature is only available during outside (CO) line calls, including Host PBX Access (→ 1.1.65 Host PBX Access Code (Access Code to the Telephone Company from a Host PBX)).

Conditions

- This feature functions only if the FLASH/RECALL button is set to "MODE 1: EFA mode" (→ 1.1.60 Flash/Recall). It is also possible to perform this feature by entering the EFA feature number when the current call is placed on consultation hold (→ 1.1.36 Consultation Hold).
- **Flash/Recall Time**
The length of an EFA signal can be selected for each outside (CO) line (→ [418] Flash/Recall Time).

Programming Manual References

[PT Programming]

[110] Flash/Recall Key Mode

[418] Flash/Recall Time

[PC Programming]

9.1.11 Detail [1-10]—Proprietary Telephone—Flash/Recall Key Mode

9.3.3 Detail [3-3]—Flash/Recall Time

Feature Manual References

1.1.36 Consultation Hold

1.1.60 Flash/Recall

1.1.65 Host PBX Access Code (Access Code to the Telephone Company from a Host PBX)

Operating Manual References

1.3.45 External Feature Access (EFA)

1.1.57 Feature Numbering

Description

To call another extension user or to access PBX features, access numbers (extension numbers or feature numbers) are required.

Feature numbers are available while:

1. a dial tone is heard
2. a busy tone or Do Not Disturb (DND) tone is heard
3. dialing or talking
4. on-hook

1. Feature Numbering (available while a dial tone is heard)

Extension numbers and features that are available while a dial tone is heard have fixed numbers shown in the following table:

The extension number can be assigned for each extension through system programming (→ [009] Extension Number).

[Feature Numbering Table (available while a dial tone is heard)]

| Feature | Numbering | Additional Number |
|---|------------------|--|
| Absent Message (set/cancel) | 75 | (1–6 [+ parameter]/0) + #/0 |
| Account Code Entry for an SLT | ** or 49 | account code + outside phone no. |
| Built-in Voice Message (BV) (record/play/erase) | 725 | ([1 + extn. no.]/2/0) + #/0 |
| Call Forwarding (FWD)—All Calls, Busy/No Answer (set/cancel) | 71 | ([1 or 2 + extn. no.]/0) + #/0 |
| Call Forwarding (FWD)—All Calls, Busy/No Answer to BV (set/cancel) | 71 | ([1 or 2 + 725]/0) + #/0 |
| Call Forwarding (FWD)—All Calls, Busy/No Answer to Voice Processing System (VPS) (set/cancel) | 71 | ([1 or 2 + extn. no.]/0) + #/0 |
| Call Forwarding (FWD)—Follow Me (set/cancel) | 71 | (5/8) + extn. no. + #/0 |
| Call Forwarding (FWD)—To Outside (CO) Line (set/cancel) | 71 | (3 + outside (CO) line access no. + outside phone no. + #)/(0 + #/0) |
| Call Hold (Hold Mode 2 or 3) for an SLT | 20 | |
| Call Hold Retrieve for outside (CO) line calls/intercom calls | 53/5 | outside (CO) line no. (1–8)/extn. no. |
| Call Log, Incoming in the Common Area—CLEAR ALL | 70** | # |
| Call Log, Incoming in the Personal Area—CLEAR ALL | 70* | # |
| Call Park/Call Park Retrieve | 22/52 | 0–9 |
| Call Log Display Lock, Incoming | 77 | 0000–9999 (2 times/one time) + # |
| Call Pickup, Directed | 4 | extn. no. |
| Call Pickup, Group | 40 | |
| Call Pickup Deny (set/cancel) | 72 | (1/0) + #/0 |
| Call Waiting for intercom calls/doorphone calls (set/cancel) | 732 | (1/0) + #/0 |
| Call Waiting for outside (CO) line calls (set/cancel) | 731 | (1/0) + #/0 |
| Common BV Outgoing Message (OGM) (record/play/erase) | 722 | 01–24 + (1/2/0) + #/0 |
| Data Line Security (set/cancel) | 730 | (1/0) + #/0 |
| Do Not Disturb (DND) (set/cancel) | 71 | (4/0) + #/0 |
| Doorphone Call/Door Open | 31/55 | 1–4 |

| Feature | Numbering | Additional Number |
|--|-----------------|------------------------------------|
| Executive Busy Override Deny (set/cancel) | 733 | (0/1) + #/0 |
| Extension Lock (set/cancel) | 77 | 0000–9999 (2 times/one time) + #/0 |
| Extension Number | 100–199 | |
| External Feature Access (EFA) for an SLT | 6 | |
| Extension Feature Clear | 79 | #/0 |
| Hot Line for an SLT (program) | 74 | 2 + phone no. + # |
| Hot Line for an SLT (set/cancel) | 74 | (1/0) + #/0 |
| Line Access, Automatic (Local Access) | 9 | outside phone no. |
| Line Access, Outside (CO) Line Group | 8 | 1–8 + outside phone no. |
| Live Call Screening (LCS) Password (set/cancel) | 77* | 000–999 (2 times/one time) + # |
| Log-in/Log-out | 736 | (0/1) + #/0 |
| Logging of Caller ID Information in the Common Area (set/cancel) | 738 | (2/0) + #/0 |
| Logging of Caller ID Information in the Personal Area (set/cancel) | 738 | (1/0) + #/0 |
| Message Waiting (leave/cancel for a caller) | 70 | (1/2) + extn. no. + #/0 |
| Message Waiting (cancel all for a called extension) | 70 | 0 + #/0 |
| Message Waiting Answer | 784 | #/0 |
| Message Waiting for Another Extension (cancel all for another extension) | 70 | 3 + extn. no. + # |
| Message Waiting for Another Extension Lock (set/cancel) | 70 | 4000–9999 (2 times/one time) + #/0 |
| Operator Call | 0 | |
| Paging—All Extensions & External | 33 | * or 9 |
| Paging—All Extensions/Group | 33 | 0/1–8 |
| Paging—External | 34 | |
| Paging Answer | 43 | |
| Paging Deny (set/cancel) | 734 | (1/0) + # |
| Personal BV OGM (record/play/erase) | 723 | (1/2/0) + #/0 |
| Personal Speed Dialing (confirm) | 3* | 0–9 + # |
| Personal Speed Dialing (dial) | 1* or # | 0–9 |
| Personal Speed Dialing (program) | 2* | 0–9 + phone no. + # |
| Redial, Last Number for an SLT | ## or 80 | |

| Feature | Numbering | Additional Number |
|---|------------|---|
| Remote Maintenance | 729 | |
| Room Monitor (set/cancel) | 735 | (1/0) + # |
| Room Monitor through a doorphone | 31 | 1–4 |
| System Speed Dialing for an SLT (dial) | * | 00–99 |
| The 21st Call Log, Incoming in the Personal Area Treatment (disregard the newest call/ overwrite the oldest call) | 737 | (0/1) + # |
| The 301st Call Log, Incoming in the Common Area Treatment (disregard the newest call/overwrite the oldest call) | 737 | (2/3) + # |
| Timed Reminder (set/cancel) | 76 | ([hhmm + parameter]*2) + #/0 |
| Timed Reminder (confirm) | 76 | 3 + # |
| Timed Reminder, Remote (set/cancel/ confirm) | 764 | extn. no. + # + 76 + ([hhmm + parameter]*2/3) + # |
| Time Service (set/cancel) | 78 | ([1–3]/0) + # |
| Walking COS | 7* | extn. password + the user's extn. no. + #/0 |

* hh: hour (01–12), mm: minute (00–59), AM/PM (0/1), one time/daily (1/2)

2. Feature Numbering (available while a busy tone or DND tone is heard)

Features that are available while a busy tone or DND tone is heard have fixed numbers, as shown in the following table:

[Feature Numbering Table (available while a busy tone or DND tone is heard)]

| Feature | Numbering |
|---|-----------|
| Automatic Callback Busy | 6 |
| Busy Station Signaling (BSS) | 1 |
| Executive Busy Override—Extension/Do Not Disturb (DND) Override | 2 |

3. Feature Numbering (available while dialing or talking)

Features that are available while dialing or talking have fixed numbers, as shown in the following table:

[Feature Numbering Table (available while dialing or talking)]

| Feature | Numbering |
|--|-----------|
| Alternate Calling—Ring/Voice | * |
| Call Retrieving from a Telephone Answering Machine (TAM) | 4* |
| Conference for an SLT | 3 |
| Door Open | 5 |

| Feature | Numbering |
|--------------------------|-----------|
| Pulse to Tone Conversion | *# |

* Dial after dialing the TAM's extension number and hearing its busy tone.

4. Feature Numbering (available while on-hook)

Features that are available while on-hook have fixed numbers, as shown in the following table:

[Feature Numbering Table (available while on-hook)]

| Feature | Numbering |
|--|-----------|
| Background Music (BGM) set/cancel | 1 |
| Time Service mode display | # |
| Extension number and extension name display/ date (month/day) and time display/ date (month/day/year/day of the week) display changing | * |

Conditions

- If a feature number includes "*" or "#" except for those that can use "0" instead of "#", rotary SLT users cannot use it.
- **Feature number + Additional number (Parameter)**
Certain feature numbers require additional digits to make the feature active. For example, to set Call Waiting, the feature number for "Call Waiting" must be followed by "1" and to cancel it, the same feature number should be followed by "0".

Programming Manual References

[PT Programming]

[009] Extension Number

[PC Programming]

9.1.3 Numbering Plan [1-3]—Ext. no.

Operating Manual References

4.2.1 Feature Number Table

1.1.58 Firmware Upgrade

Description

It is possible to upgrade the PBX software via the Serial Interface (RS-232C port) or USB port using the KX-TA Maintenance Console software. Even if a user upgrades the PBX software, the system data will not be lost. For more information on how to upgrade the PBX software, refer to the on-line help.

Conditions

- The ROM and the firmware version can be confirmed through system programming (→ [998] Firmware Version).

Installation Manual References

2.8.1 Connecting Peripherals

Programming Manual References

[PT Programming]

[998] Firmware Version

[PC Programming]

8.1 Firmware Upgrade

1.1.59 Fixed Buttons

Description

Proprietary telephones (PTs) and Direct Station Selection (DSS) Consoles feature a wide variety of feature buttons and Line Access buttons, explained below.

Note that certain models do not have certain buttons.

For a description of the buttons found on each PT or DSS Console, please refer to the Operating Instructions for each PT or DSS Console.

[PT]

| Button | Function |
|------------------------------------|--|
| Navigator Key | Used to adjust the volume of the speaker, handset and headset, and the display contrast, or to select desired items. |
| Volume Key | Used to adjust the volume of the speaker, handset and headset. |
| PROGRAM | Used to enter and exit programming mode. |
| FLASH/RECALL | Used to disconnect the current call and make another call without hanging up (Flash/Recall mode), or to send an EFA (External Feature Access) signal to the telephone company or host PBX to access external features (EFA mode). |
| HOLD | Used to place a call on hold. |
| SP-PHONE (Speakerphone) | Used to select handset or hands-free operation. |
| MONITOR | Used to select hands-free dialing and monitor operation. |
| MESSAGE | Used to leave a message waiting indication, call back the party who left a message waiting indication, or play back voice messages. This button is provided with an LED (Light Emitting Diode), except for on KX-T7700 series telephones. With KX-T7700 series telephones, the Message/Ringer Lamp is lit when a message waiting indication is left at an extension. |
| REDIAL | Used to redial the last number dialed. |

| Button | Function |
|---|---|
| TRANSFER | Used to transfer a call to another party. |
| Flexible CO | Used to access an outside (CO) line (or outside (CO) line group) when making or receiving a call. The button's preprogrammed Outside (CO) Line Access method determines which line is selected (Default: Single-CO [S-CO]). Can also be customized as a feature button. |
| INTERCOM | Used to make or receive intercom calls. |
| AUTO ANS (Auto Answer)/MUTE | Used to answer an intercom call automatically in hands-free mode, or to mute the built-in microphone during a conversation. |
| VOICE CALL | Used to answer an intercom call automatically. |
| AUTO DIAL/STORE | Used for System Speed Dialing/Saved Number Redial, playing back personal/common BV outgoing messages (OGMs) used by the Built-in Voice Message (BV) feature, and storing program changes. |
| CONF (Conference) | Used to establish a 3-party conference call. |
| FWD/DND (Call Forwarding/Do Not Disturb) | Used to set the FWD or DND feature for the extension. |
| PAUSE | Used to insert a dialing pause in a stored number. |
| PF (Programmable Feature) | Used to access a preprogrammed feature (no default). Mostly used as a One-touch Dialing button. |

[DSS Console]

| Button | Usage |
|---------------------|---|
| Flexible DSS | Used to call an extension with a one-touch operation. Each button is programmed to correspond to an extension. DSS buttons can also be customized as different feature buttons. |
| PF | Used to access a preprogrammed feature (no default). Mostly used as a One-touch Dialing button. |

Conditions

- Certain buttons are equipped with a light to indicate the status of the corresponding line or feature.

Feature Manual References

1.1.70 LED Indication

Operating Manual References

1.1.1 Before Operating a Telephone

1.1.60 Flash/Recall

Description

A proprietary telephone (PT) user can use the FLASH/RECALL button to disconnect the current call and start another call without hanging up. For example, if this button is used to disconnect an outside (CO) line, the extension user will hear a new dial tone from the same outside (CO) line.

Conditions

- **FLASH/RECALL Button Mode**
One of the following modes can be selected through system programming (→ [110] Flash/Recall Key Mode):
 - a) **MODE 1: EFA mode** (→ 1.1.56 External Feature Access (EFA))
An EFA signal is sent for the specified duration (→ [418] Flash/Recall Time).
 - b) **MODE 2: Flash/Recall mode**
A flash/recall signal is sent when the FLASH/RECALL button is pressed if the length of time that the button is pressed is longer than the specified duration (→ [418] Flash/Recall Time). If the length of time that the button is pressed is shorter than the specified duration, an EFA signal will be sent for the specified duration.
- This feature functions only if the FLASH/RECALL button is set to "MODE 2: Flash/Recall mode".
- **Disconnect Time**
The amount of time between successive accesses to the same outside (CO) line is programmable for each outside (CO) line (→ [422] Disconnect Time).
- Pressing the FLASH/RECALL button restarts the conversation duration, outputs an SMDR call record (→ 1.1.112 Station Message Detail Recording (SMDR)) and checks the Toll Restriction (TRS) class of service (COS) number again. The notation "F/" will be logged along with the new dial number on SMDR.

Programming Manual References

[PT Programming]

[110] Flash/Recall Key Mode

[418] Flash/Recall Time

[422] Disconnect Time

[PC Programming]

9.1.11 Detail [1-10]—Proprietary Telephone—Flash/Recall Key Mode

9.3.3 Detail [3-3]—Flash/Recall Time, Disconnect Time

Feature Manual References

1.1.56 External Feature Access (EFA)

1.1.112 Station Message Detail Recording (SMDR)

Operating Manual References

1.3.46 Flash/Recall

1.1.61 Flexible Buttons

Description

Flexible buttons are buttons whose functions can be customized through either system or personal programming. The following types of flexible buttons are found on proprietary telephones (PTs) and/or Direct Station Selection (DSS) Consoles:

- a) Flexible CO buttons
- b) Flexible DSS buttons
- c) Programmable Feature (PF) buttons
- d) Flexible MESSAGE button

[Button Usage]

| Button | Function |
|---|---|
| Single-CO (S-CO) | Used to access a specified outside (CO) line for making or receiving calls (→ 1.1.71 Line Access, Outside (CO) Line—SUMMARY). |
| Group-CO (G-CO) | Used to access an idle outside (CO) line in a specified outside (CO) line group for making calls. Incoming calls from outside (CO) lines in the assigned outside (CO) line group arrive at this button (→ 1.1.71 Line Access, Outside (CO) Line—SUMMARY). |
| Other-CO (O-CO) | Used to access an idle outside (CO) line for making calls. Incoming calls from the assigned outside (CO) lines, which are not assigned to S-CO or G-CO buttons, arrive at this button (→ 1.1.71 Line Access, Outside (CO) Line—SUMMARY). |
| Direct Station Selection (DSS) | Used to call an extension with a one-touch operation (→ 1.1.69 Intercom Call). |
| One-touch Dialing | Used to call a preprogrammed party or access a feature with a one-touch operation (→ 1.1.86 One-touch Dialing). |
| Message | Used to leave a message waiting indication, call back the party who left the message waiting indication, or play back voice messages (→ 1.1.82 Message Waiting). |
| Message for another extension | Used to access voice messages stored for another extension (→ 1.1.82 Message Waiting). |
| FWD/DND (Call Forwarding/Do Not Disturb) | Used to set the FWD or DND feature for the extension (→ 1.1.10 Call Forwarding (FWD)—SUMMARY). |
| Save | Used to store a telephone number while in a conversation with an outside party or while hearing a busy tone, and then easily redial the number later (→ 1.1.105 Redial, Last Number). |
| Conference | Used to establish a 3-party conference call (→ 1.1.33 Conference). |
| Caller ID Indication—Personal | Used to inform an extension user of calls logged in his or her personal area, store the information of an incoming call during a conversation, and view caller information while on-hook and then call back a caller (→ 1.1.18 Call Log, Incoming). |

| Button | Function |
|-------------------------------------|---|
| Caller ID Selection—Personal | Used to display and cycle through the information of an incoming call during a conversation, while receiving a call, or while viewing caller information, display the number of logged calls while on-hook, and inform an extension user that the personal area call log is full (→ 1.1.18 Call Log, Incoming). |
| Caller ID Indication—Common | Used to inform an extension user of calls logged in the common area, store the information of an incoming call during a conversation, and view caller information while on-hook and then call back a caller (→ 1.1.18 Call Log, Incoming). |
| Caller ID Selection—Common | Used to display and cycle through the information of an incoming call during a conversation, while receiving a call, or while viewing caller information, display the number of logged calls while on-hook, and inform an extension user that the common area call log is full (→ 1.1.18 Call Log, Incoming). |
| Log-in/Log-out | Used to switch between Log-in and Log-out status (→ 1.1.80 Log-in/Log-out). |
| Day | Used to change the time service mode to day mode (→ 1.1.114 Time Service). |
| Night | Used to change the time service mode to night mode (→ 1.1.114 Time Service). |
| Lunch | Used to change the time service mode to lunch mode (→ 1.1.114 Time Service). |
| Extension Lock | Used to remotely lock or unlock another extension (→ 1.1.87 Operator/Manager Features). |
| 2-way Record | Used to record a conversation into the user's own mailbox (→ 1.1.120 Voice Mail APT Integration). |
| 2-way Transfer | Used to record a conversation into the mailbox of a specified extension (→ 1.1.120 Voice Mail APT Integration). |
| Live Call Screening (LCS) | Used to listen while a caller is leaving a message in the user's voice mailbox and, if desired, intercept the call (→ 1.1.120 Voice Mail APT Integration). |
| LCS Cancel | Used to stop monitoring the user's own voice mailbox while a caller is leaving a message, or stop the alert tone heard in private mode while a caller is leaving a message (→ 1.1.120 Voice Mail APT Integration). |
| Voice Mail (VM) Transfer | Used to transfer a call to the mailbox of a specified extension (→ 1.1.120 Voice Mail APT Integration). |

Conditions

- **Extension button confirmation**
A display PT user can confirm the button settings, such as the flexible CO button, by pressing the corresponding button while on-hook.
- The Day, Night, Lunch, and Extension Lock buttons can only be assigned to flexible DSS buttons at an extension assigned as the operator or manager.

Programming Manual References

[PC Programming]

9.2.4 Flexible Buttons [2-4]

Feature Manual References

- 1.1.10 Call Forwarding (FWD)—SUMMARY
- 1.1.18 Call Log, Incoming
- 1.1.33 Conference
- 1.1.69 Intercom Call
- 1.1.71 Line Access, Outside (CO) Line—SUMMARY
- 1.1.80 Log-in/Log-out
- 1.1.82 Message Waiting
- 1.1.86 One-touch Dialing
- 1.1.87 Operator/Manager Features
- 1.1.105 Redial, Last Number
- 1.1.114 Time Service
- 1.1.120 Voice Mail APT Integration

Operating Manual References

- 3.1.3 Flexible Button Assignment

1.1.62 Hands-free Answerback

Description

A user with a speakerphone-equipped proprietary telephone (PT) can answer intercom calls automatically without lifting the handset. When a call is received at an extension that is in Hands-free Answerback mode, the caller hears a confirmation tone and the called extension hears a beep tone. Then the conversation is automatically established.

Conditions

- **Hands-free Answerback applies to:**
 - Intercom calls (not including outside (CO) line calls or doorphone calls)
- When an intercom call/outside (CO) line call is transferred to an extension, this feature is overridden and a ring tone is heard.

Feature Manual References

- 1.1.69 Intercom Call

Operating Manual References

- 1.3.47 Hands-free Answerback

1.1.63 Hands-free Operation

Description

A proprietary telephone (PT) user can dial and talk to another party without lifting the handset. Pressing specific buttons automatically activates hands-free mode.

Conditions

- **PTs with the MONITOR Button**
PTs with the MONITOR button can dial in hands-free mode but cannot have hands-free conversations.
- Hands-free mode is canceled if an extension user does not start dialing within 10 seconds.
- This feature can be used by pressing the following buttons when the indicator of the SP-PHONE/MONITOR button is off:
 - SP-PHONE button
 - MONITOR button
 - INTERCOM button
 - CO button

Operating Manual References

1.3.48 Hands-free Operation

1.1.64 Headset Operation

Description

This PBX supports headset-compatible proprietary telephones (PTs). A PT user can talk to another party without lifting the handset by using an optional headset.

For connection and operation, refer to the Operating Instructions for the headset.

This feature is also known as Handset/Headset Selection.

Conditions

- To set headset mode on a PT, use the handset/headset selector located on the telephone and/or on the headset.
- If headset mode is on, pressing the SP-PHONE button activates the headset, not the built-in speaker.

Operating Manual References

1.3.49 Headset Operation

1.1.65 Host PBX Access Code (Access Code to the Telephone Company from a Host PBX)

Description

This PBX can be installed behind an existing host PBX. This is performed by connecting extension jacks of the host PBX to outside (CO) line ports of this PBX. A Host PBX Access code, assigned through system programming (→ [403] Host PBX Access Code), is required to access the telephone company from the host PBX. The Outside (CO) Line Access number (9, or 81 through 88) of the host PBX should be stored as a Host PBX Access code for each outside (CO) line of this PBX. A pause of a preprogrammed length (→ [417] Pause Time) will be automatically inserted after the user-dialed Host PBX Access code.

[Example]

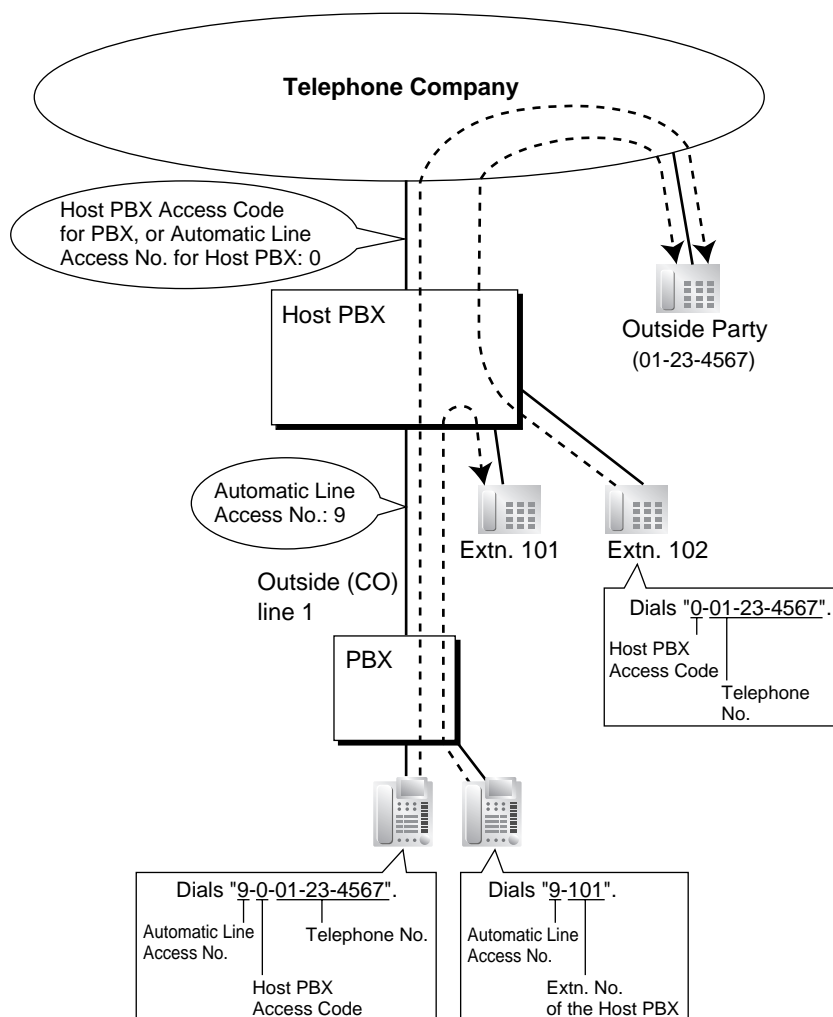

Note

In this example, "0" should be assigned as the Host PBX Access code for outside (CO) line 1 of this PBX.

Conditions

- Access to the host PBX during a conversation is also possible (→ 1.1.56 External Feature Access (EFA)).
- **TRS**
TRS checks only the dialed telephone number, excluding the Host PBX Access code, when accessing the telephone company through the host PBX (→ 1.1.117 Toll Restriction (TRS)).
- **SMDR**
The Host PBX Access code can be logged by SMDR along with the dialed number when accessing the telephone company through the host PBX (→ 1.1.112 Station Message Detail Recording (SMDR)).

Programming Manual References

[PT Programming]

[403] Host PBX Access Code

[417] Pause Time

[PC Programming]

9.3.3 Detail [3-3]—Host PBX Access Codes, Pause Time

Feature Manual References

1.1.56 External Feature Access (EFA)

1.1.98 Pause Insertion

1.1.112 Station Message Detail Recording (SMDR)

1.1.117 Toll Restriction (TRS)

1.1.66 Hot Line

Description

A single line telephone (SLT) user can make an outgoing call to a previously stored telephone number (up to 32 digits) simply by going off-hook. If the Hot Line feature is set and the user goes off-hook, a special dial tone (dial tone 2) is generated for a preprogrammed time period (→ [203] Hot Line Waiting Time), and then dialing starts. During this waiting time, the user can dial another party, overriding the Hot Line feature.

This feature is also known as Pickup Dialing.

Conditions

- This feature cannot be programmed on rotary SLTs.
- This feature will not function when the extension user goes off-hook to answer an incoming call or retrieve a call on hold.

Programming Manual References

[PT Programming]

[203] Hot Line Waiting Time

[PC Programming]

9.1.7 Timers [1-6]—Start Time—Hot Line

9.2.2 Feature settings [2-2]—Hot Line for SLT

Operating Manual References

1.3.50 Hot Line

1.1.67 Idle Extension Hunting

Description

If a called extension is busy, Idle Extension Hunting redirects the call to an idle member of the same extension group, if that group has been assigned as an idle extension hunting group through system programming (→ [100] Hunting Group Set). Idle extensions are automatically searched for according to a preprogrammed hunting type (→ [101] Hunting Type).

This feature is also known as Station Hunting.

| Type | Description |
|---------------------------|---|
| Circular Hunting | <p>An idle extension is searched for in a circular fashion one time according to the numerical order of the jacks.</p> |
| Terminated Hunting | <p>An idle extension is searched for in the numerical order of the jacks, until reaching the extension that is connected to the highest-numbered jack in the group.</p> |

Conditions

- **Idle Extension Hunting applies to:**
Intercom calls and outside (CO) line calls directed to a single extension.
- An extension can belong to only one extension group (→ [600] Extension Group). One hunting type can be programmed for each extension group.
- If all the searched extensions are busy in an idle extension hunting group, a busy tone will be heard at the extension that made the intercom call (including Direct Inward System Access [DISA] calls).
- A user can leave an idle extension hunting group temporarily by logging out of the group, and rejoin the group by logging back in (→ 1.1.80 Log-in/Log-out).
- **FWD/DND Mode**
When searching for an idle extension within an idle extension hunting group, any extension that has set

Call Forwarding (FWD), Do Not Disturb (DND), or Log-out will be skipped. However, if the extension that receives the call first has set FWD or DND, Idle Extension Hunting will not function and the call will be forwarded to the preprogrammed destination (when FWD is set) or will not be received at all (when DND is set).

- **Message Waiting**
A message waiting indication will not be sent to an idle extension hunting destination. The MESSAGE button light or Message/Ringer Lamp turns on at the original destination only (→ 1.1.82 Message Waiting).

Programming Manual References

[PT Programming]

[100] Hunting Group Set

[101] Hunting Type

[600] Extension Group

[PC Programming]

9.2.11 Extension Group [2-6]

Feature Manual References

1.1.10 Call Forwarding (FWD)—SUMMARY

1.1.44 Do Not Disturb (DND)

1.1.53 Extension Group

1.1.80 Log-in/Log-out

1.1.82 Message Waiting

1.1.68 Intercept Routing

Description

Redirects incoming outside (CO) line calls via the Direct Inward System Access (DISA) feature to a preprogrammed destination when the original destination does not, or cannot, answer the call. There are 2 types of Intercept Routing, described below.

| Type | Description |
|---|---|
| No Dial | While or after hearing a DISA outgoing message (OGM) or after hearing a dial tone (short beep), if the caller does not dial anything or enters an unrecognized input, the call is redirected to preprogrammed intercept destinations in the following priority: [438-440] DISA IRNA to BV—Day/Night/Lunch → [408-410] Flexible Ringing—Day/Night/Lunch |
| Intercept Routing—No Answer (IRNA) | If a called party does not answer a call within a preprogrammed time period (→ [508] DISA Ring Time before Intercept), the call is redirected to preprogrammed intercept destinations in the following priority: [438-440] DISA IRNA to BV—Day/Night/Lunch → [408-410] Flexible Ringing—Day/Night/Lunch |

Programming Manual References

[PT Programming]

- [408-410] Flexible Ringing—Day/Night/Lunch
- [438-440] DISA IRNA to BV—Day/Night/Lunch
- [507] DISA Intercept Mode
- [508] DISA Ring Time before Intercept
- [509] DISA Ring Time after Intercept
- [510] DISA No Dial Mode

[PC Programming]

- 9.3.2 Incoming / Outgoing [3-2]—Ring for incoming CO calls—Day, Night, Lunch
- 9.6.3 Settings [6-2]—Mode—DISA Intercept Mode, Mode—DISA No Dial Mode, Timers—DISA Ring Time before Intercept, Timers—DISA Ring Time after Intercept
- 9.8.2 Others [8-2]—DISA IRNA to BV—Day, Night, Lunch

Feature Manual References

- 1.1.8 Built-in Voice Message (BV)
- 1.1.41 Direct Inward System Access (DISA)

1.1.69 Intercom Call

Description

An extension user can call another extension user.

Conditions

- **Extension Number/Name Assignment**
Extension numbers (→ [009] Extension Number) and names (→ [604] Extension Name) can be assigned to all extensions. During intercom calls, the number and name of the other extension are shown on the displays of proprietary telephones (PTs).
- **DSS Button**
A flexible CO/DSS/MESSAGE button can be customized as a DSS button. The DSS buttons on a DSS Console can also be used.
- **Alternate Receiving—Ring/Voice**
A PT user can select to receive intercom calls by ring tone or by voice, through personal programming (Alternate Receiving—Ring/Voice). If a user selects voice-calling, the calling party can talk to the user immediately after hearing a confirmation tone.
- **Alternate Calling—Ring/Voice**
A caller can change the called party's preset call receiving method (ring tone or voice). By doing so, ring-calling is switched to voice-calling, or vice versa, at the called party. This setting is active for the current call only, after which it reverts to the called party's previous setting.
- The extension ring tone pattern for incoming intercom calls can be selected through system programming (→ [115] Extension Ring Tone Pattern). The ringback tone pattern for outgoing intercom calls and for incoming outside (CO) line calls can also be selected through system programming (→ [128] Ringback Tone Pattern).
- **Tone after Dialing**
After dialing an extension number, a user will hear one of the following:

| Type | Description |
|--------------------------|---|
| Ringback Tone | Indicates the call is being received at the called party's extension. |
| Confirmation Tone | Indicates the called party has set voice-calling. |
| Busy Tone | Indicates the called party's extension is busy. |
| DND Tone | Indicates the called party has set Do Not Disturb (DND). |

Programming Manual References

[PT Programming]

[009] Extension Number

[115] Extension Ring Tone Pattern

[128] Ringback Tone Pattern

[604] Extension Name

[PC Programming]

9.1.3 Numbering Plan [1-3]

9.1.11 Detail [1-10]—Extension—Ring Tone Pattern, Extension—Ringback Tone Pattern

9.2.3 PT personal settings [2-3]—Alternate Receiving

Feature Manual References

1.1.61 Flexible Buttons

2.2.1 Tones/Ring Tones

Operating Manual References

1.3.3 Alternate Calling—Ring/Voice

1.3.51 Intercom Call

3.1.2 Personal Feature Assignment—Alternate Receiving—Ring/Voice

3.1.3 Flexible Button Assignment—DSS button

1.1.70 LED Indication

Description

The LED (Light Emitting Diode) of the Message/Ringer Lamp and the following buttons (Line Status Buttons and Corresponding Extension Status Button) can indicate line status with a variety of light patterns.

Line Status Buttons: Single-CO (S-CO), Group-CO (G-CO), Other-CO (O-CO), INTERCOM

Corresponding Extension Status Button: Direct Station Selection (DSS)

1. Light Pattern of the Message/Ringer Lamp

- Incoming call from an outside (CO) line/another extension: Red flashing
- Message(s) present (no incoming call): Red on
- No messages present and no incoming call: Off

2. Light Pattern of the Line Status Buttons

| Line Status Button Light Pattern | Outside (CO) Line Status | | | Intercom Line Status |
|-------------------------------------|---|------|------|----------------------|
| | S-CO | G-CO | O-CO | INTERCOM |
| Off | Idle | | | |
| Green on | This extension is using the line. | | | |
| Slow green flashing | This extension is holding the line. | | | |
| Moderate-speed green flashing | This extension is holding the line using Call Hold, Exclusive or using the line for an unattended conference. | | | |
| Rapid green flashing | – | – | – | Incoming call |
| Red on | Line(s) in use | | | – |
| Slow red flashing | Another extension is holding the line. | – | – | – |
| Moderate-speed red flashing | Local carrier-based voice mail service | – | – | – |
| Rapid red flashing | Incoming call | | | – |

3. Light Pattern of the Corresponding Extension Status Button

| Corresponding Extension Status Button Light Pattern | DSS |
|--|------------------------|
| Off | Idle |
| Slow red flashing | Call Forwarding (FWD)* |
| Moderate-speed red flashing | Do Not Disturb (DND)* |
| Red on | Busy |

* This setting can be changed through system programming (→ [112] DSS Lamp Mode).

4. Flashing Light Patterns

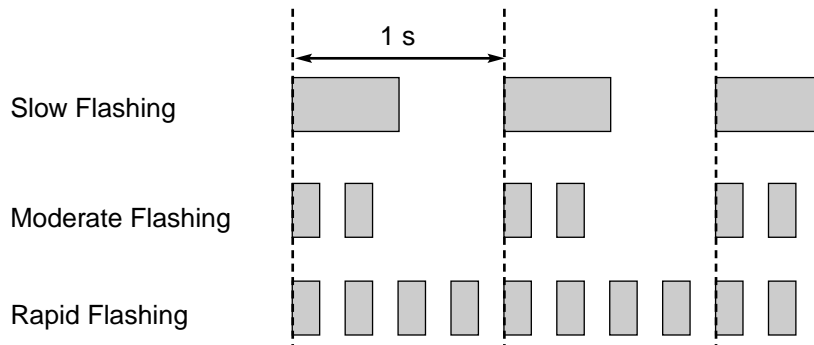

Conditions

- Incoming outside (CO) line calls arrive on available buttons in the following priority:
S-CO → G-CO → O-CO

Programming Manual References

[PT Programming]

[112] DSS Lamp Mode

[PC Programming]

9.1.11 Detail [1-10]—DSS—DSS Lamp Mode

Feature Manual References

- 1.1.10 Call Forwarding (FWD)—SUMMARY
- 1.1.15 Call Hold
- 1.1.33 Conference
- 1.1.42 Direct Inward System Access (DISA) Ring
- 1.1.44 Do Not Disturb (DND)
- 1.1.59 Fixed Buttons
- 1.1.61 Flexible Buttons

Operating Manual References

- 1.1.1 Before Operating a Telephone—INTERCOM button
- 3.1.3 Flexible Button Assignment—S-CO, G-CO, O-CO or DSS button

1.1.71 Line Access, Outside (CO) Line—SUMMARY

Description

There are 3 methods of accessing an outside (CO) line.

| Method | Description | Operation |
|--|---|--|
| Line Access, Automatic (Local Access) | Selects an idle outside (CO) line automatically from the assigned outside (CO) lines (→ [419] Automatic Designated Line Access). If Idle Line Preference (→ 1.1.76 Line Preference—Outgoing) is set on the extension through personal programming, the user can access an idle line simply by going off-hook. | Dial the Automatic Line Access number. |
| Line Access, Outside (CO) Line Group | Selects an idle outside (CO) line from the corresponding outside (CO) line group. | Dial the Outside (CO) Line Group Access number and an outside (CO) line group number, or press a Group-CO (G-CO) button. |
| Line Access, S-CO Line | Selects the desired outside (CO) line directly. | Press the Single-CO (S-CO) button. |

Line Access Using the Other-CO (O-CO) Button

To select an idle outside (CO) line from among the outside (CO) lines that are not assigned to S-CO or G-CO buttons, the proprietary telephone (PT) user can press the O-CO button.

Conditions

- **Line Access, Direct Outside (CO) Line**
If a PT user is on-hook when pressing an idle CO button, the PT automatically enables hands-free operation mode. The user can dial without lifting the handset or pressing the SP-PHONE or MONITOR button.
- The PBX waits for a preprogrammed length of time (→ [206] Dialing Start Time) after seizing an outside (CO) line before dialing.
- **Button Assignment**

A flexible CO button can be customized as an S-CO, G-CO, or O-CO button as follows:

| Type | Assignable parameter |
|-------------------------|--|
| Single-CO (S-CO) | A specified outside (CO) line is assigned (Default: CO 1–CO 8). |
| Group-CO (G-CO) | An outside (CO) line group is assigned (→ [404] CO Line Group Number). |
| Other-CO (O-CO) | Outside (CO) lines that are not assigned to S-CO or G-CO buttons are assigned. |

The same outside (CO) line group can be assigned to more than one G-CO button on the same PT. The same outside (CO) line can be assigned to an S-CO button and a G-CO button.

Dialing the Outside (CO) Line Access number selects a CO button according to the following priority:
S-CO → G-CO → O-CO

Once a flexible CO button is assigned as an Outside (CO) Line Access button, it indicates line status with a variety of light patterns (→ 1.1.70 LED Indication).

- System programming determines the extension users that can make outside (CO) line calls in each time service mode (→ [405-407] Flexible Outward Dialing—Day/Night/Lunch).

- It is possible to specify which outside (CO) lines are connected to the PBX (→ [400] CO Line Connection). This prevents extension users from trying to select or making calls using outside (CO) lines that are not connected.

Programming Manual References

[PT Programming]

[206] Dialing Start Time

[400] CO Line Connection

[404] CO Line Group Number

[405-407] Flexible Outward Dialing—Day/Night/Lunch

[419] Automatic Designated Line Access

[PC Programming]

9.1.7 Timers [1-6]—CO Dialing—Dialing Start Time

9.3.2 Incoming / Outgoing [3-2]—Outgoing Call—Day, Night, Lunch

9.3.3 Detail [3-3]—Connection, CO Line Group, Automatic Line Access

Feature Manual References

1.1.61 Flexible Buttons

1.1.70 LED Indication

1.1.76 Line Preference—Outgoing

Operating Manual References

1.3.52 Line Access, Outside (CO) Line—SUMMARY

3.1.3 Flexible Button Assignment—S-CO, G-CO, or O-CO button

1.1.72 Line Access, Automatic

Description

An extension user can select an idle outside (CO) line automatically from the assigned outside (CO) lines (→ [419] Automatic Designated Line Access) by dialing the Automatic Line Access number.

Line Access Using the Other-CO (O-CO) Button

To select an idle outside (CO) line from among the outside (CO) lines that are not assigned to S-CO or G-CO buttons, the proprietary telephone (PT) user can press the O-CO button.

Conditions

- If Idle Line Preference (→ 1.1.76 Line Preference—Outgoing) is set on the extension through personal programming, the user can access an idle line simply by going off-hook.
- The PBX waits for a preprogrammed length of time (→ [206] Dialing Start Time) after seizing an outside (CO) line before dialing.
- System programming determines the extension users that can make outside (CO) line calls in each time service mode (→ [405-407] Flexible Outward Dialing—Day/Night/Lunch).

- It is possible to specify which outside (CO) lines are connected to the PBX (→ [400] CO Line Connection). This prevents extension users from trying to select or making calls using outside (CO) lines that are not connected.

Programming Manual References

[PT Programming]

[206] Dialing Start Time

[400] CO Line Connection

[405-407] Flexible Outward Dialing—Day/Night/Lunch

[419] Automatic Designated Line Access

[PC Programming]

9.1.7 Timers [1-6]—CO Dialing—Dialing Start Time

9.3.2 Incoming / Outgoing [3-2]—Outgoing Call—Day, Night, Lunch

9.3.3 Detail [3-3]—Connection, Automatic Line Access

Feature Manual References

1.1.61 Flexible Buttons

1.1.76 Line Preference—Outgoing

Operating Manual References

1.3.53 Line Access, Automatic

3.1.3 Flexible Button Assignment—S-CO, G-CO, or O-CO button

1.1.73 Line Access, Outside (CO) Line Group

Description

An extension user can select an idle outside (CO) line from the corresponding outside (CO) line group (→ [404] CO Line Group Number) by dialing the Outside (CO) Line Group Access number and an outside (CO) line group number, or by pressing a Group-CO (G-CO) button on a proprietary telephone (PT).

Conditions

- **Line Access, Direct Outside (CO) Line**
If a PT user is on-hook when pressing an idle CO button, the PT automatically enables hands-free operation mode. The user can dial without lifting the handset or pressing the SP-PHONE or MONITOR button.
- If Idle Line Preference (→ 1.1.76 Line Preference—Outgoing) is set on the extension through personal programming, the user can access an idle line simply by going off-hook.
- The PBX waits for a preprogrammed length of time (→ [206] Dialing Start Time) after seizing an outside (CO) line before dialing.
- **Button Assignment**
A flexible CO button can be customized as a G-CO. The same outside (CO) line group can be assigned to more than one G-CO button on the same PT.

- System programming determines the extension users that can make outside (CO) line calls in each time service mode (→ [405-407] Flexible Outward Dialing—Day/Night/Lunch).
- It is possible to specify which outside (CO) lines are connected to the PBX (→ [400] CO Line Connection). This prevents extension users from trying to select or making calls using outside (CO) lines that are not connected.

Programming Manual References

[PT Programming]

[206] Dialing Start Time

[400] CO Line Connection

[404] CO Line Group Number

[405-407] Flexible Outward Dialing—Day/Night/Lunch

[PC Programming]

9.1.7 Timers [1-6]—CO Dialing—Dialing Start Time

9.3.2 Incoming / Outgoing [3-2]—Outgoing Call—Day, Night, Lunch

9.3.3 Detail [3-3]—Connection, CO Line Group

Feature Manual References

1.1.61 Flexible Buttons

1.1.76 Line Preference—Outgoing

1.1.89 Outside (CO) Line Group

Operating Manual References

1.3.54 Line Access, Outside (CO) Line Group

3.1.3 Flexible Button Assignment—G-CO button

1.1.74 Line Access, S-CO Line

Description

A proprietary telephone (PT) user can select the desired outside (CO) line directly by pressing the Single-CO (S-CO) button.

Conditions

- **Line Access, Direct Outside (CO) Line**
If a PT user is on-hook when pressing an idle CO button, the PT automatically enables hands-free operation mode. The user can dial without lifting the handset or pressing the SP-PHONE or MONITOR button.
- The PBX waits for a preprogrammed length of time (→ [206] Dialing Start Time) after seizing an outside (CO) line before dialing.
- **Button Assignment**
A flexible CO button can be customized as an S-CO button.
- System programming determines the extension users that can make outside (CO) line calls in each time service mode (→ [405-407] Flexible Outward Dialing—Day/Night/Lunch).

- It is possible to specify which outside (CO) lines are connected to the PBX (→ [400] CO Line Connection). This prevents extension users from trying to select or making calls using outside (CO) lines that are not connected.

Programming Manual References

[PT Programming]

[206] Dialing Start Time

[400] CO Line Connection

[405-407] Flexible Outward Dialing—Day/Night/Lunch

[PC Programming]

9.1.7 Timers [1-6]—CO Dialing—Dialing Start Time

9.3.2 Incoming / Outgoing [3-2]—Outgoing Call—Day, Night, Lunch

9.3.3 Detail [3-3]—Connection

Feature Manual References

1.1.61 Flexible Buttons

Operating Manual References

1.3.55 Line Access, S-CO Line

3.1.3 Flexible Button Assignment—S-CO button

1.1.75 Line Preference—Incoming

Description

A proprietary telephone (PT) user can select the method used to answer incoming calls from the following 3 line preferences.

Each of these line preferences can be selected by each extension through personal programming (Line Preference—Incoming).

| Type | Description |
|--------------------------------|---|
| No Line | A user can select a line by pressing the desired Outside (CO) Line Access button to answer an incoming call after going off-hook. |
| Prime Line | A user can answer a call arriving at a flexible CO button (assigned as the "Prime Line") simply by going off-hook. |
| Ringling Line (default) | A user can answer a call ringing at one's own telephone simply by going off-hook. |

Conditions

- Ringing methods can be selected from among immediate, delayed, no ringing, or no incoming calls (disable) through system programming (→ [408-410] Flexible Ringing—Day/Night/Lunch, [411-413] Delayed Ringing—Day/Night/Lunch).
- A single line telephone (SLT) user can select "Ringling Line" mode only.

- A flexible CO button should be assigned as an Outside (CO) Line Access button (Single-CO [S-CO], Group-CO [G-CO] or Other-CO [O-CO]) before selecting a line preference.
- Setting a new line preference clears the previous line preference.
- In "Prime Line" mode, if a PT user receives an incoming call on a line other than the "Prime Line", the user must go off-hook and then press the corresponding flashing CO button to answer the call.

Programming Manual References

[PT Programming]

[408-410] Flexible Ringing—Day/Night/Lunch

[411-413] Delayed Ringing—Day/Night/Lunch

[PC Programming]

9.2.3 PT personal settings [2-3]—Line Preference—Incoming

9.3.2 Incoming / Outgoing [3-2]—Ringling for incoming CO calls—Day, Night, Lunch

Feature Manual References

1.1.61 Flexible Buttons

Operating Manual References

1.2.2 Receiving Calls

3.1.2 Personal Feature Assignment—Line Preference—Incoming

3.1.3 Flexible Button Assignment—S-CO, G-CO, or O-CO button

1.1.76 Line Preference—Outgoing

Description

Through personal programming, a proprietary telephone (PT) user can select the preferred method of seizing a line (Line Preference—Outgoing) to be used each time the user goes off-hook.

| Method | Description |
|-------------------|---|
| Idle Line | When a user goes off-hook, an idle outside (CO) line is selected automatically from among the assigned outside (CO) lines (→ [419] Automatic Designated Line Access). |
| No Line | When a user goes off-hook, no line is selected. In order to make a call, the user must select the desired line manually. |
| Prime Line | When a user goes off-hook, the preset line is selected automatically. |

Conditions

- A flexible CO button should be assigned as an Outside (CO) Line Access button (Single-CO [S-CO], Group-CO [G-CO], or Other-CO [O-CO]) before selecting a line preference.
- Setting a new line preference clears the previous line preference.

- **Line Preference Override**
A user can override the preset line preference temporarily by pressing the desired Outside (CO) Line Access button or INTERCOM button before going off-hook.
- System programming determines the extension users that can make outside (CO) line calls in each time service mode (→ [405-407] Flexible Outward Dialing—Day/Night/Lunch).
- It is possible to specify which outside (CO) lines are connected to the PBX (→ [400] CO Line Connection). This prevents extension users from trying to select or making calls using outside (CO) lines that are not connected.

Programming Manual References

[PT Programming]

[400] CO Line Connection

[405-407] Flexible Outward Dialing—Day/Night/Lunch

[419] Automatic Designated Line Access

[PC Programming]

9.2.3 PT personal settings [2-3]—Line Preference—Outgoing

9.3.2 Incoming / Outgoing [3-2]—Outgoing Call—Day, Night, Lunch

9.3.3 Detail [3-3]—Connection, Automatic Line Access

Feature Manual References

1.1.61 Flexible Buttons

Operating Manual References

1.2.1 Making Calls

3.1.2 Personal Feature Assignment—Line Preference—Outgoing

3.1.3 Flexible Button Assignment—S-CO, G-CO, or O-CO button

1.1.77 Live Call Screening (LCS) (Voice Mail APT Integration only)

Description

Similar to a conventional home answering machine, a proprietary telephone (PT) user can monitor his or her own mailbox as a caller is leaving a message and, if desired, answer the call simply by pressing the Live Call Screening (LCS) button.

PT users can choose one of 2 ways to perform LCS, through personal programming (Live Call Screening [LCS] Mode Set):

Hands-free mode: The user can screen calls automatically through the built-in speaker.

Private mode: The user will hear an alert tone when a message is being recorded in his or her mailbox. To screen calls, the user must press the MONITOR, SP-PHONE, or LCS button.

This feature is available when the PBX is connected to a Panasonic Voice Processing System (VPS) that supports APT integration.

Conditions

- **LCS/LCS Cancel Button**
A flexible CO/DSS button can be customized as an LCS or LCS Cancel button.
- To prevent the unauthorized screening of calls, a 3-digit password must be entered when activating LCS for an extension. If the user forgets his or her password, it can be cleared by the operator or manager (LCS Password Control).
- If an extension user is screening a call and then goes off-hook to answer it, the VPS will either stop or continue recording the message, according to system programming (→ [620] LCS Recording Mode Set).
- If a call arrives while an extension user is having a conversation with another party and the extension has Call Waiting activated, the user will hear a call waiting tone. The user can put the existing call on hold before accessing LCS.

Programming Manual References

[PT Programming]

[620] LCS Recording Mode Set

[PC Programming]

9.2.1 Main [2-1]—LCS Recording Mode

9.2.2 Feature settings [2-2]—LCS Password

9.2.3 PT personal settings [2-3]—LCS Mode

Feature Manual References

1.1.61 Flexible Buttons

1.1.120 Voice Mail APT Integration

Operating Manual References

1.3.56 Live Call Screening (LCS) (Voice Mail APT Integration only)

2.1.7 System Feature Assignment—LCS Password Control

3.1.2 Personal Feature Assignment—LCS Mode Set

3.1.3 Flexible Button Assignment—LCS or LCS Cancel button

1.1.78 Local Carrier-based Voice Mail Service

Description

The PBX supports voice mail service, which is an answering system offered by the telephone company, to notify the called party of a message waiting. After subscription, the voice mail system can answer calls automatically instead of the PBX when the line is busy or calls are not answered, and callers can leave their messages in a mailbox provided by the telephone company.

The Message/Ringer Lamp lights red and the corresponding Single-CO (S-CO) button flashes red at moderate speed when a message has been recorded and stored in the mailbox of the telephone company. Going off-hook, pressing the red flashing S-CO button and then pressing the MESSAGE button allows a proprietary telephone (PT) user to access the voice mail system and listen to the messages stored in the mailbox.

This feature is available only for PTs.

Conditions

- **Hardware Requirement:** An optional Caller ID card.
- The voice mail service access number can be up to 32 digits long, assigned for each outside (CO) line through system programming (→ [436] Local Carrier-based Voice Mail Access Dial). During this programming, pressing the INTERCOM (SECRET) button before and after any confidential parts of the number allows a PT user to prevent the display of all or part of a number (→ 1.1.111 Secret Dialing).
- System programming determines which extensions can access the voice mail service for each outside (CO) line (→ [437] Extension Access to Local Carrier-based Voice Mail). More than one outside (CO) line can be assigned to one extension.
- The PBX supports both the Stutter dial tone method and FSK method, which can be assigned for each outside (CO) line through system programming (→ [435] Local Carrier-based Voice Mail Signaling). When "Stutter" is selected for an outside (CO) line and the user seizes the outside (CO) line, they will hear a stutter dial tone if there is a message in their voice mailbox. Approximately 5 seconds after the user hangs up one of the preprogrammed outside (CO) lines, or 3 minutes 46 seconds after the phone stops ringing, the PBX automatically seizes the line and checks if a message has been recorded. If a new message was recorded in the mailbox of the telephone company, the Message/Ringer Lamp lights red and the corresponding S-CO button flashes red at moderate speed.
- If the voice mail service uses a stutter dial tone and the recorded message is over 3 minutes long, in some cases the Message/Ringer Lamp may not light and the corresponding S-CO button may not flash.
- A contract with the telephone company may be required for local carrier-based voice mail service. For more information, consult your telephone company.

Installation Manual References

2.3.5 3-Port Caller ID Card (KX-TA82493)

Programming Manual References

[PT Programming]

[435] Local Carrier-based Voice Mail Signaling

[436] Local Carrier-based Voice Mail Access Dial

[437] Extension Access to Local Carrier-based Voice Mail

[PC Programming]

9.3.4 Local Carrier-based VM [3-4]

Feature Manual References

1.1.111 Secret Dialing

Operating Manual References

1.3.57 Local Carrier-based Voice Mail Service

1.1.79 Lockout

Description

If one party in a conversation goes on-hook, the call between both parties will be disconnected. A reorder tone is sent to the off-hook party before the call is disconnected.

Conditions

- **Lockout applies to:**
Intercom calls and outside (CO) line calls.
- If an extension user does not dial anything within a certain period of time after the other party goes on-hook, a reorder tone will be sent to the extension and then it will be disconnected from the speech path.

Operating Manual References

1.3.58 Lockout

1.1.80 Log-in/Log-out

Description

Members of an idle extension hunting group or Direct Inward System Access (DISA) ring group can join (Log-in) or leave (Log-out) groups manually. Group members can log in at the beginning of a work shift when they are ready to answer calls, and log out at the end of the work shift.

Conditions

- The last member of a group cannot log out.
- While logged out from a group, a member extension will not receive calls to that group via the DISA or Idle Extension Hunting features.
- **Log-in/Log-out Button**
A flexible CO button can be customized as a Log-in/Log-out button. It shows the current status as follows:

| Light Pattern | Status |
|---------------|------------|
| Red on | Logged out |
| Off | Logged in |

Programming Manual References

[PT Programming]

[100] Hunting Group Set

[600] Extension Group

[PC Programming]

9.2.2 Feature settings [2-2]—Log-in / Log-out

9.2.11 Extension Group [2-6]—Group No., Extension Hunting—Extension Hunting

Feature Manual References

- 1.1.42 Direct Inward System Access (DISA) Ring
- 1.1.61 Flexible Buttons
- 1.1.67 Idle Extension Hunting

Operating Manual References

- 1.3.59 Log-in/Log-out
- 3.1.3 Flexible Button Assignment—Log-in/Log-out button

1.1.81 Memory Dialing

Description

An extension user can store frequently dialed numbers in the PBX. A stored number can be dialed by a simple operation.

1. Features

| Feature | Storage Method | Details in |
|-------------------------------|--|----------------------------------|
| One-touch Dialing | Personal Programming, System Programming | • 1.1.86 One-touch Dialing |
| Redial, Last Number | The last or most recently dialed number is automatically stored. | • 1.1.105 Redial, Last Number |
| Redial, Saved Number | While in a conversation with an outside party or while hearing a busy tone, the current telephone number can be manually stored and redialed afterwards. | • 1.1.106 Redial, Saved Number |
| Personal Speed Dialing | Personal Programming with the Feature Number | • 1.1.100 Personal Speed Dialing |
| System Speed Dialing | System Programming | • 1.1.113 System Speed Dialing |
| Hot Line | Personal Programming with the Feature Number | • 1.1.66 Hot Line |
| Call Log, Incoming | Caller ID information is automatically stored. | • 1.1.18 Call Log, Incoming |

2. Valid Input

| Input | Displayed while Entering | Description |
|----------------------|--------------------------|--|
| 0–9/*/# | 0–9/*/# | Store digits, *, and # by pressing the corresponding buttons. |
| PAUSE (Pause) | P | Store a dialing pause by pressing the PAUSE button (→ 1.1.98 Pause Insertion). |

| Input | Displayed while Entering | Description |
|------------------------------------|--------------------------|---|
| FLASH/RECALL (Hooking)*1 | F | Store an EFA signal (EFA mode) by pressing the FLASH/RECALL button at the beginning of the number (→ 1.1.56 External Feature Access (EFA)). |
| INTERCOM (Secret)*1 | [/] | Prevent all or part of a System Speed Dialing number or One-touch Dialing number from being displayed when a call is made, by pressing the INTERCOM button at the beginning and at the end of the number to be hidden (→ 1.1.111 Secret Dialing). It is programmable whether the hidden part will be shown on SMDR (→ 1.1.112 Station Message Detail Recording (SMDR)). |
| CONF (Hyphen)*2 | - | Store a hyphen by pressing the CONF button. |

*1 Available only when in system/personal programming mode

*2 Available only when in system programming mode

[Example of Secret Dialing]

When storing the number "91234567890", to prevent the telephone number "1234567890" from being displayed when making a call:

Enter → → → .

Notes

- The characters for secret code, "[" and "]" (entered by pressing the INTERCOM button), are counted as one digit each.
- It is not possible to hide the Outside (CO) Line Access number (9, or 81 through 88) by pressing the INTERCOM button before dialing it.

Conditions

- **Outside (CO) Line Access by Memory Dialing (One-touch Dialing/System Speed Dialing)**
A specific Outside (CO) Line Access number can be stored along with the telephone number in Memory Dialing. However, if Memory Dialing is performed after selecting an outside (CO) line, the stored Outside (CO) Line Access number is ignored and the telephone number is sent using the selected outside (CO) line.

Feature Manual References

- 1.1.18 Call Log, Incoming
- 1.1.56 External Feature Access (EFA)
- 1.1.66 Hot Line
- 1.1.86 One-touch Dialing
- 1.1.98 Pause Insertion
- 1.1.100 Personal Speed Dialing
- 1.1.105 Redial, Last Number
- 1.1.106 Redial, Saved Number

- 1.1.111 Secret Dialing
- 1.1.112 Station Message Detail Recording (SMDR)
- 1.1.113 System Speed Dialing

1.1.82 Message Waiting

Description

When an extension user calls another extension user who does not answer the call, he or she can leave a message waiting indication. The MESSAGE button or Message/Ringer Lamp on the called extension user's telephone will light, indicating that a call was missed, or a message recorded by the Voice Processing System (VPS) or Built-in Voice Message (BV) feature is waiting. A MESSAGE button can be used to call the caller back or listen to the message.

When a message is left for a proprietary telephone (PT), the MESSAGE button on it lights, or the Message/Ringer Lamp turns red. Pressing the lit MESSAGE button while on-hook shows the caller's information as shown below:

[Example]

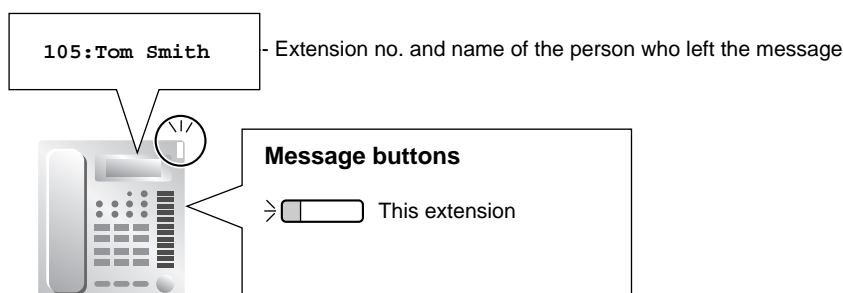

Conditions

- System programming determines the single line telephones (SLTs) that can receive the message waiting notifications left by another extension (→ [619] SLT Message Waiting).
- If a user goes off-hook with an SLT that has messages waiting, a special dial tone (dial tone 3) will be heard. The user can call a caller back or listen to the message by entering the Message Waiting Answer feature number.
- Both the calling extension and the called extension can cancel a notification after it has been left.
- Message waiting indications are always left on the originally called extension. Message waiting indications cannot be sent to an FWD destination (→ 1.1.10 Call Forwarding (FWD)—SUMMARY) or an idle extension hunting destination (→ 1.1.67 Idle Extension Hunting).
- A message waiting indication is automatically cleared when the called extension calls the caller back and the call is answered.
- **Message Waiting Indication via Voice Mail APT Integration**
If a voice message is left for the called extension, it can be heard by following the Voice Mail prompts after pressing the lit MESSAGE button (→ 1.1.120 Voice Mail APT Integration).
- **Message Waiting Indication via BV**
If a voice message is left in the user's personal message area or the common message area, it can be played back with the lit MESSAGE button by the user or the operator/manager respectively (→ 1.1.8 Built-in Voice Message (BV)).

- It is possible to activate the Message/Ringer Lamp (→ [968] KX-T7700 Series Incoming Lamp Control) on the KX-T7700 series telephones for the following incoming calls:
 - Incoming call from an outside (CO) line with Caller ID information
 - Incoming call from another extension to a busy extension when the called extension has set Call Waiting (Call Waiting Tone 1)
 - Incoming doorphone call whose ring tone pattern is set to "S-Double" (→ [706] Doorphone Ring Tone Pattern) (except when using the Paralleled Telephone feature) when an optional doorphone or doorbell/door chime is connected to the PBX

Programming Manual References

[PT Programming]

[619] SLT Message Waiting

[706] Doorphone Ring Tone Pattern

[968] KX-T7700 Series Incoming Lamp Control

[PC Programming]

9.1.11 Detail [1-10]—Proprietary Telephone—KX-T7700 Series Incoming Lamp Control

9.2.1 Main [2-1]—SLT MW

9.7.2 Others [7-2]—Doorphone Ring Tone Pattern—Door 1–4

Feature Manual References

1.1.8 Built-in Voice Message (BV)

1.1.10 Call Forwarding (FWD)—SUMMARY

1.1.59 Fixed Buttons

1.1.61 Flexible Buttons

1.1.67 Idle Extension Hunting

1.1.83 Message Waiting for Another Extension

1.1.120 Voice Mail APT Integration

1.1.121 Voice Mail Inband (DTMF) Integration

Operating Manual References

1.3.7 Built-in Voice Message (BV)

1.3.60 Message Waiting

1.3.88 Voice Mail Integration

3.1.3 Flexible Button Assignment—Message button

1.1.83 Message Waiting for Another Extension

Description

A proprietary telephone (PT) user can check messages left at another extension and call back the caller simply by pressing the lit Message for another extension button. The user can also clear all messages left at another extension. The Message for another extension button or Message/Ringer Lamp on his or her own extension will light, indicating that a call was missed, or a message recorded by the Voice Processing

System (VPS) or Built-in Voice Message (BV) feature is waiting. Pressing the lit Message for another extension button while on-hook shows the caller's information as shown below:

[Example]

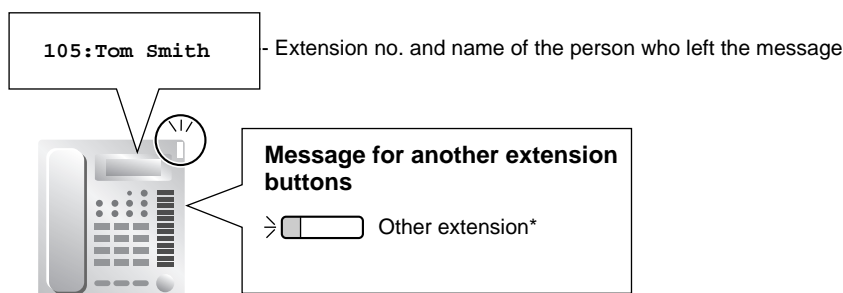

* This button is useful when, for example, the manager checks messages left for another extension.

Conditions

- Message for another extension Button**
 A flexible CO/Direct Station Selection (DSS) button can be customized as a Message for another extension button. This button can be used on a PT that is allowed through system programming (→ [618] Message Waiting for Another Extension) to access messages left for another extension.
- Message Waiting for Another Extension Lock**
 An extension user can lock or unlock message waiting indications to prevent others from viewing, calling back or clearing message waiting indications left at his or her extension. The operator and manager can override this lock to unlock it (Extension Lock—CANCEL ALL). Even while this lock is on, the user can view, call back, or clear message waiting indications left at his or her own extension.
- It is possible to activate the Message/Ringer Lamp (→ [968] KX-T7700 Series Incoming Lamp Control) on the KX-T7700 series telephones for the following incoming calls:
 - Incoming call from an outside (CO) line with Caller ID information
 - Incoming call from another extension to a busy extension when the called extension has set Call Waiting (Call Waiting Tone 1)
 - Incoming doorphone call whose ring tone pattern is set to "S-Double" (→ [706] Doorphone Ring Tone Pattern) (except when using the Paralleled Telephone feature) when an optional doorphone or doorbell/door chime is connected to the PBX

Programming Manual References

[PT Programming]

[618] Message Waiting for Another Extension

[706] Doorphone Ring Tone Pattern

[968] KX-T7700 Series Incoming Lamp Control

[PC Programming]

9.1.11 Detail [1-10]—Proprietary Telephone—KX-T7700 Series Incoming Lamp Control

9.2.1 Main [2-1]—MW for Another Extension

9.2.2 Feature settings [2-2]—MW for Another Ext. Lock

9.7.2 Others [7-2]—Doorphone Ring Tone Pattern—Door 1–4

Feature Manual References

- 1.1.8 Built-in Voice Message (BV)
- 1.1.61 Flexible Buttons
- 1.1.82 Message Waiting
- 1.1.120 Voice Mail APT Integration
- 1.1.121 Voice Mail Inband (DTMF) Integration

Operating Manual References

- 1.3.61 Message Waiting for Another Extension
- 1.3.62 Message Waiting for Another Extension Lock
- 2.1.7 System Feature Assignment—Extension Lock—CANCEL ALL
- 3.1.3 Flexible Button Assignment—Message for another extension button

1.1.84 Microphone Mute

Description

During a conversation, a proprietary telephone (PT) user can disable the built-in microphone to consult privately with others in the room while listening to the other party on the phone through the built-in speaker. When Microphone Mute is active, the user can hear the other party's voice, but the user's voice is muted.

Conditions

- This feature is only available on PTs that have an AUTO ANS/MUTE button.

Operating Manual References

- 1.3.63 Microphone Mute

1.1.85 Music on Hold

Description

An outside party on hold will hear audio to inform the party that the call is still on hold. The following types of audio are available:

- External audio source
- Tone
If "Tone" is selected, the following cyclic tone is sent to the held outside (CO) line.

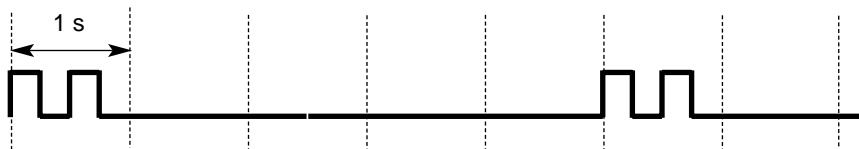

The external audio source can also be used for BGM (→ 1.1.7 Background Music (BGM)).

Conditions

- **Hardware requirement:** A user-supplied audio device, such as a CD player or radio for External audio source.
- The audio can be selected through system programming (→ [111] Music on Hold).
- Operations such as Call Hold (→ 1.1.15 Call Hold, 1.1.16 Call Hold, Exclusive) and Call Transfer (→ 1.1.25 Call Transfer—To Extension, 1.1.26 Call Transfer—To Outside (CO) Line) activate Music on Hold.

Installation Manual References

2.8.1 Connecting Peripherals

Programming Manual References

[PT Programming]

[111] Music on Hold

[PC Programming]

9.1.2 Main [1-2]—Music on Hold

Feature Manual References

1.1.7 Background Music (BGM)

1.1.15 Call Hold

1.1.16 Call Hold, Exclusive

1.1.25 Call Transfer—To Extension

1.1.26 Call Transfer—To Outside (CO) Line

1.1.86 One-touch Dialing

Description

A proprietary telephone (PT) user can make a call or access a feature with a one-touch operation. This is possible by storing the number (up to 24 digits), such as an extension number, telephone number, account code, or feature number, in a One-touch Dialing button.

Conditions

- **One-touch Dialing Button**
A flexible CO/Direct Station Selection (DSS)/Programmable Feature (PF)/MESSAGE button can be customized as a One-touch Dialing button.
- A number consisting of 25 digits or more can be stored by dividing it and storing it in 2 One-touch Dialing buttons. In this case, the Outside (CO) Line Access number should be stored in the first button.
- Speed Dialing, One-touch Dialing, and manual dialing can be used in combination.
- Personal Speed Dialing numbers (0 through 9) correspond to the numbers (F1 through F10) of the PF buttons assigned as One-touch Dialing numbers.
Assigning a One-touch Dialing number to PF button "F1" will override Personal Speed Dialing number "0", and vice versa.

Feature Manual References

1.1.61 Flexible Buttons

Operating Manual References

1.3.64 One-touch Dialing

3.1.3 Flexible Button Assignment—One-touch Dialing button

1.1.87 Operator/Manager Features

Description

This PBX supports one operator and one manager. Any extension can be designated as the operator through system programming (→ [008] Operator Assignment). The operator is the destination of Operator Call. The extension connected to extension jack 01 is the manager extension. An extension assigned as the operator or manager extension is allowed to use certain features that most extensions cannot, as follows:

| Feature | | Description | Manager Password* | Details in |
|--|--|---|-------------------|---|
| Manager Programming | [001] System Speed Dialing Number | Sets the System Speed Dialing number. | Required | • 1.1.113 System Speed Dialing |
| | [011] System Speed Dialing Name | Sets the System Speed Dialing name. | Required | • 1.1.113 System Speed Dialing |
| | [512] DISA Security Code | Sets the DISA security code. | Required | • 1.1.41 Direct Inward System Access (DISA) |
| | [530] DISA Security Code Digits | Sets the number of digits for the DISA security code. | Required | • 1.1.41 Direct Inward System Access (DISA) |
| | Extension Password Set | Sets the extension password. This password is used for the Walking COS feature and the Remote Extension Lock feature. Each extension's password should be unique. | Required | – |
| Remote Extension Lock | | Sets or cancels Extension Lock on an extension remotely. | Not required | • 1.1.107 Remote Extension Lock |
| Time Service | | Switches the time service mode manually. | Not required | • 1.1.114 Time Service |
| Timed Reminder, Remote (Wake-up Call) | | Sets or cancels Timed Reminder to any extension remotely. | Not required | • 1.1.116 Timed Reminder, Remote |

| Feature | Description | Manager Password* | Details in |
|--|---|-------------------|--|
| Call Log, Incoming in the Common Area—CLEAR ALL | Clears all Caller ID information stored in the common area. | Not required | • 1.1.18 Call Log, Incoming |
| Call Log Display Lock, Incoming in the Common Area | Locks or unlocks the Incoming Call Log for the common area. | Not required | • 1.1.18 Call Log, Incoming • 1.1.55 Extension Lock |
| The 301st Call Log, Incoming in the Common Area Treatment | Selects how new calls are treated when Incoming Call Log for the common area is full. | Not required | • 1.1.18 Call Log, Incoming |
| Outgoing Message (OGM) for DISA | Records and plays back OGMs used by DISA and 3-level Automated Attendant (AA). Erases OGMs used by DISA. | Not required | • 1.1.88 Outgoing Message (OGM) for DISA |
| Date and Time Setting | Adjusts the current date and time. | Not required | – |
| Extension Lock—CANCEL ALL | Cancels Extension Lock, Call Log Display Lock, Incoming in the Personal Area, and Message Waiting for Another Extension Lock at all extensions. | Not required | • 1.1.18 Call Log, Incoming • 1.1.55 Extension Lock • 1.1.83 Message Waiting for Another Extension |
| LCS Password Control | Clears the Live Call Screening (LCS) password. | Not required | • 1.1.77 Live Call Screening (LCS) (Voice Mail APT Integration only) |
| Common BV OGM | Records, plays back, and erases a common BV OGM in the common message area that can be accessed by either the operator or manager. | Not required | • 1.1.8 Built-in Voice Message (BV) |

* The system password may be entered instead of the extension password for the manager (manager password).

Operator Call

An extension user can call the operator by entering the Operator Call number "0". If no operator is assigned, the caller will hear a reorder tone.

Programming Manual References

[PT Programming]

- [001] System Speed Dialing Number
- [008] Operator Assignment
- [011] System Speed Dialing Name
- [512] DISA Security Code
- [530] DISA Security Code Digits

[PC Programming]

- 9.1.2 Main [1-2]—Operator
- 9.2.3 PT personal settings [2-3]—Extension Password
- 9.4 System Speed Dialing [4]
- 9.6.3 Settings [6-2]—Security—DISA Security Codes, Security—DISA Security Code Length

Feature Manual References

- 1.1.8 Built-in Voice Message (BV)
- 1.1.18 Call Log, Incoming
- 1.1.41 Direct Inward System Access (DISA)
- 1.1.55 Extension Lock
- 1.1.77 Live Call Screening (LCS) (Voice Mail APT Integration only)
- 1.1.83 Message Waiting for Another Extension
- 1.1.88 Outgoing Message (OGM) for DISA
- 1.1.107 Remote Extension Lock
- 1.1.113 System Speed Dialing
- 1.1.114 Time Service
- 1.1.116 Timed Reminder, Remote

Operating Manual References

- 1.3.65 Operator Call
- 2.1 Operator/Manager Service Features

1.1.88 Outgoing Message (OGM) for DISA

Description

An extension assigned as the operator or manager extension can record outgoing messages (OGMs) for the following features:

| Feature | Usage |
|---|--|
| Direct Inward System Access (DISA) | When a call arrives on a DISA line, the caller will hear a DISA OGM. |
| 3-level Automated Attendant (AA) | When the DISA AA service is active, the caller will hear a DISA OGM. The DISA AA service supports up to 3 levels of DISA OGMs. |

Conditions

- This feature functions differently from personal/common BV OGMs used by the BV feature (→ 1.1.8 Built-in Voice Message (BV)).
- To use this feature, "DISA" must be selected as the distribution method for the desired outside (CO) line port (→ [414-416] CO Line Mode—Day/Night/Lunch).
- The operator or manager can record a maximum of 32 messages (8 messages for DISA and 24 messages for 3-level AA). When an optional message expansion card for DISA OGMs is added, up to 2 messages can be played simultaneously for callers, and the total recording time of the PBX is increased from 3 to 6 minutes.
- After recording messages, the operator or manager can also play them back for confirmation. In addition, the operator or manager can erase messages for DISA.
- When the operator or manager tries to record or play back a message, he or she will hear an alarm tone if the message channel is in use.
- Prerecorded messages will not be cleared by a system restart. To clear them, use system programming (→ [599] Clear All OGMs of DISA).

Installation Manual References

2.3.7 Message Expansion Card for DISA OGMs (KX-TA82491)

Programming Manual References

[PT Programming]

[414-416] CO Line Mode—Day/Night/Lunch

[599] Clear All OGMs of DISA

[PC Programming]

8.5 DISA OGM Clear

9.3.1 Line Mode [3-1]—Mode of incoming CO calls—Day, Night, Lunch

Feature Manual References

1.1.8 Built-in Voice Message (BV)

1.1.41 Direct Inward System Access (DISA)

Operating Manual References

2.1.5 Outgoing Message (OGM) for DISA

1.1.89 Outside (CO) Line Group

Description

Outside (CO) lines can be grouped into 8 outside (CO) line groups based on properties such as carrier or outside (CO) line type (→ [404] CO Line Group Number).

Conditions

- Each outside (CO) line can belong to only one outside (CO) line group.

Programming Manual References

[PT Programming]

[404] CO Line Group Number

[PC Programming]

9.3.3 Detail [3-3]—CO Line Group

1.1.90 Outside (CO) Line Ringing Selection

Description

An extension user can select whether the telephone will ring or not when receiving call(s) from assigned or all outside (CO) lines through personal programming.

Conditions

- System programming determines which extension(s) will ring for incoming outside (CO) line calls in each time service mode (→ [408-410] Flexible Ringing—Day/Night/Lunch).
- If an outside (CO) line call reaches a user's extension, but the extension is set to not ring, the CO button will flash. The outside (CO) line call can be answered by pressing the flashing CO button.

Programming Manual References

[PT Programming]

[408-410] Flexible Ringing—Day/Night/Lunch

[PC Programming]

9.2.3 PT personal settings [2-3]—CO Line Ringing Selection—CO1–8

9.3.2 Incoming / Outgoing [3-2]—Ringing for incoming CO calls—Day, Night, Lunch

Operating Manual References

3.1.2 Personal Feature Assignment—Outside (CO) Line Ringing Selection

1.1.91 Outside-to-Outside (CO-to-CO) Line Call Duration

Description

When a call between 2 outside parties is established, the call duration is restricted by a timer (→ [205] CO-to-CO Line Call Duration). Both parties will hear a warning tone 15 seconds before the timer expires. When the timer expires, the call is disconnected.

Conditions

- **Lockout**
If one party in a conversation goes on-hook, the call between both parties will be disconnected. A reorder tone is sent to the off-hook party before the call is disconnected.
- The Outside-to-Outside (CO-to-CO) Line Call Duration feature applies to the following calls:

- Calls forwarded by the FWD to Outside (CO) Line feature (→ 1.1.14 Call Forwarding (FWD)—To Outside (CO) Line)
- Calls transferred by the Call Transfer to Outside (CO) Line feature (→ 1.1.26 Call Transfer—To Outside (CO) Line)
- Calls using the DISA feature (→ 1.1.41 Direct Inward System Access (DISA))
- Calls using the Unattended Conference feature (→ 1.1.34 Conference, Unattended)

Programming Manual References

[PT Programming]

[205] CO-to-CO Line Call Duration

[PC Programming]

9.1.7 Timers [1-6]—Call Duration—CO-to-CO Duration Limit

Feature Manual References

1.1.14 Call Forwarding (FWD)—To Outside (CO) Line

1.1.26 Call Transfer—To Outside (CO) Line

1.1.34 Conference, Unattended

1.1.41 Direct Inward System Access (DISA)

1.1.92 Paging—SUMMARY

Description

An extension user can make a paging announcement to several people at once.

The announcement is heard through the built-in speakers of proprietary telephones (PTs) and/or an external pager (loudspeaker), depending on the type of Paging that is performed as follows:

| Type | Paging method |
|--------------------------------------|--|
| All Extensions | The page is heard through the built-in speakers of all PTs. |
| All Extensions & External | The page is heard through the built-in speakers of all PTs and an external pager simultaneously. |
| External | The page is heard through an external pager. |
| Group | The page is heard through the built-in speakers of the PTs that belong to a certain extension group (→ [600] Extension Group). |

The paged person can answer the page from a nearby telephone (Paging Answer). It is possible to page with a call on hold in order to transfer the call (Paging and Transfer).

Paging Deny

It is possible for each extension to deny being paged.

Conditions

- Only one person can use this feature at a time.
- Extensions that cannot be paged are:

- Ringing or busy PTs
- PTs in Paging Deny mode
- PTs in DND mode (→ 1.1.44 Do Not Disturb (DND))

Installation Manual References

2.8.1 Connecting Peripherals

Programming Manual References

[PT Programming]

[106] External Pager Access Tone

[600] Extension Group

[PC Programming]

9.1.11 Detail [1-10]—Extension—External Pager Access Tone

9.2.2 Feature settings [2-2]—Paging Deny

9.2.11 Extension Group [2-6]—Group No.

Feature Manual References

1.1.44 Do Not Disturb (DND)

Operating Manual References

1.3.66 Paging—SUMMARY

1.3.71 Paging and Transfer

1.3.72 Paging Answer

1.3.73 Paging Deny

1.1.93 Paging—All Extensions

Description

An extension user can make a paging announcement to all extensions. The paging announcement can be heard through the built-in speakers of all proprietary telephones (PTs).

Operating Manual References

1.3.67 Paging—All Extensions

1.1.94 Paging—All Extensions & External

Description

An extension user can make a paging announcement to all extensions and over an external speaker. The paging announcement can be heard through both the built-in speakers of all proprietary telephones (PTs) and an external speaker.

Conditions

- **Hardware Requirement:** A user-supplied external pager.
- A confirmation tone will be sent to the external pager before the paging announcement. It is possible to eliminate the tone through system programming (→ [106] External Pager Access Tone).

Installation Manual References

2.8.1 Connecting Peripherals

Programming Manual References

[PT Programming]

[106] External Pager Access Tone

[PC Programming]

9.1.11 Detail [1-10]—Extension—External Pager Access Tone

Operating Manual References

1.3.68 Paging—All Extensions & External

1.1.95 Paging—External

Description

An extension user can make a paging announcement through an external pager. The paging announcement can be heard through an external pager.

Conditions

- **Hardware Requirement:** A user-supplied external pager.
- A confirmation tone will be sent to the external pager before the paging announcement. It is possible to eliminate the tone through system programming (→ [106] External Pager Access Tone).

Installation Manual References

2.8.1 Connecting Peripherals

Programming Manual References

[PT Programming]

[106] External Pager Access Tone

[PC Programming]

9.1.11 Detail [1-10]—Extension—External Pager Access Tone

Operating Manual References

1.3.69 Paging—External

1.1.96 Paging—Group

Description

An extension user can make a paging announcement to a certain extension group. The paging announcement can be heard through the built-in speakers of the proprietary telephones (PTs) that belong to the certain extension group (→ [600] Extension Group).

Programming Manual References

[PT Programming]

[600] Extension Group

[PC Programming]

9.2.11 Extension Group [2-6]—Group No.

Feature Manual References

1.1.53 Extension Group

Operating Manual References

1.3.70 Paging—Group

1.1.97 Paralleled Telephone

Description

Any proprietary telephone (PT) can be connected in parallel with a single line device, such as a single line telephone (SLT), fax machine, or modem.

When parallel mode is used, the 2 telephones function as follows:

- Both share one extension number.
- Either telephone or device can make or answer calls.

Conditions

- System programming determines the SLTs that can be connected in parallel with a PT (→ [610] Paralleled Telephone).
- When the SLT is in operation, the display and LED (Light Emitting Diode) indicator on the paired PT will function in the same way as when the PT is in operation.
- The following features cannot be used with an SLT connected in parallel with a PT:
 - Call Splitting
 - Call Waiting Caller ID
 - Conference
 - Door Open while connected to the doorphone
 - External Feature Access (EFA)
 - Hot Line
- An SLT connected in parallel with a PT will not ring if the PT is:

- In Hands-free Answerback mode (→ 1.1.62 Hands-free Answerback).
- In Voice-calling mode (Alternate Receiving—Ring/Voice) (→ 1.1.69 Intercom Call).
- An extension user cannot make a call from the SLT if the PT is:
 - Playing background music (BGM)
 - Receiving a paging announcement over the built-in speaker
 - In programming mode
- Both the PT and the SLT will ring for incoming calls (if the ringer is turned on).
- If one telephone goes off-hook while the other telephone is having a call, a 3-party conference call will be established. If one telephone goes on-hook, the other telephone will continue with the call.

Installation Manual References

2.5.2 Connecting Extensions in Parallel

Programming Manual References

[PT Programming]

[610] Paralleled Telephone

[PC Programming]

9.2.1 Main [2-1]—Paralleled Telephone

Feature Manual References

1.1.62 Hands-free Answerback

1.1.69 Intercom Call

Operating Manual References

1.3.74 Paralleled Telephone

1.1.98 Pause Insertion

Description

A dialing pause of a preprogrammed length can be inserted manually or automatically when dialing.

Manual Pause Insertion: A pause can be manually inserted by pressing the PAUSE button.

Automatic Pause Insertion: A pause will be automatically inserted after the user dials any one of the following numbers:

- a) Outside (CO) Line Access number
- b) Automatic Pause Insertion code
- c) Host PBX Access code (→ 1.1.65 Host PBX Access Code (Access Code to the Telephone Company from a Host PBX))

Conditions

- The pause length is programmable for each outside (CO) line (→ [417] Pause Time).

- When a dialed telephone number matches one of the Automatic Pause Insertion codes assigned through system programming (→ [311] Automatic Pause Insertion Code), a pause will be automatically inserted after the code. This is particularly convenient if a second dial tone is sent from your telephone company.
- This feature functions for Speed Dialing, One-touch Dialing, Last Number Redial, Saved Number Redial, Hot Line, and Call Forwarding—To Outside (CO) Line, as well as for normal calls.

Programming Manual References

[PT Programming]

[311] Automatic Pause Insertion Code

[403] Host PBX Access Code

[417] Pause Time

[PC Programming]

9.1.10 Automatic Pause Insertion Codes [1-9]

9.3.3 Detail [3-3]—Host PBX Access Codes, Pause Time

Feature Manual References

1.1.65 Host PBX Access Code (Access Code to the Telephone Company from a Host PBX)

1.1.117 Toll Restriction (TRS)

1.1.99 PC Programming

Description

System programming settings can be accessed using a PC and the Panasonic KX-TA Maintenance Console software as well as by using a proprietary telephone (PT) (→ 1.1.103 PT Programming). System programming and data upload/download can be performed either through on-site programming or remote programming.

1. **On-site Programming:** Programming that is performed using an on-site PC connected directly to the PBX.
2. **Remote Programming:** Programming that is performed using an off-site PC that connects to the PBX via an outside (CO) line.

1. Connection Methods for On-site Programming

| Method | Description | Required Hardware |
|--|--|-------------------|
| Serial Interface (RS-232C port) | The PC is connected to the PBX via the Serial Interface (RS-232C port) of the PBX. | — |
| USB | The PC is connected to the PBX via the USB port of the PBX. | — |

2. Connection Methods for Remote Programming

| Method | Description | Required Hardware |
|---------------------|---|---------------------|
| Remote modem | <p>Call the PBX and have the call directed to the internal modem using one of the following methods:</p> <p>Direct Access: Using a modem, dial the telephone number to connect to the internal modem. To use this feature, "MODEM" must be selected as the distribution method for the desired outside (CO) line port (→ [414-416] CO Line Mode—Day/Night/Lunch).</p> <p>DISA: Using a telephone, dial the telephone number to reach the DISA line (→ 1.1.41 Direct Inward System Access (DISA)). After hearing a DISA outgoing message (OGM), enter the Remote Maintenance feature number to access the internal modem. To use this feature, "DISA" must be selected as the distribution method for the desired outside (CO) line port (→ [414-416] CO Line Mode—Day/Night/Lunch).</p> <p>Call Transfer: Using a telephone, call an extension user, such as the operator, to request to be transferred to the internal modem using the Remote Maintenance feature number (→ 1.1.25 Call Transfer—To Extension).</p> | User-supplied modem |

Conditions

- Only one system programming session is permitted at a time. Access will be denied to a second party who tries to perform system programming, including system programming via a PT.
- System programming can be performed either in interactive or batch mode.
- **System Password**
To access system programming in interactive mode, a valid password must be entered. The password is set at the factory but can be changed through system programming (→ [002] System Password).
- A user can upload system programming data from a PC to the PBX or download it from the PBX to a PC.
- If communications between the PBX and PC fail before completing Firmware Upgrade or system programming data upload from a PC to the PBX, the successfully transferred portion of the data can still be used.
- Firmware Upgrade can be performed only through on-site programming using Serial Interface (RS-232C port) or USB.

Installation Manual References

- 3.2.1 Connection
- 3.2.3 Accessing PBX via Internal Modem

Programming Manual References

- 3.2 PC Programming

[PT Programming]

[002] System Password

[414-416] CO Line Mode—Day/Night/Lunch

[PC Programming]

9.1.2 Main [1-2]—System Password

9.3.1 Line Mode [3-1]—Mode of incoming CO calls—Day, Night, Lunch

Feature Manual References

1.1.25 Call Transfer—To Extension

1.1.40 Direct In Line (DIL)

1.1.41 Direct Inward System Access (DISA)

1.1.103 PT Programming

1.1.100 Personal Speed Dialing

Description

An extension user can use short numbers to frequently dialed numbers that are stored in the extension's Personal Speed Dialing.

Personal Speed Dialing is also known as Station Speed Dialing.

Conditions

- Any number, such as a telephone number or feature number, can be stored in Personal Speed Dialing (up to 24 digits).
- This feature is not available on rotary single line telephones (SLTs).
- Personal Speed Dialing numbers (0 through 9) correspond to the numbers (F1 through F10) of the Programmable Feature (PF) buttons assigned as One-touch Dialing numbers. Assigning a One-touch Dialing number to PF button "F1" will override Personal Speed Dialing number "0", and vice versa.
- An SLT user can check the stored number by exchanging the SLT with a PT. PF buttons (F1 through F10) correspond to Personal Speed Dialing numbers (0 through 9). Press the desired PF button to check the number.

Feature Manual References

1.1.86 One-touch Dialing

Operating Manual References

1.3.75 Personal Speed Dialing

1.1.101 Power Failure Restart

Description

When the electricity is turned back on, the PBX restarts and automatically loads stored data.

Conditions

- In the event of a power failure, PBX memory is protected by a factory-installed lithium battery. There is no memory loss except the memories of Automatic Callback Busy (→ 1.1.4 Automatic Callback Busy (Camp-on)), Call Park (→ 1.1.19 Call Park), and Redial (→ 1.1.105 Redial, Last Number, 1.1.106 Redial, Saved Number).

Feature Manual References

- 1.1.4 Automatic Callback Busy (Camp-on)
- 1.1.19 Call Park
- 1.1.105 Redial, Last Number
- 1.1.106 Redial, Saved Number

1.1.102 Power Failure Transfer

Description

If the power supply to the PBX fails, specific single line telephones (SLTs) are automatically connected to specific outside (CO) lines (**Power Failure Connections**). The PBX will switch from the current connections to Power Failure Connections, and all existing conversations will be disconnected.

Only outside (CO) line calls handled by Power Failure Connections can be made during a power failure.

Conditions

- During a power failure, each of the following outside (CO) lines will be connected to an assigned extension.
 - Outside (CO) line 1: extension jack 01
 - Outside (CO) line 4: extension jack 09
 - Outside (CO) line 7: extension jack 17
- Only outside (CO) line calls are possible during a power failure. All other features will not function.
- We recommend connecting an SLT in parallel at extension jacks 01, 09, and 17, so that the SLT can be used during a power failure.

Installation Manual References

- 2.9 Power Failure Connections

Feature Manual References

- 1.1.97 Paralleled Telephone

Operating Manual References

1.3.76 Power Failure Transfer

1.1.103 PT Programming

Description

A proprietary telephone (PT) can be used to customize the settings of the PBX or of an extension, using the following programming features:

| Programming Type | Description | Example | Authorized Programmer |
|-----------------------------|---|---|--------------------------|
| Personal Programming | Used by an extension user to customize the extension's settings. | One-touch Dialing, Line Preference—Outgoing, etc. | Extension user |
| System Programming | Used by an authorized party to customize the PBX. | System Password, Extension Number, etc. | Authorized administrator |
| Manager Programming | Used by the manager to customize 4 system programming settings of the PBX and set a password to each extension. | System Speed Dialing Number, Extension Password Set, etc. | Manager |

Conditions

- The manager extension is the extension that is connected to the lowest-numbered jack (jack 01) of the PBX and can therefore perform manager programming.
- Only one system programming (including PC programming) or manager programming session is permitted at a time. These 2 programming features cannot be performed simultaneously by 2 users.
- During programming, the PT is considered to be busy and will not receive calls.
- **System Password**
To access system programming, the administrator system password must be entered. The system password is set at the factory but can be changed through system programming (→ [002] System Password). The administrator can program all system programming.
- **Manager Password**
To set the manager password, it is necessary to use the system password to perform Extension Password Set. Once set, the manager password can be used to access manager programming. The manager can assign a password to each extension (extension password).
- **Personal Programming Data Reset**
A PT user can simultaneously reset all settings made through personal programming (Line Preference—Incoming/Outgoing, Call Waiting Tone Type Selection, etc.) to their default settings. This feature also cancels pressing the AUTO ANS/MUTE button in the Hands-free Answerback feature and the Room Monitor feature.
- **System Programming Data Reset**
The PBX can return all or specific settings made through system programming to their default settings based on the following parameters (→ [999] System Data Clear):
 - a) **All para:** All data
 - b) **System para:** All data except for "CO para", "Extn. para", and "DSS para"

- c) **CO para:** The data assigned for each outside (CO) line
- d) **Extn. para:** The data assigned for each extension
- e) **DSS para:** The data assigned on the Direct Station Selection (DSS) buttons and Programmable Feature (PF) buttons on the DSS Console
- f) **Speed dial:** The System Speed Dialing numbers and names in [001] System Speed Dialing Number and [011] System Speed Dialing Name

Installation Manual References

2.10.1 Starting the Advanced Hybrid System

Programming Manual References

2 PT Programming

[PT Programming]

[001] System Speed Dialing Number

[002] System Password

[011] System Speed Dialing Name

[999] System Data Clear

[PC Programming]

8.4 System Data Clear

9.1.2 Main [1-2]—System Password

9.4.1 System Speed Dialing [4-1]

Feature Manual References

1.1.87 Operator/Manager Features

Operating Manual References

3.1 Personal Programming

3.2 System Programming (Manager Programming)

1.1.104 Pulse to Tone Conversion

Description

An extension user can temporarily switch from Pulse mode to DTMF mode in order to access special services such as computer-accessed long-distance calling or voice mail services.

Conditions

- This feature functions only on outside (CO) lines set to "Pulse" or "Call Block" mode (→ [401] Dial Mode).
- It is programmable whether DTMF dialing is sent to the telephone company when an extension user redials after changing from Pulse mode to DTMF mode by pressing the "*#" key (→ [119] Redialing after Pulse to Tone Conversion).

- DTMF mode cannot be changed to Pulse mode.

Programming Manual References

[PT Programming]

[119] Redialing after Pulse to Tone Conversion

[401] Dial Mode

[PC Programming]

9.1.11 Detail [1-10]—CO—Redialing after Pulse to Tone Conversion

9.3.3 Detail [3-3]—Dial Mode

Feature Manual References

1.1.39 Dial Type Selection

Operating Manual References

1.3.77 Pulse to Tone Conversion

1.1.105 Redial, Last Number

Description

Every extension automatically saves the last external telephone number dialed, allowing the same number to be easily redialed.

Conditions

- Up to 64 digits plus the Outside (CO) Line Access number can be stored and redialed.
- The stored telephone number is replaced whenever a new number is dialed.

Operating Manual References

1.3.78 Redial, Last Number

1.1.106 Redial, Saved Number

Description

A proprietary telephone (PT) user can save a telephone number while in a conversation with an outside party or while hearing a busy tone, and then easily redial the number later. The saved number is kept until a new number is stored.

Conditions

- Up to 64 digits plus the Outside (CO) Line Access number can be stored and redialed.

- **Save Button**
A flexible CO button can be customized as a Save button.

Feature Manual References

1.1.61 Flexible Buttons

Operating Manual References

1.3.79 Redial, Saved Number

3.1.3 Flexible Button Assignment—Save button

1.1.107 Remote Extension Lock

Description

An extension assigned as the operator or manager extension can remotely lock or unlock an extension using a Direct Station Selection (DSS) Console. This feature functions only if the operator or manager has set the extension password. When the operator or manager locks an extension remotely, the extension's user cannot unlock it. When a user locks an extension (Extension Lock) or locks the Incoming Call Log (including associated voice messages) stored in his or her personal area (Call Log Display Lock, Incoming in the Personal Area), the operator or manager extension can override the lock and unlock the extension. This feature is also known as Remote Station Lock Control.

Conditions

- **TRS—Extension Lock Class**
The class of service (COS) of extensions locked by the Extension Lock or Remote Extension Lock feature can be assigned (→ [312] TRS—Extension Lock Class) so that even a locked extension can make outside (CO) line calls. The higher COS number will take precedence. If, for example, COS 3 is assigned to an extension (→ [601-603] TRS-COS—Day/Night/Lunch) and the COS of locked extensions is assigned as "4", when the extension is locked, the PBX allows the extension user to make outside (CO) line calls using COS 4.
- **Extension Lock—CANCEL ALL**
The operator or manager can cancel this feature for all extensions simultaneously.
- **Extension Lock Button**
A flexible DSS button on a DSS Console can be customized as an Extension Lock button.
- This feature will not block Emergency Calls (→ 1.1.49 Emergency Call).

Programming Manual References

[PT Programming]

[108] Flash/Recall Mode for a Locked Extension

[312] TRS—Extension Lock Class

[601-603] TRS-COS—Day/Night/Lunch

[PC Programming]

9.1.11 Detail [1-10]—Extension—Flash/Recall Mode for a Locked Extension

9.2.2 Feature settings [2-2]—Remote Extension Lock

9.5.1 Class of Service (COS) [5-1]—Day, Night, Lunch

9.5.4 Emergency Number & Others [5-4]—Extension Lock Class

Feature Manual References

- 1.1.18 Call Log, Incoming
- 1.1.49 Emergency Call
- 1.1.55 Extension Lock
- 1.1.61 Flexible Buttons
- 1.1.117 Toll Restriction (TRS)

Operating Manual References

- 2.1.6 Remote Extension Lock
- 2.1.7 System Feature Assignment—Extension Lock—CANCEL ALL, Extension Password Set
- 3.1.3 Flexible Button Assignment—Extension Lock button

1.1.108 Ring Tone Pattern Selection

Description

A different ring tone pattern can be assigned to each incoming call type, such as intercom calls (→ [115] Extension Ring Tone Pattern), calls from each doorphone (→ [706] Doorphone Ring Tone Pattern), and calls from each outside (CO) line (→ [423] CO Line Ring Tone Pattern). Available ring tone patterns are as follows:

[Ring Tone Patterns]

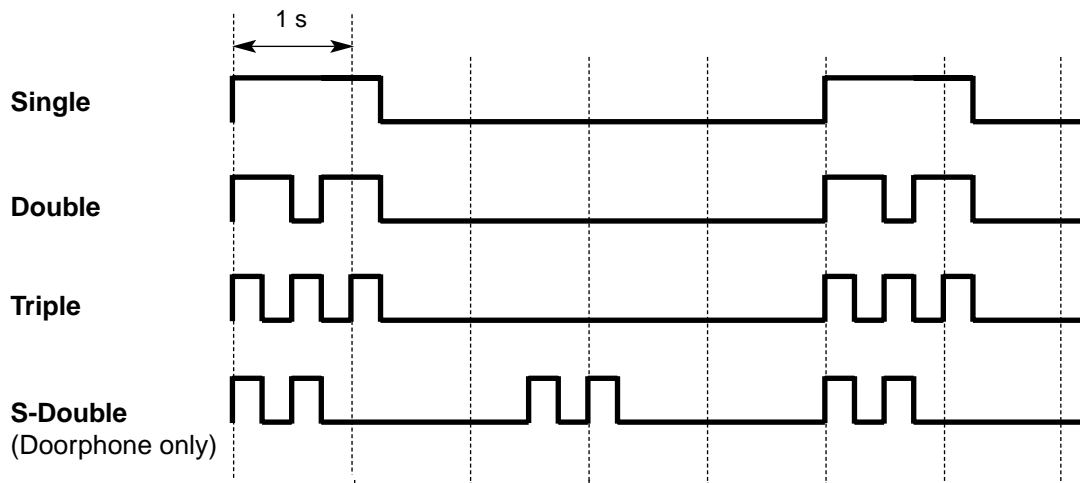

Conditions

- The ring tone pattern for incoming calls (intercom calls and outside (CO) line calls) to a single line telephone (SLT) can be fixed to "Single" or "Double" for each extension through system programming (→ [629] SLT Fixed Bell Pattern). The length of the ring tone pattern depends on the preprogrammed length of the bell-on signal (→ [143] SLT Ring Bell-on Time), combined with the ratio between the bell signals of the SLT (→ [142] SLT Ring/Silence Ratio). Depending on the type of SLT being used, the

SLT may not ring properly, if the ring tone pattern of the SLT is set differently from that used by the telephone company.

Programming Manual References

[PT Programming]

[115] Extension Ring Tone Pattern

[142] SLT Ring/Silence Ratio

[143] SLT Ring Bell-on Time

[423] CO Line Ring Tone Pattern

[629] SLT Fixed Bell Pattern

[706] Doorphone Ring Tone Pattern

[PC Programming]

9.1.11 Detail [1-10]—Extension—Ring Tone Pattern

9.3.3 Detail [3-3]—Ring Tone Pattern

9.7.2 Others [7-2]—Doorphone Ring Tone Pattern—Door 1–4

9.9.2 SLT Caller ID [9-2]—SLT Ring—Ring / Silence Ratio, SLT Ring—Bell-on Time, Fixed Bell Pattern

Feature Manual References

1.1.90 Outside (CO) Line Ringing Selection

2.2.1 Tones/Ring Tones

1.1.109 Ringing, Delayed

Description

Each extension can be programmed for Delayed Ringing (→ [411-413] Delayed Ringing—Day/Night/Lunch), which allows extensions to be alerted to calls by flashing buttons only. Received calls can be answered by pressing the flashing button even if the extension is not ringing.

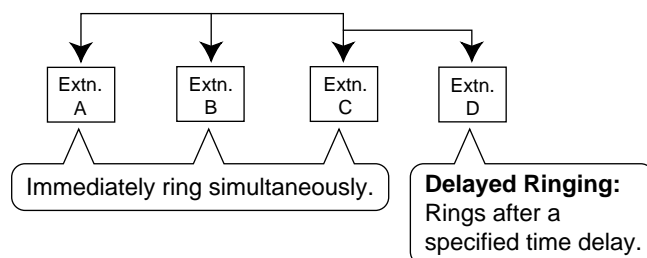

Conditions

- This feature does not apply to Direct Inward System Access (DISA) or Direct In Line (DIL) calls. If the destination is a DISA ring group, the Ringing, Delayed feature will function.

Programming Manual References

[PT Programming]

[408-410] Flexible Ringing—Day/Night/Lunch

[411-413] Delayed Ringing—Day/Night/Lunch

[PC Programming]

9.3.2 Incoming / Outgoing [3-2]—Ring for incoming CO calls—Day, Night, Lunch

Feature Manual References

1.1.42 Direct Inward System Access (DISA) Ring

1.1.110 Room Monitor

Description

An extension user can monitor a room or a door through another proprietary telephone (PT) or a doorphone without the destination party knowing.

Conditions

- To monitor using this feature, an extension must have a PT with an AUTO ANS/MUTE button or a single line telephone (SLT) with a MUTE button. To be monitored using this feature, an extension must have a PT with an AUTO ANS/MUTE button.
- System programming determines the extensions that can be monitored using this feature (→ [612] Room Monitor).
- A doorphone access tone will be sent to a monitored doorphone before monitoring starts (→ 1.1.48 Doorphone Call). If an extension user wants to monitor a doorphone without informing the other party, it is possible to eliminate the tone through system programming (→ [707] Doorphone Access Tone).
- Access tones will not be sent to a monitored PT. Paging tones will also not be received by a monitored PT.

Programming Manual References

[PT Programming]

[612] Room Monitor

[707] Doorphone Access Tone

[PC Programming]

9.2.1 Main [2-1]—Room Monitor

9.2.2 Feature settings [2-2]—Monitored PT set

9.7.2 Others [7-2]—Doorphone Access Tone—Door 1–4

Feature Manual References

1.1.48 Doorphone Call

Operating Manual References

1.3.38 Doorphone Call

1.3.80 Room Monitor

1.1.111 Secret Dialing

Description

An extension user can prevent all or part of a System Speed Dialing number (→ [001] System Speed Dialing Number) or One-touch Dialing number from being displayed when a call is made, by pressing the INTERCOM button at the beginning and at the end of the number to be hidden.

Conditions

- The characters for secret code, "[" and "]" (entered by pressing the INTERCOM button), are counted as one digit each.
- It is not possible to hide the Outside (CO) Line Access number (9, or 81 through 88) by pressing the INTERCOM button before dialing it.
- It is programmable whether the hidden part will be shown on SMDR (→ [803] Secret Number SMDR Print Suppression).

Programming Manual References

[PT Programming]

[001] System Speed Dialing Number

[803] Secret Number SMDR Print Suppression

[PC Programming]

9.1.8 SMDR [1-7]—Selection for Printing—Secret Number

9.4.1 System Speed Dialing [4-1]—Line Access Number + Telephone Number

Feature Manual References

1.1.61 Flexible Buttons

1.1.86 One-touch Dialing

1.1.112 Station Message Detail Recording (SMDR)

1.1.113 System Speed Dialing

Operating Manual References

1.3.81 Secret Dialing

3.1.3 Flexible Button Assignment—One-touch Dialing button

1.1.112 Station Message Detail Recording (SMDR)

Description

Automatically logs detailed information for the PBX.

1. SMDR Output Port

The Serial Interface (RS-232C) port can be used to output Station Message Detail Recording (SMDR) data to a PC, printer, etc.

2. SMDR Output Data

Outside (CO) line call information (Incoming/outgoing) can be logged and sent to the SMDR output port.

3. SMDR Format and Contents

| Date | Time | Ext. | CO | Dial number | Duration | Code |
|----------|----------|------|----|----------------------------------|-----------|--------|
| 12/31/05 | 12:52PM | 103 | 05 | 12345678901234567890123456789012 | 00:00'16" | |
| 12/31/05 | 12:53PM | 103 | 02 | < incoming >2013570846 | 00:01'43" | |
| 12/31/05 | *12:54PM | 101 | 02 | < incoming >1234567890123456 | 00:07'48" | |
| 12/31/05 | 12:55PM | 101B | 02 | < BV incoming >2013570846 | 00:00'43" | |
| 12/31/05 | 12:56PM | 107B | 03 | < DIL incoming >0921234557 | 00:01'43" | |
| 12/31/05 | 1:04PM | 103 | 06 | 092... 1438 | 00:00'06" | 4536 |
| 12/31/05 | 1:04PM | 102 | 05 | < DISA incoming >2013570846 | 00:00'09" | 0 |
| 12/31/05 | 1:05PM | 103 | 01 | < DISA incoming > | 00:00'08" | 0 |
| 12/31/05 | 1:06PM | 103 | 01 | 092123456789 | 00:00'08" | |
| 12/31/05 | 1:06PM | C-05 | 02 | 0921234567 | 00:00'17" | 2 |
| 12/31/05 | 1:07PM | 103 | 01 | 0921234567 | 00:11'00" | .. 13 |
| 12/31/05 | 2:15PM | 103 | 01 | 0921234567 | 00:11'00" | .101 |
| 12/31/05 | 2:26PM | 103 | 01 | F/0927654321 | 00:03'00" | |
| 12/31/05 | 2:27PM | 116 | 05 | 9=0924567123 | 00:13'55" | |

| | | | | | | |
|-----|-----|-----|-----|-----|-----|-----|
| (1) | (2) | (3) | (4) | (5) | (6) | (7) |
|-----|-----|-----|-----|-----|-----|-----|

[Explanation]

The following table explains the types of data logged by SMDR. The section numbers below refer to the field indicated by the numbers above.

| Section Number | Data | Description |
|----------------|-------------|---|
| (1) | Date | Shows the date (Month/Day/Year) of the call (→ [000] Date & Time). |
| (2) | Time | Shows the start time of a call as hour/minute/AM or PM. Also shows the following code: *: Transferred call (→ 1.1.25 Call Transfer—To Extension) |

| Section Number | Data | Description |
|----------------|------------------|--|
| (3) | Ext. (Extension) | Shows the number of the extension that was engaged in the call. Also shows the following codes: xxxB : Call answered by the BV feature (→ 1.1.8 Built-in Voice Message (BV)) (xxx=Number of the extension to which the call was directed before the BV feature answered) Even if a caller does not leave a voice message, for example, by going on-hook while hearing a personal/common BV outgoing message (OGM), the information is logged. C-xx : Outside-to-Outside (CO-to-CO) line call via the DISA feature (→ 1.1.41 Direct Inward System Access (DISA)) (xx=Outside (CO) line number that receives the DISA call) |
| (4) | CO | Shows the outside (CO) line number used for the call. |
| (5) | Dial Number | [Outside (CO) Line Call] Outgoing Outside (CO) Line Call Shows the dialed telephone number (max. 32 digits). Digits shown are as follows: 0 through 9, *, #, - (hyphen) F/ : Flash/recall signal (→ 1.1.60 Flash/Recall) = : Host PBX Access code marker (→ 1.1.65 Host PBX Access Code (Access Code to the Telephone Company from a Host PBX)) The marker is displayed between the Host PBX Access code and the dialed number when a Host PBX Access code is entered. . (dot): Secret Dialing (→ 1.1.111 Secret Dialing) Incoming Outside (CO) Line Call Shows <incoming> + the caller's telephone number (max. 16 digits). A caller's telephone number is displayed only when an optional Caller ID card is installed and "With CID" is selected in [906] Caller ID SMDR Format. It is also possible to show a caller's telephone number before the call is answered (→ [907] Caller ID SMDR Printout). Also shows the following codes: < DISA incoming > + the caller's telephone number (max. 16 digits): Incoming outside (CO) line call via the DISA feature < BV incoming >: Incoming outside (CO) line call to the common message area of the BV feature < DIL incoming >: Incoming outside (CO) line call via the DIL feature (→ 1.1.40 Direct In Line (DIL)) |
| (6) | Duration | Shows the duration of the outside (CO) line call in hours/minutes/seconds. |

| Section Number | Data | Description |
|----------------|------|---|
| (7) | Code | Shows the account code appended to the call (→ 1.1.2 Account Code Entry), the account code index number (e.g., 13), the number of the extension that used the Walking COS feature (e.g., 101), or DISA security code status (e.g., 0). 0: A DISA incoming call without a DISA security code 1 to 4: A DISA incoming call with a DISA security code number Actual DISA security codes are not printed by SMDR (→ [512] DISA Security Code). |

The following data can be controlled through system programming to adjust whether (or how) they are printed or displayed by SMDR.

[Programmable Items]

| Item | Description |
|---|---|
| Incoming/Outgoing outside (CO) line call | Controls whether incoming/outgoing outside (CO) line calls are shown (→ [802] Incoming/Outgoing Call Selection for Printing). If "Toll" is selected for outgoing outside (CO) line calls, only calls that are checked in [302-305] TRS—COS 2-5 Denied Code and are allowed, are shown. |
| Caller's identification | Controls whether a caller's telephone number is shown (→ [906] Caller ID SMDR Format). When this is set to display telephone numbers, even if the PBX receives a caller's name by the Caller ID feature, only the telephone number is shown. |
| Secret Dialing | Controls whether secret dialing numbers stored in [001] System Speed Dialing Number or stored in One-touch Dialing button are shown by SMDR (→ [803] Secret Number SMDR Print Suppression). |
| Account Code | Controls whether the account code stored in [310] Account Code or just the index of the account code is shown (→ [805] SMDR Account Code). The index of the account code is shown when "Verify-All" or "Verify-Toll" is selected in [605] Account Code Mode. |
| System programming items | Controls whether system programming items that have already been assigned are shown based on the following parameters (→ [804] System Data Dump): <ul style="list-style-type: none"> a) All para: All data b) System para: All data except for "CO para", "Extn. para", "DSS para" and "Speed dial" c) CO para: The data assigned for each outside (CO) line d) Extn. para: The data assigned for each extension e) DSS para: The data assigned on the Direct Station Selection (DSS) buttons and Programmable Feature (PF) buttons on the DSS Console f) Speed dial: The System Speed Dialing numbers and names in [001] System Speed Dialing Number and [011] System Speed Dialing Name g) Stop output: Not shown |

Conditions

- **Multilingual Display by SMDR**
It is possible to select the display language used for SMDR through system programming (→ [806] SMDR Language).
- The PBX waits for a preprogrammed length of time (→ [204] Call Duration Counter Start) after the end of seizing an outside (CO) line or dialing before starting the SMDR timer for outgoing outside (CO) line calls. When the PBX has sent out all dialed digits to the telephone company and this timer expires, the PBX begins measuring the duration of the call. A display proprietary telephone (PT) shows the elapsed time of the call. The starting time and the total duration of the call are logged by SMDR.
- **SMDR Format**
The following SMDR format parameters can be set through system programming (→ [801] SMDR Parameter) in order to match the paper size being used by the printer:
 - Page Length:** determines the number of lines per page.
 - Skip Perforation:** determines the number of lines to be skipped at the end of every page.
The page length should be at least 4 lines longer than the skip perforation length.
The title is placed on the first 3 lines of every page.

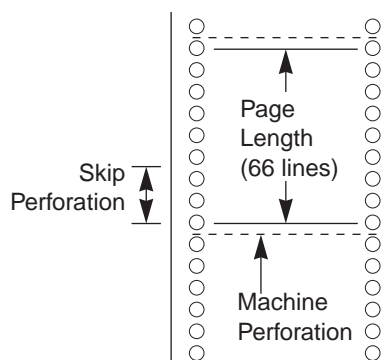

- **Serial Interface (RS-232C) Parameters**
The following communication parameters can be assigned for the Serial Interface (RS-232C port) through system programming (→ [800] SMDR RS-232C Parameter):
 - New Line (NL) Code:** Select the code appropriate for the PC or printer. If the PC or printer automatically feeds lines with carriage return, select "CR". If not, select "CR+LF".
 - Baud Rate:** Baud rate indicates the transmission speed of data from the PBX to the PC or printer.
 - Word Length:** Word length indicates how many bits compose each character.
 - Parity Bit:** Parity bit indicates what type of parity is used to detect errors in the string of bits composing a character. Make an appropriate selection depending on the requirements of the PC or printer.
 - Stop Bit Length:** Stop bit indicates the end of a bit string that composes a character. Select an appropriate value depending on the requirements of the PC or printer.

Installation Manual References

2.8.1 Connecting Peripherals

Programming Manual References

[PT Programming]

[000] Date & Time

- [001] System Speed Dialing Number
- [204] Call Duration Counter Start
- [302-305] TRS—COS 2-5 Denied Code
- [310] Account Code
- [512] DISA Security Code
- [605] Account Code Mode
- [800] SMDR RS-232C Parameter
- [801] SMDR Parameter
- [802] Incoming/Outgoing Call Selection for Printing
- [803] Secret Number SMDR Print Suppression
- [804] System Data Dump
- [805] SMDR Account Code
- [806] SMDR Language
- [906] Caller ID SMDR Format
- [907] Caller ID SMDR Printout

[PC Programming]

- 9.1.1 Date & Time [1-1]
- 9.1.6 Account Codes [1-5]
- 9.1.7 Timers [1-6]—Call Duration—Call Duration Counter Start Time
- 9.1.8 SMDR [1-7]
- 9.2.1 Main [2-1]—Account Code Mode
- 9.4.1 System Speed Dialing [4-1]—Line Access Number + Telephone Number
- 9.5.2 Denied Codes [5-2]
- 9.6.3 Settings [6-2]—Security—DISA Security Codes
- 9.9.1 Main [9-1]—Caller ID SMDR Format, Caller ID SMDR Printout

Feature Manual References

- 1.1.2 Account Code Entry
- 1.1.8 Built-in Voice Message (BV)
- 1.1.25 Call Transfer—To Extension
- 1.1.40 Direct In Line (DIL)
- 1.1.41 Direct Inward System Access (DISA)
- 1.1.60 Flash/Recall
- 1.1.65 Host PBX Access Code (Access Code to the Telephone Company from a Host PBX)
- 1.1.111 Secret Dialing

1.1.113 System Speed Dialing

Description

An extension user can use short numbers to frequently dialed numbers that are stored in the PBX.

Conditions

- Any number, such as a telephone number or feature number, can be stored in System Speed Dialing (up to 32 digits).
- This feature is not available on rotary single line telephones (SLTs).
- **TRS for System Speed Dialing** (→ [301] TRS—System Speed Dialing Class)
Calls made using System Speed Dialing are restricted depending on the class of service (COS) of System Speed Dialing numbers and the COS assigned to each extension (→ 1.1.117 Toll Restriction (TRS)).
- System Speed Dialing numbers (→ [001] System Speed Dialing Number) and names (→ [011] System Speed Dialing Name) can be assigned through system programming. The assigned name will be shown on the display of a proprietary telephone (PT) when an extension user makes calls using this feature.
- **Caller's Name**
If the dialed number matches a number stored in the System Speed Dialing table with an assigned name, the assigned name will be shown on the display (→ 1.1.30 Caller ID).
- System Speed Dialing, One-touch Dialing, and manual dialing can be used in combination.

Programming Manual References

[PT Programming]

[001] System Speed Dialing Number

[011] System Speed Dialing Name

[301] TRS—System Speed Dialing Class

[PC Programming]

9.4 System Speed Dialing [4]

9.5.4 Emergency Number & Others [5-4]—System Speed Dialing Class

Feature Manual References

1.1.30 Caller ID

1.1.117 Toll Restriction (TRS)

Operating Manual References

1.3.82 System Speed Dialing

3.2.2 System Programming (Manager Programming)

1.1.114 Time Service

Description

Time service modes are used by many PBX features to determine how they will function during different times of day. For example, incoming calls can be directed to sales staff during the day and to a Voice Processing System (VPS) at night, extension users can be prohibited from making long-distance calls during lunch time, etc.

There are 3 time service modes—day, night, and lunch. The start times of each time service mode and end time of lunch mode are programmed for each day of the week in a Time Table.

1. Time Service Switching Mode

The current time service mode can switch automatically to another time service mode at the time assigned in the Time Table. It is possible, however, to switch time service modes manually. Whether time service modes are normally switched manually or automatically is determined through system programming (→ [006] Time Service Switching Mode).

| Switching Mode | Description | Condition |
|------------------|---|---|
| Automatic | The current time service mode will switch automatically to another time service mode at the time assigned in the Time Table, and can be switched manually by pressing the Day, Night, or Lunch button or by entering the Time Service feature number. | The current time service mode (day/night/lunch) and the switching mode (automatic/manual) can be switched manually by an extension assigned as the operator or manager extension. |
| Manual | The current time service mode will switch only when the Day, Night, or Lunch button is pressed or when the Time Service feature number is entered. | |

2. Time Table

A Time Table has 3 modes—day, night, and lunch. A Time Table can be programmed to control when each time service mode starts (and therefore, the previous time service mode ends), and can be programmed separately for each day of the week.

[Programming Example: Time Table]

| Time Schedule* | Day | Night | Lunch | |
|----------------|------------|------------|------------|------------|
| | Start Time | Start Time | Start Time | End Time |
| Sunday | Not Stored | Not Stored | Not Stored | Not Stored |
| Monday | 09:00 | 17:00 | 12:00 | 13:00 |
| Tuesday | 09:00 | 17:00 | 12:00 | 13:00 |
| (Cont.) : | : | : | : | : |
| : | : | : | : | : |

* → [007] Time Service Start Time

[Visualization of Time Schedule]

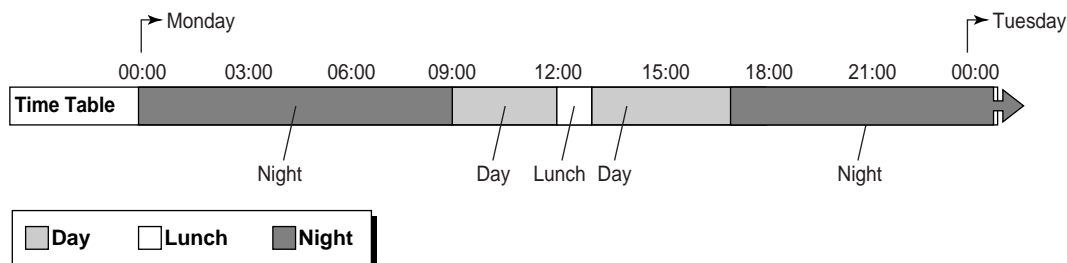

Note that time service modes can be arranged as they are needed (for example, night mode can occur in the morning and afternoon, if necessary) and not all time service modes need to be used in a time

schedule. Also note that day mode or night mode resumes automatically when lunch mode ends.

3. Programming Items Using Time Service

The following programming items will be affected by the time service:

- a) [405-407] Flexible Outward Dialing—Day/Night/Lunch
- b) [408-410] Flexible Ringing—Day/Night/Lunch
- c) [411-413] Delayed Ringing—Day/Night/Lunch
- d) [414-416] CO Line Mode—Day/Night/Lunch
- e) [438-440] DISA IRNA to BV—Day/Night/Lunch
- f) [601-603] TRS-COS—Day/Night/Lunch
- g) [700-702] Doorphone Ringing—Day/Night/Lunch
- h) [703-705] Door Opener—Day/Night/Lunch

4. Day/Night/Lunch Button

A flexible Direct Station Selection (DSS) button can be customized as a Day, Night, or Lunch button by the operator or manager.

These buttons can be used to switch the current time service mode.

Each button shows the current status as follows:

| Light Pattern | Status |
|---------------|---------------------|
| Off | Day/Night/Lunch off |
| Red on | Day/Night/Lunch on |

Note

Extension users can press the "#" key on their proprietary telephones (PTs) to display the current time service mode.

Conditions

- The start times of each time service mode and end time of lunch mode can be specified through system programming (→ [007] Time Service Start Time).

Programming Manual References

[PT Programming]

- [006] Time Service Switching Mode
- [007] Time Service Start Time
- [405-407] Flexible Outward Dialing—Day/Night/Lunch
- [408-410] Flexible Ringing—Day/Night/Lunch
- [411-413] Delayed Ringing—Day/Night/Lunch
- [414-416] CO Line Mode—Day/Night/Lunch
- [438-440] DISA IRNA to BV—Day/Night/Lunch
- [601-603] TRS-COS—Day/Night/Lunch
- [700-702] Doorphone Ringing—Day/Night/Lunch
- [703-705] Door Opener—Day/Night/Lunch

[PC Programming]

9.1.4 Time Service [1-4]

9.1.5 Time Service [1-4] Time Setting

9.3.1 Line Mode [3-1]—Mode of incoming CO calls—Day, Night, Lunch

9.3.2 Incoming / Outgoing [3-2]—Ringling for incoming CO calls—Day, Night, Lunch, Outgoing Call—Day, Night, Lunch

9.5.1 Class of Service (COS) [5-1]—Day, Night, Lunch

9.7.1 Ringling & Door Opener [7-1]—Doorphone 1–4—Day, Night, Lunch, Door Opener 1–4—Day, Night, Lunch

9.8.2 Others [8-2]—DISA IRNA to BV—Day, Night, Lunch

Feature Manual References

1.1.61 Flexible Buttons

Operating Manual References

1.3.83 Time Service

2.1.9 Time Service

3.1.3 Flexible Button Assignment—Day, Night, or Lunch button

1.1.115 Timed Reminder

Description

Each extension user can set an alarm to be used as a wake-up call or reminder. This feature can be programmed to activate daily or one time only. If the user goes off-hook during the alarm, a special dial tone (dial tone 3) will be heard.

Conditions

- Be sure that the PBX clock is set to the correct time.
- Setting a new alarm time clears the previous alarm time.
- There is no limit for the number of the extensions that can set Timed Reminder at the same time.

Programming Manual References

[PT Programming]

[000] Date & Time

[PC Programming]

9.1.1 Date & Time [1-1]

9.2.2 Feature settings [2-2]—Timed Reminder

Feature Manual References

1.1.116 Timed Reminder, Remote

Operating Manual References

1.3.84 Timed Reminder

1.1.116 Timed Reminder, Remote

Description

An extension assigned as the operator or manager extension can remotely set, cancel, and confirm the timed reminder of the desired extension. This feature is useful, for example, for a small hotel or motel to set a wake-up call for an extension in a guest room, or for a parent to set a wake-up call for an extension in a child's room.

Conditions

- Be sure that the PBX clock is set to the correct time.
- Setting a new alarm time clears the previous alarm time.
- There is no limit for the number of the extensions that can set Timed Reminder at the same time.

Programming Manual References

[PT Programming]

[000] Date & Time

[PC Programming]

9.1.1 Date & Time [1-1]

9.2.2 Feature settings [2-2]—Timed Reminder

Feature Manual References

1.1.115 Timed Reminder

Operating Manual References

2.1.10 Timed Reminder, Remote (Wake-up Call)

1.1.117 Toll Restriction (TRS)

Description

Toll Restriction (TRS) can prohibit certain extension users from making unauthorized outside (CO) line calls. Every extension is assigned to one of 5 classes of service (COSs) for each time service mode (→ [601-603] TRS-COS—Day/Night/Lunch); COS 1 grants the highest level of authorization, allowing all outside (CO) line calls to be made, and COS 5 grants the lowest level of authorization. COSs 2 through 5 are used to restrict calls with a combination of preprogrammed Denied and Exception Code Tables, explained below.

Denied Code Tables (→ [302-305] TRS—COS 2-5 Denied Code)

Denied Code Tables are preprogrammed lists containing the telephone numbers that are restricted. All outgoing outside (CO) line calls made by COS 2 through 5 users are compared to the applicable Denied

1.1 General Features

Code Table(s), and when the leading number of a dialed telephone number (not including the Outside (CO) Line Access number) matches an entry found in an applicable table, the call is denied. Up to a total of 80 denied codes, each consisting of up to 11 digits, can be stored.

Exception Code Tables (→ [306] TRS—Exception Code)

Exception Code Tables are preprogrammed lists of leading digits or complete telephone numbers that are checked against every dialed number prohibited by a Denied Code Table. When a dialed number is prohibited by a Denied Code Table, it is compared to the applicable Exception Code Table(s). If the dialed number matches an entry found in an applicable Exception Code Table, the call is permitted.

Up to 80 exception codes, each consisting of up to 11 digits, can be stored. The available number of codes depends on the COS assigned to each extension.

Applicable tables by COS

The Denied Code Tables and Exception Code Tables that apply to each COS are listed below.

| COS No. | Denied Code Tables | Exception Code Tables |
|---------|---|--|
| 1 | No restriction. (Not Programmable) | No restriction. (Not Programmable) |
| 2 | 20 denied codes programmed in [302]. (Table for Class 2) | 80 exception codes (code numbers 01–80) programmed in [306]. (Tables for Classes 2 through 5) |
| 3 | 40 denied codes programmed in [302] and [303]. (Tables for Classes 2 and 3) | 60 exceptions codes (code numbers 01–60) programmed in [306]. (Tables for Classes 3 through 5) |
| 4 | 60 denied codes programmed in [302] through [304]. (Tables for Classes 2 through 4) | 40 exception codes (code numbers 01–40) programmed in [306]. (Tables for Classes 4 and 5) |
| 5 | 80 denied codes programmed in [302] through [305]. (Tables for Classes 2 through 5) | 20 exception codes (code numbers 01–20) programmed in [306]. (Table for Class 5) |

| | | |
|-------|--|------------------------|
| COS 1 | All outside (CO) line calls permitted. | |
| COS 2 | Class 2 restriction | Class 2 – 5 exceptions |
| COS 3 | Class 2 – 3 restrictions | Class 3 – 5 exceptions |
| COS 4 | Class 2 – 4 restrictions | Class 4 – 5 exceptions |
| COS 5 | Class 2 – 5 restrictions | Class 5 exception |

Calls are restricted
 Calls are permitted

TRS for System Speed Dialing (→ [301] TRS—System Speed Dialing Class)

Calls made using System Speed Dialing are restricted depending on the COS of System Speed Dialing numbers and the COS assigned to each extension. If, for example, the COS of System Speed Dialing numbers is assigned as "2", the PBX will allow System Speed Dialing calls for the extensions with COSs 1 and 2, but not allow System Speed Dialing calls for the extensions with COSs 3, 4, and 5 according to TRS as follows:

| COS No. | System Speed Dialing Class | | | | |
|---------|----------------------------|---|---|---|---|
| | 1 | 2 | 3 | 4 | 5 |
| 1 | ✓ | ✓ | ✓ | ✓ | ✓ |
| 2 | | ✓ | ✓ | ✓ | ✓ |
| 3 | | | ✓ | ✓ | ✓ |
| 4 | | | | ✓ | ✓ |
| 5 | | | | | ✓ |

✓ Permitted

[Flowchart]

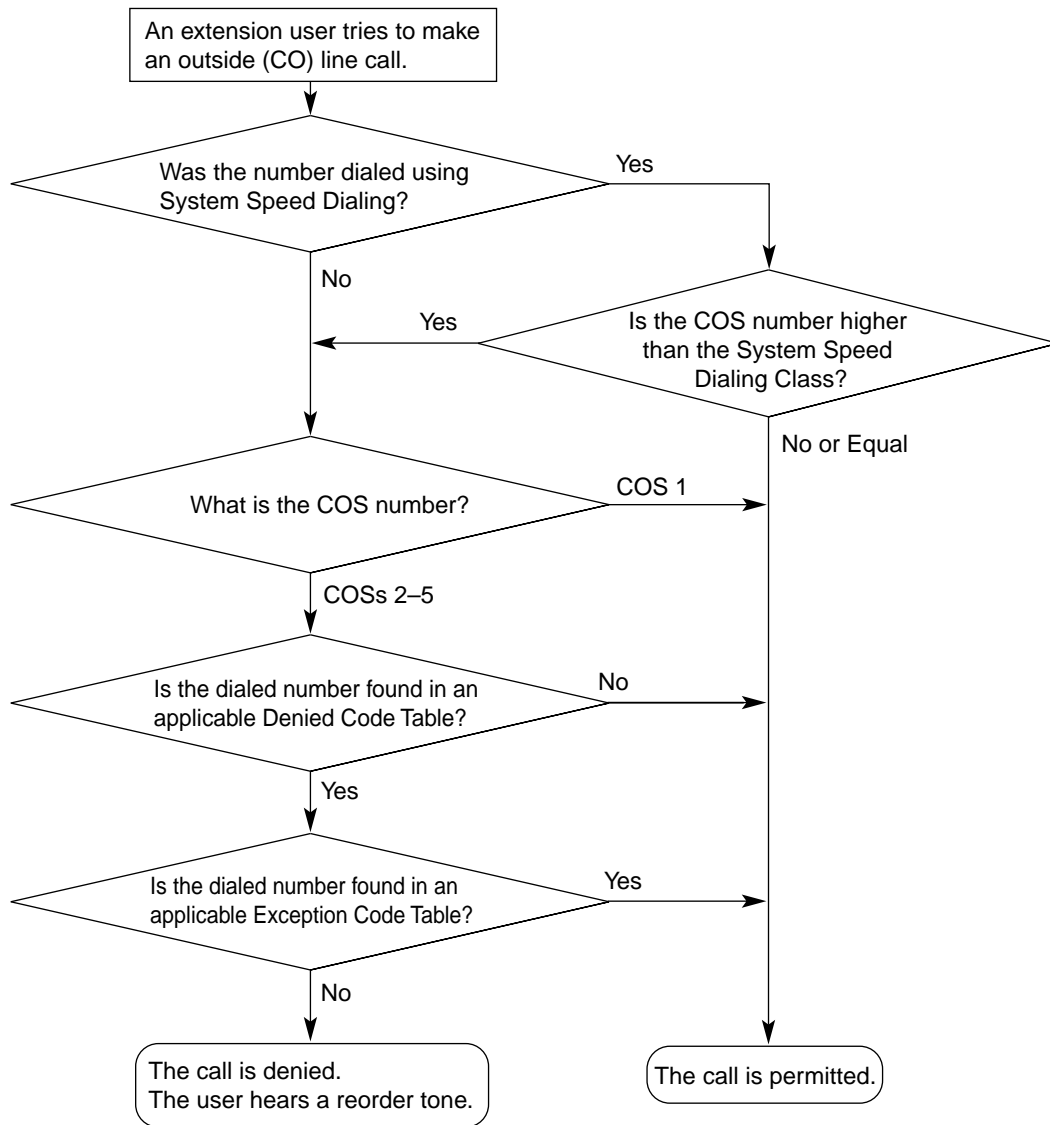

Conditions

WARNING

The software contained in the TRS feature to allow user access to the network must be upgraded to recognize newly established network area codes and exchange codes as they are placed into service.

Failure to upgrade the on-premise PBXs or peripheral equipment to recognize the new codes as they are established will restrict the customer and users of the PBX from gaining access to the network and to these codes.

KEEP THE SOFTWARE UP TO DATE WITH THE LATEST DATA.

- TRS—Extension Lock Class**
 The COS of extensions locked by the Extension Lock or Remote Extension Lock feature (→ 1.1.55 Extension Lock, 1.1.107 Remote Extension Lock) can be assigned (→ [312] TRS—Extension Lock Class) so that even a locked extension can make outside (CO) line calls. The higher COS number will take precedence. If, for example, COS 3 is assigned to an extension (→ [601-603] TRS-COS—Day/Night/Lunch) and the COS of locked extensions is assigned as "4", when the extension is locked, the PBX allows the extension user to make outside (CO) line calls using COS 4.
- Emergency numbers, such as the police or fire services, should be stored (→ [309] Emergency Number) so that they are not barred by TRS.
- Host PBX Access Code/Carrier Exception Code**
 TRS checks can be carried out on telephone numbers dialed using a Host PBX Access code (→ 1.1.65 Host PBX Access Code (Access Code to the Telephone Company from a Host PBX)) or Carrier Exception code.

| Access Code Type | Access Code is stored in the PBX | | Access Code is not stored in the PBX |
|----------------------------------|---|---|--------------------------------------|
| | Access Code is dialed | Access Code is not dialed | |
| Host PBX Access Code *1 | TRS ignores the code and checks the remaining digits. | Number dialed is not an outside (CO) line call, so TRS does not check the number. | TRS checks the entire number. |
| Carrier Exception Code *2 | TRS ignores the code and checks the remaining digits. | TRS checks the entire number. | TRS checks the entire number. |

*1 → [403] Host PBX Access Code

*2 → [300] Carrier Exception Code

- The inter-digit timer (→ [208] Inter-digit Time) applies until the TRS check is completed. When the timer expires, the outgoing outside (CO) line call is disconnected while dialing, if enabled through system programming (→ [211] No Dial Disconnection). For a single line telephone (SLT), an outgoing outside (CO) line call will be released from the DTMF (Dual Tone Multi-Frequency) receiver when the inter-digit timer expires.
- The PBX can also be programmed to perform a TRS check for numbers that contain nondigits (* or #) (→ [125] TRS Check for * and #). If TRS check is disabled, the PBX ignores any nondigits that are dialed when checking, which is useful in preventing some unauthorized calls.

Programming Manual References

[PT Programming]

- [125] TRS Check for * and #
- [208] Inter-digit Time
- [211] No Dial Disconnection
- [300] Carrier Exception Code
- [301] TRS—System Speed Dialing Class
- [302-305] TRS—COS 2-5 Denied Code
- [306] TRS—Exception Code
- [309] Emergency Number
- [312] TRS—Extension Lock Class
- [403] Host PBX Access Code
- [601-603] TRS-COS—Day/Night/Lunch

[PC Programming]

- 9.1.7 Timers [1-6]—CO Dialing—No Dial Disconnection, CO Dialing—Inter-digit Time
- 9.1.9 Carrier Exception Codes [1-8]
- 9.3.3 Detail [3-3]—Host PBX Access Codes
- 9.5.1 Class of Service (COS) [5-1]—Day, Night, Lunch
- 9.5.2 Denied Codes [5-2]
- 9.5.3 Exception Codes [5-3]
- 9.5.4 Emergency Number & Others [5-4]—Emergency Number, System Speed Dialing Class, Extension Lock Class, TRS Check for dial "**#"

Feature Manual References

- 1.1.32 Class of Service (COS)
- 1.1.55 Extension Lock
- 1.1.65 Host PBX Access Code (Access Code to the Telephone Company from a Host PBX)
- 1.1.107 Remote Extension Lock
- 1.1.113 System Speed Dialing
- 1.1.118 Toll Restriction (TRS) Override by Account Code
- 1.1.122 Walking COS

Operating Manual References

- 1.3.85 Toll Restriction (TRS)

1.1.118 Toll Restriction (TRS) Override by Account Code

Description

An extension user can override TRS temporarily to make a toll call from a toll-restricted telephone (→ 1.1.117 Toll Restriction (TRS)). The extension user can carry out this feature by entering the appropriate account code before dialing the telephone number (→ [310] Account Code).

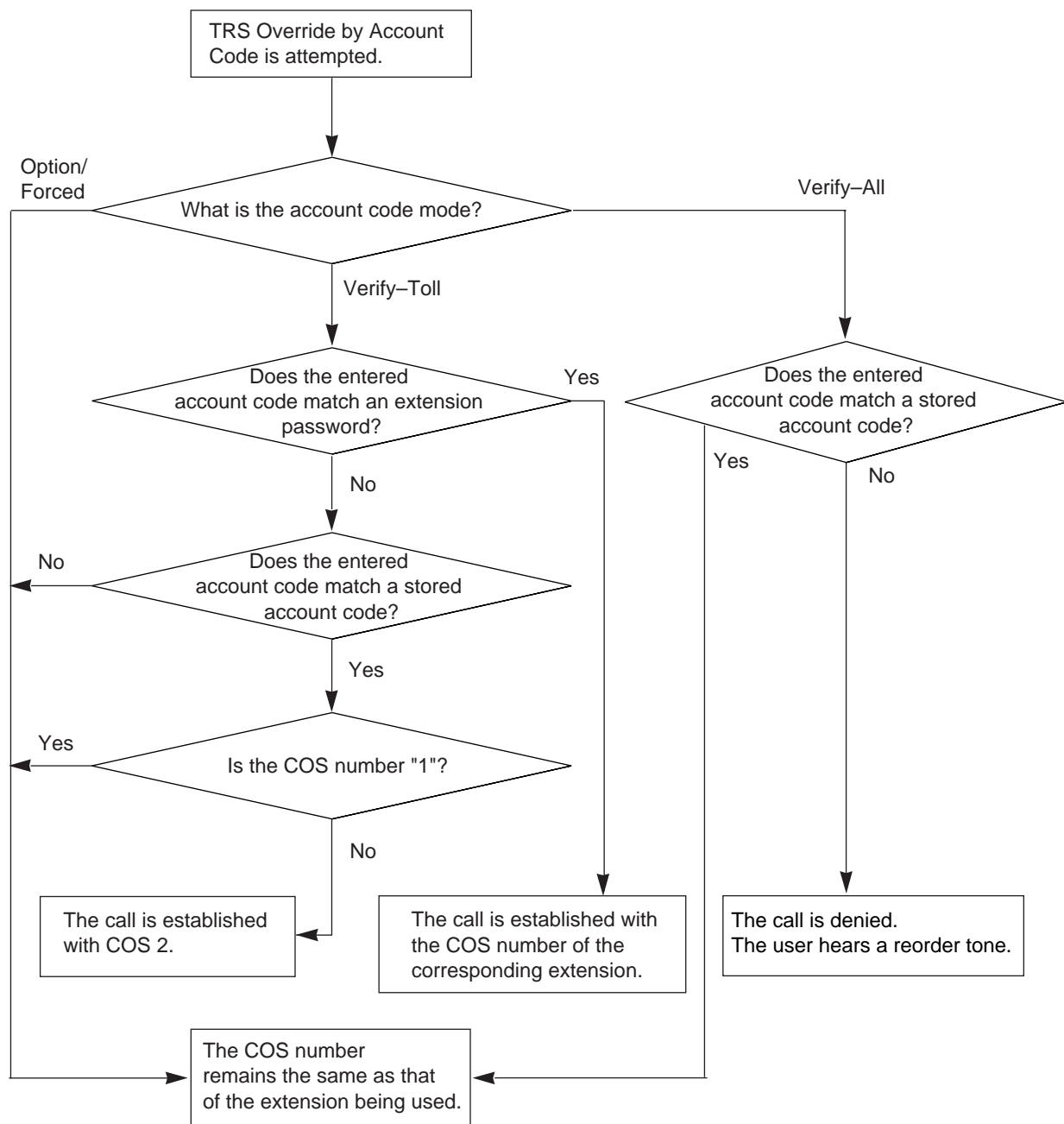
[Flowchart]**Conditions**

- This feature functions only for extensions whose:
 - Account code mode is set to "Verify-Toll" (→ [605] Account Code Mode).
 - Class of service (COS) number is set to 3 through 5.
- If the extension user does not enter an account code or enters an invalid account code, an ordinary TRS check is performed.
- System programming determines whether SMDR (→ 1.1.112 Station Message Detail Recording (SMDR)) logs the 4-digit account code or the 2-digit index of the account code when an extension user makes a call using this feature (→ [805] SMDR Account Code).

- It is also possible to override TRS at another extension using the Walking COS feature (→ 1.1.122 Walking COS).

Programming Manual References

[PT Programming]

[310] Account Code

[605] Account Code Mode

[805] SMDR Account Code

[PC Programming]

9.1.6 Account Codes [1-5]

9.1.8 SMDR [1-7]—Selection for Printing—Account Code

9.2.1 Main [2-1]—Account Code Mode

Feature Manual References

1.1.2 Account Code Entry

1.1.112 Station Message Detail Recording (SMDR)

1.1.117 Toll Restriction (TRS)

1.1.122 Walking COS

Operating Manual References

1.3.86 Toll Restriction (TRS) Override by Account Code

2.1.7 System Feature Assignment—Extension Password Set

1.1.119 Two-way Recording into the VPS (Voice Mail APT Integration only)

Description

Proprietary telephone (PT) users can record their own telephone conversations. These recordings can be stored in the PT user's own mailbox (**2-way Record**) or in another user's mailbox (**2-way Transfer**), depending on which button the user presses to begin recording.

This feature is available when the PBX is connected to a Panasonic Voice Processing System (VPS) that supports APT integration.

Note

You should inform the other party that the conversation will be recorded before beginning to record any telephone conversation.

Conditions

- **2-way Record/2-way Transfer Button**
A flexible CO/DSS button can be customized as a 2-way Record or 2-way Transfer button.
- If all ports of the VPS are busy when a user tries to record a conversation:
 - The user hears an alarm tone when pressing the 2-way Record button.

- The user hears an alarm tone after pressing the 2-way Transfer button followed by an extension number.

Feature Manual References

- 1.1.61 Flexible Buttons
- 1.1.120 Voice Mail APT Integration

Operating Manual References

- 1.3.87 Two-way Recording in the VPS (Voice Mail APT Integration only)
- 3.1.3 Flexible Button Assignment—2-way Record or 2-way Transfer button

1.1.120 Voice Mail APT Integration

Description

A Panasonic Voice Processing System (VPS) that supports APT Integration can provide many features and conveniences that are unachievable using traditional voice mail systems that rely on Inband (DTMF) Integration.

Many of these features are explained below. For more information, refer to the Installation Manual supplied with the Panasonic VPS.

1. Automatic Configuration—Quick Setup (or DIP switch initialization without a PC)

The PBX shares information with the VPS during setup that allows the VPS to automatically create the appropriate mailboxes for all extension numbers.

The following settings to enable APT Integration must be programmed through system programming to match the settings of the VPS.

When 2 VPSs are connected to the PBX, note that each extension can have only one mailbox, but when the VPSs have executed Automatic Configuration, an extension has a mailbox in both VPSs. Therefore, an extension user must delete a mailbox in either VPS so that there are no duplicates.

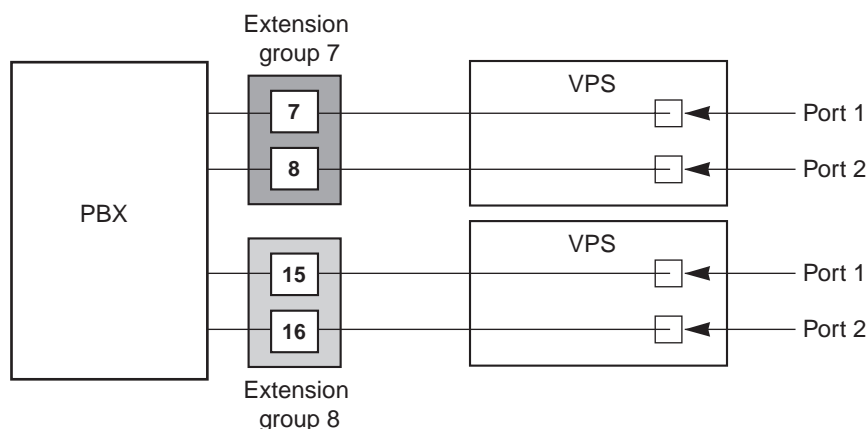

This example uses a Panasonic KX-TVS50 series VPS/KX-TVA50 series VPS, which can be connected with 4-conductor wire to 4 extension jacks of the PBX.

[Programming Example: Voice Mail Table]

| APT Integration | VM 1 APT Port*1 | VM 2 APT Port*2 |
|-----------------|-----------------|-----------------|
| Enable | Port 7 & 8 | Port 15 & 16 |

*1 → [130] VM 1 APT Port

*2 → [131] VM 2 APT Port

In this example:

When "Port 7 & 8" is selected for VPS1, extension jacks 07 and 08 are placed in extension group 7 automatically (→ [600] Extension Group). Likewise, when "Port 15 & 16" is selected for VPS2, extension jacks 15 and 16 are placed in extension group 8 automatically. Each extension group can be connected to only one VPS. Also the idle extension hunting type is set as "Circular Hunting" (→ [101] Hunting Type), and the Voice Mail (VM) Hunting Chain and Automated Attendant (AA) Hunting Chain are automatically enabled in each of these 2 extension groups (→ [100] Hunting Group Set).

Note

When "Disable" is selected, the other settings above are reset to their default values.

2. AA Service

Allows the VPS to answer calls and direct callers to dial a number in order to connect themselves to the desired party (e.g., "Enter the extension number of the desired party.").

It is possible to access VM service from AA service to, for example, record messages.

3. VM Service

Allows callers to leave voice messages for specific parties, such as an extension user. Extension users can then listen to the messages left in their mailboxes at their convenience.

AA Service

A VPS can be used for the AA service as well as the VM service. When a call is directed to a port of the VPS that is in AA service mode, the caller will hear an outgoing message (OGM). After or while listening to the OGM, the caller may dial an extension number as directed (e.g., "Enter the extension number of the desired party.").

1. AA to Extension

AA receives and answers outside (CO) line calls and offers services such as transferring to an extension or mailbox using DTMF signaling from the calling party.

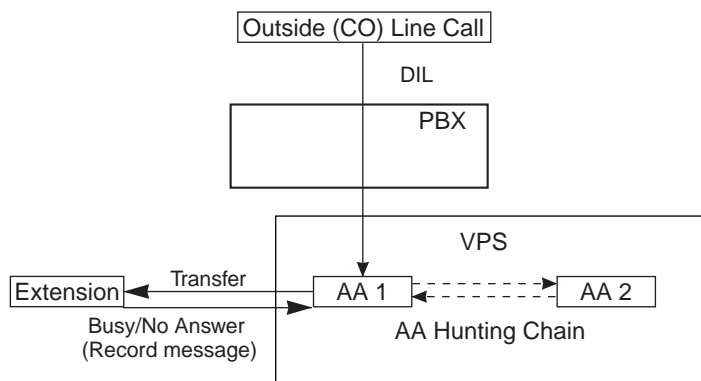

2. Extension Backup

If the VPS is assigned to ring with other extensions, for example the operator, for the same outside (CO) line, the VPS can be used as a backup for the operator when the operator cannot answer an incoming outside (CO) line call.

In order to use this feature, Delayed Ringing must be set for the VPS (→ [411-413] Delayed Ringing—Day/Night/Lunch).

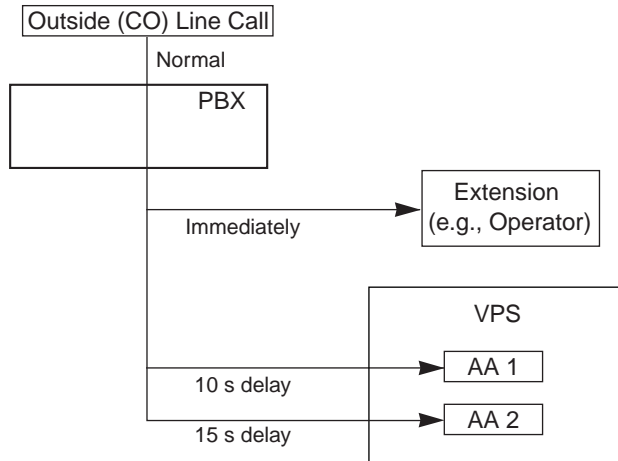

3. Status Notification to the VPS

When a call is redirected to the VPS, the PBX sends the status of the called extension to the VPS. This allows the VPS to appropriately handle the call, playing the appropriate OGM for the caller. For example, if the called extension is in Do Not Disturb (DND) mode, the OGM (e.g., "I am unable to answer your call right now, but I will get back to you shortly.") can be played.

VM Service

1. Accessing a Mailbox

The PBX sends special messages to the VPS to indicate which mailbox should be accessed (**Follow-on ID**).

2. FWD to a Mailbox of the VPS

An extension user can set his or her calls to be forwarded to the VPS (→ 1.1.10 Call Forwarding (FWD)—SUMMARY). When a call is received at the extension, the PBX sends the extension's mailbox number to the VPS, and the VPS answers the call with the appropriate OGM (e.g., "Hi, I'm out of the office today...").

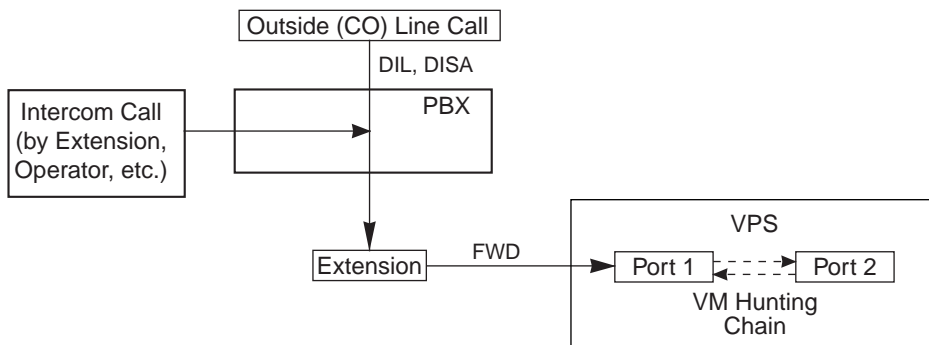

3. Intercept Routing to a Mailbox of the VPS

Outside (CO) line calls via DISA (→ 1.1.41 Direct Inward System Access (DISA)) can be programmed to be automatically redirected to an extension user's mailbox when the extension user does not or cannot answer them (→ 1.1.68 Intercept Routing). The VPS can answer the call with an OGM (e.g., "I can't take your call now...") and callers can leave messages in the mailbox. In order to use this feature, a voice mail extension number must be assigned as the intercept destination for the original destination extension that received the call (→ [414-416] CO Line Mode—Day/Night/Lunch, [408-410] Flexible Ringing—Day/Night/Lunch, [411-413] Delayed Ringing—Day/Night/Lunch), and "Intercept" must be selected through system programming (→ [507] DISA Intercept Mode).

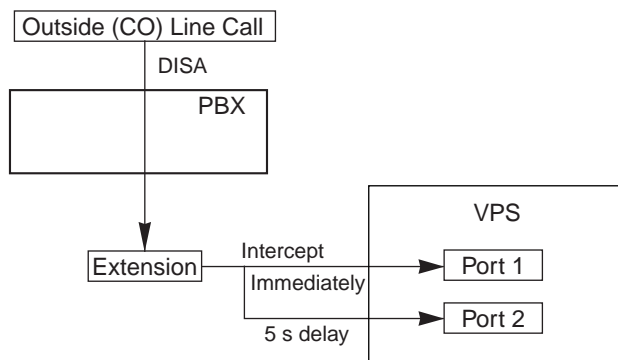

4. Transferring to a Mailbox of the VPS

Extension users can transfer calls to a mailbox, after which callers can leave a message for the desired party. While answering a call, the extension user simply presses the VM Transfer button and enters the extension number of the party the caller wishes to leave a message for. The VPS will answer the transferred call and record a message into the appropriate mailbox.

VM Transfer Button

In order to use this feature, the extension user must use a flexible CO/Direct Station Selection (DSS) button customized as a VM Transfer button. A voice mail extension number must be assigned to the button when creating it.

5. Listening to Recorded Messages

After the VPS records a message, it will light the appropriate lamp or button on the extension for which the message was intended, to indicate that there is a new message (→ 1.1.82 Message Waiting). The proprietary telephone (PT) user can play the message back simply by pressing the MESSAGE button used for mailbox access; he or she does not need to enter a mailbox number. A single line telephone (SLT) user hears a special dial tone (dial tone 3) when going off-hook if there are any messages in his or her mailbox, and can play the message back by entering the Message Waiting Answer feature number.

6. Live Call Screening (LCS)

Similar to a conventional home answering machine, LCS allows a PT user to monitor his or her own mailbox as a caller is leaving a message and, if desired, answer the call simply by pressing the LCS button.

PT users can choose one of 2 ways to perform LCS, through personal programming (Live Call Screening [LCS] Mode Set):

Hands-free mode: The user can screen calls automatically through the built-in speaker.

Private mode: The user will hear an alert tone when a message is being recorded in his or her mailbox. To screen calls, the user must press the MONITOR, SP-PHONE, or LCS button.

LCS/LCS Cancel Button

A flexible CO/DSS button can be customized as an LCS or LCS Cancel button.

7. Two-way Recording into the VPS

PT users can record their own telephone conversations. These recordings can be stored in the PT user's own mailbox (**2-way Record**) or in another user's mailbox (**2-way Transfer**), depending on which button the user presses to begin recording.

2-way Record/2-way Transfer Button

A flexible CO/DSS button can be customized as a 2-way Record or 2-way Transfer button.

Note

You should inform the other party that the conversation will be recorded before beginning to record any telephone conversation.

Conditions

- A VPS can be assigned as the destination for the following features:
 - FWD—All Calls
 - FWD—Busy/No Answer
 - DISA Intercept Routing—No Answer (IRNA)

For these features, the caller does not need to know the mailbox number of the called extension because the code is automatically transmitted to the VPS. If a DISA call is forwarded to the VPS by the IRNA feature from a DISA ring group, the PBX will send the VPS the mailbox number of the extension within the DISA ring group that is connected to the lowest-numbered jack.

Programming Manual References

[PT Programming]

[009] Extension Number

[100] Hunting Group Set

[101] Hunting Type

[130] VM 1 APT Port

[131] VM 2 APT Port

[408-410] Flexible Ringing—Day/Night/Lunch

[411-413] Delayed Ringing—Day/Night/Lunch

[414-416] CO Line Mode—Day/Night/Lunch

[507] DISA Intercept Mode

[600] Extension Group

[PC Programming]

9.1.2 Main [1-2]—Voice Mail

9.1.3 Numbering Plan [1-3]—Ext. no.

9.2.2 Feature settings [2-2]—FWD/DND

9.2.11 Extension Group [2-6]

9.3.1 Line Mode [3-1]—Mode of incoming CO calls—Day, Night, Lunch

9.3.2 Incoming / Outgoing [3-2]—Ring for incoming CO calls—Day, Night, Lunch

9.6.3 Settings [6-2]—Mode—DISA Intercept Mode

Feature Manual References

- 1.1.10 Call Forwarding (FWD)—SUMMARY
- 1.1.41 Direct Inward System Access (DISA)
- 1.1.59 Fixed Buttons
- 1.1.61 Flexible Buttons
- 1.1.67 Idle Extension Hunting
- 1.1.68 Intercept Routing
- 1.1.77 Live Call Screening (LCS) (Voice Mail APT Integration only)
- 1.1.82 Message Waiting
- 1.1.119 Two-way Recording into the VPS (Voice Mail APT Integration only)

Operating Manual References

- 1.3.56 Live Call Screening (LCS) (Voice Mail APT Integration only)
- 1.3.87 Two-way Recording in the VPS (Voice Mail APT Integration only)
- 1.3.88 Voice Mail Integration
- 1.3.89 Voice Mail Transfer (Voice Mail APT Integration only)
- 3.1.3 Flexible Button Assignment—Message, 2-way Record, 2-way Transfer, Live Call Screening (LCS), LCS Cancel, or Voice Mail (VM) Transfer button

1.1.121 Voice Mail Inband (DTMF) Integration

Description

A Panasonic Voice Processing System (VPS) or similar product from another manufacturer can provide Automated Attendant (AA) and Voice Mail (VM) services when connected to the PBX. The VPS and PBX communicate with each other by sending DTMF (Dual Tone Multi-Frequency) signals. For more information, refer to the documentation provided with the VPS.

1. AA Service

Allows the VPS to answer calls and direct callers to dial a number in order to connect themselves to the desired party (e.g., "Enter the extension number of the desired party."). It is possible to access VM service from AA service to, for example, record messages.

2. VM Service

Allows callers to leave voice messages for specific parties, such as an extension user. Extension users can then listen to the messages left in their mailboxes at their convenience.

AA Service

A VPS can be used for the AA service as well as the VM service. When a call is directed to a port of the VPS that is in AA service mode, the caller will hear an outgoing message (OGM). After or while listening to the OGM, the caller may dial an extension number as directed (e.g., "Enter the extension number of the desired party.").

If the VPS transfers a call via the AA service, the PBX will inform the VPS of the status of the called party using a DTMF status signal so that the VPS will know the status. This enables the VPS to quickly play an appropriate OGM to the caller (e.g., "I'm handling another call now...", "I'm away from my desk now...", etc.). The DTMF status signals sent by the PBX are explained below.

[DTMF Status Signals]

| Status | Condition | DTMF Status Signal |
|--------------------------------|--|--------------------|
| Ringback Tone | The PBX is ringing the corresponding extension. | 1 |
| Busy Tone | The called extension is busy. | 2 |
| Reorder Tone | The dialed number is invalid. | 3 |
| DND Tone | The called extension has set DND (→ 1.1.44 Do Not Disturb (DND)). | 4 |
| Answer | The called extension has answered the call. | 5 |
| Confirm | The PBX confirms that a feature (such as Message Waiting) has been set or canceled on the extension. | 9 |
| Disconnect | The caller has hung up. | #9 |
| FWD to VM Ringback Tone | The called extension has set FWD to VPS (→ 1.1.10 Call Forwarding (FWD)—SUMMARY) and the PBX is calling another port of the VPS. | 6 |
| FWD to VM Busy Tone | The called extension has set FWD to VPS and all ports of the VPS are busy. | 7 |
| FWD to Extension Ringback Tone | The PBX is calling an extension other than the one dialed, most likely because the called extension has set its calls to be forwarded to another extension or because it is a member of an idle extension hunting group (→ 1.1.67 Idle Extension Hunting). | 8 |

System Programming

The following settings to enable Inband (DTMF) Integration must be programmed through system programming to match the settings of the VPS. This example uses a Panasonic KX-TVS series VPS/KX-TVA series VPS, which can be connected to up to 4 extension jacks of the PBX.

[Programming Example: Voice Mail Table]

| DTMF Integration*1 | Voice Mail Port*2 | | | |
|--------------------|-------------------|---------|---------|---------|
| | Jack 07 | Jack 08 | Jack 15 | Jack 16 |
| Enable | Enable | Enable | Disable | Disable |

*1 → [103] DTMF Integration

*2 → [102] DTMF Integration Port

In this example:

To enable the VM Hunting Chain and AA Hunting Chain, program as follows:

- 1) Assign all Voice Mail extensions to one extension group in [600] Extension Group.
- 2) Assign "Enable" to the group in [100] Hunting Group Set.

- 3) Select the hunting type of the group in [101] Hunting Type.

VM Service

1. Accessing a Mailbox

The PBX sends DTMF signals to the VPS to indicate which mailbox should be accessed (**Follow-on ID**).

2. Listening to Recorded Messages

After the VPS records a message, it will light the appropriate lamp or button on the extension for which the message was intended, to indicate that there is a new message (→ 1.1.82 Message Waiting). The proprietary telephone (PT) user can play the message back simply by pressing the MESSAGE button used for mailbox access. When the button is pressed, the PBX calls the voice mail extension, then sends DTMF signals to the VPS to indicate the extension's mailbox number.

A single line telephone (SLT) user hears a special dial tone (dial tone 3) when going off-hook if there are any messages in his or her mailbox, and can play the message back by entering the Message Waiting Answer feature number.

Conditions

- A VPS can be assigned as the destination for the following features:
 - FWD—All Calls
 - FWD—Busy/No Answer
 - DISA Intercept Routing—No Answer (IRNA) (→ 1.1.68 Intercept Routing, 1.1.41 Direct Inward System Access (DISA))

For these features, the caller does not need to know the mailbox number of the called extension because the code is automatically transmitted to the VPS. If a DISA call is transferred to the VPS by IRNA from a DISA ring group, the PBX will transmit the mailbox number of the receiving extension with the lowest jack number.

- In order to achieve proper recording quality, Data Line Security should be turned on for the VPS (→ 1.1.37 Data Line Security).
- Each extension's mailbox number is the same as its extension number.
- If "TA series" cannot be selected with the PBX type setup menu of the KX-TVS series VPS/KX-TVA series VPS, select "KX-T1232". Follow the steps for the KX-T1232.

Programming Manual References

[PT Programming]

- [009] Extension Number
- [100] Hunting Group Set
- [101] Hunting Type
- [102] DTMF Integration Port
- [103] DTMF Integration
- [408-410] Flexible Ringing—Day/Night/Lunch
- [411-413] Delayed Ringing—Day/Night/Lunch
- [414-416] CO Line Mode—Day/Night/Lunch
- [507] DISA Intercept Mode
- [600] Extension Group

[PC Programming]

9.1.2 Main [1-2]—Voice Mail

9.1.3 Numbering Plan [1-3]—Ext. no.

9.2.2 Feature settings [2-2]—FWD/DND, Voice Mail Integration

9.2.11 Extension Group [2-6]

9.3.1 Line Mode [3-1]—Mode of incoming CO calls—Day, Night, Lunch

9.3.2 Incoming / Outgoing [3-2]—Ringing for incoming CO calls—Day, Night, Lunch

9.6.3 Settings [6-2]—Mode—DISA Intercept Mode

Feature Manual References

1.1.10 Call Forwarding (FWD)—SUMMARY

1.1.37 Data Line Security

1.1.41 Direct Inward System Access (DISA)

1.1.44 Do Not Disturb (DND)

1.1.59 Fixed Buttons

1.1.61 Flexible Buttons

1.1.67 Idle Extension Hunting

1.1.68 Intercept Routing

1.1.82 Message Waiting

Operating Manual References

1.3.88 Voice Mail Integration

3.1.3 Flexible Button Assignment—Message button

1.1.122 Walking COS

Description

Extension users can temporarily assign their own class of service (COS) to another extension, allowing them to make calls as if from their own telephones.

This feature is useful when a manager or supervisor needs to borrow another employee's telephone to make a call. The superior enters the extension password followed by the Walking COS feature number and his or her extension number, and then makes the call. The same privileges and restrictions normally applied to a user are applied when using Walking COS.

Conditions

- When making a call with Walking COS, the extension number of the Walking COS user's extension is also logged by SMDR (→ 1.1.112 Station Message Detail Recording (SMDR)).

Programming Manual References

[PT Programming]

[601-603] TRS-COS—Day/Night/Lunch

[PC Programming]

9.5.1 Class of Service (COS) [5-1]—Day, Night, Lunch

Feature Manual References

1.1.32 Class of Service (COS)

1.1.112 Station Message Detail Recording (SMDR)

Operating Manual References

1.3.90 Walking COS

2.1.7 System Feature Assignment—Extension Password Set

Section 2

Appendix

2.1 Capacity of System Resources

2.1.1 Capacity of System Resources

| Category | Item | KX-TA824 |
|-------------------------------|--|--|
| System | Outside (CO) Line Group | 8 |
| | Extension Group | 8 |
| | Absent Message | 6 × 16 characters |
| | Message Waiting | 8/extn. |
| | Number of Characters of Name | 10 |
| | Extension Number Digits | 3 |
| | Call Park Zone | 10 |
| | Account Code | 4 digits, 50 entries |
| | Host PBX Access Code | 1 or 2 digits, 8 entries |
| | Station Message Detail Recording (SMDR) | 64 calls |
| | Intercom Call | 4 |
| | Outgoing Message (OGM) for DISA | 32 resources/PBX (8 resources for Direct Inward System Access [DISA], 24 resources for 3-level Automated Attendant [AA]) |
| Dialing | Emergency Call | 24 digits, 5 entries |
| | System Speed Dialing | 32 digits, 100 entries |
| | Personal Speed Dialing | 24 digits, 10 entries/extn. |
| | One-touch Dialing | 24 digits |
| | Hot Line | 32 digits |
| | Redial, Last Number/Redial, Saved Number | 64 digits |
| Toll Restriction (TRS) | Class of Service (COS) | 5 |
| | Denied Code Table | 11 digits, 80 entries |
| | Exception Code Table | 11 digits, 80 entries |
| Call Log | Call Log, Incoming | 20 entries/extn., 300 entries/PBX |
| | | 125 voice messages/Built-in Voice Message (BV) resource |

| Category | Item | KX-TA824 |
|----------|---------------------------|-------------|
| Password | System Password | 4–7 digits |
| | Extension Password | 4 digits |
| | Voice Message Access Code | 4–10 digits |

2.2 Tones/Ring Tones

2.2.1 Tones/Ring Tones

Tone Patterns

Dial Tone 1

Normal



Dial Tone 2

Any of the following features is set:

- Absent Message
- Background Music (BGM) (proprietary telephone [PT] only)
- Call Forwarding (FWD)
- Call Pickup Deny
- Data Line Security
- Do Not Disturb (DND)
- Extension Lock
- Hot Line (single line telephone [SLT] only)
- Message Waiting (PT only)
- Remote Extension Lock
- Timed Reminder

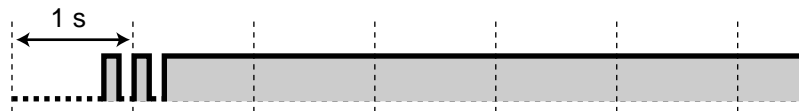

Dial Tone 3

- When going off-hook with an SLT that has messages waiting
- When Account Code Entry is performed
- When answering a call from Timed Reminder



Dial Tone 4

A new voice message has been recorded (Built-in Voice Message [BV]).

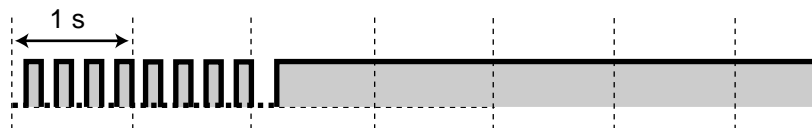

Dial Tone 5

The remaining voice message recording time is less than 5 minutes or 125 voice messages have been recorded (Built-in Voice Message [BV]).

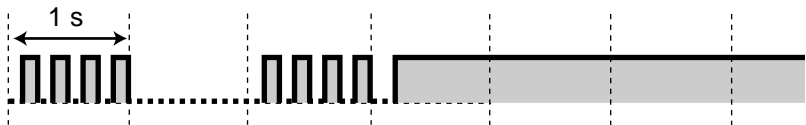

Busy Tone



Reorder Tone

The outside (CO) line you tried to seize is not assigned or was denied.

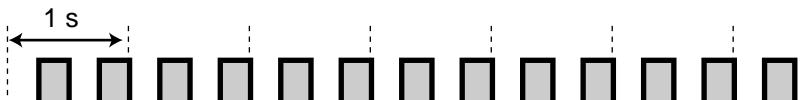

Ringback Tones

Single (3-s interval)



Double (3-s interval)

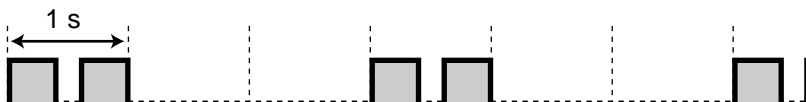

Single (5-s interval)



Double (5-s interval)



DND Tone

The dialed extension is refusing incoming calls.



Call Waiting Tone 1

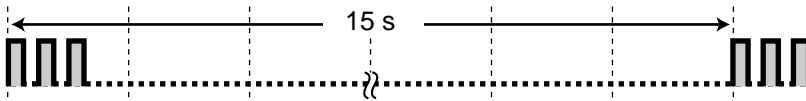

Call Waiting Tone 2

Single



Double



Triple

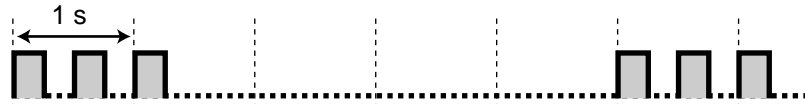

Hold Alarm Tone

A call has been on hold for longer than the specified time.

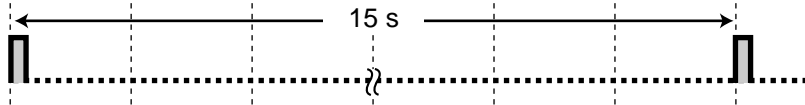

Warning Tone (Outside (CO) Line Call Limitation)

This tone is sent 15 seconds before the specified time for disconnection.

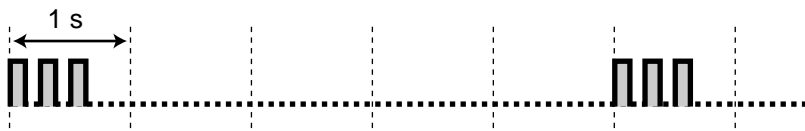

Confirmation Tone 1

The feature was set successfully, or the Extension Lock feature was set or canceled.



Confirmation Tone 2

The new feature setting was the same as the previous setting, or certain features were successfully performed or accessed (e.g., Call Hold, Automatic Callback Busy).



Confirmation Tone 3

Before the following features activate:

- Retrieving a held call
- Picking up another call
- Establishing a conference call
- Paging/Answering a paging announcement

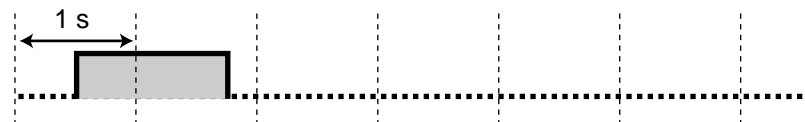

Ring Tone Patterns

Ring Tone Patterns

The following ring tone patterns can be assigned to incoming call types (outside (CO) line, intercom, or doorphone calls), or are fixed for certain call types (Hold Recall, Timed Reminder, or Camp-on Recall).

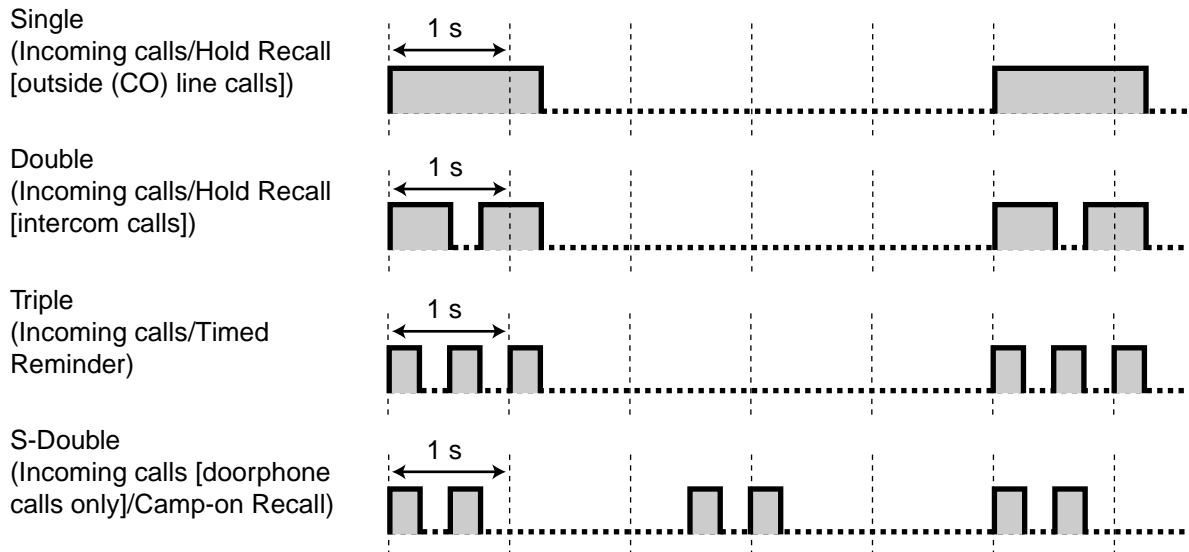

Doorphone Chime Patterns

The following doorphone chime patterns can be assigned to each doorphone when doorbells and door chimes are connected to the PBX.

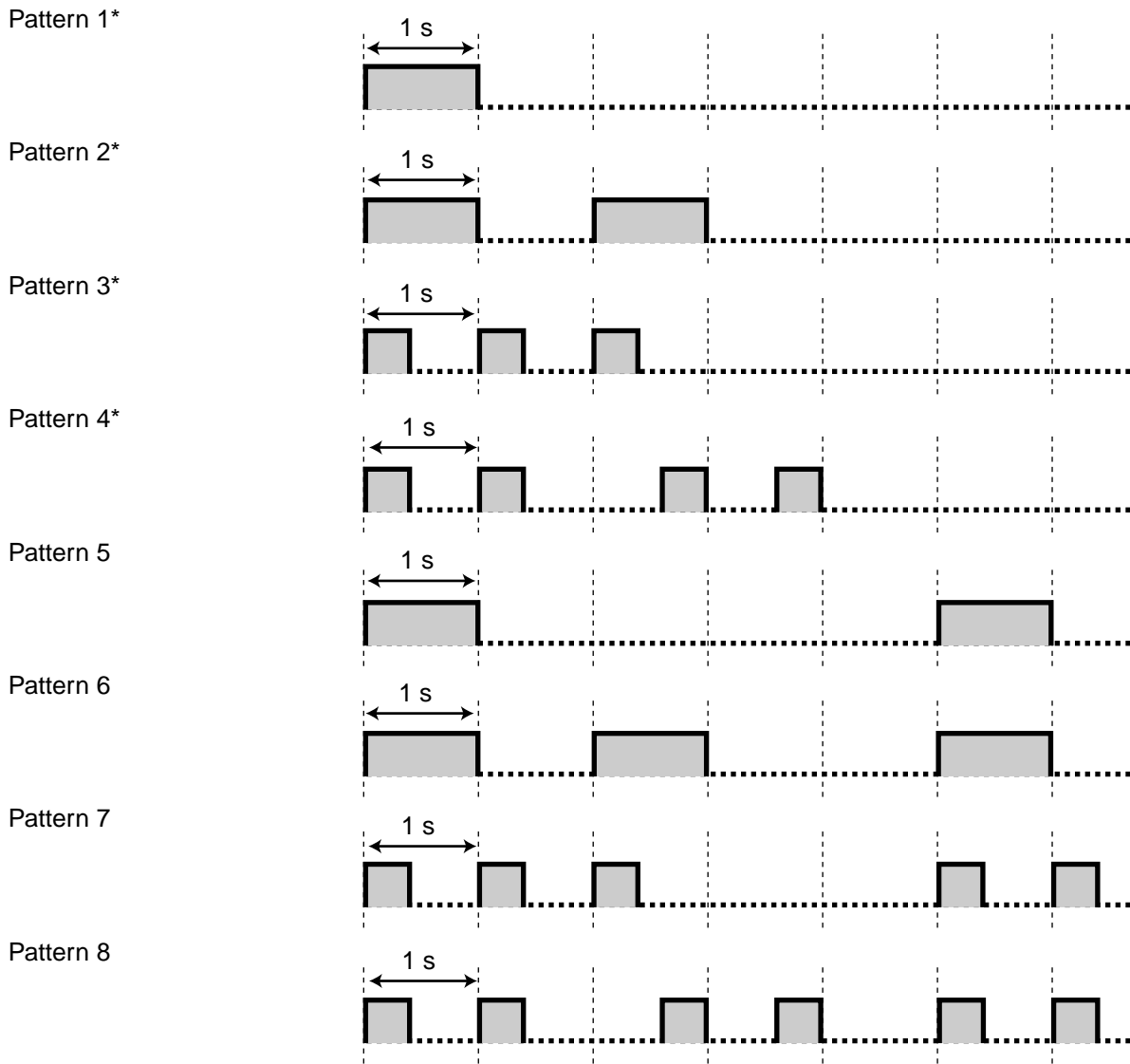

* Chime patterns 1 to 4 are played only one time during the doorphone ringing time.

Index

Numerics

3-level Automated Attendant (AA) 118

A

Absent Message 10
 Account Code Entry 10
 Alternate Calling—Ring/Voice 95
 Alternate Receiving—Ring/Voice 95
 Answering, Direct Outside (CO) Line 12
 Appendix 165
 Automatic Callback Busy (Camp-on) 12
 Automatic Configuration for Outside (CO) Line Type 13
 Automatic Time Adjustment 14

B

Background Music (BGM) 14
 BGM → Background Music (BGM) 14
 Built-in Voice Message (BV) 15
 Busy Station Signaling (BSS) 21
 Busy Tone 169
 BV → Built-in Voice Message (BV) 15

C

Call Forwarding (FWD)—All Calls 23
 Call Forwarding (FWD)—Busy/No Answer 24
 Call Forwarding (FWD)—Follow Me 26
 Call Forwarding (FWD)—SUMMARY 21
 Call Forwarding (FWD)—To Outside (CO) Line 27
 Call Hold 28
 Call Hold Retrieve 30
 Call Hold, Exclusive 30
 Call Log, Incoming 31
 Call Park 34
 Call Park Recall 34
 Call Pickup Deny 36
 Call Pickup, Directed 35
 Call Pickup, Group 36
 Call Retrieving from a TAM (Telephone Answering Machine) 37
 Call Splitting 37
 Call Transfer with Announcement 38, 39
 Call Transfer without Announcement 38
 Call Transfer—Screened → Call Transfer with Announcement 38, 39
 Call Transfer—To Extension 38
 Call Transfer—To Outside (CO) Line 39
 Call Transfer—Unscreened → Call Transfer without Announcement 38
 Call Waiting 40
 Call Waiting Caller ID 41
 Call Waiting from the Telephone Company 42
 Caller ID 43
 Caller ID Display on SLT 43
 Calling Party Control (CPC) Signal Detection 47
 Capacity of System Resources 166
 Circular Hunting 93
 Class of Service (COS) 48
 Common BV OGM 15
 Conference 49
 Conference, Unattended 50
 Confirmation Tone 51

Consultation Hold 52
 COS → Class of Service (COS) 48
 CPC → Calling Party Control (CPC) Signal Detection 47

D

Data Line Security 52
 Denied Code Tables 147
 Dial Tone 52
 Dial Type Selection 53
 DIL → Direct In Line (DIL) 54
 Direct In Line (DIL) 54
 Direct Inward System Access (DISA) 56
 Direct Inward System Access (DISA) Ring 64
 Direct Message feature 18
 DISA → Direct Inward System Access (DISA) 56, 64
 DISA AA Service 56
 Display Information 65
 DND Tone 169
 Do Not Disturb (DND) 67
 Do Not Disturb (DND) Override 68
 Door Open 68
 Doorbell/Door Chime 69
 Doorphone Call 71
 Doorphone Chime Patterns 172

E

EFA → External Feature Access (EFA) 78
 Electronic Station Lockout → Extension Lock 77
 Emergency Call 72
 Exception Code Tables 148
 Executive Busy Override—Extension 73
 Executive Busy Override—Outside (CO) Line 74
 Extension Feature Clear 75
 Extension Group 75
 Extension Jack Configuration 77
 Extension Lock 77
 Extension Lock—CANCEL ALL 78, 133
 External Feature Access (EFA) 78

F

Feature Highlights 4
 Feature Manual References 2
 Feature Numbering 79
 Firmware Upgrade 83
 Fixed Buttons 84
 Flash/Recall 86
 Flexible Buttons 87

G

General Features 9, 10

H

Handset/Headset Selection → Headset Operation 90
 Hands-free Answerback 89
 Hands-free Operation 90
 Headset Operation 90
 Hold Recall 28, 30
 Host PBX Access Code (Access Code to the Telephone Company from a

Host PBX) 91
Hot Line 92

I

Idle Extension Hunting 93
Idle Line Preference 104
Incoming Call Log Display Lock 33
Installation Manual References 2
Intercept Routing 94
Intercept Routing—No Answer (IRNA) 94
Intercept Routing—No Dial 94
Intercom Call 95
IRNA → Intercept Routing—No Answer (IRNA) 94

L

LED Indication 96
Line Access, Automatic 100
Line Access, Direct Outside (CO) Line 99
Line Access, Outside (CO) Line Group 101
Line Access, Outside (CO) Line—SUMMARY 98
Line Access, S-CO Line 102
Line Preference Override 105
Line Preference—Incoming 103
Line Preference—Outgoing 104
Live Call Screening (LCS) (Voice Mail APT Integration only) 105
Local Carrier-based Voice Mail Service 106
Lockout 108
Log-in/Log-out 108

M

Memory Dialing 109
Message Waiting 111
Message Waiting for Another Extension 112
Message Waiting for Another Extension Lock 113
Microphone Mute 114
Music on Hold 114

N

No Line Preference 103, 104

O

One-touch Dialing 115
One-touch Transfer 38
Operating Manual References 2
Operator Call 117
Operator/Manager Features 116
Outgoing Message (OGM) for DISA 118
Outside (CO) Line Group 119
Outside (CO) Line Ringing Selection 120
Outside-to-Outside (CO-to-CO) Line Call Duration 120

P

Paging Deny 121
Paging—All Extensions 122
Paging—All Extensions & External 122
Paging—External 123
Paging—Group 124
Paging—SUMMARY 121

Paralleled Telephone 124
Pause Insertion 125
PC Programming 126
Personal BV OGM 15
Personal Speed Dialing 128
Pickup Dialing → Hot Line 92
Power Failure Connections 129
Power Failure Restart 129
Power Failure Transfer 129
Prime Line Preference 103, 104
Programming Manual References 2
PT Programming 130
Pulse to Tone Conversion 131

R

Redial, Last Number 132
Redial, Saved Number 132
Remote Extension Lock 133
Remote Station Lock Control → Remote Extension Lock 133
Reorder Tone 169
Ring Tone Pattern Selection 134
Ring Tone Patterns 171
Ringback Tones 169
Ringing Line Preference 103
Ringing, Delayed 135
Room Monitor 136

S

Secret Dialing 137
SMDR → Station Message Detail Recording (SMDR) 137
Station Feature Clear → Extension Feature Clear 75
Station Hunting → Idle Extension Hunting 93
Station Message Detail Recording (SMDR) 137
Station Program Clear → Extension Feature Clear 75
Station Speed Dialing → Personal Speed Dialing 128
System Speed Dialing 142

T

Terminated Hunting 93
Time Service 143
Timed Reminder 146
Timed Reminder, Remote 147
Toll Restriction (TRS) 147
Toll Restriction (TRS) Override by Account Code 151
Tones/Ring Tones 168
Transfer Recall 38
TRS → Toll Restriction (TRS) Features 147
TRS for System Speed Dialing 148
TRS—Extension Lock Class 78, 133, 150
Two-way Recording into the VPS (Voice Mail APT Integration only) 153

U

Unattended Conference Recall 50

V

Visual Caller ID → Call Waiting Caller ID 41
Voice Mail APT Integration 154
Voice Mail Inband (DTMF) Integration 159

Index

W

Walking COS 162
Warning Tone (Outside (CO) Line Call Limitation) 170
Wireless PTs 4

DUbUgcb]WHY`Yd\cbY`GngHYa g



See More
Panasonic Manuals



www.voicesonic.com
Phone: 877-289-2829

Copyright:

This material is copyrighted by Panasonic Communications Co., Ltd., and may be reproduced for internal use only. All other reproduction, in whole or in part, is prohibited without the written consent of Panasonic Communications Co., Ltd.

© 2005 Panasonic Communications Co., Ltd. All Rights Reserved.