

# Panasonic<sup>®</sup>

## Owner's Manual for advanced features

Digital Camera

Model No. **DC-G9**



# LUMIX

Please read these instructions carefully before using this product,  
and save this manual for future use.

**Message Display**

**P321**

**Troubleshooting**

**P323**

**Finding the information you need**

**P2**

**Contents**

**P4**

**Contents by Function**

**P10**

**Menu list**

**P184**

Register online at <http://shop.panasonic.com/support>  
(U.S. customers only)

DVQP1402ZA



F1217HN0



# Finding the information you need

In this “Owner’s Manual for advanced features”, you can find the information you need from the following pages.

By clicking a page number, you can jump to the linked page and quickly find the information.

	<b>Search from “Contents”</b>	<b>P4</b>
	<b>Search from the list of function names</b>	<b>P10</b>
	<b>Search from the list of buttons and dials</b>	<b>P16</b>
	<b>Search from the list of screens and icons</b>	<b>P313</b>
	<b>Search from “Message Display”</b>	<b>P321</b>
	<b>Search from “Menu list”</b>	<b>P184</b>
	<b>Search from “Troubleshooting”</b>	<b>P323</b>



1

Click this icon to jump to “Finding the information you need”.



4

Click this icon to return to the previously displayed page.

# How to use this manual

## About the indication of the applicable mode

**Applicable modes:**  

The icons indicate the modes available for a function.

- Black icons: Applicable modes
- Gray icons: Unavailable modes

**C1**, **C2** and **C3** will differ depending on the Recording Modes registered under custom settings.

## About the symbols in the text



**MENU**: Indicates that the menu can be set by pressing [MENU/SET] button.



**Wi-Fi**: Indicates that the Wi-Fi setting can be made by pressing [Wi-Fi] button.

: Tips for skillful use and points for recording.

: Conditions in which a particular function cannot be used.

- Click a cross reference in the text to jump to the corresponding page.

In this owner's manual, steps for setting a menu item are described as follows.  
Example: In the [Rec] menu, change [Quality] from  to .

**MENU** →  **[Rec]** → **[Quality]** → 

- Description in this owner's manual is based on the interchangeable lens (H-ES12060).

# Contents

Finding the information you need .....	2
How to use this manual .....	3
Contents by Function .....	10

## 1. Before Use

Care of the camera .....	13
Standard Accessories .....	15
Names and Functions of Components .....	16
About the Lens .....	19

## 2. Getting Started/Basic Operations

Attaching the Shoulder Strap .....	20
Charging the Battery .....	21
• Charging the battery with the charger .....	21
• Inserting/Removing the Battery .....	23
• Charging the battery with the camera .....	24
• Approximate operating time and number of recordable pictures .....	27
Inserting/Removing the Card (Optional) .....	29
Card Information .....	30
• Formatting the card (initialization) .....	31
• Approximate number of recordable pictures and available recording time .....	31
Attaching/Removing the Lens .....	33
Opening the Monitor .....	37
Setting Date/Time (Clock Set) .....	38
Basic Operations .....	40
• Tips for taking good pictures .....	40
• Turn on the status LCD backlight .....	40
• Using the Viewfinder .....	41
• Shutter button (Taking pictures) .....	42
• Motion picture button (Recording motion pictures) .....	43
• Mode dial (Selecting a Recording Mode) .....	43
• Front Dial/Rear Dial .....	44
• Control Dial .....	46
• Cursor buttons/[MENU/SET] button .....	47
• Joystick .....	48
• Function lever .....	48
• [DISP.] button (Switching the displayed information) .....	49
• Touch screen (Touch operations) .....	52
• Taking Pictures Using the Touch Function .....	53
Setting menu items .....	55
Calling frequently-used menus instantly (Quick Menu) .....	58
• Customizing the Quick Menu settings .....	59

Assigning Frequently-Used Functions to Buttons/Lever (Function Buttons/Function Lever) .....	60
• Assigning functions to function buttons .....	60
• Using the function buttons during recording .....	61
• Using the function buttons during playback .....	62
• Assigning a function to the function lever .....	63
Entering Text .....	64

### 3. Recording Modes

Taking Pictures using the Automatic Function (Intelligent Auto Mode) .....	65
• [Intelligent Auto] menu .....	68
• Taking pictures with customized color, defocus control, and brightness settings .....	69
Taking Pictures with Automatically Adjusted Aperture and Shutter Speed (Program AE Mode) .....	71
Taking Pictures by Specifying the Aperture/Shutter Speed .....	73
• Aperture-Priority AE Mode .....	74
• Shutter-Priority AE Mode .....	74
• Manual Exposure Mode .....	75
• Confirm the Effects of Aperture and Shutter Speed (Preview Mode) .....	77
• Easily set aperture/shutter speed for suitable exposure (One Push AE) .....	78
Taking Pictures with different image effects (Creative Control Mode) .....	79
• Types of image effects .....	80
Registering your preferred settings (Custom Mode) .....	85
• Registering Personal Menu Settings (Registering custom settings) .....	85
• Calling up a registered set of custom settings .....	86

### 4. Focus, Brightness (Exposure) and Color tone Settings

Adjusting Focus Automatically .....	87
Setting the Focus Mode (AFS/AFF/AFC) .....	89
• Customizing the operation settings of Auto Focus for picture taking .....	90
Setting the Auto Focus Mode .....	92
Specifying the AF area position .....	97
• Specifying the AF area position on the setting screen .....	98
• Specifying the AF area position with the joystick .....	100
• Specifying the AF area position with the Touch Pad .....	101
• Specifying the AF area position with the Touch Function .....	101
Adjusting Focus Manually .....	103
Fixing the Focus and the Exposure (AF/AE Lock) .....	106
Compensating the Exposure .....	107
Setting the Light Sensitivity .....	109
Adjusting the White Balance .....	111
• Finely adjusting the White Balance .....	113

## 5. 6K/4K Photo and Drive Settings

Select a Drive Mode.....	114
Taking Pictures using Burst Mode.....	115
Recording 6K/4K Photos.....	119
• Notes on the 6K/4K Photo function .....	122
Selecting pictures from 6K/4K burst file and saving.....	125
• Correcting 6K/4K Photos After Recording (Post-Recording Refinement) ....	126
• Operations during selecting pictures .....	127
Controlling Focus After Recording (Post Focus/Focus Stacking) .....	130
• Selecting the desired focus area and saving a picture .....	132
• Merging multiple pictures to widen the focus range (Focus Stacking).....	133
Taking Pictures with the Self-timer.....	135
Taking Pictures with Time Lapse Shot/Stop Motion Animation .....	136
• Taking Pictures Automatically at Set Intervals ([Time Lapse Shot]) .....	137
• Creating Stop Motion Pictures ([Stop Motion Animation]) .....	138
• Creating motion pictures from recorded pictures .....	140
Taking Pictures While Adjusting a Setting Automatically (Bracket Recording) .....	141
• Exposure Bracket .....	142
• Aperture Bracket .....	143
• Focus Bracket .....	143
• White Balance Bracket.....	144
• White Balance Bracket (Color Temperature).....	144

## 6. Stabilizer, Zoom and Flash

Image Stabilizer.....	145
• Setting the focal length of a lens .....	147
Taking Pictures with the Zoom .....	149
• Optical zoom .....	149
• Raising the telescopic effect.....	150
• Zooming using touch operations (Touch zoom) .....	154
Taking Pictures with the External Flash (Optional).....	155
Setting the Flash Functions .....	157
• Changing the firing mode .....	157
• Changing Flash Mode .....	158
• Setting to the 2nd Curtain Synchro.....	159
• Adjust the flash output.....	160
• Synchronizing the output of the flash to the Exposure Compensation .....	160
Taking Pictures with Wireless Flashes.....	161
• Using other settings for wireless flash recording.....	163

## 7. Recording Motion Pictures

Recording Motion Picture.....	164
• Setting the format, size and frame rate .....	166
• How to set focus when recording a motion picture ([Continuous AF]) .....	167
• Recording still pictures while recording motion pictures .....	168
• Displaying/setting the sound input level .....	169
• Recording images with superimposed recording dates (Time Stamp Rec) .....	170
Recording Motion Pictures in Creative Video Mode.....	171
• Recording slow motion pictures (High Speed Video) .....	173
• Recording Motion Pictures that Pan and Zoom While Maintaining a Fixed Camera Position ([4K Live Cropping]).....	174

## 8. Playing Back and Editing Images

Playing Back Pictures .....	176
Playing Back Motion Pictures.....	177
• Creating Still Pictures from a Motion Picture .....	178
Switching the Playback Method .....	179
• Using the Playback Zoom .....	179
• Displaying multiple screens (Multi Playback) .....	180
• Displaying Pictures by Recording Date (Calendar Playback) .....	180
Playing Back Group Pictures .....	181
Deleting Pictures .....	183

## 9. Using Menu Functions

Menu list.....	184
• Menus that are only available for particular Recording Modes.....	184
• [Rec] menu .....	185
• [Motion Picture] menu .....	203
• [Custom] menu .....	206
• [Setup] menu .....	220
• [My Menu] menu.....	232
• [Playback] menu.....	233

## 10. Using the Wi-Fi/Bluetooth function

What you can do with the Wi-Fi®/Bluetooth® function .....	250
Wi-Fi function/Bluetooth function .....	251
Connecting to a smartphone/tablet .....	253
• Installing the smartphone/tablet app "Image App" .....	253
• Using a smartphones that supports Bluetooth low energy .....	254
• Using a smartphone that does not support Bluetooth low energy .....	256
• Changing the Wi-Fi connection method .....	258
• Terminating the Wi-Fi connection .....	259
Controlling with a Smartphone/Tablet .....	260



- Turning on/off the camera with a smartphone .....260
- Taking images via a smartphone (remote recording) .....261
- Operating the shutter button with a smartphone via a Bluetooth connection alone .....262
- Playing back/saving images stored on the camera, or uploading them on social media sites .....263
- Transferring recorded images to a smartphone automatically .....264
- Backing up images to a Cloud Storage automatically (Auto Cloud Backup) .....265
- Recording location information to the camera's images .....268
- Synchronizing the camera's clock with a smartphone .....269
- Saving the camera's setup information to a smartphone .....269
- Displaying pictures on a TV .....270
- Sending images .....271
- Sending images to a smartphone/tablet .....273
- Printing Wirelessly .....274
- Sending images to AV device .....275
- Sending images to PC .....276
- Using Web services .....278
  - When sending images to web service .....278
  - When sending images to [Cloud Sync. Service] .....281
  - About the [LUMIX CLUB] .....282
- About Wi-Fi connections .....285
  - Connecting via a wireless access point (via the network) .....286
  - Connecting the camera and another device directly (direct connection) .....288
  - Connecting quickly with the same settings as the previous ones ([Select a destination from History]/[Select a destination from Favorite]) ...289
- [Wi-Fi Setup] Menu .....291

## 11. Connecting to other equipment

- Watching/Saving 4K Motion Pictures on an External Device .....293
  - Watching motion pictures in 4K .....293
  - Storing 4K motion pictures .....293
- Playing Back Pictures on a TV Screen .....294
  - Recording while monitoring camera images .....295
  - Using VIERA Link (HDMI) .....297
- Saving still pictures and motion pictures on your PC .....298
  - Downloading software .....299
  - Transferring images to a PC .....301
- Saving still pictures and motion pictures on a Recorder .....303
- Controlling the Camera from a PC .....304
- Printing the Pictures .....306



## 12. Others

Optional accessories.....	309
Monitor Display/Viewfinder Display.....	313
Status LCD Indications.....	319
Message Display.....	321
Troubleshooting .....	323
Cautions for Use .....	332



MENU



# Contents by Function



## Recording

### Recording

Recording Mode .....	P43
[Preview] .....	P77
[Time Lapse Shot] .....	P137
[Stop Motion Animation] .....	P138
Aperture Bracket .....	P143
Focus Bracket .....	P143
[High Resolution Mode] .....	P196
[Silent Mode] .....	P198
[Multi Exp.] .....	P202

### 6K/4K photo

[6K/4K PHOTO] .....	P119
[Reduce Rolling Shutter] .....	P126
[6K/4K PHOTO Noise Reduction]....	P126
[Post Focus] .....	P130

### Focus (AF/MF)

[Focus Mode] .....	P89
[AF Custom Setting(Photo)] .....	P90
[AF Mode] .....	P92
Adjusting the AF area position .....	P97
Manual Focus .....	P103
[AF/AE Lock] .....	P106
[AF-Point Scope Setting] .....	P94

### Drive

[Drive Mode] .....	P114
[Burst] .....	P115
[Self Timer] .....	P135

### Picture Quality and Color Tone

[Sensitivity] .....	P109
[White Balance] .....	P111
[Picture Size] .....	P186
[Quality] .....	P187
[Photo Style] .....	P188
[Filter Settings] .....	P190
[Color Space] .....	P191
[Highlight Shadow] .....	P192
[i.Dynamic] .....	P193
[i.Resolution] .....	P193
[Long Shtr NR] .....	P195
[Shading Comp.] .....	P195
[Diffraction Compensation] .....	P196
[HDR] .....	P201

### Exposure

[Touch AE] .....	P54
[One Push AE] .....	P78
[AF/AE Lock] .....	P106
Exposure Compensation .....	P107
Exposure Bracket .....	P142
[Metering Mode] .....	P192

### Stabilizer

Dual I.S. ....	P145
5-Axis Hybrid Image Stabilizer .....	P146

### Flash

[Flash Mode] .....	P158
2nd curtain synchro .....	P159
[Flash Adjust.] .....	P160
Wireless flash settings .....	P161



## Motion Picture

### Motion Picture

[Rec Quality] .....	P166
Recording still pictures while recording motion pictures .....	P168

### Creative Video Mode

[High Speed Video] .....	P173
[4K Live Cropping] .....	P174

### Audio

[Mic Level Adj.] .....	P169
[Mic Level Limiter] .....	P169
[Wind Cut] .....	P312

[Wind Noise Canceller] .....	P204
[Lens Noise Cut] .....	P204

### Monitoring

[Sound Output] .....	P205
----------------------	------

### Screen settings

[Mic Level Disp.] .....	P169
[Monochrome Live View] .....	P212
[Center Marker] .....	P214
[Zebra Pattern] .....	P214

### Advanced recording and settings

[Time Stamp Rec] .....	P170
------------------------	------



## Setup/Custom

### Basic settings

[Format] .....	P31
[Clock Set] .....	P38
[Q.MENU] .....	P58
[Beep] .....	P222
[Economy] .....	P223
[Double Slot Function] .....	P229
[Reset] (initialization) .....	P231
[Sensor Cleaning] .....	P231

### Customization

Function buttons .....	P60
Function lever .....	P63
Custom Mode .....	P85
[Custom] menu .....	P206



## Playback

### Playback

Picture playback .....	P176
Motion picture playback .....	P177
Playback Zoom .....	P179
Multi Playback .....	P180
Delete .....	P183
[Auto Review] .....	P212
[Slide Show] .....	P234
[Rotate] .....	P247

### Edit

[6K/4K PHOTO Bulk Saving] .....	P126
Focus Stacking .....	P133
[RAW Processing] .....	P238
[Light Composition] .....	P241
[Clear Retouch] .....	P242
[Resize] .....	P245
[Cropping] .....	P246
[Title Edit] .....	P237
[Text Stamp] .....	P243

### Image settings

[Protect] .....	P236
[Rating] .....	P236



## Wi-Fi/Bluetooth

### Image App

"Image App" .....	P253
[Remote Wakeup] .....	P260
Remote recording .....	P261
[Auto Transfer] .....	P264
Auto Cloud Backup .....	P265

### In combination with other devices

Playing back pictures on a TV .....	P270
Printing images .....	P274
Sending images to an AV device .....	P275
Sending images to a PC .....	P276
Sending images to a web service .....	P278
Using [Cloud Sync. Service] .....	P281



## Connections with other devices

### PC

"PHOTOfunSTUDIO" .....	P299
"SILKYPIX Developer Studio" .....	P300
Transferring images to a PC .....	P276
"LUMIX Tether" .....	P304
Controlling the Camera from a PC .....	P304

### Recorder

Dubbing .....	P303
---------------	------

### Printer

PictBridge .....	P306
------------------	------

### TV

Playing Back Pictures on a TV Screen .....	P294
[VIERA Link] .....	P297

## Care of the camera

### Do not subject to strong vibration, shock, or pressure.

- The lens, monitor, or external case may be damaged if used in the following conditions. It may also malfunction or image may not be recorded if you:
  - Drop or hit the camera.
  - Press hard on the lens or the monitor.

### ■ Splash Proof

Splash Proof is a term used to describe an extra level of protection this camera offers against exposure to a minimal amount of moisture, water or dust. Splash Proof does not guarantee that damage will not occur if this camera is subjected to direct contact with water.

In order to minimize the possibility of damage please be sure the following precautions are taken:

- The Splash Proof feature works in conjunction with the lenses that were specifically designed to support this feature.
- The camera is not designed to be dust and splash proof when the USB connection cable is connected.
- Make sure that all doors, socket caps and terminal covers are securely closed.
- Make sure that you are in a dry and secure place when changing the battery, lens or memory card. After changing, make sure their protective doors are securely closed.
- If this camera is exposed to water, sand or any other foreign material clean it as soon as possible, taking the necessary precautions that the foreign substance does not get inside the camera.

If sand, dust, or liquids such as water droplets adhere to the monitor, wipe them off with a dry soft cloth.

- Not doing so may cause the monitor to respond incorrectly to touch operations.
- If the monitor is closed when such liquids are present, malfunction may result.

### When using in cold temperatures (–10 °C to 0 °C (14 °F to 32 °F)):

- Attach a Panasonic interchangeable lens with a minimum recommended operating temperature of –10 °C (14 °F) before use.

**Do not place your hands inside the mount of the digital camera body. Since the sensor unit is a precision apparatus, it may cause a malfunction or damage.**

**If you shake the camera while it is turned off, its sensors may move or a rattling sound may be heard. The sound is caused by the In-Body Image Stabilizer, and this is not a malfunction.**

■ **About Condensation (When the lens, the viewfinder or monitor is fogged up)**

- Condensation occurs when the ambient temperature or humidity changes. Be careful of condensation since it causes lens, viewfinder and monitor stains, fungus and camera malfunction.
- If condensation occurs, turn the camera off and leave it for about 2 hours. The fog will disappear naturally when the temperature of the camera becomes close to the ambient temperature.



MENU



## Standard Accessories

**Check that all the accessories are supplied before using the camera.**

- The accessories and their shape will differ depending on the country or area where the camera was purchased.  
For details on the accessories, refer to “Basic Owner’s Manual”.
- Digital Camera Body is indicated as **camera body** in the text.
- Battery Pack is indicated as **battery pack** or **battery** in the text.
- Battery Charger is indicated as **battery charger** or **charger** in the text.
- AC Adaptor is indicated as **AC adaptor (supplied)** in the text.
- USB Connection Cable (for exclusive use with the Battery Charger) is indicated as **USB connection cable (for charger)** in the text. (P21)
- Interchangeable Lens is indicated as **lens** in the text.
- SD Memory Card, SDHC Memory Card and SDXC Memory Card are indicated as **card** in the text.
- **The card is optional.**

# Names and Functions of Components

## ■ Camera body

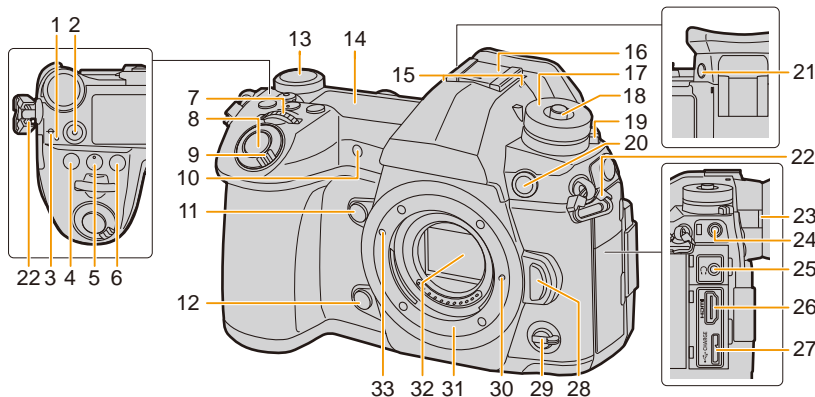

<b>1</b>	Charging lamp (P24)/ WIRELESS connection lamp (P251)	<b>16</b>	Hot shoe (Hot shoe cover) (P155) • Keep the hot shoe cover out of reach of children to prevent swallowing.
<b>2</b>	Motion picture button (P164)	<b>17</b>	Mode dial (P43)
<b>3</b>	Focus distance reference mark (P105)	<b>18</b>	Mode dial lock button (P43)
<b>4</b>	[] (Exposure Compensation) button (P107)	<b>19</b>	Drive mode dial (P114)
<b>5</b>	[ISO] (ISO sensitivity) button (P109)	<b>20</b>	Flash synchro socket (Flash synchro socket cap) (P156)
<b>6</b>	[WB] (White Balance) button (P111)	<b>21</b>	[V.MODE] button (P41)
<b>7</b>	Front dial (P44)	<b>22</b>	Shoulder strap eyelet (P20)
<b>8</b>	Shutter button (P42)	<b>23</b>	Diopter adjustment dial (P41)
<b>9</b>	Camera ON/OFF switch (P38)/ Status LCD backlight dial (P40, 225)	<b>24</b>	[MIC] socket (P311)
<b>10</b>	Self-timer indicator (P135)/ AF Assist Lamp (P208)	<b>25</b>	Headphone socket (P205)
<b>11</b>	Function button (Fn4) (P60)	<b>26</b>	[HDMI] socket (P294)
<b>12</b>	Preview button (P77)/Function button (Fn5) (P60)	<b>27</b>	[USB/CHARGE] socket (P301, 306)
<b>13</b>	Rear dial (P44)	<b>28</b>	Lens release button (P34)
<b>14</b>	Status LCD (P225, 319)	<b>29</b>	Function lever (P48)
<b>15</b>	Stereo microphone (P169) • Be careful not to cover the microphone with your finger. Doing so may make sound difficult to record.	<b>30</b>	Lens lock pin
		<b>31</b>	Mount
		<b>32</b>	Sensor
		<b>33</b>	Lens fitting mark (P33)



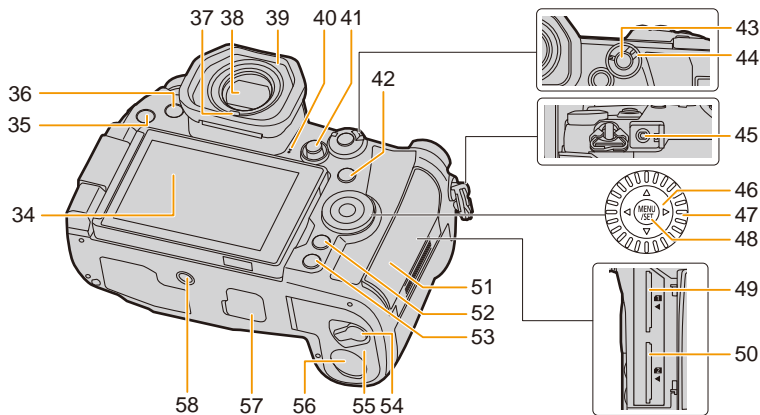

<b>34</b> Touch screen (P52)/monitor (P313)	<b>52</b> [Q.MENU] button (P58)/[Fn2] button (P60)/ [ ] (Delete) button (P183)/[ ] (Cancel) button (P57)
<b>35</b> [ ] (Playback) button (P176)	<b>53</b> [DISP.] button (P49)
<b>36</b> [LVF] button (P41)/[Fn3] button (P60)	<b>54</b> Release lever (P23)
<b>37</b> Eye sensor (P41)	<b>55</b> Battery door (P23)
<b>38</b> Viewfinder (P41)	<b>56</b> DC coupler cover (P312) • When using an AC adaptor, ensure that the Panasonic DC coupler (optional) and AC adaptor (optional) are used.
<b>39</b> Eye cup (P334)	<b>57</b> Cover for the battery grip connector (P309) • Keep the cover for the battery grip connector out of reach of children to prevent swallowing.
<b>40</b> Speaker (P222)	<b>58</b> Tripod mount (P338) • It may not be possible to attach and securely fasten a tripod with a screw length of 5.5 mm (0.22 inch) or more to the camera. Doing so may also damage the camera.
<b>41</b> Joystick (P48)/Function button (P60) Center (Fn11)/▲ (Fn12)/▶ (Fn13)/▼ (Fn14)/ ◀ (Fn15)	<b>Function buttons ([Fn6] to [Fn10]) are touch icons.</b> Touch the [ ] tab on the recording screen to display them.
<b>42</b> [ ] (Auto Focus Mode) button (P92)/ [Fn1] button (P60)	
<b>43</b> [AF/AE LOCK] button (P106)	
<b>44</b> Focus mode lever (P87, 103)	
<b>45</b> [REMOTE] socket (P310)	
<b>46</b> Cursor buttons (P47)/Function button (P60) ▲ (Fn16)/▶ (Fn17)/▼ (Fn18)/◀ (Fn19)	
<b>47</b> Control dial (P46)	
<b>48</b> [MENU/SET] button (P47, 55)	
<b>49</b> Card slot 1 (P29)	
<b>50</b> Card slot 2 (P29)	
<b>51</b> Card door (P29)	

## ■ Lens

### H-ES12060

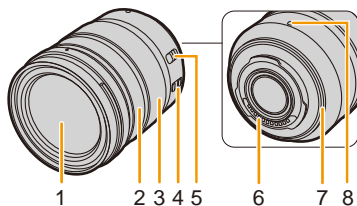

**1** Lens surface

**2** Focus ring (P103)

**3** Zoom ring (P149)

**4** O.I.S. switch (P145)

[AF/MF] switch

**5** • When either the [AF/MF] switch of the lens or the setting of the camera is set to [MF], Manual Focus (MF) is enabled.

### H-FS12060

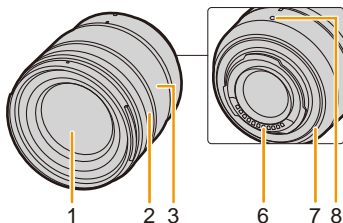

**6** Contact point

**7** Lens mount rubber (P335)

**8** Lens fitting mark (P33)

## About the Lens

This unit can use the dedicated lenses compatible with the Micro Four Thirds™ System lens mount specification (Micro Four Thirds mount).

You can also use a lens of any of the following standards by attaching a mount adaptor.



Lens	Mount adaptor
Four Thirds™ mount specification lens 	Mount Adaptor (DMW-MA1: optional)
Leica M Mount interchangeable lens	M Mount Adaptor (DMW-MA2M: optional)
Leica R Mount interchangeable lens	R Mount Adaptor (DMW-MA3R: optional)

### About the lens and functions

Depending on the lens used, certain functions, such as Auto Focus, Image Stabilizer, and zoom functions, may be disabled or operate differently.

For details on the lens used, refer to the website.

Refer to catalogs/Web pages for most current information regarding compatible lenses.

<http://panasonic.jp/support/global/cs/dsc/>

(This Site is English only.)

- The focal lengths marked on a Micro Four Thirds lens are equivalent to twice those of a 35 mm film camera. (The focal lengths will be equivalent to those of a 100 mm lens in 35 mm terms when a 50 mm lens is used.)

### About the firmware of your interchangeable lens

For smoother recording, we recommend updating the firmware of the interchangeable lens to the latest version.

- **To view the latest information on the firmware or to download the firmware, visit the support site below:**

<http://panasonic.jp/support/global/cs/dsc/>

(This Site is English only.)

- To check the firmware version of the interchangeable lens, attach it to the camera body and select [Version Disp.] in the [Setup] menu.

## Attaching the Shoulder Strap

- We recommend attaching the shoulder strap when using the camera to prevent it from dropping.

- 1 Pass the shoulder strap through the shoulder strap eyelet on the camera body.

(A): Shoulder strap eyelet

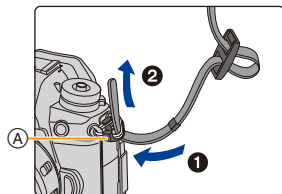

- 2 Pass the end of the shoulder strap through the ring in the direction of the arrow and then pass it through the stopper.

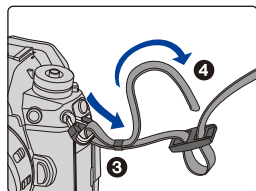

- 3 Pass the end of the shoulder strap through the hole on the other side of the stopper.

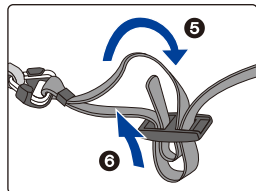

- 4 Pull the shoulder strap and then check that it will not come out.

- Perform steps 1 to 4 and then attach the other side of the shoulder strap.

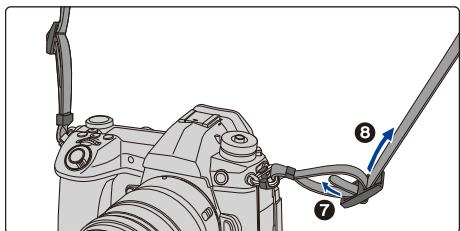

- Use the shoulder strap around your shoulder.
  - Do not wrap the strap around your neck. It may result in injury or accident.
- Do not leave the shoulder strap where an infant can reach it.
  - It may result in an accident by mistakenly wrapping around the neck.

# Charging the Battery

## About batteries that you can use with this unit

It has been found that counterfeit battery packs which look very similar to the genuine product are made available for purchase in some markets. Some of these battery packs are not adequately protected with internal protection to meet the requirements of appropriate safety standards. There is a possibility that these battery packs may lead to fire or explosion. Please be advised that we are not liable for any accident or failure occurring as a result of use of a counterfeit battery pack. To ensure that safe products are used, we recommend that a genuine Panasonic battery pack is used.

- The battery is not charged when the camera is shipped. Charge the battery before use.
- The battery can be recharged even when it still has some charge left, but it is not recommended that the battery charge be frequently topped up while the battery is fully charged. (Since characteristic swelling may occur.)

## Charging the battery with the charger

- Use the charger, AC adaptor (supplied), USB connection cable (for charger), and battery that are designed for exclusive use with the camera.
- Charge the battery with the charger indoors.

- 1 Connect the charger and the AC adaptor (supplied) with the USB connection cable (for charger).**
  - Check the direction of the terminals and plug in/out straight holding onto the plug. (It may result in malfunction by the deforming of the terminal if it is plugged in obliquely or in wrong direction.)
- 2 Insert the AC adaptor (supplied) into the power outlet.**

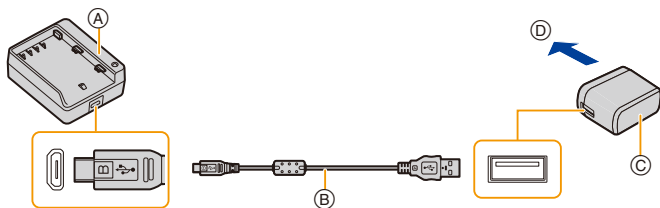

- (A) Charger (for exclusive use with the camera)      (C) AC adaptor (supplied)  
 (B) USB connection cable (for charger)      (D) To power outlet

- 3 Attach the battery by paying attention to its direction, then slide the battery in until it is secure.**

- The [CHARGE] indicator (E) lights up and charging begins.

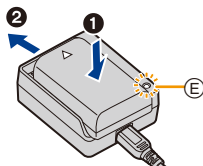

## ■ [CHARGE] indicator

**On:** Charging.

**Off:** Charging has completed.

(After charging is complete, disconnect the AC adaptor (supplied) from the power outlet and remove the battery.)

### • When the [CHARGE] indicator flashes

- The battery temperature is too high or too low. It is recommended to charge the battery again in an ambient temperature of between 10 °C and 30 °C (50 °F and 86 °F).
- The terminals of the charger or the battery are dirty. In this case, wipe them with a dry cloth.

## ■ Charging time

When the charger (supplied) is used

**Charging time**

**Approx. 190 min**

- The indicated charging time is for when the battery has been discharged completely. The charging time may vary depending on how the battery has been used. The charging time for the battery in hot/cold environments or a battery that has not been used for a long time may be longer than normal.

## ■ Battery indication

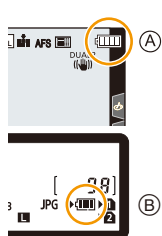

(A) Monitor display	(B) Status LCD display	
		75% or higher
		74% to 50%
		49% to 25%
		24% or below
		Low battery • Recharge the battery or replace it with a fully charged battery.
<b>Blinking red</b>	<b>Blinks</b>	

- The battery level indicated on the screen is approximate. The exact level varies depending on the environment and the operating conditions.

**• Do not leave any metal items (such as clips) near the contact areas of the power plug. Otherwise, a fire and/or electric shocks may be caused by short-circuiting or the resulting heat generated.**

- Do not use any other USB connection cables except the supplied one.

This may cause malfunction.

- Do not use any other AC adaptors except the supplied one.

This may cause malfunction.

- Do not use a USB extension cable.

- Do not use the AC adaptor (supplied) and the USB connection cable (for charger) for other devices. Doing so may cause malfunction.

- The AC adaptor is in the standby condition when the mains plug is connected. The primary circuit is always “live” as long as the mains plug is connected to an electrical outlet.

## Inserting/Removing the Battery

- Check that this unit is turned off.

1 **1:** Slide the release lever in the direction of the arrow (to the OPEN side).

**2:** Open the battery door.

- Always use genuine Panasonic batteries.
- If you use other batteries, we cannot guarantee the quality of this product.

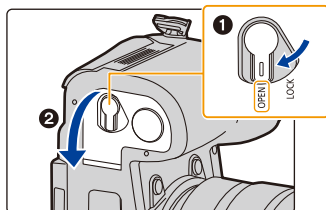

2 **Being careful about the battery orientation, insert all the way until you hear a locking sound and then check that it is locked by lever <sup>A</sup>.**

When removing the battery, push the lever <sup>A</sup> toward the arrow and pull out the battery.

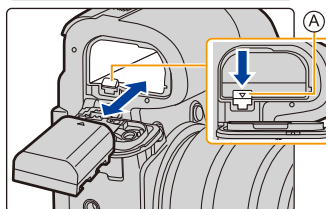

3 **1:** Close the battery door.

**2:** Slide the release lever in the direction of the arrow.

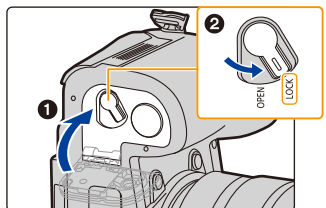

- Confirm that there is no foreign matter adhered on the inner side (rubber seal) of the battery door.
- Remove the battery after use.  
(The battery will be exhausted if left for a long period of time after being charged.)
- **The battery becomes warm after using it and during and after charging. The camera also becomes warm during use. This is not a malfunction.**
- Turn the camera off and wait for the "LUMIX" display on the monitor to clear before removing the battery.  
(Otherwise, this unit may no longer operate normally and the card itself may be damaged or the recorded pictures may be lost.)
- Be careful when removing the battery as the battery will jump out.

## Charging the battery with the camera

- Use the dedicated AC adaptor (supplied), USB connection cable (supplied) and battery.
- The battery cannot be charged when inserted in the battery grip (optional).

Camera conditions	Charge
Turned off	○
Turned on	—

**Insert the battery into this unit.  
Check that this unit is turned off.**

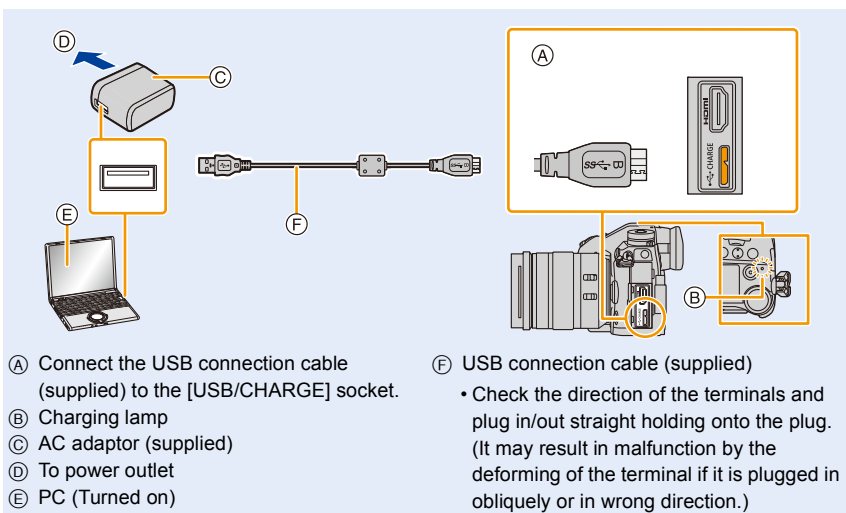

### (Charging from the power outlet)

**Connect the AC adaptor (supplied) and this camera with the USB connection cable (supplied), and insert the AC adaptor (supplied) into the power outlet.**

### (Charging from a computer)

**Connect the computer and this camera with the USB connection cable (supplied).**

- If the computer enters a suspended state while charging the battery, charging will stop.
- Connecting this camera to a notebook computer that is not connected to a power outlet will cause the notebook computer battery to drain faster. Do not leave the camera connected for extended periods of time.
- Be sure to always connect the camera to a computer USB terminal.  
Do not connect the camera to a monitor, keyboard or printer USB terminal, or a USB hub.



## ■ [CHARGE] indicator

**Lit red:** Charging.

**Off:** Charging has completed.

**(When charging is complete, disconnect the camera from the power outlet or computer.)**

### • When the charging lamp flashes

- Reconnect the USB connection cable (supplied) in a location where the ambient temperature (and the temperature of battery) is in a 10 °C to 30 °C (50 °F to 86 °F) range, and try charging again.
- If your PC is not capable of supplying sufficient power, charging is not possible.

## ■ Charging time



When using the AC adaptor (supplied)

Charging time	Approx. 230 min
---------------	-----------------

- **The indicated charging time is for when the battery has been discharged completely. The charging time may vary depending on how the battery has been used. The charging time for the battery in hot/cold environments or a battery that has not been used for a long time may be longer than normal.**
- When power is supplied from a computer, the power supply capacity of the computer determines the charging time.
- Do not use any other USB connection cables except the supplied one. This may cause malfunction.
- Do not use any other AC adaptors except the supplied one. This may cause malfunction.
- Do not use a USB extension cable.
- Do not use the AC adaptor (supplied) and the USB connection cable (supplied) for other devices. Doing so may cause malfunction.
- If a problem occurs in the power outlet, such as a power outage, charging may not be completed normally. If this happens, disconnect the USB connection cable (supplied) and connect it again.
- The AC adaptor is in the standby condition when the mains plug is connected. The primary circuit is always “live” as long as the mains plug is connected to an electrical outlet.

### About the power supply

If you connect the camera to a power outlet or PC while the camera is turned on, power can be supplied via the USB connection cable (supplied).

- Insert the battery into this unit.
- [  ] is displayed on the recording screen while power is being supplied.
- **In certain situations where the camera is used, such as during recording, the battery may drain. The camera will turn off when the battery power runs out.**
- If the ambient temperature is high or power is supplied continuously, after [  ] is displayed, the supply of power may stop. Wait until the camera cools down.
- Before connecting or disconnecting the AC adaptor (supplied), turn the camera off.
- Power may not be supplied depending on the power supply capacity of the PC.



MENU



## Approximate operating time and number of recordable pictures

- The numbers of recordable pictures listed here are based on the CIPA (Camera & Imaging Products Association) standard.
- When a Panasonic SDHC memory card and the supplied battery are used.

### ■ Recording still pictures (when using the Monitor)

When the interchangeable lens (H-ES12060) is used	
Number of recordable pictures	Approx. 380 pictures
Recording time	Approx. 190 min
When the interchangeable lens (H-FS12060) is used	
Number of recordable pictures	Approx. 400 pictures
Recording time	Approx. 200 min

### ■ Recording still pictures (when using the Viewfinder)

The numbers in parentheses indicate the values that result when [Time] in [Power Save LVF Shooting] is set to [1SEC] and the [Power Save LVF Shooting] function works as intended. (Based on the test conditions derived from the CIPA standard and specified by Panasonic)

When the interchangeable lens (H-ES12060) is used	
Number of recordable pictures	Approx. 360 pictures (Approx. 890 pictures)
Recording time	Approx. 180 min
When the interchangeable lens (H-FS12060) is used	
Number of recordable pictures	Approx. 380 pictures (Approx. 920 pictures)
Recording time	Approx. 190 min

### ■ Recording motion pictures (when using the monitor)

[AVCHD] (Recording with picture quality set to [FHD/17M/60i])

When the interchangeable lens (H-ES12060) is used	
Recordable time	Approx. 120 min
Actual recordable time	Approx. 60 min
When the interchangeable lens (H-FS12060) is used	
Recordable time	Approx. 130 min
Actual recordable time	Approx. 65 min

**[MP4]** (Recording with picture quality set to [FHD/28M/60p])

When the interchangeable lens (H-ES12060) is used	
Recordable time	Approx. 120 min
Actual recordable time	Approx. 60 min
When the interchangeable lens (H-FS12060) is used	
Recordable time	Approx. 130 min
Actual recordable time	Approx. 65 min

**[MP4]** (Recording with picture quality set to [4K/150M/60p])

When the interchangeable lens (H-ES12060) is used	
Recordable time	Approx. 110 min
Actual recordable time	Approx. 55 min
When the interchangeable lens (H-FS12060) is used	
Recordable time	Approx. 120 min
Actual recordable time	Approx. 60 min

- Actual recordable time is the time available for recording when repeating actions such as turning this unit on and off, starting/stopping recording, etc.

**■ Playback (when using the monitor)**

When the interchangeable lens (H-ES12060) is used	
Playback time	Approx. 260 min
When the interchangeable lens (H-FS12060) is used	
Playback time	Approx. 280 min

- **The operating times and number of recordable pictures will differ according to the environment and the operating conditions.**

For example, in the following cases, the operating times shorten and the number of recordable pictures is reduced.

- In low-temperature environments, such as on ski slopes.
- When the operating time of the camera becomes extremely short even after properly charging the battery, the life of the battery may have expired. Buy a new battery.

## Inserting/Removing the Card (Optional)

- Check that this unit is turned off.

**1** Slide the card door to open it.

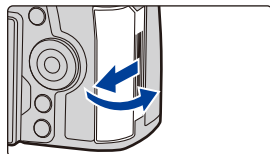

**2** Push it securely all the way until you hear a click while being careful about the direction in which you insert it.

To remove the card, push the card until it clicks, then pull the card out upright.

- One card can be inserted into each of the card slot 1 (A) and the card slot 2 (B).
- Ⓒ: Do not touch the connection terminals of the card.

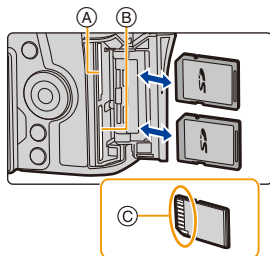

**3** **1**: Close the card door.

**2**: Slide the card door to the end and then close it firmly.

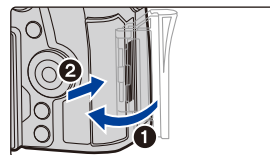

### ■ Card access indicators

#### Access indication

Lights up red while an image is being recorded to the card.



- During access (image writing, reading and deleting, formatting etc.), do not turn this unit off, remove the battery, card or disconnect the AC adaptor. Furthermore, do not subject the camera to vibration, impact or static electricity. Doing so may damage the card or recorded data or cause the camera to stop working correctly.

If operation fails due to vibration, impact or static electricity, perform the operation again.

- Turn the camera off and wait for the "LUMIX" display on the monitor to clear before removing the card.  
(Otherwise, this unit may no longer operate normally and the card itself may be damaged or the recorded pictures may be lost.)

## Card Information





The following cards which conform to the SD standard can be used with this unit.  
(These cards are indicated as **card** in the text.)

<b>SD Memory Card</b> (512 MB to 2 GB)	<ul style="list-style-type: none"> <li>This unit is compatible with UHS-I/UHS-II UHS Speed Class 3 standard SDHC/SDXC memory cards.</li> <li>Operation of the cards on the left has been confirmed with Panasonic's cards.</li> </ul>
<b>SDHC Memory Card</b> (4 GB to 32 GB)	
<b>SDXC Memory Card</b> (48 GB to 128 GB)	

### ■ Recording of motion pictures/6K photos/4K photos and speed class ratings

Use a card that meets the following ratings of the SD Speed Class or UHS Speed Class.

- SD Speed Class and UHS Speed Class are the speed standards regarding continuous writing. To check the class, see the labeled side, etc. of the card.

[Rec Format]	[Rec Quality]	Speed class	Label example
[AVCHD]	All	Class 4 or higher	CLASS  
	FHD		
[MP4]	4K	UHS Speed Class 3	
High Speed Video 6K/4K Photo Post Focus function		UHS Speed Class 3	

- Please confirm the latest information on the following website.

<http://panasonic.jp/support/global/cs/dsc/>

(This Site is English only.)

- If you set the Write-Protect switch  to "LOCK", you may not be able to write, delete or format the data or display it by recording date.
- The data on the card may be damaged or lost due to electromagnetic waves, static electricity or breakdown of the camera or the card. We recommend storing important data on a PC etc.
- Keep the memory card out of reach of children to prevent swallowing.

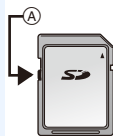

## Formatting the card (initialization)

Format the card before recording a picture with this unit.

**Since data cannot be recovered after formatting, make sure to back up necessary data in advance.**

**MENU** →  [Setup] → [Format] → [Slot 1]/[Slot 2]

- Use a battery with sufficient battery power or the AC adaptor (optional) when formatting. Do not turn the camera off during formatting.
- If the card has been formatted on a PC or other equipment, format it on the camera again.

## Approximate number of recordable pictures and available recording time

### ■ Number of recordable pictures

- Aspect ratio [4:3], Quality [■]

[Picture Size]	Card capacity			
	16 GB	32 GB	64 GB	128 GB
L (20M)	1450	2910	5810	11510
M (10M)	2630	5280	10510	20810
S (5M)	4600	9220	17640	34940

- Aspect ratio [4:3], Quality [RAW■]

[Picture Size]	Card capacity			
	16 GB	32 GB	64 GB	128 GB
L (20M)	450	900	1810	3590
M (10M)	520	1050	2110	4180
S (5M)	570	1150	2290	4550

### ■ Available recording time (when recording motion pictures)

- “h” is an abbreviation for hour, “m” for minute and “s” for second.
- The recordable time is the total time of all the motion pictures which have been recorded.

- [AVCHD]

[Rec Quality]	Card capacity			
	16 GB	32 GB	64 GB	128 GB
[FHD/28M/60p]	1h10m	2h25m	4h55m	9h55m
[FHD/17M/60i]	1h55m	4h05m	8h10m	16h20m
[FHD/24M/30p] [FHD/24M/24p]	1h20m	2h50m	5h45m	11h35m

## • [MP4]

[Rec Quality]	Card capacity			
	16 GB	32 GB	64 GB	128 GB
[4K/150M/60p]	12m00s	27m00s	56m00s	1h50m
[4K/100M/30p] [4K/100M/24p]	19m00s	40m00s	1h20m	2h45m
[FHD/28M/60p]	1h10m	2h25m	4h55m	9h55m
[FHD/20M/30p]	1h35m	3h15m	6h35m	13h15m

## • Continuous motion picture recordable times

[Rec Format]	[Rec Quality]	Continuous recordable time	Size interval for dividing files
[AVCHD]	All	29 minutes and 59 seconds	Files exceeding 4 GB in size will be divided into smaller files for recording.*
[MP4]	FHD		10 minutes
	[4K/100M/30p] [4K/100M/24p]	<b>When an SDHC card is used:</b> Files exceeding 4 GB in size will be divided into smaller files for recording and playback.*	
[4K/150M/60p]	<b>When an SDXC card is used:</b> Files are not divided for recording.		

\* You can continue recording without interruption.

- Depending on the recording conditions and the type of card, the number of recordable pictures and available recording time vary.
- **Before recording, the screen displays the available recording time derived from the amount of free space on the card; during recording, it displays the remaining time for continuous recording.**
- [9999+] is displayed on the recording screen if there are 10000 or more recordable pictures remaining.



## Attaching/Removing the Lens

- Check that the camera is turned off.
- Change lenses where there is not a lot of dirt or dust. Refer to [P333](#) when dirt or dust gets on the lens.

### ■ Attaching the lens

- 1 Turn the lens rear cap **(A)** and the body cap **(B)** in the direction of the arrow to detach them.

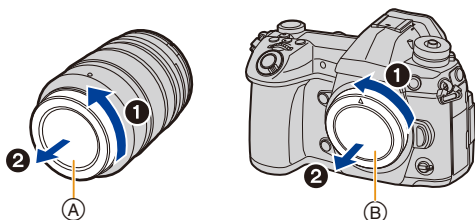

- 2 Align the lens fitting marks **(C)** and then rotate the lens in the direction of the arrow until it clicks.

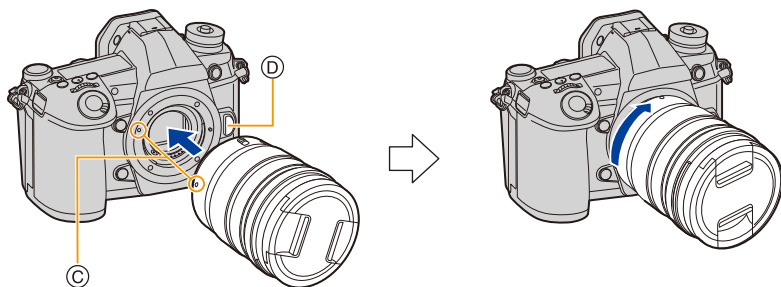

- Do not press the lens release button **(D)** when you attach a lens.
- Do not try to attach the lens when holding it at an angle to the camera body as the lens mount may get scratched.

### ■ Detaching the lens

- Attach the lens cap.

While pressing on the lens release button **(A)**, rotate the lens toward the arrow until it stops and then remove.

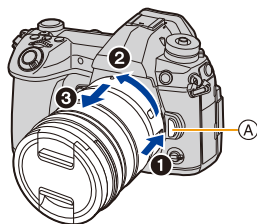

- When the lens is removed from the camera, dust and other particles may accumulate on or enter the camera or lens.

Be sure to attach the body cap and the lens rear cap.

### ■ Zoom operations

When using the interchangeable lens (H-ES12060/  
H-FS12060)

Rotate the zoom ring of the lens.

- T** side: Enlarges distant subject
- W** side: Widens angle of view

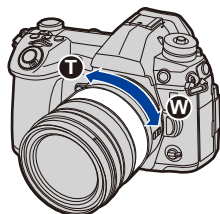

### ■ Attaching the Lens Hood

When recording into strong backlight, irregular reflection may occur within the lens. The lens hood reduces the inclusion of unwanted light in the recorded images and lowers the drop in contrast. The lens hood cuts off excess lighting and improves the picture quality.

**To attach the lens hood (flower shape) that came with the interchangeable lenses (H-ES12060/H-FS12060)**

**Hold the lens hood by placing your fingers as shown in the figure.**

- Do not hold the lens hood in such a way that it will be bent.



- 1 Align the mark **(A)** (●) on the lens hood with the mark on the tip of the lens.

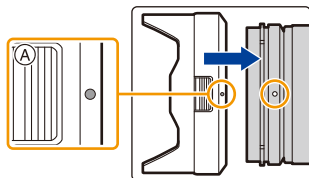

- 2 Rotate the lens hood in the direction of the arrow until it clicks and then align the mark **(B)** (◐) on the lens hood with the mark on the tip of the lens.

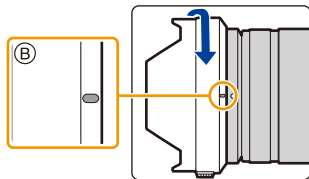

### ■ Removing the lens hood (H-ES12060)

Rotate the lens hood in the direction of the arrow while pushing the button **(C)** on the lens hood.

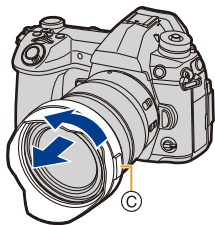

 **Temporarily Storing the Lens Hood**

Example: H-ES12060

- 1 Rotate the lens hood in the direction of the arrow while pushing the button (A) on the lens hood.
- 2 Align the mark (B) (  ) on the lens hood with the mark on the tip of the lens.
- 3 Turn the lens hood in the direction of the arrow until it clicks into place.

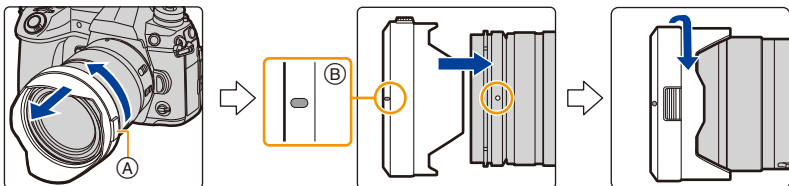

## Opening the Monitor

At the time when this camera is purchased, the monitor is stowed in the camera body. Bring out the monitor as shown below.

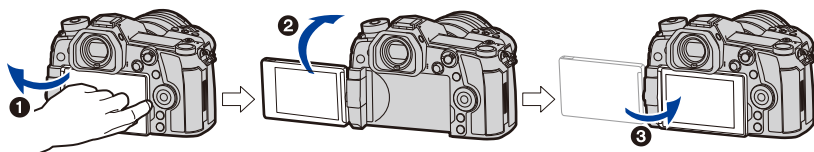

- ❶ Open the monitor. (Maximum 180°)
- ❷ It can be rotated 180° forward.
- ❸ Return the monitor to its original position.

• When rotating the monitor, be careful not to apply too much force. Doing so may cause damage.

### ■ Free angle shooting

The monitor can be rotated to suit your needs. This is convenient as it allows you to take pictures from various angles by adjusting the monitor.

#### Taking pictures at a high angle

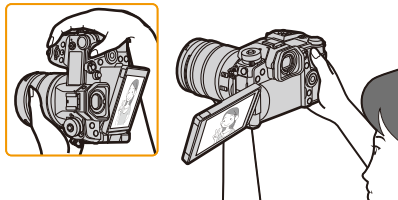

#### Taking pictures at a low angle

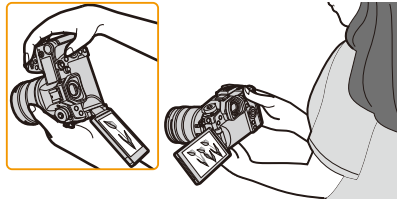

• When not using the monitor it is recommended that you close it with the screen facing inward to prevent dirt and scratches.

# Setting Date/Time (Clock Set)

• The clock is not set when the camera is shipped.

## 1 Turn the camera on.

- If the language select screen is not displayed, proceed to step 4.

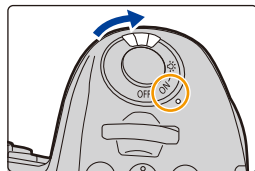

## 2 Press [MENU/SET].

## 3 Press ▲/▼ to select the language, and press [MENU/SET].

## 4 Press [MENU/SET].

## 5 Press ◀/▶ to select the items (year, month, day, hour, minute), and press ▲/▼ to set.

- Ⓐ: Time at the home area
- Ⓑ: Time at the travel destination

**To set the display order and the time display format.**

- To display the setting screen of the order/time, select [Style] and then press [MENU/SET].

## 6 Press [MENU/SET] to set.

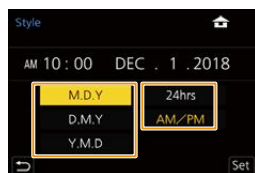
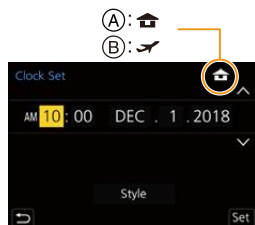

- 7 When [The clock setting has been completed.] is displayed, press [MENU/SET].
- 8 When [Please set the home area] is displayed, press [MENU/SET].
- 9 Press ◀/▶ to select the home area, and then press [MENU/SET].



#### ■ Re-adjusting the clock

**MENU** → ⚙ [Setup] → [Clock Set]

- The clock can be reset as shown in steps 5 and 6 on P38.
- **The clock setting is maintained for 3 months using the built-in clock battery even without the battery.**  
(Leave the charged battery in the unit for 24 hours to charge the built-in battery.)

• To place the correct date on pictures, set the clock before recording.  
Otherwise, the correct date will not be printed when you order a photo studio to print pictures or you will not be able to stamp the correct date on pictures.

# Basic Operations

## Tips for taking good pictures

Hold the camera gently with both hands, keep your arms still at your side and stand with your feet slightly apart.

- Do not cover the AF Assist lamp (A), or microphone (B) with your fingers or other objects.
- Make sure your footing is stable and there is no danger of colliding with another person or object in the vicinity while taking pictures.

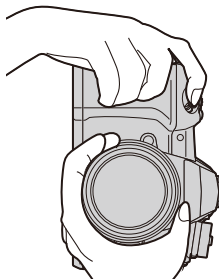
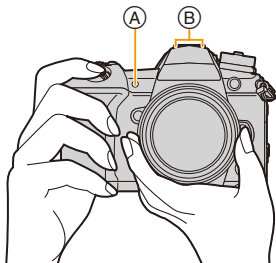

## ■ Detects orientation of camera (Direction Detection Function)

This function detects the vertical orientation when you record with the camera vertically orientated.

When you play back the recording, the recording is automatically displayed in vertical orientation.

(Only available when [Rotate Disp.] is set to [ON].)



- When the camera is held vertically and tilted significantly up or down to record, the Direction Detection Function may not work correctly.
- Motion pictures, 6K/4K burst files, and images recorded with the Post Focus function cannot be displayed vertically.

## Turn on the status LCD backlight

Set the camera ON/OFF switch to [⏻].

- When the camera ON/OFF switch is released, it returns to the [ON] position and the status LCD backlight turns off after approx. 5 seconds.
- To turn off the status LCD backlight immediately, set the camera ON/OFF switch to [⏻] again.
- If you start recording while the status LCD backlight is turned on, it will turn off.
- The status LCD backlight cannot be turned on when recording motion pictures or using [6K/4K Pre-Burst] or [Pre-Burst Recording] in [6K/4K PHOTO].

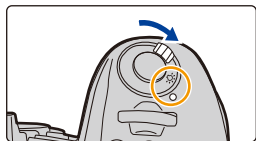



## Using the Viewfinder

### Diopter adjustment

#### Rotate the diopter adjustment dial.

- Adjust until you can see the characters displayed in the viewfinder clearly.

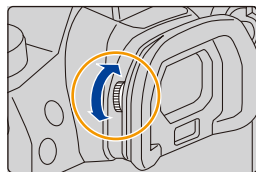

### Switching the Monitor/Viewfinder

#### Press [LVF].

- (A) [LVF] button
- (B) Eye sensor

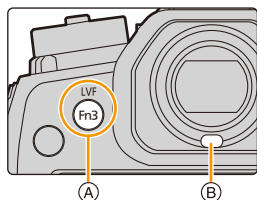

#### Automatic viewfinder/ monitor switching\*

#### Viewfinder display\*

#### Monitor display

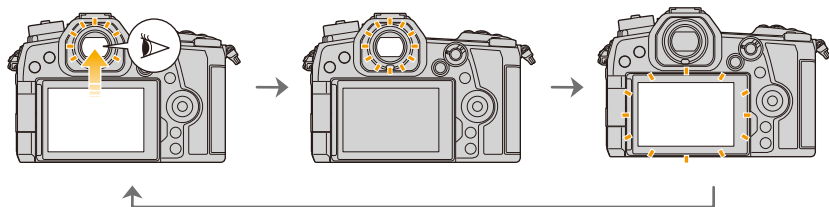

- \* If [Eye Sensor AF] in the [Custom] ([Focus / Release Shutter]) menu is set to [ON], the camera automatically adjusts the focus as the eye sensor is activated. The camera does not beep when focus is achieved with [Eye Sensor AF].

### ■ Notes on automatic viewfinder/monitor switching

Bring your eye or an object near the viewfinder to automatically switch to the viewfinder display using the eye sensor.

- To reduce the battery consumption, set [Power Save LVF Shooting] in [Economy] (P223).
- Eye sensor might not work properly depending on the shape of your eyeglasses, the way you hold the camera, or bright light shining around the eyepiece. In that case, press [LVF] to switch the display.
- During motion picture playback or a slide show, the camera does not automatically switch the display to the Viewfinder with the eye sensor.
- The eye sensor does not work depending on the angle of the monitor.

## Change the display magnification of the viewfinder

### Press [V.MODE].

- The magnification factors that can be switched between differ depending on the [LVF/Monitor Disp. Set] setting in the [Custom] ([Monitor / Display]) menu.
  - [ ] (Viewfinder Style): Two levels
  - [ ] (Monitor Style): Three levels

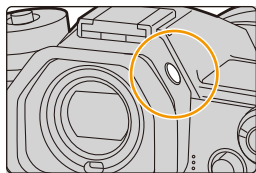

## Shutter button (Taking pictures)

The shutter button works in two steps.

### Press the shutter button halfway to focus.

- (A) Aperture value
- (B) Shutter speed
- (C) Focus indication

- Aperture value and shutter speed are displayed. (It will flash in red if the correct exposure is not achieved, except when set to flash.)
- Once the subject is in focus, the focus indication is displayed. (When the subject is not in focus, the indication flashes.)

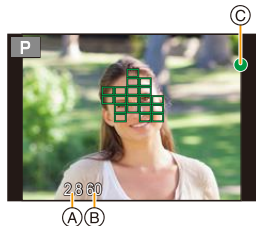
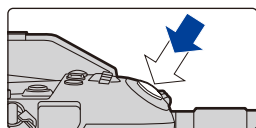

**Press the shutter button fully (push it in further), and take the picture.**

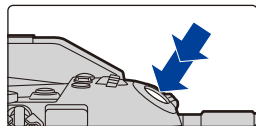

- Pictures cannot be taken until focus is achieved when [Focus/Release Priority] is set to [FOCUS].
- Even during menu operation or image playback, if you press the shutter button halfway, you can instantly set the camera ready for recording.

## Motion picture button (Recording motion pictures)

**Start recording by pressing the motion picture button.**

- Release the motion picture button right after you press it.

**Stop the recording by pressing the motion picture button again.**

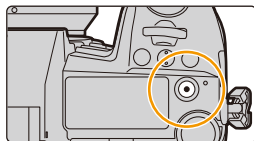

## Mode dial (Selecting a Recording Mode)

**Press the mode dial lock button ❶ to release the lock.**

- The dial is locked if the mode dial lock button is depressed.

**Rotate the mode dial ❷ and adjust the recording mode.**

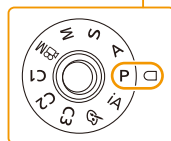
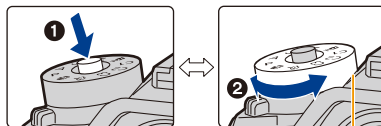

<b>iA</b>	Intelligent Auto Mode (P65)
	Intelligent Auto Plus Mode (P66)
<b>P</b>	Program AE Mode (P71)
<b>A</b>	Aperture-Priority AE Mode (P74)
<b>S</b>	Shutter-Priority AE Mode (P74)
<b>M</b>	Manual Exposure Mode (P75)
<b>M</b>	Creative Video Mode (P171)
<b>C1</b>	Custom Mode (P85)
<b>C2</b>	
<b>C3</b>	
<b>Ⓕ</b>	Creative Control Mode (P79)

## Front Dial/Rear Dial

### Rotating:

**Selection of items or setting of values is performed during the various settings.**

- This owner's manual describe operations of the front dial/rear dial as follows:

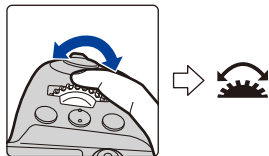

e.g.: When rotating the front dial to the left or right

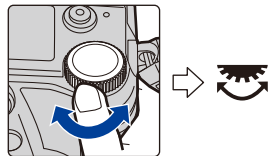

e.g.: When rotating the rear dial to the left or right



Allows you to set the aperture, shutter speed, and other settings when in **P / A / S / M** modes.

Mode dial	 Front dial	 Rear Dial
<b>P</b>	Program Shift	Program Shift
<b>A</b>	Aperture value	Aperture value
<b>S</b>	Shutter speed	Shutter speed
<b>M</b>	Aperture value	Shutter speed

**💡** **Temporarily changing the items assigned to the front/rear dials ([Dial Operation Switch])**

**1 Set a function button to [Dial Operation Switch]. (P60)**

**2 Press the function button.**

- A guide will be displayed showing the items temporarily assigned to the front/rear dials.
- If no operations are performed, the guide will disappear in a few seconds.

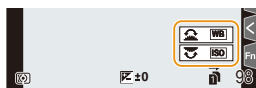

**3 Rotate the front/rear dials while the guide is displayed.**

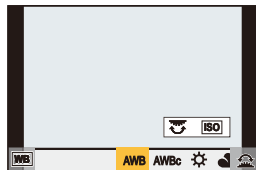

**4 Press [MENU/SET] and set.**

- You can also complete this step by performing either of the operations below:
  - Press the shutter button halfway
  - Press the function button
- You can set the items to be assigned temporarily to the front/rear dials in [Dial Operation Switch Setup] in [Dial Set.] in the [Custom] ([Operation]) menu. (P47)

## Control Dial

### Rotating:

**Selection of items or setting of values etc., is performed.**





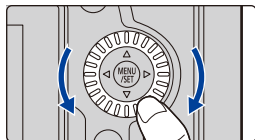













- The operation of rotating the control dial is illustrated as below in this owner's manual.





Example: When rotating the control dial to the left or right: 



### ■ Setting the operation methods of the dial

**MENU** →  [Custom] →  [Operation] → [Dial Set.]

<b>[Assign Dial (F/SS)]</b>	<p>Assigns the operations of the aperture value and shutter speed in Manual Exposure Mode.</p> <p><b>[ F  SS]:</b> Assigns the aperture value to the front dial, and the shutter speed to the rear dial.</p> <p><b>[ SS  F]:</b> Assigns the shutter speed to the front dial, and the aperture value to the rear dial.</p>
<b>[Rotation (F/SS)]</b>	<p>Changes the rotation direction of the dials for adjusting the aperture value and shutter speed.</p> <p><b>[  ]/[  ]</b></p>
<b>[Control Dial Assignment]</b>	<p>It sets the item to be assigned to the control dial while the recording screen is displayed.</p> <p><b>[ ]</b> ([Headphone Volume])/</p> <p><b>[ /  ]</b> ([Exposure / Aperture])*<sup>1</sup>/</p> <p><b>[ ]</b> ([Exposure Comp.])/[<b>[ISO]</b>] ([Sensitivity])/</p> <p><b>[ ]</b> ([Focus Frame Size])*<sup>2</sup></p> <p>*1 A function that sets the aperture value is assigned when the camera is set to Manual Exposure Mode. If it is set to a mode other than Manual Exposure Mode, a function that compensates the exposure is assigned.</p> <p>*2 When the Auto Focus Mode is set to [], [], [] or [], a function that adjusts the AF area size is assigned. When the Auto Focus Mode is set to [] or Manual Focus is used, a function that changes the magnification factor of the assist screen is assigned.</p>

<b>[Exposure Comp.]</b>	Assigns the Exposure Compensation to the front dial or rear dial so that you can directly adjust it. [  ] (Front Dial)/[  ] (Rear Dial)/[OFF]												
<b>[Dial Operation Switch Setup]</b>	Sets the items to be assigned temporarily to the front/rear dials when you press the function button to which [Dial Operation Switch] is assigned. [  ] ([Front Dial Operation])/[  ] ([Rear Dial Operation]) • Items that can be set are as follows. <table border="0" data-bbox="424 320 901 487"> <tr> <td>- [Photo Style]</td> <td>- [i.Dynamic]</td> </tr> <tr> <td>- [Filter Effect]</td> <td>- [i.Resolution]</td> </tr> <tr> <td>- [Aspect Ratio]</td> <td>- [Flash Mode]</td> </tr> <tr> <td>- [AF Mode]</td> <td>- [Flash Adjust.]</td> </tr> <tr> <td>- [6K/4K PHOTO]</td> <td>- [Sensitivity]</td> </tr> <tr> <td>- [Highlight Shadow]</td> <td>- [White Balance]</td> </tr> </table> • [Highlight Shadow] uses the two dials.	- [Photo Style]	- [i.Dynamic]	- [Filter Effect]	- [i.Resolution]	- [Aspect Ratio]	- [Flash Mode]	- [AF Mode]	- [Flash Adjust.]	- [6K/4K PHOTO]	- [Sensitivity]	- [Highlight Shadow]	- [White Balance]
- [Photo Style]	- [i.Dynamic]												
- [Filter Effect]	- [i.Resolution]												
- [Aspect Ratio]	- [Flash Mode]												
- [AF Mode]	- [Flash Adjust.]												
- [6K/4K PHOTO]	- [Sensitivity]												
- [Highlight Shadow]	- [White Balance]												

### Cursor buttons/[MENU/SET] button

**Pressing the cursor button:**

**Selection of items or setting of values etc., is performed.**

**Pressing [MENU/SET]:**

**Confirmation of setting contents, etc., is performed.**

- This owner's manual expresses the up, down, left, and right of the cursor button as ▲/▼/◀/▶.

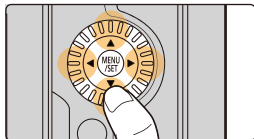

## Joystick

The joystick provides the same functions as the cursor buttons/[MENU/SET] button.

**Moving:**

**Selection of items or setting of values etc., is performed.**

**Pressing:**

**Confirmation of setting contents, etc., is performed.**



Moving

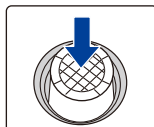

Pressing

• In this owner's manual, the up, down, left and right of the joystick are expressed as ▲/▼/◀/▶.

■ **Changing the function to be used while the recording screen is displayed**

**MENU** → [Custom] → [Operation] → [Joystick Setting]

<b>[D.FOCUS Movement]</b>	Allows you to move the display positions of the AF area and MF Assist. (P100, 103)
<b>[Fn]</b>	Uses a function assigned in [Fn Button Set].
<b>[MENU]</b>	Displays the menu when the joystick is pressed. • Operations that can be performed by moving the joystick are disabled.
<b>[OFF]</b>	Disables the joystick.

## Function lever

You can switch to the camera setting that enables the assigned function.

You can set the items to be assigned to the function lever in [Fn Lever Setting] in the [Custom] ([Operation]) menu. (P63)

**Change the function lever position.**

	<b>MODE1</b>	The normal setting where the assigned function is disabled.
	<b>MODE2</b>	The setting where the assigned function is enabled.

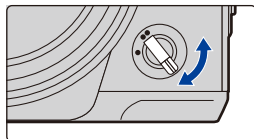

• Assigned functions may not operate, depending on the mode selected or the screen displayed.



## [DISP.] button (Switching the displayed information)

Press [DISP.].

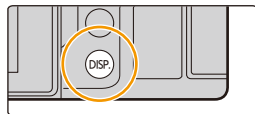

### In Recording Mode

You can select separate screen display styles for the viewfinder and the monitor.

**MENU** → [Custom] → [Monitor / Display] → [LVF/Monitor Disp. Set] → [LVF Disp. Set]/[Monitor Disp. Set]

(viewfinder style)	Scales down images slightly so that you can better review the composition of the images.
(monitor style)	Scales images to fill the entire screen so that you can see their details.

### • Live View Finder style display layout (Example of viewfinder style display)

With information  
(detailed  
information)



With information

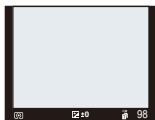

With information  
(detailed  
information, tilt  
sensor display)



With information  
(tilt sensor  
display)



• [ ] Monitor style display layout (Example of monitor style display)

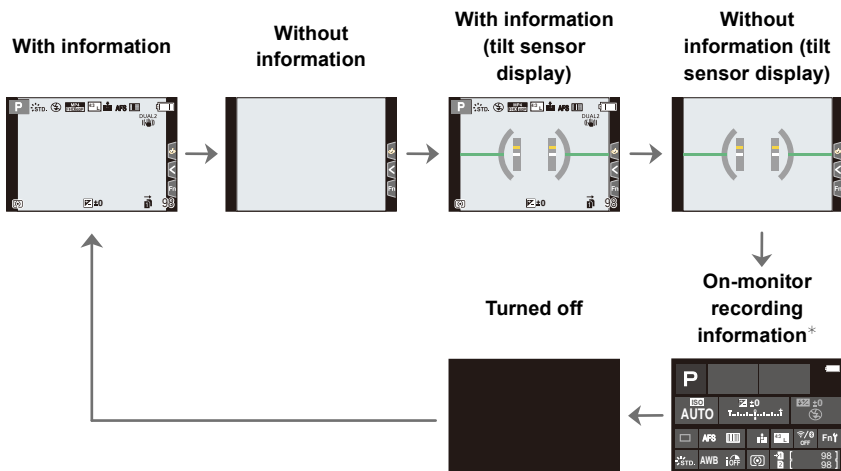

\* When the on-monitor recording information screen is displayed, you can touch the desired item and change its setting directly.

- With [Fn Button Set] in the [Custom] ([Operation]) menu, you can assign [LVF/Monitor Disp. Style] to a function button. Each time you press the assigned function button, the display style of the monitor or viewfinder ([ ]/[ ]), whichever is currently in use, will change.

■ About the tilt sensor display

With the tilt sensor displayed, it is easy to correct the tilt of the camera etc.

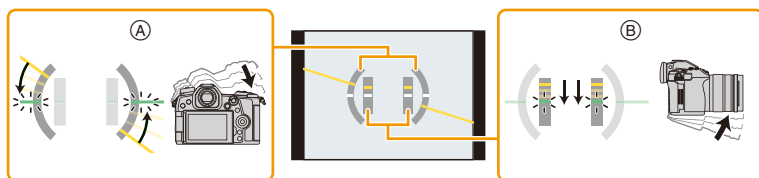

- Ⓐ **Horizontal direction:** Correcting tilt to the left
- Ⓑ **Vertical direction:** Correcting downward tilt

- When there is no tilt, the indicator color changes to green.
- Even after correcting the tilt, there may still be an error of approximately  $\pm 1^\circ$ .
- When tilted significantly upwards or downwards to record, the tilt sensor display may not be displayed correctly, and the Direction Detection Function may not work correctly.

## In Playback Mode

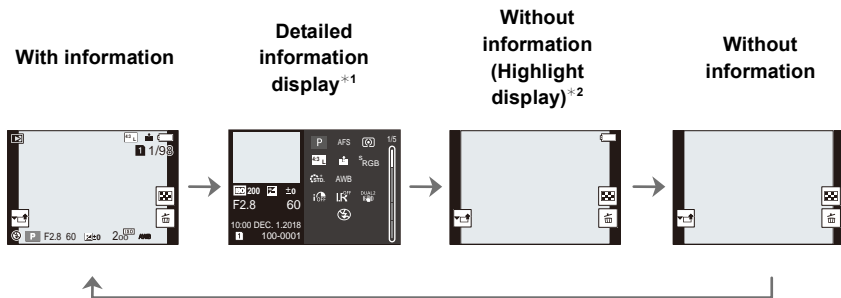

\*1 Press ▲/▼ to switch between the following display modes:

- Detailed information display
- Histogram display
- Photo style, Highlight shadow display
- White balance display
- Lens information display

\*2 This is displayed if [Highlight] in the [Custom] ([Monitor / Display]) menu is set to [ON].

- Some of the screens cannot be displayed for certain files that you play back, such as motion pictures and 6K/4K burst files.

## Touch screen (Touch operations)

### ■ Touch

To touch and release the touch screen.

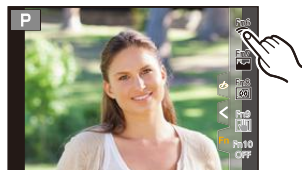

### ■ Drag

A movement without releasing the touch screen.

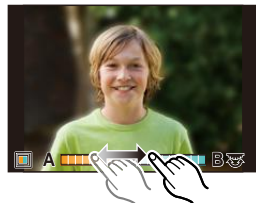

### ■ Pinch (enlarge/reduce)

Pinch the touch screen apart (enlarge) or together (reduce) with two fingers.



- Touch the screen with the clean and dry finger.
- If you use a commercially available monitor protection sheet, please follow the instructions that accompany the sheet.  
(Some monitor protection sheets may impair visibility or operability.)

### Not available in these cases:

- The touch screen may not function normally in the following cases.
  - When touched by a gloved hand
  - When the touch screen is wet

## Taking Pictures Using the Touch Function

### Touch Shutter function

Applicable modes:         

Just by touching the subject you want as your point of focus, the camera will focus on the subject and take the picture automatically.

#### 1 Touch [].



#### 2 Touch [].

- Icon will change to [], and taking a picture with the Touch Shutter function becomes possible.



#### 3 Touch the subject you wish to focus on, and then take a picture.

- The picture is taken when the focus is achieved.



#### ■ To cancel the Touch Shutter function

Touch [].

- If shooting with the touch shutter fails, the AF area turns red and disappears.

## Touch AE

Applicable modes:   P A S M  

You can easily optimize the brightness for a touched position. When the face of the subject appears dark, you can brighten the screen according to the brightness of the face.

### 1 Touch [].



### 2 Touch [].

- The setting screen for the brightness optimization position is displayed.
- [Metering Mode] is set to [, which is used exclusively for the Touch AE.



### 3 Touch the subject you want to optimize the brightness for.

- Touch [Reset] to bring the brightness optimization position back to the center.



### 4 Touch [Set].

## ■ Canceling the Touch AE function

Touch [].

- [Metering Mode] returns to the original setting, and the brightness optimization position is canceled.

## Not available in these cases:

- This function is not available in the following cases:
  - When using the Digital Zoom
  - When [4K Live Cropping] is set
  - When [Touch AF] in [Touch Settings] of the [Custom] ([Operation]) menu has been set to [AF+AE]

## Setting menu items

You can either operate the buttons or touch the monitor to set menu items.

**1** Press [MENU/SET].

**2** Press ◀.

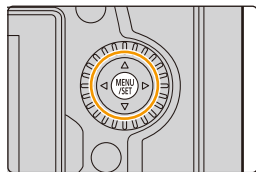

**3** Press ▲/▼ to select a menu selector icon, such as [📷].

- You can also select the menu toggle icons by rotating the front dial.



[Intelligent Auto] (P68)	These menus let you set the functions available only for their corresponding Recording Modes.
[Creative Video] (P171)	
<b>C</b> [Custom Mode] (P86)	These menus are displayed only for their corresponding Recording Modes.
[Creative Control] (P80)	
[Rec] (P185)	This menu lets you set picture settings.
[Motion Picture] (P203)	This menu lets you set motion picture settings.
[Custom] (P206)	Operation of the unit, such as displaying of the screen and button operations, can be set up according to your preferences.
[Setup] (P220)	This menu lets you perform the clock settings, select the operating beep tone settings and set other settings which make it easier for you to operate the camera. You can also configure the settings of Wi-Fi/Bluetooth related functions.
[My Menu] (P232)	This menu lets you register frequently-used menus.
[Playback] (P233)	This menu lets you set the playback and editing settings for images.

- The [Setup] menu contains some important settings relating to the camera's clock and power. Check the settings of this menu before proceeding to use the camera.

## 4 Press [MENU/SET].

Touch operation

Touch a menu selector icon, such as .

## 5 Press ▲/▼ of the cursor button to select the menu item and press [MENU/SET].

- You can also select the menu item by rotating the control dial.
- You can also move to the next screen by rotating the rear dial.

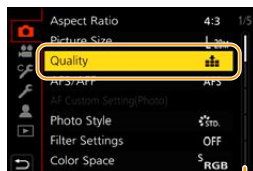

Touch operation

Touch the menu item.

- You can switch the page by touching the bar  on the right side of the screen.



**To display explanations of the menu items.**

If you press [DISP.] while a menu item or setting is selected, a description of the menu is displayed.



## 6 Press ▲/▼ of the cursor button to select the setting and press [MENU/SET].

- You can also select the setting by rotating the control dial.
- Depending on the menu item, its setting may not appear or it may be displayed in a different way.

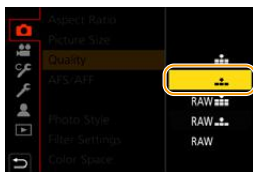

Touch operation

Touch the Setting to set.



- Menu items that are not available are displayed in gray. When a gray item is selected, if you press [MENU/SET], a message indicating that the item cannot be set is displayed along with the reason why it cannot be set under certain conditions.



### ■ Close the menu

Press [↵] or press the shutter button halfway.

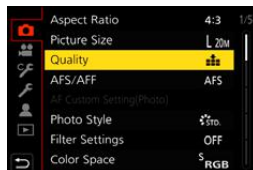

Touch operation

Touch [↵].

# Calling frequently-used menus instantly (Quick Menu)

**1** Press [Q.MENU] to display the Quick Menu.

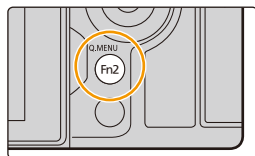

**2** Rotate the front dial to select the menu item.

- Setting can also be performed by rotating the control dial.

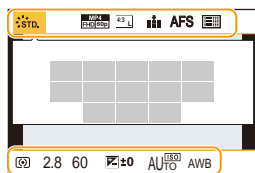

**3** Rotate the rear dial to select the setting.

**4** Press [Q.MENU] to exit the menu once the setting is complete.

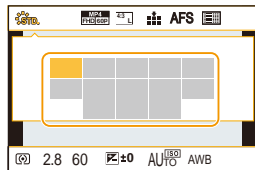

- The features that can be adjusted using Quick Menu are determined by the mode or a display style the camera is in.

## On-monitor recording information in [ ] (Monitor style) (P49)

Select the item by pressing the [Q.MENU] button and rotating the front dial, and then select the setting by rotating the rear dial.



## Customizing the Quick Menu settings

You can add a maximum of 15 preferred settings to the Quick Menu.

**MENU** →  [Custom] →  [Operation] → [Q.MENU] → [CUSTOM]

- 1 Press [Q.MENU] to display the Quick Menu.
- 2 Press ▼ to select [] and then press [MENU/SET].

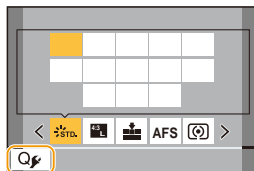

- 3 Press ▲/▼/◀/▶ to select the menu item in the top row and then press [MENU/SET].
- 4 Press ◀/▶ to select the empty space in the bottom row and then press [MENU/SET].

(A) Items that can be set

(B) Set items

- You can also set the menu item by dragging it from the top row to the bottom row.
- If there is no empty space in the bottom row, you can replace an existing item with a new select item by selecting the existing item.
- To cancel the setting, move to the bottom row by pressing ▼ and select an item to cancel, and then press [MENU/SET].

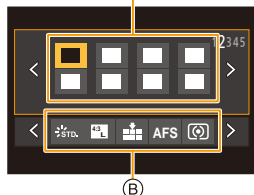

- 5 Press [↵].

- It will return to screen of step 2.  
Press [MENU/SET] to switch to the recording screen.

# Assigning Frequently-Used Functions to Buttons/Lever (Function Buttons/Function Lever)

You can assign various features, such as recording functions, to specific buttons and icons as well as the function lever.

## Assigning functions to function buttons

### 1 Select the menu.

**MENU** →  [Custom] →  [Operation] → [Fn Button Set] → [Setting in REC mode]/[Setting in PLAY mode]

### 2 Press ▲/▼ to select the function button you want to assign a function to and then press [MENU/SET].

- To select a button from [Fn11] to [Fn19] in [Setting in REC mode], press [DISP.] to switch the screen.

### 3 Press ▲/▼ to select the function you you want to assign and then press [MENU/SET].

- For details on the functions that can be assigned in [Setting in REC mode], refer to [P61](#).
- For details on the functions that can be assigned in [Setting in PLAY mode], refer to [P62](#).
- To restore the default function button settings, select [Restore to Default].
- Some functions cannot be assigned depending on the function button.

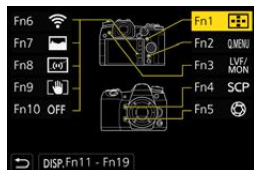

- Touching [Fn] on the on-monitor recording information screen ([P49](#)) also allows you to display the screen in step **2**.
- If you press and hold a function button (any of [Fn1] to [Fn5] or [Fn11] to [Fn19]) for 2 seconds, the screen displayed in step **3** can be displayed.  
In some cases, however, the screen cannot be displayed depending on the currently selected mode or the currently displayed screen.

## Using the function buttons during recording

You can use assigned functions by pressing a function button when recording.

### ■ Using the buttons [Fn6] to [Fn10] (touch operations)

- 1 Touch .
- 2 Touch [Fn6], [Fn7], [Fn8], [Fn9] or [Fn10].



### ■ Functions that can be assigned in [Setting in REC mode]

<ul style="list-style-type: none"> <li>– [Wi-Fi]: [Fn6]*</li> <li>– [Q.MENU]: [Fn2]*</li> <li>– [Video Record]</li> <li>– [LVF/Monitor Switch]: [Fn3]*</li> <li>– [LVF/Monitor Disp. Style]</li> <li>– [AF-Point Scope]: [Fn4]*</li> <li>– [AF/AE LOCK]</li> <li>– [AF-ON]</li> <li>– [Preview]: [Fn5]*</li> <li>– [One Push AE]</li> <li>– [Touch AE]</li> <li>– [Level Gauge]: [Fn8]*</li> <li>– [Focus Area Set]</li> <li>– [Zoom Control]</li> <li>– [1 Shot RAW+JPG]</li> <li>– [1 Shot Spot Metering]</li> <li>– [1 Shot "6K/4K PHOTO"]</li> <li>– [Operation Lock]</li> <li>– [Dial Operation Switch]</li> <li>– [Destination Slot]</li> <li>– [Photo Style]</li> <li>– [Filter Effect]</li> <li>– [Aspect Ratio]</li> <li>– [Picture Size]</li> </ul>	<ul style="list-style-type: none"> <li>– [Quality]</li> <li>– [AFS/AFF]</li> <li>– [Metering Mode]</li> <li>– [Burst Shot Setting]</li> <li>– [6K/4K PHOTO]</li> <li>– [Self Timer]</li> <li>– [High Resolution Mode]</li> <li>– [Bracket]</li> <li>– [Highlight Shadow]</li> <li>– [i.Dynamic]</li> <li>– [i.Resolution]</li> <li>– [Min. Shtr Speed]</li> <li>– [Post Focus]</li> <li>– [HDR]</li> <li>– [Shutter Type]</li> <li>– [Flash Mode]</li> <li>– [Flash Adjust.]</li> <li>– [Wireless Flash Setup]</li> <li>– [Ex. Tele Conv.]</li> <li>– [Digital Zoom]</li> <li>– [Stabilizer]</li> <li>– [I.S. Lock (Video)]: [Fn9]*</li> <li>– [4K Live Cropping]</li> <li>– [Motion Pic. Set]</li> </ul>	<ul style="list-style-type: none"> <li>– [Picture Mode in Rec.]</li> <li>– [Mic Level Adj.]</li> <li>– [Mic. Directivity Adjust]</li> <li>– [Silent Mode]</li> <li>– [Peaking]</li> <li>– [Histogram]: [Fn7]*</li> <li>– [Guide Line]</li> <li>– [Zebra Pattern]</li> <li>– [Monochrome Live View]</li> <li>– [Constant Preview]</li> <li>– [Rec Area]</li> <li>– [Step Zoom]</li> <li>– [Zoom Speed]</li> <li>– [Night Mode]</li> <li>– [Exposure Comp.]</li> <li>– [Sensitivity]</li> <li>– [White Balance]</li> <li>– Each item in [White Balance]</li> <li>– Each item in [Photo Style]</li> <li>– [AF Mode/MF]: [Fn1]*</li> <li>– [Rec / Playback Switch]</li> <li>– [Off]</li> <li>– [Restore to Default]</li> </ul>
---	---	--

\* Function button settings at the time of purchase.

• By default, [Off] is assigned to the buttons [Fn10] to [Fn19].

- With [Video Record], you can start/stop recording a motion picture in the same way as with the motion picture button.
- When set to [Focus Area Set], it is possible to display the position setting screen of either AF area or MF Assist.
- When [1 Shot RAW+JPG] is set, it will record the RAW file and a fine JPEG image simultaneously once only. It will return to original quality after recording.
- When [1 Shot Spot Metering] is set, it will record with [Metering Mode] set to [□] (spot) once only. It will return to original Metering Mode after recording.
- When [1 Shot "6K/4K PHOTO"] is set, recording is performed in a specified 6K/4K Photo Mode only once. After the recording has finished, the camera returns to normal state.
- When [Operation Lock] is set, a certain type of operation is disabled. Set the type of operation to be disabled in [Operation Lock Setting] in the [Custom] ([Operation]) menu.
- [Destination Slot] is available only when [Double Slot Function] is set to [Relay Rec].
- If you assign [Rec / Playback Switch], you can switch between recording and playback modes.

## Using the function buttons during playback

You can directly set an assigned function to a selected image by pressing the function button during playback.

Example: When [Fn1] is set to [Rating★3]

- 1 Press ◀/▶ to select the picture.
- 2 Press [Fn1], and then set the image as [Rating★3].



## ■ Functions that can be assigned in [Setting in PLAY mode]

- The following functions can be assigned to the button [Fn1], [Fn3], [Fn4] or [Fn5].

– [Wi-Fi]: [Fn1]*	– [Rating★3]
– [LVF/Monitor Switch]: [Fn3]*	– [Rating★4]
– [Rec / Playback Switch]	– [Rating★5]
– [Slot Change]	– [RAW Processing]
– [6K/4K Photo Play]	– [6K/4K PHOTO Bulk Saving]
– [Delete Single]	– [Copy]
– [Protect]	– [Night Mode]
– [Rating★1]	– [Off]
– [Rating★2]	– [Restore to Default]

\* Function button settings at the time of purchase.

- By default, [Off] is assigned to the buttons [Fn4] or [Fn5].

- If you assign [Slot Change], a screen will be displayed, allowing you to switch the card slot for playback.
- If you assign [6K/4K Photo Play], a screen will be displayed, allowing you to select the pictures to be extracted from a 6K/4K burst file and saved.

## Assigning a function to the function lever

Register a function and its setting that operate when you set the function lever (P48) to [MODE2].

### 1 Select the menu.

**MENU** → [Custom] → [Operation] → [Fn Lever Setting] → [Function of Fn Lever]

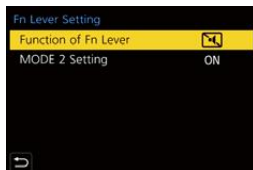

### 2 Press ▲/▼ to select the function you want to assign, and press [MENU/SET].

- [AF Mode]	- [Bracket]
- [Quality]	- [Touch Screen]
- [Photo Style]	- [Touch Pad AF]
- [Long Shtr NR]	- [Auto Review (Photo)]
- [Stabilizer]	- [Peaking]
- [6K/4K PHOTO (Pre-Burst)]	- [Night Mode]
- [Self Timer]	- [Front/Rear/Control Dial Lock]
- [Silent Mode]*	- [Off]
- [Shutter Type]	- [Restore to Default]

\* Default function lever setting.

- To reset the function lever setting to the default, select [Restore to Default].

### 3 Press ▲/▼ to select [MODE 2 Setting], and press [MENU/SET].

### 4 Press ▲/▼ to select the function setting selected in step 2, and press [MENU/SET].

- The screen shown here is an example, where [Self Timer] has been assigned to register it in combination with the [<sub>2</sub>] setting.



- Assigning [Front/Rear/Control Dial Lock] will disable the front/rear/control dial operation of screens such as the recording screen.

## Entering Text

Follow the steps below when the text entry screen is displayed.

### 1 Press ▲/▼/◀/▶ to select text and then press [MENU/SET] to register.

- To enter the same character again, rotate the control dial right to move the cursor.
- The following operations can be performed by moving the cursor to the item and pressing [MENU/SET]:



- [A/a]: Switch text between [A] (upper case characters), [a] (lower case characters), [1] (numbers), and [&] (special characters)
- [ ]: Enter a blank
- [Delete]: Delete a character
- [ < ]: Move the entry position cursor to the left
- [ > ]: Move the entry position cursor to the right
- A maximum of 30 characters can be entered.  
(Maximum of 9 characters when setting names in [Face Recog.]
- A maximum of 15 characters can be entered for [ \ ], [ [ ], [ ] ], [ • ] and [ - ].  
(Maximum of 6 characters when setting names in [Face Recog.]

### 2 Press ▲/▼/◀/▶ to move the cursor to [Set] and then press [MENU/SET] to end text input.



# 3.

## Recording Modes

### Taking Pictures using the Automatic Function (Intelligent Auto Mode)

Recording Mode:  

In this mode, the camera makes the optimal settings for the subject and scene.

#### 1 Set the mode dial to [iA].

- At the time of purchase, the mode is set to Intelligent Auto Plus Mode.

#### 2 Align the screen with the subject.

- When the camera identifies the optimum scene, the icon of the scene concerned will change. (Automatic Scene Detection)

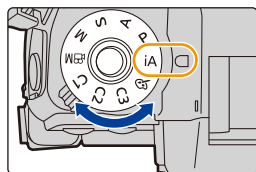

### The camera detects scenes automatically (Scene Detection)

(📷: When taking pictures, 📹: When recording motion pictures)



[i-Portrait]



[i-Scenery]



[i-Macro]



[i-Night Portrait]\*1



[i-Night Scenery]



[iHandheld Night Shot]\*2



[i-Food]



[i-Baby]\*3



[i-Sunset]

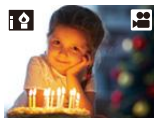

[i-Low Light]



IA

\*1 Displayed when an external flash is used.

\*2 Only displayed when [iHandheld Night Shot] is set to [ON].

\*3 When [Face Recog.] is set to [ON], [IA] will be displayed for birthdays of registered faces already set only when the Face/Eye of a person younger than 3 years old is detected.

• [IA] is set if none of the scenes are applicable, and the standard settings are set.

• When recording is performed with the 6K/4K Photo or Post Focus function, Scene Detection works in the same way as when motion picture is recorded.

### ■ The Backlight Compensation

• When there is a backlight, the subject appears darker and the camera will automatically attempt to correct it by increasing the brightness of the picture.

### ■ Switching between Intelligent Auto Plus Mode and Intelligent Auto Mode

#### 1 Select the menu.

MENU → IA [Intelligent Auto] → [Intelligent Auto Mode]



#### 2 Press ▲/▼ to select [IA+] or [IA] and then press [MENU/SET].



It is also possible to display the selection screen by touching the Recording Mode icon in recording screen.







Intelligent Auto Plus Mode allows you to adjust the settings below while also using Intelligent Auto Mode for other settings.

	 Intelligent Auto Plus Mode	 Intelligent Auto Mode
<b>Setting the brightness</b>	○	—
<b>Setting the color tone</b>	○	—
<b>Defocus Control</b>	○	—
<b>Menus that can be set</b>	Many	Few





### ■ Auto Focus, Face/Eye Detection, and Face Recognition





The Auto Focus Mode is automatically set to . If you touch the subject, the AF tracking function will work.

- The AF tracking function will also work if you press  and then press the shutter button halfway.
- You cannot specify the person or eye to be brought into focus when using .
- When [Face Recog.] is set to [ON], and the face similar to the registered face is detected, [R] is displayed in the top right of , , and .



### ■ About the flash

When recording with the flash, the camera automatically selects ,  (AUTO/Red-Eye Reduction),  or  according to the type and brightness of the subject.

- For information on the external flash, refer to P155.
- When  or  is set, Red-Eye Removal is enabled.
- Shutter speed will be slower during  or .

### ■ Scene Detection

- Use a tripod or similar support when the scene detection has been identified as . When the camera has judged that camera shake is minimal, the shutter speed becomes slower than normal.  
Take care not to move the camera while taking pictures.
- Depending on recording conditions, different scene types may be selected for the same subject.

## [Intelligent Auto] menu

Set the functions available only for Intelligent Auto Plus Mode and Intelligent Auto Mode.

**MENU** → **IA** [Intelligent Auto]

### Taking handheld shots of night scenes ([iHandheld Night Shot])

When [N] is detected while taking handheld night shots, pictures of the night scenery will be taken at a high burst speed and composed into a single picture.

**MENU** → **IA** [Intelligent Auto] → [iHandheld Night Shot] → [ON]/[OFF]

- The angle of view will be slightly narrower.
- Do not move the camera during the continuous shooting after pressing the shutter button.
- Flash is fixed to [☹] (forced flash off).

### Combining pictures into a single picture with rich gradation ([iHDR])

When there is, for example, strong contrast between the background and the subject, multiple still pictures are recorded with differing exposures and combined to create a single still picture rich in gradation.

[iHDR] works automatically as needed. When it does, [HDR] is displayed on the screen.

**MENU** → **IA** [Intelligent Auto] → [iHDR] → [ON]/[OFF]

- The angle of view will be slightly narrower.
- Do not move the camera during the continuous shooting after pressing the shutter button.
- You cannot take the next picture until the combination of pictures is complete.
- A moving subject may be recorded with unnatural blurs.



#### Not available in these cases:

- [iHandheld Night Shot]/[iHDR] do not work for the pictures taken during a motion picture recording.
- [iHandheld Night Shot]/[iHDR] are not available in the following cases:
  - When recording 6K/4K photos
  - When recording with the Post Focus function
  - When recording in Burst Mode
  - When recording with the Bracket function
  - When [Quality] is set to [RAW<sub>Hi</sub>], [RAW<sub>Lo</sub>] or [RAW]
  - When [Ex. Tele Conv.] in the [Rec] menu is set
  - When using [Time Lapse Shot]
  - When using [Stop Motion Animation] (only when [Auto Shooting] is set)
- [iHDR] is not available in the following cases:
  - When recording using the flash

## Taking pictures with customized color, defocus control, and brightness settings

Recording Mode: 

### ■ Setting color

- 1 Press [WB].
- 2 Rotate the rear dial to adjust color.
  - To return to the recording screen, press [WB] again.
  - The color setting will return to the default level (center point) when this unit is turned off or the camera is switched to another Recording Mode.

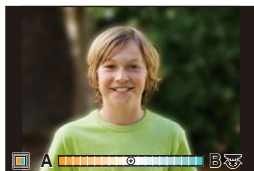

### ■ Taking a picture with a blurred background (Defocus Control)

- 1 Press [Z] to display the brightness setting screen.
- 2 Press [Fn1] to display the setting screen.
- 3 Set the blurriness by rotating the rear dial.
  - To return to the recording screen, press [MENU/SET].
  - To cancel the setting, press [Fn2] on the blurriness setting screen.
  - Auto Focus Mode is set to [AF].  
The position of the AF area can be set by touching the screen. (Its size cannot be changed)

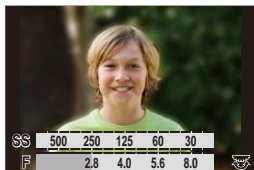



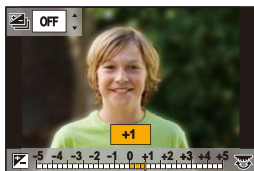

### ■ Setting brightness

- 1 Press [Z].
- 2 Rotate the rear dial to adjust brightness.
  - You can adjust the Exposure Bracket setting by pressing ▲/▼ while the brightness setting screen is displayed. (P142)
  - To return to the recording screen, press [Z] again.



### Change the settings by using the touch screen

- 1 Touch [  ].
- 2 Touch the item you want to set.
  - [  ]: Color tone
  - [  ]: Defocus level
  - [  ]: Brightness
- 3 Drag the slide bar to set.
  - To return to the recording screen, press [MENU/SET].



- Depending on the lens used, you may hear a sound from the lens while operating Defocus Control. This is due to the aperture operation of the lens and is not a malfunction.
- Depending on the lens used, operational sound of the Defocus Control may be recorded during the recording of a motion picture when the function is used.



# Taking Pictures with Automatically Adjusted Aperture and Shutter Speed (Program AE Mode)

Recording Mode: **P**

The camera automatically sets the shutter speed and the aperture value according to the brightness of the subject.

You can take pictures with greater freedom by changing various settings in the [Rec] menu.

- 1** Set the mode dial to **[P]**.
- 2** Press the shutter button halfway and display the aperture value and shutter speed value on the screen.

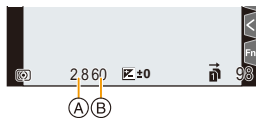

- (A) Aperture value
- (B) Shutter speed

- If the exposure is not adequate when the shutter button is pressed halfway, the aperture value and shutter speed turn red and blink.

## ■ Program Shift

You can change the preset aperture value and shutter speed without changing the exposure. This is called Program Shift.

It enables you to, for example, make the background more defocused by decreasing the aperture value or capture a moving subject more dynamically by slowing the shutter speed.

- 1 Press the shutter button halfway and display the aperture value and shutter speed value on the screen.
- 2 While the values are displayed (about 10 seconds), perform Program Shift by rotating the rear dial or front dial.

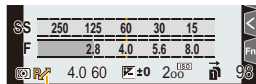

Ⓐ Program Shift indication

- To cancel Program Shift, perform either of the following operations:
  - Turn off the camera.
  - Rotate the front/rear dial until the Program Shift indication disappears.
- Program Shift can easily be canceled by setting a function button to [One Push AE]. (P78)

### Not available in these cases:

- Program Shift is not available in the following cases:
  - When recording using the flash
  - When recording 6K/4K photos
  - When recording with the Post Focus function
  - When the ISO sensitivity is set to [ISO]





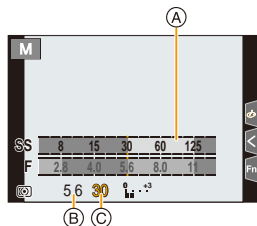

# Taking Pictures by Specifying the Aperture/ Shutter Speed

Recording Mode: **A S M**

(Example: In Manual Exposure Mode)



- (A) Exposure meter
- (B) Aperture value
- (C) Shutter speed

<p><b>Aperture value</b></p>	 <p><b>Small</b> It becomes easier to defocus the background.</p>	 <p><b>Large</b> It becomes easier to maintain focus as far as the background.</p>
<p><b>Shutter speed</b></p>	 <p><b>Slow</b> It becomes easier to express movement.</p>	 <p><b>Fast</b> It becomes easier to freeze movement.</p>

- The effects of the set aperture value and shutter speed will not be visible on the recording screen. To check on the recording screen, please use [Preview]. (P77)
- The brightness of the screen and the recorded pictures may differ. Check the pictures on the playback screen.
- Rotate the front/rear dial to display the Exposure Meter. Unsuitable areas of the range are displayed in red.
- If the exposure is not adequate, the aperture value and the shutter speed turn red and blink when the shutter button is pressed halfway.

## Aperture-Priority AE Mode

When you set the aperture value, the camera automatically optimizes the shutter speed for the brightness of the subject.

- 1 Set the mode dial to [A].
- 2 Set the aperture value by rotating the rear dial or the front dial.

- (A) Aperture value
- (B) Exposure meter

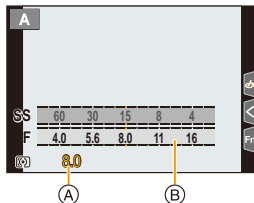

- When using a lens having an aperture ring, set the position of the aperture ring to [A] to activate the front/rear dial settings. At positions other than [A], the ring setting takes priority.

## Shutter-Priority AE Mode

When you set the shutter speed, the camera automatically optimizes the aperture value for the brightness of the subject.

- 1 Set the mode dial to [S].
- 2 Set the shutter speed by rotating the rear dial or the front dial.

- (A) Shutter speed
- (B) Exposure meter

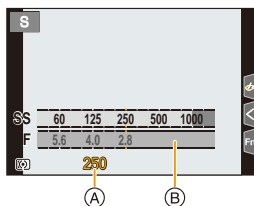

- When the flash is activated, the fastest shutter speed that can be selected is 1/250th of a second. (P159)

## Manual Exposure Mode

Determine the exposure by manually setting the aperture value and the shutter speed.

- 1 Set the mode dial to [M].
- 2 Rotate the rear dial to set the shutter speed, and rotate the front dial to set the aperture value.

- (A) Exposure meter
- (B) Aperture value
- (C) Shutter speed
- (D) Manual Exposure Assistance

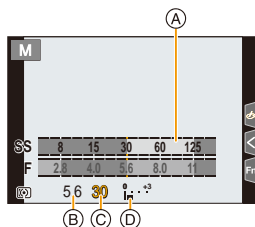

### Available Shutter Speed (Sec.)

- [B] (Bulb), 60 to 1/8000th (with the mechanical shutter)
- [B] (Bulb), 60 to 1/2000th (with the electronic front curtain)
- 1 to 1/32000th (with the electronic shutter)

### Optimizing the ISO sensitivity for the shutter speed and aperture value

When the ISO sensitivity is set to [AUTO], the camera sets the ISO sensitivity automatically so that the exposure will be appropriate for the shutter speed and aperture value.

- Depending on recording conditions, an appropriate exposure may not be set or the ISO sensitivity may become higher.

### Manual Exposure Assistance

	The exposure is adequate.
	Set to faster shutter speed or larger aperture value.
	Set to slower shutter speed or smaller aperture value.

- The Manual Exposure Assistance is an approximation. We recommend checking the pictures on the playback screen.

- When using a lens having an aperture ring, set the position of the aperture ring to [A] to activate the front/rear dial settings. At positions other than [A], the ring setting takes priority.
- When the flash is activated, the fastest shutter speed that can be selected is 1/250th of a second. (P159)

### ■ About [B] (Bulb)

If you set the shutter speed to [B], the shutter stays open while the shutter button is pressed fully (up to approximately 30 minutes).

The shutter closes if you release the shutter button.

Use this when you want to keep the shutter open for a long time to take pictures of fireworks, a night scene etc.

- It can only be used with Manual Exposure Mode.



- We recommend using a tripod or the shutter remote control (DMW-RSL1: optional) when you take pictures with the shutter speed set to [B].
- When you take pictures with the shutter speed set to [B], noise may become visible. To avoid picture noise, we recommend setting [Long Shtr NR] in the [Rec] menu to [ON] before taking pictures.



### Not available in these cases:

- This function is not available in the following cases:
  - When recording using the flash (only when [Flash Synchro] is set to [2ND])
  - When recording in Burst Mode (only when [Burst Shot Setting] is set to [SH2]/[SH1]/[SH2 PRE]/[SH1 PRE])
  - When recording 6K/4K photos
  - When recording with the Post Focus function
  - When recording in [High Resolution Mode]
  - When recording with the Bracket function
  - When [Silent Mode] is set to [ON]
  - When using the electronic shutter
  - When [HDR] is set to [ON]
  - When using [Time Lapse Shot]
  - When using [Stop Motion Animation] (only when [Auto Shooting] is set)

## Confirm the Effects of Aperture and Shutter Speed (Preview Mode)

Applicable modes: **IA** **IA** **P** **A** **S** **M** **MEM** **RECALL**

- **Confirm the effects of aperture:** You can check the depth of field (effective focus range) before taking a picture by closing the diaphragm blades to the aperture value you set.
- **Confirm the effects of shutter speed:** Movement can be confirmed by displaying the actual picture that will be taken with that shutter speed.

Switch to confirmation screen by pressing the preview button.

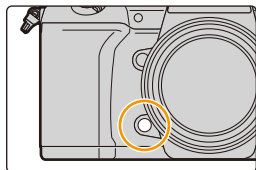

Normal recording screen



Aperture effect preview screen

Aperture effect: ○  
Shutter speed effect: —



Shutter speed effect preview screen

Aperture effect: ○  
Shutter speed effect: ○



### Depth of field properties

	Aperture value	Small	Large
*1	Focus length of the lens	Tele	Wide
	Distance to the subject	Near	Distant
	<b>Depth of field (effective focus range)</b>	<b>Shallow (Narrow)*2</b>	<b>Deep (Wide)*3</b>

\*1 Recording conditions

\*2 Example: When you want to take a picture with a blurred background etc.

\*3 Example: When you want to take a picture with everything in focus including the background etc.

• It is possible to record while in Preview Mode.

• Range for shutter speed effect check is 8 seconds to 1/32000th of a second.

### Not available in these cases:



• Preview Mode is not available when recording with [6K/4K Pre-Burst].

## Easily set aperture/shutter speed for suitable exposure (One Push AE)

Applicable modes:  **P A S M** 

When the exposure setting is too bright or too dark, you can use one push AE to achieve a suitable exposure setting.

### How to tell if the exposure is not adequate

- If the aperture values and shutter speed blink red when the shutter button is pressed halfway.
- If the Manual Exposure Assistance (P75) is anything other than   when in Manual Exposure mode.

- 1 Set a function button to [One Push AE]. (P60)
- 2 (When exposure is not adequate)  
Press function button.

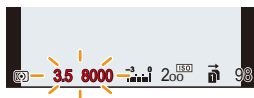

Blink red

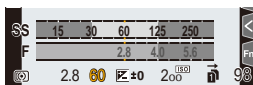

The exposure is changed to give a suitable exposure.

- The exposure meter is displayed, and the aperture and shutter speed are changed to give a suitable exposure.
- In the following cases, suitable exposure cannot be set.
  - When the subject is extremely dark and it is not possible to achieve adequate exposure by changing the aperture value or shutter speed
  - When recording using the flash
  - In Preview Mode
  - When using a lens that includes an aperture ring

# Taking Pictures with different image effects (Creative Control Mode)

Recording Mode: 

You can set the effects to add by selecting example images and checking them on the screen.

- 1 Set the mode dial to .
- 2 Press  $\blacktriangle/\blacktriangledown$  to select the image effects (filters).

(A) Preview display

- You can also select the image effects (filters) by touching the example images.

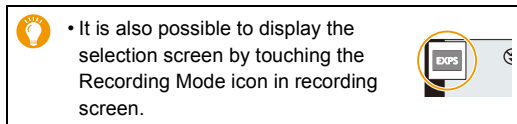

- 3 Press [MENU/SET].



Displaying the description of each image effect

Press [DISP.] while the image effect selection screen is displayed.

- When it is set to the guide display, explanations for each picture effect are displayed.

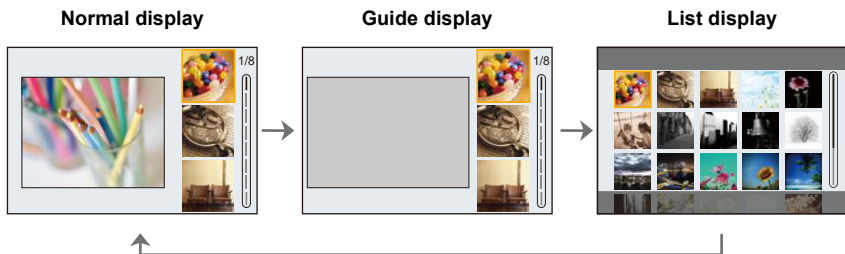

- White Balance will be fixed to [AWB], and [Sensitivity] will be fixed to [AUTO].
- Depending on the image effect, the recording screen may seem as if frames are missed.

### ■ [Creative Control] menu

Set the functions available only for Creative Control Mode.

**MENU** →  **[Creative Control]**

<b>[Filter Effect]</b>	Displays the image effect (filter) selection screen.
<b>[Simultaneous Record w/o Filter]</b>	Allows you to set the camera to take a picture with and without an image effect simultaneously.



### Types of image effects

 <b>[Expressive]</b>	 <b>[Retro]</b>	 <b>[Old Days]</b>
 <b>[High Key]</b>	 <b>[Low Key]</b>	 <b>[Sepia]</b>
 <b>[Monochrome]</b>	 <b>[Dynamic Monochrome]</b>	 <b>[Rough Monochrome]</b>
 <b>[Silky Monochrome]</b>	 <b>[Impressive Art]</b>	 <b>[High Dynamic]</b>
 <b>[Cross Process]</b>	 <b>[Toy Effect]</b>	 <b>[Toy Pop]</b>
 <b>[Bleach Bypass]</b>	 <b>[Miniature Effect]</b>	 <b>[Soft Focus]</b>
 <b>[Fantasy]</b>	 <b>[Star Filter]</b>	 <b>[One Point Color]</b>
 <b>[Sunshine]</b>		



### ■ Setting the type of defocus ([Miniature Effect])

#### 1 Press ▲ to display the setting screen.

- Setting screen can also be displayed by touching in order of [  ] then [  ].

#### 2 Press ▲/▼ or ◀/▶ to move the in-focus portion.

- You can also move the in-focus portion by touching the screen on the recording screen.
- To set the recording orientation (defocus orientation), touch [  ].



#### 3 Rotate the rear dial to change the size of in-focus portion.



- The portion can also be enlarged/reduced by pinching out/pinching in the screen.
- To reset the in-focus portion setting to the default, press [DISP.].

#### 4 Press [MENU/SET] to set.

- No sound is recorded in motion pictures.
- Approximately 1/10 of the time period is recorded.  
(If you record for 10 minutes, the resulting motion picture recording will be approximately 1 minute long.)  
The displayed available recording time is approximately 10 times.
- If you end motion picture recording after a short time, the camera may go on recording for a certain period.

### ■ Set the color to leave in ([One Point Color])

#### 1 Press ▲ to display the setting screen.

- Setting screen can also be displayed by touching in order of [  ] then [  ].

#### 2 Select the color you want to leave by moving the frame with ▲/▼/◀/▶.



- You can also select the color you want to leave by touching the screen.
- To return the frame back to the center, press [DISP.].

#### 3 Press [MENU/SET] to set.



- Depending on the subject, the set color may not be left in.

### ■ Setting the position and size of the light source ([Sunshine])

- 1 Press **▲** to display the setting screen.
  - Setting screen can also be displayed by touching in order of [  ] then [  ].
- 2 Press **▲/▼/◀/▶** to move the center position of the light source.
  - The position of the light source can also be moved by touching the screen.



#### Point for when placing the center of the light source

A more natural appearance can be created by placing the center of the light source outside the image.





- 3 Adjust the size of the light source by rotating the rear dial.
  - The display can also be enlarged/reduced by pinching out/pinching in.
  - To reset the light source setting to the default, press [DISP.].
- 4 Press [MENU/SET] to set.

### Adjust the effect to fit your preferences

- 1 Press [WB].
- 2 Rotate the rear dial to set.
  - To return to the recording screen, press [WB] again.

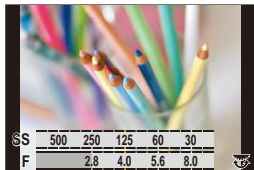

Image effect	Items that can be set		
[Expressive]	Freshness	Understated colors	↔ Pop colors
[Retro]	Color	Yellowish tinge	↔ Reddish tinge
[Old Days]	Contrast	Low contrast	↔ High contrast
[High Key]	Color	Pinkish tinge	↔ Aquamarinish tinge
[Low Key]	Color	Reddish tinge	↔ Bluish tinge
[Sepia]	Contrast	Low contrast	↔ High contrast

Image effect	Items that can be set		
<b>[Monochrome]</b>	Color	Yellowish tinge ↔	Bluish tinge
<b>[Dynamic Monochrome]</b>	Contrast	Low contrast ↔	High contrast
<b>[Rough Monochrome]</b>	Grittiness	Less gritty ↔	Grittier
<b>[Silky Monochrome]</b>	Extent of defocus	Weak defocus ↔	Strong defocus
<b>[Impressive Art]</b>	Freshness	Black and white ↔	Pop colors
<b>[High Dynamic]</b>	Freshness	Black and white ↔	Pop colors
<b>[Cross Process]</b>	Color	Greenish tinge/Bluish tinge/Yellowish tinge/ Reddish tinge	
<b>[Toy Effect]</b>	Color	Orangish tinge ↔	Bluish tinge
<b>[Toy Pop]</b>	Area with reduced peripheral brightness	Small ↔	Large
<b>[Bleach Bypass]</b>	Contrast	Low contrast ↔	High contrast
<b>[Miniature Effect]</b>	Freshness	Understated colors ↔	Pop colors
<b>[Soft Focus]</b>	Extent of defocus	Weak defocus ↔	Strong defocus
<b>[Fantasy]</b>	Freshness	Understated colors ↔	Pop colors
<b>[Star Filter]</b>		Length of the rays of light Short ↔ Long	
		Number of the rays of light Smaller ↔ Larger	
		Angle of the rays of light Rotate to the left ↔ Rotate to the right	
<b>[One Point Color]</b>	Amount of color left	Small amount of color ↔	Large amount of color
<b>[Sunshine]</b>	Color	Yellowish tinge/Reddish tinge/Bluish tinge/Whitish tinge	

### Taking a picture with a blurred background (Defocus Control)



- 1 Press [  ] to display the brightness setting screen.
- 2 Press [Fn1] to display the setting screen.
- 3 Rotate the rear dial to set.
  - To return to the recording screen, press [MENU/SET].
  - To cancel the setting, press [Fn2] on the blurriness setting screen.



#### Not available in these cases:



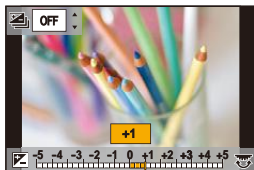

- This function is not available in the following case:
  - [Miniature Effect] (Creative Control Mode)

### Setting brightness

- 1 Press [  ].
- 2 Rotate the rear dial to set.
  - You can adjust the Exposure Bracket setting by pressing ▲/▼ while the brightness setting screen is displayed. (P142)
  - To return to the recording screen, press [  ] again.



#### ■ Change the settings by using the touch screen

- 1 Touch [  ].
- 2 Touch the item you want to set.
  - [  ]: Adjusts an image effect
  - [  ]: Defocus level
  - [  ]: Brightness
- 3 Drag the slide bar to set.
  - To return to the recording screen, press [MENU/SET].



# Registering your preferred settings (Custom Mode)

Recording Mode: **C1** **C2** **C3**

## Registering Personal Menu Settings (Registering custom settings)

Up to 5 sets of current camera settings can be registered using [Cust.Set Mem.]. (C1, C2, C3-1, C3-2, C3-3)

Initial setting of the Program AE Mode is registered as the custom settings initially.

Preparations:

Set in advance the Recording Mode you wish to save and select the desired menu settings on the camera.

**MENU** →  **[Setup]** → **[Cust.Set Mem.]** →

**Custom set where you want to register settings**

- You can register up to three custom sets to **C3** of the mode dial.
- The following menu items are not registered as custom settings.

[Custom] menu	[Setup] menu
– [Menu Guide] – Data registered with [Face Recog.] – The [Profile Setup] setting	– All menus (Excluding [Night Mode])
	[Playback] menu
	– [Rotate Disp.] – [Picture Sort] – [Delete Confirmation]

## Calling up a registered set of custom settings

### Set the mode dial to [C1], [C2] or [C3].

- The corresponding custom set will be called up. If you set the mode dial to [C3], the last used custom set will be called up.

#### ■ To change a custom set in [C3] ([Custom Mode] menu)

- 1 Set the mode dial to [C3].
- 2 Select the menu.

**MENU** → **C [Custom Mode]**

- 3 Press ▲/▼ to select the custom setting you want to use, and then press [MENU/SET].

 It is also possible to display the selection screen by touching the Recording Mode icon in recording screen.



- Saving of the selected custom settings is displayed on the screen.



#### ■ Changing the registered content

Registered contents do not change when the menu setting is changed temporarily with the mode dial set to C1, C2 or C3. To change the registered settings, overwrite the registered content using [Cust.Set Mem.] on the [Setup] menu.

# 4.

## Focus, Brightness (Exposure) and Color tone Settings

### Adjusting Focus Automatically

- 1 Set the focus mode lever to [AFS/AFF] or [AFC].

- The Focus Mode will be set. (P89)

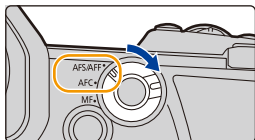

- 2 Press [  ].

- 3 Press  /  to select AF Mode and then press [MENU/SET].

- The Auto Focus Mode will be set. (P92)



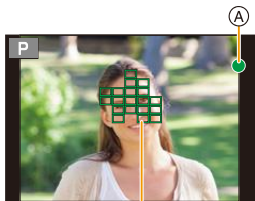

- 4 Press the shutter button halfway.

- Auto Focus will be activated.



Focus	When the subject is focused	When the subject is not focused
Focus indication (A)	On	Blinks
AF area (B)	Green	—
Sound	Beeps 2 times	—

- The focus indication is displayed as [  ] in a dark environment, and focusing may take longer than usual.
- If the camera detects stars in the night sky after displaying [  ], Starlight AF will be activated. When focus is achieved, the focus indication [  ] and AF areas in focus are displayed. (Starlight AF cannot perform detection on the edges of the screen.)

- If you zoom in/out after focusing on a subject, the focus may lose its accuracy. In that case, re-adjust the focus.



#### **Subjects and recording conditions which are difficult to focus**

- Fast-moving subjects, extremely bright subjects or subjects without contrast.
- When recording subjects through windows or near shiny objects.
- When it is dark or when jitter occurs.
- When the camera is too close to the subject or when taking a picture of both distant and near subjects.



MENU









## Setting the Focus Mode (AFS/AFF/AFC)

Applicable modes:         

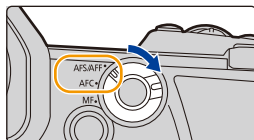
The method for achieving focus when the shutter button is pressed halfway is set.

**Set the focus mode lever.**



Item		Scene (recommended)	
[AFS/ AFF]	[AFS]	Subject is still (Scenery, anniversary photograph, etc.)	<p>"AFS" is an abbreviation of "Auto Focus Single".</p> <p>The focus stays locked while the shutter button is pressed halfway, so you can perform recording while changing the composition.</p> 
	[AFF]	Movement cannot be predicted (Children, pets, etc.)	<p>"AFF" is an abbreviation of "Auto Focus Flexible".</p> <p>If the subject moves while the shutter button is pressed halfway, the focus is readjusted automatically according to the movement of the subject.</p> 
		You can switch the setting with [AFS/AFF] in the [Rec]/[Motion Picture] menu.	
[AFC]		Subject is moving (Sport, trains, etc.)	<p>"AFC" is an abbreviation of "Auto Focus Continuous".</p> <p>In this mode, while the shutter button is pressed halfway, focusing is constantly performed to match the movement of the subject.</p> 
[MF]		Set the focus manually. (P103)	

**When recording using [AFF], [AFC]**

- When the subject is moving, the focusing is performed by predicting the subject position at the time of recording. (Movement prediction)
- It may take time to focus on the subject when you operate the zoom from Wide to Tele or suddenly change the subject from a distant one to a nearby one.
- Press the shutter button halfway again when it is difficult to focus on the subject.

- Focus Mode settings of [AFF] and [AFC] work in the same manner as [AFS] in the following situations:
  - Creative Video Mode
  - When recording with [6K/4K Burst(S/S)]
  - In low light situations
- [AFF] is not available when recording 6K/4K photos. [Continuous AF] works during recording.
- The Focus Mode setting cannot be changed when recording is performed with the Post Focus function.
- When recording in [High Resolution Mode], the Focus Mode [AFF] or [AFC] changes to [AFS].

**Customizing the operation settings of Auto Focus for picture taking**

Applicable modes: **P A S M**

- This item works only when the Focus Mode is set to [AFF] or [AFC].

**MENU** → **[Rec]** → **[AF Custom Setting(Photo)]**

<b>[Set 1]</b>	This is a basic general purpose setting.
<b>[Set 2]</b>	This is a setting suited for scenes where the subject moves in only one direction at a constant speed.
<b>[Set 3]</b>	This is a setting suited for scenes where the subject moves in random directions and obstacles are likely to appear in the image.
<b>[Set 4]</b>	This is a setting suited for scenes where the speed of the subject changes significantly.

## ■ Adjusting the AF Custom settings

- 1 Press ◀/▶ to select the AF Custom setting.
- 2 Press ▲/▼ to select the items, and then press ◀/▶ to adjust.
  - To reset to the default settings, press [DISP.].

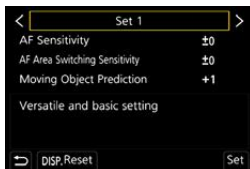

[AF Sensitivity]	+	When the distance to the subject changes drastically, the camera re-adjusts the focus immediately. You can bring different subjects into focus one after another.
	-	When the distance to the subject changes drastically, the camera waits for a short period of time before re-adjusting the focus. This allows you to prevent the focus from being accidentally re-adjusted when, for example, an object moves across the image.
[AF Area Switching Sensitivity]	+	When the subject moves out of the AF area, the camera immediately switches or moves the AF area to keep the subject in focus.
	-	The camera switches or moves the AF area at a gradual pace. Effects caused by a slight movement of the subject or by obstacles in front of the camera will be minimized.
[Moving Object Prediction]	0	This is suited to still subjects. Effects caused by a slight movement of the subject or by obstacles in front of the camera will be minimized.
	1	These are suited to a subject that changes its moving speed.
	2	You can prevent defocusing caused by a sudden movement of the subject.

- 3 Press [MENU/SET].

### Not available in these cases:

- This function is not available in the following cases:
  - When recording 6K/4K photos
  - When recording in [High Resolution Mode]

## Setting the Auto Focus Mode

Applicable modes: **P** **A** **S** **M**

This allows the focusing method that suits the positions and number of the subjects to be selected.

Press [ ].



([Face/Eye  
Detection])

A person's face, eyes, and body (the entire body or the upper half of the body) are automatically detected.

- When the camera detects a person's face (A, B) or body (C), an AF area is displayed over the detected person.

Yellow:

This is the AF area for the person to be brought into focus. The camera automatically selects the person.

White:

These are the AF areas for people other than the person to be brought into focus. This type of AF area is displayed when more than one person is detected.

- When a person's face or eyes are detected, the eye closer to the camera will be brought into focus.\*

- \* The exposure will be adjusted to the face. (When [Metering Mode] is set to [M])
- When a person's body is detected, it will be brought into focus.
- Eye Detection works only for the eyes inside the yellow frame (A).
- The camera can detect the faces of up to 15 people.
- To specify the person or eye to be brought into focus, align an AF area with the desired person or eye. You can do so easily by touching a person indicated with an AF area. To cancel the setting, touch [ ].

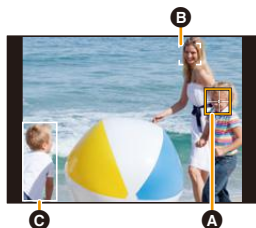

  
**[[Tracking]]**

The camera keeps adjusting the focus and exposure automatically to the specified moving object. (Dynamic Tracking)  
(When [Metering Mode] is set to [☉])

- Perform either of the following operations to lock the subject to be tracked:

Button operation:

Aim the AF tracking frame **D** over the subject, and press the shutter button halfway.

Touch operation:

Touch the subject.

- If it fails to lock, AF area will flash in red, and disappear.
- The AF area turns yellow while the subject is locked (green while the shutter button is pressed halfway).
- Lock is canceled when [MENU/SET] is pressed, or [**AF**] is touched.



  
**[[225-Area]]**

Up to 225 AF areas can be focused.  
This is effective when a subject is not in the center of the screen.



, etc.  
**[[Custom Multi]]**

From among 225 AF areas, you can freely set the optimum shape of the AF area for the subject. (P95)



  
**[[1-Area]]**

The camera focuses on the subject in the AF area on the screen.



  
**[[Pinpoint]]**

You can achieve a more precise focus on a point that is smaller than [**■**].  
If you press the shutter button halfway, the screen that lets you check the focus will be enlarged.



### ■ Displaying the AF area position in the magnification window (AF Point Scope)

You can temporarily display the magnification window to check the AF area position and focus.

- When using the [Fn] or [Fn] mode or a mode such as [Fn] ([Custom Multi]), the center area of the screen will be displayed in the magnification window.

#### Press and hold [Fn4] while the recording screen is displayed.

- The Focus Mode will change to [AFS].

When you press the shutter button halfway, the focus will be readjusted with a smaller AF area.

- You can rotate the front/rear dial to adjust the magnification factor.



 : Magnifies/reduces the window in small steps

 : Magnifies/reduces the window in large steps

- The AF area position and the magnification window position cannot be changed.



### 💡 Setting the methods for displaying the magnification window

**MENU** →  [Custom] →  [Focus / Release Shutter] → [AF-Point Scope Setting]

[Keep Enlarged Display]	[ON]:	Displays/hides the magnification window each time the appropriate function button is pressed.
	[OFF]:	Displays the magnification window while the appropriate function button is pressed and held.
[PIP Display]	[FULL]:	Displays the window in full screen mode.
	[PIP]:	Displays the window in windowed mode.

- If the ambient temperature is high or AF Point Scope is used continuously, after [] is displayed, the magnification window may be disabled to protect the camera. Wait until the camera cools down.
- In windowed mode, you can magnify the window by approximately 3× to 6×; in full screen mode, you can magnify the window by approximately 3× to 10×.

### Not available in these cases:

- This function is not available in the following cases:
  - [Miniature Effect] (Creative Control Mode)
  - When recording motion pictures
  - When recording in Burst Mode (only when [Burst Shot Setting] is set to [SH2]/[SH1]/[SH2 PRE]/[SH1 PRE])
  - When recording 6K/4K photos
  - When recording with the Post Focus function
  - When [4K Live Cropping] is set
  - When recording in [Multi Exp.]
  - When using the Digital Zoom

## ■ Setting the shape of the AF area ([Custom Multi])

- 1 Press [ ].
- 2 Select a Custom Multi icon ([ ], etc.), and press ▲.
- 3 Press ◀/▶ to select a setting and then press ▼.

(A) The current shape of the AF area

<p>([Horizontal Pattern])</p>	<p>This shape is convenient for taking panning shots or similar shots.</p>	
<p>([Vertical Pattern])</p>	<p>This shape is convenient for recording objects, such as buildings.</p>	
<p>([Central Pattern])</p>	<p>This shape is convenient when you want to bring the center area into focus.</p>	
<p>([Custom1]/[Custom2]/[Custom3])</p>	<p>You can select a customized setting.</p>	

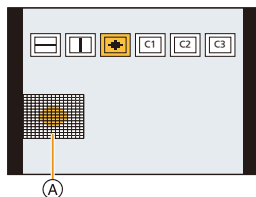

## 4 Select AF areas.

(B) The selected AF areas

When selecting [ ]/[ ]/[ ]

Button operation	Touch operation	Description of operation
▲/▼/◀/▶	Touching	Moves the position
	Pinching in/out	Changes the size
[DISP.]	[Reset]	First time: The position is reset to the center Second time: The size is reset to the default

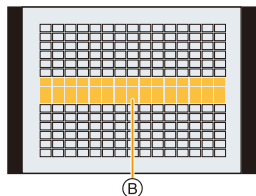

Press [MENU/SET] to set.

**When selecting [C1]/[C2]/[C3]****Touch operation**

Drag your finger over the parts you want to set as AF areas.

- To cancel the selection of a particular AF area, touch the area again.

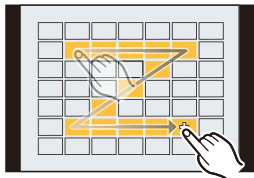
**Button operation**

Press ▲/▼/◀/▶ to select the AF area, and then press [MENU/SET] to set (repeat).

- The setting is canceled when [MENU/SET] is pressed again.
- To cancel all selections, press [DISP.].

**Press [Fn1] to set.****■ Registering the set AF area to [C1], [C2] or [C3]**

- 1 On the screen in step 3 on P95, press ▲.
- 2 Press ▲/▼ to select a destination to which the setting will be registered, and press [MENU/SET].

- Turning off this unit will return the setting adjusted with [.....]/[{}]/[⊕] back to the default setting.

**■ Restrictions on Auto Focus Mode**

- The AF Mode is fixed to [■] in the following cases.
  - When using the Digital Zoom
  - [Miniature Effect] (Creative Control Mode)
- The Auto Focus Mode is fixed to [⊕] when [4K Live Cropping] is set.
- It cannot be set the Auto Focus Mode in the following cases.
  - When recording with the Post Focus function

**👤 ([Face/Eye Detection])**

- If no faces or human bodies are detected, the AF Mode operates as [⊕].

**👤 ([Tracking])**

- In situations where AF Tracking does not work correctly due to certain recording conditions, such as when the subject is small or the location is dark, the operation of [■] is performed.
- [👤] cannot be used with [Time Lapse Shot].
- In the following cases, [👤] operates as [■].
  - [Sepia]/[Monochrome]/[Dynamic Monochrome]/[Rough Monochrome]/[Silky Monochrome]/[Soft Focus]/[Star Filter]/[Sunshine] (Creative Control Mode)
  - [Monochrome]/[L.Monochrome] ([Photo Style])

**📏 ([225-Area]), [⊕], etc. ([Custom Multi])**

- AF areas at the center are brought into focus during 6K/4K photo recording or motion picture recording using [Continuous AF].

**[+] ([Pinpoint])**

- In the following case, [+] operates as [■].
  - When recording motion pictures
  - When recording 6K/4K photos
- It cannot be set to [+] in the following cases.
  - [AFF]/[AFC] (Focus Mode)



## Specifying the AF area position

Specifying the AF area position on the setting screen

 P98

Specifying the AF area position with the joystick

 P100

Specifying the AF area position with the Touch Pad





 P101

Specifying the AF area position with the Touch Function

 P101

### ■ Creating separate AF areas for horizontal and vertical orientations

**MENU** →  [Custom] →  [Focus / Release Shutter] → [Focus Switching for Vert / Hor]

<p><b>[ON]</b></p>	<p>Memorizes separate positions for horizontal and vertical orientations (two vertical orientations, left and right, are available).</p> <ul style="list-style-type: none"> <li>The following last-specified positions will be memorized.               <ul style="list-style-type: none"> <li>The last AF area position (when [], [] or [] is used)</li> <li>The last MF Assist display position</li> </ul> </li> </ul>	
<p><b>[OFF]</b></p>	<p>Sets the same setting for both horizontal and vertical orientations.</p>	

- Before moving or resizing the AF area, cancel the Touch Shutter function.
- The spot metering target can also be moved to match the AF area when the [Metering Mode] is set to [].

#### Not available in these cases:

- This function is not available in the following cases:
  - When using the Digital Zoom
  - When [4K Live Cropping] is set

## Specifying the AF area position on the setting screen

Applicable modes: P A S M

When [], [], [] or [] in Auto Focus Mode is selected, you can change the position and size of the AF area. With [], you can set the lock-on position.

When selecting [], [], [], []

- 1 Press [].
- 2 Select [], [], [] or [] and press ▼.

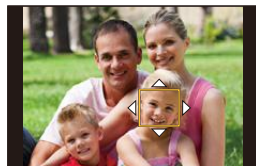

### 3 Change the position and size of the AF area.

- With [], you can set the lock-on position by changing the AF area position.
- To specify the person or eye to be brought into focus when [] has been selected, align any of the AF areas currently indicating human subjects with the desired person or eye. For any position where a person or eye is not located, an AF area that operates in the same way as [] will be set.
- Press [MENU/SET] or touch [] to cancel the AF area settings when using [], [] or [].

Button operation	Touch operation	Description of operation
	Touching	Moves the position
	Pinching out/in	Changes the size (in small steps if [] or [] has been selected)*
	—	Changes the size (in large steps if [] or [] has been selected)*
[DISP.]	[Reset]	First time: The position is reset to the center Second time: The size is reset to the default*

\* This operation is not available for [].

- 4 Press [MENU/SET] to set.



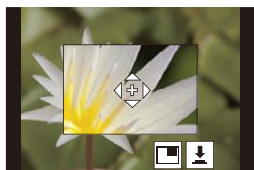

**When selecting [ + ]**

You can set the focus position precisely by enlarging the screen.

- 1 Press [  ].
- 2 Select [ + ] and press ▼.
- 3 Press ▲/▼/◀/▶ to set the focus position and then press [MENU/SET].



- 4 Move [ + ] to the position to be in focus.

Button operation	Touch operation	Description of operation
▲/▼/◀/▶	Touching	Moves [ + ].
	Pinching out/in	Enlarges/reduces the screen in small steps.
	—	Enlarges/reduces the screen in large steps.
		Switches the enlarged display (windowed/full screen). 
[DISP.]	[Reset]	Returns you to the screen in step 3.

- When the picture is displayed in windowed mode, you can enlarge the picture by approximately 3× to 6×; when the picture is displayed in full screen, you can enlarge the picture by approximately 3× to 10×.
- You can also take pictures by touching [  ].

- 5 Press [MENU/SET] to set.

## Specifying the AF area position with the joystick

Applicable modes: P A S M

### 1 Select the menu.

**MENU** → [Custom] → [Operation] → [Joystick Setting] → [D.FOCUS Movement]

### 2 Display the recording screen, and move the joystick to move the AF area.

- To specify the person or eye to be brought into focus when using , align any of the AF areas currently indicating human subjects with the desired person or eye. For any position where a person or eye is not located, an AF area that operates in the same way as will be set.
- You can change the size of the AF area by rotating the front/rear dial.

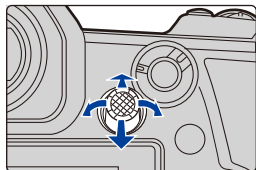

- Press the joystick to switch between the default AF area position and the position you have set. The enlarged display will appear when ([Pinpoint]) is set.

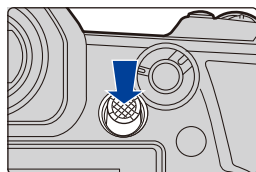

### 3 Press the shutter button halfway to set.

- Press the joystick while the recording screen is displayed to switch between the default AF area position and the position you have set.

## Specifying the AF area position with the Touch Pad

Applicable modes: **P** **A** **S** **M**

You can move the AF area displayed on the viewfinder by touching the monitor.



**MENU** → **[Custom]** → **[Operation]** → **[Touch Settings]** → **[Touch Pad AF]**

<b>[EXACT]</b>	Moves the AF area of the Viewfinder by touching a desired position on the Touch Pad.	
<b>[OFFSET]</b>	Moves the AF area of the viewfinder according to the distance you drag the touch pad.	
<b>[OFF]</b>	—	—

- Press the shutter button halfway to determine the focus position.  
To return the focus position to the center, press [DISP.] before determining the position.
- To specify the person or eye to be brought into focus when the Auto Focus Mode is set to , align any of the AF areas currently indicating human subjects with the desired person or eye. For any position where a person or eye is not located, an AF area that operates in the same way as will be set.
- To cancel the AF area frame when the Auto Focus Mode is set to , or , press [MENU/SET].

## Specifying the AF area position with the Touch Function







Applicable modes: **P** **A** **S** **M**

**MENU** → **[Custom]** → **[Operation]** → **[Touch Settings]** → **[Touch AF]**

<b>[AF]</b>	Optimizes the focus for the touched subject.
<b>[AF+AE]</b>	Optimizes the focus and brightness for the touched subject.
<b>[OFF]</b>	—





## ■ Optimizing the focus for the touched position ([AF])

### 1 Touch the subject.

	Specify the person or eye to be brought into focus when you have selected a person indicated with an AF area. If you have selected any location where a person or eye is not located, move the AF area that operates in the same way as  to the selected location to display the size and position setting screen.
	The touched subject is locked.
	The AF area moves to the subject and the size and position setting screen is displayed.
 , etc.	The AF area moves to the subject and the appropriate setting screen is displayed.
	The AF area moves to the subject and the size and position setting screen is displayed.
	The AF area moves to the subject and the setup screen for the enlarged area is displayed.

### 2 (When /[]/[], etc./[] is set) Touch [Set].

(When [] is set) Touch the [End].

- (When []/[]/[] is set) The AF area setting is cleared if you touch [].





## ■ Optimizing the focus and brightness for a touched position ([AF+AE])

### 1 Touch the subject you want to optimize the brightness for.

- The brightness optimization position is displayed on the center of the AF area. The position follows the movement of the AF area.
- [Metering Mode] is set to [], which is used exclusively for the Touch AE.
- To return the brightness optimization position and the AF area to the center, touch [Reset].



### 2 Touch [Set].

- The AF area with the same function as  is displayed on the touched position.
- To cancel the focus and brightness set with [AF+AE], touch [] ([]) when  is selected).
- When recording with the Touch Shutter, the focus and brightness are optimized for the touched position before recording takes place.

# Adjusting Focus Manually



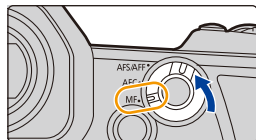

Applicable modes:   P A S M  

Use this function when you want to fix the focus or when the distance between the lens and the subject is determined and you do not want to activate Auto Focus.

## 1 Set the focus mode lever to [MF].



## 2 Press [ ].

- You can also perform the same operation by moving the joystick     (When [Joystick Setting] in the [Custom] ([Operation]) menu is set to [D.FOCUS Movement]).

## 3 Press to adjust the focus position, and press [MENU/SET].

- The assist screen is displayed, enlarging the area. (MF Assist)
- You can also enlarge the area by performing one of the following operations:
  - Rotating the focus ring
  - Moving the focus lever
  - Pinching out or touching the screen twice
- You can also adjust the focus position by dragging the screen.
- To return the focus position to the center, press [DISP].

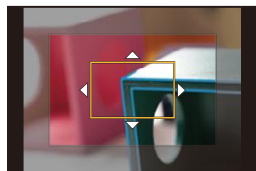

## 4 Adjust the focus.

The operations used to focus manually differ depending on the lens.

**When using an interchangeable lens (H-ES12060/H-FS12060) with a focus ring**

**Rotate to **A** side:**

Focuses on nearby subject

**Rotate to **B** side:**

Focuses on distant subjects

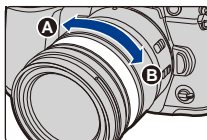

**When using the interchangeable lens having a focus lever**

**Move to **C** side:**

Focuses on nearby subject

**Move to **D** side:**

Focuses on distant subjects

- The focusing speed varies depending on how far you move the focus lever.

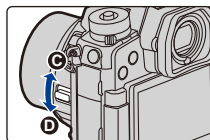

**When using an interchangeable lens with no focus ring**

Press **▶**: Focuses on nearby subject

Press **◀**: Focuses on distant subjects

(A) Slide bar

- Pressing and holding **◀/▶** will increase the focus speed.
- Focus can also be adjusted by dragging the slide bar.



(A) MF Assist (enlarged screen)

(B) Peaking

(C) MF Guide

- In-focus portions are highlighted with color. ([Peaking])
- You can check whether the point of focus is to the near side or to the far side. (MF Guide)

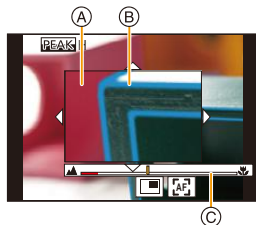

You can perform the following operations:

Button operation	Touch operation	Description of operation
<b>▲/▼/◀/▶*</b>	<b>Dragging</b>	Moves the enlarged area.
	<b>Pinching out/in</b>	Enlarges/reduces the screen in small steps.
	—	Enlarges/reduces the screen in large steps.
		Switches the enlarged display (windowed/full screen).
<b>[DISP.]*</b>	<b>[Reset]*</b>	The position of the enlarged area is reset to the center.

- \* When using an interchangeable lens with no focus ring, you can perform these operations after pressing **▼** to display the screen that lets you set the area to be enlarged.
- When the picture is displayed in windowed mode, you can enlarge the picture by approximately 3× to 6×; when the picture is displayed in full screen, you can enlarge the picture by approximately 3× to 10×.



## 5 Press the shutter button halfway.

- You can also perform the same operation by pressing [MENU/SET].
- If you have enlarged the picture by rotating the focus ring or moving the focus lever, the assist screen will close approximately 10 seconds after the operation.

- MF Assist and MF Guide may not display depending on the lens used. You can, however, display MF Assist by directly operating the camera using the touch screen or a button.
- When [Focus Switching for Vert / Hor] in the [Custom] ([Focus / Release Shutter]) menu is enabled, you can set the position of the enlarged MF Assist display for each orientation of the camera.

- The focus distance reference mark (A) is a mark used to measure the focus distance.  
Use this when taking pictures with Manual Focus or taking close-up pictures.

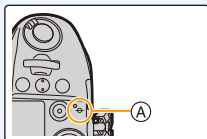

### Achieving focus quickly using Auto Focus

**MENU** →  [Custom] →  [Focus / Release Shutter] → [AF/AE Lock] → [AF-ON]

If [AF/AE LOCK] is pressed in Manual Focus, Auto Focus will work.

- Auto Focus works at the center of the frame.
- Auto Focus also works with the following operations.
  - Pressing the function button to which [AF-ON] is assigned
  - Touching []
  - Dragging the monitor and releasing your finger at the position you want to focus on
- This function is not available when [4K Live Cropping] is set.

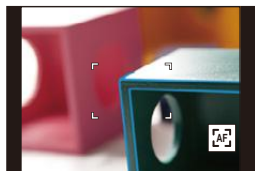

# Fixing the Focus and the Exposure (AF/AE Lock)

Applicable modes: P A S M

Lock the focus and exposure in advance to take pictures with the same focus and exposure settings while changing the composition.

This is useful when you want to bring an edge of the screen into focus or there is a backlight, for example.

- 1 Align the screen with the subject.
- 2 Press and hold [AF/AE LOCK] to fix the focus or exposure.
  - If you release [AF/AE LOCK], AF/AE Lock is canceled.
  - Only the exposure is locked in the default setting.
- 3 While pressing [AF/AE LOCK], move the camera as you compose the picture and then press shutter button fully.

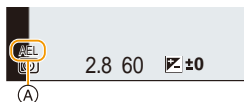
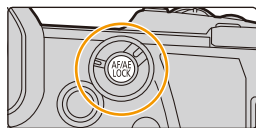

(A) AE Lock indication

## ■ Setting the functions of [AF/AE LOCK]

**MENU** → [Custom] → [Focus / Release Shutter] → [AF/AE Lock]

[AE LOCK]	Only the exposure is locked. • When the exposure is set, [AEL] is displayed.
[AF LOCK]	Only the focus is locked. • When the subject is focused, [AFL] is displayed.
[AF/AE LOCK]	Both focus and exposure are locked. • [AFL] and [AEL] are displayed when the focus and the exposure are optimized.
[AF-ON]	Auto Focus is performed.

- AF Lock only is effective when taking pictures in Manual Exposure Mode.
- AE Lock only is effective when taking pictures with Manual Focus.
- The subject can be focused again by pressing the shutter button halfway even when AE is locked.
- Program Shift can be set even when AE is locked.

## Compensating the Exposure

Applicable modes: P A S M

Use this function when you cannot achieve appropriate exposure due to the difference in brightness between the subject and the background.

**1** Press [ ].

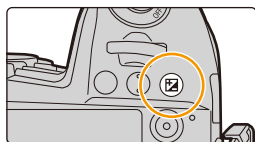

**2** Rotate the rear dial to compensate the exposure.

- (A) Exposure Bracket
- (B) Exposure Compensation
- (C) [Flash Adjust.]

- You can perform the operations below while the exposure compensation screen is displayed.

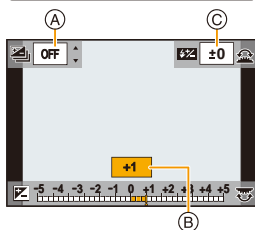

	Compensates the exposure
	Adjusts the flash output (P160)
	Sets the exposure bracket (P142)

- You can switch the functions between the rear dial and the front dial by pressing [DISP.].

Underexposed	Properly exposed	Overexposed
Compensate the exposure towards positive.		Compensate the exposure towards negative.

**3** Press [ ] to set.

- You can also press the shutter button halfway to set.

- In Manual Exposure Mode, you can compensate the exposure only when the ISO sensitivity is set to [AUTO].
- You can set the exposure compensation value in the range between  $-5$  EV and  $+5$  EV. You can set a value between  $-3$  EV and  $+3$  EV while recording motion picture or performing recording with the 6K/4K Photo or Post Focus function.
- When [Auto Exposure Comp.] in [Flash] in the [Rec] menu is set to [ON], the brightness of the flash will automatically be set to the level appropriate to the selected Exposure Compensation.
- When the exposure compensation value falls below or exceeds the  $-3$  EV to  $+3$  EV range, the brightness of the recording screen will no longer change. Values outside this range will be applied to the recording screen when the shutter button is pressed halfway or AE Lock is performed with [AF/AE LOCK].
- The set Exposure Compensation value is stored even if the camera is turned off. (When [Exposure Comp. Reset] is set to [OFF])



MENU



## Setting the Light Sensitivity

Applicable modes:   **P** **A** **S** **M**  

This allows the sensitivity to light (ISO sensitivity) to be set.

**1** Press [ISO].

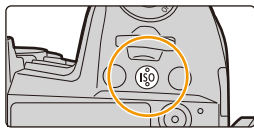

**2** Select the ISO sensitivity by rotating the rear dial.

- You can switch the functions between the rear dial and the front dial by pressing [DISP].

- Ⓐ [ISO Auto Upper Limit Setting]
- Ⓑ ISO sensitivity

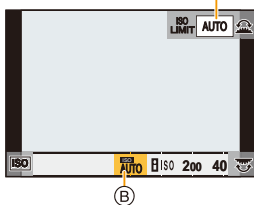

**3** Rotate the front dial to set the [ISO Auto Upper Limit Setting].

- Set the [ISO Auto Upper Limit Setting] in [ISO Sensitivity (photo)] (or in [ISO Sensitivity (video)] when using Creative Video Mode).
- It will work when the [Sensitivity] is set to [AUTO] or [ISO].

**4** Press [ISO] to set.

- You can also press the shutter button halfway to set.

<b>AUTO</b>	The ISO sensitivity is automatically adjusted according to the brightness. • Maximum [ISO3200]* <sup>1</sup>
 <b>(Intelligent)</b>	The camera automatically sets the optimum ISO sensitivity and shutter speed to suit the movement of the subject and brightness of the scene to minimize the jitter of the subject. • Maximum [ISO3200]* <sup>1</sup> • The shutter speed is not fixed when the shutter button is pressed halfway. It is continuously changing to match the movement of the subject until the shutter button is pressed fully.
<b>L.100*<sup>2</sup>, from 200 to 25600</b>	The ISO sensitivity is fixed to various settings.

\*1 When [ISO Auto Upper Limit Setting] in [ISO Sensitivity (photo)] in the [Rec] menu is set to [AUTO].

\*2 Only when [Extended ISO] in the [Custom] ([Exposure]) menu is used.



### Characteristics of the ISO sensitivity

	200  25600	
<b>Recording location (recommended)</b>	When it is light (outdoors)	When it is dark
<b>Shutter speed</b>	Slow	Fast
<b>Noise</b>	Less	Increased
<b>Jitter of the subject</b>	Increased	Less

• Cannot select  in the following cases:

- Shutter-Priority AE Mode
- Manual Exposure Mode
- When [High Resolution Mode] is set, the maximum setting is [ISO1600].
- When [Multi Exp.] is set, the maximum setting is [ISO3200].
- With Creative Video Mode, 6K/4K Photo, or Post Focus, you can set an ISO sensitivity value that falls in the range below.
  - Value range: [AUTO], [200] to [12800] ([100] to [12800] if [Extended ISO] is set)

# Adjusting the White Balance

Applicable modes:      

White Balance adjusts the color of white according to the light source to make the overall color hue closer to what is seen by the eye.



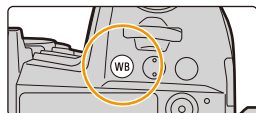

## 1 Press [WB].







## 2 Rotate the rear dial or front dial to select the White Balance.

- Setting can also be performed by rotating the control dial.



<p><b>[AWB]/ [AWBc]</b></p>	<p>Adjusting the White Balance automatically</p> <ul style="list-style-type: none"> <li>Under lighting such as incandescent lighting where reddish tones may occur:           <ul style="list-style-type: none"> <li>– With [AWB], reddish tones are maintained to reproduce the ambience of the scene more accurately.</li> <li>– With [AWBc], reddish tones are suppressed to reproduce the original colors of the subject more accurately. The same tones as [AWB] may be applied in a bright environment.</li> </ul> </li> <li>[AWB] and [AWBc] apply the same tones under light sources where reddish tones may not occur.</li> </ul>
<p></p>	<p>When taking pictures outdoors under a clear sky</p>
<p></p>	<p>When taking pictures outdoors under a cloudy sky</p>
<p></p>	<p>When taking pictures outdoors in the shade</p>
<p></p>	<p>When taking pictures under incandescent lights</p>
<p></p>	<p>When taking pictures with the flash only</p>

- \* [AWB] is applied when you record motion picture or perform recording with the 6K/4K Photo or Post Focus function.

	<p>Set the White Balance value. Use to match the condition when taking photographs.</p> <ol style="list-style-type: none"> <li>1 Press ▲.</li> <li>2 Place a white object such as a piece of paper within the frame at the center of the screen, and press [MENU/SET].</li> </ol> <ul style="list-style-type: none"> <li>• This will set the White Balance and return you to the recording screen.</li> <li>• The same operation can be performed by pressing the shutter button.</li> <li>• White Balance may not be set when the subject is too bright or too dark. Set the White Balance again after adjusting to appropriate brightness.</li> </ul>	
	<p>You can set the color temperature manually for taking natural pictures in different lighting conditions.</p> <ol style="list-style-type: none"> <li>1 Press ▲.</li> <li>2 Press ▲/▼ to select the color temperature and then press [MENU/SET].</li> </ol> <ul style="list-style-type: none"> <li>• You can set a color temperature from [2500K] to [10000K].</li> <li>• You can set the White Balance Bracket (Color Temperature) by rotating the control dial. (P144)</li> </ul>	

### 3 Press [WB] to set.

- You can also press the shutter button halfway to set.



Under fluorescent lighting, LED lighting fixture etc., the appropriate White Balance will vary depending on the lighting type.

Use [AWB], [AWBc], [AWB], [AWB], [AWB] or [AWB].

#### ■ Auto White Balance

Depending on the conditions prevailing when pictures are taken, the pictures may take on a reddish or bluish tinge. Furthermore, when a multiple number of light sources are being used or there is nothing with a color close to white, Auto White Balance may not function properly. In a case like this, set the White Balance to a mode other than [AWB] or [AWBc].

- 1 [AWB] will work within this range.
- 2 Blue sky
- 3 Cloudy sky (Rain)
- 4 Shade
- 5 Sunlight
- 6 White fluorescent light
- 7 Incandescent light bulb
- 8 Sunrise and sunset
- 9 Candlelight

K=Kelvin Color Temperature

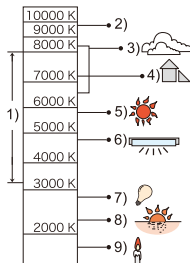



## Finely adjusting the White Balance

You can finely adjust the White Balance when you cannot acquire the desired hue by setting the White Balance.

- 1 Select the White Balance and then press ▼.
- 2 Press ▲/▼/◀/▶ to fine-adjust the White Balance.

- ◀: [A] (AMBER: ORANGE)
- ▶: [B] (BLUE: BLUISH)
- ▲: [G] (GREEN: GREENISH)
- ▼: [M] (MAGENTA: REDDISH)

- You can also make fine adjustments by touching the White Balance graph.

- To reset the position to the center, press [DISP].

- You can set the White Balance Bracket by rotating the control dial. (P144)

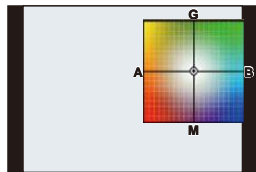

- 3 Press [MENU/SET].

- If you finely adjust the White Balance to [A] (amber), the White Balance icon on the screen will change to orange.

If you finely adjust the White Balance to [B] (blue), the White Balance icon on the screen will change to blue.

- If you finely adjust the White Balance to [G] (green) or [M] (magenta), [+ ] (green) or [- ] (magenta) appears beside the White Balance icon on the screen.





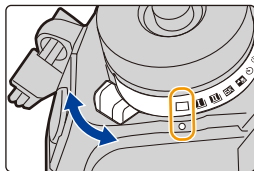

## Select a Drive Mode

Applicable modes:   **P** **A** **S** **M**  

You can change what the camera will do when you press the shutter button.

### Rotating the drive mode dial.



	<b>[Single]</b>	When the shutter button is pressed, only one picture is recorded.
	<b>[Burst] (P115)</b>	Recordings are made in succession while the shutter button is pressed.
	<b>[6K/4K PHOTO] (P119)</b>	Performs 6K/4K photo recording.
	<b>[Post Focus] (P130)</b>	Performs Post Focus recording.
	<b>[Self Timer] (P135)</b>	When the shutter button is pressed, recording takes place after the set time has elapsed.
	<b>[Time Lapse/ Animation] (P137, 138)</b>	Pictures are recorded with Time Lapse Shot or Stop Motion Animation.

# Taking Pictures using Burst Mode

Applicable modes: 

Pictures are taken continuously while the shutter button is pressed.

- You can apply different Burst Mode settings to [**I**] (Burst Shot 1) and [**II**] (Burst Shot 2) by setting [Burst Shot 1 Setting] and [Burst Shot 2 Setting] in the [Rec] menu.

- Set the drive mode dial to [**I**] (Burst Shot 1) or [**II**] (Burst Shot 2).
- Select the Burst Mode setting.

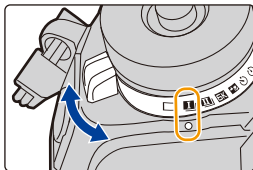

**MENU** →  **[Rec]** → [Burst Shot 1 Setting]/  
[Burst Shot 2 Setting]

[SH2]	Performs super high-speed burst recording with the electronic shutter.
[SH1]	• The burst speed will be faster with [SH2] than with [SH1].
[SH2 PRE]	Performs super high-speed burst recording with the electronic shutter. Pictures taken at the moment before the shutter button is pressed fully (a maximum of 0.4 seconds) will be saved in addition to those taken after it is pressed fully.
[SH1 PRE]	• The burst speed will be faster with [SH2 PRE] than with [SH1 PRE].
[H]	Performs high-speed burst recording.
[M]	Performs medium-speed burst recording.
[L]	Performs low-speed burst recording.

- Focus on the subject and take a picture.

- Hold down the shutter button fully to activate the Burst Mode.
- When [SH2] or [SH1] has been selected: If you press the shutter button halfway first and then press it fully, you can perform recording without a delay that occurs after it is pressed fully.



- When [SH2 PRE] or [SH1 PRE] has been selected:

- Press the shutter button halfway.
- Press and hold the shutter button fully.

- Recording starts when the shutter button is pressed halfway. [PRE] is displayed on the recording screen.

- If approx. 1 minute elapses while the shutter button is pressed and held halfway, press it halfway again.

When approx. 1 minute elapses while the shutter button is pressed and held halfway, the camera will not be able to save pictures taken before the shutter button is pressed fully.

**Notes on super high-speed burst recording ([SH2]/[SH1]/[SH2 PRE]/[SH1 PRE])**

- Shutter speeds slower than 1/60 seconds are not available.
- The aperture will be fixed during burst recording.
- Pictures taken will be recorded as a single burst picture group.

**Notes on Pre-Burst ([SH2 PRE]/[SH1 PRE])**

- Pictures taken before the shutter button is pressed fully are not saved in the following cases:
  - When recording with the Touch Shutter
  - When [Half Press Release] in the [Custom] ([Focus / Release Shutter]) menu is set to [ON]
- To protect the camera, even if you press the shutter button halfway, Pre-Burst may not operate when the camera's temperature has risen due to, for example, high ambient temperature or continuous Pre-Burst recording. Wait until the camera cools down.
- Even if you press the shutter button halfway, Pre-Burst may not operate when there is insufficient free space on the card.

**■ Notes on Burst Mode settings**

		[SH2]/ [SH2 PRE] (Super high speed 2)	[SH1]/ [SH1 PRE] (Super high speed 1)	[H] (High speed)	[M] (Middle speed)	[L] (Low speed)
Burst speed (pictures/ second)	Mechanical shutter, Electronic Front Curtain	—	—	12 <sup>*1</sup> 9 <sup>*2</sup>	7	2
	Electronic Shutter	60 <sup>*1</sup> 20 <sup>*2</sup>	20	12 <sup>*1</sup> 9 <sup>*2</sup>	7	2
Live View during Burst Mode		None	None	None <sup>*1</sup> / Available <sup>*2</sup>	Available	Available
*3	With RAW files	50 <sup>*5</sup>	50 <sup>*5</sup>	60 or more <sup>*4,6</sup>		
	Without RAW files	50 <sup>*5</sup>	50 <sup>*5</sup>	600 or more <sup>*4,6</sup>		

\*1 When the Focus Mode is set to [AFS] or [MF]

\*2 When the Focus Mode is set to [AFF] or [AFC]

\*3 Number of recordable pictures

\*4 When recording is performed under the test conditions specified by Panasonic.

Depending on recording conditions, the number of burst pictures that can be taken will be reduced.

\*5 Recording stops when the indicated number of burst pictures are taken.

\*6 The burst speed will become slower halfway. However, pictures can be taken until the capacity of the card becomes full.

- The burst speed may become slower depending on the following settings.
  - [Picture Size]/[Quality]/[Sensitivity]/Focus Mode/[Focus/Release Priority]

- The table below shows the numbers of pictures that can be taken with [SH2 PRE] and [SH1 PRE] before the shutter button is pressed fully.

Focus Mode	[SH2 PRE]	[SH1 PRE]
[AFS]/[MF]	24 pictures	8 pictures
[AFF]/[AFC]	8 pictures	

#### ■ About the maximum number of pictures that can be taken continuously

When you press the shutter button halfway, the maximum number of pictures you can take continuously will appear. You can check the approximate number of burst pictures that can be taken.



Example: When 20 pictures can be taken: [r20]

- Once recording starts, the maximum number of pictures that can be taken continuously will decrease.
- With [H], [M] or [L]: The recording speed slows down when [r0] appears.  
With [SH2], [SH1], [SH2 PRE] or [SH1 PRE]: Burst recording stops when [r0] appears.
- When [r99+] is displayed, you can take 100 or more pictures continuously.

#### ■ Notes on focus in Burst Mode

The way focus is achieved varies according to the focus mode setting and the [Focus/Release Priority] setting in the [Custom] ([Focus / Release Shutter]) menu.

Focus mode	[Focus/Release Priority]	[SH2]/[SH1]/ [SH2 PRE]/[SH1 PRE]/ [H]	[M]/[L]
[AFS]	[FOCUS]	At the first picture	
	[BALANCE]		
	[RELEASE]		
[AFF]/[AFC] <sup>*1</sup>	[FOCUS]	Predicted focusing <sup>*2</sup>	Normal focusing <sup>*3</sup>
	[BALANCE]	Predicted focusing <sup>*2</sup>	
	[RELEASE]		
[MF]	—	Focus set with Manual Focus	

\*1 When the subject is dark, the focus is fixed on the first picture.

\*2 Burst speed takes priority, and focus is estimated within possible range.

\*3 The burst speed may become slower because the camera is continuously focusing on the subject.

## ■ Notes on exposure in Burst Mode

Focus mode	[SH2]/[SH1]/[SH2 PRE]/ [SH1 PRE]/[H]	[M]/[L]
[AFS]	The exposure is fixed to the level of the first picture	The exposure is adjusted for each frame
[AFF]/[AFC]	The exposure is adjusted for each frame*	
[MF]	The exposure is fixed to the level of the first picture	

\* If the exposure compensation is set to a value outside the  $-3$  EV to  $+3$  EV range, the exposure will be fixed to the level of the first picture. (Except for when [H] is set)

• **It may take time to save pictures taken in Burst Mode on the card. If you take pictures continuously while saving, the maximum number of recordable pictures decreases. For continuous shooting, use of a high speed memory card is recommended.**

• We recommend using the shutter remote control (DMW-RSL1: optional) when you want to keep the shutter button pressed fully while taking pictures in Burst Mode.



### Not available in these cases:

• The Burst Mode is disabled in the following cases.

- [Rough Monochrome]/[Silky Monochrome]/[Miniature Effect]/[Soft Focus]/[Star Filter]/[Sunshine] (Creative Control Mode)
- When recording in [High Resolution Mode]
- When using [Multi Exp.]

## Recording 6K/4K Photos

Applicable modes:

With 6K Photo, you can take a high-speed burst of pictures at 30 frames/second and save the desired pictures, each made up of 18 million pixels (approx.), extracted from their burst file.

With 4K Photo, you can take a high-speed burst of pictures at 60 frames/second and save the desired pictures, each made up of 8 million pixels (approx.).

- "6K PHOTO" is a high-speed burst recording function which allows you to save pictures extracted from images recorded with an aspect ratio for still pictures, 4:3 or 3:2, and with an effective picture size equivalent to a particular number of pixels (approx. 18 megapixels) produced by images with a size of 6K (approx. 6,000 (horizontal)×3,000 (vertical)).
- Use a UHS Speed Class 3 card.

- 1 Set the drive mode dial to **[6K]**.
- 2 Select the picture size and burst speed.



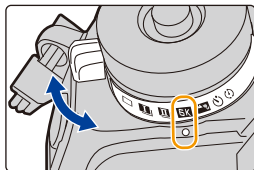



**MENU** → **[Rec]** → **[6K/4K PHOTO]** → **[Picture Size / Burst Speed]**

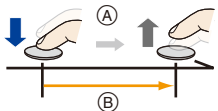

	Use (recommended)	Picture size	Burst speed (pictures/second)
<b>[6K 18M]</b>	For a larger picture size	[6K] (18M) [4:3]: (4992×3744) [3:2]: (5184×3456)	30
<b>[4K H 8M]</b>	For a faster burst speed	[4K] (8M) [4:3]: (3328×2496) [3:2]: (3504×2336)	60
<b>[4K 8M]</b>	For a long burst	[16:9]: (3840×2160) [1:1]: (2880×2880)	30

- 3 Select the recording method.

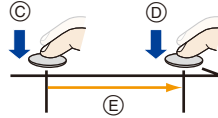
**MENU** → **[Rec]** → **[6K/4K PHOTO]** → **[Rec Method]**

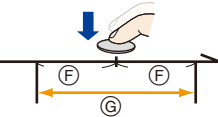
  MENU 	<p><b>For capturing the best shot of a fast-moving subject</b> (e.g., sports, aeroplanes, trains)</p> <p>Burst recording is performed while the shutter button is pressed and held. The shutter sound will be heard repeatedly.</p> <p>(A) Press and hold (B) Recording is performed</p>	
Audio recording: Not available		
<p></p> <p><b>[6K/4K Burst(S/S)]<sup>*1</sup></b></p> <p>"S/S" is an abbreviation of Start/Stop.</p>	<p><b>For capturing unpredictable photo opportunities</b> (e.g., plants, animals, children)</p> <p>Burst recording starts when the shutter button is pressed and stops when pressed again. Start and stop tones will be heard.</p> <p>(C) Start (First) (D) Stop (Second) (E) Recording is performed</p>	
Audio recording: Available <sup>*2</sup>		
<p></p> <p><b>[6K/4K Pre-Burst]</b></p>	<p><b>For recording as needed whenever a photo opportunity arises</b> (e.g., the moment when a ball is thrown)</p> <p>Burst recording is performed for approximately 1 second before and after the moment that the shutter button is pressed. The shutter sound will be heard only once.</p> <p>(F) Approximately 1 second (G) Recording is performed</p>	
Recording length: Approximately 2 seconds		Audio recording: Not available

\*1 If [Picture Size / Burst Speed] is set to [6K 18M] or [4K H 8M]:

Recording stops when the continuous recording time exceeds 10 minutes.

If [Picture Size / Burst Speed] is set to [4K 8M]:

Recording stops when the continuous recording time exceeds 29 minutes and 59 seconds.

– When using an SDHC memory card, you can continue the recording of a 6K/4K photo without interruption even if the file size exceeds 4 GB, but its burst file will be divided into smaller files for recording and playback.

– With an SDXC memory card, you can save a burst file size exceeding 4 GB as a single file.





\*2 Audio is not played back when you perform playback with the camera.

## 4 Press the shutter button halfway to exit the menu.

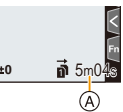

## 5 Record a 6K/4K photo.

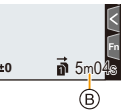
- If you are using Auto Focus, [Continuous AF] will work during recording. Focus will be adjusted continuously.

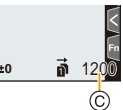
 <p><b>[6K/4K Burst]</b></p>	<ol style="list-style-type: none"> <li>1 Press the shutter button halfway.</li> <li>2 Press and hold the shutter button fully for as long as you want to perform recording.</li> </ol> <p>(A) Available recording time</p> <ul style="list-style-type: none"> <li>• Press the button fully slightly in advance. Recording starts approximately 0.5 seconds after it has been pressed fully.</li> <li>• If you remove your finger from the shutter button immediately after the start of recording, up to a period of approximately 1.5 seconds after the moment that the finger has been removed may be recorded.</li> </ul>	
 <p><b>[6K/4K Burst(S/S)]</b></p>	<ol style="list-style-type: none"> <li>1 Press the shutter button fully to start recording.</li> <li>2 Press the shutter button fully again to stop recording.</li> </ol> <p>(B) Available recording time</p> <p> <b>Adding markers to select and save pictures</b> You can add markers if you press [Fn2] during recording. (Up to 40 markers per recording) When selecting and saving pictures from a 6K/4K burst file, you can skip to the positions where you added markers.</p>	
 <p><b>[6K/4K Pre-Burst]</b></p>	<p><b>Press the shutter button fully.</b></p> <p>(C) Number of recordings that can be made</p> <ul style="list-style-type: none"> <li>• Auto Focus adjusts focus continuously, and except in Manual Exposure Mode, it also adjusts exposure continuously.</li> <li>• Images may not be displayed as smoothly as when recording with the normal recording screen.</li> </ul> <p> <b>Recording tips</b> In situations where you want to lock focus and exposure, such as when the subject is not at the center, use [AF/AE LOCK]. (P106)</p>	

- The camera will perform burst recording of a 6K/4K photo and saves it as a 6K/4K burst file with a [Rec Format] setting of [MP4].
- When [Auto Review] is enabled, the picture selection screen will be displayed automatically. To continue recording, press the shutter button halfway to display the recording screen.
- For information on how to select and save pictures from recorded 6K/4K burst files, refer to P125.
- To reduce camera shake, we recommend that you use a tripod and shutter remote control (DMW-RSL1: optional) when using [Light Composition].

### ■ Setting Pre-Burst Recording ([6K/4K Burst]/[6K/4K Burst(S/S)])

The camera starts recording approximately 1 second before the shutter button is pressed fully, so you will not miss a photo opportunity.

**MENU** → **[Rec]** → **[6K/4K PHOTO]** → **[Pre-Burst Recording]**

**Settings: [ON]/[OFF]**

- When this function is enabled, [PRE] is displayed on the recording screen.
- Auto Focus operation settings and menus that cannot be set while this function is in use are the same as those during [6K/4K Pre-Burst] operation.



#### Battery drainage and camera temperature

- When the ambient temperature is high or 6K/4K photo recording is performed continuously, the camera may display [ $\triangle$ ] and recording may stop. If you are using [6K/4K Pre-Burst], the setting will switch to [6K/4K Burst] and recording will stop. Wait until the camera cools down.
- When [6K/4K Pre-Burst] or [Pre-Burst Recording] is set, the battery drains faster and the camera temperature rises. Use these functions only when recording with them.

### Notes on the 6K/4K Photo function

#### ■ To change the aspect ratio

Selecting [Aspect Ratio] in the [Rec] menu allows you to change the aspect ratio for 6K/4K photos.

#### ■ To record the subject with reduced blur

You can reduce the blur of the subject by setting a faster shutter speed.

**1 Set the mode dial to [S].**

**2 Set the shutter speed by rotating the rear dial or the front dial.**

- Approximate shutter speed for outdoor recording in fine weather conditions: 1/1000 seconds or faster.
- If you increase the shutter speed, the ISO sensitivity becomes higher, which may increase the noise on the screen.

#### ■ Shutter sound for recording

- When using [6K/4K Burst] or [6K/4K Pre-Burst], you can change the electronic shutter sound settings in [E-Shutter Vol] and [E-Shutter Tone].
- When recording with [6K/4K Burst(S/S)], you can set the start/stop tone volume in [Beep Volume].
- High-speed burst recording can be used quietly when used in combination with [Silent Mode].

## ■ Scenes not suitable

### Recording in extremely bright locations or indoors

When subjects are recorded in an extremely bright place or under fluorescent/LED lighting, the color tone or brightness of the image may change, or horizontal stripes may appear on the screen.

Lowering the shutter speed may reduce the effect of the horizontal stripes.

### Subjects that are moving fast in the horizontal direction

If you record a subject moving fast in the horizontal direction, the subject in the recorded pictures may appear distorted.

## ■ The camera's setup for the 6K/4K Photo function

The camera's setup is automatically optimized for 6K/4K photo recording.

- The following [Rec] menu items are fixed to the settings below:

[Picture Size]*	[6K] (18M)	[Quality]	[■]
	[4K] (8M)	[Shutter Type]	[ESHTR]

- 6K/4K burst files are recorded with the settings indicated below:

Settings in the [Motion Picture] menu are not applied to 6K/4K burst files.

[Rec Format]	[MP4]	[Continuous AF]	[ON]
[Rec Quality]*	[6K/200M/30p] [4K/150M/60p] [4K/100M/30p]	[Luminance Level]	[0-1023] (for 6K photo recording) [0-255] (for 4K photo recording)

\* Switches to a setting that matches the [Picture Size / Burst Speed] setting.

- When recording with the 6K/4K Photo function, the ranges for the following functions differ from the ones available for taking pictures:

- Shutter speed: 1/30th (1/60th when [4K H 8M] is set) to 1/16000th
- [Min. Shtr Speed]: [1/1000] to [1/30] ([1/60] when [4K H 8M] is set)
- Exposure Compensation: –3 EV to +3 EV
- ISO sensitivity: [AUTO], [200] to [12800] ([100] to [12800] when [Extended ISO] is set)

- When recording with the 6K/4K Photo function, the following functions are disabled:

- Flash
- Bracket Recording
- Program Shift
- Focus mode (AFF)
- [AF Mode] ([±])
- [MF Assist] ([6K/4K Pre-Burst] only)
- White Balance ([☞])

- The following menu items are disabled:

<b>[Intelligent Auto]</b>	[iHandheld Night Shot]/[iHDR]
<b>[Creative Control]</b>	[Simultaneous Record w/o Filter]
<b>[Rec]</b>	[Picture Size]/[Quality]/[AFS/AFF]/ [AF Custom Setting(Photo)] ([6K/4K Burst(S/S)] only)/ [Color Space]/[Flash]/[Long Shtr NR]/[Shutter Type]/[Shutter Delay]/ [Bracket]/[HDR]
<b>[Custom]</b>	[Rec Area]/[Face Recog.]/[Profile Setup]
<b>[Setup]</b>	[Economy] ([6K/4K Pre-Burst] only)

- When [6K 18M] is set, [Aspect Ratio] cannot be set to [16:9] or [1:1].
- The following changes occur when recording 6K/4K photos:
  - [Location] in [Travel Date] cannot be recorded.
  - [Simultaneous Record w/o Filter] in [Filter Settings] is not available.
  - It is not possible to use the HDMI output during recording.
- If you use HDMI output, settings will be adjusted as follows:
  - [6K/4K Pre-Burst] will be switched to [6K/4K Burst].
  - The [Pre-Burst Recording] setting will be switched from [ON] to [OFF].
- [Ex. Tele Conv.] is not available when [6K 18M] is set.
- [ZOOM] is not available when [4K H 8M] or [4K 8M] is set.
- [Digital Zoom] is not available when [6K 18M] is set.
- You cannot superimpose recording dates using [Time Stamp Rec].
- When recording with [6K/4K Pre-Burst], [Step Zoom] in [Power Zoom Lens] is disabled.
- Scene Detection in Intelligent Auto Mode works the same way as when recording motion pictures.
- When the drive mode is set to 6K/4K Photo, it is not possible to take pictures while recording motion picture. (Only when [📷] ([Photo Priority]) is set)



#### **Not available in these cases:**

- The 6K/4K Photo function is disabled when using the following settings:
  - [Rough Monochrome]/[Silky Monochrome]/[Miniature Effect]/[Soft Focus]/[Star Filter]/  
[Sunshine] (Creative Control Mode)
  - When recording motion pictures
  - When recording in [High Resolution Mode]
  - When using [Multi Exp.]

# Selecting pictures from 6K/4K burst file and saving

## 1 Select an image with the or icon on the playback screen, and press **▲**.



- You can also perform the same operation by touching the icon  or .
- If the image was recorded with [6K/4K Pre-Burst], proceed to step **3**.



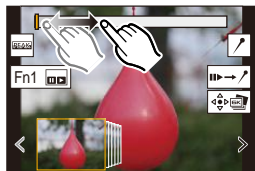

## 2 Drag the slide bar to make a rough selection of scenes.

Slide view screen

- For information on how to use the slide view screen, refer to [P127](#).
- If the image was recorded with [6K/4K Burst] or [6K/4K Burst(S/S)], you can select its scenes on the 6K/4K burst playback screen by touching  (Fn1). ([P128](#))



## 3 Drag the frames to select the frame you want to save as a picture.

- You can also perform the same operation by pressing .
- To continuously rewind/forward frame-by-frame, touch and hold  [] [].

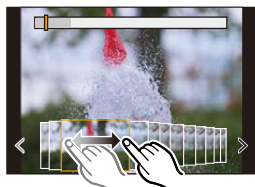

## 4 Touch or to save the picture.

- A confirmation screen will be displayed.

- The picture will be saved in JPEG format.**
- The picture will be saved with recording information (Exif information), including its shutter speed, aperture and ISO sensitivity information.

### ■ Saving pictures taken with the 6K/4K Photo function at once ([6K/4K PHOTO Bulk Saving])

You can save pictures of a 6K/4K burst file that were extracted from any 5 second period at once.

#### 1 Select the menu.

**MENU** → **[Playback]** → **[6K/4K PHOTO Bulk Saving]**

#### 2 Press **◀/▶** to select the 6K/4K photo burst files and press **[MENU/SET]**.

- If the burst time is 5 seconds or less, all frames will be saved as pictures.

#### 3 Select the first frame of the pictures to be saved at once.

- Select the frame in the same way as you select pictures from a 6K/4K burst file.
- Pictures will be saved as a group of Burst Mode pictures in JPEG format.

## Correcting 6K/4K Photos After Recording (Post-Recording Refinement)

### ■ Correcting distortion in pictures ([Reduce Rolling Shutter])

The camera corrects distortion in pictures caused by the electronic shutter (rolling shutter effect) when you save them.

#### 1 On the save confirmation screen in step 4 on P125, touch **[Reduce Rolling Shutter]**.

- Return to the confirmation screen if it cannot produce any correction result.

#### 2 Check the correction result, and touch **[Save]**.

- You can check corrected/uncorrected versions of the picture by touching **[Set/Cancel]**.
- The angle of view of the corrected picture may become narrower.
- Depending on the movement of subjects on the edges of the frame, the corrected picture may look unnatural.
- You may not be able to correct for images recorded with other devices.

### ■ Reducing the noise produced by high sensitivity ([6K/4K PHOTO Noise Reduction])

When saving pictures, reduce the noise produced during recording by high ISO sensitivity.

**MENU** → **[Playback]** → **[6K/4K PHOTO Noise Reduction]**

Settings: **[AUTO]/[OFF]**

- This function is not applied to pictures saved with **[6K/4K PHOTO Bulk Saving]**.
- You may not be able to applied for images recorded with other devices.

## Operations during selecting pictures

### ■ Navigating the slide view screen

Position of the displayed frame

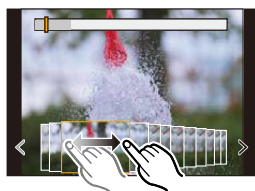
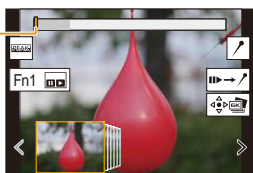

Button operation	Touch operation	Description of operation
	Dragging/ < / >	Selects a frame. • To change the frames displayed in slide view, select the frame at the left/right end, and touch [ < ] or [ > ].
 Press and hold	< / > Touch and hold	Continuously rewinds/forwards frame-by-frame.
—	 Touching/ Dragging	Selects the frame to be displayed.
	Pinching out/in	Enlarges/reduces the display.
	—	Selects a frame while maintaining the enlarged display. (during enlarged display)
	Dragging	Moves the enlarged area (during enlarged display).
[Fn1]		Displays the 6K/4K burst playback screen.
—		Switches to marker operation.
—		Adds/deletes a marker.
—		In-focus portions are highlighted with color. ([Peaking]) • Switches in order of [OFF] → [ON] ([LOW]) → [ON] ([HIGH]).
[MENU/SET]		Saves the picture

• During marker operation, you can skip to the markers that you added or the beginning or end of the 6K/4K burst file. Touch [↗→▶] to return to the original operation.

Button operation	Touch operation	Description of operation
		Moves to the next marker.
		Moves to the previous marker.

## ■ Navigating the 6K/4K burst playback screen

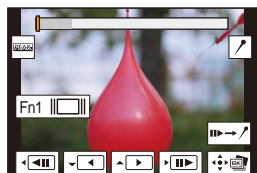

During pause



During continuous playback

Button operation	Touch operation	Description of operation
▲	▶/	Continuous playback/Pause (during continuous playback).
▼	◀/	Continuous rewind/Pause (during continuous rewind).
▶/⊙	▶▶/  ▶▶	Fast forward/Frame-by-frame forward (during pause).
◀/⊙	◀◀/  ◀◀	Fast rewind/Frame-by-frame rewind (during pause).
—	Touching/ Dragging	Selects the frames to be displayed (during pause).
	Pinching out/in	Enlarges/reduces the display (during pause).
	—	Selects a frame while maintaining the enlarged display (during enlarged display).
▲/▼/◀/▶	Dragging	Moves the enlarged area (during enlarged display).
[Fn1]	□	Displays the slide view screen (during pause).
—	▶▶→/	Switches to marker operation.
—	↗ / ↖	Adds/deletes a marker.
—	PEAK	In-focus portions are highlighted with color. ([Peaking]) • Switches in order of [OFF] → [ON] ([LOW]) → [ON] ([HIGH]).
[MENU/SET]		Saves the picture (during pause).

- Each time you touch the screen twice, the display switches between enlarged and normal view.
- To select and save pictures from 6K/4K burst files on a PC, use the software "PHOTOfunSTUDIO".  
Please note that it is not possible to edit a 6K/4K burst file as a motion picture.
- To play back and edit 6K/4K burst files recorded with [6K 18M] on a PC, a high-performance PC environment is required. We recommend choosing and saving pictures with the camera.



### Selecting and saving pictures on the TV screen

- 6K burst files recorded with [6K 18M] are output to a TV connected through HDMI at a resolution of [4K].
- Set [HDMI Mode (Play)] to either [AUTO] or a setting with a resolution of [4K].  
When connecting to a TV that does not support 4K motion picture, select [AUTO].
- If you display 6K/4K burst files on a TV connected to the camera, they will be displayed only on the 6K/4K burst playback screen.
- Panasonic TVs equipped with SD card slots cannot directly play back 6K/4K burst files from the SD card.



MENU



# Controlling Focus After Recording (Post Focus/ Focus Stacking)

Applicable modes: **[A]** **[Av]** **[P]** **[A]** **[S]** **[M]** **[M]** **[B]**

The camera can perform Burst recording in the same picture quality as 6K/4K photo recording while automatically shifting the focus to different areas.

After the recording, you can select the desired focus point for the picture to be saved. This function is suited for recording still objects.



6K/4K burst recording while automatically shifting the focus.



Touch the desired focus point.



A picture with the desired focus point is made.

- We recommend that you use a tripod when recording images to be used for Focus Stacking.
- Use a UHS Speed Class 3 card.

## 1 Set the drive mode dial to **[A]**.

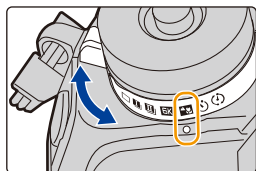

## 2 Select the picture size.

**[MENU]** → **[Rec]** → **[Post Focus]**

	Picture size	Description
<b>[6K 18M]</b>	[6K] (18M) [4:3]: (4992×3744) [3:2]: (5184×3456)	Larger-sized pictures can be created.
<b>[4K 8M]</b>	[4K] (8M) [4:3]: (3328×2496) [3:2]: (3504×2336) [16:9]: (3840×2160) [1:1]: (2880×2880)	The display can be enlarged using [Ex. Tele Conv.].

## 3 Press the shutter button halfway to exit the menu.

## 4 Decide on the composition, and press the shutter button halfway.

- Auto Focus will detect focus areas on the screen. (Excluding the edges of the screen)
- If no areas on the screen can be brought into focus, the focus display (A) will flash. Recording is not possible in this case.



## 5 Press the shutter button fully to start recording.

- The focus point changes automatically while recording. When the icon (B) disappears, recording automatically ends.



### From the time you press the shutter button halfway until the end of recording:

- Maintain the same distance to the subject and the same composition.
- Do not operate the zoom.
- A motion picture will be recorded with [Rec Format] set to [MP4]. (Audio will not be recorded.)
- When [Auto Review] is enabled, a screen that lets you select the desired focus area will be displayed. (P132)



### About camera temperature

- If the surrounding temperature is high, recording is performed continuously with the Post Focus function, or the temperature of the camera rises, [△] may be displayed and recording may stop halfway through to protect the camera. Wait until the camera cools down.

### ■ Limitations on the Post Focus function

- Since recording is performed in the same image quality as 6K/4K photos, certain limitations apply to recording functions and menu settings. For details, refer to "The camera's setup for the 6K/4K Photo function" on P123.
- In addition to the limitations of the 6K/4K Photo function, the following limitations apply to the Post Focus function:
  - Manual Focus operation is disabled.
  - Auto Focus Mode is disabled.
  - Motion pictures cannot be recorded.
  - [Digital Zoom]/[Time Stamp Rec] is disabled.
  - The following [Custom] menu items are disabled: [Shutter AF]

### Not available in these cases:

- The Post Focus function is disabled when using the following settings:
  - [Rough Monochrome]/[Silky Monochrome]/[Miniature Effect]/[Soft Focus]/[Star Filter]/[Sunshine] (Creative Control Mode)
  - When recording in [High Resolution Mode]
  - When [Multi Exp.] is set

## Selecting the desired focus area and saving a picture

### 1 Select an image with the icon on the playback screen, and press **▲**.









- You can also perform the same operation by touching the icon .





### 2 Touch the desired focus area.

- If a picture that is in focus is not available for the selected area, a red frame will be displayed. You cannot save a picture in this case.
- You cannot select the edges of the screen.



Button operation	Touch operation	Description of operation
	<b>Touching</b>	Selects a focus area. • It cannot be selected during enlarged display.
		Enlarges the display.
		Reduces the display (during enlarged display).
[Fn1]		Switches to the Focus Stacking function. (P133)
–		In-focus portions are highlighted with color. ([Peaking]) • Switches in order of [OFF]→[ON] ([LOW]) → [ON] ([HIGH]).
[MENU/SET]		Saves the picture.

- You can fine-adjust the focus by dragging the slide bar during enlarged display. (You can also perform the same operation by pressing / .)



### 3 Touch to save the picture.

- The picture will be saved in JPEG format.

- You cannot choose and save the picture from a TV screen even if the camera is connected to a TV through an HDMI cable.

## Merging multiple pictures to widen the focus range (Focus Stacking)



- (A) Focus: closer  
(B) Focus: farther away

- 1 Touch in step 2 of “Selecting the desired focus area and saving a picture”.
  - You can also perform the same operation by pressing [Fn1].
- 2 Touch the merging method.

<b>[Auto Merging]</b>	Automatically selects pictures that are suited to be merged, and merges them into a single picture. • Priority will be given to pictures with closer focus.
<b>[Range Merging]</b>	Merges pictures with specified focus areas into a single picture.

- 3 (When [Range Merging] is selected)  
Touch the desired focus area.

- Specify at least two areas.
- In-focus areas between the two areas will also be selected, and the combined in-focus area will be indicated.
- Gray areas indicate areas that may, if selected, cause the merged picture to look unnatural and areas that cannot be selected.

- To cancel the selection, touch the focus area again.
- To select multiple areas, drag the screen.

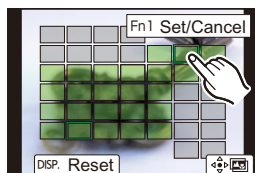
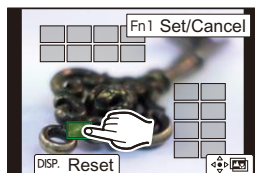

Button operation	Touch operation	Description of operation
▲/▼/◀/▶	Touching	Selects an area.
[Fn1]	[Set/Cancel]	Specifies/cancels an area.
[DISP.]	[All]	Selects all areas. (Before selecting areas)
	[Reset]	Cancels all selections. (After selecting areas)
[MENU/SET]		Merges pictures and saves the resulting picture.

#### 4 Touch [ ] to merge the pictures and save the resulting picture.

- The picture will be saved in JPEG format. Recording information (Exif information) of the original picture with the closest focus distance, including the shutter speed, aperture, and ISO sensitivity, will also be recorded to the new picture.
- The camera may automatically correct the misalignments of pictures caused by camera shake. If they are corrected, the angle of view becomes slightly narrower when pictures are merged.
- An unnatural picture may be created if a subject moves during recording or the distance between subjects is great.
- Very defocused pictures, such as those recorded with a macro lens, may be merged into an unnatural picture. If you perform recording with a larger aperture value in Aperture-Priority AE Mode or Manual Exposure Mode, the resulting picture may look less unnatural.
- You may not be able to use Focus Stacking for images recorded with other devices.



# Taking Pictures with the Self-timer

Applicable modes:   P A S M  

**1** Set the drive mode dial to [⏸].

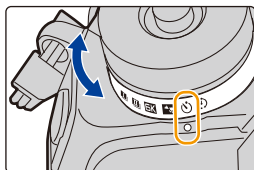

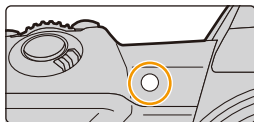

**2** Press the shutter button halfway to focus and then press it fully to take the picture.

- Focus and exposure will be set when the shutter button is pressed halfway.
- After the self-timer indicator flashes, recording starts.



## ■ Setting the self-timer

**MENU** →  [Rec] → [Self Timer]

	Picture is taken 10 seconds after shutter is pressed.
	After 10 seconds the camera takes 3 pictures at about 2 seconds intervals.
	Picture is taken 2 seconds after shutter is pressed. • When using a tripod, etc., this setting is a convenient way to avoid the jitter caused by pressing the shutter button.

- We recommend using a tripod when recording with the self-timer.

### Not available in these cases:

- It cannot be set to [⏸] in the following cases.
  - When [Simultaneous Record w/o Filter] of [Filter Settings] is set to [ON]
  - When recording with the Bracket function
  - When using [Multi Exp.]
- Self-timer is disabled in the following cases.
  - When recording motion pictures
  - When using [High Resolution Mode]

# Taking Pictures with Time Lapse Shot/Stop Motion Animation

Applicable modes:   P A S M 

You can take pictures with Time Lapse Shot or Stop Motion Animation. In addition, the pictures taken can be combined into a motion picture.

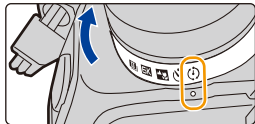



• Set the date and time settings in advance. (P38)

- Recorded pictures are displayed as group pictures.
- If you set [Double Slot Function] to [Relay Rec] and record pictures to more than one card, the resulting pictures will be recorded into separate groups. In this case, a continuous motion picture cannot be created.

## ■ To display the setup screen before recording

- 1 Set the drive mode dial to [  ].
- 2 Display the setup screen.

Button operation	Touch operation
[MENU/SET]* → [MENU/SET]	 / 

- \* The screen selected with [Time Lapse/Animation] in the recording menu will be displayed. (The screen will be displayed only when you press [MENU/SET] for the first time after switching the drive mode dial to [  ].)

## ■ To switch between Time Lapse Shot and Stop Motion Animation

Switch the [Mode] setting in [Time Lapse/Animation] in the [Rec] menu.



## Taking Pictures Automatically at Set Intervals ([Time Lapse Shot])

The camera can automatically take pictures of subjects such as animals or plants as time elapses and create a motion picture.

**1 Set the drive mode dial to [📷].**

**2 Display the setup screen.**

- Switch to [Time Lapse Shot] if it is not selected. (P136)



	[Now]	Starts the recording by fully-pressing the shutter button.
[Start Time]	[Start Time Set]	Any time up to 23 hours 59 minutes ahead can be set. ◀/▶: Select the item (hour/minute) ▲/▼: Setting [MENU/SET]: Set
[Shooting Interval]/ [Image Count]		The recording interval and the number of pictures can be set. ◀/▶: Select the item (minute/second/number of pictures) ▲/▼: Setting [MENU/SET]: Set

- Recording may not be consistent with the set recording interval or the set number of pictures depending on recording conditions.

**3 Press the shutter button halfway to exit the menu.**

- The recording screen will be displayed. You can also perform the same operation by pressing [📷] until the recording screen is displayed.



**4 Press the shutter button fully.**

- The recording starts automatically.
- During recording standby, the power will turn off automatically if no operation is performed for a certain period. The Time Lapse Shot is continued even with the power turned off. When the recording start time arrives, the power turns on automatically. To turn on the power manually, press the shutter button halfway.
- Operations during recording standby (The camera is turned on)

Button operation	Touch operation	Description of operation
[Fn2]		Displays a selection screen that lets you pause or stop the recording.
		Displays a selection screen that lets you resume or stop the recording (during pause).

- After the recording stops, a confirmation screen will be displayed, asking whether to proceed to create a motion picture.

To create a motion picture, select [Yes].

For information on creating motion pictures, refer to P140.

## ■ Changing the Time Lapse Shot settings

You can change the settings in [Time Lapse/Animation] in the [Rec] menu.

- This function is not for use in a security camera.
- [Time Lapse Shot] is paused in the following cases.
  - When the charge on the battery runs out
  - Turning the camera off
 During [Time Lapse Shot], you can replace the battery and the card, and then restart by turning on this unit. (Note that pictures taken after the restart will be saved as a separate set of group pictures) Turn off this unit when replacing the battery.
- When [Shooting Interval] is set to a longer value, if the camera turns off automatically while waiting for the next recording, we recommend that you use Time Lapse Shot in Auto Focus Mode.

### Not available in these cases:





- This function is not available in the following cases:
  - When using [High Resolution Mode]
  - When using [Multi Exp.]

## Creating Stop Motion Pictures ([Stop Motion Animation])

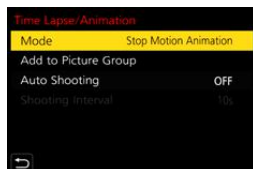
A stop motion picture is created by splicing pictures together.

- 1 Set the drive mode dial to [  ].
- 2 Display the setup screen. (P136)
  - Switch to [Stop Motion Animation] if it is not selected.



[Auto Shooting]	[ON]	Takes pictures automatically at a set recording interval.
	[OFF]	This is for taking pictures manually, frame by frame.
[Shooting Interval]	(Only when [Auto Shooting] is set to [ON])   : Select the item (second)  /  : Setting [MENU/SET]: Set	

- 3 Press the shutter button halfway to exit the menu.
  - The recording screen will be displayed. You can also perform the same operation by pressing [  ] until the recording screen is displayed.



**4 Press the shutter button fully.**

- Up to 9999 frames can be recorded.

**5 Move the subject to decide on the composition.**

- Repeat recording in the same way.
- If this unit is turned off while recording, a message for resuming the recording is displayed when the camera is turned on. Selecting [Yes] allows you to continue the recording from the interruption point.

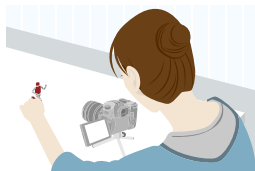
**Recording materials skillfully**

- The recording screen displays up to two pictures taken previously. Use them as reference for the amount of movement.
- To check the recorded pictures, press [▶].  
Unnecessary pictures can be deleted by pressing [🗑️].  
To return to the recording screen, press [▶] again.

**6 Touch [👉] to end the recording.**

- It can also be ended by selecting [Time Lapse/Animation] from the [Rec] menu and then pressing [MENU/SET].
- When [Auto Shooting] is set to [ON], select [End] on the confirmation screen.  
(If [Pause] has been selected, press the shutter button fully to resume the recording.)
- After the recording stops, a confirmation screen will be displayed, asking whether to proceed to create a motion picture.  
To create a motion picture, select [Yes].  
For information on creating motion pictures, refer to P140.

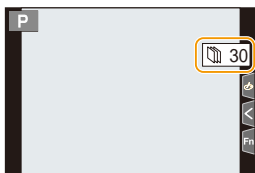
**Changing the settings of Stop Motion Animation**

You can change the settings in [Time Lapse/Animation] in the [Rec] menu.

**Adding pictures to the Stop Motion Animation group**

Selecting [Add to Picture Group] in step 2 will display group pictures recorded with [Stop Motion Animation].

Select a set of group pictures, and then press [MENU/SET].

- Recording takes time under certain recording conditions, such as when the flash is used for recording. Automatic recording, as a result, may not take place at set intervals.
- A picture cannot be selected from [Add to Picture Group] when it is the only one that was taken.

**Not available in these cases:**

- This function is not available in the following cases:
  - When using [High Resolution Mode]
  - When using [Multi Exp.]

## Creating motion pictures from recorded pictures

To create motion pictures after taking pictures, follow the steps below.

### 1 Select the methods for creating a motion picture.

- The recording format is set to [MP4].

[Rec Quality]	Sets the quality of a motion picture.
[Frame Rate]	Sets the number of frames per second. The larger the number is, the smoother the motion picture will be.
[Sequence]	<b>[NORMAL]:</b> Splices pictures together in recording order. <b>[REVERSE]:</b> Splices pictures together in reverse recording order.

### 2 Press ▲/▼ to select [OK] and then press [MENU/SET].









- You can also create motion pictures using [Time Lapse Video] (P248) or [Stop Motion Video] (P248) in the [Playback] menu.
- When creating motion pictures with a [Rec Quality] setting of [4K], recording times are limited to 29 minutes and 59 seconds.
  - When using an SDHC Memory Card, you cannot create motion pictures with a file size exceeding 4 GB.
  - When using an SDXC Memory Card, you can create motion pictures with a file size exceeding 4 GB.
- A motion picture with a [Rec Quality] setting of [FHD] cannot be created if the recording time exceeds 29 minutes and 59 seconds or the file size exceeds 4 GB.

# Taking Pictures While Adjusting a Setting Automatically (Bracket Recording)

Applicable modes:          

You can take multiple pictures while automatically adjusting a setting by pressing the shutter button.

## 1 Select the menu.

MENU →  [Rec] → [Bracket] → [Bracket Type]	
 <b>Exposure Bracket</b>	Press the shutter button to perform recording while adjusting the exposure. (P142)
 <b>Aperture Bracket</b>	Press the shutter button to perform recording while adjusting the aperture. (P143) • Available in Aperture-Priority AE Mode or when the ISO sensitivity is set to [AUTO] in Manual Exposure Mode.
FOCUS <b>Focus Bracket</b>	Press the shutter button to perform recording while adjusting the focus position. (P143)
WB  <b>White Balance Bracket</b>	Press the shutter button once to take three pictures with different white balance settings automatically. (P144)
WB  <b>White Balance Bracket (Color Temperature)</b>	Press the shutter button once to take three pictures with different White Balance Color Temperature values automatically. (P144) • Available when the White Balance is set to [  ], [  ], [  ] or [  ].

## 2 Press ▲/▼ to select [More Settings] and then press [MENU/SET].

- For information on [More Settings], refer to the page that describes each function.
- Press the shutter button halfway to exit the menu.

## 3 Focus on the subject and take a picture.

- When Exposure Bracket is selected, the bracket display flashes until all of the pictures you have set are taken. If you change the bracket settings or turn off the camera before all of the pictures you have set are taken, the camera restarts recording from the first picture.

### ■ To cancel [Bracket Type]

Select [OFF] in step 1.

### Not available in these cases:

- Bracket recording is disabled in the following cases.
  - [Rough Monochrome]/[Silky Monochrome]/[Miniature Effect]/[Soft Focus]/[Star Filter]/[Sunshine] (Creative Control Mode)
  - When recording motion pictures
  - When recording in Burst Mode (only when [Burst Shot Setting] is set to [SH2]/[SH1]/[SH2 PRE]/[SH1 PRE])
  - When recording 6K/4K photos
  - When recording with the Post Focus function
  - When recording in [High Resolution Mode]
  - When using [Multi Exp.]
  - When using [Time Lapse Shot]
  - When using [Stop Motion Animation] (only when [Auto Shooting] is set)
- White Balance Bracket and White Balance Bracket (Color Temperature) are disabled in the following cases:
  - Intelligent Auto Plus Mode
  - Creative Control Mode
  - When recording in Burst Mode
  - When [Quality] is set to [RAW $\frac{1}{2}$ ], [RAW $\frac{1}{4}$ ] or [RAW]

## Exposure Bracket

### ■ About [More Settings] (step 2 in P141)

<b>[Step]</b>	Sets the number of pictures to be taken and the exposure compensation range. [3•1/3] (Takes three pictures with an interval of 1/3 EV) to [7•1] (Takes seven pictures with an interval of 1 EV)
<b>[Sequence]</b>	Sets the order in which pictures are taken.
<b>[Single Shot Setting]*</b>	[□]: Takes one picture each time you press the shutter button. [☑]: Takes all the pictures set to be taken when you press the shutter button once.

- \* Not available for burst recording. When using burst recording, if you press and hold the shutter button, recording will be performed continuously until a specified number of pictures are taken.

**[Step]: [3•1/3], [Sequence]: [0/-/+]**

1st picture



± 0 EV

2nd picture



- 1/3 EV

3rd picture



+ 1/3 EV

- When taking pictures using Exposure Bracket after setting the Exposure Compensation value, the pictures taken are based on the selected Exposure Compensation value.

## Aperture Bracket

Recording Mode: **A** **M**

### About [More Settings] (step 2 in P141)

<b>[Image Count]</b>	<b>[3], [5]:</b> Takes a specified number of pictures with different aperture values within the range based on the initial aperture value. <b>[ALL]:</b> Takes pictures using all aperture values.
----------------------	---

• When using burst recording, if you press and hold the shutter button, recording will be performed until a specified number of pictures are taken.

The available aperture values vary depending on the lens.

**Example: when using the interchangeable lens (H-ES12060)**

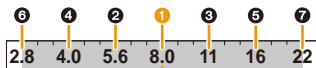

**When the initial position is set to F8.0:**

① first picture, ② second picture, ③ third picture... ⑦ seventh picture

## Focus Bracket

### About [More Settings] (step 2 in P141)

<b>[Step]</b>	Sets the interval between focus positions. • The distance by which the focus position moves in each step will be shorter if the initial position is closer to a subject, and conversely if the initial position is farther from a subject, the distance will be longer.
<b>[Image Count]*</b>	Sets the number of pictures to be taken.
<b>[Sequence]</b>	<b>[0/-/+]:</b> Alternately moves the focus position closer and farther away within the range centered on the initial position as you take pictures. <b>[0/+:]</b> Moves the focus position farther away from the initial position as you take pictures.

\* Not available for burst recording. When using burst recording, if you press and hold the shutter button, recording will be performed continuously until a specified number of pictures are taken.

**[Sequence]: [0/-/+]**



**[Sequence]: [0/+:]**



(A) Focus: closer

(B) Focus: farther away

① first picture, ② second picture... ⑤ fifth picture...

- Pictures taken with Focus Bracket are displayed as a set of group pictures.
- If you set [Double Slot Function] to [Relay Rec] and record pictures to more than one card, the resulting pictures will be displayed as separate groups.





## White Balance Bracket

### ■ About [More Settings] (step 2 in P141)

Rotate the control dial to adjust the correction range, and press [MENU/SET].

: Horizontal ([A] to [B])

: Vertical ([G] to [M])

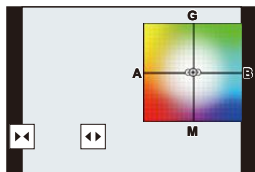

- You can also set the correction range by touching []/[]/[]/[].



## White Balance Bracket (Color Temperature)

### ■ About [More Settings] (step 2 in P141)

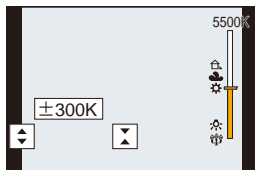

Rotate the control dial to adjust the correction range, and press [MENU/SET].

- You can also set the correction range by touching []/[].











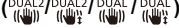





## Image Stabilizer

The camera can activate either the In-Lens Image Stabilizer or In-Body Image Stabilizer, or it can activate both of them and reduce jitter even more effectively. (Dual I.S. Mode) Dual I.S.2 (, , ), which provides more effective correction, is also supported.

- The image stabilizers to be activated differ depending on your lens. The icon for the currently activated image stabilizer is displayed on the recording screen.

	When taking pictures	When recording motion pictures
<b>Panasonic lenses compatible with Dual I.S. Mode</b> <b>(Based on the Micro Four Thirds System standard)</b> <ul style="list-style-type: none"> <li>• For the latest information on compatible lenses, please refer to our website. (P19)</li> <li>• If the [DUAL2] or [DUAL] icon is not displayed on the recording screen even when a compatible lens is used, update the lens firmware to the latest version. (P19)</li> </ul>	<b>Lens + Body (Dual I.S.)</b> 	<b>Lens + Body (Dual I.S.)</b> (  /  ) <b>5-Axis Hybrid</b>  *
<b>Lenses compatible with the image stabilizer function</b> <b>(Based on the Micro Four Thirds System standard/Four Thirds System standard)</b>	<b>Lens or Body</b> 	<b>Lens or Body</b>  , <b>5-Axis Hybrid</b>  *
<b>Lenses not compatible with the image stabilizer function</b> <b>(Based on the Micro Four Thirds System standard/Four Thirds System standard)</b>	<b>Body</b> (  ) / (  )	<b>Body</b> (  ) <b>5-Axis Hybrid</b>  *
<b>When using a Leica lens mount adaptor (optional) or mount adaptor made by another manufacturer</b>		<b>5-Axis Hybrid</b>  *

\* When [E-Stabilization (Video)] in [Stabilizer] in the [Rec] menu is set to [ON].

**Preventing jitter (camera shake)**

When the jitter alert [ⓘ] appears, use [Stabilizer], a tripod, the self-timer or the shutter remote control (DMW-RSL1: optional).

• Shutter speed will be slower particularly in the following cases. Keep the camera still from the moment the shutter button is pressed until the picture appears on the screen.

We recommend using a tripod.

– Slow Sync.

– Slow Sync./Red-Eye Reduction

– When you set to a slow shutter speed

**Applicable modes:** [A] [P] [A S] [M] [i] [v]

• When using an interchangeable lens with O.I.S. switch (such as H-ES12060), stabilizer function is activated if the O.I.S. switch of the lens is set to [ON]. ([ⓘ]) is set at the time of purchase.)

**MENU** → [Rec] → [Stabilizer]

<b>[Operation Mode]</b>	[ⓘ] ([Normal])	Camera shake is corrected for up/down, left/right, and rotational movements.	
	[ⓘ] ([Panning])	Camera shake is corrected for up/down movements. This mode is ideal for panning (a method of taking pictures which involves turning the camera to track the movements of a subject which continues to move in a fixed direction).	
	[OFF]	[Stabilizer] does not work. ([ⓘ]) • When using a lens with an O.I.S. switch, set the switch to [OFF].	
<b>[E-Stabilization (Video)]</b>	Jitter during motion picture recording is corrected along the vertical, horizontal, roll, pitch, and yaw axes by making use of the In-Lens Image Stabilizer, In-Body Image Stabilizer, and Electronic Image Stabilizer. (5-Axis Hybrid Image Stabilizer) <b>[ON]/[OFF]</b> • When [ON] is selected, the angle of view of recorded motion pictures may become narrower.		

<p>[I.S. Lock (Video)]</p>	<p>Allows you to enhance the image stabilization effect during motion picture recording. This effect can keep the motion blur in the composition minimal when you want to perform recording from a fixed perspective.</p> <p><b>[ON]/[OFF]</b></p> <ul style="list-style-type: none"> <li>This effect works only during recording.  is displayed on the recording screen.</li> <li><b>To change the composition during recording, set the effect to [OFF] first, and then move the camera.</b> Use the appropriate function button to change the setting during recording. (P60)</li> <li>In situations where the focal length becomes greater, such as when a telephoto lens is attached, the stabilization effect will be weaker.</li> <li>The stabilization effect may be weak depending on the lens used.</li> </ul>
<p>[Focal Length Set]</p>	<p>If the focal length is not set automatically, you can set it manually.</p> <ul style="list-style-type: none"> <li>When a manually selected focal length is set, a confirmation screen asking you to change the focal length setting is displayed after you turn on the camera. Selecting [Yes] allows you to set [Focal Length Set] in [Stabilizer].</li> </ul>

## Setting the focal length of a lens

### 1 Select the menu.

**MENU** →  [Rec] → [Stabilizer] → [Focal Length Set]

### 2 Enter a focal length.

◀/▶: Select the item (digit); ▲/▼: Setting

- A focal length ranging from 0.1 mm to 1000 mm can be set.

### 3 Press [MENU/SET].



## ■ Registering a focal length

### 1 Perform step 2 in “Setting the focal length of a lens”.

### 2 Press ▶ to select the focal length to be overwritten and then press [DISP.].

- Up to 3 focal length settings can be registered.



## ■ Setting a registered focal length

On the screen in step 2 of “Setting the focal length of a lens”, press ◀/▶ to select the registered focal length and then press [MENU/SET].

• **The Image Stabilizer may produce operational sound or cause vibration during its operation, but these are not malfunctions.**

- It is recommended to disable the Image Stabilizer when using a tripod.
- The stabilizer function may not be effective in the following cases. Be careful of camera jitter when you press the shutter button.
  - When there is a lot of jitter
  - When the zoom magnification is high
  - When using the Digital Zoom
  - When taking pictures while following a moving subject
  - When the shutter speed becomes slower to take pictures indoors or in dark places
- The panning effect in [ ] is more difficult to achieve in the following cases.
  - In brightly lit places such as in broad daylight on a summer's day
  - When the shutter speed is faster than 1/100th of a second
  - When you move the camera too slowly because the subject is moving slowly (The background will not become a blur)
  - When the camera does not keep up with the subject satisfactorily



**Not available in these cases:**

- In the following cases, the [Stabilizer] will switch to [ ] (Normal), even if it is set to [ ] (Panning):
  - When recording motion pictures
  - When recording 6K/4K photos
  - When recording with the Post Focus function
- In the following case, the [Stabilizer] will switch from [ <sup>DUAL2</sup> ] to [ <sup>DUAL</sup> ] even when a compatible lens is being used:
  - When [High Speed Video] is set
- The 5-Axis Hybrid Image Stabilizer function is not available in the following cases:
  - When using the Digital Zoom
  - When [High Speed Video] is set
  - When [4K Live Cropping] is set
- The Image Stabilizer is not available when [High Resolution Mode] is set.

# Taking Pictures with the Zoom

## Optical zoom

Applicable modes:   **P** **A** **S** **M**  

You can zoom-in to make people and objects appear closer or zoom-out to record landscapes, etc.

**T** side: Enlarges distant subject

**W** side: Widens angle of view

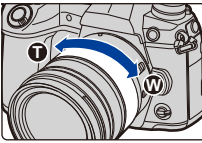
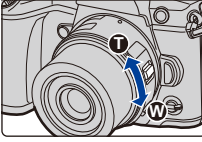
<p><b>Interchangeable lens with a zoom ring</b></p>	<p>Rotate the zoom ring.</p>	
<p><b>Interchangeable lens that supports the power zoom (electrically operated zoom)</b></p>	<p>Move the zoom lever. (The zoom speed varies depending on how far you move the lever.)</p> <ul style="list-style-type: none"> <li>• If you assign [Zoom Control] to a function button, you can operate the optical zoom slowly by pressing ◀/▶ or fast by pressing ▲/▼.</li> </ul> <p>For information on how to operate, refer to step <b>2</b> and the subsequent steps on <b>P151</b>.</p>	
<p><b>Interchangeable lens that does not support the zoom</b></p>	<p>The optical zoom is not available.</p>	

## Raising the telescopic effect

[Ex. Tele Conv.]

Applicable modes:   **P** **A** **S** **M**  

Extended Tele Conversion enables you to take pictures that are further enlarged without deteriorating the picture quality.

<b>When taking pictures</b>	[Ex. Tele Conv.] ([Rec])	1.4×: <b>[EX]</b> M 2.0×: <b>[EX]</b> S 1.4×: When recording 6K/4K photos* ([16:9]/[1:1]) 1.5×: When recording 6K/4K photos* ([3:2]) 1.6×: When recording 6K/4K photos* ([4:3]) * Only when [4K H 8M], [4K 8M] is set
-----------------------------	-----------------------------	--

• Set the picture size to **[M]** or **[S]** (picture sizes indicated with **[EX]**), and set the quality to **[iA]** or **[iB]**.

<b>When recording motion pictures</b>	[Ex. Tele Conv.] ([Motion Picture])	1.4× (motion pictures size is set to [4K] in [Rec Quality]) 2.7× (motion pictures size is set to [FHD] in [Rec Quality])
---------------------------------------	--	---

## ■ Increasing the zoom magnification in steps

- This can be used only when recording pictures.

### 1 Select the menu.

**MENU** → [Rec] → [Ex. Tele Conv.] → [ZOOM]

### 2 Set a function button to [Zoom Control]. (P60)

### 3 Press the function button.

### 4 Press ◀/▶ or ▲/▼.

▲/▶: Tele (Enlarges distant subject)

▼/◀: Wide (Widens angle of view)

- The zoom operation is terminated when the function button is pressed again or a certain amount of time passes.



(A) Optical Zoom range (Focal length)\*

(B) Extended Tele Conversion range for still picture recording (Zoom magnification)

\* This zoom slider is displayed when using an interchangeable lens that supports the power zoom.

- A constant zoom speed will be set.
- The indicated zoom magnification is an approximation.



## ■ Fixing the zoom magnification at the maximum level

**MENU** → [Rec] → [Ex. Tele Conv.] → [TELE CONV.]

**MENU** → [Motion Picture] → [Ex. Tele Conv.] → [ON]

[OFF]



[TELE CONV.]/[ON]

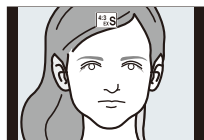

- If you assign [Ex. Tele Conv.] to [Fn Button Set] in the [Custom] ([Operation]) menu, you can display the Extended Tele Conversion setting screen for both pictures and motion pictures by pressing the assigned function button. While this screen is displayed, you can change the [Picture Size] setting by pressing [DISP.].



#### Not available in these cases:

- This function is not available in the following cases:
  - [Toy Effect]/[Toy Pop] (Creative Control Mode)
  - When [Quality] is set to [RAW]
  - When recording 6K/4K photos (only when [6K 18M] is set)
  - When recording with the Post Focus function (only when [6K 18M] is set)
  - When [HDR] is set to [ON]
  - When using [High Resolution Mode]
  - When using [Multi Exp.]
  - When [High Speed Video] is set to [180fps/FHD]
  - When [4K Live Cropping] is set
- In the following case, [ZOOM] does not work:
  - When recording 6K/4K photos
  - When recording with the Post Focus function

### [Digital Zoom]

**Applicable modes:** **P** **A** **S** **M**

Although the image quality deteriorates every time you zoom in further, you can zoom in up to four times the original zoom magnification.  
(Continuous zooming is not possible.)

**MENU** → **[Rec]** → **[Digital Zoom]** → **[4×]/[2×]**

- When using the Digital Zoom, we recommend using a tripod and the self-timer for taking pictures.



#### Not available in these cases:

- This function is not available in the following cases:
  - [Toy Effect]/[Toy Pop]/[Miniature Effect] (Creative Control Mode)
  - When [Quality] is set to [RAW<sub>4:3</sub>], [RAW<sub>3:2</sub>] or [RAW]
  - When recording 6K/4K photos (only when [6K 18M] is set)
  - When recording with the Post Focus function
  - When using [High Resolution Mode]
  - When [High Speed Video] is set
  - When using [Multi Exp.]



## Changing the settings for a power zoom lens

**Applicable modes:** **P** **A** **S** **M**

Sets the screen display and lens operations when using an interchangeable lens that is compatible with power zoom (electrically operated zoom).

- This may only be selected when using a lens that is compatible with power zoom (electrically operated zoom).

**MENU** → **[Custom]** → **[Lens / Others]** → **[Power Zoom Lens]**

<p><b>[Disp Focal Length]</b></p>	<p>When you zoom, the focal distance is displayed and you can confirm the zoom position.</p> <p>(A) Focal distance indication (B) Current focal distance</p>	
<p><b>[Step Zoom]</b></p>	<p>When you operate the zoom with this setting [ON], the zoom will stop at positions corresponding to predetermined distances.</p> <p>(C) Step zoom indication</p> <ul style="list-style-type: none"> <li>• This setting does not work when recording motion pictures or recording with [6K/4K Pre-Burst].</li> </ul>	
<p><b>[Zoom Speed]</b></p>	<p>You can set the zoom speed for zoom operations.</p> <ul style="list-style-type: none"> <li>• If you set [Step Zoom] to [ON], the zoom speed will not change.</li> </ul> <p><b>[Photo]:</b>  <b>[H]</b> (High speed)/<b>[M]</b> (Middle speed)/<b>[L]</b> (Low speed)  <b>[Video]:</b>  <b>[H]</b> (High speed)/<b>[M]</b> (Middle speed)/<b>[L]</b> (Low speed)</p>	
<p><b>[Zoom Ring]</b></p>	<p>This may only be selected when a power zoom-compatible lens with a zoom lever and zoom ring is attached.</p> <p>When set to [OFF], the operations controlled by the zoom ring are disabled to prevent accidental operation.</p>	

## Zooming using touch operations (Touch zoom)

(Optical Zoom and Extended Tele Conversion for still picture recording are operable)

- If you are using an interchangeable lens not supporting power zoom (H-ES12060/H-FS12060), you can only operate Extended Tele Conversion for pictures by setting [Ex. Tele Conv.] to [ZOOM].

**1** Touch [].

**2** Touch [].

- The slide bar is displayed.

**3** Perform zoom operations by dragging the slide bar.

- The zoom speed varies depending on the touched position.

[]/[]	Zooms slowly
[]/[]	Zooms quickly

- To end touch zoom operations, touch [] again.

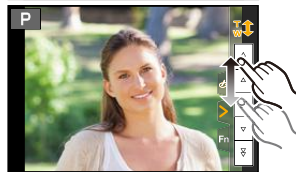

## Taking Pictures with the External Flash (Optional)

Applicable modes: **A** **Av** **P** **A** **S** **M** **M** **+**

You can attach a flash (DMW-FL580L/DMW-FL360L/DMW-FL200L: optional) and take pictures with it.

- Read the operating instructions of the external flash for how to attach the external flash.

### ■ Removing the Hot Shoe Cover

The camera comes with a hot shoe cover attached to the hot shoe.

Remove the hot shoe cover by pulling it in the direction indicated by arrow ② while pressing it in the direction indicated by arrow ①.

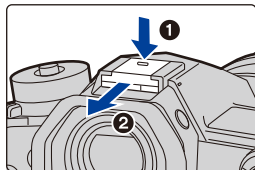

- Keep the hot shoe cover out of reach of children to prevent swallowing.



In the following cases, the flash is fixed to [☹] (forced flash off).

- When recording motion pictures
- When recording in Burst Mode (only when [Burst Shot Setting] is set to [SH2]/[SH1]/[SH2 PRE]/[SH1 PRE])
- When recording 6K/4K photos
- When recording with the Post Focus function
- When using the electronic shutter
- When an image effect in [Filter Effect] of [Filter Settings] is set
- When [Silent Mode] is set to [ON]
- When [High Resolution Mode] is set
- When [HDR] is set to [ON]



Using the flash skillfully

- When taking pictures with flash with the lens hood attached, the lower portion of the photo may turn dark and the control of the flash may be disabled because the photo flash may be obscured by the lens hood. We recommend detaching the lens hood.

**When using other commercially available external flashes without communication functions with the camera**

- It is necessary to set the exposure on the external flash. If you want to use the external flash in Auto Mode, use an external flash that allows you to set the aperture value and the ISO sensitivity to match the settings on the camera.
- Set to Aperture-Priority AE Mode or Manual Exposure Mode on the camera and then set the same aperture value and ISO sensitivity on the external flash. (The exposure cannot be compensated adequately due to the change on the aperture value in Shutter-Priority AE Mode and the external flash cannot control the light adequately in Program AE Mode because the aperture value cannot be fixed.)

**Using a external flash by connecting with a flash synchro socket**

- You can use an external flash by connecting a synchro cable with a flash synchro socket. The socket has a lock screw to prevent the cable falling off.
- Remove the flash synchro socket cap by turning in the direction of the arrow.
- Be careful not to lose the flash synchro socket cap.
- The flash synchro socket has no polarity. You can use a synchro cable regardless of its polarity.
- Use the flash with a synchronization voltage of 400 V or less.
- Do not use the synchro cables with the length of 3 m (9.8 feet) or more.

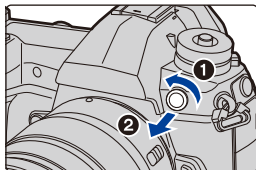

- Do not bring any objects near the flash. The heat and light from the flash may cause the objects to deform or discolor.
- It may take time to charge the flash if you repeatedly take pictures. You must wait a moment to take the next picture while the flash icon is blinking red indicating the flash is charging.
- You can set the aperture value, the shutter speed and the ISO sensitivity on the camera even when attaching the external flash.
- If you record at close range with a wide angle, light from the flash may be blocked by the lens, darkening the lower part of the screen.
- Do not use commercially available external flashes with high-voltage synchro terminals, reverse polarity or functions that enable them to communicate with the camera. Doing so may cause the camera to malfunction or operate incorrectly.
- When attaching the external flash, do not hold only the external flash because it may detach from the camera.
- Read the operating instructions of the external flash for details.

# Setting the Flash Functions

- [Flash] in the [Rec] menu is available only when an external flash is attached.

## Changing the firing mode

Applicable modes:  P A S M 

Select whether to set the flash output automatically or manually.

- The firing mode cannot be set with the camera when using a flash (DMW-FL580L/DMW-FL360L/DMW-FL200L: optional). It can be set with the camera only with certain flash models capable of allowing you to change the firing mode by operating the camera.

### 1 Select the menu.

**MENU** →  [Rec] → [Flash] → [Firing Mode]

[TTL]	The camera automatically sets the flash output.
[MANUAL]	Set the luminosity ratio of the flash manually. In [TTL] you can shoot the photograph you want even when shooting dark scenes that may otherwise be too brightly lit by the flash. <ul style="list-style-type: none"> <li>• When [MANUAL] is set, the luminosity ratio ([1/1], etc.) is displayed on the flash icon on the screen.</li> </ul>

### 2 (When [MANUAL] is selected)

Select the menu.

**MENU** →  [Rec] → [Flash] → [Manual Flash Adjust.]

### 3 Press ◀/▶ to set the luminosity ratio and then press [MENU/SET].

## Changing Flash Mode

Applicable modes: **P** **A** **S** **M**

Set the flash to match the recording.

**MENU** → [Rec] → [Flash] → [Flash Mode]

 ((Forced Flash On))  ((Forced On/Red-Eye))*	<p>The flash is activated every time regardless of the recording conditions.</p> <ul style="list-style-type: none"> <li>• <b>Use this when your subject is back-lit or under fluorescent light.</b></li> </ul>	
 ((Slow Sync.))  ((Slow Sync./Red-Eye))*	<p>When taking pictures against a dark background landscape, this feature will slow the shutter speed when the flash is activated. Dark background landscape will appear brighter.</p> <ul style="list-style-type: none"> <li>• <b>Use this when you take pictures of people in front of a dark background.</b></li> <li>• <b>Using a slower speed can cause motion blur. Using a tripod can enhance your photos.</b></li> </ul>	
 ((Forced Flash Off))	<p>The flash is not activated in any recording conditions.</p> <ul style="list-style-type: none"> <li>• <b>Use this when you take pictures in places where the use of flash is not permitted.</b></li> </ul>	

\* It can be set only when [Wireless] in [Flash] is set to [OFF] and [Firing Mode] is set to [TTL].

• Some flash modes may not be available depending on the external flash's settings.

**The flash is activated twice.**

**The interval between the first and second flash is longer when [ ] or [ ] is set. The subject should not move until the second flash is activated.**

• The Red-Eye Reduction effect differs between people. Also, if the subject was far away from the camera or was not looking at the first flash, the effect may not be evident.

### Available flash settings by Recording Mode

The available flash settings depend on the Recording Mode.

(○: Available, —: Not available)

Recording Mode		⚡	⚡Ⓞ	⚡S	⚡SⓄ	Ⓞ
<b>P</b>	Program AE Mode	○	○	○	○	○
<b>A</b>	Aperture-Priority AE Mode	○	○	○	○	○
<b>S</b>	Shutter-Priority AE Mode	○	○	—	—	○
<b>M</b>	Manual Exposure Mode	○	○	—	—	○

- In Intelligent Auto Mode ( or ), the flash will be set to [] or [].

### Shutter speed for each flash setting

Flash setting	Shutter speed (Sec.)	Flash setting	Shutter speed (Sec.)
⚡	1/60th* to 1/250th	⚡S	1 to 1/250th
⚡Ⓞ		⚡SⓄ	

\* This becomes 60 seconds in Shutter-Priority AE Mode and B (Bulb) in the Manual Exposure Mode.

- In Intelligent Auto ( or ) Mode, shutter speed changes depending on the identified scene.

## Setting to the 2nd Curtain Synchro

Applicable modes: **P** **A** **S** **M**

2nd curtain synchro activates the flash just before the shutter closes when taking pictures of moving objects such as cars using a slow shutter speed.

**MENU** → [Rec] → [Flash] → [Flash Synchro]

<b>[1ST]</b>	1st curtain synchro The normal method when taking pictures with the flash.	
<b>[2ND]</b>	2nd curtain synchro The light source appears behind the subject and picture becomes dynamic.	

- [2nd] is displayed in the flash icon on the screen if you set [Flash Synchro] to [2ND].
- Only available when [Wireless] in [Flash] is set to [OFF].
- When a fast shutter speed is set, the effect of [Flash Synchro] may deteriorate.
- You cannot set [ ] or [ ] when [Flash Synchro] is set to [2ND].

## Adjust the flash output

Applicable modes:  P A S M 

Adjust the flash brightness when pictures taken with the flash are over or underexposed.

### 1 Select the menu.

**MENU** →  [Rec] → [Flash] → [Flash Adjust.]

### 2 Press /▶ to set the flash output and then press [MENU/SET].

- You can adjust from [-3 EV] to [+3 EV] in steps of 1/3 EV.
- Select [±0] to return to the original flash output.

- [+] or [-] is displayed on the flash icon in the screen when the flash level is adjusted.
- It can be set only when [Wireless] in [Flash] is set to [OFF] and [Firing Mode] is set to [TTL].

## Synchronizing the output of the flash to the Exposure Compensation

Applicable modes:  P A S M 

**MENU** →  [Rec] → [Flash] → [Auto Exposure Comp.]

Settings: [ON]/[OFF]

- For details on Exposure Compensation, refer to [P107](#).



## Taking Pictures with Wireless Flashes

Applicable modes:  P A S M

Flashes compatible with this camera (DMW-FL580L/DMW-FL360L/DMW-FL200L: optional) come with the wireless recording function.

With this function, you can separately control the firing of three flash groups and the flash attached to the hot shoe of the camera.

### ■ Placing wireless flashes

Place the wireless flash with its wireless sensor facing toward the camera.

The following figure shows the estimated controllable range when you take pictures by holding the camera horizontally. Controllable range differs depending on the surrounding environment.

**Placement range (when a flash (DMW-FL360L: optional) is attached)**

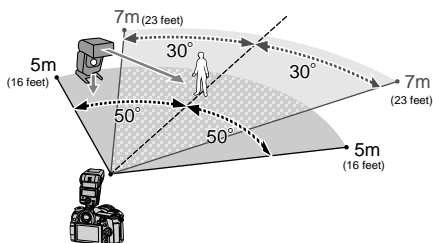

**Placement example**

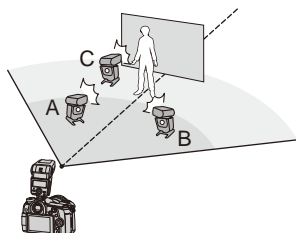

- In this placement example, flash C is placed to erase the shadow of the subject that flashes A and B will create.
- The recommended number of wireless flashes for each group is three or less.
- If the subject is too close, signal flashing may affect the exposure.  
If you set [Communication Light] to [LOW] or lower the output with a diffuser or similar product, the effect will be reduced.

**1 Attach the flash (DMW-FL580L/DMW-FL360L/DMW-FL200L: optional) to the camera.**

**2 Set the wireless flashes to RC Mode and then place them.**

- Set a channel and groups for the wireless flash.

### 3 Select the menu.

MENU →  [Rec] → [Flash]	
[Wireless]	Select [ON].
[Wireless Channel]	Select the channel you have set for the wireless flashes in step 2.
[Wireless Setup]	Proceed to step 4.

### 4 Press ▲/▼ to select an item and then press [MENU/SET].

• To fire a test flash, press [DISP.].

- (A) Firing Mode
- (B) Flash output
- (C) Luminosity ratio



[External Flash] <sup>*1</sup>	<b>[Firing Mode]</b> <b>[TTL]:</b> The camera automatically sets the output. <b>[AUTO]<sup>*2</sup>:</b> Flash output is set by the external flash. <b>[MANUAL]:</b> Set the luminosity ratio of the external flash manually. <b>[OFF]:</b> The flash on the camera side emits only communication light.
	<b>[Flash Adjust.]</b> Set the flash output of the camera manually when [Firing Mode] is set to [TTL].
	<b>[Manual Flash Adjust.]</b> Set the luminosity ratio of the external flash when [Firing Mode] is set to [MANUAL]. • You can set from [1/1] (full brightness) to [1/128] in steps of 1/3.
[A Group]/ [B Group]/ [C Group]	<b>[Firing Mode]</b> <b>[TTL]:</b> The camera automatically sets the output. <b>[AUTO]<sup>*1</sup>:</b> The wireless flashes automatically set the output. <b>[MANUAL]:</b> Set the luminosity ratio of the wireless flashes manually. <b>[OFF]:</b> The wireless flashes of the specified group will not fire.
	<b>[Flash Adjust.]</b> Adjust the output of the wireless flashes manually when [Firing Mode] is set to [TTL].
	<b>[Manual Flash Adjust.]</b> Set the luminosity ratio of the wireless flashes when [Firing Mode] is set to [MANUAL]. • You can set from [1/1] (full brightness) to [1/128] in steps of 1/3.

\*1 Not available when [Wireless FP] is set to [ON].

\*2 This option is not displayed when the flash (DMW-FL200L: optional) is attached to the camera.

## Using other settings for wireless flash recording

### Enabling FP firing for the wireless flashes

During wireless recording, an external flash fires an FP flash (high speed repetition of flash firing). This firing allows recording with the flash at a fast shutter speed.

**MENU** →  **[Rec]** → **[Flash]** → **[Wireless FP]**

Settings: **[ON]/[OFF]**

### Setting the output of communication light

**MENU** →  **[Rec]** → **[Flash]** → **[Communication Light]**

Settings: **[HIGH]/[STANDARD]/[LOW]**



MENU



## Recording Motion Picture

Applicable modes:         

This camera can record full high definition motion pictures compatible with the AVCHD format or motion pictures recorded in MP4. In addition, the camera can record 4K motion pictures in MP4.

Audio will be recorded in stereo.

### 1 Start recording by pressing the motion picture button.

- (A) Elapsed recording time
- (B) Available recording time

- Recording of motion picture appropriate for each mode is possible.
- The recording state indicator (red) (C) will flash while recording motion pictures.
- Release the motion picture button right after you press it.
- m: minute, s: second

### 2 Stop the recording by pressing the motion picture button again.

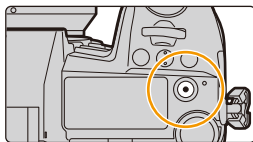

- When the ambient temperature is high or motion picture is recorded continuously, the camera may display [] and stop the recording to protect itself. Wait until the camera cools down.
- In Creative Video Mode, motion pictures are recorded at the selected ISO sensitivity; in other modes, they are recorded using [AUTO] (for motion pictures).
- You can display the available recording time before recording in Creative Video Mode.
- When the aspect ratio setting is different in still and motion pictures, the angle of view changes at the start of motion picture recording.  
When [Rec Area] in the [Custom] ([Monitor / Display]) menu is set to [], angle of view during motion picture recording is displayed.
- The operational sound of the zoom or button operation may be recorded when it is operated during the recording of a motion picture.
- The functions available when recording motion pictures differ according to the lens you are using, and the operational sound of the lens may be recorded.
- If the operation sound of the motion picture button pressed to end recording bothers you, try the following:
  - Record the motion picture about three seconds longer, and then divide the last part of the motion picture using [Video Divide] in the [Playback] menu.
  - Set the camera to Creative Video Mode, and use a shutter remote control (DMW-RSL1: optional) to record motion pictures.
- Depending on the type of the card, the card access indication may appear for a while after recording motion pictures. This is not a malfunction.

**Not available in these cases:**

- Motion pictures cannot be recorded in the following cases.
  - [Rough Monochrome]/[Silky Monochrome]/[Soft Focus]/[Star Filter]/[Sunshine] (Creative Control Mode)
  - When recording with the Post Focus function
  - When taking pictures with [Time Lapse Shot]
  - When using [Stop Motion Animation]

## Setting the format, size and frame rate

### 1 Select the menu.

**MENU** →  **[Motion Picture]** → **[Rec Format]**

<b>[AVCHD]</b>	This data format is suitable for when playing back on a high-definition TV, etc.
<b>[MP4]</b>	This data format is suitable for when playing back on a PC, etc.

### 2 Press ▲/▼ to select **[Rec Quality]** and then press **[MENU/SET]**.

#### When **[AVCHD]** is selected

Item	Size	Recording frame rate	Sensor output	Bit rate
<b>[FHD/28M/60p]</b> <sup>*1</sup>	1920×1080	60p	60 frames/second	28 Mbps
<b>[FHD/17M/60i]</b>	1920×1080	60i	60 frames/second	17 Mbps
<b>[FHD/24M/30p]</b>	1920×1080	60i	30 frames/second	24 Mbps
<b>[FHD/24M/24p]</b>	1920×1080	24p	24 frames/second	24 Mbps

\*1 AVCHD Progressive

#### When **[MP4]** is selected

Item	Size	Recording frame rate	Sensor output	Bit rate
<b>[4K/150M/60p]</b> <sup>*2</sup>	3840×2160	60p	60 frames/second	150 Mbps
<b>[4K/100M/30p]</b>	3840×2160	30p	30 frames/second	100 Mbps
<b>[4K/100M/24p]</b>	3840×2160	24p	24 frames/second	100 Mbps
<b>[FHD/28M/60p]</b>	1920×1080	60p	60 frames/second	28 Mbps
<b>[FHD/20M/30p]</b>	1920×1080	30p	30 frames/second	20 Mbps

\*2 These items are intended for motion picture editing on a computer. Playback and editing on a device other than this camera require a high-performance PC environment.

- The higher the Bit rate value is, the higher the picture quality becomes. Since the camera employs the VBR recording method, the bit rate is changed automatically depending on the subject to record. As a result, the recording time is shortened when a fast-moving subject is recorded.
- When [Miniature Effect] is selected for Creative Control Mode, you cannot select the items used for 4K motion pictures.
- When recording motion pictures in 4K, use a card rated as UHS Speed Class 3.
- All motion pictures will be recorded in 4:2:0/8 bit Long GOP format.

### ■ About the compatibility of the recorded motion pictures

Even if motion pictures suit their respective playback devices, their image or sound quality may be poor or their recording information may not be displayed correctly when played back, or they may not be able to be played back. If you experience such issues, play them back on this camera.

- To play back motion pictures recorded with [FHD/28M/60p], [FHD/24M/30p] or [FHD/24M/24p] in [AVCHD] with another device, or to transfer them to another device, you need a compatible Blu-ray disc recorder or a PC on which the software "PHOTOfunSTUDIO" is installed.
- For information about motion pictures recorded with their size set to [4K] in [Rec Quality], refer to "Watching/Saving 4K Motion Pictures on an External Device" on [P293](#).

### How to set focus when recording a motion picture ([Continuous AF])

Applicable modes:        

Focusing changes depending on the Focus Mode setting and the [Continuous AF] setting in the [Motion Picture] menu.

Focus mode	[Continuous AF]	Description of settings
[AFS]/[AFF]/ [AFC]	[ON]	The camera automatically keeps focusing on subjects during recording.
	[OFF]	The camera maintains the focus position at the start of recording.
[MF]	[ON]/[OFF]	You can focus manually.

- When the focus mode is set to [AFS], [AFF] or [AFC], if you press the shutter button halfway while recording a motion picture, the camera will re-adjust the focus.
- Depending on the recording conditions or lens used, operational sound may be recorded when the Auto Focus is operated while recording a motion picture.  
It is recommended to record with [Continuous AF] in the [Motion Picture] menu set to [OFF], if the sound of operation bothers you to avoid recording the lens noise.
- When operating the zoom while recording motion pictures, it may take time to come into focus.

## Recording still pictures while recording motion pictures

Applicable modes:

You can record still pictures while recording a motion picture. (Simultaneous recording)

**During motion picture recording, press the shutter button fully to record a still picture.**

- Simultaneous recording indicator is displayed while recording still pictures.
- Recording with the Touch Shutter function is also available.



### ■ Setting the motion picture priority or still picture priority mode

Applicable modes:

Select the menu. (P55)

**MENU** → **[Motion Picture]** → **[Picture Mode in Rec.]**

<b>[Video Priority]</b>	<ul style="list-style-type: none"> <li>• Pictures will be recorded with a picture size determined by the [Rec Quality] setting for motion pictures.</li> <li>• Only JPEG images are recorded when [Quality] is set to [RAW<sub>1</sub>], [RAW<sub>2</sub>] or [RAW]. (When set to [RAW], still pictures will be recorded in [Quality] of [RAW].)</li> <li>• Up to 80 still pictures can be recorded during recording of the motion picture. (Up to 20 still pictures during 4K motion picture recording)</li> </ul>
<b>[Photo Priority]</b>	<ul style="list-style-type: none"> <li>• Pictures will be recorded with the set picture size and quality.</li> <li>• The screen will go dark while recording pictures. A still picture will be recorded in the motion picture during that period, and audio is not recorded.</li> <li>• Up to 20 still pictures can be recorded during recording of the motion picture. (Up to 10 still pictures during 4K motion picture recording)</li> </ul>

- The picture aspect ratio will be fixed to [16:9].



#### Not available in these cases:

- This function is not available in the following cases:
  - When [Rec Quality] is set to a motion picture item with a frame rate of [24p] (only when ([Photo Priority]) is set)
  - When the drive mode is set to 6K/4K Photo (only when ([Photo Priority]) is set)
  - When using [Ex. Tele Conv.] in the [Motion Picture] menu (only when ([Photo Priority]) is set)



## Displaying/setting the sound input level

### [Mic Level Disp.]

Applicable modes:   P A S M  

Display the microphone level on the recording screen.

**MENU** →  [Motion Picture] → [Mic Level Disp.]

Settings: [ON]/[OFF]

• When [Mic Level Limiter] is set to [OFF], [Mic Level Disp.] is fixed to [ON].

### [Mic Level Adj.]

Applicable modes:   P A S M  

Adjust the sound input level to 19 different levels (−12 dB to +6 dB).

**MENU** →  [Motion Picture] → [Mic Level Adj.]

• Displayed dB values are approximate.

### [Mic Level Limiter]

Applicable modes:   P A S M  

The camera adjusts the sound input level automatically, minimizing the sound distortion (crackling noise) when the volume is too high.

**MENU** →  [Motion Picture] → [Mic Level Limiter]

Settings: [ON]/[OFF]

## Recording images with superimposed recording dates ([Time Stamp Rec])

Applicable modes:   P A S M  

• You cannot delete recording dates after superimposing them.

**MENU** →  [Motion Picture] → [Time Stamp Rec]

Settings: [ON]/[OFF]

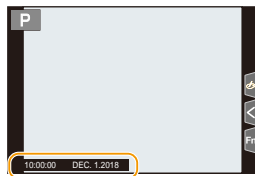

• Recording dates are not recorded to 6K/4K burst files and RAW images.

### **Not available in these cases:**

- This function is not available in the following cases:
  - When recording with the Post Focus function
  - When [High Speed Video] is set
  - When recording in [High Resolution Mode]

# Recording Motion Pictures in Creative Video Mode

Recording Mode: 

It is possible to manually change the aperture, shutter speed and ISO sensitivity and record motion pictures.

You can record motion picture with additional effects, such as the following:

Recording slow motion pictures (High Speed Video)

 **P173**

Recording Motion Pictures that Pan and Zoom While Maintaining a Fixed Camera Position ([4K Live Cropping])

 **P174**

**1** Set the mode dial to .

**2** Select the menu.

**MENU** →  **[Creative Video]** → **[Exposure Mode]** → **[P]/[A]/[S]/[M]**

- The operation for changing the aperture value or shutter speed is the same as the operation for setting the mode dial to **P**, **A**, **S** or **M**.



It is also possible to display the selection screen by touching the Recording Mode icon in recording screen.



### 3 Press the motion picture button (or shutter button) to start recording.

- The operational sound of the zoom or button operation may be recorded when it is operated during the recording of a motion picture.

Using touch icons allows silent operation while recording motion pictures.

① Touch [  ].

② Touch icon.

 : Zoom

 : Exposure Compensation



F : Aperture value



ISO : ISO sensitivity

SS : Shutter speed

 : Mic level adjustment

③ Drag the slide bar to set.

[  ]/[  ]: Changes the setting slowly

[  ]/[  ]: Changes the setting quickly

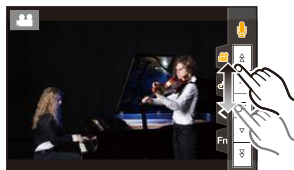

### 4 Press the motion picture button (or shutter button) again to stop recording.

- With Creative Video Mode, you can set an ISO sensitivity value that falls in the range below.
  - Value range: [AUTO], [200] to [12800] ([100] to [12800] if [Extended ISO] is set)
  - Upper limit of the [AUTO] ISO sensitivity: [6400] (When the [ISO Auto Upper Limit Setting] in [ISO Sensitivity (video)] is set to [AUTO])

#### ■ Changing the [AUTO] ISO sensitivity settings

Set the upper and lower limits of the ISO sensitivity when it is set to [AUTO].

**MENU** →  [Motion Picture] → [ISO Sensitivity (video)]

[ISO Auto Lower Limit Setting]	[200]/[400]/[800]/[1600]/[3200]/[6400]
[ISO Auto Upper Limit Setting]	[AUTO]/[400]/[800]/[1600]/[3200]/[6400]/[12800]

## Recording slow motion pictures (High Speed Video)

You can record slow motion pictures by performing ultra-high-speed recording.

- Use a UHS Speed Class 3 card. (P30)

- 1 Set the mode dial to [P/M].
- 2 Select the menu.

**MENU** → **⌘** [Creative Video] → [High Speed Video]

Settings	Frame rate (for recording)	[Rec Quality] (for storage)	Slow motion effect
[180fps/FHD]	180 frames/second	FHD/20M/30p	Approx. 1/6×
[60fps/4K]	60 frames/second	4K/100M/30p	Approx. 1/2×
[48fps/4K]	48 frames/second	4K/100M/24p	Approx. 1/2×
[OFF]	—		

- The recording format is set to [MP4].

- 3 Press the motion picture button (or shutter button) to start recording.
- 4 Press the motion picture button (or shutter button) again to stop recording.

- Auto Focus does not work.
- Audio is not recorded.
- When using an interchangeable lens with no focus ring, you cannot set focus with Manual Focus.
- Under fluorescent lighting, flicker or horizontal bars may be seen.



### Not available in these cases:

- This function is not available in the following cases:
  - When [4K Live Cropping] is set

## Recording Motion Pictures that Pan and Zoom While Maintaining a Fixed Camera Position ([4K Live Cropping])

By cropping your motion picture down from the 4K angle of view to Full High Definition, you can record a motion picture that pans and zooms in/out while leaving the camera in a fixed position.



Pan

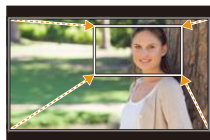

Zoom in

- [Rec Format] and [Rec Quality] in the [Motion Picture] menu will be fixed to [MP4] and [FHD/20M/30p], respectively.
- Hold the camera firmly in place while recording.

- 1 Set the mode dial to [M].
- 2 Select the menu.

**MENU** → **[Creative Video]** → **[4K Live Cropping]** → **[40SEC]/[20SEC]**

- 3 Set the cropping start frame.

(A) Cropping start frame

- When making settings for the first time, a cropping start frame of size 1920×1080 is displayed. (After setting the cropping start frame and end frame, the start frame and end frame that you set immediately before will be displayed.)
- The camera will remember the frame position and size even when the camera is turned off.

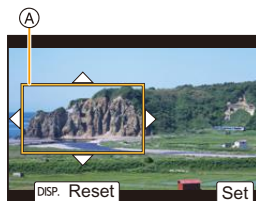

Button operation	Touch operation	Description of operation
▲/▼/◀/▶	Touching	Moves the frame.
	Pinching out/in	Enlarges/reduces the frame. (The range of settings allowed is from 1920×1080 to 3840×2160.)
[DISP.]	[Reset]	Returns the position of the frame to the center and its size to the default setting.
[MENU/SET]	[Set]	Decides the position and size of the frame.

**4 Repeat step 3, and then set the cropping end frame.****(B) Cropping end frame**

- The setting of the Auto Focus Mode switches to [AF-].  
(Human eyes and bodies cannot be detected. In addition, you cannot specify the person to be brought into focus.)

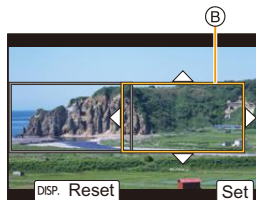
**5 Press the motion picture button (or shutter button) to start recording.****(C) Elapsed recording time****(D) Set operating time**

- Immediately release the motion picture button (or the shutter button) after pressing it.
- When the set operating time has elapsed, recording automatically ends.  
To end recording midway, press the motion picture button (or the shutter button) again.

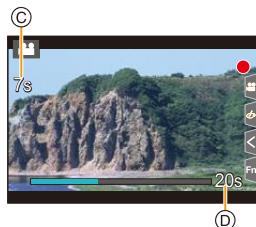
**■ Changing the position and size of a crop frame**

Press ◀ while the recording screen is displayed, and perform steps 3 and 4.

**■ To cancel [4K Live Cropping] recording**

Set [OFF] in step 2.

- Brightness is measured and focus is done in the cropping start frame. During motion picture recording, they are done in the crop frame. To lock the focus position, set [Continuous AF] to [OFF], or set the Focus Mode to [MF].
- [Metering Mode] will be [☉] (Multiple).

**ⓘ Not available in these cases:**

- This function is not available in the following cases:
  - When [High Speed Video] is set

## Playing Back Pictures

1 Press [▶].

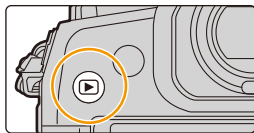

2 Press ◀/▶.

◀: Play back the previous picture

▶: Play back the next picture

(A) Card slot

- If you press and hold ◀/▶, you can play back the pictures in succession.
- Pictures can also be forwarded or rewound by rotating the control dial or dragging the screen horizontally.
- You can forward or rewind pictures continuously by keeping your finger on the left or right sides of the screen after forwarding/rewinding a picture.
- You can switch the card selected for playback by forwarding/rewinding pictures continuously.



### Switching the card selected for playback instantly

You can switch the card selected for playback instantly by assigning [Slot Change] to a function button.



### Sending an image to a web service

If you press ▼ when displaying images one by one, you can easily send an image to a web service. (P280)

### ■ To finish playback

Press [▶] again or press the shutter button halfway.



### Not available in these cases:

- This camera complies with the DCF standard "Design rule for Camera File system" established by JEITA "Japan Electronics and Information Technology Industries Association" and with Exif "Exchangeable Image File Format". This camera can only display pictures that comply with the DCF standard.
- The camera may not play back images recorded on other devices correctly, and the functions of the camera may not be available for the images.



## Playing Back Motion Pictures

This unit was designed to play motion pictures using the AVCHD and MP4 formats.

- Motion pictures are displayed with the motion picture icon (📺).

**Press ▲ to play back.**

- (A) Motion picture recording time

- After playback starts, the elapsed playback time is displayed on the screen.

For example, 8 minutes and 30 seconds is displayed as [8m30s].

- Some information (recording information, etc.) is not displayed for motion pictures recorded in [AVCHD].
- Touching [▶] in the middle of the screen allows you to play back motion pictures.

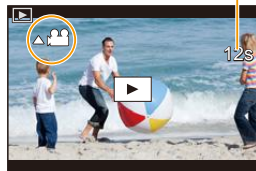

### ■ Operations during Motion Picture Playback

Button operation	Touch operation	Description of operation	Button operation	Touch operation	Description of operation
▲	▶/	Play/Pause	▼	■	Stop
◀	◀◀	Fast rewind*1	▶	▶▶	Fast forward*1
	◀	Frame-by-frame rewind (while pausing)*2		▶	Frame-by-frame forward (while pausing)
🔊	−	Reduce volume level	🔊	+	Increase volume level

\*1 The fast forward/rewind speed increases if you press ▶/◀ again.

\*2 When a motion picture recorded with [AVCHD] is rewound frame-by-frame, its frames will be shown in intervals of approximately 0.5 seconds.

- You can play back motion pictures on a PC with "PHOTOfunSTUDIO".

## Creating Still Pictures from a Motion Picture

### 1 Press ▲ to pause motion picture playback.

- Press ◀▶ to fine-adjust the pause position while the motion picture is paused.

### 2 Press [MENU/SET].

- The same operation can be performed by touching [⏏].



- Still pictures will be saved with [Aspect Ratio] set to [16:9] and [Quality] set to [📐]. The number of pixels will differ according to the motion picture you play back.
  - When the motion picture size is set to [4K] in [Rec Quality]: [M] (8 M)
  - When the motion picture size is set to [FHD] in [Rec Quality]: [S] (2 M)
- Still pictures created from a motion picture may be coarser than with normal picture quality.
- [📐] is displayed during playback of still pictures created from motion pictures.

# Switching the Playback Method

## Using the Playback Zoom

Rotate the rear dial right.

1× → 2× → 4× → 8× → 16×



Button operation	Touch operation	Description of operation
	—	Enlarges/reduces the screen in large steps.
—	Pinching out/in	Enlarges/reduces the screen in small steps.
	Dragging	Moves the enlarged area (during enlarged display).
	—	Forwards or rewinds the image while maintaining the same zoom magnification and zoom position. (During Playback Zoom)

- Each time you touch the screen twice, the display switches between enlarged and normal view.

## Displaying multiple screens (Multi Playback)

### Rotate the rear dial left.

1 screen → 12 screens → 30 screens → Calendar screen display

(A) Card slot

- Playback is performed separately by card slot. You can switch the card selected for playback by pressing [Fn1]. (Except for when the Calendar screen is displayed)

- If the rear dial is rotated to the right, the previous playback screen will be displayed.

- It is possible to switch the playback screen by touching the following icons.

- [1 screen icon]: 1 screen
- [12 screens icon]: 12 screens
- [30 screens icon]: 30 screens
- [CAL icon]: Calendar screen display

- The screen can be switched gradually by dragging the screen up or down.

- Pictures displayed using [! icon] cannot be played back.

### ■ To return to Normal Playback

Press ▲/▼/◀/▶ to select a picture and then press [MENU/SET].

- If you select a motion picture, it will be played back automatically.

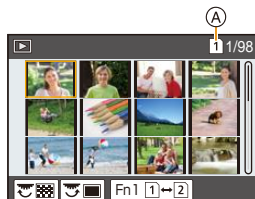

## Displaying Pictures by Recording Date (Calendar Playback)

1 Rotate the rear dial left to display the Calendar screen.

2 Press ▲/▼/◀/▶ to select the recording date and press [MENU/SET].

- Only the images recorded on that date will be displayed.
- Rotate the rear dial left to return to the Calendar screen display.

3 Press ▲/▼/◀/▶ to select a picture and then press [MENU/SET].



- Playback is performed separately by card slot. You cannot switch the card selected for playback while the Calendar is displayed.

- The recording date of the picture selected in the playback screen becomes the date selected when the Calendar screen is first displayed.

- You can display the Calendar between January 2000 and December 2099.

- If the date is not set in the camera, the recording date is set as January 1st, 2018.

- If you take pictures after setting the travel destination in [World Time], the pictures are displayed by the dates at the travel destination in Calendar Playback.

## Playing Back Group Pictures

A picture group consists of multiple pictures. You can play back pictures in a group either continuously or one by one.

- You can edit or delete all pictures in a group at once.  
(For example, if you delete a picture group, all pictures in the group are deleted.)



A picture group consisting of pictures taken in the Burst Mode with the burst speed [SH2], [SH1], [SH2 PRE] or [SH1 PRE].

A picture group saved at once with [6K/4K PHOTO Bulk Saving].



A picture group consisting of pictures taken with Focus Bracket.



A picture group consisting of pictures taken in a Time Lapse Shot.



A picture group consisting of pictures taken in the Stop Motion Animation.

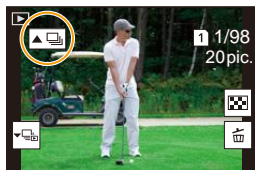

- Pictures will not be grouped if recorded without setting the clock.

## ■ Continuously playing back Group Pictures

Press ▲.

- The same operation can be performed by touching the group picture icon ([▲🖼️]), ([▲📷]), ([▲📱]).
- When playing back group pictures one at a time, options are displayed. After selecting [Burst Play] (or [Sequential Play]), select either of the following playback methods:

### [From the first picture]:

Pictures are played back continuously from the first picture of the group.

### [From the current picture]:

Pictures are played back continuously from the picture being played back.

- Operations during Group Pictures playback

Button operation	Touch operation	Description of operation
▲	▶/	Continuous playback/Pause
◀	◀◀	Fast rewind
	◀◀	Rewind (while pausing)

Button operation	Touch operation	Description of operation
▼	■	Stop
▶	▶▶	Fast forward
	▶▶	Forward (while pausing)

## ■ Playing back group pictures one by one

1 Press ▼.

- The same operation can be performed by touching [▼🖼️], [▼📷], or [▼📱].



2 Press ◀/▶ to flip through images.

- To return to the normal playback screen, press ▼ again or touch [▼🖼️].
- Each picture in a group can be treated same as normal pictures when they are played back. (Such as Multi Playback, Playback Zoom and deleting images)

## Deleting Pictures

Once deleted, pictures cannot be recovered.

### ■ To delete a single picture

- 1 In Playback Mode, select the picture to delete and then press [  ].

- The same operation can be performed by touching [  ].

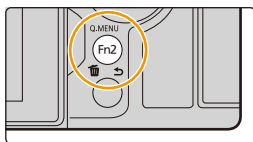

- 2 Press ▲ to select [Delete Single] and then press [MENU/SET].

### ■ To delete multiple pictures (up to 100) or all the pictures

- Picture groups are treated as a single picture. (All the pictures in the selected picture group will be deleted.)

- You can only delete images on one card at a time.

- 1 In Playback Mode, press [  ].

- 2 Press ▲/▼ to select [Delete Multi] or [Delete All] and then press [MENU/SET].

- If you select [Delete All], all the pictures on the card of the displayed icon will be deleted.
- After selecting [Delete All], if you select [Delete All Non-rating], you can delete all pictures except for those with ratings.

- 3 (When [Delete Multi] is selected)

Press ▲/▼/◀/▶ to select the picture, and then press [MENU/SET] to set. (Repeat this step.)

- [  ] appears on the selected pictures.  
To cancel the selection, press [MENU/SET] again.
- Pictures are displayed separately by card slot. You can switch the displayed card by pressing [Fn1].



- 4 (When [Delete Multi] is selected)

Press [DISP.] to execute.

• Depending on the number of pictures to be deleted, it may take some time to delete them.

# 9.

## Using Menu Functions

### Menu list

#### Menus that are only available for particular Recording Modes

 P184

The following menus are displayed only for their corresponding Recording Modes:

- [Intelligent Auto]
- [Creative Video]
- [Custom Mode]
- [Creative Control]

[Rec]

 P185

[Motion Picture]

 P203

[Custom]

 P206

[Setup]

 P220

[My Menu]

 P232

[Playback]

 P233



#### Menus that are only available for particular Recording Modes

  : [Intelligent Auto] menu

- [Intelligent Auto Mode] (P66)
- [iHDR] (P68)
- [iHandheld Night Shot] (P68)

 : [Creative Video] menu

- [Exposure Mode] (P171)
- [4K Live Cropping] (P174)
- [High Speed Video] (P173)

**C** : [Custom Mode] menu

You can change the settings registered to custom sets (C3). (P86)



 **[Creative Control] menu**

- [Filter Effect] (P80)
- [Simultaneous Record w/o Filter] (P80)

 **[Rec] menu**

- [Aspect Ratio] (P185)
- [Picture Size] (P186)
- [Quality] (P187)
- [AFS/AFF] (P89)
- [AF Custom Setting(Photo)] (P90)
- [Photo Style] (P188)
- [Filter Settings] (P190)
- [Color Space] (P191)
- [Metering Mode] (P192)
- [Highlight Shadow] (P192)
- [i.Dynamic] (P193)
- [i.Resolution] (P193)
- [Flash] (P158)
- [Red-Eye Removal] (P194)
- [ISO Sensitivity (photo)] (P194)
- [Min. Shtr Speed] (P194)
- [Long Shtr NR] (P195)
- [Shading Comp.] (P195)
- [Diffraction Compensation] (P196)
- [Stabilizer] (P145)
- [Ex. Tele Conv.] (P150)
- [Digital Zoom] (P152)
- [Burst Shot 1 Setting] (P115)
- [Burst Shot 2 Setting] (P115)
- [6K/4K PHOTO] (P119)
- [Post Focus] (P130)
- [Self Timer] (P135)
- [High Resolution Mode] (P196)
- [Time Lapse/Animation] (P137, 138)
- [Silent Mode] (P198)
- [Shutter Type] (P199)
- [Shutter Delay] (P200)
- [Bracket] (P141)
- [HDR] (P201)
- [Multi Exp.] (P202)
- [Time Stamp Rec] (P170)

**[Aspect Ratio]**

**Applicable modes:**        

This allows you to select the aspect ratio of the pictures to suit printing or the playback method.

**MENU** →  **[Rec]** → **[Aspect Ratio]**

<b>[4:3]</b>	[Aspect Ratio] of a 4:3 TV
<b>[3:2]</b>	[Aspect Ratio] of a 35 mm film camera
<b>[16:9]</b>	[Aspect Ratio] of a 16:9 TV
<b>[1:1]</b>	Square aspect ratio

- In the following case, [16:9], [1:1] does not work:
  - When recording 6K/4K photos (only when [6K 18M] is set)
  - When recording with the Post Focus function (only when [6K 18M] is set)

**[Picture Size]**

Applicable modes:   P A S M  

Set the number of pixels.

The higher the numbers of pixels, the finer the detail of the pictures will appear even when they are printed onto large sheets.

**MENU** →  **[Rec]** → **[Picture Size]**

**When the aspect ratio is [4:3].**

Settings	Image size
<b>[L]</b> (20M)	5184×3888
<b>[EXM]</b> (10M)	3712×2784
<b>[EXS]</b> (5M)	2624×1968

**When the aspect ratio is [3:2].**

Settings	Image size
<b>[L]</b> (17M)	5184×3456
<b>[EXM]</b> (9M)	3712×2480
<b>[EXS]</b> (4.5M)	2624×1752

**When the aspect ratio is [16:9].**

Settings	Image size
<b>[L]</b> (14.5M)	5184×2920
<b>[EXM]</b> (8M)	3840×2160
<b>[EXS]</b> (2M)	1920×1080

**When the aspect ratio is [1:1].**

Settings	Image size
<b>[L]</b> (14.5M)	3888×3888
<b>[EXM]</b> (7.5M)	2784×2784
<b>[EXS]</b> (3.5M)	1968×1968







- When [Ex. Tele Conv.] is set, **[EX]** is displayed on the picture sizes of each aspect ratio except for **[L]**.
- **[Picture Size]** cannot be set when recording is performed with the 6K/4K Photo, Post Focus function or **[High Resolution Mode]**.

**[Quality]**

Applicable modes:         

Set the compression rate at which the pictures are to be stored.





**MENU** →  **[Rec]** → **[Quality]**

Settings	File format	Description of settings
	JPEG	A JPEG image in which image quality was given priority.
		A standard image quality JPEG image. This is useful for increasing the number of shots without changing the number of pixels.
	RAW+JPEG	You can record a RAW image and a JPEG image (  or  ) simultaneously.
		
	RAW	You can only record RAW images.

**About RAW**

RAW format refers to a data format of images that have not been processed. Playback and editing of RAW images require the camera or the dedicated software.

- You can process RAW images in [RAW Processing] in the [Playback] menu.
- Use software ("SILKYPIX Developer Studio" by Ichikawa Soft Laboratory) to process and edit RAW files on a PC.













- RAW images are always recorded in the [4:3] (5184×3888) aspect ratio.
- When you delete an image recorded with  or , both the RAW and JPEG images will be deleted simultaneously.
- When you play back an image recorded with , gray areas corresponding to the aspect ratio at the time of recording are displayed.
- The setting is fixed to  when recording is performed with the 6K/4K Photo or Post Focus function.
- This item is not available when [High Resolution Mode] is set.

**[Photo Style]**

Applicable modes:   **P** **A** **S** **M**  

You can select effects to match the type of image you wish to record.

**MENU** →  **[Rec]** → **[Photo Style]**

 <b>[Standard]</b>	This is the standard setting.
 <b>[Vivid]</b>	Brilliant effect with high saturation and contrast.
 <b>[Natural]</b>	Soft effect with low contrast.
 <b>[Monochrome]</b>	Monochrome effect with no color shades.
 <b>[L.Monochrome]</b>	Black-and-white effect with rich gradation and crisp black accents.
 <b>[Scenery]</b>	An effect appropriate for sceneries with vivid blue skies and greens.
 <b>[Portrait]</b>	An effect appropriate for portraits with a healthy and beautiful skin tone.
 <b>[Custom1]</b>	Use the setting registered in advance.
 <b>[Custom2]</b>	
 <b>[Custom3]</b>	
 <b>[Custom4]</b>	
 <b>[Cineline D]</b>	Gives priority to the dynamic range by using a gamma curve designed to create film-like images. Suited for editing.
 <b>[Cineline V]</b>	Gives priority to the contrast by using a gamma curve designed to create film-like images.

• In Intelligent Auto Plus Mode:

- Only [Standard] or [Monochrome] can be set.
- The setting will be reset to [Standard] when the camera is switched to another Recording Mode or this unit is turned off.
- Picture quality cannot be adjusted.

## ■ Adjusting the picture quality

- 1 Press **◀/▶** to select the type of Photo Style.
- 2 Press **▲/▼** to select the items, and then press **◀/▶** to adjust.

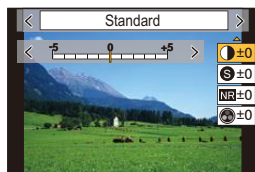

☾ [Contrast]	[+]	Increases the difference between the brightness and the darkness in the picture.
	[-]	Decreases the difference between the brightness and the darkness in the picture.
S [Sharpness]	[+]	The picture is sharply defined.
	[-]	The picture is softly focused.
NR [Noise Reduction]	[+]	The noise reduction effect is enhanced. Picture resolution may deteriorate slightly.
	[-]	The noise reduction effect is reduced. You can obtain pictures with higher resolution.
☉ [Saturation] <sup>*1</sup>	[+]	The colors in the picture become vivid.
	[-]	The colors in the picture become natural.
☉ [Color Tone] <sup>*1</sup>	[+]	Adds a bluish tone.
	[-]	Adds a yellowish tone.
🎱 [Filter Effect] <sup>*2</sup>	[Yellow]	Enhances the contrast of an subject. (Effect: Weak) The blue sky can be recorded clearly.
	[Orange]	Enhances the contrast of an subject. (Effect: Medium) The blue sky can be recorded in darker blue.
	[Red]	Enhances the contrast of an subject. (Effect: Strong) The blue sky can be recorded in much darker blue.
	[Green]	The skin and lips of people appear in natural tones. Green leaves appear brighter and more enhanced.
	[Off]	—

\*1 [Color Tone] is displayed only when [Monochrome] or [L.Monochrome] is selected. In other cases, [Saturation] will be displayed.

\*2 Displayed only when [Monochrome] or [L.Monochrome] is selected.

• If you adjust the picture quality, [+] is displayed beside the Photo Style icon on the screen.

### 3 Press [MENU/SET].

## ■ Registering settings to [Custom1] to [Custom4]

- 1 Adjust the picture quality following step 2 of “Adjusting the picture quality”, and then press [DISP.].
- 2 Press **▲/▼** to select a destination to which the setting will be registered, and press [MENU/SET].

**[Filter Settings]**

**Applicable modes:** **P** **A** **S** **M**

You can add the image effects (filters) of Creative Control Mode. (P79)

**MENU** → **[Rec]** → **[Filter Settings]** → **[Filter Effect]**

**Settings:** **[ON]/[OFF]/[SET]**

**■ Change the settings by using the touch screen**

- 1 Touch .
- 2 Touch the item you want to set.
  - : Image effect ON/OFF
  - [EXPS]**: Selects an image effect (filter)
  - : Adjusts an image effect



- **[Rough Monochrome]/[Silky Monochrome]/[Soft Focus]/[Star Filter]/[Sunshine]** are not available in the following cases.
  - Creative Video Mode
  - When recording motion pictures
- The available ISO sensitivity settings will be limited up to **[ISO 3200]**.  
The ISO sensitivity for **[High Dynamic]** will be fixed to **[AUTO]**.
- When using **[Filter Effect]**, you cannot use menus or recording functions not available in Creative Control Mode.  
For example, White Balance will be fixed to **[AWB]** and the flash will be set to (forced flash off).

**Not available in these cases:**

- In the following case, **[Filter Settings]** does not work:
  - When **[High Speed Video]** is set
  - When using **[4K Live Cropping]**
  - When recording in **[High Resolution Mode]**

## ■ Taking a picture with and without an image effect simultaneously ([Simultaneous Record w/o Filter])

You can press the shutter button once and take two pictures simultaneously, one with an image effect and the other one without it.

**MENU** → [Rec] → [Filter Settings] → [Simultaneous Record w/o Filter]

Settings: [ON]/[OFF]

- A picture with an image effect will be taken first, followed by a picture without it.
- Only an image with an image effect is displayed for Auto Review.



### Not available in these cases:

- In the following case, [Simultaneous Record w/o Filter] does not work:
  - Recording still pictures while recording a motion picture (only when set to ([Video Priority]))
  - When recording 6K/4K photos
  - When recording with the Post Focus function
  - When recording in Burst Mode
  - When [Quality] is set to [RAW<sub>4:2:0</sub>], [RAW<sub>4:2:2</sub>] or [RAW]
  - When recording with the Bracket function
  - When using [Time Lapse Shot]
  - When using [Stop Motion Animation]

## [Color Space]

Applicable modes: **P** **A** **S** **M**

Set this when you want to correct the color reproduction of the recorded pictures on a PC, printer etc.

**MENU** → [Rec] → [Color Space]

<b>[sRGB]</b>	Color space is set to sRGB color space. This is widely used in computer related equipment.
<b>[AdobeRGB]</b>	Color space is set to AdobeRGB color space. AdobeRGB is mainly used for business purposes such as professional printing because it has a greater range of reproducible colors than sRGB.

- Set to [sRGB] if you are not very familiar with AdobeRGB.
- The setting is fixed to [sRGB] in the following cases.
  - When recording motion pictures
  - When recording 6K/4K photos
  - When recording with the Post Focus function

**[Metering Mode]**

Applicable modes: P A S M

Type of optical measurement to measure brightness can be changed.

**MENU** → **[Rec]** → **[Metering Mode]**

<p> (Multiple)</p>	<p>This is the method in which the camera measures the most suitable exposure by judging the allocation of brightness on the whole screen automatically. Usually, we recommend using this method.</p>
<p> (Center weighted)</p>	<p>This is the method used to focus on the subject on the center of the screen and measure the whole screen evenly.</p>
<p> (Spot)</p>	<p>This is the method to measure the subject in the spot metering target (A). • If you set the spot metering target on the edge of the screen, the metering may be affected by the brightness around the location.</p>

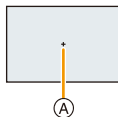
**[Highlight Shadow]**

Applicable modes: P A S M

You can adjust the brightness of bright and dark portions on an image while checking the brightness on the screen.

**MENU** → **[Rec]** → **[Highlight Shadow]**

<p><input checked="" type="checkbox"/> (Standard)</p>	<p>A state with no adjustments is set.</p>
<p><input checked="" type="checkbox"/> (Raise the contrast)</p>	<p>Bright areas are brightened, and dark areas are darkened.</p>
<p><input checked="" type="checkbox"/> (Lower the contrast)</p>	<p>Bright areas are darkened, and dark areas are brightened.</p>
<p><input checked="" type="checkbox"/> (Brighten dark areas)</p>	<p>Dark areas are brightened.</p>
<p> /  /  (Custom)</p>	<p>Registered custom settings can be applied.</p>

**1 Rotate the front/rear dial to adjust the brightness of bright/dark portions.**

(A) Bright portion

(B) Dark portion

- Adjustments can also be made by dragging the graph.
- To register a preferred setting, press ▲, and select the destination where the custom setting will be registered to ([Custom1] ( )/[Custom2] ( )/[Custom3] ( )).

**2 Press [MENU/SET].**

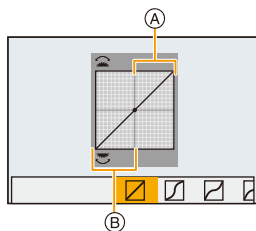



- The screen display can be switched by pressing [DISP.] on the brightness adjustment screen.

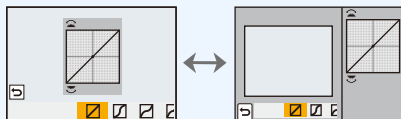

- Turning off this unit will return the setting adjusted with / / /  back to the default setting.

### [i.Dynamic]

**Applicable modes:** **P** **A** **S** **M**

Contrast and exposure are compensated when the brightness difference between the background and subject is great, etc.

**MENU** → **[Rec]** → **[i.Dynamic]**

**Settings:** **[AUTO]**/**[HIGH]**/**[STANDARD]**/**[LOW]**/**[OFF]**



#### **Not available in these cases:**

- Compensation effect may not be achieved depending on the recording conditions.
- [i.Dynamic] does not work when [HDR] is set.

### [i.Resolution]

**Applicable modes:** **P** **A** **S** **M**

Pictures with sharp profile and resolution can be taken by using the Intelligent Resolution Technology.

**MENU** → **[Rec]** → **[i.Resolution]**

**Settings:** **[HIGH]**/**[STANDARD]**/**[LOW]**/**[OFF]**

**[Red-Eye Removal]**

**Applicable modes:**

If you fire the flash when using Red-Eye Reduction ([ ] or [ ]), the camera automatically detects red-eye and corrects the picture.

**MENU** → **[Rec]** → **[Red-Eye Removal]**

**Settings:** **[ON]/[OFF]**

- [ ] is displayed on the icon when it is set to [ON].
- Under certain circumstances, red-eye cannot be corrected.

**[ISO Sensitivity (photo)]**

**Applicable modes:**

Set the upper and lower limits of the ISO sensitivity when it is set to [AUTO] or [ ].

**MENU** → **[Rec]** → **[ISO Sensitivity (photo)]**

<b>[ISO Auto Lower Limit Setting]</b>	[200]/[400]/[800]/[1600]/[3200]/[6400]/[12800]
<b>[ISO Auto Upper Limit Setting]</b>	[AUTO]/[400]/[800]/[1600]/[3200]/[6400]/[12800]/ [25600]

**[Min. Shtr Speed]**

**Applicable modes:**

Set the minimum shutter speed when the ISO sensitivity is set to [AUTO] or [ ].

**MENU** → **[Rec]** → **[Min. Shtr Speed]**

**Settings:** **[AUTO]/[1/32000] to [1/1]**

- The shutter speed may become slower than the set value in situations where proper exposure cannot be obtained.

**[Long Shtr NR]****Applicable modes:**   **P** **A** **S** **M**  

The camera automatically removes noise that appears when the shutter speed becomes slower to take pictures of night or similar scenery.

**MENU** →  **[Rec]** → **[Long Shtr NR]****Settings: [ON]/[OFF]**

- [Long shutter noise reduction ongoing] is displayed for the same time as the shutter speed for signal processing.

 **Not available in these cases:**

- This function is not available in the following cases:
  - When recording motion pictures
  - When recording in Burst Mode (only when [Burst Shot Setting] is set to [SH2]/[SH1]/[SH2 PRE]/[SH1 PRE])
  - When recording 6K/4K photos
  - When recording with the Post Focus function
  - When recording in [High Resolution Mode]
  - When using the electronic shutter

**[Shading Comp.]****Applicable modes:**   **P** **A** **S** **M**  

When the screen periphery darkens as a result of the lens characteristics, you can record pictures with the brightness of the screen periphery corrected.

**MENU** →  **[Rec]** → **[Shading Comp.]****Settings: [ON]/[OFF]**

- Compensation effect may not be achieved depending on the recording conditions.
- Noise in the periphery of the picture may stand out with higher ISO sensitivity.

 **Not available in these cases:**

- Correction is not possible in the following cases:
  - When using [Ex. Tele Conv.]
  - When using the Digital Zoom
  - When [High Speed Video] is set

**[Diffraction Compensation]****Applicable modes:**      

The camera raises the resolution by correcting the blurriness caused by diffraction when the aperture is closed.

**MENU** →  **[Rec]** → **[Diffraction Compensation]****Settings:** **[AUTO]/[OFF]**

- Compensation effect may not be achieved depending on the recording conditions.
- Noise may stand out with higher ISO sensitivity.

**[High Resolution Mode]****Applicable modes:**      

This function generates a picture with enhanced resolution from pre-recorded images. It is effective for still subjects.

**• Use a tripod to minimize camera shake.**

- If you are using a Panasonic interchangeable lens, its image stabilizer function will be automatically set to [OFF].

When using a non-Panasonic interchangeable lens provided with an image stabilizer function that can be turned ON/OFF, set it to OFF.

**MENU** →  **[Rec]** → **[High Resolution Mode]****1 Press ▲/▼ to select [Start], and press [MENU/SET].**

- The High-Res Mode icon (A) will flash when shake is detected.

It may not be possible to create pictures with the impression of high resolution. To avoid this, hold the camera firmly.

**2 Decide on the composition, and perform recording.**

- The screen will go dark during recording.
  - The recording state indicator (red) (B) will flash.
- Do not move the camera while the indicator is flashing.
- Recording will finish automatically.

When the recording has finished, the camera will combine the pictures, so it will not be able to perform the next recording for a while.

- You can proceed to the next recording.

**3 Press [Fn2] to end High-Res Mode.**

## ■ Changing the setup

<p>[Picture Size]</p>	<p>Sets the picture size.</p> <p><b>When the aspect ratio is [4:3].</b></p> <p>[XL] (80.5M): 10368×7776 [LL] (40M): 7296×5472</p> <p><b>When the aspect ratio is [3:2].</b></p> <p>[XL] (71.5M): 10368×6912 [LL] (35.5M): 7296×4864</p> <p><b>When the aspect ratio is [16:9].</b></p> <p>[XL] (60.5M): 10368×5832 [LL] (30M): 7296×4104</p> <p><b>When the aspect ratio is [1:1].</b></p> <p>[XL] (60.5M): 7776×7776 [LL] (30M): 5472×5472</p> <p>• RAW images are always recorded in the [4:3] (10368×7776) aspect ratio.</p>
<p>[Quality]</p>	<p>Set the compression rate at which the pictures are to be stored.</p> <p>[] (JPEG images with priority given to picture quality)/[] (simultaneous recording of RAW+JPEG images)/[RAW] (RAW images)</p>
<p>[Simul Record Normal Shot]</p>	<p>Saves the first picture of pictures taken before the combining process in addition to a combined picture if [ON] is selected. Pictures will be saved with [Picture Size] set to [L].</p> <p>[ON]/[OFF]</p>
<p>[Shutter Delay]</p>	<p>Sets the delay between the time the shutter button is pressed to the time the shutter is released.</p> <p>[30 SEC]/[15 SEC]/[8 SEC]/[4 SEC]/[2 SEC]/[1 SEC]/[1/2 SEC]/[1/4 SEC]/[1/8 SEC]/[OFF]</p> <p>• We recommend selecting a setting other than [OFF] when not using a shutter remote control (DMW-RSL1: optional) to prevent motion blur caused by pressing the shutter button.</p>

- Auto Review only displays combined pictures.
- The available setting ranges of the following functions during [High Resolution Mode] recording will differ from those during normal picture recording.
  - Minimum aperture value: F8
  - Shutter speed: 1 to 1/32000th
  - ISO sensitivity: Up to [ISO 1600]
  - Focus mode: Fixed to [AFS] or [MF]
- [Shutter Type] is fixed to [ESHTR].
- When subjects are recorded in an extremely bright place or under fluorescent/LED lighting, the color tone or brightness of the image may change, or horizontal stripes may appear on the screen.
 

Lowering the shutter speed may reduce the effect of the horizontal stripes.
- Other devices may not be able to play back images recorded in [High Resolution Mode].



#### **Not available in these cases:**

- This function is not available in the following cases:
  - When taking pictures with [Time Lapse Shot]
  - When using [Stop Motion Animation]
  - When recording in [Multi Exp.]
  - When an image effect in [Filter Effect] of [Filter Settings] is set

### [Silent Mode]

**Applicable modes:**

Disables operational sounds and output of light at once.

**MENU** → [Rec] → [Silent Mode]

**Settings: [ON]/[OFF]**

- Audio from the speaker will be muted and the flash and the AF Assist lamp will be disabled. The following settings are fixed.
  - [Flash Mode]: (forced flash off)
  - [Shutter Type]: [ESHTR]
  - [AF Assist Lamp]: [OFF]
  - [Beep Volume]: (OFF)
  - [E-Shutter Vol]: (OFF)
- Even when [ON] is set, the following functions light up/flash.
  - Charging lamp/WIRELESS connection lamp
  - Self-timer indicator
- Sounds that are produced by the camera regardless of your operations, such as the lens aperture sound, cannot be muted.
- **Be sure to pay special attention to the privacy, the likeness rights, etc. of the subject when you use this function. Use at your own risk.**

**[Shutter Type]**

Applicable modes: **P** **A** **S** **M**

Select the shutter to be used for taking pictures.

**MENU** → **[Rec]** → **[Shutter Type]**

<b>[AUTO]</b>	Switches the shutter type automatically depending on the recording condition and shutter speed.
<b>[MSHTR]</b>	Takes pictures in Mechanical Shutter Mode.
<b>[EFC]</b>	Takes pictures in Electronic Front Curtain Mode.
<b>[ESHTR]</b>	Takes pictures in Electronic Shutter Mode.

	Mechanical shutter	Electronic Front Curtain	Electronic Shutter
<b>Description</b>	The camera starts and ends an exposure with the mechanical shutter.	The camera starts an exposure electronically, and ends it with the mechanical shutter.	The camera starts and ends an exposure electronically.
<b>Flash</b>	○	○	—
<b>Shutter Speed (Sec.)</b>	B (Bulb) <sup>*1</sup> /60 to 1/8000th	B (Bulb) <sup>*1</sup> /60 to 1/2000th	1 <sup>*2</sup> to 1/32000th
<b>Shutter sound</b>	Mechanical shutter sound	Mechanical shutter sound	Electronic shutter sound <sup>*3</sup>

\*1 This setting is available only in Manual Exposure Mode.

\*2 Up to an ISO sensitivity of [ISO3200]. When the setting is higher than [ISO3200], the shutter speed will be faster than 1 second.

\*3 Electronic shutter sound settings can be changed in [E-Shutter Vol] and [E-Shutter Tone].

- Compared to Mechanical Shutter Mode, Electronic Front Curtain Mode produces less shutter-induced shake, so it can minimize the influence of shutter vibration.
- Electronic Shutter Mode allows you to take pictures without causing shutter vibration.

- When [] is displayed on the screen, pictures will be taken with the electronic shutter.
- **When a moving subject is recorded with the electronic shutter, the subject may appear distorted on the picture.**
- **When the electronic shutter is used under fluorescent or LED lighting, etc., horizontal stripes may appear on the picture. In such cases, lowering the shutter speed may reduce the effect of the horizontal stripes.**

**[Shutter Delay]**

**Applicable modes:**   **P** **A** **S** **M**  

To reduce the influence of hand shake or shutter vibration, shutter is released after the specified time has passed.

**MENU** →  **[Rec]** → **[Shutter Delay]**

**Settings:** **[8SEC]/[4SEC]/[2SEC]/[1SEC]/[OFF]**

 **Not available in these cases:**

- This function is not available in the following cases:
  - When recording motion pictures
  - When recording in Burst Mode (only when [Burst Shot Setting] is set to [SH2]/[SH1]/[SH2 PRE]/[SH1 PRE])
  - When recording 6K/4K photos
  - When recording with the Post Focus function
  - When recording in [High Resolution Mode]
  - When [HDR] is set to [ON]



**[HDR]**

**Applicable modes:**       

You can combine 3 pictures with different levels of exposure into a single picture with rich gradation.

You can minimize the loss of gradations in bright areas and dark areas when, for example, the contrast between the background and the subject is large.

An image combined by HDR is recorded in JPEG.

**MENU** →  **[Rec]** → **[HDR]**



**Settings:** **[ON]/[OFF]/[SET]**

### ■ Changing settings

<b>[Dynamic Range]</b>	<p><b>[AUTO]:</b> Automatically adjusts the exposure range according to the differences between the bright and dark areas.</p> <p><b>[±1 EV]/[±2 EV]/[±3 EV]:</b> Adjusts the exposure within the selected exposure parameters.</p>
<b>[Auto Align]</b>	<p><b>[ON]:</b> Automatically corrects camera shake (jitter) and other problems that can cause the images to misalign. Recommended for use during hand-held shooting.</p> <p><b>[OFF]:</b> Image misalignment not adjusted. Recommended when a tripod is used.</p>

- Do not move the unit during the continuous shooting after pressing the shutter button.
- You cannot take the next picture until the combination of pictures is complete.
- A moving subject may be recorded with unnatural blurs.
- The angle of view becomes narrow slightly when [Auto Align] is set to [ON].
- Flash is fixed to  (forced flash off).

### **Not available in these cases:**

- [HDR] does not work for the pictures taken during a motion picture recording.
- This function is not available in the following cases:
  - When recording 6K/4K photos
  - When recording with the Post Focus function
  - When recording in Burst Mode
  - When recording with the Bracket function
  - When [Quality] is set to ,  or [RAW]
  - When using [Time Lapse Shot]
  - When using [Stop Motion Animation] (only when [Auto Shooting] is set)
  - When recording in [High Resolution Mode]

**[Multi Exp.]**

**Applicable modes:**        

Gives an effect like multi exposure. (up to 4 times equivalent per a single image)

**[MENU]** →  **[Rec]** → **[Multi Exp.]**

**1 Press ▲/▼ to select [Start] and then press [MENU/SET].**

**2 Decide on the composition, and take the first picture.**

- After taking the picture, press the shutter button halfway down to take the next picture.
- Press ▲/▼ to select the item and then press [MENU/SET] for one of the following operations.
  - [Next]: Advance to the next picture.
  - [Retake]: Return to the first picture.
  - [Exit]: Record the image of the first picture, and finish the multiple exposure picture-taking session.

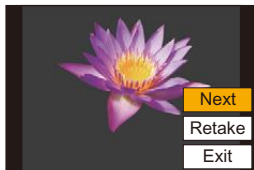

**3 Shooting the second, third, and fourth exposures.**

- To save the recorded pictures and finish Multiple Exposure, press [Fn2] when taking pictures.

**4 Press ▼ to select [Exit] and then press [MENU/SET].**

- You can also press the shutter button halfway to finish.

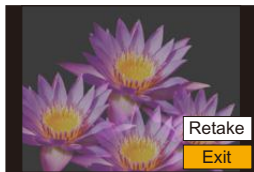

### ■ Changing settings

<b>[Auto Gain]</b>	If you select [OFF], all exposure results are superimposed as they are. Compensate the exposure as necessary, depending on the subject.
<b>[Overlay]</b>	If you select [ON], you can apply Multi Exposure to previously recorded images. After [Start] is selected, images on the card will be displayed. Select a RAW image, and press [MENU/SET] to proceed to recording.

- The recording information displayed for pictures taken with multiple exposures is the recording information for the last picture taken.
- Items shown in gray on the menu screen cannot be set during multiple exposures.
- You can perform [Overlay] only for RAW images recorded with the camera (excluding those recorded in [High Resolution Mode]).

#### **Not available in these cases:**

- This function is not available in the following cases:
  - When using [Time Lapse Shot]
  - When using [Stop Motion Animation]
  - When recording in [High Resolution Mode]

 : [Motion Picture] menu

- [Rec Format] (P166)
- [Rec Quality] (P166)
- [AFS/AFF] (P89)
- [Continuous AF] (P167)
- [Photo Style] (P188)
- [Filter Settings] (P190)
- [Luminance Level] (P203)
- [Metering Mode] (P192)
- [Highlight Shadow] (P192)
- [i.Dynamic] (P193)
- [i.Resolution] (P193)
- [ISO Sensitivity (video)] (P172)
- [Shading Comp.] (P195)
- [Diffraction Compensation] (P196)
- [Stabilizer] (P145)
- [Flkr Decrease] (P203)
- [Ex. Tele Conv.] (P150)
- [Digital Zoom] (P152)
- [Picture Mode in Rec.] (P168)
- [Time Stamp Rec] (P170)
- [Mic Level Disp.] (P169)
- [Mic Level Adj.] (P169)
- [Mic Level Limiter] (P169)
- [Wind Noise Canceller] (P204)/  
[Wind Cut] (P312)
- [Lens Noise Cut] (P204)
- [Special Mic.] (P311)
- [Sound Output] (P205)

## [Luminance Level]

Applicable modes:   P A S M  

Select the luminance range to match the use of video.

- [Luminance Level] can be set only when [MP4] has been selected as the [Rec Format] setting.

**MENU** →  [Motion Picture] → [Luminance Level]

Settings: [0-255]/[16-255]

- This function works only for motion pictures. Still pictures (including those you take during motion picture recording) will be taken with [0-255].

## [Flkr Decrease]

Applicable modes:   P A S M  

The shutter speed can be fixed to reduce the flicker or striping in the motion picture.

**MENU** →  [Motion Picture] → [Flkr Decrease]

Settings: [1/50]/[1/60]/[1/100]/[1/120]/[OFF]

**[Wind Noise Canceller]**

**Applicable modes:**   **P** **A** **S** **M**  

This will reduce the wind noise coming into the built-in microphone while maintaining sound quality.

**MENU** →  **[Motion Picture]** → **[Wind Noise Canceller]**

**Settings:** **[HIGH]**/**[STANDARD]**/**[OFF]**

- **[HIGH]** effectively reduces the wind noise by minimizing the low-pitched sound when a strong wind is detected.
- **[STANDARD]** extracts and reduces only the wind noise without deteriorating the sound quality.
- You may not see the full effect depending on the recording conditions.
- This function works only with the built-in microphone.  
When an external microphone is connected, **[Wind Cut]** is displayed.

**[Lens Noise Cut]**

**Applicable modes:**   **P** **A** **S** **M**  

You can reduce the zoom sound of an interchangeable lens compatible with power zoom that is produced during motion picture recording.

**MENU** →  **[Motion Picture]** → **[Lens Noise Cut]**

**Settings:** **[ON]**/**[OFF]**

- This function works only when an interchangeable lens that supports power zoom is used.
- When this function is used, the sound quality may differ from that during normal operation.

**[Sound Output]**

Applicable modes:       

You can record motion pictures while hearing the sounds that are being recorded by connecting a commercially available headphones to this unit.

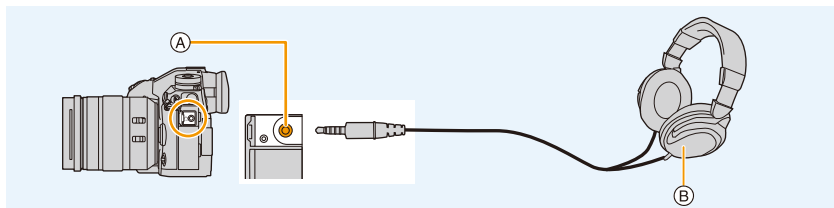

(A) Headphone socket

(B) Commercially available headphone

- Do not use the headphone cables with the length of 3 m (9.8 feet) or more.
- When headphones are connected, electronic sounds and electronic shutter sounds are muted.

### ■ Switch the sound output method



**MENU** →  **[Motion Picture]** → **[Sound Output]**

<b>[REALTIME]</b>	Actual sound without time lag. It may be different to the audio recorded in the motion picture.
<b>[REC SOUND]</b>	Sound that is being recorded in motion pictures. The audio may be output slower than the actual audio.

• If you use the HDMI output during recording, the setting is fixed to **[REC SOUND]**.

### ■ Adjusting the headphone volume



1 Select the menu.

**MENU** →  **[Custom]** →  **[Operation]** → **[Dial Set.]** → **[Control Dial Assignment]** → 

2 Connect headphones, and rotate the control dial while the recording screen is displayed or a motion picture is being played back.

: Reduce volume level

: Increase volume level

- You can also adjust the volume by touching  or  during playback.

To adjust the volume using the menu:

**MENU** →  **[Setup]** → **[Headphone Volume]**

 : **[Custom] menu**
 **[Exposure]**

- [ISO Increments] (P207)
- [Extended ISO] (P207)
- [Exposure Comp. Reset] (P207)

 **[Focus / Release Shutter]**

- [AF/AE Lock] (P106)
- [AF/AE Lock Hold] (P207)
- [Shutter AF] (P207)
- [Half Press Release] (P207)
- [Quick AF] (P208)
- [Eye Sensor AF] (P208)
- [Pinpoint AF Setting] (P208)
- [AF-Point Scope Setting] (P94)
- [AF Assist Lamp] (P208)
- [Focus/Release Priority] (P209)
- [Focus Switching for Vert / Hor] (P97)
- [Loop Movement Focus Frame] (P209)
- [AF Area Display] (P209)
- [AF+MF] (P210)
- [MF Assist] (P210)
- [MF Assist Display] (P210)

 **[Operation]**

- [Fn Button Set] (P60)
- [Fn Lever Setting] (P60)
- [Q.MENU] (P211)
- [Dial Set.] (P46)
- [Joystick Setting] (P48)
- [Operation Lock Setting] (P211)
- [Video Button] (P211)
- [Touch Settings] (P211)

 **[Monitor / Display]**

- [Auto Review] (P212)
- [Monochrome Live View] (P212)
- [Constant Preview] (P212)
- [Peaking] (P213)
- [Histogram] (P213)
- [Guide Line] (P213)
- [Center Marker] (P214)
- [Highlight] (P214)
- [Zebra Pattern] (P214)
- [Expo.Meter] (P215)
- [MF Guide] (P215)
- [LVF/Monitor Disp. Set] (P49)
- [Monitor Info. Disp.] (P215)
- [Rec Area] (P215)
- [Remaining Disp.] (P215)
- [Menu Guide] (P215)

 **[Lens / Others]**

- [Lens Position Resume] (P216)
- [Power Zoom Lens] (P153)
- [Lens Fn Button Setting] (P216)
- [Face Recog.] (P217)
- [Profile Setup] (P219)

**MENU** →  **[Custom]** →  **[Exposure]**

### **[ISO Increments]**

You can adjust the ISO sensitivity settings for every 1/3 EV.

**Settings: [1/3 EV]/[1 EV]**

### **[Extended ISO]**

ISO sensitivity can be set up to minimum [ISO100].

### **[Exposure Comp. Reset]**

An exposure value can be reset when the Recording Mode is changed or the camera is turned off.

**MENU** →  **[Custom]** →  **[Focus / Release Shutter]**

### **[AF/AE Lock Hold]**

When [ON] is selected, focus and exposure stays locked even if you press and release [AF/AE LOCK].

To clear the lock, press [AF/AE LOCK] again.

### **[Shutter AF]**

Set whether or not the focus is adjusted automatically when the shutter button is pressed halfway.

### **[Half Press Release]**

The shutter will immediately fire when the shutter button is pressed halfway.

**[Quick AF]**

As long as the camera is held steady, the camera will automatically adjust the focus and focus adjustment will then be quicker when the shutter is pressed.

- The battery will be consumed faster than usual.

**Not available in these cases:**

- This function is not available in the following cases:
  - In Preview Mode
  - In low light situations

**[Eye Sensor AF]**

The camera automatically adjusts the focus when the eye sensor is active.

- [Eye Sensor AF] may not work in dimly lit conditions.

**[Pinpoint AF Setting]**

<b>[Pinpoint AF Time]</b>	Sets the time for which the screen is enlarged when the shutter button is pressed halfway.
<b>[Pinpoint AF Display]</b>	Sets whether to display the assist screen in a window or full screen.

**[AF Assist Lamp]**

AF assist lamp will illuminate the subject when the shutter button is pressed half-way making it easier for the camera to focus when recording in low light conditions.

- The effective range of the AF Assist Lamp is different depending on the lens used.
  - When the interchangeable lens (H-ES12060) is attached and at Wide:  
Approx. 1.0 m (3.3 feet) to 3.5 m (11 feet)
  - When the interchangeable lens (H-FS12060) is attached and at Wide:  
Approx. 1.0 m (3.3 feet) to 3.0 m (9.8 feet)
- Remove the lens hood.
- The AF Assist Lamp gets slightly blocked when the interchangeable lens (H-ES12060/ H-FS12060) is used, but it does not affect the performance.
- The AF Assist Lamp may be greatly blocked, and it may become harder to focus when a lens with large diameter is used.
- The setting is fixed to [OFF] in the following cases.
  - When [Silent Mode] is set to [ON]



**[Focus/Release Priority]**

Set whether to give priority to focus or shutter release during Auto Focus.

- Different settings can be applied to different Focus Mode settings ([AFS/AFF], [AFC]).

<b>[FOCUS]</b>	Disables recording when focus is not achieved.
<b>[BALANCE]</b>	Performs recording while controlling the balance between focusing and shutter release timing.
<b>[RELEASE]</b>	Enables recording even when focus is not achieved.

**[Loop Movement Focus Frame]**

When setting the AF area position or the MF Assist display position, you can now loop the position from one edge to the other edge of the screen.

**[AF Area Display]**

This changes the AF area display setting to be applied when the Auto Focus Mode is set to [ ] ([225-Area]) or [ ] (MF Assist), etc. ([Custom Multi]).

<b>[ON]</b>	<p>Displays AF areas on the recording screen.</p> <ul style="list-style-type: none"> <li>• AF areas are not displayed when [ ] (225-Area) or [C1], [C2] or [C3] in [Custom Multi] is set to the default AF area setting.</li> </ul>
<b>[OFF]</b>	Displays AF areas on the recording screen for just a few seconds after you start using them.

- Even when [ON] is set, the same operation as [OFF] is performed in the following cases:
  - When recording motion pictures
  - When recording 6K/4K photos
  - Creative Video Mode

**[AF+MF]**





When AF Lock is ON (press the shutter button halfway with the focus mode set to [AFS] or set AF Lock using [AF/AE LOCK]), you can make fine adjustments to the focus manually.

**[MF Assist]**

Sets the display method of MF Assist (enlarged screen).

- Available settings vary depending on the lens used.

**When an interchangeable lens having a focus ring (H-ES12060/H-FS12060) is used**

	The screen is enlarged by operating the lens or by pressing [  ].
	The screen is enlarged by operating the lens.
	The screen is enlarged by pressing [  ].
<b>[OFF]</b>	The screen is not be enlarged.

**When an interchangeable lens with no focus ring is used****Settings: [ON]/[OFF]**

- MF Assist is not displayed in the following cases:
  - When recording motion pictures
  - When recording with [6K/4K Pre-Burst]
  - When using the Digital Zoom

**[MF Assist Display]**

Sets whether MF Assist (enlarged screen) will appear in a windowed screen display or in a full screen display.

**MENU** →  **[Custom]** →  **[Operation]**

### [Q.MENU]

If you select [CUSTOM], you can customize the Quick Menu settings. (P59)

### [Operation Lock Setting]

Sets the control functions to be disabled with the function button [Operation Lock].

<b>[Cursor]</b>	Disables the functions of the cursor buttons, the [MENU/SET] button, and the control dial.
<b>[Joystick]</b>	Disables the functions of the joystick.
<b>[Touch Screen]</b>	Disables the touch functions of the touch panel.



### [Video Button]

Enables/disables the motion picture button.

### [Touch Settings]

Enables/disables the Touch operation.

<b>[Touch Screen]</b>	All touch operations.
<b>[Touch Tab]</b>	Operations of tabs, such as  on the right side of the screen.
<b>[Touch AF]</b>	Operation to bring the subject you touch into focus ([AF]) or adjust the focus and brightness ([AF+AE]). (P101)
<b>[Touch Pad AF]</b>	Operation to move the AF area by touching the monitor when the viewfinder is in use. (P101)

**MENU** →  **[Custom]** →  **[Monitor / Display]****[Auto Review]**

Displays a picture immediately after it is taken.

- [Duration Time (6K/4K PHOTO)] works only for 6K/4K photo recording, while [Duration Time (Post Focus)] works only for Post Focus recording.
- If you set [Playback Operation Priority] to [ON], you can perform certain playback operations during Auto Review. For example, you can switch between different types of playback screens or delete pictures.
- If you select [HOLD], the picture taken stays displayed until the shutter button is pressed halfway. [Playback Operation Priority] will be fixed to [ON].

**[Monochrome Live View]**

You can display the recording screen in black and white.

- Even if you use the HDMI output during recording, this function will not work for the connected device.
- Recorded images will not be affected.

**Not available in these cases:**

- [Monochrome Live View] is not available when [Night Mode] is used.

**[Constant Preview]**











You can check the effects of the chosen aperture and shutter speed on the recording screen in Manual Exposure Mode.



- This function does not work when using the flash.

**[Peaking]**

In-focus portions (portions on the screen with clear outlines) are highlighted when focus is being adjusted manually.





- When [Detect Level] in [SET] is set to [HIGH], portions to be highlighted are reduced, allowing you to achieve a more precise focus.
- Changing the [Detect Level] setting also changes the [Display Color] setting as follows.

[Detect Level]	[HIGH]	↔	[LOW]
	[  ] (Light blue)		[  ] (Blue)
	[  ] (Yellow)		[  ] (Orange)
[Display Color]	[  ] (Yellow-green)		[  ] (Green)
	[  ] (Pink)		[  ] (Red)
	[  ] (White)		[  ] (Gray)

- Each time [] in [] is touched, the setting is switched in order of [ON] ([Detect Level]: [LOW]) → [ON] ([Detect Level]: [HIGH]) → [OFF].
- [Peaking] does not work with [Rough Monochrome] in Creative Control Mode.

**[Histogram]**

Display the histogram.

You can set the position by pressing ///.

- Direct touch operation is also possible from the recording screen.
- A histogram is a graph that displays brightness along the horizontal axis (black to white) and the number of pixels at each brightness level on the vertical axis. It allows you to easily check a picture's exposure.



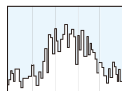

- (A) dark
- (B) bright



- **When the recorded picture and the histogram do not match each other under the following conditions, the histogram is displayed in orange.**
  - During Exposure Compensation
  - When the flash is activated
  - When the correct exposure is not achieved, such as when the lighting is low.
- The histogram is an approximation in the Recording Mode.

**[Guide Line]**

This will set the pattern of guide lines displayed when taking a picture.

When [] is set, guideline positions can be set by pressing ///.

- You can also set the position directly by touching [] on the guideline of the recording screen.

**[Center Marker]**

The center of the recording screen will be displayed as [+].

**[Highlight]**

When the Auto Review function is activated or when playing back, white saturated areas appear blinking in black and white.



- If there are any white saturated areas, we recommend compensating the exposure towards negative referring to the histogram and then taking the picture again. It may result in a better quality picture.
- This function is disabled during 6K/4K photo playback, playback of images recorded with the Post Focus function, Multi Playback, Calendar Playback, or Playback Zoom.

**[Zebra Pattern]**

Indicates parts that may become white saturated through overexposure in a zebra pattern.

**[ZEBRA1]****[ZEBRA2]**

Select [SET] to set the brightness to be processed as a zebra pattern.

- You can select a brightness value between [50%] and [105%]. In [Zebra 2], you can select [OFF]. If you select [100%] or [105%], only the areas that are already white saturated are displayed in a zebra pattern. The smaller the value is, the wider the brightness range to be processed as a zebra pattern will be.
- If there are any white saturated areas, we recommend compensating the exposure towards negative referring to the histogram and then taking the picture.
- Displayed zebra patterns will not be recorded.
- If you assign [Zebra Pattern] to [Fn Button Set] in the [Custom] ([Operation]) menu, each time you press the function button to which the setting is assigned, the zebra pattern toggles as follows:  
[Zebra 1] → [Zebra 2] → [OFF].  
When [Zebra 2] is set to [OFF], the setting toggles in the order of [Zebra 1] → [OFF], allowing you to switch the setting quickly.

**[Expo.Meter]**

Display the exposure meter.

- Set to [ON] to display the Exposure meter when performing Program Shift, setting aperture, and setting shutter speed.
- Unsuitable areas of the range are displayed in red.
- When the Exposure meter is not displayed, switch the display information for screen by pressing [DISP].
- If no operations are performed for approximately 4 seconds, the Exposure meter disappears.

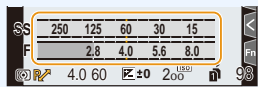
**[MF Guide]**

When you set the focus manually, an MF guide that allows you to check the direction to achieve focus is displayed.

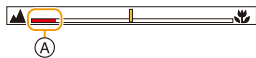

- (A) Indicator for ∞ (infinity)

**[Monitor Info. Disp.]**

Display the recording information screen. (P50, 316)

**[Rec Area]**

This changes the angle of view during motion picture recording and still picture recording.

	Displays the recording area according to the angle of view for still picture recording.
	Displays the recording area according to the angle of view for motion picture recording.

- The recording area indicated is an approximation.

 **Not available in these cases:**



- When recording with the 6K/4K Photo function or Post Focus function, [Rec Area] is fixed to .

**[Remaining Disp.]**

This will switch display between the number of recordable pictures and available recording time.

**[Menu Guide]**

Display a selection screen when you set the mode dial to .

**MENU** →  **[Custom]** →  **[Lens / Others]**

### **[Lens Position Resume]**

Saves the focus position when you turn off the camera. When an interchangeable lens that is compatible with power zoom is in use, the zoom position is also saved.

### **[Lens Fn Button Setting]**

Sets the function to be assigned to the focus button of an interchangeable lens.

- You can call up the assigned function by setting the focus selector switch of a compatible interchangeable lens to [Fn] and then pressing the focus button of the lens.



**Settings:** **[Focus Stop]/[AF/AE LOCK]/[AF-ON]/[AF-Point Scope]/[Stabilizer]/  
[Focus Area Set]/[AF Mode/MF]/[Preview]/[Off]/[Restore to Default]**

- When [Focus Stop] is used, the focus is locked while the focus button is pressed and held.

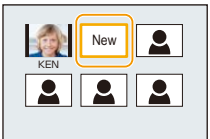

**[Face Recog.]**

Face Recognition is a function which finds a face resembling a registered face and priorities focus and exposure automatically. Even if the person is located towards the back or on the end of a line in a group photo, the camera can still take a clear picture.

<b>[ON]</b>	Enables the Face Recognition function.		
<b>[OFF]</b>	Disables the Face Recognition function.		
<b>[MEMORY]</b>	Allows you to register face images, or edit or delete registered information.		
	<b>Face Settings</b>		
	You can register information such as names and birthdays for face images of up to 6 people.		
	<ol style="list-style-type: none"> <li>Press ▲/▼/◀/▶ to select the Face Recognition frame that is not registered, and then press [MENU/SET].</li> </ol>		
	<ol style="list-style-type: none"> <li>Take the picture adjusting the face with the guide.           <ul style="list-style-type: none"> <li>The faces of subjects other than people (pets, etc.) cannot be registered.</li> <li>To display the description of the face registration, press ▶ or touch [i].</li> </ul> </li> </ol>		
	<ol style="list-style-type: none"> <li>Set the item.           <ul style="list-style-type: none"> <li>You can register up to 3 face images.</li> </ul> </li> </ol>		
	<b>[Name]</b>	It is possible to register names. <ul style="list-style-type: none"> <li>For information on how to enter characters, refer to P64.</li> </ul>	
	<b>[Age]</b>	It is possible to register the birthday.	
	<b>[Add Images]</b>	<b>(Add Images)</b>	To add additional face images. <ul style="list-style-type: none"> <li>Select a blank face image frame to register a new image.</li> </ul>
		<b>(Delete)</b>	To delete one of the face images. <ul style="list-style-type: none"> <li>Select the face image you want to delete.</li> </ul>
<b>Change or delete the information for a registered person</b>			
<ol style="list-style-type: none"> <li>Press ▲/▼/◀/▶ to select the face image to edit or delete and then press [MENU/SET].</li> </ol>			
<ol style="list-style-type: none"> <li>Set the item.</li> </ol>			
<b>[Info Edit]</b>	Changing the information of an already registered person. <ul style="list-style-type: none"> <li>Perform step ③ in "Face Settings".</li> </ul>		
<b>[Priority]</b>	The focus and exposure are preferentially adjusted for higher-priority faces. <ul style="list-style-type: none"> <li>Rearrange and set the face priority.</li> </ul>		
<b>[Delete]</b>	Deleting information of a registered person.		

**Point of recording when registering the face images**

- Face front with eyes open and mouth closed, making sure the outline of the face, the eyes, or the eyebrows are not covered with hair when registering.
- Make sure there is no extreme shading on the face when registering.  
(Flash will not flash during registration.)

(Good example for registering)

**When face is not recognized during recording**

- Register the face of same person indoors and outdoors, or with different expressions or angles.
- Additionally register at the location of recording.
- When a person who is registered is not recognized, correct by re-registering.
- Face Recognition may not be possible or may not recognize faces correctly even for registered faces, depending on the facial expression and environment.

**• The following functions will also work with the Face Recognition function.****In Recording Mode**

- Display of corresponding name when camera detects a registered face\*

**In Playback Mode**

- Display of name and age
- \* Names of up to 3 people are displayed.

Precedence for the names displayed when taking pictures is determined according to the order of registration.

**• [Face Recog.] only works when the AF Mode is set to [☺].**

- It works only when a face has been detected.
- When you specify the person to be brought into focus, [Face Recog.] is not work.
- During the Burst Mode, [Face Recog.] picture information can be attached to only the first picture.
- When group pictures are played back, the name of the first picture of the set is displayed.

**Not available in these cases:**

- This function is not available in the following cases:
  - [Miniature Effect] (Creative Control Mode)
  - When recording motion pictures
  - When recording 6K/4K photos
  - When recording with the Post Focus function
  - When using [Time Lapse Shot]

**[Profile Setup]**

If you set the name and birthday of your baby or pet in advance, you can record their name and age in months and years in the images.

You can display these at playback or stamp the recorded images using [Text Stamp].

**Settings:** [**☺**<sup>1</sup>] ([Baby1])/[**☺**<sup>2</sup>] ([Baby2])/[**🐾**] ([Pet])/[OFF]/[SET]

■ **Setting [Age] or [Name]**

- 1 Press ▲/▼ to select [SET] and then press [MENU/SET].
- 2 Press ▲/▼ to select [Baby1], [Baby2] or [Pet] and then press [MENU/SET].
- 3 Press ▲/▼ to select [Age] or [Name] and then press [MENU/SET].
- 4 Press ▲/▼ to select [SET] and then press [MENU/SET].

Enter [Age] (birthday).

Enter [Name].

- For information on how to enter characters, refer to P64.



- You can print out ages and names with "PHOTOfunSTUDIO".



**Not available in these cases:**

- [Profile Setup] is not available when recording is performed with the 6K/4K Photo or Post Focus function.
- Ages and names are not recorded in the following cases:
  - When recording motion pictures
  - Still pictures recorded during motion picture recording ([**🎥**] ([Video Priority]))

 : [Setup] menu

- [Online Manual] (P220)
- [Cust.Set Mem.] (P85)
- [Clock Set] (P38)
- [World Time] (P220)
- [Travel Date] (P221)
- [Wi-Fi] (P222)
- [Bluetooth] (P222)
- [Wireless Connection Lamp] (P222)
- [Beep] (P222)
- [Headphone Volume] (P205)
- [Economy] (P223)
- [Monitor Display Speed] (P224)
- [LVF Display Speed] (P224)
- [Night Mode] (P224)
- [Monitor Display]/[Viewfinder] (P225)
- [Monitor Luminance] (P225)
- [Status-LCD Backlight] (P225)
- [Eye Sensor] (P226)
- [Battery Use Priority] (P309)
- [USB Mode] (P226)
- [USB Power Supply] (P226)
- [TV Connection] (P227)
- [Language] (P227)
- [Version Disp.] (P227)
- [Folder / File Settings] (P228)
- [Double Slot Function] (P229)
- [Save/Restore Camera Setting] (P230)
- [No.Reset] (P230)
- [Reset] (P231)
- [Reset Network Settings] (P231)
- [Pixel Refresh] (P231)
- [Sensor Cleaning] (P231)
- [Level Gauge Adjust.] (P232)
- [Format] (P31)

**MENU** →  [Setup]

**[Online Manual]**

Settings: [URL display]/[QR Code display]

**[World Time]**

Sets the times for the region where you live and your holiday destination.

- [Destination] can be set after setting up [Home].

**After selecting [Destination] or [Home], press ◀▶ to select an area, and press [MENU/SET] to set.**

 **[Destination]:**

Travel destination area

- (A) Current time of the destination area
- (B) Time difference from home area

 **[Home]:**

Your home area

- (C) Current time
- (D) Time difference from GMT (Greenwich Mean Time)

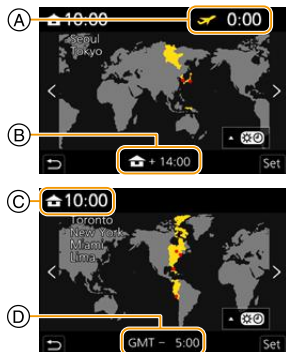

- If you are using Daylight Savings [, press ▲. (The time will move forward by 1 hour.) To return to the normal time, press ▲ again.
- If you cannot find the travel destination in the areas displayed on the screen, set by the time difference from the home area.

### [Travel Date]

<b>[Travel Setup]</b>	<p>If you set [Travel Setup], elapsed days of your trip (i.e. which day of the trip) based on its departure and return dates will be recorded.</p> <ul style="list-style-type: none"> <li>• The travel date is automatically canceled if the current date is after the return date.</li> <li>• If the [Travel Setup] is set to [OFF], [Location] will also be set to [OFF].</li> </ul>
<b>[Location]</b>	<p>If you set [Location], the name of the travel destination that you enter will be recorded.</p> <ul style="list-style-type: none"> <li>• For information on how to enter characters, refer to <a href="#">P64</a>.</li> </ul>

- You can display the elapsed days and travel destination during playback or stamp them on recorded pictures in [Text Stamp].
- The elapsed days and travel destination can be printed out using the software "PHOTOfunSTUDIO".
- The travel date is calculated using the date in the clock setting and the departure date you set. If you set [World Time] to the travel destination, the travel date is calculated using the date in the clock setting and the travel destination setting.
- The [Travel Date] feature is disabled when recording [AVCHD] motion pictures.
- [Location] cannot be recorded in the following cases:
  - When recording motion pictures
  - When recording 6K/4K photos
  - When recording with the Post Focus function

**[Wi-Fi]**

<b>[Wi-Fi Function]</b>	P250	<b>[Wi-Fi Setup]</b>	P291
-------------------------	------	----------------------	------

**[Bluetooth]**

<b>[Bluetooth]</b>	P254, P255	<b>[Location Logging]</b>	P268
<b>[Remote Wakeup]</b>	P260	<b>[Auto Clock Set]</b>	P269
<b>[Auto Transfer]</b>	P264	<b>[Wi-Fi network settings]</b>	P265

**[Wireless Connection Lamp]**

This enables/disables the WIRELESS connection lamp.  
If you select [OFF], they will not light/flash.

**[Beep]**

This allows you to set the electronic sound and the electronic shutter sound.

**Settings: [Beep Volume]/[E-Shutter Vol]/[E-Shutter Tone]**

- When [Silent Mode] is set to [ON], [Beep Volume] and [E-Shutter Vol] are set to [OFF].

**[Economy]**

<b>[Sleep Mode]</b>	The camera is automatically turned off if the camera has not been used for the time selected on the setting.		
<b>[Sleep Mode(Wi-Fi)]</b>	The camera is automatically turned off if it is not connected to a Wi-Fi network and has not been used for 15 minutes (approx.).		
<b>[Auto LVF/Monitor Off]</b>	The monitor/viewfinder is automatically turned off if the camera has not been used for the time selected on the setting.		
<b>[Power Save LVF Shooting]</b>	If you display the monitor using the viewfinder/monitor automatic switching function, the camera will turn off automatically after being left idle.		
	<table border="1"> <tr> <td data-bbox="301 380 405 500"><b>[Time]</b></td> <td data-bbox="405 380 1011 500">           Sets the amount of time before the camera turns off automatically.  <b>[10SEC]/[5SEC]/[3SEC]/[2SEC]/[1SEC]/[OFF]</b>            • When not using [Power Save LVF Shooting], select [OFF].         </td> </tr> </table>	<b>[Time]</b>	Sets the amount of time before the camera turns off automatically. <b>[10SEC]/[5SEC]/[3SEC]/[2SEC]/[1SEC]/[OFF]</b> • When not using [Power Save LVF Shooting], select [OFF].
	<b>[Time]</b>	Sets the amount of time before the camera turns off automatically. <b>[10SEC]/[5SEC]/[3SEC]/[2SEC]/[1SEC]/[OFF]</b> • When not using [Power Save LVF Shooting], select [OFF].	
<b>[Display]</b>	Sets whether to turn off the camera automatically only while the [Monitor Info. Disp.] screen is displayed or while any screen is displayed. <b>[Only Monitor Info.]:</b> Sets the camera to turn off automatically only when [Monitor Info. Disp.] is displayed. <b>[All Live View]:</b> Sets the camera to turn off automatically when any screen is displayed.		

- To cancel [Sleep Mode], [Sleep Mode(Wi-Fi)] or [Power Save LVF Shooting], perform either of the following operations:
  - Press the shutter button halfway.
  - Turn off and on the camera.
- To turn the monitor/viewfinder on again, press any button.
- [Economy] does not work in the following cases.
  - When connecting to a PC or a printer
  - When recording or playing back motion pictures
  - During a slide show
  - When recording with [6K/4K Pre-Burst]
  - When recording in [Multi Exp.]
  - When using [Time Lapse Shot]
  - When using [Stop Motion Animation] (only when [Auto Shooting] is set)
  - When using the HDMI output during recording
- When using the AC adaptor (optional), [Sleep Mode], [Sleep Mode(Wi-Fi)] and [Power Save LVF Shooting] are disabled.
- When using the AC adaptor (optional), [Auto LVF/Monitor Off] is fixed to [5MIN.].

**[Monitor Display Speed]**

This sets the monitor frame rate.

<b>[30fps]</b>	Reduces the power consumption, extending the operating time.
<b>[60fps]</b>	Displays movements smoother.

- When [Monitor Display Speed] is set to [30fps], the monitor image quality may be lower than when it is set to [60fps], but this does not affect the recorded image.

**[LVF Display Speed]**

This sets the viewfinder frame rate.

<b>[60fps]</b>	Reduces the power consumption, extending the operating time.
<b>[120fps]</b>	Displays movements smoother.

- [LVF 120] is displayed on the viewfinder when it is displayed at [120fps].
- When [LVF Display Speed] is set to [120fps], the viewfinder image quality is lower than when it is set to [60fps], but this does not affect the recorded image.
- Images are displayed at [60fps] in the following cases:
  - When recording motion pictures
  - During playback
  - During Creative Video Mode
  - When recording in Burst Mode  
(only when [Burst Shot Setting] is set to [SH2]/[SH1]/[SH2 PRE]/[SH1 PRE])
  - When recording 6K/4K photos
  - During HDMI output

**[Night Mode]**

This displays the monitor and viewfinder screens in red. It reduces the difficulty in seeing the surroundings caused by brightly-lit screens at night or in any low-light environment.

- 1 Press ▲/▼/◀/▶ to select [ON] for the red display setting of the monitor or viewfinder (LVF).**
- 2 Press [DISP.] to display the brightness adjustment screen.**
- 3 Press ◀/▶ to adjust the brightness, and press [MENU/SET].**

- This mode does not affect recorded images.
- This effect is not applied to images output via HDMI.







**[Monitor Display]/[Viewfinder]**

Brightness, color, or red or blue tint of the Monitor/viewfinder is adjusted.

- 1 Select the settings by pressing ▲/▼, and adjust with ◀/▶.
- 2 Press [MENU/SET] to set.

- It will adjust the monitor when the monitor is in use, and the viewfinder when the viewfinder is in use.
- Some subjects may appear differently from actuality on the monitor. However, this does not affect the recorded pictures.

**[Monitor Luminance]**

 <b>[AUTO]</b>	The brightness is adjusted automatically depending on how bright it is around the camera.
 <b>[MODE1]</b>	Make the monitor brighter.
 <b>[MODE2]</b>	Set the monitor to the standard brightness.
 <b>[MODE3]</b>	Make the monitor darker.

- Some subjects may appear differently from actuality on the monitor. However, this does not affect the recorded pictures.
- The monitor automatically returns to standard brightness if no operations are performed for 30 seconds when recording in [MODE1]. It will light up brightly again with button or touch operation.
- When [AUTO] or [MODE1] is set, the usage time is reduced.
- [AUTO] is only available in the Recording Mode.
- The initial setting when using the AC adaptor (optional) is [MODE2].

**Not available in these cases:**

- [Monitor Luminance] is not available when [Night Mode] is set.

**[Status-LCD Backlight]**

<b>[H]</b>	Brightens the status LCD backlight.
<b>[L]</b>	Dims the status LCD backlight.
<b>[OFF]</b>	Turns off the status LCD backlight.





**[Eye Sensor]**

<b>[Sensitivity]</b>	This will set the sensitivity of the eye sensor.
----------------------	--

<b>[LVF/Monitor Switch]</b>	<p>This will set the method for switching between the monitor and viewfinder.</p> <p><b>[LVF/MON AUTO] (automatic switching between the monitor and viewfinder)/</b>  <b>[LVF] (viewfinder)/[MON] (monitor)</b></p> <ul style="list-style-type: none"> <li>• If you press [LVF] to switch the display, the [LVF/Monitor Switch] setting will also switch.</li> </ul>
-----------------------------	--

**[USB Mode]**

Sets the communication method when connecting using the USB connection cable (supplied).

 <b>[Select on connection]</b>	Select this setting to select the USB communication system when connecting to another device.
 <b>[PC(Storage)]</b>	Select this setting to export images to a connected PC.
 <b>[PC(Tether)]</b>	Select this setting to control the camera from a PC installed with supported software.
 <b>[PictBridge(PTP)]</b>	Select this setting when connecting to a printer supporting PictBridge.

**[USB Power Supply]**

Supplies power via the USB connection cable when the camera is connected to a PC.

- Even if this item is set to [OFF], power will be supplied when the AC adaptor (supplied) is connected.

**[TV Connection]****[HDMI Mode (Play)]:**

Set the format for the HDMI output when playing back on the HDMI compatible TV and monitor connected with this unit using the HDMI cable.

<b>[AUTO]</b>	Outputs images at an output resolution suited to the connected TV.
<b>[4K/60p]/[4K/30p]/[1080p]/[1080i]/[720p]/[480p]</b>	Outputs images at the selected resolution. • The output resolution for [4K/60p] and [4K/30p] is 3840×2160.

- This will work only during playback.
- If no image appears on your TV when [AUTO] is set, switch to a setting other than [AUTO] that can display images on the TV.

**[HDMI Info Display (Rec)]:**

Sets whether to display or hide information while monitoring the camera image being recorded on a TV connected with an HDMI cable. (P296)

**[VIERA Link]:**

If you select [ON], operations of the camera and the VIERA Link compatible equipment connected to the camera with an HDMI cable are automatically linked, enabling you to control the camera with the remote control of the VIERA Link compatible equipment.

**[Language]**

Set the language displayed on the screen.

- If you set a different language by mistake, select [00] from the menu icons to set the desired language.

**[Version Disp.]**

This enables the firmware versions of the camera and lens to be checked.

- To display information about the software on the unit, press [MENU/SET] on the version display screen.

**[Folder / File Settings]**

Set the folder and file name patterns in which images are to be saved.

Folder name		File name	
100ABCDE 		PABC0001.JPG 	
①	Folder number (3-digits, 100–999)	①	Color space ([P]: sRGB, [_]: AdobeRGB)
②	5-digit user-defined segment	②	3-digit user-defined segment
		③	File number (4-digits, 0001–9999)
		④	File extension



<b>[Select Folder]</b> *	Specifies the folder to which images are to be saved. • The folder name is indicated with the number of files that can be stored.	
<b>[Create a New Folder]</b>	<b>[OK]</b>	Creates a new folder with the same 5-digit user-defined segment as the current folder name setting.
	<b>[Change]</b>	Allows you to redefine the 5-digit user-defined segment before creating a new folder. • Available characters: alphabet (upper case characters), numbers, and [ _ ] • For information on how to enter characters, refer to <a href="#">P64</a> .
	• A new folder with an incremented folder number is created. • If there are no recordable folders in the card, a screen for resetting the folder number is displayed.	
<b>[File Name Setting]</b>	<b>[Folder Number Link]</b>	Uses the folder number of the folder name as the file name's 3-digit user-defined segment.
	<b>[User Setting]</b>	Allows you to define and set the 3-digit user-defined segment of the file name. • Available characters: alphabet (upper case characters), numbers, and [ _ ] • For information on how to enter characters, refer to <a href="#">P64</a> .

\* When [Double Slot Function] is set to [Allocation Rec], [Select Folder (SD1)] and [Select Folder (SD2)] are displayed.

- Each folder can store up to 1000 files.
- File numbers are assigned sequentially from 0001 to 9999 in the order of recording. If you change the storage folder, a continuing number from the last file number will be assigned.
- In the following cases, a new folder with an incremented folder number will be created automatically when the next file is saved:
  - The current folder contains 1000 files
  - The current folder contains a file with the file number "9999"
- New folders cannot be created when there are folders numbered from 100 all the way up to 999. In this case, we recommend saving their data to a computer or similar device and formatting the card.

### [Double Slot Function]

Set the way recording to the card slots 1 and 2 is performed.

[Recording Method]	 ([Relay Rec])	Relays recording to the other card slot even after the first card runs out of free space during recording. <b>[Destination Slot]: [1→2]/[2→1]</b> <ul style="list-style-type: none"> <li>• If you keep replacing the full card before the other card runs out of free space during motion picture recording, you can perform recording for a long period of time using 3 or more cards. Replace the card when there is still sufficient free space left on the card being used for recording.</li> </ul>
	 ([Backup Rec])	Records same images to the two cards.
	 ([Allocation Rec])	Allows you to specify the card slot to be used for recording for different image formats. <b>[JPEG Destination]/[RAW Destination]/[6K/4K Photo Destination]/[Video Destination]</b>

#### Notes on the Relay Rec. function

- In the following cases, recording cannot be relayed to the other card:
  - When recording a motion picture in [AVCHD] format

#### Notes on the Backup Rec. function

- We recommend using cards with the same Speed Class rating and capacity.
- When recording a motion picture in [AVCHD] format, backup recording of motion picture is not possible. Data will be recorded only to the one card.
- When different types of cards (SDHC/SDXC) are inserted in any of the following situations, recording cannot be performed to the cards:
  - When recording motion pictures (Excluding [AVCHD])
  - When recording 6K/4K photos
  - When recording with the Post Focus function

**[Save/Restore Camera Setting]**

Save the camera's setup information to the card. Since saved setup information can be imported to the camera, you can apply the same setup to more than one camera.

- Save/load setup information using the card inserted to the card slot 1.

<b>[Save]</b>	Saves the camera's setup information to the card.	
	<ul style="list-style-type: none"> <li>• To save new information, select [New File]; to overwrite an existing file, select that file.</li> <li>• When [New File] has been selected, the name of the file to be saved is displayed on the screen.</li> </ul>	
	<b>[OK]</b>	Saves the file with an automatically created name displayed on the screen.
	<b>[Change the file name]</b>	Allows you to rename the file before saving it. <ul style="list-style-type: none"> <li>• Available characters: alphabet (upper case characters) and numbers; up to 8 characters</li> <li>• For information on how to enter characters, refer to <a href="#">P64</a>.</li> </ul>
<b>[Load]</b>	Loads the setup information on the card to the camera.	
<b>[Delete]</b>	Deletes the setup information on the card.	

- The setup information of the menu items below cannot be saved/loaded.

<b>[Custom]</b>	• Data registered with [Face Recog.]		
<b>[Setup]</b>	• [Clock Set]	• [Wi-Fi Setup] in [Wi-Fi]	• [Viewfinder]
	• [World Time]	• [Bluetooth]	• [Level Gauge Adjust.]
	• [Travel Date]	• [Monitor Display]	

- Setup information can be loaded only to cameras of the same model as this camera.
- You can save up to 10 sets of setup information to one card.

**[No.Reset]**

Reset the file number of the next recording to 0001.

**Settings: [Slot 1]/[Slot 2]**

- When recording is performed after resetting this item, the folder number is updated and the file number starts from 0001.
- A folder number between 100 and 999 can be assigned.  
The folder number should be reset before it reaches 999. We recommend formatting the card after saving the data on a PC or elsewhere.
- To reset the folder number to 100:
  - 1 Perform [Format] to format the card.
  - 2 Perform [No.Reset] to reset the file number.
  - 3 Select [Yes] on the folder number reset screen.

### [Reset]

The following settings are reset to the default:

- Recording settings
- Setup settings ([Wi-Fi Setup] and [Bluetooth] settings)
- Custom settings ([Face Recog.] and [Profile Setup] settings)
- Setup/custom settings (except for [Wi-Fi Setup], [Bluetooth], [Face Recog.] and [Profile Setup])

- When the setup/custom settings are reset, the following settings are also reset.
  - The [World Time] setting
  - The settings of [Travel Date] (departure date, return date, location)
  - The settings of [Rotate Disp.], [Picture Sort] and [Delete Confirmation] in the [Playback] menu
- The folder number and the clock setting are not changed.

### [Reset Network Settings]

The following network settings are reset to the default:

- [Wi-Fi Setup] (Excluding [LUMIX CLUB])
- Registered device information in [Bluetooth] and values in [Wi-Fi network settings]

- Always reset the camera when disposing or selling it to prevent personal information saved within the camera from being misused.
- Always reset the camera after making a copy of personal information when sending the camera in to be repaired.

### [Pixel Refresh]

It will perform optimization of imaging device and image processing.

- Imaging device and image processing is optimized when the camera is purchased. Use this function when bright spots that do not exist in the subject get recorded.
- Turn the camera off and on after the pixels are corrected.

### [Sensor Cleaning]

Dust reduction to blow off the debris and dust that have affixed to the front of the imaging device is performed.

- Dust Reduction Function will operate automatically when the camera is turned on, but you can use this function when you see dust.

**[Level Gauge Adjust.]**

<b>[Adjust.]</b>	Hold the camera in a horizontal position, and press [MENU/SET]. The level gauge will be adjusted.
<b>[Level Gauge Value Reset]</b>	Restores the default level gauge setting.

**PERSON :** **[My Menu] menu****[My Menu Setting]**

Register frequently-used menus and display them in [My Menu]. You can register up to 23 menus.

**MENU** → **PERSON** **[My Menu]** → **[My Menu Setting]**

<b>[Add]</b>	Specifies the menu to be displayed in My Menu to register it.
<b>[Sorting]</b>	Rearranges the menus displayed in My Menu. Select the menu you want to move and set the destination.
<b>[Delete]</b>	Deletes registered menus from the displayed menu list. <b>[Delete Item]:</b> Deletes a selected menu from the displayed menu list. <b>[Delete All]:</b> Deletes all of the displayed menus.
<b>[Display from My Menu]</b>	Sets the type of the menu screen to be displayed. <b>[ON]:</b> Displays My Menu. <b>[OFF]:</b> Displays the last-used menu.



: **[Playback] menu**

- [Slide Show] (P234)
- [Playback Mode] (P235)
- [Protect] (P236)
- [Rating] (P236)
- [Title Edit] (P237)
- [Face Rec Edit] (P237)
- [RAW Processing] (P238)
- [6K/4K PHOTO Bulk Saving] (P126)
- [6K/4K PHOTO Noise Reduction] (P126)
- [Light Composition] (P241)
- [Clear Retouch] (P242)
- [Text Stamp] (P243)
- [Copy] (P244)
- [Resize] (P245)
- [Cropping] (P246)
- [Rotate] (P247)
- [Video Divide] (P247)
- [Time Lapse Video] (P248)
- [Stop Motion Video] (P248)
- [Rotate Disp.] (P248)
- [Picture Sort] (P249)
- [Delete Confirmation] (P249)

• The camera may not play back images recorded on other devices correctly, and the functions of the camera may not be available for the images.

### ■ How to select an image(s) after selecting [Single] or [Multi]

- When [Single] and [Multi] are not available, select an image in the same way as when [Single] is selected.

#### [Single] setting

- 1 Press **◀/▶** to select the picture.
- 2 Press **[MENU/SET]**.
  - If [Set/Cancel] is displayed at the right bottom of the screen, the setting is canceled when [MENU/SET] is pressed again.



#### [Multi] setting

When a screen similar to the one on the right is displayed:

- 1 Press **▲/▼/◀/▶** to select the picture and then press **[MENU/SET]** (repeat).
  - The setting is canceled when [MENU/SET] is pressed again.
- 2 Press **[DISP.]** to execute.

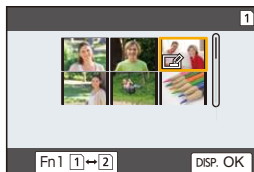

When a screen similar to the one on the right is displayed:

- Press **▲/▼/◀/▶** to select the picture, and then press **[MENU/SET]** to set (repeat).
- The setting is canceled when [MENU/SET] is pressed again.
  - Pictures are displayed separately by card slot. You can switch the displayed card by pressing [Fn1].
  - You can only select images on one card at a time.

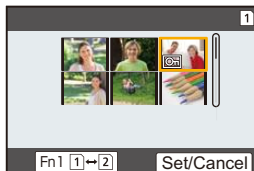

**[Slide Show]**

You can play back the pictures you have taken in synchronization with music, and you can do this in sequence while leaving a fixed interval between each of the pictures.





You can also put together a slide show composed of only still pictures, only motion pictures, etc.





We recommend this feature when you view your pictures by connecting the camera to a TV.

**MENU** →  **[Playback]** → **[Slide Show]**

- Select the group to play back by pressing ▲/▼, and then press [MENU/SET].**
  - If you select [Picture Only], 6K/4K burst files and images recorded with the Post Focus function will also be played back.
  - For images recorded with the Post Focus function, only an in-focus representative image will be chosen and played back.
- Press ▲ to select [Start] and then press [MENU/SET].**

#### ■ Operations during a slide show

Button operation	Touch operation	Description of operation
▲		Play/Pause
◀		Back to previous picture
		Reduce volume level

Button operation	Touch operation	Description of operation
▼		Exit slide show
▶		Ahead to next picture
		Increase volume level

## ■ Changing the slide show settings

You can change the settings for slide show playback by selecting [Effect] or [Setup] on the slide show menu screen.

[Effect]	This allows you to select the screen effects when switching from one picture to the next.	
[Setup]	[Duration]	• [Duration] can be set only when [OFF] has been selected as the [Effect] setting.
	[Repeat]	[ON]/[OFF]
	[Sound]	<p><b>[AUTO]:</b> Music is played when the still pictures are played back, and audio is played when the motion pictures are played back.</p> <p><b>[Music]:</b> Music is played back.</p> <p><b>[Audio]:</b> Audio (only for motion pictures) is played back.</p> <p><b>[OFF]:</b> There will be no sound.</p>

- When playing back the following pictures, the [Effect] setting is disabled.
  - 6K/4K burst files
  - Images recorded with the Post Focus function
  - Group Pictures
- When playing back the following pictures, the [Duration] setting is disabled.
  - Motion pictures
  - 6K/4K burst files
  - Images recorded with the Post Focus function
  - Group Pictures

### [Playback Mode]

Playback in [Normal Play], [Picture Only] or [Video Only] can be selected.

**MENU** →  **[Playback]** → **[Playback Mode]**

Select the group to play back by pressing ▲/▼, and then press [MENU/SET].

- If you select [Picture Only], 6K/4K burst files and images recorded with the Post Focus function will also be played back.

**[Protect]**

You can set protection for pictures you do not want to delete by mistake.

**MENU** →  **[Playback]** → **[Protect]**

**Select the picture. (P233)**

- [999+] is displayed on the screen, if the total number of protects you set for a group pictures is more than 1000 pictures.

**■ Canceling all the [Protect] settings**

Press **▲/▼** to select **[Cancel]**, and then press **[MENU/SET]**.

- You can only cancel the setting of images on one card at a time.



Even if you do not protect pictures on a card, they cannot be deleted when the card's Write-Protect switch is set to [LOCK].

- The [Protect] feature is only designed to work with this camera.
- Even if you protect pictures on a card, they will be deleted if the card is formatted.

**[Rating]**

You can set five different rating levels for images to do the following:

- Delete all the pictures not set as ratings.
- Checking the rating level on the file detail display of an operating system, such as Windows 10, Windows 8.1, or Windows 8. (JPEG images only)

**MENU** →  **[Playback]** → **[Rating]**

**1 Select the picture. (P233)****2 Press ◀/▶ to set the rating level (1–5), and press [MENU/SET] to set.**

- When [Multi] has been selected, repeat steps **1** and **2** for each picture.  
(It is not possible to use the same setting for a multiple number of pictures.)
- The number of a group pictures will be displayed, if you set for a group pictures. [999+] is displayed, if the group pictures is more than 1000 pictures.

**■ Canceling all the [Rating] settings**

Press **▲/▼** to select **[Cancel]**, and then press **[MENU/SET]**.

- You can only cancel the setting of images on one card at a time.
- In [Playback Mode], the [Cancel] is disabled.

- Only the rating level "5" can be set for motion pictures in [AVCHD] format.

**[Title Edit]**

You can add text (comments) to pictures. After text has been registered, it can be stamped in prints using [Text Stamp].

**MENU** →  **[Playback]** → **[Title Edit]**

**1 Select the picture. (P233)**

-  is displayed for pictures with titles already registered.

**2 Enter the text. (P64)**

- To delete the title, erase all the text in the text input screen.
- You can print out texts (comments) using the software "PHOTOfunSTUDIO".
- You can set up to 100 pictures at one time with [Multi].

 **Not available in these cases:**

- This function is not available in the following cases:
  - Motion pictures
  - 6K/4K burst files
  - Images recorded with the Post Focus function
  - Images recorded with [Quality] set to [RAW $\frac{1}{2}$ ], [RAW $\frac{1}{4}$ ] or [RAW]

**[Face Rec Edit]**

You can clear and replace all information relating to face recognition in selected images.

**MENU** →  **[Playback]** → **[Face Rec Edit]**





- 1 Press ▲/▼ to select [REPLACE] or [DELETE], and then press [MENU/SET].**
- 2 Press ◀/▶ to select the picture and then press [MENU/SET].**
- 3 Press ◀/▶ to select the person and then press [MENU/SET].**
- 4 (When [REPLACE] is selected)  
Press ▲/▼/◀/▶ to select the person to replace and then press [MENU/SET].**

- Cleared information regarding the [Face Recog.] cannot be restored.
- The Face Recognition information of pictures in a group has to be edited at once. (You cannot edit one picture at a time.)
- Editing of group pictures can be performed only on the first picture of each set.

**[RAW Processing]**

You can process the pictures taken in RAW format. The processed pictures will be saved in JPEG format.

**MENU** →  **[Playback]** → **[RAW Processing]**

- 1 Select RAW images with  , and then press **[MENU/SET]**.
- 2 Press   to select an item.

- You can set the following items. The settings you used for the recording are selected when you start setting these items.



<b>[White Balance]</b>	Allows you to select a White Balance preset and adjust it. If you select an item with  , you can process the image with the setting at the time of recording.
<b>[Brightness correction]</b>	Allows you to correct the brightness within the range between $-2$ EV and $+2$ EV.
<b>[Photo Style]</b>	Allows you to select a photo style effect.
<b>[i.Dynamic]</b>	Allows you to select an [i.Dynamic] setting.
<b>[Contrast]</b>	Allows you to adjust the contrast.
<b>[Highlight]</b>	Allows you to adjust the brightness of bright portions.
<b>[Shadow]</b>	Allows you to adjust the brightness of dark portions.
<b>[Saturation]/[Color Tone]</b>	Allows you to adjust the saturation. (When [Monochrome] or [L.Monochrome] is selected in [Photo Style], you can adjust the color tone.)
<b>[Filter Effect]</b>	Allows you to select a filter effect. (Only when [Monochrome] or [L.Monochrome] is selected in [Photo Style])
<b>[Noise Reduction]</b>	Allows you to adjust the noise reduction setting.
<b>[i.Resolution]</b>	Allows you to select an [i.Resolution] setting.
<b>[Sharpness]</b>	Allows you to adjust the resolution effect.
<b>[Setup]</b>	<p>You can set the following items:</p> <p><b>[Reinstate Adjustments]:</b> Returns the settings to the ones you used during the recording.</p> <p><b>[Color Space]:</b> Allows you to select a [Color Space] setting from [sRGB] or [Adobe RGB].</p> <p><b>[Picture Size]:</b> Allows you to select the size in which the image will be saved in JPEG format.</p>



**3 Press [MENU/SET] and set.**

- Refer to "How to set each item" on P239.

**4 Press [MENU/SET].**

- This operation returns you to the screen in step 2. To set other items, repeat steps 2 through 4.

**5 Select [Begin Processing] with ▲/▼, and then press [MENU/SET].****■ How to set each item**

Button operation	Touch operation	Description of operation
	<b>Dragging</b>	Selects a setting.
	<b>[WB K Set]</b>	Displays the screen that lets you set the color temperature. (only when [White Balance] is set to [K], [K], [K], [K])
	<b>[Adjust.]</b>	Displays the screen that lets you fine-adjust the White Balance. (only when [White Balance] is set)
<b>[DISP.]</b>	<b>[DISP.]</b>	Displays the comparison screen.
<b>[MENU/SET]</b>	<b>[Set]</b>	Sets the adjusted level and returns you to the item selection screen.

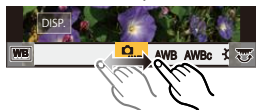

- When [Noise Reduction], [i.Resolution] or [Sharpness] is selected, the comparison screen cannot be displayed.
- Each time you touch the screen twice, the display switches between enlarged and normal view.

On the comparison screen, you can use the following operations to make adjustments:

**(A) Current setting**

Button operation	Touch operation	Description of operation
	<b>Dragging</b>	Selects a setting.
<b>[DISP.]</b>	<b>[DISP.]</b>	Returns you to the setting screen.
<b>[MENU/SET]</b>	<b>[Set]</b>	Sets the adjusted level and returns you to the item selection screen.



- If you touch the picture at the center, it will be enlarged. If you touch [A], the picture will be reduced to the original size.

**[Setup] setting**

When you select an item, the screen that asks you to select [Reinstate Adjustments], [Color Space], or [Picture Size] will be displayed.

- 1 Press ▲/▼ to select an item, and press [MENU/SET].
  - If you select [Reinstate Adjustments], a confirmation screen will be displayed. Selecting [Yes] will execute the operation and return you to the item selection screen.
- 2 Press ▲/▼ to select a setting, and press [MENU/SET].

- The effects applied through the RAW processing on the camera and those applied through the RAW processing on the software “SILKYPIX Developer Studio” are not completely identical.
- RAW images recorded with the camera are always recorded in the [4:3] (5184×3888) aspect ratio. When you process them with [RAW Processing] in the [Playback] menu, however, their aspect ratio and [Ex. Tele Conv.] settings at the time of recording will be applied to them.
- Zoomed-in images recorded with [Ex. Tele Conv.] cannot be processed if you select a [Picture Size] setting larger than their size at the time of recording.
- The [White Balance] setting of pictures taken with multiple exposures is fixed to the setting at the time of recording.
- The [Brightness correction] effect differs from the effect of exposure compensation during recording.

** Not available in these cases:**

- [RAW Processing] is not available when an HDMI cable is connected.
- You can process only the RAW images you recorded with the camera.



**[Light Composition]**

Select multiple frames from 6K/4K burst files that you wish to combine. Parts of the image that are brighter than the preceding frame will be superimposed on the preceding frame to combine the frames into one picture.

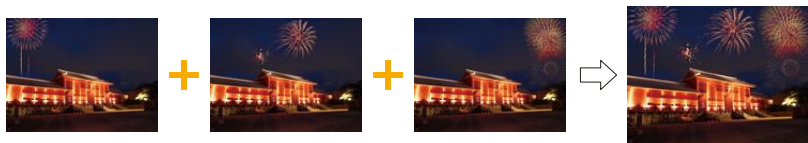

**[MENU]** → **[Playback]** → **[Light Composition]**

- 1 Press **◀/▶** to select the 6K/4K photo burst files and press **[MENU/SET]**.
- 2 Choose the combining method, and then press **[MENU/SET]**.

**[Composite Merging] setting**

Select the frames you want to combine to superimpose brighter parts.

- 1 Select the frames.

For information on button and touch operation, refer to [P128](#).

- Images displayed cannot be enlarged or shrunk or shown as in slide view.
- **[◀/▶]** / **[◀/▶]** in touch operation becomes **[◀/▶]**.

- 2 Press **[MENU/SET]**.

The selected frames are remembered, and the display goes to the preview screen.

Press **▲/▼** to select items and press **[MENU/SET]** to perform the following operations.

- **[Next]**: Lets you select more frames for combining. Goes back to step 1.
- **[Reselect]**: Discards the frame selected immediately before and lets you select a different image.
- **[Save]**: Ends frame selection

- 3 Repeat steps 1 and 2 to select more frames to combine.

- You can select up to 40 frames.

- 4 Press **▼** to select **[Save]**, and then press **[MENU/SET]**.

**[Range Merging] setting**

Select the first and last frames to superimpose the brighter parts of the frames between them.

- 1 Select the frame of the first picture, and press **[MENU/SET]**.

The selection method is the same as in step 1 of **[Composite Merging]** setting.

- 2 Select the frame of the last picture, and press **[MENU/SET]**.

- 3 Select **[Yes]** at the confirmation screen, and then press **[MENU/SET]**.

The combined picture is displayed.

- Pictures are saved in JPEG format. Recording information (Exif information) of the first frame such as shutter speed, aperture, and ISO sensitivity are also registered.

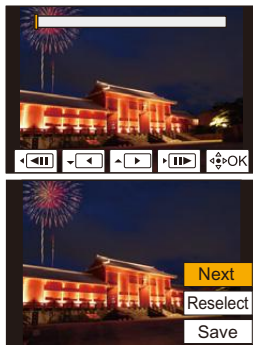

**[Clear Retouch]**

- The erasure operation can only be performed by touching. [Clear Retouch] automatically enables the touch operation.

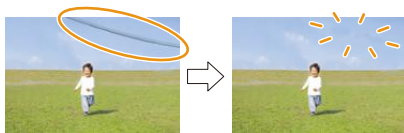

**MENU** → **[Playback]** → **[Clear Retouch]**

- 1 Press **◀/▶** to select a picture, and then press **[MENU/SET]**.
- 2 Drag your finger over the part you want to delete.
  - The parts to be erased are colored.
  - To return the colored part back to its previous state, touch **[Undo]**.

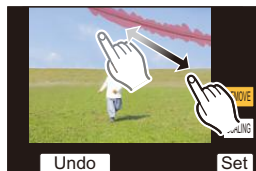

**💡 Erasing details (enlarging the display)**

- 1 Touch **[SCALING]**.
  - Pinching out/pinching in the screen allows you to enlarge/reduce it.
  - Dragging the screen allows you to move the enlarged part.
- 2 Touch **[REMOVE]**.
  - This will bring you back to the operation of dragging your finger over the part you want to delete. The part you want to delete can be dragged even while the picture is enlarged.



- 3 Touch **[Set]**.
- 4 Touch **[Save]** or press **[MENU/SET]**.

- Pictures may appear unnatural because the background of deleted parts is artificially created.
- For group pictures, perform [Clear Retouch] on each picture. (They cannot be edited at once.)
- When [Clear Retouch] is performed on group pictures, they are saved as new pictures separate from the original ones.

**🚫 Not available in these cases:**

- Not available when the viewfinder is in use.
- This function is not available in the following cases:
  - Motion pictures
  - 6K/4K burst files
  - Images recorded with the Post Focus function
  - Pictures taken with **[RAW]**

**[Text Stamp]**

You can stamp recording information on recorded images.



**MENU** → **[Playback]** → **[Text Stamp]**

**1 Select the picture. (P233)**

- **[☑]** appears on screen if the picture is stamped with text.

**2 Press ▲/▼ to select [Set], and then press [MENU/SET].**

<b>[Shooting Date]</b>	Stamps the recording date.
<b>[Name]</b>	<b>[👤]</b> ([Face Recognition]): Name registered in [Face Recog.] will be stamped. <b>[👶/🐾]</b> ([Baby/Pet]): Name registered in [Profile Setup] will be stamped.
<b>[Location]</b>	Stamps the travel destination name set under [Location].
<b>[Travel Date]</b>	Stamps the travel date set under [Travel Date].
<b>[Title]</b>	Title input in the [Title Edit] will be stamped.

**3 Press [↩] to return to the previous screen.**

**4 Press ▲ to select [OK], and then press [MENU/SET].**

- When you print pictures stamped with text, the date will be printed over the stamped text if you specify printing of the date at the photo shop or on the printer.
- You can set up to 100 pictures at one time in [Multi].
- The picture quality may deteriorate when text stamping is carried out.
- When you stamp pictures in a group, the stamped ones are saved separately from the original ones in the group.

**ⓘ Not available in these cases:**

- This function is not available in the following cases:
  - Motion pictures
  - 6K/4K burst files
  - Images recorded with the Post Focus function
  - Pictures recorded without setting the clock and title
  - Pictures stamped with [Text Stamp]
  - Pictures taken with [RAW]

**[Copy]**

Copy images on the card to the other card.

**MENU** →  **[Playback]** → **[Copy]**

- 1 Press **▲/▼** to select **[Copy Direction]**, and then press **[MENU/SET]**.

<b>1</b> → <b>2</b>	Copies card slot 1 images to the card slot 2.
<b>2</b> → <b>1</b>	Copies card slot 2 images to the card slot 1.

- 2 Press **▲/▼** to select the copying method, and copy images.

<b>[Select Copy]</b>	<p>Copies selected images.</p> <p>❶ Select the folder containing the images to copy.</p> <p>❷ Select the picture. (P233)</p> <ul style="list-style-type: none"> <li>• Select images in the same way as when <b>[Multi]</b> is selected.</li> </ul>
<b>[Copy All in Folder]</b>	<p>Copies all images in a folder.</p> <p>❶ Select the folder to copy.</p> <p>❷ After checking the images to copy, press <b>[MENU/SET]</b> to start the operation.</p>
<b>[Copy All in Card]</b>	Copies all images on the card.

- Copied images will be saved in a new folder.

### ■ Using a function button to copy images

When images are displayed one at a time, press the function button to which **[Copy]** is assigned to copy the displayed image from the card that is playing it back to the other card.

- If the image is not in a group, select the copy destination folder using one of the following methods:

<b>[Same Folder No. as Source]</b>	Copies the image to a folder with the same name.
<b>[Create a New Folder]</b>	Creates a new folder with an incremented folder number and copies to it.
<b>[Select Folder]</b>	Specifies the folder to which the image is to be saved and copies to it.

- You can set up to 100 pictures at one time in **[Select Copy]**.
- The **[Protect]** setting in the **[Playback]** menu will not be copied.
- It may take some time to finish copying.

### **Not available in these cases:**

- Motion pictures in **[AVCHD]** format cannot be copied.
- The following types of images cannot be copied from an **SDXC** memory card to an **SD** memory card or **SDHC** memory card.
  - Motion pictures
  - 6K/4K burst files
  - Images recorded with the **Post Focus** function

**[Resize]**

To allow easy posting to web pages, attachment to e-mail etc., picture size (number of pixels) is reduced.



**MENU** → **[Playback]** → **[Resize]**

Select the picture and size.

**[Single] setting**

- 1 Press to select the picture, and then press [MENU/SET].
- 2 Press to select the size, and then press [MENU/SET].

**[Multi] setting**

- 1 Press to select the size, and then press [MENU/SET].
- 2 Press to select the picture, and then press [MENU/SET] to set (repeat).
  - The setting is canceled when [MENU/SET] is pressed again.
- 3 Press [DISP.] to execute.
  - Pictures are displayed separately by card slot. You can switch the displayed card by pressing [Fn1].
  - You can only select images on one card at a time.

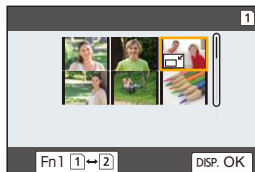

- You can set up to 100 pictures at one time in [Multi].
- The picture quality of the resized picture will deteriorate.

**Not available in these cases:**

- This function is not available in the following cases:
  - Motion pictures
  - 6K/4K burst files
  - Images recorded with the Post Focus function
  - Group Pictures
  - Pictures stamped with [Text Stamp]
  - Pictures taken with [RAW]

**[Cropping]**

You can enlarge and then clip the important part of the recorded picture.



**MENU** → **[Playback]** → **[Cropping]**

- 1 Press **◀/▶** to select the picture, and then press **[MENU/SET]**.
- 2 Use the rear dial and press **▲/▼/◀/▶** to select the parts to be cropped.

Rear dial (right): Enlargement

Rear dial (left): Reduction

**▲/▼/◀/▶**: Move

• You can also touch [] / []

• You can also move by dragging on the screen.

- 3 Press **[MENU/SET]**.

- The picture quality of the cropped picture will deteriorate.
- Crop one picture at a time when you want to crop the pictures in a picture group. (You cannot edit all pictures in a group at once.)
- When you crop pictures in a group, the cropped ones are saved separately from the original ones in the group.
- Information regarding the Face Recognition in the original picture will not be copied to images having undergone [Cropping].

**Not available in these cases:**

- This function is not available in the following cases:
  - Motion pictures
  - 6K/4K burst files
  - Images recorded with the Post Focus function
  - Pictures stamped with [Text Stamp]
  - Pictures taken with [RAW]

**[Rotate] (The picture is rotated manually.)**

Rotate pictures manually in 90° steps.

- The [Rotate] function is disabled when [Rotate Disp.] is set to [OFF].

**MENU** →  **[Playback]** → **[Rotate]**

**1 Press ◀/▶ to select the picture and then press [MENU/SET].**

**2 Select the rotation direction.**

:

The picture rotates clockwise in steps of 90°.

:

The picture rotates counter-clockwise in steps of 90°.

**[Video Divide]**

Recorded motion picture and 6K/4K burst files can be divided in two. It is recommended for when you want to divide a part you need with a part you do not need.

**Dividing a file is permanent. Decide before you divide!**

**MENU** →  **[Playback]** → **[Video Divide]**

**1 Press ◀/▶ to select the file to divide, and then press [MENU/SET].**

**2 Press ▲ at the location to divide.**

- You can finely adjust the location for division by pressing ◀/▶ while the file is paused.

**3 Press ▼.**

- The file may be lost if the card or battery is removed while processing the dividing.

** Not available in these cases:**

- It may not be possible to divide a file at a point near the beginning or end.
- This function is not available in the following cases:
  - When the recording time is short.

**[Time Lapse Video]**

This function allows you to create a motion picture from a picture group recorded with [Time Lapse Shot].

**MENU** →  **[Playback]** → **[Time Lapse Video]**

- 1 Select the [Time Lapse Shot] picture group with ◀/▶, and then press [MENU/SET].
- 2 Create a motion picture by selecting the methods for creating it.
  - Refer to P140 for details.

**[Stop Motion Video]**

A Motion picture is created from group pictures taken with [Stop Motion Animation].

**MENU** →  **[Playback]** → **[Stop Motion Video]**

- 1 Select the Stop Motion Animation group with ◀/▶, and then press [MENU/SET].
- 2 Create a motion picture by selecting the methods for creating it.
  - Refer to P140 for details.

**[Rotate Disp.] (The picture is automatically rotated and displayed.)**

This mode allows you to display pictures vertically if they were recorded holding the camera vertically.

**MENU** →  **[Playback]** → **[Rotate Disp.]** → **[ON]**

 **Not available in these cases:**

- When you play back pictures on a PC, they cannot be displayed in the rotated direction unless the OS or software is compatible with Exif.  
Exif is a file format for still pictures which allows recording information etc. to be added. It was established by “JEITA (Japan Electronics and Information Technology Industries Association)”.



**[Picture Sort]**

You can set the order in which the camera displays images during playback.

**MENU** →  **[Playback]** → **[Picture Sort]**

<b>[FILE NAME]</b>	Displays images by folder name/file name. This display format allows you to locate images in the card easily.
<b>[DATE/TIME]</b>	Displays images by recording date. If the card contains pictures taken with more than one camera, this display format is convenient for looking for images.

- When you insert another card, images may not be displayed by **[DATE/TIME]** first. The images will be displayed by **[DATE/TIME]** if you wait for a while.

**[Delete Confirmation]**

This sets which option, **[Yes]** or **[No]**, will be highlighted first when the confirmation screen for deleting a picture is displayed.

It is set to **[“No” first]** at the time of purchase.

**MENU** →  **[Playback]** → **[Delete Confirmation]**

<b>[“Yes” first]</b>	<b>[Yes]</b> is highlighted first, so deletion can be done quickly.
<b>[“No” first]</b>	<b>[No]</b> is highlighted first. Accidental deletion of pictures is avoided.

## What you can do with the Wi-Fi®/Bluetooth® function

### Controlling with a Smartphone/Tablet (P260)

- Recording with a smartphone (P261)
- Playing back or saving images stored on the camera, or uploading them on social media sites (P263)

#### Explore more enjoyment possibilities with Bluetooth®

You can connect to a smartphone that supports Bluetooth low energy any time. Connect to a smartphone to use a full range of features.

- Connecting easily by pairing (P254)
- Turning on/off the camera by remote control (P260)
- Operating the shutter button of the camera (P262)
- Sending recorded images automatically (P264)
- Auto Cloud Backup (P265)
- Recording location information to the camera's images (P268)
- Synchronizing the camera's clock (P269)
- Saving the camera's setup information to a smartphone (P269)

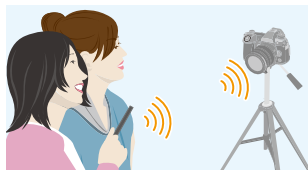

### Displaying pictures on a TV (P270)



### Printing Wirelessly (P274)



### Sending images to AV device (P275)



### Sending images to PC (P276)



### Using Web services (P278)

This owner's manual refer to both smartphones and tablets as smartphones from this point on unless noted otherwise.

## Wi-Fi function/Bluetooth function

### ■ Before Use

- Set the clock before using the Wi-Fi/Bluetooth function. (P38)
- To use the Wi-Fi function on this unit, a wireless access point or a destination device equipped with the wireless LAN function is required.

### ■ About the WIRELESS connection lamp

Lit blue	Wi-Fi	When the Wi-Fi function is ON or connected by Wi-Fi
	Bluetooth	When the Bluetooth function is ON or connected by Bluetooth
Blinking blue	When sending data	

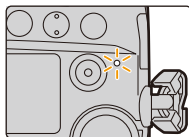

- In [Wireless Connection Lamp] in the [Setup] menu, you can set the lamp so that it will not light/flash. (P222)

### ■ About the [Wi-Fi] button

In this owner's manual, a function button to which [Wi-Fi] is assigned is referred to as the [Wi-Fi] button.

(By default, [Wi-Fi] is assigned to [Fn6] when the camera is in Recording Mode, while it is assigned to [Fn1] when the camera is in Playback Mode.)

- For information about the function button, refer to P60.

### Steps for pressing [Wi-Fi] (in Recording Mode)

1 Touch [Wi-Fi].



2 Touch [Fn6].



**When the camera is not connected to Wi-Fi, press [Wi-Fi]. The camera will then be ready to be connected to the smartphone. You can connect the camera directly to the smartphone. (P256)**

- When the camera is ready to be connected, you can press [DISP.] to connect with the same settings as used previously. This is a convenient and quick way to establish a connection. (P289)

**After connecting to a Wi-Fi network, you can perform the following operations by pressing [Wi-Fi]:**

[Terminate the Connection]	Terminates the Wi-Fi connection.
[Change the Destination]	Terminates the Wi-Fi connection, and allows you to select a different Wi-Fi connection.
[Change Settings for Sending Images]	Refer to <a href="#">P272</a> for details.
[Register the Current Destination to Favorite]	Registering the current connection destination or the connection method, you can easily connect with the same connection method next time.
[Network Address]	Displays the MAC address and IP address of this unit.

• Depending on the Wi-Fi function being used or the connection destination, you may not be able to perform some of these operations.

### ■ Describing method

When “**select [Select a destination from History]**”, etc. is described in a step, perform any of the following operations.





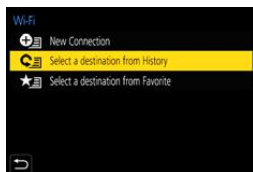

Button operation: Select [Select a destination from History] with the cursor button, and then press [MENU/SET].

Touch operation: Touch [Select a destination from History].



- The camera cannot be used to connect to a public wireless LAN connection.
- We strongly recommend that you set an encryption to maintain information security.
- It is recommended to use a fully charged battery when sending images.
- When the battery indicator is flashing red, the connection with other equipment may not start or the connection may be disrupted.  
(A message such as [Communication error] is displayed.)
- When sending images on a mobile network, high packet communication fees may be incurred depending on the details of your contract.
- Pictures may not be completely sent depending on radio wave conditions. If the connection is terminated while sending pictures, pictures with missing sections may be sent.
- **Do not remove the memory card or battery or move to an area without any reception while sending images.**

## Connecting to a smartphone/tablet

Using a smartphones that supports Bluetooth low energy	 <b>P254</b>
Using a smartphone that does not support Bluetooth low energy	 <b>P256</b>
Connecting without using the password	 <b>P256</b>
Using a password to set up a connection	 <b>P257</b>
Using the QR code to set up a connection	 <b>P257</b>
Manually entering a password to set up a connection	 <b>P258</b>

- You need to install “Panasonic Image App” (referred to as “Image App” from this point on) on your smartphone.

### Installing the smartphone/tablet app “Image App”

The “Image App” is an application provided by Panasonic.

#### • OS

- App for Android™: Android 4.2 or higher  
**(Android 5.0 or higher is required to use the Bluetooth function)**
- App for iOS: iOS 9.0 or higher  
 (The Bluetooth function cannot be used with the iPad 2)

- 1 Connect the smartphone to a network.**
- 2 (Android) Select “Google Play™ Store”.**  
**(iOS) Select “App Store”.**
- 3 Enter “Panasonic Image App” or “LUMIX” into the search box.**
- 4 Select “Panasonic Image App”  and install it.**

- Use the latest version.
- Supported OSs are current as of November 2017 and are subject to change.
- Read the [Help] in the “Image App” menu for further details on how to operate.
- When you operate the “Image App” on the smartphone that is connected to the camera via Wi-Fi, [Help] in the “Image App” may not be displayed depending on the smartphone. In this case, after terminating the connection to the camera, reconnect the smartphone to a mobile phone network such as the 3G or LTE network or to a Wi-Fi router, and then display [Help] in the “Image App”.
- Some of the screens and information provided in this owner’s manual may differ from your device depending on the supported OS and “Image App” version.
- The service may not be able to be used properly depending on the type of smartphone being used.

For information on the “Image App”, refer to the support site below.

<http://panasonic.jp/support/global/cs/dsc/>

(This Site is English only.)

- When downloading the app on a mobile network, high packet communication fees may be incurred depending on the details of your contract.

## Using a smartphones that supports Bluetooth low energy

Follow a simple connection setup procedure (pairing) to connect to a smartphone that supports Bluetooth low energy. When pairing is set up, the camera also automatically connects to the smartphone via Wi-Fi.

### • Supported smartphones

**Android:** Android 5.0 or higher equipped with Bluetooth 4.0 or higher (excluding those that do not support Bluetooth low energy)

**iOS:** iOS 9.0 or higher (excluding the iPad 2)

#### On the camera

**MENU** → **⌘ [Setup]** → **[Bluetooth]** → **[Bluetooth]** → **[SET]** → **[Pairing]**

- The camera enters pairing standby mode and displays its device name.

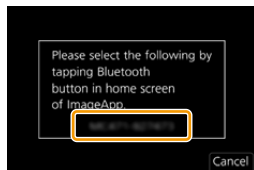

#### On your smartphone

### 1 Start “Image App”.

- If a message is displayed indicating that the smartphone is searching for cameras, close the message.

### 2 Select [Bluetooth].

### 3 Turn on the Bluetooth.

### 4 Select the device name displayed on the camera’s screen from the [Camera enable to be registered] list.

- Bluetooth connection between the camera and the smartphone will be made.  
(For Android devices) A Wi-Fi connection will be made by selecting [Connection].

**If you are using an Android device, follow the steps up to here to complete the setup. Proceed to the steps below only if you are using an iOS device (iPhone/iPod touch/iPad).**

- If [Wi-Fi Password] (P291) is set to [OFF] on the camera, select [Wi-Fi Setup]. (At the time of purchase, [Wi-Fi Password] is set to [OFF])
- If [Wi-Fi Password] is set to [ON] on the camera, you need to install the profile.

### ① Install the profile.

- If a pass code is set on the smartphone, you need to enter it.

### ② Press the home button to close the browser.

### 5 Turn on the Wi-Fi function in the smartphone’s setting menu.

### 6 On the Wi-Fi setting screen, select the SSID (the device name selected in step 4) displayed on the camera.

- If the SSID is not displayed, it may be displayed after the Wi-Fi function is turned off and on.



### 7 Press the home button, and select “Image App” to display “Image App”.

- The paired smartphone will be registered as a paired device after connected via Wi-Fi.
- Pairing needs to be set up only for the first connection. For the second and subsequent connections: (P255)

When connected via Bluetooth, the camera automatically makes a Wi-Fi connection.

- (iOS devices) If you need to change the connected device on the Wi-Fi setup screen, follow the on-screen message to change the setting.

#### ■ Connecting to the paired smartphone (connecting for the second and subsequent times)

On the camera

**MENU** → ⚙ [Setup] → [Bluetooth] → [Bluetooth] → [ON]

On your smartphone

- 1 **Start “Image App”.**
  - If a message is displayed indicating that the smartphone is searching for cameras, close the message.
- 2 **Select [Bluetooth].**
- 3 **Turn on the Bluetooth.**
- 4 **Select the camera (device name) you want to connect to from the [Camera registered] list.**

If you set [Bluetooth] to [ON] on the camera in advance, you can make a connection just by operating the smartphone.

- Even if you set up pairing with more than one smartphone, you can only connect to one smartphone at a time.

#### ■ Enabling the Bluetooth function

**MENU** → ⚙ [Setup] → [Bluetooth] → [Bluetooth] → [ON]

#### ■ Terminating the Bluetooth connection to the smartphone and disabling the Bluetooth function

**MENU** → ⚙ [Setup] → [Bluetooth] → [Bluetooth] → [OFF]

- The connection will be terminated and the camera's Bluetooth function will be deactivated.
- Even if you terminate the connection, the pairing information for it will not be deleted.

#### ■ Deleting the pairing information of a smartphone

- 1 **Select the camera's menu.**

**MENU** → ⚙ [Setup] → [Bluetooth] → [Bluetooth] → [SET] → [Delete]

- 2 **Select the smartphone you want to delete.**

- [Bluetooth icon] is displayed on the recording screen during Bluetooth connection. When the Bluetooth function is enabled, but a connection is not established, [Bluetooth icon] appears translucent.
- Up to 16 smartphones can be registered. If you try to register more than 16 devices, the smartphone with the oldest registration history will be replaced.
- Performing [Reset Network Settings] will delete registered device information.

## Using a smartphone that does not support Bluetooth low energy

Connect to a smartphone via Wi-Fi.

- You can also connect via Wi-Fi to a smartphone that supports Bluetooth low energy by following the same steps.

## Connecting without using the password

You can easily set up a direct connection to your smartphone without entering a password.

On the camera

**MENU** →  [Setup] → [Wi-Fi] → [Wi-Fi Function] → [New Connection] → [Remote Shooting & View]

**A** SSID

- When the camera is ready to be connected to the smartphone, the SSID is displayed.
- You can also display the information by pressing [Wi-Fi] on the camera.



On your smartphone

- 1 Turn on the Wi-Fi function in the smartphone's setting menu.**
- 2 On the Wi-Fi setting screen, select the SSID displayed on the camera.**
- 3 Start "Image App".**
  - When the connection confirmation screen is displayed on the camera, select [Yes] to connect. (For first time connection only)



## At the time of purchase, [Wi-Fi Password] is set to [OFF].

Before connecting to a Wi-Fi network, ensure that the device displayed on the connection confirmation screen is the one you actually want to connect to. When a wrong device is displayed, if you select [Yes], the camera will automatically connect to that device.

We recommend that you set [Wi-Fi Password] (P291) to [ON] if, for example, there is another Wi-Fi device nearby.



## Using a password to set up a connection

Connecting with a password further enhances security. You can scan a QR code or manually enter a password to set up a connection.

Preparations: (On the camera)

**MENU** → **[Setup]** → **[Wi-Fi]** → **[Wi-Fi Setup]** → **[Wi-Fi Password]** → **[ON]**

### Using the QR code to set up a connection

On the camera

**MENU** → **[Setup]** → **[Wi-Fi]** → **[Wi-Fi Function]** → **[New Connection]** → **[Remote Shooting & View]**

- (A) SSID and password
- (B) QR code

- When the camera is ready to be connected to the smartphone, the QR code, SSID and password are displayed.
- You can also display the information by pressing [Wi-Fi] on the camera.

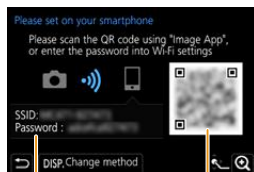

On your smartphone

- 1 Start "Image App".
- 2 Select [QR code].
  - When the smartphone is connected to a wireless access point, it may take time to display [QR code].
  - (For iOS devices) A confirmation screen will be displayed. Select [OK] to proceed.
- 3 Use the "Image App" to scan the QR code displayed on the screen of the camera.
  - To enlarge the QR code, press [MENU/SET] on the camera.

**If you are using an Android device, follow the steps up to here to complete the setup. Proceed to the steps below only if you are using an iOS device (iPhone/iPod touch/iPad).**

- 4 Install the profile.
  - If a pass code is set on the smartphone, you need to enter it.
- 5 Press the home button to close the browser.
- 6 Turn on the Wi-Fi function in the smartphone's setting menu.
- 7 On the Wi-Fi setting screen, select the SSID displayed on the camera.
- 8 Press the home button, and select "Image App" to display "Image App".

- (iOS devices) Steps 1 through 5 are not required from the second time on.

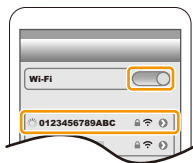

## Manually entering a password to set up a connection

On the camera

**MENU** →  [Setup] → [Wi-Fi] → [Wi-Fi Function] → [New Connection] → [Remote Shooting & View]

- (A) SSID and password
- (B) QR code

- When the camera is ready to be connected to the smartphone, the QR code, SSID and password are displayed.
- You can also display the information by pressing [Wi-Fi] on the camera.

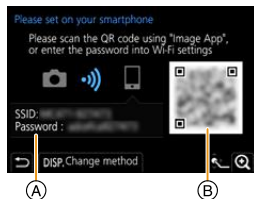

On your smartphone

- 1 Turn on the Wi-Fi function in the smartphone's setting menu.
- 2 On the Wi-Fi setting screen, select the SSID displayed on the camera.
- 3 Enter the password displayed on the camera into the smartphone. (For first time connection only)
- 4 Start "Image App".

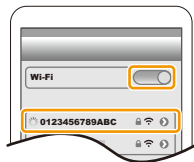

## Changing the Wi-Fi connection method

To change the connection method, follow the steps below:

**MENU** →  [Setup] → [Wi-Fi] → [Wi-Fi Function] → [New Connection] → [Remote Shooting & View] → [DISP.] button

or

**Wi-Fi** → [DISP.] button → [New Connection] → [Remote Shooting & View] → [DISP.] button

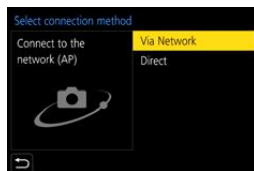

### ■ When connecting via a wireless access point ([Via Network]):

On the camera

**1 Select [Via Network].**

- Follow the connection procedure described on [P286](#) to connect the camera to a wireless access point.

On your smartphone

- 2 Turn on the Wi-Fi function in the smartphone's setting menu.**  
**3 Connect the smartphone to the wireless access point to which the camera is connected.**  
**4 Start "Image App".**

### ■ When directly connecting the camera and smartphone ([Direct]):

On the camera

**1 Select [Direct].**

- Select [WPS Connection], and follow the connection procedure described on [P288](#) to connect the camera to the smartphone.

On your smartphone

- 2 Start "Image App".**

## Terminating the Wi-Fi connection

- 1 Set the camera to Recording Mode.**  
**2 Select the camera's menu items to terminate the Wi-Fi connection.**

**MENU** →  **[Setup]** → **[Wi-Fi]** → **[Wi-Fi Function]**  
→ **[Yes]**

- You can also terminate the connection by pressing [Wi-Fi] on the camera.

- 3 On the smartphone, close "Image App".**



## Controlling with a Smartphone/Tablet

### ■ Required wireless connectivity mode

The wireless connectivity mode required varies depending on the function to be used after connecting to a smartphone.

Wireless connectivity required	Support for Bluetooth low energy
Bluetooth	Indicates that the function can be used with smartphones that support Bluetooth low energy.
Wi-Fi	Indicates that the function can be used with smartphones that do not support Bluetooth low energy.
Bluetooth Wi-Fi	Indicates that the function can be used with smartphones that support Bluetooth low energy. • Indicates that the function requires you to connect to a smartphone using both Bluetooth and Wi-Fi.

### Turning on/off the camera with a smartphone

Wireless connectivity required: Bluetooth Wi-Fi

The function allows you to view images on the camera placed in your bag, or turn on the camera left in a separate place only when you record images with it.



- 1 Make a Bluetooth connection to the smartphone. (P254)
- 2 Select the camera's menu.

MENU → [Setup] → [Bluetooth] → [Remote Wakeup] → [ON]



- 3 Set the camera on/off switch to [OFF].
- 4 On the smartphone, start up the "Image App", and set the Bluetooth function to a state in which a connection can be made (standby state).
- 5 Operate the smartphone.

- 1 Select [Home].
- 2 Select [Remote operation].



- The camera automatically turns on, allowing it to make a Wi-Fi connection automatically.
  - (iOS devices) Depending on the connection status of the smartphone, you may need to change the connected device on the Wi-Fi setup screen. Follow the on-screen message on the smartphone to change the setting.

## ■ Turning off the camera with the smartphone

- 1 Select [  ].
- 2 Select [  OFF].

- When [Remote Wakeup] is set to [ON], the Bluetooth function continues to operate even after the camera is turned off, thus causing the battery to drain.

## Taking images via a smartphone (remote recording)

Wireless connectivity required: Wi-Fi

- 1 Connect to a smartphone. (P253)
- 2 Operate the smartphone.

- If the smartphone is already connected via Wi-Fi, proceed to step 3.

- 1 (When connected via Bluetooth) Select [  ].
- 2 (When connected via Bluetooth) Select [Remote operation].

- Make a Wi-Fi connection automatically.

- (iOS devices) Depending on the connection status of the smartphone, you may need to change the connected device on the Wi-Fi setup screen. Follow the on-screen message on the smartphone to change the setting.

- 3 Select [  ].

- 4 Record an image.

- The recorded images are saved in the camera.
- Some settings are not available.





### Not available in these cases:

- In the following case, remote recording does not work:
  - When using [Time Lapse Shot]

## ■ Changing the camera's dial settings, etc. with your smartphone

Set either the camera or the smartphone as the priority control device to be used during remote recording.

**MENU** →  **[Setup]** → **[Wi-Fi]** → **[Wi-Fi Setup]** → **[Priority of Remote Device]**

 <b>[Camera]</b>	Allows you to perform operations with both the camera and the smartphone during remote recording. <ul style="list-style-type: none"> <li>• The camera's dial settings, etc. cannot be changed with the smartphone.</li> </ul>
 <b>[Smartphone]</b>	Allows you to perform operations only with the smartphone during remote recording. <ul style="list-style-type: none"> <li>• The camera's dial settings, etc. can be changed with the smartphone.</li> <li>• To end remote recording, press any of the buttons on the camera to turn on the screen, and select [End].</li> </ul>

- The setting of this function cannot be changed while the connection is active.

## Operating the shutter button with a smartphone via a Bluetooth connection alone

Wireless connectivity required: **Bluetooth**

- 1 **Make a Bluetooth connection to the smartphone. (P254)**
- 2 **Operate the smartphone.**

① Select [  ].

② Select [Shutter Remote Control].

③ Remotely operate the shutter button or motion picture button of the camera.

- Read the [Help] in the "Image App" menu for further details on how to operate.
- The live view image of the camera cannot be monitored on the smartphone.

- To cancel [Sleep Mode] with this function, select the following settings and connect via Bluetooth.

– [Remote Wakeup]: [ON]

– [Auto Transfer]: [OFF]

- When the camera is turned off, even if you set [Remote Wakeup] to [ON] on the camera, it cannot be turned on with this function.



## Playing back/saving images stored on the camera, or uploading them on social media sites

Wireless connectivity required: Wi-Fi

- 1 Connect to a smartphone. (P253)
- 2 Operate the smartphone.

- If the smartphone is already connected via Wi-Fi, proceed to step 3.

- 1 (When connected via Bluetooth) Select [  ].

- 2 (When connected via Bluetooth) Select [Remote operation].

- Make a Wi-Fi connection automatically.

- (iOS devices) Depending on the connection status of the smartphone, you may need to change the connected device on the Wi-Fi setup screen. Follow the on-screen message on the smartphone to change the setting.

- 3 Select [  ].

- You can switch the images to be displayed by selecting the icon (A) on the top left of the screen. To display images stored in the camera, select [LUMIX(SD1)] or [LUMIX(SD2)].

**(To play back the image)**

- 4 Touch the image to enlarge it.

**(To save the image or upload it on a social media site or other web service)**

- 5 Touch and hold an image, and drag it to save it.

- When you play a motion picture, image quality differs from that of the actual recorded motion picture. In addition, depending on the smartphone or conditions of use, the image quality may deteriorate or the sound may skip during motion picture or picture playback.

- An OS version of Android 7.0 or higher or iOS 10.0 or higher is required to save pictures in RAW format.

- Depending on the smartphone or its OS version, pictures in RAW format may not be displayed correctly.

- You cannot save the following types of images:

- Motion pictures in [AVCHD], [MP4] (only those with a size of [4K]) format
- 6K/4K burst files
- Images recorded with the Post Focus function





## Transferring recorded images to a smartphone automatically



Wireless connectivity required: **Bluetooth** **Wi-Fi**

The camera automatically transfers recorded images to a Bluetooth-connected smartphone via Wi-Fi.

- 1 **Make a Bluetooth connection to the smartphone.** (P254)
- 2 **Select the camera's menu.**

**MENU** →  **[Setup]** → **[Bluetooth]** → **[Auto Transfer]** → **[ON]**

- If a confirmation screen is displayed on the camera asking you to terminate the Wi-Fi connection, select [Yes] to terminate it.
- 3 **On the smartphone, select [Yes] (Android devices) or [Wi-Fi Setup] (iOS devices).**
    - The camera automatically makes a Wi-Fi connection.
      - (iOS devices) Follow the on-screen message on the smartphone to change the connected device on the Wi-Fi setup screen.
  - 4 **Check the send settings on the camera, and select [Set].**
    - To change the send setting, press [DISP.]. (P272)
    - The camera will enter a mode where it can automatically transfer images and  will be displayed on the recording screen.
  - 5 **Take pictures on the camera.**
    - While sending a file,  is displayed on the recording screen.
- **When [Auto Transfer] is set to [ON], [Wi-Fi Function] in [Wi-Fi] in the [Setup] menu cannot be used.**
  - If the [Bluetooth] and [Auto Transfer] settings of the camera are [ON], the camera automatically connects to the smartphone via Bluetooth and Wi-Fi when you turn on the camera. Start up the “Image App” to connect to the camera.
 

The camera will enter a mode where it can automatically transfer images and  will be displayed on the recording screen.
  - If  is not displayed on the recording screen, images cannot be transferred automatically. Check the status of the Wi-Fi connections to the smartphone.

### ■ To stop the automatic transfer of images

#### Set [Auto Transfer] to [OFF] on the camera.

- A confirmation screen is displayed, asking you to terminate the Wi-Fi connection.
  - If you turn off the camera while sending files, the file transfer will be canceled. In that case, the camera will resend the files as soon as it is turned on again.
- An OS version of Android 7.0 or higher or iOS 10.0 or higher is required to save pictures in RAW format.
  - You cannot automatically transfer the following types of images:
    - Motion pictures
    - 6K/4K burst files
    - Images recorded with the Post Focus function



## Backing up images to a Cloud Storage automatically (Auto Cloud Backup)

Wireless connectivity required: Bluetooth Wi-Fi

The camera detects the connection between the smartphone and wireless access point and backs up images stored on the camera to a preset Cloud Storage.

- Check the "FAQ/Contact us" on the following site for compatible Cloud Storage.

[https://lumixclub.panasonic.net/eng/c/lumix\\_faqs/](https://lumixclub.panasonic.net/eng/c/lumix_faqs/)

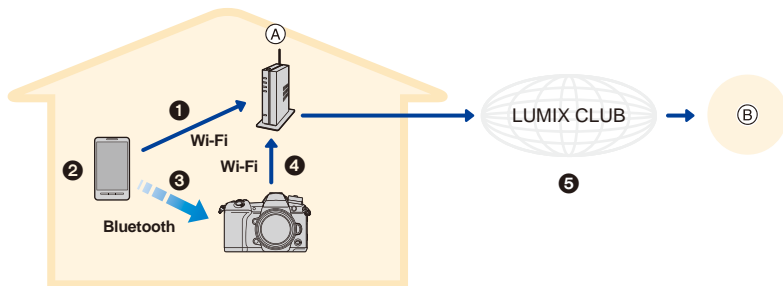

(A) Wireless access point

(B) Cloud Storage

- 1 The smartphone automatically connects to the wireless access point.
- 2 Start up the "Image App" in foreground (a state in which the app can be operated).
- 3 The camera automatically turns on.
- 4 The camera automatically connects to the wireless access point connected in step 1.
- 5 Images on the camera are automatically backed up to a Cloud Storage via "LUMIX CLUB".

Once the setup procedure below is completed, you can back up data to a cloud storage service just by performing step 2.

- Refer to the operating instructions of your smartphone for more information on how to set up a connection automatically in step 1.

### Setting up Auto Cloud Backup

#### ■ Registering a wireless access point to the camera (Setup 1)

- If you have connected the camera to the wireless access point you want to use before, the procedure below is not required.

#### 1 Select the camera's menu.

**MENU** → **⌘ [Setup]** → **[Bluetooth]** → **[Wi-Fi network settings]**

#### 2 Select [New connection].

#### 3 Connect to the wireless access point.

- Refer to the connection methods described on P286 to connect the camera to the wireless access point.

- A wireless access point will be registered automatically after the camera connects to it via Wi-Fi.
- You can register up to 17 wireless access points. If you try to register more than 17 devices, the wireless access point with the oldest registration history will be replaced.
- Performing [Reset Network Settings] will delete registered wireless access points.

### ■ Setting up “LUMIX CLUB” (Setup ②)

Preparations:

- Create an account for the Cloud Storage you want to use, and have the login information available.
- Register to “LUMIX CLUB”. (P282)

- 1 Connect to the “LUMIX CLUB” site using a smartphone or computer.**  
<https://lumixclub.panasonic.net/eng/c/>
- 2 Enter your “LUMIX CLUB” login ID and password and log in to the service.**
  - If you are required to register an email address, operate following the on-screen instructions.
- 3 Select and register the cloud storage service you want to use in Cloud Storage Link Settings in Web service link settings.**
  - Operate following the on-screen instructions.

### ■ Setting up “Image App” (Setup ③)

- 1 Make a Bluetooth connection to the smartphone. (P254)**
- 2 Operate the smartphone.**

- 1** Select [  ].
- 2** Select [Bluetooth].
- 3** Select [ > ] for the connected camera.
- 4** Enable Automatic Backup, and set backup settings.



- Below are the required backup settings.
  - Connection information of wireless access point (SSID): Select the wireless access point registered in (Setup ①).
  - Cloud setting: Enter the login ID and password for the “LUMIX CLUB” used in (Setup ②), and select the cloud storage service you want to use in Upload destination.
- You can try a connection test. Turn on the camera and run the test when the camera is not connected to a Wi-Fi network. If the camera is connected to a Wi-Fi network, follow steps **1** and **2** of “Terminating the Wi-Fi connection” on P259 to terminate the Wi-Fi connection of the camera.

## Running a backup

Preparations:

- Set the camera to a state in which it can be turned on with the smartphone (standby state). (P260)
  - Camera: [Bluetooth] and [Remote Wakeup] are set to [ON].
  - Camera: The Camera On/Off switch is set to [OFF].
- Camera: The card's Write-Protect switch is not set to [LOCK].

### Start up the “Image App” in foreground (a state in which the app can be operated), and run a backup.

- A backup will start if the smartphone is connected to the wireless access point set up in (Setup ③).
- It may be possible to run a backup even if the app is running in background (a state in which it cannot be operated).

- The first job backs up all images on the card. The second and subsequent jobs back up only those that have not been backed up yet.
- If you change the backup destination, images that have already been backed up are not saved to a new destination.
- A backup job will stop in the following cases:
  - When you set the camera on/off switch to [ON]
  - When you remove or insert the card
  - During USB charging (The job restarts when charging has completed)
  - When the battery runs out of power (The job will resume after the battery is recharged.)
- You cannot back up the following types of images:
  - Motion pictures
  - 6K/4K burst files
  - Images recorded with the Post Focus function
  - Images recorded with the [High Resolution Mode]

## Recording location information to the camera's images

Wireless connectivity required: **Bluetooth**

The smartphone sends its location information to the camera via Bluetooth, and the camera performs recording while writing the acquired location information.

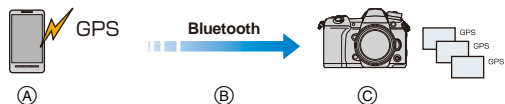

- (A) The smartphone acquires location information.
- (B) The smartphone sends the location information.
- (C) The camera performs recording while writing the location information.

Preparations:

Enable the GPS function on the smartphone.

- 1 **Make a Bluetooth connection to the smartphone.** (P254)
- 2 **Select the camera's menu.**

**MENU** → **⌘ [Setup]** → **[Bluetooth]** → **[Location Logging]** → **[ON]**

- The camera will enter a mode where location information can be recorded and **[GPS]** will be displayed on the recording screen.

- 3 **Take pictures on the camera.**

- Location information will be written to the recorded pictures.

### When **[GPS]** appears translucent

Location information is not acquired, so data cannot be written. Positioning with the GPS on the smartphone may not be possible if the smartphone is in a location such as a building or a bag. Move the smartphone to a location where positioning performance can be optimized, such as one that offers a wide view of the sky, to try positioning. In addition, refer to the operating instructions of your smartphone.

- Images with location information are indicated with **[GPS]**.
- **Be sure to pay special attention to the privacy, the likeness rights, etc. of the subject when you use this function. Use at your own risk.**
- The smartphone drains its battery faster while acquiring location information.



### **Not available in these cases:**

- Location information is not written to motion pictures recorded in **[AVCHD]** format.

## Synchronizing the camera's clock with a smartphone

Wireless connectivity required: **Bluetooth**

Synchronize the clock and the time zone setting of the camera with those of a smartphone.

- 1 **Make a Bluetooth connection to the smartphone. (P254)**
- 2 **Select the camera's menu.**

**MENU** →  **[Setup]** → **[Bluetooth]** → **[Auto Clock Set]** → **[ON]**

- The [Clock Set] setting and the [Home] or [Destination] setting in [World Time], which are all located in the [Setup] menu, will be synchronized with the corresponding settings of the smartphone.

## Saving the camera's setup information to a smartphone

Wireless connectivity required: **Bluetooth** **Wi-Fi**

Since saved setup information can be imported to cameras, you can apply the same setup to more than one camera.

- 1 **Make a Bluetooth connection to the smartphone. (P254)**
- 2 **Operate the smartphone.**

- 1 Select [  ].
- 2 Select [  ].
- 3 Save or load setup information.



- Read the [Help] in the "Image App" menu for further details on how to operate.

When transferring setup information, the camera automatically makes a Wi-Fi connection.

- (iOS devices) Depending on the connection status of the smartphone, you may need to change the connected device on the Wi-Fi setup screen. Follow the on-screen message on the smartphone to change the setting.

- Setup information can be loaded only to cameras of the same model as this camera.
- You can save or load the setup information of items identical to those in [Save/Restore Camera Setting] in the [Setup] menu.

# Displaying pictures on a TV

You can display pictures on a TV that supports DLNA (DMR).

## 1 Select the menu.

**MENU** →  [Setup] → [Wi-Fi] → [Wi-Fi Function] → [New Connection] → [Playback on TV]

## 2 Select [Via Network] or [Direct], and connect. (P285)

## 3 Select a device you want to connect.

- When the connection is established, the screen is displayed.

## 4 Play back pictures on this unit.

- To terminate the connection, follow the steps below:

**MENU** →  [Setup] → [Wi-Fi] → [Wi-Fi Function] → [Yes]  
(You can also terminate the connection by pressing [Wi-Fi].)

- If you display pictures using the Wi-Fi function, they cannot be output in 4K resolution.
- When a TV is connected to this unit, the TV screen may temporarily return to the status before the connection. Pictures are displayed again when you take or play back pictures.
- The [Effect] and [Sound] settings for slide shows are not applied to the TV.

### Not available in these cases:

- Motion pictures and 6K/4K burst files cannot be played back.
- Images displayed on certain screens of the camera (multi playback screen, etc.) are not displayed on the TV.
- When [Auto Transfer] in [Bluetooth] is set to [ON], [Wi-Fi Function] is not available.

## Sending images

When sending images, select the method for sending them after selecting [New Connection] in [Wi-Fi Function] in [Wi-Fi] in the [Setup] menu.

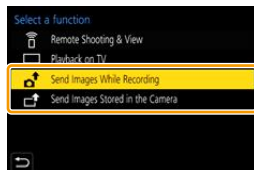

### ■ Images that can be sent

Destination	JPEG	RAW	MP4 <sup>*1</sup>	MP4(LPCM)	AVCHD <sup>*1,2</sup>	6K/4K Burst File <sup>*1</sup> Images recorded with the Post Focus function <sup>*1</sup>
[Smartphone]	○	○ <sup>*3</sup>	○ <sup>*4</sup>	—	—	—
[PC]	○	○	○	○ <sup>*1</sup>	○	○
[Cloud Sync. Service]	○	—	○ <sup>*4</sup>	—	—	—
[Web service]	○	—	○ <sup>*4</sup>	—	—	—
[AV device]	○	—	—	—	—	—
[Printer] <sup>*1</sup>	○	—	—	—	—	—

\*1 Sending by [Send Images While Recording] is not available.

\*2 A motion picture recorded in [AVCHD] can be sent to [PC] if the file size is 4 GB or smaller. It cannot be sent if the size is greater than 4 GB.

\*3 An OS version of Android 7.0 or higher or iOS 10.0 or higher is required.

\*4 Excluding motion pictures recorded with their size set to [4K] in [Rec Quality]

- Some images may not be played back or sent depending on the device.
- Refer to the manual of the destination equipment or the web service for more information on how to playback pictures.

### ■ Send Images While Recording

A picture can be automatically sent to a specified device every time you take it.

- While sending a file, [📶] is displayed on the recording screen.
- To terminate the connection, follow the steps below:

**MENU** → 🏠 [Setup] → [Wi-Fi] → [Wi-Fi Function] → [Yes]

- You cannot change the sending settings while sending pictures.

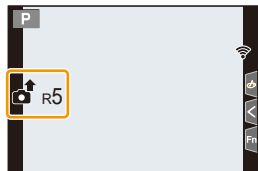

- Since the camera gives priority to recording, sending may take longer during the recording.
- If you cancel the transmission before its completion by, for example, terminating the Wi-Fi connection, unsent files will not be resent.
- You may not be able to delete files or use the playback menu while sending.

## ■ Send Images Stored in the Camera

Images can be selected and sent after recording.

### [Single Select] setting

- 1 Select the picture.
- 2 Select [Set].



### [Multi Select] setting

- 1 Select the picture. (repeat)
  - The setting is canceled when the picture is selected again.
  - Pictures are displayed separately by card slot. You can switch the displayed card by pressing [Fn1].
  - You can only select images on one card at a time.
- 2 Select [OK].

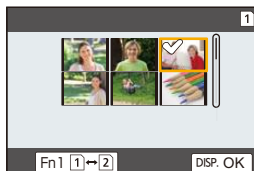

### Not available in these cases:

- Images recorded with a device other than the camera and images modified or edited on a PC may not be sent.

## ■ Changing the settings for sending images

Pressing [DISP.] after completing a connection allows you to change the settings for sending such as the image size for sending.

<b>[Size]</b>	<p>Resize the image to send.</p> <p><b>[Original]/[Auto]/[Change] ([L], [M], [S] or [VGA])</b></p> <ul style="list-style-type: none"> <li>• [Auto] is available only for [Web service]. It changes the image size according to the status of the destination.</li> </ul>
<b>[File Format]</b> (Destination: Only [Smartphone], [PC])	<b>[JPG]/[RAW+JPG]/[RAW]</b>
<b>[Delete Location Data]</b> (Destination: Only [Cloud Sync. Service], [Web service])	<p>Select whether to delete the location information from images before sending them.</p> <p><b>[ON]/[OFF]</b></p> <ul style="list-style-type: none"> <li>• This operation only deletes the location information from the images that are set to be sent.</li> </ul>
<b>[Cloud Limit]</b> (Destination: Only [Cloud Sync. Service])	<p>You can select whether to send images when the Cloud Folder runs out of free space.</p> <p><b>[ON]:</b> Do not send images.</p> <p><b>[OFF]:</b> Delete images from the oldest ones, then send new images.</p>



# Sending images to a smartphone/tablet

Preparations:

- Install the “Image App” in advance. (P253)

## 1 Select the menu.

**MENU** →  [Setup] → [Wi-Fi] → [Wi-Fi Function] → [New Connection] → [Send Images While Recording] or [Send Images Stored in the Camera] → [Smartphone]

## 2 Select [Via Network] or [Direct], and connect. (P285)

### On your smartphone

When connecting with [Via Network]:

- 1 Turn on the Wi-Fi function.
- 2 Select the wireless access point you want to connect to, and set.
- 3 Start “Image App”.

When connecting with [WPS Connection] in [Direct]:

- 1 Start “Image App”.

When connecting with [Manual Connection] in [Direct]:

- 1 Turn on the Wi-Fi function.
- 2 Select the SSID that matches the one displayed on the screen of this unit.
- 3 Start “Image App”.

## 3 Select a device you want to connect.

## 4 Check the send settings, and select [Set].

- To change the send setting, press [DISP.]. (P272)

## 5 When [Send Images While Recording] has been selected

Take pictures. (P271)

When [Send Images Stored in the Camera] has been selected

Select the picture. (P272)

### Not available in these cases:

- When [Auto Transfer] in [Bluetooth] is set to [ON], [Wi-Fi Function] is not available.

## Printing Wirelessly

You can print pictures on printers that support PictBridge (wireless LAN)\*.

\* Compliant with the DPS over IP standards.

- For details on the PictBridge (wireless LAN-compatible) printer, contact the respective company.

### 1 Select the menu.

**MENU** →  [Setup] → [Wi-Fi] → [Wi-Fi Function] → [New Connection] → [Send Images Stored in the Camera] → [Printer]

### 2 Select [Via Network] or [Direct], and connect. (P285)

### 3 Select a printer you want to connect.

### 4 Select pictures, and then print.

- The procedure for selecting pictures is the same as the one for when the USB connection cable is connected. (P307)
  - To terminate the connection, press .
- (You can also terminate the connection by pressing [Wi-Fi].)

#### Not available in these cases:

- When [Auto Transfer] in [Bluetooth] is set to [ON], [Wi-Fi Function] is not available.

## Sending images to AV device

You can send pictures and motion pictures to an AV device (home AV device) that supports DLNA, such as a recorder.

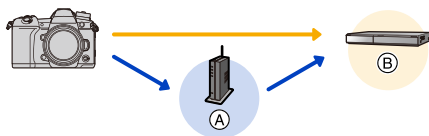

Ⓐ Wireless access point

Ⓑ Home AV device

### 1 Select the menu.

**MENU** → ⚙ [Setup] → [Wi-Fi] → [Wi-Fi Function] → [New Connection] → [Send Images While Recording] or [Send Images Stored in the Camera] → [AV device]

### 2 Select [Via Network] or [Direct], and connect. (P285)

### 3 Select a device you want to connect.

### 4 Check the send settings, and select [Set].

- To change the send setting, press [DISP.]. (P272)

### 5 When [Send Images While Recording] has been selected

Take pictures. (P271)

When [Send Images Stored in the Camera] has been selected

Select the picture. (P272)

- Sending may fail depending on the operational status of the AV device. Also, sending may take a while.

#### Not available in these cases:

- When [Auto Transfer] in [Bluetooth] is set to [ON], [Wi-Fi Function] is not available.

# Sending images to PC

Preparations:

- Turn the computer on.
- Prepare folders for receiving images on the PC. (P276)
- If the workgroup of the destination PC has been changed from the standard setting, change the setting of this unit in [PC Connection]. (P291)

## ■ To create a folder that receives images

- Create a PC account name (up to 254 characters) and password (up to 32 characters) consisting of alphanumeric characters. An attempt to create a receive folder may fail if the account name includes non-alphanumeric characters.

### When using "PHOTOfunSTUDIO"

- 1 Install "PHOTOfunSTUDIO" to the PC. (P299)**
- 2 Create a folder that receives images with "PHOTOfunSTUDIO".**
  - To create the folder automatically, select [Auto-create]. To specify a folder, create a new folder, or set a password to the folder, select [Create manually].
  - For details, refer to the operating instructions of "PHOTOfunSTUDIO" (PDF).

### When not using "PHOTOfunSTUDIO"

(For Windows)

Supported OS: Windows 7/Windows 8/Windows 8.1/Windows 10

Example: Windows 7

- 1 Select a folder you intend to use for receiving, then right-click.**
- 2 Select [Properties], then enable sharing of the folder.**
  - For details, refer to the operating instructions of your PC or Help on the OS.

(For Mac)

Supported OS: OS X v10.5 to v10.11, macOS 10.12

Example: OS X v10.8

- 1 Select a folder you intend to use for receiving, then click on the items in the following order.**  
[File] → [Get Info]
- 2 Enable sharing of the folder.**
  - For details, refer to the operating instructions of your PC or Help on the OS.

## ■ Sending images to the PC

### 1 Select the menu.

**MENU** →  [Setup] → [Wi-Fi] → [Wi-Fi Function] → [New Connection] → [Send Images While Recording] or [Send Images Stored in the Camera] → [PC]

### 2 Select [Via Network] or [Direct], and connect. (P285)

### 3 Select the PC you want to connect to.

- When the PC you want to connect to is not displayed, select [Manual Input], and enter the computer name of the PC (NetBIOS name for Mac).

### 4 Select the folder you want to send.

### 5 Check the send settings, and select [Set].

- To change the send setting, press [DISP.]. (P272)

### 6 When [Send Images While Recording] has been selected

Take pictures. (P271)

When [Send Images Stored in the Camera] has been selected

Select the picture. (P272)

- Folders sorted by the sent date are created in the specified folder, and pictures are saved in those folders.
- If the screen for a user account and password entry appears, enter the one you set on your PC.
- When the computer name (NetBIOS name for Mac) contains a space (blank character), etc., it may not be recognized.  
In that case, we recommend changing the name to one consisting only of 15 or less alphanumeric characters.
- When the firewall of the OS, security software, etc. is enabled, connecting to the PC may not be possible.



#### Not available in these cases:

- When [Auto Transfer] in [Bluetooth] is set to [ON], [Wi-Fi Function] is not available.

## Using Web services

You can send pictures and motion pictures to a social media site, etc. via “LUMIX CLUB”. By setting up automatic transfers of pictures and motion pictures to the Cloud Sync Service, you can receive the transferred pictures or motion pictures on a PC or smartphone.

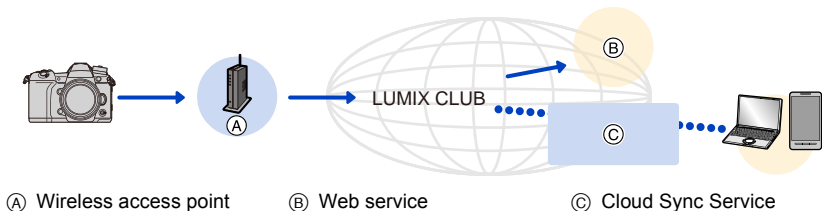

### When sending images to web service

Preparations:

- Register to “LUMIX CLUB”. (P282)
- To send images to a web service, register the web service. (P279)

- Images uploaded to the web service cannot be displayed or deleted with this camera.
- If sending images fails, a report email outlining the failure will be sent to the email address registered with “LUMIX CLUB”.
- **Images may contain personal information that can be used to identify the user, such as a title, the time and date when the images was taken, and the location where the image was taken. Check this information before uploading images to web services.**

- Panasonic assumes no responsibility for the damages resulting from the leakage, loss, etc. of images uploaded on web services.
- When uploading images to the web service, do not delete images from this camera, even after they have finished sending, until you have checked that they have been properly uploaded to the web service. Panasonic assumes no responsibility for the damages resulting from the deletion of images stored in this unit.

## Registering web services

- Check the “FAQ/Contact us” on the following site for compatible web services.

[https://lumixclub.panasonic.net/eng/c/lumix\\_faqs/](https://lumixclub.panasonic.net/eng/c/lumix_faqs/)

Preparation:

Make sure that you have created an account on the web service you want to use, and have the login information available.

- 1 **Connect to the “LUMIX CLUB” site using a smartphone or computer.**  
<https://lumixclub.panasonic.net/eng/c/>
- 2 **Enter your “LUMIX CLUB” login ID and password and log in to the service.**
- 3 **If your email address has not been registered to the “LUMIX CLUB” yet, register it.**
- 4 **Select and register the cloud storage service you want to use in Web service link settings.**
  - Follow the instructions on the screen to register the service.

## Sending images

- 1 **Select the menu.**

**MENU** → **⌘** [Setup] → [Wi-Fi] → [Wi-Fi Function] → [New Connection] → [Send Images While Recording] or [Send Images Stored in the Camera] → [Web service]

- 2 **Select [Via Network], and connect. (P285)**
- 3 **Select a web service.**
- 4 **Check the send settings, and select [Set].**
  - To change the send setting, press [DISP.]. (P272)

- 5 **When [Send Images While Recording] has been selected**

**Take pictures. (P271)**

**When [Send Images Stored in the Camera] has been selected**

**Select the picture. (P272)**





## ■ Sending images in the camera to a web service with simple operations

### 1 Display an image.

### 2 Press ▼.

(When group pictures are selected, press ▲, and select [Upload(Wi-Fi)] or [Upload All(Wi-Fi)].)

- The same operation can be performed by touching [  ].

(When group pictures are selected, select [Upload(Wi-Fi)] or [Upload All(Wi-Fi)] after touch [  ], [  ], [  ], or [  ], and then touch [  ].)

- If a screen is displayed asking you to select the connection method: (P286)
- If a screen is displayed asking you to acquire a new login ID: (P282)

### 3 Select [Yes] on the confirmation screen.

### 4 Select a web service.

### 5 Check the send settings, and select [Set].

- To change the send setting, press [DISP]. (P272)
- Step 4, 5 are not necessary when you continue to send another image.
- To terminate the connection, press [MENU/SET] or operate other controls to exit the playback screen. You can also terminate the connection by pressing [Wi-Fi]. (P252)



## To change the settings for sending images or web service

Terminate the Wi-Fi connection, and follow step 1 and onwards again.

- You can also change the send settings by pressing [Wi-Fi] while using a Wi-Fi connection. (P252)

- When group pictures are displayed continuously, all pictures in the group will be sent. When group pictures are displayed one by one, the currently displayed picture will be sent.



### Not available in these cases:

- When [Auto Transfer] in [Bluetooth] is set to [ON], [Wi-Fi Function] is not available.



## When sending images to [Cloud Sync. Service]

### ■ Using [Cloud Sync. Service] (As of November 2017)

You need to register to “LUMIX CLUB” (P282) and configure the Cloud Sync. setting to send a picture to a Cloud Folder.

For a PC, use “PHOTOfunSTUDIO” to set up Cloud Sync settings. For a smartphone, use “Image App” to set them up.

- Sent images are temporarily saved in the cloud folder so that they can be synchronized with your device, such as a PC or a smartphone.
- A Cloud Folder stores transferred images for 30 days (up to 1000 pictures). Transferred images are deleted 30 days after the transfer. Furthermore, when the number of stored images exceeds 1000, some images may be deleted depending on the [Cloud Limit] (P272) setting even within 30 days after the transfer.
- When the download of images from a Cloud Folder to all specified devices is complete, images may be deleted from the Cloud Folder even within 30 days after the transfer.

#### 1 Select the menu.

**MENU** →  [Setup] → [Wi-Fi] → [Wi-Fi Function] → [New Connection] → [Send Images While Recording] or [Send Images Stored in the Camera] → [Cloud Sync. Service]

#### 2 Select [Via Network], and connect. (P285)

#### 3 Check the send settings, and select [Set].

- To change the send setting, press [DISP.]. (P272)

#### 4 When [Send Images While Recording] has been selected

Take pictures. (P271)

When [Send Images Stored in the Camera] has been selected

Select the picture. (P272)



#### Not available in these cases:

- When [Auto Transfer] in [Bluetooth] is set to [ON], [Wi-Fi Function] is not available.

## About the [LUMIX CLUB]

Acquire a “LUMIX CLUB” login ID (free).

**Refer to the “LUMIX CLUB” site for details.**

<https://lumixclub.panasonic.net/eng/c/>



Please note:

- The service may be suspended due to regular maintenance or unexpected troubles, and the service contents may be changed or added, without prior notice to the users.
- The service may be stopped in whole or in part with a reasonable period of advance notice.

## Acquiring a new login ID ([New account])

### 1 Select the menu.

**MENU** →  [Setup] → [Wi-Fi] → [Wi-Fi Setup] → [LUMIX CLUB] → [Set/Add Account] → [New account]

- Connect to the network.  
Proceed to the next page by selecting [Next].
- ### 2 Select the method for connecting to a wireless access point, and set. (P286)
- Except for the first-time connection, the camera will connect to the previously-used wireless access point. To change the connection destination, press [DISP].
  - Proceed to the next page by selecting [Next].
- ### 3 Read through the “LUMIX CLUB” terms of use and select [Agree].
- Switch pages: ▲/▼
  - Enlarge the display:  (reset the enlarged display: )
  - Move the position of the enlarged display: ▲/▼/◀/▶
  - Cancel without registering information: [🗑️/↵]
- ### 4 Enter a password.
- Enter any combination of 8 to 16 characters and numbers for the password.
  - For information on how to enter characters, refer to P64.
- ### 5 Check the login ID and select [OK].
- **Be sure to make a note of the login ID and password.**
  - The login ID (12-digit number) will be displayed automatically.  
When logging in to the “LUMIX CLUB” with a computer, you only need to enter the numbers.

## Checking or changing the login ID or password ([Set Login ID])

Preparation:

When using the acquired login ID, check the ID and password.

To change the "LUMIX CLUB" password on the camera, access the "LUMIX CLUB" website from your smartphone or PC and change the "LUMIX CLUB" password in advance.

### 1 Select the menu.

**MENU** → ⚙ [Setup] → [Wi-Fi] → [Wi-Fi Setup] → [LUMIX CLUB] → [Set/Add Account] → [Set Login ID]

- The login ID and password are displayed.
- The password is displayed as "★".

### 2 Select the item to change.

### 3 Enter the login ID or password.

- For information on how to enter characters, refer to [P64](#).
- Enter the new password you have created on your smartphone or PC into the camera.

### 4 Select [Exit].

## To set the same login ID for the camera and the smartphone

Setting the same login ID on this unit and your smartphone is convenient for sending images on this unit to other devices or web services.

### ■ When either this unit or the smartphone has acquired the login ID:

- 1 Connect this unit to the smartphone. ([P253](#))
- 2 From the "Image App" menu, set the common login ID.

- A screen for setting a common login ID may be displayed after the camera and the smartphone are connected.

### ■ When this unit and the smartphone have acquired different login IDs:

#### Change the login ID and password of either device.

- To change the camera's login ID and password: ([P283](#))

### Check the “LUMIX CLUB” terms of use

Check the details if the terms of use have been updated.

**MENU** →  [Setup] → [Wi-Fi] → [Wi-Fi Setup] → [LUMIX CLUB] → [Terms of use]

### Delete your login ID and account from the “LUMIX CLUB”

Delete the login ID from the camera when transferring it to another party or disposing of it. You can also delete your “LUMIX CLUB” account.

• Changes and other actions to login IDs can only be made to the login ID acquired with the camera.

#### 1 Select the menu.

**MENU** →  [Setup] → [Wi-Fi] → [Wi-Fi Setup] → [LUMIX CLUB] → [Delete account]

• The message is displayed. Select [Next].

#### 2 Select [Yes] in the login ID delete confirmation screen.

• The message is displayed. Select [Next].

#### 3 Select [Yes] on the confirmation screen for deleting the “LUMIX CLUB” account.

• The message is displayed. Select [Next].

• If you want to continue using the service, selecting [No] will only delete the login ID.

#### 4 Select [OK].

## About Wi-Fi connections

When you use [New Connection], select the connection method to set up a connection.

On the other hand, when you use [Select a destination from History] or [Select a destination from Favorite], the camera connects to the selected device with the previously-used settings.

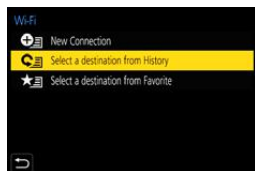



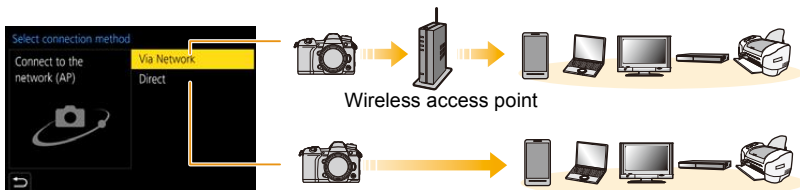

When a screen similar to the one below is displayed, select a connection method.



<b>[Via Network]</b>	Connects via a wireless access point.	<a href="#">P286</a>
<b>[Direct]</b>	Your device connects directly to this unit.	<a href="#">P288</a>

## Connecting via a wireless access point (via the network)

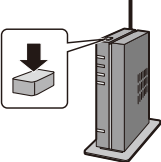
    <p><b>[WPS (Push-Button)]</b></p>	<p>Press the WPS button on the wireless access point to set up a connection.</p> <p><b>Press the wireless access point WPS button until it switches to WPS mode.</b> e.g.:</p> 
<p><b>[WPS (PIN code)]</b></p>	<p>Enter a PIN code into the wireless access point to set up a connection.</p> <ol style="list-style-type: none"> <li><b>1 On the camera screen, select the wireless access point you are connecting to.</b></li> <li><b>2 Enter the PIN code displayed on the camera screen into the wireless access point.</b></li> <li><b>3 Press [MENU/SET] of the camera.</b></li> </ol>
<p><b>[From List]</b></p>	<p>Select this option when you are not sure about the WPS compatibility, or when you want to search for and connect to a wireless access point. (P287)</p>

- When [Via Network] is selected, except for the first-time connection, the camera will connect to the previously-used wireless access point. To change the connection destination, press [DISP].
- WPS refers to a function that allows you to easily configure the settings related to the connection and security of wireless LAN devices.

For details about the compatibility and operation of the function, refer to the operating instructions for the wireless access point.

**If you are not sure about the WPS compatibility (connecting by [From List])**

- Confirm encryption key of the selected wireless access point if the network authentication is encrypted.

**1 Select the wireless access point you are connecting to.**

- To search for wireless access points again, press [DISP].
- If no wireless access point is found, refer to “When connecting with [Manual Input]” on P287.

**2 (If network authentication is encrypted) Enter the encryption key.**

- For information on how to enter characters, refer to P64.
- Except for the first-time connection, a connection will be made automatically using the previously-used encryption key.

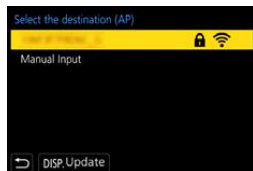
**■ When connecting with [Manual Input]**

- When connecting by [Manual Input], confirm SSID, authentication type, encryption type, encryption key of the wireless access point you are using.
- 1 On the screen displayed in step 1 of “If you are not sure about the WPS compatibility (connecting by [From List])”, select [Manual Input].
  - 2 Enter the SSID of the wireless access point you are connecting to, then select [Set].
    - For information on how to enter characters, refer to P64.
  - 3 Select the network authentication type.

[WPA2-PSK]	Supported encryption methods: [TKIP], [AES]
[WPA2/WPA-PSK]	
[No Encryption]	—

**4 (When an option other than [No Encryption] is selected) Enter the encryption key.**

- Check the wireless access points instruction manual and settings when saving a wireless access point.
- If no connection can be established, the wireless access point's radio waves may be too weak. Refer to “Message Display” (P321) and “Troubleshooting” (P323) for details.
- Depending on your environment, transmission speed between the camera and wireless access point may decrease. In addition, the wireless access point may not be available for use.

## Connecting the camera and another device directly (direct connection)

<p>[WPS Connection]</p>	<p>[WPS (Push-Button)]</p> <ol style="list-style-type: none"> <li>1 On the camera, select [WPS (Push-Button)].</li> <li>2 Set the device to WPS mode.           <ul style="list-style-type: none"> <li>• You can wait longer for a connection by pressing [DISP.] on this unit.</li> </ul> </li> </ol> <hr/> <p>[WPS (PIN code)]</p> <ol style="list-style-type: none"> <li>1 On the camera, select [WPS (PIN code)].</li> <li>2 Enter the PIN code of the device into this camera.</li> </ol>
<p>[Manual Connection]</p>	<p>Enter the SSID and password into the device. The SSID and password are displayed on the connection waiting screen of this unit.</p> <ul style="list-style-type: none"> <li>• If the destination is set to [Smartphone], the password is not displayed. Select the SSID to establish a connection. (P256)</li> </ul> <div data-bbox="741 404 1009 583" style="border: 1px solid black; padding: 5px;"> </div>

- Please also refer to the operating instructions of the device to be connected.



## Connecting quickly with the same settings as the previous ones ([Select a destination from History]/[Select a destination from Favorite])

When the Wi-Fi function is used, a record is saved in the history. You can register records as favorites. Using the history or favorites list, you can easily connect with the same settings as used previously.

- If the settings of the device to connect to have been changed, it may not be possible to connect to the device.

### 1 Select the menu.

MENU → ⌂ [Setup] → [Wi-Fi] → [Wi-Fi Function]	
[Select a destination from History]	Connects with the same settings as the previous ones.
[Select a destination from Favorite]	Connects with settings registered as favorites.

### 2 Select item.

- You can display details of the connection by pressing [DISP].

## ■ Registering records as favorites

### 1 Select the menu.

MENU → ⌂ [Setup] → [Wi-Fi] → [Wi-Fi Function] → [Select a destination from History]
--

- Select the history you want to register to favorites, and then press ►.
- Enter a registration name.

- For information on how to enter characters, refer to [P64](#).
- A maximum of 30 characters can be entered. A two-byte character is treated as two characters.

## ■ Editing the items registered to favorites

- 1 Select the menu.

**MENU** → ⚙ [Setup] → [Wi-Fi] → [Wi-Fi Function] →  
[Select a destination from Favorite]

- 2 Select the favorite history you want to edit, and then press ▶.

[Remove from Favorite]	—
[Change the Order in Favorite]	Specify the destination location of the desired item to change the display order.
[Change the Registered Name]	Enter text to change the registered name.

- Because the number of records that can be saved is limited, register frequently-used connection settings as favorites.
- Performing [Reset Network Settings] clears the history and the contents saved in [Select a destination from Favorite].
- If the device you want to connect to (smartphone, etc.) is connected to a wireless access point other than the camera, you cannot connect the device to the camera using [Direct]. Change the Wi-Fi settings of the device you want to connect to so that the access point to be used is set to the camera.  
You can also select [New Connection] and reconnect the devices. (P253)
- A connection may not be established easily when you try to connect to a network to which many PCs are connected.  
If a connection attempt fails, reconnect by using [New Connection].

## [Wi-Fi Setup] Menu

Configure the settings required for the Wi-Fi function.  
The settings cannot be changed when connected to Wi-Fi.

**MENU** →  **[Setup]** → **[Wi-Fi]** → **[Wi-Fi Setup]**

### [Priority of Remote Device]

Sets either the camera or the smartphone as the priority control device to be used during remote recording. (P262)

### [Wi-Fi Password]

You can improve security by enabling password entry for a direct connection to a smartphone.

<b>[ON]</b>	Connects the camera and a smartphone using an SSID and password. (P257)
<b>[OFF]</b>	Connects the camera and a smartphone using an SSID. (P256)

• When [ON] is selected, you can also set up a connection by scanning a QR code.

### [LUMIX CLUB]

Acquires or changes the “LUMIX CLUB” login ID. (P282)

### [PC Connection]

You can set the workgroup.

To send images to a PC, a connection to the same workgroup as the destination PC is required.

(The default setting is “WORKGROUP”.)

- 1 Press [MENU/SET].
- 2 Enter the workgroup of the connecting PC.
  - For information on how to enter characters, refer to P64.

• To reset to the default setting, press [DISP].

**[Device Name]**

You can change the name (SSID) of this unit.

- ❶ Press [DISP.].
- ❷ Enter the desired device name.
  - For information on how to enter characters, refer to [P64](#).
  - A maximum of 32 characters can be entered.

**[Wi-Fi Function Lock]**

To prevent incorrect operation and use of the Wi-Fi function by a third party and to protect saved personal information, protect the Wi-Fi function with a password.

<b>[Setup]</b>	Enter any 4-digit numbers as the password. • For information on how to enter characters, refer to <a href="#">P64</a> .
<b>[Cancel]</b>	Cancel the password.

- Once a password is set, you are required to enter it each time you use the Wi-Fi function.
- If you forget the password, you can reset it with [Reset Network Settings] in the [Setup] menu.

**[Network Address]**

Displays the MAC address and IP address of this unit.

- A MAC Address is a unique address that is used to identify network equipment.
- IP address refers to a number that identifies a PC connected to a network such as the Internet. Usually, the addresses for homes are automatically assigned by the DHCP function such as a wireless access point. (Example: 192.168.0.87)

**[Approved Regulations]**

Displays the certification number for radio regulations.

## Watching/Saving 4K Motion Pictures on an External Device

### Watching motion pictures in 4K

#### ■ Playing Back on a TV Screen

Preparation:

Set [HDMI Mode (Play)] (P227) to [AUTO] or a resolution of [4K].

- When connecting to a TV that does not support 4K motion picture, select [AUTO].



**Connect the camera and a 4K-compatible TV with an HDMI cable, and display the playback screen. (P294)**

- Even though the output resolution will be lower, you can also play them back by connecting the camera to a TV that does not support motion pictures in 4K.
- You can also play back 4K motion pictures recorded with [Rec Format] set to [MP4] (except for those recorded with [Rec Quality] set to [4K/150M/60p]) on a Panasonic TV with SD card slots that supports 4K motion picture by inserting the card into the TV.
- Read the operating instructions for the TV.



#### ■ Watching on a PC

To play back 4K motion pictures on a PC, use the software "PHOTOfunSTUDIO".

- To play back and edit motion pictures in 4K, you need a high-performance PC environment.
- Refer to the operating instructions of "PHOTOfunSTUDIO" (PDF).



### Storing 4K motion pictures

You cannot dub 4K motion pictures to Blu-ray discs and DVDs with Panasonic recorders.

#### ■ Storing on a PC

Use the software "PHOTOfunSTUDIO" to import 4K motion pictures to a PC.

- Refer to the operating instructions of "PHOTOfunSTUDIO" (PDF).

# Playing Back Pictures on a TV Screen

Preparations: Turn this unit and the TV off.

## 1 Connect the camera and the TV with an HDMI cable.

- Check the direction of the terminals and plug in/out straight holding onto the plug. (It may result in malfunction by the deforming of the terminal if it is plugged in obliquely or in wrong direction.)

Do not connect devices to incorrect terminals. Doing so may cause malfunction.

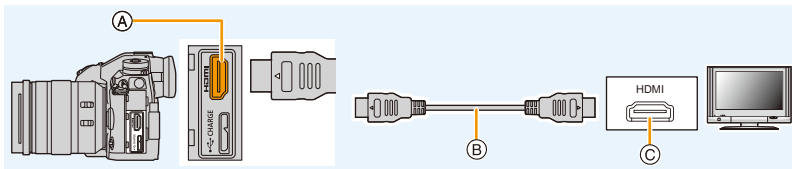

(A) [HDMI] socket (Type A)

(C) HDMI socket (on the TV)

(B) HDMI cable

- Use a "High Speed HDMI cable" with the HDMI logo. Cables that do not comply with the HDMI standards will not work. "High Speed HDMI cable" (Type A–Type A plug, up to 1.5 m (4.9 feet) long)
- Check the [HDMI Mode (Play)]. (P227)
- No picture is displayed on the screen of this unit.

## 2 Turn on the TV and select the input to match the connector in use.

## 3 Turn the camera on and then press [▶].

- If the ambient temperature is high or a signal is continuously output via HDMI, after [⚠] is displayed, the HDMI signal output may stop to protect the camera. Wait until the camera cools down.
- Depending on the [Aspect Ratio], black bands may be displayed on the top and bottom or the left and right of the pictures.
- Change the screen mode on your TV if the picture is displayed with the top or bottom cut off.
- HDMI output will be canceled if a USB connection cable (supplied) is connected simultaneously.
- No sound is output from the camera speakers.
- Read the operating instructions for the TV.

**The recorded pictures can be played back on a TV with an SD Memory Card slot**

- Depending on the TV model, pictures may not be displayed on the full screen.
- The file format of the motion pictures that can be played back differs depending on the TV model.
- For cards compatible with playback, refer to the operating instructions of the TV.

**Recording while monitoring camera images**

When using the HDMI output, you can record pictures and motion pictures while monitoring the camera image on an external monitor, TV or similar device.

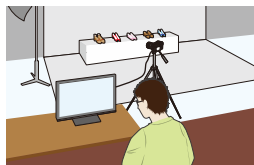
**Notes on images output via HDMI (sorted by Recording Mode)**

Recording Mode		
<b>Aspect ratio</b>	Images are output in 16:9 format.	The output setting is determined by the [Aspect Ratio] setting in the [Rec] menu. • Black bars appear on both sides of images, except for those with an aspect ratio of [16:9].
<b>Size/frame rate</b>	The output setting is determined by the [Rec Quality] setting in the [Motion Picture] menu.	The output setting is determined by the connected device.

- When [Rec Area] is set to [] in a mode except Creative Video Mode, the output setting of aspect ratio, size, and frame rate are determined by the [Rec Quality] setting in the [Motion Picture] menu.
- When recording motion pictures, the output method changes to a setup equivalent to the one used in Creative Video Mode.
- It may take some time for the output method to change.

### ■ Switching the information displayed

You can change the display shown during HDMI output using [HDMI Info Display (Rec)] in [TV Connection] on the [Setup] menu.

[ON]: The camera display is output as is.

[OFF]: Only images are output.

- When you use the HDMI output during recording, the image may be displayed with a time lag.
- Electronic sounds and electronic shutter sounds are muted.
- When you check the image and sound from the TV connected to the camera, the microphone of the camera may pick up the sound from the speakers of the TV, producing an abnormal sound (audio feedback). If this occurs, move the camera away from the TV or lower the volume on the TV.
- Certain setting screens are not output via HDMI.
- This function is not available in the following cases:
  - When recording 6K/4K photos
  - When recording with the Post Focus function



MENU





## Using VIERA Link (HDMI)

### What is the VIERA Link (HDMI) (HDAVI Control™)?

- This function allows you to use your remote control for the Panasonic TV for easy operations when this unit has been connected to a VIERA Link compatible device using an HDMI cable for automatic linked operations.  
(Not all operations are possible.)
- VIERA Link is a unique Panasonic function built on an HDMI control function using the standard HDMI CEC (Consumer Electronics Control) specification.  
Linked operations with HDMI CEC compatible devices made by other companies are not guaranteed. When using devices made by other companies that are compatible with VIERA Link, refer to the operating instructions for the respective devices.
- This unit supports “VIERA Link Ver.5” function. “VIERA Link Ver.5” is the standard for Panasonic’s VIERA Link compatible equipment. This standard is compatible with Panasonic’s conventional VIERA Link equipment.

Preparations:

**MENU** →  [Setup] → [TV Connection] → [VIERA Link] → [ON]

- 1 **Connect this unit to a Panasonic TV compatible with VIERA Link with an HDMI cable (P294).**
- 2 **Turn the camera on and then press .**
- 3 **Operate with the remote control for the TV.**

### Turning this unit off:

If you use the remote control for the TV to turn the TV off, this unit is also turned off.

### Automatic input switching:

- If you connect with an HDMI cable and then turn this unit on, and then press , the input channel on the TV automatically switches to this unit’s screen. If the TV’s power is in standby status, it will turn on automatically (if [Set] has been selected for the TV’s [Power on link] setting).
- Operation using the buttons on this unit will be limited.
- To play back the sound of a film during a slide show, set [Sound] to [AUTO] or [Audio] on the Slide Show setting screen.
- Use a “High Speed HDMI cable” with the HDMI logo.  
Cables that do not comply with the HDMI standards will not work.  
“High Speed HDMI cable” (Type A–Type A plug, up to 1.5 m (4.9 feet) long)

## Saving still pictures and motion pictures on your PC

You can acquire recorded pictures to a PC by connecting the camera and the PC.

- Some PCs can read directly from the card removed from the camera. For details, refer to the operating instructions of your PC.

### ■ PC that can be used

The unit can be connected to any PC capable of recognizing a mass storage device.

- Windows support: Windows 7/Windows 8/Windows 8.1/Windows 10
- Mac support: OS X v10.5 to v10.11, macOS 10.12



### **AVCHD motion pictures may not be imported correctly when copied as files or folder**

- When using Windows, import AVCHD motion pictures with “PHOTOfunSTUDIO”.
  - With a Mac, AVCHD motion pictures can be imported using “iMovie”.
- Please note that importing is not possible depending on the picture quality.  
(For details about iMovie, please contact Apple Inc.)

## Downloading software

- To download the software, you need to connect the PC to the Internet.
- It may take some time to download the software depending on the communication environment.
- Supported OSs are current as of November 2017 and are subject to change.

### PHOTOfunSTUDIO 10.0 PE

This software allows you to manage images. For example, you can send pictures and motion pictures to a PC and sort them by recording date or model name. You can also perform operations such as writing images to a DVD, processing and correcting images, and editing motion pictures.

Check the site below to download and install the software.

Download the software while it is available for download.

[http://panasonic.jp/support/global/cs/soft/download/d\\_pfs10pe.html](http://panasonic.jp/support/global/cs/soft/download/d_pfs10pe.html)

(This Site is English only.)

- Download expiration: January 2023

- Operating environment

OS	Windows® 7 (32bit/64bit) SP1, Windows® 8.1 (32bit/64bit), Windows® 10 (32bit/64bit) • For 4K motion pictures and 6K/4K photos, a 64 bit OS version of Windows 7/Windows 8.1/Windows 10 is required.
CPU	Pentium® 4 (2.8 GHz or higher)
Display	1024×768 pixels or more (1920×1080 pixels or more recommended)
RAM	1 GB or more (32bit), 2 GB or more (64bit)
Free hard disk space	450 MB or more for installing software

- When using the playback and editing functions for 4K motion pictures or the picture cropping function for 6K/4K photos, refer to the operating instructions of "PHOTOfunSTUDIO" (PDF file) for details.
- "PHOTOfunSTUDIO" is not compatible with Mac.

**SILKYPIX Developer Studio SE**

This is software to edit RAW format images.

Edited images can be saved in a format (JPEG, TIFF, etc.) that can be displayed on a personal computer.

Check the site below to download and install the software.

**<http://www.isl.co.jp/SILKYPIX/english/p/>**

- Operating environment

OS	Windows	Windows® 7, Windows® 8, Windows® 8.1, Windows® 10
	Mac	OS X v10.6 to v10.11, macOS 10.12

- For details on how to use the “SILKYPIX Developer Studio”, refer to the Help or the Ichikawa Soft Laboratory’s support website.

**LoiLoScope 30 day full trial version  
(Windows 7/Windows 8/Windows 8.1/Windows 10)**

This software allows you to edit motion pictures with ease.

Check the site below to download and install the software.

**<http://loilo.tv/product/20>**

- Only the trial version can be installed.
- For more information on how to use LoiLoScope, read the LoiLoScope manual available for download at the site.
- “LoiLoScope” is not compatible with Mac.

## Transferring images to a PC

Preparations:

Install "PHOTOfunSTUDIO" to the PC. (P299)

### 1 Connect the computer and camera with the USB connection cable (supplied).

- Please turn on this unit and your PC before connecting.
- Check the direction of the terminals and plug in/out straight holding onto the plug. (It may result in malfunction by the deforming of the terminal if it is plugged in obliquely or in wrong direction.)  
Do not connect devices to incorrect terminals. Doing so may cause malfunction.
- Do not use any other USB connection cables except the supplied one.

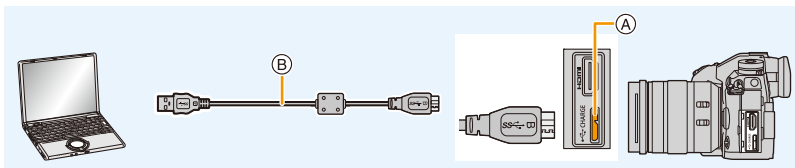

- (A) [USB/CHARGE] socket
- (B) USB connection cable (supplied)

### 2 Press **▲/▼** to select [PC(Storage)], and then press [MENU/SET].

- If [USB Mode] is set to [PC(Storage)] in the [Setup] menu in advance, the camera will be automatically connected to the PC without displaying the [USB Mode] selection screen.

### 3 Copy the images to a PC using "PHOTOfunSTUDIO".

- Do not delete or move copied files or folders in Windows Explorer.  
When viewing in "PHOTOfunSTUDIO", you will not be able to play back or edit.

- Use a battery with sufficient battery power or the AC adaptor (optional). If the remaining battery power becomes low while the camera and the PC are communicating, the alarm beeps.

Disconnect the USB connection cable safely. Otherwise, data may be destroyed.

- Before inserting or removing a card, turn the camera off and disconnect the USB connection cable. Otherwise, data may be destroyed.

### ■ Copying to a PC without using “PHOTOfunSTUDIO” (For Mac)

Even if you are using a Mac, or in any situation where “PHOTOfunSTUDIO” cannot be installed, you can still copy files and folders by connecting the camera to the computer and then dragging and dropping them to it.

• The content (folder structure) on the card of this unit is as follows.

**For Windows:** A drive ([LUMIX]) is displayed in [Computer]

**For Mac:** A drive ([LUMIX]) is displayed on the desktop

#### • Card

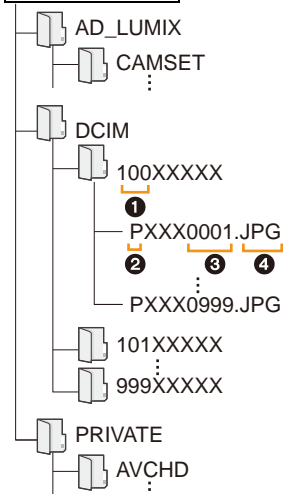

**CAMSET:** The camera's setup information

**DCIM:** Images

① Folder number

② Color space  
P: sRGB  
\_: AdobeRGB

③ File number

④ JPG: Still pictures

MP4: [MP4] Motion pictures

RW2: Pictures in RAW files

**AVCHD:** [AVCHD] Motion pictures

## Saving still pictures and motion pictures on a Recorder

If you insert card holding content recorded with this unit into a Panasonic recorder, you can dub the content to a Blu-ray Disc or DVD etc.

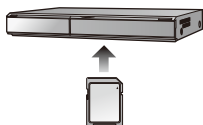

Methods to export still pictures and motion pictures to other devices will vary depending on the file format. (JPEG, RAW, AVCHD or MP4).

- 6K/4K burst files (MP4 format) are not supported by Panasonic recorders.

Dubbing can be performed when the camera and a Panasonic recorder with a USB socket are connected with a USB connection cable.



- Use the card slot 1.

• See the operating instructions for the recorder about the details about copying and playing back.

## Controlling the Camera from a PC

By selecting [PC(Tether)] and connecting the camera to a PC, you can control the camera from supported software.

### ■ Downloading software

#### “LUMIX Tether”

This software is used to control a Panasonic digital camera from a PC. It allows you to change various settings of the camera, perform remote recording, and save remotely recorded images to the PC.

Check the site below to download and install the software.

**[http://panasonic.jp/support/global/cs/soft/download/d\\_lumixtether.html](http://panasonic.jp/support/global/cs/soft/download/d_lumixtether.html)**

- Operating environment

OS	Windows	Windows® 7, Windows® 8.1, Windows® 10
	Mac	OS X v10.10 to v10.11, macOS 10.12
Interface	USB port (Super Speed USB (USB 3.0))	

- Supported OSs are current as of November 2017 and are subject to change.
- For details on how to use the “LUMIX Tether”, refer to the operation guide of “LUMIX Tether” (PDF file).
- To download the software, you need to connect the PC to the Internet.
- It may take some time to download the software depending on the communication environment.



## ■ Operating the camera from a PC

Preparations:

Install "LUMIX Tether" to the PC.

### 1 Connect the computer and camera with the USB connection cable (supplied).

- Please turn on this unit and your PC before connecting.
- Check the direction of the terminals and plug in/out straight holding onto the plug. (It may result in malfunction by the deforming of the terminal if it is plugged in obliquely or in wrong direction.)  
Do not connect devices to incorrect terminals. Doing so may cause malfunction.
- Do not use any other USB connection cables except the supplied one.

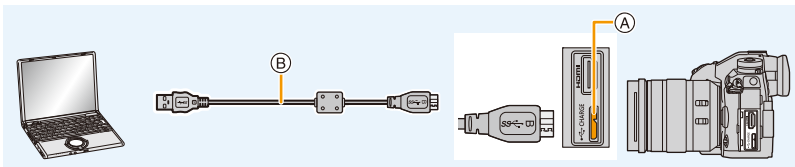

- (A) [USB/CHARGE] socket  
(B) USB connection cable (supplied)

### 2 Press ▲/▼ to select [PC(Tether)], and then press [MENU/SET].

- If [USB Mode] is set to [PC(Tether)] in the [Setup] menu in advance, the camera will be automatically connected to the PC without displaying the [USB Mode] selection screen.

### 3 Use "LUMIX Tether" to operate the camera from the PC.

• When the camera is connected to the PC via [PC(Tether)]:

- The camera will be set to Recording Mode.
- Wi-Fi/Bluetooth function cannot be used.
- [📶] is displayed on the screen.
- Instead of the number of recordable pictures, [PC] will appear on the screen if you perform recording without inserting a card into the camera.
- The HDMI cable can be connected to the camera at the same time.

## Printing the Pictures

If you connect the camera to a printer supporting PictBridge, you can select the pictures to be printed out and instruct that printing be started on the camera's monitor.

- Group pictures will not be displayed as group pictures but as single pictures.
- Some printers can print directly from the card removed from the camera. For details, refer to the operating instructions of your printer.

Preparations:

Turn on the camera and the printer.

Perform the print quality and other settings at the printer before printing the pictures.

**1** Press [▶] on the camera.

**2** Rotate the rear dial to the left to display the multi playback screen, and press [Fn1] to select the card to display the images you want to print.

- You can only print images on one card at a time. You cannot change the displayed card while a printer is connected.
- You can also select the card to be displayed using the function button [Slot Change] (P62).

**3** Connect the printer and camera with the USB connection cable (supplied).

- Check the direction of the terminals and plug in/out straight holding onto the plug. (It may result in malfunction by the deforming of the terminal if it is plugged in obliquely or in wrong direction.)  
Do not connect devices to incorrect terminals. Doing so may cause malfunction.
- Do not use any other USB connection cables except the supplied one.

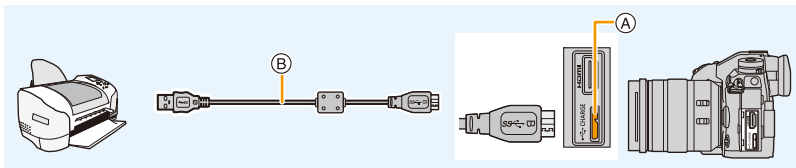

- (A) [USB/CHARGE] socket  
(B) USB connection cable (supplied)

**4** Press ▲/▼ to select [PictBridge(PTP)], and then press [MENU/SET].

- If a connection to the printer cannot be made, set [USB Power Supply] in the [Setup] menu to [OFF] and try reconnecting to the printer.
- Disconnect the USB connection cable after printing.
- Use a battery with sufficient battery power or the AC adaptor (optional). If the remaining battery power becomes low while the camera and the printer are connected, the alarm beeps. If this happens during printing, stop printing at once. If not printing, disconnect the USB connection cable.
- Do not disconnect the USB connection cable while [🚫] (Cable disconnect prohibit icon) is displayed.  
(May not be displayed depending on the type of printer used.)
- Before inserting or removing a card, turn the camera off, and disconnect the USB connection cable.

#### Not available in these cases:

- Motion pictures, 6K/4K burst files, and images recorded with the Post Focus function cannot be printed.

### Selecting a single picture and printing it

- 1 Press **◀/▶** to select the picture and then press **[MENU/SET]**.
- 2 Press **▲** to select **[Print start]** and then press **[MENU/SET]**.



### Selecting multiple pictures and printing them

- 1 Press **▲**.
- 2 Press **▲/▼** to select an item and then press **[MENU/SET]**.

<b>[Multi Select]</b>	Multiple pictures are printed at one time. • Press <b>▲/▼/◀/▶</b> to select the pictures and then press <b>[MENU/SET]</b> . (Press <b>[MENU/SET]</b> again to cancel the setting.) • After the pictures have been selected, press <b>[DISP.]</b> .
<b>[Select All]</b>	Prints all the stored pictures.
<b>[Rating]</b>	Prints all images with [Rating] levels between [★1] and [★5].

- 3 Press **▲** to select **[Print start]** and then press **[MENU/SET]**.

## ■ Print Settings

Select and set the items both on the screen in step **2** of the “Selecting a single picture and printing it” and in step **3** of the “Selecting multiple pictures and printing them” procedures.

<b>[Print with Date]</b>	Sets date printing.
<b>[Num.of prints]</b>	Sets the number of pictures to be printed (up to 999 pictures).
<b>[Paper Size]</b>	Sets the paper size.
<b>[Page Layout]</b>	Sets whether or not to add borders and how many pictures to be printed on each sheet of paper.

- When you want to print pictures on a paper size or a layout which is not supported by the camera, set [Paper Size] or [Page Layout] to  and then set the paper size or the layout on the printer.  
(For details, refer to the operating instructions of the printer.)
- If the printer does not support date printing, the date cannot be printed on the picture.
- Depending on the printer, the date print settings of the printer may take precedence so check if this is the case.

- The camera is receiving an error message from the printer when the  indication lights yellow during printing. After finishing printing, make sure there are no problems with the printer.
- If the number of prints is high, the pictures may be printed several times. In this case, the remaining number of prints indicated may differ from the number set.
- Only pictures taken in JPEG format can be printed. Those taken in RAW will use the JPEG pictures that were simultaneously created. If an equivalent JPEG picture is not available, no print will take place.

## Optional accessories

### Battery Grip (optional)

Using a battery grip (DMW-BGG9: optional) improves ease of operation and grip when held vertically. Installing a spare battery will allow you to record for a longer time.

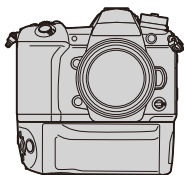

### ■ Setting a priority for the use of spare batteries

Preparations:

- Turn this unit off, and then remove the terminal cover.

- 1 **Attach the battery grip to this unit, and then turn this unit on.**
- 2 **Select the menu.**

**MENU** →  **[Setup]** → **[Battery Use Priority]**

[BODY]: The battery in this unit is used first.

[BG]: The battery in the battery grip is used first.

- When the battery in the battery grip is used, **[BG]** is displayed on the screen.
- If the terminal cover is hard to remove, flip the cover's corner by the camera's recess toward the center.
- Read the operating instructions of the battery grip for details.

### Shutter Remote Control (optional)

If you use the shutter remote control (DMW-RSL1: optional), you can avoid jitter (camera shake) when using a tripod and you can keep the shutter pressed fully when taking pictures with [B] (Bulb) or Burst Mode. The shutter remote control works similar to the shutter button on the camera.



- Always use a genuine Panasonic shutter remote control (DMW-RSL1: optional).
- Record with Creative Video Mode when using for motion picture recording. Motion picture recording can be started/stopped with the shutter remote control.
- Read the operating instructions of the shutter remote control for details.

#### **Not available in these cases:**

- You cannot use the shutter remote control for the following operation.
  - Canceling [Sleep Mode], [Sleep Mode(Wi-Fi)] or [Power Save LVF Shooting]

## External Microphone (optional)

Using a stereo shotgun microphone (DMW-MS2: optional) or stereo microphone (VW-VMS10: optional), you can record sounds with quality superior to those recorded with the built-in microphone.

- Some optional accessories may not be available in some countries.

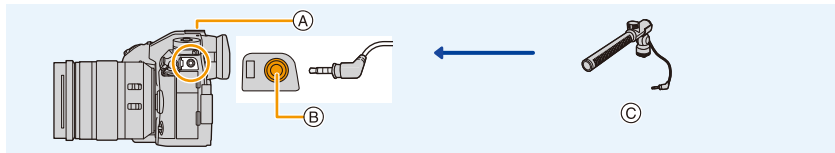

- (A) Hot shoe
- (B) [MIC] socket
- (C) Stereo shotgun microphone (DMW-MS2: optional)  
Stereo microphone (VW-VMS10: optional)

- Do not use the stereo microphone cables with the length of 3 m (9.8 feet) or more.

Preparations:

- Turn this unit off.
- When attaching the stereo shotgun microphone to the camera, remove the hot shoe cover. (P155)

### ■ Setting the range within which the stereo shotgun microphone (DMW-MS2: optional) will record sounds

- 1 Attach the dedicated stereo shotgun microphone to this unit, and then turn this unit on.
- 2 Select the menu.

**MENU** → **[Motion Picture]** → **[Special Mic.]**

- This item is available only when using a stereo shotgun microphone.

<b>[STEREO]</b>	Allows stereo recording of sound over a wide area.
<b>[LENS AUTO]</b>	Allows recording within the range that is set automatically according to the angle of view of the lens.
<b>[SHOTGUN]</b>	Allows recording from one direction by shutting out background and surrounding noise.
<b>[S.SHOTGUN]</b>	Allows recording within the range even narrower than that of [SHOTGUN].
<b>[MANUAL]</b>	Allows recording within the range you set manually.

- 3 (When [MANUAL] is selected)

Press ◀/▶ to select a range, and press [MENU/SET].

## ■ Reducing the wind noise when using an external microphone

**MENU** →  [Motion Picture] → [Wind Cut]

Settings: [HIGH]/[STANDARD]/[LOW]/[OFF]

- This item is available only when using an external microphone.
  - Setting [Wind Cut] may alter the usual sound quality.
- While the external microphone is connected,  is displayed on the screen.
  - When the external microphone is connected, [Mic Level Disp.] is automatically set to [ON], and the mic level is displayed on the screen.
  - When an external microphone is attached to the camera, do not hold only the external microphone to prevent the camera from falling.
  - If the noises are recorded when you use an AC adaptor (optional), use a battery.
  - When a stereo microphone (VW-VMS10: optional) is used, [Special Mic.] is fixed to [STEREO].
  - When [Special Mic.] is set to [LENS AUTO], [S.SHOTGUN] or [MANUAL], [Sound Output] in the [Motion Picture] menu is fixed to [REC SOUND].
  - If you press the function button to which [Mic. Directivity Adjust] in [Fn Button Set] in the [Custom] ([Operation]) menu is assigned when [Special Mic.] is set to [MANUAL], the screen that lets you set the range will be displayed.
  - For details, refer to the operating instructions of the external microphone.

## AC adaptor (optional)/DC coupler (optional)

By using the AC adaptor (optional) and DC coupler (optional), you can record and play back without worrying about the remaining battery charge.

The optional DC coupler can only be used with the designated Panasonic AC adaptor (optional).

- Always use a genuine Panasonic AC adaptor (optional).
- When using an AC adaptor (optional), use the AC cable supplied with the AC adaptor.
- **When the DC coupler is being mounted, the DC coupler cover opens, so the structure ceases to be dust-proof and splash-proof.**  
Be careful not to allow sand, dust and water etc. to adhere to or enter the structure. After use, check that there is no foreign matter attached to the coupler cover, and close it firmly.
- Also read the operating instructions for the AC adaptor (optional) and DC coupler.



# Monitor Display/Viewfinder Display

- The following images are examples of when the display screen is set to [ ] (monitor style) in the monitor.

## In recording

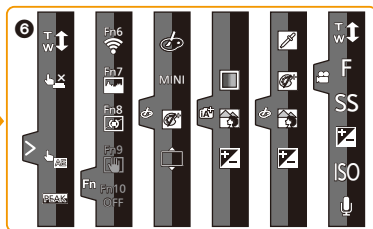
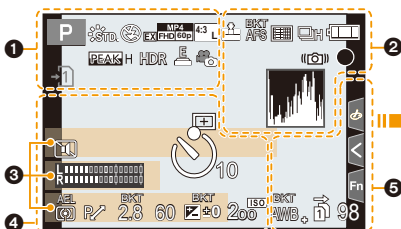

1

IA IAY P A	Recording Mode (P43)
S M MF P	
EXP	
C 1	Custom settings (P85)
STD.	Photo Style (P188)
⚡ ⚡ S ⚡ S ⚡ S	Flash Mode (P158)
⚡ 2nd ⚡ WL	Flash (P159, 162)
MPX EXPHOLD	Extended Tele Conversion (when recording motion pictures) (P150)
MPX HOLD	Recording format/Recording quality (P166)
4.3 L	Picture size/Aspect Ratio (P185)
4.3 CM	Extended Tele Conversion (when taking still pictures) (P150)
🌀	Image effect (filter) adjustment display (P82, 190)
EXP	Image effect (filter) setting (P190)
-1 -2	Card (displayed only during recording) (P29)

🗑️ 🗑️	No card
FULL FULL	The card is full
8m30s	Elapsed recording time*1 (P164)
📷	Simultaneous recording indicator (P168)
LVF/MON/AUTO	Automatic viewfinder/monitor switching (P41)
PEAK H PEAK L	Peaking (P213)
📏	Highlight Shadow (P192)
HDR	HDR (P201)/iHDR (P68)
📷	Multi exposure (P202)
📷	Digital Zoom (P152)
📷	High-Res Mode (P196)
E	Electronic shutter (P199)
180fps	High speed video (P173)
📷	Picture-taking during motion picture recording (Photo Priority) (P168)
⚠️	Overheat indicator (P323)

2

	RAW	Quality (P187)
	AFS AFF AFC MF	Focus Mode (P89, 103)
	BKT AFS	Focus Bracket (P143)
	Post Focus	(P130)
	AF Mode	(P92)
	Face Recognition	(P217)
	AFL	AF Lock (P106)
	Burst	(P115)
	6K/4K Photo	(P119)
	Self-timer	(P135)
	Battery indication	(P22)
	Power is being supplied	(P26)
	Battery Grip	(P309)
	Image Stabilizer	(P145)
	Jitter alert	(P146)
	Recording state (Flashes red.)/ Focus (Lights green.)	(P42)
	Focus (Under low illumination)	(P87)
	Focus (Starlight AF)	(P87)
	Pre-Burst	(P115)
	Connected to Wi-Fi	
	Connected to Bluetooth	(P256)
	GPS	Location Logging (P268)
	Histogram	(P213)







3

	Name <sup>*2</sup>	(P219)
	Number of days that have passed since the departure date <sup>*3</sup>	(P221)
	Age <sup>*2</sup>	(P219)
	Location <sup>*3</sup>	(P221)
	Current date and time/Travel destination setting <sup>*3</sup> :	(P221)
	Exposure meter	(P215)
	Focal distance display	(P153)
	Step zoom	(P153)
	Time Stamp Recording	(P170)



















4

	AF area	(P97)
	Spot metering target	(P192)
	Center marker display	(P214)
	Self-timer	(P135)
	Mic level display	(P169)
	Mic Level Limiter (OFF)	(P169)
	Silent Mode	(P198)
	External Microphone	(P311)
	AEL	AE Lock (P106)
	Metering Mode	(P54, 192)
	Program Shift	(P72)
	2.8	Aperture value (P42)
	BKT 2.8	Aperture Bracket (P143)
	60	Shutter speed (P42)
	Exposure compensation value	(P107)
	Exposure Bracket	(P142)
	Brightness	(P69, 84)
	Manual Exposure Assistance	(P75)
	200 <sup>ISO</sup>	ISO sensitivity (P109)

5

	White Balance Bracket, White Balance Bracket (Color Temperature) (P144)
	White Balance Fine Adjustment (P113)
	White Balance (P111)
	Color (P69)
98	Number of recordable pictures (P31)
r20	Maximum number of pictures that can be taken continuously (P117)
8m30s	Available recording time*1 (P31)
	Relay recording (P229)
	Backup recording (P229)
	Allocation recording (P229)

6

Touch tab (P211)	
	 Touch zoom (P154)
	 Touch Shutter (P53)
	 Touch AE (P54)
	 Peaking (P213)
	 Function button (P61)
   (P172)	 Color (P69)
	 Defocus control function (P69, 84)
	 Brightness (P69, 84)
	 Type of defocus ([Miniature Effect]) (P81)
	 One point color (P81)
	 Position of the light source (P82)
	 Image effect (filter) adjustment (P84, 190)
	 Image effect ON/OFF (P190)
	<b>MINI</b> Image effect (filter) (P190)
	<b>F</b> Aperture value (P42)
	<b>SS</b> Shutter speed (P42)
	<b>ISO</b> ISO sensitivity (P109)
 Microphone level adjustment (P169)	

\*1 m: minute, s: second

\*2 This is displayed for about 5 seconds when the camera is turned on if the [Profile Setup] setting is set.

\*3 This is displayed for about 5 seconds when the camera is turned on, after setting the clock and after switching from Playback Mode to Recording Mode.

## In recording

## On-monitor recording information

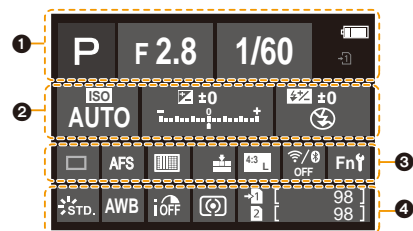

<b>1</b>		Recording Mode (P43)
	F2.8	Aperture value (P42)
	1/60	Shutter speed (P42)
		Battery indication (P22)
		Power is being supplied (P26)
		Card (displayed only during recording) (P29)

<b>2</b>		ISO sensitivity (P109)
	AUTO	ISO sensitivity (P109)
		Exposure compensation value (P107)
		Brightness (P69)
		Manual Exposure Assistance (P75)
		Flash Mode (P158)
		Flash (P159, 161)

<b>3</b>		Single (P114)
		Burst (P115)
		6K/4K Photo (P119)
		Post Focus (P130)
		Self-timer (P135)
		High-Res Mode (P196)
	AFS AFF AFC MF	Focus Mode (P89, 103)
		AF Mode (P92)
		Quality (P187)
		Picture size/Aspect Ratio (P186)
		Wi-Fi/Bluetooth (P250)
		Function button setting (P60)

<b>4</b>		Photo Style (P188)
		White Balance (P111)
		White Balance (P111)
		Intelligent Dynamic Range Control (P193)
		Metering Mode (P192)
		Relay recording (P229)
		Backup recording (P229)
		Allocation recording (P229)
	98	Number of recordable pictures (P31)
	r20	Maximum number of pictures that can be taken continuously (P117)
	r8m30s	Available recording time (P31)
	----	No card

## In playback

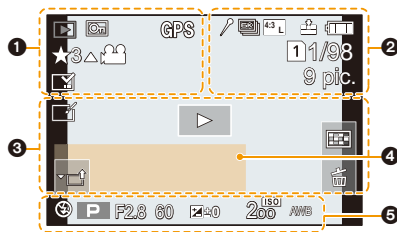

<b>1</b>		Playback Mode (P235)
		Protected picture (P236)
	<b>GPS</b>	Location Logging (P268)
		Rating (P236)
		Cable disconnect prohibit icon (P307)
		Motion picture playback (P177)
		Save pictures from the 6K/4K burst file (P125)
		Create pictures from an image recorded with the Post Focus function (P132)
		Continuous group picture playback (P182)
		Focus Bracket (P143, 181)
		Stamped with text indication (P243)
	8m30s	Elapsed playback time*1 (P177)
<b>2</b>		Icon indicating the presence of a marker (P127)
		6K/4K Photo (6K/4K burst file) (P119)
		Post Focus (P130)
		Focus Stacking (P133)
		High-Res Mode (P196)
		Picture size/Aspect Ratio (P186)
		Recording format/Recording quality (P166)

180fps	High speed video (P173)
	RAW Quality (P187)
	Battery indication (P22)
	Power is being supplied (P26)
<b>BG</b>	Battery Grip (P309)
	Card slot (P29)
1/98	Picture number/Total pictures
	Connected to Wi-Fi
9 pic.	Number of group pictures
8m30s	Motion picture recording time*1 (P177)
<b>3</b>	
	Clear Retouch completed icon (P242)
	Currently retrieving information icon
	Playback (Motion Pictures) (P177)
	Upload (Wi-Fi) (P280)
	Group Display (P182)
	Sub Menu (P280)
	Silent Mode (P198)
	Number of days that have passed since the departure date (P221)
	Multi Playback (P180)
	Delete (P183)
<b>4</b>	
Name*2	(P217, 219)
Location*2	(P221)
Title*2	(P237)
Age	(P217, 219)
<b>5</b>	
Recording information	
Time Stamp Recording	(P170)

## In playback

## Detailed information display

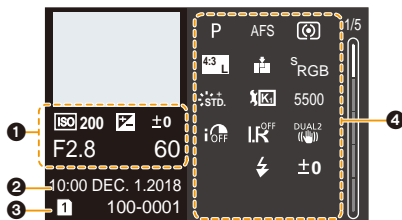

## Histogram display

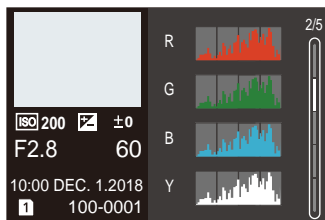

## Photo style, Highlight shadow display

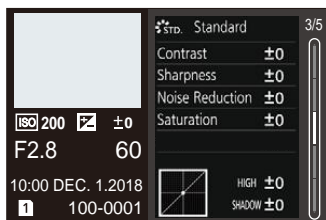

## White balance display

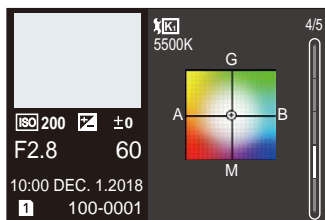

## Lens information display

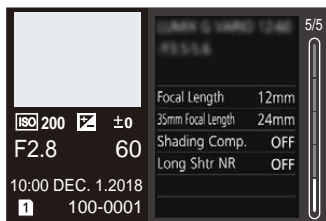

1

Recording information (basic)

2

Recorded date and time/World Time (P220)

3

1 2

Card slot (P29)

100-0001

Folder/File number (P302)

4

Recording information (advanced)

5500

White Balance Color Temperature (P112)

iOFF

Intelligent Dynamic Range Control (P193)

HDR ON

HDR (P201)/iHDR (P68)

iR OFF

Intelligent Resolution (P193)

\*1 m: minute, s: second

\*2 It is displayed in order of [Title], [Location], [Name] ([Baby1]/[Baby2], [Pet]), [Name] ([Face Recog.]).

## Status LCD Indications

The camera's recording information is displayed.

\*All pieces of information are shown here for explanatory purposes.

### In recording

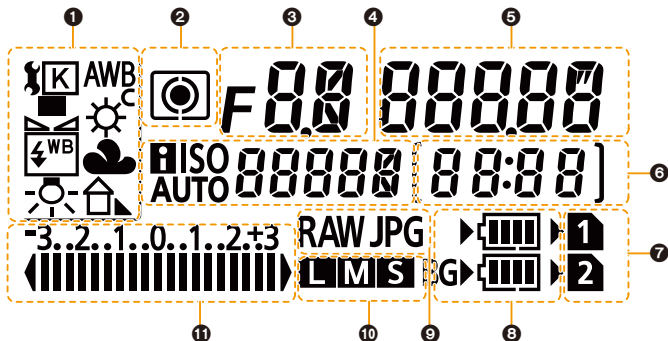

<b>1</b>	White Balance (P111)	<b>7</b>	Card slot (P29)
<b>2</b>	Metering Mode (P192)	<b>8</b>	Battery indication (P22)
<b>3</b>	Aperture value (P42)	<b>9</b>	Quality (P187)
<b>4</b>	ISO sensitivity (P109)	<b>10</b>	Picture size (P186) • This is not displayed when recording in [High Resolution Mode].
<b>5</b>	Shutter speed (P42)	<b>11</b>	Exposure compensation value (P107)/ Exposure Bracket (P142) • The status LCD displays an exposure compensation value ranging between -3 EV and +3 EV. Values outside this range are displayed as [ ◀   [ ▶ ].
<b>6</b>	Number of recordable pictures (P31)/ Maximum number of pictures that can be taken continuously (P117)/ Available recording time (P31) • [9999] is displayed if there are 10000 or more recordable pictures remaining. • If the remaining available recording time is 29 minutes and 59 seconds, it will be displayed as [29:59].		

**Battery level indicator**

- Ⓐ This indicates the power supply source.
- Ⓑ The battery level of the battery in the camera
- Ⓒ The battery level of the battery in the battery grip



- The battery level icon for the battery in the camera is not displayed when a AC adaptor (optional) is used.
- Recording information is not displayed on the status LCD while an image is being played back or a menu screen is being displayed.



## Message Display

Confirmation messages or error messages will be displayed on the screen in some cases. The major messages are described below as examples.

### **[Some pictures cannot be deleted]/[This picture cannot be deleted]**

- This feature can only be used with pictures that comply with the DCF standard. Perform formatting (P31) on this unit after saving necessary data on a PC, etc.

### **[Cannot be set on this picture]**

- [Title Edit], [Text Stamp], etc. cannot be set for pictures not based on the DCF standard.

### **[Memory Card Error Format this card?]**

- It is a format that cannot be used with this unit.
  - Insert a different card.
  - Format the card again with the camera after saving necessary data on a PC etc. (P31)  
Data will be deleted.

### **[The lens is not attached properly. Do not push lens release button while lens is attached.]**

- Detach the lens once, and then attach it again without pressing the lens release button. (P33)  
Turn this unit on again, and if it is still displaying, contact the dealer.

### **[Lens attachment failed. Please make sure the lens is attached correctly.]**

- Detach the lens from the camera body and gently wipe the contacts on the lens and the camera body using a dry cotton swab.  
Attach the lens, turn this unit on again, and if it is still displaying, contact the dealer.

### **[Memory Card Error]/[This memory card cannot be used]**

- Use a card compatible with this unit. (P30)

### **[Insert SD card again]/[Try another card]**

- An error has occurred accessing the card.  
Insert the card again.
- Insert a different card.

### **[Read Error/Write Error Please check the card]**

- It has failed to read or write data.  
Remove the card after turning this unit off. Insert the card again, turn this unit on, and try to read or write the data again.
- The card may be broken.
- Insert a different card.

**[Recording was cancelled due to the limitation of the writing speed of the card]**

- Depending on the [Rec Format] and [Rec Quality] of a motion picture, the speed class rating required for the card differs. 6K/4K photo recording requires a card that meets a particular speed class rating. Use a card that meets the rating. (P30)
- If the recording stops even when you are using a card that meets the speed class rating, the data writing speed is too slow. We recommend making a backup and then format the card (P31).

Depending on the type of the card, recording may stop in the middle.

**[A folder cannot be created]**

- A folder cannot be created because there are no remaining folder numbers that can be used. Format the card on this unit after saving necessary data on a PC etc. (P31)

If you execute [No.Reset] in the [Setup] menu after formatting, the folder number is reset to 100. (P230)

**[This battery cannot be used]**

- Use a genuine Panasonic battery. If this message is displayed even when a genuine Panasonic battery is used, contact the dealer or Panasonic.
- If the battery terminal is dirty, clean it and remove any objects.

**[Failed to connect wireless access point]/[Connection failed]/[No destination found]**

- The wireless access point information set on this unit is wrong.  
Check the authentication type and encryption key. (P287)
- Radio waves from other devices may block the connection to a wireless access point.  
Check the status of other devices that are connected to the wireless access point as well as the status of other wireless devices.

**[Connection failed. Please retry in a few minutes.]/[Network disconnected. Transfer stopped.]**

- Radio waves from the wireless access point are getting weak.  
Perform the connection closer to the wireless access point.
- Depending on the wireless access point, connection may be automatically disconnected after specific time has passed.  
Reconnect the connection again.

**[Connection failed]**

- Change the access point to connect to in the smartphone Wi-Fi settings to this camera.

# Troubleshooting

First, try out the following procedures ([P323](#) to [P331](#)).

**If the problem is not resolved, it may be improved by selecting [Reset] ([P231](#)) on the [Setup] menu.**

## When I shake the camera, I hear a rattling sound from the camera.

The sound is caused by the In-Body Image Stabilizer. This is not a malfunction.

## Recording stops before finishing. Cannot record. Cannot use some functions.

- When the ambient temperature is high or continuous recording is performed, the camera's temperature will rise. After [, ] is displayed, recording may stop or the functions below may be temporarily disabled to protect the camera. Wait until the camera cools down.
  - [6K/4K PHOTO]
  - [Post Focus]
  - [Motion Picture]
  - [AF-Point Scope]
  - HDMI output
  - Power supply via the USB connection cable

## Battery and power source

### The camera cannot be operated even when it is turned on.

### The camera turns off immediately after it is turned on.

- The battery is exhausted. Charge the battery. ([P21](#))

### This unit is turned off automatically.

- [Economy] is enabled. ([P223](#))

### The battery becomes flat too quickly.

- When [6K/4K Pre-Burst] or [Pre-Burst Recording] is set, the battery drains faster.
  - Use these functions only when recording with them.
- Is a Wi-Fi connection being used for a long period of time?
  - The battery can become flat quickly when connected to Wi-Fi.
  - Turn the camera off frequently by using the [Economy] etc. ([P223](#))

## Recording

### Taking pictures is not possible.

#### The shutter will not operate immediately when the shutter button is pressed.

- Is [Focus/Release Priority] in the [Custom] menu set to [FOCUS]? (P209)  
You cannot take a picture until the subject is brought into focus.

### The recorded picture is whitish.

- Picture might look whitish when lens or image sensor gets dirty with fingerprints or similar.  
→ If the lens is dirty turn the camera off and then gently wipe the lens surface with a soft, dry cloth.  
→ Refer to P333 when the image sensor gets dirty.

### The recorded picture is too bright or dark.

- Is the AE Lock (P106) applied incorrectly?

### Multiple pictures are taken at one time.

- Check the drive mode setting. (P114)
- Are you using the bracket function? (P141)

### The subject is not focused properly.

- The subject is beyond the focus range of the camera.
- Is [Shutter AF] in the [Custom] menu set to [OFF]? (P207)
- Is [Focus/Release Priority] in the [Custom] menu set to [RELEASE]? (P209)
- Is the AF Lock (P106) applied incorrectly?

### The recorded picture is blurred.

#### The Image Stabilizer is not effective.

- The shutter speed will become slower and the Image Stabilizer function may not work properly when taking pictures especially in dark places.  
→ We recommend using a tripod and the self-timer when taking pictures with a slow shutter speed.

### The recorded picture looks rough.

#### Noise appears on the picture.

- Try the following:  
→ Decrease the ISO sensitivity. (P109)  
→ Increase the setting for [Noise Reduction] in [Photo Style] or lower the setting for each of the items other than [Noise Reduction]. (P189)  
→ Set the [Long Shtr NR] to [ON]. (P195)

### The subject appears distorted on the picture.

- If you record a moving subject when using the electronic shutter or recording motion picture or a 6K/4K photo, the subject may appear distorted on the picture. This is characteristic of MOS sensors which serve as the camera's pickup sensors. This is not a malfunction.

### Striping or flicker may appear under lighting such as fluorescent lighting and LED lighting fixture.

- This is characteristic of MOS sensors which serve as the camera's pickup sensors. This is not a malfunction.
- When using the electronic shutter (P199), lowering the shutter speed may reduce the effect of the horizontal stripes.
- If noticeable flicker or striping is seen under lighting such as a fluorescent or LED lighting fixture when recording motion pictures, set [Flkr Decrease] (P203). It can reduce the flicker or striping by allowing you to set a fixed shutter speed. You can set the shutter speed manually in the Creative Video Mode. (P171)



### Stripes appear in high ISO sensitivity.

- Stripes may appear in high ISO sensitivity or depending on the lens you use.  
→ Decrease the ISO sensitivity. (P109)

### The brightness or the hue of the recorded picture is different from the actual scene.

- When recording under fluorescent or LED lighting fixture, etc., increasing the shutter speed may introduce slight changes to brightness and color. These are a result of the characteristics of the light source and do not indicate a malfunction.
- When recording subjects in extremely bright locations or recording under fluorescent lighting, LED lighting fixture, mercury lamp, sodium lighting, etc., the colors and screen brightness may change or horizontal striping may appear on the screen.

### Bright spot not in subject is recorded.

- There may be defective pixels in the image sensor.  
→ Perform [Pixel Refresh] (P231).

### Cannot set [Silent Mode] to [OFF].

- At the time of purchase, [Silent Mode] is assigned to the function lever. If the function lever is set to [MODE2], change the setting to [MODE1]. (P48)

## Motion pictures

### Recording motion pictures is not possible.

- You may not be able to record for a short while after turning this unit on when using a large capacity card.

### Motion picture recording stops in the middle.

- Depending on the [Rec Format] and [Rec Quality] of a motion picture, the speed class rating required for the card differs. Use a card that meets the rating. (P30)

### In motion pictures, abnormal clicking and buzzing sounds are recorded. The recorded sound is very quiet.

- With recording in a quiet environment, depending on the lenses used, the sound of aperture and focus actions may be recorded in motion pictures.  
Focus operation can be set to [OFF] in [Continuous AF] (P167).
- While recording motion pictures, plugging the aperture of the microphone with a finger may reduce the level of audio recording or audio may not record at all. Also be careful because the operation sound of lenses can easily be recorded at this time.

### An operation sound is recorded in a motion picture.

- We recommend recording in Creative Video Mode if you are concerned about operational sounds. (P172)

## Flash

### The flash is not activated.

- When the electronic shutter is used, the flash is not activated. (P199)
- When [Silent Mode] is set to [ON], the flash is not activated. (P198)

## Monitor/Viewfinder

### The Monitor/Viewfinder turns off although the camera is turned on.

- If no operations are performed during the set time period, [Auto LVF/Monitor Off] (P223) is activated, and the Monitor/Viewfinder turns off.
- When an object or your hand is positioned near the eye sensor, the Monitor display may switch to the Viewfinder display.

### It may flicker for an instant or the brightness of the screen may change significantly for an instant.

- This occurs due to the aperture of the lens changing when the shutter button is pressed halfway, or when the brightness of the subject changes. This is not a malfunction.

### Monitor and viewfinder do not switch when [LVF] is pressed.

- It is only displayed on the monitor when the camera is connected to a PC or printer.

### Unevenly bright parts or irregular colors appear on the Viewfinder.

- Viewfinder of this unit adopts OLED. Screen burn-in may occur on the screen/viewfinder when a same image is displayed for a long period of time, but it does not affect the recorded images.

### The color tone of the viewfinder differs from the actual tone.



- Being a characteristic of the viewfinder of this unit, this phenomenon is not a problem. Recorded images are not affected.

## Playback

### The picture is not played back. There are no recorded pictures.

- Is the card inserted?
- Is this a folder or picture which was processed in the PC?  
If it is, it cannot be played back by this unit.  
→ It is recommended to use the software "PHOTOfunSTUDIO" to write pictures from PC to card.
- Has [Playback Mode] been set for playback?  
→ Change to [Normal Play]. (P235)

### Red part of the recorded image has changed color to black.

- When Red-Eye Removal ([] or []) is performed, red parts may be corrected to black.  
→ We recommend recording images with Flash Mode set to [] or [Red-Eye Removal] set to [OFF]. (P194)

## Wi-Fi function

**A Wi-Fi connection cannot be established.  
Radio waves get disconnected.  
Wireless access point is not displayed.**

### ■ General tips for using a Wi-Fi connection

- Use within the communication range of the device to be connected.
- Is any device, such as microwave oven, cordless phone, etc., that uses 2.4 GHz frequency operated nearby?
  - Radio waves may get interrupted when used simultaneously. Use them sufficiently away from the device.
- When the battery indicator is flashing red, the connection with other equipment may not start or the connection may be disrupted.  
(A message such as [Communication error] is displayed.)
- If you place the camera on a metal table or shelf, the radio waves may be adversely affected. In such cases, you may not be able to establish a connection. Move the camera away from the metal surface.

### ■ About a wireless access point

- Check if the wireless access point to connect is in operating state.
- Check the radio wave condition of the wireless access point.
  - Move this unit closer to the wireless access point.
  - Change the location and orientation of the wireless access point.
- It may not display even if the radio waves exist depending on the setting of the wireless access point.
  - Turn off and on the wireless access point.
  - Check the settings of the wireless access point.
  - When the network SSID of the wireless access point is set not to broadcast, the wireless access point may not be detected. Enter the network SSID to start the connection (P287) or enable the SSID broadcast of the wireless access point.

**This unit is not displayed in the Wi-Fi setting screen of the smartphone.**

- From the Wi-Fi setting menu on the smartphone, turn off and then on the Wi-Fi function.

**When I try to set up a Wi-Fi connection with a Windows 8 PC, my user name and password are not recognized, so I cannot connect to the PC.**

- Some OS versions, including Windows 8, use two types of accounts: a local account and a Microsoft account.  
Be sure to use the user name and password for the local account.



**The PC is not recognized when I use a Wi-Fi connection. The camera cannot be connected to PC via Wi-Fi connection.**

- The default workgroup name is set to "WORKGROUP". If you changed the workgroup name, the PC will not be recognized.  
In [PC Connection] of the [Wi-Fi Setup] menu, change the workgroup name to that of the PC you are connecting to. (P291)
- Please confirm login name and password are correctly typed.
- When the system time of Mac computer or Windows PC connected to a camera differs severely from that of the camera, the camera cannot be connected to the computer or PC in some OSs.  
→ Please confirm [Clock Set] and [World Time] of the camera matches with time, date and time zone in Windows PC or Mac computer. When both settings do not match severely, please match them.

**Images cannot be transmitted to the web service.**

- Confirm that the login information (login ID/user name/email address/password) is correct.

**It takes time to transmit an image to the web service.****Transmission of the image fails midway. Some images cannot be transmitted.**

- Is the size of the image too large?  
→ Reduce the image size at [Size] (P272), and then send.  
→ Transmit after dividing the motion picture with [Video Divide] (P247).
- It may take longer time to transmit when distance to the wireless access point is far.  
→ Transmit closer to the wireless access point.
- File format of the motion picture that can be sent differs depending on the destination. (P271)

**I have forgotten the password for the Wi-Fi.**

- Execute the [Reset Network Settings] in the [Setup] menu. (P231)  
However, all the information you have set on the [Wi-Fi Setup] menu and [Bluetooth] menu will be reset. (excluding [LUMIX CLUB])

## TV, PC and printer

### The picture does not appear on the television.

- Is the camera connected to the TV correctly? (P294)  
→ Set the TV input to external input mode.

### VIERA Link does not work.

- Is the [VIERA Link] on this unit set to [ON]? (P227)  
→ Check the VIERA Link setting on the connected device.  
→ Turn this unit off and on.

### Cannot communicate with the PC.

- Set to [PC(Storage)] in [USB Mode]. (P226)
- Turn this unit off and on.

### The card is not recognized by the PC. (SDXC memory card is used.)

- Check if your PC is compatible with SDXC memory cards.
- A message prompting to format the card may be displayed when connecting, but do not format.
- If the [Access] displayed on the monitor does not disappear, disconnect the USB connection cable after turning this unit off.

### The picture cannot be printed when the camera is connected to a printer.

- Pictures cannot be printed using a printer that does not support PictBridge.
- Set to [PictBridge(PTP)] in [USB Mode]. (P226)

### The ends of the pictures are cut at printing.

- When using a printer with a Cropping or borderless printing function, cancel this function before printing.  
(For details, refer to the operating instructions for the printer.)
- When you order photo studios to print pictures, ask the photo studio if the 16:9 pictures can be printed.

## Others

### When I shake the camera, I hear a rattling sound from the attached lens.

- Depending on the lens you attach, it may move inside and create a sound. This is not a malfunction.

### The camera makes a noise when this unit is turned on.

- This is the noise of the Dust Reduction Function working (P333); it is not a malfunction.

### There is a sound from lens unit.

- It is a sound of lens movement or aperture operation when this unit is turned on or off, and it is not a malfunction.
- The sound, which is caused by the automatic adjustment of the aperture, is heard when the brightness has changed due to, for example, zooming or the movement of the camera. This is not a malfunction.

### An unreadable language was selected by mistake.

- Press [MENU/SET], select the [Setup] menu icon [🔧] and then select the [30] icon to set the desired language. (P227)

### A red lamp sometimes turns on when the shutter button is pressed halfway.

- In dark places, the AF Assist Lamp (P208) lights red to make it easier to focus on a subject.

### The camera becomes warm.

- The surface of the camera and the reverse side of the monitor may become warm during use. This does not affect the performance or quality of the camera.

### The clock is reset.

- If you do not use the camera for a long time, the clock may be reset.  
→ [Please set the clock] message will be displayed; please reset the clock. (P38)

## Cautions for Use

### Optimal use of the camera

**Keep this unit as far away as possible from electromagnetic equipment (such as microwave ovens, TVs, video games etc.).**

- If you use this unit on top of or near a TV, the pictures and/or sound on this unit may be disrupted by electromagnetic wave radiation.
- Do not use this unit near cell phones because doing so may result in noise adversely affecting the pictures and/or sound.
- Recorded data may be damaged, or pictures may be distorted, by strong magnetic fields created by speakers or large motors.
- Electromagnetic wave radiation may adversely affect this unit, disturbing the pictures and/or sound.
- If this unit is adversely affected by electromagnetic equipment and stops functioning properly, turn this unit off and remove the battery or disconnect AC adaptor. Then reinsert the battery or reconnect AC adaptor and turn this unit on.

**Do not use this unit near radio transmitters or high-voltage lines.**

- If you record near radio transmitters or high-voltage lines, the recorded pictures and/or sound may be adversely affected.

**Always use the supplied cords and cables.**

**If you use optional accessories, use the cords and the cables supplied with them.**

**Do not extend the cords or the cables.**

**Do not spray the camera with insecticides or volatile chemicals.**

- If the camera is sprayed with such chemicals, the body of the camera may be damaged and the surface finish may peel off.

**Do not keep rubber or plastic products in contact with the camera for a long period of time.**

### When using in a cold climate or at low temperatures

- It may cause injury to the skin if you directly touch the metal parts of the unit in places where temperature is very low (environments under 0 °C (32 °F), such as ski resorts or places at high altitude) for a long period of time.  
Use gloves or similar when using it for long periods.
- The performance of the battery (number of recordable pictures/operating time) may decrease temporarily when using in a temperature between -10 °C and 0 °C (14 °F and 32 °F) (cold places such as ski resorts or places at high altitude).
- The battery cannot be recharged in a temperature less than 0 °C (32 °F). (The [CHARGE] indicator blinks when the battery cannot be recharged.)
- If the camera is used in cold places such as ski resorts or places at high altitude with snow or water droplets adhered to the camera, some parts of the camera may become hard to move or the sound may become dim with snow or water droplets freezing in the gap of the camera on/off switch, speakers, and microphone. This is not a malfunction.

### Cleaning

**Before cleaning the camera, remove the battery or the DC coupler (optional), or disconnect the power plug from the outlet. Then wipe the camera with a dry, soft cloth.**

- When the camera is soiled badly, it can be cleaned by wiping the dirt off with a wrung wet cloth, and then with a dry cloth.
- Do not use solvents such as benzine, thinner, alcohol, kitchen detergents, etc., to clean the camera, since it may deteriorate the external case or the coating may peel off.
- When using a chemical cloth, be sure to follow the accompanying instructions.

#### ■ About dirt on the image sensor

This camera features an interchangeable lens system so dirt may get inside the camera body when changing lenses. Depending on the recording conditions, dirt on the image sensor may appear on the recorded picture.

To prevent debris or dust adhering to internal parts of the body, avoid changing the lens in a dusty environment and always fit the body cap or a lens when storing the camera. Remove any dirt on the body cap before attaching it.

#### Dust reduction function

This unit has a dust reduction function that will blow off the debris and dust that have affixed to the front of the imaging device.

This function will function automatically when the camera is turned on, but if you see dust, perform the [Sensor Cleaning] in the [Setup] menu.

### Removing dirt on the image sensor

The image sensor is very precise and delicate, so be sure to observe the following when you do have to clean it yourself.

- Blow off the dust on the surface of the image sensor with a commercially available blower brush. Be careful not to blow too strongly.
- Do not put the blower brush further inside than the lens mount.
- Do not let the blower brush touch the image sensor as the image sensor may get scratched.
- Do not use any objects except a blower brush to clean the image sensor.
- If you cannot remove the dirt or dust with the blower, consult the dealer or Panasonic.

### ■ For care of the viewfinder/Eye cup

- Before you remove stains on the viewfinder and eye cup or start other types of cleaning, remove the eye cup (1). Blow away the dust on the viewfinder surface with a blower (commercially available), and wipe the surface lightly with a dry, soft cloth. Attach the eye cup after the cleaning (2).

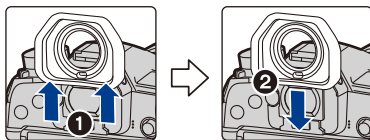

- Be careful not to lose the eye cup.
- Keep the eye cup out of reach of children to prevent swallowing.

### About the Monitor/Viewfinder

- Do not press the monitor with excessive force. Uneven colors may appear on the monitor and it may malfunction.
- If the camera is cold when you turn it on, the picture on the Monitor/Viewfinder will be slightly darker than usual at first. However, the picture will return to normal brightness when the internal temperature of the camera increases.

**Extremely high precision technology is employed to produce the Monitor/Viewfinder screen. However there may be some dark or bright spots (red, blue or green) on the screen. This is not a malfunction. Though the Monitor/Viewfinder screen parts are produced with highly controlled precision technology, some pixels may be inactive or always lit. The spots will not be recorded on pictures on a card.**

## About the Lens

- Do not press the lens with excessive force.
- Do not leave the camera with the lens facing the sun as rays of light from the sun may cause it to malfunction. Also, be careful when placing the camera outside or near a window.
- When there is dirt (water, oil, and fingerprints, etc.) on the surface of the lens, the picture may be affected. Lightly wipe the surface of the lens with a soft, dry cloth before and after taking pictures.
- To prevent dust and other particles from accumulating on or entering the lens, attach the lens rear cap when the lens is not in use.
- To protect the lens contact points (A), do not place the lens with its mount surface facing down. In addition, do not allow the lens contact points to become dirty.
- To improve the dust- and splash-proof performance, the mount of the interchangeable lens (H-ES12060/H-FS12060) is embedded with the lens mount rubber. If you change the lens repeatedly, friction with the lens mount rubber may leave scratches on the camera's mount. However, those scratches do not affect the performance of this unit. For the replacement of the lens mount rubber, contact Panasonic.

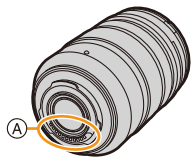

## Battery

**The battery is a rechargeable lithium ion battery. Its ability to generate power comes from the chemical reaction that takes place inside it. This reaction is susceptible to the surrounding temperature and humidity. If the temperature is too high or too low, the operating time of the battery will become shorter.**

**Always remove the battery after use.**

- Place the removed battery in a plastic bag, and store or keep away from metallic objects (clips, etc.).

**If you drop the battery accidentally, check to see if the body of the battery and the terminals are damaged.**

- Inserting a damaged battery in the camera will damage the camera.

**Bring charged spare batteries when going out.**

- Be aware that the operating time of the battery becomes shorter in low temperature conditions such as at a ski resort.
- When you travel, do not forget to bring the battery charger (supplied), AC adaptor (supplied) and the USB connection cable (for charger) so that you can charge the battery in the country that you are traveling in.

**Dispose of unusable battery.**

- The battery has a limited life.
- Do not throw the battery into fire because it may cause an explosion.
- The unusable battery should be discarded in accordance with battery recycling laws. Call the RBRC hotline at 1-800-822-8837 for information.

**Do not allow battery terminals to come into contact with metal objects (such as necklaces, hairpins, etc.).**

- This can cause short-circuiting or heat generation and you may be badly burned if you touch a battery.

### About the Charger/AC adaptor (supplied)

- The [CHARGE] indicator may blink under the influence of static electricity or electromagnetic wave. This phenomenon has no effects on charging.
- If you use the AC adaptor (supplied) near a radio, the radio reception may be disturbed. Keep the AC adaptor (supplied) 1 m (3.3 feet) or further away from radios.
- The AC adaptor (supplied) may generate whirring sounds when it is being used. This is not a malfunction.
- After use, be sure to disconnect the power supply device from the electrical outlet. (A very small amount of current is consumed if it is left connected.)
- Keep the terminals of the charger and battery clean.

### Card

**Do not leave the card where the temperature is high, where electromagnetic waves or static electricity are easily generated or exposed to direct sunlight.**

**Do not bend or drop the card.**

- The card may be damaged or the recorded content may be damaged or deleted.
- Put the card in the card case or the storage bag after use and when storing or carrying the card.
- Do not allow dirt, dust, or water to get into the terminals on the back of the card and do not touch the terminals with your fingers.

**Notice for when transferring to another party, or disposing of the memory card**

**Format or delete using the camera or a PC will only modify the file management information, it will not erase the data in the memory card completely.**

**It is recommended to physically destroy the memory card or use the commercially available computer data deletion software to completely erase the data in the memory card before transferring to another party or disposing.**

**Management of data in the memory card is the responsibility of the user.**



## About the personal information

If a name or birthday is set for [Profile Setup]/Face Recognition function, this personal information is kept in the camera and recorded in the image.

We recommend that you enable [Wi-Fi Password] and [Wi-Fi Function Lock] to protect personal information. (P291 , 292)

### Disclaimer

- Information including personal information may be altered or vanish due to erroneous operation, effect of static electricity, accident, malfunction, repair, or other handlings. Please note in advance that Panasonic is not liable in any way for any direct or indirect damage from the alteration or vanishing of information or personal information.

### When requesting a repair, transferring to another party, or disposing.

- After making a copy of personal information, always delete information such as personal information and wireless LAN connection settings that you have saved within the camera with [Reset Network Settings]/[Delete account] (P231, 284).
- Reset the settings to protect the personal information. (P231)
- Remove the memory card from the camera when requesting a repair.
- Settings may return to factory default when camera is repaired.
- Please contact the dealer where you purchased the camera or Panasonic if above operations are not possible due to malfunction.

**When transferring to another party, or disposing of the memory card, please refer to “Notice for when transferring to another party, or disposing of the memory card”.** (P336)

### When uploading images on web services

- Images may contain information that can be used for identifying individuals such as titles, recording dates, and location information. When uploading images on web services, check carefully, and then upload.

## When not using the camera for a long period of time

- Store the battery in a cool and dry place with a relatively stable temperature: (Recommended temperature: 15 °C to 25 °C (59 °F to 77 °F), Recommended humidity: 40%RH to 60%RH)
- Always remove the battery and the card from the camera.
- If the battery is left inserted in the camera, it will discharge even if the camera is turned off. If the battery continues to be left in the camera, it will discharge excessively and may become unusable even if charged.
- When storing the battery for a long period of time, we recommend charging it once a year. Remove the battery from the camera and store it again after it has completely discharged.
- We recommend storing the camera with a desiccant (silica gel) when you keep it in a closet or a cabinet.
- Check all the parts before taking pictures when you have not used the camera for a long period of time.

### About the picture data

- Recorded data may be damaged or lost if the camera breaks down due to inappropriate handling. Panasonic will not be liable for any damage caused due to loss of recorded data.

### About tripods or unipods

- When you use a tripod, make sure the tripod is stable when this unit is attached to it.
- You may not be able to remove the card or the battery when using a tripod or unipod.
- Make sure that the screw on the tripod or unipod is not at an angle when attaching or detaching the camera. You may damage the screw on the camera if you use excessive force when turning it. Also, the camera body and the rating label may be damaged or scratched if the camera is attached too tightly to the tripod or unipod.
- When using this unit with a large-diameter lens, the lens may come into contact with the pedestal depending on the tripod/unipod. Tightening the screw with the lens and pedestal in contact with each other may damage this unit or the lens. Therefore it is recommended to attach the tripod adaptor (DMW-TA1: optional) before mounting on the tripod/unipod.
- Read the operating instructions for the tripod or unipod carefully.

### About the shoulder strap

- If you attach a heavy interchangeable lens (more than about 1 kg/35.3 oz) to the camera body, do not carry the camera by the shoulder strap.  
Hold the camera and the lens when carrying them.



## Wi-Fi function

### ■ Use the camera as a wireless LAN device

When using equipment or computer systems that require more reliable security than wireless LAN devices, ensure that the appropriate measures are taken for safety designs and defects for the systems used. Panasonic will not take any responsibility for any damage that arises when using the camera for any purpose other than as a wireless LAN device.

### ■ Use of the Wi-Fi function of this camera is presumed to be in countries where this camera is sold

There is the risk that the camera violates the radio wave regulations if used in countries other than those where this camera is sold, and Panasonic takes no responsibility for any violations.

### ■ There is the risk that data sent and received via radio waves may be intercepted

Please note that there is the risk that data sent and received via radio waves may be intercepted by a third party.

### ■ Do not use the camera in areas with magnetic fields, static electricity or interference

- Do not use the camera in areas with magnetic fields, static electricity or interference, such as near microwave ovens. These may cause the interruption of the radio waves.
- Using the camera near devices such as microwave ovens or cordless telephones that use the 2.4 GHz radio wave band may cause a decrease in performance in both devices.

### ■ Do not connect to the wireless network you are not authorized to use

When the camera utilizes its Wi-Fi function, wireless networks will be searched automatically. When this happens, wireless networks that you are not authorized to use (SSID\*) may be displayed, however do not attempt to connect to the network as it may be considered as unauthorized access.

- \* SSID refers to the name that is used to identify a network over a wireless LAN connection. If the SSID matches for both devices, transmission is possible.

- G MICRO SYSTEM is a lens exchange type digital camera system of LUMIX based on a Micro Four Thirds System standard.
- Micro Four Thirds™ and Micro Four Thirds Logo marks are trademarks or registered trademarks of Olympus Corporation, in Japan, the United States, the European Union and other countries.
- Four Thirds™ and Four Thirds Logo marks are trademarks or registered trademarks of Olympus Corporation, in Japan, the United States, the European Union and other countries.
- SDXC Logo is a trademark of SD-3C, LLC.
- The terms HDMI and HDMI High-Definition Multimedia Interface, and the HDMI Logo are trademarks or registered trademarks of HDMI Licensing Administrator, Inc. in the United States and other countries.
- “AVCHD”, “AVCHD Progressive” and the “AVCHD Progressive” logo are trademarks of Panasonic Corporation and Sony Corporation.
- Dolby, Dolby Audio, and the double-D symbol are trademarks of Dolby Laboratories.
- HDAVI Control™ is a trademark of Panasonic Corporation.
- Adobe is a trademark or registered trademark of Adobe Systems Incorporated in the United States and/or other countries.
- Pentium is a trademark of Intel Corporation in the U.S. and/or other countries.
- Windows is a registered trademark or trademark of Microsoft Corporation in the United States and/or other countries.
- iMovie, Mac, OS X and macOS are trademarks of Apple Inc., registered in the U.S. and other countries.
- iPad, iPhone, iPod, and iPod touch are trademarks of Apple Inc., registered in the U.S. and other countries.
- App Store is a service mark of Apple Inc.
- Android and Google Play are trademarks or registered trademarks of Google Inc.



- The Bluetooth® word mark and logos are registered trademarks owned by the Bluetooth SIG, Inc. and any use of such marks by Panasonic Corporation is under license. Other trademarks and trade names are those of their respective owners.
- The Wi-Fi CERTIFIED™ Logo is a certification mark of Wi-Fi Alliance®.
- The Wi-Fi Protected Setup™ Logo is a certification mark of Wi-Fi Alliance®.
- “Wi-Fi®” is a registered trademarks of Wi-Fi Alliance®.
- “Wi-Fi Protected Setup™”, “WPA™”, and “WPA2™” are trademarks of Wi-Fi Alliance®.
- DLNA, the DLNA Logo and DLNA CERTIFIED are trademarks, service marks, or certification marks of the Digital Living Network Alliance.
- This product uses “DynaFont” from DynaComware Corporation. DynaFont is a registered trademark of DynaComware Taiwan Inc.
- QR Code is a registered trademark of DENSO WAVE INCORPORATED.
- Other names of systems and products mentioned in these instructions are usually the registered trademarks or trademarks of the manufacturers who developed the system or product concerned.



This product is licensed under the AVC Patent Portfolio License for the personal use of a consumer or other uses in which it does not receive remuneration to (i) encode video in compliance with the AVC Standard (“AVC Video”) and/or (ii) decode AVC Video that was encoded by a consumer engaged in a personal activity and/or was obtained from a video provider licensed to provide AVC Video. No license is granted or shall be implied for any other use. Additional information may be obtained from MPEG LA, L.L.C.

See <http://www.mpegla.com>