

# Panasonic®

## Basic Owner's Manual Digital Camera

Model No. **DMC-FZ70**

LUMIX

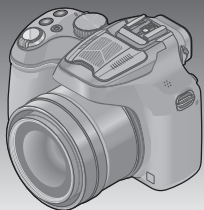

Please read these instructions carefully before using this product, and save this manual for future use.



More detailed instructions on the operation of this camera are contained in "Owner's Manual for advanced features (PDF format)" in the supplied CD-ROM. Install it on your PC to read it.



Register online at [www.panasonic.com/register](http://www.panasonic.com/register) (U.S. customers only)

For USA and Puerto Rico assistance, please call: 1-800-211-PANA(7262) or, contact us via the web at: <http://www.panasonic.com/contactinfo>

P



VQT5B59  
M0713KZ0

**Dear Customer,  
Thank you for choosing Panasonic!**

You have purchased one of the most sophisticated and reliable products on the market today. Used properly, we're sure it will bring you and your family years of enjoyment. Please take time to fill in the information below. The serial number is on the tag located on the underside of your camera. Be sure to **retain this manual** as your convenient camera information source.

Date of Purchase	Dealer Phone No.
Dealer Purchased From	Model No.
Dealer Address	Serial No.

Please note that the actual controls and components, menu items, etc. of your Digital Camera may look somewhat different from those shown in the illustrations in this Owner's Manual.

**Carefully observe copyright laws.**

- Recording of pre-recorded tapes or discs or other published or broadcast material for purposes other than your own private use may infringe copyright laws. Even for the purpose of private use, recording of certain material may be restricted.



A lithium ion battery that is recyclable powers the product you have purchased. Please call 1-800-8-BATTERY for information on how to recycle this battery.

### **WARNING:**

To reduce the risk of fire, electric shock or product damage,

- Do not expose this unit to rain, moisture, dripping or splashing.
- Use only the recommended accessories.
- Do not remove covers.
- Do not repair this unit by yourself. Refer servicing to qualified service personnel.

The socket outlet shall be installed near the equipment and shall be easily accessible.

### ■ Product identification marking

Product	Location
Digital camera	Bottom
Battery charger	Bottom

**FCC Note:**

This equipment has been tested and found to comply with the limits for a Class B digital device, pursuant to Part 15 of the FCC Rules. These limits are designed to provide reasonable protection against harmful interference in a residential installation. This equipment generates, uses, and can radiate radio frequency energy and, if not installed and used in accordance with the instructions, may cause harmful interference to radio communications. However, there is no guarantee that interference will not occur in a particular installation. If this equipment does cause harmful interference to radio or television reception, which can be determined by turning the equipment off and on, the user is encouraged to try to correct the interference by one or more of the following measures:

- Reorient or relocate the receiving antenna.
- Increase the separation between the equipment and receiver.
- Connect the equipment into an outlet on a circuit different from that to which the receiver is connected.
- Consult the dealer or an experienced radio/TV technician for help.

**FCC Caution:** To assure continued compliance, follow the attached installation instructions and use only shielded interface cables with ferrite core when connecting to computer or peripheral devices.

Any changes or modifications not expressly approved by the party responsible for compliance could void the user's authority to operate this equipment.

**Declaration of Conformity**

**Trade Name:** Panasonic

**Model No.:** DMC-FZ70

Responsible Party: Panasonic Corporation of North America

Two Riverfront Plaza, Newark, NJ 07102-5490

Support Contact Telephone No.: 1-800-211-PANA (7262)

This device complies with Part 15 of the FCC Rules. Operation is subject to the following two conditions: (1) This device may not cause harmful interference, and (2) this device must accept any interference received, including interference that may cause undesired operation.



## ■ About the battery pack

### **CAUTION**

Battery pack (Lithium ion battery pack)

- Use the specified unit to recharge the battery pack.
- Do not use the battery pack with equipment other than the specified unit.
- Do not get dirt, sand, liquids, or other foreign matter on the terminals.
- Do not touch the plug terminals (+ and -) with metal objects.
- Do not disassemble, remodel, heat or throw into fire.

If any electrolyte should come into contact with your hands or clothes, wash it off thoroughly with water.

If any electrolyte should come into contact with your eyes, never rub the eyes. Rinse eyes thoroughly with water, and then consult a doctor.

### **CAUTION**

- Danger of explosion if battery is incorrectly replaced. Replace only with the type recommended by the manufacturer.
- When disposing the batteries, please contact your local authorities or dealer and ask for the correct method of disposal.

- Do not heat or expose to flame.
- Do not leave the battery(ies) in a car exposed to direct sunlight for a long period of time with doors and windows closed.

### **Warning**

Risk of fire, explosion and burns. Do not disassemble, heat above 60 °C (140 °F) or incinerate.

## ■ About the battery charger

### **CAUTION!**

To reduce the risk of fire, electric shock or product damage,

- Do not install or place this unit in a bookcase, built-in cabinet or in another confined space. Ensure this unit is well ventilated.

### **Battery charger**

This battery charger operates on AC between 110V and 240V.

But

- In the U.S.A. and Canada, the battery charger must be connected to a 120V AC power supply only.
- When connecting to an AC supply outside of the U.S.A. or Canada, use a plug adaptor to suit the AC outlet configuration.

## ■ Cautions for Use

- Do not use any other USB connection cables except the supplied one or a genuine Panasonic USB connection cable (DMW-USBC1: optional).
- Use a "High Speed HDMI mini cable" with the HDMI logo.  
Cables that do not comply with the HDMI standards will not work.  
"High Speed HDMI mini cable" (Type C-Type A plug, up to 3 m (9.8 feet) long)
- Always use a genuine Panasonic AV cable (DMW-AVC1: optional).

### **Keep this unit as far away as possible from electromagnetic equipment (such as microwave ovens, TVs, video games etc.).**

- If you use this unit on top of or near a TV, the pictures and/or sound on this unit may be disrupted by electromagnetic wave radiation.
- Do not use this unit near cell phones because doing so may result in noise adversely affecting the pictures and/or sound.
- Recorded data may be damaged, or pictures may be distorted, by strong magnetic fields created by speakers or large motors.
- Electromagnetic wave radiation generated by microprocessors may adversely affect this unit, disturbing the pictures and/or sound.
- If this unit is adversely affected by electromagnetic equipment and stops functioning properly, turn this unit off and remove the battery or disconnect AC adaptor (DMW-AC8PP: optional). Then reinsert the battery or reconnect AC adaptor and turn this unit on.

### **Do not use this unit near radio transmitters or high-voltage lines.**

- If you record near radio transmitters or high-voltage lines, the recorded pictures and/or sound may be adversely affected.

## Contents

Information for Your Safety ....	3	Using the rear dial .....	20
Care of the camera .....	8	Setting the menu .....	21
Standard accessories .....	9	Reading the Owner's Manual (PDF format).....	22
Names and Functions of Main Parts .....	10	Keeping the pictures on your PC.....	23
Attaching the lens cap/ shoulder strap.....	12	Specifications .....	25
Charging the battery .....	13	Digital Camera Accessory System.....	28
Inserting and removing the card (optional)/the battery ....	14	Digital Camera Accessory Order Form.....	29
Sequence of operations.....	15	Limited Warranty (ONLY FOR U.S.A. AND PUERTO RICO) .....	30
Taking pictures with automatic settings [Intelligent Auto] Mode.....	17		
Taking Pictures with different picture effects [Creative Control] Mode.....	19		

## Care of the camera

### ■ Camera handling



**Keep the camera away from excessive vibration, force, or pressure.**

- Avoid using the camera under the following conditions, which may damage the lens, LCD monitor, viewfinder, or camera body. This may also cause the camera to malfunction or prevent recording.

- Dropping or hitting the camera against a hard surface
- Pushing with excessive force on the lens, LCD monitor, or viewfinder



- **When camera is not in use or when using the playback feature, ensure that the lens is in the stored position, with lens cap on.**

- **There are times when rattling sounds or vibrations will come from the camera, but these are due to the motion of the aperture, the zoom and the motor and do not indicate a defect.**



**The camera is not dust resistant, splash resistant, or waterproof.**

**Avoid using the camera in places with excessive dust or sand, or where water can come into contact with the camera.**

- Avoid using the camera under the following conditions, which present a risk that sand, water, or foreign material may enter the camera through the lens or openings around buttons. Be especially careful because these conditions may damage the camera, and such damage may not be repairable.

- In extremely dusty or sandy places
- In the rain or by the shore, where the camera may be exposed to water







### ■ Condensation (When the lens, the LCD monitor, or viewfinder, is fogged up)

- Condensation may occur when the camera is exposed to sudden changes of temperature or humidity. Avoid these conditions, which may make the lens, LCD monitor, or viewfinder, dirty, cause mold, or damage the camera.
- If condensation does occur, turn off the camera and wait about two hours before using it. Once the camera adjusts to the surrounding temperature, the fogging will clear naturally.



## Standard accessories





Check that all the accessories are supplied before using the camera. Part numbers are as of July 2013. These may be subject to change.

<input type="checkbox"/> <b>Battery pack</b> DMW-BMB9PP • Charge the battery before use. Battery pack is indicated as battery pack or battery in the text. 	<input type="checkbox"/> <b>USB connection cable</b> K1HY08YY0031 
<input type="checkbox"/> <b>Battery Charger</b> DE-A83B  Battery charger is indicated as battery charger or charger in the text.	<input type="checkbox"/> <b>Lens Cap/ Lens Cap String</b> VYQ8752 
<input type="checkbox"/> <b>Shoulder Strap</b> VFC4453 	<input type="checkbox"/> <b>CD-ROM</b> VFF1231 • Software: Use it to install the software on your PC. • Owner's Manual for advanced features 

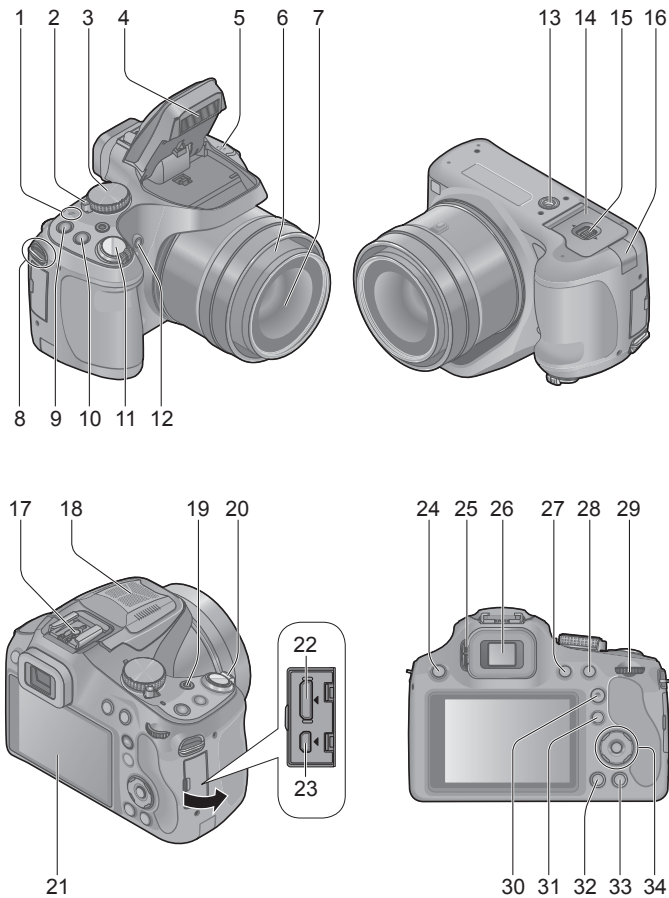
- SD Memory Card, SDHC Memory Card and SDXC Memory Card are indicated as card in the text.
- **Cards are optional. You can record or play back pictures on the built-in memory when you are not using a card.**
- Please dispose of all packaging appropriately.
- For information about optional accessories, refer to the "Digital Camera Accessory System".
- If any accessories are lost, customers should contact Panasonic's parts department at 1-800-833-9626 for further information about obtaining replacement parts.
- Keep small parts in a safe place out of the reach of children.
- The illustrations and screens in this manual may differ from the actual product.
- A lens hood is not supplied with this unit.
- **SILKYPIX Developer Studio is not provided on the supplied CD-ROM. Download this software from the website and install it on your computer to use. (→24)**

## Names and Functions of Main Parts



- 1 Power lamp
- 2 Camera [ON/OFF] switch
- 3 Mode dial
- 4 Flash
- 5 Speaker
  - Be careful not to cover the speaker with your finger. Doing so may make sound difficult to hear.
- 6 Lens barrel
- 7 Lens
- 8 Shoulder strap eyelet
- 9 [FOCUS] button
- 10 [] (Burst Mode) button
- 11 Shutter button
- 12 Self-timer indicator/  
AF Assist Lamp
- 13 Tripod mount
  - Do not attach to a tripod with a 5.5 mm (0.22 inch) or longer screw. Doing so may damage this unit.
- 14 Card/Battery door
- 15 Release lever
- 16 DC coupler cover
  - When using an AC adaptor, ensure that the Panasonic DC coupler (DMW-DCC6: optional) and AC adaptor (DMW-AC8PP: optional) are used.
  - Always use a genuine Panasonic AC adaptor (DMW-AC8PP: optional).
- 17 Hot shoe
  - Do not attach other than the external flash on the hot shoe.
- 18 Stereo microphone
- 19 Motion picture button
- 20 Zoom lever
- 21 LCD monitor
- 22 [HDMI] socket
- 23 [AV OUT/DIGITAL] socket
- 24 [] (Flash open) button
- 25 Diopter adjustment dial
- 26 Viewfinder ([LVF])
  - In this manual, “viewfinder” is used to indicate the LVF.
- 27 [LVF] button
- 28 [AF/AE LOCK (Fn1)] button
- 29 Rear dial
- 30 [AF/AF-LOCK/MF] button
- 31 [] (Playback) button
  - Use this to select the recording mode or playback mode.
- 32 [DISP.] button
- 33 [] (Delete/Cancel/Quick menu) button
- 34 Cursor button / [MENU/SET] button
  - In this manual, the button that is to be used is indicated by .

## Attaching the lens cap/shoulder strap

### ■ Attaching the Lens Cap

- When you turn the camera off or carry the camera, attach the lens cap to protect the surface of the lens.

#### 1 Pass the string through the hole on the camera

#### 2 Pass the same string through the hole on the lens cap

- Pass the lens cap through the loop of the string and tighten it.

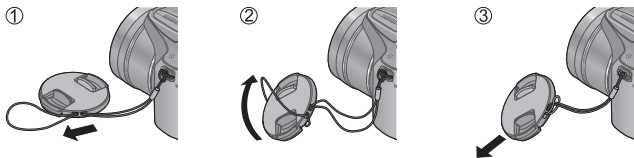

#### 3 Attach the lens cap

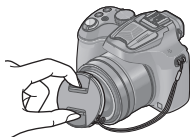

### ■ Attaching the Shoulder Strap

- We recommend attaching the shoulder strap when using the camera to prevent it from dropping.

#### 1 Pass the shoulder strap through the hole at the shoulder strap eyelet

- Attach the shoulder strap so that the "LUMIX" Logo is on the outside.

#### 2 Pass the shoulder strap through the stopper and fasten the shoulder strap

- Ⓐ Pull the shoulder strap 2 cm (0.066 feet) or more.

- Attach the shoulder strap to the other side of the camera being careful not to twist it.

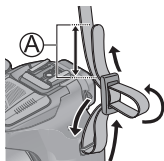

- Make sure that the shoulder strap does not come loose.

## Charging the battery

- Use the dedicated charger and battery.
- The battery is not charged when the camera is shipped. Charge the battery before use.
- We recommend charging in a location where the ambient temperature is between 10 °C and 30 °C (50 °F to 86 °F).

### 1 Position the battery contacts to meet the charger, then insert the battery into the charger

Ensure [LUMIX] faces outwards.

### 2 Plug the charger into the AC power

#### Charging light ([CHARGE])

**On:** Charging in progress  
(approx. 155 min. if fully depleted)

**Off:** Charging complete

#### If light is flashing:

- Charging may take longer than normal if battery temperature is too high or too low (charging may not be completed).
- Battery/charger connector is dirty. Clean with a dry cloth.

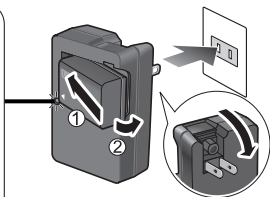

- The battery becomes warm after using it and during and after charging. The camera also becomes warm during use. This is not a malfunction.
- You cannot charge the battery of this unit using a USB connection cable.

#### ■ About batteries that you can use with this unit

The battery that can be used with this unit is DMW-BMB9PP.

## Inserting and removing the card (optional)/ the battery

- Turn this unit off and confirm that the lens barrel is retracted.

**1** Slide the release lever to the [OPEN] position and open the card/battery door

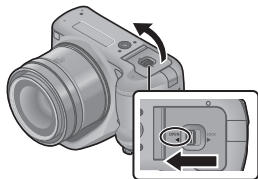

**2** **Battery:**  
Being careful about the battery orientation, insert all the way and then check that it is locked by lever

- Pull the lever in the direction of the arrow to remove the battery.

**Card:**  
Push it securely all the way until you hear a “click” while being careful about the direction in which you insert it

- To remove the card, push the card until it clicks, then pull the card out upright.

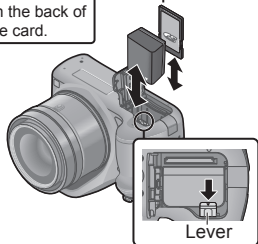
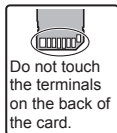

**3** Close the card/battery door and slide the release lever to the [LOCK] position

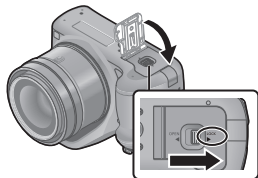

- Always use genuine Panasonic batteries (DMW-BMB9PP).
- If you use other batteries, we cannot guarantee the quality of this product.
- Keep the Memory Card out of reach of children to prevent swallowing.
- We recommend using a Panasonic card.

## Sequence of operations

Before using the camera, remove the lens cap.

### 1 Turn the camera on (A)

- The clock is not set when the camera is shipped. Set the date and time before using the camera.

### 2 Set to the desired recording mode

Rotate the mode dial slowly to select the desired mode.

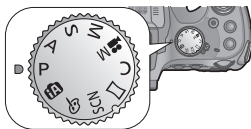

### ■ Recording mode

<b>iA</b>	Take pictures with automatic settings.
<b>P</b>	Take pictures with automatic shutter speed and aperture value settings.
<b>A</b>	Determine aperture, then record pictures.
<b>S</b>	Determine shutter speed, then record pictures.
<b>M</b>	Determine aperture and shutter speed, then record pictures.
<b>M</b> (with video icon)	Record motion picture with manual settings.
<b>C</b>	Record pictures using pre-registered settings.
<b>□</b>	Record panorama pictures.
<b>SCN</b>	Take pictures using Scene modes.
<b>👉</b>	Take pictures by selecting your preferred picture effect.

### 3 Take pictures

#### ■ Taking still pictures (Shutter button)

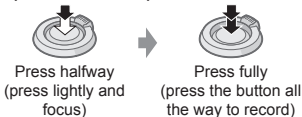

#### ■ Recording motion pictures (Motion picture button)



#### ■ Use the zoom lever to adjust the range of the picture to be captured

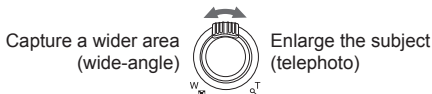

#### ■ Viewing your Pictures

① Press the Playback button (A)



② Press ◀▶ to select a picture to be displayed

- Ending Playback

Press the Playback button (A) or the motion picture button again, or press the shutter button halfway.

#### ■ Deleting Pictures

① Press [🗑️ (Q.MENU)] button to delete the displayed picture

- A confirmation screen is displayed. When you select [Yes], the selected picture is deleted.

#### ■ About recording motion pictures

- You can continuously record a motion picture in [MP4] for up to 29 minutes 59 seconds or approx. 4 GB. (Since recording in [MP4] with [FHD] creates larger files, the recording time for such motion pictures will be shorter than 29 minutes 59 seconds.)
- You can record a motion picture to the built-in memory only in [MP4] using the [VGA] setting.



# Taking pictures with automatic settings

## [Intelligent Auto] Mode

The camera will set the most appropriate settings to match the subject and the recording conditions so we recommend this mode for beginners or those who want to leave the settings to the camera and take pictures easily.

### 1 Set to [iA] ([Intelligent Auto] Mode)

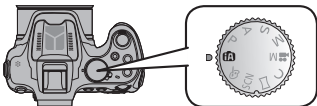

### 2 Take a picture

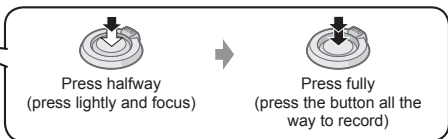
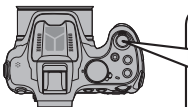

#### Focus display

(When focus is aligned: illuminated  
When focus is not aligned: flashing)

#### AF area

- The AF area is displayed around the subject's face by the Face Detection function. In other cases, it is displayed at the point on the subject which is in focus.

### ■ Defocusing the background

You can easily set the blurriness of the background while checking the screen.

### 1 Press the rear dial to display [ ]

### 2 Press ◀▶ or rotate the rear dial to adjust

- Press [ ] (Q.MENU) button to reset the setting to the default state (AUTO).
- To adjust automatically, reset the setting to the default state (AUTO).

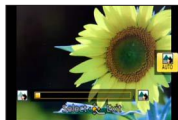

### 3 Press [MENU/SET] or the rear dial to finalize the setting

### Recording using [Intelligent Auto Plus] Mode

When [Intelligent Auto Plus] (iA+) mode is selected, you can easily adjust the brightness and coloring, in addition to the background defocusing, without compromising the user-friendly operation of the [Intelligent Auto] Mode.

#### 1 Press [MENU/SET] when in [Intelligent Auto] Mode

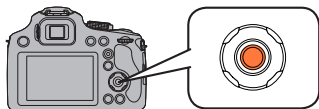

#### 2 Press $\blacktriangleright$ to select [iA+] and then press [MENU/SET]



#### ■ Adjusting brightness, coloring, and background defocusing

#### 1 Press the rear dial to display the options

#### 2 Press $\blacktriangle$ $\blacktriangledown$ to select the item

- [ $\blacktriangle$ ]: Adjust the brightness.
- [ $\blacktriangledown$ ]: Adjust the background blur.
- [ $\blacksquare$ ]: Adjust the color balance.



#### 3 Press $\blacktriangleleft$ $\blacktriangleright$ or rotate the rear dial to adjust

- Press [ $\blacksquare$ ] ( $\rightarrow$  Q.MENU) button to reset the setting to the default state (AUTO).
- To adjust automatically, reset the setting to the default state (AUTO).

#### 4 Press [MENU/SET] or the rear dial to set

# Taking Pictures with different picture effects

## [Creative Control] Mode

You can select your own settings from various effects and take pictures while confirming these effects on the LCD monitor.

### 1 Set mode dial to [📷]

### 2 Press ▲▼ to select an effect, and then press [MENU/SET]

- A brief description of selected picture effect appears when you press [DISP.] button.

Preview screen



### ■ Adjust the effect to fit your preferences

### 1 Press the rear dial to display the options

### 2 Press ▲▼ to select the item

- The items that can be adjusted differ depending on the selected picture effect.

[☑]: Adjust the brightness.

[🌫]: Adjust the background blur.

[🔧]: Adjust the setting conditions of the selected effect, etc.

### 3 Press ◀▶ or rotate the rear dial to adjust

- Press [🏠] (Q.MENU) button to reset the setting to the default state (AUTO).
- To adjust automatically, reset the setting to the default state (AUTO).

### 4 Press [MENU/SET] or the rear dial to set

## Using the rear dial

You can use the rear dial to compensate the exposure or adjust the aperture value and shutter speed. The items that can be adjusted differ according to the recording mode.

### Compensating the exposure

- 1 Press the rear dial to set Exposure Compensation to a selected state

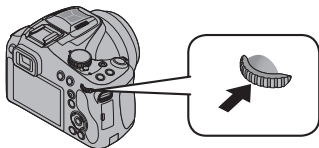

- 2 Rotate the rear dial to compensate the exposure

- If the picture is too dark, adjust the exposure to the “+” direction.
- If the picture is too bright, adjust the exposure to the “-” direction.

### Setting the aperture value/the shutter speed

- 1 Press the rear dial to select the items to set

- Items that can be set will switch every time the rear dial is pressed.

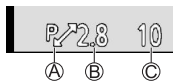

- (A) Program Shift (Recording mode: P)
  - To adjust the setting, display the aperture value and shutter speed by pressing the shutter button halfway.
- (B) Aperture Value (Recording mode: A / M)
- (C) Shutter Speed (Recording mode: S / M)



- 2 Rotate the rear dial to set

## Setting the menu

Refer to the following procedures to operate the menus.

**Example: Setting [AF Mode] from  to  in the [Program AE] Mode**

- 1 Press [MENU/SET] to display the menu

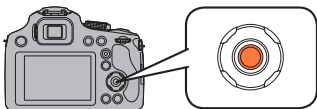

- 2 Press ▲ ▼ to select [AF Mode] and then press ►

- Depending on the item, its setting may not appear or it may be displayed in a different way.

- 3 Press ▲ ▼ to select  and then press [MENU/SET] to set

- 4 Press [MENU/SET] to close the menu



### Switching to other menus

**Example: Switching to the [Setup] menu from [Rec] menu**

- 1 Press [MENU/SET] to display the menu
- 2 Press ◀
- 3 Press ▼ to select the [Setup] menu icon 
- 4 Press ►

- Select a menu item next and set it.



## Reading the Owner's Manual (PDF format)

More detailed instructions on the operation of this camera are contained in "Owner's Manual for advanced features (PDF format)" in the supplied CD-ROM. Install it on your PC to read it.

### ■ For Windows

- 1 Turn the PC on and insert the CD-ROM containing the Owner's Manual (supplied)
- 2 Click the [Owner's Manual]
- 3 Select the desired language and then click [Owner's Manual] to install  
Ⓐ To return to the install menu.
- 4 Double-click the "Owner's Manual" shortcut icon on the desktop

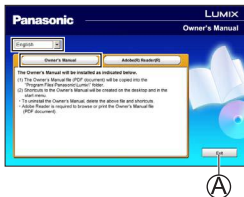

### ■ When the Owner's Manual (PDF format) will not open

You will need Adobe Acrobat Reader 5.0 or later, or Adobe Reader 7.0 or later to browse or print the Owner's Manual (PDF format).

- You can download and install a version of Adobe Reader that you can use with your OS from the following website.  
<http://get.adobe.com/reader/otherversions/>

### ■ For Mac

- 1 Turn the PC on and insert the CD-ROM containing the Owner's Manual (supplied)
- 2 Open the "Manual" folder in the CD-ROM and then copy the PDF file with the desired language inside the folder
- 3 Double click the PDF file to open it

# Keeping the pictures on your PC

## Installing supplied software

The supplied CD-ROM contains the following software.

Install the software on your computer to use.

For details about operating environment and usage, please read "Owner's Manual for advanced features" (PDF format) or the manuals for each software.

- PHOTOfunSTUDIO / LoiLoScope are not compatible with Mac.

PHOTOfunSTUDIO 9.2 AE	Pictures can be captured to a PC, and can be viewed, organized, printed, etc. Also, still pictures can be corrected and motion pictures can be edited. <ul style="list-style-type: none"><li>• Compatible OS: Windows 8 / 7 / Vista / XP</li></ul>
LoiLoScope (30-day full-trial version)	You can edit motion pictures easily. This will only install a shortcut to the trial version download site. For details about using LoiLoScope, please download and see the manual from the following site. <a href="http://loilo.tv/product/20/">http://loilo.tv/product/20/</a> <ul style="list-style-type: none"><li>• Compatible OS: Windows 8 / 7 / Vista / XP</li></ul>

### Preparations:

- Check your PC's specifications and operating environment for each software.
- Before inserting the CD-ROM (supplied), close all running applications.

### ■ For Windows

#### 1 Insert the supplied CD-ROM with the supplied software

- The installation menu runs.

#### 2 Click [Applications] on the install menu

#### 3 Click [Recommended Installation]

- Continue the installation procedure following the instructions displayed on the screen.

- The software compatible with your PC will be installed.

### Downloading SILKYPIX Developer Studio

This software develops and edits RAW file pictures. Edited pictures can be saved in a file format such as JPEG or TIFF that can be displayed on a PC, etc.

#### ■ Download procedure

Download SILKYPIX Developer Studio from the following site and install it on your computer to use. (This software is not provided on the supplied CD-ROM.)  
<http://www.isl.co.jp/SILKYPIX/english/p/>

- Compatible OS: Windows 8 / 7 / Vista / XP  
Mac OS X (10.4 - 10.8)
- For details on how to use the SILKYPIX Developer Studio, refer to the “Help” or the Ichikawa Soft Laboratory’s support website.
- To download the software, the unit must be connected to the Internet.
- It may take time to download the software in some communication environments.

### Copying still pictures and motion pictures

#### 1 Turn on the camera and a computer, and then connect the camera to the computer using the USB connection cable (supplied)

- Do not use any other USB connection cables except the supplied one or a genuine Panasonic USB connection cable (DMW-USBC1: optional). Doing so may cause damage to this unit.
- Check the plug direction and insert straight in. (If the cable is inserted in the wrong direction, the plug could become deformed and cause faulty operation)

#### 2 Press ▲ ▼ on the camera to select [PC], and press [MENU/SET]

#### 3 Copy the pictures to the computer

- For Windows  
Use “PHOTOfunSTUDIO” to copy pictures to your computer.
- For Mac  
Copy the picture files in the “DCIM” folder to your computer (except AVCHD motion pictures).

#### 4 Cancel the connection and disconnect the USB connection cable (supplied)



## Specifications

### Digital Camera: Information for your safety

<b>Power Source</b>	DC 8.4 V
<b>Power Consumption</b>	When recording with LCD Monitor: 1.6 W When recording with Viewfinder: 1.5 W When playing back with LCD Monitor: 1.0 W When playing back with Viewfinder: 0.7 W
<b>Camera effective pixels</b>	16,100,000 pixels
<b>Image sensor</b>	1/2.3" MOS sensor, total pixel number 16,800,000 pixels Primary color filter
<b>Lens</b>	Optical 60 x zoom f=3.58 mm to 215 mm (35 mm film camera equivalent: 20 mm to 1200 mm)/ Max. Wide: F2.8 to F8.0 Max. Tele: F5.9 to F8.0
<b>Image Stabilizer</b>	Optical method
<b>Focus range</b>	
<b>AF</b>	30 cm (0.98 feet) (Max. Wide) / 1.5 m (4.9 feet) (Max. Tele) to ∞
<b>AF Macro / MF / Intelligent Auto / Motion picture</b>	1 cm (0.033 feet) (Max. Wide) / 1.5 m (4.9 feet) (Max. Tele) to ∞
<b>Scene Mode</b>	The focus ranges listed above may vary depending on the selected Scene Mode.
<b>Shutter system</b>	Electronic shutter + Mechanical shutter
<b>Minimum Illumination</b>	Approx. 9 lx (when i-Low light is used, the shutter speed is 1/30th of a second)
<b>Shutter speed</b>	8 seconds to 1/2000th of a second [Starry Sky] Mode: 15 seconds, 30 seconds, 60 seconds

## Specifications

<b>Exposure (AE)</b>	Program AE (P) / Aperture-Priority AE (A) / Shutter-Priority AE (S) / Manual Exposure (M)
<b>Metering Mode</b>	[Multi Metering] / [Center Weighted] / [Spot]
<b>LCD monitor</b>	3.0" TFT LCD (3:2) (Approx. 460,800 dots) (field of view ratio about 100%)
<b>Viewfinder</b>	Color LCD Viewfinder (Approx. 201,600 dots) (field of view ratio about 100%) (with diopter adjustment -4 to +4 diopter)
<b>Flash</b>	Built-in pop up flash
<b>Microphone</b>	Stereo
<b>Speaker</b>	Monaural
<b>Recording media</b>	Built-in Memory (Approx. 200 MB) / SD Memory Card / SDHC Memory Card / SDXC Memory Card
<b>Recording file format</b>	
<b>Still picture</b>	RAW / JPEG (based on Design rule for Camera File system, based on Exif 2.3 standard / DPOF corresponding) / MPO
<b>Motion pictures</b>	AVCHD / MP4
<b>Audio compression format</b>	AVCHD: Dolby® Digital (2 ch) MP4: AAC (2 ch)
<b>Interface</b>	
<b>Digital</b>	USB 2.0 (High Speed)
<b>Analog video</b>	NTSC Composite
<b>Audio</b>	Audio line output (Monaural)
<b>Terminal</b>	HDMI: MiniHDMI Type C AV OUT/DIGITAL: Dedicated jack (8 pin)
<b>Dimensions</b>	Approx. 130.2 mm (W) x 97.0 mm (H) x 118.2 mm (D) [5.13" (W) x 3.82" (H) x 4.65" (D)] (excluding the projection part)

<b>Mass (Weight)</b>	With card and battery: Approx. 606 g (1.34 lb) Excluding card and battery: Approx. 562 g (1.24 lb)
<b>Operating temperature</b>	0 °C to 40 °C (32 °F to 104 °F)
<b>Operating humidity</b>	10%RH to 80%RH
<b>Language select</b>	[ENGLISH] / [ESPAÑOL]

### Battery Charger

**(Panasonic DE-A83B):** Information for your safety

<b>Input</b>	~ 110 V to 240 V, 50/60 Hz, 0.15 A
<b>Output</b>	=== 8.4 V, 0.43 A

**Equipment mobility: Movable**

### Battery pack (lithium-ion)

**(Panasonic DMW-BMB9PP):** Information for your safety

<b>Voltage / capacity</b>	7.2 V / 895 mAh
---------------------------	-----------------

Specifications are subject to change without notice.

## Digital Camera Accessory System

Description	Accessory#
Battery pack	DMW-BMB9
DC coupler*1	DMW-DCC6
AC adaptor*1	DMW-AC8
Flash	DMW-FL220, DMW-FL360, DMW-FL360L, DMW-FL500
MC protector	DMW-LMCH55
ND filter	DMW-LNDH55
PL filter (Circular Type)	DMW-LPL55
AV Cable	DMW-AVC1
USB connection cable	DMW-USBC1
Lens adaptor	DMW-LA8
Tele Conversion Lens*2	DMW-LT55
Close-up Lens*2	DMW-LC55

\*1 The AC adaptor (optional) can only be used with the designated Panasonic DC coupler (optional). The AC adaptor (optional) cannot be used by itself.

\*2 The lens adaptor (optional) is necessary to attach a tele conversion lens or close-up lens.

- Product numbers are correct as of July 2013. These may be subject to change.
- Accessories and/or model numbers may vary between countries. Consult your local dealer.

# Digital Camera Accessory Order Form

Please photocopy this form when placing an order.

1. Digital Camera Model # \_\_\_\_\_

2. Items Ordered

Accessory #	Description	Price Each	Quantity	Total Price
Shipping & Handling				\$6.95
Subtotal				
Your State & Local Sales Tax				
Total				

3. Method of payment (check one)

- American Express  
 VISA  
 MasterCard  
 Discover

Credit Card # \_\_\_\_\_

Expiration Date \_\_\_\_\_

Customer Signature \_\_\_\_\_

(Please do not send cash)

4. Shipping information (UPS delivery requires complete street address)

Ship To:

Mr.

Mrs.

Ms.

First \_\_\_\_\_ Last \_\_\_\_\_

Street Address \_\_\_\_\_

City \_\_\_\_\_ State \_\_\_\_\_ Zip \_\_\_\_\_

Phone#: \_\_\_\_\_

Day ( ) \_\_\_\_\_

Night ( ) \_\_\_\_\_

TO OBTAIN ANY OF OUR DIGITAL CAMERA ACCESSORIES YOU CAN DO ANY OF THE FOLLOWING:

VISIT YOUR LOCAL PANASONIC DEALER

OR

CALL PANASONIC'S ACCESSORY ORDER LINE AT 1-800-332-5368  
[6 AM-6 PM M-F, PACIFIC TIME]

OR

MAIL THIS ORDER TO: PANASONIC NATIONAL PARTS CENTER  
20421 84th Ave S., Kent, WA 98032

## Limited Warranty (ONLY FOR U.S.A. AND PUERTO RICO)

### Panasonic Products Limited Warranty

#### Limited Warranty Coverage (For USA and Puerto Rico Only)

If your product does not work properly because of a defect in materials or workmanship, Panasonic Corporation of North America (referred to as “the warrantor”) will, for the length of the period indicated on the chart below, which starts with the date of original purchase (“warranty period”), at its option either (a) repair your product with new or refurbished parts, (b) replace it with a new or a refurbished equivalent value product, or (c) refund your purchase price. The decision to repair, replace or refund will be made by the warrantor.

Product or Part Name	Parts	Labor
Digital Camera	1 Year	1 Year
All included Accessories (Except Non-Rechargeable Batteries)	90 Days	Not Applicable
Only Non-Rechargeable Batteries	10 Days	Not Applicable

During the “Labor” warranty period there will be no charge for labor. During the “Parts” warranty period, there will be no charge for parts. This Limited Warranty excludes both parts and labor for non-rechargeable batteries, antennas, and cosmetic parts (cabinet). This warranty only applies to products purchased and serviced in the United States or Puerto Rico. This warranty is extended only to the original purchaser of a new product which was not sold “as is”.

## Mail-In Service--Online or Telephone Repair Request

### Online Repair Request

To submit a new repair request and for quick repair status visit our Web Site at [www.panasonic.com/repair](http://www.panasonic.com/repair).

### Telephone Repair Request

You may contact us at : 1-800-211-PANA (7262)

When shipping the unit, carefully pack, include all supplied accessories listed in the Owner's Manual, and send it prepaid, adequately insured and packed well in a carton box. When shipping Lithium Ion batteries please visit our Web Site at [www.panasonic.com/BatteryHandling](http://www.panasonic.com/BatteryHandling) as Panasonic is committed to providing the most up to date information. Include a letter detailing the complaint, a return address and provide a daytime phone number where you can be reached. A valid registered receipt is required under the Limited Warranty.

**IF REPAIR IS NEEDED DURING THE WARRANTY PERIOD, THE PURCHASER WILL BE REQUIRED TO FURNISH A SALES RECEIPT/PROOF OF PURCHASE INDICATING DATE OF PURCHASE, AMOUNT PAID AND PLACE OF PURCHASE. CUSTOMER WILL BE CHARGED FOR THE REPAIR OF ANY UNIT RECEIVED WITHOUT SUCH PROOF OF PURCHASE.**

### **Limited Warranty Limits And Exclusions**

This warranty ONLY COVERS failures due to defects in materials or workmanship, and DOES NOT COVER normal wear and tear or cosmetic damage. The warranty ALSO DOES NOT COVER damages which occurred in shipment, or failures which are caused by products not supplied by the warrantor, or failures which result from accidents, misuse, abuse, neglect, mishandling, misapplication, alteration, faulty installation, set-up adjustments, misadjustment of consumer controls, improper maintenance, power line surge, lightning damage, modification, introduction of sand, humidity or liquids, commercial use such as hotel, office, restaurant, or other business or rental use of the product, or service by anyone other than a Factory Service Center or other Authorized Servicer, or damage that is attributable to acts of God.

**THERE ARE NO EXPRESS WARRANTIES EXCEPT AS LISTED UNDER "LIMITED WARRANTY COVERAGE".**

**THE WARRANTOR IS NOT LIABLE FOR INCIDENTAL OR CONSEQUENTIAL DAMAGES RESULTING FROM THE USE OF THIS PRODUCT, OR ARISING OUT OF ANY BREACH OF THIS WARRANTY.**

(As examples, this excludes damages for lost time, travel to and from the servicer, loss of or damage to media or images, data or other memory or recorded content. The items listed are not exclusive, but for illustration only.)

**ALL EXPRESS AND IMPLIED WARRANTIES, INCLUDING THE WARRANTY OF MERCHANTABILITY, ARE LIMITED TO THE PERIOD OF THE LIMITED WARRANTY.**

Some states do not allow the exclusion or limitation of incidental or consequential damages, or limitations on how long an implied warranty lasts, so the exclusions may not apply to you.

This warranty gives you specific legal rights and you may also have other rights which vary from state to state. If a problem with this product develops during or after the warranty period, you may contact your dealer or Service Center. If the problem is not handled to your satisfaction, then write to the warrantor's Consumer Affairs Department at the addresses listed for the warrantor.

**PARTS AND SERVICE, WHICH ARE NOT COVERED BY THIS LIMITED WARRANTY, ARE YOUR RESPONSIBILITY.**



## Customer Services Directory (United States and Puerto Rico)

Obtain Product Information and Operating Assistance; locate your nearest Dealer or Service Center; purchase Parts and Accessories; or make Customer Service and Literature requests by visiting our Web Site at:

<http://www.panasonic.com/help>

or, contact us via the web at:

<http://www.panasonic.com/contactinfo>

You may also contact us directly at:

1-800-211-PANA (7262)

Monday-Friday 9am-9pm, Saturday-Sunday 10am-7pm EST

**For hearing or speech impaired TTY users, TTY: 1-877-833-8855**

## Accessory Purchases (United States and Puerto Rico)

Purchase Parts, Accessories and Owner's Manual online for all Panasonic Products by visiting our Web Site at:

<http://www.pstc.panasonic.com>

Or, send your request by E-mail to:

[npcparts@us.panasonic.com](mailto:npcparts@us.panasonic.com)

You may also contact us directly at:

1-800-332-5368 (Phone) 1-800-237-9080 (Fax Only)

(Monday-Friday 9am-9pm EST)

Panasonic National Parts Center

20421 84th Ave S., Kent, WA 98032

(We accept Visa, MasterCard, Discover Card, American Express)

**For hearing or speech impaired TTY users, TTY: 1-866-605-1277**

As of July 2013

**HDMI**

**AVCHD**™

**DOLBY**  
DIGITAL



- SDXC Logo is a trademark of SD-3C, LLC.
- HDMI, the HDMI Logo, and High-Definition Multimedia Interface are trademarks or registered trademarks of HDMI Licensing LLC in the United States and other countries.
- “AVCHD” and the “AVCHD” logo are trademarks of Panasonic Corporation and Sony Corporation.
- Manufactured under license from Dolby Laboratories. Dolby and the double-D symbol are trademarks of Dolby Laboratories.
- Windows and Windows Vista are either registered trademarks or trademarks of Microsoft Corporation in the United States and/or other countries.
- Mac and Mac OS are trademarks of Apple Inc., registered in the U.S. and other countries.
- QuickTime and the QuickTime logo are trademarks or registered trademarks of Apple Inc., used under license therefrom.
- This product uses “DynaFont” from DynaComware Corporation. DynaFont is a registered trademark of DynaComware Taiwan Inc.
- Other names, company names, and product names mentioned in these instructions are trademarks or registered trademarks of the companies concerned.

**-If you see this symbol-**



**Information on Disposal in other Countries outside the European Union**

This symbol is only valid in the European Union. If you wish to discard this product, please contact your local authorities or dealer and ask for the correct method of disposal.

**Panasonic Corporation of North America**

Two Riverfront Plaza, Newark, NJ 07102-5490

© Panasonic Corporation 2013

Printed in China