

Panasonic®

Operating Instructions

Digital Camera

Model No. **DMC-FZ8**

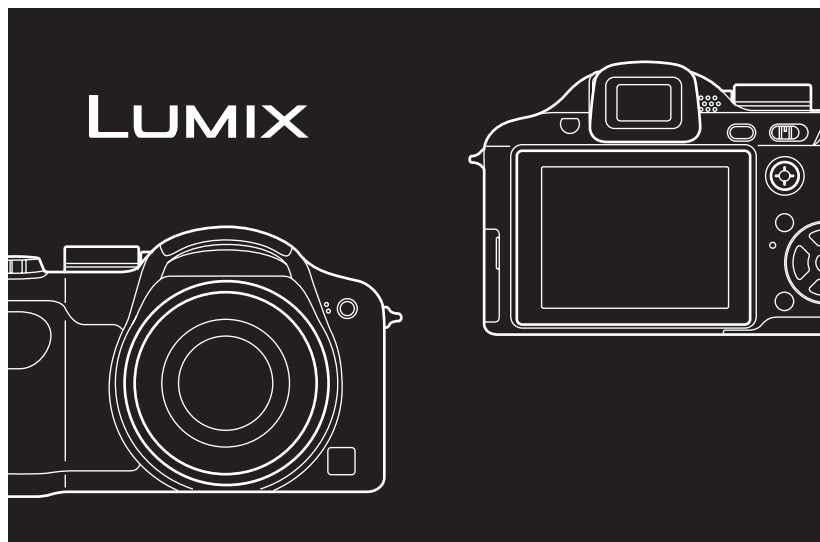
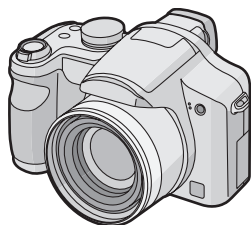

Before connecting, operating or adjusting this product, please read the instructions completely.

LEICA
DC VARIO-ELMARIT

For USA assistance, please call: 1-800-272-7033 or send e-mail to : digitalstillcam@us.panasonic.com

For Canadian assistance, please call: 1-800-99-LUMIX (1-800-995-8649) or
send e-mail to: lumixconciierge@ca.panasonic.com



VQT1B25

Dear Customer,

Thank you for choosing Panasonic!

You have purchased one of the most sophisticated and reliable products on the market today. Used properly, we're sure it will bring you and your family years of enjoyment. Please take time to fill in the information on the below.

The serial number is on the tag located on the underside of your Camera. Be sure to **retain this manual** as your convenient Camera information source.

Model No. _____

Serial No. _____

Information for Your Safety

WARNING:

TO REDUCE THE RISK OF FIRE, ELECTRIC SHOCK OR PRODUCT DAMAGE,

- **DO NOT EXPOSE THIS APPARATUS TO RAIN, MOISTURE, DRIPPING OR SPLASHING AND THAT NO OBJECTS FILLED WITH LIQUIDS, SUCH AS VASES, SHALL BE PLACED ON THE APPARATUS.**
- **USE ONLY THE RECOMMENDED ACCESSORIES.**
- **DO NOT REMOVE THE COVER (OR BACK); THERE ARE NO USER SERVICEABLE PARTS INSIDE. REFER SERVICING TO QUALIFIED SERVICE PERSONNEL.**

Carefully observe copyright laws. Recording of pre-recorded tapes or disks or other published or broadcast material for purposes other than your own private use may infringe copyright laws. Even for the purpose of private use, recording of certain material may be restricted.



A lithium ion/polymer battery that is recyclable powers the product you have purchased. Please call 1-800-8-BATTERY for information on how to recycle this battery.

- Please note that the actual controls and components, menu items, etc. of your Digital Camera may look somewhat different from those shown in the illustrations in these Operating Instructions.
- SDHC Logo is a trademark.
- Leica is a registered trademark of Leica Microsystems IR GmbH.
- Elmarit is a registered trademark of Leica Camera AG.
- Other names, company names, and product names printed in these instructions are trademarks or registered trademarks of the companies concerned.

THE SOCKET OUTLET SHALL BE INSTALLED NEAR THE EQUIPMENT AND SHALL BE EASILY ACCESSIBLE.

CAUTION

Danger of explosion if battery is incorrectly replaced. Replace only with the same or equivalent type recommended by the manufacturer. Dispose of used batteries according to the manufacturer's instructions.

Warning

Risk of fire, explosion and burns. Do not disassemble, heat above 60 °C (140 °F) or incinerate.

Marking sign is located on bottom of the unit.

THE FOLLOWING APPLIES ONLY IN THE U.S.A.

FCC Note:

This equipment has been tested and found to comply with the limits for a Class B digital device, pursuant to Part 15 of the FCC Rules. These limits are designed to provide reasonable protection against harmful interference in a residential installation. This equipment generates, uses, and can radiate radio frequency energy and, if not installed and used in accordance with the instructions, may cause harmful interference to radio communications. However, there is no guarantee that interference will not occur in a particular installation. If this equipment does cause harmful interference to radio or television reception, which can be determined by turning the equipment off and on, the user is encouraged to try to correct the interference by one or more of the following measures:

- Reorient or relocate the receiving antenna.
- Increase the separation between the equipment and receiver.
- Connect the equipment into an outlet on a circuit different from that to which the receiver is connected.
- Consult the dealer or an experienced radio/TV technician for help.

FCC Caution: To assure continued compliance, follow the attached installation instructions and use only shielded interface cables with ferrite core when connecting to computer or peripheral devices.

Any changes or modifications not expressly approved by the party responsible for compliance could void the user's authority to operate this equipment.

Declaration of Conformity

Trade Name: Panasonic
Model No.: DMC-FZ8
Responsible party: Panasonic Corporation of North America
One Panasonic Way, Secaucus, NJ 07094
Support Contact: Panasonic Consumer Electronics Company
1-800-272-7033

This device complies with Part 15 of the FCC Rules. Operation is subject to the following two conditions: (1) This device may not cause harmful interference, and (2) this device must accept any interference received, including interference that may cause undesired operation.



THE FOLLOWING APPLIES ONLY IN CANADA

This Class B digital apparatus complies with Canadian ICES-003.

-If you see this symbol-

Information on Disposal in other Countries outside the European Union

This symbol is only valid in the European Union.

If you wish to discard this product, please contact your local authorities or dealer and ask for the correct method of disposal.



■ About the battery pack

CAUTION

Battery pack (Lithium ion battery pack)

- Use the specified unit to recharge the battery pack.
- Do not use the battery pack with equipment other than the specified unit.
- Do not get dirt, sand, liquids, or other foreign matter on the terminals.
- Do not touch the plug terminals (+ and -) with metal objects.
- Do not disassemble, remodel, heat or throw into fire.

If any electrolyte should come into contact with your hands or clothes, wash it off thoroughly with water. If any electrolyte should come into contact with your eyes, never rub the eyes. Rinse eyes thoroughly with water, and then consult a doctor.

■ About the battery charger

CAUTION!

DO NOT INSTALL OR PLACE THIS UNIT IN A BOOKCASE, BUILT-IN CABINET OR IN ANOTHER CONFINED SPACE. ENSURE THE UNIT IS WELL VENTILATED. TO PREVENT RISK OF ELECTRIC SHOCK OR FIRE HAZARD DUE TO OVERHEATING, ENSURE THAT CURTAINS AND ANY OTHER MATERIALS DO NOT OBSTRUCT THE VENTILATION VENTS.

Battery charger

This battery charger operates on AC between 110 V and 240 V.

But

- In the U.S.A. and Canada, the battery charger must be connected to a 120V AC power supply only.
- When connecting to an AC supply outside of the U.S.A. or Canada, use a plug adaptor to suit the AC outlet configuration.

■ Care of the camera

• Do not strongly shake or bump the camera.

This unit may malfunction, recording pictures may no longer be possible or the lens or the LCD monitor may be damaged.

• Retract the lens before carrying the camera or playing back pictures.

• Be particularly careful when using the camera in the following places as it may cause this unit to malfunction.

- Places with a lot of sand or dust.
- Places where water can come into contact with this unit such as when using it on a rainy day or on a beach.

• If water or seawater splashes on the camera, use a dry cloth to wipe the camera body carefully.

■ About Condensation (When the lens or the Viewfinder is fogged up)

- Condensation occurs when the ambient temperature or humidity changes as described below. Be careful of condensation since it causes lens stains, fungus and camera malfunction.
 - When the camera is taken from the cold outdoors to the warm indoors.
 - When the camera is taken from outside to inside an air-conditioned car.
 - When cool wind from an air conditioner etc. blows directly on the camera.
 - In humid places
- To prevent condensation, put the camera in a plastic bag until the temperature of the camera is close to the ambient temperature. If condensation occurs, turn the camera off and leave it for about 2 hours. The fog will disappear naturally when the temperature of the camera becomes close to the ambient temperature.
- Read together with the “Cautions for Use”. (P122)

■ About cards that can be used in this unit

You can use an SD Memory Card, an SDHC Memory Card and a MultiMediaCard.

- When the term **card** is used in these operating instructions this refers to the following types of Memory Cards.
 - SD Memory Card (8 MB to 2 GB)
 - SDHC Memory Card (4 GB)
 - MultiMediaCard

More specific information about memory cards that can be used with this unit.

- You can only use an SDHC Memory Card if using cards with 4 GB or more capacity.
- A 4 GB Memory Card without an SDHC logo is not based on the SD Standard and will not work in this product.

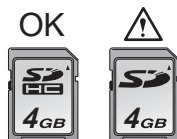

- A MultiMediaCard is compatible with still pictures only.

Contents

Before Use

Information for Your Safety	2
-----------------------------------	---

Preparation

Standard Accessories	8
Names of the Components	9
Attaching the Lens Cap/Strap	11
Attaching the Lens Hood	12
Quick Guide	14
Charging the Battery with the Charger ...	15
About the Battery (charging/ number of recordable pictures)	16
Inserting and Removing the Battery/ the Card (optional)	17
About the Built-in Memory/the Card (optional)	18
Setting Date/Time (Clock Set)	19
• Changing the clock setting	19
About the Mode Dial	20
Setting the Menu	21
About the Setup Menu	22
LCD Monitor Display/Switching the LCD Monitor Display	26

Basic

Taking Pictures	27
Taking Pictures in Simple Mode	30
Taking Pictures with the Zoom	32
• Using the Optical Zoom	32
• Using the Extended Optical Zoom (EZ)	33
• Using the Digital Zoom Further extending the zoom	34
Checking the Recorded Picture (Review)	35
Playing back/Deleting Pictures	36

Advanced (Recording pictures)

About the LCD Monitor/Viewfinder	38
• Changing the information displayed	38
• Brightening the LCD Monitor (Power LCD/High angle mode)	41

Taking Pictures using the Built-in Flash	43
Taking Pictures with the Self-timer	47
Compensating the Exposure	48
Taking Pictures using Auto Bracket.....	49
Optical Image Stabilizer	50
Taking Pictures using Burst Mode	51
Changing the sensitivity according to the movement of the subject being recorded	52
Taking Close-up Pictures	54
Aperture-priority AE	56
Shutter-priority AE	56
Manual exposure	57
Aperture Value and Shutter Speed	58
Taking Pictures with Manual Focus	59
Taking pictures that match the scene being recorded (Scene mode).....	62
– [PORTRAIT]	63
– [SOFT SKIN]	63
– [SCENERY]	63
– [SPORTS].....	63
– [PANNING]	64
– [NIGHT PORTRAIT]	64
– [NIGHT SCENERY]	65
– [FOOD]	65
– [PARTY]	65
– [CANDLE LIGHT]	65
– [BABY1]/[BABY2]	66
– [PET]	67
– [SUNSET].....	67
– [HIGH SENS.].....	67
– [STARRY SKY].....	67
– [FIREWORKS].....	68
– [BEACH]	69
– [SNOW]	69
– [AERIAL PHOTO].....	69
Motion Picture Mode	70
Recording which day of the vacation you take the picture	72
Displaying the time at the travel destination (World Time)	74
Using the [REC] Mode Menu	76
• [W.BALANCE] Adjusting the hue for a more natural picture	77
• [WB ADJUST.] Finely adjusting the white balance ...	78
• [SENSITIVITY] Setting the light sensitivity	79
• [ASPECT RATIO] Setting the aspect ratio of pictures	80

• [PICT.SIZE]/[QUALITY]	Setting a picture size and quality that matches your use of the pictures.....	80
• [AUDIO REC.]	Recording still pictures with audio	82
• [METERING MODE]	Deciding the method to measure brightness	82
• [AF MODE]	Setting the focus method.....	83
• [CONT.AF]	Continuously focusing on a subject	84
• [AF ASSIST LAMP]	Focusing in low light conditions becomes easier	85
• [COL.EFFECT]	Setting color effects for the recorded pictures.....	85
• [PICT.ADJ.]	Adjusting the picture quality for the recorded pictures.....	86
• [FLIP ANIM.]	Connecting images to create a motion picture file	86
• [CONVERSION]	Using an optional lens	88
• [CLOCK SET]	Set the date, time and display	90

Advanced (Playback)

Displaying Multiple Screens (Multi Playback).....	91	
Displaying pictures by recording date (Calendar playback)	92	
Using the Playback Zoom	93	
Playing Back Motion Pictures/ Pictures with Audio.....	94	
Creating still pictures from a motion picture.....	95	
Using the [PLAY] mode menu	97	
• [SLIDE SHOW]	Playing back pictures in order for a fixed duration.....	97
• [FAVORITE]	Setting your favorite pictures	99
• [ROTATE DISP.]/[ROTATE]	To display the picture rotated	99

• [DATE STAMP]	Stamping information such as the date on the recorded pictures	100
• [DPOF PRINT]	Setting the picture to print and the number of prints.....	102
• [PROTECT]	Preventing accidental erasure of pictures	104
• [AUDIO DUB.]	Adding audio after taking pictures	105
• [RESIZE]	Making the picture smaller.....	105
• [TRIMMING]	Enlarging a picture and trimming it....	106
• [ASPECT CONV.]	Changing the aspect ratio of a 16:9 picture.....	107
• [COPY]	Copying the picture data.....	108
• [FORMAT]	Initializing the card.....	109

Connecting to other equipment

Connecting to a PC.....	110
Printing the Pictures.....	113
Playing Back Pictures on a TV Screen....	117

Others

Using the MC Protector/ND Filter	118
Screen Display	119
Cautions for Use	122
Message Display	124
Troubleshooting	126
Number of recordable pictures and available recording time	131
Specifications.....	134
Digital Camera Accessory System.....	136
Digital Camera Accessory Order Form (For USA Customers).....	137
Request for Service Notice (For USA Only).....	138
Limited Warranty (For USA Only)	139
Customer Services Directory (For USA Only).....	141
Précautions à prendre (pour le Canada)	142
Index	144

Standard Accessories

Check that all the accessories are included before using the camera.

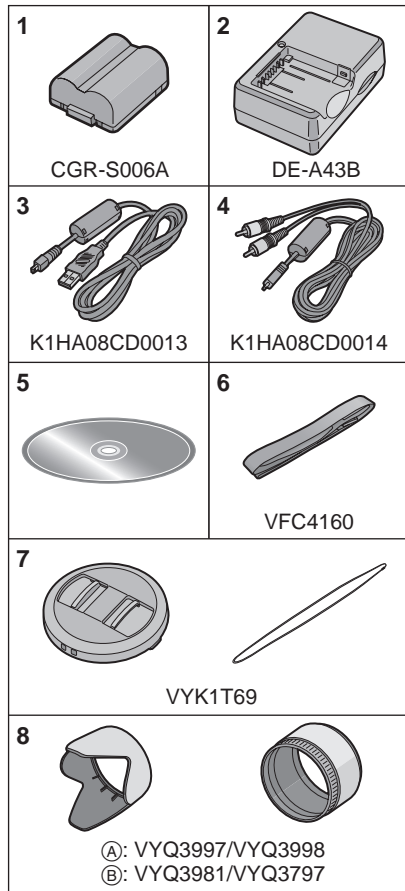

- 1 Battery Pack
(Indicated as **battery** in the text)
- 2 Battery Charger
(Indicated as **charger** in the text)
- 3 USB Connection Cable
- 4 AV Cable
- 5 CD-ROM
- 6 Shoulder Strap
- 7 Lens Cap/Lens Cap String
- 8 Lens Hood/Hood Adaptor
 - (A): Silver
 - (B): Black

- SD Memory Card, SDHC Memory Card and MultiMediaCard are indicated as **card** in the text.
- **The card is optional.**
You can record or play back pictures on the built-in memory when you are not using a card. (P18)
- For information about optional accessories, refer to the "Digital Camera Accessory System". (P136)

Names of the Components

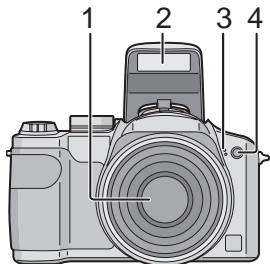

- 1 Lens (P123)
- 2 Flash (P43)
- 3 Microphone (P82, 105)
- 4 Self-timer indicator (P47)
AF assist lamp (P85)

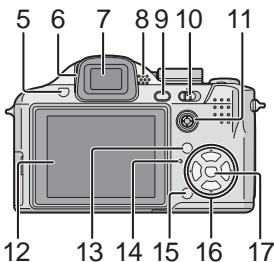

- 5 Flash open button (P43)
- 6 Diopter adjustment dial (P39)
- 7 Viewfinder (P38, 119)
- 8 Speaker (P94)
- 9 [EVF/LCD] button (P38)
- 10 Camera ON/OFF switch (P14, 19)
- 11 Joystick (P29, 36, 56, 57)
- 12 LCD monitor (P38, 119)
- 13 [DISPLAY/LCD MODE] button (P38, 41)
- 14 Status indicator (P27)
- 15 Single or burst mode button (P51)/
Delete button (P36)
- 16 Cursor buttons
◀/Self-timer button (P47)
▼/[REV] button (P35)
▶/Flash Setting button (P43)
▲/Exposure compensation (P48)/
Auto bracket (P49)/Flash output
adjustment (P46)/Backlight
compensation in simple mode (P31)
button
- 17 [MENU/SET] button (P21)

11 Joystick (P29, 36, 56, 57)

In these operating instructions, the operations using the joystick are described as illustrated below shown.
e.g.: When you tilt the joystick right



e.g.: When you press the center of the joystick



- 12 LCD monitor (P38, 119)
- 13 [DISPLAY/LCD MODE] button (P38, 41)
- 14 Status indicator (P27)
- 15 Single or burst mode button (P51)/
Delete button (P36)
- 16 Cursor buttons
◀/Self-timer button (P47)
▼/[REV] button (P35)
▶/Flash Setting button (P43)
▲/Exposure compensation (P48)/
Auto bracket (P49)/Flash output
adjustment (P46)/Backlight
compensation in simple mode (P31)
button

In these operating instructions, operations using the cursor button are described with illustrations below.
e.g.: When you press the ▼ button

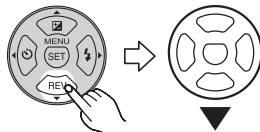

17 [MENU/SET] button (P21)

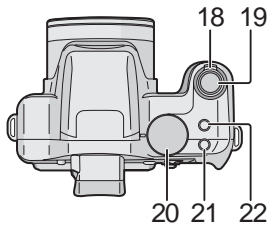

- 18 Zoom lever (P32)
- 19 Shutter button (P27, 70)
- 20 Mode dial (P20)
- 21 Focus switch button (P59)
- 22 Optical image stabilizer button (P50)

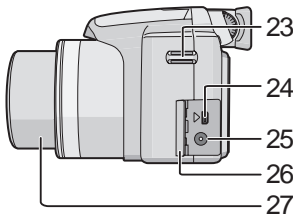

- 23 Strap eyelet (P11)
- 24 [DIGITAL/AV OUT] Socket (P110, 113, 117)
- 25 [DC IN] Socket (P110, 113)
 - Always use a genuine Panasonic AC adaptor (DMW-AC7PP; optional).
 - The camera cannot charge the battery even if the AC adaptor (DMW-AC7PP; optional) is connected.
- 26 Terminal door
- 27 Lens Barrel

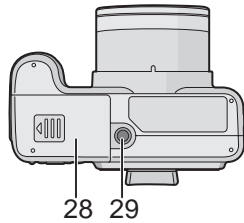

- 28 Card/Battery door (P17)
- 29 Tripod receptacle
 - When you use a tripod, make sure it is stable when the camera is attached to it.

Attaching the Lens Cap/Strap

■ Lens Cap (supplied)

- 1 Pass the string through the hole on the lens cap.

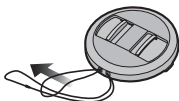

- 2 Pass the same string through the hole on the camera.

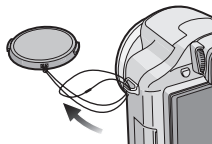

- 3 Attach the lens cap.

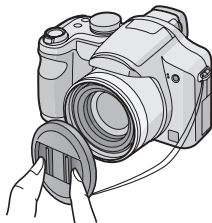

- When you turn the camera off, carry the camera or play back the pictures, attach the lens cap to protect the surface of the lens.
- Detach the lens cap before turning on the camera in the recording mode.
- Be careful not to lose the lens cap.

■ Strap (supplied)

- 1 Pass the strap through the hole at the strap eyelet.

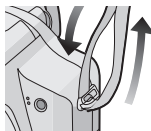

- 2 Pass the strap through the stopper and fasten the strap.

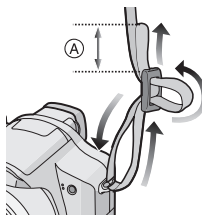

Ⓐ: Pull the strap 2 cm or more.



- Attach the strap to the other side of the camera being careful not to twist it.
- Check that the strap is firmly attached to the camera.
- Attach the strap so that the "LUMIX" LOGO is on the outside.

Attaching the Lens Hood

In bright sunlight or backlight, the lens hood will minimize lens flare and ghosting. The lens hood cuts off excess lighting and improves the picture quality.

- Check that the camera is turned off.
- Close the flash.

1 Attach the hood adaptor (supplied).

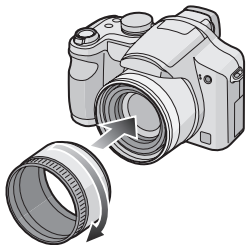

- Do not tighten the hood adaptor too much.

2 Place the camera upside down, align the mark on the lens hood with the mark (A) on the camera and then insert the lens hood.

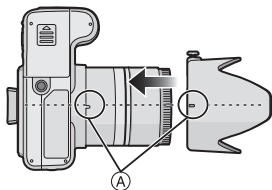

- Check if the screw is loose and then attach the lens hood.

3 Tighten the screw.

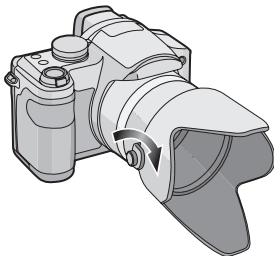

- Do not tighten the screw too much.

■ Removing the hood adaptor

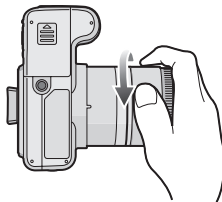

- Hold the edge of the hood adaptor to remove it.

■ Temporarily storing the lens hood

1 Loosen the screw and remove the lens hood.

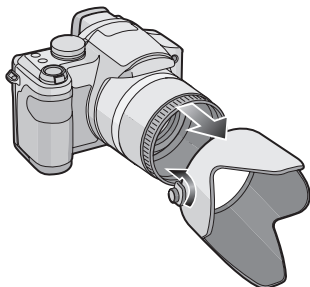

2 Reverse the lens hood.

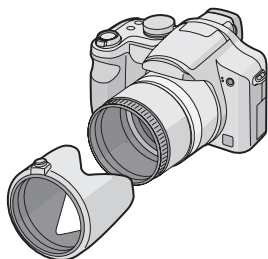

3 Attach the lens hood with the screw facing upwards and then tighten the screw again.

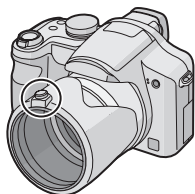

- Make sure the screw is loose and then attach the lens hood.
- Do not tighten the screw too much.

4 Attach the lens cap.

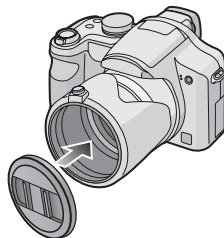

- Ensure that the lens cap is firmly attached.
- Do not take a picture while the lens hood is temporarily stored.



- When taking pictures with flash with the lens hood attached, the lower portion of the photo may turn dark (vignetting effect) and the control of the flash may be disabled because the photo flash may be obscured by the lens hood. We recommend detaching the lens hood.
- When using the AF assist lamp in the dark, detach the lens hood.
- For details on how to attach the MC protector and the ND filter, refer to P118.
- You cannot attach the conversion lenses and the close-up lens when the hood adaptor is attached.
- The lens adaptor (DMW-LA2; optional) is necessary to attach a conversion lenses.
- If any accessories are lost, customers in the USA should contact Panasonic's parts department at 1 800 833-9626 and customers in Canada should contact 1 800 99-LUMIX (1-800-995-8649) for further information about obtaining replacement parts.

Quick Guide

This is an overview of how to record and playback pictures with the camera. For each step, be sure to refer to the pages indicated in brackets.

1 Charge the battery. (P15)

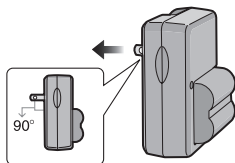

- The battery is not charged when the camera is shipped. Charge the battery before use.

2 Insert the battery and the card. (P17)

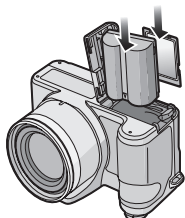

3 Turn the camera on to take pictures.

- Set the clock. (P19)

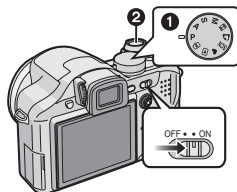

- 1 Set the mode dial to **[P]**.
- 2 Press the shutter button to take pictures. (P27)

4 Play back the pictures.

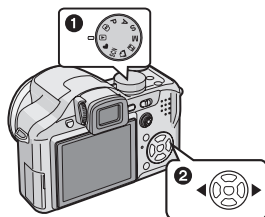

- 1 Set the mode dial to **[▶]**.
- 2 Select the picture you want to view. (P36)

Charging the Battery with the Charger

The battery is not charged when the camera is shipped. Charge the battery before use.

1 Insert the battery terminals and attach the battery to the charger.

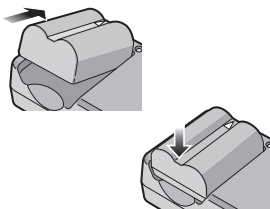

2 Connect the charger to the electrical outlet.

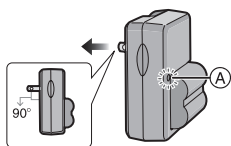

- Charging starts when the [CHARGE] indicator (A) lights green.
- Charging is complete when the [CHARGE] indicator (A) turns off (after about 120 minutes).
- If the [CHARGE] indicator blinks, refer to P16.

3 Detach the battery after charging is complete.

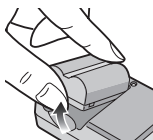

- After charging is completed, be sure to disconnect the charger from the electrical outlet.
- The battery becomes warm after using it and during and after charging. The camera also becomes warm during use. This is not a malfunction.
- The battery will be exhausted if left for a long period of time after being charged. Recharge the battery when it is exhausted.
- The battery can be charged even if it is not fully discharged.
- **Use the dedicated charger and battery.**
- **Charge the battery with the charger indoors.**
- **Do not disassemble or modify the charger.**

About the Battery

(charging/number of recordable pictures)

■ The battery life

The number of recordable pictures (By CIPA standard in program AE mode [P])

Number of recordable pictures	Approx. 380 pictures (Approx. 190 min)
-------------------------------	-------------------------------------------

Recording conditions by CIPA standard

- Temperature: 23 °C (73.4 °F)/
- Humidity: 50% when LCD monitor is on.*
- Using a Panasonic SD Memory Card (16 MB).
- Using the supplied battery.
- Starting recording 30 seconds after the camera is turned on. (When the optical image stabilizer function is set to [MODE1])
- **Recording once every 30 seconds** with full flash every second recording.
- Rotating the zoom lever from Tele to Wide or vice versa in every recording.
- Turn the camera off every 10 recordings.
- *The number of recordable pictures decreases when the power LCD function or high angle function (P41) are used.
- CIPA is an abbreviation of [Camera & Imaging Products Association].

The number of recordable pictures varies depending on the recording interval time.

If the recording interval time becomes longer, the number of recordable pictures decreases.

[e.g. When recording once every 2 minutes, the number of recordable pictures decreases to about 95.]

The number of recordable pictures when using the Viewfinder

(Recording conditions comply with CIPA standard.)

Number of recordable pictures	Approx. 380 pictures (Approx. 190 min)
-------------------------------	-------------------------------------------

Playback time when using the LCD monitor

Playback time	Approx. 420 min
---------------	-----------------

The number of recordable pictures and playback time will vary depending on the operating conditions and storing condition of the battery.

■ Charging

Charging time	Approx. 120 min
---------------	-----------------

Charging time and number of recordable pictures with the optional battery pack (CGR-S006A) are the same as above.

- The [CHARGE] indicator lights when charging starts.
- **When the [CHARGE] indicator flashes**
- The battery is over discharged (discharged excessively). In a while, [CHARGE] indicator will light up and normal charging will start.
- When the battery temperature is excessively high or low, the charging time will be longer than normal.
- The terminals of the charger or the battery are dirty. In this case, wipe them with a dry cloth.
- When the operating time of the camera becomes extremely short even after properly charging the battery, the life of the battery may have expired. Buy a new battery.

■ Charging conditions

- Charge the battery in a temperature between 10 °C to 35 °C (50 °F to 95 °F). (The battery temperature should also be the same.)
- The performance of the battery may temporarily deteriorate and the operating time may become shorter in low temperature conditions (e.g. skiing/snowboarding).

Inserting and Removing the Battery/ the Card (optional)

- Check that this unit is turned off.
- Close the flash.
- Prepare a card. (optional)
- You can record or play back pictures on the built-in memory when you are not using a card. (P18)

1 Slide the release lever in the direction of arrow and open the card/battery door.

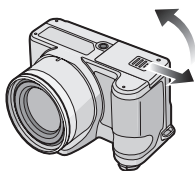

- Always use genuine Panasonic batteries (CGR-S006A).
- If you use other batteries, we cannot guarantee the quality of this product.

2 Battery:

Insert it fully being careful about the direction you insert it. Pull the lever (A) in the direction of the arrow to remove the battery.

Card:

Push it fully until it clicks being careful about the direction you insert it. Push it until it clicks and then pull it out upright.

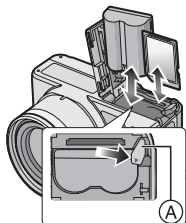

- Do not touch the connection terminals of the card.
- The card may be damaged if it is not fully inserted.

3 **1** Close the card/battery door.
2 Slide the release lever in the direction of the arrow.

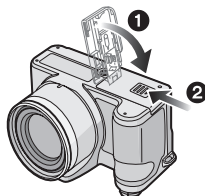

- If the card/battery door cannot be completely closed, remove the card, check its direction and then insert it again.



- Remove the battery after use.
- Do not remove the card or the battery while the card is being accessed. The data may be damaged.
- Do not remove the battery with the camera turned on since the settings on the camera may not be stored properly.
- The supplied battery is designed only for the camera. Do not use it with any other equipment.
- Do not insert or remove the battery or the card while this unit is turned on. The data on the built-in memory or the card may be damaged. Be particularly careful while the built-in memory or the card is being accessed. (P26)
- We recommend using Panasonic's card.

About the Built-in Memory/the Card (optional)

The built-in memory can be used as a temporary storage device when the card being used becomes full.

■ Built-in Memory []

You can record or play back pictures with the built-in memory. (The built-in memory cannot be used when a card is inserted.)

- **The built-in memory capacity is about 27 MB.**
- **Picture size is fixed to QVGA (320×240 pixels) when recording motion pictures to the built-in memory. (P70)**

■ Card []

When a card is inserted, you can record or play back pictures on a card.

■ Card (optional)

- The SD Memory Card, SDHC Memory Card and MultiMediaCard are small, lightweight, removable external cards. Read P5 for information about cards that can be used in this unit.
- The SDHC Memory Card is a memory card standard decided by the SD Association in 2006 for high capacity memory cards more than 2 GB.
- The reading/writing speed of an SD Memory Card and an SDHC Memory Card is fast. Both types of card are equipped with a Write-Protect switch  that prevents writing and formatting the card. (If the switch is slid to the [LOCK] side, it is not possible to write or delete data on the card and format it. When the switch is slid to the other side, these functions become available.)



- This unit (SDHC compatible equipment) is compatible with SD Memory Cards based on SD Memory Card Specifications and formatted in FAT12 system and FAT16 system. It is also compatible with SDHC Memory Cards based on SD Memory Card Specifications and formatted in FAT32 system.
- You can use an SDHC Memory Card in equipment that is compatible with SDHC Memory Cards however you cannot use an SDHC Memory Card in equipment that is only compatible with SD Memory Cards. (Always read the operating instructions for the equipment being used. If you also order a photo studio to print pictures, ask the photo studio before printing.) Please confirm the latest information on the following website.

<http://panasonic.co.jp/pavc/global/cs>

(This Site is English only.)

- Refer to P131 for information about the number of recordable pictures and the available recording time for each Card.
- We recommend using High Speed SD Memory Cards/SDHC Memory Cards when recording motion pictures. (P70)



- The data on the built-in memory or the card may be damaged or lost due to electromagnetic waves, static electricity or breakdown of the camera or the card. We recommend storing important data on a PC etc.
- The reading/writing speed of a MultiMediaCard is slower than an SD Memory Card or SDHC Memory Card. When a MultiMediaCard is used, the performance of certain features may be slightly slower than advertised.
- Do not format the card on your PC or other equipment. Format it on the camera only to ensure proper operation. (P109)
- Keep the Memory Card out of reach of children to prevent swallowing.

Setting Date/Time (Clock Set)



■ Initial setting

The clock is not set so the following screen appears when you turn the camera on.

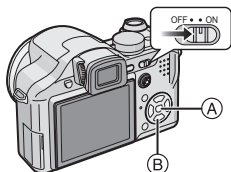

(A): [MENU/SET] button

(B): Cursor buttons

1 Press [MENU/SET].

2 Press ▲/▼/◀/▶ to select the date and time.

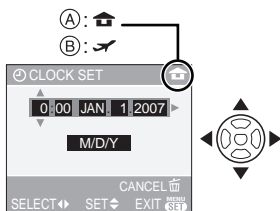

(A): Time at the home area

(B): Time at the travel destination (P74)

- ◀/▶: Select the desired item.
- ▲/▼: Set the display order for the date and time.
- 🗑️: Cancel without setting the clock.

3 Press [MENU/SET] to set.

- Turn the camera off after setting the clock. Then set the mode dial to a recording mode to turn the camera on and check whether or not the clock setting is correct.

■ Changing the clock setting

- 1 Press [MENU/SET].
- 2 Press ▲/▼ to select [CLOCK SET]. (P90)
- 3 Press ▶ and then perform steps **2** and **3** to set the clock.
- 4 Press [MENU/SET] to close the menu.
 - You can also set the clock in the [SETUP] menu. (P22)



- When a fully charged battery has been inserted for more than 24 hours, the clock setting is stored (in the camera) for at least 3 months even if the battery is removed. (If you insert a battery that is not sufficiently charged, the length of time that the clock setting is stored may become less.) However, the clock setting is canceled after this length of time. In this case, set the clock again.
- You can set the year from 2000 to 2099. The 24-hour system is used.
- If the clock is not set, the correct date cannot be printed when you stamp the date on the pictures with [DATE STAMP] (P100) or order a photo studio to print the pictures. (P103)

About the Mode Dial

If you turn on this unit and then rotate the mode dial, you can not only switch between recording and playback but also switch to a scene mode that matches your recording purpose.

■ Switching the mode by rotating the mode dial

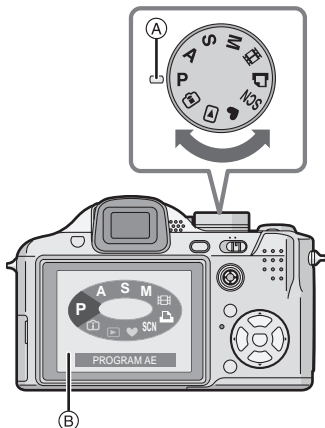

- **Adjust part ① to the desired mode.**
Rotate the mode dial slowly and surely to adjust to each mode. (The mode dial rotates 360 °)
- The above screen ② appears on the LCD monitor/Viewfinder if the mode dial is rotated. (P25)
- The mode currently selected appears on the LCD monitor/Viewfinder when the camera is turned on.

■ Basic

P : Program AE mode (P27)

The exposure is automatically adjusted by the camera.

♥ : Simple mode (P30)

This mode is recommended for beginners.

▶ : Playback mode (P36)

This mode allows you to play back recorded pictures.

■ Advanced

🔒 : Intelligent ISO sensitivity mode (P52)

This allows you to set the optimal ISO sensitivity and shutter speed according to the movement and the brightness of the subject.

A : Aperture-priority AE mode (P56)

The shutter speed is automatically determined by the aperture value you set.

S : Shutter-priority AE mode (P56)

The aperture value is automatically determined by the shutter speed you set.

M : Manual exposure mode (P57)

The exposure is adjusted by the aperture value and the shutter speed which are manually adjusted.

SCN : Scene mode (P62)

This allows you to take pictures that match the scene being recorded.

📹 : Motion picture mode (P70)

This mode allows you to record motion pictures.

🖨️ : Print mode (P113)

Use this to print pictures.

Setting the Menu

■ Displaying the menu screens

Press [MENU/SET].

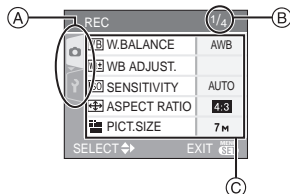

A Menu icons

B Current page

C Menu items and settings

- Rotate the zoom lever to switch to the next/previous page easily.
- The menu icons and the menu items that are displayed differ depending on the position of the mode dial.

■ About the menu icons

📷 [REC] mode menu (P76):

This is displayed when the mode dial is set to [P] / [A] / [S] / [M] / [E] / [SCN] / [C].

▶ [PLAY] mode menu (P97):

This is displayed when the mode dial is set to [▶].

SCN [SCENE MODE] menu (P62):

This is displayed when the mode dial is set to [SCN].

⤵ [SETUP] menu (P22):

This is displayed when the mode dial is set to [P] / [A] / [S] / [M] / [E] / [SCN] / [▶] / [C].

■ Setting menu items

- The following example shows how to set [QUALITY] when program AE mode [P] is selected.

1 Press ▲/▼ to select the menu item.

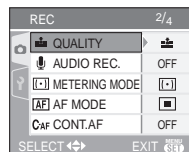
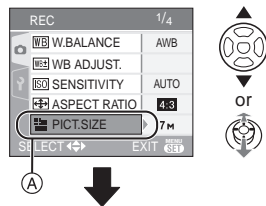

- Press ▼ at (A) to switch to the next screen.

2 Press ▶.

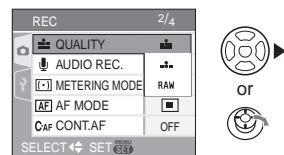

3 Press ▲/▼ to select the setting.

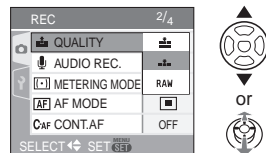

4 Press [MENU/SET] to set.

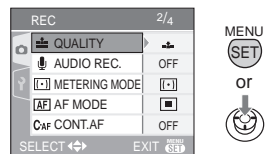

■ Closing the menu screen

Press [MENU/SET].

- When the mode dial is set to [P] [A] [S] [M] [E] [SCN] [A], you can also close the menu screen by pressing the shutter button halfway or press the center of the joystick to finish.

■ Switching to the [SETUP] menu

1 Press ◀ on a menu screen.

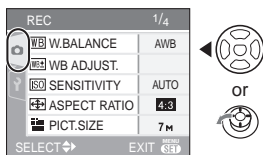

2 Press ▼ to select the [SETUP] menu icon.

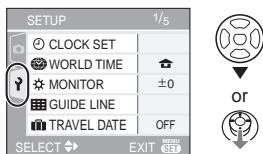

3 Press ▶.

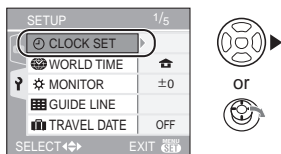

- Select a menu item next and set it.

About the Setup Menu

- Set items as required. (Refer to P22 to 25 for each menu item.)
- Select [RESET] to return the settings to the initial settings at the time of purchase. (P24)
- [CLOCK SET], [AUTO REVIEW] and [POWER SAVE] are important items. Check their settings before using them.

⌚ [CLOCK SET] (P19)

(Changing the date and time.)

Press [MENU] to display the [SETUP] menu and select the item to set. (P21)
Change date and time.

📷 [AUTO REVIEW]

(Displaying the recorded picture.)

Press [MENU] to display the [SETUP] menu and select the item to set. (P21)
Set the length of time that the picture is displayed after taking it.

[1SEC.], [3SEC.], [ZOOM], [OFF]

- The auto review function is not activated in motion picture mode [E].
- When pictures are recorded in auto bracket (P49) or burst mode (P51), the auto review function is activated regardless of the setting on the auto review function. (The picture is not enlarged.)
- The auto review function is activated while pictures with audio (P82) are being recorded regardless of its setting. (The picture is not enlarged.)
- When the quality is set to [RAW], the auto review function works until the end of recording onto the card. (The picture is not enlarged.)
- The auto review setting is disabled when using auto bracket or burst mode, in motion picture mode [E], when [AUDIO REC.] is set to [ON] or when the quality is set to [RAW].
- In simple mode [♥], the auto review function is fixed to [1SEC.].

 **[POWER SAVE]****(Turning off this unit automatically.)**

Press [] to display the [SETUP] menu and select the item to set. (P21)

Power save mode is activated (the camera is automatically turned off to save the battery life) if the camera has not been used for the time selected on the setting.

[1MIN.]/[2MIN.]/[5MIN.]/[10MIN.], [OFF]:

- Press the shutter button halfway or turn the camera off and on to cancel power save mode.
- In simple mode [, power save mode is fixed to [5MIN.].
- Power save mode is not activated in the following cases.
 - When using the AC adaptor (DMW-AC7PP; optional)
 - When connecting to a PC or a printer
 - When recording or playing back motion pictures
 - During a slide show (P97)

 **[WORLD TIME] (P74)**

Press [] to display the [SETUP] menu and select the item to set. (P21)

Set the time in your home area and travel destination.

[]: Home area.

[]: Travel destination area.

 **[MONITOR/VIEWFINDER]**

Press [] to display the [SETUP] menu and select the item to set. (P21)

You can adjust the brightness of the monitor or the Viewfinder in 7 steps.

 **[GUIDE LINE]**

Press [] to display the [SETUP] menu and select the item to set. (P21)

Set the pattern of the guide lines displayed when taking pictures.

You can also set whether or not to have the recording information and histogram displayed when the guide lines are displayed. (P38, 40)

[REC. INFO.]: [ON]/[OFF]

[HISTOGRAM]: [ON]/[OFF]

[PATTERN]: []/[]

 **[TRAVEL DATE] (P72)**

Press [] to display the [SETUP] menu and select the item to set. (P21)

Set the departure date and the return date of the vacation.

[SET], [OFF]

 **[PLAY ON LCD] (P40)**

Press [] to display the [SETUP] menu and select the item to set. (P21)

If you selected the Viewfinder in a recording mode, the display will automatically switch to the LCD monitor when reviewing or playing back the pictures.



[ON], [OFF]

 **[ZOOM RESUME]**

Press [] to display the [SETUP] menu and select the item to set. (P21)

The zoom position is stored when this unit is turned off. When this unit is turned on again, the zoom automatically returns to the position it was at when this unit was turned off. (P32)

[ON], [OFF]

- The zoom resume cannot be set in the following cases.
 - In simple mode [].
 - When [CONVERSION] on the [REC] mode menu is set to [] or [].

MF **[MF ASSIST] (P59)****(Recording mode only)**

Press [] to display the [SETUP] menu and select the item to set. (P21)

In manual focus, the assistance screen appears on the center of the screen to facilitate focusing on the subject.

[MF1]: The center of the screen is enlarged. You can adjust the focus while determining the composition of the whole of the screen.

[MF2]: The whole of the screen is enlarged. This is convenient for adjusting the focus in Wide angle shots.

[OFF]: The screen is not enlarged.

■)) [BEEP]

Press [] to display the [SETUP] menu and select the item to set. (P21)

This allows you to set the beep.

[]: No operation sound

[]: Soft operation sound

[]: Loud operation sound

 [AF BEEP]

Press [] to display the [SETUP] menu and select this item. (P21)

This allows you to set the AF beep.

[]: No AF beep

[]: Soft AF beep

[]: Loud AF beep

 [SHUTTER]

Press [] to display the [SETUP] menu and select the item to set. (P21)

This allows you to set the shutter sound.

[]: No shutter sound

[]: Soft shutter sound

[]: Loud shutter sound

 [VOLUME]

Press [] to display the [SETUP] menu and select the item to set. (P21)

The volume of speakers can be adjusted in 7 steps from level 6 to 0.

- When you connect the camera to a TV, the volume of the TV speakers does not change.

 [NO.RESET]

Press [] to display the [SETUP] menu and select the item to set. (P21)

The folder number is updated and the file number starts from 0001. (P111)

- A folder number between 100 and 999 can be assigned.

When the folder number reaches 999, the number cannot be reset. We recommend formatting the card after saving the data on a PC or elsewhere.

- To reset the folder number to 100, format the built-in memory (P109) or the card first and then use this function to reset the file number.

A reset screen for the folder number will then appear. Select [YES] to reset the folder number. (P111)

 [RESET]

Press [] to display the [SETUP] menu and select the item to set. (P21)

The [REC] or [SETUP] menu settings are reset to the initial settings.

- [FAVORITE] (P99) is fixed to [OFF] and [ROTATE DISP.] (P99) is fixed to [ON].
- If the [SETUP] menu settings are reset, the following settings are also reset.
 - The birthday settings for [BABY1]/[BABY2] (P66) and [PET] (P67) in scene mode.
 - The number of days that have passed since the departure date in [TRAVEL DATE]. (P72)
 - The [WORLD TIME] (P74) setting.
 - [ZOOM RESUME] (P23)
- The folder number and the clock setting are not changed.

 **[VIDEO OUT] (P117)****(Playback mode only)**

Press [] to display the [SETUP] menu and select the item to set. (P21)

Set to match the color television system in each country.

[NTSC]: Video output is set to NTSC system.

[PAL]: Video output is set to PAL system.

 **[TV ASPECT] (P117)****(Playback mode only)**

Press [] to display the [SETUP] menu and select the item to set. (P21)

Set to match the type of TV.

[16:9]:

When connecting to a 16:9 screen TV.

[4:3]:

When connecting to a 4:3 screen TV.

 **[MF m/ft] (P59)**

Press [] to display the [SETUP] menu and select the item to set. (P21)

Change the unit displayed for the focus distance in manual focus.

[m]: The distance is displayed in metres.

[ft]: The distance is displayed in feet.

 **[SCN] [SCENE MENU] (P62)**

Press [] to display the [SETUP] menu and select the item to set. (P21)

Set the screen that will appear when the mode dial is set to [].

[AUTO]: The [SCENE MODE] menu screen appears.

[OFF]: The recording screen in the currently selected scene mode appears.

 **[DIAL DISPLAY] (P20)**

Press [] to display the [SETUP] menu and select the item to set. (P21)

Set whether or not to show the mode dial display when the mode dial is rotated.

[ON], [OFF]

 **[LANGUAGE]**

Press [] to display the [SETUP] menu and select the item to set. (P21)

Set the language displayed on the screen.

[ENGLISH], [DEUTSCH], [FRANÇAIS], [ESPAÑOL], [ITALIANO], [中文]*,

[日本語]

* Not displayed on DMC-FZ8P.

• If you set a different language by mistake, select [] from the menu icons to set the desired language.

LCD Monitor Display/ Switching the LCD Monitor Display

■ Screen display in program AE mode [P] (at the time of purchase)

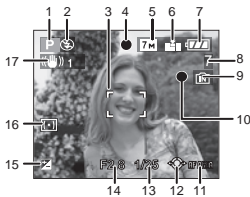

- 1 Recording mode
- 2 Flash mode (P43)
- 3 AF area (P27)
 - The AF area displayed is bigger than usual when taking pictures in dark places.
- 4 Focus (P27)
- 5 Picture size (P80)
- 6 Quality (P80)
 - [P] [Q]: Jitter alert (P29)
- 7 Battery indication
 - 
 - The indication turns red and blinks if the remaining battery power is exhausted. (The status indicator blinks when the LCD monitor turns off.) Recharge the battery or replace it with fully charged battery.
 - It does not appear when you use the camera with the AC adaptor (DMW-AC7PP; optional) connected.
- 8 Number of recordable pictures (P131)
- 9 Built-in memory/Card

- The access indication lights red when pictures are being recorded on the built-in memory (or the card).
 - When using the built-in memory



- When using the card



- Do not do the following when the access indication lamps lights. The card or the data on the card may be damaged and this unit may no longer operate normally.
 - Turn this unit off.
 - Remove the battery or the card. (when using a card)
 - Shake or bump this unit.
 - Disconnect the AC adaptor. (DMW-AC7PP; optional) (when using the AC adaptor)
- Do not do the above when pictures are being read or deleted or the built-in memory (or the card) is being formatted (P109).
- The access time for the built-in memory may be longer than the access time for a card.

- 10 Recording state
- 11 AF area selection (P84)
- 12 Joystick operation (P29, 36, 56, 57)
- 13 Shutter speed (P27)
- 14 Aperture value (P27)
 - If the exposure is not adequate, the aperture value and the shutter speed turn red. (They do not turn red when the flash is activated.)
- 15 Exposure compensation (P48)
- 16 Metering mode (P82)
- 17 Optical Image Stabilizer (P50)



- Refer to P119 for information about other screen displays.

■ Switching the screen display

You can change the screen display by pressing [DISPLAY]. This allows you to display information while taking pictures such as the picture size or the number of recordable pictures or take pictures without displaying any information. Refer to P38 for details.

Taking Pictures



The camera automatically sets the shutter speed and the aperture value according to the brightness of the subject.

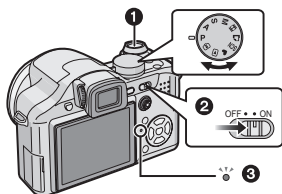

1: Shutter button

- The status indicator **3** lights for about 1 second when you turn this unit on **2**. (When using the LCD monitor.)
- The status indicator continues to light if you turn the camera on when using the viewfinder.

1 Hold this unit gently with both hands, keep your arms still at your side and stand with your feet slightly apart.

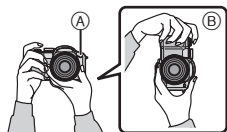

(A): AF assist lamp

(B): When holding the camera vertically

2 Aim the AF area at the point you want to focus on.

3 Press the shutter button halfway to focus.

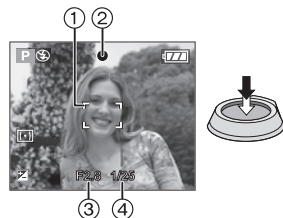

- The focus indication **2** lights green and the AF area **1** turns white to green.
- ③: Aperture value
- ④: Shutter speed
- The subject is not focused in the following cases.
 - The focus indication blinks (green).
 - The AF area turns white to red or there is no AF area.
 - The focus sound beeps 4 times.
- If the distance is beyond the focus range, the picture may not be properly focused even if the focus indication lights.

4 Press the shutter button fully to take a picture.



- When you press the shutter button, the screen may become bright or dark for a moment. This function allows easy adjustment of focus and the recorded picture will not be affected.
- Be careful not to move the camera when you press the shutter button.
- Do not cover the microphone or the AF assist lamp with your fingers or other objects.
- Do not touch the front of the lens.
- When taking pictures, make sure your footing is stable and there is no danger of colliding with another person, a ball etc.

■ Exposure (P48)

- The exposure is automatically adjusted to the appropriate exposure on this unit (AE=Auto Exposure). However, depending on the recording conditions such as when there is backlight, the recorded picture will be dark.

In this case, compensate the exposure. This allows you to take bright pictures.

■ Focusing (P28, 54, 61)

- The picture is automatically focused on this unit (AF=Auto Focus). However, the picture may not be properly focused in the following cases.

The focus range is 30 cm (0.98 feet) to ∞ (Wide), 2 m (6.56 feet) to ∞ (Tele)

- When there are both near and distant subjects in a scene.
- When there is dirt or dust on glass between the lens and the subject.
- When there are illuminated or glittering objects around the subject.
- When taking a picture in dark places.
- When the subject is moving fast.
- When the scene has low contrast.
- When recording a very bright subject.
- When taking close-up pictures of a subject.
- When jitter occurs.

Try using prefocus, the AF/AE lock technique or [AF MACRO].

■ Color (P77, 78)

- The color of the subject will differ if the color of the light surrounding it differs such as when the light comes from sunlight or halogen lighting. However, this unit automatically adjusts the hue to one close to real life. (auto white balance)

Set the white balance if you want to change the hue you get with auto white balance.

Adjust the white balance finely for additional white balance adjustment.

■ When you want to take a subject outside the AF area (AF/AE Lock)

When recording a picture of people with a composition like the following picture, you will not be able to focus the camera on the subject because the people are outside the AF area.



In this case,

- 1 Aim the AF area at the subject.
- 2 Press the shutter button halfway to fix the focus and the exposure.
 - The focus indication lights when the subject is focused.
- 3 Press and hold the shutter button halfway while moving the camera as you compose the picture.
- 4 Press the shutter button fully.
 - You can repeatedly retry AF/AE lock before pressing the shutter button fully.



■ Direction detection function

Pictures recorded with the camera held vertically are played back vertically (rotated). (Only when [ROTATE DISP.] (P99) is set to [ON])

- Pictures may not be displayed vertically if they were taken with the camera aimed up or down.
- Pictures cannot be displayed vertically when recording motion pictures or creating flip animations.

■ Preventing jitter (camera shake)

- Be careful of jittering when pressing the shutter button.
- If jitter could occur because of slow shutter speed, the jitter alert **(A)** appears.

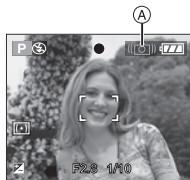

- When the jitter alert appears, we recommend using a tripod. If you cannot use a tripod, be careful how you hold the camera (P27). The use of the self-timer prevents jittering caused by pressing the shutter button when you are using a tripod (P47).
- Shutter speed will be slower particularly in the following cases. Keep the camera still from the moment the shutter button is pressed until the picture appears on the screen. We recommend using a tripod.
 - Slow sync./Red-eye reduction (P43)
 - [NIGHT PORTRAIT] (P64)
 - [NIGHT SCENERY] (P65)
 - [PARTY] (P65)
 - [CANDLE LIGHT] (P65)
 - [STARRY SKY] (P67)
 - [FIREWORKS] (P68)
 - When you set to a slow shutter speed (P56, 57)

■ Program shift

In program AE mode, you can change the preset aperture value and shutter speed without changing the exposure. This is called program shift.

You can make the background more blurred by decreasing the aperture value or record a moving subject more dynamically by slowing the shutter speed when taking a picture in program AE mode.

- Press the shutter button halfway and then use the joystick to activate program shift while the aperture value and the shutter speed are displayed on the screen (about 10 seconds).

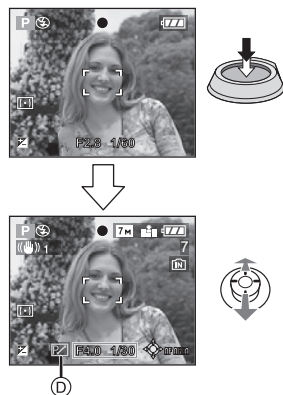

- The program shift indication **(D)** appears on the screen when program shift is activated.
- Program shift is canceled if the camera is turned off or the joystick is moved up and down until the program shift indication disappears.

■ Example of program shift

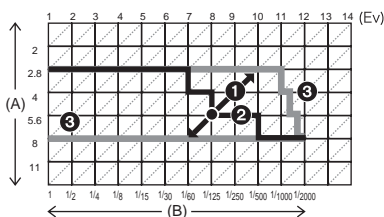

(A): Aperture value

(B): Shutter speed

- 1 Program shift amount
- 2 Program shift line chart
- 3 Program shift limit



- If the exposure is not adequate when the shutter button is pressed halfway, the aperture value and shutter speed turns red.
- Program shift is canceled and the camera returns to normal program AE mode if more than 10 seconds pass after program shift is activated. However, the program shift setting is memorized.
- Depending on the brightness of the subject, program shift may not be activated.

Taking Pictures in Simple Mode



This mode allows beginners to take pictures easily. Only the basic functions appear in the menu to make operations simple.

Basic menu settings

1 Press [MENU/SET].

2 Press ▲/▼ to select the desired menu item and then press ►.

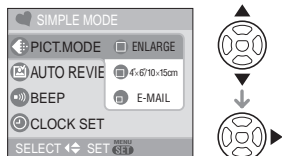

3 Press ▲/▼ to select the desired setting and then press [MENU/SET].

4 Press [MENU/SET] to close the menu.

- You can also press the shutter button halfway to close the menu.
- You can also use the joystick to perform **2** to **4**.

Settings in Simple mode

[PICT.MODE]

[ENLARGE]	Suitable for enlarging the pictures to be printed to 8"×10" size, letter size etc.
[4"×6"/10×15cm]	Suitable for regular size printing.
[E-MAIL]	Suitable for attaching pictures to e-mails or adding pictures to websites.

[AUTO REVIEW]

[OFF]	The recorded picture does not automatically appear.
[ON]	The recorded picture automatically appears on the screen for about 1 second.

[BEEP]

[OFF]	No operation sound
[LOW]	Soft operation sound
[HIGH]	Loud operation sound

[CLOCK SET]

Change date and time. (P19)

- If [4"×6"/10×15cm] or [E-MAIL] is set in [PICT.MODE], the extended optical zoom is activated. (P33)
- The settings for [BEEP] and [CLOCK SET] in simple mode are also applied to other recording modes.
- The settings for [WORLD TIME] (P23), [MONITOR/VIEWFINDER] (P23), [TRAVEL DATE] (P23), [ZOOM RESUME] (P23), [BEEP] (P24), [AF BEEP] (P24), [SHUTTER] (P24), [NO.RESET] (P24), [DIAL DISPLAY] (P25) and [LANGUAGE] (P25) in the [SETUP] menu are applied to simple mode.

Other Settings in Simple mode

In simple mode, other settings are fixed as follows. For more information about each setting, refer to the page indicated.

- [AUTO REVIEW] (P22): [1SEC.]
- [POWER SAVE] (P23): [5MIN.]
- Self-timer (P47): 10 seconds
- Optical Image Stabilizer (P50): [MODE1]
- Burst speed (P51): Low speed (2 frames/second)
- [W.BALANCE] (P77): [AWB]

- [SENSITIVITY] (P79):
This setting becomes the same as when the highest ISO sensitivity is set to [ISO800] in intelligent ISO sensitivity mode []. (P52)
- [ASPECT RATIO]/[PICT.SIZE]/[QUALITY] (P80):
 - [] ENLARGE]:
 4:3 : 7M (7M)/
 - [] 4"×6"/10×15cm]:
 3:2 : 2.5M (2.5M EZ)/
 - [] E-MAIL]:
 4:3 : 0.3M (0.3M EZ)/
- [AF MODE] (P83):
[]
- [AF ASSIST LAMP] (P85):
[ON]
- [METERING MODE] (P82):
[]

• You cannot use the following functions.

- High angle mode
- White balance fine adjustment
- Exposure compensation
- Flash output adjustment
- Auto bracket
- [AUDIO REC.]
- [D.ZOOM]
- [COL.EFFECT]
- [PICT.ADJ.]
- [CONT.AF]
- [PLAY ON LCD]
- Out-of-frame display
- [GUIDE LINE]

• You cannot set the following items.

- [ZOOM RESUME]
- [TRAVEL DATE]
- [WORLD TIME]
- [CONVERSION]

■ Focus range in simple mode

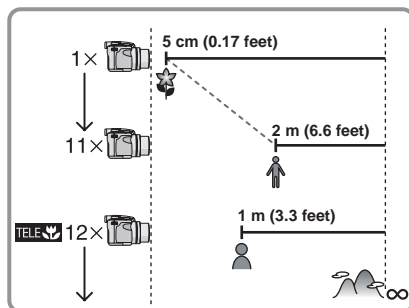

- The zoom magnification values will change when using the extended optical zoom.
- Refer to P54 for the tele-macro.

■ The Backlight Compensation

Backlight refers to when light comes from behind a subject.

In this case, the subject, such as a person, will become dark so this function compensates the backlight by brightening the whole of the picture.

Press ▲.

- When the backlight compensation function is activated, [] (compensating backlight ON indication (A)) appears. Press ▲ again to cancel this function.



- We recommend using the flash when you use the backlight compensation function. (The flash is fixed to Forced ON [].)
- The flash setting is fixed to AUTO/ Red-eye reduction [] when the backlight compensation function is set to [OFF].

Taking Pictures with the Zoom

Using the Optical Zoom



You can make people and objects appear closer and landscapes can be recorded in wide angle with the 12× optical zoom. (35 mm film camera equivalent: 36 mm to 432 mm)

■ To make subjects appear closer use (Tele)

Rotate the zoom lever towards **Tele**.



■ To make subjects appear further away use (Wide)

Rotate the zoom lever towards **Wide**.



■ Changing the zoom speed

You can operate the zoom at 2 speeds depending on the rotation angle of the zoom lever.

The zoom speed becomes slower when the rotation angle is small and the zoom speed becomes faster when the rotation angle is large.

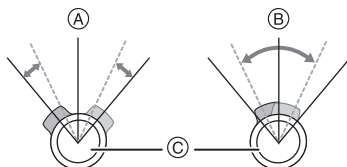

- (A): Fast
- (B): Slow
- (C): Zoom lever

■ Storing the zoom position (Zoom resume)

If [ZOOM RESUME] (P23) in the [SETUP] menu is set to [ON], the zoom position is stored when this unit is turned off. When this unit is turned on again, the zoom position automatically returns to the position it was at when this unit was turned off.

- The focus position is not stored.



- If you use the zoom function after focusing on the subject, focus on the subject again.
- The indicated zoom magnification is an approximation.
- The lens barrel (P10) extends or retracts according to the zoom position. Take care not to interrupt the motion of the lens barrel while the zoom lever is rotated.
- In motion picture mode [M], the zoom magnification is fixed to the value set at the start of recording.
- When you rotate the zoom lever, you may hear some sound from the camera or the camera may be shaken. This is not a malfunction.

Using the Extended Optical Zoom (EZ)



This camera has a 12× optical zoom. However, if the picture size is not set to the highest setting for each aspect ratio [4:3 / 3:2 / 16:9], a maximum of 18× optical zoom can be achieved with no picture quality deterioration.

Extended optical zoom mechanism

When you set the picture size to [3M] (3M EZ) (3 million pixels), the 7M (7 million pixels) CCD area is cropped to the center 3M (3 million pixels) area, allowing a picture with a higher zoom effect.

Picture size and maximum zoom magnification

(○: Available, —: Not available)

Aspect ratio (P80)	Picture size (P31, 80)	Maximum zoom magnification (Tele)	Extended optical zoom
4:3	7M / (7M)	12×	—
3:2	6M (6M)		
16:9	5.5M (5.5M)		
4:3	5M (5M EZ)	14.4×	○
4:3	3M (3M EZ)	18×	○
	2M (2M EZ)		
1M (1M EZ)			
0.3M / (0.3M EZ)			
3:2	2.5M / (2.5M EZ)		
16:9	2M (2M EZ)		



- “EZ” is an abbreviation of “Extended optical Zoom”.
- If you set a picture size that activates the extended optical zoom, the extended optical zoom icon [EZ] is displayed on the screen when you use the zoom function.
- The indicated zoom magnification is an approximation.
- The on-screen zoom indication may not change consecutively if you rotate the zoom lever near the Tele position when the extended optical zoom is used. This is not a malfunction.
- In motion picture mode [H] and [HIGH SENS.] in scene mode, the extended optical zoom does not work.



Using the Digital Zoom

Further extending the zoom



A maximum of 48× zoom can be achieved with the 12× optical zoom and the 4× digital zoom when [D.ZOOM] is set to [ON] in the [REC] menu. However, if a picture size that can use extended optical zoom is selected, a maximum of 72× zoom can be achieved with the 18× extended optical zoom and the 4× digital zoom.

Menu operation

1 Press [MENU/SET].

- When a scene mode is selected, select the [REC] menu [] and then press .

2 Press / to select [D.ZOOM] and then press .

3 Press to select [ON] and then press [MENU/SET].

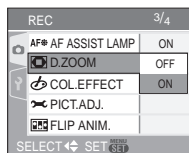

4 Press [MENU/SET] to close the menu.

- You can also press the shutter button halfway or press the center of the joystick to finish.

Entering the digital zoom range

The on-screen zoom indication may momentarily stop moving when you rotate the zoom lever to the extreme Tele position. You can enter the digital zoom range by continuously rotating the zoom lever to Tele or releasing the zoom lever once and then rotating it to Tele again.

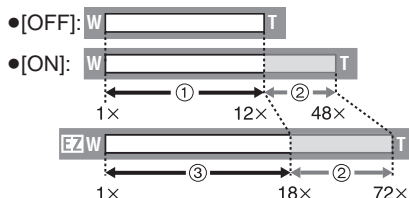

(When using the digital zoom and the extended optical zoom [] (3M EZ) at the same time.)

- Optical zoom
- Digital zoom
- Extended optical zoom



- A big AF area (P83) is displayed when using the digital zoom. Also, the stabilizer function may not be effective.
- In digital zoom, the larger the picture the lower the picture quality.
- When using the digital zoom, we recommend using a tripod and the self-timer (P47) for taking pictures.
- The indicated zoom magnification is an approximation.
- The digital zoom is temporarily set to [OFF] in the following cases.
 - When the quality is set to [RAW] (P80)
 - When [CONVERSION] on the [REC] menu is set to [] (P88)
- The digital zoom does not work in the following cases:
 - In simple mode [].
 - In intelligent ISO sensitivity mode [].
 - In [SPORTS], [BABY1]/[BABY2], [PET] and [HIGH SENS.] in scene mode.

Checking the Recorded Picture (Review)



You can check the recorded pictures while still in [REC] mode.

1 Press ▼ [REV].

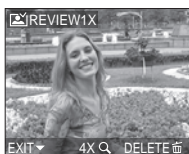

- The last recorded picture appears for about 10 seconds.
- Review is canceled when the shutter button is pressed halfway or the ▼ [REV] is pressed again.

2 Press ◀/▶ to select the picture.

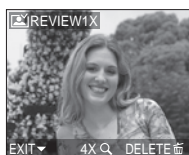

- ◀: Play back the previous picture
- ▶: Play back the next picture

■ Enlarging the picture

1 Rotate the zoom lever towards [Q] (T).

- Rotate the zoom lever to [Q] [T] for a 4× magnification and then rotate it even more for a 8× magnification. When you rotate the zoom lever towards [Q] [W] after enlarging the picture, the magnification becomes lower.

2 Press ▲/▼/◀/▶ to move the position.

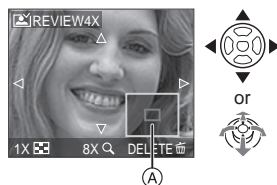

- When you change the magnification or the position to be displayed, the zoom position indication (A) appears for about 1 second.

■ Deleting the recorded picture during Review (Quick deletion)

A single picture, multiple pictures or all the pictures can be deleted during review. Refer to P36 to 37 for information about how to delete pictures.



- When [ROTATE DISP.] (P99) is set to [ON], pictures recorded holding the camera vertically are played back vertically (rotated).

Playing back/Deleting Pictures



The picture data on the built-in memory is played back or deleted when a card is not inserted. The picture data on the card is played back or deleted when a card is inserted. (P18)

Once deleted, pictures cannot be recovered. Check the pictures one by one and delete unwanted pictures.

■ Playing back pictures

Press ◀/▶ to select the picture.



◀: Play back the previous picture

▶: Play back the next picture

■ Fast forwarding/Fast rewinding

Press and hold ◀/▶ during playback.

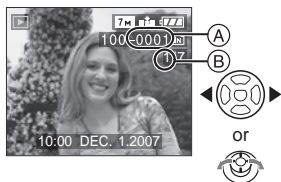

◀: Fast rewind

▶: Fast forward

- The file number (A) and the picture number (B) only change one by one. Release ◀/▶ when the number of the desired picture appears to play back the picture.

- If you keep pressing ◀/▶, the number of pictures forwarded/ rewound increases.

- In review playback in recording mode and in multi playback (P91), the pictures can only be forwarded or rewound one by one.



- This camera is based on the DCF standard "Design rule for Camera File system" which was established by the "JEITA (Japan Electronics and Information Technology Industries Association)".
- The LCD monitor may not be able to display the details of the recorded pictures. You can use the playback zoom (P93) to check the details of the pictures.
- If you play back pictures that have been recorded with other equipment, the picture quality may deteriorate. (The pictures are displayed as [THUMBNAIL IS DISPLAYED] on the screen.)
- If you change a folder name or file name on your PC, the pictures may not play back on the camera.
- If you play back a non-standard file, the folder/file number is indicated by [—] and the screen may turn black.
- Depending on the subject, an interference fringe may appear on the screen. This is called moire. This is not a malfunction.

■ To delete a single picture

1 Press [] while the picture is being played back.

2 Press ▲ to select [YES] and then press [MENU/SET].



- While the picture is being deleted, [] appears on the screen.

■ To delete [MULTI DELETE]/ [ALL DELETE]

1 Press [] twice.

2 Press ▲/▼ to select
[MULTI DELETE] or
[ALL DELETE] and then press
[MENU/SET].

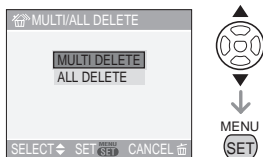

- [MULTI DELETE] → step **3**.
- [ALL DELETE] → step **5**.
- [ALL DELETE EXCEPT ★] (When [FAVORITE] (P99) is set only) → step **5**.
(However, this cannot be selected if none of the pictures have [★] displayed.)

3 Press ◀/▶ to select the picture
and then press ▼ to set.

(Only when selecting [MULTI DELETE])

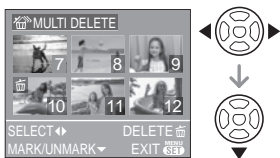

- Repeat the above procedure.
- [] appears on the selected pictures. If ▼ is pressed again, the setting is canceled.
- The icon [] blinks red if the selected picture is protected and cannot be deleted. Cancel the protect setting and then delete the picture. (P104)

4 Press [].

5 Press ▲ to select [YES] and then
press [MENU/SET] to set.

(Screen when selecting [MULTI DELETE])



- When you delete pictures, only pictures in either of the built-in memory or the card can be deleted. (You cannot delete pictures in both the built-in memory and the card at the same time.)
- [DELETE ALL PICTURES IN THE INTERNAL MEMORY ?] is displayed when using [ALL DELETE] and [DELETE ALL EXCEPT ★ ?] is displayed when using [ALL DELETE EXCEPT ★].
- If you press [MENU/SET] while deleting pictures using [ALL DELETE] or [ALL DELETE EXCEPT ★], the deleting will stop halfway.



- Do not turn off the camera while deleting.
- When deleting pictures, use a battery with sufficient battery power (P26) or the AC adaptor (DMW-AC7PP; optional).
- It is possible to delete up to 50 pictures at one time using [MULTI DELETE].
- The greater the number of pictures the longer it takes to delete them.
- If there are pictures that are protected [] (P104), do not conform to the DCF standard (P36) or are in a card with the Write-Protect switch slid to the [LOCK] side (P18), they are not deleted even if [ALL DELETE] or [ALL DELETE EXCEPT ★] is selected.

About the LCD Monitor/Viewfinder

Changing the information displayed

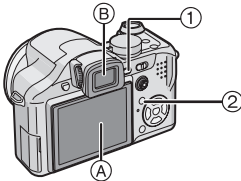

① Switching the LCD monitor/Viewfinder

Press the [EVF/LCD] button to switch the monitor screen.

- A LCD monitor (LCD)
- B Viewfinder (EVF)

• When the LCD monitor turns on, the Viewfinder turns off (and vice versa).

② Selecting the screen to be used

Press the [DISPLAY] button to change the display.

• When the menu screen appears, the [DISPLAY] button is not activated.
In playback zoom (P93), while playing back motion pictures (P94) and during a slide show (P97), you can only select “Normal display J” or “No display L”.

In simple mode [♥]

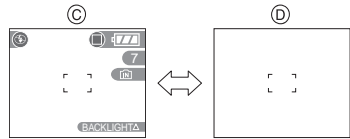

- C Normal display
- D No display

In recording mode

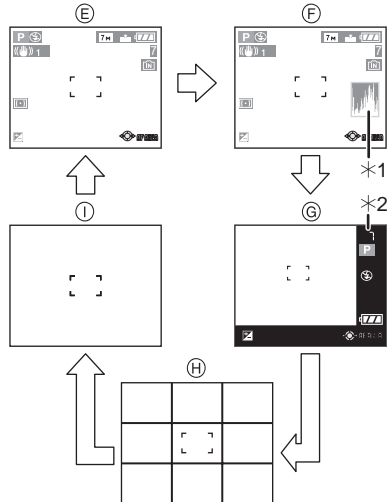

- E Normal display
- F Display with histogram
- G Out-of-frame display
- H No display (Recording guide line)^{*3}
- I No display
- *1 Histogram
- *2 When the number of pictures remaining is more than 1000 or the time remaining in motion picture mode is more than 1000 seconds, [+9999] is displayed.
- *3 The display information will differ depending on what has been set using the [GUIDE LINE] (P23) on the [SETUP] menu. (P40)

In playback mode

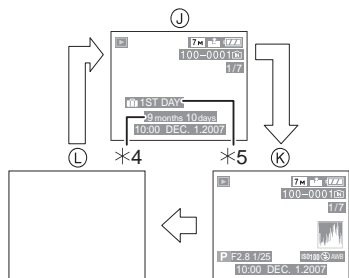

- Ⓝ Normal display
- Ⓚ Display with recording information and histogram
- Ⓛ No display
- *4 Displayed if [BIRTHDAY SET.] and [WITH AGE] were set in [BABY1]/[BABY2] (P66) and [PET] (P67) in scene mode before taking pictures.
- *5 The number of days that have passed since the travel date are displayed if [TRAVEL DATE] (P72) is set.



- In [NIGHT PORTRAIT] (P64), [NIGHT SCENERY] (P65), [STARRY SKY] (P67) and [FIREWORKS] (P68) in scene mode, the lines are gray.

■ Out-of-frame display

Recording information is displayed on the bottom and right edges of the screen. You can therefore concentrate on the subject when taking pictures without being obstructed by information displayed on the screen.

■ Diopter adjustment

Adjust the diopter to suit your vision so that you can see the Viewfinder clearly.

- Press the [EVF/LCD] button to display the viewfinder.

Look at the display on the Viewfinder and rotate the diopter adjustment dial to where the screen is clearest.

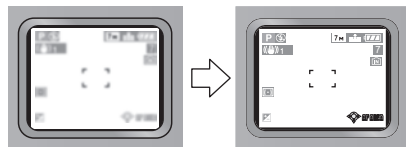
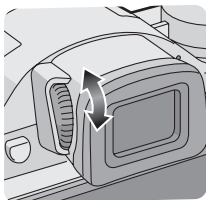

■ Monitor priority

When [PLAY ON LCD] is set to [ON] on the [SETUP] menu (P23), the LCD monitor is turned on in the following cases.



You can save the time it would take to switch the display to the LCD monitor even when using the Viewfinder to record.

- When switching from recording mode to playback mode.
- When reviewing pictures. (P35)
- When turning the camera on in playback mode.

■ Recording guide line

When you align the subject on the horizontal and vertical guide lines or the cross point of these lines, you can take pictures with well-designed composition by viewing the size, the slope and the balance of the subject.



- (A) : This is used when dividing the entire screen into 3×3 for taking pictures with a well-balanced composition.
- (B) : This is used when you want to position the subject at the exact center of the screen.

■ Histogram

- A histogram is a graph that displays brightness along the horizontal axis (black to white) and the number of pixels at each brightness level on the vertical axis.
 - It allows you to easily check a picture's exposure.
 - It is very useful if manual adjustments of the lens aperture and shutter speed are available, especially in those situations where automatic exposure may be difficult due to uneven lighting. Using the histogram feature allows you to get the maximum performance from your camera.
- (A) When the values are concentrated on the left, the picture is under exposed.
- (B) When the values are distributed evenly, the exposure is proper and the brightness is well-balanced.
- (C) When the values are concentrated on the right, the picture is over exposed.

Example of histogram

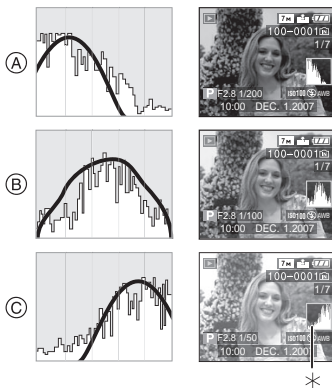

- (A) Under Exposed
- (B) Properly Exposed
- (C) Over Exposed
- *Histogram



- When the recorded picture and the histogram do not match each other under the following conditions, the histogram is displayed in orange.
 - When the manual exposure assistance is other than [$\pm 0\text{EV}$] during exposure compensation or in the manual exposure mode
 - When the flash is activated
 - In [STARRY SKY] (P67) or [FIREWORKS] (P68) in scene mode
 - When the flash is closed
 - ① When the brightness of the screen is not correctly displayed in dark places
 - ② When the exposure is not adequately adjusted
- The histogram is an approximation in recording mode.
- The histogram of a picture may not match in recording mode and playback mode.
- The histogram displayed in this camera does not match histograms displayed by picture editing software used in PCs etc.
- The histogram does not appear during the following.
 - Simple mode [♥]
 - Motion picture mode [MOV]
 - Multi playback
 - Playback zoom
 - Calendar playback

Brightening the LCD Monitor (Power LCD/High angle mode)



- 1 Press [LCD MODE] (A) for 1 second.

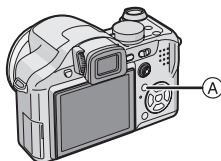

- 2 Press $\blacktriangle/\blacktriangledown$ to select a mode.

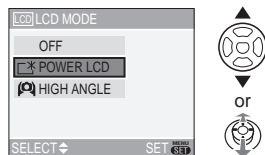

[*]: [POWER LCD]	The LCD monitor becomes brighter and easier to see even when taking pictures outdoors.
[]: [HIGH ANGLE]	The LCD monitor is easier to see when taking pictures with the camera held high above your head. This is useful when you cannot get close to the subject because there is a person in the way. (However it becomes more difficult to see when looked at straight on.) 
[OFF]	The LCD monitor returns to the normal brightness.

3 Press [MENU/SET].

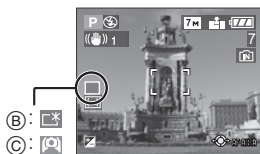

- The [POWER LCD] (B) or [HIGH ANGLE] (C) icon appears.

■ Canceling Power LCD or High angle mode

- If you press and hold [LCD MODE] again for 1 second the screen shown in step 2 is displayed. Select [OFF] to cancel Power LCD mode or High angle mode.



- High angle mode is also canceled if you turn the camera off or power save mode is activated.
- The brightness of the pictures displayed on the LCD monitor is adjusted when Power LCD mode or High angle mode is activated. Therefore, some subjects may look different on the LCD monitor. However, this does not affect the recorded pictures.
- The LCD monitor automatically returns to normal brightness after 30 seconds when recording in Power LCD mode. Press any button to make the LCD monitor bright again.
- If the LCD monitor screen is difficult to see because of light from the sun etc. shining on it, we recommend using your hand or another object to block the light when using the camera.
- High angle mode is not activated in the following cases.
 - In simple mode []
 - In playback mode []
 - In print mode []
 - While the menu screen is displayed
 - While the review screen is displayed

Taking Pictures using the Built-in Flash

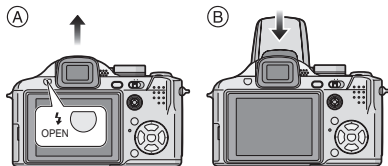

A To open the flash

Press the [⚡ OPEN] button.

B To close the flash

Press the flash until it clicks.

- Be sure to close the flash when not in use.
- The flash setting is fixed to Forced OFF [☺] while the flash is closed.

Switching to the appropriate flash setting

Set the flash to match the recording.

1 Press ► [⚡].

2 Press ▲/▼ to select a mode.

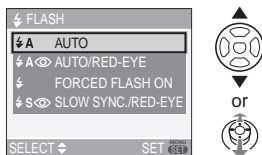

- You can also press ► [⚡] to select.
- For information about flash settings that can be selected, refer to “Available flash settings by recording mode”. (P44)

3 Press [MENU/SET].

- You can also press the shutter button halfway or press the center of the joystick to finish.
- The menu screen disappears after about 5 seconds. At this time, the selected item is automatically set.

⚡A : AUTO

The flash is automatically activated when the recording conditions make it necessary.

⚡A⊕ : AUTO/Red-eye reduction*1

The flash is automatically activated when the recording conditions make it necessary. It is activated once before the actual recording to reduce the red-eye phenomenon (eyes of the subject appearing red in the picture) and then activated again for the actual recording.

- Use this when you take pictures of people in low lighting conditions.

⚡ : Forced ON

The flash is activated every time regardless of the recording conditions.

- Use this when your subject is back-lit or under fluorescent light.

⚡A⊕ : Forced ON/Red-eye reduction*1

- The flash setting is set to Forced ON/Red-eye reduction only when you set [PARTY] (P65) or [CANDLE LIGHT] (P65) in scene mode.

⚡S⊕ : Slow sync./Red-eye reduction*1

If you take a picture with a dark background landscape, this feature will slow the shutter speed when the flash is activated so that the dark background landscape will become bright. Simultaneously it reduces the red-eye phenomenon.

- Use this when you take pictures of people in front of a dark background.

☺ : Forced OFF

The flash is not activated in any recording conditions.

- Use this when you take pictures in places where the use of the flash is not permitted.

*1 The flash is activated twice. The subject should not move until the second flash is activated.

[ISO1250]	Wide
	1 m (3.28 feet) to 8.5 m (27.9 feet)
	Tele
	1 m (3.28 feet) to 7.7 m (25.2 feet)

- The available flash range is an approximation.
- The available focus range differs depending on the recording mode. (P134)
- If ISO sensitivity is set to [AUTO] or [] when using the flash, it will be automatically increased to a maximum of [ISO400].
- In motion picture mode [] and [SCENERY] (P63), [NIGHT SCENERY] (P65), [SUNSET] (P67), [HIGHSENS.] (P67), [STARRY SKY] (P67), [FIREWORKS] (P68) or [AERIAL PHOTO] (P69) in scene mode, the flash setting is fixed to Forced OFF [] even if the flash is opened.

■ Shutter speed for each flash setting

Flash setting	Shutter speed (Sec.)
A : AUTO	1/30 to 1/2000
A : AUTO/ Red-eye reduction	
: Forced ON : Forced ON/ Red-eye reduction	
S : Slow sync./ Red-eye reduction	1 to 1/2000 1/8 to 1/2000*
: Forced OFF	1 to 1/2000 (In program AE mode)

* [PARTY] (P65) in scene mode

- Refer to P58 for the Aperture-priority AE, Shutter-priority AE or Manual exposure mode.
- There may be differences in the above shutter speeds in scene mode.
 - [NIGHT SCENERY] (P65):
8 seconds to 1/2000th of a second
 - [STARRY SKY] (P67):
15 seconds, 30 seconds, 60 seconds
 - [FIREWORKS] (P68):
1/4th of a second, 2 seconds

■ Adjusting flash output

Adjust the flash output when the subject is small or reflection ratio is extremely high or low.

1 Press \blacktriangle (FLASH) several times until [FLASH] appears and then press $\blacktriangle/\blacktriangleright$ to set the flash output.

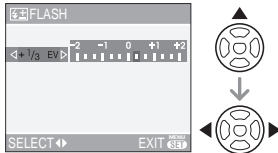

- Select [0] to return to the original flash output.

2 Press [MENU/SET] to finish.

- You can adjust from [-2 EV] to [+2 EV] in steps of [1/3 EV].
- When the flash output is adjusted, the flash output value appears on the upper left of the screen.
- The flash output setting is memorized even if the camera is turned off.
- The flash output cannot be adjusted in the following cases:
 - In simple mode [\heartsuit]
 - In the motion picture mode [H]
 - In [SCENERY] (P63), [NIGHT SCENERY] (P65), [SUNSET] (P67), [HIGH SENS.] (P67), [STARRY SKY] (P67), [FIREWORKS] (P68) or [AERIAL PHOTO] (P69) in scene mode



- **Do not look directly at the flash at close range when it is activated.**
- **Do not bring the flash too close to objects or close the flash while it is activated. The objects may be discolored by its heat or lighting.**
- If you press the shutter button halfway when the flash is activated, the flash icon turns red.
- When you take a picture beyond the available flash range, the exposure may not be adjusted properly and the picture may become bright or dark.
- The white balance may not be properly adjusted if the flash level is insufficient for the subject. (P77)
- When the shutter speed is fast, the flash effect may not be sufficient.
- It may take time to charge the flash if you repeat taking a picture. Take a picture after the access indication disappears.
- When the flash is being charged, the flash icon blinks red, and you cannot take a picture even when you press the shutter button fully.
- **When taking a picture with the flash, we recommend removing the lens hood. In some cases it may not allow the scene to be illuminated properly.**
- Do not close the flash soon after the flash is activated prior to taking pictures due to AUTO/Red-eye reduction etc. It causes a malfunction.
- The red-eye reduction effect differs between people. Also, if the subject was far away from the camera or was not looking at the first flash, the effect may not be evident.
- When using a conversion lens (optional) or a close-up lens (optional), the built-in flash setting is fixed to Forced OFF [OFF].
- When you set burst mode or auto bracket, only 1 picture is recorded for every flash activated.

Taking Pictures with the Self-timer



1 Press ◀ [⏸].

2 Press ▲/▼ to select a mode.

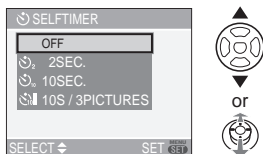

- You can also press ◀ [⏸] to select.
- If you set [10S/3PICTURES], after 10 seconds the camera takes 3 pictures at about 2 second intervals.

3 Press [MENU/SET].

- You can also press the shutter button halfway or press the center of the joystick to finish.
- The menu screen disappears after about 5 seconds. At this time, the selected item is automatically set.

4 Press the shutter button halfway to focus and then press it fully to take the picture.



- (A): Press the shutter button halfway to focus.
- (B): Press the shutter button fully to take the picture.
- When [10S/3PICTURES] is selected, the self-timer indicator blinks again after the first and the second pictures are taken and the shutter is activated 2 seconds after it blinks.

- The self-timer indicator

Ⓢ blinks and the shutter is activated after 10 seconds (or 2 seconds).

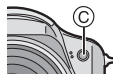

- If you press [MENU/SET] while the self-timer is set, the self-timer setting is canceled.



- When using a tripod etc., setting the self-timer to 2 seconds is a convenient way to avoid the jitter caused by pressing the shutter button.

- When you press the shutter button once fully, the subject is automatically focused just before recording. In dark places, the self-timer indicator will blink and then may turn on brightly operating as an AF assist lamp (P85) to allow the camera to focus on the subject.

- In simple mode [♥], the self-timer is fixed to 10 seconds.

- When you set the self-timer to [2SEC.] or [10SEC.] in burst mode, the camera starts taking pictures 2 or 10 seconds after the shutter button is pressed. The number of pictures taken at one time is fixed to 3.

- We recommend using a tripod when recording with the self-timer.

- Depending on the recording conditions, the recording interval may become more than 2 seconds when [10S/3PICTURES] is selected.

- The flash output may not be constant when [10S/3PICTURES] is selected.

- You cannot select [10S/3PICTURES] when auto bracket is set.

- You cannot use the following functions when [10S/3PICTURES] is selected.

- Burst mode
- [AUDIO REC.]

Compensating the Exposure



Use this function when you cannot achieve appropriate exposure due to the difference in brightness between the subject and the background. Look at the following examples.

Under exposed



Compensate the exposure towards positive.



Properly exposed



Over exposed



Compensate the exposure towards negative.

■ Operation with the joystick

1 Select [EXPOSURE] with ◀ on the joystick and then compensate the exposure with ▲/▼.

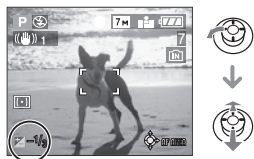

- You can compensate from [-2 EV] to [+2 EV] in steps of [1/3 EV].
- Select [EXPOSURE] only to return to the original exposure (0 EV).

■ Operation with the cursor buttons

1 Press ▲ [EXPOSURE] until [EXPOSURE] appears, compensate the exposure with ◀/▶.

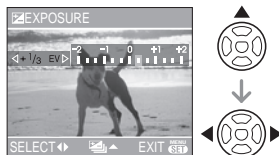

- You can compensate from [-2 EV] to [+2 EV] in steps of [1/3 EV].
- Select [0 EV] to return to the original exposure.

2 Press [MENU/SET] to finish.

- You can also press the shutter button halfway to finish.



- EV is an abbreviation of "Exposure Value". It refers to the amount of light given to the CCD by the aperture value and the shutter speed.
- The exposure compensation value appears on the lower left of the screen.
- The set exposure value is memorized even if the camera is turned off.
- The compensation range of the exposure will be limited depending on the brightness of the subject.
- Exposure cannot be compensated when using [STARRY SKY] in scene mode.

Taking Pictures using Auto Bracket



In this mode, 3 pictures are automatically recorded in the selected exposure compensation range each time the shutter button is pressed. You can select the picture with the desired exposure from the 3 pictures with different exposures.

1 Press **▲** [**FZ**] several times until **[AUTO BRACKET]** appears, set the compensation range of the exposure with **◀/▶**.

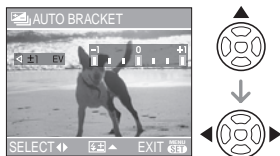

- You can select [OFF] (0), [$\pm 1/3$ EV], [$\pm 2/3$ EV] or [± 1 EV].
- When you do not use auto bracket, select [OFF] (0).

2 Press **[MENU/SET]** to finish.

- You can also press the shutter button halfway to finish.



- When setting auto bracket, the auto bracket icon [,] appears on the lower left of the screen.
- When taking pictures using auto bracket after setting the exposure compensation range, the pictures taken are based on the selected exposure compensation range. When the exposure is compensated, the exposure compensation value appears on the lower left of the screen.

- The auto bracket setting is canceled if you turn the camera off or power save mode is activated.
- When setting auto bracket and burst mode simultaneously, auto bracket will be performed.
- When auto bracket is set, the auto review function is activated regardless of the auto review setting. (The picture is not enlarged.) You cannot set the auto review function in the [SETUP] menu.
- When auto bracket is activated, [AUDIO REC.] cannot be used.
- The exposure may not be compensated with auto bracket depending on the brightness of the subject.
- When setting the quality to [RAW], you cannot take pictures with the auto bracket.
- In shutter-priority AE and manual exposure, if the shutter speed is set to more than 1 second auto bracket is disabled.
- When the flash is activated or the number of recordable pictures is 2 or less, you can take only 1 picture.
- Auto bracket cannot be set in [STARRY SKY] in scene mode.

Optical Image Stabilizer



This mode detects jitter and compensates for it.



1 Press and hold the optical image stabilizer button until [STABILIZER] appears.

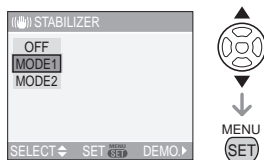

2 Press ▲/▼ to select the stabilizer function mode and then press [MENU/SET].



• You can also use the joystick to select.

[MODE1] ()	The stabilizer operates continuously and can assist during photo composition.
[MODE2] ()	The jitter is compensated for when the shutter button is pressed. There is a greater stabilizing effect.
[OFF] ()	When the stabilizer is not desired.

■ About the jitter/movement detection demonstration screen

Press ► on the screen shown in step 2 to display the jitter/movement detection demonstration screen. (You cannot take pictures while the demonstration screen is displayed.)

Press ► to exit the demonstration screen.

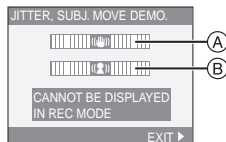



(A): Jitter detection demonstration

(B): Movement detection demonstration

- The camera automatically detects the jitter and the movement of the subject and displays these on the indicator.
- We recommend using a bright subject with high contrast for the subject movement demonstration.
- The jitter/movement detection demonstration screen is an approximation.
- The camera also detects the movement of the subject when automatically setting the ISO sensitivity in intelligent ISO sensitivity mode [] (P52) and [SPORTS] (P63), [BABY1]/[BABY2] (P66) and [PET] (P67) in scene mode.



- The stabilizer function may not be effective in the following cases.
 - When there is a lot of jitter.
 - When the zoom magnification is high.
 - In digital zoom range.
 - When taking pictures while following a moving subject.
 - When the shutter speed becomes slower to take pictures indoors or in dark places.
- Be careful of camera jitter when you press the shutter button.
- In simple mode [, the setting is fixed to [MODE1] and in [STARRY SKY] (P67) in scene mode it is fixed to [OFF]. The stabilizer function mode selection menu does not appear.
- In motion picture mode [, or [PANNING] in scene mode, [MODE2] cannot be set.

Taking Pictures using Burst Mode



1 Press and hold the burst mode button.

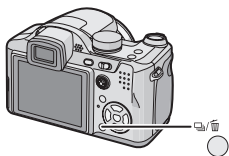

2 Press ▲/▼ to select a mode.

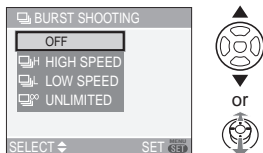

- You can also use the single or burst mode button to select.

3 Press [MENU/SET].

- You can also press the shutter button halfway or press the center of the joystick to finish.
- The menu screen disappears after about 5 seconds. At this time, the selected item is automatically set.

4 Take a picture.

- Hold down the shutter button fully to activate the burst mode.

■ Number of pictures recorded in burst mode

	Burst speed (pictures/second)	Number of recordable pictures (pictures)	
	3*	max. 5	max. 7
	2*		
	approx. 2	Depends on the remaining capacity of the built-in memory/card.	

- * The burst speed is constant regardless of the transfer speed of the card.
 - The number of pictures indicated is when the shutter speed is faster than 1/60 and the flash is not activated.
 - The burst speed (pictures/second) may become slower depending on the recording environment such as in dark places or if the ISO sensitivity is high.
 - If you take pictures in burst mode with the built-in memory, it will take time to write the picture data.
 - In simple mode [], the settings become as follows. [] appears on the left of the screen. (P120)
 - []ENLARGE]:
/Max. 5 pictures
 - [4"×6"/10×15cm]/[E-MAIL]:
/Max. 7 pictures
-
- When the flash is activated, you can take only 1 picture.
 - When the burst mode setting is set to **Unlimited**
 - The burst speed becomes slower halfway. The exact timing of this depends on the type of card, the picture size and the quality.
 - You can take pictures until the capacity of the built-in memory or the card is full.
 - The focus is fixed when the first picture is taken.

- The exposure and the white balance vary depending on the burst mode setting. When burst mode is set to [] , they are fixed to the values set for the first picture. When the burst speed is set to [] or [] , they are adjusted each time you take a picture.
- If you are following a moving subject while taking pictures in a place (landscape) indoors, outdoors etc. where there is a large difference between the light and shade, it may take time until the exposure is stable. If burst is used at this time, the exposure may not become optimal.
- When the self-timer is used, the number of recordable pictures in burst mode is fixed to 3.
- Burst mode is not canceled when the camera is switched off.
- When auto bracket and burst mode are set simultaneously, auto bracket will be performed.
- When burst mode is set, the auto review function is activated regardless of the auto review setting. (The picture is not enlarged.) You cannot set the auto review function in the [SETUP] menu.
- When burst mode is activated, [AUDIO REC.] cannot be used.
- You cannot take pictures in burst mode when the quality is set to [RAW] or [STARRY SKY] in scene mode is selected.

Changing the sensitivity according to the movement of the subject being recorded



The camera detects the movement of the subject near the center of the screen and then sets the optimal ISO sensitivity and shutter speed according to the movement and the brightness of the subject.

1 Press [MENU/SET].

2 Press ▲/▼ to select [ISO LIMIT] and then press ►.

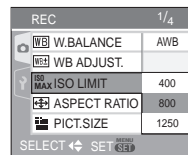

3 Press ▲/▼ to select the item and then press [MENU/SET].

Item	Settings
400	The ISO sensitivity automatically increases up to the set value according to the movement and brightness of the subject.
800	
1250	

- The higher the value set for the ISO sensitivity, the more effectively the jitter will be reduced. However, picture noise will increase.

- Jitter is avoided when taking pictures indoors of a moving subject by increasing the ISO sensitivity and making the shutter speed faster.



1/125 ISO800

- Noise is avoided when taking pictures indoors of a subject with no movement by decreasing the ISO sensitivity.



1/30 ISO200

- When you press the shutter button halfway, [ISO] (A) appears. When you press the shutter button fully, the shutter speed and the ISO sensitivity appear for a while.



- When the flash is activated, the ISO sensitivity is automatically increased to a maximum of [ISO400].
- Depending on the brightness and how fast the subject is moving, jitter may not be avoided.
- The camera may not be able to detect the movement of the subject in the following cases.
 - When the moving subject is small
 - When the moving subject is at the edge of the screen
 - When the subject starts moving the instant the shutter button is pressed fully
- To avoid picture noise, we recommend decreasing the highest ISO sensitivity or setting [NOISE REDUCTION] in [PICT.ADJ.] to [HIGH] or setting the items except [NOISE REDUCTION] to [LOW] to take pictures. (P86)
- The digital zoom cannot be used.

Taking Close-up Pictures



This mode allows you to take close-up pictures of a subject, e.g. when taking pictures of flowers. You can take pictures of a subject as close as 5 cm (0.17 feet) from the lens by rotating the zoom lever upmost to Wide (1×).

As you rotate the zoom lever towards Tele, the distance from the subject that you can take close-up pictures increases in steps up to a maximum of 2 m (6.6 feet). (11×)

1 Press and hold the focus switch button until the focus switch selection screen appears.



2 Press ▲/▼ to select [AF MACRO].

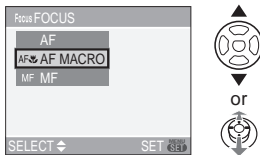

- You can also use the focus switch button to select.

3 Press [MENU/SET].

- You can also press the shutter button halfway or press the center of the joystick to finish.
- The menu screen disappears after about 5 seconds. At this time, the selected item is automatically set.

■ Focus range

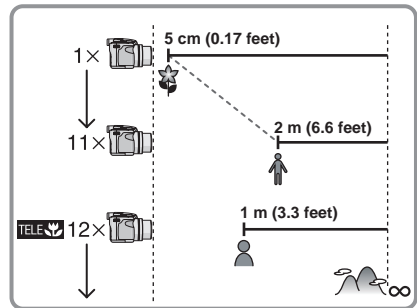

- The zoom magnification values will change when using the extended optical zoom.

■ Tele-macro function



When you rotate the zoom lever upmost to Tele, you can take pictures approaching the subject at a distance up to 1 m (3.3 feet) from the lens. (The tele-macro icon [TELE] appears.) It is convenient when taking close-up pictures of flowers blooming near the ground while standing up or when taking close-up pictures of insects from a distant position.



- We recommend using a tripod and the self-timer (P47) in macro mode.
- When a subject is close to the camera, the effective focus range (depth of field) is significantly narrowed. Therefore, if the distance between the camera and the subject is changed after focusing on the subject, it may become difficult to focus on it again.
- In tele macro mode, the depth of field is narrowed and camera jitter occurs easier than usual. Therefore, when you cannot use a tripod, we recommend taking pictures with a brightness equivalent to having the aperture value set to F4.0 or a higher number and the shutter speed is set to 1/125th of a second or faster to keep the depth of field and the performance of the stabilizer function.
- If the distance between the camera and the subject is beyond the focus range of the camera, the picture may not be properly focused even if the focus indication lights.
- AF Macro gives priority to a subject close to the camera. Therefore, if the distance between the camera and the subject is more than 1 m (3.3 feet) it takes longer to focus than in program AE mode **[P]**.

- The available flash range is about 30 cm (0.98 feet) to 6 m (19.7 feet) (Wide). (When the ISO sensitivity is set to [AUTO].) We recommend setting the flash to Forced OFF  when you take pictures at close range.
- If you focus on the subject at 2 m (6.6 feet) or less distant position with tele-macro function when setting the optical zoom magnification in 12× and then rotate the zoom lever for setting the optical zoom magnification to 11× or less, the subject becomes unfocused.
- When you take pictures at close range, the resolution of the periphery of the picture may decrease slightly. This is not a malfunction.

Aperture-priority AE



Set the aperture value to a higher number when you want a sharp focus background. Set the aperture value to a lower number when you want a soft focus background.

1 Tilt the joystick towards ▲/▼ to set the aperture value.



2 Take a picture.



- Refer to P58 for the available aperture values and the shutter speed.
- Set the aperture value to a higher number when the subject is too bright. Set the aperture value to a lower number when the subject is too dim.
- The brightness of the screen and the recorded pictures may differ. Check the pictures using the review function or playback mode.
- The aperture value and the shutter speed displayed on the screen turn red when the exposure is not adequate.

Shutter-priority AE



When you want to take a sharp picture of a fast moving subject, set with a faster shutter speed. When you want to create a trail effect, set to a slower shutter speed.

1 Tilt the joystick towards ▲/▼ to set the shutter speed.



2 Take a picture.



- Refer to P58 for the available aperture values and the shutter speed.
- The brightness of the screen may differ from the brightness of the actual pictures. Check the pictures using the review function or playback mode.
- You cannot set the following items in Shutter-priority AE.
 - Slow sync./Red-eye reduction [⚡S⊙] (P43)
- The aperture value and the shutter speed displayed on the screen turn red when the exposure is not adequate.
- We recommend using a tripod when the shutter speed is slow.

Manual exposure



Determine the exposure by manually setting the aperture value and the shutter speed.

- 1 Tilt the joystick towards ▲/▼/◀/▶ to set the aperture value and the shutter speed.



	Set the aperture value and the shutter speed.
	Switch between the aperture value and the shutter speed.

- 2 Press the shutter button halfway.



- The manual exposure assistance (A) appears for about 10 seconds to indicate the exposure.
- Set the aperture value and the shutter speed again when the exposure is not adequate.

- 3 Take the picture.



Manual Exposure Assistance

	The exposure is adequate.
	Set to faster shutter speed or larger aperture value.
	Set to slower shutter speed or smaller aperture value.

- The manual exposure assistance is an approximation. We recommend checking the pictures after taking them using the review function.



- Refer to P58 for the available aperture values and the shutter speed.
- The brightness of the screen may differ from the brightness of the actual pictures. Check the pictures using the review function or playback mode.
- If the exposure is not adequate, the aperture value and the shutter speed turn red when the shutter button is pressed halfway.
- You cannot set the following items in manual exposure.
 - Slow sync./Red-eye reduction [] (P43)
 - [AUTO] in ISO sensitivity (P79) (The ISO sensitivity is automatically set to [ISO100] when you switch from [AUTO] to Manual exposure.)
 - Exposure compensation (P48)

Aperture Value and Shutter Speed

Aperture-priority AE

Available Aperture Value (Per 1/3 EV)			Shutter Speed (Sec)
F8.0			8 to 1/2000
F7.1	F6.3	F5.6	8 to 1/1600
F5.0	F4.5	F4.0	8 to 1/1300
F3.6	F3.2	F2.8	8 to 1/1000

Shutter-priority AE

Available Shutter Speed (Sec) (Per 1/3 EV)		Aperture Value
8	6	F2.8 to F8.0
5	4	
3.2	2.5	
2	1.6	
1.3	1	
1/1.3	1/1.6	
1/2	1/2.5	
1/3.2	1/4	
1/5	1/6	
1/8	1/10	
1/13	1/15	
1/20	1/25	
1/30	1/40	
1/50	1/60	
1/80	1/100	
1/125	1/160	
1/200	1/250	
1/320	1/400	
1/500	1/640	
1/800	1/1000	
1/1300		F4.0 to F8.0
1/1600		F5.6 to F8.0
1/2000		F8.0

Manual exposure

Available Aperture Value (Per 1/3 EV)	Available Shutter Speed (Sec) (Per 1/3 EV)
F2.8 to F3.6	60 to 1/1000
F4.0 to F5.0	60 to 1/1300
F5.6 to F7.1	60 to 1/1600
F8.0	60 to 1/2000



- The aperture values given in the table above are values when the zoom lever is rotated to Wide.
- Depending on the zoom magnification, some of the aperture values cannot be selected.

Taking Pictures with Manual Focus



Use this function when you want to fix the focus or when the distance between the lens and the subject is determined and you do not want to activate auto focus.

- 1 Press and hold the focus switch button until the focus switch selection screen appears.**



- 2 Press ▲/▼ to select [MF].**

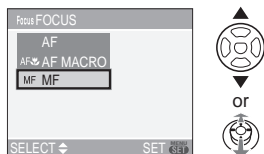

- You can also use the focus switch button to select.

- 3 Press [MENU/SET].**

- You can also press the shutter button halfway or press the center of the joystick to finish.
- The menu screen disappears after about 5 seconds. At this time, the selected item is automatically set.

- 4 Tilt the joystick towards ▲/▼ to focus on the subject.**

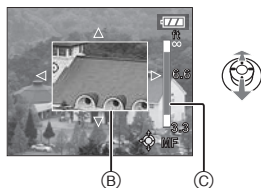

- Ⓑ: MF assistance
- Ⓒ: Focus range
- MF assistance disappears about 2 seconds after you stop operating the joystick.
- Focus range disappears about 5 seconds after you stop operating the joystick.

- 5 Take the picture.**



MF ASSIST

If you tilt the joystick towards ▲/▼ when [MF ASSIST] is set to [MF1] or [MF2], MF assistance is activated and the screen is enlarged. This allows you to focus on the subject more easily.

1 Press [MENU/SET] and then press ◀.

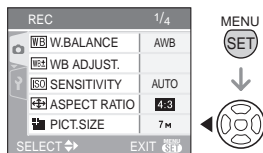

2 Press ▼ to select the [SETUP] menu icon [Y] and then press ▶.

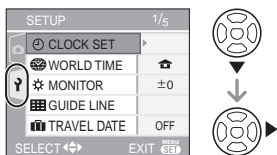

3 Press ▲/▼ to select [MF ASSIST] and then press ▶.

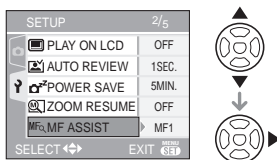

4 Press ▲/▼ to select [MF1] or [MF2] and then press [MENU/SET].

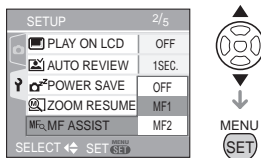

- [MF1]: The center of the screen is enlarged. You can adjust the focus while determining the composition of the whole of the screen.
- [MF2]: The whole of the screen is enlarged. This is convenient when adjusting the focus in Wide.
- [OFF]: The screen is not enlarged.

5 Press [MENU/SET] to close the menu.

- You can also close the menu by pressing the shutter button halfway.
- You can also use the joystick to perform steps 2 to 5.

Technique for Manual focus

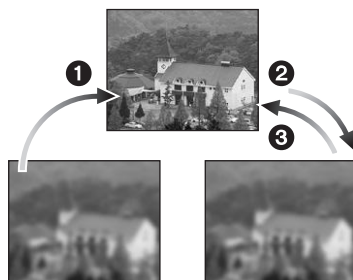

- 1 Tilt the joystick towards ▲/▼.
- 2 Tilt it a little more.
- 3 Tilt the joystick in the opposite direction to finely focus on the subject.

■ Prefocus

This is a technique for focusing in advance on the point the pictures will be taken when it is difficult to focus on the subject with auto focus due to its quick motion. [e.g. [PANNING] (P64) in scene mode]

This function is suitable when the distance between the camera and the subject is certain.

■ Changing the zoom area

The magnified area can be changed while the screen is expanded using MF Assist. This is convenient when you want to change the focus position to take pictures.

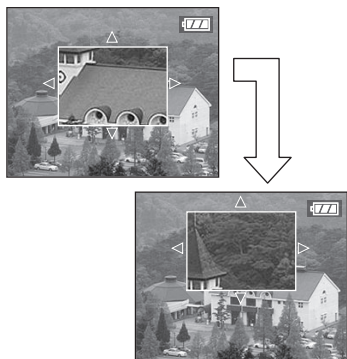

- 1 Display MF Assist with ▲/▼ on the joystick.
- 2 Change the expanded area with the cursor buttons ▲/▼/◀/▶.
 - The expansion is canceled after approximately 2 seconds.
- The following will return the AF area to the original position.
 - Switching the focus to [AF] or [AF MACRO].
 - Changing the picture size or aspect.
 - Turning the camera off.



- You can also record with manual focus in motion picture mode [M]. However the focus is fixed while recording motion pictures.
- If you focus on the subject in Wide and then rotate the zoom lever to Tele, the focus may not be adequate. In this case, focus on the subject again.
- You cannot set continuous AF (P84) when manual focus is set.
- The MF assistance screen does not appear when using the digital zoom.
- The distance to the subject displayed on the screen in manual focus is an approximation of the focus position. Remember that the distance is an approximation when taking a picture.
- Use the assistance screen for a final check of the focus.
- After canceling power save mode, focus on the subject again.

Taking pictures that match the scene being recorded (Scene mode)



When you select a scene mode to match the subject and recording situation, the camera sets the optimal exposure and hue to obtain the desired picture.

- Refer to P63 to 69 and “About the information ” for details about each scene mode.

1 Press for the [SCENE MODE] menu.

2 Press to select the scene mode.

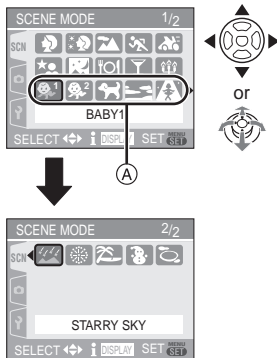

- Press at (A) to switch to the next menu screen.
- You can switch menu screens from any menu item by rotating the zoom lever.

3 Press [MENU/SET] to set.

- You can also press the center of the joystick to set.
- The menu screen is switched to the recording screen in the selected scene mode.
- Press [MENU/SET] and then perform steps **1**, **2** and **3** to change the scene mode.

■ About the information

- If you press [DISPLAY] when selecting a scene mode in step **2**, explanations about each scene mode are displayed. (If you press [DISPLAY] again, the screen returns to the [SCENE MODE] menu.)

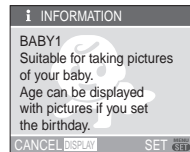

- The flash setting is memorized even if the camera is turned off. However, the scene mode flash setting is reset to the initial setting when the scene mode is changed. (P44)
- When you take a picture with a scene mode that is not adequate for the purpose, the hue of the picture may differ from the actual scene.
- If you press when selecting [PORTRAIT] or [STARRY SKY] in step **2**, the [SCENE MODE] menu [] is displayed. If you then select either the [REC] menu [] or the [SETUP] menu [], you can set the desired items. (P21)
- The following cannot be set in scene mode because the camera automatically adjusts them to the optimal setting.
 - [SENSITIVITY]
 - [METERING MODE]
 - [COL.EFFECT]
 - [PICT.ADJ.]

 **[PORTRAIT]**

Press [MENU/SET] to display the [SCENE MODE] menu and select a scene mode. (P62)

The person stands out from the background and has a healthier complexion.

■ **Technique for Portrait mode**

To increase the effectiveness of this mode:

- 1 Rotate the zoom lever as far as possible to Tele.
- 2 Move close to the subject to make this mode more effective.



- This mode is only suitable when taking pictures outdoors in the daytime.

 **[SOFT SKIN]**

Press [MENU/SET] to display the [SCENE MODE] menu and select a scene mode. (P62)

This allows you to achieve a smoother appearance of the skin than in [PORTRAIT].

■ **Technique for Soft skin mode**

To make this mode more effective:

- 1 Rotate the zoom lever as far as possible to Tele.
- 2 Move close to the subject to make this mode more effective.



- This mode is only suitable when taking pictures outdoors in the daytime.
- If a part of the background etc. is a color close to skin color, this part is also smoothed.
- This mode may not be effective when there is insufficient brightness.

 **[SCENERY]**

Press [MENU/SET] to display the [SCENE MODE] menu and select a scene mode. (P62)

This allows you to take pictures of a wide landscape.



- Set [AF] with the focus switch button.
- The focus range is 5 m (16.4 feet) to ∞.
- The flash setting is fixed to Forced OFF [OFF].
- The setting on the AF assist lamp is disabled.
- The white balance cannot be set.

 **[SPORTS]**

Press [MENU/SET] to display the [SCENE MODE] menu and select a scene mode. (P62)

Set here when you want to take pictures of sports scenes or other fast-moving events.



- Set [AF] with the focus switch button.
- This mode is suitable for taking pictures of subjects 5 m (16.4 feet) or more from the camera.
- If you take pictures of a fast-moving subject indoors, the ISO sensitivity becomes the same as when intelligent ISO sensitivity mode [i] is set to a highest ISO sensitivity of [ISO800]. (P52)
- Digital zoom cannot be used.

 **[PANNING]**

Press [MENU/SET] to display the [SCENE MODE] menu and select a scene mode. (P62)

When you move the camera to follow a subject moving in one direction such as a runner or car, the background becomes a blur and the subject stays focused. This effect is called “panning”. This mode allows you to obtain this effect easier.

■ Technique for Panning mode

To obtain good pictures in panning mode, move the camera in a horizontal plane as you take the pictures.

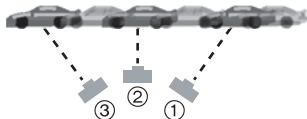

- ① Move the camera smoothly while following the subject in the viewfinder.
- ② Press the shutter button while you are moving the camera.
- ③ Move the camera continuously.

- We recommend the following:
 - Using the Viewfinder. (P38)
 - Selecting a subject with quick motion.
 - Using prefocus. (P61)
 - Use this mode with burst mode. (P51) (You can then select the best pictures from all the pictures taken.)



- The shutter speed in panning mode becomes slower to achieve the panning effect. As a result, jitter can easily occur.
- The panning function does not work well in the following situations.
 - During very bright days in summer. We recommend using an ND filter (DMW-LND52; optional). (P118)
 - When the shutter speed is faster than 1/100th.
 - When you move the camera too slowly because the subject is moving slowly. (The background will not become a blur.)
- You cannot set the stabilizer function mode to [MODE2]. When you set it to [MODE1], only vertical jitters can be compensated in panning mode.
- The settings on the AF assist lamp and the continuous AF are disabled.
- The white balance cannot be set.

 **[NIGHT PORTRAIT]**

Press [MENU/SET] to display the [SCENE MODE] menu and select a scene mode. (P62)

This allows you to take pictures of a person and the background with near real-life brightness.

■ Technique for Night portrait mode

- Use the flash.
- Since the shutter speed becomes slower, we recommend using a tripod and the self-timer (P47) for taking pictures.
- Keep the subject still for about 1 second after taking the picture.
- We recommend rotating the zoom lever to Wide (1×) and being about 1.5 m (4.92 feet) from the subject when taking a picture.



- The focus range is 1.2 m (3.94 feet) to 5 m (16.4 feet). (Refer to P44 for the available flash range to take pictures.)
- Be sure to close the flash when not in use.
- The shutter may remain closed (max. about 1 sec.) after taking the picture because of signal processing. This is not a malfunction.
- Noise may become visible when you take pictures in dark places.
- When using the flash, Slow sync./Red-eye reduction [⚡S⊕] is selected and the flash is activated every time.
- The continuous AF setting is disabled.
- The white balance cannot be set.

 **[NIGHT SCENERY]**

Press [] to display the [SCENE MODE] menu and select a scene mode. (P62)
This allows you to take vivid pictures of the nightscape.

■ Technique for Night scenery mode

- Set [AF] with the focus switch button.
- Since the shutter speed becomes slower (up to about 8 sec.) use a tripod. We also recommend using the self-timer (P47) for taking pictures.



- The focus range is 5 m (16.4 feet) to ∞.
- The shutter may remain closed (max. about 8 sec.) after taking the picture because of signal processing. This is not a malfunction.
- Noise may become visible when you take pictures in dark places.
- The flash setting is fixed to Forced OFF [].
- The setting on the AF assist lamp and continuous AF are disabled.
- The white balance cannot be set.

 **[FOOD]**

Press [] to display the [SCENE MODE] menu and select a scene mode. (P62)
This mode allows you to take pictures of food with a natural hue without being affected by the ambient light in restaurants etc.



- The focus range is 5 cm (0.16 feet) (Wide)/2 m (6.56 feet) (Tele) to ∞.
- The white balance cannot be set.





 **[PARTY]**

Press [] to display the [SCENE MODE] menu and select a scene mode. (P62)
Select this when you want to take pictures at a wedding reception, an indoor party etc. This allows you to take pictures of people and the background with near real-life brightness.

■ Technique for Party mode**• Open the flash. (P43)**

- We recommend using a tripod and the self-timer (P47) for taking pictures.
- We recommend rotating the zoom lever to Wide (1×) and being about 1.5 m (4.92 feet) from the subject when taking pictures.



- The flash setting can be set to Slow sync./Red-eye reduction [S] or Forced ON/Red-eye reduction [].
- The white balance cannot be set.





 **[CANDLE LIGHT]**

Press [] to display the [SCENE MODE] menu and select a scene mode. (P62)
This mode allows you to take pictures with a candle-lit atmosphere.

■ Technique for Candle light mode

- If you make the most of the candle light, you can take successful pictures without using the flash.
- We recommend using a tripod and the self-timer (P47) for taking pictures.



- The focus range is 5 cm (0.16 feet) (Wide)/2 m (6.56 feet) (Tele) to ∞.
- The flash setting can be set to Slow sync./Red-eye reduction [S] or Forced ON/Red-eye reduction [].
- The white balance cannot be set.

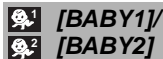

Press [MENU/SET] to display the [SCENE MODE] menu and select a scene mode. (P62)

This takes pictures of a baby with a healthy complexion. When you use the flash, the light from it is weaker than usual.

You can set two different birthdays by using [BABY1] and [BABY2]. You can display the set age when playing back the pictures and stamp the age on the recorded pictures with [DATE STAMP] (P100).

- The age can also be printed on each picture by using the software [LUMIX Simple Viewer] or [PHOTOfunSTUDIO-viewer-] in the CD-ROM (supplied). (For information about printing, refer to the separate operating instructions for PC connection.)

■ Age display setting

- To have the age displayed, first set the birthday and then be sure to set [WITH AGE] before taking the pictures.



■ Birthday setting

- 1 Press ▲/▼ to select [BIRTHDAY SET.] and then press [MENU/SET].
- 2 When a message appears, press ◀/▶ to select items (Year/Month/Day) and then press ▲/▼ to set them.
- 3 Press [MENU/SET] to finish the setting.



- The focus range is 5 cm (0.16 feet) (Wide)/2 m (6.56 feet) (Tele) to ∞.
- The ISO sensitivity becomes the same as when intelligent ISO sensitivity mode [] is set to a highest ISO sensitivity of [ISO400]. (P52)
- If you turn on the camera in [BABY1]/[BABY2], the age and current date and time are displayed for about 5 seconds on the bottom of the screen.
- The age display style differs depending on the language setting in the recording mode.
- The display style when printing may differ slightly from the display style on the screen.
- If the age is not properly displayed, check the clock and birthday settings.
- If the camera is set to [WITHOUT AGE], the age is not recorded even if the time and birthday are set. This means the age cannot be displayed even if camera is set to [WITH AGE] after taking the pictures.
- The birthday setting can be reset with [RESET]. (P24)
- Digital zoom cannot be used.

 **[PET]**

Press [MENU/SET] to display the [SCENE MODE] menu and select a scene mode. (P62)

Select this when you want to take pictures of a pet such as a dog or a cat.

This allows you to set the birthday of your pet.

You can display the set age when playing back the pictures and stamp the age on the recorded pictures with [DATE STAMP] (P100).

- The age can also be printed on each picture by using the software [LUMIX Simple Viewer] or [PHOTOfunSTUDIO-viewer-] in the CD-ROM (supplied). (For information about printing, refer to the separate operating instructions for PC connection.)

Refer to [BABY1]/[BABY2] (P66) for information about age display setting and birthday setting.



- The initial setting for the AF assist lamp is [OFF]. (P85)
- Refer to [BABY1]/[BABY2] for other information about this mode.

 **[SUNSET]**

Press [MENU/SET] to display the [SCENE MODE] menu and select a scene mode. (P62)

This allows you to take vivid pictures of the red color of the sun.



- The flash setting is fixed to Forced OFF [OFF].
- The setting on the AF assist lamp is disabled.
- The white balance cannot be set.

 **[HIGH SENS.]**

Press [MENU/SET] to display the [SCENE MODE] menu and select a scene mode. (P62)

Select this mode for high-sensitivity processing. You can take pictures at ISO 3200 sensitivity.



- The resolution of the recorded picture significantly decreases because of high sensitivity processing. This is not a malfunction.
- The focus range is 5 cm (0.16 feet) (Wide)/2 m (6.56 feet) (Tele) to ∞.
- You can take pictures suitable for 4"×6"/10×15 cm printing.
- The flash setting is fixed to Forced OFF [OFF].
- The quality cannot be set to [RAW].
- The extended optical zoom and digital zoom cannot be used.

 **[STARRY SKY]**

Press [MENU/SET] to display the [SCENE MODE] menu and select a scene mode. (P62)

This allows you to take vivid pictures of a starry sky or a dark subject.

■ Setting the shutter speed

- Select a shutter speed of [15 SEC.], [30 SEC.] or [60 SEC.].
- 1 Press ▲/▼ to select the number of seconds and then press [MENU/SET].

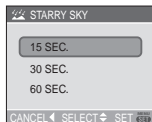

- If you want to change the number of seconds, press [MENU/SET] and then press ► again to select [STARRY SKY].

2 Taking Pictures.

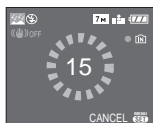

- Press the shutter button fully to display the countdown screen. Do not move the camera after this screen is displayed. When countdown finishes, [PLEASE WAIT...] is displayed for the same length of time as the set shutter speed for signal processing.
- Press [MENU/SET] to stop taking the picture while the countdown screen is displayed.

■ Technique for Starry sky mode

- The shutter opens for 15, 30 or 60 seconds. Be sure to use a tripod. We also recommend taking pictures with the self-timer. (P47)
- We recommend using prefocus (P61) to focus in advance on a subject, such as a bright star or a distant light, that is easy to focus on.



- The LCD monitor automatically becomes darker.
- Histograms are always displayed in orange. (P40)
- The flash setting is fixed to Forced OFF [🚫].
- The optical image stabilizer function is fixed to [OFF].
- The following functions cannot be used.
 - [EXPOSURE]
 - [AUTO BRACKET]
 - Burst mode
 - [AUDIO REC.]
 - [CONT.AF]
 - [W.BALANCE]

[FIREWORKS]

Press [MENU/SET] to display the [SCENE MODE] menu and select a scene mode. (P62)
This mode allows you to take beautiful pictures of fireworks exploding in the night sky.

■ Technique for Fireworks mode

We recommend performing the following steps to prefocus on the point the pictures will be taken so that you do not miss taking pictures of the fireworks when they are fired.

- 1 Aim the camera at an object, such as a distant light, that is about the same distance from the camera as the point where the fireworks will rise.
 - 2 Press the shutter button halfway until the focus indication (P27) lights.
 - 3 Switch the focus switch button to [MF]. (P59)
 - 4 Aim the camera in the direction that the fireworks will be fired and wait.
 - 5 Press the shutter button fully to take the picture when the fireworks are fired.
- If zoom was used, the focus position will not be correct. Perform steps 2 to 5 again.
 - We recommend using a tripod.



- The focus range is 5 m (16.4 feet) to ∞ in AF mode. (We recommend performing steps 1 to 5 above for prefocus.)
- The shutter speed becomes the following.
 - When [OFF] is set on the optical image stabilizer function: Fixed to 2 second
 - When [MODE1] or [MODE2] is set on the optical image stabilizer function: 1/4th or 2 second (The shutter speed becomes 2 second only when the camera has determined that there is little jitter such as when using a tripod etc.)
- Histograms are always displayed in orange. (P40)
- The flash setting is fixed to Forced OFF [🚫].
- The setting on the AF assist lamp and continuous AF are disabled.
- The white balance cannot be set.

 **[BEACH]**

Press [] to display the [SCENE MODE] menu and select a scene mode. (P62)
This allows you to take even more vivid pictures of the blue color of the sea, sky etc. It also prevents under exposure of people under strong sunlight.



- Do not touch the camera with wet hands.
- Sand or seawater will cause the camera to malfunction. Make sure that sand or seawater does not get into the lens or the terminals.
- Problems caused by sand or seawater are not covered by the product warranty.
- The white balance cannot be set.

 **[SNOW]**

Press [] to display the [SCENE MODE] menu and select a scene mode. (P62)
This allows you to take pictures that show the snow as white as possible at a ski resort or a snow-covered mountain.



- The white balance cannot be set.

 **[AERIAL PHOTO]**

Press [] to display the [SCENE MODE] menu and select a scene mode. (P62)
This mode allows you to take pictures through an airplane window.

■ Technique for Aerial photo mode

- We recommend using this technique if it is difficult to focus when taking pictures of clouds etc. Aim the camera at something with high contrast, press the shutter button halfway to fix the focus and then aim the camera at the subject and press the shutter button fully to take the picture.



- **Turn the camera off when taking off or landing.**
- **When using the camera, follow all instructions from the cabin crew.**
- Be careful about the reflection from the window.
- The flash setting is fixed to Forced OFF [].
- The setting on the AF assist lamp is disabled.
- The white balance cannot be set.

Motion Picture Mode



1 Press the shutter button halfway to focus and then press it fully to start recording.

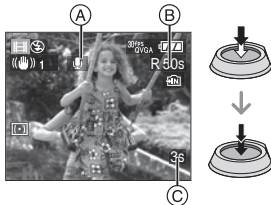

A: Audio recording

- The available recording time **B** is displayed on the top right and the elapsed recording time **C** is displayed on the bottom right of the screen.
- When the subject is focused, the focus indication lights.
- The focus, zoom and aperture value are fixed to the setting when recording starts (the first frame).
- The audio is also recorded simultaneously from the built-in microphone on this unit. (Motion pictures cannot be recorded without audio.)
- When using the stabilizer function, it is fixed to [MODE1].

2 Press the shutter button fully to stop recording.

- If the built-in memory or the card becomes full in the middle of recording, the camera stops recording automatically.

■ Changing the settings for the aspect ratio and the picture quality

1 Press [MENU/SET].

2 Press ▲/▼ to select [ASPECT RATIO] and then press ►.

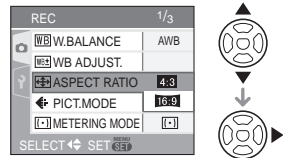

3 Press ▲/▼ to select the item and then press [MENU/SET].

4 Press ▲/▼ to select [PICT.MODE] and then press ►.

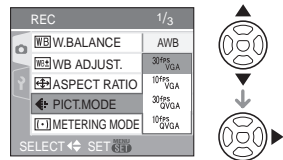

5 Press ▲/▼ to select the item and then press [MENU/SET].

If you selected [4:3] on the screen shown in step 2

Item	Picture size	fps
[30fpsVGA]	640×480 pixels	30
[10fpsVGA]		10
[30fpsQVGA]	320×240 pixels	30
[10fpsQVGA]		10

If you selected [16:9] on the screen shown in step 2

Item	Picture size	fps
[30fps16:9]	848×480 pixels	30
[10fps16:9]		10

- fps “frames per second”; This refers to the number of frames used in 1 second.

- You can record smoother motion pictures with “30 fps”.
 - You can record longer motion pictures with “10 fps” although the picture quality is lower.
 - The file size with [10fpsQVGA] is small so it is suitable for e-mails.
- * **You can only record motion pictures to the built-in memory when the [ASPECT RATIO] is [4:3] and the picture size is [30fpsQVGA] or [10fpsQVGA] (320×240 pixels).**

6 Press [MENU/SET] to close the menu.

- **You can also press the shutter button halfway to close the menu.**



- Refer to P133 for information about the available recording time.
- The available recording time displayed on the screen may not decrease regularly.
- This unit does not support recording motion pictures on MultiMediaCards.
- When you set the picture quality to [30fpsVGA] or [30fps16:9], we recommend using a High Speed SD Memory Card with “10MB/s” or greater displayed on the package.
- Depending on the type of the card, recording may stop in the middle.
- **We recommend using Panasonic's SD Memory Card/SDHC Memory Card.**
- Depending on the type of the card, the card access indication may appear for a while after recording motion pictures. This is not a malfunction.

- Motion pictures can be recorded continuously up to 2 GB. The maximum available recording time for up to 2 GB only is displayed on the screen.
- When motion pictures recorded with the camera are played back on other equipment, the quality of the picture and sound may deteriorate and it may not be possible to play them back. Also the recording information may not be displayed correctly.
- In motion picture mode [, you cannot use the direction detection function and the review function.
- You cannot set [MODE2] on the optical image stabilizer function.
- The bundled software includes QuickTime to play back motion picture files recorded with the camera on the PC.

Recording which day of the vacation you take the picture



If you set the departure date of the vacation in advance, the number of days that have passed since the departure date (which day of the vacation it is) is recorded when you take the picture. You can display the the number of days that have passed when playing back the pictures and stamp it on the recorded pictures with [DATE STAMP] (P100).

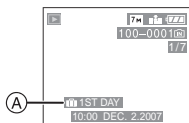

- Ⓐ: The number of days that have passed since the departure date
- The number of days that have passed since the departure date can be printed on each picture by using the software [LUMIX Simple Viewer] or [PHOTOfunSTUDIO-viewer-] in the CD-ROM (supplied). (For information about printing, refer to the separate operating instructions for PC connection.)

- **Setting the departure/return date**
(The following screens are shown when program AE mode [P] is selected.)

- 1 Press [MENU/SET] and then press **◀**.
- 2 Press **▼** to select the [SETUP] menu icon [Ⓜ] and then press **▶**.
- 3 Press **▲/▼** to select [TRAVEL DATE] and then press **▶**.
- 4 Press **▼** to select [SET] and then press [MENU/SET].

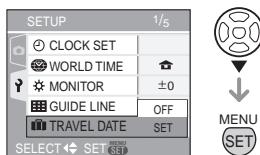

- 5 Press **▲/▼/◀/▶** to set the departure date and then press [MENU/SET].



◀/▶: Select the desired item.

▲/▼: Set the year, month and date.

6 Press ▲/▼/◀/▶ to set the return date and then press [MENU/SET].

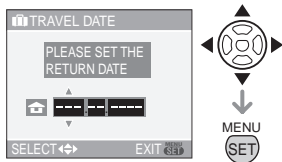

◀/▶: Select the desired item.

▲/▼: Set the year, month and date.

- The travel date is canceled if the current date is after the return date.
- If you do not want to set the return date, press [MENU/SET] while the date bar is displayed.
- You cannot set a date that is before the departure date.

7 Press [MENU/SET] to close the menu.

8 Take a picture.



(A): The number of days that have passed since the departure date

- The number of days that have passed since the departure date is displayed for about 5 seconds if this unit is turned on etc. after setting the travel date or when the travel date is set.
- When the travel date is set, [] appears on the lower right of the screen. (It is not displayed if the current date is after the return date.)

■ Canceling the travel date

The travel date is automatically canceled if the current date is after the return date. If you want to cancel the travel date before the end of the vacation, select [OFF] on the screen shown in step 4 and then press [MENU/SET] twice.



- The travel date is calculated using the date in the clock setting (P19) and the departure date you set. If you set [WORLD TIME] (P74) to the travel destination, the travel date is calculated using the date in the clock setting and the travel destination setting.
- The travel date setting is memorized even if the camera is turned off.
- If you set a departure date and then take a picture on a date before this departure date, [-] (minus) is displayed in orange and the day of the vacation that you took the picture is not recorded.
- If you set a departure date and then change the clock setting to the date and time at the travel destination, [-] (minus) is displayed in white and the day of the vacation that you took the picture is recorded when the travel destination date is, for example, one day before the departure date.
- If [TRAVEL DATE] is set to [OFF], the number of days that have passed since the departure date will not be recorded even if you set the travel date or the return date. Even if [TRAVEL DATE] is set to [SET] after taking the pictures, which day of the vacation you took them is not displayed.
- Set the clock if the message [PLEASE SET THE CLOCK] appears. (P19)
- The [TRAVEL DATE] setting also affects simple mode [♥].

Displaying the time at the travel destination (World Time)



If you set your home area and the travel destination area when traveling abroad etc., the local time at the travel destination area can be displayed on the screen and recorded on the pictures taken.

• Select [CLOCK SET] to set the current date and time in advance. (P19)

1 Press [MENU/SET] and then press ◀.

2 Press ▼ to select the [SETUP] menu icon [⌘] and then press ▶.

3 Press ▲/▼ to select [WORLD TIME] and then press ▶.

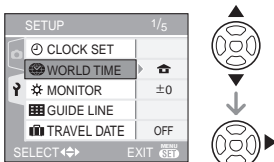

• If you are setting the world time for the first time, the message [PLEASE SET THE HOME AREA] appears. If this message appears, press [MENU/SET] and then set home area from the screen shown in step ② in "Setting the home area [HOME]".

■ Setting the home area [HOME]

(Perform steps 1, 2 and 3.)

① Press ▼ to select [HOME] and then press [MENU/SET] to set.



② Press ◀/▶ to select your home area and then press [MENU/SET] to set.



- The current time is displayed on the top left of the screen and the time difference from GMT "Greenwich Mean Time" is displayed on the bottom left of the screen.
- If daylight saving time [☀️🌙] is used at the home area, press ▲. Press ▲ again to return to the original time.
- The daylight saving time setting for the home area does not advance the current time. Advance the clock setting by one hour. (P19)

■ Finishing setting the home area

- If you are setting the home area for the first time, the screen returns to the screen shown in step **1** of “Setting the home area [HOME]” after you press [MENU/SET] to set your home area. Press **▲** to return to the screen shown in step **3** and then press [MENU/SET] to close the menu.
- If you are setting the home area for the second time etc., the screen returns to the screen shown in step **3** after you press [MENU/SET] to set your home area. Press [MENU/SET] again to close the menu.

■ Setting the travel destination area

(Perform steps **1**, **2** and **3**.)

- 1** Press **▲** to select [DESTINATION] and then press [MENU/SET] to set.



(A): Depending on the setting, the time at the travel destination area or the home area is displayed.

- If you are setting the travel destination area for the first time, the date and time are displayed as shown in the screen above.
- 2** Press **◀/▶** to select the area the travel destination is in and then press [MENU/SET] to set.

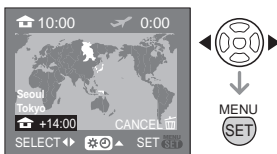

- The current time at the selected travel destination area is displayed on the top right of the screen and the time difference from the home area is displayed at the bottom left of the screen.
 - If daylight saving time [**☀**] is used at the travel destination, press **▲**. (The time advances by one hour.) Press **▲** again to return to the original time.
- 3** Press [MENU/SET] to close the menu.

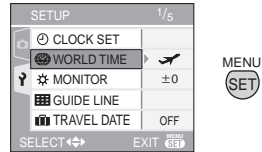

- The icon changes from [**🏠**] to [**✈️**] after setting the travel destination.



- Return the setting to [HOME] when the vacation is finished by performing steps **1**, **2**, **3** and then steps **1** and **2** of “Setting the home area [HOME]”.
- If you cannot find the travel destination in the areas displayed on the screen, set by the time difference from the home area.
- The [WORLD TIME] setting also affects simple mode [**♥**].
- The travel destination icon [**✈️**] appears when playing back pictures taken at the travel destination.

Using the [REC] Mode Menu



Increase the variety of pictures you can take by setting the white balance, color mode etc.

The menu items that can be set differ depending on the recording mode.

■ Setting from the menu screen

Press [MENU/SET] to display the [REC] mode menu and then select the item to set. (P21)

Items that can be set

(Recording in program AE mode [P])

Menu screen	Item
1/4	[WB] : [W.BALANCE] (P77)
	[WB±] : [WB ADJUST.] (P78)
	[ISO] : [SENSITIVITY] (P79)
	[↔] : [ASPECT RATIO] (P80)
	[P] : [PICT.SIZE] (P80)
2/4	[Q] : [QUALITY] (P80)
	[M] : [AUDIO REC.] (P82)
	[METER] : [METERING MODE] (P82)
	[AF] : [AF MODE] (P83)
	[C.A.F.] : [CONT.AF] (P84)
3/4	AF* : [AF ASSIST LAMP] (P85)
	[D.ZOOM] : [D.ZOOM] (P34)
	[COL.EFFECT] : [COL.EFFECT] (P85)
	[PICT.ADJ.] : [PICT.ADJ.] (P86)
	[FLIP ANIM.] : [FLIP ANIM.] (P86)
4/4	[CONVERSION] : [CONVERSION] (P88)
	[CLOCK SET] : [CLOCK SET] (P90)

■ Using quick setting

You can use the joystick to easily set the following items when recording.

(in program AE mode [P])

- AF mode (P83)
- Metering mode (P82)
- White balance (P77)
- ISO sensitivity (P79)
- Picture size (P80)
- Quality (P80)

1 Keep pressing the joystick when recording.

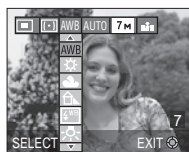

2 Tilt the joystick towards ▲/▼/◀/▶ to select the menu item and the setting and then press the center of the joystick to finish.

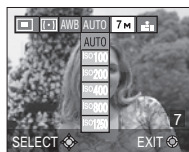

- The [MENU/SET] setting for white balance does not appear when using the quick setting.

[W.BALANCE]

Adjusting the hue for a more natural picture



Press [MENU] to display the [REC] mode menu and select the item to set. (P76)
This function allows you to reproduce a white color close to real life in pictures recorded under sunlight, halogen lighting etc. in which the white color may appear reddish or bluish. Select a setting that matches the recording conditions.

[AWB] (Auto white balance)	for auto setting
 (Daylight)	for recording outdoors on a bright day
 (Cloudy)	for recording outdoors on a cloudy day
 (Shade)	for recording outdoors in the shade on a bright day
 (Flash)	for recording with the flash only
 (Halogen)	for recording under halogen lighting
 (White set 1)	for using the preset white balance
 (White set 2)	
 (White set)	for setting the white balance again

■ Auto white balance

The available white balance range is shown in the following illustration. When you take a picture beyond the available white balance range, the picture may appear reddish or bluish. Even within the confines of the range, the auto white balance may not operate properly if there are many light sources or there is no color close to white. In these cases, set the white balance to a mode other than [AWB].

- 1 Auto white balance will work within this range.
- 2 Blue sky
- 3 Cloudy sky (Rain)
- 4 Shade
- 5 TV screen
- 6 Sunlight
- 7 White fluorescent light
- 8 Incandescent light bulb
- 9 Sunrise and sunset
- 10 Candlelight

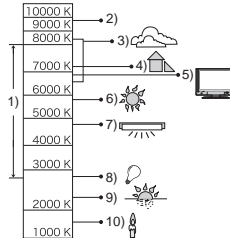

K=Kelvin Color Temperature

■ Setting the white balance manually
(SET)

Use this to set the white balance manually.

- 1 Select [SET] (White set) and then press [MENU/SET].
- 2 Select [WHITE SET 1] or [WHITE SET 2] and then press [MENU/SET].



- You can also use the joystick to select or set.

- 3 Aim the camera at a sheet of white paper etc. so that the frame in the center is filled by the white object only and then press [MENU/SET].

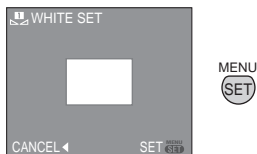

- 4 Press [MENU/SET] twice to close the menu.
- You can also press the shutter button halfway or press the center of the joystick to finish.



- When you take a picture with the flash, the white balance may not be properly adjusted if the flash level is insufficient for the subject.
- The white balance setting is memorized even if the camera is turned off. However, the white balance setting for a scene mode returns to [AWB] when the scene mode is changed.
- The white balance cannot be set in the following cases.
 - In simple mode [♥].
 - In [SCENERY], [PANNING], [NIGHT PORTRAIT], [NIGHT SCENERY], [FOOD], [PARTY], [CANDLE LIGHT], [SUNSET], [STARRY SKY], [FIREWORKS], [BEACH], [SNOW] and [AERIAL PHOTO] in scene mode.

[WB ADJUST.] Finely adjusting the white balance



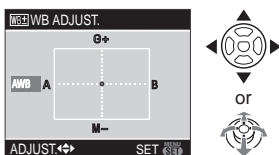

Press [MENU/SET] to display the [REC] mode menu and select the item to set. (P76) You can adjust the white balance finely when you cannot acquire the desired hue by setting the white balance.

1 Press ▲/▼/◀/▶ to finely adjust the white balance.



- ◀ : A (AMBER: ORANGE)
- ▶ : B (BLUE: BLUISH)
- ▲ : G+ (GREEN: GREENISH)
- ▼ : M- (MAGENTA: REDDISH)

2 Press [MENU/SET] to finish.

- You can also press the center of the joystick to finish.
- If you finely adjust the white balance to A (amber), the white balance icon on the LCD monitor will change to orange. If you finely adjust the white balance to B (blue), the white balance icon on the LCD monitor will change to blue.
- If you finely adjust the white balance to G+ (green) or M- (magenta), [+] (e.g. : ) or [-] (e.g. : ) appears beside the white balance icon on the LCD monitor/Viewfinder.
- Select the center point if you are not finely adjusting the white balance.



- You can finely adjust the white balance independently for each white balance item.
- The white balance fine adjustment setting is reflected in the picture when using the flash.
- The white balance fine adjustment setting is memorized even if the camera is turned off.
- You cannot finely adjust the white balance when [COL.EFFECT] (P85) is set to [COOL], [WARM], [B/W] or [SEPIA].
- The fine adjustment levels in [] or [] return to the standard setting (center point) if you reset the white balance in [SET].
- You cannot finely adjust the white balance in [SCENERY], [PANNING], [NIGHT PORTRAIT], [NIGHT SCENERY], [FOOD], [PARTY], [CANDLE LIGHT], [SUNSET], [STARRY SKY], [FIREWORKS], [BEACH], [SNOW] and [AERIAL PHOTO] in scene mode.

**[SENSITIVITY]***Setting the light sensitivity***P A S M**

Press [] to display the [REC] mode menu and select the item to set. (P76)
ISO is a measure of sensitivity to light. The higher the sensitivity is set, the less light is needed to take a picture so the camera becomes more suitable for recording in dark places.

- When setting to [AUTO], the ISO sensitivity is automatically adjusted from [ISO100] to [ISO200] according to the brightness. (It can be adjusted from [ISO100] to [ISO400] when using the flash.)

ISO sensitivity	100 \longleftrightarrow 1250	
Use in bright places (e.g. outdoors)	Suitable	Not suitable
Use in dark places	Not suitable	Suitable
Shutter speed	Slow	Fast
Noise	Less	Increased





- The ISO sensitivity cannot be set to [AUTO] in Manual exposure.
- ISO sensitivity is fixed to [ISO3200] in [HIGH SENS.] (P67) in scene mode.
- To avoid picture noises, we recommend reducing the ISO sensitivity, setting [NOISE REDUCTION] in [PICT.ADJ.] to [HIGH] or setting the items except [NOISE REDUCTION] to [LOW] to take pictures. (P86)
- The ISO sensitivity is set to [ISO LIMIT] in intelligent ISO sensitivity mode []. (P52)
- Refer to P58 for information about Shutter speed.
- ISO sensitivity cannot be set in the following cases.
 - Simple mode []
 - Motion picture mode []
 - Scene mode

**[ASPECT RATIO]**

Setting the aspect ratio of pictures



Press [MENU] to display the [REC] mode menu and select the item to set. (P76)
By changing the aspect ratio, you can select an angle of view that matches the subject.

4:3	<p>Select to take pictures with the same aspect ratio as a 4:3 TV or a computer monitor.</p> 
3:2	<p>Select to take pictures with the same 3:2 aspect ratio as 35 mm film.</p> 
16:9	<p>This is suitable for landscapes etc. where a wide view is preferable. This is also suitable for playing back pictures on a wide-screen TV, high-definition TV etc.</p> 



- In motion picture mode [M], you cannot select [3:2]. (P70)
- The ends of the recorded pictures may be cut at printing. (P129)

[PICT.SIZE]/[QUALITY]

Setting a picture size and quality that matches your use of the pictures



Press [MENU] to display the [REC] mode menu and select the item to set. (P76)
A digital picture is made of numerous dots called pixels. Although you cannot see the difference on the camera's screen, the more the pixels the finer the picture will be when it is printed on a large piece of paper or displayed on a computer monitor. Picture quality refers to the compression rate when saving digital pictures.

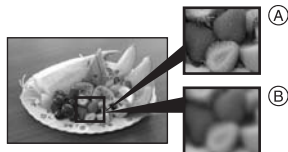

- (A) Many pixels (Fine)
- (B) Few pixels (Rough)



Number of pixels

You can print pictures more clearly when a large picture size [7M] (7M) is selected. When a smaller picture size [0.3M] (0.3M EZ) is selected, you can record more pictures and attach them to an e-mail or post them on a website because their file size is small.



When the aspect ratio is [4:3].

7M (7M)	3072×2304 pixels
5M (5M EZ)	2560×1920 pixels
3M (3M EZ)	2048×1536 pixels
2M (2M EZ)	1600×1200 pixels
1M (1M EZ)	1280×960 pixels
0.3M (0.3M EZ)	640×480 pixels



■ When the aspect ratio is [].

 (6M)	3072×2048 pixels
 (2.5M EZ)	2048×1360 pixels



■ When the aspect ratio is [].













 (5.5M)	3072×1728 pixels
 (2M EZ)	1920×1080 pixels

■ Quality

	Fine (Low compression): This gives priority to picture quality. Picture quality will be high.
	Standard (High compression): This gives priority to the number of recordable pictures. Standard quality pictures are recorded.
RAW	RAW file: Set this when altering the pictures on a PC.



- The number of pixels that can be selected differs depending on the aspect ratio. If you change the aspect ratio, set the picture size.
- “EZ” is an abbreviation of “Extended optical Zoom”. (P33)
- The extended optical zoom does not work in [HIGH SENS.] in scene mode so the picture size for [EZ] is not displayed.
- Pictures may appear mosaic depending on the subject and the recording conditions.
- Refer to P131 for information about the number of recordable pictures.
- When the quality is set to [RAW]
 - A JPEG file is also created simultaneously. Its quality is equal to [, [7M], [6M]] or [].
 - When the RAW file is deleted on the camera, the created JPEG file is also deleted.

- If a RAW picture is recorded with the built-in memory, it will take time to write the picture data.
- When the quality is set to [RAW], the digital zoom cannot be used.
- The quality cannot be set to [RAW] in the [HIGH SENS.] mode (P67).
- In simple mode [, the settings become as follows.
 - [] ENLARGE:
 -  :  (7M)/
 - [] 4"×6"/10×15cm:
 -  : [] (2.5M EZ)/
 - [] E-MAIL:
 -  : [] (0.3M EZ)/
- You cannot select the following functions when the quality is set to [RAW].
 - Burst mode
 - Auto Bracket
 - Audio Recording
 - Date Stamp
 - Audio Dubbing
 - Resize
 - Trimming
 - Aspect Ratio Conversion
- You can enjoy more advanced picture editing if you use RAW files. You can save RAW files in a file format (JPEG, TIFF etc.) that can be displayed on your PC etc., develop them and edit them using the software “SILKYPIX Developer Studio” by Ichikawa Soft Laboratory on the CD-ROM (supplied).

**[AUDIO REC.]**

Recording still pictures with audio



Press [MENU/SET] to display the [REC] mode menu and select the item to set. (P76)
You can record audio with the still picture if this is set to [ON]. This means you can record the conversation that took place when you were recording or an explanation of the picture.

- [U] appears on the screen when you set [AUDIO REC.] to [ON].
- Focus on the subject and press the shutter button to start recording. Recording will automatically stop about 5 seconds later. There is no need to press and hold the shutter button.
- Audio is recorded from the built-in microphone on the camera.
- If you press [MENU/SET] during audio recording, the audio recording is canceled. The audio is not recorded.
- The total number of pictures that can be stored on each card will decrease slightly when audio is recorded with each picture.



-
- You cannot take pictures with audio in the following cases:
 - Auto bracket
 - Burst mode
 - When the quality is set to [RAW]
 - [STARRY SKY] in scene mode

[METERING MODE]

Deciding the method to measure brightness

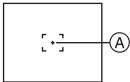

Press [MENU/SET] to display the [REC] mode menu and select the item to set. (P76)
You can switch to the following metering modes.

	<p>Multiple: This is the method in which the camera measures the most suitable exposure by judging the allocation of brightness on the whole screen automatically. Usually, we recommend using this method.</p>
	<p>Center weighted: This is the method used to focus on the subject on the center of the screen and measure the whole screen evenly.</p>
	<p>Spot: This is the method to measure the subject in the spot metering target (A).</p> 



-
- Metering mode is fixed to multiple [(•)] in simple mode [♥].

AF [AF MODE] Setting the focus method

PASM [MENU] [SCN] []

Press [MENU] to display the [REC] mode menu and select the item to set. (P76)
Select the mode that matches the recording conditions and the composition.

[] Multi-area-focusing:

The camera focuses on any of the selected areas. This is effective when the subject is not in the center of the screen.



[] 3-area-focusing (High speed):

The camera quickly focuses on any of 3 focus areas points – left, right or center. This is effective when the subject is not in the center of the screen.



[] 1-area-focusing (High speed):

The camera quickly focuses on the subject in the AF area on the center of the screen.



[] 1-area-focusing:

The camera focuses on the subject in the AF area on the center of the screen.



[] Spot-focusing:

The camera focuses on a limited narrow area in the screen.



■ About [] or []

- You can focus on the subject more quickly than other AF modes.
- The picture may stop moving for a moment before being brought into focus when you press the shutter button halfway. This is not a malfunction.



- The AF area displayed is bigger than usual when taking pictures in dark places or when using the digital zoom.



- The camera is focusing on all the AF areas when multiple AF areas (max. 5 areas) light at the same time. The focus position is not predetermined. It is set to a position automatically determined by the camera at the time of focusing. If you want to determine the focus position to take pictures, switch the AF mode to [], [] or [].
- If the AF mode is set to [] or [], the AF area is not displayed until the picture is brought into focus.
- Switch the AF mode to [] or [] mode if it is difficult to focus using [].
- The AF mode cannot be set in simple mode [].

■ About AF area selection

You can select the AF area when [AF], [AF H], [AF] or [AF] is selected.

- 1 Press the focus switch button until the focus mode appears and then press ▲/▼ to select [AF] or [AF MACRO].



- 2 Select AF area with ► on the joystick and then press the center of the joystick.



- 3 Move the AF area with the cursor buttons or ▲/▼/◀/▶ on the joystick.



- 4 Press [MENU/SET] or press the center of the joystick to set.

When selecting [AF H], [AF] or [AF]

You can select 1 AF area from the 11 areas.

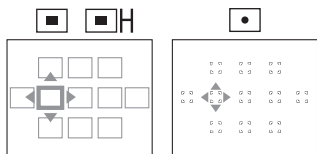

When selecting [AF]

You can select AF areas as shown in the following illustration by tilting the joystick towards ▲/▼/◀/▶.

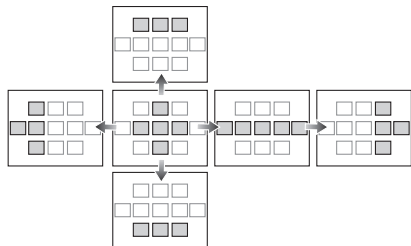

- The spot metering target can also be moved to match the AF area when using [AF].
- The following operations will return the AF area to the previous position.
 - When the mode dial is set to simple mode [♥]
 - When the power save mode is activated
 - When this unit is turned off

[CONT.AF]

CAF Continuously focusing on a subject



Press [MENU/SET] to display the [REC] mode menu and select the item to set. (P76)
This mode allows you to compose a picture more easily by always focusing on the subject.

The time required for focusing when the shutter button is pressed halfway will be reduced when the AF mode is set to [AF H], [AF] or [AF].

- The [CAF] indication appears when it is set to [ON].



- The battery will be consumed faster than usual.
- It may take time to focus on the subject if you rotate the zoom lever from Wide to Tele or suddenly change the subject from a distant one to a nearby one.
- Press the shutter button halfway again when it is difficult to focus on the subject.
- The [CONT.AF] setting is fixed to [OFF] in [PANNING] (P64), [NIGHT PORTRAIT] (P64), [NIGHT SCENERY] (P65), [STARRY SKY] (P67) and [FIREWORKS] (P68) in scene mode, in simple mode [♥] and when manual focus is set.

[AF ASSIST LAMP]

AF* *Focusing in low light conditions becomes easier*



Press [MENU] to display the [REC] mode menu and select the item to set. (P76)
Illuminating the subject makes it easier for the camera to focus when recording in low light conditions that make focusing difficult.

- If the AF assist lamp is set to [ON], an AF area with a size wider than usual is displayed and the AF assist lamp  turns on when you press the shutter button halfway in dark places etc.

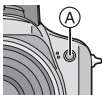

[ON]	The AF assist lamp turns on in low light conditions. At this time, the AF assist lamp icon  appears on the screen. The effective range of the AF assist lamp is 1.5 m (4.92 feet).
[OFF]	The AF assist lamp does not turn on.



- Be careful about the following when using the AF assist lamp.

- Do not look at the AF assist lamp from close up.
- Detach the lens hood.
- Do not cover the AF assist lamp with your fingers or other objects.
- When you do not want to use the AF assist lamp (e.g. when taking pictures of animals in dark places), set the [AF ASSIST LAMP] to [OFF]. In this case, it will become more difficult to focus on the subject.
- The setting for [AF ASSIST LAMP] is fixed to [ON] in simple mode [♥].
- A vignetting effect may appear on the circumference of the AF assist lamp because the AF assist lamp may be obscured by the lens, however, this does not cause a problem with the performance of the camera.
- The setting for the [AF ASSIST LAMP] is fixed to [OFF] in [SCENERY] (P63), [PANNING] (P64), [NIGHT SCENERY] (P65), [SUNSET] (P67), [FIREWORKS] (P68) and [AERIAL PHOTO] (P69) in scene mode.
- The initial setting for [PET] (P67) in scene mode is [OFF] .

[COL.EFFECT]

 *Setting color effects for the recorded pictures*



Press [MENU] to display the [REC] mode menu and select the item to set. (P76)
Select a color effect that matches the recording conditions and your image of the recording.

[COOL]	The picture becomes bluish.
[WARM]	The picture becomes reddish.
[B/W]	The picture becomes black and white.
[SEPIA]	The picture becomes sepia.

[PICT.ADJ.]

Adjusting the picture quality for the recorded pictures

P A S M

Press [] to display the [REC] mode menu and select the item to set. (P76)
Select an effect that matches the recording situation and your image of the recording.

[CONTRAST]

[HIGH]	Increases the difference between the brightness and the darkness in the picture.
[LOW]	Decreases the difference between the brightness and the darkness in the picture.

[SHARPNESS]

[HIGH]	The picture is sharply defined.
[LOW]	The picture is softly focused.

[SATURATION]

[HIGH]	The colors in the picture become vivid.
[LOW]	The colors in the picture become natural.

[NOISE REDUCTION]

[HIGH]	The noise reduction effect is enhanced. Picture resolution may deteriorate slightly.
[LOW]	The noise reduction effect is reduced. You can obtain pictures with higher resolution.



- When you take pictures in dark places, noise may become visible. To avoid picture noise, we recommend setting [NOISE REDUCTION] in [PICT.ADJ.] to [HIGH] or setting the items except [NOISE REDUCTION] to [LOW] to take pictures.

[FLIP ANIM.]

Connecting images to create a motion picture file

P A S M **SCN**

Press [] to display the [REC] mode menu and select the item to set. (P76)
This camera allows you to create motion picture files up to 20 seconds long by connecting images recorded in flip animation mode.

Example:

When capturing images of the subject in sequence moving the camera little by little and aligning the images, the subject looks as if it is moving.

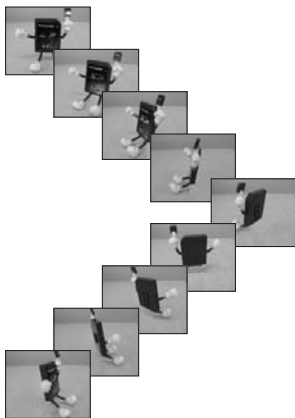

- You can play back created flip animations with the same method used to play back motion pictures. (P94)

1 Press ▲/▼ to select [FLIP ANIM.] and then press ►.

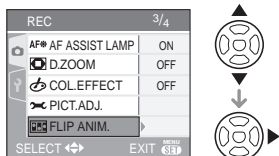

4 Press [MENU/SET], press ▲/▼ to select [CREATE MOTION PICTURE] and then press ►.

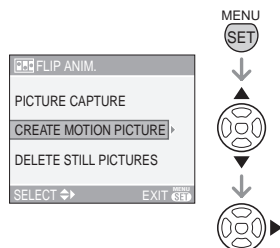

2 Select [PICTURE CAPTURE] and then press ►.

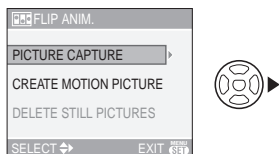

• The picture size is 320×240 pixels.

5 Select [FRAME RATE] and then press ►.

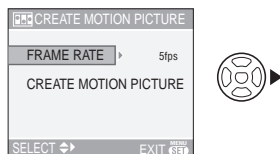

3 Press the shutter button and capture the images one frame at a time.

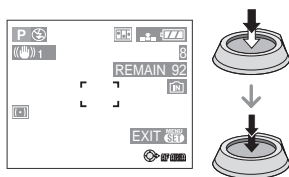

- You can check the recorded image with ▼ and the previous or following image with ◀/▶.
- Delete unnecessary images with the [🗑️] button.
- You can record up to 100 pictures. The number of recordable pictures displayed is an approximation.

6 Press ▲/▼ to select [5fps] or [10fps] and then press [MENU/SET].

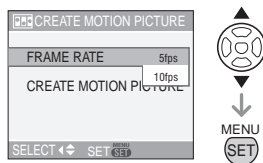

[5fps]	5 frames/sec.
[10fps]	10 frames/sec. (The motion pictures become smoother.)

7 Press ▼ to select [CREATE MOTION PICTURE], press ► and then create a flip animation.

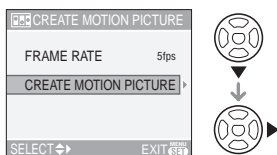

- The file number appears after creating a flip animation.
- Press [MENU/SET] three times to close the menu after creating the flip animation.

■ Deleting all still images used to create flip animation

When selecting [DELETE STILL PICTURES] in [FLIP ANIM.] menu, a confirmation screen appears. Select [YES] with ▲ and then press [MENU/SET].



- You cannot use the direction detection function, burst mode, auto bracket and [AUDIO REC.].
- The images in each frame do not appear in normal review. (P35)
- If you execute [CREATE MOTION PICTURE], flip animation is made from all pictures recorded for flip animation. Delete unnecessary pictures.
- Audio cannot be recorded.
- You cannot record audio using the audio dubbing. (P105)
- Playback may not be possible on other equipment. You may also hear noise during playback on other equipment which does not have a mute function.

[CONVERSION]
Using an optional lens



Press [MENU/SET] to display the [REC] mode menu and select the item to set. (P76) The tele conversion lens (DMW-LT55; optional) allows you to record even more close-up pictures (1.7× more). The wide conversion lens (DMW-LW55; optional) allows you to record even wider angle pictures (0.7× wider). The close-up lens (DMW-LC55; optional) allows you to take close-up pictures of a small subject.

- The lens adaptor (DMW-LA2; optional) is necessary to attach a conversion lens or close-up lens.

1 Remove the lens cap, lens hood and hood adaptor.

2 Attach the lens adaptor (DMW-LA2; optional).

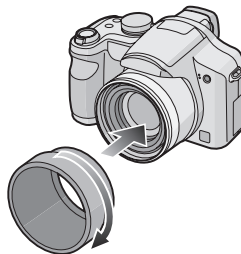

- **Conversion lens cannot be used together with the ND filter (DMW-LND52) and the MC protector (DMW-LMC52).** Always detach the ND filter or MC protector before attaching the conversion lens.
- Rotate the lens slowly and carefully.

3 Attach the conversion lens or close-up lens.

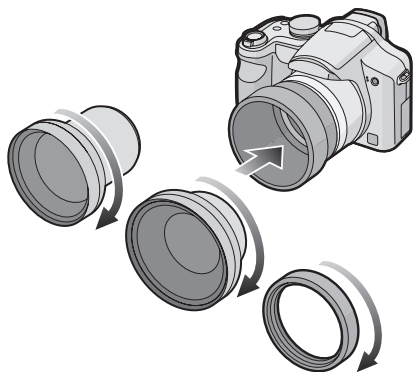

- You cannot attach a conversion lens or the close-up lens to the hood adaptor (supplied).

4 Turn the camera on, press ▲/▼ to select [CONVERSION] and then press ►.

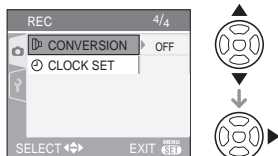

5 Press ▲/▼ to set to [0.7x], [1.4x] or [0.4x] and then press [MENU/SET].

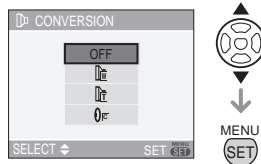

- [OFF]:
When you do not attach the conversion lens.
- [0.7x]:
When you attach the wide conversion lens.
- [1.4x]:
When you attach the tele conversion lens.
- [0.4x]:
When you attach the close-up lens
- Press the shutter button halfway or press [MENU/SET] to close the menu after finishing the setting.

Recordable range when using a conversion lens

When attaching the tele conversion lens

	Wide	Tele
Normal	—	5.4 m (18 feet) to ∞
Macro	—	5.4 m (18 feet) to ∞

When attaching the wide conversion lens

	Wide	Tele
Normal	15 cm (0.5 feet) to ∞	—
Macro	15 cm (0.5 feet) to ∞	—

When attaching the close-up lens

	Wide	Tele
Normal	20 cm (0.7 feet) to 50 cm (1.7 feet)	40 cm (1.3 feet) to 50 cm (1.7 feet)
Macro	5 cm (0.17 feet) to 50 cm (1.7 feet)	40 cm (1.3 feet) to 50 cm (1.7 feet)
Tele Macro	—	33 cm (1.1 feet) to 50 cm (1.7 feet)

- The zoom is fixed to Tele when using the tele conversion lens and is fixed to Wide when using the wide conversion lens.

	Indication	Actual magnification
Tele conversion lens	12×	20.4× *
Wide conversion lens	1×	0.7×

- * The actual magnification when using the digital zoom (P34) and the extended optical zoom (P33) is 1.7× the zoom magnification displayed when set to Tele.
- The full range of the zoom can be used when using the close-up lens.



- Digital zoom cannot be used when using a wide conversion lens.
- When there is dirt (water, oil, and fingerprints, etc.) on the surface of the lens, the image may be affected. Lightly wipe the surface of the lens with a soft, dry cloth before and after taking pictures.
- Ensure that [CONVERSION] is set to [OFF] when not using a conversion lens.
- When using the conversion lens or close-up lens:
 - The built-in flash cannot be activated.
 - If you set [CONVERSION] to [OFF], the performance of the conversion lens or close-up lens will not be optimal.
- When using the tele conversion lens:
 - We recommend using a tripod.
 - The stabilizer function may not work sufficiently.
 - The focus indication may light due to the jitter even if the subject is not focused.
 - The time required for focusing may become longer than usual.
- If you set [CONVERSION] to [0.7], [1.7] or [0.7], you cannot use the built-in flash or AF assist lamp. (P85)
- Read the operating instructions of the conversion lens for details.



[CLOCK SET]

Set the date, time and display



Press [MENU] to display the [REC] mode menu and select the item to set. (P76)
Change date and time. (P19)

Displaying Multiple Screens (Multi Playback)



1 Rotate the zoom lever towards [W] [T] to display multiple screens.

(Screen when 9 screens are displayed)



1 screen → 9 screens → 25 screens →
Calendar screen display (P92)

- Rotate the zoom lever towards [Q] [T] to return to the previous screen.

2 Press ▲/▼/◀/▶ to select a picture.

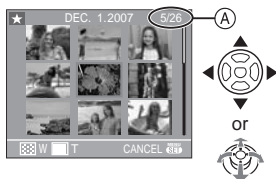

Ⓐ: Number of the selected picture and the total number of recorded pictures

- You can also use the joystick for operation.
- Depending on the recorded picture and the setting, the following icons will appear.
 - [★] (Favorites)
 - [🎬] (Motion picture)
 - [👶] [🐕] ([BABY1]/[BABY2]/[PET] in scene mode)
 - [📅] (Travel date)
 - [✈️] (Travel destination)

- [🔄] (Flip animation)
- [📅] (Pictures stamped with [DATE STAMP])

■ Examples of 25 screens



■ To return to normal playback

Rotate towards [Q] [T] or press [MENU/SET].

- The picture appears framed in orange.

■ To delete a picture during multi playback

- 1 Press ▲/▼/◀/▶ to select a picture and then press [🗑️].
- 2 Press ▲ to select [YES].
- 3 Press [MENU/SET].



- The recording information etc. on the LCD monitor cannot be deleted in multi playback even if you press [DISPLAY].
- Pictures will not be displayed in the rotated direction even if [ROTATE DISP.] is set to [ON]. (P99)

Displaying pictures by recording date

(Calendar playback)



You can display pictures by recording date using the calendar playback function.

1 Rotate the zoom lever several times towards [] [W] to display the calendar screen.



- The recording date of the picture selected in the playback screen becomes the date selected when the calendar screen is first displayed.
- If there are multiple pictures with the same recording date, the first picture recorded on that day is displayed.

2 Press ▲/▼/◀/▶ to select the date to be played back.

- ◀/▶: Select the date
- ▲/▼: Select the month
- If there were no pictures recorded during a month, the month is not displayed.

3 Press [MENU/SET] to display the pictures that were recorded on the selected date.



- Rotate the zoom lever towards [] [W] to return to the calendar screen.

4 Press ▲/▼/◀/▶ to select a picture and then press [MENU/SET].

- The picture that was selected will appear.

■ To return to the 1 screen playback screen.

After the calendar screen is displayed, rotate the zoom lever towards [Q] [T] to display 25 screens, 9 screens and the 1 screen. (P91)



- The pictures are displayed without being rotated even if you set [ROTATE DISP.] to [ON]. (P99)
- You can display the calendar between January 2000 and December 2009.
- If the recording date of the picture selected in 25 screen multi playback is not between January 2000 and December 2009, the camera automatically displays it in the oldest calendar date.
- Pictures edited on a PC will be displayed with dates different from the actual recording dates.
- If the date is not set in the camera (P19), the recording date is set as January 1st, 2007.
- If you take pictures after setting the travel destination in [WORLD TIME] (P74), the pictures are displayed by the dates at the travel destination in calendar playback.
- You can also select or set by using the joystick.

Using the Playback Zoom



1 Rotate the zoom lever towards [Q] [T] to enlarge the picture.



- Q : 1× → 2× → 4× → 8× → 16×
- When you rotate the zoom lever towards [W] after enlarging the picture, the magnification becomes lower. When you rotate the zoom lever towards [Q] [T], the magnification becomes higher.
- When you change the magnification, the zoom position indication (A) appears for about 1 second so that you can check the position of the enlarged section.

2 Press ▲/▼/◀/▶ to move the position.



- When you move the position to be displayed, the zoom position indication appears for about 1 second.

■ To stop using the playback zoom

Rotate the zoom lever towards [W] or press [MENU/SET].

■ To delete a picture during the playback zoom

- 1 Press [DELETE].
- 2 Press ▲ to select [YES].
- 3 Press [MENU/SET].



- You can also delete the recording information etc. on the LCD monitor/Viewfinder during playback zoom by pressing [DISPLAY].
- The more a picture is enlarged, the more its quality deteriorates.
- If you want to save the enlarged picture, use the trimming function. (P106)
- The playback zoom may not operate if pictures have been recorded with other equipment.

Playing Back Motion Pictures/Pictures with Audio



■ Motion pictures

Press ◀/▶ to select a picture

with a motion picture icon [30fps_VGA] /

[10fps_VGA] / [30fps_QVGA] / [10fps_QVGA] / [30fps_16.9] /

[10fps_16.9] and then press ▼ to play back.

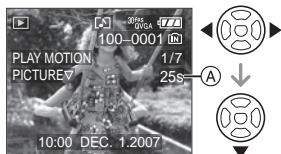

Ⓐ: The motion picture recording time

- After playback starts, the elapsed playback time is displayed on the bottom right of the screen.

For example, 1 hour 20 minutes and 30 seconds is displayed as [1h20m30s].

- The cursor displayed during playback is the same as ▲/▼/◀/▶.



Stopping motion picture playback

Press ▼.

Fast forwarding/Fast rewinding

Press and hold ◀/▶ during motion picture playback.

◀: Fast rewind

▶: Fast forward

- The camera returns to normal motion picture playback when ◀/▶ is released.

To pause

Press ▲ during motion picture playback.

- Press ▲ again to cancel pause.

Frame-by-frame forwarding/ frame-by-frame rewinding

- Press ◀/▶ while paused.

■ Pictures with audio

Press ◀/▶ to select a picture

with the audio icon [] and then

press ▼ to play back.



- Refer to [AUDIO REC.] (P82) and [AUDIO DUB.] (P105) for information about how to create still pictures with audio.



- Sound can be heard through the speaker. Refer to [VOLUME] (P24) for information about how to adjust the volume in the [SETUP] menu.
- The file format that can be played back with this camera is QuickTime Motion JPEG.
- Please note that the bundled software includes QuickTime to play back motion picture files created with the camera on the PC. (P111)
- Some QuickTime Motion JPEG files recorded by a PC or other equipment may not play back on the camera.
- If you play back motion pictures that have been recorded with other equipment, the picture quality may deteriorate or the pictures may not play back.
- When using a high capacity card, it is possible that fast rewinding may be slower than usual.
- You cannot use the following functions with motion pictures and pictures with audio.
 - Playback zoom (during motion picture playback/pause)
 - [ROTATE DISP.]/[ROTATE]/[AUDIO DUB.] (Motion pictures only)
 - [DATE STAMP]/[RESIZE]/[TRIMMING]/[ASPECT CONV.]

Creating still pictures from a motion picture



You can create still pictures from a motion picture that has been recorded. This is effective in moving scenes when you want to look carefully at the movement of a sportsperson etc.

- 1 Press ◀/▶ to select a picture with a motion picture icon [30fps_VGA] / [10fps_VGA] / [30fps_QVGA] / [10fps_QVGA] / [30fps_16:9] / [10fps_16:9] and then press ▼ to play back.



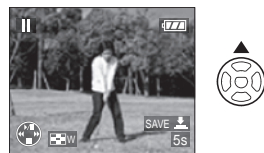

- 2 Press ▲ to pause motion picture playback.

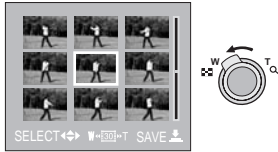

- Press ▲ again to return to motion picture playback.
- Press ◀/▶ while paused to move forward frame-by-frame.
- If you press the shutter button, you can save the displayed still pictures as one single picture. (Perform step 4)

3 Rotate the zoom lever towards [] [W] to display the 9 screens playback screen.









- After the 9 screens playback screen is displayed, rotate the zoom lever towards [] [W] to switch the frames/second.

When []/[]/[] is selected

30 frames/second → 15 frames/second
→ 10 frames/second
→ 5 frames/second

When []/[]/[] is selected

10 frames/second → 5 frames/second

- Rotate the zoom lever towards [] [T] to return to the previous frames/second screen.
- You can move forward frame-by-frame by pressing  /  /  /  .
 : Move forward/backward 3 frames at a time.
 : Move forward/backward 1 frame at a time.

4 Press the shutter button.

- The message [SAVE THESE NINE PICTURES AS ONE SINGLE PICTURE ?] appears. Also, the message [SAVE AS A SINGLE PICTURE ?] appears if you saved the picture in step 2.

5 Press to select [YES] and then press [MENU/SET].

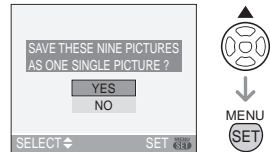

- The nine pictures are saved as one single picture.

Picture size

Item	1 picture	9 pictures
[30fpsVGA]	0.3 M	2 M
[10fpsVGA]	0.3 M	2 M
[30fpsQVGA]	0.3 M	1 M
[10fpsQVGA]	0.3 M	1 M
[30fps16:9]	2 M	2 M
[10fps16:9]	2 M	2 M

- [QUALITY] (P80) is fixed to [].



- You may not be able to save still pictures from a motion picture taken on other equipment.

Using the [PLAY] mode menu



You can use various functions in playback mode to rotate pictures, set protection for them etc.

• Refer to P97 to 109 for each menu item.

1 Press [MENU/SET].

2 Press ▲/▼ to select the menu item and then press ►.

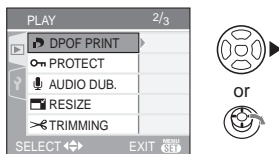
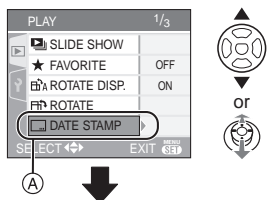

- Press ▼ at (A) to switch to the next menu screen.
- You can switch menu screens from any menu item by rotating the zoom lever.
- After performing steps 1 and 2, refer to the description of the menu item in the operating instructions and then set it.

Items that can be set

Menu screen	Item
1/3	: [SLIDE SHOW] (P97)
	: [FAVORITE] (P99)
	: [ROTATE DISP.] (P99)
	: [ROTATE] (P99)
	: [DATE STAMP] (P100)
2/3	: [DPOF PRINT] (P102)
	: [PROTECT] (P104)
	: [AUDIO DUB.] (P105)
	: [RESIZE] (P105)
	: [TRIMMING] (P106)
3/3	: [ASPECT CONV.] (P107)
	: [COPY] (P108)
	: [FORMAT] (P109)

[SLIDE SHOW]

Playing back pictures in order for a fixed duration

Press [MENU/SET] to display the [PLAY] mode menu and select the item to set. (P97)
This is recommended when playing back pictures on a TV screen. You can skip unwanted pictures if [FAVORITE] (P99) has been set.

- When [FAVORITE] is set to [ON] → step 1.
- When [FAVORITE] is set to [OFF] → step 2.

1 Press ▲/▼ to select [ALL] or [★] and then press [MENU/SET].

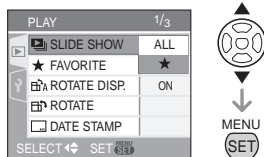

[ALL]	Displays all pictures.
[★]	Displays only those pictures that have been set as favorites (P99).

- If none of the pictures have [★] displayed, you cannot select [★] even if [FAVORITE] is set to [ON].

2 Press ▲ to select [START] and then press [MENU/SET].

(Screen when [ALL] is selected)

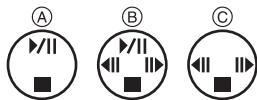
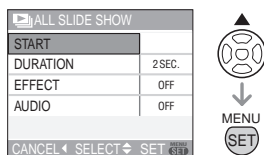

- The cursor displayed during a slide show (A) or while a slide show is paused (B) or during [MANUAL] slide show (C) is the same as ▲/▼/◀/▶.
- Press ▲ to pause the slide show. Press ▲ again to cancel pause.
- Press ◀/▶ while paused to display the previous or next picture. (However, the selected effect is disabled.)

3 Press ▼ to finish.

■ Setting the audio, duration and effect

Select [DURATION], [EFFECT] or [AUDIO] on the screen shown in step 2 and set.

[DURATION]	<p>Can be set to [1SEC.], [2SEC.], [3SEC.], [5SEC.] or [MANUAL] (manual playback).</p> <ul style="list-style-type: none"> • The playback durations are approximations only. They differ depending on the pictures which are played back.
[EFFECT]	<p>A slide show effect can be selected.</p> <p>[OFF]: No effect</p> <ul style="list-style-type: none"> <input type="checkbox"/>: New pictures slide across the screen. <input checked="" type="checkbox"/>: Current pictures fade out and new pictures fade in. <input checked="" type="checkbox"/>: New pictures gradually fill the screen from the center. [MIX]: An effect is selected at random. <ul style="list-style-type: none"> • If you set [DURATION] to [MANUAL] the settings in [EFFECT] are disabled.
[AUDIO]	<p>If set to [ON], the audio of the pictures with audio is played back.</p>

- You can only select [MANUAL] when [★] was selected in step 1.
- Press ◀/▶ to display the previous or next picture when [MANUAL] is selected.



- If you set [AUDIO] to [ON] and then play back a picture with audio, the next picture will be displayed after the audio has finished.
- You cannot play back motion pictures and use power save in a slide show. (However, the setting for power save mode is fixed to [10MIN.] while pausing a slide show or playing back a manual slide show.)

★ [FAVORITE] Setting your favorite pictures

Press [MENU/SET] to display the [PLAY] mode menu and select the item to set. (P97)

You can do the following if a mark has been added to pictures and they have been set as favorites.

- Delete all the pictures not set as favorites. ([ALL DELETE EXCEPT ★]) (P36)
- Play back the pictures set as favorites only as a slide show. (P97)

1 Press ▼ to select [ON] and then press [MENU/SET].

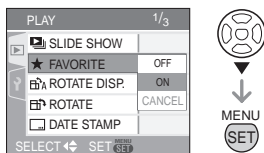

- You cannot set pictures as favorites if [FAVORITE] is set to [OFF]. Also the favorites icon [★] will not appear when [FAVORITE] is set to [OFF] even if it was previously set to [ON].
- You cannot select [CANCEL] if none of the pictures have [★] displayed.

2 Press [MENU/SET] to close the menu.

3 Press ◀/▶ to select the picture then press ▲.

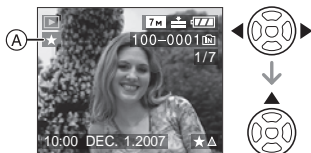

- Repeat the above procedure.
- If ▲ is pressed while the [★] favorites icon (A) is displayed, [★] is cleared, and the favorites setting is canceled.
- You can set up to 999 pictures as favorites.

■ Deleting all favorites

- 1 Select [CANCEL] on the screen shown in step 1 and then press [MENU/SET].
- 2 Press ▲ to select [YES] and then press [MENU/SET].
- 3 Press [MENU/SET] to close the menu.



- When printing pictures at a photo printing store, [ALL DELETE EXCEPT ★] (P37) is useful so only the pictures you want to be printed remain on the card.
- Use [LUMIX Simple Viewer] or [PHOTOfunSTUDIO-viewer] on the CD-ROM (supplied), to set, confirm or delete favorites. (For information about this, refer to the separate operating instructions for PC connection.)
- You may not be able to set pictures taken with other equipment as favorites.

▶ [ROTATE DISP.]/[ROTATE] To display the picture rotated

Press [MENU/SET] to display the [PLAY] mode menu and select the item to set. (P97) This mode allows you to automatically display pictures vertically if they were recorded holding the camera vertically or rotate pictures manually in 90° steps.

■ Rotate display (The picture is automatically rotated and displayed.)

1 Press ▼ to select [ON] and then press [MENU/SET].

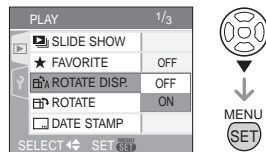

- The pictures are displayed without being rotated when you select [OFF].
- Refer to P36 for information about how to play back pictures.

2 Press [MENU/SET] to close the menu.

■ Rotate

(The picture is rotated manually.)

1 Press **◀/▶** to select the picture and then press **▼**.



- The [ROTATE] function is disabled when [ROTATE DISP.] is set to [OFF].
- Motion pictures and protected pictures cannot be rotated.

2 Press **▲/▼** to select the direction to rotate the picture and then press **[MENU/SET]**.

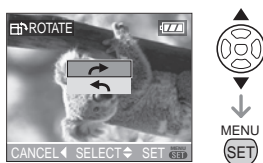

	The picture rotates clockwise in steps of 90°.
	The picture rotates counter-clockwise in steps of 90°.

3 Press **[MENU/SET]** twice to close the menu.



- If you take pictures when aiming the camera up or down, it may not be possible to display the pictures vertically. (P28)
- The picture may be slightly blurred when the camera is connected to the TV with the AV cable (supplied) and played back vertically.

- When you play back pictures on a PC, they cannot be displayed in the rotated direction unless the OS or software is compatible with Exif. Exif is a file format for still pictures which allows recording information etc. to be added. It was established by JEITA [Japan Electronics and Information Technology Industries Association].
- Rotated pictures are displayed rotated when they are played back in review playback and playback zoom however are displayed without being rotated when they are played back in multi playback.
- It may not be possible to rotate pictures that have been recorded with other equipment.

[DATE STAMP]



Stamping information such as the date on the recorded pictures

Press [**MENU**] to display the [PLAY] mode menu and select the item to set. (P97)
You can stamp the date and time of recording, the age and the travel date on the recorded pictures.

Press **▲/▼** to select **[SINGLE]** or **[MULTI]** and then press **[MENU/SET]**.

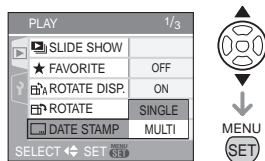

- The date information cannot be stamped on the following pictures.
 - Pictures recorded without setting the clock
 - Pictures recorded when the quality is set to [RAW]
 - Pictures recorded with other equipment
 - Pictures that were previously stamped with [DATE STAMP]
 - Motion pictures
 - Pictures with audio

■ Single setting

1 Press **◀/▶** to select the picture and then press **▼**.



2 Press **▲/▼/◀/▶** to select **[SHOOTING DATE]**, **[AGE]** or **[TRAVEL DATE]** and then press **[MENU/SET]** to set each item.

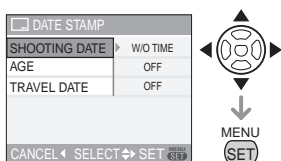

[SHOOTING DATE]

[W/O TIME]	Stamp the year, month and date.
[WITH TIME]	Stamp the year, month, day, hour and minutes.

[AGE] (P66, 67)

If this is set to [ON], the age is stamped on pictures recorded when the camera was set to [WITH AGE].

[TRAVEL DATE] (P72)

If this is set to [ON], the travel date is stamped on pictures recorded when [TRAVEL DATE] was set to [ON].

3 Press **[MENU/SET]**.

- If you set [DATE STAMP] for a picture with a picture size larger than [**3M**], the picture size will become smaller as shown below.

Aspect ratio	Picture size
4:3	7M / 5M → 3M
3:2	6M → 25M
16:9	55M → 2M

4 Press **▲/▼** to select **[YES]** or **[NO]** and then press **[MENU/SET]**.
(The screen shown appears when you select a picture recorded with a [**7M**] picture size.)

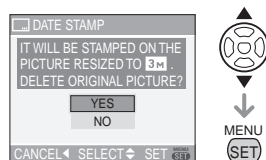

- The message [DELETE ORIGINAL PICTURE?] appears if the picture was recorded with a picture size [**3M**] or less.
- The picture is overwritten when you select [YES]. Pictures stamped with date stamp cannot be restored when they are overwritten.
- The picture stamped with date stamp is newly created when you select [NO].
- If the original picture is protected, you cannot overwrite it. Select [NO] and newly create the picture stamped with date stamp.

5 Press **[MENU/SET]** twice to close the menu.

- The date stamp icon [**3M**] (A) appears on the screen if the picture has been stamped with the date stamp.
- Use the playback zoom (P93) to check the stamped date information (B).

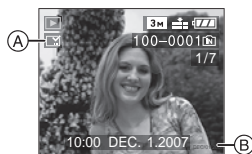

Multi setting

1 Press **◀▶** to select the picture and then press **▼** to **SET/CANCEL**.

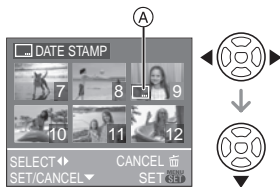

[SET]	The [DATE STAMP] icon (A) appears.
[CANCEL]	The [DATE STAMP] icon (A) disappears.

• Repeat this step.

2 Press **[MENU/SET]**.

• After performing step 2, perform step 2 onwards in “When [SINGLE] is selected”.



• When you print pictures stamped with the date stamp, the date will be printed over the stamped date if you set date printing at the photo printing store or on the printer.

• We recommend setting date stamp when there is plenty of space on the built-in memory or the card.

• You can set up to 50 pictures at one time in [MULTI].

• If you select [YES] in step 4 when the pictures selected in [MULTI] include protected pictures, the message appears and the protected pictures only cannot be stamped with date stamp.

• Depending on the printer being used, some characters may be cut at printing. Check before printing.

• You cannot use the following functions if the date information has been stamped on the picture.

- [DATE STAMP]
- The [PRINT WITH DATE] setting for DPOF print
- [RESIZE]
- [TRIMMING]
- [ASPECT CONV.]

102

VQT1B25

[DPOF PRINT]

▶ Setting the picture to print and the number of prints

Press **[MENU/SET]** to display the [PLAY] mode menu and select the item to set. (P97) DPOF “Digital Print Order Format” is a system that allows the user to select which pictures to print, how many copies of each picture to print and whether or not to print the recording date on the pictures when using a DPOF compatible photo printer or photo printing store. For details, ask at your photo printing store.

When you want to use a photo printing store to print pictures recorded on the built-in memory, copy them to a card (P108) and then set the DPOF setting.

For more information visit:
http://panasonic.jp/dc/dpof_110/white_e.htm

Press **▲/▼** to select [SINGLE], [MULTI] or [CANCEL] and then press **[MENU/SET]**.

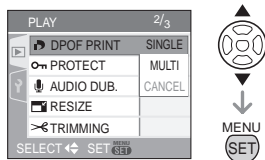

• You cannot select [CANCEL] if there are no prints that have been set in the DPOF print settings.

■ Single setting

1 Press **◀/▶** to select the picture to print and then press **▲/▼** to set the number of prints.

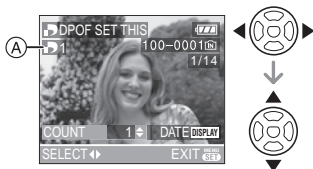

- The number of prints icon [] **A** appears.
- The number of prints can be set from 0 to 999. The DPOF print setting is canceled when the number of prints is set to [0].

2 Press **[MENU/SET]** twice to close the menu.

■ Multi setting

1 Press **◀/▶** to select the picture to print then press **▲/▼** to set the number of prints.

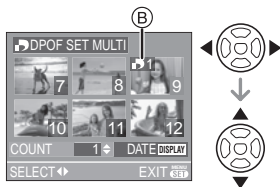

- The number of prints icon [] **B** appears.
- Repeat the above procedure. (You cannot set all the pictures at one time.)
- The number of prints can be set from 0 to 999. The DPOF print setting is canceled when the number of prints is set to [0].

2 Press **[MENU/SET]** twice to close the menu.

■ To cancel all settings

1 Press **▲** to select **[YES]** and then press **[MENU/SET]**.

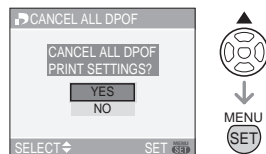

2 Press **[MENU/SET]** to close the menu.

- DPOF print settings on the built-in memory are canceled when a card is not inserted. DPOF print settings on the card are canceled when a card is inserted.

■ To print the date

After setting the number of prints, set/cancel printing with the recording date by pressing **[DISPLAY]**.

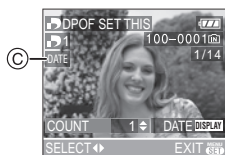

- The date print icon [] **C** appears.
- When you go to a photo printing store for digital printing, be sure to order the printing of the date additionally if required.
- Depending on the photo printing store or the printer, the date may not be printed even if you set to print the date. For further information, ask at your photo printing store or refer to the operating instructions for the printer.
- You cannot set date printing if the pictures have been stamped with the date stamp.
- If you set **[DATE STAMP]** for pictures that have been set for date printing, the date printing setting is canceled.



- DPOF is an abbreviation of “Digital Print Order Format”. This feature allows you to write print information to media and then use the information on a DPOF-compliant system.
- DPOF print setting is a convenient function when printing pictures with a printer that supports PictBridge (P113). The date printing setting on the printer may take priority over the date printing setting on the camera. Check the date printing setting on the printer also. (P113)
- It is necessary to delete all previous DPOF print information made on other equipment when setting DPOF print on the camera.
- If the file is not based on the DCF standard, the DPOF print setting cannot be set.

[PROTECT]**Preventing accidental erasure of pictures**

Press [**MENU/SET**] to display the [PLAY] mode menu and select the item to set. (P97)
You can set protection for pictures you do not want to be deleted by mistake.

Press ▲/▼ to select [SINGLE], [MULTI] or [CANCEL] and then press [MENU/SET].

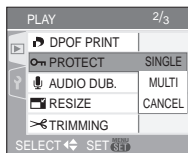
**■ Single setting**

1 Press ◀/▶ to select the picture and then press ▼ to set/cancel.



[SET]	The protect icon [] (A) appears.
[CANCEL]	The protect icon [] (A) disappears.

2 Press [MENU/SET] twice to close the menu.

■ Multi setting/To cancel all settings

Perform the same operation as in “[DPOF PRINT] Setting the picture to print and the number of prints”. (P102 to 104)



- If you press [MENU/SET] while canceling protection, the canceling will stop halfway.
- The protect setting may not be effective on other equipment.
- If you want to delete protected pictures, cancel their protection.
- Even if you protect pictures on a card, they will be deleted if the card is formatted. (P109)
- Even if you do not protect pictures on an SD Memory Card or an SDHC Memory Card, they cannot be deleted when the card's Write-Protect switch (B) is set to [LOCK].



- The following functions cannot be used with protected pictures.
 - [ROTATE]
 - [AUDIO DUB.]

[AUDIO DUB.] Adding audio after taking pictures

Press [**MENU/SET**] to display the [PLAY] mode menu and select the item to set. (P97)
You can add the audio after taking a picture.

1 Press **◀/▶** to select the picture and then press **▼** to start audio recording.



- The message [OVERWRITE AUDIO DATA?] screen appears when audio has already been recorded. Press **▲** to select [YES] and then press [MENU/SET] to start audio recording. (The original audio is overwritten.)
- Audio dubbing cannot be used with the following pictures.
 - Motion pictures
 - Protected pictures
 - Pictures recorded when the quality is set to [RAW]

2 Press **▼** to stop recording.

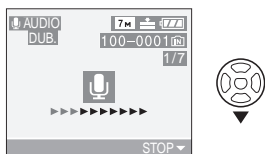

- The audio recording stops automatically if **▼** is not pressed after about 10 seconds.

3 Press [MENU/SET] twice to close the menu.



- Audio dubbing may not work properly on pictures recorded by other equipment.

[RESIZE] Making the picture smaller

Press [**MENU/SET**] to display the [PLAY] mode menu and select the item to set. (P97)
This function is useful if you want to reduce the file size of a picture to attach it to an e-mail or upload it to a website.

1 Press **◀/▶** to select the picture and then press **▼**.

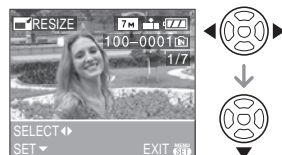

- The following pictures cannot be resized.

Aspect ratio	Picture size
4:3	0.3M
3:2	25M
16:9	2M

- Pictures recorded when the quality is set to [RAW]
- Motion pictures
- Pictures with audio
- Flip animation
- Pictures stamped with [DATE STAMP]

2 Press **◀/▶** to select the size and then press **▼**.



- Sizes smaller than the recorded picture are displayed.

Aspect ratio	Picture size
4:3	[5M]/[3M]/[2M]/ [1M]/[0.3M]
3:2	[25M]
16:9	[2M]

- The message [DELETE ORIGINAL PICTURE?] appears.

3 Press **▲/▼** to select [YES] or [NO] and then press [MENU/SET].



- The picture is overwritten when you select [YES]. Resized pictures cannot be restored when they are overwritten.
- A resized picture is newly created when you select [NO].
- If the original picture is protected, you cannot overwrite it. Select [NO] and newly create a resized picture.

4 Press [MENU/SET] twice to close the menu.



- It may not be possible to resize pictures recorded with other equipment.

[TRIMMING] *Enlarging a picture and trimming it*

Press [**MENU**] to display the [PLAY] mode menu and select the item to set. (P97)
You can enlarge and then clip the important part of the recorded picture.

1 Press **◀/▶** to select the picture and then press **▼**.



- The following pictures cannot be trimmed.
 - Pictures recorded when the quality is set to [RAW]
 - Motion pictures
 - Pictures with audio
 - Flip animation
 - Pictures stamped with [DATE STAMP]

2 Enlarge or decrease the parts to be trimmed with the zoom lever.

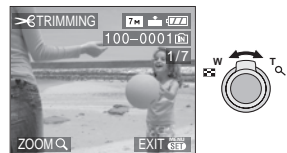

3 Press **▲/▼/◀/▶** to move the position of the part to be trimmed.

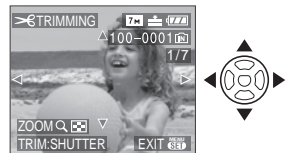

4 Press shutter button.

- The message [DELETE ORIGINAL PICTURE?] appears.

5 Press ▲/▼ to select [YES] or [NO] and then press [MENU/SET].

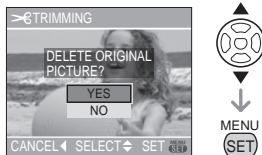

- The picture is overwritten when you select [YES]. The trimmed pictures cannot be restored when they are overwritten.
- A trimmed picture is newly created when you select [NO].
- When the original picture is protected, you cannot overwrite it. Select [NO] and newly create a trimmed picture.

6 Press [MENU/SET] twice to close the menu.



- Depending on the cut size, the picture size of the trimmed picture may become smaller than that of the original picture.
- The picture quality of the trimmed picture will deteriorate.
- It may not be possible to trim pictures recorded with other equipment.

[ASPECT CONV.]



Changing the aspect ratio of a 16:9 picture

Press [MENU/SET] to display the [PLAY] mode menu and select the item to set. (P97) You can convert pictures taken with a [16:9] aspect ratio to a [3:2] or a [4:3] aspect ratio.

1 Press ▲/▼ to select [3:2] or [4:3] and then press [MENU/SET].

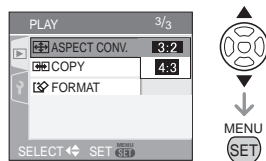

- The following pictures cannot be converted.
 - Pictures recorded when the quality is set to [RAW]
 - Motion pictures
 - Pictures with audio
 - Pictures stamped with [DATE STAMP]

2 Press ◀/▶ to select a picture and then press ▼.



- If you select and set a picture with an aspect ratio other than [16:9], the message [CANNOT BE SET ON THIS PICTURE] is displayed on the screen.

3 Press **◀/▶** to determine the horizontal position and press the shutter button to set.



- Use **▲/▼** to set the frame position for pictures rotated vertically.
- The message [DELETE ORIGINAL PICTURE?] appears.

4 Press **▲/▼** to select [YES] or [NO] and then press [MENU/SET].

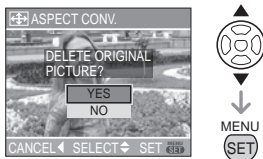

- The picture is overwritten when you select [YES]. If you convert the aspect ratio of a picture and then overwrite it, you cannot restore it.
- A picture with the converted aspect ratio is newly created when you select [NO].
- When the original picture is protected, you cannot overwrite it. Select [NO] and newly create a picture with the converted aspect ratio.

5 Press [MENU/SET] twice to close the menu.



- After converting the aspect ratio, the picture size may become larger than that of the original picture.
- Files that do not conform to the DCF standard cannot be converted.
- You may not be able to convert pictures taken on other equipment.

[COPY]

Copying the picture data

Press [**MENU**] to display the [PLAY] mode menu and select the item to set. (P97)
You can copy recorded picture data from the built-in memory to a card or vice versa.

1 Press **▲/▼** to select the copy destination and then press [MENU/SET].

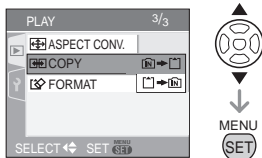

- **[IN] → []**:
All the picture data in the built-in memory are copied onto the card at one time. → step 3.
- **[] → [IN]**:
One picture at a time is copied from the card to the built-in memory. → step 2.

2 Press **◀/▶** to select the picture and then press **▼**.

(Only when selecting [**] → [IN]**)

3 Press **▲** to select [YES] and then press [MENU/SET].

(The illustration shows the screen when pictures are copied from the built-in memory to a card.)

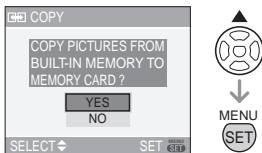

- The message [COPY THIS PICTURE TO BUILT-IN MEMORY?] appears when you copy pictures from the card to the built-in memory.
- If you press [MENU/SET] while copying pictures from the built-in memory to the card, the copying will stop halfway.

- Do not turn the camera off or perform any other operations before copying is finished. The data on the built-in memory or the card may be damaged or lost.

4 Press [MENU/SET] several times to close the menu.

- If you copy picture data from the built-in memory to a card, the screen automatically returns to the playback screen when all the pictures are copied.



- If you copy picture data from the built-in memory to a card, we recommend using a card which has more free space than the built-in memory (about 27 MB).
- If a picture with the same name as the picture to be copied exists in the copy destination, the picture will not be copied. (P124)
- It may take time to copy the picture data.
- Only pictures recorded with a Panasonic digital camera (LUMIX) will be copied. (Even if the pictures were recorded with a Panasonic digital camera, you may not be able to copy them if they were edited with a PC.)
- DPOF settings on the original picture data will not be copied. Set the DPOF settings again after copying is finished. (P102)



[FORMAT] Initializing the card

Press [MENU/SET] to display the [PLAY] mode menu and select the item to set. (P97) Usually, it is not necessary to format the built-in memory and the card. Format them when the message [BUILT-IN MEMORY ERROR] or [MEMORY CARD ERROR] appears.

Press ▲ to select [YES] and then press [MENU/SET].

(The illustration shows the screen when the built-in memory is formatted.)

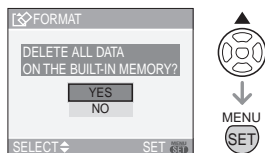

- When a card is not inserted, you can format the built-in memory. When a card is inserted, you can format the card.
- If you press [MENU/SET] while formatting the built-in memory, the formatting will stop halfway. (However, all the pictures will be deleted.)



- Formatting irretrievably deletes all the data including any protected pictures. Check the data carefully before formatting.
- If the card has been formatted on a PC or other equipment, format it on the camera again.
- Use a battery with sufficient battery power (P26) or the AC adaptor (DMW-AC7PP; optional) when formatting.
- Do not turn the camera off during formatting.
- It may take longer to format the built-in memory than the card. (Max. about 15 sec.)
- You cannot format an SD Memory Card or an SDHC Memory Card when the card's Write-Protect switch (A) is set to [LOCK].



- If the built-in memory or the card cannot be formatted, consult your nearest Service Center.

For USA assistance, please call: 1-800-272-7033
or send e-mail to : digitalstillcam@us.panasonic.com

For Canadian assistance, please call:
1-800-99-LUMIX (1-800-995-8649) or
send e-mail to: lumixconciierge@ca.panasonic.com

Connecting to a PC



You can acquire recorded pictures to a PC by connecting the camera and the PC. The software [LUMIX Simple Viewer] or [PHOTOfunSTUDIO-viewer-] (for Windows®) in the CD-ROM (supplied) allows you to easily acquire pictures recorded with the camera to a PC, print them and send them by e-mail.

If you use "Windows 98/98SE", install the USB driver and then connect it to the computer.

For information about the software in the CD-ROM (supplied) and installing this software, refer to the separate operating instructions for PC connection.

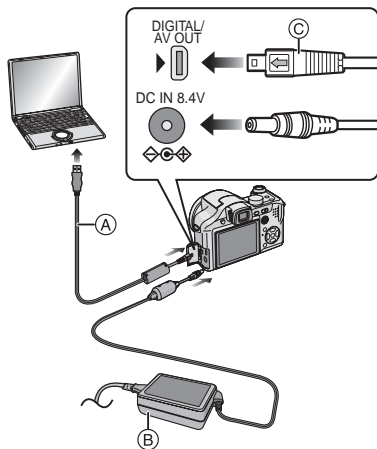

(A): USB connection cable (supplied)

(B): AC adaptor (DMW-AC7PP; optional)

- Use a battery with sufficient battery power or the AC adaptor (DMW-AC7PP; optional).
- Turn the camera off before inserting or removing the cable for the AC adaptor (DMW-AC7PP; optional).

- Set the camera to a mode other than [] mode.

1 Turn on the camera and the PC.

2 Connect the camera to a PC via the USB connection cable (A) (supplied).

- Connect the USB connection cable with the [] mark facing the [] mark on the [DIGITAL] socket.
- Hold the USB connection cable at (C) and insert straight in or take straight out. (If you forcibly insert the USB connection cable at a slant or upside down you can deform the connection terminals and damage the camera or the connected equipment.)

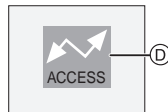

(D): This message appears during data transfer.

[Windows]

The drive appears in the [My Computer] folder.

- If you are connecting the camera to a PC for the first time, the required driver is installed automatically so that the camera can be recognized by "Windows Plug and Play". The drive then appears on the [My Computer] folder.

[Macintosh]

The drive is displayed on the screen.

- The drive is displayed as [LUMIX] when you connect the camera with no card inserted.
- The drive is displayed as [NO_NAME] or [Untitled] when you connect the camera with a card inserted.

■ About motion picture playback on a PC

Use the software "QuickTime" (for Windows 2000/XP) in the CD-ROM (supplied) to play back motion pictures recorded on this camera on a PC.

- If you use "Windows 98/98SE/Me", download "QuickTime 6.5.2 for PC" from the following site, and install it.
<http://www.apple.com/support/quicktime/>
- This software is installed as standard on a "Macintosh OS".

■ Folder Composition

Folders are displayed as shown in the following illustration.

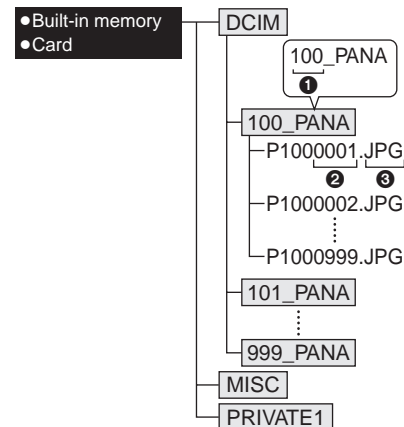

- MISC: Folder containing files on which the DPOF print settings are recorded
- PRIVATE1: Pictures recorded in flip animation function

- The data for up to 999 pictures recorded by the camera can be included in 1 folder. If the number of pictures exceeds 999, another folder is created.
- To reset the file number or the folder number, select [NO.RESET] in the [SETUP] menu. (P24)

■ Conditions under which a different folder number is used

In the following cases, the picture is not recorded in the same folder as the previously recorded picture. It is recorded in a folder with a new number.

- 1 When the folder just recorded to contains a picture file with the number 999 in it (example: P1000999.JPG).
- 2 When the card just recorded to contains, for example, a folder with the number 100 [100_PANA] in it and that card is removed and replaced with a card that has a folder with the number 100 in it recorded by a camera from a different maker (100XXXXX, with XXXXX being the name of the maker) and then a picture is recorded.
- 3 When recording after selecting [NO.RESET] (P24) from the [SETUP] menu. (Pictures will be recorded to a new folder with a number sequential to the folder recorded to immediately before. By using [NO.RESET] on a card that does not contain folders or pictures, such as one just formatted, the folder number can be reset to 100.)

■ About the PTP connection

If the OS is "Windows XP" or "Mac OS X", you can connect in PTP mode if you set the camera to [] mode and then connect to your PC.

- Pictures can only be read on the camera. They cannot be written to a card or deleted.
- When there are 1000 or more pictures on a card, the pictures may not be imported.



- Do not use any other USB connection cables except the supplied one.
- Do not disconnect the USB connection cable while [ACCESS] is displayed.
- If there are a lot of pictures on the built-in memory or a card, it may take time to transfer them.
- It may not be possible to playback the motion pictures on the built-in memory or a card normally when this unit and the PC are connected. Import the motion picture files to the PC and then play them back.
- If battery power is exhausted while the camera and the PC are communicating, the recorded data may be damaged. When you connect the camera to the PC, use a battery with sufficient battery power (P26) or the AC adaptor (DMW-AC7PP; optional).
- If the remaining battery power becomes low while the camera and the PC are communicating, the status indicator blinks and the alarm beeps. In this case, stop the communication at once on the PC.
- **When connecting the camera to a “Windows 2000” OS PC with the USB connection cable, do not replace the card while the camera and the PC are connected. The information on the card may be damaged. Use “Safely Remove Hardware” in the task tray on your PC when replacing the card.**
- Pictures edited or rotated with a PC may be displayed in black in playback mode (P36), multi playback (P91) and calendar playback (P92).
- Read the operating instructions for the PC.
- If a card is not inserted when the camera is connected to the PC, you can edit or access the pictures on the built-in memory. If a card is inserted, you can edit or access the pictures on it.
- You cannot switch between the built-in memory and the card while the camera is connected to the PC. When you want to switch between the built-in memory and the card, disconnect the USB connection cable, insert (or remove) the card and then connect the USB connection cable to the PC again.
- The message [PLEASE RE-CONNECT THE PRINTER.] appears if you change the mode dial to [] while the camera and the PC are connected. If a printer is connected, change the mode to a mode other than [] mode and then check that no data is being transferred. ([ACCESS] appears on the LCD monitor of the camera while data is being transferred.)

Printing the Pictures



By connecting the camera directly to a printer supporting PictBridge via the USB connection cable (supplied), you can select the pictures to print and start printing on the camera's screen.

Set print settings such as the print quality on the printer beforehand. (Read the printer operating instructions.)

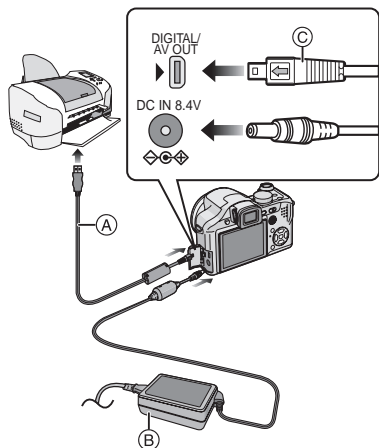

- (A): USB connection cable (supplied)
 (B): AC adaptor (DMW-AC7PP; optional)

- It may take time to print some pictures. Use a battery with sufficient battery power (P26) or the AC adaptor (DMW-AC7PP; optional) when you connect to a printer.
- Turn the camera off before inserting or removing the cable for the AC adaptor (DMW-AC7PP; optional).

1 Turn on the camera and the printer.

2 Set the mode dial to [P].

3 Connect the camera to a printer via the USB connection cable (A) (supplied).

- Connect the USB connection cable with the [←] mark facing the [▶] mark on the [DIGITAL] socket.
- Hold the USB connection cable at (C) and insert straight in or take straight out.



- If the mode dial is not set to [P] when the camera is connected to the PC, disconnect the USB connection cable, set the mode dial to [P] and then connect the USB connection cable again. (Depending on the printer, it may be necessary to turn it off and then on again.)
- Do not use any other USB connection cables except the supplied one.
- If a card is not inserted when the camera is connected to the PC, you can edit or access the picture data on the built-in memory. If a card is inserted, you can edit or access the picture data on it.
- You cannot switch between the built-in memory and the card while the camera is connected to the printer. When you want to switch between the built-in memory and the card, disconnect the USB connection cable, insert (or remove) the card and then connect the USB connection cable to the printer again.
- If you want to print the age in [BABY1]/[BABY2] (P66) or [PET] (P67) in scene mode or the number of days that have been passed since the departure date in [TRAVEL DATE] (P72), use the software [LUMIX Simple Viewer] or [PHOTOfunSTUDIO-viewer-] in the CD-ROM (supplied) and print from the PC. For information about this, refer to the separate operating instructions for PC connection.
- To find out more about PictBridge compliant printers, contact your local dealer.

■ Selecting a single picture and printing it

1 Press ◀/▶ to select the picture and then press [MENU/SET].



- The message disappears in about 2 seconds.

2 Press ▲ to select [PRINT START] and then press [MENU/SET].

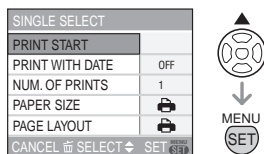

- Press [MENU/SET] to cancel printing halfway.

3 Disconnect the USB connection cable after printing.

■ Selecting multiple pictures and printing them

1 Press ▲.

2 Press ▲/▼ to select an item and then press [MENU/SET].

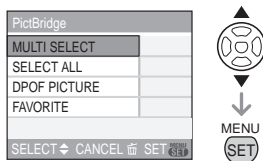

[MULTI SELECT]	Multiple pictures are printed at one time. <ul style="list-style-type: none"> • After selecting [MULTI SELECT], press ◀/▶ to select the pictures to print and then press ▼. The icon [] appears on the pictures to be printed. (Press ▼ again to cancel the setting.) Press [MENU/SET] after finishing the setting.
[SELECT ALL]	Prints all the stored pictures.
[DPOF PICTURE]	Prints the pictures set in [DPOF] only. (P102)
[FAVORITE]*	Prints the pictures set as favorites only. (P99)

*This only appears when [FAVORITE] (P99) is set to [ON]. (However if none of the pictures have [★] displayed, you cannot select it even if [FAVORITE] is set to [ON].)

3 Press ▲ to select [PRINT START] and then press [MENU/SET].

MULTI SELECT	
PRINT START	
PRINT WITH DATE	OFF
NUM. OF PRINTS	1
PAPER SIZE	
PAGE LAYOUT	
CANCEL	SELECT
	SET



- The items [PRINT WITH DATE] and [NUM. OF PRINTS] are not displayed when [DPOF PICTURE] is set.
- The DPOF settings are displayed when [DPOF PICTURE] is selected. If you selected DPOF settings, refer to P102 and set them.
- Press [MENU/SET] to cancel printing.
- When you select [MULTI SELECT], [SELECT ALL] or [FAVORITE], a print confirmation screen appears. Select [YES] and print the pictures.
- The message [PRINTING ## PICTURE(S) DO YOU WANT TO PROCEED ?] appears on the print confirmation screen if the number of prints is more than 1000.

4 Disconnect the USB connection cable after printing.

■ Setting date printing, the number of prints, the paper size and the page layout

Select and set each item in step 3.

- Items not supported by the printer are displayed in gray and cannot be selected.
- When you want to print pictures in a paper size or a layout which is not supported by the camera, set [PAPER SIZE] or [PAGE LAYOUT] to and then set the paper size or the layout on the printer. (For details, refer to the operating instructions of the printer.)

• [PRINT WITH DATE]

[OFF]	Date is not printed.
[ON]	Date is printed.

- If the printer does not support date printing, the date cannot be printed on the picture.

• [NUM. OF PRINTS]

- Set the number of prints.
- You can set up to 999 prints.

• [PAPER SIZE]

- (Paper sizes that can be set with this unit)
- The paper sizes are displayed on pages 1/2 and 2/2. Press ▼ to select.

1/2	
	Settings on the printer are prioritized.
[L/3.5"×5"]	89 mm×127 mm
[2L/5"×7"]	127 mm×178 mm
[POSTCARD]	100 mm×148 mm
[A4]	210 mm×297 mm
2/2*	
[CARD SIZE]	54 mm×85.6 mm
[10×15cm]	100 mm×150 mm
[4"×6"]	101.6 mm×152.4 mm
[8"×10"]	203.2 mm×254 mm
[LETTER]	216 mm×279.4 mm

- *These items cannot be displayed when the printer does not support the paper sizes.

• [PAGE LAYOUT]

- (Layouts for printing that can be set with this unit)

	Settings on the printer are prioritized.
	1 picture with no frame on 1 page
	1 picture with a frame on 1 page
	2 pictures on 1 page
	4 pictures on 1 page

- An item cannot be selected if the printer does not support the page layout.

■ Setting the date printing with the DPOF print in advance

We recommend setting DPOF date printing with [DPOF PRINT] (P103) in advance when the printer supports it. If you select [DPOF PICTURE], printing starts and the recording date is printed.

■ Layout printing

• When printing the same picture on 1 sheet of paper



For example, if you want to print the same picture 4 times on 1 sheet of paper, set [PAGE LAYOUT] to  and then set [NUM. OF PRINTS] to 4 for the picture that you want to print.

• When printing different pictures on 1 sheet of paper

For example, if you want to print 4 different pictures on 1 sheet of paper, set [PAGE LAYOUT] to  and then set [COUNT] in [DPOF PRINT] (P102) to 1 for each of the 4 pictures.



- Do not disconnect the USB connection cable when the cable disconnection warning icon  is displayed. (Depending on the printer, the icon may not be displayed.)
- If the remaining battery power becomes low while the camera and the printer are connected, the status indicator blinks and the alarm beeps. If this happens during printing, press [MENU/SET] and stop printing at once. If not printing, disconnect the USB connection cable.

- The camera is receiving an error message from the printer when the  indication lights orange during printing. After finishing printing, make sure there are no problems with the printer.
- If the total number of DPOF prints or the number of DPOF pictures printed is high, pictures may be printed several times. The remaining number of prints indicated may differ from the number set. This is not a malfunction.
- With date printing, the setting on the printer may take priority over the setting on the camera. Check the date print setting on the printer also.
- The message [USB MODE CHANGED. PLEASE REMOVE THE USB CABLE.] appears if you change the mode dial to a mode other than  while the camera and the printer are connected. Set the mode dial to  again and then disconnect the USB connection cable. If this happens during printing, stop printing and then disconnect the USB connection cable.
- When the pictures in RAW files are to be printed, the JPEG pictures recorded simultaneously by the camera will be printed. If JPEG pictures do not exit, RAW file pictures cannot be printed.

Playing Back Pictures on a TV Screen



■ Playing back pictures using the AV cable (supplied)

- Set the [TV ASPECT]. (P25)
- Turn this unit and the TV off.

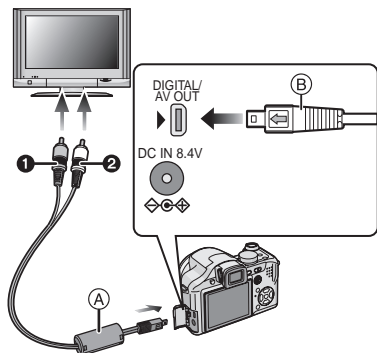

1 Connect the AV cable (A) (supplied) to the [AV OUT] socket on the camera.

- Connect the AV cable with the [◀] mark facing the [▶] mark on the [AV OUT] socket.
- Hold the AV cable at (B) and insert straight in or take straight out.

2 Connect the AV cable to the video input and the audio input sockets on the TV.

- ① Yellow: to the video input socket
- ② White: to the audio input socket

3 Turn the TV on and select external input.

4 Turn the camera on.



- Depending on the aspect setting, black bands may be displayed on the top and bottom or the left and right of the pictures.
- Do not use any other AV cables except the supplied one.
- Audio playback is monaural.
- Read the operating instructions for the TV.
- When you play back a picture vertically, it may be blurry.
- You can view pictures on TVs in other countries (regions) which use the NTSC or PAL system when you set [VIDEO OUT] in the [SETUP] menu. Even if you set [VIDEO OUT] to [PAL], the output signal will still be NTSC in the recording mode.

■ Playing back pictures on a TV with an SD Memory Card slot

Still pictures recorded on an SD Memory Card can be played back on a TV with an SD Memory Card slot.



- You cannot play back an SDHC Memory Card if the TV model does not support it.
- Depending on the TV model, pictures may not be displayed on the full screen.
- Motion pictures cannot be played back. To play back motion pictures, connect the camera to the TV with the AV cable (supplied).
- You may not be able to play back MultiMediaCards.

Using the MC Protector/ND Filter

The MC protector (DMW-LMC52; optional) is a transparent filter which affects neither the colors nor the amount of light, so it can always be used to protect the camera's lens.

The ND filter (DMW-LND52; optional) reduces the amount of light to approximately 1/8th (equal to adjusting the aperture value 3 increments) without affecting the color balance.

1 Attach the hood adaptor.

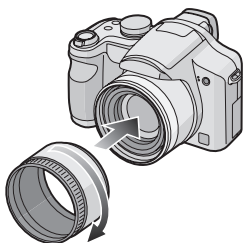

2 Attach the MC protector ① or the ND filter ②.

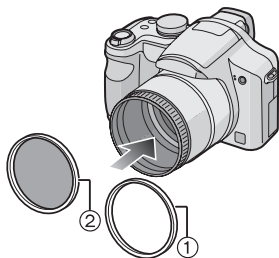

- You cannot attach the MC protector and the ND filter at the same time.
- If the MC protector/ND filter are tightened too much, you may not be able to remove them. Do not tighten them too much.
- Do not hold the MC protector/ND filter too tightly.
- When taking pictures with the flash using the MC protector or ND filter, vignetting effect may occur.
- If the MC protector/ND filter are dropped, they may be destroyed. Be careful not to drop them when attaching them to the camera.
- You can attach the lens hood when the MC Protector and ND Filter are attached.
- You cannot attach a conversion lens or the close-up lens to the hood adaptor.
- The lens adaptor (DMW-LA2; optional) is necessary to attach a conversion lens or close-up lens.
- **MC** = "Multi-coated"
- **ND** = "Neutral Density"

Screen Display

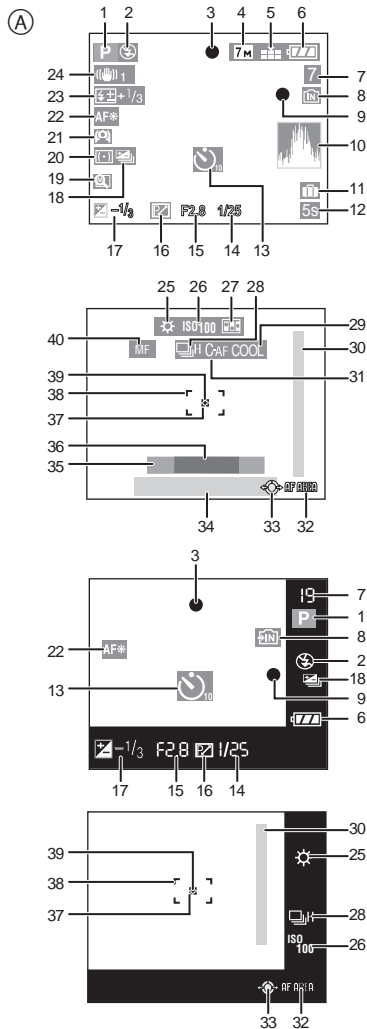

(A) In recording

- 1 Recording mode
- 2 Flash mode (P43)
- 3 Focus (P27)
- 4 Picture size (P80)
- 5 Quality (P80)
In Motion picture mode (P70)

30fps VGA	10fps VGA	30fps QVGA	10fps QVGA	30fps 16_g
10fps 16_g				
- 6 Battery indication (P26)

[[[]]]

- 7 Number of recordable pictures/
Available recording time
In Motion picture mode (P70)
e.g.: **R1h20m30s**
- 8 Built-in memory (P18, 26)

[[[]]]

- 9 Recording state
- 10 Histogram (P40)
- 11 Travel date (P72)
- 12 Elapsed recording time (P70)
- 13 Self-timer mode (P47)
- 14 Shutter speed (P27)

ISO

- 15 Aperture value (P27)
- 16 Program shift (P29)
- 17 Exposure compensation (P48)
- 18 Auto bracket (P49)
- 19 Zoom resume (P32)

[[[]]]	[[[]]]	[[[]]]
---------	---------	---------
- 20 Metering mode (P82)
- 21 High angle mode (P41)

[[[]]]

- 22 AF assist lamp (P85)

TELE	[[[]]]
------	---------
- 23 Flash output adjustment (P46)

- 24 Optical image stabilizer (P50)
- 25 White balance (P77)
White balance fine adjustment (P78)

- 26 ISO sensitivity (P79)
: ISO limit (P52)

- 27 Flip animation (P86)

- 28 Burst (P51)
: Audio recording (P70, 82)

- 29 Color effect mode (P85)

- 30 Focus range (P59)

- 31 Continuous AF (P84)

- 32 AF area selection (P84)
MF operation (P59)

- 33 Joystick operation (P29, 36, 56, 57)

- 34 Current date and time/
: Travel destination setting (P74)
 • This is displayed for about 5 seconds when the camera is turned on, after setting the clock and after switching from playback mode to recording mode.

Zoom (P32)/Extended optical zoom (P33)/Digital zoom (P34)



- 35 Age (P66)
 • This is displayed for about 5 seconds when this unit is turned on in [BABY1]/[BABY2] or [PET] in scene mode.

- 36 Number of days that have passed since the travel date (P72)
 • This is displayed for about 5 seconds if the camera is turned on when the travel date is set etc.

- 37 Spot AF area (P83)



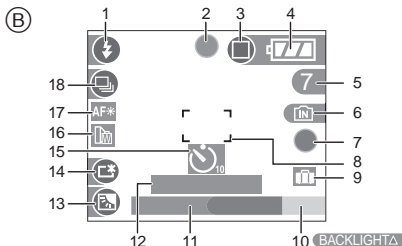

- 38 AF area (P27)

- 39 Spot metering target (P82)

- 40 MF (P59)
: AF macro (P54)



(B) Recording in simple mode

- 1 Flash mode (P43)
- 2 Focus (P27)
- 3 Picture mode (P30)
: Jitter alert (P29)
- 4 Battery indication (P26)
- 5 Number of recordable pictures
- 6 Built-in memory (P18, 26)
: Card (P18, 26)
- 7 Recording state
- 8 AF area (P27)
- 9 Travel date (P72)
- 10 Operation for backlight compensation (P31)
- 11 Current date and time
 This is displayed for about 5 seconds when the camera is turned on, after setting the clock and after switching from playback mode to simple mode.
 Zoom (P32)/Extended optical zoom (P33)

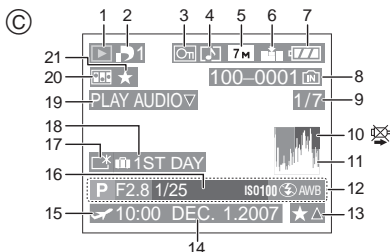
- 12 Number of days that have passed since the travel date (P72)
- 13 Backlight compensation (P31)
- 14 Power LCD (P41)
- 15 Self-timer mode (P47)
- 16 Conversion lens (P88)
: Zoom resume (P32)
- 17 AF assist lamp (P85)
: Tele macro (P54)
- 18 Burst (P51)



© In playback

- 1 Playback mode (P36)
- 2 Number of DPOF prints (P102)
- 3 Protected picture (P104)
- 4 Picture with audio/Motion pictures (P94)
- 5 Picture size (P80)
- 6 Quality (P80)

In Motion picture mode (P94)

30FPS VGA / 10FPS VGA / 30FPS QVGA / 10FPS QVGA / 30FPS 16:9 / 10FPS 16:9

In Simple mode (P30)

: ENLARGE

: 4"×6"/10×15cm

: E-MAIL
- 7 Battery indication (P26)
- 8 Folder/File number (P111)
Built-in memory (P18)
: Card (P18)
- 9 Picture number/Total pictures

- 10 Cable disconnection warning icon (P116)
 - This is displayed when printing using a printer supporting PictBridge.
(Depending on the printer, the icon may not be displayed.)
 Motion picture recording time (P94): **1h20m30s**
- 11 Histogram (P40)
- 12 Recording information
- 13 Favorites settings (P99)/Elapsed playback time (P94): **1h20m30s**
- 14 Recorded date and time
- 15 Travel destination setting (P74)
- 16 Age (P66)
- 17 Power LCD (P41)
- 18 Number of days that have passed since the travel date (P72)
- 19 Audio playback (P94)

PLAY MOTION PICTURE : In motion picture mode (P94)
- 20 Flip animation (P86)
- 21 Favorites (P99)

Cautions for Use

■ Optimal use of the camera

Take care not to drop or knock the unit or put a lot of pressure on it.

- Take care not to drop or knock the bag that you inserted the unit in as it may strongly shock the unit.
- A strong shock may break the lens, screen or outer case and cause the camera to malfunction.

Keep the camera as far away as possible from electromagnetic equipment (such as microwave ovens, TVs, video games etc.).

- If you use the camera on top of or near a TV, the pictures and sound on the camera may be disrupted by electromagnetic wave radiation.
- Do not use the camera near cell phones because doing so may result in noise adversely affecting the pictures and sound.
- Recorded data may be damaged, or pictures may be distorted, by strong magnetic fields created by speakers or large motors.
- Electromagnetic wave radiation generated by microprocessors may adversely affect the camera, disturbing the pictures and sound.
- If the camera is adversely affected by electromagnetic equipment and stops functioning properly, turn the camera off and remove the battery or disconnect AC adaptor (DMW-AC7PP; optional). Then reinsert the battery or reconnect AC adaptor and turn the camera on.

Do not use the camera near radio transmitters or high-voltage lines.

- If you record near radio transmitters or high-voltage lines, the recorded pictures and sound may be adversely affected.

Always use the supplied cords and cables. If you use optional accessories, use the cords and the cables supplied with them.

Do not extend the cords or the cables.

Do not spray the camera with insecticides or volatile chemicals.

- If the camera is sprayed with such chemicals, the body of the camera may be damaged and the surface finish may peel off.
- Do not keep rubber or plastic products in contact with the camera for a long period of time.

Do not use benzine, thinner or alcohol for cleaning the camera.

- Before cleaning the camera, remove the battery or disconnect the AC adaptor (DMW-AC7PP; optional) from the electrical outlet.
- The body of the camera may be damaged and the surface finish may peel off.
- Wipe the camera with a soft, dry cloth.
- Wipe the dust or fingerprints with a soft, dry cloth.
- Do not use a kitchen detergent or a chemically treated cloth.
- If rain water or other drops of water splash onto the camera, use a dry cloth to wipe the camera body carefully.

■ About the LCD monitor/Viewfinder

- **Do not press the LCD monitor with excessive force. Uneven colors may appear on the LCD monitor and it may malfunction.**
- Condensation may form on the LCD monitor in places with large temperature differences. Wipe the condensation with a soft, dry cloth.
- If the camera is cold when you turn it on, the picture on the LCD monitor/Viewfinder will be slightly darker than usual at first. However, the picture will return to normal brightness when the internal temperature of the camera increases.

Extremely high precision technology is employed to produce the LCD monitor/Viewfinder screen. However there may be some dark or bright spots (red, blue or green) on the screen. This is not a malfunction. The LCD monitor/Viewfinder screen has more than 99.99% effective pixels with a mere 0.01% of the pixels inactive or always lit. The spots will not be recorded on pictures on the built-in memory or a card.

■ About the Lens

- Do not press the lens with excessive force.
- Do not leave the camera with the lens facing the sun as it may cause the camera to malfunction. Also, be careful when you leave the camera outside or near a window.
- When there is dirt (water, oil, and fingerprints, etc.) on the surface of the lens, the picture may be affected. Lightly wipe the surface of the lens with a soft, dry cloth before and after taking pictures.

■ Card

Do not leave the card where the temperature is high, where electromagnetic waves or static electricity are easily generated or exposed to direct sunlight.

Do not bend or drop the card.

- The card may be damaged or the recorded content may be damaged or deleted.
- Put the card in the card case or the storage bag after use and when storing or carrying the card.
- Do not allow dirt, dust or water to get into the terminals on the back of the card and do not touch the terminals with your fingers.

■ Battery

The battery is a rechargeable lithium ion battery. Its ability to generate power comes from the chemical reaction that takes place inside it. This reaction is susceptible to the surrounding temperature and humidity. If the temperature is too high or too low, the operating time of the battery will become shorter.

If you drop the battery accidentally, check to see if the body of the battery and the terminals are damaged.

- Inserting a damaged battery in the camera will damage the camera.

Bring charged spare batteries when going out.

- Be aware that the operating time of the battery becomes shorter in low temperature conditions such as at a ski resort.
- When you travel, do not forget to bring the battery charger (supplied) so that you can charge the battery in the country that you are travelling in.

Dispose of unusable battery.

- Batteries have a limited life.
- Do not throw batteries into fire because it may cause an explosion.
- Unusable batteries should be discarded in accordance with battery recycling laws. Call the RBRC hotline on 1-800-822-8837 for information.

Do not allow battery terminals to come into contact with metal objects (such as necklaces, hairpins etc.).

- This can cause short circuiting or heat generation and you may be badly burned if you touch a battery.

■ Charger

- If you use the battery charger near a radio, the radio reception may be disturbed. Keep the charger 1 m (3.28 feet) or more away from radios.
- The charger may generate whirring sounds when it is being used. This is not a malfunction.
- After using the charger, be sure to disconnect it from the electrical outlet. (A very small amount of current is consumed if it is left connected.)
- Keep the terminals of the charger and battery clean.

■ When not using the camera for a long period of time

- Store the battery in a cool and dry place with a relatively stable temperature.
[Recommended temperature: 15 °C to 25 °C (59 °F to 77 °F), Recommended humidity: 40% to 60%]
- Always remove the battery and the card from the camera.
- If the battery is left inserted in the camera it will discharge even if the camera is turned off. If the battery continues to be left in the camera, it will discharge excessively and may become unusable even if charged.
- When storing the battery for a long period of time, we recommend charging it once a year. Remove the battery from the camera and store it again after it has completely discharged.
- We recommend storing the camera with a desiccant (silica gel) when you keep it in a closet or a cabinet.
- **If you have not used the camera for a long period of time, check all the parts before taking pictures.**

Message Display

Confirmation messages or error messages will be displayed on the screen in some cases.

The major messages are described below as examples.

[THIS MEMORY CARD IS LOCKED]

The Write-Protect switch on the SD Memory Card or the SDHC Memory Card is slid to the [LOCK] side. Slide it to the other side to unlock it. (P18, 104, 109)

[NO VALID PICTURE TO PLAY]

Record a picture or insert a card with a recorded picture and then play it.

[THIS PICTURE IS PROTECTED]

Delete or overwrite the picture after canceling the protect setting. (P104)

[THIS PICTURE CANNOT BE DELETED]/ [SOME PICTURES CANNOT BE DELETED]

Pictures not based on the DCF standard cannot be deleted. If you want to delete some pictures, format the card after saving necessary data on a PC etc. (P109)

[NO ADDITIONAL DELETE SELECTIONS CAN BE MADE]

You have exceeded the number of pictures that can be set at one time with [MULTI] in [DATE STAMP] or [MULTI DELETE].

Delete the set pictures or stamp the date information on them and then do the operation for any remaining pictures.

More than 999 favorites have been set.

[CANNOT BE SET ON THIS PICTURE]
DPOF print cannot be set for pictures not based on the DCF standard.

[NOT ENOUGH SPACE ON BUILT-IN MEMORY]/[NOT ENOUGH MEMORY ON THE CARD]

There is no space left on the built-in memory or the card.

- When you copy pictures from the built-in memory to the card (batch copy), the pictures are copied until the capacity of the card becomes full.

[SOME PICTURES CANNOT BE COPIED]/[COPY COULD NOT BE COMPLETED]

The following pictures cannot be copied.

- When a picture with the same name as the picture to be copied exists in the copy destination.
- Files not based on the DCF standard.

Moreover, pictures recorded or edited by other equipment may not be copied.

[BUILT-IN MEMORY ERROR FORMAT BUILT-IN MEMORY?]

This message will be displayed when you formatted the built-in memory on a PC. Format the built-in memory on the camera again. (P109) The data on the built-in memory will be deleted.

[MEMORY CARD ERROR FORMAT THIS CARD?]

The card format cannot be recognized by the camera. Format the card again with the camera after saving necessary data on a PC etc. (P109)

[PLEASE TURN CAMERA OFF AND THEN ON AGAIN]

This message appears when the camera is not operating properly. Turn the camera off and on. If the message persists, contact the dealer or your nearest Service Center.

[MEMORY CARD PARAMETER ERROR]

- Use a card compatible with this unit. (P5, 18)
- You can only use an SDHC Memory Card if using cards with 4 GB or more capacity.

[MEMORY CARD ERROR PLEASE CHECK THE CARD]

- An error has occurred accessing the card. Insert the card again.

[READ ERROR PLEASE CHECK THE CARD]

An error has occurred reading the data. Insert the card again. Make sure the card is inserted properly and then play back again.

[WRITE ERROR PLEASE CHECK THE CARD]

An error has occurred writing the data. Turn the camera off and remove the card. Insert the card again and turn the camera on. Make sure the camera is turned off before removing or inserting the card to avoid damage.

[MOTION RECORDING WAS CANCELLED DUE TO THE LIMITATION OF THE WRITING SPEED OF THE CARD]

- When you set the picture quality to [30fpsVGA] or [30fps16:9], we recommend using a High Speed SD Memory Card with "10MB/s" or greater displayed on the package.
- Depending on the type of SD Memory Card or SDHC Memory Card, motion picture recording may stop in the middle.

[A FOLDER CANNOT BE CREATED]









A folder cannot be created because there are no remaining folder numbers that can be used. (P111)

Format the card after saving necessary data on a PC etc. (P109) If you execute [NO.RESET] in the [SETUP] menu after formatting, the folder number is reset to 100. (P24)

**[PICTURE IS DISPLAYED FOR 4:3 TV]/
[PICTURE IS DISPLAYED FOR 16:9 TV]**

- The AV cable is connected to the camera. Press [MENU/SET] if you want to delete this message at once.
- Select [TV ASPECT] in the [SETUP] menu if you want to change the TV aspect. (P25)
- This message also appears when the USB connection cable is connected to the camera only. In this case, connect the other end of the USB connection cable to a PC or a printer. (P110, 113)

[PLEASE RE-CONNECT THE PRINTER.]

This message will be displayed if you change the mode dial to print mode [, , , , , , , , , , , , , , , , , , , , , , , , , , , , , , , , , , , , , , , , , , , , , , , , , , , , , , , , , , , , , , , , , , , , , , , , , , , , , , , , , , , , , , , , , , , , , , , , , , , , , , , , , , , , , , , , , , , , , , , , , , , , , , , , , , , , , , , , , , , , , , , , , , , , , , , , , , , , , , , , , , , , , , , , , , , , , , , , , , , , , , , , , , , , , , , , , , , , , , , , , , , , , , , , , , , , , , , , , , , , , , , , , , , , , , , , , , , , , , , , , , , , , , , , , , , , , , , , , , , , , , , , , , , , , , , , , , , , , , , , , , , , , , , , , , , , , , , , , , , , , , , , , , , , , , , , , , , , , , , , , , , , , , , , , , , , , , , , , , , , , , , , , ,

Troubleshooting

If you return the menu settings to the initial settings at the time of purchase, the condition may improve.

Select **[RESET]** in the **[SETUP]** menu. (P24)

■ Battery and power source

1: The camera cannot be operated even when it is turned on.

- Is the battery inserted correctly?
- Is the battery sufficiently charged?
 - Use a battery that has been sufficiently charged.

2: The LCD monitor turns off while the camera is turned on.

- Does the picture appear on the Viewfinder?
 - Press the [EVF/LCD] button to switch to LCD monitor display.
- Is power save mode (P23) activated?
 - Press the shutter button halfway to cancel these modes.
- Is the battery exhausted?
 - Use a battery that has been sufficiently charged.

3: The camera turns off immediately after it is turned on.

- Is the battery charge insufficient to operate the camera?
 - Use a battery that has been sufficiently charged.
 - Check the time set in power save mode. (P23)
 - If you leave the camera on, the battery will be exhausted. Turn the camera off frequently by using power save mode (P23) etc.
-

■ Recording

1: The picture cannot be recorded.

- Is the mode dial correctly set?
- Is there any memory remaining on the built-in memory or the card?
 - Before recording, delete some pictures. (P36)

2: The recorded picture is whitish. The lens is dirty.

- The picture can become whitish if there is dirt e.g. fingerprints on the lens. If the lens is dirty, turn the camera off, retract the lens barrel (P10) and gently wipe the lens surface with a soft dry cloth.

3: The recorded picture is too bright or dark.

- Check that the exposure is correctly compensated. (P48)

4: 2 or 3 pictures are taken at one time.

- Is auto bracket (P49) or burst mode set? (P51)
- Is the self-timer set to [10S/3PICTURES]? (P47)

5: The subject is not focused properly.

- The focus range varies depending on the recording mode.
 - Rotate the mode dial to set the proper mode for the distance to the subject.
- Is the subject beyond the focus range of the camera? (P28, 54)
- Have you taken a picture with jitter?

6: The recorded picture is blurred. The optical image stabilizer is not effective.

- The shutter speed will become slower and the optical image stabilizer function may not work properly when taking pictures especially in dark places. In this case, we recommend holding the camera firmly with both hands when taking pictures. (P27) We recommend using a tripod and the self-timer (P47) when taking pictures with a slow shutter speed.

7: The recorded picture looks rough.**Noise appears on the picture.**

- Is the ISO sensitivity high or the shutter speed slow?
(ISO sensitivity is set to [AUTO] when the camera is shipped. Therefore, when taking pictures indoors etc. the ISO sensitivity increases.)
– Decrease the ISO sensitivity. (P79)
– Set [NOISE REDUCTION] in [PICT.ADJ.] to [HIGH] or set every item except [NOISE REDUCTION] to [LOW]. (P86)
– Take pictures in bright places.
- In [HIGH SENS.] (P67) in scene mode, the resolution of the recorded picture decreases slightly because of high sensitivity processing.
This is not a malfunction.

8: The brightness or the hue of the recorded picture is different from the actual scene.

- If recording under fluorescent light, the brightness or the hue may change slightly when the shutter speed becomes fast. This occurs due to the characteristics of fluorescent light. It is not a malfunction.

9: A reddish vertical line appears on the LCD monitor when the shutter button is pressed halfway or when recording motion pictures.

- This is a phenomenon called smear. It is a characteristic of CCD and appears when the subject has a bright part. Black or green vertical lines may also appear or uneven colors may appear around the smear. This is not a malfunction. It is recorded in motion pictures but is not recorded on still pictures.

**10: Motion picture recording stops in the middle.**

- Are you using a MultiMediaCard?
– This unit does not support MultiMediaCards.
- When you set the picture quality to [30fpsVGA] or [30fps16:9], we recommend using a High Speed SD Memory Card with "10MB/s" or greater displayed on the package.
- Depending on the type of the card, recording may stop in the middle.

11: When the shutter button is pressed halfway, the image becomes a still image for that instant.

- Is 3-area focusing (High speed) or 1-area focusing (High speed) selected as the AF mode? (P83)

12: The zoom does not move.

- Is [CONVERSION] set to [] or []? (P88)

■ LCD monitor/Viewfinder**1: The LCD monitor/Viewfinder becomes darker or brighter for a moment.**

- This phenomenon appears when you press the shutter button halfway to set the aperture value and does not affect the recorded pictures.

2: The LCD monitor flickers indoors.

- The LCD monitor may flicker for a few seconds after turning the camera on indoors under fluorescent light.
This is not a malfunction.

3: The LCD monitor/Viewfinder is too bright or dark.

- Adjust the brightness of the screen. (P23)
- Is the power LCD function or high angle mode activated?

4: The picture is not displayed on the LCD monitor.

- Does the picture appear on the Viewfinder?
– Press the [EVF/LCD] button to switch to LCD monitor display.

5: Black, red, blue and green dots appear on the LCD monitor.

- These pixels do not affect the recorded pictures.
This is not a malfunction.

6: Noise appears on the LCD monitor.



- In dark places, noise may appear to maintain the brightness of the LCD monitor.
This does not affect the pictures you are recording.

7: Distortion in the LCD monitor.

- When holding the edge of the LCD monitor, there may be some distortion, however this is not a malfunction.
Moreover, this has no effect on the pictures taken or playback.

■ Flash

1: The flash is not activated.

- Is the flash setting set to Forced OFF [?
– Press the [ OPEN] button to open the flash. (P43)
- The flash is not activated when motion picture mode [], [SCENERY] (P63), [NIGHT SCENERY] (P65), [SUNSET] (P67), [HIGH SENS.] (P67), [STARRY SKY] (P67), [FIREWORKS] (P68) or [AERIAL PHOTO] (P69) in scene mode is selected.

2: The flash is activated 2 times.

- When you select red-eye reduction (P43), the flash is activated once before the actual recording to reduce the red-eye phenomenon (eyes of the subject appearing red in the picture) and then activated again for the actual recording.

■ Playback

1: The picture being played back is rotated and displayed in an unexpected direction.

The camera has a function that automatically rotates the display of pictures recorded holding the camera vertically. (If you take pictures when aiming the camera up or down, the camera may recognize that it is being held vertically.)

- You can display the pictures without being rotated when [ROTATE DISP.] (P99) is set to [OFF].
- You can rotate pictures with the [ROTATE] function. (P99)

2: The picture is not played back.

- Is the mode dial set to playback [?
 - Is there a picture on the built-in memory or the card?
The pictures on the built-in memory appears when a card is not inserted. The picture data on the card appears when a card is inserted. (P18)

3: The folder number and the file number are displayed as [—] and the screen turns black.

- Is the picture edited with a PC or recorded with a digital camera from another manufacturer?
This may also happen if the battery is removed immediately after recording or if recording with a exhausted battery.
– Format the data to delete the pictures mentioned above. (P109) (Formatting irretrievably deletes all data including the other pictures. Check the data carefully before formatting.)

4: The picture is displayed with a date different from the actual recording date in calendar playback.

- Was the picture edited with a PC or recorded with a digital camera from another manufacturer?
This kind of picture may be displayed with a date different from the actual recording date in calendar playback. (P92)

- Did you record the pictures after setting the clock correctly on this unit? (P19)
For example, if the clock setting on the camera is different from the date and time set on the PC and you acquire pictures recorded with the camera to the PC and then write them back to the card, the pictures may be displayed with dates different from the actual recording dates in calendar playback etc.

■ TV, PC and printer

1: The picture does not appear on the television.

- Is the camera connected to the TV correctly?
- Set the TV input to external input mode.

2: The display areas on the TV screen and the camera's LCD monitor are different.

Depending on the TV model, the area display may be smaller so the picture may be stretched horizontally or vertically and the top and bottom or left and right of the picture may be cut off when it is displayed. This is due to the TV specifications and is not a malfunction.

3: The motion pictures cannot be played back on a TV.

- Are you trying to play back the motion pictures by directly inserting the card in the card slot of the TV?
– Connect the camera to the TV with the AV cable (supplied) and then play back the pictures on the camera.

4: The picture is not displayed fully on the TV.

- Set the aspect of the TV on the camera. (P25)

5: The picture cannot be transferred when the camera is connected to a PC.

- Is the camera connected to the PC correctly?
- Is the camera recognized by the PC correctly?
- Set the camera to a mode other than [] mode. (P110)

6: The card is not recognized by the PC. (The built-in memory is recognized.)

- Disconnect the USB connection cable.
Connect it again while the card is inserted in the camera.

7: The picture cannot be printed when the camera is connected to a printer.



- Does the printer support PictBridge?
– You cannot print pictures with printers which do not support PictBridge. (P113)
- Reset the mode to []. (P113)

8: The ends of the pictures are cut at printing.

- When using a printer with a trimming or borderless printing function, cancel this function before printing. (For details, refer to the operating instructions for the printer.)
- When you order photo studios to print pictures, ask the photo studio if the pictures can be printed with both ends.

■ Others

1: An unreadable language was selected by mistake.

- Press [MENU/SET], select the [SETUP] menu icon [] and then select the [] icon to set the desired language. (P25)

2: The camera will make sounds caused by internal mechanical movement when it is shaken.

- The sound arises when the lens moves.
This is not a malfunction.

3: The setting for the auto review function is disabled.

- Are you taking pictures using auto bracket (P49)? Is the camera in burst mode (P51) or motion picture mode [] (P70)? Is [AUDIO REC.] set to [ON] (P82)?
– In these cases, you cannot set the auto review function in the [SETUP] menu.

4: A red lamp sometimes turns on when the shutter button is pressed halfway.

- In dark places, the AF assist lamp (P85) lights red to make it easier to focus on a subject.

5: The AF assist lamp does not turn on.

- Is [AF ASSIST LAMP] on the [REC] mode menu set to [ON]? (P85)
- Are you taking pictures in dark places?
– The AF assist lamp does not turn on in bright places.
- The AF assist lamp does not turn on when [SCENERY] (P63), [PANNING] (P64), [NIGHT SCENERY] (P65), [SUNSET] (P67), [FIREWORKS] (P68) or [AERIAL PHOTO] (P69) in scene mode is selected.

6: The camera becomes warm.

- The surface of the camera may become warm during use. This does not affect the performance or quality of the camera.

7: The lens clicks.

- When the brightness changes due to zoom or camera movement etc., the lens may click and the picture on the screen may drastically change. However, the picture is not affected. The sound is caused by the automatic adjustment of the aperture. This is not a malfunction.

8: The clock is reset.

- If you do not use the camera for a long time, the clock may be reset. When the message [PLEASE SET THE CLOCK] appears, set the clock again. (P19)
- When you take a picture before setting the clock, [0:00 0. 0. 0] is recorded.

9: The displayed picture is slightly distorted.

- Depending on the zoom magnification, the recorded picture is slightly distorted. This is called distortion aberration. The closer you get to the subject to take pictures of in wide angle, the more distorted the picture you take is. However this is not a malfunction.

10: Colors appear on the picture which were not found in the actual scene.

- Depending on the zoom magnification, the picture may have some colored fringes around the subject. This is called chromatic aberration and may be more visible when recording distant subjects. However this is not a malfunction.

11: The file numbers are not recorded consecutively.

- When you perform an operation after taking a certain action, the pictures may be recorded in folders with different numbers from the ones used prior to the operation. (P111)

12: The file numbers are recorded in ascending order.

- If the battery is inserted or removed when the camera is not turned off, the recorded folder numbers are lost. However if you turn the camera on again and record pictures, the recorded folder numbers are different from the prior recorded folder numbers.





13: The picture is displayed in black.





- Pictures edited or rotated with a PC may be displayed in black in playback mode (P36), multi playback (P91) and calendar playback (P92).





Number of recordable pictures and available recording time





- The number of recordable pictures and the available recording time are an approximation. (These vary depending on the recording conditions and the type of card.)
- The number of recordable pictures and the available recording time varies depending on the subjects.
- The numbers inside the thick black line are the number of recordable pictures in simple mode [♥]. (P30)

■ Number of recordable pictures

Aspect ratio		4:3				
Picture size		7M /  (7M): (3072×2304 pixels)			5M (5M EZ): (2560×1920 pixels)	
Quality		RAW				
Built-in Memory (Approx. 27 MB)		1	7	14	10	21
Card	16 MB	0	3	7	5	10
	32 MB	1	7	16	11	23
	64 MB	3	16	34	24	48
	128 MB	7	35	69	50	99
	256 MB	14	68	135	98	190
	512 MB	29	135	270	195	380
	1 GB	58	270	540	390	770
	2 GB	115	550	1090	790	1530
4 GB	230	1090	2150	1560	3010	

Aspect ratio		4:3			
Picture size		3M (3M EZ): (2048×1536 pixels)		2M (2M EZ): (1600×1200 pixels)	
Quality					
Built-in Memory (Approx. 27 MB)		16	33	27	53
Card	16 MB	8	16	13	27
	32 MB	18	36	29	58
	64 MB	38	75	61	120
	128 MB	78	150	125	240
	256 MB	150	290	240	470
	512 MB	300	590	480	940
	1 GB	600	1180	970	1880
	2 GB	1220	2360	1920	3610
4 GB	2410	4640	3770	7090	

Aspect ratio		4:3			
Picture size		1M (1M EZ): (1280×960 pixels)		0.3M/0.3M (0.3M EZ): (640×480 pixels)	
Quality					
Built-in Memory (Approx. 27 MB)		41	78	130	210
Card	16 MB	21	40	68	110
	32 MB	45	85	145	230
	64 MB	93	175	290	480
	128 MB	190	350	600	970
	256 MB	370	690	1170	1900
	512 MB	730	1370	2320	3770
	1 GB	1470	2740	4640	7550
	2 GB	2920	5120	8780	12290
4 GB	5740	10050	17240	24130	

Aspect ratio		3:2				
Picture size		6M (6M): (3072×2048 pixels)			2.5M/2.5M (2.5M EZ): (2048×1360 pixels)	
Quality		RAW				
Built-in Memory (Approx. 27 MB)		1	8	16	19	37
Card	16 MB	0	3	8	9	18
	32 MB	1	8	18	20	40
	64 MB	4	19	38	43	83
	128 MB	8	39	78	88	165
	256 MB	16	77	150	170	330
	512 MB	32	150	300	340	650
	1 GB	65	300	600	680	1310
	2 GB	130	620	1220	1360	2560
4 GB	260	1230	2410	2680	5020	

Aspect ratio		16:9				
Picture size		5.5M (5.5M): (3072×1728 pixels)			2M (2M EZ): (1920×1080 pixels)	
Quality		RAW				
Built-in Memory (Approx. 27 MB)		2	9	19	25	48
Card	16 MB	1	4	10	12	25
	32 MB	2	10	21	27	53
	64 MB	4	22	45	57	105
	128 MB	9	46	92	115	220
	256 MB	19	91	180	230	430
	512 MB	38	180	350	450	860
	1 GB	77	360	710	910	1720
	2 GB	155	730	1420	1800	3410
	4 GB	300	1450	2800	3540	6700

■ Available recording time (when recording motion pictures)

Aspect ratio		4:3				16:9	
Picture quality setting		30fps VGA	10fps VGA	30fps QVGA	10fps QVGA	30fps 16:9	10fps 16:9
Built-in Memory (Approx. 27 MB)		—	—	53 s	2 min 40 s	—	—
Card	16 MB	6 s	26 s	26 s	1 min 23 s	5 s	22 s
	32 MB	17 s	59 s	59 s	2 min 55 s	14 s	50 s
	64 MB	39 s	2 min	2 min	6 min	33 s	1 min 46 s
	128 MB	1 min 23 s	4 min 10 s	4 min 10 s	12 min 20 s	1 min 11 s	3 min 35 s
	256 MB	2 min 45 s	8 min 10 s	8 min 10 s	24 min	2 min 20 s	7 min
	512 MB	5 min 30 s	16 min 20 s	16 min 20 s	47 min 50 s	4 min 40 s	14 min
	1 GB	11 min	32 min 50 s	32 min 50 s	1 h 35 min	9 min 20 s	28 min 10 s
	2 GB	22 min 30 s	1 h 7 min	1 h 7 min	3 h 15 min	19 min 20 s	57 min 30 s
	4 GB*	44 min 20 s	2 h 11 min	2 h 11 min	6 h 22 min	38 min	1 h 53 min

* Motion pictures can be recorded continuously up to 2 GB.

The maximum available recording time for up to 2 GB only is displayed on the screen.



- If you set the quality to [RAW], the picture size is fixed to the maximum picture size for each aspect ratio.
- The number of recordable pictures and the available recording time displayed on the LCD monitor/Viewfinder may not decrease in order.
- This unit does not support recording motion pictures on MultiMediaCards.
- The extended optical zoom does not work in [HIGH SENS.] (P67) in scene mode so the picture size for [EZ] is not displayed.

Specifications

Digital Camera: Information for your safety

Power Source:	DC 8.4 V
Power Consumption:	1.6 W (When recording with LCD Monitor) 1.6 W (When recording with Viewfinder) 0.7 W (When playing back with LCD Monitor) 0.7 W (When playing back with Viewfinder)

Camera effective pixels:	7,200,000 pixels
Image sensor:	1/2.5" CCD, total pixel number 7,380,000 pixels Primary color filter
Lens:	Optical 12× zoom, f=6 mm to 72 mm (35 mm film camera equivalent: 36 mm to 432 mm)/F2.8 to F3.3
Digital zoom:	Max. 4×
Extended optical zoom:	(Except for the maximum picture size for each aspect ratio) Max. 18×
Focus:	Normal/AF Macro/Manual focus, Multi-area-focusing/ 3-area-focusing (High speed)/1-area-focusing (High speed)/ 1-area-focusing/Spot-focusing
Focus range:	AF: 30 cm (0.98 feet) (Wide)/2 m (6.56 feet) (Tele) to ∞ AF Macro/MF/Simple: 5 cm (0.16 feet) (Wide)/2 m (6.56 feet) (Tele) to ∞ [However, the focus range is only in Tele.: 1 m (3.28 feet) (Tele) to ∞]
Shutter system:	Electronic shutter+Mechanical shutter
Motion picture recording:	When the aspect ratio setting is [4:3] 640×480 pixels (Only when using a card)/320×240 pixels When the aspect ratio setting is [16:9] 848×480 pixels (Only when using a card) 30 or 10 frames/second with audio.
Burst recording	
Burst speed:	3 pictures/second (High speed), 2 pictures/second (Low speed), Approx. 2 pictures/second (Unlimited)
Number of recordable pictures:	Max. 7 pictures (Standard), max. 5 pictures (Fine), Depends on the remaining capacity of the card (Unlimited). (Performance in burst recording is only with SD Memory Card. MultiMediaCard performance will be less.)
ISO sensitivity:	AUTO/100/200/400/800/1250 [HIGH SENS.] mode: 3200
Shutter speed:	60 seconds to 1/20000th of a second [STARRY SKY] mode: 15 seconds, 30 seconds, 60 seconds Motion picture mode: 1/30th of a second to 1/20000th of a second
White balance:	AUTO/Daylight/Cloudy/Shade/Flash/Halogen/White set1/White set2
Exposure (AE):	Program AE (P)/Aperture-priority AE (A)/ Shutter-priority AE (S)/Manual exposure (M) Exposure compensation (1/3 EV Step, -2 EV to +2 EV)
Metering mode:	Multiple/Center weighted/Spot
LCD monitor:	2.5" low-temperature polycrystalline TFT LCD (Approx. 207,000 pixels) (field of view ratio about 100%)
Viewfinder:	Color LCD Viewfinder (Approx. 188,000 pixels) (field of view ratio about 100%) (with diopter adjustment -4 to +4 diopter)

Flash:	Built-in pop up flash Flash range: (ISO AUTO) Approx. 30 cm (0.98 feet) to 6 m (19.7 feet) (Wide) AUTO, AUTO/Red-eye reduction, Forced ON (Forced ON/ Red-eye reduction), Slow sync./Red-eye reduction, Forced OFF
Microphone:	Monaural
Speaker:	Monaural
Recording media:	Built-in Memory (Approx. 27 MB)/SD Memory Card/ SDHC Memory Card/MultiMediaCard (Still pictures only)
Picture size	
Still picture:	When the aspect ratio setting is [4:3] 3072×2304 pixels, 2560×1920 pixels, 2048×1536 pixels, 1600×1200 pixels, 1280×960 pixels, 640×480 pixels When the aspect ratio setting is [3:2] 3072×2048 pixels, 2048×1360 pixels When the aspect ratio setting is [16:9] 3072×1728 pixels, 1920×1080 pixels
Motion pictures:	When the aspect ratio setting is [4:3] 640×480 pixels (Only when using a card)/320×240 pixels When the aspect ratio setting is [16:9] 848×480 pixels (Only when using a card) Fine/Standard/RAW
Quality:	
Recording file format	
Still Picture:	JPEG (based on Design rule for Camera File system, based on Exif 2.21 standard)/RAW/DPOF corresponding
Picture with audio:	JPEG (based on Design rule for Camera File system, based on Exif 2.21 standard) QuickTime (picture with audio)
Motion pictures:	QuickTime Motion JPEG (motion pictures with audio)
Interface	
Digital:	USB 2.0 (Full Speed)
Analog video/audio:	NTSC/PAL Composite (Switched by menu), Audio line output (monaural)
Terminal	
DIGITAL/AV OUT:	Dedicated jack (8 pin)
DC IN:	Type 3 jack
Dimensions:	Approx. 112.5 mm (W)×72.2 mm (H)×79.0 mm (D) [4 7/16" (W)×2 13/16" (H)×3 1/8" (D)] (excluding the projecting parts)
Mass:	Approx. 310 g/10.9 oz (excluding card and battery), Approx. 357 g/12.6 oz (with card and battery)
Operating temperature:	0 °C to 40 °C (32 °F to 104 °F)
Operating humidity:	10% to 80%
Battery Charger (Panasonic DE-A43B):	Information for your safety









Input:	110 V to 240 V ~ 50/60 Hz, 0.15 A
Output:	CHARGE 8.4 V = 0.43 A

Equipment mobility: Movable

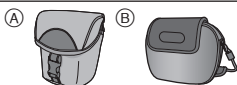
Battery Pack (lithium-ion)
(Panasonic CGR-S006A): Information for your safety

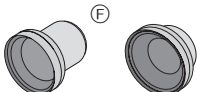
Voltage/capacity:	7.2 V, 710 mAh
--------------------------	----------------

Digital Camera Accessory System

Accessory#	Figure	Description
CGR-S006A		Lithium Ion Battery
DMW-AC7PP		AC Adaptor
(A): DMW-CZS7 (B): DMW-CHFZ8		(A): Soft Case (B): Semi Hard Case
(C): DMW-LMC52 (D): DMW-LND52		(C): MC Protector (D): ND Filter
(E): DMW-LT55 (F): DMW-LW55		(E): Tele Conversion Lens (F): Wide Conversion Lens
DMW-LC55		Close-up Lens
DMW-LA2		Lens Adaptor
RP-SDR04GU1K RP-SDK02GU1A RP-SDR02GU1A RP-SDK01GU1A RP-SDH01GU1A RP-SDR01GU1A RP-SDK512U1A RP-SDR512U1A RP-SDH256U1A RP-SDR256U1A RP-SD128BU1A RP-SD064BPPA		4 GB SDHC Memory Card 2 GB SD Memory Card 2 GB SD Memory Card 1 GB SD Memory Card 1 GB SD Memory Card 1 GB SD Memory Card 512 MB SD Memory Card 512 MB SD Memory Card 256 MB SD Memory Card 256 MB SD Memory Card 128 MB SD Memory Card 64 MB SD Memory Card

- Refer to P16 for information about the battery charging time and the number of recordable pictures.
- NOTE: Accessories and/or model numbers may vary between countries. Consult your local dealer.

Digital Camera Accessory Order Form

(For USA Customers)

Please photocopy this form when placing an order.

1. Digital Camera Model # _____

2. Items Ordered

Accessory #	Description	Price Each	Quantity	Total Price
Subtotal				
Your State & Local Sales Tax				
Shipping & Handling				6.95
Total Enclosed				

3. Method of payment (check one)

- Check of Money Order enclosed (NO C.O.D.SHIPMENTS)
- VISA Credit Card # _____
- MasterCard Expiration Date _____
- Discover Customer Signature _____

Make Check or Money Order to: PANASONIC ACCESSORIES

(Please do not send cash)

4. Shipping information (UPS delivery requires complete street address)

Ship To:

Mr.

Mrs.

Ms.

First _____ Last _____

Phone#:

Day () _____

Street Address _____

Night () _____

City _____ State _____ Zip _____

TO OBTAIN ANY OF OUR DIGITAL CAMERA ACCESSORIES YOU CAN DO ANY OF THE FOLLOWING:

VISIT YOUR LOCAL PANASONIC DEALER

OR

CALL PANASONIC'S ACCESSORY ORDER LINE AT 1-800-332-5368

[6 AM-6 PM M-F, PACIFIC TIME]

OR

MAIL THIS ORDER TO: PANASONIC SERVICE AND TECHNOLOGY COMPANY

ACCESSORY ORDER OFFICE

20421 84th Avenue South Kent, WA. 98032

In CANADA, please contact your local Dealer for more information about accessories.

Request for Service Notice (For USA Only)

Please photocopy this form when making a request for service notice.

In the unlikely event this product needs service.

Request for Service Notice: • Please include your **proof of purchase.**
(Failure to do so will delay your repair.)
(USA Only)

- To further speed your repair, please provide an explanation of what wrong with the unit and any symptom it is exhibiting.
-
-
-
-

Mail this completed form and your Proof of Purchase along with your unit to:
Panasonic Camera and Digital Service Center
1590 Touhy Ave.
Elk Grove Village, IL 60007

Limited Warranty (For USA Only)

PANASONIC CONSUMER ELECTRONICS COMPANY, DIVISION OF
 PANASONIC CORPORATION OF NORTH AMERICA
 One Panasonic Way, Secaucus, New Jersey 07094
 PANASONIC PUERTO RICO, INC.
 Ave. 65 de Infantería, Km. 9.5, San Gabriel Industrial Park, Carolina, Puerto
 Rico 00985

Panasonic Digital Still Camera Limited Warranty

Limited Warranty Coverage

If your product does not work properly because of a defect in materials or workmanship, Panasonic Consumer Electronics Company or Panasonic Puerto Rico, Inc. (collectively referred to as “the warrantor”) will, for the length of the period indicated on the chart below, which starts with the date of original purchase (“warranty period”), at its option either (a) repair your product with new or refurbished parts, or (b) replace it with a new or refurbished product. The decision to repair or replace will be made by the warrantor.

PRODUCT OR PART NAME	PARTS	LABOR
DIGITAL STILL CAMERA (EXCEPT ITEMS LISTED BELOW)	1 (ONE) YEAR	1 (ONE) YEAR
CCD	6 (SIX) MONTHS	90 (NINETY) DAYS
RECHARGEABLE BATTERY PACK (IN EXCHANGE FOR DEFECTIVE BATTERY PACK)	90 (NINETY) DAYS	NOT APPLICABLE
SD MEMORY CARD (IN EXCHANGE FOR DEFECTIVE SD CARD)	90 (NINETY) DAYS	NOT APPLICABLE

During the “Labor” warranty period there will be no charge for labor. During the “Parts” warranty period, there will be no charge for parts. You must carry-in or mail-in your product during the warranty period. If non-rechargeable batteries are included, they are not warranted. This warranty only applies to products purchased and serviced in the United States or Puerto Rico. This warranty is extended only to the original purchaser of a new product which was not sold “as is”. A purchase receipt or other proof of the original purchase date is required for warranty service.

Carry-In or Mail-In Service

For Carry-In or Mail-In Service in the United States call
1-800-272-7033.

For assistance in Puerto Rico call Panasonic Puerto Rico, Inc.
(787)-750-4300 or fax (787)-768-2910.

This warranty **ONLY COVERS** failures due to defects in materials or workmanship, and **DOES NOT COVER** normal wear and tear or cosmetic damage. The warranty **ALSO DOES NOT COVER** damages which occurred in shipment, or failures which are caused by products not supplied by the warrantor, or failures which result from accidents, misuse, abuse, neglect, mishandling, misapplication, alteration, faulty installation, set-up adjustments, misadjustment of consumer controls, improper maintenance, power line surge, lightning damage, modification, or commercial use (such as in a hotel, office, restaurant, or other business), rental use of the product, service by anyone other than a Factory Service Center or other Authorized Servicer, or damage that is attributable to acts of God.

THERE ARE NO EXPRESS WARRANTIES EXCEPT AS LISTED UNDER "LIMITED WARRANTY COVERAGE". THE WARRANTOR IS NOT LIABLE FOR INCIDENTAL OR CONSEQUENTIAL DAMAGES RESULTING FROM THE USE OF THIS PRODUCT, OR ARISING OUT OF ANY BREACH OF THIS WARRANTY. (As examples, this excludes damages for lost time, travel to and from the servicer, loss of media or images, data or other memory content. The items listed are not exclusive, but are for illustration only.) **ALL EXPRESS AND IMPLIED WARRANTIES, INCLUDING THE WARRANTY OF MERCHANTABILITY, ARE LIMITED TO THE PERIOD OF THE LIMITED WARRANTY.**

Some states do not allow the exclusion or limitation of incidental or consequential damages, or limitations on how long an implied warranty lasts, so the exclusions may not apply to you.

This warranty gives you specific legal rights and you may also have other rights which vary from state to state. If a problem with this product develops during or after the warranty period, you may contact your dealer or Service Center. If the problem is not handled to your satisfaction, then write to the warrantor's Consumer Affairs Department at the addresses listed for the warrantor.

PARTS AND SERVICE WHICH ARE NOT COVERED BY THIS LIMITED WARRANTY ARE YOUR RESPONSIBILITY.

Customer Services Directory (For USA Only)

For Product Information, Operating Assistance, Literature Request, Dealer Locations, and all Customer Service inquiries please contact:
1-800-272-7033, Monday-Friday 8:30am-8pm EST.

Web Site: <http://www.panasonic.com/consumersupport>
 You can purchase parts, accessories or locate your nearest Service Center by visiting our Web Site.

Accessory Purchases

Purchase Parts, Accessories and Instruction Books online for all Panasonic Products by visiting our Web Site at:

<http://www.pasc.panasonic.com>

or, send your request by E-mail to:

npcparts@us.panasonic.com

You may also contact us directly at:

1-800-332-5368 (Phone) 1-800-237-9080 (Fax Only)

(Monday - Friday 9 am to 9 pm, EST.)

PANASONIC SERVICE AND TECHNOLOGY COMPANY

20421 84th Avenue South, Kent, WA 98032

(We Accept Visa, MasterCard, Discover Card, American Express, and Personal Checks)

Product Repairs

Centralized Factory Service Center

Panasonic Camera and Digital Service Center

1590 Touhy Ave.

MAIL TO : Elk Grove Village, IL 60007

Please carefully pack and ship, prepaid and insured, to the Elk Grove Village Centralized Factory Service Center.

Customer's in Puerto Rico, please ship or carry in to location below ("Service in Puerto Rico").

Service in Puerto Rico

Panasonic Puerto Rico, Inc.:

*Ave. 65 de Infantería, Km. 9.5, San Gabriel Industrial Park,
 Carolina, Puerto Rico 00985*

Phone (787) 750-4300 Fax (787) 768-2910

As of January 2007

Précautions à prendre

(pour le Canada)

AVERTISSEMENT :

POUR RÉDUIRE LES RISQUES D'INCENDIE, DE CHOC ÉLECTRIQUE OU DE DOMMAGES À L'APPAREIL,

• N'EXPOSEZ PAS CET APPAREIL À LA PLUIE, À L'HUMIDITÉ, À L'ÉGOUTTEMENT OU AUX ÉCLABOUSSEMENTS, ET NE PLACEZ SUR L'APPAREIL AUCUN OBJET REMPLI DE LIQUIDE, COMME PAR EXEMPLE DES VASES.

• UTILISEZ EXCLUSIVEMENT LES ACCESSOIRES RECOMMANDÉS.

• NE RETIREZ PAS LE COUVERCLE (OU LE PANNEAU ARRIÈRE) ; IL N'Y A AUCUNE PIÈCE RÉPARABLE PAR L'UTILISATEUR À L'INTÉRIEUR. CONFIEZ TOUTE RÉPARATION À UN TECHNICIEN DE SERVICE QUALIFIÉ.

LA PRISE DE COURANT DOIT SE TROUVER À PROXIMITÉ DE L'APPAREIL ET ÊTRE FACILEMENT ACCESSIBLE.

ATTENTION

Danger d'explosion si la batterie/pile n'est pas remplacée correctement. Remplacez-la uniquement par une batterie/pile identique ou du même type recommandée par le fabricant. Suivez les instructions du fabricant pour jeter les batteries usées.

Avertissement

Risque d'incendie, d'explosion et de brûlures. Ne pas démonter, chauffer à plus de 60 °C (140 °F) ou incinérer.

La plaque signalétique se trouve sur le dessous de l'appareil.

- Assurez-vous d'utiliser un adaptateur secteur de marque Panasonic (DMW-AC7PP; en option).
- Assurez-vous d'utiliser une batterie de marque Panasonic (CGA-S006A).
- Si vous utilisez d'autres batteries, nous ne pouvons pas garantir la qualité de ce produit.
- N'utilisez pas d'autres câbles de connexion USB à l'exception de celui fourni.
- N'utilisez pas d'autres câbles AV à l'exception de celui fourni.
- Conservez la carte mémoire hors de portée des enfants afin qu'ils ne puissent pas l'avaler.

Évitez d'approcher l'appareil photo de tout équipement magnétisé (four à micro-ondes, téléviseur, équipement de jeux vidéo, etc.).

- Si vous utilisez l'appareil photo à proximité d'un téléviseur, les radiations électromagnétiques pourraient nuire au son et à l'image.
- N'utilisez pas l'appareil photo à proximité d'un téléphone cellulaire; cela pourrait entraîner un bruit nuisible à l'image et au son.
- Le puissant champ magnétique de haut-parleurs ou de moteurs peut endommager les données enregistrées sur support magnétique et distordre les images.
- Les ondes électromagnétiques émises par un microprocesseur peuvent nuire à l'appareil photo numérique et perturber l'image et le son.
- Advenant le cas où le fonctionnement de l'appareil serait dérangé par un champ magnétique, coupez le contact, retirez la batterie ou débranchez l'adaptateur secteur (modèle DMW-AC7PP; en option) pour ensuite soit remettre la batterie en place, soit rebranché l'adaptateur. Remettez l'appareil en marche.

N'utilisez pas l'appareil photo à proximité d'un émetteur radio ou de lignes à haute tension.

- L'utilisation de l'appareil photo à proximité d'un émetteur radio ou de lignes à haute tension pourrait nuire à l'image ou au son.

■ **À propos du bloc-batterie**

ATTENTION

Batterie (batterie au lithium-ion)

- Utilisez l'unité spécifiée pour recharger la batterie.
- N'utilisez la batterie avec aucun autre appareil que l'appareil spécifiée.
- Évitez le contact des saletés, du sable, du liquide ou autres corps étrangers avec les bornes.
- Ne touchez pas les bornes des fiches (+ et -) avec des objets métalliques.
- Évitez de démonter, remodeler, chauffer ou jeter au feu.

Si de l'électrolyte entre en contact avec vos mains ou vos vêtements, lavez-les avec beaucoup d'eau.

Si de l'électrolyte pénètre dans vos yeux, ne les frottez pas.

Rincez-vous les yeux avec beaucoup d'eau, puis consultez un médecin.

■ **À propos du chargeur de batterie**

ATTENTION!

NE PAS INSTALLER CET APPAREIL DANS UNE BIBLIOTHÈQUE, UNE ARMOIRE OU TOUT AUTRE ESPACE CONFINÉ. S'ASSURER QUE LA VENTILATION DE L'APPAREIL EST ADÉQUATE. AFIN D'ÉVITER TOUT RISQUE DE CHOC ÉLECTRIQUE OU D'INCENDIE DÛ À UN SURCHAUFFEMENT, S'ASSURER QUE RIDEAUX OU TOUT OBJET QUELCONQUE NE BOUCHENT LES ÉVÉNEMENTS D'AÉRATION DE L'APPAREIL.

Index

A

AC Adaptor	110, 113
Adjusting Flash Output	46
Aerial Photo Mode	69
AF Area Selection	84
AF Assist Lamp	85
AF Mode	83
AF Operation Sound	24
AF/AE Lock	28
Aperture-priority AE	56, 58
Aspect Ratio	80
Aspect Ratio Conversion	107
Audio Dubbing	105
Audio Recording	70, 82
Auto Bracket	49
Auto Review	22
Auto White Balance	77
Available Recording Time	133

B

Baby Mode	66
Backlight Compensation	31
Battery	17
Beach Mode	69
Brightness of the LCD Monitor/ Viewfinder	23
Built-in Flash	43
Built-in Memory	18
Burst Mode	51

C

Calendar Playback	92
Candle Light Mode	65
Card	17
Center Weighted	82
Changing the Zoom Area	61
Charger	123
Charging	16
Clock Set	19, 22, 90
Close-up Lens	13, 88, 118
Color	28
Color Effect	85
Condensation	5
Continuous AF	84
Conversion Lens	88
Copy	108
Creating still pictures from a motion picture	95

D

Date Printing	103, 115, 116
Date Stamp	100
Deleting Picture	36
Dial Display	25
Digital Zoom	34
Dioptr Adjustment	39
DPOF Print Setting	102

E

Exposure	28
Exposure Compensation	48
Extended Optical Zoom	33
EZ	33, 80

F

File Number	111, 121
Fine	81
Fireworks Mode	68
Flip Animation	86
Focus	28
Folder Composition	111
Folder Number	111, 121
Food Mode	65
Formatting	109

G

Guide Line	23, 40
------------------	--------

H

High Angle Mode	41
High Sensitivity Mode	67
Histogram	40
Hood Adaptor	12

I

Intelligent ISO Sensitivity Mode	52
ISO Sensitivity	79

J

Jitter	29
Jitter/Movement Detection Demonstration	50

L

Language Setting	25
Layout	115
LCD Monitor	119
LCD Monitor/Viewfinder	38
Lens Cap	11
Lens Hood	12

M	
Macro Mode	54
MANUAL	98
Manual Exposure	57, 58
Manual Exposure Assistance	57
Manual Focus	59
MC Protector	118
Metering Mode	82
MF Assist	24, 60
MF m/ft	25
Monitor Priority	23, 40
Motion Picture Mode	70
Multi Playback	91
Multiple	82

N	
ND Filter	118
Night Portrait Mode	64
Night Scenery Mode	65
NO.RESET	24
NTSC	25
Number of Prints	103, 115
Number of Recordable Pictures	16, 131

O	
Operational Sound	24
Optical Image Stabilizer	50
Optical Zoom	32
Out-of-frame Display	39

P	
PAL	25
Panning Mode	64
Paper Size	115
Party Mode	65
PC	110
Pet Mode	67
PictBridge	113
Picture Adjustment	86
Picture Quality Setting (Motion Picture Mode)	70
Picture Quality Setting (Simple Mode)	30
Picture Size	80
Pictures with Audio	94
Playback Pictures on TV	117
Playback Zoom	93
Playing Back Motion Pictures	94
Portrait Mode	63
Power LCD	41
Power Save	23
Prefocus	61
Print Mode	113
Protect	104

Q	
Quality	80

R	
RAW	81
Reset of Setting	24
Resizing	105
Review	35
Rotate	99
Rotate Display	99

S	
Scene Menu	25
Scene Mode	62
Scenery Mode	63
Self-timer	47
Setting Favorites	99
Setup Menu	22
Shutter sound	24
Shutter-priority AE	56, 58
Simple Mode	30
Slide Show	97
Snow Mode	69
Soft Skin Mode	63
Sports Mode	63
Spot	82
Standard	81
Starry Sky Mode	67
Strap	11
Sunset Mode	67

T	
Tele-macro Function	54
Travel Date	23, 72
Trimming	106
TV Aspect	25

U	
USB Connection Cable	110, 113

V	
Video Output	25, 117
Volume of Speakers	24

W	
White Balance	77
White Balance Fine Adjustment	78
White Set	77
World Time	23, 74

Z	
Zoom Resume	23

MEMO



QuickTime and the QuickTime logo are trademarks or registered trademarks of Apple Computer, Inc., used under license therefrom.

**Panasonic Consumer Electronics Company,
Division of Panasonic Corporation of North America**

One Panasonic Way, Secaucus, NJ 07094

Panasonic Puerto Rico, Inc.

Ave. 65 de Infantería, Km. 9.5, San Gabriel Industrial Park, Carolina, Puerto Rico 00985

Panasonic Canada Inc.

5770 Ambler Drive, Mississauga, Ontario, L4W 2T3

© 2007 Matsushita Electric Industrial Co., Ltd.



VQT1B25

F1206Hd0 (20000 Ⓐ)

