

# Panasonic®

## Basic Owner's Manual Digital Camera

Model No. **DMC-LX10**

**LUMIX**

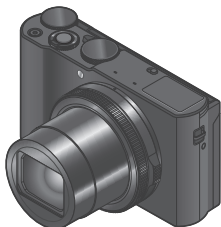

Please read these instructions carefully before using this product, and save this manual for future use.

More detailed owner's manual is available in "Owner's Manual for advanced features (PDF format)". To read it, download it from the website. (→53)

Register online at <http://shop.panasonic.com/support> (U.S. customers only)

If you have any questions, visit:

USA : <http://shop.panasonic.com/support>

Canada : [www.panasonic.ca/english/support](http://www.panasonic.ca/english/support)



SQT1380  
M0916KZ0

**Dear Customer,  
Thank you for choosing Panasonic!**

You have purchased one of the most sophisticated and reliable products on the market today. Used properly, we're sure it will bring you and your family years of enjoyment. Please take time to fill in the information below. The serial number is on the tag located on the underside of your camera. Be sure to **retain this manual** as your convenient camera information source.

|                       |                  |
|-----------------------|------------------|
| Date of Purchase      | Dealer Phone No. |
| Dealer Purchased From | Model No.        |
| Dealer Address        | Serial No.       |

Please note that the actual controls and components, menu items, etc. of your Digital Camera may look somewhat different from those shown in the illustrations in this Owner's Manual.

**Carefully observe copyright laws.**

- Recording of pre-recorded tapes or discs or other published or broadcast material for purposes other than your own private use may infringe copyright laws. Even for the purpose of private use, recording of certain material may be restricted.

**For the U.S.A. and Canada only**



A lithium ion battery that is recyclable powers the product you have purchased. Please call 1-800-8-BATTERY for information on how to recycle this battery.

## Information for Your Safety

### **WARNING:**

To reduce the risk of fire, electric shock or product damage,

- Do not expose this unit to rain, moisture, dripping or splashing.
- Use only the recommended accessories.
- Do not remove covers.
- Do not repair this unit by yourself. Refer servicing to qualified service personnel.

The socket outlet shall be installed near the equipment and shall be easily accessible.

### ■ Product identification marking

| Product        | Location |
|----------------|----------|
| Digital camera | Bottom   |

## THE FOLLOWING APPLIES ONLY IN THE U.S.A.

### **Certification and Compliance**

See Camera for the certification and compliance mark specific to that device.

- 1 Select [Wi-Fi] in the [Setup] menu**
- 2 Select [Wi-Fi Setup] in the [Wi-Fi]**
- 3 Press ▲ ▼ to select [Approved Regulations], and press [MENU/SET]**

Contains FCC ID : VPYLBXN604

This transmitter must not be co-located or operated in conjunction with any other antenna or transmitter.

This equipment complies with FCC radiation exposure limits set forth for an uncontrolled environment and meets the FCC radio frequency (RF) Exposure Guidelines in Supplement C to OET65.

This equipment has very low levels of RF energy that are deemed to comply without testing of specific absorption ratio (SAR).



## THE FOLLOWING APPLIES ONLY IN THE U.S.A.

### **FCC Note:**

This equipment has been tested and found to comply with the limits for a Class B digital device, pursuant to Part 15 of the FCC Rules. These limits are designed to provide reasonable protection against harmful interference in a residential installation. This equipment generates, uses, and can radiate radio frequency energy and, if not installed and used in accordance with the instructions, may cause harmful interference to radio communications. However, there is no guarantee that interference will not occur in a particular installation. If this equipment does cause harmful interference to radio or television reception, which can be determined by turning the equipment off and on, the user is encouraged to try to correct the interference by one or more of the following measures:

- Reorient or relocate the receiving antenna.
- Increase the separation between the equipment and receiver.
- Connect the equipment into an outlet on a circuit different from that to which the receiver is connected.
- Consult the dealer or an experienced radio/TV technician for help.

**FCC Caution:** To assure continued compliance, follow the attached installation instructions and use only shielded interface cables with ferrite core when connecting to computer or peripheral devices.

Any changes or modifications not expressly approved by the party responsible for compliance could void the user's authority to operate this equipment.

This device complies with Part 15 of the FCC Rules. Operation is subject to the following two conditions: (1) This device may not cause harmful interference, and (2) this device must accept any interference received, including interference that may cause undesired operation.

### **Declaration of Conformity**

**Trade Name:** Panasonic

**Model No.:** DMC-LX10

Responsible Party: Panasonic Corporation of North America  
Two Riverfront Plaza, Newark, NJ 07102-5490

Support Contact: <http://shop.panasonic.com/support>

## THE FOLLOWING APPLIES ONLY IN CANADA.

### **Certification and Compliance**

See Camera for the certification and compliance mark specific to that device.

- 1 Select [Wi-Fi] in the [Setup] menu**
- 2 Select [Wi-Fi Setup] in the [Wi-Fi]**
- 3 Press ▲ ▼ to select [Approved Regulations], and press [MENU/SET]**

CAN ICES-3(B)/NMB-3(B)

Contains IC : 772C-LBXN604

This device complies with Industry Canada's licence-exempt RSSs. Operation is subject to the following two conditions:

- (1) this device may not cause interference, and
- (2) this device must accept any interference, including interference that may cause undesired operation of the device.

This equipment complies with IC radiation exposure limits set forth for an uncontrolled environment and meets RSS-102 of the IC radio frequency (RF) Exposure rules. This equipment has very low levels of RF energy that are deemed to comply without testing of specific absorption ratio (SAR).

## ■ About the AC adaptor (supplied)

### **CAUTION!**

To reduce the risk of fire, electric shock or product damage,

- Do not install or place this unit in a bookcase, built-in cabinet or in another confined space. Ensure this unit is well ventilated.

### **AC adaptor**

This AC adaptor operates on AC between 110V and 240V.

But

- In the U.S.A. and Canada, the AC adaptor must be connected to a 120V AC power supply only.
- When connecting to an AC supply outside of the U.S.A. or Canada, use a plug adaptor to suit the AC outlet configuration.

## ■ About the battery pack

### **CAUTION**

Battery pack (Lithium ion battery pack)

- Use the specified unit to recharge the battery pack.
- Do not use the battery pack with equipment other than the specified unit.
- Do not get dirt, sand, liquids, or other foreign matter on the terminals.
- Do not touch the plug terminals (+ and -) with metal objects.
- Do not disassemble, remodel, heat or throw into fire.

If any electrolyte should come into contact with your hands or clothes, wash it off thoroughly with water.

If any electrolyte should come into contact with your eyes, never rub the eyes. Rinse eyes thoroughly with water, and then consult a doctor.

### **CAUTION**

- Danger of explosion if battery is incorrectly replaced. Replace only with the type recommended by the manufacturer.
- When disposing of the batteries, please contact your local authorities or dealer and ask for the correct method of disposal.

- Do not heat or expose to flame.
- Do not leave the battery(ies) in a car exposed to direct sunlight for a long period of time with doors and windows closed.

### **Warning**

Risk of fire, explosion and burns. Do not disassemble, heat above 60 °C (140 °F) or incinerate.



## ■ Cautions for Use

- Do not use any other USB connection cables except the supplied one.
- Use a “High Speed HDMI micro cable” with the HDMI logo. Cables that do not comply with the HDMI standards will not work.  
“High Speed HDMI micro cable” (Type D-Type A plug, up to 2 m (6.6 feet) long)

### **Keep this unit as far away as possible from electromagnetic equipment (such as microwave ovens, TVs, video games etc.).**

- If you use this unit on top of or near a TV, the pictures and/or sound on this unit may be disrupted by electromagnetic wave radiation.
- Do not use this unit near cell phones because doing so may result in noise adversely affecting the pictures and/or sound.
- Recorded data may be damaged, or pictures may be distorted, by strong magnetic fields created by speakers or large motors.
- Electromagnetic wave radiation may adversely affect this unit, disturbing the pictures and/or sound.
- If this unit is adversely affected by electromagnetic equipment and stops functioning properly, turn this unit off and remove the battery or disconnect AC adaptor (supplied)/AC adaptor (DMW-AC10PP: optional). Then reinsert the battery or reconnect AC adaptor and turn this unit on.

### **Do not use this unit near radio transmitters or high-voltage lines.**

- If you record near radio transmitters or high-voltage lines, the recorded pictures and/or sound may be adversely affected.

# Contents

|                                     |   |
|-------------------------------------|---|
| ■ Information for Your Safety ..... | 3 |
|-------------------------------------|---|

## Preparations

|   |    |
|---|----|
| ■ Before use .....  | 11 |
| ■ Standard accessories .....  | 12 |
| ■ Names and Functions of Main Parts .....                               | 13 |
| ■ Inserting and removing the battery or SD memory card (optional) ..... | 15 |
| ■ Charging the battery .....  | 16 |
| ■ Setting the clock .....   | 18 |

## Basics

|                          |    |
|--------------------------|----|
| ■ Basic operations ..... | 19 |
| ■ Setting the menu ..... | 26 |

## Recording

|   |    |
|---|----|
| ■ Taking pictures with automatic settings (Intelligent Auto Mode) .....             | 27 |
| ■ [Self Shot] .....   | 28 |
| ■ Recording 4K photos .....   | 29 |
| ■ [Post Focus] / [Focus Stacking] .....   | 33 |
| ■ Taking Pictures While Adjusting a Setting Automatically (Bracket Recording) ..... | 36 |
| ■ Recording Motion Picture/ 4K Motion Picture .....                                 | 37 |
| ■ [4K Live Cropping] .....  | 39 |

## Playback

|                               |    |
|-------------------------------|----|
| ■ Viewing your pictures ..... | 41 |
| ■ [Light Composition] .....   | 42 |

## Menu

|                   |    |
|-------------------|----|
| ■ Menu list ..... | 44 |
|-------------------|----|

## Wi-Fi

|   |    |
|---|----|
| ■ What you can do with the Wi-Fi® function .....              | 47 |
| ■ Operating the camera by connecting it to a smartphone ..... | 48 |



## Others

|   |    |
|---|----|
| ■ Downloading software .....                    | 51 |
| ■ Reading the Owner's Manual (PDF format) ..... | 53 |
| ■ List of monitor displays .....                | 54 |
| ■ Q&A Troubleshooting .....                     | 57 |
| ■ Specifications .....                          | 59 |
| ■ Digital Camera Accessory System .....         | 63 |
| ■ Limited Warranty (ONLY FOR U.S.A.) .....      | 64 |
| ■ Limited Warranty (ONLY FOR CANADA) .....      | 68 |

## ■ About the symbols in the text

**MENU** Indicates that the menu can be set by pressing [MENU/SET] button.

In this Owner's Manual, steps for setting a menu item are described as follows:

**MENU** →  [Rec] → [Quality] → []

## Before use

### ■ Camera handling

- Keep the camera away from excessive vibration, force, or pressure.
- The camera is not dust resistant, splash resistant, or waterproof.  
Avoid using the camera in places with excessive dust or sand, or where water can come into contact with the camera.
- Do not allow camera to come into contact with pesticides or volatile substances (can cause surface damage or coating to peel).

### ■ Condensation (When the lens or the monitor is fogged up)



- Condensation may occur when the camera is exposed to sudden changes of temperature or humidity. Avoid these conditions, which may make the lens or monitor dirty, cause mold, or damage the camera.
- If condensation does occur, turn off the camera and wait about two hours before using it. Once the camera adjusts to the surrounding temperature, the fogging will clear naturally.

### ■ Caring for your camera

- To clean your camera, remove the battery, the DC coupler (DMW-DCC15A: optional) or a card, or disconnect the power plug from the outlet, and wipe with a soft, dry cloth.
- Do not press the monitor with excessive force.
- Do not press the lens with excessive force.
- Do not keep rubber or plastic products in contact with the camera for a long period of time.
- Do not use solvents such as benzene, thinner, alcohol, kitchen detergents, etc., to clean the camera, since it may deteriorate the external case or the coating may peel off.
- Do not leave the camera with the lens facing the sun, as rays of light from the sun may cause it to malfunction.
- Do not extend the supplied cord or cable.
- While the camera is accessing the card (for an operation such as picture writing, reading, deletion, or formatting), do not turn off the camera or remove the battery, card, AC adaptor (DMW-AC10PP: optional) or DC coupler (DMW-DCC15A: optional).
- The data on the card may be damaged or lost due to electromagnetic waves, static electricity or breakdown of the camera or the card. We recommend storing important data on a PC etc.
- Do not format the card on your PC or other equipment. Format it on the camera only to ensure proper operation.

## Standard accessories

Check that all the accessories are supplied before using the camera. Part numbers are as of October 2016. These may be subject to change.

|  |  |
|--|--|
| <input type="checkbox"/> <b>Battery pack</b><br>DMW-BLH7PP <ul style="list-style-type: none"> <li>• Charge the battery before use.</li> <li>• Battery pack is indicated as battery pack or battery in the text.</li> </ul> | <input type="checkbox"/> <b>Hand strap</b><br>VFC4297                 |
| <input type="checkbox"/> <b>AC adaptor</b><br>SAE0012A    | <input type="checkbox"/> <b>USB connection cable</b><br>K1HY04YY0106  |

- **Cards are optional.** (SD Memory Card, SDHC Memory Card and SDXC Memory Card are indicated as card in the text.)
  - This unit is compatible with UHS-I UHS Speed Class 3 standard SDHC/SDXC memory cards.
  - The following SD standard-based cards can be used.  
 SD Memory Card (512 MB to 2 GB)/SDHC Memory Card (4 GB to 32 GB)/SDXC Memory Card (48 GB to 128 GB)
  - Depending on recording conditions, the required card differs.

### (For U.S.A. only)

- If accessories are lost, customers can visit us at <http://shop.panasonic.com/support> for further information about obtaining replacement parts.

### (For Canada only)



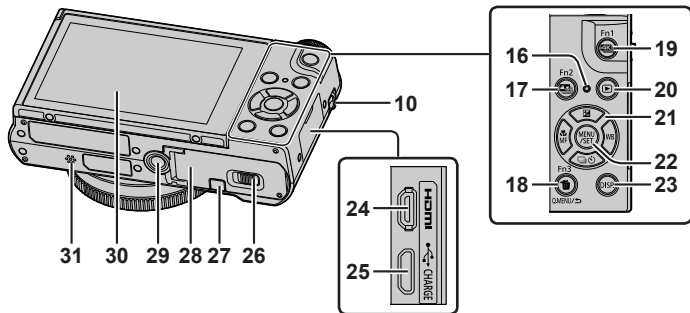
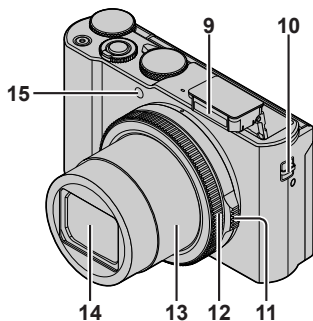
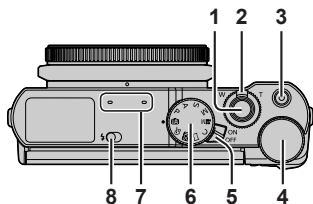

- If any accessories are lost, customers in Canada should visit our support page at [www.panasonic.ca/english/support](http://www.panasonic.ca/english/support) for further information about obtaining replacement parts.
- Please dispose of all packaging appropriately.
- The illustrations and screens in this manual may differ from the actual product.

# Names and Functions of Main Parts



## Preparations

---

- 1 Shutter button (→20)
  - 2 Zoom lever (→19)
  - 3 Motion picture button (→37)
  - 4 Rear dial (→24)
  - 5 Camera [ON/OFF] switch
  - 6 Mode dial (→21)
  - 7 Stereo microphone
  - 8 Flash open lever
  - 9 Flash
  - 10 Strap eyelet
    - To prevent dropping, be sure to attach the supplied strap and fit it to your wrist.
  - 11 Aperture ring (→24)
  - 12 Control ring (→24)
  - 13 Lens barrel
  - 14 Lens
  - 15 Self-timer indicator/AF Assist Lamp
  - 16 Charging lamp (→16)/  
Wi-Fi® connection lamp
  - 17  ([Post Focus]) button (→33)/  
[Fn2] button
  - 18 [Q.MENU/↵] (Cancel) button/  
 (Delete) button (→41)/  
[Fn3] button
    - You can easily call some of the menu items and set them during recording.
  - 19  (4K photo mode) button (→29)/  
[Fn1] button
  - 20  (Playback) button (→41)
  - 21 Cursor button (→22)
  - 22 [MENU/SET] button
  - 23 [DISP.] button
    - Use this to change display.
  - 24 [HDMI] socket
  - 25 [USB/CHARGE] socket (→16)
  - 26 Release lever (→15)
  - 27 DC coupler cover (→63)
  - 28 Card/Battery door (→15)
  - 29 Tripod mount
    - Do not attach this unit to tripods that have screws with a length of 5.5 mm (0.22 inch) or more. Doing so may damage this unit or the unit may not be secured properly on the tripod.
  - 30 Touch screen (→25)/monitor (→54)
  - 31 Speaker
- Always use a genuine Panasonic AC adaptor (DMW-AC10PP: optional). (→63)  
When using an AC adaptor (DMW-AC10PP: optional), ensure that the Panasonic DC coupler (DMW-DCC15A: optional) and AC adaptor (DMW-AC10PP: optional) are used. The optional DC coupler (DMW-DCC15) cannot be used.
  - [Fn4] to [Fn8] (→22) are touch icons. They are displayed by touching the  tab on the recording screen.

## Inserting and removing the battery or SD memory card (optional)

Make sure that the camera is turned off.

**1 Slide the release lever (A) to the [OPEN] position and open the card/battery door**

**2 Insert the battery and card, making sure that their orientation is correct**

- Battery: Insert the battery all the way firmly and check that it is locked by lever (B).
- Card: Insert the card all the way firmly until it clicks. Do not touch the terminals on the back of the card.

**3 Close the door**

Slide the release lever to the [LOCK] position.

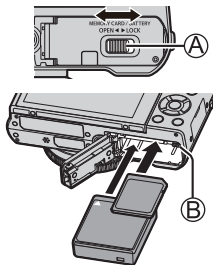

### ■ To remove

#### • To remove battery:

Move lever (B) in direction of arrow.

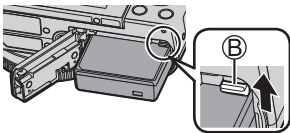

#### • To remove card:

Push the card until it clicks, then pull the card out.

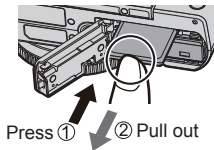

- Always use genuine Panasonic batteries (DMW-BLH7PP).
- If you use other batteries, we cannot guarantee the quality of this product.
- Keep the Memory Card out of reach of children to prevent swallowing.

## Charging the battery

- The battery that can be used with this unit is **DMW-BLH7PP**.
- The battery is not charged when the camera is shipped. Charge the battery before use.
- We recommend charging in a location where the ambient temperature is between 10 °C and 30 °C (50 °F to 86 °F).

Insert the battery into the camera.  
Make sure that the camera is turned off.

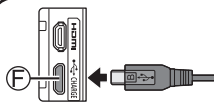
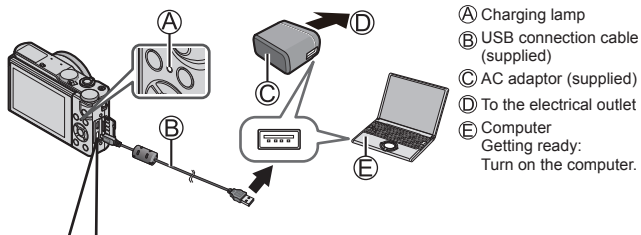

### F [USB/CHARGE] socket

- This terminal is located at the bottom when the camera is in an upright position.

- Always check the direction of the pins and hold the plug straight to insert or remove it. (If the cable is inserted in the wrong direction, the pins could become deformed and cause faulty operation.) Also, do not insert into the wrong socket. Doing so may cause damage to this unit.



## ■ Charging lamp

**On:** Charging in progress

**Off:** Charging stops (After charging stops, disconnect the camera from the electrical outlet or your computer.)

**Flashing:** Charging error (→57)

## ■ Charging time (When using the AC adaptor (supplied))

**Approx. 130 min.**

- The battery is a rechargeable lithium ion battery. If the temperature is too high or too low, the operating time of the battery will become shorter.
- The battery becomes warm after using and during and after charging. The camera also becomes warm during use. This is not a malfunction.
- **Do not leave any metal items (such as clips) near the contact areas of the power plug or near the batteries.**
- Do not use any other USB connection cables except the supplied one.
- Do not use any other AC adaptors except the supplied one.
- Do not use the AC adaptor (supplied) or the USB connection cable (supplied) with other devices.

## Setting the clock

The clock is not set when the camera is shipped.

- 1 Turn the camera on
- 2 Press [MENU/SET]
- 3 Press ▲ ▼ to select the language and press [MENU/SET]
  - The [Please set the clock] message appears.
- 4 Press [MENU/SET]
- 5 Press ◀ ▶ to select the items (year, month, day, hour, minute), and press ▲ ▼ to set
- 6 Press [MENU/SET]
- 7 When [The clock setting has been completed.] is displayed, press [MENU/SET]
- 8 When [Please set the home area] is displayed, press [MENU/SET]
- 9 Press ◀ ▶ to set your home area and press [MENU/SET]

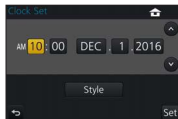

## Basic operations

### Zoom lever (Use zoom)



#### ■ Zoom types and use

##### Optical Zoom:

You can zoom in without degrading the picture quality.

**Maximum magnification: 3x**

##### Extended optical zoom:

This function works when picture sizes with [EX] have been selected in [Picture Size]. Extended optical zoom allows you to zoom in using a higher zoom ratio than optical zoom, without degrading the picture quality.

**Maximum magnification: 6x\***

\*Including the optical zoom ratio. The maximum zoom ratio varies depending on the picture size.

##### [i.Zoom]:

You can use the camera's intelligent resolution technology to increase the zoom ratio up to 2x higher than the original zoom ratio with limited deterioration of picture quality. (Up to 1.5x the original zoom ratio when [Picture Size] is set to [S]) Set the [i.Zoom] in the [Rec] menu to [ON].

##### [Digital Zoom]:

Zoom 4x further than Optical/Extended optical zoom. When [Digital Zoom] is used simultaneously with [i.Zoom], you can only increase the zoom ratio up to 2x. Note that, with Digital Zoom, enlarging will decrease picture quality. Set the [Digital Zoom] in the [Rec] menu to [ON].

- When [Live View Mode] is set to [ECO 30fps], Digital Zoom is not available (default setting).

## Shutter button (Taking pictures)

### 1 Press the shutter button halfway (press lightly) to focus on the subject

- The aperture value and shutter speed are displayed. (If the aperture value and shutter speed are shown in red and flashing, you do not have the appropriate exposure, unless you are using the flash.)

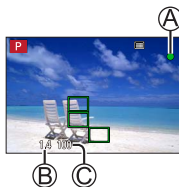

- (A) Focus display  
(When focus is aligned: illuminated  
When focus is not aligned: flashing)
- (B) Aperture value
- (C) Shutter speed

### 2 Press the shutter button fully (push the button all the way), and take the picture



- Pictures can be taken only when the image is correctly focused as long as the [Focus/Release Priority] is set to [FOCUS].

#### ■ Estimated number of recordable pictures

1450\*

- \* (When [Aspect Ratio] is set to [3:2], [Quality] is set to , [Picture Size] is set to [L] (20M), and using a card of 16 GB)

#### ■ Check the picture you have taken

- [Auto Review] displays the pictures you have taken after taking still pictures.
- Press the  (Playback) button to display the picture. (→41)

## Mode dial (Select the recording mode)

### 1 Set to the desired recording mode

- Rotate the mode dial slowly to select the desired mode.

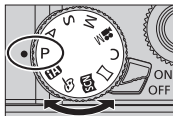

|     |   |
|-----|---|
| iA  | <b>iA</b> Intelligent Auto Mode (→27)   |
|     | <b>iA+</b> Intelligent Auto Plus Mode (→27)   |
| P   | <b>Program AE Mode</b><br>Take pictures with automatic shutter speed and aperture value settings.                                     |
| A   | <b>Aperture-Priority AE Mode</b><br>Determine aperture, then take pictures.   |
| S   | <b>Shutter-Priority AE Mode</b><br>Determine shutter speed, then take pictures.   |
| M   | <b>Manual Exposure Mode</b><br>Determine aperture and shutter speed, then take pictures.  |
| M   | <b>Creative Video Mode</b><br>Determine aperture and shutter speed, then record motion pictures.<br>• You cannot take still pictures. |
| C   | <b>Custom Mode</b><br>Take pictures using pre-registered settings.  |
| □   | <b>Panorama Shot Mode</b><br>Take panorama pictures.  |
| SCN | <b>Scene Guide Mode</b><br>Take pictures that match the scene being recorded.   |
| ☞   | <b>Creative Control Mode</b><br>Take pictures by selecting your preferred picture effect.   |

## Function buttons

- [Fn1] to [Fn3] are buttons on the camera.
- [Fn4] to [Fn8] are touch icons. They are displayed by touching the [Fn] tab on the recording screen.
- You can assign frequently-used functions to particular buttons with [Fn Button Set] in [Custom] menu.

## Cursor button

- This button is used to move the cursor on the menu screens and for other functions.
- In this manual, the button that is to be used is indicated by ▲ ▼ ◀ ▶.

You can perform the following operations while recording. (Some items or settings cannot be selected depending on the mode or display style the camera is in.)

### [] (Exposure compensation) (▲)

- Corrects the exposure when there is a backlight or when the subject is too dark or too bright.

### [WB] (White balance) (▶)

- Adjusts the color depending on the light source to ensure natural color.

### [] (Drive mode) (▼)

- [Burst]\*
  - Records a burst of still pictures while you press the shutter button fully.
- [4K PHOTO]\* (→29)
- [Post Focus]\* (→33)
- [Self Timer]\*

\* To cancel drive mode, select [] ([Single]) or [].

**[MF] (Focus mode) (◀)**

- [AF]
  - Focus is set automatically when the shutter button is pressed halfway.
- [AF👁] ([AF Macro])
  - You can take pictures of a subject as close as 3 cm (0.098 feet) from the lens by rotating the zoom lever upmost to Wide.
- [👁🔍] ([Macro Zoom])
  - Use this setting to get close to the subject and then further enlarge when taking the picture. You can take a picture with the digital zoom up to 3x while maintaining the distance to the subject for the extreme Wide position (3 cm (0.098 feet)).
- [MF]
  - Manual focus is convenient when you want to lock the focus to take pictures or when it is difficult to adjust focus using auto focus.

**Adjusting the angle of the monitor**

You can adjust the angle of the monitor.



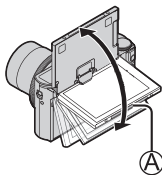

- **Be careful not to catch your finger, etc. in the monitor.**
  - **When rotating the angle of the monitor, be careful not to apply too much force. Doing so may cause damage or malfunction.**
- (Open and close with your finger on point (A).)**
- When not using this camera, close the monitor completely back to the original position.



## Control ring/Aperture ring/Rear dial

You can perform frequently used operations and settings directly.

- You can adjust the aperture using the aperture ring. Gently turn the aperture ring until it snaps into place with an audible click. (The aperture can be set between [1.4] and [11].)
- Items that can be set by the control ring/rear dial vary depending on recording modes. Following are the pre-assigned settings.

| Mode dial   | Control ring*1         | Rear dial                  |
|---|------------------------|----------------------------|
|  A   | Step Zoom              | —                          |
| P   | Step Zoom              | Program Shift              |
| A   | Step Zoom              | —                          |
| S   | Step Zoom              | Shutter speed adjustment   |
| M   | Step Zoom              | Shutter speed adjustment   |
|  M   | Step Zoom              | Shutter speed adjustment*2 |
|  SCN | Step Zoom              | Shutter speed adjustment*3 |
|      | Picture effects change | —                          |

\*1 When Manual Focus is set, the control ring is assigned to focus adjustment.

\*2 The operation is possible only when [Exposure Mode] is set to [S] or [M].

\*3 The operation is possible only when the Scene Guide Mode is set to [Artistic Nightscape].

- You can change the assigned operation of the control ring and rear dial from [Ring/Dial Set] in the [Custom] menu. For details, refer to “Owner’s Manual for advanced features (PDF format)”.



## Touch screen (Touch operations)

Touch screen of this unit is capacitive. Touch the panel directly with your bare finger.

### Touch

To touch and release the touch screen. Be sure to touch the center of the desired icon.



### Drag

To touch and slide your finger across the touch screen. This can also be used to forward or rewind a picture during playback, etc.



### Pinch (spread/pinch)

On the touch screen, spread (pinch out) your 2 fingers to zoom in, and pinch (pinch in) your 2 fingers to zoom out.



## Setting the menu

- 1 Press [MENU/SET] to bring up the menu
- 2 Press ▲ ▼ to select the menu item and press [MENU/SET]

- 3 Press ▲ ▼ to select the setting and press [MENU/SET]

- The setting methods vary depending on the menu item.



- 4 Press [Q.MENU/↵] button repeatedly until the recording or playback screen reappears

- During recording, the menu screen can also be exited by pressing the shutter button halfway.

### ■ Switching menu type

- ① Press ◀ after performing step 1 above
- ② Press ▲ ▼ to select a tab such as [🔧]
- ③ Press [MENU/SET]





### ■ Menu types (→44)

- [Rec]
- [Motion Picture]
- [Custom]
- [Setup]
- [Playback]

# Taking pictures with automatic settings

## (Intelligent Auto Mode)

Recording mode:  

This mode is recommended for those who want to point and shoot as the camera optimizes settings to match the subject and recording environment.

### 1 Set mode dial to





- The camera will switch to either the most recently used of Intelligent Auto Mode or Intelligent Auto Plus Mode.

### 2 Point the camera at the subject

- When the camera identifies the optimal scene, the icon for each scene turns blue for 2 seconds and then changes to the normal red indication.



### ■ Switching between Intelligent Auto Plus Mode and Intelligent Auto Mode

Select the  or  tab on the menu screen, press ► to select  or , and press [MENU/SET].

- If [DISP.] button is pressed, the description of the selected mode will be displayed.



## [Self Shot]

Recording mode: 

You can easily take pictures of yourself while looking at the screen.

### 1 Rotate the monitor as shown in the figure

### 2 Touch the item

Settings:

- Ⓐ [Soft Skin] / Ⓑ [Filter Select] / Ⓒ [Slimming Mode] /
- Ⓓ [Shutter] / Ⓔ [Countdown] / [Shots]

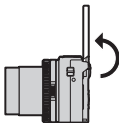

### 3 Touch the slide bar

- If you select the left edge of the slide bar (Ⓕ), it will be set to "Off".
- In the case of [Filter Select], [Shutter], or [Shots], select from the icons.

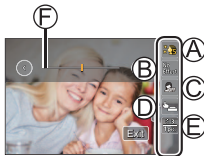

### 4 Touch [Exit]

### 5 Decide on your poses while looking at the monitor

### 6 Press the shutter button halfway to focus and then press it fully to take the picture

- Look at the lens when recording.
- Be careful not to look at the light from the flash and the AF Assist Lamp directly.



# Recording 4K photos

Recording mode:

You can select the desired moment from a burst of 4K photos taken at 30 frames/second and save that moment as a picture of approx. 8 million pixels.

- To record pictures, use a UHS Speed Class 3 card.
- When recording, the angle of view becomes narrower.

## 1 Press [] button

## 2 Press to select the recording method and press [MENU/SET]





|   |  |  |
|---|--|--|
| <p><b>[4K Burst]</b></p>  | <p><b>For capturing the best shot of a fast-moving subject</b><br/>(e.g., sports, aeroplanes, trains)<br/>Burst recording is performed while the shutter button is pressed and held.</p> <p>(A) Press and hold<br/>(B) Recording is performed</p>  |  |
| <p><b>[4K Burst(S/S)]</b><br/>“S/S” is an abbreviation of “Start/Stop”.</p> | <p><b>For capturing unpredictable photo opportunities</b><br/>(e.g., plants, animals, children)<br/>Burst recording starts when the shutter button is pressed and stops when pressed again.</p> <p>(C) Start (First)<br/>(D) Stop (Second)<br/>(E) Recording is performed</p>                                      |  |
| <p><b>[4K Pre-Burst]</b></p>  | <p><b>For recording as needed whenever a photo opportunity arises</b><br/>(e.g. the moment when a ball is thrown)<br/>Burst recording is performed for approximately 1 second before and after the moment that the shutter button is pressed.</p> <p>(F) Approximately 1 second<br/>(G) Recording is performed</p> |  |

### 3 Record a 4K photo

- When you perform 4K burst photo recording, a 4K burst file will be saved in the MP4 format.
- When [Auto Review] is enabled, the picture selection screen will be displayed automatically.
- You can compare multiple frames captured in a 4K burst file, overlay the bright areas, and combine them into one picture. ([Light Composition]) (→42)

#### ■ To cancel the 4K Photo functions

In step 2, select [].

- If the surrounding temperature is high or 4K photos are recorded continuously, [] may be displayed and recording may be stopped halfway through. Wait until the camera cools down.
- **When [] ([4K Pre-Burst]) is set, the battery drains faster and the camera temperature rises. (to protect itself, the camera may switch to [] ([4K Burst]))**  
**Select [] ([4K Pre-Burst]) only when recording.**
- The continuous recording time is the same as when [Rec Format] is set to [MP4], and [Rec Quality] is set to [4K/100M/30p] or [4K/100M/24p]. (→38)

## Saving a picture from a 4K burst file

- To select and save a picture, perform the following operations.
- To bulk save the pictures (→32).

### 1 Select a picture with the [▲] on the playback screen, and press ▲

- In the case of recording with [4K] ([4K Pre-Burst]), proceed to the step 3.



### 2 Drag the slide bar to perform rough scene selection



### 3 Drag to select the frame you want to save as a picture

- Touch [◀]/[▶] to display the previous or next set of frames (45) in slide view.



### 4 Touch [ ] to save the picture

- The picture will be saved in JPEG format.
- For details, refer to “Owner’s Manual for advanced features (PDF format)” or “Quick Guide for 4K Photo (supplied)”.

## ■ [4K PHOTO Bulk Saving]

You can bulk save 5 seconds' worth of 4K recording from a 4K burst file.

- If [Auto Review] is set, the slide view screen appears automatically. Press the shutter button halfway to display the recording screen, and then perform the following operations.

**MENU** →  **[Playback]** → **[4K PHOTO Bulk Saving]**

- ① Use ◀▶ to select the 4K burst files and press [MENU/SET]
  - If the burst time is 5 seconds or less, all the frames can be saved as a picture.
- ② Select the first frame to be bulk saved as a picture
  - The selection method is the same as the operation to choose the frame you want to save as a picture from a 4K burst file.
  - The picture will be saved in JPEG format as a single burst picture group.



## [Post Focus] / [Focus Stacking]

Recording mode:         

You can record bursts of photos with the same quality as a 4K photo while automatically changing the focus point. After recording, you can select a point on the screen to save a picture with that point as the focus point.

You can combine multiple pictures, each with a different focus, to increase the focus range. ([Focus Stacking])

- We recommend using a tripod to perform [Focus Stacking].
- To record pictures, use a UHS Speed Class 3 card.
- During recording, the angle of view will be narrower.

### 1 Press button

### 2 Press ◀▶ to select [ON] and press [MENU/SET]

### 3 Determine the composition and press the shutter button halfway

- Auto Focus activates and automatically detects the focus point on the screen.
- If there is no focus point on the screen, the Focus indicator (Ⓐ) blinks and you cannot record.



#### From halfway pressing the shutter button to completion of recording

- Do not change the distance to subject or the composition.

### 4 Press the shutter button fully to start recording



- The focus point changes automatically while recording. When the recording progress bar (Ⓑ) disappears, recording automatically ends.
- A motion picture will be recorded in MP4 format. (No audio is recorded.)
- If Auto Review is set, a screen will automatically appear that lets you select the focus point. (→34)

- If the surrounding temperature is high or [Post Focus] recording is performed continuously, [△] may be displayed and recording may be stopped halfway through. Wait until the camera cools down.

## Select the focus point and save the picture ([Post Focus])

- 1 On the playback screen, select the image with the [△] icon and press ▲



- 2 Touch the focus point

- If there are no pictures with the focus on the selected point, a red frame will be displayed, and pictures cannot be saved.
- The edge of the screen cannot be selected.
- Press [Fn1] to switch to the [Focus Stacking] operations screen. (→35)
- To highlight in-focus portion with color, touch [PEAK].
- To enlarge the display, touch [Q].
- You can make fine adjustments to the focus by dragging the slide bar during enlarged display.

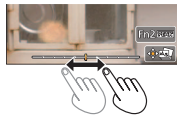

- 3 Touch [△] to save the picture

- The picture will be saved in JPEG format.

- You cannot choose and save the picture from a TV screen even if the camera is connected to a TV through an HDMI micro cable.

## Combine multiple pictures to increase the focus range ([Focus Stacking])

You can combine multiple pictures from pictures recorded using [Post Focus] to create a single picture with an expanded focus range.

- 1 Touch  on screen in step 2 of “Select the focus point and save the picture ([Post Focus])” (→34)
- 2 Choose a stacking method and touch it

|                 |  |
|-----------------|--|
| [Auto Merging]  | Automatically select photos suitable for stacking and combine them into one picture. <ul style="list-style-type: none"> <li>• Choose by giving preference to near-focus pictures.</li> <li>• Perform the focus stacking and save the picture.</li> </ul> |
| [Range Merging] | Combine the pictures with the selected focus position into one picture.  |

- 3 (When selecting [Range Merging])  
Touch the focus point

- Select positions at two or more points.
- Focus positions between the two points are selected and the range of the in-focus portion is displayed in green.
- The ranges that are greyed out are positions that cannot be selected, or that would produce an unnatural result if selected for focus stacking.

- Touch a position again to deselect it.
- If you drag the screen you can then continue to select positions.

- 4 Touch  to combine and save the picture
  - The picture will be saved in JPEG format.

- Only pictures taken using [Post Focus] are eligible for [Focus Stacking].

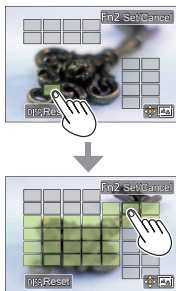

## Taking Pictures While Adjusting a Setting Automatically (Bracket Recording)

Recording mode:

You can take multiple pictures while automatically adjusting a setting by pressing the shutter button.

### 1 Set the menu (→26)

|  |   |
|--|---|
| MENU →  [Rec] → [Bracket] → [Bracket Type] |   |
| (Exposure Bracket)                         | Press the shutter button to perform recording while adjusting the exposure.                               |
| (Aperture Bracket)                         | Press the shutter button to perform recording while adjusting the aperture.                               |
| FOCUS (Focus Bracket)                      | Press the shutter button to perform recording while adjusting the focus position.                         |
| (White Balance Bracket)                    | Press the shutter button once to take three pictures with different white balance settings automatically. |

### 2 Press ▼ to select [More settings] and then press [MENU/SET]

- If is set, rotate the rear dial to set the adjustment range.
- Press the shutter button halfway to exit the menu.

### 3 Focus on the subject and take a picture

#### ■ To cancel [Bracket]

Select [OFF] in step 1.

# Recording Motion Picture/4K Motion Picture

Recording mode: 

You can record full high-definition quality images that comply with the AVCHD standard, as well as motion pictures or 4K motion pictures recorded in MP4.

## 1 Press the motion picture button to start recording

- (A) Recording (red)
- (B) Elapsed recording time
- (C) Remaining recording time

- Recording of motion picture appropriate for each motion picture mode is possible.
- Immediately release the motion picture button after pressing it.
- If you press the shutter button down fully, you can take still pictures while recording motion pictures.

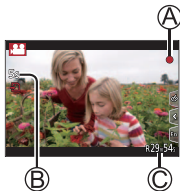

## 2 Press the motion picture button again to end recording

- If the surrounding temperature is high, or a motion picture is recorded continuously, [  ] is displayed and recording may be stopped halfway through. Wait until the camera cools down.
- **With recording in a quiet environment, the sound of aperture, focus and other actions may be recorded in motion pictures. This is not a malfunction.**
- To record 4K motion pictures, use a UHS Speed Class 3 card.
- When you record 4K motion pictures, the angle of view will be narrower than motion pictures of other sizes.
- To ensure highly accurate focus, 4K motion pictures are recorded at reduced Auto Focus speeds. It may be difficult to focus on the subject with Auto Focus, but this is not a malfunction.

## ■ Setting the format, picture size and recording frame rate

**MENU** →  **[Motion Picture]** → **[Rec Format]**

Settings: **[AVCHD]** / **[MP4]**

**MENU** →  **[Motion Picture]** → **[Rec Quality]**

When **[AVCHD]** is selected:

**[FHD/28M/60p]\*1** / **[FHD/17M/60i]** / **[FHD/24M/30p]** / **[FHD/24M/24p]**

● **[AVCHD]** motion pictures:

Files are split into smaller motion picture files for recording when the file size exceeds 4 GB.

● Motion pictures with **[Rec Quality]** setting of **[FHD/28M/60p]/[FHD/17M/60i]** in **[AVCHD]**:

Recording stops when the continuous recording time exceeds 29 minutes and 59 seconds.

When **[MP4]** is selected:

**[4K/100M/30p]\*2** / **[4K/100M/24p]\*2** / **[FHD/28M/60p]** / **[FHD/20M/30p]** / **[HD/10M/30p]**

● Motion pictures with their file size set to **[FHD]** or **[HD]** in **[MP4]**:

Files are split into smaller motion picture files for recording and playback when the file size exceeds 4 GB. (You can continue to record motion pictures without interruption.)

● Motion pictures with **[Rec Quality]** setting of **[FHD/28M/60p]** in **[MP4]**:

Recording stops when the continuous recording time exceeds 29 minutes and 59 seconds.

● Motion pictures with their file size set to **[4K]** in **[MP4]**:

Recording stops when the continuous recording time exceeds 15 minutes.

When using an SDHC memory card, files are split into smaller motion picture files for recording and playback if the file size exceeds 4 GB. (You can continue to record motion pictures without interruption.)

If using an SDXC Memory Card, you can record a motion picture in a single file even if the size is greater than 4 GB.

\*1 AVCHD Progressive

\*2 4K motion pictures

## [4K Live Cropping]

Recording mode: 

By cropping your motion picture down from the 4K angle of view to Full High Definition, you can record a motion picture that pans and zooms in/out while leaving the camera in a fixed position.

- Hold the camera firmly in place while recording.
- A motion picture will be recorded at [FHD/20M/30p] under [MP4].



Pan



Zoom in

- When you want to zoom in/out, set different angles of view for the cropping start and end frames. For example, to zoom in, set a larger angle of view for the start frame and a smaller angle of view for the end frame.

**1 Set mode dial to [M]**

**2 Set the menu (→26)**

**MENU** →  **[Motion Picture]** → **[4K Live Cropping]**

**Settings: [40SEC] / [20SEC] / [OFF]**

- The angle of view narrows.

### 3 Set the crop start frame



### 4 Repeat step 3, and then set the crop end frame



### 5 Press the motion picture button (or the shutter button) to start recording

- (A) Elapsed recording time
- (B) Set operating time

- Immediately release the motion picture button (or the shutter button) after pressing it.
- When the set operating time has elapsed, recording automatically ends. To end recording midway, press the motion picture button (or the shutter button) again.



#### ■ Changing the position and size of a crop frame

Press [Fn1] button while the recording screen is displayed, and perform steps 3 and 4.

- Focus is adjusted and fixed in the crop start frame.
- [Continuous AF] is set to [OFF].



## Viewing your pictures

### 1 Press [▶] (Playback) button

- When [Lens Retraction] is set to [ON], the lens barrel is retracted after approx. 15 seconds as the camera is switched to the playback screen from the recording screen.

### 2 Press ◀▶ to select a picture to be displayed

#### ■ Viewing motion pictures

This unit was designed to play motion pictures using the AVCHD and MP4 formats.

- Motion pictures are displayed with the motion picture icon ([▶]).

① Press ▲ to start playback

- If you press [MENU/SET] during a pause, you can create a picture from a motion picture.



#### ■ Sending pictures to the WEB services

If you press ▼ while a single picture is being displayed, you can send the picture to the WEB service quickly.

#### ■ Deleting pictures

**Deleted pictures cannot be recovered.**

① Press [⏏] button to delete displayed picture

② Use ▲ to select [Delete Single] and press [MENU/SET]

#### ■ Ending Playback

Press [▶] (Playback) button again or press the motion picture button.

The playback can also be ended by pressing the shutter button halfway.

## [Light Composition]

Select multiple frames from 4K burst files that you wish to combine. Parts of the image that are brighter than the preceding frame will be superimposed on the preceding frame to combine the frames into one picture.



- When using [Light Composition], it is recommended to use a tripod or use a smartphone instead of the shutter and do remote recording (→50) to control camera shaking.

**MENU** → **▶** [**Playback**] → [**Light Composition**]

**1 Use ◀▶ to select the 4K burst files and press [MENU/SET]**

**2 Choose the combining method and press [MENU/SET]**

### ■ When [Composite Merging] is selected

Select the frames you wish to combine, and then camera superimposes brighter parts of the image.

① Select the frames

- Images displayed cannot be enlarged or shrunk or shown as in slide view.
- [**⏏**] in touch operation becomes [**⏏OK**].



**② Press [MENU/SET]**

The selected frames are remembered, and the display goes to the preview screen.

Use ▲ ▼ to select items and press [MENU/SET] to perform the following operations.

- [Next]: Lets you select more frames for combining. Goes back to step ①.
- [Reselect]: Discards the frame selected immediately before and lets you select a different image.
- [Save]: Ends frame selection.

**③ Repeat steps ① - ② to select more frames to combine**

- You can select up to 40 frames.

**④ Press ▼ to select [Save] and press [MENU/SET]****■ When [Range Merging] is selected**

Select the first and last frames, and the brighter parts of frames within that range will be superimposed.

**① Select the frame of the first picture and then press [MENU/SET]**

The selection method is the same as in step ① when selecting [Composite Merging].

**② Select the frame of the last picture and then press [MENU/SET]****3 Select [Yes] at the confirmation screen and press [MENU/SET]**

The combined picture is displayed.

- The picture will be saved in JPEG format.

## Menu list

- The [Photo Style], [Filter Settings], [Sensitivity], [AF Mode], [AFS/AFF/AFC], [Metering Mode], [Highlight Shadow], [i.Dynamic], [i.Resolution], [Diffraction Compensation], [i.Zoom], [Digital Zoom], and [Stabilizer] menu items are common for both [Rec] and [Motion Picture] menus. If a setting in one menu is changed, the setting with the same name in other menu will also be changed automatically.

### [Rec]

|                   |                         |                            |
|-------------------|-------------------------|----------------------------|
| [Photo Style]     | [Highlight Shadow]      | [ISO Limit Set]            |
| [Filter Settings] | [i.Dynamic]             | [ISO Increments]           |
| [Aspect Ratio]    | [i.Resolution]          | [Extended ISO]             |
| [Picture Size]    | [iHandheld Night Shot]  | [Long Shtr NR]             |
| [Quality]         | [iHDR]                  | [Diffraction Compensation] |
| [Sensitivity]     | [HDR]                   | [i.Zoom]                   |
| [AF Mode]         | [Multi Exp.]            | [Digital Zoom]             |
| [AFS/AFF/AFC]     | [Time Lapse Shot]       | [Color Space]              |
| [Metering Mode]   | [Stop Motion Animation] | [Stabilizer]               |
| [Burst Rate]      | [Panorama Settings]     | [Face Recog.]              |
| [4K PHOTO]        | [Shutter Type]          | [Profile Setup]            |
| [Bracket]         | [Flash]                 |                            |
| [Self Timer]      | [Red-Eye Removal]       |                            |

 [Motion Picture]

[4K Live Cropping]

[Exposure Mode]

[Flkr Decrease]

[Snap Movie]

[High Speed Video]

[Silent Operation]

[Rec Format]

[Continuous AF]

[Wind Noise Canceller]

[Rec Quality]

[Level Shot]

 [Custom]

[Cust.Set Mem.]

[MF Assist Display]

[Remaining Disp.]

[Silent Mode]

[MF Guide]

[Auto Review]

[AF/AE Lock]

[Peaking]

[Fn Button Set]

[AF/AE Lock Hold]

[Histogram]

[Zoom lever]

[Shutter AF]

[Guide Line]

[Lens Position Resume]

[Half Press Release]

[Center Marker]

[Lens Retraction]

[Quick AF]

[Highlight]

[Q.MENU]

[Pinpoint AF Time]

[Zebra Pattern]

[Ring/Dial Set]

[Pinpoint AF Display]

[Monochrome Live View]

[Self Shot]

[AF Assist Lamp]

[Constant Preview]

[Touch Settings]

[Focus/Release Priority]

[Expo.Meter]

[Touch Scroll]

[AF+MF]

[Dial Guide]

[Menu Guide]

[MF Assist]

[Rec Area]

 [Setup]

|                     |                    |                        |
|---------------------|--------------------|------------------------|
| [Online Manual]     | [Economy]          | [Exposure Comp. Reset] |
| [Clock Set]         | [USB Mode]         | [Self Timer Auto Off]  |
| [World Time]        | [TV Connection]    | [No.Reset]             |
| [Travel Date]       | [m/ft]             | [Reset]                |
| [Wi-Fi]             | [Menu Resume]      | [Reset Wi-Fi Settings] |
| [Beep]              | [Menu Background]  | [Level Gauge Adjust.]  |
| [Live View Mode]    | [Menu Information] | [Demo Mode]            |
| [Monitor Display]   | [Language]         | [Format]               |
| [Monitor Luminance] | [Version Disp.]    |                        |

 [Playback]

|                        |                     |                 |
|------------------------|---------------------|-----------------|
| [Slide Show]           | [Title Edit]        | [Rotate]        |
| [Playback Mode]        | [Text Stamp]        | [Rotate Disp.]  |
| [Location Logging]     | [Video Divide]      | [Favorite]      |
| [RAW Processing]       | [Time Lapse Video]  | [Print Set]     |
| [4K PHOTO Bulk Saving] | [Stop Motion Video] | [Protect]       |
| [Light Composition]    | [Resize]            | [Face Rec Edit] |
| [Clear Retouch]        | [Cropping]          | [Picture Sort]  |

## What you can do with the Wi-Fi<sup>®</sup> function

### ● **Operating the camera by connecting it to a smartphone**

- Taking pictures via a smartphone (→50)
- Playing back pictures in the camera on a smartphone (→50)
- Saving pictures in the camera to a smartphone
- Sending pictures in the camera to social networking services
- Adding location information to pictures in the camera from a smartphone
- Combining motion pictures recorded with Snap Movie according to your preference on a smartphone

### ● **Displaying still pictures on a TV**

#### ● **Wireless printing**

#### ● **Sending pictures to AV device**

#### ● **Sending pictures to a PC**

#### ● **Using WEB services**

- This manual uses the term “smartphone” for both smartphones and tablets unless it is necessary to distinguish between them.
- The camera cannot be used to connect to a public wireless LAN connection.

## Operating the camera by connecting it to a smartphone

### Installing the smartphone app “Panasonic Image App”

The “Image App” is an application provided by Panasonic.

|                               |   |
|-------------------------------|---|
| <b>Supported OS</b>           | Android™: Android 4.0 or later<br>iOS: iOS 7.0 or later   |
| <b>Installation procedure</b> | <ol style="list-style-type: none"> <li>① Connect your device to a network</li> <li>② (Android) Select “Google Play™ Store”<br/>(iOS) Select “App Store”</li> <li>③ Enter “Panasonic Image App” or “LUMIX” to search for the app</li> <li>④ Select “Panasonic Image App” and install it</li> </ol> |



- Use the latest version.
- Supported OS versions as of October 2016. Supported OS versions may be changed without prior notice.
- The service may not be able to be used properly depending on the type of smartphone being used.  
For the latest information on the “Image App”, refer to the support site below.  
<http://panasonic.jp/support/global/cs/dsc/> (This site is available in English only.)
- When downloading the app on a mobile network, high packet communication fees may be incurred depending on the details of your contract.
- For details about the operating procedure, etc., refer to [Help] in the “Image App” menu.
- If you connect the camera and smartphone over a Wi-Fi connection and run “Image App”, [Help] may not be displayed in the “Image App” menu for some smartphones. In such a case, disconnect the Wi-Fi connection with the camera, connect the camera to a cellular data line such as 3G and LTE, or the Internet to display [Help] in the “Image App” menu.
- Some of the screens and information provided in this document may be different depending on the supported operating system and “Image App” version.



## Connecting to a smartphone

You can easily establish a Wi-Fi connection on this unit without entering a password on your smartphone.

### (On the camera)

**MENU** →  **[Setup]** → **[Wi-Fi]** → **[Wi-Fi Function]** → **[New Connection]**  
→ **[Remote Shooting & View]**

- The information required for directly connecting your smartphone to this unit (SSID (A)) is displayed.
- You can also display the information by pressing the function button that [Wi-Fi] function is assigned. (At the time of purchase, [Wi-Fi] is assigned to [Fn4] button in recording mode, and [Fn1] in playback mode.)



### (On your smartphone)

- 1 Turn on the Wi-Fi function in the setting menu
- 2 Select the SSID displayed on the screen of the camera
- 3 Start “Image App” (→48)

- When the connection confirmation screen appears on the camera, select [Yes] and press [MENU/SET]. (Only when making a connection for the first time.)

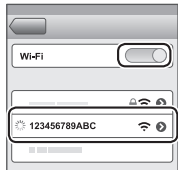

**[Wi-Fi Password] is set to [OFF] at the time of purchase.** When you start a Wi-Fi connection, be sure to verify that the device displayed on the camera's connection confirmation screen is really the device you want to connect to. Even if the wrong device is displayed, you will still be connected to it if you select “Yes”. If there seem to be other Wi-Fi enabled devices in the vicinity, we recommend that you set [Wi-Fi Password] to [ON]. For details, refer to “Owner’s Manual for advanced features (PDF format)”.

## Closing the connection

### 1 Set the camera to Recording Mode

- Press the shutter button halfway to return to recording mode.

### 2 Select the camera's menu items to terminate the Wi-Fi connection

MENU →  [Setup] → [Wi-Fi] → [Wi-Fi Function]  
→ [Yes]

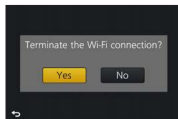

### 3 On the smartphone, close "Image App"

- For details on how to close the application, refer to the operating instructions of your device.

## Taking pictures via a smartphone (remote recording)

### 1 Connect to a smartphone (→49)

### 2 Operate the smartphone

① Select 

② Take pictures

- The recorded images are saved in the camera.
- Some settings are not available.



## Playing back pictures in the camera on a smartphone

### 1 Connect to a smartphone (→49)

### 2 Operate the smartphone

① Select 

- When the picture is touched, it is played back at a larger size.



## Downloading software

Still/motion pictures can be copied from the camera to your computer by connecting the two together. If you wish to play back or edit pictures on a PC, download software from the supplier's website and install it on your PC.

- To download the software, your PC must be connected to the Internet.
- It may take time to download the software in some communication environments.

### PHOTOfunSTUDIO 9.9 PE

You can capture still pictures or motion pictures to your PC, or organize captured pictures by categorizing by recording date, model name of the digital camera used to record, etc. You can also correct still pictures, edit motion pictures, or write to DVD.

- Check the website below to download/install the software.  
The software is available for download until the end of October 2021.  
[http://panasonic.jp/support/global/cs/soft/download/d\\_pfs99pe.html](http://panasonic.jp/support/global/cs/soft/download/d_pfs99pe.html)

#### • Operating environment

|                             |  |   |
|-----------------------------|--|---|
| <b>Supported OS</b>         | Windows® 10 (32-bit/64-bit)                                    |   |
|                             | Windows® 8.1 (32-bit/64-bit)                                   |   |
|                             | Windows® 8 (32-bit/64-bit)                                     |   |
|                             | Windows® 7 (32-bit/64-bit) SP1                                 |   |
| <b>CPU</b>                  | Windows® 10  | Pentium® 4 2.8 GHz or higher                  |
|                             | Windows® 8.1   |   |
|                             | Windows® 8   |   |
|                             | Windows® 7   |   |
| <b>Display</b>              | 1024×768 pixels or more (1920×1080 pixels or more recommended) |   |
| <b>RAM</b>                  | Windows® 10  | 1 GB or more (32-bit) / 2 GB or more (64-bit) |
|                             | Windows® 8.1   |   |
|                             | Windows® 8   |   |
|                             | Windows® 7   |   |
| <b>Free hard disk space</b> | 450 MB or more for installing software                         |   |

- To edit 4K motion pictures, you need the 64-bit versions of Windows 10, Windows 8.1, Windows 8, or Windows 7.
- “PHOTOfunSTUDIO” is not compatible with Mac.
- Refer to the operating instructions of “PHOTOfunSTUDIO” (PDF) for further information about the operating environment.

## **SILKYPIX Developer Studio SE**

This software develops and edits RAW file pictures. Edited pictures can be saved in a file format such as JPEG or TIFF that can be displayed on a PC, etc.

- Check the website below to download/install the software.  
<http://www.isl.co.jp/SILKYPIX/english/p/>
- Supported OS: Windows® 10 / 8.1 / 8 / 7  
Mac® OS X v10.6 - v10.11
- For details on the operating environment and how to use the SILKYPIX Developer Studio SE, refer to the “Help” or the Ichikawa Soft Laboratory’s support website.

## **LoiLoScope 30 day full trial version**

Motion pictures can be edited easily.

- Check the website below to download/install the software.  
<http://loilo.tv/product/20>
- Supported OS: Windows® 10 / 8.1 / 8 / 7
- For more information on how to use LoiLoScope and its operating environment, read the LoiLoScope manual available for download at the website.
- “LoiLoScope” is not compatible with Mac.

## Reading the Owner's Manual (PDF format)

More detailed operating instructions are available in "Owner's Manual for advanced features (PDF format)". To read it, download it from the website.

<http://panasonic.jp/support/dsc/oi/index.html?model=DMC-LX10&dest=P>



- Click the desired language.

### ■ Confirming URLs and QR codes with the camera



















**MENU** →  **[Setup]** → **[Online Manual]**

#### Settings: [URL display] / [QR Code display]

- The URL or QR code will be displayed on the camera monitor.
- You will need Adobe Reader to browse or print the Owner's Manual (PDF format). You can download and install a version of Adobe Reader that you can use with your OS from the following website. (As of October 2016)  
<http://www.adobe.com/products/acrobat/readstep2.html>









2

|  |  |
|--|--|
|     | [Quality]  |
| 120fps   | [High Speed Video]   |
| AFS  | [AFS/AFF/AFC]/MF   |
| BKT<br>AFS   | Focus Bracket  |
|     | AF Mode  |
|     | [Pull Focus]   |
|     | [Face Recog.]  |
| AFL  | AF Lock  |
|     | Burst  |
|     | [4K PHOTO] (→29)   |
|     | [Post Focus] (→33)   |
|     | [Self Timer]   |
|     | Remaining battery  |
| AF  | Macro recording (→23)  |
|     | [Level Shot]   |
|     | [Stabilizer]   |
|     | Jitter alert   |
|     | Recording state<br>(Flashes red.) (→37)/<br>Focus (Lights green.)<br>(→20) |
|     | Focus (Under low<br>illumination)  |
|     | Focus (Starlight AF)   |
|     | Wi-Fi connection status  |
|     | Histogram  |

3

|   |
|---|
| Name*2  |
| Travel elapsed days*3   |
| Age in years/months*2   |
| Location*3  |
| Current date/time*3   |
| Travel destination setting*3:  |
| Exposure meter  |
| Zoom (→19)  |

4

|  |                                |
|--|--------------------------------|
|         | AF area                        |
| +  | Spot metering target           |
| +  | [Center Marker]                |
|         | [Self Timer]                   |
|         | [Silent Mode]                  |
| AEL  | AE Lock                        |
|         | [Metering Mode]                |
|         | Program Shift                  |
| 1.4  | Aperture value                 |
| BKT<br>1.4   | Aperture Bracket               |
| 60   | Shutter speed                  |
|  | Exposure compensation<br>value |
| BKT<br> | Exposure Bracket               |
|  | Brightness (exposure)          |
|  | Manual Exposure Assist         |
| 200     | ISO sensitivity                |

5

|             |                                      |
|-------------|--------------------------------------|
|             | <b>[Dial Guide]</b>                  |
| BKT<br>AWB+ | <b>White Balance Bracket</b>         |
|             | <b>White Balance Fine Adjustment</b> |
|             | <b>White Balance</b>                 |
|             | <b>Coloring</b>                      |
| 98          | <b>Number of recordable pictures</b> |
| RXXmXXs     | <b>Available recording time*1</b>    |

6

## Touch tab

|  |                          |
|--|--------------------------|
|  | <b>Touch zoom</b>        |
|  | <b>Touch Shutter</b>     |
|  | <b>[Touch AE]</b>        |
|  | <b>[Peaking]</b>         |
|  | <b>[Self Shot] (→28)</b> |

|  |   |
|--|---|
|  | <b>Function buttons (→22)</b>                     |
|  | <b>Coloring</b>                                   |
|  | <b>Defocus control function</b>                   |
|  | <b>Brightness (exposure)</b>                      |
|  | <b>Type of defocus ([Miniature Effect])</b>       |
|  | <b>[One Point Color]</b>                          |
|  | <b>[Sunshine]</b>                                 |
|  | <b>Picture effect (Filter) adjustment display</b> |
|  | <b>Picture effects ON or OFF</b>                  |
|  | <b>Picture effects (Filter)</b>                   |
|  | <b>Shutter speed</b>                              |
|  | <b>ISO sensitivity</b>                            |

\*1 [h], [m] and [s] indicate “hour”, “minute” and “second”.

\*2 This is displayed for about 5 seconds when the camera is turned on if the [Profile Setup] setting is set.

\*3 This is displayed for about 5 seconds when the camera is turned on, after setting the clock and after switching from Playback Mode to Recording mode.

- The information displayed, such as histograms, magnifications, and numeric values, are only for the purpose of reference.



## Q&A Troubleshooting

- Performing [Reset] in the [Setup] menu may resolve the issue.
- Further information is provided in the “Owner’s Manual for advanced features (PDF format)”. Check it together with the information in this section.

### The charging lamp blinks.

- Charging is being performed in a place with extremely high or low temperature.  
→ **Reconnect the USB connection cable (supplied) and retry charging in a place where ambient temperature is 10 °C to 30 °C (50 °F to 86 °F) (temperature conditions also apply to the battery itself).**
- Charging is not possible if the power supply capacity of the computer is low.

### Sometimes focus adjustment with auto focus mode is difficult while recording 4K motion pictures.

- This may occur when taking a picture by reducing the auto focus speed in order to adjust the focus at high precision. This is not a malfunction.

**It cannot connect to the wireless LAN. Radio waves get disconnected.  
Wireless access point is not displayed.**

**General tips for using a Wi-Fi connection**

- Use within the communication range of the wireless LAN network.
- If any device, such as microwave oven, cordless phone, etc., that uses 2.4 GHz frequency are used nearby this unit simultaneously, radio waves may get interrupted.  
→ Use them sufficiently away from the device.
- When the battery indicator is flashing red, the connection with other equipment may not start or the connection may be disrupted. (A message such as [Communication error] is displayed.)
- When this unit is placed on a metal table or shelf, the connection may not be established easily because the camera is affected by radio waves. Use the camera away from metal surfaces.

**About a wireless access point**

- Check if the wireless access point to connect is in operating state.
- Check the radio wave condition of the wireless access point.  
→ Perform the connection closer to the wireless access point.  
→ Move the location or change the angle of the wireless access point.
- It may not display even if the radio waves exist depending on the setting of the wireless access point.  
→ Turn off the wireless access point and then turn it back on.
- If the network SSID of the wireless access point is set not to broadcast, it may not be detected.  
→ Enter and set the network SSID. Alternatively, set the network SSID of the wireless access point to broadcast.

## Specifications

### Digital Camera: Information for your safety

|                     |                           |
|---------------------|---------------------------|
| <b>Power Source</b> | DC 8.4 V (≡ 8.4 V)        |
| <b>Power</b>        | 1.9 W (When recording)    |
| <b>Consumption</b>  | 1.6 W (When playing back) |

|                                |   |
|--------------------------------|---|
| <b>Camera effective pixels</b> | 20,100,000 pixels   |
| <b>Image sensor</b>            | 1" MOS sensor,<br>total pixel number 20,900,000 pixels<br>Primary color filter  |
| <b>Lens</b>                    | Optical 3x zoom<br>f=8.8 mm to 26.4 mm<br>(35 mm film camera equivalent: 24 mm to 72 mm)<br>Max. Wide: F1.4 to F11<br>Max. Tele: F2.8 to F11  |
| <b>Image Stabilizer</b>        | Optical method  |
| <b>Focus range</b>             | AF:<br>30 cm (0.98 feet) (Max. Wide)/<br>30 cm (0.98 feet) (Max. Tele) to ∞<br>AF Macro/MF/Intelligent Auto/Motion picture:<br>3 cm (0.098 feet) (Max. Wide)/<br>30 cm (0.98 feet) (Max. Tele) to ∞ |
| <b>Shutter system</b>          | Electronic shutter + Mechanical shutter   |
| <b>Minimum Illumination</b>    | Approx. 3 lx (when i-Low light is used, the shutter speed is 1/30th of a second)  |

|                        |   |
|------------------------|---|
| <b>Shutter speed</b>   | <p>Still picture:<br/> T (Time) (Max. approx. 120 seconds),<br/> 60 seconds to 1/4000th of a second<br/> (When the mechanical shutter is used),<br/> 1 second to 1/16000th of a second<br/> (When the electronic shutter is used)</p> <p>Motion picture:<br/> 1/25th of a second to 1/16000th of a second<br/> (When [FHD/24M/24p] is set in [AVCHD], or<br/> [4K/100M/24p] is set in [MP4]),<br/> 1/2 second to 1/16000th of a second<br/> (When [M] is selected in Creative Video Mode, MF),<br/> 1/30th of a second to 1/16000th of a second<br/> (Other than the above)</p> |
| <b>Exposure (AE)</b>   | Program AE (P)/Aperture-priority AE (A)/<br>Shutter-priority AE (S)/Manual exposure (M)/AUTO<br>Exposure Compensation (1/3 EV steps, -5 EV to +5 EV)  |
| <b>[Metering Mode]</b> | Multiple/Center weighted/Spot   |
| <b>Monitor</b>         | 3.0" TFT LCD (3:2) (Approx. 1,040,000 dots)<br>(field of view ratio about 100%)<br>Touch screen   |
| <b>Flash</b>           | Built-in pop up flash<br>AUTO, AUTO/Red-Eye Reduction, Forced ON,<br>Forced ON/Red-Eye Reduction, Slow Sync.,<br>Slow Sync./Red-Eye Reduction, Forced OFF   |
| <b>Microphones</b>     | Stereo  |
| <b>Speaker</b>         | Monaural  |

|                                 |  |
|---------------------------------|--|
| <b>Recording media</b>          | SD Memory Card/SDHC Memory Card*/<br>SDXC Memory Card*<br>* UHS-I UHS Speed Class 3                                    |
| <b>Recording file format</b>    |  |
| <b>Still picture</b>            | RAW/JPEG (based on Design rule for Camera File system, based on Exif 2.3 standard/DPOF corresponding)                  |
| <b>Motion picture</b>           | AVCHD Progressive/AVCHD/MP4  |
| <b>Audio compression format</b> | AVCHD: Dolby® Digital (2 ch)<br>MP4: AAC (2 ch)  |
| <b>Interface</b>                |  |
| <b>Digital</b>                  | USB 2.0 (High Speed)   |
| <b>Terminal</b>                 |  |
| <b>[HDMI]</b>                   | Micro HDMI Type D  |
| <b>[USB/CHARGE]</b>             | USB 2.0 micro-B  |
| <b>Dimensions</b>               | Approx. 105.5 mm (W) x 60 mm (H) x 42 mm (D)<br>[4.15" (W) x 2.36" (H) x 1.65" (D)]<br>(excluding the projection part) |
| <b>Mass (weight)</b>            | With card and battery: Approx. 310 g (0.68 lb)<br>Excluding card and battery: Approx. 280 g (0.62 lb)                  |
| <b>Operating temperature</b>    | 0 °C to 40 °C (32 °F to 104 °F)  |
| <b>Operating humidity</b>       | 10%RH to 80%RH   |
| <b>Language select</b>          | [ENGLISH] / [DEUTSCH] / [FRANÇAIS] / [ESPAÑOL] /<br>[PORTUGUÊS] / [ITALIANO] / [繁體中文] / [日本語]                          |

## ■ Wi-Fi

|   |   |
|---|---|
| <b>Compliance standard</b>                      | IEEE 802.11b/g/n (standard wireless LAN protocol) |
| <b>Frequency range used (central frequency)</b> | 2412 MHz to 2462 MHz (1 to 11 ch)                 |
| <b>Encryption method</b>                        | Wi-Fi compliant WPA™/WPA2™                        |
| <b>Access method</b>                            | Infrastructure mode                               |

## ■ AC adaptor

(Panasonic SAE0012A): Information for your safety

|                |                                |
|----------------|--------------------------------|
| <b>Input:</b>  | 110 V – 240 V ~ 50/60 Hz 0.2 A |
| <b>Output:</b> | 5 V === 1.0 A                  |

## ■ Battery pack (lithium-ion)

(Panasonic DMW-BLH7PP): Information for your safety

|                          |               |
|--------------------------|---------------|
| <b>Voltage/capacity:</b> | 7.2 V/680 mAh |
|--------------------------|---------------|

The symbols on this product (including the accessories) represent the following:

|  |   |
|--|---|
| ~  | AC  |
| ===  | DC  |
|  | Class II equipment (The construction of the product is double-insulated.) |

Specifications are subject to change without notice.

## Digital Camera Accessory System

|                                 |  |
|---------------------------------|--|
| <b>Battery pack</b><br>DMW-BLH7 | The battery pack can be charged from the camera using the AC adaptor (supplied).   |
| <b>AC adaptor</b><br>DMW-AC10   | By using the AC adaptor (DMW-AC10: optional) and DC coupler (DMW-DCC15A: optional), you can record and play back without worrying about the remaining battery charge.  |
| <b>DC coupler</b><br>DMW-DCC15A | <ul style="list-style-type: none"> <li>• The optional DC coupler (DMW-DCC15) cannot be used. The AC adaptor (optional) can only be used with the designated Panasonic DC coupler (optional). The AC adaptor (optional) cannot be used by itself.</li> <li>• When using an AC adaptor (optional), use the AC cable supplied with the AC adaptor.</li> </ul> |

- Part numbers are as of October 2016. These may be subject to change.
- Some optional accessories may not be available in some countries.
- (For U.S.A. only)  
To order optional accessories please visit <http://shop.panasonic.com> or your local Photo Specialty Dealer.

## Limited Warranty (ONLY FOR U.S.A.)

### Panasonic Products Limited Warranty

#### Limited Warranty Coverage (For USA Only)

If your product does not work properly because of a defect in materials or workmanship, Panasonic Corporation of North America (referred to as “the warrantor”) will, for the length of the period indicated on the chart below, which starts with the date of original purchase (“warranty period”), at its option either (a) repair your product with new or refurbished parts, (b) replace it with a new or a refurbished equivalent value product, or (c) refund your purchase price. The decision to repair, replace or refund will be made by the warrantor.

| Product or Part Name  | Parts   | Labor          |
|---|---------|----------------|
| Digital Camera  | 1 Year  | 1 Year         |
| All included Accessories<br>(Except Non-Rechargeable Batteries) | 90 Days | Not Applicable |
| Only Non-Rechargeable Batteries                                 | 10 Days | Not Applicable |

During the “Labor” warranty period there will be no charge for labor. During the “Parts” warranty period, there will be no charge for parts. This Limited Warranty excludes both parts and labor for non-rechargeable batteries, antennas, and cosmetic parts (cabinet). This warranty only applies to products purchased and serviced in the United States. This warranty is extended only to the original purchaser of a new product which was not sold “as is”.



---

## Mail-In Service--Online Repair Request

### Online Repair Request

To submit a new repair request and for quick repair status visit our Web Site at <http://shop.panasonic.com/support>.

When shipping the unit, carefully pack, include all supplied accessories listed in the Owner's Manual, and send it prepaid, adequately insured and packed well in a carton box. When shipping Lithium Ion batteries please visit our Web Site at <http://shop.panasonic.com/support> as Panasonic is committed to providing the most up to date information. Include a letter detailing the complaint, a return address and provide a daytime phone number where you can be reached. A valid registered receipt is required under the Limited Warranty.

**IF REPAIR IS NEEDED DURING THE WARRANTY PERIOD, THE PURCHASER WILL BE REQUIRED TO FURNISH A SALES RECEIPT/PROOF OF PURCHASE INDICATING DATE OF PURCHASE, AMOUNT PAID AND PLACE OF PURCHASE. CUSTOMER WILL BE CHARGED FOR THE REPAIR OF ANY UNIT RECEIVED WITHOUT SUCH PROOF OF PURCHASE.**

### **Limited Warranty Limits and Exclusions**

This warranty ONLY COVERS failures due to defects in materials or workmanship, and DOES NOT COVER normal wear and tear or cosmetic damage. The warranty ALSO DOES NOT COVER damages which occurred in shipment, or failures which are caused by products not supplied by the warrantor, or failures which result from accidents, misuse, abuse, neglect, mishandling, misapplication, alteration, faulty installation, set-up adjustments, misadjustment of consumer controls, improper maintenance, power line surge, lightning damage, modification, introduction of sand, humidity or liquids, commercial use such as hotel, office, restaurant, or other business or rental use of the product, or service by anyone other than a Factory Service Center or other Authorized Servicer, or damage that is attributable to acts of God.

**THERE ARE NO EXPRESS WARRANTIES EXCEPT AS LISTED UNDER “LIMITED WARRANTY COVERAGE”.**

**THE WARRANTOR IS NOT LIABLE FOR INCIDENTAL OR CONSEQUENTIAL DAMAGES RESULTING FROM THE USE OF THIS PRODUCT, OR ARISING OUT OF ANY BREACH OF THIS WARRANTY.**

(As examples, this excludes damages for lost time, travel to and from the servicer, loss of or damage to media or images, data or other memory or recorded content. The items listed are not exclusive, but for illustration only.)

**ALL EXPRESS AND IMPLIED WARRANTIES, INCLUDING THE WARRANTY OF MERCHANTABILITY, ARE LIMITED TO THE PERIOD OF THE LIMITED WARRANTY.**

Some states do not allow the exclusion or limitation of incidental or consequential damages, or limitations on how long an implied warranty lasts, so the exclusions may not apply to you.

This warranty gives you specific legal rights and you may also have other rights which vary from state to state. If a problem with this product develops during or after the warranty period, you may contact your dealer or Service Center. If the problem is not handled to your satisfaction, then write to:

Consumer Affairs Department  
Panasonic Corporation of North America  
661 Independence Pkwy  
Chesapeake, VA 23320

**PARTS AND SERVICE, WHICH ARE NOT COVERED BY THIS LIMITED WARRANTY, ARE YOUR RESPONSIBILITY.**

# **Shop** **Accessories!**

for all your Panasonic gear

Go to

<http://shop.panasonic.com/support>

Get everything you need to get the most out of your Panasonic products  
Accessories & Parts for your Camera, Phone, A/V products, TV,  
Computers & Networking, Personal Care, Home Appliances, Headphones,  
Batteries, Backup Chargers & more...

## **Customer Services Directory**

For Product Information, Operating Assistance, Parts, Owner's Manuals,  
Dealer and Service info go to <http://shop.panasonic.com/support>

For the hearing or speech impaired TTY: 1- 877-833-8855

**As of July 2015**

## Limited Warranty (ONLY FOR CANADA)

### Panasonic Canada Inc.

5770 Ambler Drive, Mississauga, Ontario L4W 2T3

### PANASONIC PRODUCT – LIMITED WARRANTY

Panasonic Canada Inc. warrants this product to be free from defects in material and workmanship under normal use and for a period as stated below from the date of original purchase agrees to, at its option either (a) repair your product with new or refurbished parts, (b) replace it with a new or a refurbished equivalent value product, or (c) refund your purchase price. The decision to repair, replace or refund will be made by Panasonic Canada Inc.

|                                   |   |
|-----------------------------------|---|
| <b>Digital Camera</b>             | <b>One (1) year, parts and labour</b>     |
| <b>Digital Camera Peripherals</b> | <b>One (1) year, parts and labour</b>     |
| <b>Digital Camera Accessories</b> | <b>Ninety (90) days, parts and labour</b> |

This warranty is given only to the original purchaser, or the person for whom it was purchased as a gift, of a Panasonic brand product mentioned above sold by an authorized Panasonic dealer in Canada and purchased and used in Canada, which product was not sold “as is”, and which product was delivered to you in new condition in the original packaging.

**IN ORDER TO BE ELIGIBLE TO RECEIVE WARRANTY SERVICE  
HEREUNDER, A PURCHASE RECEIPT OR OTHER PROOF OF DATE  
OF ORIGINAL PURCHASE, SHOWING AMOUNT PAID AND PLACE OF  
PURCHASE IS REQUIRED**

## **LIMITATIONS AND EXCLUSIONS**

This warranty **ONLY COVERS** failures due to defects in materials or workmanship, and **DOES NOT COVER** normal wear and tear or cosmetic damage. The warranty **ALSO DOES NOT COVER** damages which occurred in shipment, or failures which are caused by products not supplied by Panasonic Canada Inc., or failures which result from accidents, misuse, abuse, neglect, mishandling, misapplication, alteration, faulty installation, set-up adjustments, misadjustment of consumer controls, improper maintenance, improper batteries, power line surge, lightning damage, modification, introduction of sand, humidity or liquids, commercial use such as hotel, office, restaurant, or other business or rental use of the product, or service by anyone other than a Authorized Servicer, or damage that is attributable to acts of God.

Dry cell batteries, printer ink cartridge and paper are also excluded from coverage under this warranty.

Rechargeable batteries are warranted for ninety (90) days from date of original purchase.

THIS EXPRESS, LIMITED WARRANTY IS IN LIEU OF ALL OTHER WARRANTIES, EXPRESS OR IMPLIED, INCLUDING ANY IMPLIED WARRANTIES OF MERCHANTABILITY AND FITNESS FOR A PARTICULAR PURPOSE. IN NO EVENT WILL PANASONIC CANADA INC. BE LIABLE FOR ANY SPECIAL, INDIRECT OR CONSEQUENTIAL DAMAGES RESULTING FROM THE USE OF THIS PRODUCT OR ARISING OUT OF ANY BREACH OF ANY EXPRESS OR IMPLIED WARRANTY. (As examples, this warranty excludes damages for lost time, travel to and from the Authorized Servicer, loss of or damage to media or images, data or other memory or recorded content. This list of items is not exhaustive, but for illustration only.)

In certain instances, some jurisdictions do not allow the exclusion or limitation of incidental or consequential damages, or the exclusion of implied warranties, so the above limitations and exclusions may not be applicable. This warranty gives you specific legal rights and you may have other rights which vary depending on your province or territory.

## **WARRANTY SERVICE**

For product operation, repairs and information assistance, please visit our Support page :

[www.panasonic.ca/english/support](http://www.panasonic.ca/english/support)

- SDXC Logo is a trademark of SD-3C, LLC.
- The terms HDMI and HDMI High-Definition Multimedia Interface, and the HDMI Logo are trademarks or registered trademarks of HDMI Licensing, LLC in the United States and other countries.
- HDAVI Control™ is a trademark of Panasonic Corporation.
- “AVCHD”, “AVCHD Progressive” and the “AVCHD Progressive” logo are trademarks of Panasonic Corporation and Sony Corporation.
- Manufactured under license from Dolby Laboratories. Dolby and the double-D symbol are trademarks of Dolby Laboratories.
- Pentium is a trademark of Intel Corporation in the U.S. and/or other countries.
- Windows is either registered trademark or trademark of Microsoft Corporation in the United States and/or other countries.
- iMovie, Mac and Mac OS are trademarks of Apple Inc., registered in the U.S. and other countries.
- iPad, iPhone, iPod, and iPod touch are trademarks of Apple Inc., registered in the U.S. and other countries.
- App Store is a service mark of Apple Inc.
- Android and Google Play are trademarks or registered trademarks of Google Inc.
- The Wi-Fi CERTIFIED™ Logo is a certification mark of Wi-Fi Alliance®.
- The Wi-Fi Protected Setup™ Identifier mark is a certification mark of Wi-Fi Alliance®.
- “Wi-Fi®” and “Wi-Fi Direct®” are registered trademarks of Wi-Fi Alliance®.
- “Wi-Fi Protected Setup™”, “WPA™”, and “WPA2™” are trademarks of Wi-Fi Alliance®.
- DLNA, the DLNA Logo and DLNA CERTIFIED are trademarks, service marks, or certification marks of the Digital Living Network Alliance.
- QR Code is a registered trademark of DENSO WAVE INCORPORATED.
- This product uses “DynaFont” from DynaComware Corporation. DynaFont is a registered trademark of DynaComware Taiwan Inc.
- Other names, company names, and product names mentioned in these instructions are trademarks or registered trademarks of the companies concerned.



**WiFi**  
**CERTIFIED**

**PictBridge**



**Panasonic Corporation of North America**

Two Riverfront Plaza, Newark, NJ 07102-5490

**<http://shop.panasonic.com>**

**Panasonic Canada Inc.**

5770 Ambler Drive  
Mississauga, Ontario  
L4W 2T3

**[www.panasonic.com](http://www.panasonic.com)**

© Panasonic Corporation 2016

Printed in China