

Panasonic[®]

Operating Instructions

Digital Camera

Model No. **DMC-LX3**

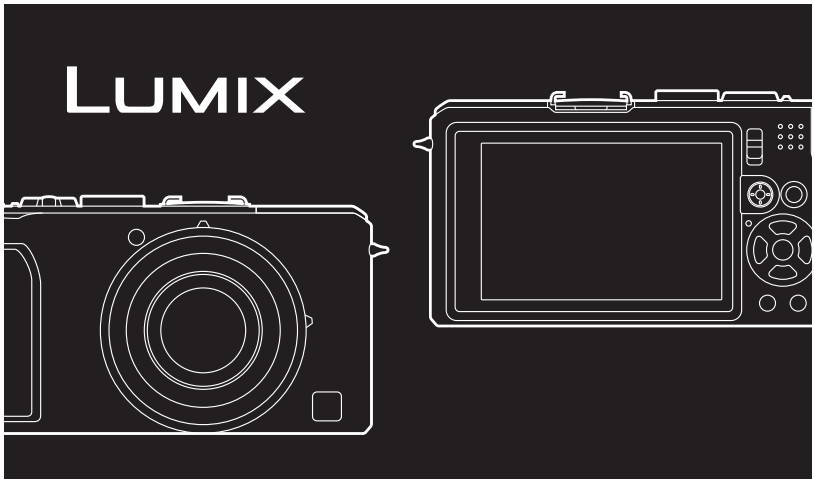
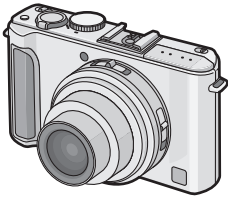

Before connecting, operating or adjusting this product,
please read the instructions completely.



For USA assistance, please call: 1-800-211-PANA(7262) or, contact us via the web at: <http://www.panasonic.com/contactinfo>

For Canadian assistance, please call: 1-800-99-LUMIX (1-800-995-8649) or
send e-mail to: lumixconcierge@ca.panasonic.com

**Dear Customer,
Thank you for choosing Panasonic!**

You have purchased one of the most sophisticated and reliable products on the market today. Used properly, we're sure it will bring you and your family years of enjoyment. Please take time to fill in the information on the below.

The serial number is on the tag located on the underside of your Camera. Be sure to **retain this manual** as your convenient Camera information source.

Model No. _____

Serial No. _____



A lithium ion battery that is recyclable powers the product you have purchased. Please call 1-800-8-BATTERY for information on how to recycle this battery.

Information for Your Safety

WARNING:

TO REDUCE THE RISK OF FIRE, ELECTRIC SHOCK OR PRODUCT DAMAGE,

- DO NOT EXPOSE THIS APPARATUS TO RAIN, MOISTURE, DRIPPING OR SPLASHING AND THAT NO OBJECTS FILLED WITH LIQUIDS, SUCH AS VASES, SHALL BE PLACED ON THE APPARATUS.

- USE ONLY THE RECOMMENDED ACCESSORIES.

- DO NOT REMOVE THE COVER (OR BACK); THERE ARE NO USER SERVICEABLE PARTS INSIDE. REFER SERVICING TO QUALIFIED SERVICE PERSONNEL.

Carefully observe copyright laws.

Recording of pre-recorded tapes or discs or other published or broadcast material for purposes other than your own private use may infringe copyright laws. Even for the purpose of private use, recording of certain material may be restricted.

- Please note that the actual controls and components, menu items, etc. of your Digital Camera may look somewhat different from those shown in the illustrations in these Operating Instructions.
- SDHC Logo is a trademark.
- Microsoft product screen shot(s) reprinted with permission from Microsoft Corporation.
- Other names, company names, and product names printed in these instructions are trademarks or registered trademarks of the companies concerned.

THE SOCKET OUTLET SHALL BE INSTALLED NEAR THE EQUIPMENT AND SHALL BE EASILY ACCESSIBLE.

CAUTION

Danger of explosion if battery is incorrectly replaced. Replace only with the same or equivalent type recommended by the manufacturer. Dispose of used batteries according to the manufacturer's instructions.

Warning

Risk of fire, explosion and burns. Do not disassemble, heat above 60 °C (140 °F) or incinerate.

Product Identification Marking is located on the bottom of units.

THE FOLLOWING APPLIES ONLY IN CANADA.

This Class B digital apparatus complies with Canadian ICES-003.

THE FOLLOWING APPLIES ONLY IN THE U.S.A.**FCC Note:**

This equipment has been tested and found to comply with the limits for a Class B digital device, pursuant to Part 15 of the FCC Rules. These limits are designed to provide reasonable protection against harmful interference in a residential installation. This equipment generates, uses, and can radiate radio frequency energy and, if not installed and used in accordance with the instructions, may cause harmful interference to radio communications. However, there is no guarantee that interference will not occur in a particular installation. If this equipment does cause harmful interference to radio or television reception, which can be determined by turning the equipment off and on, the user is encouraged to try to correct the interference by one or more of the following measures:

- Reorient or relocate the receiving antenna.
- Increase the separation between the equipment and receiver.
- Connect the equipment into an outlet on a circuit different from that to which the receiver is connected.
- Consult the dealer or an experienced radio/TV technician for help.

FCC Caution: To assure continued compliance, follow the attached installation instructions and use only shielded interface cables with ferrite core when connecting to computer or peripheral devices.

Any changes or modifications not expressly approved by the party responsible for compliance could void the user's authority to operate this equipment.

Declaration of Conformity

Trade Name: Panasonic

Model No.: DMC-LX3

Responsible party: Panasonic Corporation of North America One Panasonic Way,
Secaucus, NJ 07094

Support Contact: Panasonic Consumer Electronics Company 1-800-211-PANA (7262)

This device complies with Part 15 of the FCC Rules. Operation is subject to the following two conditions: (1) This device may not cause harmful interference, and (2) this device must accept any interference received, including interference that may cause undesired operation.



-If you see this symbol-

Information on Disposal in other Countries outside the European Union

This symbol is only valid in the European Union.

If you wish to discard this product, please contact your local authorities or dealer and ask for the correct method of disposal.



■ About the battery pack

CAUTION

Battery pack (Lithium ion battery pack)

- Use the specified unit to recharge the battery pack.
- Do not use the battery pack with equipment other than the specified unit.
- Do not get dirt, sand, liquids, or other foreign matter on the terminals.
- Do not touch the plug terminals (+ and -) with metal objects.
- Do not disassemble, remodel, heat or throw into fire.

If any electrolyte should come into contact with your hands or clothes, wash it off thoroughly with water.

If any electrolyte should come into contact with your eyes, never rub the eyes. Rinse eyes thoroughly with water, and then consult a doctor.

- Do not heat or expose to flame.
- Do not leave the battery(ies) in an automobile exposed to direct sunlight for a long period of time with doors and windows closed.

■ About the battery charger

CAUTION!

DO NOT INSTALL OR PLACE THIS UNIT IN A BOOKCASE, BUILT-IN CABINET OR IN ANOTHER CONFINED SPACE. ENSURE THE UNIT IS WELL VENTILATED. TO PREVENT RISK OF ELECTRIC SHOCK OR FIRE HAZARD DUE TO OVERHEATING, ENSURE THAT CURTAINS AND ANY OTHER MATERIALS DO NOT OBSTRUCT THE VENTILATION VENTS.

Battery charger

This battery charger operates on AC between 110 V and 240 V.

But

- In the U.S.A. and Canada, the battery charger must be connected to a 120 V AC power supply only.
- When connecting to an AC supply outside of the U.S.A. or Canada, use a plug adaptor to suit the AC outlet configuration.

■ Care of the camera

• Do not strongly shake or bump the camera by dropping it etc.

This unit may malfunction, recording pictures may no longer be possible or the lens or the LCD monitor may be damaged.

- We strongly recommend you do not leave the camera in your pants pocket when you sit down or forcefully insert it into a full or tight bag etc. Damage to the LCD monitor or personal injury may result.

• Be particularly careful in the following places as they may cause this unit to malfunction.

- Places with a lot of sand or dust.
- Places where water can come into contact with this unit such as when using it on a rainy day or on a beach.
- Do not touch the lens or the sockets with dirty hands. Also, be careful not to allow liquids, sand and other foreign matter to get into the space around the lens, buttons etc.
- If water or seawater splashes on the camera, use a dry cloth to wipe the camera body carefully.



■ About Condensation (When the lens is fogged up)

- Condensation occurs when the ambient temperature or humidity changes. Be careful of condensation since it causes lens stains, fungus and camera malfunction.
- If condensation occurs, turn the camera off and leave it for about 2 hours. The fog will disappear naturally when the temperature of the camera becomes close to the ambient temperature.

■ Read together with the “Cautions for Use”. (P126)

Contents

Before Use

Information for Your Safety	2
Quick Guide	8
Standard Accessories	9
Names of the Components	10
Attaching the Lens Cap/Strap	13

Preparation





















Charging the Battery	15
About the Battery (charging/number of recordable pictures)	16
Inserting and Removing the Card (optional)/the Battery	17
About the Built-in Memory/the Card	18
Setting Date/Time (Clock Set)	19
• Changing the clock setting	20
Setting the Menu	20
• Setting menu items	21
• Using the quick menu	23
About the Setup Menu	23
Selecting the [REC] Mode	29
• Select the Aspect Ratio	31

Basic

Taking pictures with your favorite settings (Program AE mode)	32
• Focusing	33
• When the subject is not in focus (such as when it is not in the center of the composition of the picture you want to take)	33
• Preventing jitter (camera shake)	34
• Direction detection function	34
• Enlarge the focus point at the center (display focus point)	34
• Program shift	34
Taking pictures using the automatic function (Intelligent Auto Mode)	35
• Scene detection	36
• AF Tracking Function	37
• About the flash	37
• Settings in Intelligent auto mode	37
Taking Pictures with the Zoom	38
• Using the Optical Zoom/ Using the Extended Optical Zoom (EZ)/Using the Digital Zoom	38
Playing back Pictures ([NORMAL PLAY])	40
• Confirm the picture in [REC] mode (Review)	40
• Displaying Multiple Screens	

(Multi Playback)	41
• Using the Playback Zoom	41
• Switching the [PLAYBACK] mode	42
Deleting Pictures	42
• To delete a single picture	42
• To delete multiple pictures (up to 50) or all the pictures	43

Advanced (Recording pictures)

About the LCD Monitor	44
Taking Pictures using the Built-in Flash	46
• Switching to the appropriate flash setting	46
Taking Close-up Pictures	49
Taking Pictures with the Self-timer	50
Compensating the Exposure	51
Taking Pictures using Auto Bracket/Multi Aspect	52
• Auto Bracket	52
• Multi Aspect	53
Taking Pictures using Burst Mode	54
Taking pictures by specifying the aperture/shutter speed	55
• Aperture-priority AE	55
• Shutter-priority AE	55
Taking picture by setting the exposure manually	56
Aperture Value and Shutter Speed	57
Taking Pictures with Manual Focus	58
• MF ASSIST	58
Registering Personal Menu Settings (Registering custom settings)	60
Taking pictures in Custom mode	61
Taking pictures that match the scene being recorded (Scene mode)	62
•  [PORTRAIT]	62
•  [SOFT SKIN]	63
•  [SELF PORTRAIT]	63
•  [SCENERY]	63
•  [SPORTS]	64
•  [NIGHT PORTRAIT]	64
•  [NIGHT SCENERY]	64
•  [FOOD]	64
•  [PARTY]	65
•  [CANDLE LIGHT]	65
•  [BABY1] /  [BABY2]	65
•  [PET]	66
•  [SUNSET]	66
•  [HIGH SENS.]	66
•  [HI-SPEED BURST]	66
•  [FLASH BURST]	67
•  [STARRY SKY]	67
•  [FIREWORKS]	68
•  [BEACH]	68
•  [SNOW]	68

• [AERIAL PHOTO]	68
• [PIN HOLE]	69
• [FILM GRAIN]	69
Motion Picture Mode	70
Useful Functions at Travel	
Destinations	71
• Recording which Day of the Vacation and the Location of the Vacation	71
• Recording Dates/Times at Overseas Travel Destinations (World Time)	73
Using the [REC] Mode Menu	74
• [FILM MODE]	74
• [PICTURE SIZE]	76
• [QUALITY]	77
• [INTELLIGENT ISO]	78
• [SENSITIVITY]	78
• [ISO LIMIT SET]	79
• [WHITE BALANCE]	79
• [METERING MODE]	81
• [AF MODE]	82
• [PRE AF]	84
• [AF/AE LOCK]	84
• [I.EXPOSURE]	85
• [MULTI. EXPO.]	85
• [DIGITAL ZOOM]	87
• [STABILIZER]	87
• [MIN. SHTR SPEED]	88
• [AUDIO REC.]	88
• [AF ASSIST LAMP]	88
• [FLASH SYNCHRO]	89
• [EXT. VIEWFINDER]	89
• [CONVERSION]	90
• [CLOCK SET]	90

Advanced (Playback)

Playing Back Pictures on the Dual Display (Dual Play)	91
Playing Back Pictures in Sequence (Slide Show)	92
Selecting Pictures and Playing them Back ([CATEGORY PLAY]/ [FAVORITE PLAY])	94
• [CATEGORY PLAY]	94
• [FAVORITE PLAY]	95
Playing Back Motion Pictures/ Pictures with Audio	95
• Motion pictures	95
• Pictures with audio	95
Creating still pictures from a motion picture	96
Using the [PLAYBACK] mode menu	97
• [CALENDAR]	97
• [TITLE EDIT]	98
• [TEXT STAMP]	99

• [RESIZE]	101
• [TRIMMING]	102
• [LEVELING]	103
• [ASPECT CONV.]	103
• [ROTATE]/ [ROTATE DISP.]	104
• [FAVORITE]	105
• [DPOF PRINT]	106
• [PROTECT]	107
• [AUDIO DUB.]	108
• [COPY]	108

Connecting to other equipment

Connecting to a PC	110
Printing the Pictures	112
• Selecting a single picture and printing it	114
• Selecting multiple pictures and printing them	114
• Print Settings	115
Playing Back Pictures on a TV Screen	116
• Playing back pictures using the AV cable (supplied)	116
• Playing back pictures on a TV with an SD Memory Card slot	117
• Playing back on the TV with component socket	118
Using the Conversion Lens (optional) ..	119
Using the Protector/Filter	120
Using the External Flash (optional) ..	121
Using External Viewfinder (optional) ..	123

Others

Screen Display	124
Cautions for Use	126
Message Display	128
Functions that cannot be set or will not work under some conditions	130
Troubleshooting	134
Number of Recordable Pictures and Available Recording Time	142
Specifications	146
Digital Camera Accessory System	150
Digital Camera Accessory Order Form (For USA Customers)	151
Request for Service Notice (For USA Only)	152
Limited Warranty (For USA Only)	153
Customer Services Directory (For USA Only)	155
Précautions à prendre (pour le Canada)	156
Index	158

Quick Guide

This is an overview of how to record and play back pictures with the camera. For each step, be sure to refer to the pages indicated in brackets.

1 Charge the battery. (P15)

- The battery is not charged when the camera is shipped. Charge the battery before use.

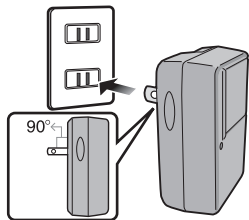

2 Insert the battery and the card. (P17)

- When you do not use the card, you can record or play back pictures on the built-in memory. (P18) Refer to P18 when you use a card.

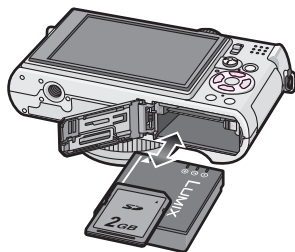

3 Turn the camera on to take pictures.

- 1 Slide the [REC]/[PLAYBACK] selector switch to [RECORD].
- 2 Press the shutter button to take pictures. (P32)

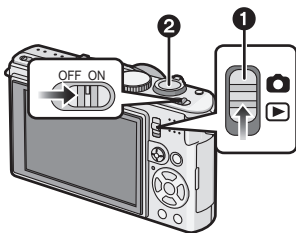

4 Play back the pictures.

- 1 Slide the [REC]/[PLAYBACK] selector switch to [PLAYBACK].
- 2 Select the picture you want to view. (P40)

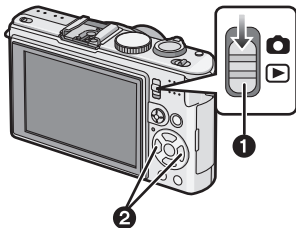

Standard Accessories

Check that all the accessories are included before using the camera.

- 1 Battery Pack
(Indicated as **battery** in the text)
Charge the battery before use.
 - 2 Battery Charger
(Indicated as **charger** in the text)
 - 3 USB Connection Cable
 - 4 AV Cable
 - 5 CD-ROM
 - Software:
Use it to install the software to your PC.
 - 6 Shoulder Strap
 - 7 Battery Carrying Case
 - 8 Lens Cap
 - Ⓐ: Black
 - Ⓑ: Silver (DMC-LX3P) U.S. version
 - 9 Lens Cap String
- SD Memory Card, SDHC Memory Card and MultiMediaCard are indicated as **card** in the text.
 - **The card is optional.**
You can record or play back pictures on the built-in memory when you are not using a card.
 - For information about optional accessories, refer to the “Digital Camera Accessory System”. (P150)
 - If any accessories are lost, customers in the USA should contact Panasonic’s parts department at 1 800 833-9626 and customers in Canada should contact 1 800 99-LUMIX (1-800-995-8649) for further information about obtaining replacement parts.

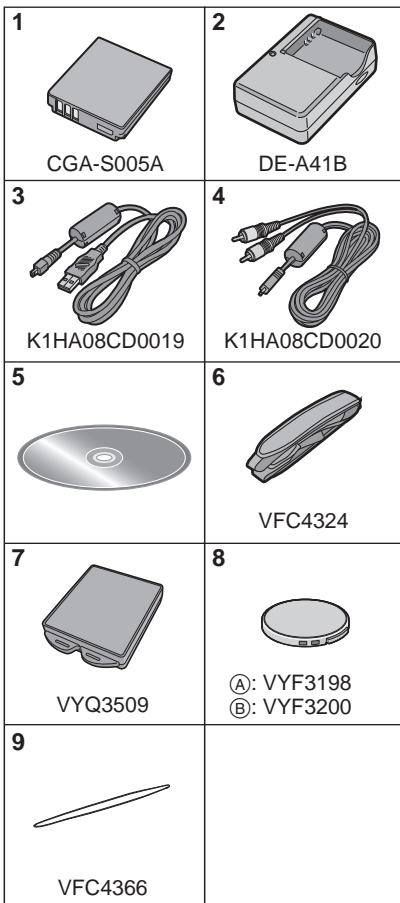

Names of the Components

- 1 Lens (P5, 127)
- 2 Self-timer indicator (P50)
AF assist lamp (P88)
- 3 Flash (P46)
- 4 Strap eyelet (P13)
 - Be sure to attach the strap when using the camera to ensure that you will not drop it.
- 5 Focus selector switch (P49, 58)

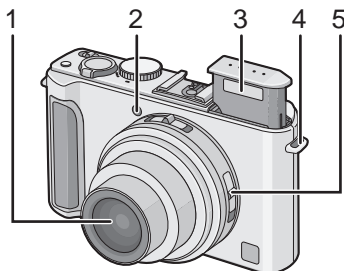

- 6 LCD monitor (P44, 124)
- 7 Joystick (P23, 34, 55, 56, 58)

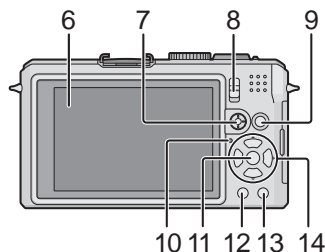

The joystick is operated in two different ways: it can be moved in the up, down, left and right directions to perform an operation, or it can be pressed to select. In these operating instructions, it is pictured as shown in the figure below or described with ▲/▼/◀/▶.

Example: When the joystick is moved toward ◀ (left)
Place your finger on the right side of the joystick, and move the joystick toward the left.

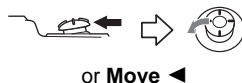

Push the joystick straight in.



- 8 [REC]/[PLAYBACK] selector switch (P21)
- 9 [AF/AE LOCK] button (P84)
- 10 Status indicator (P18, 26, 32)
- 11 [MENU/SET] button (P19)

- 12 [DISPLAY] button (P42)
 13 Delete button (P42)/
 Single or burst mode button (P54)
 14 Cursor buttons
 ◀/Self-timer button (P50)
 ▼Function button (P24)
 Assign [REC] Mode Menu to ▼ button. It is convenient to register [REC] Mode Menu that is used often.
 [REVIEW]/[FILM MODE]/[SENSITIVITY]/[WHITE BALANCE]/[METERING MODE]/
 [AF MODE]/[I.EXPOSURE]
 ▶/Flash setting button (P46)
 ▲/Exposure compensation (P51)/
 Auto bracket (P52)/Multi aspect (P53)/Flash output adjustment (P48)

In these operating instructions, the cursor buttons are described as shown in the figure below or described with ▲/▼/◀/▶.
 e.g.: When you press the ▼ (down) button

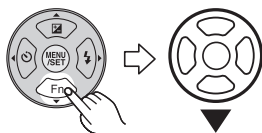

or

Press ▼

- 15 Aspect ratio selector switch (P31, 70)
 16 Microphone (P70, 88, 108)
 17 Speaker (P95)
 18 Zoom lever (P38)
 19 [FOCUS] button (P34, 37, 59, 83)
 20 Flash open button (P46)
 21 Hot Shoe (P121, 123)
 22 Mode dial (P29)
 23 Shutter button (P32, 70)
 24 Camera ON/OFF switch (P19)
 25 [COMPONENT OUT] socket (P118)
 26 [AV OUT/DIGITAL] socket (P110, 112, 116)
 27 [DC IN] socket (P110, 112)
 • Always use a genuine Panasonic AC adaptor (DMW-AC5PP; optional).
 • This camera cannot charge the battery even when the AC adaptor (DMW-AC5PP; optional) is connected to it.
 28 Terminal door
 29 Lens ring front (P119, 120)
 30 Lens barrel

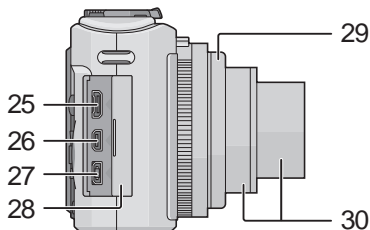
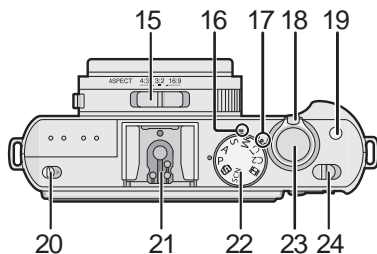

- 31 Tripod receptacle
 - When you use a tripod, make sure the tripod is stable when the camera is attached to it.
- 32 Card/Battery door (P17)
- 33 Release lever (P17)

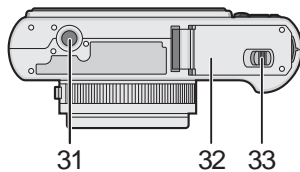

Attaching the Lens Cap/Strap

■ Lens Cap

- When you turn the camera off, carry the camera or play back the pictures, attach the lens cap to protect the surface of the lens.

1 Pass the string through the hole on the lens cap.

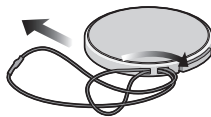

2 Pass the same string through the hole on the camera.

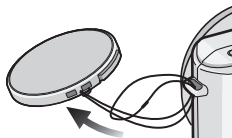

3 Attach the lens cap.

- Detach the lens cap before turning on the camera in the recording mode.
- Do not hang or swing around this unit with the lens cap string attached.
- Be careful not to lose the lens cap.

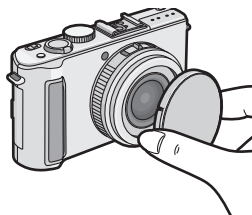

■ Strap

- We recommend attaching the strap when using the camera to prevent it from dropping.

1 Pass the strap through the hole at the strap eyelet.

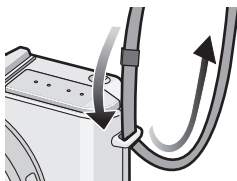

2 Pass the strap through the ring first, and then pass through the stopper and fasten the strap.

- (A) Pull the strap 2 cm (0.07 feet) or more.
- Attach the strap to the other side of the camera being careful not to twist it.
 - Check that the strap is firmly attached to the camera.
 - Attach the strap so that the "LUMIX" LOGO is on the outside.

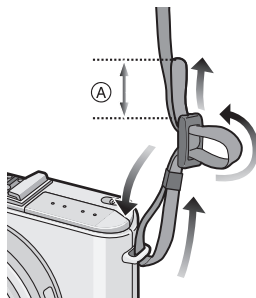

Charging the Battery

- Use the dedicated charger and battery.
- The battery is not charged when the camera is shipped. Charge the battery before use.
- Charge the battery with the charger indoors.
- Charge the battery in a temperature between 10 °C to 35 °C (50 °F to 95 °F). (The battery temperature should also be the same.)

- 1** Attach the battery with attention to the direction of the battery.

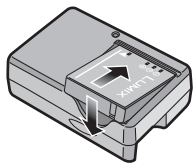

- 2** Connect the charger to the electrical outlet.

- Charging starts when the [CHARGE] indicator (A) lights green.

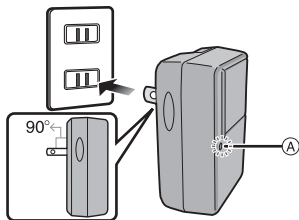

- 3** Detach the battery after charging is completed.

- Charging is complete when the [CHARGE] indicator (A) turns off (after approx. 130 min maximum).

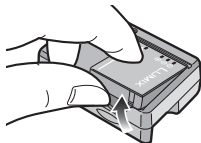

■ When the [CHARGE] indicator flashes

- The battery temperature is excessively high or low. The charging time will be longer than normal. Also, charging may not be completed.
- The terminals of the charger or the battery are dirty. In this case, wipe them with a dry cloth.

🔧 Note

- After charging is completed, be sure to disconnect the power supply device from the electrical outlet.
- The battery becomes warm after using it and during and after charging. The camera also becomes warm during use. This is not a malfunction.
- The battery will be exhausted if left for a long period of time after being charged.
- The battery can be recharged even when it still has some charge left, but it is not recommended that the battery charge be frequently topped up while the battery is fully charged. (The battery has characteristics that will reduce its operating duration and cause the battery to swell up.)
- When the operating time of the camera becomes extremely short even after properly charging the battery, the life of the battery may have expired. Buy a new battery.

- Do not leave any metal items (such as clips) near the contact areas of the power plug. Otherwise, a fire and/or electric shocks may be caused by short-circuiting or the resulting heat generated.

About the Battery (charging/number of recordable pictures)

■ Battery indication

The battery indication is displayed on the LCD monitor.

[It does not appear when you use the camera with the AC adaptor (DMW-AC5PP; optional) connected.]



- The indication turns red and blinks if the remaining battery power is exhausted. (The status indicator blinks when the LCD monitor turns off.) Recharge the battery or replace it with a fully charged battery.

■ The battery life

Number of recordable pictures	Approx. 380 pictures	(By CIPA standard in program AE mode)
Recording time	Approx. 190 min	

Recording conditions by CIPA standard

- CIPA is an abbreviation of [Camera & Imaging Products Association].
 - Temperature: 23 °C (73.4 °F)/Humidity: 50% when LCD monitor is on.*
 - Using a Panasonic SD Memory Card (32 MB).
 - Using the supplied battery.
 - Starting recording 30 seconds after the camera is turned on. (When the optical image stabilizer function is set to [AUTO].)
 - **Recording once every 30 seconds** with full flash every second recording.
 - Rotating the zoom lever from Tele to Wide or vice versa in every recording.
 - Turning the camera off every 10 recordings and leaving it until the temperature of the battery decreases.
- * The number of recordable pictures decreases in Auto Power LCD mode and Power LCD mode. (P25)

The number of recordable pictures varies depending on the recording interval time. If the recording interval time becomes longer, the number of recordable pictures decreases. [e.g. When recording once every 2 minutes, the number of recordable pictures decreases to about 95.]

Playback time	Approx. 360 min
----------------------	------------------------

The number of recordable pictures and playback time will vary depending on the operating conditions and storing condition of the battery.

■ Charging

Charging time	Approx. 130 min maximum
----------------------	--------------------------------

Charging time and **number of recordable pictures** with the optional battery pack (CGA-S005A) are the same as above.

The **charging time** will vary slightly depending on the status of the battery and the conditions in the charging environment.

When the charging has been completed successfully, the [CHARGE] indicator turns off.

Note

- The battery may swell and its operating time may become shorter as the number of times it is charged increases. For long term battery use, we recommend you do not frequently charge the battery before it is exhausted.
- The performance of the battery may temporarily deteriorate and the operating time may become shorter in low temperature conditions (e.g. skiing/snowboarding).

Inserting and Removing the Card (optional)/the Battery

- Check that this unit is turned off.
- Close the flash.
- We recommend using a Panasonic card.

1 Slide the release lever in the direction of the arrow and open the card/battery door.

- Always use **genuine Panasonic batteries (CGA-S005A)**.
- If you use other batteries, we cannot guarantee the quality of this product.

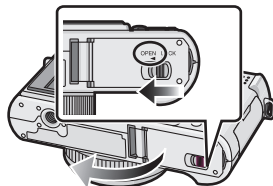

2 Battery: Insert it fully being careful about the direction you insert it. Pull the lever (A) in the direction of the arrow to remove the battery.

Card: Push it fully until it clicks being careful about the direction you insert it. To remove the card, push the card until it clicks, then pull the card out upright.

(B): Do not touch the connection terminals of the card.

- The card may be damaged if it is not fully inserted.

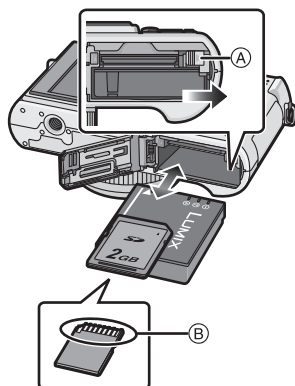

3

①: Close the card/battery door.

②: Slide the release lever in the direction of the arrow.

- If the card/battery door cannot be completely closed, remove the card, check its direction and then insert it again.

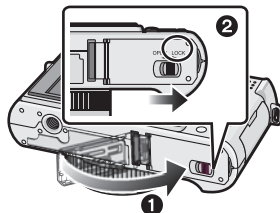



Note

- Remove the battery after use. Store the removed battery in the battery carrying case (supplied).
- Do not remove the battery until the LCD monitor and the status indicator (green) turn off as the settings on the camera may not be stored properly.
- The supplied battery is designed only for the camera. Do not use it with any other equipment.
- Before removing the card or battery, turn the camera off, and wait until the status indicator has gone off completely. (Otherwise, this unit may no longer operate normally and the card itself may be damaged or the recorded pictures may be lost.)

About the Built-in Memory/the Card

The following operations can be performed using this unit.

- **When a card has not been inserted: Pictures can be recorded in the built-in memory and played back.**
- **When a card has been inserted: Pictures can be recorded on the card and played back.**
- **When using the built-in memory**
 →  (access indication*)
- **When using the card**
 (access indication*)



- * The access indication lights red when pictures are being recorded on the built-in memory (or the card).

Built-in Memory

- **Memory size: Approx. 50 MB**
- **Recordable motion pictures: QVGA (320×240 pixels) only**
- The built-in memory can be used as a temporary storage device when the card being used becomes full.
- You can copy the recorded pictures to a card. (P108)
- The access time for the built-in memory may be longer than the access time for a card.

Card

The following types of cards can be used with this unit.
 (These cards are indicated as **card** in the text.)

Type of card	Characteristics
SD Memory Card (8 MB to 2 GB) (Formatted using the FAT12 or FAT16 format in compliance with the SD standard)	<ul style="list-style-type: none"> • Fast recording and writing speed • Write-Protect switch (A) provided (When this switch is set to the [LOCK] position, no further data writing, deletion or formatting is possible. The ability to write, delete and format data is restored when the switch is returned to its original position.)
SDHC Memory Card (4 GB, 8 GB, 16 GB, 32 GB)* (Formatted using the FAT32 format in compliance with the SD standard)	
MultiMediaCard	<ul style="list-style-type: none"> • Still pictures only.

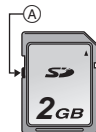

- * The SDHC Memory Card is a memory card standard decided by the SD Association in 2006 for high capacity memory cards more than 2 GB.
- * You can use an SDHC Memory Card in equipment that is compatible with SDHC Memory Cards however you cannot use an SDHC Memory Card in equipment that is only compatible with SD Memory Cards. (Always read the operating instructions for the equipment being used.)
- You can only use cards with SDHC logo (indicating compliance with the SD standard) if using cards with 4 GB or more capacity.
- Please confirm the latest information on the following website.
<http://panasonic.co.jp/pavc/global/cs>
(This Site is English only.)

Note

- Do not turn this unit off, remove its battery or card or disconnect the AC adaptor (DMW-AC5PP; optional) when the access indication is lit [when pictures are being read or deleted or the built-in memory or the card is being formatted (P28)]. Furthermore, do not subject the camera to vibration or impact. The card or the data on the card may be damaged, and this unit may no longer operate normally.
- The data on the built-in memory or the card may be damaged or lost due to electromagnetic waves, static electricity or breakdown of the camera or the card. We recommend storing important data on a PC etc.
- Do not format the card on your PC or other equipment. Format it on the camera only to ensure proper operation. (P28)
- Keep the Memory Card out of reach of children to prevent swallowing.

Setting Date/Time (Clock Set)

- The clock is not set when the camera is shipped.

1 Turn the camera on.

- The [PLEASE SET THE CLOCK] message appears. (This message does not appear in [PLAYBACK] mode.)

- (A) [MENU/SET] button
- (B) Cursor buttons

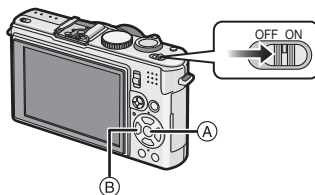

2 Press [MENU/SET].

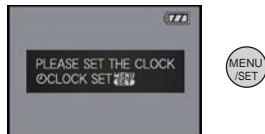

3 Press ◀/▶ to select the items (year, month, day, hour, minute, display sequence or time display format), and press ▲/▼ to set.

- (A): Time at the home area
- (B): Time at the travel destination (P73)
- ☒: Cancel without setting the clock.

- Select either [24HRS] or [AM/PM] for the time display format.
- AM/PM is displayed when [AM/PM] is selected.
- When [AM/PM] is selected as the time display format, midnight is displayed as AM 12:00 and noon is displayed as PM 12:00. This display format is common in the US and elsewhere.

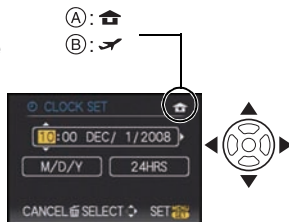

4 Press [MENU/SET] to set.

- After completing the clock settings, turn the camera off. Then turn the camera back on, switch to recording mode, and check that the display reflects the settings that were performed.
- When [MENU/SET] has been pressed to complete the settings without the clock having been set, set the clock correctly by following the “Changing the clock setting” procedure below.

Changing the clock setting

Select [CLOCK SET] in the [REC] or [SETUP] menu, and press ▶. (P21)

- It can be changed in steps 3 and 4 to set the clock.
- **The clock setting is maintained for 3 months using the built-in clock battery even without the battery. (Leave the charged battery in the unit for 24 hours to charge the built-in battery.)**

Note

- The clock is displayed when [DISPLAY] is pressed several times during recording.
- You can set the year from 2000 to 2099.
- If the clock is not set, the correct date cannot be printed when you stamp the date on the pictures with [TEXT STAMP] (P99) or order a photo studio to print the pictures.
- If the clock is set, the correct date can be printed even if the date is not displayed on the screen of the camera.

Setting the Menu

The camera comes with menus that allow you to set the settings for taking pictures and playing them back just as you like and menus that enable you to have more fun with the camera and use it more easily.

In particular, the [SETUP] menu contains some important settings relating to the camera's clock and power. Check the settings of this menu before proceeding to use the camera.

[MODE] playback mode menu (P40, 91 to 95)

- This menu lets you select the setting of the playback methods such as playback or slide show of only the pictures set as [FAVORITE].

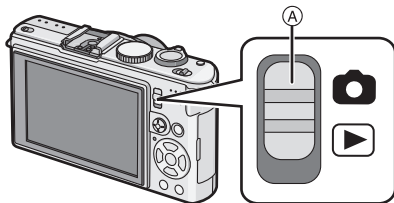
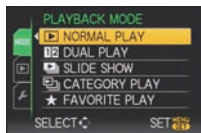

Ⓐ [REC]/[PLAYBACK] selector switch

[PLAYBACK] mode menu (P97 to 109)

- This menu lets you make the rotation, protection, trimming or DPOF settings, etc. of recorded pictures.

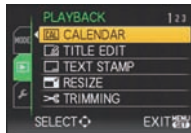

[REC] mode menu (P74 to 90)

- This menu lets you set the coloring, sensitivity, number of pixels and other aspects of the pictures you are recording.



[SETUP] menu (P23 to 29)

- This menu lets you perform the clock settings, select the operating beep tone settings and set other settings which make it easier for you to operate the camera.
- The [SETUP] menu can be set from either the [REC MODE] or [PLAYBACK MODE].

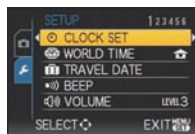

■ Functions that cannot be set or will not work under some conditions

Due to the camera's specifications, it may not be possible to set some of the functions or some functions may not work in some of the conditions under which the camera is used. For details, refer to P130.

Setting menu items

This section describes how to select the program AE mode settings, and the same setting can be used for the [PLAYBACK] menu and [SETUP] menu as well.

Example: Setting [AF MODE] from [□] to [⦿] in the program AE mode

- ▲/▼/◀/▶ in the steps can be operated with the joystick too.

1 Turn the camera on.

- (A) [MENU/SET] button
- (B) [REC]/[PLAYBACK] selector switch
- (C) Mode dial

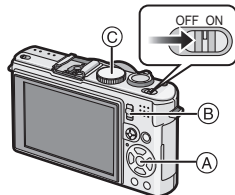
**2 Slide the [REC]/[PLAYBACK] selector switch to [ON].**

- When selecting the [PLAYBACK] mode menu settings, set the [REC]/[PLAYBACK] selector switch to [▶], and proceed to step 4.

3 Set the mode dial to [P].**4 Press [MENU/SET] to display the menu.**

- You can switch menu screens from any menu item by rotating the zoom lever.

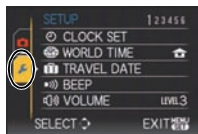

Switching to the [SETUP] menu

1 Press ◀.**2 Press ▼ to select the [SETUP] menu icon [⌘].****3 Press ▶.**

- Select a menu item next and set it.

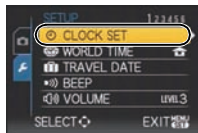
**5 Press ▲/▼ to select [AF MODE].**

- Select the item at the very bottom, and press ▼ to move to the second screen.

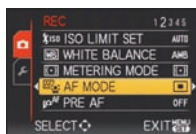

6 Press **▶**.

- Depending on the item, its setting may not appear or it may be displayed in a different way.

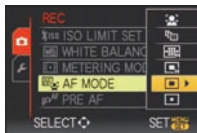

7 Press **▲/▼** to select [**☺**].

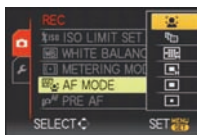

8 Press [**MENU/SET**] to set.

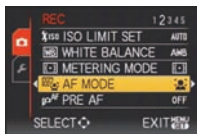

9 Press [**MENU/SET**] to close the menu.

Using the quick menu

By using the quick menu, some of the menu settings can be easily found.

- Some of the menu items cannot be set by the modes.

1 Press and hold down the joystick in recording mode until the [**Q.MENU**] is displayed.

2 Press **▲/▼/◀/▶** to select the menu item and the setting and then press [**MENU/SET**] to close the menu.



- (A) The items to be set and the settings are displayed.
- You can set the following items in detail by pressing [**DISPLAY**].
[WHITE BALANCE] (P79)/[AF MODE] (P82)









Perform these settings if you need to.

About the Setup Menu

[CLOCK SET], [AUTO REVIEW] and [ECONOMY] are important items. Check their settings before using them.



- In the Intelligent auto mode, only [CLOCK SET], [WORLD TIME], [TRAVEL DATE], [BEEP] and [LANGUAGE] can be set.

For details on how to select the [SETUP] menu settings, refer to P21.

 [CLOCK SET]	Setting Date/Time.	
• Refer to P19 for details.		
 [WORLD TIME]	Set the time in your home area and travel destination.	
	✈ [DESTINATION]: Travel destination area 🏠 [HOME]: Your home area	
• Refer to P73 for details.		
 [TRAVEL DATE]	Set the departure date and the return date of the vacation.	
	[TRAVEL SETUP] [OFF]/[SET]	[LOCATION] [OFF]/[SET]
• Refer to P71 for details.		
 [BEEP]	This allows you to set the beep and shutter sound.	
	••• [BEEP LEVEL]: [X] (Muted) [1] (Low) [2] (High)	 [SHUTTER VOL.]: [X] (Muted) [1] (Low) [2] (High)
	•• [BEEP TONE]: [1]/[2]/[3]	•• [SHUTTER TONE]: [1]/[2]/[3]
 [VOLUME]	Adjust the volume of the speaker to any of 7 levels.	
• When you connect the camera to a TV, the volume of the TV speakers does not change.		
 [CUST. SET MEM.]	Up to 4 current camera settings can be registered as custom settings. (Recording mode only)	
• Refer to P60 for details.		
 [Fn BUTTON SET]	Assign [REC] Mode Menu to ▼ button. It is convenient to register [REC] Mode Menu that is used often.	
	[REVIEW]/[FILM MODE]/[SENSITIVITY]/[WHITE BALANCE]/ [METERING MODE]/[AF MODE]/[EXPOSURE] (Recording mode only)	
• Refer to P40 for details about the review. • Refer to P74 for details about the [REC] Mode Menu.		
 [MONITOR]	Adjust the brightness of the LCD monitor in 7 steps.	

LCD [LCD MODE]	These menu settings make it easier to see the LCD monitor when you are in bright places.
	<p>[OFF]</p> <p>[A* [AUTO POWER LCD]: The brightness is adjusted automatically depending on how bright it is around the camera.</p> <p>[□* [POWER LCD]: The LCD monitor becomes brighter and easier to see even when taking pictures outdoors.</p>

- The brightness of the pictures displayed on the LCD monitor is increased so some subjects may appear differently from actuality on the LCD monitor. However, this does not affect the recorded pictures.
- The LCD monitor automatically returns to normal brightness after 30 seconds when recording in Power LCD mode. Press any button to make the LCD monitor bright again.
- If the screen is difficult to see because of light from the sun etc. shining on it, use your hand or another object to block the light.
- The number of recordable pictures decreases in Auto Power LCD mode and Power LCD mode.

[GUIDE LINE]	Set the pattern of the guide lines displayed when taking pictures. You can also set whether or not to have the recording information displayed when the guide lines are displayed. (P44)	
	[REC. INFO.]: [OFF]/[ON]	[PATTERN]: []/

- The [PATTERN] setting is fixed to [] in the Intelligent auto mode.

[HISTOGRAM]	This allows you to set either to display or not display the histogram. (P44)
	[OFF]/[ON]

[HL] [HIGHLIGHT]	When the auto review or review function is activated, white saturated areas appear blinking in black and white.
	[OFF]/[ON]



- If there are any white saturated areas, we recommend compensating the exposure towards negative (P51) referring to the histogram (P45) and then taking the picture again. It may result in a better quality picture.
- There may be white saturated areas if the distance between the camera and the subject is too close when taking pictures with the flash.

If [HIGHLIGHT] is set to [ON] in this case, the area directly illuminated by the photo flash will become white saturated and appear blinking in black and white.

[ON]**[OFF]**

 [MF ASSIST]	In manual focus, the assistance screen appears on the center of the screen to facilitate focusing on the subject.
	[OFF]:
	[MF1]: The center of the screen is enlarged. [MF2]: The center of the screen is enlarged over the whole screen.

- Refer to P58 for details.

ECO [ECONOMY]	You can conserve the battery life by setting these menus. Also, it will turn off the LCD monitor automatically when not in use to prevent discharge of the battery.
	 [POWER SAVE]: The camera is automatically turned off if the camera has not been used for the time selected on the setting. [OFF]/[2MIN.]/[5MIN.]/[10MIN.]
	 [AUTO LCD OFF]: The LCD monitor is automatically turned off if the camera has not been used for the time selected on the setting. [OFF]/[15SEC.]/[30SEC.]

- Press the shutter button halfway or turn the camera off and on to cancel [POWER SAVE].
- [POWER SAVE] is set to [5MIN.] in the Intelligent auto mode.
- [POWER SAVE] is fixed to [2MIN.] when [AUTO LCD OFF] is set to [15SEC.] or [30SEC.].
- The status indicator lights while the LCD monitor is turned off. Press any button to turn on the LCD monitor again.
- [AUTO LCD OFF] does not work while operating menu or playback zoom.
- AV and HD output is turned off while LCD monitor is turned off.

 [AUTO REVIEW]	Set the length of time that the picture is displayed after taking it.
	[OFF] [1SEC.] [2SEC.]
	[HOLD]: The pictures are displayed until one any of the buttons is pressed. [ZOOM]: The picture is displayed for 1 second and then enlarged 4× and displayed for 1 more second.

- The auto review function is activated regardless of its setting when using auto bracket (P52)/ multi aspect (P53), [MULTI FILM] (P76), [HI-SPEED BURST] (P66) and [FLASH BURST] (P67) in scene mode, burst mode (P54) and when recording still pictures with audio (P95). (The pictures cannot be enlarged.)
- In Intelligent auto mode, the auto review function is fixed to [2SEC.].
- If [HIGHLIGHT] (P25) is set to [ON], white saturated areas appear blinking in black and white when the auto review function is activated.

 [NO.RESET]	Reset the file number of the next recording to 0001.
--	--

- The folder number is updated and the file number starts from 0001. (P112)
- A folder number between 100 and 999 can be assigned.





When the folder number reaches 999, the number cannot be reset. We recommend formatting the card (P28) after saving the data on a PC or elsewhere.

- To reset the folder number to 100, format the built-in memory or the card first and then use this function to reset the file number.

A reset screen for the folder number will then appear. Select [YES] to reset the folder number.

 [RESET]	The [REC] or [SETUP] menu settings are reset to the initial settings.
--	---

- When the [RESET] setting is selected during recording, the operation that resets the lens is also performed at the same time. You will hear the sound of the lens operating but this is normal and not indicative of malfunctioning.
- When [SETUP] menu settings are reset, the following settings are also reset. In addition, [FAVORITE] (P105) in [PLAYBACK] mode menu is set to [OFF], and [ROTATE DISP.] (P104) is set to [ON].
 - The birthday and name settings for [BABY1]/[BABY2] (P65) and [PET] (P66) in scene mode.
 - The [CUST. SET MEM.] (P60) setting.
 - The [TRAVEL DATE] (P71) setting. (Departure date, return date, destination)
 - The [WORLD TIME] (P73) setting.
- The folder number and the clock setting are not changed.

 [USB MODE]	Select the USB communication system after or before connecting the camera to your PC or your printer with the USB connection cable (supplied).
	<p> [SELECT ON CONNECTION]: Select either [PC] or [PictBridge(PTP)] if you connected the camera to a PC or a printer supporting PictBridge.</p> <p> [PictBridge(PTP)]: Set after or before connecting to a printer supporting PictBridge.</p> <p> [PC]: Set after or before connecting to a PC.</p>

- When [PC] is selected, the camera is connected via the “USB Mass Storage” communication system.
- When [PictBridge(PTP)] is selected, the camera is connected via the “PTP (Picture Transfer Protocol)” communication system.

 [VIDEO OUT]*	Set to match the color television system in each country. (Playback mode only)
	<p>[NTSC]: Video output is set to NTSC system.</p> <p>[PAL]: Video output is set to PAL system.</p>

- This will work when the AV cable is connected.

* PAL video out is not available on the version DMC-LX3P sold in the U.S.

 [TV ASPECT]	Set to match the type of TV. (Playback mode only)
	<p>[16:9]: When connecting to a 16:9 screen TV.</p> <p>[4:3]: When connecting to a 4:3 screen TV.</p>

- This will work when the AV cable is connected.

 [m/ft]	Change the unit displayed for the focus distance in manual focus, or recordable range display.
	[m]: The distance is displayed in meters. [ft]: The distance is displayed in feet.

 [SCENE MENU]	Set the screen that will appear when a scene mode has been selected.
	[OFF]: The recording screen in the currently selected scene mode appears. [AUTO]: The [SCENE MODE] menu screen appears.

 [VERSION DISP.]	It is possible to check which version of firmware is on the camera.
--	---



 [FORMAT]	The built-in memory or card is formatted. Formatting irretrievably deletes all the data so check the data carefully before formatting.
---	--

- Use a battery with sufficient battery power or the AC adaptor (DMW-AC5PP; optional) when formatting. Do not turn the camera off during formatting.
- If a card has been inserted, only the card is formatted. To format the built-in memory, remove the card.
- If the card has been formatted on a PC or other equipment, format it on the camera again.
- It may take longer to format the built-in memory than the card.
- If the built-in memory or the card cannot be formatted, consult your nearest Service Center.

For USA assistance, please call:
1-800-211-PANA(7262) or, contact us via the web at:
<http://www.panasonic.com/contactinfo>

For Canadian assistance, please call:
1-800-99-LUMIX (1-800-995-8649) or
send e-mail to: lumixconcierge@ca.panasonic.com

 [LANGUAGE]	Set the language displayed on the screen.
	[ENGLISH]/[DEUTSCH]/[FRANÇAIS]/[ESPAÑOL]/[ITALIANO]/ [繁體中文] [†] /[日本語] *Not available on the version DMC-LX3P sold in the U.S.

- If you set a different language by mistake, select [] from the menu icons to set the desired language.

DEMO [DEMO MODE]	Select this to display [JITTER, SUBJ. MOVE DEMO.] or the camera's features.
	<p>[JITTER, SUBJ. MOVE DEMO.]</p> <p>[AUTO DEMO]: The camera's features are displayed as a slide show.</p>

(A) Jitter detection demonstration

(B) Movement detection demonstration

- In playback mode, [JITTER, SUBJ. MOVE DEMO.] cannot be displayed.
- Press [DISPLAY] to close [JITTER, SUBJ. MOVE DEMO].
Press [MENU/SET] to close [AUTO DEMO].
- [JITTER, SUBJ. MOVE DEMO.] is an approximation.
- [AUTO DEMO] has no TV output capability.

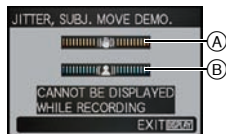

Mode switching

Selecting the [REC] Mode

When the [REC] mode is selected, the camera can be set to the Intelligent auto mode in which the optimal settings are established in line with the subject to be recorded and the recording conditions, or to the scene mode which enables you to take pictures that match the scene being recorded.

1 Turn the camera on.

(A) [REC]/[PLAYBACK] selector switch

2 Slide the [REC]/[PLAYBACK] selector switch to [REC].

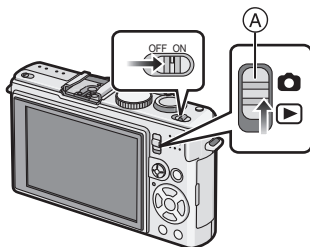

3 Switch the mode by rotating the mode dial.

Align a desired mode with part ⑥.

- Rotate the mode dial slowly and surely to adjust to each mode. (The mode dial rotates 360°)

The screen ⑦ is displayed on the LCD monitor when the mode dial is turned.

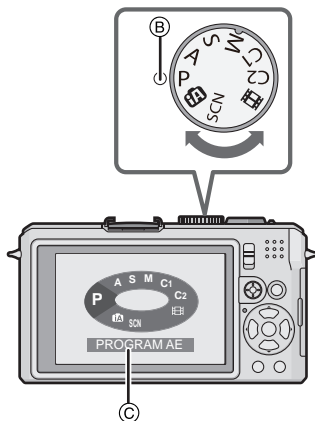

■ Basic

P Program AE mode (P32)

The subjects are recorded using your own settings.

iA Intelligent auto mode (P35)

The subjects are recorded using settings automatically selected by the camera.

■ Advanced

A Aperture-priority AE mode (P55)

The shutter speed is automatically determined by the aperture value you set.

S Shutter-priority AE mode (P55)

The aperture value is automatically determined by the shutter speed you set.

M Manual exposure mode (P56)

The exposure is adjusted by the aperture value and the shutter speed which are manually adjusted.

C1 C2 Custom mode (P61)

Use this mode to take pictures with previously registered settings.

Motion picture mode (P70)

This mode allows you to record motion pictures.

SCN Scene mode (P62)



This allows you to take pictures that match the scene being recorded.

Select the Aspect Ratio

This allows you to select the aspect ratio of the pictures to suit printing or the playback method.

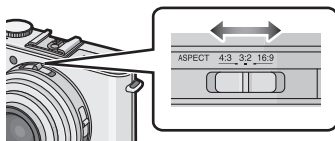
Switching the aspect ratio selector switch.



[4:3]	[3:2] (still pictures only)	[16:9]
		
[ASPECT RATIO] of a 4:3 TV	[ASPECT RATIO] of a 35 mm film camera	[ASPECT RATIO] of a high-definition TV, etc.

- The ends of the recorded pictures may be cut at printing so check before printing. (P139)

[REC] mode: **P**

Taking pictures with your favorite settings

(**P** : Program AE mode)

The camera automatically sets the shutter speed and the aperture value according to the brightness of the subject.

You can take pictures with greater freedom by changing various settings in [REC] menu.

- The status indicator **3** lights when you turn this unit on **2**. (It turns off after about 1 second.)
1: Shutter button

1 Slide the [REC]/[PLAYBACK] selector switch to **[P]**.

2 Set the mode dial to [**P**].

- Set the focus selector switch to [AF].
- To change the setting while taking pictures, refer to “Using the [REC] Mode Menu” (P74).

3 Hold this unit gently with both hands, keep your arms still at your side and stand with your feet slightly apart.

(A) AF assist lamp

4 Aim the AF area at the point you want to focus on.

5 Press the shutter button halfway to focus.

- The focus indication **1** (green) lights when the subject is focused.
- The AF area **2** is displayed around the subject's face by the face detection function. In other cases, it is displayed at the point on the subject which is in focus.
- The focus range is 50 cm (1.64 feet) to ∞ .
- If pictures are to be taken at an even closer range, refer to “Taking Close-up Pictures” (P49).

6 Press the shutter button fully (push it in further), and take the picture.

- The access indication lights (P18) red when pictures are being recorded on the built-in memory (or the card).
- Do not cover the flash or the AF assist lamp with your fingers or other objects.

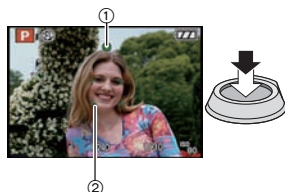
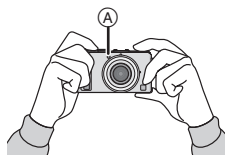
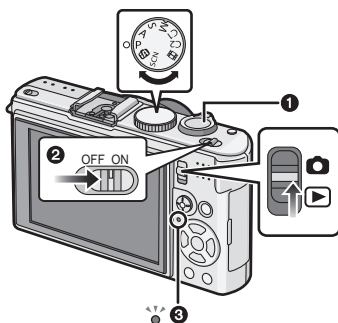

- Setting the color tone of the picture by using the [REC] mode menu (P74)
- When taking pictures using the Built-in flash (P46)
- When taking pictures using the zoom (P38)
- To adjust the exposure and take pictures at times when the image appears too dark (P51)
- To adjust the colors and take pictures at times when the image appears too red (P79)

Note

- Be careful not to move the camera when you press the shutter button.
- Do not touch the front of the lens.

Focusing

Aim the AF area at the subject, and then press the shutter button halfway.

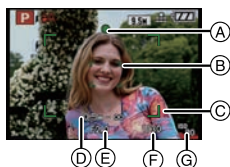

Focus	When the subject is focused	When the subject is not focused
Focus indication	On	Blinks
AF area	White→Green	White→Red
Sound	Beeps 2 times	Beeps 4 times

- (A) Focus indication
- (B) AF area (normal)
- (C) AF area (when using the digital zoom or when it is dark)
- (D) Focus range
- (E) Aperture value*
- (F) Shutter speed*
- (G) ISO sensitivity

* If correct exposure cannot be achieved, it will be displayed in red. (However, it will not be displayed in red when the flash is used.)

When the subject is not in focus (such as when it is not in the center of the composition of the picture you want to take)

- 1 Aim the AF area at the subject, and then **press the shutter button halfway** to fix the focus and exposure.
 - 2 **Press and hold the shutter button halfway** while moving the camera as you compose the picture.
- You can repeatedly retry the actions in step 1 before pressing the shutter button fully.

We recommend that you use the face detection function when taking pictures of people. (P82)

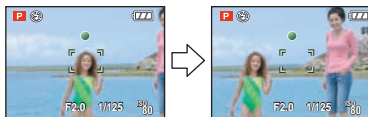

Subjects and recording conditions which are difficult to focus

- Fast-moving subjects, extremely bright subjects or subjects without contrast
- When the recordable range display has appeared in red.
- When recording subjects through windows or near shiny objects

- When it is dark or when jitter occurs
- When the camera is too close to the subject or when taking a picture of both distant and near subjects

Preventing jitter (camera shake)

When the jitter alert [ⓘ(⊕)] appears, use [STABILIZER] (P87), a tripod or the self-timer (P50).

- Shutter speed will be slower particularly in the following cases. Keep the camera still from the moment the shutter button is pressed until the picture appears on the screen. We recommend using a tripod.
 - Slow sync./Red-eye reduction
 - In [NIGHT PORTRAIT], [NIGHT SCENERY], [PARTY], [CANDLE LIGHT], [STARRY SKY] or [FIREWORKS] in scene mode (P62)
 - When the shutter speed is slowed in [MIN. SHTR SPEED]

Direction detection function

Pictures recorded with the camera held vertically are played back vertically (rotated). (Only when [ROTATE DISP.] (P104) is set to [ON])

- Pictures may not be displayed vertically if they were taken with the camera aimed up or down.
- Motion pictures taken with the camera held vertically are not displayed vertically.

Enlarge the focus point at the center (display focus point)

This unit will remember the focus point during the recording, and it can be enlarged with that point as a center.

Press [FOCUS] during image playback

- Focus point may not be the center of enlargement when it is at the edge of the image.
- Refer to “Using the Playback Zoom” (P41) for operation during zooming.
- It will return to the original enlargement if [FOCUS] is pressed again during zooming.
- Focus point is enlarged during zoom in auto review.
- Following pictures cannot be enlarged because there is no focus point:
 - Picture that was taken without focusing
 - Picture that was taken with manual focus
 - Picture that was taken with a different camera

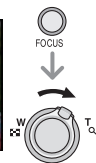

Program shift

In program AE mode, you can change the preset aperture value and shutter speed without changing the exposure. This is called program shift. You can make the background more blurred by decreasing the aperture value or record a moving subject more dynamically by slowing the shutter speed when taking a picture in program AE mode.



- Press the shutter button halfway and then use the joystick to activate program shift while the aperture value and the shutter speed are displayed on the screen (about 10 seconds).
- The program shift indication (A) appears on the screen when program shift is activated.

- Program shift is canceled if the camera is turned off or the joystick is moved up and down until the program shift indication disappears.

■ Example of program shift

(A): Aperture value

(B): Shutter speed

- Program shift amount
- Program shift line chart
- Program shift limit

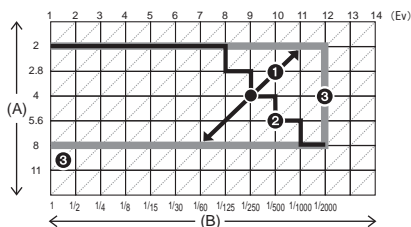

Note

- If the exposure is not adequate when the shutter button is pressed halfway, the aperture value and shutter speed turns red.
- Program shift is canceled and the camera returns to normal program AE mode if more than 10 seconds pass after program shift is activated. However, the program shift setting is memorized.
- Depending on the brightness of the subject, program shift may not be activated.

[REC] mode: **iA**

Taking pictures using the automatic function

(iA): Intelligent Auto Mode

The camera will set the most appropriate settings to match the subject and the recording conditions so we recommend this mode for beginners or those who want to leave the settings to the camera and take pictures easily.

- The following functions are activated automatically.
 - Scene detection/[STABILIZER]/[INTELLIGENT ISO]/Face detection/[QUICK AF]/[I.EXPOSURE]/Digital Red-eye Correction/Backlight Compensation

1 Slide the [REC]/[PLAYBACK] selector switch to **[CAMERA]**.

- Mode dial
- [REC]/[PLAYBACK] selector switch

2 Set the mode dial to **(iA)**.

- [MF] cannot be set in **(iA)** (P58).

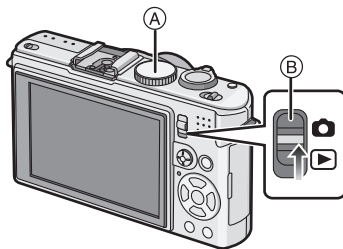

3 Press the shutter button halfway to focus.

- The focus indication ① (green) lights when the subject is focused.
- The AF area ② is displayed around the subject's face by the face detection function. In other cases, it is displayed at the point on the subject which is in focus.
- The focus range is 1 cm (0.04 feet) (Wide)/30 cm (0.99 feet) (Tele) to ∞.

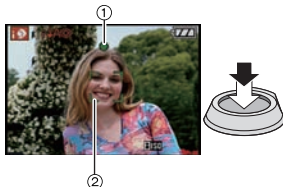

4 Press the shutter button fully (push it in further), and take the picture.

- The access indication (P18) lights red when pictures are being recorded on the built-in memory (or the card).



■ To adjust the exposure and take pictures at times when the image appears too dark (P51)

Scene detection

When the camera identifies the optimum scene, the icon of the scene concerned is displayed in blue for 2 seconds, after which its color changes to the usual red.

	[i- PORTRAIT]	
	[i- SCENERY]	
	[i- MACRO]	
	[i- NIGHT PORTRAIT]	• Only when [A+] is selected
	[i- NIGHT SCENERY]	• Only when [S] is selected

- [iA] is set if none of the scenes are applicable, and the standard settings are set.
- If a tripod is used, for instance, and the camera has judged that camera shake is minimal when the scene mode has been identified as [iS], the shutter speed will be set to a maximum of 8 seconds. Take care not to move the camera while taking pictures.
- An optimum scene for the specified subject will be chosen when set to AF tracking (P83).

■ Face detection

When [iA] or [iS] is selected, the camera automatically detects a person's face, and it will adjust the focus and exposure (P82).

Note

- Due to conditions such as the ones below, a different scene may be identified for the same subject.
 - Subject conditions: When the face is bright or dark, The size of the subject, The distance to the subject, The contrast of the subject, When the subject is moving, When zoom is used
 - Recording conditions: Sunset, Sunrise, Under low brightness conditions, When the camera is shaken
- To take pictures in an intended scene, it is recommended that you take pictures in the appropriate recording mode.

■ Backlight compensation

Backlight refers to when light comes from the back of a subject.

In this case, the subject will become dark, so this function compensates the backlight by brightening the whole of the picture automatically.

AF Tracking Function

It is possible to set the focus to the specified subject. Focus will keep following the subject automatically even if it moves. Refer to P83 for details.

- Set the [AF TRACKING] in the [REC] mode menu to [ON]. ([AF TRACKING] is displayed on the screen.)

Bring the subject to the AF tracking frame, and press [AF/AE LOCK] to lock the subject.

- AF tracking frame will turn yellow.
- An optimum scene for the specified subject will be chosen.
- Press [AF/AE LOCK] again to cancel.



About the flash

- **Open the flash when the flash is to be used. (P46)**
- When [iA] is selected, [iA], [iA] or [iS] is set depending on the type of subject and brightness.
- When [iA] or [iS] is set, digital red-eye correction (P47) will turn on and flash is activated twice.
- Flash modes cannot be switched using ► (i) in the intelligent auto mode.

Settings in Intelligent auto mode

- Only the following functions can be set in this mode.
 - [REC] mode menu**
 - [PICTURE SIZE]* (P76)/[AF TRACKING] (P83)
 - * The settings which can be selected are different from when other [REC] modes are used.
 - [SETUP] menu**
 - [CLOCK SET]/[WORLD TIME]/[TRAVEL DATE]/[BEEP]/[LANGUAGE]
- The settings of the following items are fixed.

Item	Settings
[Fn BUTTON SET] (P24)	
[GUIDE LINE] (P25)	([REC. INFO.]: [OFF])
[ECONOMY] ([POWER SAVE]) (P26)	[5MIN.]
[AUTO REVIEW] (P26)	[2SEC.]
Focus range	The focus range becomes the same as AF macro mode. [1 cm (0.04 feet) (Wide)/30 cm (0.99 feet) (Tele) to ∞] (P49) • The maximum close-up distance (the shortest distance at which the subject can be taken) differs depending on the zoom magnification.
Self-timer (P50)	10 seconds
[FILM MODE] (P74)	[STANDARD]
[QUALITY] (P77)	(Set to when picture size is [] (0.3M))
[INTELLIGENT ISO] (P78)	[ON] (The maximum ISO sensitivity: ISO800)
[ISO LIMIT SET] (P79)	800
[WHITE BALANCE] (P79)	[AWB]

[METERING MODE] (P81)	[□]
[AF MODE] (P82)	☺ (Set to [☺] when a face cannot be detected)
[PRE AF] (P84)	QAF
[I.EXPOSURE] (P85)	[STANDARD]
[STABILIZER] (P87)	[AUTO]
[AF ASSIST LAMP] (P88)	[ON]
[FLASH SYNCHRO] (P89)	[1ST]

- The following functions cannot be used.
 - Flash output adjustment/Auto bracket/Multi aspect/White balance fine adjustment/[AF/AE LOCK]/[MULTI. EXPO.]/[DIGITAL ZOOM]/[AUDIO REC.]/[MIN. SHTR SPEED]/[HISTOGRAM]/[HIGHLIGHT]
- The other items on the [SETUP] menu can be set in a mode such as program AE mode. What is set will be reflected in the Intelligent auto mode.

[REC] mode: **IA P A S M C1 C2**  **SCN**

Taking Pictures with the Zoom

Using the Optical Zoom/Using the Extended Optical Zoom (EZ)/Using the Digital Zoom

You can zoom-in to make people and objects appear closer or zoom-out to record landscapes in wide angle. To make subjects appear even closer [maximum of 4.5×], do not set the picture size to the highest setting for each aspect ratio (4:3/3:2/16:9). Even higher levels of magnification are possible when [DIGITAL ZOOM] is set to [ON] in [REC] menu.

To make subjects appear closer use (Tele)

Rotate the zoom lever towards Tele.





To make subjects appear further away use (Wide)

Rotate the zoom lever towards Wide.



■ Types of zooms

Feature	Optical zoom	Extended optical zoom (EZ)	Digital zoom
Maximum magnification	2.5×	4.5×*1	10× [including optical zoom 2.5×] 17.9× [including extended optical zoom 4.5×]
Picture quality	No deterioration	No deterioration	The higher the magnification level, the greater the deterioration.
Conditions	None	[PICTURE SIZE] with [EZ] (P76) is selected.	[DIGITAL ZOOM] (P87) on the [REC] menu is set to [ON].
Screen display		 A [EZ] is displayed.	 B The digital zoom range is displayed. The AF area becomes larger when the shutter button is pressed halfway in the digital zoom range*2.

• When using the zoom function, an estimate of the focus range will appear in conjunction with the zoom display bar. (Example: 0.5 m (1.64 ft.) – ∞)

*1 The magnification level differs depending on [PICTURE SIZE] and [ASPECT RATIO] setting.

*2 The on-screen zoom indication may momentarily stop moving when you rotate the zoom lever to the extreme Tele position. You can enter the digital zoom range by continuously rotating the zoom lever to Tele or releasing the zoom lever once and then rotating it to Tele again.

■ Extended optical zoom mechanism

When you set the picture size to [3M] (3 million pixels), the 10M (10.1 million pixels) CCD area is cropped to the center 3M (3 million pixels) area, allowing a picture with a higher zoom effect.

Note

- The digital zoom cannot be set when [A] has been selected.
- The indicated zoom magnification is an approximation.
- "EZ" is an abbreviation of "Extended optical Zoom".
- The optical zoom is set to Wide (1×) when the camera is turned on.
- If you use the zoom function after focusing on the subject, focus on the subject again.
- The lens barrel extends or retracts according to the zoom position. Take care not to interrupt the motion of the lens barrel while the zoom lever is rotated.
- When using the digital zoom, [STABILIZER] may not be effective.
- When using the digital zoom, we recommend using a tripod and the self-timer (P50) for taking pictures.

[PLAYBACK] mode: 



Playing back Pictures ([NORMAL PLAY])

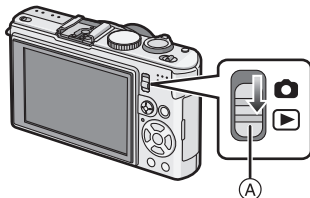

1 Slide the [REC]/[PLAYBACK] selector switch to .

- Normal playback is set automatically in the following cases.
 - When the mode was switched from the [REC] to [PLAYBACK].
 - When the camera was turned on while the [REC]/[PLAYBACK] selector switch was at .



2 Press / to select the picture.



-  File number
-  Picture number







- : Play back the previous picture
- : Play back the next picture

- Speed of picture forwarding/rewinding changes depending on the playback status.







■ Fast forwarding/Fast rewinding Press and hold / during playback.

- : Fast rewind
- : Fast forward

- The file number  and the picture number  only change one by one. Release /  when the number of the desired picture appears to play back the picture.
- If you keep pressing / , the number of pictures forwarded/rewound increases.

Confirm the picture in [REC] mode (Review)

You can confirm the picture in [REC] mode. You can also move between pictures using , use zoom playback (P41), or delete pictures (P42).

- 1 Select the [Fn BUTTON SET] on the [SETUP] menu, and then press .
- 2 Press /  to select [REVIEW] and then press [MENU/SET] to set.
 - You can review by pressing  in [REC] mode if it is set.

Displaying Multiple Screens (Multi Playback)

Rotate the zoom lever towards [W] (W).

1 screen → 12 screens → 30 screens → Calendar screen display (P97)

(A) Number of the selected picture and the total number of recorded pictures

- Rotate the zoom lever towards [Q] (T) to return to the previous screen.
- Pictures are not rotated for display.



■ To return to normal playback

1 Press ▲/▼/◀/▶ to select a picture.

- An icon will be displayed depending on the recorded picture and the settings.

2 Press [MENU/SET].

- The picture that was selected will appear.

Using the Playback Zoom

Rotate the zoom lever towards [Q] (T).

1× → 2× → 4× → 8× → 16×

- When you rotate the zoom lever towards [W] (W) after enlarging the picture, the magnification becomes lower.
- When you change the magnification, the zoom position indication (A) appears for about 1 second, and the position of the enlarged section can be moved by pressing ▲/▼/◀/▶.
- The more a picture is enlarged, the more its quality deteriorates.
- When you move the position to be displayed, the zoom position indication appears for about 1 second.
- Focus point will be enlarged when [FOCUS] is pressed. (P34)
- You can review next picture in enlarged view by tilting ◀/▶ of the joystick.



Note

- This camera complies with the DCF standard "Design rule for Camera File system" established by JEITA "Japan Electronics and Information Technology Industries Association" and with Exif "Exchangeable Image File Format". Files which do not comply with the DCF standard cannot be played back.
- The lens barrel retracts about 15 seconds after switching from [REC] mode to [PLAYBACK] mode.
- You can also delete the recording information etc. on the LCD monitor during playback zoom by pressing [DISPLAY].
- If you want to save the enlarged picture, use the trimming function. (P102)
- The playback zoom may not operate if pictures have been recorded with other equipment.

Switching the [PLAYBACK] mode

- 1 Press [MENU/SET] during playback.
- 2 Press **▶**.
- 3 Press **▲/▼** to select the item and then press [MENU/SET].

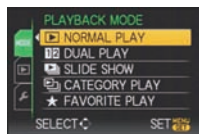

[NORMAL PLAY] (P40)

All the pictures are played back.

[DUAL PLAY] (P91)

Playing Back Pictures on the Dual Display

[SLIDE SHOW] (P92)

The pictures are played back in sequence.

[CATEGORY PLAY] (P94)

The pictures grouped together in categories are played back.

[FAVORITE PLAY] (P95)*

Your favorite pictures are played back.

- * [FAVORITE PLAY] is not displayed when [FAVORITE] has not been set.

[PLAYBACK] mode:

Deleting Pictures

Once deleted, pictures cannot be recovered.

- Pictures on the built-in memory or the card, which is being played back will be deleted.

To delete a single picture

- 1 Select the picture to be deleted, and then press **[DISP]**.

- (A) [DISPLAY] button
(B) **[DISP]** button

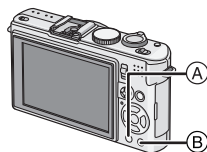

- 2 Press **◀** to select [YES] and then press [MENU/SET].



To delete multiple pictures (up to 50) or all the pictures

- 1 Press [🗑️].
- 2 Press ▲/▼ to select [DELETE MULTI] or [DELETE ALL] and then press [MENU/SET].
 - [DELETE ALL] → step 5.
- 3 Press ▲/▼/◀/▶ to select the picture, and then press [DISPLAY] to set. (Repeat this step.)
 - [🗑️] appears on the selected pictures. If [DISPLAY] is pressed again, the setting is canceled.

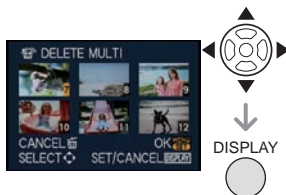

- 4 Press [MENU/SET].
- 5 Press ▲ to select [YES] and then press [MENU/SET] to set.
 - When [DELETE ALL] has been selected with the [FAVORITE] (P105) setting
The selection screen is displayed again. Select [DELETE ALL] or [ALL DELETE EXCEPT ★], press ▲ to select [YES] and delete the pictures. ([ALL DELETE EXCEPT ★] cannot be selected if no pictures have been set as [FAVORITE].)

Note

- Do not turn the camera off while deleting (while [🗑️] is displayed). Use a battery with a sufficient power or the AC adaptor (DMW-AC5PP; optional).
- If you press [MENU/SET] while deleting pictures using [DELETE MULTI], [DELETE ALL] or [ALL DELETE EXCEPT ★], the deleting will stop halfway.
- Depending on the number of pictures to be deleted, it may take some time to delete them.
- If pictures do not conform to the DCF standard or are protected (P107), they will not be deleted even if [DELETE ALL] or [ALL DELETE EXCEPT ★] is selected.

About the LCD Monitor

Press [DISPLAY] to change.

- (A) LCD monitor
- (B) [DISPLAY] button

• When the menu screen appears, the [DISPLAY] button is not activated. During playback zoom (P41), while playing back motion pictures (P95) and during a slide show (P92), you can only select "Normal display (C)" or "No display (I)".

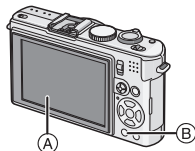

In recording mode

- (C) Normal display*1
- (D) No display
- (E) No display (Recording guide line)*1, 2
- (F) Screen not displayed*3

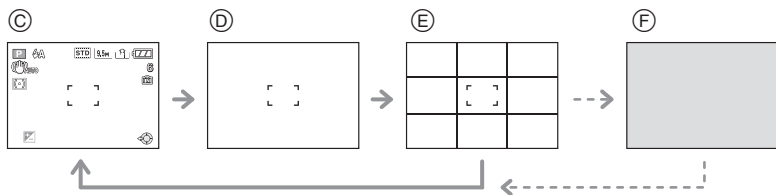

In playback mode

- (G) Normal display
- (H) Display with recording information*1
- (I) No display

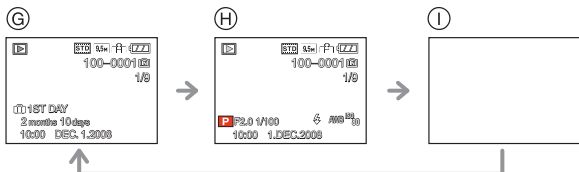

*1 If the [HISTOGRAM] in [SETUP] menu is set to [ON], histogram will be displayed.

*2 Set the pattern of the guide lines displayed by setting [GUIDE LINE] in [SETUP] menu. You can also set whether or not to have the recording information displayed when the guide lines are displayed.

*3 It is only possible to switch between screens when [EXT. VIEWFINDER] (P89) in the [REC] mode menu has been set to [ON]. The screen is normally off. However elements such as the focus icon (P33) and the flash charging icon are lit.

Note

• In [NIGHT PORTRAIT], [NIGHT SCENERY], [STARRY SKY] and [FIREWORKS] in scene mode, the guide line is gray. (P62)

■ Recording guide line

When you align the subject on the horizontal and vertical guide lines or the cross point of these lines, you can take pictures with well-designed composition by viewing the size, the slope and the balance of the subject.



- Ⓐ []: This is used when dividing the entire screen into 3×3 for taking pictures with a well-balanced composition.
- Ⓑ []: This is used when you want to position the subject at the exact center of the screen.

■ About the Histogram

A histogram is a graph that displays brightness along the horizontal axis (black to white) and the number of pixels at each brightness level on the vertical axis.

It allows you to easily check a picture's exposure.

- Dark area, mid-tone, and bright area are balanced out evenly, making it suitable to take a picture.
- The picture will become underexposed with more dark area. The pictures with mostly dark area, such as night scenery, will also have a histogram like this.
- The picture will become overexposed with more bright area. The pictures with mostly white area will also have a histogram like this.

Examples of histogram

- Properly Exposed
 - Under Exposed
 - Overexposed
- * Histogram

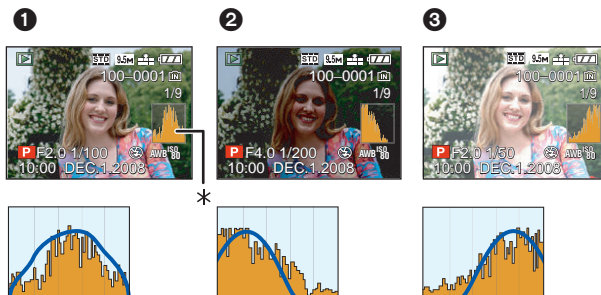

Note

• When the recorded picture and the histogram do not match each other under the following conditions, the histogram is displayed in orange.

- When the manual exposure assistance is other than $[\pm 0EV]$ during exposure compensation or in the manual exposure mode
- When the flash is activated
- In [STARRY SKY] or [FIREWORKS] in scene mode (P62)
- When the flash is closed
 - When the brightness of the screen is not correctly displayed in dark places
 - When the exposure is not adequately adjusted
- The histogram is an approximation in recording mode.
- The histogram of a picture may not match in recording mode and playback mode.
- The histogram displayed in this camera does not match histograms displayed by picture editing software used in PCs etc.

[REC] mode: **iA P A S M C1 C2 SCN**

Taking Pictures using the Built-in Flash

(A) To open the flash
Press the flash open button.

(B) To close the flash
Press the flash until it clicks.

- Be sure to close the flash when not in use.
- The flash setting is fixed to [☺] while the flash is closed.

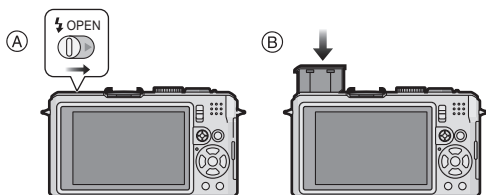

Switching to the appropriate flash setting

Set the flash to match the recording.

- Open the flash.

1 Press **▶** [**⚡**].

2 Press **▲/▼** to select a mode.



- You can also press **▶** [**⚡**] to select.
- For information about flash settings that can be selected, refer to “Available flash settings by recording mode”. (P47)

3 Press [**MENU/SET**].

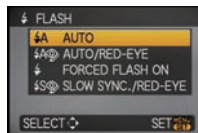
- You can also press the shutter button halfway to finish.
- The menu screen disappears after about 5 seconds. At this time, the selected item is automatically set.





Item	Description of settings
⚡A: AUTO	The flash is automatically activated when the recording conditions make it necessary.
⚡A☺: AUTO/Red-eye reduction*	The flash is automatically activated when the recording conditions make it necessary. It is activated once before the actual recording to reduce the red-eye phenomenon (eyes of the subject appearing red in the picture) and then activated again for the actual recording. • Use this when you take pictures of people in low lighting conditions.
⚡: Forced flash ON ⚡☺: Forced ON/Red-eye reduction*	The flash is activated every time regardless of the recording conditions. • Use this when your subject is back-lit or under fluorescent light. • The flash setting is set to [⚡☺] only when you set [PARTY] or [CANDLE LIGHT] in scene mode. (P62)

 : Slow sync./Red-eye reduction*	<p>If you take a picture with a dark background landscape, this feature will slow the shutter speed when the flash is activated so that the dark background landscape will become bright. Simultaneously it reduces the red-eye phenomenon.</p> <ul style="list-style-type: none"> • Use this when you take pictures of people in front of a dark background.
 : Forced flash OFF	<p>The flash is not activated in any recording conditions.</p> <ul style="list-style-type: none"> • Use this when you take pictures in places where the use of the flash is not permitted.

* The flash is activated twice. The subject should not move until the second flash is activated. Interval until the second flash depends on the brightness of the subject.

■ About the digital red-eye correction























When the flash is used with the Red-eye reduction ([, [, []) selected, it will automatically detect and correct the red-eye in the image data.

































* It may not be able to correct the red-eye depending on the recording conditions. It may also correct objects other than red-eye.

■ Available flash settings by recording mode

The available flash settings depend on the recording mode.

(○: Available, —: Not available, ●: Scene mode initial setting)

						
	○*	—	—	—	—	○
	○	○	○	○	—	○
	○	○	○	○	—	○
	○	○	○	—	—	○
	○	○	○	—	—	○
	—	—	—	—	—	○
	○	●	○	—	—	○
	○	●	○	—	—	○
	○	●	○	—	—	○
	—	—	—	—	—	●
	●	—	○	—	—	○
	—	—	—	●	—	○
	—	—	—	—	—	●
	●	—	○	—	—	○
	—	—	—	—	—	●
	●	—	○	—	—	○
	—	—	—	●	○	○

						
	—	—	—	○	●	○
	○	●	○	—	—	○
	○	●	○	—	—	○
	●	—	○	—	—	○
	—	—	—	—	—	●
	●	—	○	—	—	○
	—	—	—	—	—	●
	—	—	—	—	—	●
	—	—	—	—	—	●
	—	—	—	—	—	●
	—	—	—	—	—	●
	—	—	—	—	—	●
	—	—	—	—	—	●
	—	—	—	—	—	●
	—	—	—	—	—	●
	—	—	—	—	—	●
	—	—	—	—	—	●
	—	—	—	—	—	●
	—	—	—	—	—	●
	—	—	—	—	—	●
	—	—	—	—	—	●
	—	—	—	—	—	●
	—	—	—	—	—	●
	—	—	—	—	—	●
	—	—	—	—	—	●
	—	—	—	—	—	●
	—	—	—	—	—	●

* When [] is selected, [], [] or [] is set depending on the type of subject and brightness.

- The flash setting may change if the recording mode is changed. Set the flash setting again if necessary.
- The flash setting is memorized even if the camera is turned off. However, the scene mode flash setting is reset to the initial setting when the scene mode is changed.

■ The available flash range to take pictures

- The available flash range is an approximation.

ISO sensitivity	Available flash range	
	Wide	Tele
AUTO	80 cm (2.62 feet) to 8.3 m (27.2 feet)*	30 cm (0.99 feet) to 5.9 m (19.4 feet)*
ISO80	80 cm (2.62 feet) to 2.3 m (7.54 feet)	30 cm (0.99 feet) to 1.6 m (5.24 feet)
ISO100	80 cm (2.62 feet) to 2.6 m (8.53 feet)	30 cm (0.99 feet) to 1.8 m (5.91 feet)
ISO200	80 cm (2.62 feet) to 3.7 m (12.1 feet)	30 cm (0.99 feet) to 2.6 m (8.53 feet)
ISO400	80 cm (2.62 feet) to 5.3 m (17.4 feet)	40 cm (1.31 feet) to 3.7 m (12.1 feet)
ISO800	80 cm (2.62 feet) to 7.4 m (24.3 feet)	60 cm (1.97 feet) to 5.3 m (17.4 feet)
ISO1600	1.15 m (3.77 feet) to 10.6 m (34.8 feet)	90 cm (2.95 feet) to 7.5 m (24.6 feet)
ISO3200	1.60 m (5.24 feet) to 14.9 m (48.9 feet)	1.30 m (4.26 feet) to 10.7 m (35.1 feet)

* When the [ISO LIMIT SET] (P78) is set to [AUTO]

- In [HIGH SENS.] (P66) in scene mode, the ISO sensitivity automatically switches to between [ISO1600] and [ISO6400] and the available flash range also differs.

Wide: Approx. 1.15 m (3.77 feet) to approx. 21.2 m (69.6 feet)

Tele: Approx. 90 cm (2.95 feet) to approx. 15.1 m (49.5 feet)

- In [FLASH BURST] (P67) in scene mode, the ISO sensitivity automatically switches to between [ISO80] and [ISO3200] and the available flash range also differs.

Wide: Approx. 80 cm (2.62 feet) to approx. 5.6 m (18.4 feet)

Tele: Approx. 30 cm (0.99 feet) to approx. 4.0 m (13.1 feet)

■ Adjust the flash output

Adjust the flash output when the subject is small, or the reflectivity is very high or low.

- 1 Press **▲** () several times to display [FLASH], and then press **◀/▶** to set the flash output.

- You can adjust from [-2 EV] to [+2 EV] in steps of [1/3 EV].
- Select [0 EV] to return to the original flash output.

- 2 Press [MENU/SET] to close the menu.

- You can also close the menu by pressing the shutter button halfway.



Note

- When the flash output is adjusted, the flash output value appears on the upper left of the screen.
- The flash output setting is memorized even if the camera is turned off.
- The flash output adjustment cannot be used while in [FLASH BURST] in scene mode.

■ Shutter speed for each flash setting

Flash setting	Shutter speed (Sec.)
	1/30 ^{*1} to 1/2000th

Flash setting	Shutter speed (Sec.)
	1 to 1/2000th 1 or 1/4th to 1/2000th ^{*2}
	1 ^{*1} to 1/2000th 1 or 1/4th to 1/2000th ^{*2, 3}

*1 It may vary depending on the [MIN. SHTR SPEED] setting (P88).

*2 When Intelligent ISO is set (P78)

*3 [SPORTS], [BABY1]/[BABY2] and [PET] in scene mode (P62)

• Refer to P57 for the Aperture-priority AE, Shutter-priority AE or Manual exposure mode.

• *2, 3: The shutter speed becomes a maximum of 1 second in the following cases.

– When the optical image stabilizer is set to [OFF].

– When the camera has determined that there is little jitter when the optical image stabilizer is set to [MODE1], [MODE2] or [AUTO].

• In Intelligent auto mode, shutter speed changes depending on the identified scene.

• There will be differences in the above shutter speeds in the scene modes.

– [NIGHT PORTRAIT]/[NIGHT SCENERY]: 8 or 1/8th of a second to 1/2000th of a second^{*4}

– [CANDLE LIGHT]: 1 or 1/8th of a second to 1/2000th of a second^{*4}

– [FLASH BURST]: 1/30th of a second to 1/2000th of a second

– [STARRY SKY]: 15 seconds, 30 seconds, 60 seconds

– [FIREWORKS]: 1/4th of a second, 2 seconds^{*4}

– All other scene modes: 1/8th of a second to 1/2000th of a second

*4 The maximum shutter speed is selected when the amount of jitter is minimal while [STABILIZER] is set or when [STABILIZER] is set to [OFF].

Note

• **Do not bring the flash too close to objects or close the flash while it is activated. The objects may be discolored by its heat or lighting.**

• Do not close the flash soon after the flash is activated prior to taking pictures due to AUTO/Red-eye reduction etc. It causes a malfunction.

• When you take a picture beyond the available flash range, the exposure may not be adjusted properly and the picture may become bright or dark.

• When the flash is being charged, the flash icon blinks red, and you cannot take a picture even when you press the shutter button fully.

• The white balance may not be properly adjusted if the flash level is insufficient for the subject.

• When the shutter speed is fast, the flash effect may not be sufficient.

• It may take time to charge the flash if you repeat taking a picture. Take a picture after the access indication disappears.

• The red-eye reduction effect differs between people. Also, if the subject was far away from the camera or was not looking at the first flash, the effect may not be evident.

• When the [CONVERSION] (P90) is set to , the flash is fixed to .

• When the external flash is installed, it will be prioritized. See P121 for more information on the external flash.

[REC] mode: **P A S M C1 C2**

Taking Close-up Pictures

This mode allows you to take close-up pictures of a subject, e.g. when taking pictures of flowers. You can take pictures of a subject as close as 1 cm (0.04 feet) from the lens by rotating the zoom lever upmost to Wide (1×).

1 Slide the focus selector switch to [AF].

- In AF macro mode, [AF] is displayed.

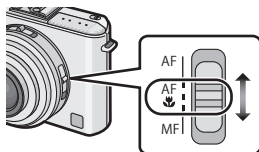
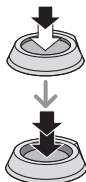
**2** Take the pictures.**Focus range**

- * The focus range changes in steps.

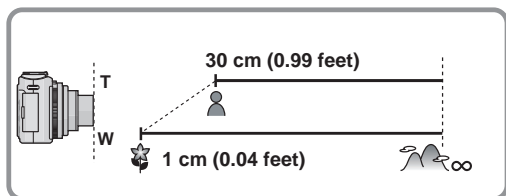
**Note**

- We recommend using a tripod and the self-timer.
- We recommend setting the flash to [ON] when you take pictures at close range.
- If the distance between the camera and the subject is beyond the focus range of the camera, the picture may not be properly focused even if the focus indication lights.
- When a subject is close to the camera, the effective focus range is significantly narrowed. Therefore, if the distance between the camera and the subject is more than 50 cm (1.64 feet) it takes longer to focus on it again.
- AF macro mode gives priority to a subject close to the camera. Therefore, if the distance between the camera and the subject is more than 50 cm (1.64 feet) it takes longer to focus on it in AF macro mode than program AE mode.
- When you take pictures at close range, the resolution of the periphery of the picture may decrease slightly. This is not a malfunction.

[REC] mode: [iA] P A S M C1 C2 SCN

Taking Pictures with the Self-timer**1** Press ◀ [⏸].**2** Press ▲/▼ to select a mode.

- You can also press ◀ [⏸] to select.



3 Press [MENU/SET].

- You can also press the shutter button halfway to finish.
- The menu screen disappears after about 5 seconds. At this time, the selected item is automatically set.

4 Press the shutter button halfway to focus and then press it fully to take the picture.

- The self-timer indicator (A) blinks and the shutter is activated after 10 seconds (or 2 seconds).
- If you press [MENU/SET] while the self-timer is set, the self-timer setting is canceled.

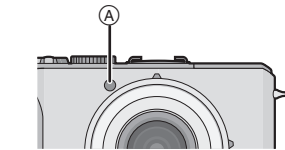

Note

- When using a tripod etc., setting the self-timer to 2 seconds is a convenient way to avoid the jitter caused by pressing the shutter button.
- When you press the shutter button once fully, the subject is automatically focused just before recording. In dark places, the self-timer indicator will blink and then may turn on brightly operating as an AF assist lamp (P88) to allow the camera to focus on the subject.
- We recommend using a tripod when recording with the self-timer.
- The number of pictures which can be taken in [BURST] is fixed to 3.
- The number of pictures which can be taken in [FLASH BURST] in scene mode is fixed to 5.
- Self-timer cannot be set to 2 seconds in Intelligent auto mode.
- Self-timer cannot be set to 10 seconds in [SELF PORTRAIT] in scene mode.
- Self-timer cannot be used while in [HI-SPEED BURST] in scene mode.

[REC] mode: **iA P A S C1 C2** **REB** **SCN**

Compensating the Exposure

Use this function when you cannot achieve appropriate exposure due to the difference in brightness between the subject and the background. Look at the following examples.

Under exposed

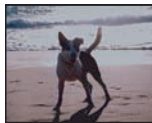

Properly exposed

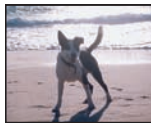

Overexposed



Compensate the exposure towards positive.

Compensate the exposure towards negative.

1 Press \blacktriangle [$\frac{+}{-}$] until [EXPOSURE] appears, compensate the exposure with $\blacktriangle/\blacktriangleright$.

- Select [0 EV] to return to the original exposure.



2 Press [MENU/SET] to finish.

- You can also press the shutter button halfway to finish.

■ Operate with the joystick

Tilt the joystick toward \blacktriangleleft to select [$\frac{+}{-}$], and then move $\blacktriangle/\blacktriangledown$ to compensate the exposure.

(A) Exposure compensation value

- Select [$\frac{+}{-}$] only to return to the original exposure (0 EV).
- Press the shutter button halfway to finish.

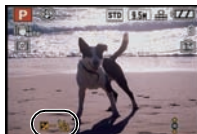

(A)

Note

- EV is an abbreviation of [Exposure Value]. It refers to the amount of light given to the CCD by the aperture value and the shutter speed.
- The exposure compensation value appears on the lower left of the screen.
- The set exposure value is memorized even if the camera is turned off.
- The compensation range of the exposure will be limited depending on the brightness of the subject.

[REC] mode: **P A S M C1 C2 SCN**

Taking Pictures using Auto Bracket/Multi Aspect

Auto Bracket

In this mode, 3 pictures are automatically recorded in the selected exposure compensation range each time the shutter button is pressed. You can select the picture with the desired exposure from the 3 pictures with different exposures.

With auto bracket ± 1 EV

1st picture

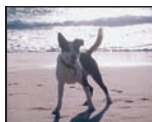

± 0 EV

2nd picture

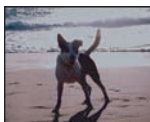

-1 EV

3rd picture



+1 EV

- 1 Press **▲** [] until **[AUTO BRACKET]** appears, set the compensation range of the exposure with **◀/▶**.

- When you do not use auto bracket, select [OFF] (0).



- 2 Press **[MENU/SET]** to finish.

- You can also press the shutter button halfway to finish.

Multi Aspect

Pressing the shutter button once automatically takes three pictures with aspect ratios of [4:3], [3:2] and [16:9] (with a single shutter sound).

- 1 Press **[DISPLAY]** to display **[MULTI ASPECT]** from the auto bracket.

- It is switched between auto bracket and multi aspect every time [DISPLAY] is pressed.



- 2 Press **◀/▶** to select **[ON]**.

- 3 Press **[MENU/SET]** to close the menu.

- You can also press the shutter button halfway to finish.
- The combinations of picture sizes are as follows.



[4:3]	→	[3:2]	→	[16:9]
10M		9.5M		9M
7M		6.5M		6M
5M		4.5M		4.5M
3M*		3M*		2.5M*

E.g. If setting is 6.5M (3:2)

- 7M (4:3), 6.5M (3:2) and 6M (16:9).

*When the multi aspect option is selected, the number of pixels cannot be set lower than the above values. If values have been set previously, they are temporarily changed to the above values.

Note

- When setting auto bracket, [] appears on the screen.
- When setting multi aspect, [] appears on the screen.
- When taking pictures using auto bracket after setting the exposure compensation range, the pictures taken are based on the selected exposure compensation range. When the exposure is compensated, the exposure compensation value appears on the lower left of the screen.
- The auto bracket/multi aspect setting is canceled if you turn the camera off or [POWER SAVE] is activated.
- When auto bracket/multi aspect is set, the auto review function is activated regardless of the auto review setting. (The picture is not enlarged.) You cannot set the auto review function in the [SETUP] menu.

- The exposure may not be compensated with auto bracket depending on the brightness of the subject.
- **When auto bracket is set, the flash is [☹].**
- **When auto bracket/multi aspect is set, burst mode and [MULTI FILM] (P76) settings will be canceled.**
- In shutter-priority AE and manual exposure, if the shutter speed is set to more than 1 second auto bracket is disabled.
- **The one set last will take precedence. (auto bracket and multi aspect cannot be set simultaneously.)**

[REC] mode: **[A] P A S M C1 C2 SCN**

Taking Pictures using Burst Mode

Pictures are taken continuously while the shutter button is pressed. Select the ones you really like from among the pictures you have taken.

- 1 Press [ / ] to display the burst mode selection menu, and then press ▲/▼ to select the burst mode.

(A) [ / ] button

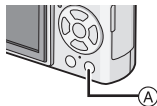





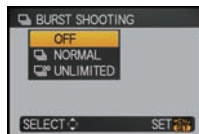

- 2 Press [MENU/SET].

- You can also press the shutter button halfway to finish.
- The menu screen disappears after about 5 seconds. At this time, the selected item is automatically set.



- 3 Take a picture.

- Hold down the shutter button fully to activate the burst mode.

		[OFF]		
Burst speed (pictures/second)		—	2.5*	approx. 2
Number of recordable pictures		—	max. 4	Depends on the remaining capacity of the built-in memory/card.
		—	max. 8	
	RAW	—	max. 3	max. 3
	RAW 	—		
	RAW 	—		

* The burst speed is constant regardless of the transfer speed of the card.

- The burst speed values given above apply when the shutter speed is 1/60 or faster and when the flash is not activated.

Note

- **When the burst mode setting is set to Unlimited**
 - **The burst speed becomes slower halfway.** The exact timing of this depends on the type of card, the picture size and the quality.
 - You can take pictures until the capacity of the built-in memory or the card is full.
- The focus is fixed when the first picture is taken.
- When the burst speed is set to [] , the exposure and white balance are fixed at the settings used for the first picture for the subsequent pictures as well. When the burst speed is set to [] , they are adjusted each time you take a picture.
- When the self-timer is used, the number of recordable pictures in burst mode is fixed to 3.
- If you are following a moving subject while taking pictures in a place (landscape) indoors, outdoors etc. where there is a large difference between the light and shade, it may take time until the exposure is stable. If burst is used at this time, the exposure may not become optimal.
- The burst speed (pictures/second) may become slower depending on the recording environment such as in dark places, if the ISO sensitivity is high etc.
- Burst mode is not canceled when the camera is switched off.
- If you take pictures in burst mode with the built-in memory, it will take time to write the picture data.
- [] is set for the flash when burst is set.
- When burst mode is set, auto bracket, multi aspect and [MULTI FILM] settings will be canceled.
- Number of burst mode is fixed to 3 pictures when external flash is used.

[REC] mode: **AS**

Taking pictures by specifying the aperture/shutter speed

A Aperture-priority AE

Set the aperture value to a higher number when you want a sharp focus background. Set the aperture value to a lower number when you want a soft focus background.

- 1 Set the [REC]/[PLAYBACK] selector switch to [], and then set the mode dial to [A].
- 2 Tilt the joystick towards ▲/▼ to set the aperture value.
- 3 Take a picture.



S Shutter-priority AE

When you want to take a sharp picture of a fast moving subject, set with a faster shutter speed. When you want to create a trail effect, set to a slower shutter speed.

- 1 Set the [REC]/[PLAYBACK] selector switch to [📷], and then set the mode dial to [S].
- 2 Tilt the joystick towards ▲/▼ to set the shutter speed.
- 3 Take a picture.



Note

- Refer to P57 for the available aperture values and the shutter speed.
- The brightness of the LCD monitor and the recorded pictures may differ. Check the pictures using the review function or playback mode.
- Set the aperture value to a higher number when the subject is too bright. Set the aperture value to a lower number when the subject is too dim.
- The aperture value and the shutter speed displayed on the screen turn red when the exposure is not adequate.
- We recommend using a tripod when the shutter speed is slow.
- [AS] cannot be set for shutter-priority AE.

[REC] mode: [M]

Taking picture by setting the exposure manually

Determine the exposure by manually setting the aperture value and the shutter speed.

- 1 Set the [REC]/[PLAYBACK] selector switch to [📷], and then set the mode dial to [M].
- 2 Tilt the joystick towards ▲/▼/◀/▶ to set the aperture value and the shutter speed.
 - Focus can be set manually when [MF] is displaying. (P58)
- 3 Press the shutter button halfway.
 - The manual exposure assistance (A) appears for about 10 seconds to indicate the exposure.
 - Set the aperture value and the shutter speed again when the exposure is not adequate.
- 4 Take the picture.



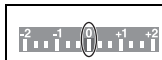

(A)

Manual Exposure Assistance



The exposure is adequate.

	Set to faster shutter speed or larger aperture value.
	Set to slower shutter speed or smaller aperture value.

- The manual exposure assistance is an approximation. We recommend checking the pictures after taking them using the review function.

Note

- Refer to P57 for the available aperture values and the shutter speed.
- The brightness of the LCD monitor and the recorded pictures may differ. Check the pictures using the review function or playback mode.
- If the exposure is not adequate, the aperture value and the shutter speed turn red when the shutter button is pressed halfway.
- [**ISO**] for flash cannot be set.

Aperture Value and Shutter Speed

Aperture-priority AE

Available Aperture Value (Per 1/3 EV)			Shutter Speed (Sec)
F8.0			8 to 1/2000
F7.1	F6.3	F5.6	
F5.0	F4.5	F4.0	
F3.5	F3.2	F2.8	
F2.5	F2.2	F2.0	

Shutter-priority AE

Available Shutter Speed (Sec) (Per 1/3 EV)				Aperture Value
8	6	5	4	F2.0 to F8.0
3.2	2.5	2	1.6	
1.3	1	1/1.3	1/1.6	
1/2	1/2.5	1/3.2	1/4	
1/5	1/6	1/8	1/10	
1/13	1/15	1/20	1/25	
1/30	1/40	1/50	1/60	
1/80	1/100	1/125	1/160	
1/200	1/250	1/320	1/400	
1/500	1/640	1/800	1/1000	
1/1300	1/1600	1/2000		

Manual exposure

Available Aperture Value (Per 1/3 EV)	Available Shutter Speed (Sec) (Per 1/3 EV)
F2.0 to F8.0	60 to 1/2000

Note

- The aperture values given in the table above are values when the zoom lever is rotated to Wide.
- Depending on the zoom magnification, some of the aperture values cannot be selected.

[REC] mode: **P A S M C1 C2**  **SCN**

Taking Pictures with Manual Focus

Use this function when you want to fix the focus or when the distance between the lens and the subject is determined and you do not want to activate auto focus.

1 Set the focus selector switch to [MF].

- [MF] is displayed while in manual focus mode.

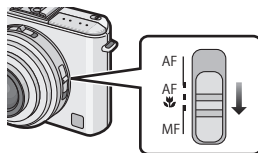

2 Tilt the joystick towards ▲/▼ to focus on the subject.

- (A) MF assistance
- (B) Focus range
 - MF assistance disappears about 2 seconds after you stop operating the joystick.
 - Focus range disappears about 5 seconds after you stop operating the joystick.

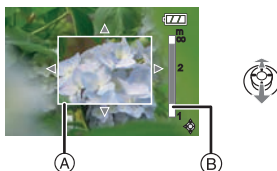

3 Take the picture.

MF ASSIST

If you tilt the joystick towards ▲/▼ when [MF ASSIST] is set to [MF1] or [MF2], MF assistance is activated and the screen is enlarged. This allows you to focus on the subject more easily.

1 Select [MF ASSIST] on the [SETUP] menu.

2 Press ▲/▼ to select [MF1] or [MF2] and then press [MENU/SET].

[MF1]	The center of the screen is enlarged. You can adjust the focus while determining the composition of the whole of the screen.
[MF2]	The center of the screen is enlarged over the whole screen. This is convenient for adjusting the focus in wide angle shots for which changes in focus are difficult to grasp.
[OFF]	The screen is not enlarged.

3 Press [MENU/SET] to close the menu.

- You can also press the shutter button halfway to finish.

■ Changing the zoom area

The magnified area can be changed while the screen is expanded using MF Assist. This is convenient when you want to change the focus position to take pictures.

- 1 Display MF Assist with ▲/▼ on the joystick.
- 2 Change the area to be expanded with the cursor buttons ▲/▼/◀/▶.
- 3 Press [MENU/SET] to set.

• The following will return the MF assistance to the original position.

- Changing the picture size or aspect.
- Turning the camera off.

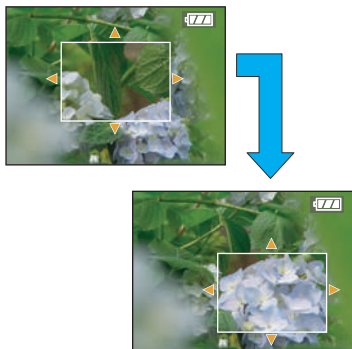

■ Technique for Manual focus

- 1 Focus by tilting the joystick toward ▲/▼.
- 2 Tilt it a little more in the same direction.
- 3 Tilt the joystick in the opposite direction to finely focus on the subject.



■ One shot AF

You can focus on the subject with auto focus by selecting [MF] with Focus selector switch and then pressing the [FOCUS] button. This is convenient for prefocus.

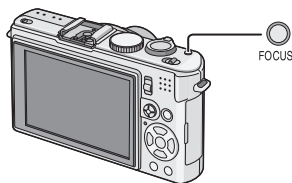

■ Prefocus

This allows the camera to be focused in advance on an arbitrary point. It is useful when it is difficult to achieve a sharp focus using autofocus or the subject is fast-moving. This function is suitable when the distance between the camera and the subject is certain.

Note

- You can also use manual focus while in motion picture mode, but the focus cannot be adjusted during recording.
- If you focus on the subject in Wide and then rotate the zoom lever to Tele, the focus may not be adequate. In this case, focus on the subject again.
- The MF assistance does not appear when using the digital zoom.
- The distance to the subject displayed on the screen in manual focus is an approximation of the focus position. Use the MF assistance screen for a final check of the focus.
- After canceling power save mode, focus on the subject again.

[REC] mode: **P A S M C1 C2**  **SCN**

Registering Personal Menu Settings (Registering custom settings)

It is possible to register up to 4 sets of current camera settings as custom sets.
 • Set to the mode dial to the desired mode and select the desired menu settings in advance.

1 Select **[CUST. SET MEM.]** on the **[SETUP]** menu.

2 Press **▲/▼** to select the custom set to register and then press **[MENU/SET]**.

- The custom settings registered in **[C 1]** can be used with the **[C1]** of the mode dial. It will be convenient if the custom setting used often is registered, since it can be used by just setting the mode dial.
- The custom settings registered in **[C 2-1]**, **[C 2-2]**, or **[C 2-3]** can be selected in the **[C2]** of the mode dial. Up to 3 custom settings can be registered, so select the one matching the needs.



3 Press **▲** to select **[YES]** and then press **[MENU/SET]**.

- When **[YES]** is selected, the settings that were previously stored are overwritten.
- You cannot save the following menu items because they affect other recording modes.
 - [CLOCK SET]
 - [TRAVEL DATE]
 - [SCENE MENU]
 - [RESET]
 - [NO.RESET]
 - [BABY1]/[BABY2] or [PET] birthday and name settings in scene mode



4 Press **[MENU/SET]** to close the menu.

[REC] mode: **C1 C2**

Taking pictures in Custom mode

You can select one of your own custom settings saved with [CUST. SET MEM.] to suit the picture-taking conditions.

Initial setting of the program AE mode is registered as the custom settings initially.

1 Slide the [REC]/[PLAYBACK] selector switch to **[CAMERA]**.

2 Set the mode dial to **[C1]** or **[C2]**.

(A) Display custom settings

- When set to **[C1]**
→ You can take pictures with the custom settings registered in the [C 1]. ([C 1] is displayed on the screen)
- When set to **[C2]**
→ To steps 3 and 4

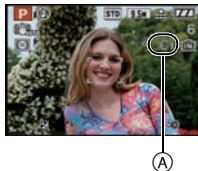

3 Press **▲/▼** to select the custom settings you want to use, and then press **[MENU/SET]**.

- In **[C2]**, press [DISPLAY] to display the settings for each menu item. (Press **◀/▶** to change between screens, and press [DISPLAY] to return to the selection screen.)
- Only the main menu items are displayed.



4 Press **[MENU/SET]** to enter the settings.

- Saving of the selected custom settings is displayed on the screen.



■ When changing the menu settings

Even if the menu settings are changed temporarily with [C 1], [C 2-1], [C 2-2] or [C 2-3] selected, what has been registered will remain unchanged.

To change what has been registered, overwrite the registered data using [CUST. SET MEM.] (P60) on the setup menu.

Note

- You cannot register the settings of the following menu items as a custom mode. If they are changed, other recording modes will also be affected.
 - [CLOCK SET], [TRAVEL DATE], [SCENE MENU], [RESET] and [NO.RESET] in the [SETUP] menu
 - [BABY1]/[BABY2] or [PET] birthday and name settings in scene mode

[REC] mode: **SCN**

Taking pictures that match the scene being recorded (SCN: Scene mode)

When you select a scene mode to match the subject and recording situation, the camera sets the optimal exposure and hue to obtain the desired picture.

1 Slide the [REC]/[PLAYBACK] selector switch to **[RECORD]**.

2 Set the mode dial to **[SCN]**.

3 Press **▲/▼/◀/▶** to select the scene mode.

- You can switch menu screens from any menu item by rotating the zoom lever.

4 Press **[MENU/SET]** to set.

- The menu screen is switched to the recording screen in the selected scene mode.



■ About the information **[i]**

- If you press [DISPLAY] when selecting a scene mode in step **3**, explanations about each scene mode are displayed. (If you press [DISPLAY] again, the screen returns to the scene mode menu.)

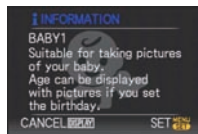

Note

- To change the scene mode, press [MENU/SET] and then press **▶**, and return to step **3** above.
- Refer to P49 for information about the shutter speed.
- The scene mode flash setting is reset to the initial setting when the scene mode is changed.
- When you take a picture with a scene mode that is not adequate for the purpose, the hue of the picture may differ from the actual scene.
- The following items cannot be set in scene mode because the camera automatically adjusts them to the optimal setting.
 - [INTELLIGENT ISO]/[SENSITIVITY]/[ISO LIMIT SET]/[I.EXPOSURE]/[MULTI. EXPO.]/[METERING MODE]/[FILM MODE]/[MIN. SHTR SPEED]
- [I.EXPOSURE] is activated automatically in the following scene modes.
 - [PORTRAIT]/[SOFT SKIN]/[SELF PORTRAIT]/[SCENERY]/[SPORTS]/[NIGHT PORTRAIT]/[PARTY]/[CANDLE LIGHT]/[BABY1]/[BABY2]/[SUNSET]/[HIGH SENS.]

[PORTRAIT]

When taking pictures of people outdoors during the daytime, this mode allows you to improve the appearance of the persons concerned and make their skin tones look healthier.

■ Technique for Portrait mode

To make this mode more effective:

- Rotate the zoom lever as far as possible to Tele.

- Move close to the subject to make this mode more effective.

Note

- The initial setting for [AF MODE] is [∞].

[SOFT SKIN]

When taking pictures of people outdoors during the daytime, this mode enables the texture of their skin to appear even softer than with [PORTRAIT]. (It is effective when taking pictures of people from the chest up.)

■ Technique for Soft skin mode

To make this mode more effective:

- Rotate the zoom lever as far as possible to Tele.
- Move close to the subject to make this mode more effective.

Note

- If a part of the background etc. is a color close to skin color, this part is also smoothed.
- This mode may not be effective when there is insufficient brightness.
- The initial setting for [AF MODE] is [∞].

[SELF PORTRAIT]

Select this to take pictures of yourself.

■ Technique for Self portrait mode

- Press the shutter button halfway to focus. The self-timer indicator lights up when you are brought into focus. Making sure you hold the camera still, press the shutter button fully to take the picture.
- The subject is not focused when the self-timer indicator is blinking. Make sure to press the shutter button halfway again to focus.
- The recorded picture automatically appears on the LCD monitor for reviewing.
- If the picture is blurry due to the slow shutter speed, we recommend using the 2 second self-timer.



Note

- The focus range is about 30 cm (0.99 feet) to 70 cm (2.29 feet).
- You can take a picture of yourself with audio (P88). If you do this, the self-timer indicator will light up while recording the audio.
- The zoom magnification is automatically moved to Wide (1×).
- The self-timer can only be set to off or 2 seconds. If it is set to 2 seconds, this setting will remain until the camera is turned off, the scene mode is changed or [REC] mode or [PLAYBACK] mode is selected.
- The stabilizer function mode is fixed to [MODE2]. (P87)
- The initial setting for [AF MODE] is [∞].

[SCENERY]

This allows you to take pictures of a wide landscape.

Note

- The focus range is 5 m (16.4 feet) to ∞.

 [SPORTS]

Set here when you want to take pictures of sports scenes or other fast-moving events.

 **Note**

- This mode is suitable for taking pictures of subjects at distances of 5 m (16.4 feet) or more.
- [INTELLIGENT ISO] is activated, and maximum ISO sensitivity level becomes [ISO800].

 [NIGHT PORTRAIT]

This allows you to take pictures of a person and the background with near real-life brightness.

■ Technique for Night portrait mode

- **Open the flash (the flash setting will be [4S], indicating a compulsory flash).**
- Since the shutter speed becomes slower, we recommend using a tripod and the self-timer for taking pictures.
- Ask the subject not to move while taking a picture.
- We recommend rotating the zoom lever to Wide (1×) and being about 1.5 m (4.92 feet) from the subject when taking a picture.

 **Note**

- The focus range is 0.8 m (2.62 feet) (Wide)/1.2 m (3.94 feet) (Tele) to 5 m (16.4 feet).
- The shutter may remain closed (max. about 8 sec.) after taking the picture because of signal processing. This is not a malfunction.
- Noise may become visible when you take pictures in dark places.
- The initial setting for [AF MODE] is [AF-ON].

 [NIGHT SCENERY]

This allows you to take vivid pictures of the nightscape.

■ Technique for Night scenery mode

- When the camera is set to [STABILIZER] and there is very little jitter, or if [STABILIZER] is set to [OFF], shutter speed may slow down up to 8 seconds. We recommend using the tripod and the self-timer for taking picture.

 **Note**

- The focus range is 5 m (16.4 feet) to ∞.
- The shutter may remain closed (max. about 8 sec.) after taking the picture because of signal processing. This is not a malfunction.
- Noise may become visible when you take pictures in dark places.

 [FOOD]

This mode allows you to take pictures of food with a natural hue without being affected by the ambient light in restaurants etc.

 **Note**

- The focus range becomes the same as AF macro mode. [1 cm (0.04 feet) (Wide)/30 cm (0.99 feet) (Tele) to ∞]

[PARTY]

Select this when you want to take pictures at a wedding reception, an indoor party etc. This allows you to take pictures of people and the background with near real-life brightness.

■ Technique for Party mode

- Use the flash. (You can set to [⚡📷] or [📷].)
- We recommend using a tripod and the self-timer for taking pictures.
- We recommend rotating the zoom lever to Wide (1×) and being about 1.5 m (4.92 feet) from the subject when taking pictures.



Note

- The initial setting for [AF MODE] is [👤].

[CANDLE LIGHT]

This mode allows you to take pictures with a candle-lit atmosphere.

■ Technique for Candle light mode

- This is more effective when taking pictures without using the flash.
- We recommend using a tripod and the self-timer for taking pictures.



Note

- The focus range becomes the same as AF macro mode.
- The initial setting for [AF MODE] is [👤].

[BABY1]/ [BABY2]

This takes pictures of a baby with a healthy complexion. When you use the flash, the light from it is weaker than usual.

It is possible to set different birthdays and names for [BABY1] and [BABY2]. You can select to have these appear at the time of playback, or have them stamped on the recorded image using [TEXT STAMP] (P99).

■ Birthday/Name setting

- 1 Press **▲/▼** to select [AGE] or [NAME] and then press **▶**.
- 2 Press **▲/▼** to select [SET] and then press [MENU/SET].
- 3 Enter the birthday or name.

Birthday:

◀/▶: Select the items (year/month/day).

▲/▼: Setting.

[MENU/SET]: Exit.

Name: For details on how to enter characters, read the [TITLE EDIT] section on P98.

- When the birthday or name is set, [AGE] or [NAME] is automatically set to [ON].
- If [ON] is selected when the birthday or name has not been registered, the setting screen appears automatically.

- 4 Press [MENU/SET] to finish.

■ To cancel [AGE] and [NAME]

Select the [OFF] setting in step 2 of the “Birthday/Name setting” procedure.



Note

- The age and name can be printed out using the “PHOTOfunSTUDIO-viewer-” bundled software on the CD-ROM (supplied).
- If [AGE] or [NAME] is set to [OFF] even when the birthday or name has been set, the age or name will not be displayed. Before taking pictures, set [AGE] or [NAME] to [ON].

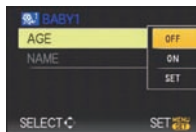

- The focus range becomes the same as AF macro mode. [1 cm (0.04 feet) (Wide)/30 cm (0.99 feet) (Tele) to ∞]
- [INTELLIGENT ISO] is activated, and maximum ISO sensitivity level becomes [ISO400].
- If the camera is turned on with [BABY1]/[BABY2] set, the age and name are displayed at the lower left of the screen for about 5 seconds, along with the current date and time.
- If the age is not properly displayed, check the clock and birthday settings.
- If the quality is set to [RAW], [RAW] or [RAW] and pictures are taken, the name is not registered on the pictures.
- The birthday setting and name setting can be reset with [RESET].
- The initial setting for [AF MODE] is [].

[PET]

Select this when you want to take pictures of a pet such as a dog or a cat. You can set your pet's birthday and name. You can select to have these appear at the time of playback, or have them stamped on the recorded image using [TEXT STAMP] (P99). For information about [AGE] or [NAME], refer to [BABY1]/[BABY2] on P65.

Note

- The initial setting for the AF assist lamp is [OFF].
- [INTELLIGENT ISO] is activated, and maximum ISO sensitivity level becomes [ISO800].
- The initial setting for [AF MODE] is [].
- Refer to [BABY1]/[BABY2] for other information about this mode.
- The focus range becomes the same as AF macro mode. [1 cm (0.04 feet) (Wide)/30 cm (0.99 feet) (Tele) to ∞]

[SUNSET]

Select this when you want to take pictures of sunset view. This allows you to take vivid pictures of the red color of the sun.

[HIGH SENS.]

This mode minimizes the jitter of the subjects, and enables you to take pictures of these subjects in dimly lit rooms. (Select this for high-sensitivity processing. The sensitivity automatically switches to between [ISO1600] and [ISO6400].)

- 3M (4:3), 2.5M (3:2) or 2M (16:9) is selected as the picture size.

Note

- [QUALITY] is automatically fixed to [].
- You can take pictures suitable for 4"×6"/10×15 cm printing.
- The focus range becomes the same as AF macro mode. [1 cm (0.04 feet) (Wide)/30 cm (0.99 feet) (Tele) to ∞]

[HI-SPEED BURST]

This is a convenient mode for shooting rapid movement or a decisive moment.

- Still pictures are taken continuously while the shutter button is pressed fully.

Maximum Burst speed	approx. 6 pictures/second (built-in memory)
Number of recordable pictures	approx. 35 (built-in memory)/approx. 35 to 100* (card) * the maximum is 100.

- 3M (4:3), 2.5M (3:2) or 2M (16:9) is selected as the picture size.

- The burst speed changes according to the recording conditions.
- The number of burst recording pictures are limited by the picture-taking conditions and the type and/or status of the card used.
- The number of burst recording pictures increase immediately after formatting.

Note

- [QUALITY] is automatically fixed to [L].
- You can take pictures suitable for 4"×6"/10×15 cm printing.
- The shutter speed becomes 1/8th of a second to 1/2000th of a second.
- The focus range becomes the same as AF macro mode. [1 cm (0.04 feet) (Wide)/30 cm (0.99 feet) (Tele) to ∞]
- The focus, zoom, exposure, white balance, shutter speed and ISO sensitivity are fixed to the settings for the first picture.
- The ISO sensitivity automatically switches to between [ISO500] and [ISO800]. However, the ISO sensitivity is increased to make the shutter speed become high-speed.

[FLASH BURST]

Still pictures are taken continuously with flash. It is convenient to take continuous still pictures in dark places.

- Still pictures are taken continuously while the shutter button is pressed fully.

Number of recordable pictures	max. 5 pictures (while pressing the shutter)
--------------------------------------	--

- The burst speed changes according to the recording conditions.
- 3M (4:3), 2.5M (3:2) or 2M (16:9) is selected as the picture size.

Note

- [QUALITY] is automatically fixed to [L].
- You can take pictures suitable for 4"×6"/10×15 cm printing.
- The focus range becomes the same as AF macro mode. [1 cm (0.04 feet) (Wide)/30 cm (0.99 feet) (Tele) to ∞]
- The focus, zoom, exposure, shutter speed, ISO sensitivity, and flash level are fixed to the settings for the first picture.
- [INTELLIGENT ISO] is activated, and maximum ISO sensitivity level becomes [ISO3200].
- See the Note on P49 when using the flash.

[STARRY SKY]

This allows you to take vivid pictures of a starry sky or a dark subject.

■ Setting the shutter speed

Select a shutter speed of [15 SEC.], [30 SEC.] or [60 SEC.].

- 1 Press **▲/▼** to select the number of seconds and then press **[MENU/SET]**.

- It is also possible to change the number of seconds using the quick menu. (P23)

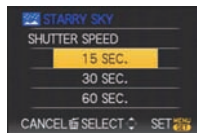

2 Take pictures.

- Press the shutter button fully to display the countdown screen. Do not move the camera after this screen is displayed. When countdown finishes, [PLEASE WAIT...] is displayed for the same length of time as the set shutter speed for signal processing.
- Press [MENU/SET] to stop taking the picture while the countdown screen is displayed.

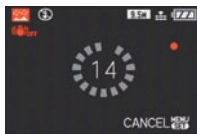

■ Technique for Starry sky mode

- The shutter opens for 15, 30 or 60 seconds. Be sure to use a tripod. We also recommend taking pictures with the self-timer.

Note

- The optical image stabilizer function is fixed to [OFF].
- ISO sensitivity is fixed to [ISO80].

[FIREWORKS]

This mode allows you to take beautiful pictures of fireworks exploding in the night sky.

■ Technique for Fireworks mode

- Since the shutter speed becomes slower, we recommend using a tripod.

Note

- This mode is most effective when the subject is 10 m (32.8 feet) or more away.
- The shutter speed becomes the following.
 - Image stabiliser function [OFF]: 2 seconds
 - When [AUTO], [MODE1] or [MODE2] is set on the optical image stabilizer function: 1/4th of a second or 2 seconds (The shutter speed becomes 2 seconds only when the camera has determined that there is little jitter such as when using a tripod etc.)
 - You can change the shutter speed by compensating the exposure.
- The AF area is not displayed.
- ISO sensitivity is fixed to [ISO80].

[BEACH]

This allows you to take even more vivid pictures of the blue color of the sea, sky etc. It also prevents under exposure of people under strong sunlight.

Note

- The initial setting for [AF MODE] is [].
- Do not touch the camera with wet hands.
- Sand or seawater will cause the camera to malfunction. Make sure that sand or seawater does not get into the lens or the terminals.
- Problems caused by sand or seawater are not covered by the product warranty.

[SNOW]

This allows you to take pictures that show the snow as white as possible at a ski resort or a snow-covered mountain.

[AERIAL PHOTO]

This mode allows you to take pictures through an airplane window.

■ Technique for Aerial photo mode

- We recommend using this technique if it is difficult to focus when taking pictures of clouds etc. Aim the camera at something with high contrast, press the shutter button halfway to fix the focus and then aim the camera at the subject and press the shutter button fully to take the picture.

Note

- The focus range is 5 m (16.4 feet) to ∞ .
- **Turn the camera off when taking off or landing.**
- **When using the camera, follow all instructions from the cabin crew.**
- Be careful about the reflection from the window.

[PIN HOLE]

Picture is taken darker and with soft focus around the subjects.

- 3M (4:3), 2.5M (3:2) or 2M (16:9) is selected as the picture size.

Note

- [QUALITY] is automatically fixed to [..].
- You can take pictures suitable for 4"×6"/10×15 cm printing.
- The focus range becomes the same as AF macro mode. [1 cm (0.04 feet) (Wide)/30 cm (0.99 feet) (Tele) to ∞]
- Face detection may not operate normally in the dark areas around the edges of the screen.

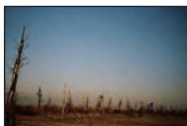

[FILM GRAIN]

Picture is taken with a grainy texture as though blasted with sand.

- 3M (4:3), 2.5M (3:2) or 2M (16:9) is selected as the picture size.

Note

- [QUALITY] is automatically fixed to [..].
- You can take pictures suitable for 4"×6"/10×15 cm printing.
- The focus range becomes the same as AF macro mode. [1 cm (0.04 feet) (Wide)/30 cm (0.99 feet) (Tele) to ∞]
- ISO sensitivity is fixed to [ISO1600].



[REC] mode: 

Motion Picture Mode

1 Slide the [REC]/[PLAYBACK] selector switch to .

2 Select the aspect ratio using the aspect ratio selector switch.

- You cannot record motion picture in [3:2].

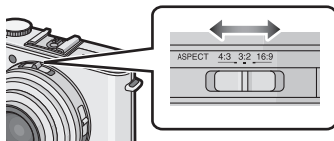

3 Set the mode dial to .

4 Press the shutter button halfway to focus and then press it fully to start recording.

A Audio recording

- The available recording time **B** is displayed on the top right and the elapsed recording time **C** is displayed on the bottom right of the screen.
- After pressing the shutter button fully, release it straight away. If the button is held down, the sound will not be recorded for a few seconds when recording starts.
- When the subject is focused, the focus indication lights.
- The focus and zoom are fixed to the setting when recording starts (the first frame).
- The audio is also recorded simultaneously from the built-in microphone on this unit. (Motion pictures cannot be recorded without audio.)

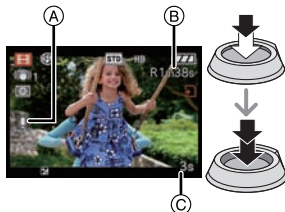

5 Press the shutter button fully to stop recording.

- If the built-in memory or the card becomes full in the middle of recording, the camera stops recording automatically.

Changing the settings for the aspect ratio and the picture quality

- When you set the picture quality to [HD], [WVGA] or [VGA], we recommend using a high-speed card with "10MB/s" or greater displayed on the package.

1 Press [MENU/SET].

2 Press $\blacktriangle/\blacktriangledown$ to select [PICTURE MODE] and then press \blacktriangleright .

3 Press $\blacktriangle/\blacktriangledown$ to select the item and then press [MENU/SET].

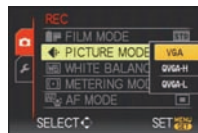



Item	Picture size	fps	Aspect ratio
HD *	1280×720 pixels	24	16:9
WVGA *	848×480 pixels	30	
VGA *	640×480 pixels	30	
QVGA-H	320×240 pixels	30	4:3
QVGA-L		10	

- fps “frames per second”; This refers to the number of frames used in 1 second.
 - You can record smoother motion pictures with “30 fps” and “24 fps”.
 - You can record longer motion pictures with “10 fps” although the picture quality is lower.
 - [HD] can be enjoyed on the TV as high quality motion picture by using the component cable (DMW-HDC2; optional). Refer to “Playing back on the TV with component socket” (P118) for details.
 - The file size with [QVGA-L] is small so it is suitable for e-mails.
- *Cannot be recorded in the built-in memory.

4 Press [MENU/SET] to close the menu.

- You can also press the shutter button halfway to close the menu.

Note

- When using a memory card, [3:2] cannot be selected in motion picture mode. When using the built-in memory, [16:9] and [3:2] cannot be selected in motion picture mode.
- Refer to P145 for information about the available recording time.
- The available recording time displayed on the screen may not decrease regularly.
- Depending on the type of the card, the card access indication may appear for a while after recording motion pictures. This is not a malfunction.
- Motion pictures can be recorded continuously up to 2 GB. The maximum available recording time for up to 2 GB only is displayed on the screen.
- When motion pictures recorded with the camera are played back on other equipment, the quality of the picture and sound may deteriorate and it may not be possible to play them back. Also the recording information may not be displayed correctly.
- LUMIX model sold after August 2008 has made audio improvement, so it cannot be played back on the previous models.
- This unit does not support recording motion pictures on MultiMediaCards.
- In motion picture mode, the following functions cannot be used.
 - [] and [] in [AF MODE]
 - Direction detection function
 - Review
 - [MODE2] and [AUTO] on the optical image stabilizer function

[REC] mode:        

Useful Functions at Travel Destinations

Recording which Day of the Vacation and the Location of the Vacation

For details on the [SETUP] menu settings, refer to P21.

If you set the departure date and the location of the vacation in advance, the number of days that have passed since the departure date (which day of the vacation it is) is recorded when you take the picture. You can display the number of days that have passed when playing back the pictures and stamp it on the recorded pictures with [TEXT STAMP] (P99).

- The number of days that have passed since the departure date can be printed out using the "PHOTOfunSTUDIO-viewer" bundled software on the CD-ROM (supplied).
- Select [CLOCK SET] to set the current date and time in advance. (P19)

1 Select [TRAVEL DATE] from the [SETUP] menu, and then press **▶**.

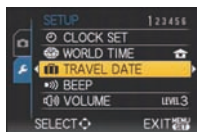

2 Press **▲** to select [TRAVEL SETUP] and then press **▶**.

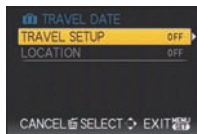

3 Press **▼** to select [SET] and then press [MENU/SET].

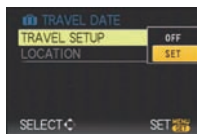

4 Press **▲/▼/◀/▶** to set the departure date (year/month/day), and then press [MENU/SET].

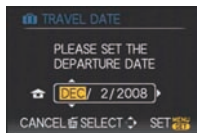

5 Press **▲/▼/◀/▶** to set the return date (year/month/day), and then press [MENU/SET].

- If you do not want to set the return date, press [MENU/SET] while the date bar is displayed.

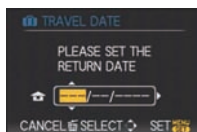

6 Press **▼** to select [LOCATION] and then press **▶**.

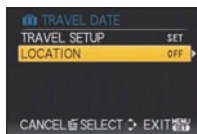

7 Press **▼** to select [SET] and then press [MENU/SET].

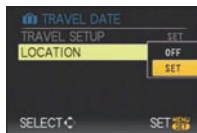

8 Enter the location.

- For details on how to enter characters, read the [TITLE EDIT] section on P98.

9 Press [MENU/SET] twice to close the menu.

10 Take a picture.

- The number of days that have passed since the departure date is displayed for about 5 seconds if this unit is turned on etc. after setting the travel date or when the travel date is set.
- When the travel date is set,  appears on the lower right of the screen.

■ Canceling the travel date

The travel date is automatically canceled if the current date is after the return date. If you want to cancel the travel date before the end of the vacation, select [OFF] on the screen shown in step 3 or 7 and then press [MENU/SET] twice. If the [TRAVEL SETUP] is set to [OFF] in step 3, [LOCATION] will be also set to [OFF].

Note

- The travel date is calculated using the date in the clock setting and the departure date you set. If you set [WORLD TIME] (P73) to the travel destination, the travel date is calculated using the date in the clock setting and the travel destination setting.
- The travel date setting is memorized even if the camera is turned off.
- If [TRAVEL DATE] is set to [OFF], the number of days that have passed since the departure date will not be recorded even if you set the travel date or the return date. Even if [TRAVEL DATE] is set to [SET] after taking the pictures, which day of the vacation you took them is not displayed.
- For the date before the departure date, [-] (minus) is displayed in orange and the day of the vacation is not recorded.
- If the travel date is displayed as [-] (minus) in white, there is a time difference that involves date change between the [HOME] and [DESTINATION]. (It will be recorded)
- The text set as [LOCATION] can be edited later with [TITLE EDIT].
- The names for [BABY1]/[BABY2] and [PET] of the scene mode will not be recorded when [LOCATION] is set.
- [LOCATION] cannot be recorded when taking motion pictures.

Recording Dates/Times at Overseas Travel Destinations (World Time)

For details on the [SETUP] menu settings, refer to P21.

You can display the local times at the travel destinations and record them on the pictures you take.

- Select [CLOCK SET] to set the current date and time in advance. (P19)

1 Select [WORLD TIME] from the [SETUP] menu, and then press .

- When first using the camera after purchasing it, the [PLEASE SET THE HOME AREA] message appears. Press [MENU/SET], and set the home area on the screen in step 3.

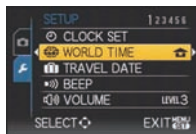

2 Press to select [HOME], and then press [MENU/SET].

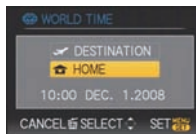

3 Press **◀/▶** to select the home area, and then press **[MENU/SET]**.

- (A) Current time
- (B) Time difference from GMT (Greenwich Mean Time)
- If daylight saving time [☀️🕒] is used at the home area, press **▲**. Press **▲** again to return to the original time.
- The daylight saving time setting for the home area does not advance the current time. Advance the clock setting by one hour.

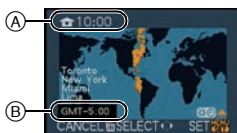

4 Press **▲** to select **[DESTINATION]** and then press **[MENU/SET]** to set.

- (C) Depending on the setting, the time at the travel destination area or the home area is displayed.

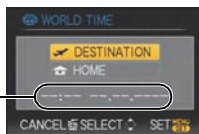

5 Press **◀/▶** to select the area the travel destination is in and then press **[MENU/SET]** to set.

- (D) Current time of the destination area
- (E) Time difference
- If daylight saving time [☀️🕒] is used at the travel destination, press **▲**. (The time advances by one hour.) Press **▲** again to return to the original time.



6 Press **[MENU/SET]** to close the menu.

Note

- Return the setting to [HOME] when the vacation is finished by performing steps 1, 2 and 3.
- If [HOME] is already set, change only the travel destination, and use.
- If you cannot find the travel destination in the areas displayed on the screen, set by the time difference from the home area.
- The travel destination icon [✈️] appears when playing back pictures taken at the travel destination.

Using the [REC] Mode Menu

🎬 [FILM MODE]

For details on [REC] mode menu settings, refer to P21.

Every type of film for film cameras has its own color tone and contrast characteristics. In film mode, you can select the color tone of the pictures from 9 types in the same way as you would select different films for film cameras.

Select different settings in film mode to match the recording situation and your picture of the recording.

Applicable modes: **P A S M G M 2**

- [STANDARD]***: This is the standard setting.
- [DYNAMIC]***: The saturation and contrast of the stored colors are increased.
- [NATURE]**: Brighter red, green and blue. Enhanced beauty of nature.
- [SMOOTH]***: The contrast is lowered for smoother and clearer color.
- [VIBRANT]**: Higher saturation and contrast than dynamic.
- [NOSTALGIC]**: Lower saturation and contrast. Reflecting passage of time.
- [STANDARD] (B&W)***: This is the standard setting.
- [DYNAMIC] (B&W)**: The contrast is increased.
- [SMOOTH] (B&W)**: Smooths the picture without losing the skin texture.
- [MY FILM 1]**
- [MY FILM 2]**: The saved setting is used.
- [MULTI FILM]**: One press of the shutter button automatically records the picture to a selected number of films (up to a maximum of three films).

* You can also use in motion picture mode.

Note

- You cannot adjust [SATURATION] in the black and white settings in film mode.
- Film mode adjustments cannot be made in scene mode.

1 Press **◀/▶** to select a film.

- Press [DISPLAY] to display descriptions of the film modes (press again to return to the previous screen).

2 Press **[MENU/SET]** to close the menu.

- You can also press the shutter button halfway to close the menu.

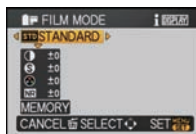

■ Adjusting each film mode to the desired setting

1 Press **◀/▶** to select a film.

2 Press **▲/▼** to select an item and **◀/▶** to adjust.

- Registered settings are memorized even if the camera is turned off.



3 Press **▲/▼** to select **[MEMORY]**, and press **[MENU/SET]**.

4 Press **▲/▼** to select an item, and then press **[MENU/SET]**.

- You can register 2 settings. ([MY FILM 1] and [MY FILM 2]) (After registering, the film mode name that was registered previously is displayed.)
- [STANDARD] is registered in [MY FILM 1] and [STANDARD] (B&W) is registered in [MY FILM 2] at the time of purchase.

5 Press **[MENU/SET]** to close the menu.

- You can also press the shutter button halfway to close the menu.



[CONTRAST]	[+]	Increases the difference between the brightness and the darkness in the picture.
	[-]	Decreases the difference between the brightness and the darkness in the picture.
[SHARPNESS]	[+]	The picture is sharply defined.
	[-]	The picture is softly focused.
[SATURATION]	[+]	The colors in the picture become vivid.
	[-]	The colors in the picture become natural.
[NOISE REDUCTION]	[+]	The noise reduction effect is enhanced. Picture resolution may deteriorate slightly.
	[-]	The noise reduction effect is reduced. You can obtain pictures with higher resolution.

■ Select the film you would like to use with [MULTI FILM]

- 1 Press ◀▶ to select [MULTI FILM], and then press ▼.
- 2 Press ▲/▼ to select multifilms 1 to 3 and press ◀▶ to pick out the films you wish to use as the multifilms.

- One press of the shutter button automatically records the picture to a selected number of films (up to a maximum of three films).

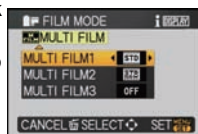

Note

- In film mode, the camera may do something equivalent to pull processing or push processing to create a picture with particular characteristics. The shutter speed may become very slow at this time.
- Noise may become visible when you take pictures in dark places. To avoid picture noise, we recommend setting [NOISE REDUCTION] towards [+] or setting the items except [NOISE REDUCTION] towards [-] to take pictures.
- When you adjust the film mode, film mode name is displayed in orange on the LCD monitor.

■ [PICTURE SIZE]

For details on [REC] mode menu settings, refer to P21.

Set the number of pixels. The higher the numbers of pixels, the finer the detail of the pictures will appear even when they are printed onto large sheets.

Applicable modes: **[A] [P] [ASM] [C1] [C2] [SCN]**

■ When the aspect ratio is [4:3].

- * This item cannot be set in the Intelligent auto mode.

10M (10M)	3648×2736 pixels
7M (7M [7])*	3072×2304 pixels
5M (5M [5])	2560×1920 pixels
3M (3M [3])	2048×1536 pixels
2M (2M [2])*	1600×1200 pixels
0.3M (0.3M [0.3])	640×480 pixels

■ When the aspect ratio is [3:2].

9M (9.5M)	3776×2520 pixels
6.5M (6.5M [EZ])*	3168×2112 pixels
4.5M (4.5M [EZ])	2656×1768 pixels
3M (3M [EZ])*	2112×1408 pixels
2.5M (2.5M [EZ])	2048×1360 pixels

■ When the aspect ratio is [16:9].

9M (9M)	3968×2232 pixels
6M (6M [EZ])*	3328×1872 pixels
4.5M (4.5M [EZ])	2784×1568 pixels
2.5M (2.5M [EZ])*	2208×1248 pixels
2M (2M [EZ])	1920×1080 pixels

Note

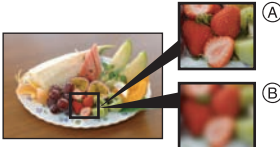
- “EZ” is an abbreviation of “Extended optical Zoom”.
 - A digital picture is made of numerous dots called pixels. The higher the numbers of pixels, the finer the picture will be when it is printed on a large piece of paper or displayed on a PC monitor.
- 

(A) Many pixels (Fine)

(B) Few pixels (Rough)
- * These pictures are examples to show the effect.
 - If you change the aspect ratio, set the picture size again.
 - The extended optical zoom does not work in [HIGH SENS.], [HI-SPEED BURST], [FLASH BURST], [PIN HOLE], or [FILM GRAIN] in scene mode so the picture size for [**[EZ]**] is not displayed.
 - Pictures may appear mosaic depending on the subject and the recording conditions.
 - Refer to P142 for information about the number of recordable pictures.

📶 [QUALITY]

For details on [REC] mode menu settings, refer to P21.

Set the compression rate at which the pictures are to be stored.

Applicable modes: **PASMC1C2SCH**

[📶]: Fine (when giving priority to the picture quality)

[📶]: Standard (when using the standard picture quality and increasing the number of pictures to be recorded without changing the number of pixels)

[RAW]: RAW file (When the image is to be edited with a PC in high quality)*¹

[RAW]: RAW+JPEG (fine)*²

[RAW]: RAW+JPEG (standard)*²

*¹ It is fixed to maximum recordable pixels of each aspect ratio(**[10M]**, **[9.5M]**, **[9M]**).

*² If you delete a RAW file from the camera, the corresponding JPEG image will also be deleted.

 **Note**

- If a RAW picture is recorded with the built-in memory, it will take time to write the picture data.
- If you delete a RAW file from the camera, the corresponding JPEG image will also be deleted.
- Refer to P142 for information about the number of recordable pictures.
- You can enjoy more advanced picture editing if you use RAW files. You can save RAW files in a file format (JPEG, TIFF etc.) that can be displayed on your PC etc., develop them and edit them using the software "SILKYPIX Developer Studio" by Ichikawa Soft Laboratory on the CD-ROM (supplied).
- [RAW] gives a smaller data size for the same file than [$\frac{RAW}{\dots}$] or [$\frac{RAW}{\dots}$].
- The following functions are available when the quality is set to [RAW], [$\frac{RAW}{\dots}$] or [$\frac{RAW}{\dots}$].
 - [CALENDAR]
 - [ROTATE]
 - [PROTECT]

ISO [INTELLIGENT ISO]

For details on [REC] mode menu settings, refer to P21.

The camera automatically sets the optimum ISO sensitivity and shutter speed to suit the movement of the subject and brightness of the scene to minimize the jitter of the subject.

Applicable modes: P A C1 C2

[OFF]/[ON]

 **Note**

- Refer to P48 for the flash range.
- Depending on the brightness and how fast the subject is moving, jitter may not be avoided.
- Movements may not be detected when a moving subject is small, when a moving subject is at the edge of the screen or when a subject has moved at the very moment when the shutter button was pressed fully.
- The maximum ISO sensitivity will be set to the value set in [ISO LIMIT SET] when set to [ON]. When the [ISO LIMIT SET] is set to [AUTO], it will be set automatically within the range up to [ISO800] depending on the brightness.

ISO [SENSITIVITY]

For details on [REC] mode menu settings, refer to P21.

This allows the sensitivity to light (ISO sensitivity) to be set. Setting to a higher figure enables pictures to be taken even in dark places without the resulting pictures coming out dark.

Applicable modes: P A S M C1 C2

[AUTO]/[80]/[100]/[200]/[400]/[800]/[1600]/[3200]

ISO sensitivity	80  3200	
Recording location (recommended)	When it is light (outdoors)	When it is dark
Shutter speed	Slow	Fast
Noise	Less	Increased

 **Note**

- When setting to [AUTO], the ISO sensitivity is automatically adjusted to a maximum of value set with [ISO LIMIT SET].

- ISO sensitivity will adjust automatically depending on brightness within the maximum setting of [ISO400] ([ISO1000] when the flash is used) when [AUTO] is selected for [ISO LIMIT SET].
- The setting is not available when [INTELLIGENT ISO] is being used. ([iISO] is displayed.)
- It is recommended to set the ISO sensitivity lower, adjust the [NOISE REDUCTION] under [FILM MODE] toward the positive side, or adjust the setting for each of the items other than [NOISE REDUCTION] toward the negative side if the noise is predominant. (P74)

[ISO LIMIT SET]

For details on [REC] mode menu settings, refer to P21.

Most appropriate sensitivity within the range set will be set depending on the brightness of the subject.

Applicable modes: **P A S M C1 C2**

[AUTO]/[200]/[400]/[800]/[1600]/[3200]

Note

- The upper limit of the ISO sensitivity can be set.
- The higher the value set for the ISO sensitivity, the more the jitter is reduced but the greater the amount of picture noise.
- It will work when the [SENSITIVITY] is set to [AUTO] or [INTELLIGENT ISO] is set to [ON].

WB [WHITE BALANCE]

For details on [REC] mode menu settings, refer to P21.

In sunlight, under incandescent lights or in other such conditions where the color of white takes on a reddish or bluish tinge, this item adjusts to the color of white which is closest to what is seen by the eye in accordance with the light source.

Applicable modes: **P A S M C1 C2  SCN**

[AWB]: Automatic adjustment

: When taking pictures outdoors under a clear sky

: When taking pictures outdoors under a cloudy sky

: When taking pictures outdoors in the shade

* : When taking pictures with the flash only

: When taking pictures under incandescent lights

: When using the preset white balance

[SETK]: When using the preset color temperature setting

* It cannot be selected in the motion picture mode.

Note

- The optimal white balance will differ depending on the type of halogen lighting being recorded under so use [AWB], [A] or [B].
- The white balance might not be adjusted for the subject where the flash does not reach when the flash is used.
- The white balance is memorized even if the camera is turned off, but [WHITE BALANCE] for the scene mode is set to [AWB] when the scene mode is changed.

Setting the white balance manually

- 1 Select [A] or [B] and then press \blacktriangleright .
- 2 Aim the camera at a sheet of white paper etc. so that the frame in the center is filled by the white object only and then press [MENU/SET].



Finely adjusting the white balance [$\text{WB}+$]

You can finely adjust the white balance when you cannot acquire the desired hue by setting the white balance.

- You can set from the quick menu. (P23)
- 1 Select [WHITE BALANCE] and then press \blacktriangleright .
 - Press \blacktriangleright again if [A], [B] or [SET/K] is selected.
 - 2 Press \blacktriangle / \blacktriangledown / \blacktriangleleft / \blacktriangleright to adjust the white balance and then press [MENU/SET].



- \blacktriangleleft : A (AMBER: ORANGE)
- \blacktriangleright : B (BLUE: BLUISH)
- \blacktriangle : G+ (GREEN: GREENISH)
- \blacktriangledown : M- (MAGENTA: REDDISH)

Note

- If you finely adjust the white balance to A (amber), the white balance icon on the LCD monitor will change to orange. If you finely adjust the white balance to B (blue), the white balance icon on the LCD monitor will change to blue.
- If you finely adjust the white balance to G+ (green) or M- (magenta), [+] (green) or [-] (magenta) appears beside the white balance icon on the LCD monitor.
- Select the center point if you are not finely adjusting the white balance.
- The white balance fine adjustment setting is reflected in the picture when using the flash.
- You can finely adjust the white balance independently for each white balance item.
- The white balance fine adjustment setting is memorized even if the camera is turned off.
- The white balance fine adjustment level returns to the standard setting (center point) in the following cases.
 - When you reset the white balance in [A] or [B]
 - When you reset the color temperature manually in [SET/K]

Auto white balance

Depending on the conditions prevailing when pictures are taken, the pictures may take on a reddish or bluish tinge. Furthermore, when a multiple number of light sources are being used or there is nothing with a color close to white, auto white balance may not function properly. In a case like this, set the white balance to a mode other than [AWB].

- 1 Auto white balance will work within this range.
 - 2 Blue sky
 - 3 Cloudy sky (Rain)
 - 4 Shade
 - 5 TV screen
 - 6 Sunlight
 - 7 White fluorescent light
 - 8 Incandescent light bulb
 - 9 Sunrise and sunset
 - 10 Candlelight
- K=Kelvin color Temperature

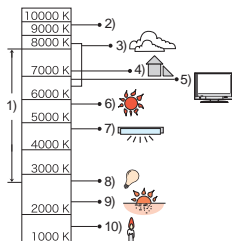

■ Setting the color temperature

You can set the color temperature manually for taking natural pictures in different lighting conditions. The color of light is measured as a number in degrees Kelvin. As the color temperature becomes high the picture becomes bluish and as the color temperature becomes low the picture becomes reddish.

- 1 Select **[SET/K]** and then press **▶**.
- 2 Press **▲/▼** to select the color temperature and then press **[MENU/SET]**.
 - You can set a color temperature from [2500K] to [10000K].



[METERING MODE]

For details on **[REC]** mode menu settings, refer to P21.

Type of optical measurement to measure brightness can be changed.

Applicable modes: **P A S M C 1 2**

[□]: Multiple

This is the method in which the camera measures the most suitable exposure by judging the allocation of brightness on the whole screen automatically. Usually, we recommend using this method.

[□]: Center weighted

This is the method used to focus on the subject on the center of the screen and measure the whole screen evenly.

[□]: Spot

This is the method to measure the subject in the spot metering target (A).

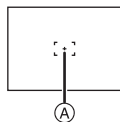

Note







- When [□] is selected and **[AF MODE]** is set to [☺], the camera will adjust the exposure to suit the person's face.

 [AF MODE]











For details on [REC] mode menu settings, refer to P21.

This allows the focusing method that suits the positions and number of the subjects to be selected.

Applicable modes: **P A S M C 1 2**  **SCN**

 : Face detection	The camera automatically detects the person's face. The focus and exposure can then be adjusted to fit that face no matter what portion of the picture it is in. (max. 15 areas)
 : AF Tracking	Focus and exposure can be adjusted to a specified subject. Focus will keep on following the subject even if it moves. (Dynamic tracking)
 : Multi-area-focusing	The camera focuses on up to 5 focus areas per AF area. This is effective when the subject is not in the center of the screen.
 : 1-area-focusing (High speed)	The camera quickly focuses on the subject in the AF area on the center of the screen.
 : 1-area-focusing	The camera focuses on the subject in the AF area on the center of the screen.
 : Spot-focusing	The camera focuses on a limited narrow area in the screen.

 **Note**

- The camera is focusing on all the AF areas when multiple AF areas (max. 5 areas) light at the same time in . If you want to determine the focus position to take pictures, switch the AF mode to ,  or .
- If the AF mode is set to , the AF area is not displayed until the picture is brought into focus.
- Switch the AF mode to  or  if it is difficult to focus using .
- The camera may detect the subjects other than a person as the face. In this case, switch the AF mode to any modes other than  and then take a picture.
- The AF mode cannot be set in [FIREWORKS] in scene mode.
- It is not possible to set  in the following cases.
 - In [NIGHT SCENERY], [FOOD], [STARRY SKY] and [AERIAL PHOTO] in scene mode.
 - In motion picture mode.

■ About 

The following AF area frames are displayed when the camera detects the faces.

Yellow:

When the shutter button is pressed halfway, the frame turns green when the camera is focused.

White:

Displayed when more than one face is detected. Other faces that are the same distance away as faces within the yellow AF areas are also focused.

- Under certain picture-taking conditions including the following cases, the facial recognition function may fail to work, making it impossible to detect faces. [AF MODE] is switched to .
 - When the face is not facing the camera
 - When the face is at an angle
 - When the face is extremely bright or dark
 - When there is little contrast on the faces

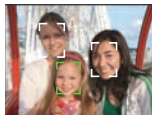

- When the facial features are hidden behind sunglasses, etc.
- When the face appears small on the screen
- When there is rapid movement
- When the subject is other than a human being
- When the camera is shaking
- When digital zoom is used

■ About []

- You can focus on the subject more quickly than in other AF modes.
- The picture may stop moving for a moment before being brought into focus when you press the shutter button halfway. This is not a malfunction.

■ Setting up [] (AF Tracking)

1 Bring the subject to the AF tracking frame, and press [AF/AE LOCK] to lock the subject.

- AF area will continuously focus on the subject's movement once the subject is recognized. (Dynamic tracking)
- AF tracking is turned off when [AF/AE LOCK] is pressed again.

Before locking

Locked

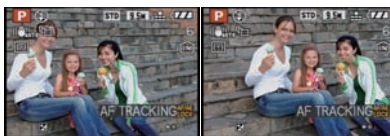

2 Take the picture.

Note

- If it fails to lock, AF area will flash in red, and disappear. Try to lock again.
- AF Tracking will not operate when the subject is not specified, the subject is lost, or has failed to be tracked. The picture will be taken with [] in [AF MODE] in that case.
- It is not possible to set [] in [STARRY SKY], [FIREWORKS], [PIN HOLE] or [FILM GRAIN] in scene mode, or in the motion picture mode.
- [Q:AF] does not work in AF tracking.
- The focus range becomes the same as AF macro mode. [1 cm (0.04 feet) (Wide)/30 cm (0.99 feet) (Tele) to ∞]
- Dynamic tracking function may not work in the following cases:
 - When the subject is too small
 - When the recording location is too dark or bright
 - When the subject is moving too fast
 - When the background has the same or similar color to the subject.
 - When jitter is occurring
 - When using the zoom

■ About AF area selection

You can select the AF area by pressing [FOCUS] when [], [], [] or [] is selected.

It is also possible to switch to AF area selection screen by pressing ► when AF mode is selected with ▲/▼.

- You can set from the quick menu. (P23)

When selecting [], [] or []

1 Press ▲/▼/◀/▶ to move the AF area.

- You can set to arbitrary position of the screen. (It cannot be set to edge of the screen)
- After moving the AF area, press [DISPLAY] to return it to the center.

2 Press [MENU/SET] to set.

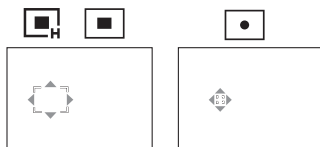

When selecting [AF-ON]

- 1 Press **▲/▼/◀/▶** to select AF area as shown in the figure to the right.
- 2 Press **[MENU/SET]** to set.

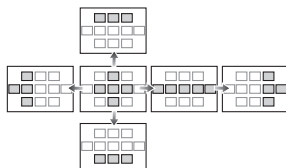
**Note**

- The spot metering target can also be moved to match the AF area when using [M] in [METERING MODE].
- Position of the AF area will return to initial state when the camera is set to Intelligent auto mode, When the power save mode is activated, or When this unit is turned off.

PRE AF

For details on [REC] mode menu settings, refer to P21.

The camera will adjust focus automatically depending on the settings.

Applicable modes: **P A S M C1 C2 SCN**

[OFF]:	
[Q _{AF}]: Quick AF	[Q _{AF}] is displayed on the screen.
[C _{AF}]: Continuous AF	[C _{AF}] is displayed on the screen.

About [Q_{AF}] and [C_{AF}]

[Q_{AF}] will adjust the focus automatically when the jitter of the camera gets small. [C_{AF}] will adjust the focus at all times (continuous AF operation).

The camera will adjust the focus automatically, and the focus adjustment when the shutter button is pressed becomes faster. It is effective when you do not want to miss the photo opportunity.

**Note**

- The battery will be consumed faster than usual.
- Press the shutter button halfway again when it is difficult to focus on the subject.
- When [PRE AF] is set to C_{AF}, it may take time to focus on the subject if you rotate the zoom lever from Wide to Tele or suddenly change the subject from a distant one to a nearby one.

AF-L AE-L [AF/AE LOCK]

For details on [REC] mode menu settings, refer to P21.

Take a picture with the focus or exposure locked.

This is a technique for setting the focus and the exposure in advance when the subject is outside the focus area or when the contrast is too sharp and the appropriate exposure cannot be achieved.

Applicable modes: **PASMCM2**   

[AF]:	Only the focus is locked. • [AF-L] is displayed when the focus is adjusted.
[AE]:	Only the exposure is locked. • [AE-L], aperture value, and shutter speed is displayed when the exposure is adjusted.
[AF/AE]:	Both focus and exposure are locked. • [^{AE-L} AE-L], aperture value, and shutter speed are displayed when the focus and exposure are adjusted.

■ Setting the AF/AE lock

- 1 Aim the AF area at the subject.
- 2 Press [AF/AE LOCK] to fix the focus and exposure.
- 3 Move the camera to compose the picture and then press the shutter button fully.

■ To cancel the AF/AE lock

The setting is canceled by pressing the [AF/AE LOCK] again.

Note

- Exposure is set even if the brightness of the subject changes in [AE].
- The subject can be focused again by pressing the shutter button halfway even when AE is locked.
- Program shift can be set even when AE is locked.
- Lock is canceled when zooming is performed after locking. Perform the locking again.

[I.EXPOSURE] (Intelligent exposure adjustment)



For details on [REC] mode menu settings, refer to P21.

Contrast and exposure will be adjusted automatically when there is a big difference in brightness between the background and subject, to bring the image close to how you see.

Applicable modes: **PASMCM2**

[OFF]/[LOW]/[STANDARD]/[HIGH]

Note

- [LOW], [STANDARD], or [HIGH] represents the maximum range of effect.
- When it is set to [LOW], [STANDARD] or [HIGH],  is displayed on the screen.
- When ISO sensitivity is set to [ISO80] or [ISO100], the ISO sensitivity might become higher than [ISO80] or [ISO100] when the [I.EXPOSURE] is set.
- Compensation effect may not be achieved depending on the conditions.
-  in the screen turns to yellow when [I.EXPOSURE] is in effect.

[MULTI. EXPO.]

For details on [REC] mode menu settings, refer to P21.

Using this function, you can achieve the kind of effect that is obtained when an image is exposed two or three times.

Applicable modes: **PASMCM2**

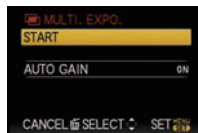
1 Select [START] and then press [MENU/SET].**2 Decide on the composition, and take the first picture.**

- After taking the picture, press the shutter button halfway down to take the next picture.
- Press ▲/▼ to select the item and then press [MENU/SET] for one of the following operations.

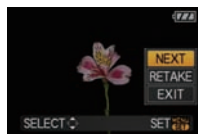

[NEXT]: Advance to the next picture.

[RETAKE]: Return to the first picture.

[EXIT]: Record the image of the first picture, and finish the multiple exposure picture-taking session.

3 Decide on the composition, and take the second picture.

- After taking the picture, the first and second pictures taken will be superimposed over each other and displayed.
- After taking the picture, press the shutter button halfway down to take the next picture.
- Press ▲/▼ to select the item and then press [MENU/SET] for one of the following operations.

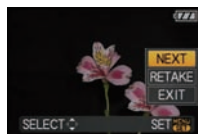

[NEXT]: Advance to the next picture.

[RETAKE]: Return to the second picture.

[EXIT]: Record images up to the second picture taken, and finish the multiple exposure picture-taking session.

4 Decide on the composition, and take the third picture.

- After taking the picture, the images of the first, second and third pictures taken will be superimposed over one another and displayed.
- Press ▲ to select [RETAKE] and then press [MENU/SET] to return to the third picture.

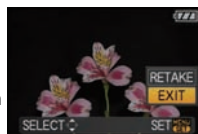
**5 Press ▼ to select [EXIT] and then press [MENU/SET].**

- You can also press the shutter button halfway to finish.
- The images up to the third picture taken are recorded, and the multiple exposure picture-taking session will be completed.

■ About automatic gain control setting

Select [AUTO GAIN] on the screen shown in step 1 and set it.

[ON]: The brightness level is adjusted according to the number of pictures taken and the pictures are superimposed over each other.

[OFF]: Compensate the exposure to match the subject so that all the superimposed exposure effects will be just right.

 **Note**

- The recording information displayed for pictures taken with multiple exposures is the recording information for the last picture taken.
- If [MENU/SET] is pressed while taking pictures, the photographed images are recorded, and the multiple exposure picture-taking session will be completed.
- Image is not recorded until completion.
- Some functions have restrictions. You will not be able to use the following functions:
 - Burst mode/[AUTO BRACKET]/[MULTI ASPECT]/Extended optical zoom/[I.EXPOSURE]/Digital zoom/[AUDIO REC.]
- [PICTURE SIZE] is fixed when [START] is selected.
- The zoom position and white balance are fixed when the first picture is taken.

 **[DIGITAL ZOOM]**

For details on [REC] mode menu settings, refer to P21.

This can enlarge subjects even more than the optical zoom or extended optical zoom.

Applicable modes: **P A S M C1 C2**  **SCN**

[OFF]/[ON]

 **Note**

- Refer to P38 for details.
- If camera shake (jitter) is a problem during zooming, it is recommended that [STABILIZER] be set to [AUTO] or [MODE 1].

 **[STABILIZER]**

For details on [REC] mode menu settings, refer to P21.

Using one of these modes, jitter during picture taking is detected, and the camera automatically compensates the jitter, enabling jitter-free images to be taken.

Applicable modes: **P A S M C1 C2**  **SCN**

[OFF]

[AUTO]: The optimum jitter compensation is selected depending on the condition.

[MODE1]: Jitter is always compensated during [REC] mode.

[MODE2]: The jitter is compensated for when the shutter button is pressed.

 **Note**

- The stabilizer function may not be effective in the following cases.
 - When there is a lot of jitter.
 - When the zoom magnification is high.
 - In digital zoom range.
 - When taking pictures while following a moving subject.
 - When the shutter speed becomes slower to take pictures indoors or in dark places.
- Be careful of camera jitter when you press the shutter button.
- The setting is fixed to [MODE2] with [SELF PORTRAIT] in scene mode and to [OFF] in [STARRY SKY] in scene mode.
- In motion picture mode, [AUTO] or [MODE2] cannot be set.

MIN [MIN. SHTR SPEED]

For details on [REC] mode menu settings, refer to P21.

You can take a picture brightly in dark places by setting [MIN. SHTR SPEED] slower. Also, you can set it faster to reduce the blur of the subject.

Applicable modes: **P C1 C2**

[1/250], [1/125], [1/60], [1/30], [1/15], [1/8], [1/4], [1/2], [1]

Minimum shutter speed setting	1/250 ←	→ 1
Brightness	Darker	Brighter
Jitter	Less	More

Note

- This should usually be set to [1/8] to take pictures. (When you select a minimum shutter speed other than [1/8], **MIN** appears on the screen.)
- Setting [MIN. SHTR SPEED] to slower speed might increase the chance of jitter, so we recommend using a tripod and the self-timer for taking pictures.
- Setting [MIN. SHTR SPEED] to faster speed might make the picture darker, so we recommend recording the picture in well-lit area. If correct exposure cannot be achieved, **MIN** will flash in red when the shutter button is pressed halfway.

U [AUDIO REC.]

For details on [REC] mode menu settings, refer to P21.

Audio can be recorded simultaneously with the image. You can record the conversation during the shooting or the situation as a memo.

Applicable modes: **P A S M C1 C2 SCN**

[OFF]: Audio will not be recorded.

[ON]: **U** is displayed on the screen.

Audio will be recorded as soon as the image is recorded.
(It will stop in 5 seconds)

- If you press [MENU/SET] during audio recording, the audio recording is canceled.

Note

- Audio is recorded from the built-in microphone on the camera.
- Audio recorded with this unit may not playback on other equipment.

AF* [AF ASSIST LAMP]

For details on [REC] mode menu settings, refer to P21.

Illuminating the subject makes it easier for the camera to focus when recording in low light conditions that make focusing difficult.

Applicable modes: **P A S M C1 C2 SCN**

[OFF]: The AF assist lamp does not turn on.

[ON]: When taking pictures in dark places, the AF assist lamp lights while the shutter button is pressed halfway. (Larger AF areas are now displayed.)

Note

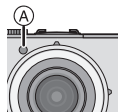

- The effective range of the AF assist lamp is 1.5 m (4.92 feet).
- When you do not want to use the AF assist lamp **A** (e.g. when taking pictures of animals in dark places), set the [AF ASSIST LAMP] to [OFF]. In this case, it will become more difficult to focus on the subject.

**[FLASH SYNCHRO]**

For details on [REC] mode menu settings, refer to P21.

[2ND] (2nd synchro) activates the flash just before the shutter closes when taking pictures of moving objects such as cars using a slow shutter speed.

Applicable modes: **P A S M C1 C2**

[1ST]:	The normal method when taking pictures with the flash.	
[2ND]:	The light source appears behind the subject and picture becomes dynamic.	

Note

- Set it to [1ST] normally.
- [2ND] is displayed in the flash icon on the LCD monitor if you set [FLASH SYNCHRO] to [2ND].
- When a fast shutter speed is set, the effect of [FLASH SYNCHRO] may deteriorate.
- [FLASH SYNCHRO] can be used with an external flash.

[EXT. VIEWFINDER]

When using the external viewfinder (optional), you can switch the screen to a suitable display.

Applicable modes: **P A S M C1 C2 SCN**

[OFF]:

[ON]: LCD monitor is off

Note

- Display on the LCD monitor is switched by pressing [DISPLAY] for a few times. Refer to P44 for switching display on the LCD monitor.
- The screen is normally off. However elements such as the focus icon (P33) and the flash charging icon are lit.
- See P123 for details about how to install the external viewfinder.

- Set to [OFF] when not using the external viewfinder.
- The default setting for AF mode is [□].

[CONVERSION]

For details on [REC] mode menu settings, refer to P21.

You can widen the field of view when taking pictures of landscapes or the like by using a wide conversion lens (optional).

Applicable modes: **P A S M C1 C2**  **SCN**

[OFF]:

: When the wide conversion lens is fitted.

Note

- When  is set, the camera is permanently fixed in the Wide-angle position. The image quality will be set to optimal for the wide conversion lens.
- Refer to P119 for details about attaching the lens.
- Ensure that [CONVERSION] is set to [OFF] when not using a conversion lens.
- Read the operating instructions of the conversion lens for details.

[CLOCK SET]

For details on [REC] mode menu settings, refer to P21.

To set the year, month, day and time.





It functions in exactly the same way as [CLOCK SET] in the [SETUP] menu.

- Refer to P19 for details.

[PLAYBACK] mode: 

Playing Back Pictures on the Dual Display (Dual Play)

You can display two recorded pictures on the screen to compare them.

- 1 Slide the [REC]/[PLAYBACK] selector switch to , and then press [MENU/SET].
- 2 Press .
- 3 Move / to select [DUAL PLAY], and then press [MENU/SET].

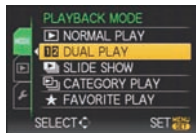



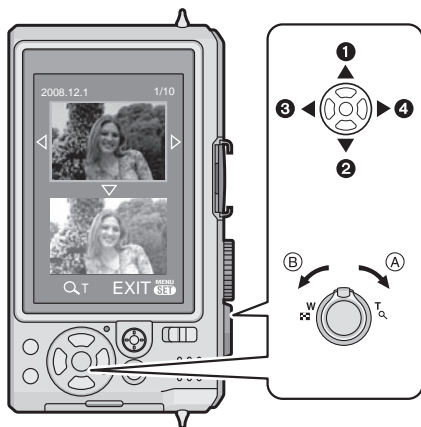

- You cannot select [DUAL PLAY] if there are no recorded pictures or only 1 recorded picture.

- 4 Move /// to select a picture.



- 1 The orange frame switches to the top. (You can select the picture at the top.)
 - 2 The orange frame switches to the bottom. (You can select the picture at the bottom.)
 - 3 The previous picture is displayed.
 - 4 The next picture is displayed.
- (A) Enlargement
(B) Reduction

- When the magnification is changed, the zoom position indication is displayed for about 1 second, and then you can move the position of the enlarged part by moving ///.
- You cannot display the same picture on the dual display at the same time.
- During dual play the selected picture can be deleted by pressing .

- 5 Press [MENU/SET] to end dual play.

- The selected picture is now played back filling the screen (normal playback).

Note

- When [ROTATE DISP.] is set to [ON], pictures which were recorded with the camera held vertically or pictures which were rotated will be displayed vertically.

[PLAYBACK] mode: 

Playing Back Pictures in Sequence (Slide Show)

You can play back the pictures you have taken in synchronisation with music, and you can do this in sequence while leaving a fixed interval between each of the pictures.

Furthermore, you can play back the pictures grouped together by category or play back only those pictures you have set as favorites as a slide show.

This playback method is recommended when you have connected the camera to a TV set to view the pictures you have taken.

1 Slide the [REC]/[PLAYBACK] selector switch to , and then press [MENU/SET].

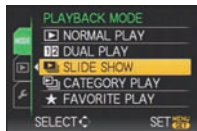

2 Press **▶**.

3 Press **▲/▼** to select [SLIDE SHOW], and then press [MENU/SET].

4 Press **▲/▼** to select the item and then press [MENU/SET].

- [FAVORITE] can be selected only when [FAVORITE] on the [PLAYBACK] menu (P105) is at [ON] and there are pictures already set as favorites.

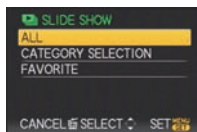

When [ALL] or [FAVORITE] has been selected in step 4

5 Press **▲** to select [START] and then press [MENU/SET].

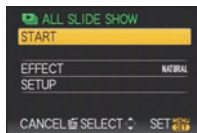

6 Press **▼** to finish the slide show.

- Normal playback resumes after the slide show finishes.

When [CATEGORY SELECTION] has been selected in step 4

5 Press **▲/▼/◀/▶** to select the category to play back and then press [MENU/SET] to set.

- For details on categories, refer to P94.



- 6** Press ▲ to select [START] and then press [MENU/SET].

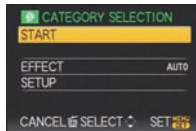

- 7** Press ▼ to finish the slide show.

- Normal playback resumes after the slide show finishes.

■ Operations performed during slide show

The cursor displayed during playback is the same as ▲/▼/◀/▶.

- The menu screen is restored when [⏏] is pressed.

- (A) Play/Pause
- (B) Stop
- (C) Back to previous picture*
- (D) Ahead to next picture*

- * These operations can be performed only in the pause mode.

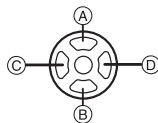

- (E) Reduce volume level
- (F) Increase volume level

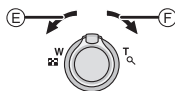

■ Changing the slide show settings

You can change the settings for slide show playback by selecting [EFFECT] or [SETUP] on the slide show menu screen.

[EFFECT]

This allows you to select the screen effects or music effects when switching from one picture to the next.

[NATURAL], [SLOW], [SWING], [URBAN], [OFF], [AUTO]

- When [URBAN] has been selected, the picture may appear in black and white as a screen effect.
- [AUTO] can be used only when [CATEGORY SELECTION] has been selected. The pictures are played back with the recommended effects in each category.

[SETUP]

[DURATION] or [REPEAT] can be set.

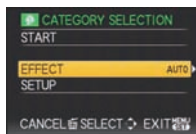

Item	Settings
[DURATION]	1SEC./2SEC./3SEC./5SEC.
[REPEAT]	ON/OFF
[MUSIC]/[AUDIO]	ON/OFF

- [DURATION] can be set only when [OFF] has been selected as the [EFFECT] setting.
- [AUDIO] will be displayed only when the [EFFECT] is set to [OFF]. Audio will be played along with the still picture with audio by setting the [AUDIO] to [ON].

Note

- Motion pictures cannot be played back as a slide show.
- It is not possible to add new music effects.

[PLAYBACK] mode: 

Selecting Pictures and Playing them Back ([CATEGORY PLAY]/[FAVORITE PLAY])



[CATEGORY PLAY]

This mode allows you to search images by scene mode or other categories (such as [PORTRAIT], [SCENERY] or [NIGHT SCENERY]) and sort the pictures into each of the categories. You can then play back the pictures in each category.

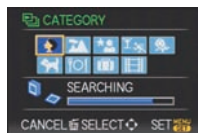
- 1 Perform steps 1 and 2 on page 92.
- 2 Press **▲/▼** to select [CATEGORY PLAY], and then press [MENU/SET].
- 3 Press **▲/▼/◀/▶** to select the category and then press [MENU/SET] to set.



- If a picture is found in a category, the category icon turns blue.
- It may take time to search the picture files if there are a lot on the card or the built-in memory.
- If you press [] while searching, the searching will stop halfway.
- Pictures are sorted into the categories shown below.

[CATEGORY]	Recording information e.g. scene modes
	[PORTRAIT], [i-PORTRAIT], [SOFT SKIN], [SELF PORTRAIT], [NIGHT PORTRAIT], [i-NIGHT PORTRAIT], [BABY1]/[BABY2]
	[SCENERY], [i-SCENERY], [SUNSET], [AERIAL PHOTO]
	[NIGHT PORTRAIT], [i-NIGHT PORTRAIT], [NIGHT SCENERY], [i-NIGHT SCENERY], [STARRY SKY]

[CATEGORY]	Recording information e.g. scene modes
	[SPORTS], [PARTY], [CANDLE LIGHT], [FIREWORKS], [BEACH], [SNOW], [AERIAL PHOTO]
	[BABY1]/[BABY2]
	[PET]
	[FOOD]
	[TRAVEL DATE]
	[MOTION PICTURE]

- Still pictures created from a motion picture cannot be played back from the motion pictures category in category playback.

[FAVORITE PLAY]

You can play back the pictures you have set as [FAVORITE] (P105) (Only when [FAVORITE] is set to [ON] and there are pictures which have been set to [FAVORITE]).

1 Perform steps 1 and 2 on page 92.

2 Press ▲/▼ to select [FAVORITE PLAY], and then press [MENU/SET].

Note

- You can use only [ROTATE], [ROTATE DISP.], [DPOF PRINT], [PROTECT] or [AUDIO DUB.] in the [PLAYBACK] menu.

[PLAYBACK] mode: 

Playing Back Motion Pictures/Pictures with Audio

Motion pictures

Press ◀/▶ to select a picture with a motion picture icon (such as [QVGA-H]), and then press ▲ to play back.

- (A) The motion picture recording time
- (B) Motion picture icon
- (C) Motion picture playback icon

- After playback starts, the elapsed playback time is displayed on the upper right of the screen.

For example, 8 minutes and 30 seconds is displayed as [8m30s].

Operations performed during motion picture playback

The cursor displayed during playback is the same as ▲/▼/◀/▶.

- (A) Play/Pause
- (B) Stop
- (C) Fast rewind, Frame-by-frame rewind*
- (D) Fast forward, Frame-by-frame forward*

* These operations can be performed only in the pause mode.

- (E) Reduce volume level
- (F) Increase volume level

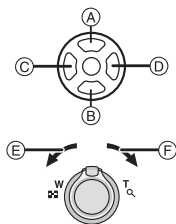
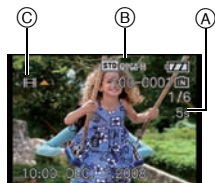

Pictures with audio

Press ◀/▶ to select a picture with the audio icon [] and then press ▲ to play back.

- (A) Audio icon
- Refer to [AUDIO REC.] (P88) and [AUDIO DUB.] (P108) for information about how to create still pictures with audio.



Note

- Sound can be heard through the speaker. Refer to [VOLUME] (P24) for information about how to adjust the volume in the [SETUP] menu.
- The file format that can be played back with this camera is QuickTime Motion JPEG.
- Please note that the bundled software includes QuickTime to play back motion picture files created with the camera on the PC.
- Some QuickTime Motion JPEG files recorded by a PC or other equipment may not play back on the camera.
- If you play back motion pictures that have been recorded with other equipment, the picture quality may deteriorate or the pictures may not play back.
- Motion picture with audio recorded on other cameras might not play on this unit.
- When using a high capacity card, it is possible that fast rewinding may be slower than usual.

[PLAYBACK] mode: 

Creating still pictures from a motion picture

You can create a single still picture (with 1 screen or 9 screens) from a recorded motion picture. This is effective in moving scenes when you want to look carefully at the movement of a sports person etc.

1 Press **▲** to pause motion picture playback.

- To save the displayed image as 1 picture → go to step 3
- To save the motion picture as 1 picture with 9 screens → go to step 2



2 Press [MENU/SET] to display the 9 screens playback screen.

(A): 30 frames: Display image every 1/30 second as picture

To advance frame-by-frame

▲/▼: Advance every 3 frames

◀/▶: Advance every 1 frames

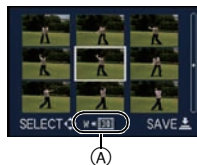

Change the number of frame rate per second

Turn the zoom lever toward  (W)

Quality	Frame rate per second
HD	24→12→6
WVGA / VGA / QVGA-H	30→15→10→5
QVGA-L	10→5

To end 9 screen display

Press [MENU/SET]

3 Press the shutter button.

- 4** Press **▲** to select [YES] and then press [MENU/SET].



Picture size

The picture size are as following.

Item	1 picture	9 pictures
HD / WVGA	2 M	2 M
VGA	0.3 M	2 M
QVGA-H/QVGA-L	0.3 M	1 M

- [QUALITY] is fixed to [..].

Note

- You may not be able to save still pictures from a motion picture taken on other equipment.

[PLAYBACK] mode:

Using the [PLAYBACK] mode menu

You can use various functions in playback mode to rotate pictures, set protection for them etc.

- With [TEXT STAMP], [RESIZE], [TRIMMING], [LEVELING] or [ASPECT CONV.], a new edited picture is created. A new picture cannot be created if there is no free space on the built-in memory or the card so we recommend checking that there is free space and then editing the picture.

[CALENDAR]

You can display pictures by recording date.

1 Select [CALENDAR] on the [PLAYBACK] mode menu. (P21)

- You can also rotate the zoom lever several times towards (W) to display the calendar screen. (P41)

2 Press **▲/▼/◀/▶** to select the date to be played back.

- ▲/▼: Select the month
- ◀/▶: Select the date

- If there were no pictures recorded during a month, the month is not displayed.



3 Press [MENU/SET] to display the pictures that were recorded on the selected date.

- Press [←] to return to the calendar screen.



4 Press ▲/▼/◀/▶ to select a picture and then press [MENU/SET].

- The picture that was selected will appear.

Note

- The recording date of the picture selected in the playback screen becomes the date selected when the calendar screen is first displayed.
- If there are multiple pictures with the same recording date, the first picture recorded on that day is displayed.
- You can display the calendar between January 2000 and December 2009.
- If the date is not set in the camera, the recording date is set as January 1st, 2008.
- If you take pictures after setting the travel destination in [WORLD TIME], the pictures are displayed by the dates at the travel destination in calendar playback.

[TITLE EDIT]

You can add text (comments) to pictures. After text has been registered, it can be included in prints using [TEXT STAMP] (P99). (Only alphabetic characters and symbols can be entered.)

1 Select [TITLE EDIT] on the [PLAYBACK] mode menu. (P21)

2 Press ▲/▼ to select [SINGLE] or [MULTI] and then press [MENU/SET].

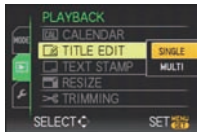

[SINGLE]

[MULTI]

3 Select the picture, and then press [MENU/SET] to set.

- [TITLE EDIT] is displayed for pictures that have already been recorded with text in [BABY1]/[BABY2] or [PET] name settings in scene mode, [LOCATION] in travel date or [TITLE EDIT].

[MULTI] setting

Press [DISPLAY] to set (repeat), and then press [MENU/SET] to set.

- The setting is canceled when [DISPLAY] is pressed again.



Press ◀/▶ to select the picture.

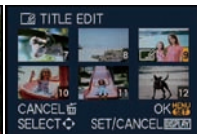

Press ▲/▼/◀/▶ to select the pictures.

4 Press ▲/▼/◀/▶ to select text and then press [MENU/SET] to register.

- Press [DISPLAY] to switch text between [A] (capitals), [a] (small case) and [&/1] (special characters and numbers).
- The cursor at the entry position can be moved to the left with [◀], and to the right with [▶].
- To enter a blank, move the cursor to [SPACE] or to delete an entered character, move the cursor to [DELETE], and press [MENU/SET].
- To stop editing at any time during text entry, press [◻].
- A maximum of 30 characters can be entered.

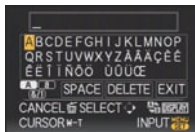

5 Press ▲/▼/◀/▶ to move the cursor to [EXIT] and then press [MENU/SET] to end text input.

6 Press [◻] to return to the menu screen.*

- *The menu screen is automatically restored when [MULTI] is selected.
- Press [MENU/SET] to close the menu.

■ Delete the title ([SINGLE] setting)

- 1 In step 4 when [SINGLE] (P99) is selected, delete all the texts, select [EXIT], and press [MENU/SET].
- 2 Press [◻].
- 3 Press [MENU/SET] to close the menu.

([MULTI] setting)

- 1 In step 4, delete all the texts, select [EXIT], and press [MENU/SET].
- 2 Press [MENU/SET] to close the menu.

Note

- Text can be scrolled if all of the registered text does not fit on the screen.
- The name setting of [BABY1]/[BABY2] or [PET] in scene mode or [LOCATION] in travel date can also be registered by using the operation in steps 4 and following.
- The name setting of [BABY1]/[BABY2] or [PET] in scene mode, [LOCATION] in travel date and [TITLE EDIT] cannot be registered at the same time.
- You can print out texts (comments) using the "PHOTOfunSTUDIO-viewer-" bundled software on the CD-ROM (supplied).
- You can set up to 50 pictures at one time with [MULTI].
- You cannot use titles edit for pictures taken with other equipment.

[TEXT STAMP]

You can stamp the recording date/time, age, travel date or title onto the recorded pictures. It is suitable for regular size printing. (Pictures with a picture size larger than [3M] will be resized when stamping the date etc. on them.)

1 Select [TEXT STAMP] on the [PLAYBACK] mode menu. (P21)

- 2** Press **▲/▼** to select **[SINGLE]** or **[MULTI]** and then press **[MENU/SET]**.

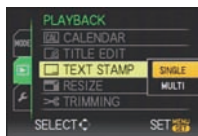

[SINGLE]

[MULTI]

- 3** Select the picture, and then press **[MENU/SET]** to set.

- appears on screen if the picture is stamped with text.

[MULTI] setting

Press **[DISPLAY]** to set (repeat), and then press **[MENU/SET]** to set.

- The setting is canceled when **[DISPLAY]** is pressed again.

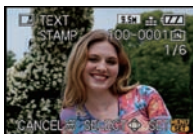

Press **◀/▶** to select the picture.

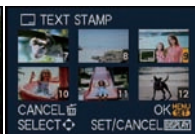

Press **▲/▼/◀/▶** to select the pictures.

- 4** Press **▲/▼/◀/▶** to select **[SHOOTING DATE]**, **[AGE]**, **[TRAVEL DATE]** or **[TITLE]** and then press **[MENU/SET]** to set each item.

[SHOOTING DATE]

[W/OTIME]: Stamp the year, month and date.

[WITHTIME]: Stamp the year, month, day, hour and minutes.

[AGE] (P65)

If this is set to **[ON]**, **[AGE]** is stamped on the pictures.

[TRAVEL DATE]

If this is set to **[ON]**, **[TRAVEL DATE]** is stamped on the pictures.

[TITLE]

Text is printed together with the image for pictures that have already been recorded with text in **[BABY1]/[BABY2]** or **[PET]** name settings in scene mode, **[LOCATION]** in travel date or **[TITLE EDIT]**.

- 5** Press **[MENU/SET]**.

- If you set **[TEXT STAMP]** for a picture with a picture size larger than $4:3/[3M]$, $3:2/[25M]$ or $16:9/[2M]$, the number of pixels in the picture is reduced as follows.

Aspect ratio setting	Picture size
4:3	10M / 7M / 5M → 3M
3:2	95M / 65M / 45M / 3M → 25M
16:9	9M / 6M / 4.5M / 25M → 2M

- The picture becomes slightly rougher.

- 6** Press **▲** to select **[YES]** and then press **[MENU/SET]**.

- When the picture size is $4:3/[3M]$, $3:2/[25M]$, $16:9/[2M]$ or smaller, the picture is not resized and the message will simply read **[SAVE NEW PICTURES?]**.



7 Press [] to return to the menu screen.*

*The menu screen is automatically restored when [MULTI] is selected.

- Press [MENU/SET] to close the menu.

Note

- When you print pictures stamped with text, the date will be printed over the stamped text if you specify printing of the date at the photo shop or on the printer.
- You can set up to 50 pictures at one time in [MULTI].
- Depending on the printer being used, some characters may be cut at printing. Check before printing.
- When text is stamped onto the [0.3M] pictures, it is difficult to read it.
- Text and dates cannot be stamped on the pictures taken with other equipment.

[RESIZE] Reducing the picture size (number of pixels)

We recommend resizing to [0.3M] if you want to attach a picture to an e-mail or use it on a website. (Pictures set to the minimum number of pixels for [ASPECT RATIO] cannot be further reduced in size.)

1 Select [RESIZE] on the [PLAYBACK] mode menu. (P21)

2 Press ▲/▼ to select [SINGLE] or [MULTI] and then press [MENU/SET].

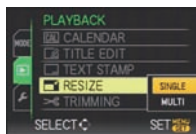

3 Select the picture and size.

[SINGLE] setting

- 1 Press ◀/▶ to select the picture, and then press [MENU/SET].
- 2 Press ◀/▶ to select the size*, and then press [MENU/SET].

- * Only the sizes to which the pictures can be resized is displayed.

[MULTI] setting

- 1 Press ▲/▼ to select the size, and then press [MENU/SET].
 - When [DISPLAY] is pressed, an explanation of resizing is displayed.
- 2 Press ▲/▼/◀/▶ to select the picture, and then press [DISPLAY].
 - Repeat this step for each picture, and press [MENU/SET] to set.

[SINGLE]

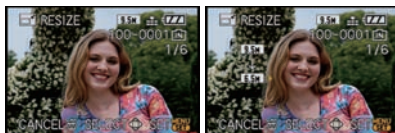

[MULTI]

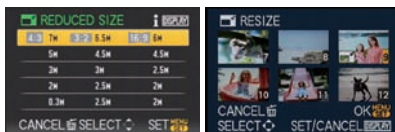

- 4** Press **▲** to select [YES] and then press [MENU/SET].

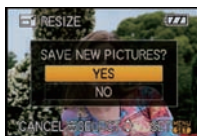

- 5** Press [🗑️] to return to the menu screen.*

*The menu screen is automatically restored when [MULTI] is selected.

- Press [MENU/SET] to close the menu.

Note

- You can set up to 50 pictures at one time in [MULTI].
- The picture quality of the resized picture will deteriorate.
- It may not be possible to resize pictures recorded with other equipment.

✂️ [TRIMMING]

You can enlarge and then clip the important part of the recorded picture.

- 1** Select [TRIMMING] on the [PLAYBACK] mode menu. (P21)

- 2** Press **◀/▶** to select the picture, and then press [MENU/SET].



- 3** Use the zoom lever and press **▲/▼/◀/▶** to select the parts to be trimmed.



Zoom lever (T): Enlargement

Zoom lever (W): Reduction

▲/▼/◀/▶: Move

Reduction



Enlargement



Move the position



- 4** Press [MENU/SET].

- 5** Press **▲** to select [YES] and then press [MENU/SET].

- 6** Press [🗑️] to return to the menu screen.

- Press [MENU/SET] to close the menu.

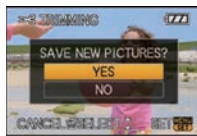

Note

- Depending on the cut size, the picture size of the trimmed picture may become smaller than that of the original picture.
- The picture quality of the trimmed picture will deteriorate.
- It may not be possible to trim pictures recorded with other equipment.

[LEVELING]

Minute tilting of the image can be adjusted.

- 1** Select **[LEVELING]** on the **[PLAYBACK]** mode menu. (P21)
- 2** Press **◀/▶** to select the picture, and then press **[MENU/SET]**.
- 3** Press **◀/▶** to adjust the tilting, and press **[MENU/SET]**.
 - ▶: clockwise
 - ◀: counterclockwise
 - Up to 2° can be adjusted.
- 4** Press **▲** to select **[YES]** and then press **[MENU/SET]**.
- 5** Press **[🗑️]** to return to the menu screen.
 - Press **[MENU/SET]** to close the menu.

**Note**

- Quality of image may become coarse when levelling is performed.
- Recorded pixels may decrease compared to original image when levelling is performed.
- Levelling may not be performed on images recorded with other equipment.

[ASPECT CONV.]

You can convert pictures taken with a [16:9] aspect ratio to a [3:2] or a [4:3] aspect ratio.

- 1** Select **[ASPECT CONV.]** on the **[PLAYBACK]** mode menu. (P21)
- 2** Press **▲/▼** to select **[3:2]** or **[4:3]** and then press **[MENU/SET]**.
- 3** Press **◀/▶** to select a picture taken with [16:9] aspect ratio, and then press **[MENU/SET]**.



- 4** Press **◀/▶** to determine the horizontal position, and press **[MENU/SET]** to set.
- Use **▲/▼** to set the frame position for pictures rotated vertically.



- 5** Press **▲** to select **[YES]** and then press **[MENU/SET]**.

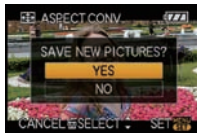

- 6** Press **[⏮]** to return to the menu screen.
- Press **[MENU/SET]** to close the menu.

Note

- After converting the aspect ratio, the picture size may become larger than that of the original picture.
- You may not be able to convert pictures taken on other equipment.

[⏮] [ROTATE]/[⏮]A [ROTATE DISP.]

This mode allows you to automatically display pictures vertically if they were recorded holding the camera vertically or rotate pictures manually in 90° steps.

Rotate (The picture is rotated manually)

- 1** Select **[ROTATE]** on the **[PLAYBACK]** mode menu. (P21)
- The **[ROTATE]** function is disabled when **[ROTATE DISP.]** is set to **[OFF]**.

- 2** Press **◀/▶** to select the picture and then press **[MENU/SET]**.
- Motion pictures and protected pictures cannot be rotated.



- 3** Press **▲/▼** to select the direction to rotate the picture and then press **[MENU/SET]**.

- ↻**: The picture rotates clockwise in steps of 90°.
- ↺**: The picture rotates counter-clockwise in steps of 90°.

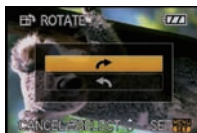

- 4** Press **[⏮]** to return to the menu screen.
- Press **[MENU/SET]** to close the menu.

Rotate display (The picture is automatically rotated and displayed)

1 Select **[ROTATE DISP.]** on the **[PLAYBACK]** mode menu. (P21)

2 Press **▼** to select **[ON]** and then press **[MENU/SET]**.

- The pictures are displayed without being rotated when you select **[OFF]**.
- Refer to P40 for information about how to play back pictures.



3 Press **[MENU/SET]** to close the menu.

Note

- When you play back pictures on a PC, they cannot be displayed in the rotated direction unless the OS or software is compatible with Exif. Exif is a file format for still pictures which allows recording information etc. to be added. It was established by "JEITA (Japan Electronics and Information Technology Industries Association)".
- It may not be possible to rotate pictures that have been recorded with other equipment.

★ [FAVORITE]

You can do the following if a mark has been added to pictures and they have been set as favorites.

- Play back only the pictures set as favorites. ([FAVORITE PLAY])
- Play back the pictures set as favorites only as a slide show.
- Delete all the pictures not set as favorites. ([ALL DELETE EXCEPT★])

1 Select **[FAVORITE]** on the **[PLAYBACK]** mode menu. (P21)

2 Press **▼** to select **[ON]** and then press **[MENU/SET]**.

- You cannot set pictures as favorites if **[FAVORITE]** is set to **[OFF]**. Also **[★]** will not appear when **[FAVORITE]** is set to **[OFF]** even if it was previously set to **[ON]**.

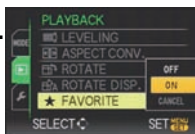

3 Press **[MENU/SET]** to close the menu.

4 Press **◀▶** to select the picture and then press **▼**.

- Repeat the above procedure.
- If **▼** is pressed again, the favorite setting is canceled.



■ Canceling all the [FAVORITE] settings

1 Select **[CANCEL]** on the screen shown in step 2 and then press **[MENU/SET]**.

2 Press **▲** to select **[YES]** and then press **[MENU/SET]**.

3 Press **[MENU/SET]** to close the menu.

- You cannot select **[CANCEL]** if not even one picture has been set as a favorite.

Note

- You can set up to 999 pictures as favorites.
- When printing pictures at a photo printing store, [ALL DELETE EXCEPT★] (P43) is useful so only the pictures you want to be printed remain on the card.
- You may not be able to set pictures taken with other equipment as favorites.
- You can perform, check and cancel the settings of images as favorites using the "PHOTOfunSTUDIO-viewer-" bundled software on the CD-ROM (supplied).

[DPOF PRINT]

DPOF "Digital Print Order Format" is a system that allows the user to select which pictures to print, how many copies of each picture to print and whether or not to print the recording date on the pictures when using a DPOF compatible photo printer or photo printing store. For details, ask at your photo printing store.

When you want to use a photo printing store to print pictures recorded on the built-in memory, copy them to a card (P108) and then set the DPOF setting.

For more information visit:

http://panasonic.jp/dc/dpof_110/white_e.htm

1 Select [DPOF PRINT] on the [PLAYBACK] mode menu. (P21)

2 Press ▲/▼ to select [SINGLE] or [MULTI] and then press [MENU/SET].

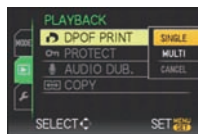

[SINGLE]

[MULTI]

3 Select the picture, and then press [MENU/SET].



Press ◀/▶ to select the picture.

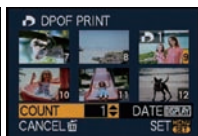

Press ▲/▼/◀/▶ to select the pictures.

4 Press ▲/▼ to set the number of prints, and then press [MENU/SET] to set.

- When [MULTI] has been selected, repeat steps 3 and 4 for each picture. (It is not possible to use the same setting for a multiple number of pictures.)

5 Press [EXIT] to return to the menu screen.

- Press [MENU/SET] to close the menu.

■ Canceling all the [DPOF PRINT] settings

- 1 Select [CANCEL] on the screen shown in step 2 and then press [MENU/SET].
- 2 Press ▲ to select [YES] and then press [MENU/SET].
- 3 Press [MENU/SET] to close the menu.

- You cannot select [CANCEL] if not even one picture has been set for DPOF printing.

■ To print the date

After setting the number of prints, set/cancel printing with the recording date by pressing [DISPLAY].

- When you go to a photo printing store for digital printing, be sure to order the printing of the date additionally if required.
- Depending on the photo printing store or the printer, the date may not be printed even if you set to print the date. For further information, ask at your photo printing store or refer to the operating instructions for the printer.
- The date cannot be printed on pictures stamped with text.
- If you set [TEXT STAMP] for pictures that have been set for date printing, the date printing setting is canceled.

📌 Note

- The number of prints can be set from 0 to 999.
- With a printer supporting PictBridge, the date print settings of the printer may take precedence so check if this is the case.
- It may not be possible to use the DPOF print settings with other equipment. In this case, cancel all the settings, and reset the settings.
- If the file is not based on the DCF standard, the DPOF print setting cannot be set.

🔑 [PROTECT]

You can set protection for pictures you do not want to be deleted by mistake.

1 Select [PROTECT] on the [PLAYBACK] mode menu. (P21)

2 Press ▲/▼ to select [SINGLE] or [MULTI] and then press [MENU/SET].

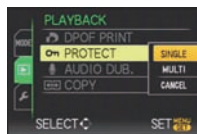

[SINGLE]

[MULTI]

3 Select the picture, and then press [MENU/SET].

When [MULTI] has been selected

- Repeat these steps for each picture.
- The settings are canceled when [MENU/SET] is pressed again.

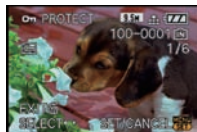

Press ◀/▶ to select the picture.

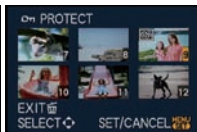

Press ▲/▼/◀/▶ to select the pictures.

4 Press [🗑️] to return to the menu screen.

- Press [MENU/SET] to close the menu.

■ Canceling all the [PROTECT] settings

- 1 Select [CANCEL] on the screen shown in step 2 and then press [MENU/SET].
- 2 Press ▲ to select [YES] and then press [MENU/SET].
- 3 Press [MENU/SET] to close the menu.

- If you press [MENU/SET] while canceling protection, the canceling will stop halfway.

Note

- The protect setting may not be effective on other equipment.
- Even if you protect pictures in the built-in memory or a card, they will be deleted if the built-in memory or the card is formatted.
- Even if you do not protect pictures on an SD Memory Card or an SDHC Memory Card, they cannot be deleted when the card's Write-Protect switch is set to [LOCK].

[AUDIO DUB.]

You can add the audio after taking a picture.

1 Select [AUDIO DUB.] on the [PLAYBACK] mode menu. (P21)

2 Press ◀/▶ to select the picture and then press [MENU/SET] to start audio recording.

- The message [OVERWRITE AUDIO DATA?] screen appears when audio has already been recorded. Press ▲ to select [YES] and then press [MENU/SET] to start audio recording. (The original audio is overwritten.)
- Audio is recorded from the built-in microphone on the camera.
- If you press [⏏], the audio dubbing is canceled.



3 Press [MENU/SET] to stop recording.

- It will automatically stop after recording about 10 seconds without pressing [MENU/SET].



4 Press [⏏] to return to the menu screen.

- Press [MENU/SET] to close the menu.

Note

- Audio dubbing may not work properly on pictures recorded by other equipment.

[COPY]

You can copy the data of the pictures you have taken from the built-in memory to a card or from a card to the built-in memory.

1 Select [COPY] on the [PLAYBACK] mode menu. (P21)

2 Press ▲/▼ to select the copy destination and then press [MENU/SET].

: All the picture data in the built-in memory are copied onto the card at one time. → step 4.

: One picture at a time is copied from the card to the built-in memory. → step 3.

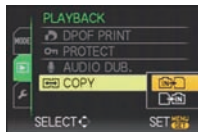

3 Press ◀▶ to select the picture and then press [MENU/SET].

4 Press ▲ to select [YES], and then press [MENU/SET].

- If you press [MENU/SET] while copying pictures from the built-in memory to the card, the copying will stop halfway.
- Do not turn the camera off at any point during the copying process.



5 Press [] to return to the menu screen.

- Press [MENU/SET] to close the menu.
- If you copy from the built-in memory to a card, all the pictures are copied and then the screen automatically returns to the playback screen.

Note

- If you copy picture data from the built-in memory to a card which does not have sufficient free space, the picture data will only be copied halfway. We recommend using a card which has more free space than the built-in memory (about 50 MB).
- If a picture exists with the same name (folder number/file number) as the picture to be copied in the copy destination when [IN] is selected, a new folder is created and the picture is copied. If a picture exists with the same name (folder number/file number) as the picture to be copied in the copy destination when [OUT] is selected, that picture is not copied. (P129)
- It may take time to copy the picture data.
- Only pictures recorded with a Panasonic digital camera (LUMIX) will be copied. (Even if the pictures were recorded with a Panasonic digital camera, you may not be able to copy them if they were edited with a PC.)
- DPOF settings on the original picture data will not be copied. Set the DPOF settings again after copying is finished.

Connecting to a PC

You can acquire recorded pictures to a PC by connecting the camera and the PC.

- You can easily print out or mail the pictures you have imported. Use of the “PHOTOfunSTUDIO-viewer-” bundled software on the CD-ROM (supplied) is a convenient way of doing this.
- Read the separate operating instructions for the supplied software for more information about the software in the CD-ROM (supplied) and how to install it.

Preparations:

Turn on the camera and the PC.

Remove the card before using the pictures in the built-in memory.

1 Connect the camera to a PC via the USB connection cable (A) (supplied).

- Do not use any other USB connection cables except the supplied one. Use of cables other than the supplied USB connection cable may cause malfunction.

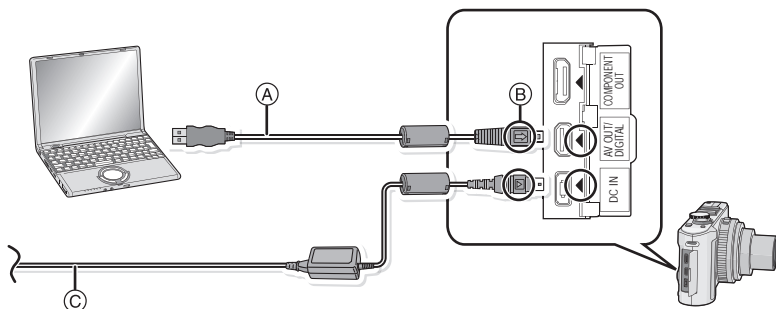

(A) USB connection cable (supplied)

- Check the directions of the connectors, and plug them straight in or unplug them straight out. (Otherwise the connectors may be bent out of shape which will cause trouble.)

(B) Align the marks, and insert.

(C) AC adaptor (DMW-AC5PP; optional)

- Use a battery with sufficient battery power or the AC adaptor (DMW-AC5PP; optional). If the remaining battery power becomes low while the camera and the PC are communicating, the status indicator blinks and the alarm beeps.

Refer to “Disconnecting the USB connection cable safely” (P111) before disconnecting the USB connection cable. Otherwise, data may be destroyed.

2 Press ▲/▼ to select [PC], and then press [MENU/SET].

- If [USB MODE] (P27) is set to [PC] in the [SETUP] menu in advance, the camera will be automatically connected to the PC without displaying the [USB MODE] selection screen. Since there is no need to set this each time you connect to the PC, it is convenient.
- When the camera has been connected to the PC with [USB MODE] set to [PictBridge(PTP)], a message may appear on the PC's screen. Select [Cancel] to close the screen, and disconnect the camera from the PC. Then set [USB MODE] to [PC] again.

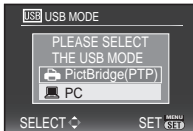

3 Double-click on [Removable Disk] in [My Computer].

- When using a Macintosh, the drive is displayed on the desktop. ("LUMIX", "NO_NAME" or "Untitled" is displayed.)

4 Double-click [DCIM] folder.

5 Using a drag-and-drop operation, move the pictures you want to acquire or the folder storing those pictures to any different folder on the PC.

■ Disconnecting the USB connection cable safely

- Proceed with the hardware removal using "Safely Remove Hardware" on the task tray of the PC. If the icon is not displayed, check that [ACCESS] is not displayed on the LCD monitor of the digital camera before removing the hardware.

Note

- Turn the camera off before connecting or disconnecting the AC adaptor (DMW-AC5PP; optional).
- Before inserting or removing a card, turn the camera off and disconnect the USB connection cable. Otherwise, data may be destroyed.
- With the Mac OS X v10.2 or an earlier operating system, set the Write-Protect switch of the SDHC memory card to the [LOCK] position when importing pictures from an SDHC memory card.

■ Viewing the contents of the built-in memory or card (folder composition)

- Built-in memory
- Card

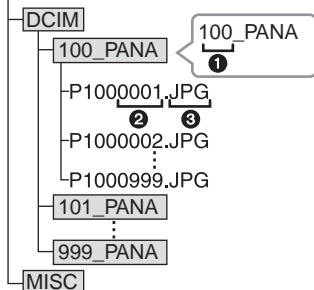

- ❶ Folder number
- ❷ File number
- ❸ JPG: Pictures
- MOV: Motion pictures
- RW2: Pictures in RAW files
- MISC: DPOF print favorite

A new folder is created when pictures are taken in the following situations.

- After [NO.RESET] (P26) in the [SETUP] menu has been executed
- When a card containing a folder with the same folder number has been inserted (Such as when pictures were taken using another make of camera)
- When there is a picture with file number 999 inside the folder

■ Connection in the PTP mode (Windows® XP, Windows Vista® and Mac OS X only)

Set [USB MODE] to [PictBridge(PTP)].

Data can now be read only from the card into the PC.

- When there are 1000 or more pictures on a card, the pictures may not be imported in the PTP mode.

Printing the Pictures

If you connect the camera to a printer supporting PictBridge, you can select the pictures to be printed out and instruct that printing be started on the camera's LCD monitor.

Preparations:

Turn on the camera and the printer.

Remove the card before printing the pictures in the built-in memory.

Perform the print quality and other settings at the printer before printing the pictures.

1 Connect the camera to a printer via the USB connection cable (supplied).

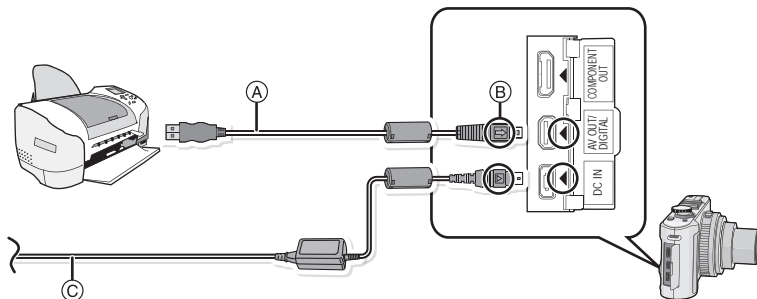

(A) USB connection cable (supplied)

• Check the directions of the connectors, and plug them straight in or unplug them straight out. (Otherwise the connectors may be bent out of shape which will cause trouble.)

(B) Align the marks, and insert.

(C) AC adaptor (DMW-AC5PP; optional)

• Use a battery with a sufficient battery power or the AC adaptor (DMW-AC5PP; optional). If the remaining battery power becomes low while the camera and the printer are connected, the status indicator blinks and the alarm beeps. If this happens during printing, stop printing at once. If not printing, disconnect the USB connection cable.

• When the camera is connected to the printer, the cable disconnect prohibit icon [⊘] appears. Do not disconnect the USB cable while [⊘] is displayed.

2 Press ▲/▼ to select [PictBridge(PTP)], and then press [MENU/SET].



Note

- Do not use any other USB connection cables except the supplied one. Use of cables other than the supplied USB connection cable may cause malfunction.
- Turn the camera off before connecting or disconnecting the AC adaptor (DMW-AC5PP; optional).
- Before inserting or removing a card, turn the camera off, and disconnect the USB connection cable.
- You cannot switch between the built-in memory and the card while the camera is connected to the printer. Disconnect the USB connection cable, insert (or remove) the card and then connect the USB connection cable to the printer again.
- When the pictures in RAW files are to be printed, the JPEG pictures recorded simultaneously by the camera will be printed. If JPEG pictures do not exit, RAW file pictures cannot be printed.

Selecting a single picture and printing it

- 1 Press **◀/▶** to select the picture and then press **[MENU/SET]**.

- The message disappears in about 2 seconds.

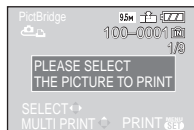

- 2 Press **▲** to select **[PRINT START]** and then press **[MENU/SET]**.

- Refer to P115 for the items which can be set before starting to print the pictures.
- Press **[MENU/SET]** to cancel printing halfway.
- Disconnect the USB connection cable after printing.

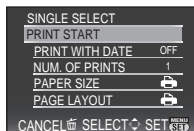

Selecting multiple pictures and printing them

- 1 Press **▲**.

- 2 Press **▲/▼** to select an item and then press **[MENU/SET]**.

- If the print check screen has appeared, select **[YES]**, and print the pictures.

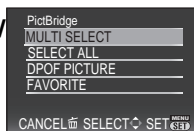

Item	Description of settings
[MULTI SELECT]	Multiple pictures are printed at one time. <ul style="list-style-type: none"> • Press ▲/▼/◀/▶ to select the pictures, and then When [DISPLAY] is pressed, [] appears on the pictures to be printed. (When [DISPLAY] is pressed again, the setting is canceled.) • After the pictures have been selected, press [MENU/SET].
[SELECT ALL]	Prints all the stored pictures.
[DPOF PICTURE]	Prints the pictures set in [DPOF PRINT] only. (P106)
[FAVORITE]*	Prints the pictures set as favorites only. (P105)

- * Only when **[FAVORITE]** is at **[ON]** and when there are pictures set as favorites. (P105)

- 3 Press **▲** to select **[PRINT START]** and then press **[MENU/SET]**. Select **[YES]** on the print confirmation screen and press **[MENU/SET]** to begin printing.

- Refer to P115 for the items which can be set before starting to print the pictures.
- Press **[MENU/SET]** to cancel printing.
- Disconnect the USB connection cable after printing.

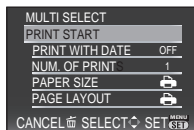

Print Settings

Select and set the items both on the screen in step 2 of the “Selecting a single picture and printing it” and in step 3 of the “Selecting multiple pictures and printing them” procedures.

- When you want to print pictures in a paper size or a layout which is not supported by the camera, set [PAPER SIZE] or [PAGE LAYOUT] to  and then set the paper size or the layout on the printer. (For details, refer to the operating instructions of the printer.)
- When [DPOF PICTURE] has been selected, the [PRINT WITH DATE] and [NUM. OF PRINTS] items are not displayed.

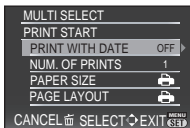

[PRINT WITH DATE]

Item	Description of settings
[OFF]	Date is not printed.
[ON]	Date is printed.

- If the printer does not support date printing, the date cannot be printed on the picture.
- Since the printer's settings may take precedence over the print with date setting, check the printer's print with date setting as well.



Note

When asking the photo shop to print the pictures

- By stamping the date using [TEXT STAMP] (P99) or setting date printing at the time of the [DPOF PRINT] (P106) setting before going to a photo shop, the dates can be printed at the photo shop.

[NUM. OF PRINTS]





You can set the number of prints up to 999.

[PAPER SIZE]

Item	Description of settings
	Settings on the printer are prioritized.
[L/3.5"×5"]	89 mm×127 mm
[2L/5"×7"]	127 mm×178 mm
[POSTCARD]	100 mm×148 mm
[16:9]	101.6 mm×180.6 mm
[A4]	210 mm×297 mm
[A3]	297 mm×420 mm
[10×15cm]	100 mm×150 mm
[4"×6"]	101.6 mm×152.4 mm
[8"×10"]	203.2 mm×254 mm
[LETTER]	216 mm×279.4 mm
[CARD SIZE]	54 mm×85.6 mm

- Paper sizes not supported by the printer will not be displayed.

[PAGE LAYOUT] (Layouts for printing that can be set with this unit)

Item	Description of settings
	Settings on the printer are prioritized.
	1 picture with no frame on 1 page
	1 picture with a frame on 1 page
	2 pictures on 1 page
	4 pictures on 1 page

- An item cannot be selected if the printer does not support the page layout.

■ Layout printing**When printing a picture several times on 1 sheet of paper**

For example, if you want to print the same picture 4 times on 1 sheet of paper, set [PAGE LAYOUT] to  and then set [NUM. OF PRINTS] to 4 for the picture that you want to print.

When printing different pictures on 1 sheet of paper

For example, if you want to print 4 different pictures on 1 sheet of paper, set [PAGE LAYOUT] to  and then set [NUM. OF PRINTS] to 1 for each of the 4 pictures.

Note

- The camera is receiving an error message from the printer when the  indication lights orange during printing. After finishing printing, make sure there are no problems with the printer.
- If the number of prints is high, the pictures may be printed several times. In this case, the remaining number of prints indicated may differ from the number set.

Playing Back Pictures on a TV Screen

Playing back pictures using the AV cable (supplied)

Preparations:

Set the [TV ASPECT]. (P27)

Turn this unit and the TV off.

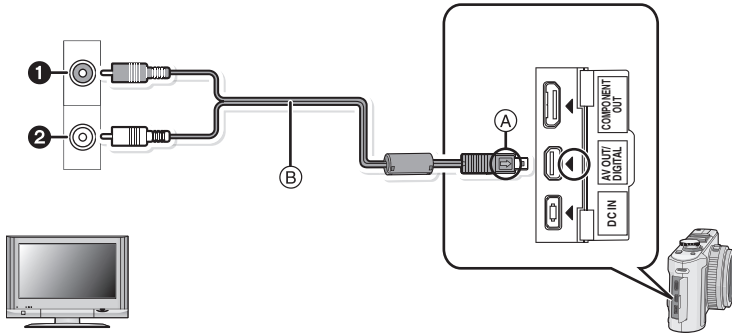

① Yellow: to the video input socket

② White: to the audio input socket

(A) Align the marks, and insert.

(B) AV cable (supplied)

• Check the directions of the connectors, and plug them straight in or unplug them straight out. (Otherwise the connectors may be bent out of shape which will cause trouble.)

1 Connect the AV cable (B) (supplied) to the video input and the audio input sockets on the TV.

2 Connect the AV cable to the [AV OUT] socket on the camera.

3 Turn the TV on and select external input.

4 Turn the camera on.

Note

- Depending on the [ASPECT RATIO], black bands may be displayed on the top and bottom or the left and right of the pictures.
- Do not use any other AV cables except the supplied one.
- Read the operating instructions for the TV.
- When you play back a picture vertically, it may be blurry.
- You can view pictures on TVs in other countries (regions) which use the NTSC or PAL system when you set [VIDEO OUT] in the [SETUP] menu. (PAL video out is not available on the version DMC-LX3P sold in the U.S.)
- Even if you set [VIDEO OUT] to [PAL], the output signal will still be NTSC in the recording mode. (PAL video out is not available on the version DMC-LX3P sold in the U.S.)

Playing back pictures on a TV with an SD Memory Card slot

Still pictures recorded on an SD Memory Card can be played back on a TV with an SD Memory Card slot.

Note

- Depending on the TV model, pictures may not be displayed on the full screen.
- Motion pictures cannot be played back. To play back motion pictures, connect the camera to the TV with the AV cable (supplied).
- You cannot play back pictures on SDHC cards if the TV does not support these cards.
- You may not be able to play back MultiMediaCards.

Playing back on the TV with component socket

You can enjoy high quality pictures and motion pictures on the TV by connecting the camera with the TV using component cable (DMW-HDC2: optional).

Component output is output as 1080i. Connect with a TV compatible with the 1080i.

Preparations: Turn this unit and the TV off.

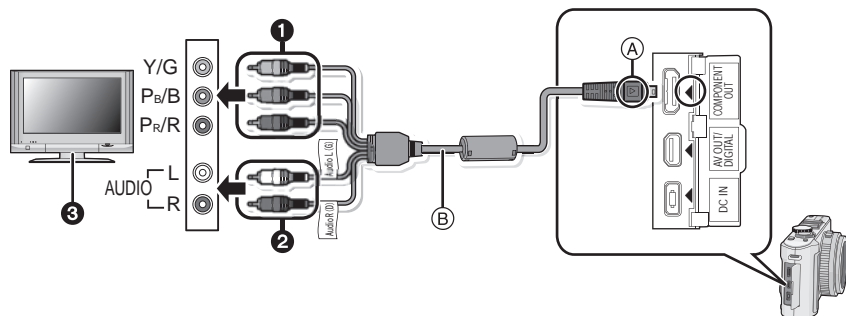

- ❶ Component Plugs: Connect the plugs to the component video input sockets on the TV with same color. (Indication on the TV might be different.)
 - ❷ Audio Pin Plugs: to the audio input socket
 - ❸ TV with component socket
 - Ⓐ Align the marks, and insert.
 - Ⓑ Component cable (DMW-HDC2: optional)
- Check the directions of the connectors, and plug them straight in or unplug them straight out. (Otherwise the connectors may be bent out of shape which will cause trouble.)

- 1 **Connect the component cable ❷ (DMW-HDC2; optional) to the component input and the audio input sockets on the TV.**
- 2 **Connect the component cable to the [COMPONENT OUT] socket on the camera.**
- 3 **Turn on the TV and switch to component input.**
- 4 **Turn the camera on.**
 - Play back the pictures.

Note

- Depending on the [ASPECT RATIO], bands may be displayed on the top and bottom or the left and right of the pictures.
- Do not use any other cables except a genuine Panasonic component cable (DMW-HDC2; optional).
- Audio will be output as monaural.
- When you play back a picture vertically, it may be blurry.
- Image is not displayed on the LCD monitor when the component cable is connected.
- There are some playback menus that cannot be used while the component cable is connected. (P134)

- When pictures are displayed, they may not be displayed properly depending on the type of TV.
- Read the operating instructions for the TV.

Using the Conversion Lens (optional)

When the wide conversion lens is used, it is possible to achieve a wider field of view in pictures of landscapes or the like.

Refer to P90 for details.

Preparations: Turn off the camera and remove the lens cap.

1 Remove the lens ring front.

- Be careful not to lose the lens ring front.

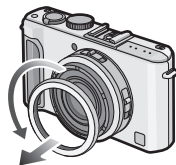

2 Attach the lens adaptor.

- (A) Lens adaptor (DMW-LA4; optional)
- The conversion lens and filters cannot be used together. If any of these are fitted, be sure to remove before fitting the conversion lens.
 - Rotate the lens slowly and carefully.

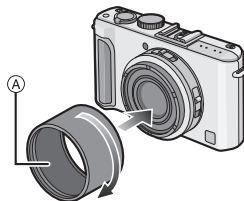

3 Attach the wide conversion lens.

- (B) Wide conversion lens (DMW-LW46; optional)
- Ensure that screw parts of the lens adaptor and wide conversion lens are properly tightened.

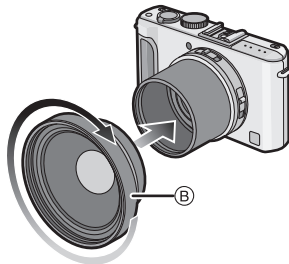

■ The Focus Range When Using the Wide Conversion Lens



Wide Conversion Lens	
Indication	1×
Actual magnification	0.75×
35 mm film camera equivalent	18 mm

- The focus range is 0.75 times the focal distance of the camera.

4 Select [CONVERSION] on the [REC] menu.

- Refer to P90 for [CONVERSION].

5 Press ▲/▼ to select [, and then press [MENU/SET] to set.**Note**

- When there is dirt (water, oil, and fingerprints, etc.) on the surface of the lens, the image may be affected. Lightly wipe the surface of the lens with a soft, dry cloth before and after taking pictures.
- When the wide conversion lens is removed, set [CONVERSION] to [OFF].
- When you take pictures at close range, the resolution of the periphery of the picture may decrease slightly. This is not a malfunction.
- Refer to operating instructions of the wide conversion lens for details.
- Turn off the camera when removing the conversion lens.
- When the [CONVERSION] (P90) is set to [, the flash is fixed to [].

Using the Protector/Filter

The MC protector (DMW-LMC46; optional) is a transparent filter which affects neither the colors nor the amount of light, so it can always be used to protect the camera's lens. The ND filter (DMW-LND46; optional) reduces the amount of light to approximately 1/8th (equal to adjusting the aperture value 3 increments) without affecting the color balance. PL filter (DMW-LPL46; optional) will suppress the reflected light from a metal or non spherical surfaces (flat non-metallic surfaces, water vapour or invisible particles in the air), making it possible to take a picture with enhanced contrast. Preparations: Turn off the camera and remove the lens cap.

1 Remove the lens ring front.

- Be careful not to lose the lens ring front.

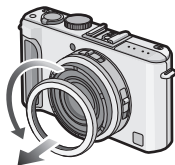
**2** Attach the lens adaptor.

- Rotate the lens slowly and carefully.
- Ⓐ Lens adaptor (DMW-LA4; optional)

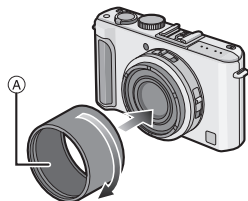
**3** Attach a filter.

- Ⓑ MC protector
- Ⓒ ND filter
- Ⓓ PL filter

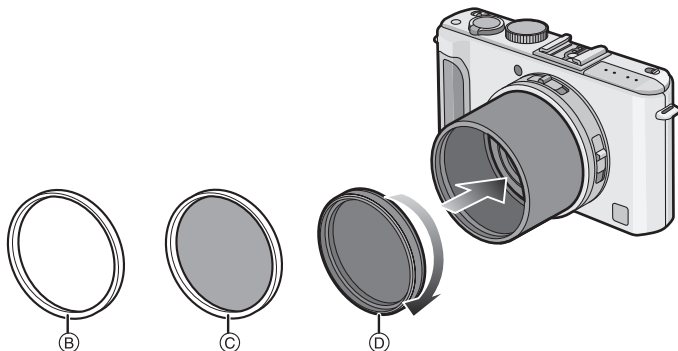

- Ensure that the screw parts of the lens adaptor and the filter are properly tightened.

Note

- Do not attach multiple filters at the same time.
- If the filter is tightened too much, you may not be able to remove it. Do not tighten it too much.
- If the filter is dropped, it may be destroyed. Be careful not to drop it when attaching it to the camera.
- Be careful not to get a fingerprint, dirt, etc., on the filter when it is attached, otherwise the focus may be adjusted to the lens, resulting in the subject being out of focus.
- Refer to the instructions for each filter for details.
- Turn off the camera when removing the filter.
- **MC**="Multi-coated"
- **ND**="Neutral Density"

Using the External Flash (optional)

After attaching the external flash, the effective range will be increased when compared to the camera's built in flash.

Preparations: Turn off the camera and close the built-in flash.

■ Using the dedicated flash (DMW-FL360; optional)

- 1 Attach the dedicated flash to the hot shoe (A) and then turn on the camera and the dedicated flash.**

- Be sure to firmly secure to dedicated flash with the lock ring (B).

- 2 Press \blacktriangleright [⚡].**

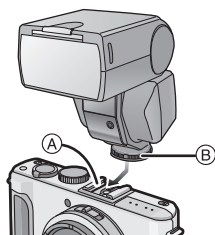

3 Press ▲/▼ to select a mode.

- What screen will be displayed here depends on the flash mode setting of the external flash unit

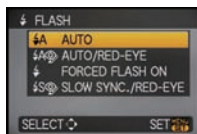
**4 Press [MENU/SET].**

- While the external flash is connected, the following icons are displayed.



External flash active



External flash Forced OFF

■ Number of pictures taken in burst mode when using external flash.

- You can take up to 3 pictures by keeping the shutter button pressed down.

	[OFF]	[]	[]
Burst speed (pictures/second)	—	2.5	Approx. 2
Number of recordable pictures (pictures)	—	max. 3	

- Depending on the extra flash you use or the recording conditions, you cannot take pictures in this mode or the amount of light may become insufficient for the second or subsequent pictures.

Note

- When the flash mode of the dedicated flash is set to [TTL AUTO], various different flash settings can be selected to suit the recording mode. For the flash settings that can be selected, refer to P46.
- When the flash mode of the dedicated flash is set to [TTL AUTO] or [AUTO], the flash output can be adjusted by the camera. For details, refer to the operating instructions of the dedicated flash.
- You can set the aperture value, the shutter speed and the ISO sensitivity on the camera even when attaching the external flash.
- Some commercial external flashes have synchro terminals with high-voltage or reversed polarity. Using such extra flashes may cause a malfunction or the camera may not operate normally.
- If you use commercially available external flashes with communication functions other than the dedicated one, they may not operate normally or they may be damaged. Do not use them.
- Even if the external flash is turned off, the camera may enter the external flash mode when the external flash is attached. When you are not using the external flash, detach it or set it to Forced OFF.
- When attaching the external flash, the built-in flash cannot be activated.
- Do not open the built-in flash when an external flash is attached.
- The camera will become unstable when attaching the external flash, it is recommended to use a tripod when taking picture.
- Turn off the camera when removing the external flash.
- Detach the external flash when carrying the camera.
- When attaching the external flash, do not hold only the external flash because it may detach from the camera.
- If you use the external flash when the white balance is set to [] finely adjust the white balance depending on the picture quality. (P80)
- If you take pictures close to the subject in Wide, the vignetting effect may appear on the bottom of the recorded picture.
- Read the operating instructions of the external flash for details.

Using External Viewfinder (optional)

When using the external viewfinder (DMW-VF1; optional), the screen for taking the wide-angle pictures can be displayed on the viewfinder.

Preparations: Turn off the camera and close the built-in flash.

1 Insert the external viewfinder (DMW-VF1; optional) all the way into the hot shoe (A).

- Insert by pressing the bottom part of the external viewfinder.
- (Do not press on the viewfinder part.)
- When attaching or removing the external viewfinder, please take your time and do so with care.

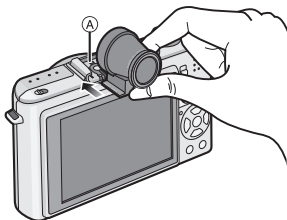

2 Select [EXT. VIEWFINDER] on [REC] menu.

- For more about [EXT. VIEWFINDER], refer to P89.

3 Press ▲/▼ to select [ON] and then press [MENU/SET].

- You can switch the LCD monitor to a blank screen by repeatedly pressing [DISPLAY]. (P44)

Note

- The frame lines show the usable area for a 24 mm lens (35 mm film camera equivalent, aspect ratio 3:2, Wide).
- Frame lines is only an approximation. Check the LCD monitor for precise view.
- When the lens surface is dirty, wipe with a soft dry cloth.
- Turn off the camera when removing the external viewfinder.
- Read the operating instructions of the external viewfinder for details.
- Keep the external viewfinder out of reach of children to prevent swallowing.

Screen Display

■ In recording

Recording in program AE mode [P] (Initial setting)

- 1 Recording mode
- 2 Flash mode (P46)
- 3 AF area (P33)
- 4 Focus (P33)
- 5 Film mode (P74)
- 6 Picture size (P76)
- 7 Quality (P77)
- 8 Battery indication (P16)
- 9 Number of recordable pictures (P142)
- 10 Built-in memory (P18)
[C]: Card (P18) (displayed only during recording)
- 11 Recording state
- 12 Joystick (P23, 34, 55, 56, 58)
ISO sensitivity (P78)
- 13 Shutter speed (P33)
- 14 Aperture value (P33)
- 15 Exposure compensation (P51)
- 16 Metering mode (P81)
- 17 Optical image stabilizer (P87)/[O.I.S.]: Jitter alert (P34)

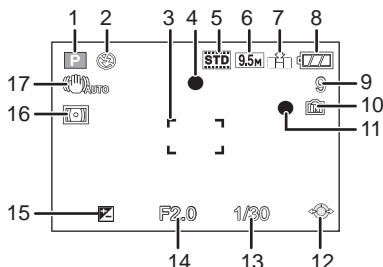

■ In recording (after settings)

- 18 AF macro mode (P49)
MF: MF (P58)
[AF-ON]: AF tracking (P83)
- 19 Flash output adjustment (P48)
- 20 White balance (P79)
White balance fine adjustment (P80)
- 21 ISO sensitivity (P78)
maximum ISO sensitivity level (P79)
- 22 Picture quality setting (P70)
- 23 Custom settings (P60)
- 24 Focus range (P58)
- 25 Available recording time (P70): R8m30s
- 26 Spot AF area (P82)
[+]: Spot metering target (P81)
- 27 Name*1 (P65)
- 28 Histogram (P45)
- 29 Travel date (P71)
AF tracking operation (P37, 83)
- 30 Elapsed recording time (P70)
[ISO]: Intelligent ISO (P78)
- 31 Current date and time/[>]: Travel destination setting*2 (P73)
[EZ] [W] [T] [1X]: Zoom/Extended optical zoom (P38)/Digital zoom (P38, 87)

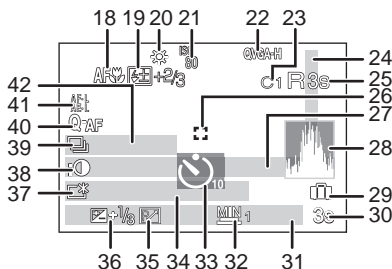

- 32 Minimum shutter speed (P88)
- 33 Self-timer mode (P50)
- 34 Age*1 (P65)
Location*2 (P71)
- 35 Program shift (P34)
- 36 Exposure compensation (P51)
- 37 Power LCD (P25)
[A*]: Auto Power LCD (P25)
- 38 Intelligent Exposure (P85)
- 39 Burst (P54)/[]: Auto bracket (P52)/[]: Multi aspect (P53)/
[]: Multi exposure (P85)/[]: Audio recording (P88)
- 40 Quick AF (P84)/Continuous AF (P84)/AF*: AF assist lamp (P88)
- 41 AF/AE LOCK (P84)
- 42 Number of days that have passed since the travel date (P71)
- *1 This is displayed for about 5 seconds when this unit is turned on in [BABY1]/[BABY2] or [PET] in scene mode.
- *2 This is displayed for about 5 seconds when the camera is turned on, after setting the clock and after switching from playback mode to recording mode.

■ In playback

- 1 Playback mode (P40)
- 2 Protected picture (P107)
- 3 Favorites (P105)
- 4 Stamped with text indication (P99)
- 5 Film mode (P74)
- 6 Picture size (P76)
Picture quality setting (P70)
- 7 Quality (P77)
- 8 Battery indication (P16)
- 9 Folder/File number (P112)
Built-in memory (P18)
Elapsed playback time (P95): 8m30s
- 10 Picture number/Total pictures
- 11 Motion picture recording time (P95): 8m30s
- 12 Histogram (P45)
- 13 Exposure compensation (P51)
- 14 Recording information (P44)
- 15 Favorites settings (P105)
- 16 Recorded date and time/Travel destination setting (P73)/Name (P65)/Location (P71)/
Title (P98)
- 17 Age (P65)
- 18 Number of days that have passed since the travel date (P71)
- 19 Power LCD (P25)
- 20 Number of DPOF prints (P106)
- 21 Audio playback (P95)
[]: Motion picture playback (P95)
Cable disconnection warning icon (P113)

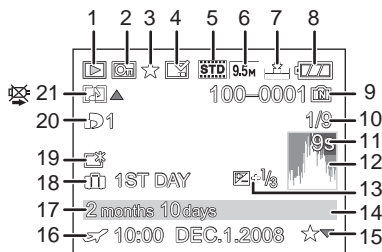

Cautions for Use

Optimal use of the camera

Take care not to drop or knock the unit or put a lot of pressure on it.

- Take care not to knock or drop the bag/case that you inserted the camera in as the shock may cause damage to the camera, lens or LCD monitor.
- Do not attach any other items to the wrist strap that's included with your camera. While being stored, that item can rest against the LCD monitor and damage it.
- Do not use a paper bag as it can easily rip causing the camera to fall and be damaged.
- We strongly recommend you purchase a good camera bag/case from your local dealer to protect your camera.

Keep the camera as far away as possible from electromagnetic equipment (such as microwave ovens, TVs, video games etc.).

- If you use the camera on top of or near a TV, the pictures and sound on the camera may be disrupted by electromagnetic wave radiation.
- Do not use the camera near cell phones because doing so may result in noise adversely affecting the pictures and sound.
- Recorded data may be damaged, or pictures may be distorted, by strong magnetic fields created by speakers or large motors.
- Electromagnetic wave radiation generated by microprocessors may adversely affect the camera, disturbing the pictures and sound.
- If the camera is adversely affected by electromagnetic equipment and stops functioning properly, turn the camera off and remove the battery or disconnect AC adaptor (DMW-AC5PP; optional). Then reinsert the battery or reconnect AC adaptor and turn the camera on.

Do not use the camera near radio transmitters or high-voltage lines.

- If you record near radio transmitters or high-voltage lines, the recorded pictures and sound may be adversely affected.

Always use the supplied cords and cables. If you use optional accessories, use the cords and the cables supplied with them.**Do not extend the cords or the cables.****Do not spray the camera with insecticides or volatile chemicals.**

- If the camera is sprayed with such chemicals, the body of the camera may be damaged and the surface finish may peel off.
- Do not keep rubber or plastic products in contact with the camera for a long period of time.

Cleaning

Before cleaning the camera, remove the battery or disconnect the power plug from the outlet. Then wipe the camera with a dry soft cloth.

- When the camera is soiled badly, it can be cleaned by wiping the dirt off with a wrung wet cloth, and then with a dry cloth.
- Do not use solvents such as benzene, thinner, alcohol, kitchen detergents, etc., to clean the camera, since it may deteriorate the external case or the coating may peel off.
- When using a chemical cloth, be sure to follow the accompanying instructions.

About the LCD monitor

- Do not press the LCD monitor with excessive force. Uneven colors may appear on the LCD monitor and it may malfunction.

- If the camera is cold when you turn it on, the picture on the LCD monitor will be slightly darker than usual at first. However, the picture will return to normal brightness when the internal temperature of the camera increases.

Extremely high precision technology is employed to produce the LCD monitor screen. However, there may be some dark or bright spots (red, blue or green) on the screen. This is not a malfunction. The LCD monitor screen has more than 99.99% effective pixels with a mere 0.01% of the pixels inactive or always lit. The spots will not be recorded on pictures on the built-in memory or a card.

About the Lens

- Do not press the lens with excessive force.
- Do not leave the camera with the lens facing the sun as rays of light from the sun may cause it to malfunction. Also, be careful when placing the camera outside or near a window.

Battery

The battery is a rechargeable lithium ion battery. Its ability to generate power comes from the chemical reaction that takes place inside it. This reaction is susceptible to the surrounding temperature and humidity. If the temperature is too high or too low, the operating time of the battery will become shorter.

Always remove the battery after use.

- Store the removed battery in the battery carrying case (supplied).

If you drop the battery accidentally, check to see if the body of the battery and the terminals are damaged.

- Inserting a damaged battery in the camera will damage the camera.

Bring charged spare batteries when going out.

- Be aware that the operating time of the battery becomes shorter in low temperature conditions such as at a ski resort.
- When you travel, do not forget to bring the battery charger (supplied) so that you can charge the battery in the country that you are traveling in.

Dispose of unusable battery.

- The battery has a limited life.
- Do not throw the battery into fire because it may cause an explosion.
- The unusable battery should be discarded in accordance with battery recycling laws. Call the RBRC hotline at 1-800-822-8837 for information.

Do not allow battery terminals to come into contact with metal objects (such as necklaces, hairpins etc.).

- This can cause short circuiting or heat generation and you may be badly burned if you touch a battery.

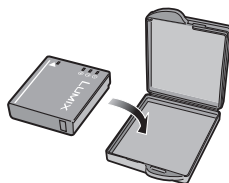

Charger

- If you use the battery charger near a radio, the radio reception may be disturbed.
- Keep the charger 1 m (3.28 feet) or more away from radios.
- The charger may generate whirring sounds when it is being used. This is not a malfunction.
- After use, be sure to disconnect the power supply device from the electrical outlet. (A very small amount of current is consumed if it is left connected.)
- Keep the terminals of the charger and battery clean.

Card

Do not leave the card where the temperature is high, where electromagnetic waves or static electricity are easily generated or exposed to direct sunlight.

Do not bend or drop the card.

- The card may be damaged or the recorded content may be damaged or deleted.
- Put the card in the card case or the storage bag after use and when storing or carrying the card.
- Do not allow dirt, dust or water to get into the terminals on the back of the card and do not touch the terminals with your fingers.

When not using the camera for a long period of time

- Store the battery in a cool and dry place with a relatively stable temperature: [Recommended temperature: 15 °C to 25 °C (59 °F to 77 °F), Recommended humidity: 40% to 60%]
- Always remove the battery and the card from the camera.
- If the battery is left inserted in the camera, it will discharge even if the camera is turned off. If the battery continues to be left in the camera, it will discharge excessively and may become unusable even if charged.
- When storing the battery for a long period of time, we recommend charging it once a year. Remove the battery from the camera and store it again after it has completely discharged.
- We recommend storing the camera with a desiccant (silica gel) when you keep it in a closet or a cabinet.

About the picture data

- Recorded data may be damaged or lost if the camera breaks down due to inappropriate handling. Panasonic will not be liable for any damage suffered due to loss of recorded data.

About tripods

- When you use a tripod, make sure the tripod is stable when this unit is attached to it.
- You may not be able to remove the card or the battery when using a tripod.
- Make sure that the screw on the tripod is not at an angle when attaching or detaching the camera. You may damage the screw on the camera if you use excessive force when turning it. Also, the camera body and the rating label may be damaged or scratched if the camera is attached too tightly to the tripod.
- Read the operating instructions for the tripod carefully.

Message Display

Confirmation messages or error messages will be displayed on the screen in some cases. The major messages are described below as examples.

[THIS MEMORY CARD IS LOCKED]

- The Write-Protect switch on the SD Memory Card and the SDHC Memory Card are moved to [LOCK]. Move the switch back to unlock it. (P19)

[NO VALID PICTURE TO PLAY]

- Record a picture or insert a card with a recorded picture and then play it.

[THIS PICTURE IS PROTECTED]

→ Delete the picture after canceling the protect setting. (P107)

[THIS PICTURE CANNOT BE DELETED]/[SOME PICTURES CANNOT BE DELETED]

- Pictures not based on the DCF standard cannot be deleted.
 - If you want to delete some pictures, format the card after saving necessary data on a PC etc. (P28)

[NO ADDITIONAL SELECTIONS CAN BE MADE]

- The number of pictures, which can be set at one time when [MULTI] has been selected for [DELETE MULTI] (P43), [FAVORITE] (P105), [TITLE EDIT] (P98), [TEXT STAMP] (P99) or [RESIZE] (P101) has been exceeded.
 - Reduce the number of pictures set, and then repeat the operation.
- More than 999 favorites have been set.

[CANNOT BE SET ON THIS PICTURE]

- [TITLE EDIT], [TEXT STAMP] or [DPOF PRINT] cannot be set for pictures not based on the DCF standard.

[NOT ENOUGH SPACE ON BUILT-IN MEMORY]/[NOT ENOUGH MEMORY ON THE CARD]

- There is no space left on the built-in memory or the card.
 - When you copy pictures from the built-in memory to the card (batch copy), the pictures are copied until the capacity of the card becomes full.

[SOME PICTURES CANNOT BE COPIED]/[COPY COULD NOT BE COMPLETED]

- The following pictures cannot be copied.
 - When a picture with the same name as the picture to be copied exists in the copy destination. (Only when copying from a card to the built-in memory.)
 - Files not based on the DCF standard.
- Moreover, pictures recorded or edited by other equipment may not be copied.

**[BUILT-IN MEMORY ERROR
FORMAT BUILT-IN MEMORY?]**

- This message will be displayed when you formatted the built-in memory on a PC.
 - Format the built-in memory on the camera again. (P28) The data on the built-in memory will be deleted.

**[MEMORY CARD ERROR
FORMAT THIS CARD?]**

- This card has a format which is not recognized by the camera.
 - Format the card again with the camera after saving necessary data on a PC etc. (P28)

[PLEASE TURN CAMERA OFF AND THEN ON AGAIN]/[SYSTEM ERROR]

- This message appears when the camera is not operating properly.
 - Turn the camera off and on. If the message persists, contact the dealer or your nearest Service center.

[MEMORY CARD PARAMETER ERROR]

- Use a card compatible with this unit. (P18)
- You can only use an SDHC Memory Card if using cards with 4 GB or more capacity.

**[MEMORY CARD ERROR
PLEASE CHECK THE CARD]**

- An error has occurred accessing the card.
→ Insert the card again.
- Or try with a different card.

**[READ ERROR
PLEASE CHECK THE CARD]**

- An error has occurred reading the data.
→ Insert the card again.

**[WRITE ERROR
PLEASE CHECK THE CARD]**

- An error has occurred writing the data.
→ Turn the camera off and remove the card. Insert the card again and turn the camera on. Make sure the camera is turned off before removing or inserting the card to avoid damage.
- Or try with a different card.

[MOTION RECORDING WAS CANCELLED DUE TO THE LIMITATION OF THE WRITING SPEED OF THE CARD]

- When you set the picture quality to [HD], [WVGA] or [VGA], we recommend using a high-speed card with "10MB/s" or greater displayed on the package.
- Depending on the type of SD Memory Card or SDHC Memory Card, motion picture recording may stop in the middle.

[A FOLDER CANNOT BE CREATED]

- A folder cannot be created because there are no remaining folder numbers that can be used. (P112)
→ Format the card after saving necessary data on a PC etc. (P28) If you execute [NO.RESET] in the [SETUP] menu after formatting, the folder number is reset to 100. (P26)

[PICTURE IS DISPLAYED FOR 4:3 TV]/[PICTURE IS DISPLAYED FOR 16:9 TV]

- The AV cable is connected to the camera.
→ Press [MENU/SET] if you want to delete this message at once.
→ Select [TV ASPECT] in the [SETUP] menu if you want to change the TV aspect. (P27)
- This message also appears when the USB connection cable is connected to the camera only. In this case, connect the other end of the USB connection cable to a PC or a printer. (P110, 112)











































[PRINTER BUSY]/[PLEASE CHECK THE PRINTER]

- The printer cannot print.
→ Check the printer.











Functions that cannot be set or will not work under some conditions

Due to the camera's specifications, it may not be possible to set some of the functions or some functions may not work in some of the conditions under which the camera is used. The table below lists these functions and the corresponding conditions.

- For the functions which cannot be set or will not work in the Intelligent auto mode, refer to “Settings in Intelligent auto mode” (P37).

Functions that cannot be set or will not work	Main conditions in which the functions cannot be set or will not work
[AUTO POWER LCD] (P25)	<ul style="list-style-type: none"> •  mode
[HISTOGRAM] (P25)	<ul style="list-style-type: none"> •  mode • During multi playback • During playback zoom • [CALENDAR]
[POWER SAVE] (P26)	<ul style="list-style-type: none"> • When using the AC adaptor • When connecting to a PC or a printer • When recording or playing back motion pictures • [MULTI. EXPO.] • During a slide show • [AUTO DEMO]
[AUTO LCD OFF] (P26)	<ul style="list-style-type: none"> • When using the AC adaptor • While the menu screen is displayed • While the self-timer is set • [MULTI. EXPO.] • While recording motion pictures • When connecting to a PC or a printer
[AUTO REVIEW] (P26)	<ul style="list-style-type: none"> •  mode
Extended Optical Zoom (P38)	<ul style="list-style-type: none"> • , , ,  and  in [SCENE MODE] •  mode • When [QUALITY] is set to [RAW], [RAW] or [RAW] • [MULTI. EXPO.]
[DIGITAL ZOOM] (P38)	<ul style="list-style-type: none"> • , , , , , , , ,  and  in [SCENE MODE] • When Intelligent ISO is set • When [QUALITY] is set to [RAW], [RAW] or [RAW] • [MULTI. EXPO.] • When using the conversion lens
[FLASH] (P46)	<ul style="list-style-type: none"> • When auto bracket has been set • [BURST] • , , , ,  and  in [SCENE MODE] •  mode • [MULTI FILM] in [FILM MODE] is set • When using the conversion lens
Flash output adjustment (P48)	<ul style="list-style-type: none"> • , , , ,  and  in [SCENE MODE] •  mode
[SELFTIMER] (P50)	<ul style="list-style-type: none"> •  in [SCENE MODE] •  mode
[EXPOSURE] (P51)	<ul style="list-style-type: none"> • M mode •  in [SCENE MODE]
[AUTO BRACKET] (P52)	<ul style="list-style-type: none"> • , , ,  and  in [SCENE MODE] •  mode • [MULTI. EXPO.]

[MULTI ASPECT] (P53)	<ul style="list-style-type: none"> • and in [SCENE MODE] • mode • When [QUALITY] is set to [RAW], [] or [] • [MULTI. EXPO.]
[BURST] (P54)	<ul style="list-style-type: none"> • and in [SCENE MODE] • [MULTI. EXPO.] • mode • [AUDIO REC.]
[PICTURE SIZE] (P76)	<ul style="list-style-type: none"> • and in [SCENE MODE] • mode
[QUALITY] (P77)	<ul style="list-style-type: none"> • and in [SCENE MODE] • mode
[INTELLIGENT ISO] (P78)	<ul style="list-style-type: none"> • S mode • M mode • SCN mode • mode
[SENSITIVITY] (P78)	<ul style="list-style-type: none"> • SCN mode • mode • When Intelligent ISO is set
[ISO LIMIT SET] (P79)	<ul style="list-style-type: none"> • SCN mode • mode
[WHITE BALANCE] (P79)	<ul style="list-style-type: none"> • and in [SCENE MODE]
[WB ADJUST.] (P80)	<ul style="list-style-type: none"> • and in [SCENE MODE]
[METERING MODE] (P81)	<ul style="list-style-type: none"> • SCN mode
[AF TRACKING] (P83)	<ul style="list-style-type: none"> • and in [SCENE MODE] • mode • [STANDARD] (), [DYNAMIC] () and [SMOOTH] () in [FILM MODE] is set
[QUICK AF] (P84)	<ul style="list-style-type: none"> • When AF tracking is set • and in [SCENE MODE] • mode • When manual focus is set
Continuous AF (P84)	<ul style="list-style-type: none"> • and in [SCENE MODE] • When manual focus is set • mode
AF Lock (P84)	<ul style="list-style-type: none"> • When AF tracking is set • mode
AE Lock (P84)	<ul style="list-style-type: none"> • When AF tracking is set • mode • SCN mode
[I.EXPOSURE] (P85)	<ul style="list-style-type: none"> • SCN mode • mode • [MULTI. EXPO.] • When [QUALITY] is set to [RAW], [] or []
[MULTI. EXPO.] (P85)	<ul style="list-style-type: none"> • SCN mode • mode

[MIN. SHTR SPEED] (P88)	<ul style="list-style-type: none"> • A mode • S mode • M mode • SCN mode • [H] mode • When Intelligent ISO is set
[AUDIO REC.] (P88)	<ul style="list-style-type: none"> • [AUTO BRACKET] • [MULTI ASPECT] • [BURST] • ,  and  in [SCENE MODE] • [H] mode • [MULTI FILM] in [FILM MODE] is set • [MULTI. EXPO.] • When [QUALITY] is set to [RAW], [^{RAW}] or [^{RAW}]
[AF ASSIST LAMP] (P88)	<ul style="list-style-type: none"> • , , , ,  and  in [SCENE MODE] • When using the conversion lens
[FLASH SYNCHRO] (P89)	<ul style="list-style-type: none"> • SCN mode • [H] mode
[CONVERSION] (P90)	<ul style="list-style-type: none"> • [AF ASSIST LAMP] •  in [SCENE MODE]
Playback Zoom (P41)	<ul style="list-style-type: none"> • When playing back motion pictures • Still pictures with audio (when playing back audio)
[TITLE EDIT] (P98)	<ul style="list-style-type: none"> • Motion pictures • Protected pictures • When [QUALITY] is set to [RAW], [^{RAW}] or [^{RAW}]
[TEXT STAMP] (P99)	<ul style="list-style-type: none"> • Pictures recorded without setting the clock or title • Motion pictures • Still pictures with audio • Pictures stamped with [TEXT STAMP] • When [QUALITY] is set to [RAW], [^{RAW}] or [^{RAW}]
[RESIZE] (P101)	<ul style="list-style-type: none"> • Motion pictures • Still pictures with audio • Pictures stamped with [TEXT STAMP] • When [QUALITY] is set to [RAW], [^{RAW}] or [^{RAW}]
[TRIMMING] (P102)	<ul style="list-style-type: none"> • Motion pictures • Still pictures with audio • Pictures stamped with [TEXT STAMP] • When [QUALITY] is set to [RAW], [^{RAW}] or [^{RAW}]
[LEVELING] (P103)	<ul style="list-style-type: none"> • Motion pictures • Still pictures with audio • Pictures stamped with [TEXT STAMP] • When [QUALITY] is set to [RAW], [^{RAW}] or [^{RAW}]
[ASPECT CONV.] (P103)	<ul style="list-style-type: none"> • Pictures taken with 3:2 or 4:3 • Motion pictures • Still pictures with audio • Pictures stamped with [TEXT STAMP] • When [QUALITY] is set to [RAW], [^{RAW}] or [^{RAW}]
[ROTATE] (P104)	<ul style="list-style-type: none"> • Motion pictures • Protected pictures

[ROTATE DISP.] (P104)	<ul style="list-style-type: none"> • Multi playback • [CALENDAR]
[FAVORITE] (P105)	<ul style="list-style-type: none"> • When [QUALITY] is set to [RAW]
[DPOF PRINT] (P106)	<ul style="list-style-type: none"> • When set to [RAW]
PRINT WITH DATE	<ul style="list-style-type: none"> • Pictures stamped with [TEXT STAMP]
[AUDIO DUB.] (P108)	<ul style="list-style-type: none"> • Motion pictures • Protected pictures • When [QUALITY] is set to [RAW], [$\frac{RAW}{\text{---}}$] or [$\frac{RAW}{\text{---}}$]

■ Functions that cannot be used when the component cable is connected

[LCD MODE]/[HISTOGRAM]/[TITLE EDIT]/[TEXT STAMP]/[RESIZE]/[TRIMMING]/[LEVELING]/[ASPECT CONV.]/[AUDIO DUB.]/[COPY]/[MULTI] settings of [DPOF PRINT]/[MULTI] settings of [PROTECT]/[DELETE MULTI]/Creation of still pictures from motion pictures

Troubleshooting

First, try out the following procedures (P134–141).

If the problem is not resolved, it may be improved by selecting [RESET] (P27) on the [SETUP] menu when taking pictures.

Battery and power source

The camera cannot be operated even when it is turned on.

- The battery is not inserted correctly. (P17)
- The battery is exhausted.
- Charge the battery.

The LCD monitor turns off while the camera is turned on.

- Is the [EXT. VIEWFINDER] (P89) set to [ON]?
→ Press [DISPLAY] to switch to the LCD monitor.
- Is [AUTO LCD OFF] (P26) of the [ECONOMY] mode active?
→ Press the shutter button halfway to cancel these modes.
- The battery is exhausted.
- Charge the battery.

The camera turns off immediately after it is turned on.

- The battery is exhausted.
- Charge the battery.
- If you leave the camera on, the battery will be exhausted.
→ Turn the camera off frequently by using the [ECONOMY] mode etc. (P26)

The [CHARGE] lamp flashes.

- Is the temperature of the battery excessively high or low? If it is, it will take longer than usual to charge the battery or charging may remain incomplete.
- Are the terminals of the charger or battery dirty?
→ Wipe off the dirt using a dry cloth.

Recording

The picture cannot be recorded.

- Is the [REC]/[PLAYBACK] selector switch at the  setting? (P29)
- Is the mode dial correctly set?
- Is there any memory remaining on the built-in memory or the card?
 - Delete the pictures which are not necessary to increase the available memory. (P42)

The recorded picture is whitish.

- The picture can become whitish if there is dirt e.g. fingerprints on the lens.
 - If the lens is dirty, turn on the camera, eject the lens barrel (P11) and gently wipe the lens surface with a soft dry cloth.

The area around where the pictures were taken becomes dark.

- Was this picture taken with the flash at the close range when the zoom is near [W] (1×)?
 - Zoom in a little, and then take the pictures. (P38)
 - Is this a picture taken in [PIN HOLE] in scene mode?

The recorded picture is too bright or dark.

- Check that the exposure is correctly compensated. (P51)
- Setting the [MIN. SHTR SPEED] to faster speed might make the picture darker.
 - Set the [MIN. SHTR SPEED] to slower speed.

2 or 3 pictures are taken at one time.

- Set auto bracket (P52), multi aspect (P53), [HI-SPEED BURST], [FLASH BURST] in scene mode (P66, 67), or the burst mode (P54) to [OFF].

The subject is not focused properly.

- The focus range varies depending on the recording mode.
 - Set to the proper mode for the distance to the subject.
- The subject is beyond the focus range of the camera. (P32)
- There is camera shake (jitter) or the subject is moving slightly. (P34)

The recorded picture is blurred.

The optical image stabilizer is not effective.

- The shutter speed becomes slower when pictures are taken in dark places so hold the camera firmly with both hands to take the pictures. (P32)
- When taking pictures at a slow shutter speed, use the self-timer. (P50)

Taking pictures using auto bracket/multi aspect is not possible.

- Is the number of recordable pictures 2 or less?

The recorded picture looks rough.

Noise appears on the picture.

- Is the ISO sensitivity high or the shutter speed slow?
 - (ISO sensitivity is set to [AUTO] when the camera is shipped. Therefore, when taking pictures indoors etc. noise will appear.)
 - Decrease the ISO sensitivity. (P78)

- Set [NOISE REDUCTION] in [FILM MODE] towards [+] or set every item except [NOISE REDUCTION] towards [-]. (P74)
- Take pictures in bright places.
- Has [HIGH SENS.] or [HI-SPEED BURST] in the scene mode been set? If so, the resolution of the recorded picture decreases slightly because of high sensitivity processing, but this is not a malfunction.

The brightness or the hue of the recorded picture is different from the actual scene.

- If recording under fluorescent light, the brightness or the hue may change slightly when the shutter speed becomes fast. This occurs due to the characteristics of fluorescent light. It is not a malfunction.

A reddish vertical line (smear) appears on the LCD monitor during picture-taking.

- This is a characteristic of CCDs, and it appears when the subject has a bright part. Some unevenness may occur in the surrounding areas, but this is not a malfunction. It is recorded in motion pictures but is not recorded on still pictures.
- It is recommended that you take pictures while taking care not to expose the screen to sunlight or any other source of strong light.



Motion picture recording stops in the middle.

- Are you using a MultiMediaCard? This unit does not support MultiMediaCards.
 - When you set the picture quality to [HD], [WVGA] or [VGA], we recommend using a high-speed card with "10MB/s" or greater displayed on the package.
- Depending on the type of the card, recording may stop in the middle.

Zoom does not operate properly

- Is the [CONVERSION] (P90) set to []?

The subject cannot be locked. (AF track fails)

- Set the AF area to the distinctive color of the subject if there is a part that is different from the surrounding color. (P83)

Lens

Recorded image may be warped, or nonexistent color is surrounding the subject.

- It is possible that the subject may be warped slightly, or the borders get colored, depending on the zoom magnification, due to the characteristics of the lens. Also, the peripherals of the image might look warped because the perspective is enhanced when the wide angle is used. This is not a malfunction.

LCD monitor

The LCD monitor turns off although the camera is turned on.

- The LCD monitor turns off and the status indicator lights when [AUTO LCD OFF] (P26) is selected for the [ECONOMY] mode.
[This does not happen when using the AC adaptor (DMW-AC5PP; optional).]
If the remaining battery power is low, it may take longer for the flash to be charged, and the time during which the LCD monitor is turned off may become longer.

The LCD monitor becomes darker or brighter for a moment.

- This phenomenon appears when you press the shutter button halfway to set the aperture value and does not affect the recorded pictures.
- This phenomenon also appears when the brightness changes when the camera is zoomed or when the camera is moved. This is because of operation of the automatic aperture of the camera, and it is not a malfunction.

The LCD monitor flickers indoors.

- The LCD monitor may flicker for a few seconds after turning the camera on indoors under fluorescent light. This is not a malfunction.

The LCD monitor is too bright or dark.

- Adjust the brightness of the screen. (P24)
- [POWER LCD] is activated. (P25)

The picture is not displayed on the LCD monitor.

- Is the [EXT. VIEWFINDER] (P89) set to [ON]?
→ Press [DISPLAY] to switch to the LCD monitor.

Black, red, blue and green dots appear on the LCD monitor.

- This is not a malfunction.
These pixels do not affect the recorded pictures.

Noise appears on the LCD monitor.

- In dark places, noise may appear to maintain the brightness of the LCD monitor. This does not affect the pictures you are recording.

Flash

The flash is not activated.

- Is the flash closed?
→ Open the flash by sliding  OPEN]. (P46)
- Flash mode is not available when auto bracket (P52) or burst have been set.

The flash is activated multiple times.

- The flash is activated twice when red-eye reduction (P46) has been set.
- Is it set to [FLASH BURST] (P67) in scene mode?

Playback

The picture being played back is rotated and displayed in an unexpected direction.

- [ROTATE DISP.] (P104) is set to [ON].
- You can rotate pictures with the [ROTATE] function. (P104)

The picture is not played back.

- Is the [REC]/[PLAYBACK] selector switch set to [▶]? (P40)
- Is there a picture on the built-in memory or the card?
 - The pictures on the built-in memory appear when a card is not inserted. The picture data on the card appears when a card is inserted.
- Is this a picture whose file name has been changed in the PC? If it is, it cannot be played back by this unit.

The recorded pictures are not displayed.

- Has [CATEGORY PLAY] or [FAVORITE PLAY] been set for playback?
 - Change to [NORMAL PLAY]. (P40)

The folder number and the file number are displayed as [—] and the screen turns black.

- Is this a non-standard picture, a picture which has been edited using a PC or a picture which was taken by another make of digital camera?
- Did you remove the battery immediately after picture-taking or did you take the picture using a battery with a low remaining charge?
 - Format the data to delete the pictures mentioned above. (P28)
(Other pictures will be deleted as well and it will not be possible to restore them. Therefore, check well before formatting.)

With a calendar search, pictures are displayed on dates differing from the actual dates on which the pictures were taken.

- Is the clock in the camera set properly? (P19)
- When pictures edited using a PC or pictures taken by other equipment are searched, they may be displayed on dates differing from the actual dates on which the pictures were taken.

White round spots like soap bubbles appear on the recorded picture.

- If you take a picture with the flash in a dark place or indoors, white round spots may appear on the picture caused by the flash reflecting of particles of dust in the air. This is not a malfunction. A characteristic of this is that the number of round spots and their position differ in every picture.



[THUMBNAIL IS DISPLAYED] appears on the screen.

- Is it a picture that has been recorded with other equipment? In such cases, these pictures may be displayed with a deteriorated picture quality.

A clicking sound is recorded in the motion pictures.

- This unit automatically adjusts the aperture during motion picture recording. At such times, a clicking sound is heard, and this sound may be recorded on the motion pictures. This is not a malfunction.

TV, PC and printer**The picture does not appear on the television.**

- Is the camera connected to the TV correctly?
→ Set the TV input to external input mode.
- Output from the [COMPONENT OUT] socket is not possible when it is connected to the PC or the printer.
→ Connect it only to the TV.

The display areas on the TV screen and the camera's LCD monitor are different.

- Depending on the TV model, the pictures may be extended horizontally or vertically or they may be displayed with their edges cut off.

The motion pictures cannot be played back on a TV.

- Are you trying to play back the motion pictures by directly inserting the card in the card slot of the TV?
→ Connect the camera to the TV with the AV cable (supplied), or with the component cable (DMW-HDC2; optional), and then play back the motion pictures on the camera. (P116, 118)

The picture is not displayed fully on the TV.

- Check [TV ASPECT] setting. (P27)

The picture cannot be transferred when the camera is connected to a PC.

- Is the camera connected to the PC correctly?
- Is the camera recognized by the PC correctly?
→ Set to [PC] in [USB MODE]. (P27, 110)

The card is not recognized by the PC. (The built-in memory is recognized.)

- Disconnect the USB connection cable. Connect it again while the card is inserted in the camera.

The picture cannot be printed when the camera is connected to a printer.

- Pictures cannot be printed using a printer which does not support PictBridge.
→ Set to [PictBridge(PTP)] in [USB MODE]. (P27, 112)

The ends of the pictures are cut at printing.

- When using a printer with a trimming or borderless printing function, cancel this function before printing. (For details, refer to the operating instructions for the printer.)
- When you order photo studios to print pictures, ask the photo studio if the pictures can be printed with both ends.

Others

An unreadable language was selected by mistake.

→ Press [MENU/SET], select the [SETUP] menu icon [🔧] and then select the [🌐] icon to set the desired language. (P28)

A red lamp sometimes turns on when the shutter button is pressed halfway.

- In dark places, the AF assist lamp (P88) lights red to make it easier to focus on a subject.

Part of the picture is flashing in black and white.

- This is a highlight function showing the white saturated area. (P25)
- Is the [HIGHLIGHT] set to [ON]?

The AF assist lamp does not turn on.

- Is [AF ASSIST LAMP] on the [REC] mode menu set to [ON]? (P88)
- The AF assist lamp does not turn on in bright places.

The camera becomes warm.

- The surface of the camera may become warm during use. This does not affect the performance or quality of the camera.

The lens clicks.

- When the brightness changes due to zoom or camera movement etc., the lens may click and the picture on the screen may drastically change. However, the picture is not affected. The sound is caused by the automatic adjustment of the aperture. This is not a malfunction.

The clock is reset.

- If you do not use the camera for a long time, the clock may be reset.
→ When the message [PLEASE SET THE CLOCK] appears, set the clock again. When you take a picture before setting the clock, [0:00 0. 0. 0] is recorded. (P20)

When pictures are taken using the zoom, they are slightly distorted and the areas around the subject contain colors which are not actually present.

- It is possible that the subject may be warped slightly, or the borders get colored, depending on the zoom magnification, due to the characteristics of the lens, but this is not a malfunction.

Zooming stops instantaneously.

- When using the extended optical zoom, the zooming action will stop temporarily near [W]. This is not a malfunction.

The file numbers are not recorded consecutively.

- When you perform an operation after taking a certain action, the pictures may be recorded in folders with different numbers from the ones used prior to the operation. (P112)

The file numbers are recorded in ascending order.

- If the battery was inserted or removed without first turning the camera's power off, the folder and file numbers for the pictures taken will not be stored in the memory. When the power is then turned back on and pictures are taken, they may be stored under file numbers which should have been assigned to previous pictures.

[AGE] is not displayed correctly.

- Check the clock (P19) and birthday settings (P65).











The lens barrel is retracted.

- The lens barrel retracts about 15 seconds after switching from [REC] mode to [PLAYBACK] mode.

Number of Recordable Pictures and Available Recording Time

- The number of recordable pictures and the available recording time are an approximation. (These vary depending on the recording conditions and the type of card.)
- The number of recordable pictures and the available recording time varies depending on the subjects.

■ Number of recordable pictures

Aspect ratio		4:3												
Picture size		10M (10M): (3648×2736)					7M (7M $\frac{4}{3}$): (3072×2304)				5M (5M $\frac{4}{3}$): (2560×1920)			
Quality		RAW												
Built-in Memory (Approx. 50 MB)		4	2	3	9	20	3	3	14	28	3	3	20	40
Card	32 MB	2	1	1	5	11	1	2	7	16	1	2	11	23
	64 MB	5	3	4	11	24	3	4	16	34	4	4	24	48
	128 MB	10	7	8	24	49	7	8	35	69	8	9	50	99
	256 MB	19	14	16	48	97	15	17	68	135	16	18	98	190
	512 MB	39	27	32	97	190	30	34	135	270	32	35	195	380
	1 GB	79	56	65	195	380	61	69	270	540	65	71	390	770
	2 GB	160	110	130	390	770	120	140	550	1090	130	145	790	1530
	4 GB	310	220	260	770	1520	240	270	1090	2150	260	280	1560	3010
	8 GB	640	450	530	1580	3100	490	560	2230	4380	530	580	3180	6130
	16 GB	1290	920	1070	3180	6250	1000	1120	4490	8820	1070	1170	6410	12350
32 GB	2590	1840	2150	6390	12540	2010	2260	9010	17700	2150	2340	12870	24780	

Aspect ratio		4:3											
Picture size		3M (3M $\overline{7}$): (2048×1536)				2M (2M $\overline{7}$): (1600×1200)				0.3M (0.3M $\overline{7}$): (640×480)			
Quality		RAW ≡≡≡	RAW ≡≡	$\overline{\equiv}$ ≡≡	$\overline{\equiv}$ ≡	RAW ≡≡≡	RAW ≡≡	$\overline{\equiv}$ ≡≡	$\overline{\equiv}$ ≡	RAW ≡≡≡	RAW ≡≡	$\overline{\equiv}$ ≡≡	$\overline{\equiv}$ ≡
Built-in Memory (Approx. 50 MB)		3	3	32	62	3	4	51	97	4	4	240	400
Card	32 MB	2	2	18	36	2	2	29	56	2	2	145	230
	64 MB	4	4	38	75	4	4	61	115	4	4	290	480
	128 MB	8	9	78	150	9	9	125	230	10	10	600	970
	256 MB	17	18	150	290	18	19	240	460	19	19	1170	1900
	512 MB	34	37	300	590	36	37	480	910	38	39	2320	3770
	1 GB	70	74	600	1180	73	75	970	1830	77	78	4640	7550
	2 GB	140	150	1220	2360	145	150	1920	3610	155	155	8780	12290
	4 GB	270	290	2410	4640	290	300	3770	7090	310	310	17240	24130
	8 GB	560	600	4910	9440	590	610	7670	14440	630	630	35080	49120
	16 GB	1140	1210	9880	19000	1190	1230	15440	29070	1270	1270	70590	98840
32 GB	2290	2420	19820	38120	2390	2480	30970	58310	2540	2560	141620	198270	

Aspect ratio		3:2											
Picture size		9.5M (9.5M): (3776×2520)					6.5M (6.5M $\overline{7}$): (3168×2112)						
Quality		RAW	RAW ≡≡≡	RAW ≡≡	$\overline{\equiv}$ ≡≡	$\overline{\equiv}$ ≡	RAW ≡≡≡	RAW ≡≡	$\overline{\equiv}$ ≡≡	$\overline{\equiv}$ ≡			
Built-in Memory (Approx. 50 MB)		4	2	3	10	21	3	3	14	30			
Card	32 MB	2	1	2	5	11	1	2	8	17			
	64 MB	5	3	4	12	25	3	4	17	36			
	128 MB	10	7	8	25	51	8	9	36	73			
	256 MB	21	14	17	51	100	16	18	72	140			
	512 MB	41	29	34	100	200	32	36	140	280			
	1 GB	83	59	69	200	400	64	73	280	570			
	2 GB	170	120	140	410	810	130	145	580	1150			
	4 GB	330	230	270	810	1600	250	290	1140	2270			
	8 GB	680	480	560	1650	3270	520	590	2330	4630			
	16 GB	1360	970	1130	3330	6580	1060	1190	4700	9320			
32 GB	2740	1940	2270	6690	13210	2120	2390	9440	18700				

Aspect ratio		3:2											
Picture size		45M (4.5M FZ): (2656×1768)				3M (3M FZ): (2112×1408)				25M (2.5M FZ): (2048×1360)			
Quality		RAW ===	RAW -2-			RAW ===	RAW -2-			RAW ===	RAW -2-		
Built-in Memory (Approx. 50 MB)		3	3	21	42	3	4	33	65	3	4	36	69
Card	32 MB	2	2	12	24	2	2	19	37	2	2	20	40
	64 MB	4	4	25	50	4	4	40	78	4	4	43	83
	128 MB	8	9	52	100	9	10	82	155	9	10	88	165
	256 MB	17	19	100	200	18	19	160	310	18	19	170	330
	512 MB	34	37	200	400	36	39	320	610	37	39	340	650
	1 GB	69	75	410	800	74	78	640	1230	74	78	680	1310
	2 GB	140	150	820	1610	150	155	1270	2450	150	155	1360	2560
	4 GB	270	300	1630	3170	290	310	2510	4820	290	310	2680	5020
	8 GB	560	610	3310	6460	600	630	5110	9820	600	630	5450	10230
	16 GB	1130	1230	6670	13000	1200	1280	10290	19760	1210	1280	10980	20590
32 GB	2270	2480	13390	26080	2420	2560	20650	39650	2440	2570	22020	41300	

Aspect ratio		16:9									
Picture size		9M (9M): (3968×2232)					6M (6M FZ): (3328×1872)				
Quality		RAW	RAW ===	RAW -2-			RAW ===	RAW -2-			
Built-in Memory (Approx. 50 MB)		4	3	3	11	22	3	4	15	32	
Card	32 MB	2	1	2	6	12	1	2	9	18	
	64 MB	5	3	4	13	27	4	4	19	38	
	128 MB	11	8	9	27	55	8	10	39	79	
	256 MB	22	15	18	54	105	17	19	77	150	
	512 MB	44	31	37	105	210	34	39	155	300	
	1 GB	89	63	74	210	430	69	78	310	610	
	2 GB	180	125	150	440	870	140	155	620	1220	
	4 GB	350	250	290	870	1720	270	310	1230	2410	
	8 GB	720	510	600	1770	3500	560	630	2500	4910	
	16 GB	1460	1040	1210	3580	7050	1130	1270	5040	9880	
32 GB	2940	2080	2430	7180	14160	2270	2560	10110	19820		

Aspect ratio		16:9											
Picture size		4.5M (4.5M 37): (2784×1568)				2.5M (2.5M 37): (2208×1248)				2M (2M 37): (1920×1080)			
Quality		RAW ===	RAW --2--	=== +	==+	RAW ===	RAW --2--	=== +	==+	RAW ===	RAW --2--	=== +	==+
Built-in Memory (Approx. 50 MB)		3	4	22	45	4	4	36	71	4	4	47	92
Card	32 MB	2	2	13	26	2	2	21	41	2	2	27	53
	64 MB	4	5	27	54	4	5	43	85	5	5	57	105
	128 MB	9	10	56	110	10	10	89	170	10	10	115	220
	256 MB	18	20	110	210	19	21	170	330	20	21	220	430
	512 MB	37	40	210	430	39	42	340	670	40	42	450	860
	1 GB	74	81	440	860	79	84	690	1340	81	85	900	1720
	2 GB	150	160	890	1700	160	170	1390	2670	165	170	1800	3410
	4 GB	290	320	1740	3350	310	330	2740	5240	320	330	3540	6700
	8 GB	600	650	3550	6820	640	680	5580	10670	660	690	7220	13640
	16 GB	1210	1320	7160	13720	1290	1370	11230	21480	1330	1390	14530	27450
32 GB	2440	2650	14360	27530	2600	2750	22530	43100	2670	2790	29150	55070	

■ Available recording time (when recording motion pictures)

Aspect ratio		HD	WVGA	VGA	QVGA-H	QVGA-L
Picture quality setting						
Built-in Memory (Approx. 50 MB)		–	–	–	1 min 38 s	4 min 20 s
Card	32 MB	6 s	14 s	17 s	56 s	2 min 35 s
	64 MB	16 s	33 s	39 s	1 min 58 s	5 min 20 s
	128 MB	37 s	1 min 10 s	1 min 22 s	4 min 00 s	10 min 50 s
	256 MB	1 min 15 s	2 min 15 s	2 min 40 s	7 min 50 s	21 min 10 s
	512 MB	2 min 30 s	4 min 30 s	5 min 20 s	15 min 40 s	42 min 00 s
	1 GB	5 min 00 s	9 min 20 s	10 min 50 s	31 min 20 s	1 h 24 min
	2 GB	10 min 30 s	19 min 00 s	22 min 10 s	1 h 4 min	2 h 51 min
	4 GB	20 min 40 s	37 min 30 s	43 min 40 s	2 h 5 min	5 h 36 min
	8 GB	42 min 00 s	1 h 16 min	1 h 28 min	4 h 15 min	11 h 23 min
	16 GB	1 h 24 min 50 s	2 h 33 min	2 h 59 min	8 h 35 min	22 h 55 min
32 GB	2 h 50 min 10 s	5 h 8 min	5 h 59 min	17 h 13 min	46 h 00 min	

- * Motion pictures can be recorded continuously up to 2 GB.
The maximum available recording time for up to 2 GB only is displayed on the screen.

**Note**

- The number of recordable pictures and the available recording time displayed on the screen may not decrease in order.
- This unit does not support recording motion pictures on MultiMediaCards.
- The extended optical zoom does not work in [HIGH SENS.], [FLASH BURST], [PIN HOLE], [FILM GRAIN] or [HI-SPEED BURST] in scene mode so the picture size for [7] is not displayed.

Specifications

Digital Camera: Information for your safety

Power Source:	DC 5.1 V
Power Consumption:	1.4 W (When recording) 0.7 W (When playing back)

Camera effective pixels:	10,100,000 pixels
Image sensor:	1/1.63" CCD, total pixel number 11,300,000 pixels, Primary color filter
Lens:	Optical 2.5×zoom, f=5.1 mm to 12.8 mm (35 mm film camera equivalent: 24 mm to 60 mm)/F2.0 to F2.8
Digital zoom:	Max. 4×
Extended optical zoom:	Max. 4.5×
Focus:	Normal/AF Macro/Manual focus Face detection/Multi-area-focusing/ 1-area-focusing (High speed)/1-area-focusing/Spot-focusing/ AF Tracking
Focus range:	Normal: 50 cm (1.64 feet) to ∞ AF Macro/Intelligent auto: 1 cm (0.04 feet) (Wide)/30 cm (0.99 feet) (Tele) to ∞ Scene mode: There may be differences in the above settings.
Shutter system:	Electronic shutter+Mechanical shutter
Motion picture recording:	When the aspect ratio setting is [4:3] 640×480 pixels (30 frames/second, only when using a Card) 320×240 pixels (30 frames/second, 10 frame/second) When the aspect ratio setting is [16:9] 1280×720 pixels (24 frames/second, only when using a Card) 848×480 pixels (30 frames/second, only when using a Card) With audio

Burst recording

Burst speed: 2.5 pictures/second (Normal), Approx. 2 pictures/second (Unlimited)

Number of recordable pictures: Max. 8 pictures (Standard), max. 4 pictures (Fine), max. 3 pictures (RAW, RAW+ Fine, RAW+ Standard), Depends on the remaining capacity of the built-in memory or the card (Unlimited).
(Performance in burst recording is only with SD Memory Card/SDHC Memory Card. MultiMediaCard performance will be less.)

Hi-speed burst

Burst speed: Approx. 6 pictures/second
(3M (4:3), 2.5M (3:2) or 2M (16:9) is selected as the picture size.)

Number of recordable pictures: When using the built-in memory:
Approx. 35 pictures (immediately after formatting)
When using a Card: Max. 100 pictures (differs depending on the type of Card and the recording conditions)

ISO sensitivity: AUTO/80/100/200/400/800/1600/3200
[HIGH SENS.] mode: 1600 to 6400

Shutter speed: 60 seconds to 1/2000th of a second

[STARRY SKY] mode: 15 seconds, 30 seconds, 60 seconds
Auto white balance/Daylight/Cloudy/Shade/Flash/Incandescent lights/White set1/White set2/White balance K set









White balance: Auto white balance/Daylight/Cloudy/Shade/Flash/Incandescent lights/White set1/White set2/White balance K set

Exposure (AE): Program AE (P)/Aperture-priority AE (A)/Shutter-priority AE (S)/Manual exposure (M)
Exposure compensation (1/3 EV Step, -2 EV to +2 EV)

Metering mode:	Multiple/Center weighted/Spot
LCD monitor:	3.0" low-temperature polycrystalline TFT LCD (Approx. 460,000 dots) (field of view ratio about 100%)
Flash:	Built-in pop up flash Flash range: [ISO AUTO] Approx. 80 cm (2.62 feet) to 8.3 m (27.2 feet) (Wide) AUTO, AUTO/Red-eye reduction, Forced flash ON (Forced ON/ Red-eye reduction), Slow sync./Red-eye reduction, Forced flash OFF
Microphone:	Monaural
Speaker:	Monaural
Recording media:	Built-in Memory (Approx. 50 MB)/SD Memory Card/SDHC Memory Card/MultiMediaCard (Still pictures only)
Picture size	
Still picture:	When the aspect ratio setting is [4:3] 3648×2736 pixels, 3072×2304 pixels, 2560×1920 pixels, 2048×1536 pixels, 1600×1200 pixels, 640×480 pixels When the aspect ratio setting is [3:2] 3776×2520 pixels, 3168×2112 pixels, 2656×1768 pixels, 2112×1408 pixels, 2048×1360 pixels When the aspect ratio setting is [16:9] 3968×2232 pixels, 3328×1872 pixels, 2784×1568 pixels, 2208×1248 pixels, 1920×1080 pixels
Motion pictures:	When the aspect ratio setting is [4:3] 640×480 pixels (Only when using a Card), 320×240 pixels When the aspect ratio setting is [16:9] 1280×720 pixels (Only when using a Card) 848×480 pixels (Only when using a Card)

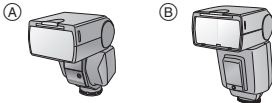
Quality:	Fine/Standard/RAW/RAW+ Fine/RAW+ Standard
Recording file format	
Still Picture:	JPEG (based on "Design rule for Camera File system", based on "Exif 2.21" standard)/RAW, DPOF corresponding
Pictures with audio:	JPEG (based on "Design rule for Camera File system", based on "Exif 2.21" standard)+"QuickTime" (pictures with audio)
Motion pictures:	"QuickTime Motion JPEG" (motion pictures with audio)
Interface	
Digital:	"USB 2.0" (High Speed)
Analog video/audio:	NTSC (DMC-LX3P) U.S. version NTSC/PAL Composite (Switched by menu), (DMC-LX3PC) Canada version Component Audio line output (monaural)
Terminal	
[COMPONENT OUT]:	Dedicated jack (10 pin)
[AV OUT/DIGITAL]:	Dedicated jack (8 pin)
[DC IN]:	Dedicated jack (2 pin)
Dimensions:	Approx. 108.7 mm (W)×59.5 mm (H)×27.1 mm (D) [4 1/4" (W)×2 3/8"(H)×1 1/8" (D)] (excluding the projecting parts)
Mass (weight):	Approx. 229 g/8.08 oz (excluding card, battery and lens cap) Approx. 265.4 g/9.36 oz (with card, battery and lens cap)
Operating temperature:	0 °C to 40 °C (32 °F to 104 °F)
Operating humidity:	10% to 80%
Battery Charger (Panasonic DE-A41B):	
Input:	110 V to 240 V ~50/60 Hz, 0.2 A
Output:	CHARGE 4.2 V --- 0.8 A
Equipment mobility:	Movable
Battery Pack (lithium-ion) (Panasonic CGA-S005A):	
Voltage:	3.7 V

Digital Camera Accessory System

Accessory#	Figure	Description
CGA-S005A		Battery Pack
DMW-AC5		AC Adaptor*1
DMW-CLX3		Leather Case
DMW-HDC2		Component Cable
(A): DMW-FL360 (B): DMW-FL500		Flash
DMW-VF1		External Viewfinder
(C): DMW-LA4 (D): DMW-LW46		(C): Lens Adapter (D): Wide Conversion Lens*2
(E): DMW-LPL46 (F): DMW-LMC46 (G): DMW-LND46		(E): PL Filter*2 (F): MC Protector*2 (G): ND Filter*2
RP-SDV32GU1K RP-SDV16GU1K RP-SDV08GU1K RP-SDM04GU1K RP-SDV04GU1K RP-SDM02GU1A RP-SDV02GU1A RP-SDR01GU1A RP-SDV01GU1A		32 GB SDHC Memory Card 16 GB SDHC Memory Card 8 GB SDHC Memory Card 4 GB SDHC Memory Card 4 GB SDHC Memory Card 2 GB SD Memory Card 2 GB SD Memory Card 1 GB SD Memory Card 1 GB SD Memory Card

*1 The battery cannot be charged with the AC adaptor. Use the supplied charger.

*2 The lens adaptor (DMW-LA4; optional) is necessary to attach a wide conversion lens or filter.

- Refer to P16 for information about the battery charging time and the number of recordable pictures.
- NOTE: Accessories and/or model numbers may vary between countries. Consult your local dealer.

Digital Camera Accessory Order Form

(For USA Customers)

Please photocopy this form when placing an order.

1. Digital Camera Model # _____

2. Items Ordered

Accessory #	Description	Price Each	Quantity	Total Price
Subtotal				
Your State & Local Sales Tax				
Shipping & Handling				6.95
Total Enclosed				

3. Method of payment (check one)

- Check of Money Order enclosed (NO C.O.D.SHIPMENTS)
- VISA Credit Card # _____
- MasterCard Expiration Date _____
- Discover Customer Signature _____

Make Check or Money Order to: PANASONIC ACCESSORIES

(Please do not send cash)

4. Shipping information (UPS delivery requires complete street address)

Ship To:

Mr.

Mrs.

Ms. _____

First Last

Phone#:

Day () _____

Street Address

Night () _____

City State Zip

TO OBTAIN ANY OF OUR DIGITAL CAMERA ACCESSORIES YOU CAN DO ANY OF
THE FOLLOWING:
VISIT YOUR LOCAL PANASONIC DEALER
OR
CALL PANASONIC'S ACCESSORY ORDER LINE AT 1-800-332-5368
[6 AM-6 PM M-F, PACIFIC TIME]
OR
MAIL THIS ORDER TO: PANASONIC SERVICE AND TECHNOLOGY COMPANY
ACCESSORY ORDER OFFICE
20421 84th Avenue South Kent, WA. 98032

In CANADA, please contact your local Dealer for more information about accessories.

Request for Service Notice (For USA Only)

Please photocopy this form when making a request for service notice.

In the unlikely event this product needs service.

Request for Service Notice: (USA Only)

- Please include your **proof of purchase**.
(Failure to do so will delay your repair.)
- To further speed your repair, please provide an explanation of what wrong with the unit and any symptom it is exhibiting.

Mail this completed form and your Proof of Purchase along with your unit to:
Panasonic Camera and Digital Service Center
1590 Touhy Ave.
Elk Grove Village, IL 60007

Limited Warranty (For USA Only)

PANASONIC CONSUMER ELECTRONICS COMPANY, DIVISION OF
 PANASONIC CORPORATION OF NORTH AMERICA
 One Panasonic Way, Secaucus, New Jersey 07094
 PANASONIC PUERTO RICO, INC.
 Ave. 65 de Infantería, Km. 9.5, San Gabriel Industrial Park, Carolina, Puerto
 Rico 00985

Panasonic Digital Still Camera Limited Warranty

Limited Warranty Coverage

If your product does not work properly because of a defect in materials or workmanship, Panasonic Consumer Electronics Company or Panasonic Puerto Rico, Inc. (collectively referred to as "the warrantor") will, for the length of the period indicated on the chart below, which starts with the date of original purchase ("warranty period"), at its option either (a) repair your product with new or refurbished parts, or (b) replace it with a new or refurbished product. The decision to repair or replace will be made by the warrantor.

PRODUCT OR PART NAME	PARTS	LABOR
DIGITAL STILL CAMERA (EXCEPT ITEMS LISTED BELOW)	1 (ONE) YEAR	1 (ONE) YEAR
CCD	6 (SIX) MONTHS	90 (NINETY) DAYS
RECHARGEABLE BATTERY PACK (IN EXCHANGE FOR DEFECTIVE BATTERY PACK)	90 (NINETY) DAYS	NOT APPLICABLE
SD MEMORY CARD (IN EXCHANGE FOR DEFECTIVE SD CARD)	90 (NINETY) DAYS	NOT APPLICABLE

During the "Labor" warranty period there will be no charge for labor. During the "Parts" warranty period, there will be no charge for parts. You must carry-in or mail-in your product during the warranty period. If non-rechargeable batteries are included, they are not warranted. This warranty only applies to products purchased and serviced in the United States or Puerto Rico. This warranty is extended only to the original purchaser of a new product which was not sold "as is". A purchase receipt or other proof of the original purchase date is required for warranty service.

Carry-In or Mail-In Service

For Carry-In or Mail-In Service in the United States call
1-800-211-PANA (7262).

For assistance in Puerto Rico call Panasonic Puerto Rico, Inc.
(787)-750-4300 or fax (787)-768-2910.

This warranty **ONLY COVERS** failures due to defects in materials or workmanship, and **DOES NOT COVER** normal wear and tear or cosmetic damage. The warranty **ALSO DOES NOT COVER** damages which occurred in shipment, or failures which are caused by products not supplied by the warrantor, or failures which result from accidents, misuse, abuse, neglect, mishandling, misapplication, alteration, faulty installation, set-up adjustments, misadjustment of consumer controls, improper maintenance, power line surge, lightning damage, modification, or commercial use (such as in a hotel, office, restaurant, or other business), rental use of the product, service by anyone other than a Factory Service center or other Authorized Servicer, or damage that is attributable to acts of God.

THERE ARE NO EXPRESS WARRANTIES EXCEPT AS LISTED UNDER "LIMITED WARRANTY COVERAGE". THE WARRANTOR IS NOT LIABLE FOR INCIDENTAL OR CONSEQUENTIAL DAMAGES RESULTING FROM THE USE OF THIS PRODUCT, OR ARISING OUT OF ANY BREACH OF THIS WARRANTY. (As examples, this excludes damages for lost time, travel to and from the servicer, loss of media or images, data or other memory content. The items listed are not exclusive, but are for illustration only.) **ALL EXPRESS AND IMPLIED WARRANTIES, INCLUDING THE WARRANTY OF MERCHANTABILITY, ARE LIMITED TO THE PERIOD OF THE LIMITED WARRANTY.**

Some states do not allow the exclusion or limitation of incidental or consequential damages, or limitations on how long an implied warranty lasts, so the exclusions may not apply to you.

This warranty gives you specific legal rights and you may also have other rights which vary from state to state. If a problem with this product develops during or after the warranty period, you may contact your dealer or Service center. If the problem is not handled to your satisfaction, then write to the warrantor's Consumer Affairs Department at the addresses listed for the warrantor.

PARTS AND SERVICE WHICH ARE NOT COVERED BY THIS LIMITED WARRANTY ARE YOUR RESPONSIBILITY.

Customer Services Directory (For USA Only)

Obtain Product Information and Operating Assistance; locate your nearest Dealer or Service Center; purchase Parts and Accessories; or make Customer Service and Literature requests by visiting our Web Site at:

<http://www.panasonic.com/consumersupport>

or, contact us via the web at:

<http://www.panasonic.com/contactinfo>

You may also contact us directly at:

1-800-211-PANA (7262),

Monday-Friday 9 am-9 pm; Saturday-Sunday 10 am-7 pm, EST

For hearing or speech impaired TTY users, TTY :1-877-833-8855

Accessory Purchases

Purchase Parts, Accessories and Instruction Books online for all Panasonic Products by visiting our Web Site at:

<http://www.pstc.panasonic.com>

or, send your request by E-mail to:

npcparts@us.panasonic.com

You may also contact us directly at:

1-800-332-5368 (Phone) 1-800-237-9080 (Fax Only)

(Monday - Friday 9 am to 9 pm, EST.)

PANASONIC SERVICE AND TECHNOLOGY COMPANY

20421 84th Avenue South, Kent, WA 98032

(We Accept Visa, MasterCard, Discover Card, American Express, and Personal Checks)

For hearing or speech impaired TTY users, TTY :1-866-605-1277

Product Repairs

Centralized Factory Service Center

Panasonic Camera and Digital Service Center

MAIL TO : 1590 Touhy Ave.
Elk Grove Village, IL 60007

Please carefully pack and ship, prepaid and insured, to the Elk Grove Village Centralized Factory Service Center.

Customer's in Puerto Rico, please ship or carry in to location below ("Service in Puerto Rico").

Service in Puerto Rico

Panasonic Puerto Rico, Inc.:

Ave. 65 de Infantería, Km. 9.5, San Gabriel Industrial Park,
Carolina, Puerto Rico 00985

Phone (787) 750-4300 Fax (787) 768-2910

Précautions à prendre (pour le Canada)

AVERTISSEMENT :

POUR RÉDUIRE LES RISQUES D'INCENDIE, DE CHOC ÉLECTRIQUE OU DE DOMMAGES À L'APPAREIL,

- N'EXPOSEZ PAS CET APPAREIL À LA PLUIE, À L'HUMIDITÉ, À L'ÉGOUTTEMENT OU AUX ÉCLABOUSSEMENTS, ET NE PLACEZ SUR L'APPAREIL AUCUN OBJET REMPLI DE LIQUIDE, COMME PAR EXEMPLE DES VASES.
- UTILISEZ EXCLUSIVEMENT LES ACCESSOIRES RECOMMANDÉS.
- NE RETIREZ PAS LE COUVERCLE (OU LE PANNEAU ARRIÈRE) ; IL N'Y A AUCUNE PIÈCE RÉPARABLE PAR L'UTILISATEUR À L'INTÉRIEUR. CONFIEZ TOUTE RÉPARATION À UN TECHNICIEN DE SERVICE QUALIFIÉ.

LA PRISE DE COURANT DOIT SE TROUVER À PROXIMITÉ DE L'APPAREIL ET ÊTRE FACILEMENT ACCESSIBLE.

ATTENTION

Danger d'explosion si la batterie/pile n'est pas remplacée correctement. Remplacez-la uniquement par une batterie/pile identique ou du même type recommandée par le fabricant.

Suivez les instructions du fabricant pour jeter les batteries/piles usées.

Avertissement

Risque d'incendie, d'explosion et de brûlures. Ne pas démonter, chauffer à plus de 60 °C (140 °F) ou incinérer.

La plaque signalétique se trouve sur le dessous des appareils.

Cet appareil numérique de la classe B est conforme à la norme NMB-003 du Canada.

- Assurez-vous d'utiliser un adaptateur secteur de marque Panasonic (DMW-AC5PP; en option).
- Assurez-vous d'utiliser une batterie de marque Panasonic (CGA-S005A).
- Si vous utilisez d'autres batteries, nous ne pouvons pas garantir la qualité de ce produit.
- N'utilisez pas d'autres câbles de connexion USB à l'exception de celui fourni.
- N'utilisez pas d'autres câbles AV à l'exception de celui fourni.
- Conservez la carte mémoire hors de portée des enfants afin qu'ils ne puissent pas l'avaler.

Évitez d'approcher l'appareil photo de tout équipement magnétisé (four à micro-ondes, téléviseur, équipement de jeux vidéo, etc.).

- Si vous utilisez l'appareil photo à proximité d'un téléviseur, les radiations électromagnétiques pourraient nuire au son et à l'image.
- N'utilisez pas l'appareil photo à proximité d'un téléphone cellulaire; cela pourrait entraîner un bruit nuisible à l'image et au son.

- Le puissant champ magnétique de haut-parleurs ou de moteurs peut endommager les données enregistrées et distordre les images.
- Les ondes électromagnétiques émises par un microprocesseur peuvent nuire à l'appareil photo numérique et perturber l'image et le son.
- Advenant le cas où le fonctionnement de l'appareil serait dérangé par un champ magnétique, coupez le contact, retirez la batterie ou débranchez l'adaptateur secteur (modèle DMW-AC5PP; en option) pour ensuite soit remettre la batterie en place, soit rebranché l'adaptateur. Remettez l'appareil en marche.

N'utilisez pas l'appareil photo à proximité d'un émetteur radio ou de lignes à haute tension.

- L'utilisation de l'appareil photo à proximité d'un émetteur radio ou de lignes à haute tension pourrait nuire à l'image ou au son.

■ À propos du bloc-batterie

ATTENTION

Batterie (batterie au lithium-ion)

- Utilisez l'unité spécifiée pour recharger la batterie.
 - N'utilisez la batterie avec aucun autre appareil que l'appareil spécifiée.
 - Évitez le contact des saletés, du sable, du liquide ou autres corps étrangers avec les bornes.
 - Ne touchez pas les bornes des fiches (+ et -) avec des objets métalliques.
 - Évitez de démonter, remodeler, chauffer ou jeter au feu.
- Si de l'électrolyte entre en contact avec vos mains ou vos vêtements, lavez-les avec beaucoup d'eau.
- Si de l'électrolyte pénètre dans vos yeux, ne les frottez pas.
- Rincez-vous les yeux avec beaucoup d'eau, puis consultez un médecin.

- N'exposez pas la batterie à la chaleur et tenez-la éloignée de toute flamme.
- Ne laissez pas la ou les batteries dans un véhicule exposé au soleil avec vitres et portes fermées pendant une longue période de temps.

■ À propos du chargeur de batterie

ATTENTION!

NE PAS INSTALLER CET APPAREIL DANS UNE BIBLIOTHÈQUE, UNE ARMOIRE OU TOUT AUTRE ESPACE CONFINÉ. S'ASSURER QUE LA VENTILATION DE L'APPAREIL EST ADÉQUATE. AFIN D'ÉVITER TOUT RISQUE DE CHOC ÉLECTRIQUE OU D'INCENDIE DÙ À UN SURCHAUFFEMENT, S'ASSURER QUE RIDEAUX OU TOUT OBJET QUELCONQUE NE BOUCHENT LES ÉVENTS D'AÉRATION DE L'APPAREIL.

Chargeur de batterie

Ce chargeur fonctionne sur le secteur entre 110 V et 240 V.

Toutefois

- Aux États-Unis et au Canada, le chargeur doit être branché sur une prise secteur de 120 V seulement.
- Lors du branchement à une prise secteur à l'extérieur des États-Unis ou du Canada, utilisez un adaptateur conforme à la configuration de la prise secteur.

Index

A

AC Adaptor	110, 113
Access Indication	18
Aerial Photo Mode	68
AF Area Selection	83
AF Assist Lamp	88
AF Macro Mode	49
AF Mode	82
AF tracking	37, 83
AF/AE lock	84
Aperture-priority AE	55, 57
Aspect Ratio	70, 142
Aspect Ratio Conversion	103
Audio Dubbing	108
Audio Recording	70, 88
Auto Bracket	52
Auto Demonstration	29
Auto LCD Off	26
Auto Power LCD	25
Auto Review	26
Auto White Balance	80
AV cable	116
Available Recording Time	145

B

Baby Mode	65
Backlight Compensation	36
Battery	15, 16, 17
Battery Carrying Case	127
Beach Mode	68
Beep	24
Brightness of the LCD Monitor	24
Built-in Flash	46
Built-in Memory	18
Burst Mode	54

C

Calendar	97
Candle Light Mode	65
Card	17, 18
Category	94
Center Weighted	81
Changing the Zoom Area	59
Charger	127
Charging	15, 16
Cleaning	126
Clock Set	19, 24
Color Temperature Setting	81
Component Cable	118
Condensation	5
Conversion	90
Copy	108

D

Date Printing	107, 115
---------------------	----------

DCF standard	41
Deleting Pictures	42
Demo. Mode	29
Digital Zoom	38, 87
DPOF Print Setting	106
Dual Play	91

E

Economy Mode	26
Exposure Compensation	51
Extended Optical Zoom	38
External viewfinder	89
EZ	38, 39, 76, 142

F

Face Detection	36, 82
Favorite	105
Favorite Play	95
File Number	26, 112, 125
Film Grain Mode	69
Film Mode	74
Fine	77
Fireworks Mode	68
Flash Burst Mode	67
Flash Synchro	89
Focus	33
Folder Composition	112
Folder Number	26, 112, 125
Food Mode	64
Formatting	28

G

Guide Line	25, 45
------------------	--------

H

High Sensitivity Mode	66
Highlight Display	25
Hi-speed burst Mode	66
Histogram	25, 45

I

Intelligent Auto Mode	35
Intelligent Exposure	85
Intelligent ISO	78
ISO Sensitivity	78, 79

J

Jitter	34
--------------	----

L

Language Setting	28
Layout	116
LCD Mode	25
LCD Monitor	44, 124
Lens Cap	13
Leveling	103

<hr/>	
M	
<hr/>	
Manual Exposure	58
Manual Exposure Assistance	56
Manual Focus	58
MC Protector	120
Metering Mode	81
MF ASSIST	26
MF Assist	58
MF m/ft	28
Minimum Shutter Speed	88
Motion Picture Mode	70
Multi Exposure	85
Multi Film	76
Multi Playback	41
Multiple	81
<hr/>	
N	
<hr/>	
ND Filter	120
Night Portrait Mode	64
Night Scenery Mode	64
NO.RESET	26
NTSC	27
Number of Prints	115
Number of Recordable Pictures	16, 142
<hr/>	
O	
<hr/>	
One Shot AF	59
Optical Image Stabilizer	87
Optical Zoom	38
<hr/>	
P	
<hr/>	
PAL	27
Paper Size	115
Party Mode	65
PC	27
Pet Mode	66
PictBridge	112
Picture Size	76, 142
Pictures with Audio	95
Pin Hole Mode	69
Playback Pictures on TV	116, 118
Playback Zoom	41
Playing Back Motion Pictures	95
Portrait Mode	62
Power LCD	25
Power Save	26
Prefocus	60
Program AE mode	32
Protect	107
<hr/>	
Q	
<hr/>	
Quality	77, 142
Quick Menu	23
<hr/>	
R	
<hr/>	
RAW	77

Reset of Setting	27
Resizing	101
Rotate	104
Rotate Display	104

S

<hr/>	
Scene Detection	36
Scene Menu	28
Scene Mode	62
Scenery Mode	63
Self Portrait Mode	63
Self-timer	50
Setup Menu	23
Shutter Volume	24
Shutter-priority AE	55, 57
Slide Show	92
Snow Mode	68
Soft Skin Mode	63
Sound	24
Sports Mode	64
Spot	81
Spot-focusing	82
Standard	77
Starry Sky Mode	67
Status Indicator	26
Sunset Mode	66

T

<hr/>	
Text Stamp	99
Thumbnail	138
Title Edit	98
Travel Date	24
Trimming	102
Tripods	128
TV Aspect	27

U

<hr/>	
USB Connection Cable	110, 113
USB Mode	27

V

<hr/>	
Version Display	28
Video Output	27, 117
Volume of Speakers	24

W

<hr/>	
White Balance	79
White Balance Fine Adjustment	80
World Time	24, 73

Z

<hr/>	
Zoom	38



QuickTime and the QuickTime logo are trademarks or registered trademarks of Apple Inc., used under license therefrom.

**Panasonic Consumer Electronics Company,
Division of Panasonic Corporation of North America**

One Panasonic Way, Secaucus, NJ 07094

Panasonic Puerto Rico, Inc.

Ave. 65 de Infantería, Km. 9.5, San Gabriel Industrial Park, Carolina, Puerto Rico 00985

Panasonic Canada Inc.

5770 Ambler Drive, Mississauga, Ontario, L4W 2T3

© 2008 Matsushita Electric Industrial Co., Ltd.



VQT1T27

F0708JT0 (4000 ^(A))

