

PENTAX™

SLR Digital Camera

K10D

Operating Manual



For optimum camera performance, please read the Operating Manual before using the camera.

Thank you for purchasing this PENTAX **K10D** Digital Camera. Please read this manual before using the camera in order to get the most out of all the features and functions. Keep this manual safe, as it can be a valuable tool in helping you to understand all the camera's capabilities.

Lenses you can use

In general, lenses that can be used with this camera are DA, D FA and FA J lenses and lenses that have an Aperture **A** (Auto) position.

To use any other lens or accessory, see p.58 and p.210.

Regarding copyrights

Images taken using the **K10D** that are for anything other than personal enjoyment cannot be used without permission according to the rights as specified in the Copyright Act. Please take care, as there are even cases where limitations are placed on taking pictures even for personal enjoyment during demonstrations, performances or of items on display. Images taken with the purpose of obtaining copyrights also cannot be used outside the scope of use of the copyright as laid out in the Copyright Act, and care should be taken here also.

Regarding trademarks

PENTAX and smc PENTAX are trademarks of PENTAX Corporation.



SD logo and SDHC logo are trademarks.



The DNG logo is either registered trademarks or trademarks of Adobe Systems Incorporated in the United States and/or other countries.

All other brands or product names are trademarks or registered trademarks of their respective owners.

To users of this camera

- There is a possibility that recorded data may be erased or that the camera may not function correctly when used in surroundings such as installations generating strong electromagnetic radiation or magnetic fields.
- The liquid crystal panel used in the LCD display is manufactured using extremely high precision technology. Although the level of functioning pixels is 99.99% or better, you should be aware that 0.01% or fewer of the pixels may not illuminate or may illuminate when they should not. However, this has no effect on the recorded image.

This product supports PRINT Image Matching III. PRINT Image Matching enabled digital still cameras, printers and software help photographers to produce images more faithful to their intentions. Some functions are not available on printers that are not PRINT Image Matching III compliant.

Copyright 2001 Seiko Epson Corporation. All Rights Reserved.

PRINT Image Matching is a trademark of Seiko Epson Corporation.

The PRINT Image Matching logo is a trademark of Seiko Epson Corporation.

Regarding PictBridge

PictBridge allows the user to connect the printer and digital camera directly, using the unified standard for the direct printout of images. You can print images directly from the camera through a few simple operations.

- There is a possibility that the illustrations and the display screen of the LCD monitor in this manual are different from the actual product.

FOR USING YOUR CAMERA SAFELY

We have paid close attention to the safety of this product. When using this product, we request your special attention regarding items marked with the following symbols.



Warning

This symbol indicates that violating this item could cause serious personal injury.



Caution

This symbol indicates that violating this item could cause minor or medium personal injury, or material loss.

ABOUT THE CAMERA



Warning

- Do not disassemble or modify the camera. High voltage areas are present inside the camera, with the risk of electric shock.
- If the camera interior is exposed due to dropping or otherwise damaging the camera, never touch the exposed portion. There is the risk of electric shock.
- To avoid the risk of it being swallowed by mistake, keep the SD Memory Card out of the reach of small children. Seek medical attention immediately if a memory card is accidentally swallowed.
- Wrapping the strap around your neck is dangerous. Take care that small children do not hang the strap over their necks.
- Do not look directly at the sun through the camera with the telephoto lens attached, as viewing the sun may damage your eyes. Viewing the sun directly with the telephoto lens may lead to a loss of eyesight.
- Be sure to store batteries out of the reach of children. Seek medical assistance immediately if a battery is accidentally swallowed.
- Always use the AC adapter exclusively developed for this product, with the specified power and voltage. Using an AC adapter not exclusive to this product, or using the exclusive AC adapter with an unspecified power or voltage can cause a fire, electric shock, or camera breakdown.
- If any irregularities occur during use, such as smoke or a strange odor, stop use immediately, remove the batteries or the AC adapter, and contact your nearest PENTAX service center. Continued use could cause a fire or electric shock.
- During thunderstorms, unplug and discontinue use of the AC adapter. Continued use could cause equipment failure, a fire, or electric shock.



Caution

- Do not short the batteries or dispose of the batteries in fire. Do not disassemble the batteries. The batteries could explode or catch fire.
- Remove the batteries from the camera immediately if they become hot or begin to smoke. Be careful not to burn yourself during removal.
- Some portions of the camera heat up during use. There is the risk of low temperature burns when holding such portions for long periods.
- Do not place your finger over or cover the flash with clothing when discharging the flash. Fingers or clothing may be burned.

PRECAUTIONS FOR BATTERY USAGE

- Only use specified battery with this camera. Use of other batteries can cause a fire or explosion.
- Keep wires, hairpins, and other metal objects away from the + and – contacts of the battery. When storing with the battery removed from the camera, be sure to attach the included protective cap to avoid shorting.
- Do not disassemble the batteries. Disassembling the batteries can cause explosion or leakage.
- If any of the battery leakage should come in contact with your eyes, do not rub them. Flush your eyes with clean water and get medical attention immediately.
- If any of the battery leakage should come in contact with skin or clothes, wash the affected areas thoroughly with water.
- Remove the batteries from the camera immediately if they become hot or begin to smoke. Be careful not to burn yourself during removal.

PRECAUTIONS FOR BATTERY CHARGER USAGE

- Only use the battery charger D-BC50 supplied with the camera. Do not use the product at a voltage other than the specified voltage. Use with a power source or voltage other than that designed can cause a fire or electrical shock. The specified voltage is 100 - 240V AC.
- Do not use the battery charger to charge batteries other than rechargeable lithium-ion battery D-LI50. This can cause explosion or a fire or breakdown of the battery charger.
- Do not disassemble or modify the product. This can cause a fire or electrical shock.

- If the generation of smoke or strange odor from the product or other abnormality occurs, immediately discontinue using and consult a PENTAX Service Center. Continued use could cause a fire or electric shock.
- If water should happen to get inside the product, consult a PENTAX Service Center. Continuing to use the product can cause a fire or electrical shock.
- If lightning should be present during use of the battery charger, unplug the power cord and discontinue use. Continuing to use the product can cause damage to the equipment, fire or electrical shock.
- Wipe off the plug of the power cord if it should become covered with dust. This can cause a fire.
- To reduce the risk of hazards, use only CSA/UL Certified power supply cord set, cord is Type SPT-2 or heavier, minimum NO.18 AWG copper, one end with a molded-on male attachment plug cap (with a specified NEMA configuration), and the other is provided with a molded-on female connector body (with a specified IEC nonindustrial type configuration) or the equivalent.

Care to be Taken During Handling

- When traveling, take the Worldwide Service Network that is included in the package. This will be useful if you experience problems abroad.
- When the camera has not been used for a long time, confirm that it is still working properly, particularly prior to taking important pictures (such as at a wedding or during traveling). Pictures cannot be guaranteed if recording, playback or transferring your data to a computer, etc. is not possible due to a malfunction of your camera or recording media (SD Memory Card), etc.
- Do not clean the product with organic solvents such as thinner or alcohol benzene.
- Do not subject the camera to high temperatures or high humidity. Do not leave the camera in a vehicle, as the temperature can get very high.
- Do not store the camera with preservatives and chemicals. Storage in high temperatures and high humidity can cause molding. Remove from case and store in a dry and well-ventilated location.
- Do not subject the camera to strong vibrations, shocks, or pressure. Use a cushion to protect the camera from vibrations of motorcycles, automobiles, or ships.
- The temperature range for camera use is 0°C to 40°C (32°F to 104°F).
- The LCD display may appear black under high temperatures, but will return to normal as temperatures normalize.
- The LCD display may respond more slowly at low temperatures. This is due to liquid crystal properties, and is not a fault.

- Periodic inspections are recommended every one to two years to maintain high performance.
- Sudden temperature changes will cause condensation on the inside and outside of the camera. Place the camera in your bag or a plastic bag, removing the camera after temperature of the camera and surroundings are equalized.
- Avoid contact with garbage, mud, sand, dust, water, toxic gases, or salts. These could cause a camera breakdown. Wipe dry any rain or water drops on the camera.
- Refer to “Precautions When Using the SD Memory Card” (p.49) regarding the SD Memory Card.
- Use a lens brush to remove dust accumulated on the lens or viewfinder. Never use a spray blower for cleaning as it may damage the lens.
- Please contact PENTAX service center for professional cleaning of the CCD. (This will involve a fee.)
- Please do not press forcefully on the LCD monitor. This could cause breakage or malfunction.

Regarding Product Registration





In order to better serve you, we request that you complete the product registration, which can be found on the CD-ROM supplied with the camera or on the PENTAX website. Thank you for your cooperation.

Refer to the PENTAX PHOTO Browser 3/PENTAX PHOTO Laboratory 3 Operating Manual (Windows users: p.9, Mac OS users: p.10) for more information.

Contents

FOR USING YOUR CAMERA SAFELY	1
ABOUT THE CAMERA.....	1
PRECAUTIONS FOR BATTERY USAGE	2
PRECAUTIONS FOR BATTERY CHARGER USAGE	2
Care to be Taken During Handling	3
Contents	6
Composition of the Operating Manual	11

Before Using Your Camera 13

<i>K10D</i> Camera Characteristics.....	14
Checking the Contents of the Package.....	16
Names and Functions of Working Parts.....	17
Camera.....	17
Capture Mode	18
Playback Mode	20
Display Indicators	22
LCD Monitor.....	22
Viewfinder	26
LCD Panel	28
Using the Menu	29
How to Operate the Menu.....	29
[ Rec. Mode] Menu Setting Items	31
[ Playback] Menu Setting Items	31
[ Set-up] Menu Setting Items.....	32
[ Custom Setting] Menu Setting Items	33
Using the Fn Menu	36
Capture Mode	36
Playback Mode	37
Using the Mode Dial.....	38

Getting Started 41

Attaching the Strap	42
Using the Battery	43
Charging the Battery.....	43
Inserting/Removing the Battery	44
Battery Level Indicator	46
Approximate Image Storage Capacity and Playback Time (Exclusive Battery Fully Charged)	46
Using the AC Adapter (Optional)	47
Inserting/Removing the SD Memory Card	48
Recorded Pixels and Quality Level.....	50
Turning the Camera On and Off	52
Initial Settings	53
Setting the Display Language.....	53
Setting the Date and Time.....	56
Attaching the Lens	58
Adjusting the Viewfinder Diopter	60

Basic Operations 61

Basic Shooting Operation	62
Holding the Camera.....	62
Letting the Camera Choose the Optimal Settings	63
Taking Pictures Using the Shake Reduction Function	67
Turning On the Shake Reduction Function.....	68
Setting the Shake Reduction Function	69
Using a Zoom Lens	70
Using the Built-in Flash	71
Other Shooting Modes	75
Continuous Shooting	75
Self-Timer Shooting.....	77
Remote Control Shooting (Remote Control F: Sold Separately)	81
Using Mirror Up Function to Prevent Camera Shake	84

Playing Back Still Pictures	85
Playing Back Images	85
Rotating Images	87
Enlarging Playback Images	88
Displaying Multiple Images	89
Displaying a Folder	91
Slideshow	92
Connecting the Camera to AV Equipment	94
Processing Images with Filters	95
Processing Images with Digital Filters	95
Editing RAW Images	98
Deleting Images	100
Deleting a Single Image	100
Deleting All Images	101
Deleting Selected Images (from Multi-image Display)	102
Protecting Images from Deletion (Protect)	104
Setting the Printing Service (DPOF)	106
Printing Single Images	106
Settings for All Images	107
Printing Using PictBridge	109
Setting [Transfer Mode]	110
Connecting the Camera to the Printer	111
Printing Single Images	112
Printing All Images	114
Printing Images Using the DPOF Settings	116
Disconnecting the USB Cable	116
Function Reference	117
<hr/>	
Setting the File Format	118
Setting the JPEG Recorded Pixels	118
Setting the JPEG Quality Level	119
Setting the Image Tone	120
Setting the Saturation/Sharpness/Contrast	121
Setting the File Format	122
Setting the White Balance	123
Setting the Color Space	129
Focusing	130
Using the Autofocus	130
Selecting the Focusing Area (AF Point)	132
Fixing the Focus (Focus Lock)	134
Adjusting the Focus Manually (Manual Focus)	136
Using the AF Button	137

Setting the Exposure	138
Effect of Aperture and Shutter Speed.....	138
Setting the Sensitivity	140
Selecting the Metering Method.....	142
Changing the Exposure Mode	144
Setting the Exposure	161
Changing the Shooting Conditions Automatically when Shooting (Auto Bracket).....	163
Shooting in Multi-exposure Mode	166
Storing User Settings.....	167
Checking the Composition, Exposure and Focus Before Shooting	169
Selecting the Preview Method	169
Displaying the Preview	170
Using the Built-in Flash.....	172
Compensating Flash Output.....	172
Allowing Shooting while Charging Flash.....	173
Flash Characteristics in Each Exposure Mode.....	173
Distance and Aperture when Using the Built-in Flash	176
DA, D FA , FA J, FA and F Lens Compatibility with the Built-in Flash.....	177
Using an External Flash (Optional).....	179
Settings During Playback.....	186
Changing Playback Display Method	186
Setting the Slideshow Display Interval.....	187
Camera Settings.....	188
Formatting the SD Memory Card.....	188
Turning the Beep On and Off.....	189
Changing the Date and Time and the Display Style	190
Setting the World Time	191
Setting the Display Language.....	194
Setting the Guide Display Time	194
Adjusting the Brightness of the LCD Monitor	195
Selecting the Video Output Format.....	195
Setting Auto Power Off	196
Selecting the Folder Name	196
Setting the Display Instant Review and Digital Preview	197
Selecting a Battery.....	198
Selecting Capture Mode Settings to Save in the Camera	199
Resetting to Default Settings.....	201
Resetting Rec. Mode/Playback/Set-up Menu	201
Resetting the Custom Function Menu	202

Default Settings	204
Functions Available with Various Lens Combinations	208
Notes on [Using Aperture Ring]	210
Cleaning the CCD	211
Removing Dust by Shaking the CCD.....	211
Removing Dust with a Blower.....	212
Optional Accessories	214
Error Messages	217
Troubleshooting	219
Main Specifications	221
Glossary	224
Index	228
WARRANTY POLICY	232

Composition of the Operating Manual

This operating manual contains the following chapters.

1 Before Using Your Camera

Explains camera characteristics, accessories and the names and functions of various parts.

2 Getting Started

Explains your first steps from purchasing the camera to taking pictures. Be sure to read it and follow the instructions.

3 Basic Operations

Explains the procedures for taking, playing back, and printing still pictures. Read it to learn all of the basic operations about capturing, playing back, and printing.



4 Function Reference

Introduces functions to further enhance your *K10D* experience.

5 Appendix

Explains troubleshooting, introduces optional accessories and provides various resources.

The symbols used in this operating manual are explained below.

	Shows reference page number explaining a related operation.
	Shows useful information.
	Shows precautions to take when operating the camera.

1 Before Using Your Camera

Check the package contents and names and functions of working parts before use.

<i>K10D</i> Camera Characteristics	14
Checking the Contents of the Package	16
Names and Functions of Working Parts	17
Display Indicators	22
Using the Menu	29
Using the Fn Menu	36
Using the Mode Dial	38

When using menus and Fn menu, items which cannot be changed due to camera settings appear gray and cannot be selected.
--

- Features a 23.5×15.7 mm CCD with 10.20 million effective pixels for high precision and a wide dynamic range.
- Features Shake Reduction (SR), a CCD shifting shake reduction system. This enables you to capture sharp pictures with minimal camera shake regardless of the lens type.
- Features an AF sensor with 11 focusing points. The central 9 are wide cross area sensors.
- Features a viewfinder similar to that of a conventional 35 mm camera, with a 0.95 magnification and 95% field of view, for easier manual focusing. Also features a superimpose function in which the AF points on the viewfinder illuminate red.
- Features a large 2.5-inch LCD monitor with 210,000 pixels, a wide viewing angle and a brightness adjusting function for high-precision viewing performance.
- Features a Digital Preview function for checking the image to ensure that the desired result is achieved.
- A user-friendly design has been implemented in various parts of the camera. The large, high-resolution LCD monitor and easy-to-use menus make the camera easier to operate.
- Dials, buttons, body joints, and retractable parts of the camera are splash and dust resistant.
- The CCD features a special SP coating against dust deposit. The Dust Removal function also shakes the CCD for removing collected dust.
- Supports the optional Battery Grip D-BG2 with vertical shutter release button. If a battery (D-LI50) is inserted in both the camera and grip, the battery with more power is prioritized. This enables you to get the best camera performance for an extended period. A menu item also allows you to prioritize a battery and use its full power before switching to the other battery.
- Records in the versatile JPEG format or the high quality and fully editable RAW format. You can also select JPEG+RAW and record in both formats. Pictures taken in RAW format can be processed easily.
- Features Hyper-program and Hyper-manual modes that let you take pictures with the intended exposure. Also features Sensitivity Priority mode **Sv** that automatically adjusts aperture and shutter speed according to the set sensitivity, and Shutter & Aperture Priority mode **TAv** that automatically adjusts sensitivity according to the set aperture and shutter speed.

The captured area (view angle) will differ between the **K10D** and 35 mm SLR cameras even if the same lens is used because the format size for 35 mm film and CCD are different.

Sizes for 35 mm film and CCD

35 mm film : 36×24 mm

K10D CCD : 23.5×15.7 mm

Angles of view being equal, the focal length of a lens used with a 35 mm camera must be approximately 1.5 times longer than that of **K10D**. To obtain an angle of view framing the same area, divide the focal length of the 35 mm lens by 1.5.

Example) To capture the same image as a 150 mm lens attached to a 35 mm camera

$$150 \div 1.5 = 100$$

Use a 100 mm lens with the **K10D**.

Inversely, multiply the focal length of the lens used with **K10D** by 1.5 to determine the focal length for 35 mm cameras.

Example) If 300 mm lens is used with **K10D**

$$300 \times 1.5 = 450$$

Focal length is equivalent to a 450 mm lens on a 35 mm camera.

Checking the Contents of the Package

The following accessories are packaged with your camera.
Check that all accessories are included.

1

Before Using Your Camera



Hot shoe cover F_k
(Installed on camera)

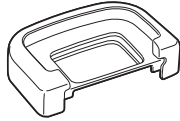

Eyecup F_p
(Installed on camera)



ME Viewfinder cap

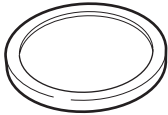

Body mount cover
(Installed on camera)

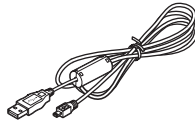

USB cable
I-USB17

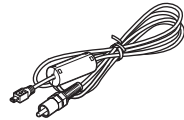

Video cable
I-VC28

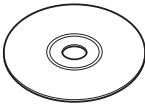

Software (CD-ROM)
S-SW55

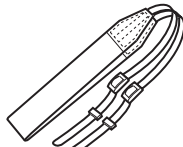

Strap
O-ST53

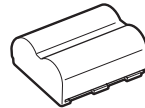

Rechargeable lithium-ion
D-LI50 battery

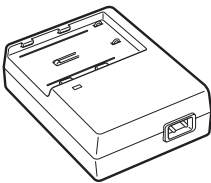

Battery charger
D-BC50



AC plug cord
D-CO2

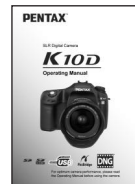

Operating Manual
(this manual)

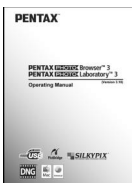

PENTAX PHOTO Browser 3/
PENTAX PHOTO Laboratory 3
Operating Manual

Camera

1

Before Using Your Camera

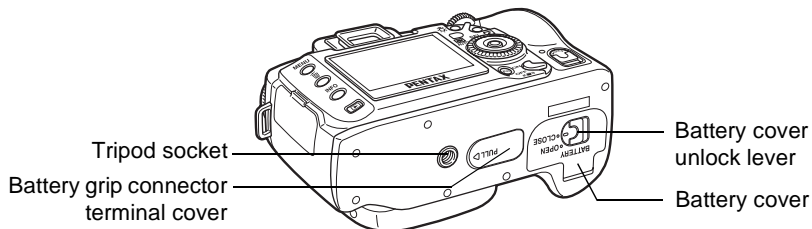
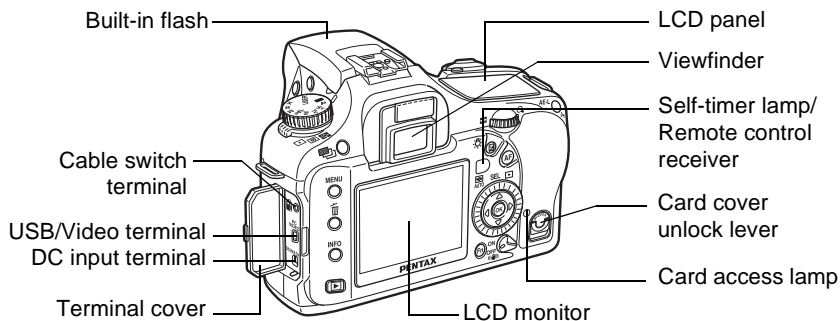
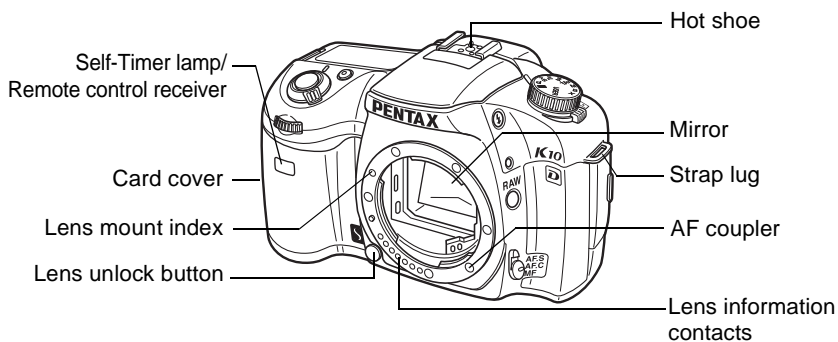

Capture Mode

Functions of buttons used during shooting are noted.

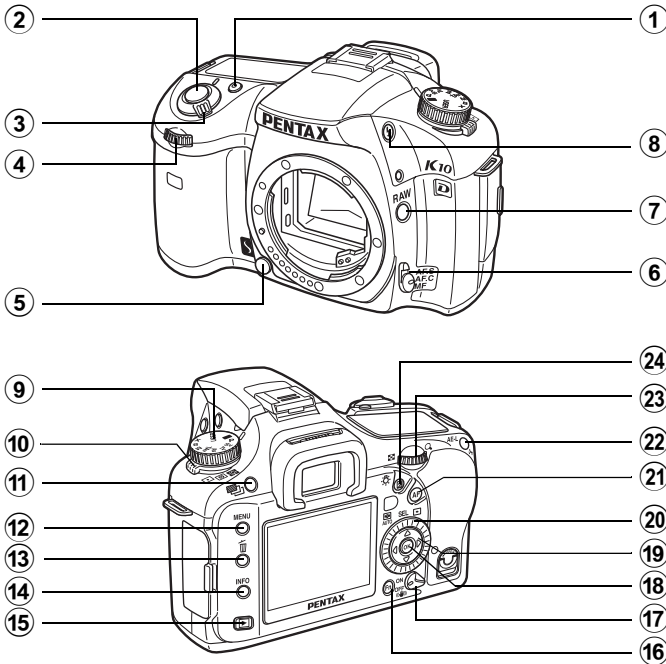

① Green button

Resets exposure settings (p.148) and automatically adjusts the appropriate exposure in **M** (Hyper-manual) mode. (p.158)

② Shutter release button

Press to capture images. (p.65)

③ Main switch







Move to turn the power on/off (p.52) or to preview (p.170).

④ Front e-dial

Sets shutter speed and EV compensation values.

⑤ Lens unlock button









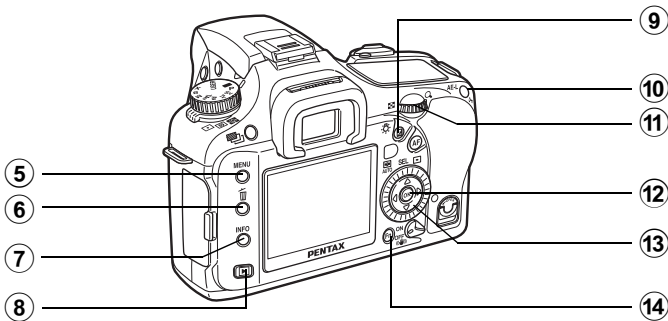
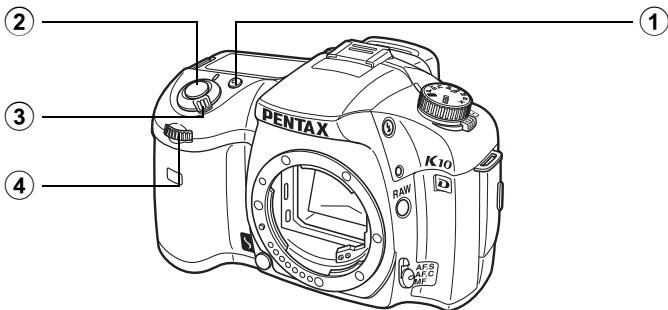



Press to detach lens. (p.59)

- ⑥ **Focus mode lever**
Switches between autofocus mode (**A.F.C**, **A.F.S**) (p.130) and manual focus mode (p.136).
- ⑦ **RAW button**
Saves JPEG and RAW file. (p.122)
- ⑧ **⚡UP button**
Press to pop up the built-in flash. (p.71)
- ⑨ **Mode dial**
Changes the Exposure mode. (p.38)
- ⑩ **Metering mode lever**
Changes the Metering mode. (p.142)
- ⑪  **button**
Sets Exposure bracket shooting. (p.163)
- ⑫ **MENU button**
Displays the [ Rec. Mode] menu (p.31). Next, press the four-way controller (▶) to display [ Playback] menu (p.31), [ Set-up] menu (p.32) and [**C** Custom Setting] menu (p.33).
- ⑬  **button**
Press to delete images. (p.100)
- ⑭ **INFO button**
Press to show shooting information on the LCD monitor. (p.23)
- ⑮  **button**
Switches to the Playback mode. (p.85)
- ⑯ **Fn button**
Press to display the Fn menu. Press the four-way controller (▲▼◀▶) to determine the following operation. (p.36)
- ⑰ **Shake Reduction switch**
Turns the Shake Reduction function on or off. (p.67)
- ⑱ **OK button**
Saves the setting you selected in the menu.
Press when menu is not displayed to display the currently selected sensitivity in the LCD panel and viewfinder.
- ⑲ **Four-way controller (▲▼◀▶)**
Use this to move cursor or change items in menus and Fn menu.
- ⑳ **AF point switching dial**
Sets focus area. (p.133)
- ㉑ **AF button**
Focuses on the target before metering. (p.130)
- ㉒ **AE-L button**
Locks the exposure before shooting. (p.162)
- ㉓ **Rear e-dial**
Sets the aperture and sensitivity values.
- ㉔  **button**
Turn the front e-dial while pressing this button to set the EV Compensation value. (p.161)

Playback Mode

Functions of buttons used during playback are noted.



- ① **Green button**
Press in Enlarged view to increase the magnification. (p.88)
- ② **Shutter release button**
Press halfway to switch to Capture mode.
- ③ **Main switch**
Move to turn the camera on and off. (p.52) Set to the  position to switch to Capture mode and preview.
- ④ **Front e-dial**
Use it to display the previous or next image in magnified playback (p.88) or adjust the digital filter (p.95).
- ⑤ **MENU button**
Press to display the [ Playback] menu (p.31). Next, press the four-way controller () to display [ Set-up] menu (p.32), [ Custom Setting] menu (p.33) and [ Rec. Mode] menu (p.31).
- ⑥ ** button**
Press to delete images. (p.100)
- ⑦ **INFO button**
Press to show shooting information on the LCD monitor. (p.24)
- ⑧ ** button**
Press to switch to Capture mode.
- ⑨ ** button**
Press in Enlarged view to decrease the magnification. (p.88)
- ⑩ ** button**
Press to protect images from being accidentally erased. (p.104)
- ⑪ **Rear e-dial**
Use it to enlarge an image (p.88) or display multiple images at the same time (p.89).
- ⑫ **OK button**
Saves the setting you selected in the menu or playback screen.
- ⑬ **Four-way controller ()**
Use it to move cursor or change items in menus, Fn menu and playback screen.
- ⑭ **Fn button**
Press to display the Fn menu. Press the four-way controller () to determine the following operation. (p.36)

LCD Monitor

The following indicators appear on the LCD monitor depending on the status of the camera.

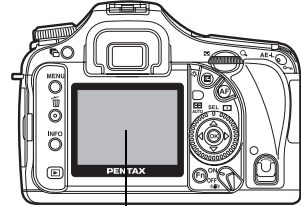

LCD Monitor

At Start-up or when Operating the Mode Dial

Guides appear on the LCD monitor for 3 seconds when the camera is switched on or the mode dial is turned.



Select Off for [Guide display] in [Set-up] menu to not show indicators. (p.32)

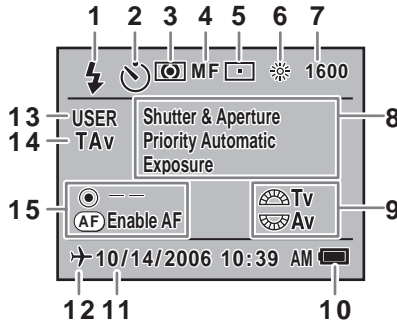

- | | |
|---|-----------------------------|
| 1 Flash mode
(Active mode appears) (p.72) | 8 Exposure mode name (p.38) |
| 2 Drive mode/Auto bracket/
Multi-exposure (p.36) | 9 e-dial guide |
| 3 AE metering (p.142) | 10 Battery level |
| 4 Focus mode (p.130) | 11 Date and time (p.190) |
| 5 AF point (p.132) | 12 World time (p.191) |
| 6 White balance (p.123) | 13 USER mode |
| 7 Sensitivity (p.140) | 14 Exposure mode |
| | 15 Button guide |

* Indicators 3, 5, 6 and 7 only appear when a setting other than the default setting is selected. 12 only appears when World Time is On.

Capture Mode

Press the **INFO** button in Capture mode to display the capture function settings on the LCD monitor for 15 seconds.

● Detailed Information

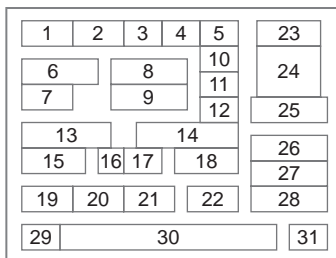
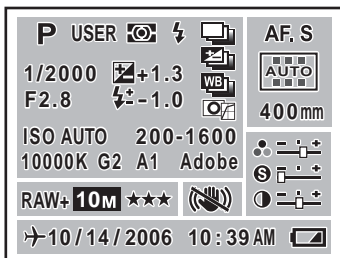

- | | |
|--|---|
| <ul style="list-style-type: none"> 1 Exposure mode (p.38) 2 USER mode (p.167) 3 AE metering (p.142) 4 Flash mode (p.72) 5 Drive mode (p.36) 6 Shutter speed (p.138) 7 Aperture (p.139) 8 EV compensation (p.161) 9 Flash compensation (p.172) 10 Exposure bracket (p.163)/
Multi-exposure (p.166) 11 Extended bracket (p.165) 12 Image tone (p.120) 13 Sensitivity (p.140) 14 ISO correction in AUTO (p.140) 15 White balance (p.123) | <ul style="list-style-type: none"> 16 GM compensation (p.124) 17 BA compensation (p.124) 18 Color space 19 File format (p.122) 20 JPEG recorded pixels (p.118) 21 JPEG quality (p.119) 22 Shake reduction (p.67) 23 Focus mode (p.130) 24 AF point position (p.132) 25 Lens focal length (p.67) 26 Saturation (p.121) 27 Sharpness (p.121) 28 Contrast (p.121) 29 World Time (p.191) 30 Date and time (p.190) 31 Battery power (p.46) |
|--|---|

Playback Mode

Every time you press the **INFO** button during playback, the camera switches screen displays in the following order: Standard display, Histogram display, Detailed information display and No information display (image only).



You can change the information initially displayed by pressing the button.

● Detailed Information

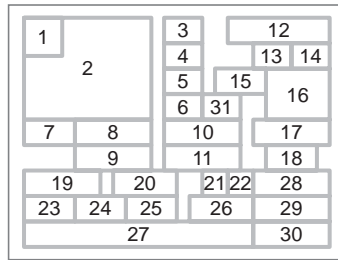
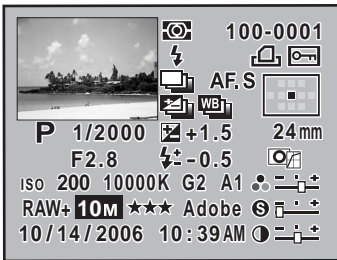

- | | | | |
|----|---------------------------------|----|---------------------------------|
| 1 | Rotation information | 17 | Lens focal length |
| 2 | Captured image | 18 | Image tone |
| 3 | Metering mode | 19 | Sensitivity |
| 4 | Flash mode | 20 | White balance/Color temperature |
| 5 | Drive mode | 21 | WB compensation (GM) |
| 6 | Exposure bracket/Multi-exposure | 22 | WB compensation (BA) |
| 7 | Exposure mode | 23 | File format |
| 8 | Shutter speed | 24 | JPEG recorded pixels |
| 9 | Aperture | 25 | JPEG quality |
| 10 | EV compensation | 26 | Color space |
| 11 | Flash exposure compensation | 27 | Shooting date/time |
| 12 | Folder number, file number | 28 | Saturation |
| 13 | DPOF settings | 29 | Sharpness |
| 14 | Protect | 30 | Contrast |
| 15 | Focus mode | 31 | Extended bracket |
| 16 | AF point position | | |

* Indicators 4 (Flash mode) and 11 (Flash exposure compensation) only appear for images in which the flash was discharged.

● Histogram Display

The **K10D** features two histogram displays. The “Brightness histogram” shows the distribution of brightness and the “RGB histogram” shows the distribution of color intensity. Press the four-way controller (▲▼) to switch between “Brightness histogram” and “RGB histogram”.

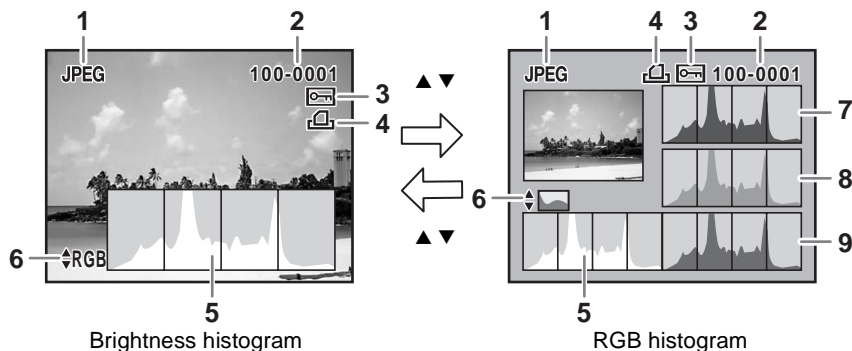

- | | | | |
|---|---|---|---|
| 1 | Image file type | 6 | Switch Brightness histogram/
RGB histogram |
| 2 | Image folder number and file
number (p.196, p.199) | 7 | Histogram (R) |
| 3 | Protect icon (p.104) | 8 | Histogram (G) |
| 4 | DPOF settings | 9 | Histogram (B) |
| 5 | Histogram (Brightness) (p.186) | | |

* Indicator 4 (DPOF settings) only appears for images with DPOF settings.



Areas where blooming or dark portions blink if [Bright/Dark area] warning is set to On in [Playback display] in the [▶ Playback] menu. (p.186)

Viewfinder

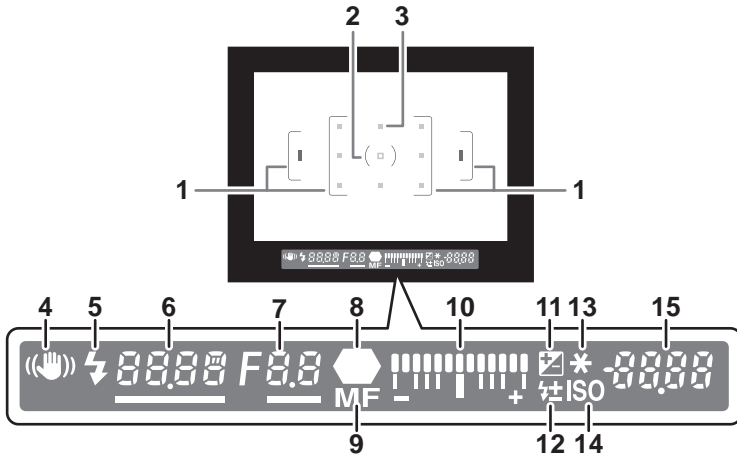

- 1 AF frame (p.60)
- 2 Spot metering frame (p.142)
- 3 AF point (p.132)
- 4 Shake Reduction (p.67)
Appears during Shake Reduction.
- 5 Flash status (p.71)
Appears when flash is available and blinks when flash is recommended but not set or is being charged.
- 6 Shutter speed (p.150)
Shutter speed when capturing or adjusting (underlined when shutter speed can be adjusted with the front e-dial).
- 7 Aperture (p.152)
Aperture when capturing or adjusting (underlined when aperture can be adjusted with the rear e-dial).
- 8 Focus indicator (p.64)
Appears when image is focused.
- 9 Manual focus (p.136)
Appears when focus mode is **MF**.
- 10 EV bar (p.157)
Shows the EV compensation values or difference between the appropriate and current exposure values when Exposure mode is set to **M**.

- 11 EV compensation (p.161)
Appears when EV compensation is available or in use.
- 12 Flash exposure compensation
Appears when Flash exposure compensation is in use.
- 13 AE lock indicator (p.162)
Appears during AE lock.
- 14 ISO warning (p.141)
Appears when warning value is reached or exceeded.
- 15 Number of recordable images/EV compensation/Confirm sensitivity
Show the number of recordable images with current file format (p.122), JPEG recorded pixels (p.118) and JPEG quality (p.119).
Show the number of continuous shooting recordable images. (p.34)
EV compensation value appears when EV compensation is being adjusted. (p.147)
ISO sensitivity appears if Sensitivity Priority Mode/Shutter & Aperture Priority Mode is set.



- The AF point in use for autofocus is superimposed in red when the shutter release button is pressed halfway. (p.132)
- When [AF Button Function] is set to [Cancel AF] in the [C Custom Setting] menu, press the **AF** button to display **MF** in the viewfinder.
- When set to a mode other than Sensitivity Priority Mode/Shutter & Aperture Priority Mode, press the **OK** button to display the ISO sensitivity in 14.

LCD Panel

The following information appears in the LCD panel on top of the camera.

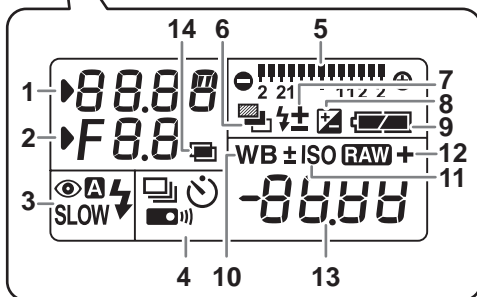
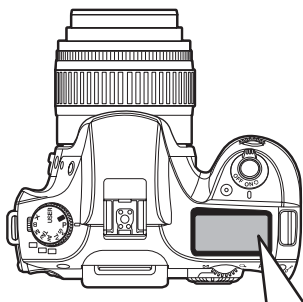

- | | |
|--|--|
| <p>1 Shutter speed (p.150)</p> <p>2 Aperture (p.152)</p> <p>3 Flash mode (p.71)</p> <p>⚡ : Built-in flash is ready
(when blinking, flash should be used or incompatible lens is being used)</p> <p>👁️ : Red-eye reduction flash on</p> <p>A : Auto discharge</p> <p>SLOW: Slow-speed sync</p> <p>4 Drive mode (p.36)</p> <p>□ : Single frame shooting</p> <p>📄 : Continuous shooting</p> <p>⌚ : Self-Timer shooting</p> <p>📡 : Remote control shooting</p> <p>5 EV bar (p.157)</p> | <p>6 Auto bracket (p.163)
(blinks when Exposure Bracket and Extended Bracket are both set)</p> <p>7 Flash exposure compensation</p> <p>8 EV compensation (p.161)</p> <p>9 Battery level</p> <p>10 White balance (p.123)
(Not displayed when set to Auto)</p> <p>± : White balance correction</p> <p>11 ISO warning</p> <p>12 RAW : RAW capture
RAW + : RAW+JPEG capture</p> <p>13 Number of recordable images/
EV compensation value/PC (Pb)
(PC=Personal Computer (mass storage), Pb=PictBridge)</p> <p>14 Multi-exposure (p.166)</p> |
|--|--|



Press the button to illuminate the LCD panel. You can set not to illuminate in [Illuminate LCD panel] in the [C Custom Setting] menu.

How to Operate the Menu

This section explains operation methods for [📷 Rec. Mode] menu, [▶ Playback] menu, [⚙️ Set-up] menu and [C Custom Setting] menu.

Displaying the Menu screen

1 Press the MENU button in Capture mode.

The [📷 Rec. Mode] menu appears on the LCD monitor.

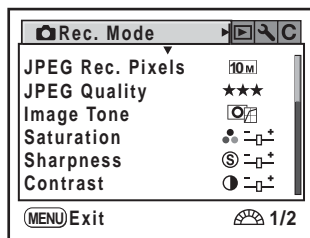
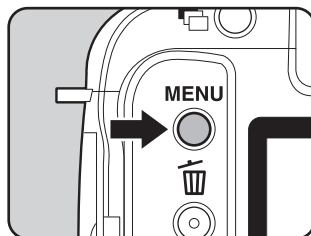

2 Press the four-way controller (▶).

The [▶ Playback] menu, [⚙️ Set-up] menu and [C Custom Setting] menu appear in order each time the four-way controller is pressed. (The screen for the [⚙️ Set-up] menu is shown on the right.)

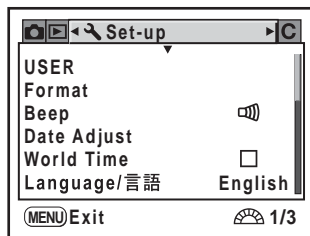

Selecting and Setting a Menu Item

Procedure to set the [JPEG Quality] on the [📷 Rec. Mode] menu is explained as an example.

3 Use the four-way controller (▲▼) to choose an item.

Turn the front e-dial to navigate the menu a page at a time.

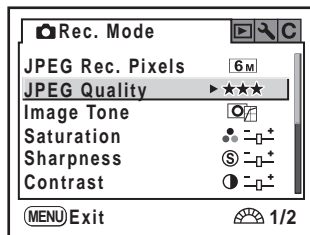

4 Press the four-way controller (▶).

Quality levels available when recording in JPEG format are displayed.

Press the four-way controller (▶) to move to the pop-up menu if there is one.

When the quality level is changed, the number of recordable images at that quality level appears at the top right of the screen.

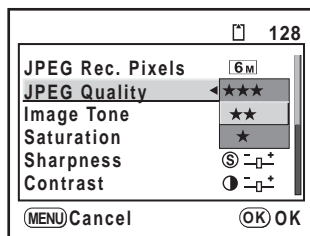

5 Use the four-way controller (▲▼) to select a setting.

6 Press the OK button.

The camera returns to the menu screen. Next, set other items.

Press the **MENU** button to return to Capture or Playback mode.



Even after you press the **MENU** button and close the menu screen, your settings will not be saved if the camera is turned off improperly (such as by removing the battery while the camera is on).



- You can use the front e-dial to display the previous/next page and the rear e-dial to switch among the [📷 Rec. Mode] menu, the [▶ Playback] menu, [🔧 Set-up] menu, and [C Custom Setting] menu when no pop-up menu is displayed.
- If the **MENU** button is pressed in Capture mode, the [📷 Rec. Mode] menu appears. If the **MENU** button is pressed in Playback mode, the [▶ Playback] menu appears.

[📷 Rec. Mode] Menu Setting Items

Perform settings related to capturing in the [📷 Rec. Mode] menu.

Item	Function	Page
Exposure mode	Sets the Exposure mode. *Appears only when the mode dial is set to USER .	p.167
JPEG Rec. Pixels	Sets the recording size of images for JPEG shooting.	p.118
JPEG Quality	Sets the image quality for JPEG shooting.	p.119
Image Tone	Sets the color tone of pictures.	p.120
Saturation	Sets the color saturation.	p.121
Sharpness	Makes the image outlines sharp or soft.	p.121
Contrast	Sets the image contrast.	p.121
File Format	Sets the file format.	p.122
RAW file format	Sets the file format for RAW shooting.	p.122
Extended Bracket	Sets Extended Bracket shooting.	p.165
Multi-exposure	Sets Multi-exposure shooting.	p.166
Memory	Sets the settings to save when the power is turned off.	p.199
Shake Reduction	Sets the [Focal Length] when using a lens for which focal length information cannot be acquired.	p.69

[▶ Playback] Menu Setting Items

Perform settings related to playback and editing images in the [▶ Playback] menu.

Item	Function	Page
Playback display	Sets shooting information to show during playback and whether to display Bright/Dark area warning.	p.186
Instant Review	Sets how long to display Instant Review and whether to display Bright/Dark area warning and histogram.	p.197

Item	Function	Page
Digital Preview	Sets whether to display Bright/Dark area warning and histogram during Digital Preview.	p.198
Digital Filter	Changes the color tone of captured images, adds softening and slimming effects, or adjusts the brightness.	p.95
Slideshow	Plays back recorded images one after another.	p.187

[Set-up] Menu Setting Items

Perform various settings related to the camera in the [ Set-up] menu.

Item	Function	Page
USER	Registers the current camera settings to USER.	p.167
Format	Formats the SD Memory Card.	p.188
Beep	Switches the beep tone on/off.	p.189
Date Adjust	Sets the date format and time.	p.190
World Time	Sets display of local time when traveling abroad.	p.191
Language/言語	Changes the language in which menus and messages appear.	p.194
Guide display	Sets to display indicators in LCD monitor.	p.194
Brightness Level	Changes the brightness of the LCD monitor.	p.195
Video Out	Sets the output format to the TV monitor.	p.195
Transfer Mode*	Sets the USB cable connection (PC or printer).	p.110
Auto Power Off	Sets the time to turn off automatically.	p.196
Folder Name	Sets the method used to assign folder names for storing images.	p.196
Select battery	Sets battery priority for when battery grip is attached.	p.198
Dust Removal	Cleans the CCD by shaking it.	p.211
Sensor Cleaning	Locks the mirror in the up position for cleaning the CCD.	p.212
Reset	Resets all settings other than Date Adjust, Language, Video Out and World Time.	p.201

* Refer to p.11 of the “PENTAX PHOTO Browser 3/PENTAX PHOTO Laboratory 3 Operating Manual” for details on connecting the camera to a PC.

[C Custom Setting] Menu Setting Items

Set custom functions to fully use the functions of a SLR camera with the Custom Function Menu. The default setting does not use Custom Function.

The [C Custom Setting] menu settings are activated when [Setting], the first item, is (on).

Item	Function	Page
Setting	Sets to use the Custom Function Menu.	-
Program line	Set the type of Program line.	-
EV Steps	Sets the adjustment steps for exposure.	p.162
Sensitivity Steps	Sets the adjustment steps for ISO sensitivity.	p.140
ISO warning	Sets the maximum sensitivity level. ISO warning appears when exceeded.	p.141
Meter Operating Time	Sets the exposure metering time.	p.143
AE-L with AF locked	Sets whether to lock exposure value when focus is locked.	p.135
Link AF Point and AE	Sets whether to adjust AE and Focusing Area in multi-segment metering based on AF point.	p.143
Auto Bracketng order	Sets the order for bracket shooting.	p.163
Auto EV Compensation	Sets whether to compensate automatically when proper exposure cannot be determined.	-
WB when using flash	Sets whether to fix white balance when flash is discharged.	-
Fine tune when AWB	Sets whether fine tune is available when white balance is set to Auto.	p.124
AF Button Function	Set whether to perform AF while the AF button is pressed or not perform AF while the AF button is pressed and the shutter release button is pressed halfway.	-
AF by Press Halfway	Sets whether to perform AF when the shutter release button is pressed halfway.	-
Superimpose AF Area	Sets whether to display the selected AF point (focus position) in the viewfinder.	p.132

Item	Function	Page
AF in remote control	Sets whether to use Autofocus when shooting with remote control. Shutter releases after AF activates if shutter is released from remote control when [On]. Shutter cannot be released until in focus. AF does not activate at shutter release from remote control when [Off].	-
Noise Reduction	Sets whether to use Noise Reduction in slow speed shooting.	p.159
Color Space	Sets the color space to use.	p.129
Color temp. steps	Sets the adjustment steps for color temperature.	p.127
e-dial in Program	Sets the e-dials in P (Hyper-program) mode.	-
e-dial in Sv mode	Sets the e-dials in Sv (Sensitivity Priority) mode.	-
e-dial in Tv mode	Sets the e-dials in Tv (Shutter Priority) mode.	-
e-dial in Av mode	Sets the e-dials in Av (Aperture Priority) mode.	-
Green Btn in Manual	Selects the exposure adjustment method when the Green mode button is pressed in M (Hyper-manual) mode.	p.158
One-touch RAW + JPEG	Sets whether to capture RAW+JPEG once or retain settings when the RAW button is pressed.	p.122
Illuminate LCD panel	Sets whether to illuminate the LCD panel.	p.28
Release when Chrging	Sets to release shutter while the built-in flash is charging.	p.173
Preview Method	Sets to use Digital Preview or Optical Preview when the main switch is turned to the preview position (🔄). Digital Preview lets you check the composition, exposure and focus on the LCD monitor before taking the picture. Optical Preview lets you check the depth of field with the viewfinder.	p.169
Recordable Image No.	Sets to switch number of recordable images in the LCD panel and viewfinder to number of continuous shooting recordable images when shutter release button is pressed halfway.	-
Initial zoom display	Sets the initial magnification of the zoom playback. Choose from [1.2 times], [2 times], [4 times], [8 times] and [16 times]. The default setting is [1.2 times].	-

Item	Function	Page
Auto Image Rotation	Sets to automatically rotate images when playing back.	-
Saving rotation info	Sets whether to save rotation information when shooting.	-
Using aperture ring	Sets to enable shutter release when lens aperture ring is set at other than A .	p.210
Reset Custom Fncion	Resets all the settings in the Custom Function menu to the defaults.	p.202

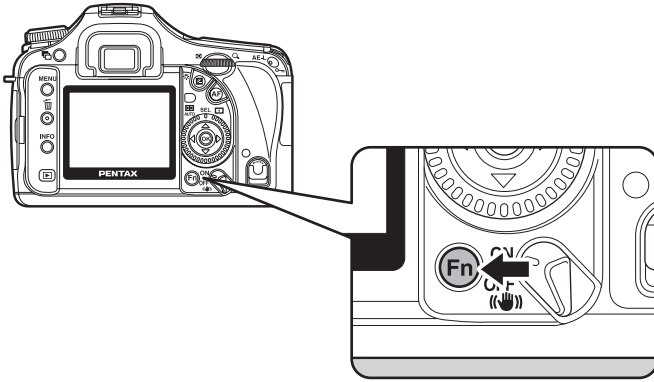

Capture Mode

Press the **Fn** button during playback. The Fn menu appears.

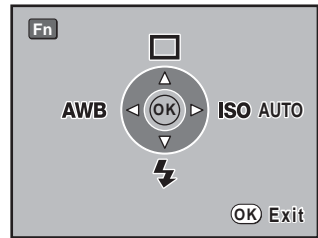

Press the four-way controller (▲▼◀▶) to set the operation.

Four-way controller	Item	Function	Page
▲	Drive Mode	Selects Continuous shooting, Self-timer or Remote control.	p.75, p.77, p.81
▼	Flash Mode	Adjusts the method of flash discharge.	p.72
◀	White Balance	Adjusts the color balance to match the type of the light source illuminating the subject.	p.123
▶	Sensitivity	Sets the sensitivity.	p.140

Playback Mode

Press the **Fn** button during playback. The Fn menu appears.

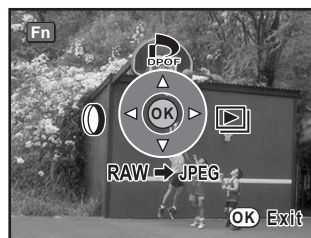

Press the four-way controller (▲▼◀▶) to set the operation.

Four-way controller	Item	Function	Page
▲	DPOF Settings	Sets the DPOF settings.	p.106
◀	Digital Filter	Changes the color tone of captured images, adds softening and slimming effects, or adjusts the brightness.	p.95
▶	Slideshow	Plays back recorded images one after another.	p.92
▼	RAW Display	Converts RAW images to JPEG format.	p.98



- RAW Display (▼) cannot be selected when displaying a JPEG image.
- DPOF Settings (▲) and Digital Filter (◀) cannot be selected when displaying a RAW image.

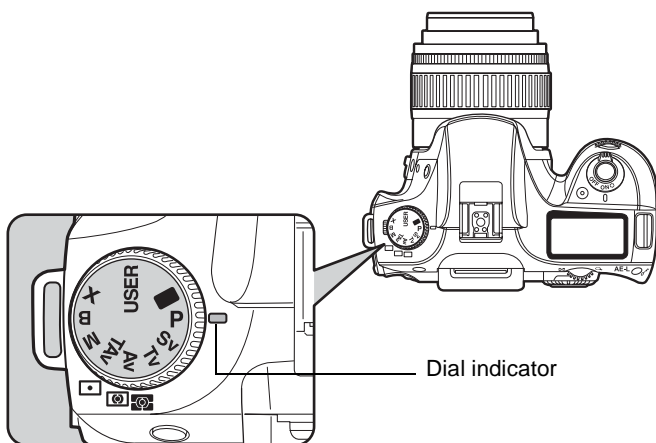

You can switch the Exposure mode by setting the icons on the mode dial to the dial indicator.

Item	Function	Page
USER (USER)	Lets you capture images with settings that you set.	p.167
 (Green)	Automatically sets shutter speed and aperture to the proper exposure according to Program line when taking pictures.	p.146
P (Hyper-program)	Automatically sets shutter speed and aperture to the proper exposure according to Program line when taking pictures. Use the front e-dial and rear e-dial to change the shutter speed and aperture while maintaining the proper exposure.	p.147
Sv (Sensitivity Priority)	Automatically sets the shutter speed and aperture to the proper exposure according to the set sensitivity.	p.148
Tv (Shutter Priority)	Lets you set the desired shutter speed for expressing moving subjects. Take pictures of fast moving subjects that look still or subjects that give a sense of movement.	p.150
Av (Aperture Priority)	Lets you set the desired aperture for controlling the depth of field. Use it to obtain a blurred or sharp background.	p.152

Item	Function	Page
TAv (Shutter & Aperture Priority)	Automatically sets the sensitivity so that shutter speed and aperture give the proper exposure according to the brightness of the subject.	p.154
M (Hyper-manual)	Lets you set shutter speed and aperture to capture the picture with creative intent.	p.156
B (Bulb)	Lets you capture images that require slow shutter speeds such as fireworks and night scenes.	p.159
X (Flash X-sync speed)	Locks shutter speed at 1/180 seconds. Use this when using an External flash that does not automatically change the shutter speed.	p.160

2 Getting Started

This chapter explains your first steps from purchasing the camera to taking pictures. Be sure to read it and follow the instructions.

Attaching the Strap	42
Using the Battery	43
Inserting/Removing the SD Memory Card	48
Turning the Camera On and Off	52
Initial Settings	53
Attaching the Lens	58
Adjusting the Viewfinder Diopter	60

Attaching the Strap

- 1** Pass the end of the strap through the strap lug, then secure it on the inside of the clasp.

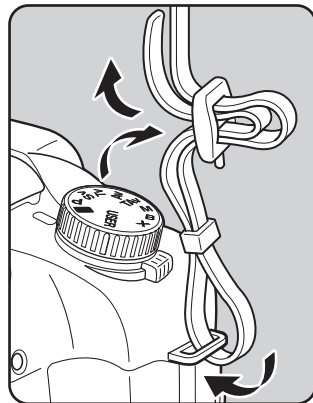

- 2** Pass the other end of the strap through the other strap lug on the camera, then secure it on the inside of the clasp.

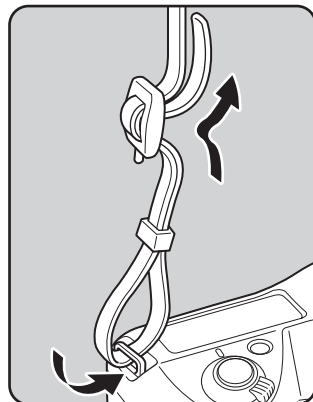

Insert the battery into the camera. Use only a D-LI50 battery.

Charging the Battery

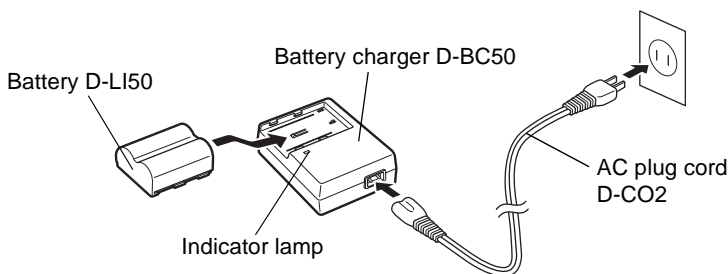

When using the battery for the first time, or when the battery has not been used in a long time, or when [Battery depleted] appears, recharge the battery.

- 1** Connect the AC plug cord to the battery charger.
- 2** Plug the AC plug cord into the power outlet.
- 3** Face the ▲ mark on the exclusive battery up and insert it into the battery charger.
The indicator lamp is lit red during charging.
The indicator lamp turns off when the battery is fully charged.
- 4** When the battery is fully charged, remove the battery from the battery charger.



- Do not use the provided battery charger to charge batteries other than rechargeable lithium-ion battery D-LI50. Charging other batteries may cause damage or heating.
- If the battery is correctly oriented and inserted into the battery charger but the indicator lamp is not lit, the battery is faulty. Install a new battery in the battery charger.



- The maximum charging time is approximately 180 minutes. Charge in a location where the temperature is between 0°C and 40°C. (Charge time depends on temperature and remaining battery power.)
- If usage time is reduced even when properly charged, the battery has reached the end of its usage span. Install a new battery in the camera.

Inserting/Removing the Battery

When using the battery for the first time, charge the battery before inserting it into the camera.



- Do not open the battery cover or remove the battery while the power is on.
- Remove the battery when you will not use the camera for a long while. The battery may leak.
- If the date and time settings have been reset when you insert a new battery after a long while, follow the procedure for “Setting the Date and Time”. (p.56)
- Insert the battery correctly. If the battery is inserted incorrectly, it may cause camera breakdown. Wipe the electrodes of the battery with a soft dry cloth before inserting.

1

Open the battery cover.

Lift the battery cover unlock lever, turn towards OPEN (①) to unlock, and then pull the cover open (②).

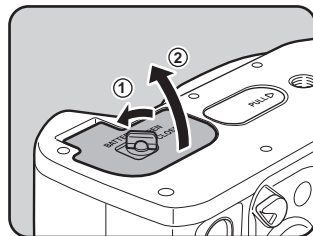

- 2** Face the ▲ mark on the battery towards the LCD monitor, push the battery lock lever in the direction of the arrow (①) and insert the battery.

Insert until the battery locks.

To remove the battery, push the battery lock lever in the direction of the arrow (①) with your hand. The battery pops out slightly. Remove it.

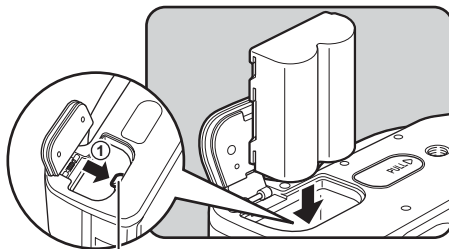

Battery lock lever

- 3** Close the battery cover (①) and turn the battery cover unlock lever towards CLOSE (②) to lock.



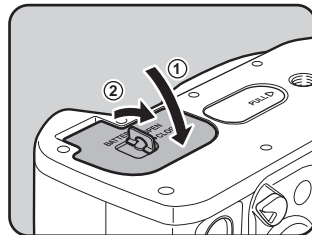

Stow the battery cover unlock lever when finished closing.



Use the AC adapter D-AC50 (optional) when using the camera for a prolonged period. (p.47)

Battery Level Indicator

You can confirm remaining battery level by checking the  displayed on the LCD panel.

	lit	: Battery is full.
↓		
	lit	: Battery is running low.
↓		
	lit	: Battery is almost empty.
↓		
	blink	: The camera turns off after displaying a message.

Approximate Image Storage Capacity and Playback Time (Exclusive Battery Fully Charged)

Battery	(Temperature)	Normal recording	Flash photography		Playback time
			50% use	100% use	
D-LI50	(23°C)	500	480	350	330 minutes
	(0°C)	470	420	320	300 minutes

The picture storage capacity (flash use 50%) is based on measuring conditions in accordance with CIPA standards and the others are based on PENTAX measuring conditions. Some deviation from the above figures may occur in actual use depending on shooting mode and shooting conditions.



- Battery performance temporarily decreases as the temperature decreases. When using the camera in cold climates, have extra batteries on hand and keep them warm in your pocket. Battery performance will return to normal when returned to room temperature.
- Have extra batteries ready when traveling overseas, taking pictures in cold climates, or when you will be taking a lot of pictures.

Using the AC Adapter (Optional)

1

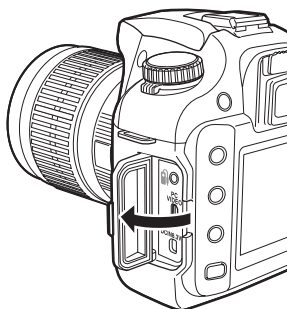

2

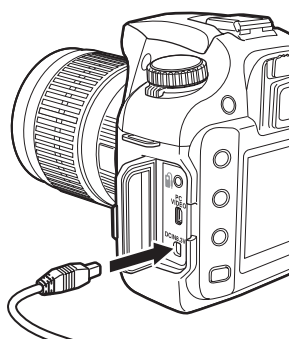

We recommend using the AC adapter D-AC50 (optional) when using the LCD monitor for a long time or when connecting to your PC.

1

Make sure the camera is turned off before opening the terminal cover.

2

Connect the DC terminal on the AC adapter to the DC input terminal on the camera.

3

Connect the AC plug cord to the AC adapter.

4

Plug the AC cord into the power outlet.



- Make sure the camera is turned off before connecting or disconnecting the AC adapter.
- Make sure connections are secure between the camera, AC adapter, AC plug cord terminal and the power outlet. SD Memory Card and data will be corrupted if disconnected while camera is recording or reading data.



- Be sure to read the AC adapter D-AC50 operating manual when using the AC adapter.
- The batteries in your camera will not charge when connected to the AC adapter.

Inserting/Removing the SD Memory Card

Captured images are recorded on the SD Memory Card. Make sure the camera is turned off before inserting or removing the SD Memory Card (market product).



- Do not remove the SD Memory Card while card access lamp is lit.
- Use this camera to format (initialize) an SD Memory Card that is unused or has been formatted and used on other cameras or digital devices. Refer to "Formatting the SD Memory Card" (p.188) for details on formatting.

2

Getting Started

1

Lift the card cover unlock lever (①) and turn it towards OPEN (②).

The card cover opens.

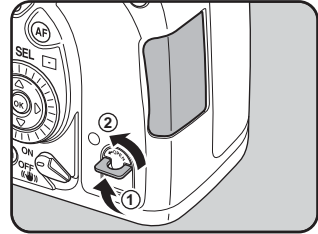

2

Insert the card all the way with the SD Memory Card label toward the LCD monitor.

Push the SD Memory Card in once to remove.

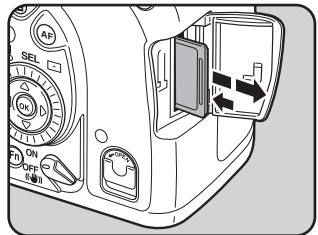
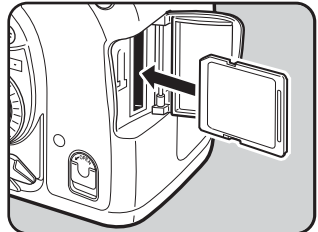

3

Close the card cover.



Be sure to fully close the card cover. The camera will not turn on if the card cover is open.

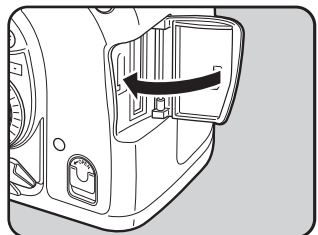

Precautions When Using the SD Memory Card

- The SD Memory Card is equipped with a write-protect switch. Setting the switch to LOCK protects the existing data by prohibiting recording of new data, deletion of existing data or formatting of the card.
- Care should be taken when removing the SD Memory Card immediately after using the camera because the card may be hot.
- Do not remove the SD Memory Card or turn the camera off while data is being saved to the card, images are being played back, or the camera is connected to a computer with the USB cable. This may cause the data to be lost or the card to be damaged.
- Do not bend the SD Memory Card or subject it to violent impact. Keep it away from water and store away from high temperatures.
- Do not remove the SD Memory Card during formatting. The card may be damaged beyond use.
- Data on the SD Memory Card may be deleted in the following circumstances. PENTAX does not accept any liability for data that is deleted if
 - (1) the SD Memory Card is mishandled by the user.
 - (2) the SD Memory Card is exposed to static electricity or electrical interference.
 - (3) the card has not been used for a long time.
 - (4) the card is ejected or the battery is removed while the data on the card is being recorded or accessed.
- The SD Memory Card has a limited service life. If it is not used for a long time, the data on the card may become unreadable. Be sure to regularly make a backup of important data on a computer.
- Avoid using or storing the card where it may be exposed to static electricity or electrical interference.
- Avoid using or storing the card in direct sunlight or where it may be exposed to rapid changes in temperature or to condensation.
- For information on compatible SD Memory Card, visit the PENTAX website or contact your nearest PENTAX customer service center.
- Format new SD Memory Cards. Also format SD Memory Cards that have been used with other cameras.  Formatting the SD Memory Card (p.188)
- If you are going to discard, give away or sell your SD memory card you should ensure that the data on the card is completely deleted or the card itself is destroyed if it contains any personal or sensitive information. Please note that formatting the SD card will not necessarily delete the data so that it cannot be recovered using off the shelf data recovery software. There are off the shelf secure data deletion software programs available that will completely delete the data. In any case the data on your SD memory card should be managed at your own risk.

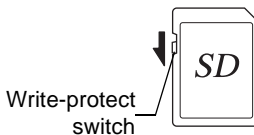

Recorded Pixels and Quality Level

When File Format is JPEG

Choose the number of pixels (size) and quality level (JPEG data compression rate) of pictures according to how you intend to use the pictures you have taken.

Pictures with larger recorded pixels or more ★s are clearer when printed. The number of pictures that can be taken (the number of pictures that can be recorded on an SD Memory Card) decreases less with larger file sizes. The quality of the captured photo or printed picture depends on the quality level, exposure control, resolution of the printer and a variety of other factors so you do not need to select more than the required number of pixels. For example, to print in postcard size, **2M** (1824×1216) is adequate. Set the appropriate recorded size and quality level depending on purpose.

Choose the appropriate number of recorded pixels and quality level for JPEG images on the [ Rec. Mode] menu.

- ☞ Setting the JPEG Recorded Pixels (p.118)
- ☞ Setting the JPEG Quality Level (p.119)

● JPEG Recorded Pixels, JPEG Quality and Approximate Image Storage Capacity

JPEG Quality \ JPEG Rec. Pixels	★★★ Best	★★ Better	★ Good
10M (3872×2592)	101	172	296
6M (3008×2000)	168	287	495
2M (1824×1216)	457	774	1313

- The above table shows the approximate image storage capacity and recording time when using a 512 MB SD Memory Card.
- The above figures may vary depending on the subject, shooting conditions, shooting mode and SD Memory Card, etc.



When the number of storable images exceeds 500, captured images are divided into folders of 500 images each. However, in Auto Bracket, images will be stored in the same folder until shooting is completed, even if the number of images exceeds 500.

When File Format is RAW

With **K10D**, you can record in the versatile JPEG format or the high quality and editable RAW format. For RAW file format, you can select the PENTAX original PEF format or general-purpose DNG (Digital Negative) format designed by Adobe Systems. On a 512 MB SD Memory Card, you can record up to 29 images in PEF format or DNG format.

☞ Setting the File Format (p.122)

1 Move the main switch to [ON] position.

The camera will turn on.

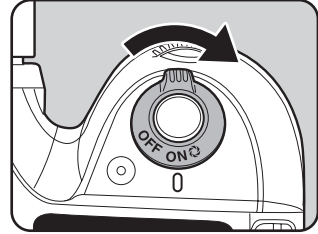

Move the main switch to [OFF] position to turn off the camera.



2

Getting Started



- Always turn the camera off when not in use.
- The power will automatically turn off when you do not perform any operations within a set period of time. After the camera turns off automatically, turn it on again or perform any of the following.
 - Press the shutter release button halfway.
 - Press the  button.
 - Press the **INFO** button.
- By default, the camera is set to power off automatically after 1 minute of inactivity. You can change the setting with [Auto Power Off] on the [ Set-up] menu. (p.196)

The first time the camera is turned on after purchasing, the [Language/言語] screen appears on the LCD monitor. Follow the procedure below to set the language displayed on the LCD monitor and the current date and time. Once setting is done, these will not need to be set again when turning your camera on.

Setting the Display Language

You can choose the language in which the menus, error messages, etc. are displayed from the following: English, French, German, Spanish, Portuguese, Italian, Swedish, Dutch, Russian, Korean, Chinese (traditional/simplified) and Japanese.

- 1 Use the four-way controller (▲▼◀▶) to select the desired language.**

The default setting is English.

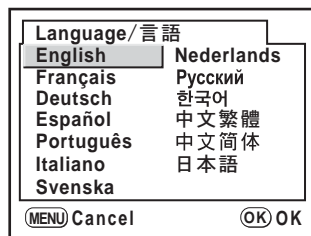

- 2 Press the OK button.**

The [Initial Setting] screen for the selected language appears.

Proceed to Step 6 if [Hometown] and [DST] do not have to be adjusted.

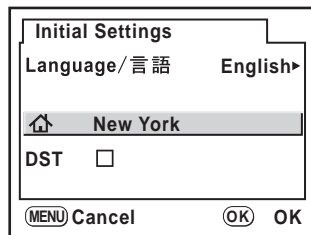

- 3 Use the four-way controller (◀▶) to select the city.**

4 Press the four-way controller (▼).

The cursor moves to DST (daylight saving time).

5 Use the four-way controller (◀▶) to select (On) or (Off).

6 Press the OK button.

The screen for setting the date and time will be displayed.

When an Incorrect Language is Set

● If You Have Not Yet Proceeded to the Screen to Set Date and Time
If you mistakenly select a language in the [Language/言語] screen, you can perform the following operations to show the [Initial Setting] screen in that language if you have not yet proceeded to the screen to set the date and time.

- 1 Turn the camera off and turn it on again.**
- 2 Use the four-way controller (▲▼◀▶) to select the desired language and press the OK button.**

The [Initial Setting] screen for the selected language appears. Return to Step 2 of "Setting the Display Language" (p.53) and perform settings again.

● If You Have Already Proceeded to the Screen to Set Date and Time
Once the screen to set date and time has been displayed, Initial Setting cannot be performed again. Perform the following operations and set the language from the menu screen.

- 1 Turn the camera off and turn it on again.**
- 2 Press the MENU button.**
- 3 Press the four-way controller (▶) twice.**
- 4 Press the four-way controller (▼) six times.**
- 5 Press the four-way controller (▶) once.**

The screen for setting the language will be displayed.

- 6 Use the four-way controller (▲▼◀▶) to select the desired language and press the OK button.**

The [ Set-up] menu for the selected language appears. Refer to the following pages and set the desired city for [Hometown] and the current date and time as necessary.

- To change Hometown: "Setting the World Time" (p.191)
- To change date and time: "Changing the Date and Time and the Display Style" (p.190)



Pressing the **MENU** button during initial settings cancels the settings made so far and displays the [Date Adjust] screen (p.56). In this case, the [Language/言語] screen will appear again the next time you turn the camera on.

Setting the Date and Time

Set the current date and time and the display style.

- 1 Press the four-way controller (▶).

The frame moves to [mm/dd/yy].

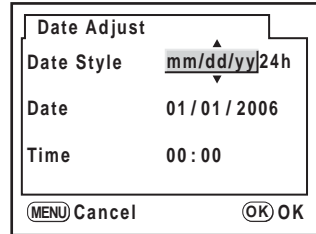

- 2 Use the four-way controller (▲ ▼) to choose the date style.

- 3 Press the four-way controller (▶).

The frame moves to [24h].

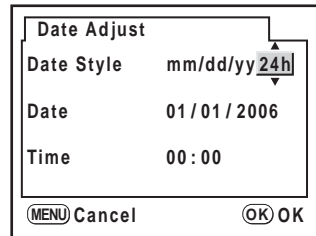

- 4 Use the four-way controller (▲ ▼) to select 24h (24-hour display) or 12h (12-hour display).

- 5 Press the four-way controller (▶).

The frame returns to [Date Style].

- 6 Press the four-way controller (▼).

The frame moves to [Date].

7 Press the four-way controller (▶).

The frame moves to the month.

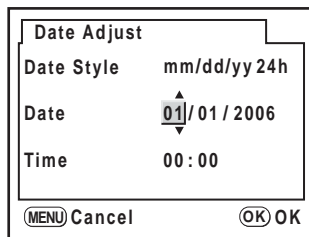

8 Use the four-way controller (▲ ▼) to set the month.

Set the day and year in the same manner.

Next, set the time.

If you select [12h] in Step 4, the setting switches between am and pm depending on the time.

9 Press the OK button.

The camera is ready to take pictures. If you set the date and time with the menu operations, the screen will return to the [🔍 Set-up] menu. Press the **OK** button again.



Pressing the **MENU** button while adjusting the date cancels the settings made so far and switches the camera to Capture mode. If the power is turned on without the date and time set, the Date Adjust screen is displayed if Initial Setting has been performed. You can also set the date later by menu operations. (p.190)



- When you finish the settings and press the **OK** button, the camera clock is reset to 00 seconds. To set the exact time, press the **OK** button when the time signal (on the TV, radio, etc.) reaches 00 seconds.
- You can change the language and date and time settings with the menu operations. (p.190, p.194)

Attaching the Lens

All camera exposure modes are available when using DA, D FA, FA J or other lenses with Aperture **A** (Auto) position. Some functions are restricted when lenses are not set to Aperture **A** (Auto). Also see “Notes on [Using Aperture Ring]” (p.210). Other lenses and accessories will not be available with factory default settings. To allow shutter release with lenses or accessories not listed above, set [Using aperture ring] in custom function settings. (p.35)



Turn the camera off before attaching or removing the lens to prevent unexpected lens movement.

1 Check that the camera is turned off.

2 Remove the body mount cover (①) and lens mount cover (②).

Be sure to put the lens down with the lens mount side facing upward to protect the lens mount from damage after removal.

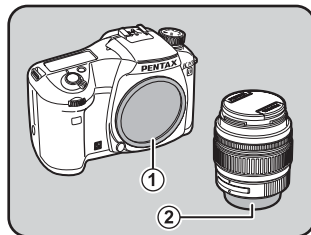

3 Align the red dots on the camera and the lens, and secure by turning the lens clockwise until it clicks.

After attaching, turn the lens counterclockwise to check that the lens is locked in place.

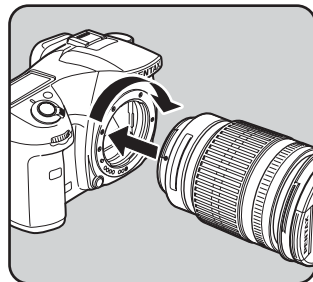

4 Remove the front lens cap by pushing the indicated portions inward.

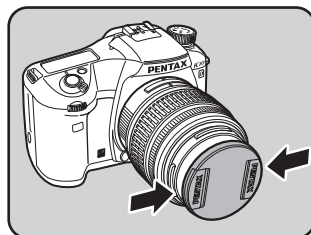

To detach the lens, hold down the lens unlock button (③) and turn the lens counterclockwise.

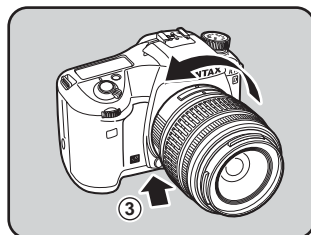

2

Getting Started



- The body mount cover (①) is a cover to prevent scratches and block dust when shipped. Body Mount Cap K is sold separately and has a lock function.
- We assume no responsibility nor liability for accidents, damages and malfunctions resulting from the use of lenses made by other manufacturers.
- The camera body and lens mount incorporate lens information contacts and an AF coupler. Dirt, dust, or corrosion may damage the electrical system. When necessary, clean the contacts with a soft dry cloth.

Adjusting the Viewfinder Diopter

Adjust the viewfinder to suit your eyesight.

If it is difficult to see the viewfinder image clearly, slide the diopter adjustment lever sideways.

You can adjust the diopter from -2.5m^{-1} to $+1.5\text{m}^{-1}$.

- 1** Look through the viewfinder and point the camera at a white wall or other bright and consistent surface. Slide the diopter adjustment lever left or right.

Adjust the lever until the AF frame in the viewfinder is focused.

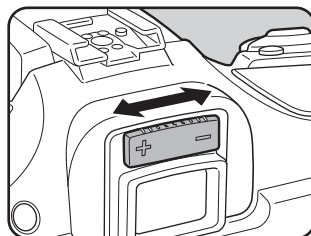

AF frame



- The F_P Eyecup is attached to the viewfinder portion when camera leaves the factory. Diopter adjustment is available with the F_P Eyecup attached. However, adjustment is easier with the eyecup removed. To remove the F_P Eyecup, press in one side and pull it out in the direction of the arrow.

To attach the F_P Eyecup, align it with the groove on the viewfinder eyepiece and push it into position.

- If it is difficult to see the viewfinder image clearly even if you set the diopter adjustment lever, use the diopter correction lens adapter M. However, the eyecup must be removed to use this adapter. (p.216)

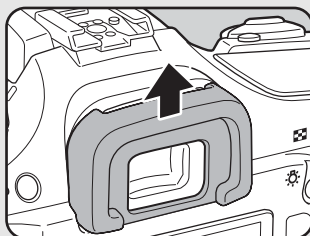

3 Basic Operations

This chapter explains basic operations for shooting by setting mode dial to Green mode (automatic exposure according to the Normal program line) to ensure successful capturing.

For information about advanced functions and settings for taking pictures, refer to chapter 4 and onward.

Basic Shooting Operation	62
Taking Pictures Using the Shake Reduction Function	67
Using a Zoom Lens	70
Using the Built-in Flash	71
Other Shooting Modes	75
Playing Back Still Pictures	85
Connecting the Camera to AV Equipment	94
Processing Images with Filters	95
Deleting Images	100
Setting the Printing Service (DPOF)	106
Printing Using PictBridge	109

Holding the Camera

How you hold the camera is important when taking pictures.

- Hold the camera firmly with both hands.
- Press the shutter release button gently when taking a picture.

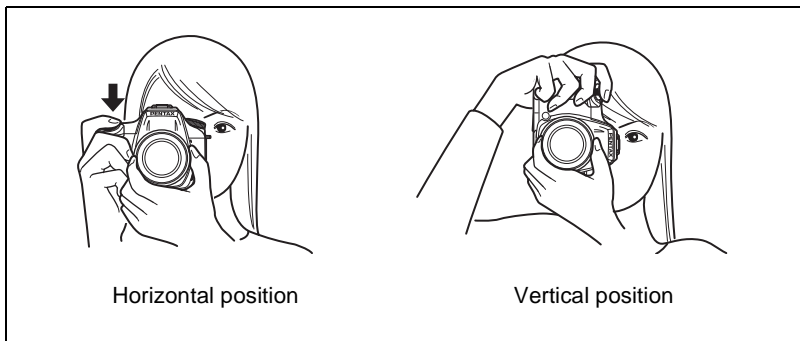

3

Basic Operations





- To reduce camera shake, support your body or the camera on a solid object such as a table, tree, or wall.
- Although there are individual differences among photographers, the shutter speed for a handheld camera is generally $1/(\text{focal length} \times 1.5)$. For example, it is $1/75$ of a second for a focal length of 50 mm and $1/150$ of a second for 100 mm. Use a tripod or the Shake Reduction function (p.67) when using a lower shutter speed.
- When using a telephoto lens, a tripod that is heavier than the total weight of the camera and lens is recommended to avoid camera shake.
- Do not use the Shake Reduction function when using the camera on a tripod.

Letting the Camera Choose the Optimal Settings

The **K10D** features various Capture modes, Focus modes, and Drive modes suited for your intentions. This section explains how to take pictures by simply pressing the shutter release button.

1 Set the mode dial to .

The Exposure mode changes to  (Green) mode. In , proper exposure is determined by the camera and the shutter speed and aperture are automatically set. (p.146)

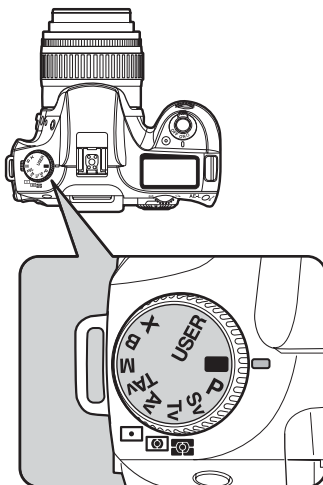

2 Set the focus mode lever to **AF.S**.

The Focus mode changes to **AF.S** (Autofocus/Single) mode. In **AF.S**, the lens automatically operates when the shutter release button is pressed halfway. When the image is focused, the shutter can be released. (p.130)

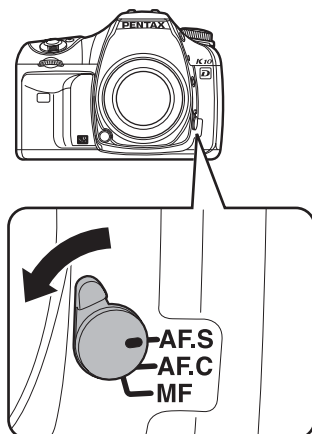



3 Look through the viewfinder to view the subject.

A zoom lens can be used to change the size of the subject in the viewfinder.

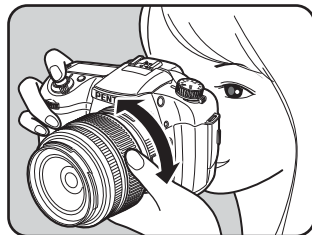
☞ Using a Zoom Lens (p.70)



4 Position the subject inside the AF frame and press the shutter release button halfway.

The autofocus system operates. The focus indicator  appears in the viewfinder when the subject is in focus. The flash does not pop up automatically. If the flash is necessary, flash status  blinks. Press the  button (p.73) to pop up the flash manually.

☞ Operating the shutter release button (p.65)

☞ Subjects that are Difficult to Focus on (p.66)

☞ Using the Built-in Flash (p.71)

☞ Selecting the Focusing Area (AF Point) (p.132)



Flash status

Focus indicator status



You can preview the image in the LCD monitor and check the composition, exposure, and focus before taking the picture. (p.169)

5 Press the shutter release button fully.

The picture is taken.



6 Review the captured image on the LCD monitor.

Image appears for 1 second on the LCD monitor after capturing (Instant Review).

You can magnify the image during Instant Review with the rear e-dial. (p.89)

You can delete the image during Instant Review by pressing the  button.

 Setting the Instant Review (p.197)

 Deleting Images (p.100)

 Bright/Dark Area Display (p.197)

 Histogram Display (p.197)

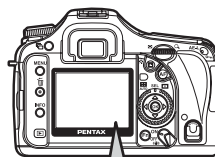

Operating the shutter release button

The shutter release button has two positions.

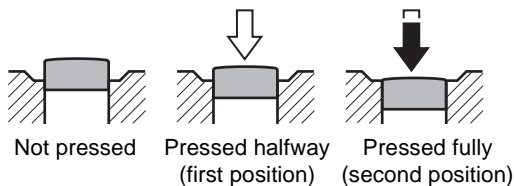

Pressing it down halfway (first position) turns on the viewfinder and LCD panel indicators and the autofocus system operates. Pressing it fully (second position) takes the picture.



- Press the shutter release button gently when taking a picture to prevent camera shake.
- Practice pressing the shutter release button halfway to learn where the first position is.
- The viewfinder indicators stay on while shutter release button is pressed. The indications stay on for about 10 seconds (default setting) after the button is released. (p.26)

Subjects that are Difficult to Focus on

The autofocus mechanism is not perfect. Focusing may be difficult when taking pictures under the following conditions ((a) to (f) below). These also apply to manual focusing using the focus indicator ● in the viewfinder. If the subject cannot be focused automatically, set the focus mode lever to **MF** and use the manual focus mode to focus on the subject with the aid of the matte field in the viewfinder. (p.137)

- (a) Extremely low-contrast subjects such as a white wall in the focusing area.
- (b) Subjects which do not reflect much light within the focusing area.
- (c) Fast moving objects.
- (d) Strongly reflected light or strong backlighting (bright background).
- (e) If repeating vertical or horizontal line patterns appear within the focusing area.
- (f) Multiple subjects in the foreground and background within the focusing area.



Subject may not be focused even when ● (focus indicator) is displayed when (f) above applies.

Taking Pictures Using the Shake Reduction Function

You can easily take sharp pictures using the Shake Reduction function by simply turning on the Shake Reduction switch.

Shake Reduction

The Shake Reduction function reduces camera shake that occurs when the shutter release button is pressed. This is useful for taking pictures in situations where camera shake is likely to occur. The Shake Reduction function allows you to take pictures at approximately 2 to 4 steps slower shutter speed without the risk of the camera shake. The Shake Reduction function is ideal when taking pictures in the following situations.

- When taking pictures in dimly lit locations, such as indoors, at night, on cloudy days and in the shade
- When taking telephoto pictures

Blurred picture

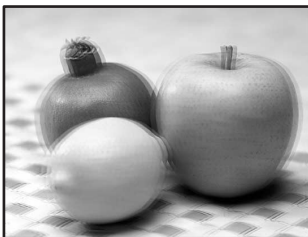

Picture taken with the Shake Reduction function



- The Shake Reduction function does not compensate for blurring caused by movement of the subject. To take pictures of a moving subject, increase the shutter speed.
- The Shake Reduction function may not fully reduce camera shake when taking close-up shots. In this case, it is recommended that the Shake Reduction function be turned off and the camera be used with a tripod.
- The Shake Reduction function will not fully work when shooting with a slower shutter speed, for example when shooting a moving subject or night scenes. In this case, it is recommended that the Shake Reduction function be turned off and the camera be used with a tripod.

Shake Reduction Function and Lens Focal Length

The Shake Reduction function operates by acquiring the lens information such as focal length.

If the camera uses a DA, D FA, FA J, FA or F lens, the lens information is automatically acquired when the Shake Reduction function is activated.

[Focal Length] cannot be set from [Shake Reduction] menu in the [Rec. Mode] (The menu items cannot be selected).

If another type of lens is used, the lens information cannot be automatically acquired even when the Shake Reduction function is activated. In this case, the [Shake Reduction] setting menu appears. Set [Focal Length] manually on the [Shake Reduction] setting menu.  Setting the Shake Reduction Function (p.69)

Turning On the Shake Reduction Function

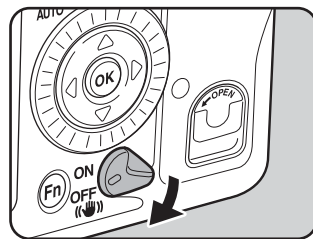

1 Turn on the Shake Reduction switch.

When the shutter release button is pressed halfway,  appears in the viewfinder and the Shake Reduction function turns on.



- Be sure to turn off the Shake Reduction switch when using the camera with a tripod.
- The Shake Reduction function automatically turns off in the following situations.
When using self-timer, 2 sec. self-timer, remote control shooting, 3 sec. delay shooting, bulb shooting, or wireless mode with an external flash



- If a type of lens that does not support automatic acquisition of lens information such as focal length is used (p.67), the [Shake Reduction] menu appears. Set [Focal Length] manually on the [Shake Reduction] menu.
 Setting the Shake Reduction Function (p.69)
- Turn the Shake Reduction switch off if you will not use the Shake Reduction function.
- The Shake Reduction function will not fully work (for about 2 seconds) right after turning on the camera or restoring from Auto Power Off. Wait for the Shake Reduction function to become stable before gently pressing the shutter release button to take a picture. Press the shutter release button halfway. The camera is ready to take pictures when  appears in the viewfinder.
- Shake Reduction is available with any **K10D** compatible PENTAX lens. However, when the aperture ring is set at other than **A** (Auto) or a lens without an **A** (Auto) position is used, camera does not operate unless [Using aperture ring] is set to [Permitted] in the [C Custom Setting] menu (see p.35; see p.29 and 30 for operation method). Set this beforehand. Note that some functions are restricted when [Using aperture ring] is set to [Permitted] in the [C Custom Setting] menu. Refer to “Notes on [Using Aperture Ring]” (p.210) for details.

Setting the Shake Reduction Function

The [Shake Reduction] setting menu appears when the camera is turned on with the Shake Reduction switch on and a type of lens that does not support automatic acquisition of lens information such as focal length (p.67) is mounted.

Use the [Shake Reduction] setting menu to set [Focal Length].



- The [Shake Reduction] setting menu does not appear when using a lens that supports automatic acquisition of lens information such as focal length because [Focal Length] is set automatically.
- When using a lens without the **A** position on the aperture or with the aperture set to a position other than the **A** position, set [Using aperture ring] on the [**C** Custom Setting] menu to [Permitted].

1

Use the four-way controller (◀▶) to set [Focal Length].

Select from the following 34 focal length values. (The default setting is 35.)

8	10	12	15	18	20	24	28	30	35
40	43	50	55	65	70	77	85	100	120
135	150	180	200	250	300	350	400	450	500
550	600	700	800						

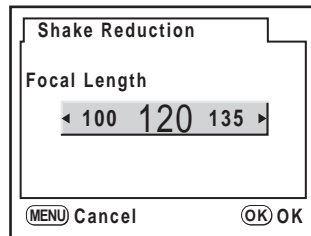

- If the focal length for your lens is not listed above, select the value closest to the actual focal length (example: [18] for 17 mm and [100] for 105 mm).
- When using a zoom lens, select the actual focal length at the zoom setting in the same manner.
- Effect of Shake Reduction is influenced by the shooting distance as well as focal length information. The Shake Reduction function may not perform as expected when shooting at close ranges.

2

Press the OK button.

The camera is ready to take a picture.



To change the [Focal Length] setting, use [Shake Reduction] on the [📷 Rec. Mode] menu. (p.31)

Enlarge the subject (telephoto) or capture a wider area (wide angle) with a zoom lens. Adjust it to the desired size and take the picture.

1 Turn the zoom ring to the right or left.

Turn the zoom ring clockwise for telephoto and counterclockwise for wide angle.

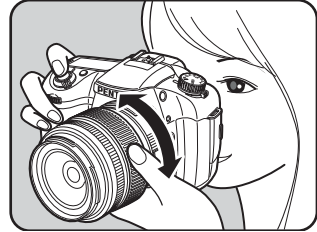

- The smaller the number of the displayed focal length, the wider the angle. The larger the number, the more magnified the image appears.
- Power Zoom (Auto Zoom) is available if a Power Zoom compatible FA lens is used with this camera.

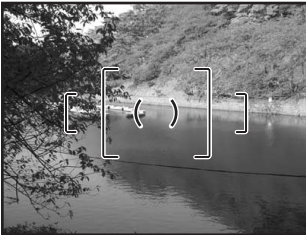

Wide Angle

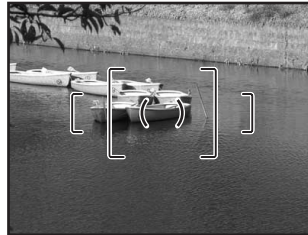

Telephoto

If you wish to discharge the flash in a dark or backlit location, press the **⬆** button to pop up the flash. Select a flash mode to suit your purpose from the Flash options screen in the Fn menu. You can adjust the flash output with the rear e-dial in any Exposure mode other than Green mode. The built-in flash is optimum at about 0.7 m to 4 m from the subject. Exposure will not be properly controlled and vignetting may occur when used at a distance closer than 0.7 m (this distance varies slightly depending on the lens being used and set sensitivity (p.176)).







Compatibility of built-in flash and lens

Vignetting (darkening of the corners of the image due to a lack of light) may occur depending on the lens being used and the capture conditions. We recommend taking a test shot to confirm this.

☞ DA, D FA , FA J, FA and F Lens Compatibility with the Built-in Flash (p.177)



- When using the built-in flash, remove the lens hood before shooting.
- The built-in flash fully discharges for lenses without a function to set aperture lens ring to **A** (Auto).

 Auto discharge	Discharges the flash automatically in dark or backlit locations.
 Auto flash+Redeye reduct	Lights a red-eye reduction light before automatic flash.
 Flash On	Discharges the flash each time.
 Flash On+Red-eye	Lights a red-eye reduction light before discharging the flash with Flash On.
 Slow-speed sync	Sets the shutter speed slower depending on the brightness. Use this when shooting a portrait in front of a sunset or other scenery to capture both the person and background clearly.
 Slow-speed sync+Red-eye	Lights a red-eye reduction light before discharging the flash with Slow-speed sync.
 Trailing curtain sync	Discharges flash immediately before closing the shutter curtain. Capture moving images as if they are leaving a trail behind.



When using Slow-speed sync or Slow-speed sync+Red-eye, the shutter speed becomes slower depending on the brightness. Use Shake Reduction (p.67) or fix the camera on a tripod to prevent camera shake.

Selecting Flash Mode

1 Press the Fn button.

The Fn menu appears.

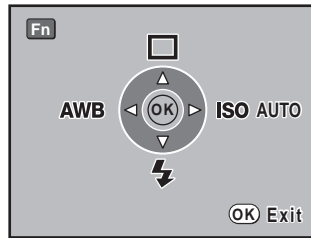

2 Press the four-way controller (▼).

The Flash options screen appears.

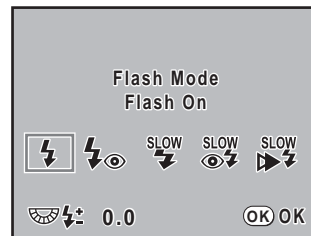

- When the mode dial is set to **■**, **⚡^A** and **⚡^A** can be selected, when set to **Tv**, **TAv**, **M** or **B**, **⚡**, **⚡^{SLOW}** and **⚡^{SLOW}** can be selected, and when set to **X**, **⚡** and **⚡^{SLOW}** can be selected. For any other mode, **⚡**, **⚡^{SLOW}**, **⚡^{SLOW}** and **⚡^{SLOW}** can be selected.
- When the mode dial is set to **USER**, the available flash modes vary depending on the settings that have been saved.

3 Use the four-way controller (◀▶) to choose a flash mode.

When not in **■** (Green) mode, turn the rear e-dial to perform Flash Compensation. The compensation range is -2.0 to +1.0.

4 Press the OK button.

The camera returns to the Fn menu screen.

5 Press the Fn button.

The camera is ready to take a picture.

Using Built-in Flash

1 Press the **⚡UP** button.

The built-in flash pops up and begins charging. When the flash is fully charged, **⚡** appears in the LCD panel and viewfinder. (p.23, p.26, p.28)

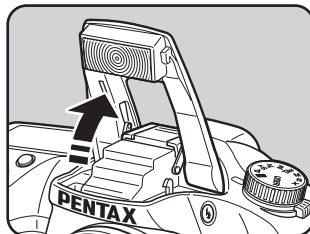
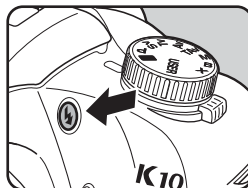

2 Press the shutter release button halfway.

The focus indicator **●** appears in the viewfinder when focused.

3 Press the shutter release button fully.

The picture is taken.



- When the mode dial is at **■**, the flash is not discharged when the lighting conditions do not require flash for correction even if the flash is popped up.
- The Flash On is used when the flash is popped up if the mode dial is at a setting other than **■**.

4 Push down on the portion indicated in the illustration to retract the flash.

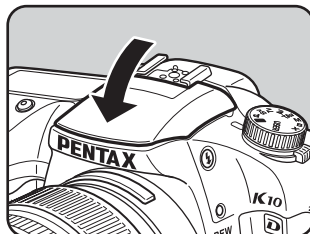



Using Red-eye Reduction Flash

“Red-eye” is the phenomenon where eyes look reddish in photographs taken in dark environments with a flash. This is caused by the reflection of the electronic flash in the retina of the eye. Red-eye occurs because pupils are dilated in dark environments.

This phenomenon cannot be averted but the following measures can be used to combat it.

- Brighten the surroundings when shooting.
- Set to wide angle and shoot from closer if a zoom lens is in use.
- Use a flash that supports red-eye reduction.
- Position the flash as far away from the camera as possible when using an external flash.

The red-eye reduction function on this camera reduces red-eye by discharging the flash twice. With the red-eye reduction function, the pre-flash is discharged just before the shutter is released. This reduces pupil dilation. The main flash is then discharged while the pupils are smaller, reducing the red-eye effect. To use the red-eye reduction function, set  (Auto flash+Redeye reduct) in Green mode, or  (Flash On+Red-eye) or  (Slow-speed sync+Red-eye) in other modes for Flash mode.

Daylight-Sync Shooting

In daylight conditions, the flash will eliminate shadows when a portrait picture is taken with a person’s face cast in shadow. Use of the flash in this way is called Daylight-Sync Shooting. Flash On is used when shooting with Daylight-Sync Shooting.

● Taking pictures (Hyper-program)

- 1 Pop the flash manually and confirm that the flash mode is set to  (Flash On). (p.73)
- 2 Confirm that the flash is fully charged.
- 3 Take the picture.



The picture may be overexposed if the background is too bright.



Without Daylight-Sync



With Daylight-Sync

Continuous Shooting

Pictures can be taken continuously while the shutter release button is held down.

- 1 Press the Fn button.

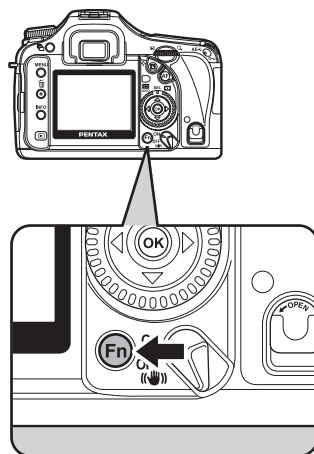

The Fn menu appears.

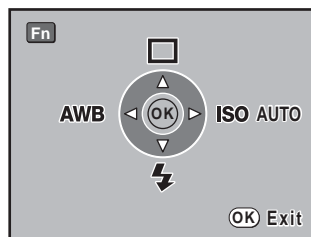

2 Press the four-way controller (▲).

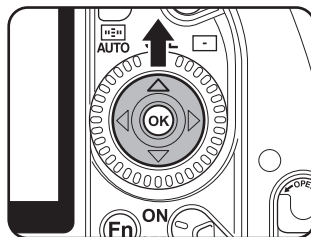

The Drive Mode options screen appears.



3 Use the four-way controller (◀▶) to select .



4 Press the OK button.

The camera returns to the Fn menu screen.

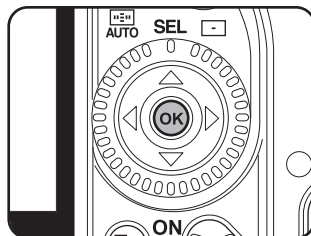

5 Press the OK button.

The camera is ready to take pictures.

6 Press the shutter release button halfway.

The autofocus system operates. The focus indicator  appears in the viewfinder when the subject is in focus.



Set [Rcd img no. (cont.)] in [Recordable Image No.] of the [C Custom Setting] menu. The number of continuously recordable images (buffer space) appears when shutter is pressed halfway. (p.34)

7

Press the shutter release button fully.

Pictures are taken continuously while the shutter release button is fully pressed. Take your finger off the shutter release button to stop.

Continuous shooting settings are retained when the power is turned off. Display the Fn menu again and set to □ (Single frame shooting) to stop Continuous shooting.



- The focus is adjusted each time the shutter is released while exposure metering timer is set (shutter release button is pressed halfway) if the focus mode is set to **A.F.S** (Single mode). (p.130)
- Focusing is continuously active when the focus mode is set to **A.F.C** (Continuous mode). Note that in **A.F.C**, the shutter will release when the shutter release button is pressed fully even if focusing is not complete.
- The shutter cannot be released until charging is complete when using the built-in flash. Use a custom function to enable shutter release before the built-in flash is ready. (p.173)

Self-Timer Shooting

This camera has two types of self-timers: ☺ and ☹.

☺	Shutter will be released after about 12 seconds. Use this mode to include the photographer in the picture.
☹	A mirror pops up immediately after shutter release button is pressed. Shutter is released after about 2 seconds. Use this mode to avoid camera shake when the shutter release button is pressed.

1

Mount the camera onto a tripod.

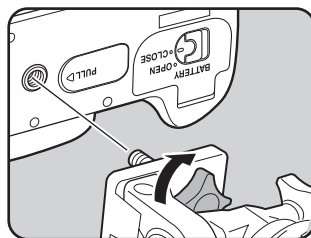

2 Press the Fn button.

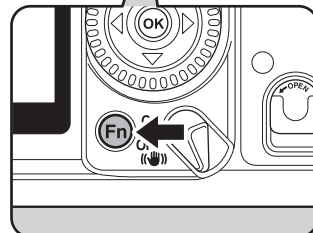
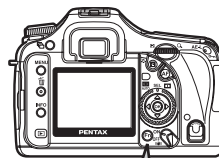

The Fn menu appears.

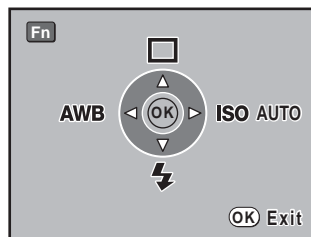

3 Press the four-way controller (▲).

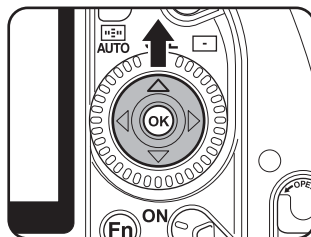

The Drive Mode options screen appears.

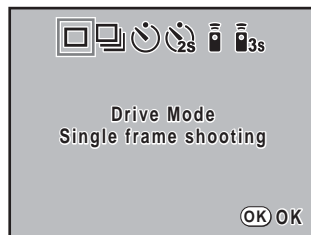

- 4** Use the four-way controller (◀▶) to select  or .

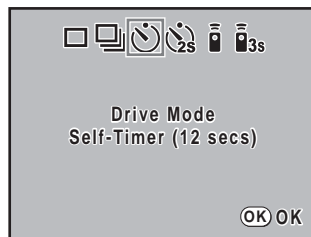

- 5** Press the OK button.

The camera returns to the Fn menu screen.

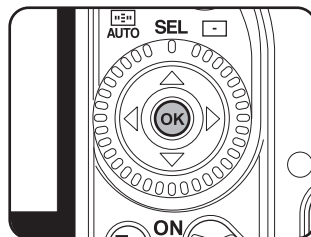

- 6** Press the OK button.

The camera is ready to take pictures.

- 7** Confirm in the viewfinder that the subject you wish to shoot is in the display and press the shutter release button halfway.

The focus indicator  appears when the subject is in focus.



8

Press the shutter release button fully.

For , the front and back self-timer lamps start blinking slowly and blink rapidly 2 seconds before the shutter is released. The beep is heard and the rate increases. The shutter will be released about 12 seconds after the shutter release button is pressed fully.

For , the shutter will be released about 2 seconds after the shutter release button is pressed fully.

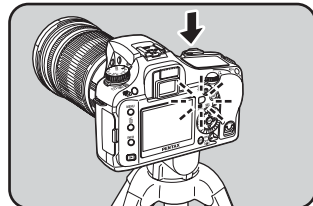
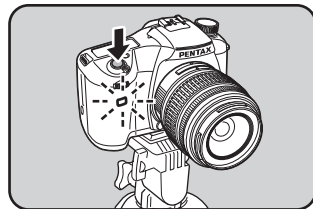

3



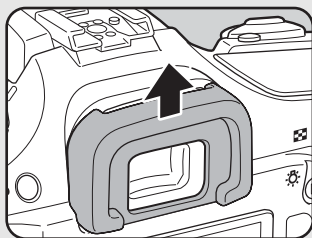

- The beep can be turned off (p.189).
- Exposure may be affected if light enters the viewfinder. Attach the provided ME viewfinder cap or use the AE lock function (p.162). (Ignore the light entering the viewfinder when the exposure mode is set to **M** (Hyper-manual) (p.156).)



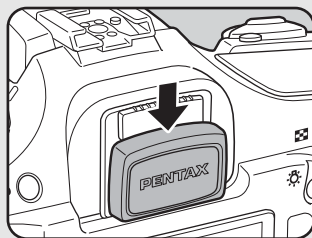

Removing the Eyecup FP





Attaching the ME Viewfinder cap

- Select a setting other than  or  in the Drive Mode options screen to cancel self-time shooting. The setting is canceled when the camera is turned off if [Drive Mode] in [Memory] of [ Rec. Mode] (p.199) is set to (Off).

Remote Control Shooting (Remote Control F: Sold Separately)

The shutter can be released with the optional remote control unit. You can select from  (remote control) and  (3 sec. delayed release) for remote control shooting.

	The shutter will be released immediately after the shutter release button on the remote control unit is pressed.
	When the shutter release button on the remote control unit is pressed, the shutter is released after about 3 seconds.

- 1 **Mount the camera onto a tripod.**

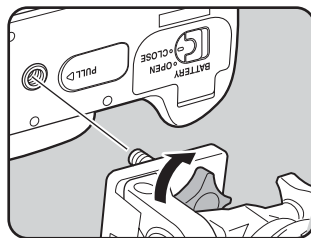

- 2 **Press the Fn button.**

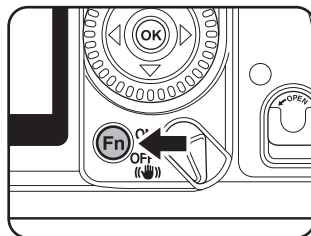

The Fn menu appears.

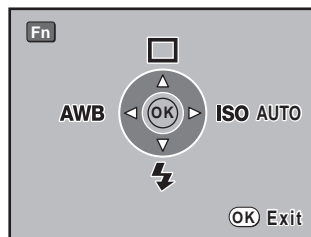

3 Press the four-way controller (▲).

The Drive Mode options screen appears.

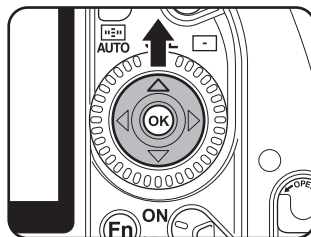

4 Use the four-way controller (◀▶) to select ii or ii_{ss} .

The self-timer lamp will blink to let you know that the camera is in remote control wait status.



5 Press the OK button.

The camera returns to the Fn menu screen.

6 Press the OK button.

The camera is ready to take pictures.

7 Press the shutter release button halfway.

The autofocus system operates. The focus indicator ● appears in the viewfinder when the subject is in focus.



You cannot focus with the remote control unit in default settings. Focus on the subject first before operating with the remote control. You can set [AF in remote control] to [On] in the custom function. (p.34)

8

Point the remote control unit towards the remote control receiver on the front or back of the camera and press the shutter release button on the remote control.

The operating distance of the remote control unit is about 5 m from the front or back of the camera. For $\bar{\text{M}}$, the shutter will be released immediately after the shutter release button is pressed.

For $\bar{\text{M}}_{\text{SS}}$, the shutter will be released approximately 3 seconds after the shutter release button is pressed.

When the picture is taken, the self-timer lamps light for 2 seconds and will then resume blinking.

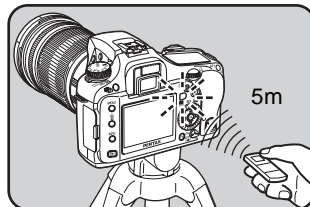
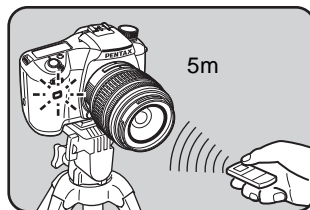

3



- Exposure may be affected if light enters the viewfinder. Attach the provided ME viewfinder cap or use the AE lock function (p.162) (ignore the light entering the viewfinder when the exposure mode is set to **M** (Hyper-manual) (p.156)).

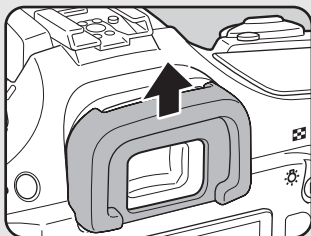

Removing the Eyecup Fp

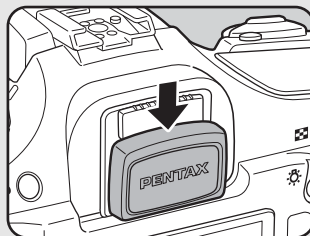

Attaching the ME Viewfinder cap

- Select a setting other than $\bar{\text{M}}$ or $\bar{\text{M}}_{\text{SS}}$ in the Drive Mode options screen to stop the remote control operation after it has been activated. The setting is canceled when the camera is turned off if [Drive Mode] in [Memory] of [CAMERA] (p.199) is set to \square (Off).
- The remote control may not operate in backlit conditions.
- The remote control does not work while the flash is being charged.
- When using the built-in flash, raise the flash into position first.
- The camera automatically returns to single frame shooting after the remote control shooting mode is left unused for 5 minutes.
- The remote control unit battery can send a remote control signal about 30,000 times. Contact PENTAX service center to replace the battery (this will involve a fee).

Using Mirror Up Function to Prevent Camera Shake

Use the Mirror Up function if camera shake is evident even when cable switch (optional) or remote control unit (optional) is used.



When shooting with the 2 sec. Self-Timer, the mirror pops up and the shutter is released 2 seconds after you press it, thereby avoiding the vibration of the mirror.

Follow the procedure below to take a picture with the Mirror Up function.

3

Basic Operations

- 1** **Mount the camera onto a tripod.**

- 2** **Use the Fn button and the four-way controller (▲) to select  (2 sec. Self-Timer).**
 Self-Timer Shooting (p.77)

- 3** **Press the shutter release button halfway.**
The autofocus system operates. The focus indicator  appears in the viewfinder when the subject is in focus.

- 4** **Press the shutter release button fully.**
The mirror pops up and the picture is taken 2 seconds later. AE lock is enabled with the exposure value set immediately before the mirror goes up.

Playing Back Images

You can play back captured still pictures with the camera.



Use the included "PENTAX PHOTO Browser 3" software to play back using a PC. Refer to the "PENTAX PHOTO Browser 3/PENTAX PHOTO Laboratory 3 Operating Manual" for details.

1 Press the button after taking a picture.

The most recently captured image (image with the largest file number) is displayed on the LCD monitor.

Press the **INFO** button during playback to display information such as the image data for the displayed image.

Refer to p.24 and 25 for display information details.

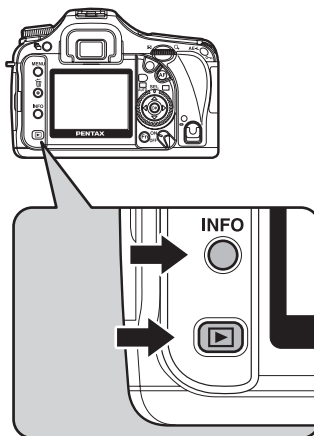

Standard display

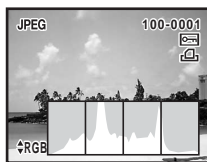

Histogram display



No information display

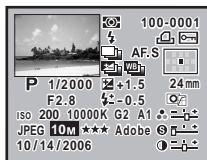

Detailed information display

2 Press the four-way controller (◀▶).

- ◀ : The previous image appears.
- ▶ : The next image appears.

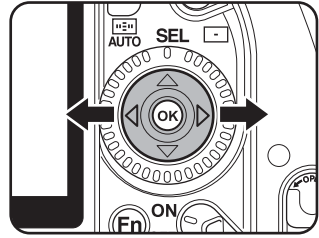

Using the Histogram

3

Basic Operations

A histogram shows the brightness distribution of an image. The horizontal axis represents brightness (dark at the left and bright at the right) and the vertical axis represents the number of pixels.

The *K10D* features two histogram displays. The “Brightness histogram” shows the distribution of brightness and the “RGB histogram” shows the distribution of color intensity.

☞ Histogram Display (p.25)

The shape of the histogram before and after shooting tells you whether the brightness and contrast are correct or not, and lets you decide if you need to use EV compensation and take the picture again.

☞ Setting the Exposure (p.161)

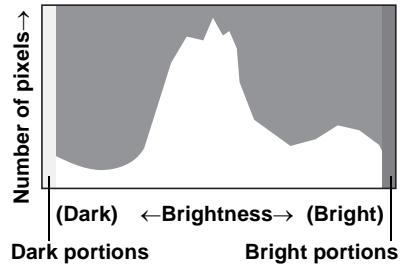

Understanding Brightness

If the brightness is correct, the graph peaks in the middle. If the image is too dark, the peak is on the left side, and if it is too bright, the peak is on the right side.



Dark image

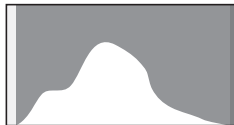

Correct image

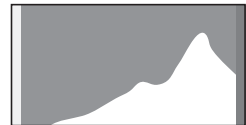

Bright image

When the image is too dark, the part to the left is cut off (dark portions with no detail) and when the image is too bright, the part to the right is cut off (bright portions with no detail).

Bright portions blink red on the LCD monitor and dark portions blink yellow when Bright/Dark area is on.

☞ Playing Back Images (p.85)

☞ Settings During Playback (p.186)

☞ Setting the Display Instant Review and Digital Preview (p.197)

Understanding Contrast

The graph peaks gradually for images in which contrast is balanced. The graph peaks on both sides but sinks in the middle for images with a large difference in contrast and low amounts of mid-level brightness.

Understanding Color Balance

Distribution of color intensity is displayed for each color in the RGB histogram. The right side of the graphs look similar for images that have White Balance adjusted well. If only one color is lopsided to the left, that color is too intense.

☞ Setting the White Balance (p.123)

Rotating Images

The **K10D** features a function that uses a sensor to rotate and correct the direction of the image when an image is captured with the side of the shutter release button facing up and the Mode dial facing down. You can also rotate the captured image 90° counterclockwise at a time with the steps below.



- 1 Press the  button after taking a picture.

The most recently captured image (image with the largest file number) is displayed on the LCD monitor.

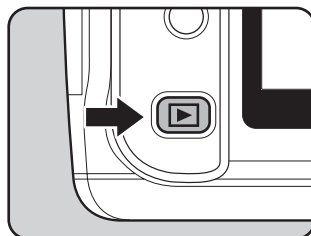

- 2 Press the four-way controller (▼).

The image is rotated 90° counterclockwise each time the button is pressed.

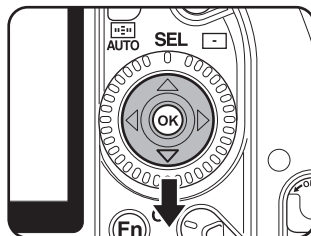

3 Press the OK button.

Image rotation information is saved.

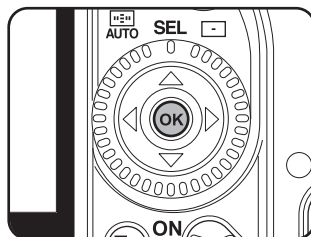

You cannot rotate the image if [Auto Image Rotation] in the [C Custom Setting] menu is set to Off.

Enlarging Playback Images

Images can be magnified up to 20 times in playback mode.

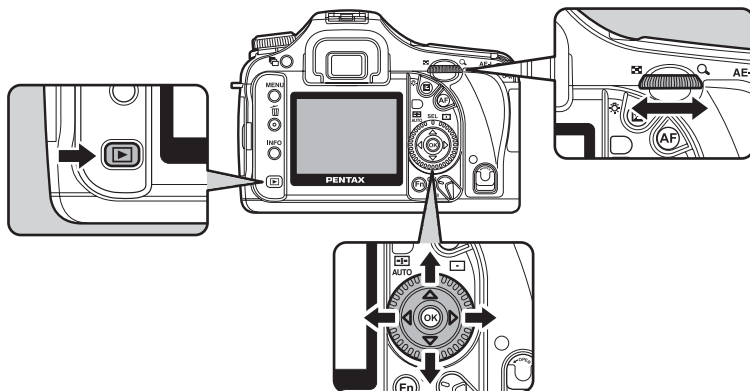

1 Press the button and use the four-way controller (◀▶) to select an image.

The most recently captured image (image with the largest file number) is displayed first on the LCD monitor.

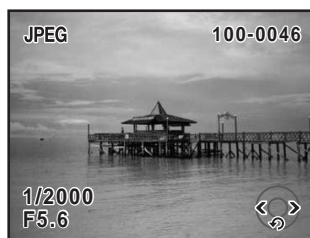

2 Turn the rear e-dial to the right (toward Q).

Image enlarges at each calibration (1.2 times* to 20 times).



Operations available during Enlarged view

Four-way controller (▲▼◀▶)	Moves area to enlarge
Rear e-dial (toward right)/ Green button	Enlarges image (up to 20 times)
Rear e-dial (toward left)/ ☒ button	Reduces image (up to 1.2 times*)
OK button	Returns to the original size
INFO button	Switches information display On/ Off
Front e-dial	Retains magnification and magnification area and shows previous/next image

* The default setting for the first click (minimum magnification) on the rear e-dial (toward right) is 1.2 times. You can change this in [Initial zoom display] in [C Custom Setting] menu. (p.34)



You can enlarge the image by following the same procedure during Instant Review (p.65) or Digital Preview (p.171).

Displaying Multiple Images

You can display 4, 9 or 16 images on the LCD monitor at the same time.

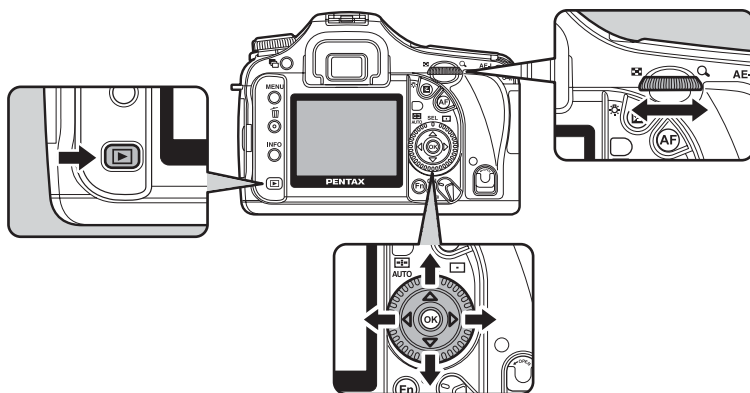

The default setting is 9-image display. The number of images can be changed but 9-image display is explained here.



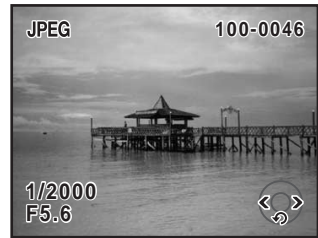

1 Press the button.

The most recently captured image (image with the largest file number) is displayed on the LCD monitor.



2 Turn the rear e-dial to the left (toward).

The multi-image display screen appears.

Up to nine thumbnail images will be displayed at once. Use the four-way controller (   ) to select an image. A scroll bar appears at the right of the screen. With an image selected in the bottom row, pressing the four-way controller () displays the next nine images.

[?] appears for an image that cannot be displayed.

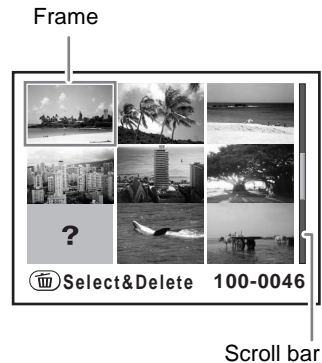

3 Turn the rear e-dial to the right (towards) or press the OK button.

A full screen display of the selected image appears.

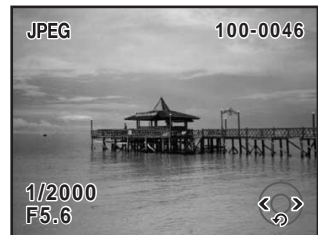

Selecting the Number of Images to Display

- 1 In the multi-image display screen, press the Fn button.

The multi-image options screen appears.

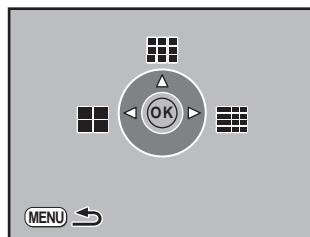

- 2 Use the four-way controller (◀▲▶) to select the number of images to display at once.

◀	4 images
▲	9 images
▶	16 images

The camera returns to the multi-image display screen.

Displaying a Folder

You can display the contents of folders in the multi-image display screen.

- 1 Turn the rear e-dial to the left in the multi-image display screen (in Step 3 on the previous page).

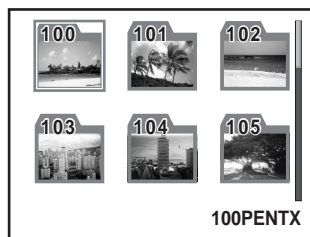

- 2 Use the four-way controller (▲▼◀▶) to select the folder you want to display and press the OK button.

The images in the folder are displayed according to the number selected in the multi-image options screen.

Slideshow

You can play back all images recorded on your SD Memory Card successively. To start continuous playback, use the menu screen displayed on the LCD monitor.

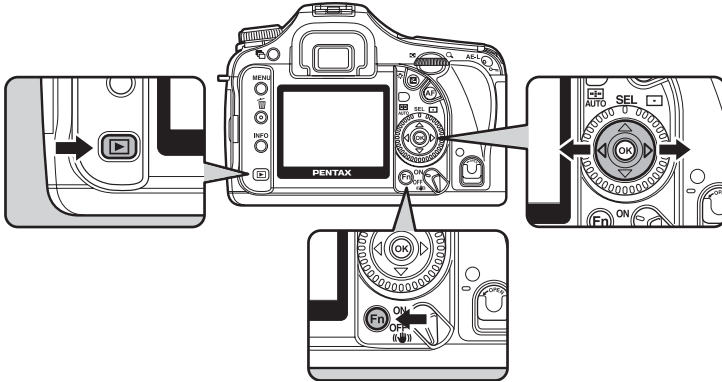

3

Basic Operations

- 1 Press the  button and use the four-way controller ( ) to select an image to be displayed first.

The most recently captured image (image with the largest file number) is displayed first on the LCD monitor.



- 2 Press the Fn button.

The Fn menu appears.

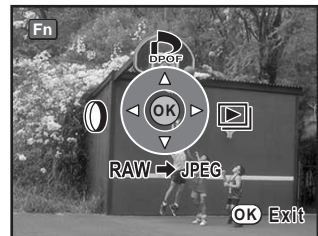

3 Press the four-way controller (▶).

Start screen is displayed and slideshow begins.

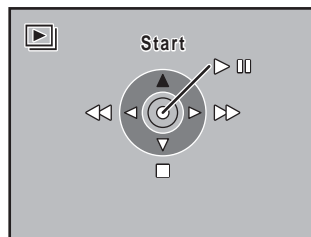

Operations available during a slideshow

- | | |
|-------------------------|----------------------|
| OK button | Pause |
| Four-way controller (◀) | Shows previous image |
| Four-way controller (▶) | Shows next image |
| Four-way controller (▼) | Stop |

Operations available when paused

- | | |
|-------------------------|----------------------------|
| OK button | Resumes playback (Restart) |
| Four-way controller (◀) | Shows previous image |
| Four-way controller (▶) | Shows next image |
| Four-way controller (▼) | Stop |

4 Stop the slideshow.

Slideshow ends when one of the following is performed during playback or when paused.

- Four-way controller (▼) is pressed *¹
- Shutter release button is pressed halfway or fully *²
- **AF** button is pressed *²
- **▶** button is pressed *²
- Main switch is turned to the  position *²
- Mode dial is turned *²
- **MENU** button is pressed *³

*¹ After slideshow ends, the camera switches to Playback mode.

*² After slideshow ends, the camera switches to Capture mode.

*³ After slideshow ends, the Playback menu appears.



Set the display time for slideshow in the [**▶** Playback] menu. Alternatively, start the slideshow from the [**▶** Playback] menu. (p.187)

Connecting the Camera to AV Equipment

By using the video cable, you can play back images using a TV or other device with a video IN jack as your monitor. Make sure that both the TV and the camera are turned off before connecting the cable.

☞ Selecting the Video Output Format (p.195)

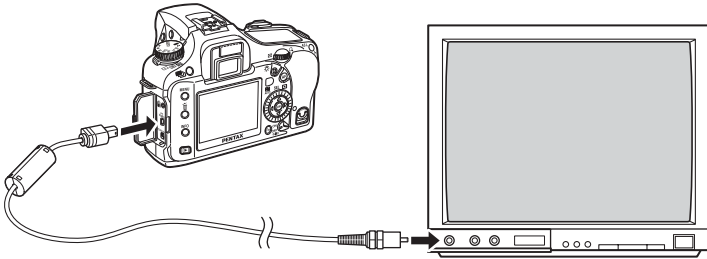

- 1** Open the terminal cover and connect the video cable to the USB/Video terminal.
- 2** Connect the other end of the video cable to the video IN jack on the AV device.
- 3** Turn the AV device and camera on.



- If you intend to use the camera continuously for a long period, use of the AC adapter D-AC50 (optional) is recommended. (p.47)
- For AV equipment with multiple video IN jacks (such as TVs), check the operating manual of the AV device, and select the video IN jack to which the camera is connected.
- Depending on the country or region, images may fail to be played back if the video output format is set different from the one in use there. If this happens, change the video output format setting. (p.195)
- The camera LCD monitor turns off while the camera is connected to the AV device.

Processing Images with Digital Filters

You can edit shot images using digital filters. Processed images are saved under a different name.



- RAW images cannot be processed using the digital filter.
- Additionally, set digital filters from the [▶ Playback] menu.

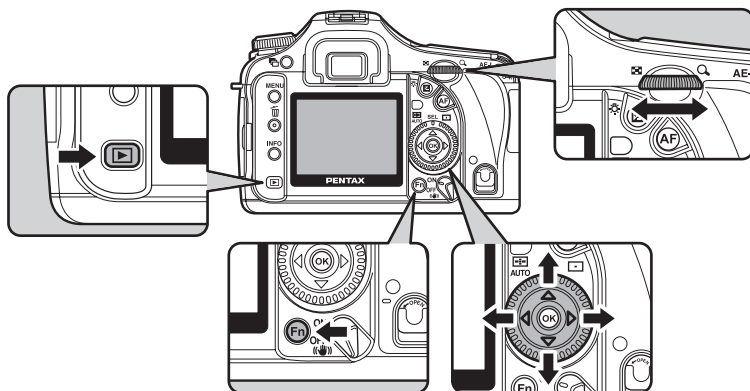

1 Press the Fn button in Playback mode.

The Fn menu appears.

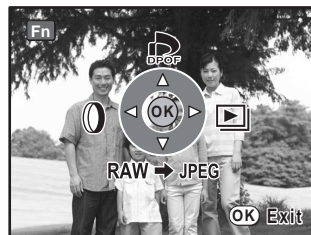

2 Press the four-way controller (◀).

The screen for selecting the filter appears.

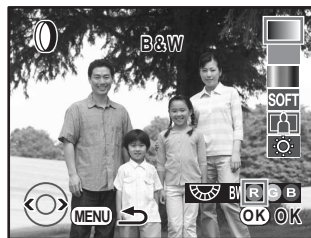

3 Use the four-way controller (◀▶) to select an image.

4 Use the four-way controller (▲▼) to select a filter.

Select a filter and preview the effects on the image.

5 Adjust with the front e-dial and rear e-dial.

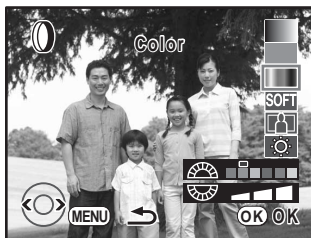

Color Filter

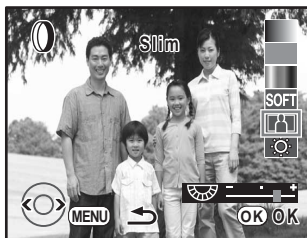

Slim Filter

Filter name	Function	Front e-dial	Rear e-dial
B&W	Converts to a black and white image. Changes the contrast to appear as if a B&W color filter was used.	—	BW/R/G/B
Sepia	Adds a vintage touch to photos by converting them to sepia color. Selects from three levels of density.	—	Density (3 levels)
Color	Adds a color filter to the image. Selects from 18 filters (6 colors × 3 tones).	Red/Green/Blue/Yellow/Magenta/Cyan	Density of each color (3 levels)
Soft	Creates a soft image by lightly fading the entire image. Selects from three levels.	—	Softness (3 levels)
Slim	Changes the horizontal and vertical ratio of images. Adjusts height or width up to two times the original size.	—	Left: Wide Right: Slim
Brightness	Changes the brightness of images. Adjusts in a range of ±8 levels.	—	Left: Dark Right: Light

When another image is selected with the four-way controller (◀▶), the image appears in the set filter.

6 Press the OK button.

The save confirmation screen appears.

7 Use the four-way controller (▲) to select [Save as].



8 Press the OK button.

The filtered image is saved under a different name.

Editing RAW Images

You can convert captured RAW files into JPEG files.

1 Press the Fn button in Playback mode.

The Fn menu appears.

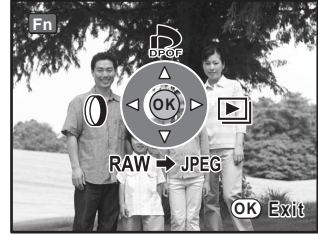

3

Basic Operations

2 Press the four-way controller (▼).

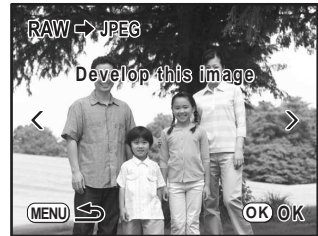

3 Press the OK button.

The parameters recorded in the image file appear.

Proceed to Step 7 if you do not want to change the current parameters.

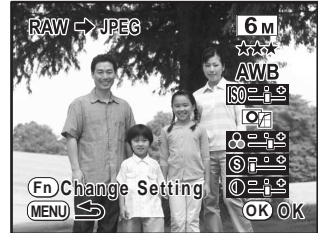

4 Press the Fn button.

5 Use the four-way controller (▲ ▼) to choose the parameter you want to change.

The following parameters can be changed.

Recorded Pixels	10M (3872×2592), 6M (3008×2000), 2M (1824×1216)
Quality Level	★★★ (Best), ★★ (Better), ★ (Good)
White Balance	AWB (Auto), ☀ (Daylight), ☷ (Shade), ☁ (Cloudy), ☀N (Daylight white fluorescent lights), ☀W (White light fluorescent lights), ☀D (Daylight colors fluorescent lights), ☀ (Tungsten Light), ⚡ (Flash), 📷 (Manual), Color Temperature (three types*)
Sensitivity	-2.0~+2.0
Image Tone	☐ (Natural), ☐ (Bright)
Saturation	-3.0~+3.0
Sharpness	-3.0~+3.0
Contrast	-3.0~+3.0

* Four types for images captured with White Balance set to [Color Temperature]



Fine-tuning White Balance, metering Manual White Balance, and entering Color Temperature are not available.

6 Use the four-way controller (◀ ▶) to change the parameter.

7 Press the OK button.

The save confirmation screen appears.



8 Use the four-way controller (▲) to select [Save as].

9 Press the OK button.

The edited image is saved under a different name.

Deleting a Single Image

You can delete one image at a time.



- Deleted images cannot be restored.
- Protected images cannot be deleted.

3

Basic Operations

- 1** Press the button and use the four-way controller () to select an image to delete.

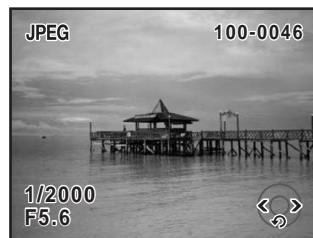

- 2** Press the button.

The Delete screen appears.

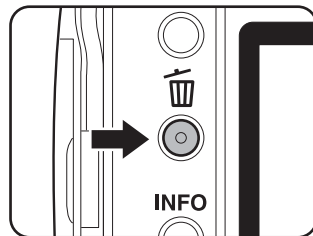

- 3** Use the four-way controller () to select [Delete].

Select the file format to delete for images saved in RAW+ format.

Delete JPEG	Deletes only the JPEG image.
Delete RAW	Deletes only the RAW image.
Delete RAW+JPEG	Deletes both file formats.



4 Press the OK button.

The image is deleted.

Deleting All Images

You can delete all saved images at once.



- Deleted images cannot be restored.
- Protected images cannot be deleted.

1 Press the button.

2 Press the button twice.

The Delete All screen appears.

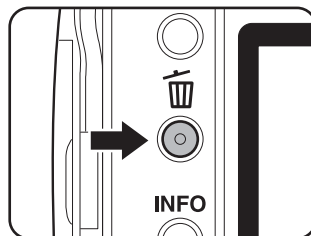

3 Use the four-way controller () to select [Delete All].

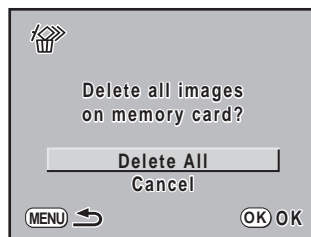

4 Press the OK button.

All images are deleted.

Deleting Selected Images (from Multi-image Display)

You can delete multiple images from the multi-image display at once.



- Deleted images cannot be restored.
- Protected images cannot be deleted.
- Only files in the same folder can be selected at once.

3

Basic Operations

1 Press the button.

The most recently captured image (image with the largest file number) is displayed first on the LCD monitor.

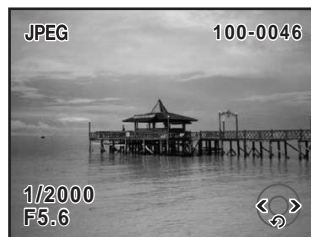

2 Turn the rear e-dial to the left (toward).

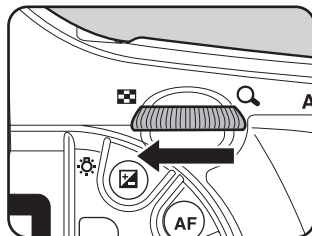

The multi-image display screen appears.



3 Press the button.

appears on the images.

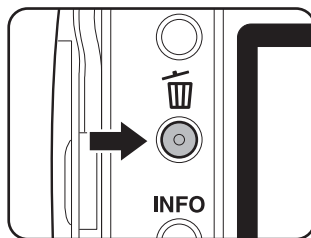

4 Use the four-way controller () to move to the images to delete and press the OK button.

Image is selected and appears.

Press the **Fn** button to select all images (the selection of images may take time to complete depending on the number of images).

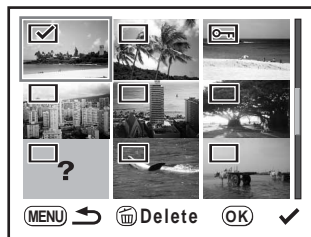

5 Press the button.

The Delete confirmation screen appears.

6 Use the four-way controller () to select [Select&Delete].



7 Press the OK button.

The selected images are deleted.

Protecting Images from Deletion (Protect)

You can protect images from being accidentally deleted.



Even protected images are deleted if the SD Memory Card is formatted.

- 1 Press the button and use the four-way controller (◀▶) to select an image.

The most recently captured image (image with the largest file number) is displayed first on the LCD monitor.

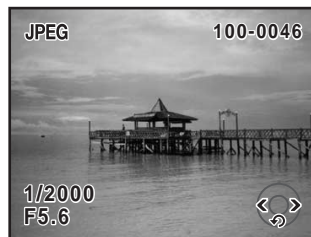

- 2 Press the button.

The Protect screen appears.

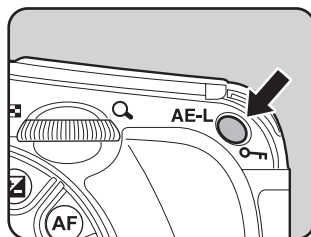

- 3 Use the four-way controller (▲) to select [Protect].





- 4 Press the **OK** button.

The selected image is protected.





- Select [Unprotect] in Step 3 to cancel the Protect setting.
- The icon is displayed when playing back protected images. (p.24, 25)

Protecting All Images

- 1 Press the  button.
- 2 Press the  button twice.

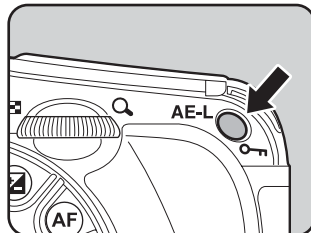
The Protect all images screen appears.



- 3 Press the four-way controller () to select [Protect] and press the OK button.

All images saved in the SD Memory Card are protected.



Select [Unprotect] in Step 3 to cancel the Protect setting on all of the images.

Setting the Printing Service (DPOF)

You can order conventional photograph prints by taking the SD Memory Card with recorded images to a store for a printing service.

DPOF (Digital Print Order Format) settings allow you to specify the number of copies or to imprint the date.



DPOF settings cannot be applied to RAW images.

3

Basic Operations

Printing Single Images

Set the following items for each image.

Copies	Selects the number of copies. You can print up to 99 copies.
Date	Specifies whether you want the date inserted on the print or not.

1 Press the button and use the four-way controller (◀▶) to select an image.

2 Press the Fn button.

The Fn menu appears.

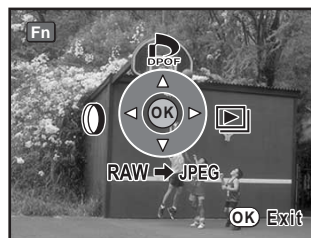

3 Press the four-way controller (▲).

The DPOF screen appears.

If DPOF settings have already been made for an image, the previous number of prints and date setting (☑ (on) or ☐ (off)) will be displayed.

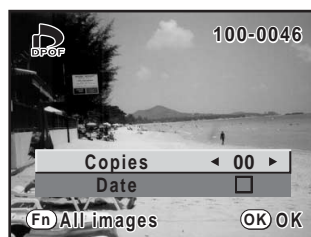

- 4** Use the four-way controller (◀▶) to choose the number of copies and press the four-way controller (▼).

The frame moves to [Date].

- 5** Use the four-way controller (◀▶) to choose whether to insert the date (☑) or not (☐).

- ☑ : The date will be imprinted.
 ☐ : The date will not be imprinted.

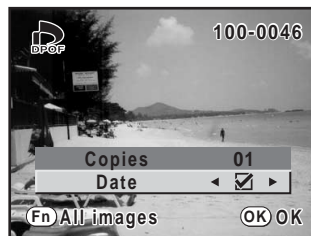

- 6** Press the **OK** button.

The DPOF settings are saved and the camera returns to playback status.



Depending on the printer or printing equipment at the photo processing lab, the date may not be imprinted on the pictures even if the DPOF setting was made.



To cancel DPOF settings, set the number of copies to [00] in Step 4 and press the **OK** button.

Settings for All Images

- 1** Press the **Fn** button in Playback mode.

The Fn menu appears.

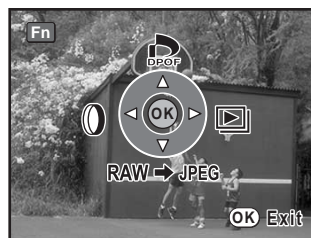

2 Press the four-way controller (▲).

The DPOF screen appears.



3 Press the Fn button.

The screen for making DPOF settings for all images appears.

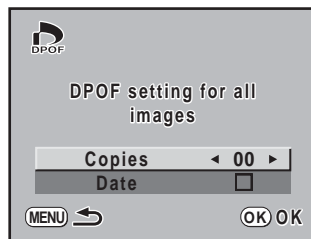

4 Use the four-way controller (◀▶) to choose the number of copies and whether to insert the date (☑) or not (☐).

Refer to Steps 4 and 5 of “Printing Single Images” (p.107) for details of how to make the settings.

5 Press the OK button.

The DPOF settings for all the images are saved and the camera returns to playback status.



The number of copies specified in settings for all images applies to all the images. Before printing, check that the number is correct.



Settings for single images are canceled when settings are made for all images.

This function lets you print images directly from the camera without using a PC (direct printing).

Connect the camera and PictBridge compatible printer with the included USB cable (I-USB17) to print directly.

Select the images you want to print, the number of copies and whether to insert the date or not on the camera after connecting to the printer.

Direct printing is performed in the following steps.

Set [Transfer Mode] on camera to [PictBridge] (p.110)



Connect the camera to the printer (p.111)



Set the printing options (p.106)

Print single images (p.112)

Print all images (p.114)

Print with DPOF settings (p.116)



- Use of the AC adapter D-AC50 (optional) is recommended when connecting the camera to a printer. The printer may not work properly or the image data may be lost if the batteries run out of power while the camera is connected to the printer.
- Do not disconnect the USB cable during data transfer.
- Depending on the type of printer, not all the settings made on the camera (such as print settings and DPOF settings) may be valid.
- A printing error may occur if the selected number of copies exceeds 500.
- Printing an index of images, where multiple images appear on a single sheet, may not be possible unless the printer supports index printing. For index prints, you may need to use a PC.
- RAW images cannot be printed directly from the camera. Use [RAW display] (p.98) to convert to a JPEG image or transfer to a PC and use PHOTO Browser 3 to print RAW images.
- See the “PENTAX PHOTO Browser 3/PENTAX PHOTO Laboratory 3 Operating Manual” when connecting to a PC.

Setting [Transfer Mode]

1 Press the MENU button.

The [📷 Rec. Mode] menu appears.

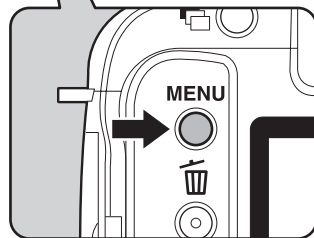
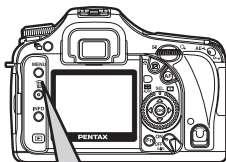

2 Use the four-way controller (◀▶) to select the [🔧 Set-up] menu.

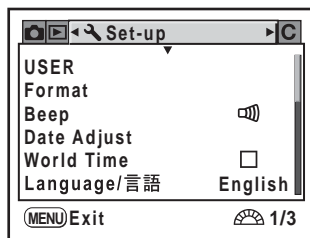

3 Use the four-way controller (▲▼) to select [Transfer Mode].

4 Press the four-way controller (▶).

A pop-up menu appears.

- 5** Use the four-way controller (▲▼) to select [PictBridge].

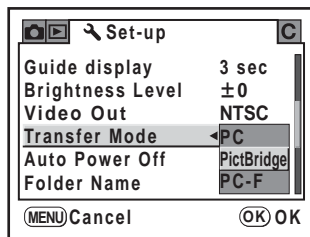

- 6** Press the **OK** button.

The setting is changed.

- 7** Press the **MENU** button.

Connecting the Camera to the Printer

- 1** Turn the camera off.

- 2** Connect the camera and PictBridge compatible printer using the USB cable supplied with the camera.

The PictBridge logo is displayed on PictBridge compatible printers.

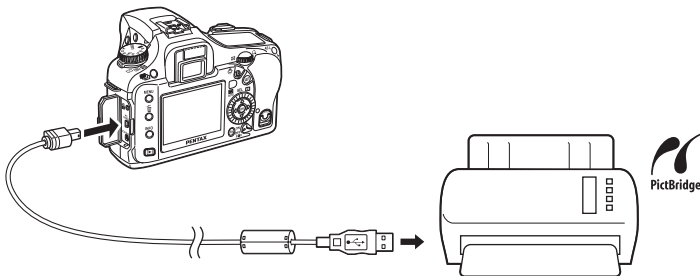

3 Turn the printer on.

4 After printer start-up is complete, turn the camera on.

The PictBridge menu appears.

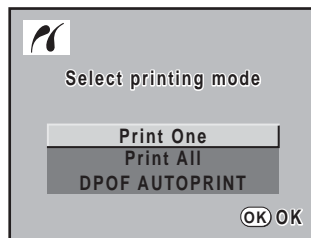

PictBridge menu is not displayed if [Transfer Mode] is set to [PC] or [PC-F].

Printing Single Images

1 Use the four-way controller (▲▼) to select [Print One] on the PictBridge menu.

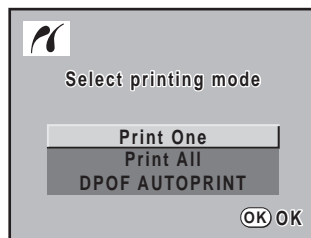

2 Press the OK button.

The Print One screen appears.

3 Use the four-way controller (◀▶) to choose an image to print.

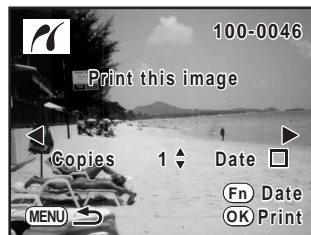

4 Use the four-way controller (▲▼) to choose the number of copies.

You can print up to 99 copies.

5 Use the Fn button to choose whether to insert the date (☑) or not (☐).

☑ : The date will be printed.

☐ : The date will not be printed.

6 Press the OK button.

The print settings confirmation screen appears.

Proceed to Step 12 to print the images by default.

To change the print settings, go to Step 7.

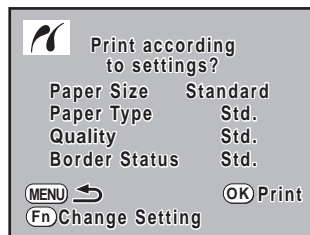

7 Press the Fn button.

The screen for changing print settings appears.

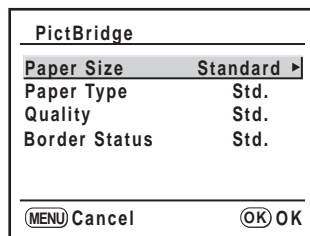

8 Select [Paper Size] and press the four-way controller (▶).

The Paper Size screen appears.

9 Use the four-way controller (▲▼◀▶) to choose the paper size.

You can only choose a size that is supported by your printer.

When the [Paper Size] is set to [Standard], images are printed according to the printer settings.

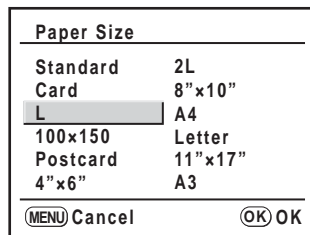

10 Press the **OK** button.

11 Repeat Steps 8 to 10 to set **[Paper Type]**, **[Quality]** and **[Border Status]**.

The print settings change screen appears after each item has been set. When [Std.] is selected for these print settings, images are printed according to the printer settings.

[Paper Type] with more ★s supports higher quality paper.

[Quality] with more ★s indicates higher print quality.

12 Press the **OK** button twice.

The image is printed according to the settings.

Press the **MENU** button to cancel printing.

Printing All Images

1 Use the four-way controller (▲▼) to select **[Print All]** on the **PictBridge** menu.

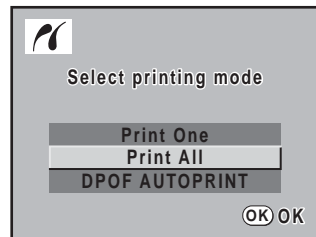

2 Press the **OK** button.

The Print all images screen appears.

3 Choose the number of copies and whether to imprint the date or not.

The number of copies and the date setting that you choose apply to all of the images.

Refer to Steps 4 and 5 of “Printing Single Images” (p.113) for details on how to make the settings.

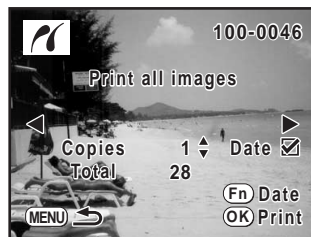

4 Press the OK button.

The print settings confirmation screen appears.

Refer to Steps 7 to 11 of “Printing Single Images” (p.113 and 114) for details on how to change the settings.

5 Press the OK button on the print settings confirmation screen.

All the images are printed according to the settings.

Press the **MENU** button to cancel printing.

Printing Images Using the DPOF Settings

1 Use the four-way controller (▲▼) to select [DPOF AUTOPRINT] on the PictBridge menu.

2 Press the **OK** button.

The Print w/DPOF settings screen appears. Use the four-way controller (◀▶) to check the number of copies for each image, whether the date is imprinted or not, and total number of copies. Print settings are set with the Print Service. (p.106)

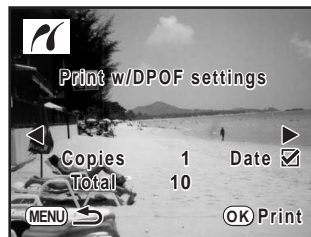

3 Press the **OK** button.

The print settings confirmation screen appears.

Refer to Steps 7 to 11 of “Printing Single Images” (p.113 and 114) for details on how to change the settings.

4 Press the **OK** button on the print settings confirmation screen.

The images are printed according to the settings.

Press the **MENU** button to cancel printing.

Disconnecting the USB Cable

Disconnect the USB cable from the camera and printer when you have finished printing.

1 Turn off the camera.

2 Disconnect the USB cable from the camera and printer.

4 Function Reference

Introduces functions to further enhance your *K10D* experience.

Setting the File Format	118
Focusing	130
Setting the Exposure	138
Checking the Composition, Exposure and Focus Before Shooting	169
Using the Built-in Flash	172
Settings During Playback	186
Camera Settings	188
Resetting to Default Settings	201

Setting the JPEG Recorded Pixels

You can select the number of recorded pixels from **10M**, **6M** and **2M**. The more pixels there are, the larger the picture and the bigger the file size. The file size will also differ according to the [JPEG Quality] setting. The default setting is **10M** 3872×2592.

10M	3872×2592	10"×12" / A3 paper
6M	3008×2000	8"×10" / A4 paper
2M	1824×1216	5"×7" / A5 paper

The paper sizes above are references for optimal printing by recorded pixels. The quality of the captured photo or printed picture depends on the quality level, exposure control, resolution of the printer and a variety of other factors.

You can set the JPEG recorded pixels in [JPEG Rec. Pixels] in the [📷 Rec. Mode] menu. (p.29)

When the number of recorded pixels is changed, the number of recordable images appears at the top right of the screen.

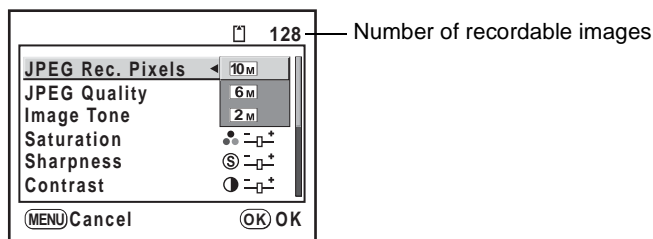

Setting the JPEG Quality Level

You can set the image quality level. The file size will also differ according to the [JPEG Rec. Pixels] setting. The default setting is ★★★ (Best).

★★★	Best	↑ Images will be clearer but file size will be larger. ↓ Images will be grainier but file size will be smaller.
★★	Better	
★	Good	

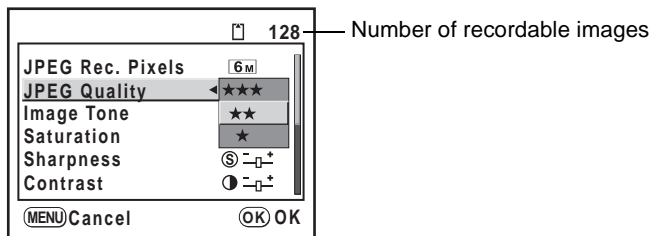

You can set the JPEG quality level in [JPEG Quality] in the [📷 Rec. Mode] menu. (p.29)

When the quality level is changed, the number of recordable images at that quality level appears at the top right of the screen.





Setting the Image Tone

Set the basic color tone of pictures. The default setting is  (Natural).

	Natural	Images are finished naturally and suitable for retouching.
	Bright	Images are finished brightly, with high contrast and sharpness.

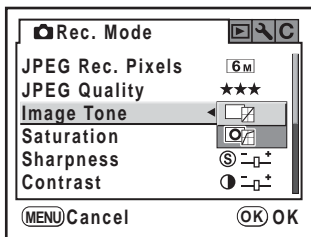
Set in [Image Tone] in the [ Rec. Mode] menu. (p.29)



Different saturation, sharpness and contrast values can be set for  (Bright) and  (Natural).

Setting the Saturation/Sharpness/Contrast

Select from five levels of Saturation, Sharpness and Contrast. The default setting is [0 (Standard)] for all.

Saturation	Sets the color saturation.
Sharpness	Makes the image outlines sharp or soft.
Contrast	Sets the image contrast.

Set [Saturation], [Sharpness] and [Contrast] in the [📷 Rec. Mode] menu. (p.29)

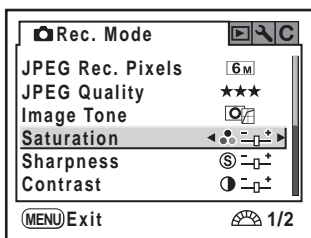

Towards + : Higher saturation

Towards - : Lower saturation

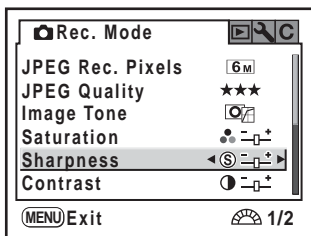

Towards + : Higher sharpness

Towards - : Lower sharpness

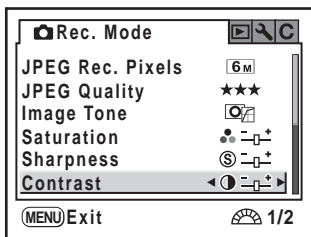

Towards + : Higher contrast

Towards - : Lower contrast

Setting the File Format

You can set the format of image files. The default setting is JPEG.

JPEG	Captures images in JPEG format. You can change the number of recorded pixels from [JPEG Rec. Pixels] in the [📷 Rec. Mode] menu, and the image quality level from [JPEG Quality] in the [📷 Rec. Mode] menu. The file size varies according to the settings.
RAW	RAW data is CCD output data saved without processing. Effects such as White Balance, Contrast, Saturation and Sharpness are not applied to the image but such information is saved. Use Raw Display (p.98) or transfer to a PC, apply effects with the enclosed PENTAX PHOTO Laboratory 3 and create JPEG and TIFF images.
RAW+	Images are captured in both RAW and JPEG formats. Similarly, images are captured in both formats when the RAW button is pressed.

Set [File Format] in the [📷 Rec. Mode] menu. (p.29)

When the file format is changed, the number of recordable images appears at the top right of the screen.

You can select PEF or DNG format in [RAW file format] in the [📷 Rec. Mode] menu when images are captured in RAW format. The default setting is PEF format.

PEF: PENTAX original RAW file format

DNG: General-purpose, publicly available RAW file format designed by Adobe Systems



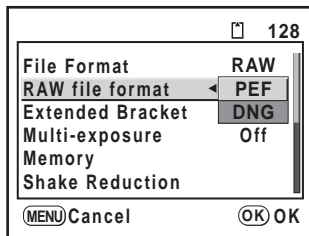
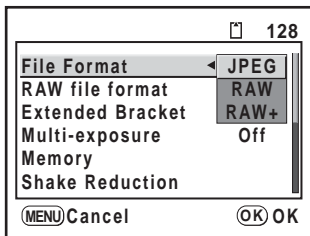



When the File Format is set to RAW or RAW+, the number of recordable images in the format appears at the top right of the screen. The number of recordable images does not appear when the RAW file format is changed when File Format is set to JPEG.



If you press the **RAW** button, RAW+ capture and save is exited after one shot. To continue until the **RAW** button is pressed again, set [One-touch RAW+JPEG] in the [C Custom Setting] menu.

Setting the White Balance

White balance is a function for adjusting the color of an image so that white objects appear white. Set the white balance if you are not satisfied with the color balance of pictures taken with white balance set to **AWB** (Auto), or to intentionally apply a creative effect to your images. The default setting is **AWB** (Auto).

AWB	Auto	Automatically adjusts the white balance. (About 4000 to 8000K)
	Daylight	For use when taking pictures in sunlight. (About 5200K)
	Shade	For use when taking pictures in the shade. It reduces the bluish color tones in a picture. (About 8000K)
	Cloudy	For use when taking pictures on cloudy days. (About 6000K)
	Fluorescent Light	For use when taking pictures under fluorescent lighting. Select the type of fluorescent light, from W (white) (About 4200K), N (neutral white) (About 5000K), and D (daylight) (About 6500K).
	Tungsten Light	For use when taking pictures under light bulb or other tungsten light. It reduces the reddish color tones in a picture. (About 2850K)
	Flash	For use when taking pictures using the built-in flash. (About 5400K)
	Manual	Use this to manually adjust the white balance according to the lighting so that white objects appear as a natural white.
K	Color Temperature	Use this to set the color temperature in figures. You can save three settings.

* The color temperature (K) is an estimate. This does not indicate precise colors.

1 Press the Fn button.

The Fn menu appears.

2 Press the four-way controller (◀).

The White Balance screen appears.

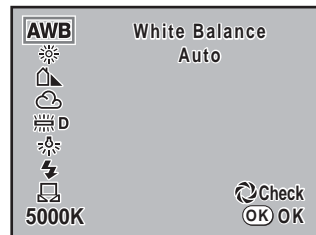

3 Press the four-way controller (▲▼) and set.

Set the main switch to  to display Digital Preview with the set White Balance.

Fine-tuning White Balance is easier with Digital Preview.

4 Press the OK button twice.

The camera is ready to take a picture with the set White Balance.



- Refer to p.125 for manual adjustment method.
- Preview is Digital Preview, regardless of the [Preview Method] setting in the [C Custom Setting] menu.

Fine-Tuning the White Balance

The **K10D** allows you to fine tune the White Balance setting.

1 Perform desired settings in Steps 1 to 3 of “Setting the White Balance”.**2 Press the four-way controller (▶).**

The White Balance fine tune screen appears.

3 Use the four-way controller (▲▼◀▶) to fine tune White Balance.

Seven levels and 225 patterns are available on the G-M and B-A axes.

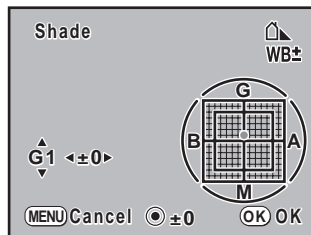

GM compensation	Adjusts the tone of the colors between green and magenta.	▲▼
BA compensation	Adjusts the tone of the colors between blue and amber.	◀▶

Press the Green button to reset the GM compensation and BA compensation.

4 Press the OK button.

The camera returns to the White Balance screen.

5 Press the OK button twice.

The camera is ready to take a picture with the set White Balance.



Set [Fine tune when AWB] in [C Custom Setting] to [Enabled] when fine-tuning in AWB.

Adjusting the White Balance Manually

You can adjust the white balance depending on the light source when taking pictures. With Manual White Balance, the camera can store delicate shades that cannot be precisely adjusted with the white balance preset values provided in the camera (p.123). This provides the optimum white balance for your surroundings.

1 Press the Fn button.

The Fn menu appears.

2 Press the four-way controller (◀).

The White Balance screen appears.

3 Use the four-way controller (▼) to select (Manual).

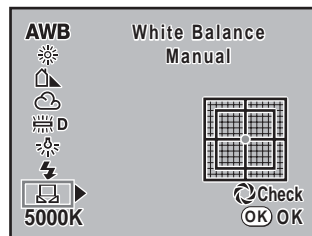

4 Press the four-way controller (▶).

The White Balance fine tune screen appears.

5 Under the light to adjust the white balance, fully display a white sheet of paper in the viewfinder or select a white area as the subject.

6 Press the shutter release button fully.

Slide the focus mode lever to **MF** when the shutter cannot be released.

The screen to select the measuring range is displayed.



7 Use the rear e-dial to select the entire screen or spot area for the measuring range.

Proceed to Step 9 if the entire screen is selected.

8 Use the four-way controller (▲▼◀▶) to move the frame to the area you want to measure.

9 Press the OK button.

The White Balance fine-tuning screen appears when measuring is completed.

Tune using steps in “Fine-Tuning the White Balance” if fine-tuning is necessary. (p.123)

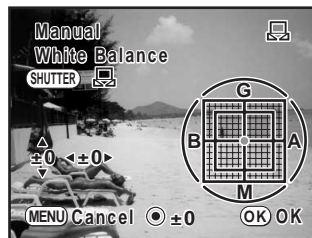

10 Press the OK button.

The camera returns to the White Balance screen.

11 Press the OK button twice.

The camera is ready to take a picture with the set White Balance.



- No image is recorded when the shutter release button is pressed to adjust the white balance.
- [NG] appears when measuring is unsuccessful. Press the **OK** button while displayed to return to the White Balance fine tune screen.
- If the picture is extremely overexposed or underexposed, white balance may not be adjusted. In this case, adjust appropriate exposure and adjust the white balance.

Adjusting the White Balance with Color Temperature

Use figures to set the color temperature.

- 1 Press the Fn button.**
The Fn menu appears.
- 2 Press the four-way controller (◀).**
The White Balance screen appears.
- 3 Use the four-way controller (▼) to select Color temperature (the default setting is 5000K).**

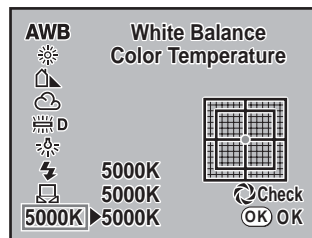

- 4 Press the four-way controller (▶).**
- 5 Use the four-way controller (▲ ▼) to select the Color Temperature to change.**

You can save three settings. Settings are saved to the location selected here. Additionally, perform the same operations to change Color Temperature that has already been set.

- 6 Press the four-way controller (▶).**
The screen to enter the color temperature appears.

7

Adjust the Color Temperature with the front and rear e-dial.

Color Temperature steps differ depending on the e-dial.

	Kelvin	Mired*
Front e-dial	1 Step (100K)	1 Step (20M)
Rear e-dial	10 Steps (1000K)	5 Steps (100M)

* The default setting for Color Temperature step units is Kelvin. You can change the step units to Mired in [Color temp. steps] in the [C Custom Setting] menu. However, figures are converted to Kelvin and displayed.

You can also use the steps for “Fine-Tuning the White Balance” (p.123) to fine tune.

8

Press the OK button.

The settings are saved and the camera returns to the White Balance screen.

Set the main switch to  to display Digital Preview with the set Color Temperature.

9

Press the OK button twice.

The camera is ready to take a picture with the set White Balance.

Color Temperature

The color of light shifts towards blue as the color temperature rises, and towards red as the color temperature falls. Color temperature describes this change in light color in terms of absolute temperature (K: Kelvin). This camera is capable of setting the white balance to enable taking pictures with natural coloring under a variety of lighting conditions.

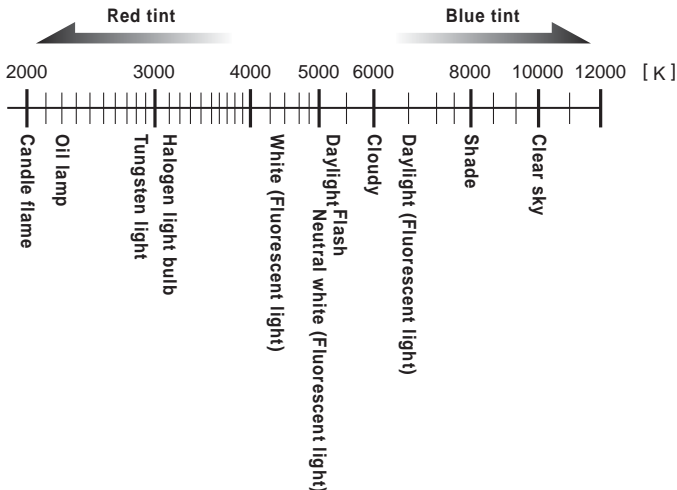

Setting the Color Space

You can set the color space to use. The default setting is [sRGB].

1	sRGB	Sets to sRGB color space.
2	AdobeRGB	Sets to AdobeRGB color space.

Set in [Color Space] in the [**C** Custom Setting] menu. (p.34)

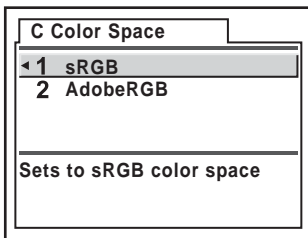

File names differ depending on the color space setting as shown below.

For sRGB : IMGpxxxx.JPG

For AdobeRGB : _IGPxxxx.JPG

[xxxx] is the file number and numbering continues from the last stored file number.

Color Space

Color ranges for various input/output devices, such as digital cameras, monitors, and printers, differ.

This color range is called the Color Space.

To recreate different color spaces in different devices, standard color spaces have been proposed. This camera supports sRGB and AdobeRGB.

sRGB is mainly used for devices such as a PC.

AdobeRGB covers a wider area than sRGB and is used for occupational uses such as industrial printing.

An image created in AdobeRGB may appear lighter than an image created in sRGB when output from a sRGB compatible device.

You can focus with the following methods.

AF	Autofocus	The camera is focused when the shutter release button is pressed halfway.
MF	Manual focus	Manually adjust the focus.

Using the Autofocus

You can also choose the autofocus mode from **A.F.S** (Single mode) where the shutter release button is pressed halfway to focus on the subject and the focus is locked at that position, and **A.F.C** (Continuous mode) where the subject is kept in focus by continuous adjustment while the shutter release button is pressed halfway. The factory default setting is **A.F.S**.

- 1 Set the focus mode lever to **A.F.S** or **A.F.C**.

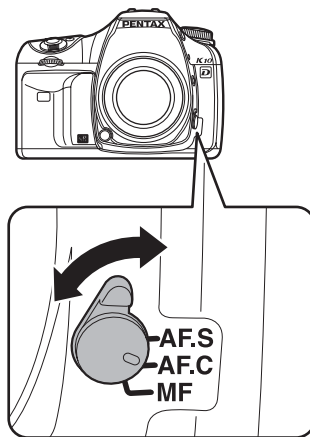

A.F.S	Single mode	When the shutter release button is pressed halfway to focus on the subject, the focus is locked at that position.
A.F.C	Continuous mode	The subject is kept in focus by continuous adjustment while the shutter release button is pressed halfway.

2 Look through the viewfinder and press the shutter release button halfway.



The focus indicator ● appears in the viewfinder when focused (if it is blinking, the subject is not in focus).

☞ Subjects that are Difficult to Focus on (p.66)



Focus indicator





- The camera can be focused by pressing the **AF** button as well as by pressing the shutter release button halfway.
- In **A.F.S** (Single mode), the focus is locked (focus lock) while ● is lit. To focus on another subject, take your finger off the shutter release button first.
- In **A.F.C** (Continuous mode) (p.130), focus is adjusted continuously, tracking the moving object as long as the shutter release button is kept pressed halfway.
- The shutter cannot be released until the subject is in focus in **A.F.S** (Single mode) (p.130). If the subject is too close to the camera, move back and take the picture. Adjust the focus manually if the subject is difficult to focus (p.66). (p.136)
- In **A.F.S** (Single mode), press the shutter release button halfway. The built-in flash will discharge automatically several times, enabling the autofocus to focus on the subject easier if the subject is in a dark area and the built-in flash is available.
- When the shutter release button is pressed halfway to focus and the subject is determined to be a moving object, the **A.F.C** automatically tracks the subject. The camera will automatically operate and continuously focus on the subject.

Selecting the Focusing Area (AF Point)

Choose the part of the viewfinder to set focus to. The factory default setting is  (Auto).

The selected AF point lights red in the viewfinder. (Superimpose AF Area)

	Auto	The camera selects the optimum AF point even if the subject is not centered.
SEL	Select	Sets the focusing area to one of the eleven points in the AF area.
	Center	Sets the focusing area to the center of the viewfinder.

4 Set with the AF point switching dial. (p.18).



- AF point is not displayed in the viewfinder when [Off] is selected for [Superimpose AF Area] in the [C Custom Setting] menu. (p.33)
- The AF point is fixed to the center position regardless of this setting with lenses other than DA, D FA, FA J, FA or F lenses.

Setting the Focus Position in the Viewfinder

- 1 Select SEL (Select) with the AF point switching dial.

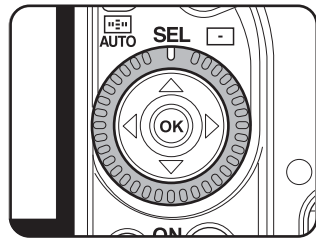

- 2 Look through the viewfinder and check the position of the subject.

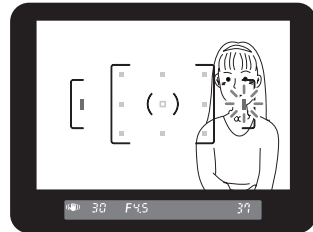

- 3 Use the four-way controller (▲▼◀▶) to select the desired AF point.

The AF point lights red in the viewfinder (Superimpose AF Area) and you can check where you set the AF point.

Fixing the Focus (Focus Lock)

If the subject is outside the range of the focusing area, the camera cannot automatically focus on the subject. In this situation, you can aim the focusing area toward the subject, use focus lock and recompose the picture.

1 Frame the desired composition for your picture in the viewfinder.

Use focus lock function when the subject you wish to focus on is not inside the focusing area.

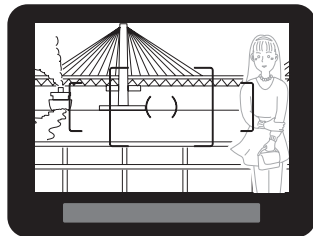

(Example)

The person is out of focus and the background is focused instead.

2 Center the subject to focus in the viewfinder and press the shutter release button halfway.

The focus indicator  appears and you will hear a beep when the subject comes into focus (if it is blinking, the subject is not in focus).

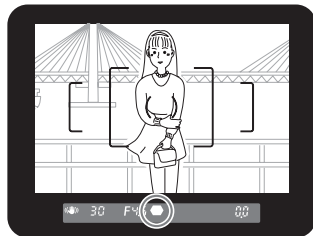

3 Lock the focus.

Keep the shutter release button pressed halfway. The focus will remain locked.

4 Re-compose the picture while keeping the shutter release button pressed halfway.

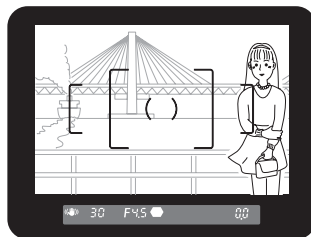

- The focus is locked while the focus indicator ● is lit.
- Turning the zoom ring in focus lock mode may cause the subject to be out of focus.
- The beep can be turned off. (p.189)

Locking Exposure when Focus is Locked

Set [AE-L with AF locked] in the [C Custom Setting] menu (p.33) to lock the exposure value while focus is locked. Exposure is not locked by default during focus lock.

1	Off	Exposure is not locked when focus is locked.
2	On	Exposure is locked when focus is locked.

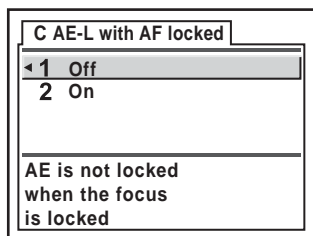

Adjusting the Focus Manually (Manual Focus)

When you adjust the focus manually, you can either check with the focus indicator in the viewfinder or use the viewfinder matte field to adjust focus.

Using the Focus Indicator

You can manually adjust the focus using the focus indicator .

- 1 **Set the focus mode lever to MF.**

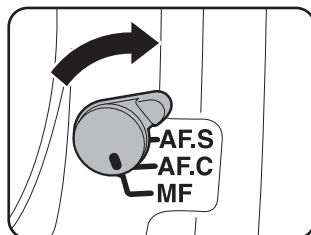

- 2 **Look through the viewfinder, press the shutter release button halfway and turn the focusing ring.**

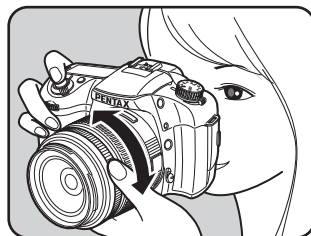

The focus indicator  appears and you will hear a beep when the subject comes into focus.



Focus indicator



- Use the matte field in the viewfinder when the subject is difficult to focus (p.66) and the focus indicator will not stay lit.
- The beep can be turned off. (p.189)

Using the Viewfinder Matte Field

You can manually adjust the focus using the viewfinder matte field.

- 1 **Set the focus mode lever to MF.**

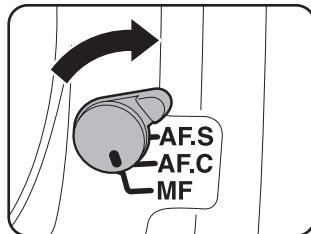

- 2 **Look through the viewfinder and turn the focusing ring until the subject looks sharp on the focusing screen.**

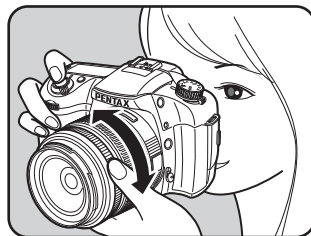

Using the AF Button

The **AF** button operates the autofocus mechanism like when the shutter release button is pressed halfway. (Capturing is performed with the shutter release button.) When the subject is focused with the **AF** button in **A.F.S** (Single mode), focus lock is activated while the button is pressed. The subject will continue to be focused (Autofocus activates) while the **AF** button is pressed in **A.F.C** (Continuous mode).

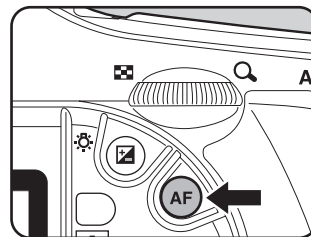

Effect of Aperture and Shutter Speed

Correct exposure of the subject is determined by the combination of shutter speed and aperture setting. There are many correct combinations of shutter speed and aperture for a particular subject. Different combinations produce different effects.

Effect of Shutter Speed

The shutter speed determines the length of time that light is allowed to strike the CCD.

- **Using slower shutter speed**

If the subject is moving, the image will be blurred because the shutter is open longer.

It is possible to enhance the effect of motion (rivers, waterfalls, waves, etc.) by intentionally using a slower shutter speed.

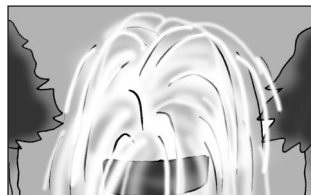

- **Using faster shutter speed**

Choosing a faster shutter speed will allow freezing the action of a moving subject.

A faster shutter speed also helps preventing camera shake.

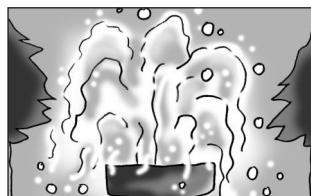

Effect of Aperture

Adjust the amount of light hitting the CCD by changing the aperture.

● Opening the aperture (reduce the aperture value)

Objects closer and farther than the focused subject will be more out of focus. For instance, if you take a picture of a flower against a landscape with the aperture open, the landscape in front and behind the flower will be blurred, emphasizing only the flower.

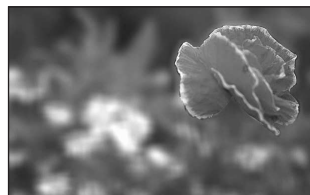

● Closing the aperture (increase the aperture value)

The range in focus expands forward and backward. For instance, if you take a picture of a flower against a landscape with the aperture narrowed, the landscape in front and behind the flower will be in focus.



Depth of Field

When you focus on a portion of the subject, there is a range in which both objects closer and farther will also be in focus. This focused range is called the depth of field.

- The depth of field for the **K10D** differs depending on the lens but compared to a 35 mm camera, the value is roughly one aperture setting lower (the focused range becomes narrower).
- The wider the wide-angle lens, and the farther away the subject, the deeper the depth of field is (some zoom lenses do not have a scale for depth of field because of their designs).

Depth of field	Shallow	←————→	Deep
Area of focus	Narrow	←————→	Wide
Aperture	Open (Smaller value)	←————→	Close (Larger value)
Lens focal length	Longer (Telephoto)	←————→	Shorter (Wide-angle)
Distance to the subject	Near	←————→	Far

Setting the Sensitivity

You can set the sensitivity to suit the brightness of the surroundings. The sensitivity can be set to [AUTO] or within a sensitivity range equivalent to ISO 100 to 1600. The default setting is [AUTO]. Set [Sensitivity] in the Fn menu. (p.36)

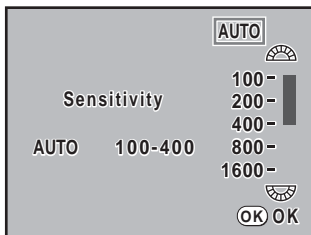

4



- [Sensitivity] in the Fn menu is not available when the exposure mode is set to **Sv** (Sensitivity Priority).
- Settings other than [AUTO] are not available in [Sensitivity] when the exposure mode is set to **TAv** (Shutter & Aperture Priority).
- Captured images can show more noise if higher Sensitivity is set.
- You can set whether to lock the ISO sensitivity adjustment to increments of 1 EV or to coordinate it with the EV Steps (p.162) in [Sensitivity Steps] in the [C Custom Setting] menu.

Setting the Range of Automatic Correction in AUTO

Set range to automatically correct sensitivity when Sensitivity is set to [AUTO]. The sensitivity is automatically corrected in the range of [ISO 100-400] by default.

Turn the front or rear e-dial to set [Sensitivity] in the Fn menu. (p.33)

Front e-dial	Sets the lower sensitivity limit.
Rear e-dial	Sets the upper sensitivity limit.



When the exposure mode is set to **M** (Hyper-manual), **B** (Bulb) or **X** (Flash X-sync speed), the sensitivity cannot be set to [AUTO].

ISO Warning

ISO warning appears in the viewfinder when a sensitivity value of your choice is reached or exceeded. Set a sensitivity that is not regularly used to avoid forgetting to reset when sensitivity is raised. ISO warning is not displayed by default.

1	Off	ISO warning is not displayed.
2	ISO 400	ISO warning is displayed when ISO 400 is set or exceeded.
3	ISO 800	ISO warning is displayed when ISO 800 is set or exceeded.
4	ISO 1600	ISO warning is displayed when ISO 1600 is set.

Set in [ISO warning] in the [C Custom Setting] menu. (p.33)

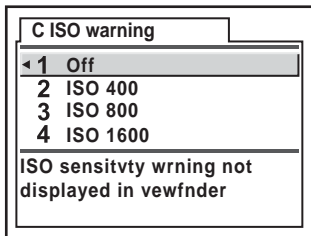







ISO (ISO warning) appears in the viewfinder when the set sensitivity is set or exceeded.



When the sensitivity is set to Auto (p.140), ISO warning is not displayed even if the automatically corrected sensitivity exceeds the set sensitivity setting.

Selecting the Metering Method

Choose the part of the screen to use for measuring brightness and determining exposure.  (Multi-segment metering),  (Center-weighted metering) or  (Spot metering) mode can be selected. The factory default setting is  (Multi-segment metering).

	Multi-segment metering	Segments the screen in 16 parts, meters each portion and determines the appropriate exposure.
	Center-weighted metering	Measures the entire screen with an emphasis on the center and determines the exposure.
	Spot metering	Measures only the center of the screen and determines exposure.

Set with the metering mode lever. (p.18)

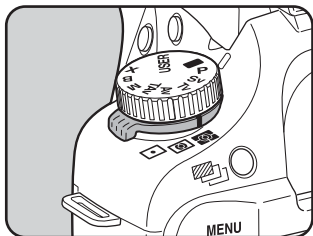

Using the Multi-Segment Metering

The scene in the viewfinder is metered in 16 different zones as shown in the illustration when using the multi-segment metering. This mode automatically determines what level of brightness is in which portion.

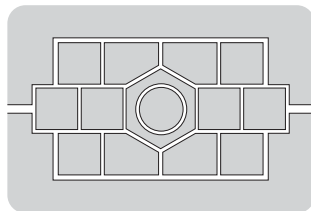

The center-weighted metering mode is automatically set even if you select the multi-segment metering mode when using a lens other than a DA, D FA, FA J, FA, F or A lens, or when lens aperture ring is set at other than **A**. (Can only be used if permission is set in [Using aperture ring] (p.35) in the [C Custom Setting] menu.)

Linking AF Point and AE During Multi-Segmented Metering

In [Link AF Point and AE] (p.33) of the [C Custom Setting] menu, you can link the exposure and AF point in the focusing area during multi-segment metering. The default setting is [Off].

1	Off	Exposure is set separately from AF point.
2	On	Exposure is set in accordance with AF point.

Using the Center-Weighted Metering

Metering is weighted at the center of the screen. Use this metering when you want to compensate the exposure by experience, instead of leaving it to the camera. The illustration shows that sensitivity increases as the pattern height increases (center). This mode does not automatically compensate for backlit scenes.

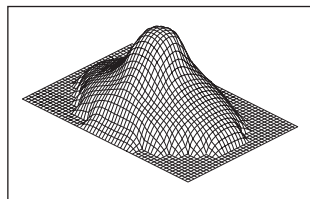

Using the Spot Metering

With spot metering, brightness is measured only within a limited area at the center of the screen as shown in the illustration. You can use this in combination with the AE lock (p.162) when the subject is extremely small and proper exposure is difficult to obtain.

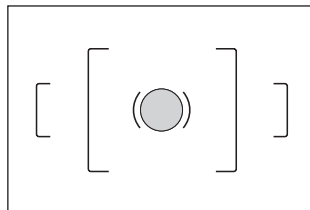

Setting the Meter Operating Time

Sets the exposure metering time in [Meter Operating Time] (p.33) in the [C Custom Setting] menu. The default setting is [10 sec].

1	10 sec	Sets exposure metering timer to 10 seconds.
2	3 sec	Sets exposure metering timer to 3 seconds.
3	30 sec	Sets exposure metering timer to 30 seconds.

Changing the Exposure Mode

This camera features the following nine exposure modes. Use the mode dial (p.38) to change the exposure mode.

Exposure Mode	Description	EV Compensation	Change Shutter Speed	Change Aperture	Page
 (Green)	Automatically sets shutter speed and aperture to the proper exposure according to Program line when taking pictures.	No	No	No	p.146
P (Hyper-program)	Automatically sets shutter speed and aperture to the proper exposure according to Program line when taking pictures. Use the front e-dial and rear e-dial to change the shutter speed and aperture while maintaining the proper exposure.	Yes	Yes	Yes	p.147
Sv (Sensitivity Priority)	Automatically sets the shutter speed and aperture to the proper exposure according to the set sensitivity.	Yes	No	No	p.148
Tv (Shutter Priority)	Lets you set the desired shutter speed for expressing moving subjects. Take pictures of fast moving subjects that look still or subjects that show movement.	Yes	Yes	No	p.150
Av (Aperture Priority)	Lets you set the desired aperture for controlling the depth of field. Use to blur or sharpen the background.	Yes	No	Yes	p.152
TAv (Shutter & Aperture Priority)	Automatically sets the sensitivity so that shutter speed and aperture give the proper exposure according to the brightness of the subject.	Yes	Yes	Yes	p.154

Exposure Mode	Description	EV Compensation	Change Shutter Speed	Change Aperture	Page
M (Hyper-manual)	Lets you set shutter speed and aperture to capture the picture with creative intent.	No	Yes	Yes	p.156
B (Bulb)	Lets you capture images that require slow shutter speeds such as fireworks and night scenes.	No	No	Yes	p.159
X (Flash X-sync speed)	Locks the shutter speed at 1/180 sec. Use this when using an External flash that does not automatically change the shutter speed.	No	No	Yes	p.160

About Program Line

In [Program Line] in the [**C** Custom Setting] menu, choose normal Program line or one of the following. In **■** and **P**, exposure is regulated according to the set Program line.

Normal	Normal program is the basic Program Automatic Exposure.
Hi Speed (Hi-speed priority)	Hi-speed priority program is a Program Automatic Exposure that prioritizes high shutter speeds.
Depth (Depth-of-field priority)	Depth-of-field priority program is a Program Automatic Exposure that prioritizes lower aperture.
MTF (MTF priority)	MTF priority program is a Program Automatic Exposure that prioritizes the best aperture settings for the attached lens and is most effective when combined with a DA, D FA, FA, or FA J lens.

Using the (Green) Mode

Automatically sets shutter speed and aperture value to the proper exposure according to Program line when taking pictures.

- 1 Set the mode dial to .

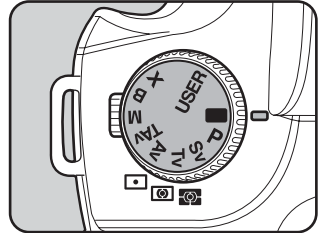

- 2 Confirm the shutter speed and aperture in the viewfinder and on the LCD panel.



Shutter speed, aperture, AE lock, EV compensation, Auto bracket, Multi-exposure, and Flash compensation cannot be set in  (Green) mode.



Set the aperture to the **A** position while holding down the auto-lock button when using a lens with an aperture ring.

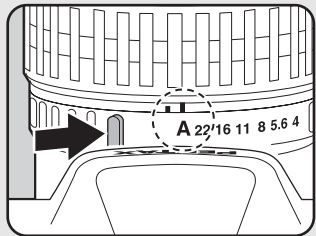

Using the P (Hyper-program) Mode

Automatically sets shutter speed and aperture to the proper exposure according to Program line when taking pictures.

Use the front e-dial and rear e-dial to change the shutter speed and aperture while maintaining the proper exposure (Hyper-program).

1 Set the mode dial to P.

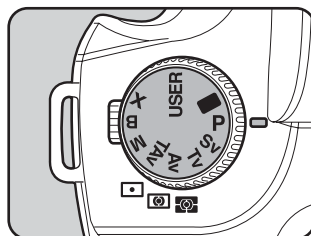

2 Confirm the shutter speed and aperture in the viewfinder and on the LCD panel.

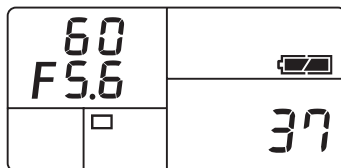

- Set the aperture to the **A** position while holding down the auto-lock button when using a lens with an aperture ring.
- You can change the Program line to use. Set in [Program Line] in the [C Custom Setting] menu.
- You can automatically correct the sensitivity if appropriate exposure cannot be set with the set criteria. Set [Sensitivity] to [AUTO] in the Fn menu. (p.140)

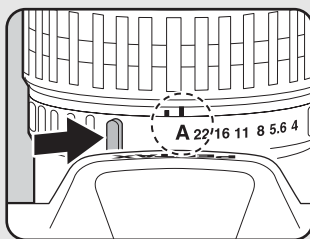

Hyper-program

● To change the shutter speed

You can switch to Shutter Priority automatic exposure by turning the front e-dial in **P** (Hyper-program) mode.

- You can only set the shutter speed to a value that is in relation to aperture.
- If the brightness changes and the aperture value is outside the relative range, the aperture will blink in the viewfinder and on the LCD panel.
- Press the Green button to return to Hyper-program automatic exposure.

● To change the aperture

You can switch to Aperture Priority automatic exposure by turning the rear e-dial in **P** (Hyper-program) mode.

- You can only set the aperture to a value that is in relation to shutter speed.
- If the brightness changes and the shutter speed is outside the relative range, the shutter speed will blink in the viewfinder and on the LCD panel.
- Press the Green button to return to Hyper-program automatic exposure.

Using the Sv (Sensitivity Priority) Mode

You can set the sensitivity to suit the brightness of the subject.

The shutter speed and aperture are automatically set according to the selected sensitivity to obtain the appropriate exposure.

1 Set the mode dial to Sv.

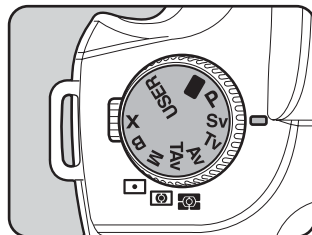

2 Turn the rear e-dial and adjust the sensitivity.

The shutter speed, aperture value and sensitivity are displayed in the viewfinder and on the LCD panel.

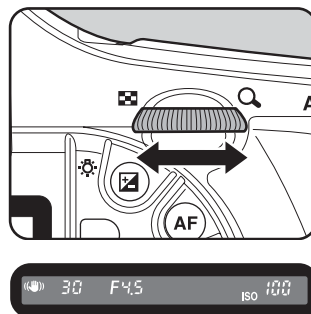

- You can set the sensitivity to values equivalent to ISO 100 to ISO 1600. [AUTO] is not available.
- Turn the front e-dial while pressing the button and change the EV Compensation value. (p.161)
- Set the sensitivity in increments of 1/2 EV or 1/3 EV. Set in [EV Steps] in the [C Custom Setting] menu. (p.162)
- You cannot set the sensitivity in [Sensitivity] in the Fn menu.
- Set the aperture to the **A** position while holding down the auto-lock button when using a lens with an aperture ring.

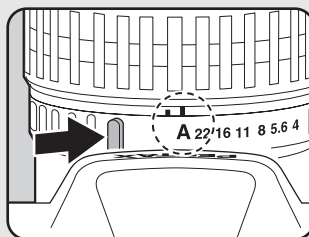

Exposure Warning

If the subject is too bright or too dark, the sensitivity will blink in the viewfinder and on the LCD panel. If the subject is too bright, lower the sensitivity. If it is too dark, raise the sensitivity. When the sensitivity value indication stops blinking, you can take the picture with proper exposure. Use an ND (Neutral Density) filter if the subject is too bright. Use a flash if it is too dark.

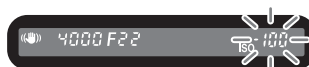

Using the Tv (Shutter Priority) Mode

Set the shutter speed faster and capture fast moving subjects as if they are still or slow down the shutter speed and capture images emphasizing subject movement.

Aperture value is automatically set to give the appropriate exposure depending on the shutter speed.

☞ Effect of Aperture and Shutter Speed (p.138)

1 Set the mode dial to Tv.

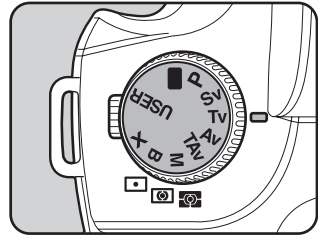

2 Turn the front e-dial and adjust the shutter speed.

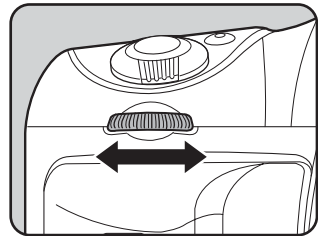

The shutter speed and aperture value are displayed in the viewfinder and on the LCD panel.





- Turn the front e-dial while pressing the button to change the EV Compensation value. (p.161)
- Set the shutter speed in increments of 1/2 EV or 1/3 EV. Set in [EV Steps] in the [C Custom Setting] menu. (p.162)
- You can automatically correct the sensitivity if appropriate exposure cannot be set with the set criteria. Set [Sensitivity] to [AUTO] in the Fn menu. (p.140)
- Set the aperture to the **A** position while holding down the auto-lock button when using a lens with an aperture ring.

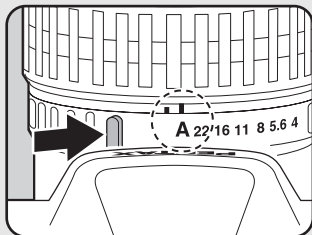

Exposure Warning

If the subject is too bright or too dark, the aperture value will blink in the viewfinder and on the LCD panel. If the subject is too bright, choose a faster shutter speed. If it is too dark, choose a slower shutter speed. When the aperture value indication stops blinking, you can take the picture with proper exposure.

Use an ND (Neutral Density) filter if the subject is too bright.
Use a flash if it is too dark.



Using the Av (Aperture Priority) Mode

Set aperture for controlling the depth of field. The depth of field is deeper and the front and back of the focused object is clear when aperture is set to a large value. The depth of field is shallower and the front and back of the focused object is blurred when aperture is set to a small value.

Shutter speed is automatically set to appropriate exposure depending on the aperture value.

☞ Effect of Aperture and Shutter Speed (p.138)

1 Set the mode dial to Av.

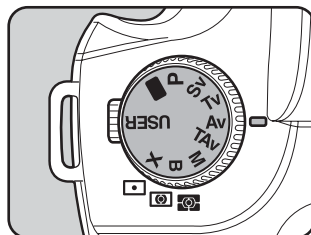

2 Turn the rear e-dial and adjust the aperture value.

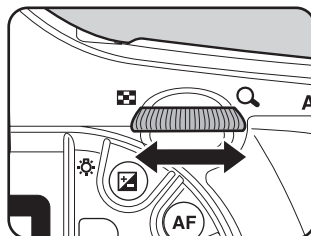

The shutter speed and aperture value are displayed in the viewfinder and on the LCD panel.





- Turn the front e-dial while pressing the  button to change the EV Compensation value. (p.161)
- Set the aperture value in increments of 1/2 EV or 1/3 EV. Set in [EV Steps] in the [C Custom Setting] menu. (p.162)
- You can automatically correct the sensitivity if appropriate exposure cannot be set with the set criteria. Set [Sensitivity] to [AUTO] in the Fn menu. (p.140)
- Set the aperture to the **A** position while holding down the auto-lock button when using a lens with an aperture ring.

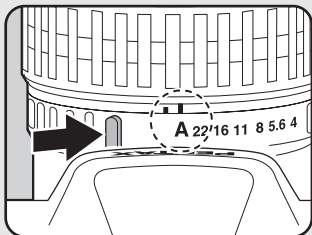

Exposure Warning

If the subject is too bright or too dark, the shutter speed will blink in the viewfinder and on the LCD panel. If the subject is too bright, set the aperture smaller (larger number), and when too dark, open the aperture further (smaller number). Once blinking stops, you can take the picture.

Use an ND (Neutral Density) filter if the subject is too bright.

Use a flash if it is too dark.



Using the TAv (Shutter & Aperture Priority) Mode

You can set both the desired shutter speed and aperture to take the picture.

Automatically sets the sensitivity so that shutter speed and aperture will give the proper exposure according to the brightness of the subject.

1 Set the mode dial to TAv.

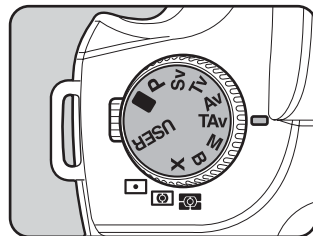

2 Turn the front e-dial and adjust the shutter speed.

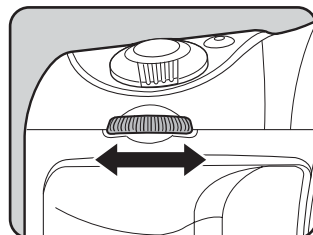

3 Turn the rear e-dial and adjust the aperture value.

The shutter speed, aperture value and sensitivity are displayed in the viewfinder and on the LCD panel.

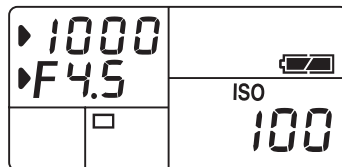
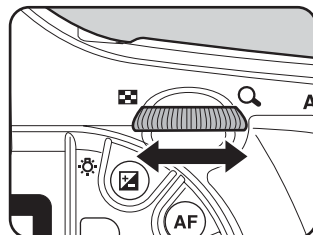



- Turn the front e-dial while pressing the  button to change the EV Compensation value. (p.161)
- Set the shutter speed and aperture values in increments of 1/2 EV or 1/3 EV. Set in [EV Steps] in the [C Custom Setting] menu. (p.162)
- Settings other than [AUTO] are not available in [Sensitivity] in the Fn menu.
- Set the aperture to the **A** position while holding down the auto-lock button when using a lens with an aperture ring.

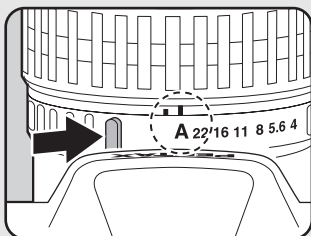

Exposure Warning

If the subject is too bright or too dark, the shutter speed and aperture value will blink in the viewfinder and on the LCD panel. Change the shutter speed and aperture value. When the indication stops blinking, you can take the picture with proper exposure.



Use an ND (Neutral Density) filter if the subject is too bright.
Use a flash if it is too dark.

Using M (Hyper-manual) Mode

This mode is convenient for taking pictures using the same shutter speed and aperture setting combination or taking intentionally underexposed (darker) or over-exposed (brighter) photographs.

☞ Effect of Aperture and Shutter Speed (p.138)

1 Set the mode dial to M.

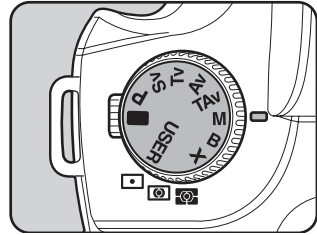

2 Press the Green button.

Automatically switches shutter speed and aperture to the proper exposure.

Turn the front or rear e-dial to change to the exposure to your liking and take a picture.

Adjust the shutter speed with the front e-dial and aperture with the rear e-dial.

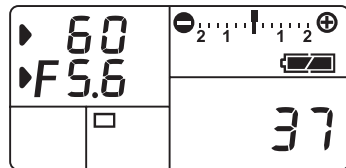
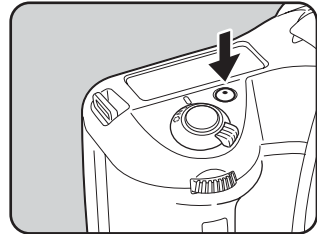



- When the sensitivity is set to [AUTO] and exposure mode is set to **M** (Hyper-manual) mode, the sensitivity is the lowest sensitivity set in “Setting the Range of Automatic Correction in AUTO” (p.140).
- The viewfinder indicator blinks when the difference from appropriate exposure is over ± 3.0 .
- Set the shutter speed and aperture values in increments of 1/2 EV or 1/3 EV. Set in [EV Steps] in the [C Custom Setting] menu. (p.162)
- Set the aperture to the **A** position while holding down the auto-lock button when using a lens with an aperture ring.

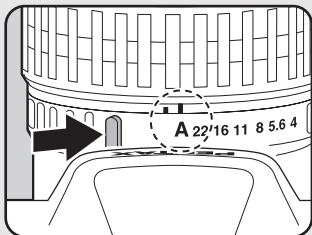

EV Bar

The EV bar appears in the LCD panel and viewfinder in **M** (Hyper-manual) mode. The appropriate exposure is set when **|** is in the middle of the EV bar. If it is towards **-**, it is underexposed. If it is towards **+**, it is overexposed. If the value exceeds the range of the EV bar, the “+” or “-” blinks.

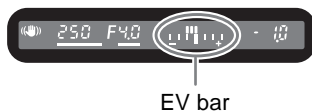

EV bar

Exposure Warning

If the subject is too bright or too dark, “+” or “-” in the EV bar will blink in the viewfinder and on the LCD panel.



Combining with AE-L

Press the **AE-L** button (p.162) to record the exposure value in Hyper-manual. If the shutter speed or aperture is then changed, the combination of shutter speed and aperture changes while exposure is retained.

Example) If the shutter speed is 1/125 sec and aperture is F5.6 and is recorded with the **AE-L** button, and the shutter speed is changed to 1/30 sec with the front e-dial, the aperture automatically changes to F11.

About the Green Button

The aperture and shutter speed are automatically adjusted to the appropriate exposure at that moment if the Green button is pressed in **M** (Hyper-manual) mode. You can choose from the following three adjustment methods in [Green Btn in Manual] in the [**C** Custom Setting] menu.

1	Program Line	The aperture and shutter speed are adjusted automatically.
2	Tv Shift	The aperture is locked and the shutter speed is adjusted automatically.
3	Av Shift	The shutter speed is locked and the aperture is adjusted automatically.

Shutter speed is adjusted to appropriate exposure according to lens aperture when lens aperture is not set to **A** position.

 Notes on [Using Aperture Ring] (p.210)

Using the **B** (Bulb) Mode

This mode is useful for the long exposures required for shooting night scenes and fireworks.

The shutter remains open as long as the shutter release button is kept pressed.

1 Set the mode dial to **B**.

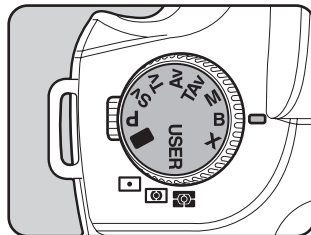

- Turn the rear e-dial to adjust the aperture value.
- Set the aperture value in increments of 1/2 EV or 1/3 EV. Set in [EV Steps] in the [C Custom Setting] menu. (p.162)
- Use a sturdy tripod and the cable switch CS-205 (optional) to prevent camera shake when using **B** (Bulb) mode. Connect the cable switch to the cable switch terminal (p.17).
- Bulb shooting is available when using the remote control shooting mode (p.81). The shutter remains open as long as the shutter release button of the optional remote control is held down.
- Noise reduction is a process to reduce noise (image roughness or unevenness) caused by low shutter speed. Set [Noise Reduction] in the [C Custom Setting] menu. (p.34)
- When the sensitivity is set to [AUTO] and exposure mode is set to **B** (Bulb) mode, the sensitivity is the lowest sensitivity set in “Setting the Range of Automatic Correction in AUTO” (p.140).

Using the **X** (Flash X-Sync Speed) Mode

The shutter speed is locked at 1/180 seconds. Use this when using an External flash that does not automatically change the shutter speed.

1 Set the mode dial to **X**.

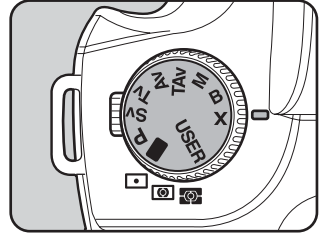

4



- Turn the rear e-dial to adjust the aperture value.
- Press the Green button to retain the shutter speed at 1/180 sec and automatically adjust the aperture.
- When the sensitivity is set to [AUTO] and exposure mode is set to **X** (Flash X-sync speed) mode, the sensitivity is the lowest sensitivity set in “Setting the Range of Automatic Correction in AUTO” (p.140).

Setting the Exposure

This allows you to deliberately overexpose (brighten) or under-expose (darken) your picture.

Select 1/2 EV or 1/3 EV in [EV Steps] in the [C Custom Setting] menu. (p.162)

You can adjust the EV Compensation from -3 to +3 (EV) in increments of 1/2 EV or -2 to +2 (EV) in increments of 1/3 EV.

- 1 **Set the compensation with the front e-dial while the  button is pressed.**

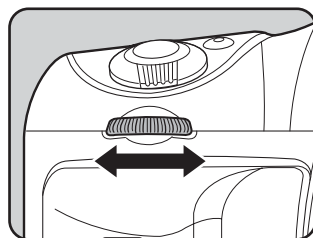
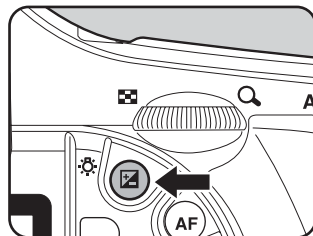

- 2 **Confirm the compensation value in the viewfinder.**

 is displayed during compensation.

 appears when the flash compensation is set.



Compensation value



EV compensation is not available when the exposure mode is set to **■** (Green), **M** (Hyper-manual), **B** (Bulb) or **X** (Flash X-sync speed) mode.



- The EV compensation cannot be canceled by turning the camera off or by setting any other exposure mode.
- The EV compensation value is reset to 0 when the Green button is pressed while holding down the  button.

Changing the Exposure Steps

Set Exposure Steps in [EV Steps] in [C Custom Setting] to increments of 1/2 EV or 1/3 EV.

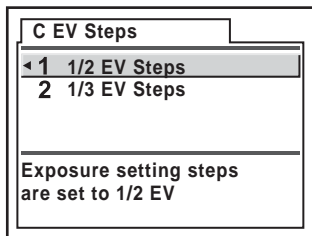

Recording the Exposure Before Shooting (AE Lock)

AE Lock is a function that memorizes the exposure prior to taking the picture. Use this when the subject is too small or backlit and a proper exposure setting cannot be obtained.

1 Press the **AE-L** button.

The camera memorizes the exposure (brightness) at that instant. Press it again to unlock.

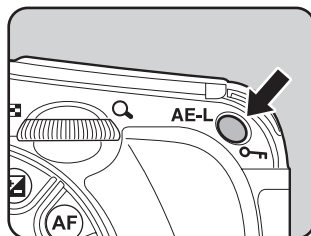

- * is displayed in the viewfinder while the AE lock is engaged. (p.26)
- The exposure remains in memory for twice as much time as the metering timer after releasing the **AE-L** button. The exposure remains locked as long as the **AE-L** button is kept pressed or the shutter release button is kept pressed halfway.
- You will hear a beep when the **AE-L** button is pressed. The beep can be turned off. (p.189)
- AE lock is not available when the exposure mode is **■** (Green), **B** (Bulb) or **X** (Flash X-sync speed) mode.
- The combination of shutter speed and aperture value changes depending on the zooming position even while the AE lock is engaged when using a zoom lens for which maximum aperture varies depending on the focal length. However, the exposure value does not change and the picture is taken at the brightness level set by the AE lock.
- Exposure can be locked when focus is locked. Set in [AE-L with AF locked] in the [C Custom Setting] menu. (p.135)

Changing the Shooting Conditions Automatically when Shooting (Auto Bracket)

Shooting in Exposure Bracket Mode

You can take continuous pictures with different exposure when the shutter release button is pressed. The first frame is exposed with no compensation, the second frame is underexposed (negative compensation) and the third is overexposed (positive compensation) (when the number of frames is set to [3]).



Normal exposure



Underexposure



Overexposure

You can set [Auto Bracketng order] in the [C Custom Setting] menu.

Auto Bracketng order	0 → - → +, - → 0 → +, + → 0 → -
----------------------	---------------------------------

1 Set the number of frames.

Turn the front e-dial while pressing the  button. Select OFF (no frames), 3 or 5.

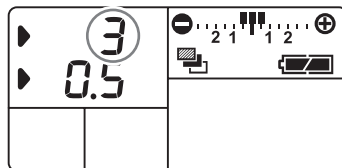
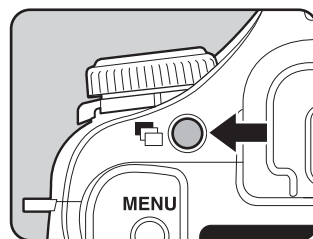

2 Set the step interval.

Turn the rear e-dial while pressing the  button. The available bracketing amounts in [EV Steps] in the [C Custom Setting] menu (p.33) are as follows.

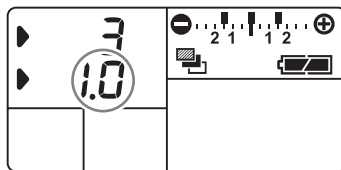

Bracketing amount (Step interval)	1/2 EV	$\pm 0.5, \pm 1.0, \pm 1.5, \pm 2.0$
	1/3 EV	$\pm 0.3, \pm 0.7, \pm 1.0, \pm 1.3, \pm 1.7, \pm 2.0$

3 Press the shutter release button halfway.

Focus indicator  appears in the viewfinder when focused.

4 Press the shutter release button fully.

Three continuous pictures will be taken, the first with no compensation, the second with negative compensation, and the third with positive compensation (when the number of frames is set to [3]).



- When the focus mode is set to **A.F.S** (Single mode), the focus is locked in the first frame position and used for subsequent continuous frames.
- When you release your finger from the shutter release button during Auto Bracket, the Auto Bracket exposure setting will remain effective for twice as much time as the exposure metering timer (default setting is 20 seconds) (p.143) and you can take a picture at the next compensation value. In this case, auto focusing works for each frame. After about twice as much time as the exposure metering timer (default setting is 20 seconds), the camera returns to settings for taking the first picture.
- You can combine Auto Bracket with the built-in flash or external flash (P-TTL auto only) to change only the flash output continuously. However, when using an external flash, holding the shutter release button down to take three continuous frames may cause the second and third frame to be taken before the flash is fully recharged. Always take one frame at a time after confirming that charging is complete.
- Exposure Bracket is not available when the exposure mode is set to **B** (Bulb) mode.
- Exposure Bracket and Multi-exposure cannot be used together. The mode set afterwards is set.

Taking Only Overexposed or Underexposed Pictures

You can use Auto Bracket mode for only underexposure or overexposure shots by combining the operation with EV compensation (p.161). Auto Bracket is performed in both cases on the basis of the specified EV compensation value.

Shooting in Extended Bracket Mode

You can save pictures with three different white balance, saturation, sharpness and contrast levels.

Unlike exposure bracketing, three pictures are saved with each shot.

You can set the saving order with [Auto Bracketng order] in the [C Custom Setting] menu.

Auto Bracketng order	0 → - → +, - → 0 → +, + → 0 → -
----------------------	---------------------------------

- 1 Select [Extended Bracket] in the [Rec. Mode] menu and press the four-way controller (▶).

The Extended Bracket screen appears.

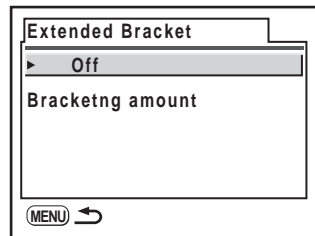

- 2 Press the four-way controller (▶).

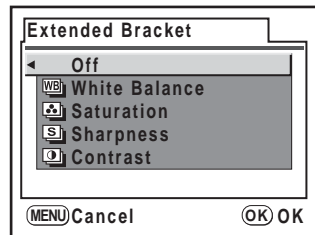

- 3 Use the four-way controller (▲ ▼) to choose an item.

- 4 Press the OK button.

- 5 Use the four-way controller (▼) to select the step and press the four-way controller (▶).

For [White Balance], select from BA±1, BA±2, BA±3, GM±1, GM±2 and GM±3. The default setting is BA±1.

For [Sharpness], [Saturation] and [Contrast], select from ±1, ±2 and ±3. The default setting is ±1.

- 6 Press the OK button twice.

7 Press the **MENU** button.

The camera returns to the Capture mode.

8 Shoot.

Three frames are saved.



- You can use extended bracketing in combination with exposure bracketing (p.163).
- Extended Bracket and Multi-exposure cannot be used together. The mode set afterwards is set.
- Extended bracket is disabled when File Format is set to RAW or RAW+.
- If Extended Bracket is set when File Format is RAW or RAW+, File Format changes to JPEG.

4

Shooting in Multi-exposure Mode

You can take multiple frames while creating a single picture.

1 Select [Multi-exposure] in the [CAMERA] menu and press the four-way controller (▶).

The Multi-exposure screen appears.

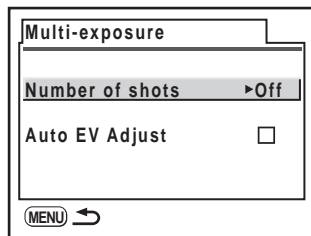

2 Use the four-way controller (▶) to select the number of shots.

Use the four-way controller (▲▼) to select from 2 to 9 shots.

3 Press the **OK** button.

4 Use the four-way controller (▼) to set Auto EV Adjust.

5 Use the four-way controller (▶) to set Auto EV Adjust to (On) or (Off).

When (On) is set, the exposure is adjusted automatically according to the number of shots.

6 Press the OK button.

The camera returns to the Capture mode.

7 Shoot.

The created picture is displayed in Instant Review each time the shutter release button is pressed. Press the  button during Instant Review to discard pictures created to that point and create again from the first picture. The picture is saved when the set number of shots has been taken.



- If the **RAW** button or **MENU** button is pressed, or the Exposure Bracket is set during Multi-exposure shooting, the pictures that have already been taken are saved and Multi-exposure is exited.
- Multi-exposure and Auto Bracket or Extended Bracket cannot be used together. The mode set afterwards is set.

Storing User Settings











You can store the current camera settings and easily retrieve them simply by setting the mode dial to **USER**.



The following settings can be stored.

Exposure mode	White Balance
Flash mode	File Format
EV Compensation	JPEG Rec. Pixels
Exposure Bracketing Steps & No. of Frames	JPEG Quality
Drive mode	Image Tone
Flash Exposure Compensation	Saturation
Extended Bracketing Steps & Type	Sharpness
Sensitivity	Contrast
Auto Sensitivity Adjustment Range	

Store the settings in [USER] in the [ Set-up] menu.

Saves current shooting
settings in USER mode

P   +1.3  1.0x5
 -1.0  AE±3
 ISO AUTO 200-1600  
 10000K G2 A1  
 RAW+10M ***  

 Cancel  OK

Changing the Settings in USER Mode

You can also perform settings when the mode dial is set to **USER**. To change the Exposure Mode, press the **MENU** button in Capture mode and perform settings in [Exposure Mode] in the [USER] menu.

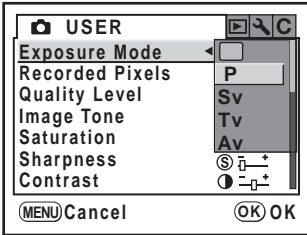

4



Settings performed in **USER** mode are not saved unless they are registered in [USER] in the [Set-up] menu.

Checking the Composition, Exposure and Focus Before Shooting

You can use the preview function to check the depth of field, composition, exposure and focus before taking a picture. There are 2 preview methods.

Optical Preview	For checking the depth of field with the viewfinder.
Digital Preview	For checking the composition, exposure and focus in the LCD monitor.

Selecting the Preview Method

Choose the preview method to use when the main switch is turned to the preview position (Ⓢ). The default setting is Optical Preview. Set in [Preview Method] in the [C Custom Setting] menu. (p.34)

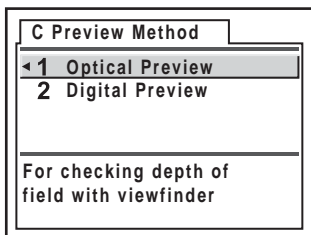



Displaying the Preview

Display the Optical Preview or Digital Preview.

Displaying the Optical Preview

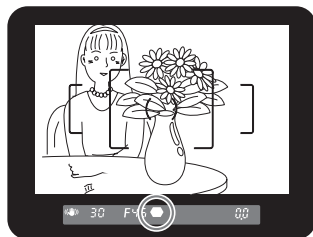
- 1 **Position the subject inside the AF frame and press the shutter release button halfway.**



- 2 **Turn the main switch to  while looking through the viewfinder.**

You can check the depth of field in the viewfinder while the main switch is on .

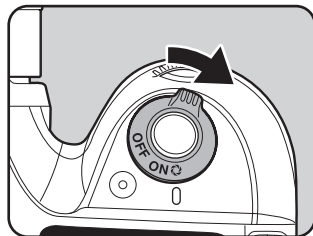

- No shooting information is displayed in the viewfinder, and the shutter cannot be released while the main switch is in the preview position (.
- You can check the depth of field in all exposure modes.

Displaying the Digital Preview

- 1 **Focus on the subject, then compose the picture in the viewfinder and move the main switch to .**

The icon () appears in the LCD monitor during preview and you can check the composition, exposure and focus.

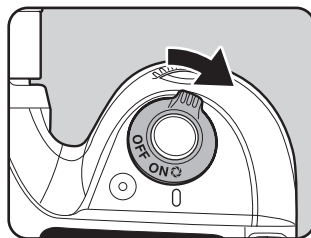

Press the shutter release button halfway to end Digital Preview and start focusing. The image displayed in Digital Preview is not saved.



- You can display the Bright/Dark area warning or histogram in Digital Preview. Set in [Digital Preview] (p.198) in the [▶ Playback] menu.
- The maximum display time for Digital Preview is 60 seconds.
- You can magnify the image during Digital Preview with the rear e-dial. (p.89)

Compensating Flash Output

You can change the flash output in a range of -2.0 to $+1.0$. The Flash Compensation values are as follows for $1/2$ EV and $1/3$ EV.

Step interval	Flash Compensation
$1/2$ EV	$-2.0, -1.5, -1.0, -0.5, 0.0, +0.5, +1.0$
$1/3$ EV	$-2.0, -1.7, -1.3, -1.0, -0.7, -0.3, 0.0, +0.3, +0.7, +1.0$

* Set interval of steps in [EV Steps] in the [C Custom Setting] menu. (p.162)

Turn the rear e-dial to set [Flash Mode] in the Fn menu (p.36).

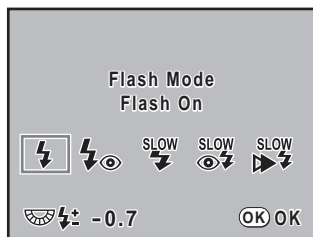

- The flash output cannot be compensated in Green mode.
- appears in the LCD panel and the viewfinder during Flash Compensation. (p.26)
- If the maximum flash output is exceeded when corrected to the plus (+) side, no compensation will be effective.
- Compensating to the minus (-) side may not effect the image if the subject is too close, aperture is low or sensitivity is high.
- This flash compensation is also effective for external flash units which support P-TTL auto flash mode.

Allowing Shooting while Charging Flash

You can set to enable shooting while flash is being charged. Set [On] for [Release when Chrging] in the [C Custom Setting] menu (p.34). Pictures cannot be taken while the flash is charging by default.

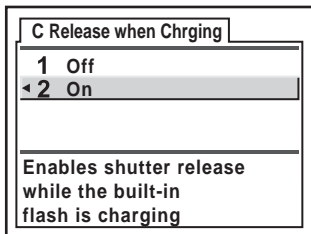

Flash Characteristics in Each Exposure Mode

Using the Flash in Tv (Shutter Priority) Mode

- When taking a moving subject, you can use the flash to change the blur effect.
- Any desired shutter speed 1/180 sec. or slower can be set for taking a flash photograph.
- The aperture value automatically changes according to the ambient brightness.
- The shutter speed is locked at 1/180 sec. when lens other than DA, D FA, FA J, FA, F or A is used.

Using the Flash in Av (Aperture Priority) Mode

- You can set the desired aperture to take a flash photograph when you want to change the depth of field or shoot a subject farther away.
- The shutter speed automatically changes with the ambient brightness.
- The shutter speed shifts automatically anywhere from 1/180 sec. to a slow shutter speed (p.62) that reduces camera shake. The slowest shutter speed depends on the focal length of the lens in use.
- The shutter speed is locked at 1/180 sec. when lens other than DA, D FA, FA J, FA or F is used.



Using Slow-Speed-Sync

You can use slow-speed-sync when shooting portraits with the sunset in the background. Both the portrait and the background are captured beautifully.





- Slow-speed-sync slows the shutter speed. Use the Shake Reduction function or turn off the Shake Reduction function and use a tripod to avoid camera shake. The picture will also blur if the subject moves.
- Slow-speed-sync shooting can also be performed with an external flash.

● Using P/Sv/Av mode

- 1 Set the mode dial to **P**, **Sv** or **Av**.
- 2 Press the **⚡UP** button.
- 3 Press the **Fn** button and press the four-way controller (▼).
- 4 Select  or  and press the **OK** button twice.
Shutter speed is set slower to obtain proper exposure for the background.
- 5 Take the picture.

● Using Tv/TAv/M mode

- 1 Set the mode dial to **Tv**, **TAv** or **M**.
- 2 Press the **Fn** button and press the four-way controller (▼).
- 3 Select  or  and press the **OK** button twice.
- 4 Set the shutter speed (**Tv**) or shutter speed and aperture (**TAv/M**).
Set so that proper exposure is obtained in under 1/180 sec.
- 5 Press the **⚡UP** button.
- 6 Take the picture.

Using Trailing Curtain Sync

Trailing curtain sync discharges the flash immediately before the shutter curtain closes. When shooting moving objects with a slow shutter speed, Trailing curtain sync and Slow-speed sync produce different effects depending on when the flash is discharged.

For example, when shooting a moving car with Trailing curtain sync, trailing light is captured while the shutter is open and the flash captures the car when the shutter is released. Therefore, a picture that looks as if light is trailing is captured.

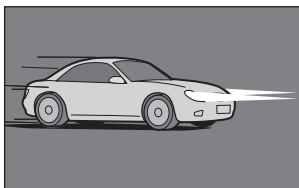

Slow-speed sync

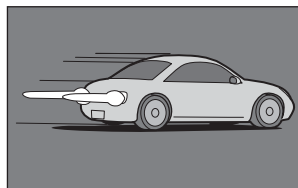

Trailing curtain sync

- 1 Set the mode dial to any mode other than **■** or **X**.
- 2 Press the **Fn** button and press the four-way controller (**▼**).
- 3 Select **▶▶**^{SLOW}**▶▶** and press the **OK** button twice.
- 4 Press the **⚡UP** button.
- 5 Take the picture.



Trailing curtain sync slows the shutter speed. Turn off the Shake Reduction function and use a tripod to avoid camera shake.

Distance and Aperture when Using the Built-in Flash

A set criteria is necessary between the guide number, aperture and distance when shooting with the flash.

Calculate and adjust the shooting conditions if flash is not sufficient.

Built-in flash guide number

Sensitivity	Built-in flash guide number
ISO 100	11
ISO 200	15.6
ISO 400	22
ISO 800	31
ISO 1600	44

4

Function Reference

Calculating Shooting Distance from Aperture Value

The following equation calculates the distance of the flash for aperture values.

Maximum flash distance $L1 = \text{Guide number} \div \text{Selected aperture}$

Minimum flash distance $L2 = \text{Maximum flash distance} \div 5^*$

* The value 5 used in the formula above is a fixed value which applies only when using the built-in flash alone.

Example

When sensitivity is [ISO 100] and aperture value is F2.8

$L1 = 11 \div 2.8 = \text{approx. } 3.9 \text{ (m)}$

$L2 = 3.9 \div 5 = \text{approx. } 0.8 \text{ (m)}$

Therefore, the flash can be used in a range of about 0.8 m to 3.9 m.

The flash cannot be used when the distance is less than 0.7 m. When the flash is used at closer than 0.7 m, it causes vignetting in the picture corners, light is distributed unevenly and the picture may be over-exposed.

Calculating Aperture Value from Shooting Distance

The following equation calculates the aperture value for shooting distances.

Aperture value used $F = \text{Guide number} \div \text{Shooting distance}$

When sensitivity is [ISO 100] and shooting distance is 5 m, aperture value is:

$F = 11 \div 5 = 2.2$

If the resulting number (2.2, in the above example) is not available as a lens aperture, the smaller number that is closest (2, in the above example) is generally used.

DA, D FA , FA J, FA and F Lens Compatibility with the Built-in Flash

When using DA, D FA, FA J, FA and F lenses with the *K10D* without the hood, built-in flash compatibility is shown below.

Yes : Available

: Available depending on other factors

No : Unavailable due to vignetting

Following are evaluated without a hood.

Lens Name	Compatibility
DA Fish-eye 10-17 mm F3.5-4.5ED (IF)	No
F Fish-eye 17-28 mm F3.5-4.5	# Vignetting may occur if focal length is less than 20 mm.
DA12-24 mm F4ED AL	No
DA16-45 mm F4ED AL	# When the focal length is less than 28 mm or when the focal length is 28 mm and the shooting distance is less than 1 m, vignetting may occur.
FA J18-35 mm F4-5.6AL	Yes
DA18-55 mm F3.5-5.6AL	Yes
FA20-35 mm F4AL	Yes
FA24-90 mm F3.5-4.5AL (IF)	Yes
FA28-70 mm F4AL	Yes
FA★28-70 mm F2.8AL	# Vignetting may occur if focal length is 28 mm and the shooting distance is less than 1 m.
FA J28-80 mm F3.5-5.6	Yes
FA28-80 mm F3.5-5.6	Yes
FA28-90 mm F3.5-5.6	Yes
FA28-105 mm F4-5.6	Yes
FA28-105 mm F4-5.6 (IF)	Yes
FA28-105 mm F3.2-4.5AL (IF)	Yes
FA28-200 mm F3.8-5.6AL (IF)	Yes
FA35-80 mm F4-5.6	Yes
DA50-200 mm F4-5.6ED	Yes
FA70-200 mm F4-5.6	Yes

Lens Name	Compatibility
FA J75-300 mm F4.5-5.8AL	Yes
FA★80-200 mm F2.8ED (IF)	Yes
FA80-320 mm F4.5-5.6	Yes
FA80-200 mm F4.7-5.6	Yes
FA100-300 mm F4.7-5.8	Yes
FA★250-600 mm F5.6ED (IF)	No
DA14 mm F2.8ED (IF)	No
FA20 mm F2.8	Yes
DA21 mm F3.2AL Limited	Yes
FA★24 mm F2AL (IF)	Yes
FA28 mm F2.8AL	Yes
FA31 mm F1.8AL Limited	Yes
FA35 mm F2AL	Yes
DA40 mm F2.8 Limited	Yes
FA43 mm F1.9 Limited	Yes
FA50 mm F1.4	Yes
FA50 mm F1.7	Yes
DA70 mm F2.4 Limited	Yes
FA77 mm F1.8 Limited	Yes
FA★85 mm F1.4 (IF)	Yes
FA135 mm F2.8 (IF)	Yes
FA★200 mm F2.8ED (IF)	Yes
FA★300 mm F2.8ED (IF)	No
FA★300 mm F4.5ED (IF)	Yes
FA★400 mm F5.6ED (IF)	Yes
FA★600 mm F4ED (IF)	No
D FA Macro 50 mm F2.8	Yes
D FA Macro 100 mm F2.8	Yes
FA Macro 50 mm F2.8	Yes
FA Macro 100 mm F2.8	Yes
FA Macro 100 mm F3.5	Yes
FA★ Macro 200 mm F4ED (IF)	Yes
FA Soft 28 mm F2.8	# Built-in flash always discharges fully.
FA Soft 85 mm F2.8	# Built-in flash always discharges fully.

Using an External Flash (Optional)

Using the optional external flash AF540FGZ or AF360FGZ enables a variety of flash modes, such as P-TTL auto flash mode, high-speed flash sync mode, and wireless mode. See the chart below for details.

(Yes: Available #: Restricted No: Not available)

Camera Function \ Flash	Built-in Flash	AF540FGZ AF360FGZ
Red-eye reduction flash	Yes	Yes
Automatic flash discharge	Yes	Yes
After the flash is charged, the camera automatically switches to the flash sync speed.	Yes	Yes
Aperture is automatically set in P (Hyper-program) mode and Tv (Shutter Priority) mode.	Yes	Yes
Auto check in the viewfinder	No	No
P-TTL auto flash (appropriate sensitivity: 100 to 1600)	Yes ^{*1}	Yes ^{*1}
Slow-speed sync	Yes	Yes
Flash Exposure Compensation	Yes	Yes
AF illuminator	Yes	Yes
Trailing curtain sync ^{*2}	Yes	Yes
Contrast-control-sync flash mode	# ^{*3}	Yes
Slave flash	No	Yes
Multiple flash	No	No
High-speed flash sync	No	Yes
Wireless flash ^{*4}	No	Yes

*1 When using DA, D FA, FA J, FA, F or A lens.

*2 Shutter speed of 1/90 sec. or slower.

*3 When combined with the AF540FGZ or AF360FGZ, 1/3 of the flash discharge can be output by the built-in flash and 2/3 can be output by the external flash.

*4 Two or more AF540FGZ or AF360FGZ units are required.

About the LCD Panel Display for AF360FGZ

The AF360FGZ does not have the function to set the FORMAT size to [DIGITAL], but the difference in angle of view between standard 35 mm format and the **K10D** is automatically calculated based on the focal length of the lens used (when using DA, D FA, FA J, FA or F lenses). The conversion indicator appears and the format size indicator disappears when the exposure metering timer of the **K10D** is on (it returns to 35 mm format display when the exposure metering timer is turned off).

Lens focal length		85mm	77mm	50mm	35mm	28mm	24mm	20mm	18mm
AF360FGZ LCD panel	Exposure metering timer Off	85mm	70mm	50mm	35mm	28mm	24mm	20mm	18mm
	Exposure metering timer On	58mm	48mm	34mm	24mm	19mm	16mm*	14mm	12mm

* Using wide-angle panel

Using P-TTL Auto Mode

Use this flash mode with the AF540FGZ or AF360FGZ flash unit. When flash mode is set to [P-TTL auto], the flash pre-fires right before taking pictures using 16-segment metering and allows more precise control. P-TTL auto is available in wireless flash mode when two or more AF540FGZ or AF360FGZ units are used.

- 1 Remove the cover of the hot shoe and attach the external flash (AF540FGZ or AF360FGZ).
- 2 Turn on the camera and the external flash.
- 3 Set the external flash mode to [P-TTL auto].
- 4 Confirm that the external flash is fully charged and then take the picture.



- P-TTL auto is only available with the AF540FGZ or AF360FGZ flash unit.
- The will light in the viewfinder when the flash is ready (fully charged).
- For details such as operation method and effective distance, please read the external flash manual.
- The flash does not discharge when the subject is bright enough when Flash Mode is or . Therefore, it may not be suitable for daylight-sync shooting.
- Never press the flash pop up button when any external flash unit is attached to the camera. The built-in flash will hit the external flash. If you want to use both at once, see p.183 for the connection method.

Using High-Speed Flash Sync Mode

With the AF540FGZ or AF360FGZ, you can discharge the flash to take a picture at a shutter speed faster than 1/180 second. High-speed flash sync can be used with the flash attached to the camera, or wireless.

Attaching and Using the AF540FGZ or AF360FGZ on the Camera

- 1 Remove the cover of the hot shoe and attach the external flash (AF540FGZ or AF360FGZ).
- 2 Turn the mode dial and set the exposure mode to **Tv** or **M**.
- 3 Turn on the camera and the external flash.
- 4 Set the external flash sync mode to HS  (high-speed flash sync).
- 5 Confirm that the external flash is fully charged and then take the picture.



- The  will light in the viewfinder when the flash is ready (fully charged).
- High-speed flash sync is only available when the shutter speed is faster than 1/180 sec.
- High-speed flash sync is not available when the exposure mode is set to **B** (Bulb).

Using in Wireless Mode

You can shoot using the flash without connecting the camera and flash with a cord by using two external flashes (AF540FGZ or AF360FGZ). The High-speed sync mode is also available in wireless mode.



Be sure to set the two external flashes (AF540FGZ or AF360FGZ) to the same channel. See the AF540FGZ or AF360FGZ operating manual for details.

● Using in Wireless Mode

- 1 Place the external flash (AF540FGZ or AF360FGZ) at the desired location.
- 2 Set the power switch of the above external flash to [WIRELESS].
- 3 Set the wireless mode of the above external flash to [S] (Slave).
- 4 Turn on the camera, and then turn the mode dial and set the exposure mode to **■**, **P**, **Sv**, **Tv**, **Av**, **TAv** or **M**.
- 5 Set the power switch of the external flash on the camera to [WIRELESS].
- 6 Set the wireless mode of the external flash on the camera to **M** (Master) or **C** (Control).



- Wireless mode is not available for the built-in flash.
- Set the wireless slave mode of the external flash to [SLAVE1].
- Shake Reduction is not available in Wireless mode.

Wireless Flash Control (P-TTL Flash Mode)

The following information is exchanged between the two external flash units (AF540FGZ or AF360FGZ) before the flash is discharged when the external flash units are used for wireless flash.

Press the shutter release button fully.

- 1 The flash unit on the camera emits a small control flash (relays the flash mode of the camera).
- 2 The external wireless flash unit emits a small control flash (relays confirmation of subject).
- 3 The flash unit on the camera emits a small control flash (relays flash output to the external wireless flash unit).
 - * The flash unit on the camera will emit a small control flash one more time after this to relay the flash duration time when HS  (High-speed sync) is set.
- 4 The external flash unit(s) discharges as main flash.



Set the wireless slave mode of the external flash to [SLAVE1].

Red-Eye Reduction

As with the built-in flash, red-eye reduction is available with an external flash. This may not be available on some flashes or may have restrictions for usage conditions. See the chart on p.179.



- The red-eye reduction feature works even when only an external flash is used. (p.74)
- If red-eye reduction is used when the external flash is set as the slave unit or with the wireless function, the preflash for red-eye reduction will trigger the external flash. Do not use red-eye reduction when using a slave unit.

Trailing Curtain Sync

When using the built-in flash with an external flash (AF540FGZ or AF360FGZ) that is set to the Trailing curtain sync function, the built-in flash will also use this mode. Confirm that both flash units are fully charged before shooting.

Using the Built-in Flash with the External Flash

As shown in the figure below, attach the hot shoe adapter F₆ (optional) to the camera hot shoe and an off-camera shoe adapter F (optional) to the bottom of the external flash, and connect these with the extension cord F5P (optional). The off camera shoe adapter F can be mounted using the tripod screw to your tripod.

Only the P-TTL auto flash can be used in combination with the built-in flash.

When combining with the built-in flash

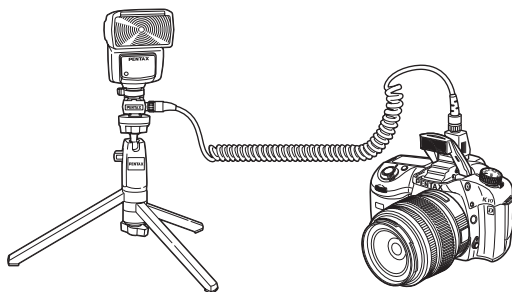

Discharging Multiple Flashes

You can combine two or more external flashes (AF540FGZ or AF360FGZ) or you can use an external flash in combination with the built-in flash. You can use the extension cord connection terminal on the flash to connect the AF540FGZ. You can connect AF360FGZ units as shown in the illustration below. Connect an external flash and the Hot Shoe Adapter F (optional) to the Off-Camera Shoe Adapter F (optional) and then connect another Off-Camera Shoe Adapter F with external flash using the Extension Cord F5P (optional). Refer to the flash manual for details.



- Do not combine with accessories that have a different number of contacts such as a Hot Shoe Grip. A malfunction may occur.
- Combining with flashes from other manufacturers may cause equipment breakdown. We recommend using the AF540FGZ or AF360FGZ.

4

Function Reference

When combining two or more external flashes

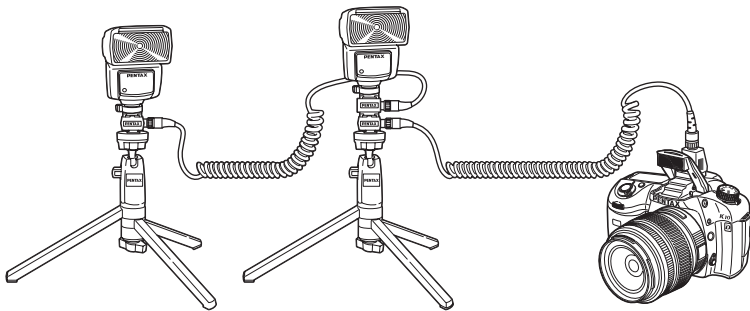

When using multiple external flashes or an external flash with the built-in flash, P-TTL is used for flash control.

Contrast-Control-Sync Flash

Combining two or more external flashes (AF540FGZ or AF360FGZ) or using an external flash in combination with the built-in flash allows multiple flash photography (contrast-control-sync flash photography). This is based on the difference between the amounts of light discharged from multiple units.



- Do not combine with accessories that have a different number of contacts such as a Hot Shoe Grip as a malfunction may occur.
- Combining with flashes from other manufacturers may cause equipment breakdown. We recommend using PENTAX automatic flashes.

- 1 Connect the external flash to the camera indirectly. (p.183)
- 2 Set the sync mode for the external flash to the Contrast-Control-Sync mode.
- 3 Turn the mode dial and set the exposure mode to **P**, **Tv**, **Av** or **M**.
- 4 Confirm that both the external flash and built-in flash are fully charged and then take the picture.



- When using two or more external flashes and the Contrast-Control-Sync mode is set on the external master flash unit, the flash output ratio is 2 (master unit) : 1 (slave units). When external flash is used in combination with the built-in flash, the flash output ratio is 2 (external flash) : 1 (built-in flash).
- When using multiple external flashes or an external flash with the built-in flash, P-TTL is used for flash control.
- The fastest flash synchronization speed is 1/180 second in the Contrast-Control-Sync mode.

Changing Playback Display Method

The camera switches display information when you press the **INFO** button in the Playback screen.

Standard	Captured image and indicators are displayed.
Histogram	Images and histogram (Brightness/RGB) are displayed.
Detailed Info	Shooting information appears with a small image in the upper left.
No info. Display	Only captured images are displayed.

4



- Refer to p.24 for various display information details.
- The information that is shown first during Playback is the last screen that was displayed in the previous session. The information can also be displayed from Standard in [Memory] (p.199) in the [📷 Rec. Mode] menu.

1 Select [Playback display] in the [▶ Playback] menu.

2 Press the four-way controller (▶).

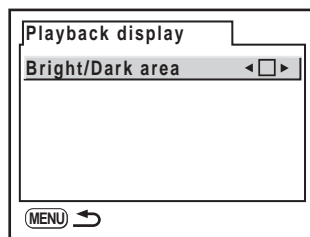

3 Use the four-way controller (◀▶) to select (On) or (Off).

4 Press the **MENU** button twice.

The camera is ready to take a picture.

Setting the Slideshow Display Interval

You can play back all images recorded on your SD Memory Card successively. (p.92)

Set image display interval to [3 sec], [5 sec], [10 sec] or [30 sec]. The default setting is [3 sec].

Set whether or not to play back repeatedly. The default setting is [Off].

- 1 Select [Slideshow] in the [▶ Playback] menu.

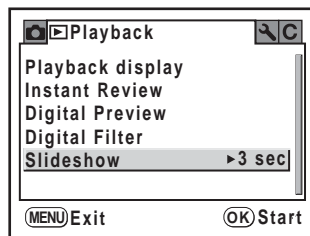

- 2 Press the four-way controller (▶).

- 3 Press the four-way controller (▶) and use the four-way controller (▲ ▼) to select the image display interval.

Press the **OK** button.

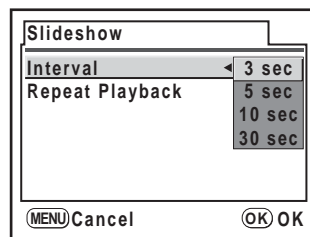

- 4 Use the four-way controller (▼) to select [Repeat Playback].

- 5 Use the four-way controller (◀ ▶) to select (On) or (Off).

- 6 Press the **MENU** button.

The camera returns to the [▶ Playback] menu.

Press the **OK** button to start slideshow.

Formatting the SD Memory Card

Use this camera to format (initialize) an SD Memory Card that is unused or has been used on other cameras or digital devices.

Formatting will delete all the data on the SD Memory Card.



- Do not open the card cover while formatting SD Memory Card. The card may be damaged beyond use.
- Formatting will delete protected data. Be aware.

4

Function Reference

1 Select [Format] in the [**↖** Set-up] menu (p.32).

2 Use the four-way controller (**▶**) to display the Format screen.

3 Use the four-way controller (**▲**) to select [Format].

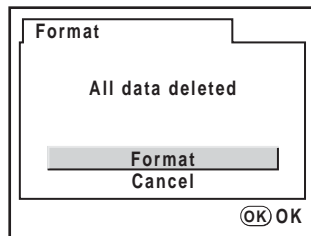

4 Press the OK button.

Formatting starts. When formatting is completed, the LCD display turns off and the camera is ready to take pictures.

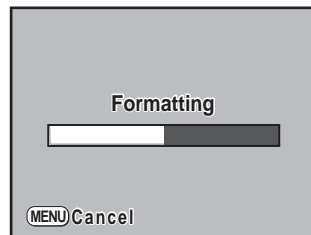

Turning the Beep On and Off

You can turn the camera operation beep on or off. The default setting is all (On).

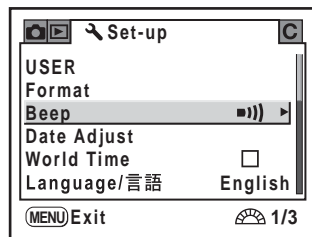

There are five items that you can set: In-focus, AE Lock, **RAW** button, Self-timer and Remote Control.

- 1 Select [Beep] in the [ Set-up] menu.

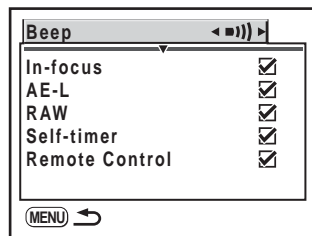

- 2 Press the four-way controller ().





- 3 Select an item and use the four-way controller ( ) to select On or Off.

You can turn all the beeps off by selecting the items and pressing the four-way controller (.

Changing the Date and Time and the Display Style

You can change the initial date and time settings. You can also set the display style. Choose [mm/dd/yy], [dd/mm/yy] or [yy/mm/dd]. Choose [12h] (12 hour) or [24h] (24 hour) for time display method.

Set in [Date Adjust] in the [ Set-up] menu. (p.32)

 Setting the Date and Time (p.56)

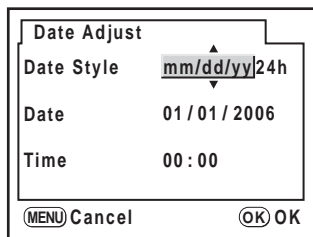

The screenshot shows a menu titled "Date Adjust" with the following settings:

Date Style	mm/dd/yy 24h
Date	01 / 01 / 2006
Time	00 : 00

At the bottom of the menu, there are two options: **MENU** Cancel and **OK** OK.

Setting the World Time

The date and time selected in “Initial Settings” (p.53) serve as the date and time of your present location.



Setting [World Time] enables you to display the local date and time on the LCD monitor when traveling overseas.

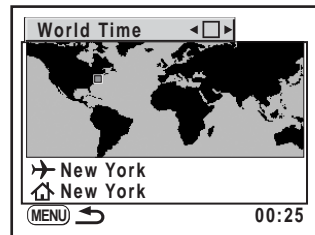

1 Select [World Time] in the [ Set-up] menu. (p.32)

2 Press the four-way controller ().

The World Time screen appears.



3 Use the four-way controller ( ) to select (On) or (Off).

<input checked="" type="checkbox"/>	Applies time of city set in  (Destination)
<input type="checkbox"/>	Applies time of city set in  (Hometown)

4 Press the four-way controller ().

The selection frame moves to .

5 Press the four-way controller ().

The screen for magnifying the Destination region appears.

Use the four-way controller () to change the region to magnify.

6 Press the four-way controller ().

The frame moves to city.

7 Use the four-way controller (◀▶) to select the Destination city.

The current time, location and time difference of the selected city appears.

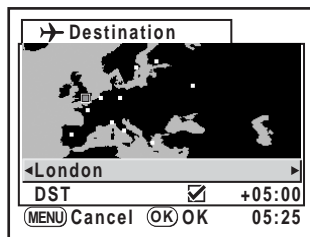

8 Use the four-way controller (▼) to select [DST].

9 Use the four-way controller (◀▶) to select (On) or (Off).

Select (On) if the Destination city uses daylight saving time (DST).

10 Press the OK button.

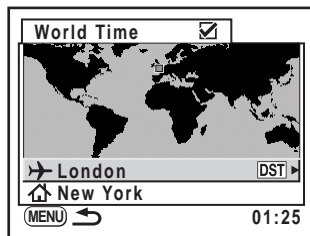

The World Time setting is saved.
To continue with World Time setting operations, press the **OK** button to return to the World Time screen.



11 Press the MENU button twice.

The camera is ready to take pictures.



- See "List of World Time Cities" (p.193) for cities that can be specified as a destination.
- Select  in Step 4 to set the city and DST setting.
-  appears on the guide display screen if World Time is On () . (p.22)

List of World Time Cities

Region	City	Region	City
North America	Honolulu	Africa/ West Asia	Jerusalem
	Anchorage		Nairobi
	Vancouver		Jeddah
	San Francisco		Tehran
	Los Angeles		Dubai
	Calgary		Karachi
	Denver		Kabul
	Chicago		Male
	Miami		Delhi
	Toronto		Colombo
	New York		Kathmandu
	Halifax		Dacca
Central and South America	Mexico City	East Asia	Yangon
	Lima		Bangkok
	Santiago		Kuala Lumpur
	Caracas		Vientiane
	Buenos Aires		Singapore
	Sao Paulo		Phnom Penh
	Rio de Janeiro		Ho chi Minh
Europe	Lisbon		Jakarta
	Madrid		Hong Kong
	London		Beijing
	Paris		Shanghai
	Amsterdam		Manila
	Milan		Taipei
	Rome		Seoul
	Berlin		Tokyo
	Stockholm	Guam	
	Athens	Oceania	Perth
	Helsinki		Adelaide
	Moscow		Sydney
	Africa/ West Asia		Dakar
Algiers			Wellington
Johannesburg			Auckland
Istanbul		Pago Pago	
Cairo			

Setting the Display Language

You can change the language in which the menus, error messages, etc. are displayed.

Set in [Language/言語] in the [Set-up] menu. (p.32)

You can choose from twelve languages: English, French, German, Spanish, Portuguese, Italian, Swedish, Dutch, Russian, Korean, Chinese (Traditional/Simplified) and Japanese.

Setting the Display Language (p.53)

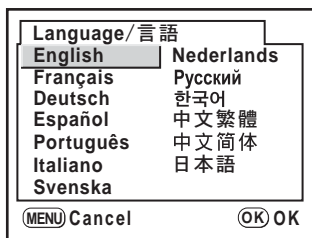

Setting the Guide Display Time

Set the length of time that the guides are displayed on the LCD monitor when the main switch is turned on or the exposure mode is changed. (p.22)

Select from [Off], [3 sec], [10 sec] and [30 sec]. The default setting is [3 sec].

Set in [Guide display] in the [Set-up] menu. (p.32)

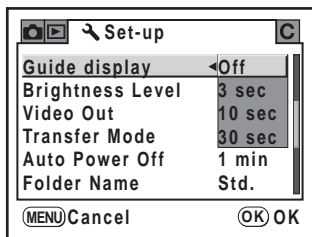

Adjusting the Brightness of the LCD Monitor

You can adjust the brightness of the LCD monitor. Adjust settings when the LCD monitor is hard to see.

Set in [Brightness Level] in the [Set-up] menu. (p.32)

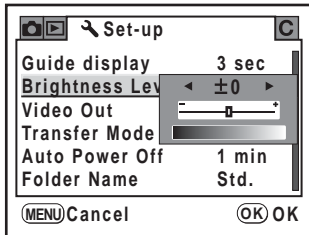

Selecting the Video Output Format

When you connect the camera to AV equipment such as a TV, choose the appropriate video output format (NTSC or PAL) for playing back images. Set in [Video Out] in the [Set-up] menu. (p.32)

Connecting the Camera to AV Equipment (p.94)

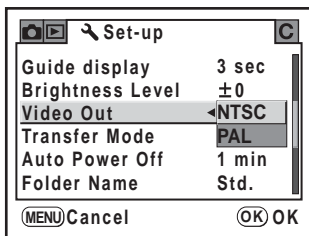

The video output format varies according to region.

Setting Auto Power Off

You can set the camera to turn off automatically if unused after a certain length of time. Select from [1 min], [3 min], [5 min], [10 min], [30 min] or [Off]. The default setting is [1 min].

Set in [Auto Power Off] in the [Set-up] menu. (p.32)

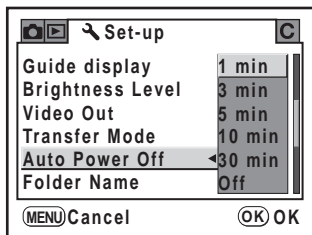

Auto Power Off will not work during slideshow playback, a USB connection, remote control shooting or while displaying menu or Fn menu.

Selecting the Folder Name

You can select the method for assigning the folder names for storing images. The default setting is [Std.].

Std.	The folder name is assigned in the form of [xxxPENTX]. [xxx] is a sequential number from 100 to 999. (Example) 101PENTX
Date	The two digits of the [month] and [day] on which the picture was taken are assigned as the folder name in the form of [xxx_MMDD]. (Example) 101_0125 : for folders with pictures taken on January 25th

Set in [Folder Name] in the [Set-up] menu. (p.32)

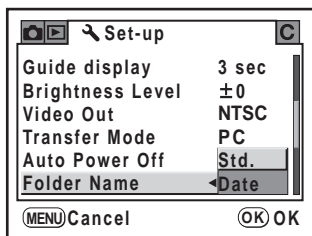

Setting the Display Instant Review and Digital Preview

You can perform the settings related to Instant Review and Digital Preview.

Setting the Instant Review

You can set the Instant Review display time and whether or not to display the histogram and Bright/Dark area warning. The default settings are [1 sec] for the display time and [Off] for the histogram and Bright/Dark area warning.

1 Select [Instant Review] in the [▶] Playback] menu.

2 Press the four-way controller (▶).

The screen for setting the Instant Review appears.

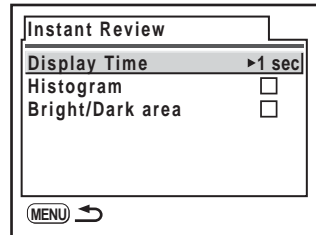

3 Press the four-way controller (▶) and use the four-way controller (▲▼) to select from [1 sec], [3 sec], [5 sec] or [Off].

Press the **OK** button.

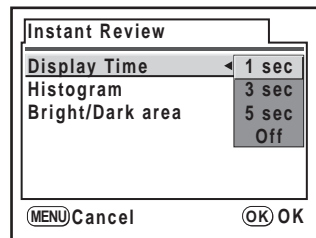

4 Use the four-way controller (▼) to select [Histogram].

5 Use the four-way controller (◀▶) to select (On) or (Off) for [Histogram].

6 Use the four-way controller (▼) to select [Bright/Dark area].

7 Use the four-way controller (◀▶) to select (On) or (Off).

8 Press the **MENU** button twice.

The camera is ready to take a picture.

Setting the Digital Preview

You can set whether or not to display the histogram and Bright/Dark area warning during Digital Preview. The default setting is [Off] for the histogram and Bright/Dark area warning.

1 Select [Digital Preview] in the [▶ Playback] menu.

2 Press the four-way controller (▶).

The screen for setting the Digital Preview appears.

Proceed as from Step 4 in Instant Review.

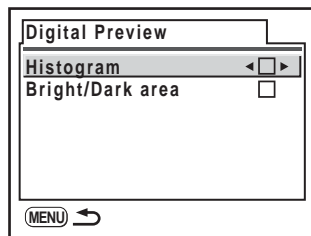

Selecting a Battery

You can set the battery priority to the camera or the battery grip when a battery grip (p.214) is attached. The default setting is [Auto].

1 Select [Select battery] in the [↖ Set-up] menu.

2 Press the four-way controller (▶).

The screen for selecting the battery appears.

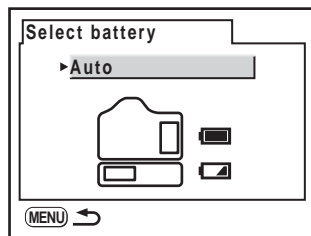

3 Press the four-way controller (▶).

Use the four-way controller (▲▼) to select from [Auto], [Body First] and [Grip First].

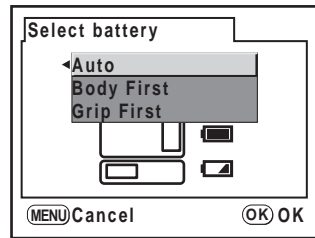

4 Press the OK button.

5 Press the MENU button twice.

The camera is ready to take a picture.



When the battery is inserted into both the body and grip, both batteries are slightly used to check remaining battery level regardless of [Select Battery] settings.

Selecting Capture Mode Settings to Save in the Camera

You can select which settings to save when the camera is turned off. The following settings can be saved: Flash mode, Drive mode, White Balance, Sensitivity, EV Compensation, Auto Bracket, Playback Display and File No. The default setting is all [On].

1 Select [Memory] in the [📷 Rec. Mode] menu.

2 Press the four-way controller (▶).

The memory screen appears.

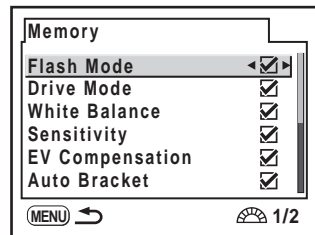

3 Use the four-way controller (▲▼) to choose an item.

4 Use the four-way controller (◀▶) to select (On) or (Off).

5 Press the **MENU** button twice.

The camera is ready to take a picture.



- When [File No.] is set to (On), the file number of the last image taken is saved and subsequent images are assigned sequential file numbers even if a new SD Memory Card is inserted.
- When [File No.] is set to (Off), the file number returns to the lowest number each time a new SD Memory Card is inserted. When an SD Memory Card with stored images is inserted, numbering continues from the last stored file number.
- When the number of storable images exceeds 500, captured images are divided into folders of 500 images each. However, in Auto Bracket, images will be stored in the same folder until shooting is completed, even if the number of images exceeds 500.

Resetting Rec. Mode/Playback/Set-up Menu

Settings in [📷 Rec. Mode] menu, [▶ Playback] menu and [⚙ Set-up] menu can be reset to default settings.

However, Date Adjust, Language, Video Out and World Time are not reset.

- 1** Select [Reset] in the [⚙ Set-up] menu.
- 2** Use the four-way controller (▶) to display the [Reset] screen.
- 3** Use the four-way controller (▲) to select [Reset].

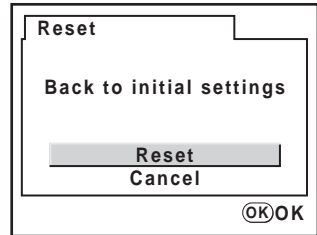

- 4** Press the **OK** button.

The camera is ready to take or play back images.

Resetting the Custom Function Menu

Reset settings in [C Custom Setting] menu to default settings. Settings in [CAM Rec. Mode] menu, [▶ Playback] menu and [↶ Set-up] menu are not reset.

- 1 Select [Reset] in the [C Custom Setting] menu.
- 2 Use the four-way controller (▶) to display the Reset Custom Function screen.
- 3 Use the four-way controller (▲) to select [Reset].

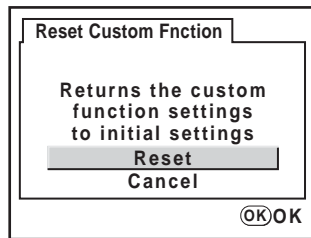

- 4 Press the OK button.

The camera is ready to take or play back images.

5 Appendix

Default Settings	204
Functions Available with Various Lens Combinations	208
Notes on [Using Aperture Ring]	210
Cleaning the CCD	211
Optional Accessories	214
Error Messages	217
Troubleshooting	219
Main Specifications	221
Glossary	224
Index	228
WARRANTY POLICY	232

Default Settings

The table below lists the factory default settings.

Table notations are as follows.

The current setting (last memory) is saved when the camera is turned off.

Reset Setting

Yes : The setting returns to the default setting with the reset function (p.201).

No : The setting is saved even after reset.

[📷 Rec. Mode] Menu

Item		Default Setting	Reset Setting	Page
Exposure Mode*		P (Hyper-program)	Yes	p.168
JPEG Rec. Pixels		10M (3872×2592)	Yes	p.118
JPEG Quality		★★★ (Best)	Yes	p.119
Image Tone		<input checked="" type="checkbox"/> (Natural)	Yes	p.120
Saturation		● ◯ ± (0)	Yes	p.121
Sharpness		Ⓢ ◯ ± (0)	Yes	p.121
Contrast		Ⓢ ◯ ± (0)	Yes	p.121
File Format		JPEG	Yes	p.122
RAW file format		PEF	Yes	p.122
Extended Bracket	Type	Off	Yes	p.165
	White Balance	BA ±1	Yes	
	Saturation/Sharpness/Contrast	±1	Yes	
Multi-exposure	Number of shots	Off	Yes	p.166
	Auto EV Adjust	<input type="checkbox"/> (Off)	Yes	
Memory		All <input checked="" type="checkbox"/> (On)	Yes	p.199
Shake Reduction		35 (Focal Length)	Yes	p.69

* Appears only when Mode dial is set to **USER** (USER).

[▶ Playback] Menu

Item		Default Setting	Reset Setting	Page
Playback display	Bright/Dark area	<input type="checkbox"/> (Off)	Yes	p.186

Item		Default Setting	Reset Setting	Page
Instant Review	Display Time	1 sec	Yes	p.197
	Histogram	<input type="checkbox"/> (Off)	Yes	
	Bright/Dark area	<input type="checkbox"/> (Off)	Yes	
Digital Preview	Histogram	<input type="checkbox"/> (Off)	Yes	p.198
	Bright/Dark area	<input type="checkbox"/> (Off)	Yes	
Digital Filter*		B&W	Yes	p.95
Slideshow	Interval	3 sec	Yes	p.187
	Repeat Playback	Off	Yes	

* The slimness setting for the slim filter, the softness setting for the soft filter, the brightness setting for the brightness filter, and the color setting for the color filter can be saved/reset.

[↶ Set-up] Menu

Item		Default Setting	Reset Setting	Page
USER		-	Yes*	p.167
Format		-	-	p.188
Beep		All <input checked="" type="checkbox"/> (On)	Yes	p.189
Date Adjust		According to default setting	No	p.190
World Time	World Time setting	<input type="checkbox"/> (Off)	Yes	p.191
	Hometown (City)	According to default setting	No	
	Hometown (DST)	According to default setting	No	
	Destination (City)	Same as Hometown	No	
	Destination (DST)	Same as Hometown	No	
Language/言語		According to default setting	No	p.194
Guide display		3 sec	Yes	p.194
Brightness Level		0	Yes	p.195
Video Out		NTSC	No	p.195
Transfer Mode		PC	Yes	p.110
Auto Power Off		1min	Yes	p.196
Folder Name		Std.	Yes	p.196
Select battery		Auto	Yes	p.198

Item		Default Setting	Reset Setting	Page
Dust Removal	Dust Removal	-	-	p.211
	Start-up action	<input type="checkbox"/> (Off)	Yes	
Sensor Cleaning		-	-	p.211
Reset		-	-	p.201

* Return to the default settings only when Mode dial is set to **USER** (USER) and is reset.

[C Custom Setting] Menu

Item	Default Setting	Reset Setting	Page
Settings	<input type="checkbox"/> (Off)	Yes	p.33
Program Line	Normal	Yes	-
EV Steps	1/2 EV Steps	Yes	p.162
Sensitivity Steps	1 EV Steps	Yes	p.140
ISO warning	Off	Yes	p.141
Meter Operating Time	10 sec	Yes	p.143
AE-L with AF locked	Off	Yes	p.135
Link AF Point and AE	Off	Yes	p.143
Auto Bracketng order	0 - +	Yes	p.163
Auto EV Compensation	Off	Yes	-
WB when using flash	Unchanged	Yes	-
Fine tune when AWB	Disabled	Yes	p.124
AF Button Function	Enable AF	Yes	-
AF by Press Halfway	On	Yes	-
Superimpose AF Area	On	Yes	p.132
AF in remote control	Off	Yes	p.34
Noise Reduction	On	Yes	p.159
Color Space	sRGB	Yes	p.129
Color temp. steps	Kelvin	Yes	p.127
e-dial in Program	Front: Tv Rear: Av	Yes	-
e-dial in Sv mode	Front: - Rear: ISO	Yes	-
e-dial in Tv mode	Front: Tv Rear: -	Yes	-
e-dial in Av mode	Front: - Rear: Av	Yes	-
Green Btn in Manual	Program Line	Yes	p.158
One-touch RAW + JPEG	One time	Yes	p.122
Illuminate LCD panel	On	Yes	p.28

Item	Default Setting	Reset Setting	Page
Release when Chrging	Off	Yes	p.173
Preview Method	Optical Preview	Yes	p.169
Recordable Image No.	Recordable image no.	Yes	p.34
Initial zoom display	1.2 times	Yes	p.34
Auto Image Rotation	On	Yes	-
Saving rotation info	On	Yes	-
Using aperture ring	Prohibited	Yes	p.210
Reset Custom Fnction*	-	-	p.202

* Reset settings in [C Custom Setting] menu.

Fn Menu

Item	Default Setting	Reset Setting	Page
Drive Mode	<input type="checkbox"/> (Single frame shooting)	Yes	p.75, p.77, p.81
Flash Mode	(Flash On)*1	Yes	p.71
White Balance	AWB (Auto)	Yes	p.123
Sensitivity	AUTO	Yes	p.140
DPOF settings	-	No	p.106
Digital Filter*2	B&W	Yes	p.95
Slideshow	3 sec	Yes	p.92
RAW Display	Recorded Pixels: 10M Quality Level: ★★★ Sensitivity: ±0	Yes	p.98

*1 Automatically discharged in Green Mode.

*2 The slimness setting for the slim filter, the softness setting for the soft filter, the brightness setting for the brightness filter, and the color setting for the color filter are saved/reset.

Functions Available with Various Lens Combinations

Lenses that can be used with this camera

Only DA and FA J lenses and D FA/FA/F/A lenses having an **A** position on the aperture ring can be used with this camera. Refer to “Notes on [Using Aperture Ring]” (p.210) for other lenses and D FA/FA/F/A lenses with aperture ring set to a position other than **A**.

Function \ Lens [Mount type]	DA/D FA/ FA J/FA lens [KAF, KAF2] ^{*3}	F lens [KAF] ^{*3}	A lens [KA]
Autofocus (Lens only) (With AF adapter 1.7x) ^{*1}	Yes —	Yes —	— Yes ^{*5}
Manual focus (With the focus indicator) ^{*2} (With Matte field)	Yes Yes	Yes Yes	Yes Yes
Eleven AF points	Yes	Yes	No ^{*5}
Power zoom	Yes ^{*6}	—	—
Aperture Priority Auto Exposure	Yes	Yes	Yes
Shutter Priority Automatic Exposure	Yes	Yes	Yes
Manual Exposure	Yes	Yes	Yes
P-TTL Auto Flash ^{*4}	Yes	Yes	Yes
Multi (16-segment) metering	Yes	Yes	Yes
Automatic lens focal length acquirement when using the Shake Reduction function	Yes	Yes	No

Yes : Functions are available when the aperture ring is set to the **A** position.

No : Functions are unavailable.

*1 Lenses with a maximum aperture of f/2.8 or brighter. Only available at **A** position.

*2 Lenses with a maximum aperture of f/5.6 or brighter.

*3 To use an F/FA soft 85 mm f/2.8 lens or FA soft 28 mm f/2.8 lens, set [Using aperture ring] to [Permitted] in the [C Custom Setting] menu (p.33). Pictures can be taken with the aperture you set, but only within manual aperture range.

*4 When using the built-in flash and AF540FGZ or AF360FGZ.

*5 The AF point becomes  (Center).

*6 Only available with KAF2 mount FA lenses.

Lens names and mount names

FA prime lenses (non-zoom lenses) and DA, D FA, FA J and F lenses use the KAF mount. Of the FA zoom lenses, power zoom enabled lenses use the KAF2 mount. Lenses without power zoom use the KAF mount. See the lens manual for details.

Lenses and accessories that cannot be used with this camera

When aperture ring is set at other than **A** (Auto) or a lens without a **A** (Auto) position or accessories such as an auto extension tube or auto bellows are used, camera does not operate unless [Using aperture ring] is set to [Permitted] in the [**C** Custom Setting] menu (p.35). Refer to “Notes on [Using Aperture Ring]” (p.210) for restriction that apply when [Using aperture ring] is set to [Permitted] in the [**C** Custom Setting] menu. All camera exposure modes are available when using DA/FA J or lenses with Aperture **A** (Auto) position set to the **A** position.

Lens and Built-in Flash

The built-in flash cannot be regulated and fully fires when pre A lenses or soft focus lenses are used.

Note that the built-in flash cannot be used as an Auto Flash.

Aperture Ring Use

When [Using aperture ring] is set to [Permitted] in [**C** Custom Setting] menu (p.35), the shutter can be released even if the aperture ring of the D FA, FA, F or A lens is not set to the **A** position or a lens without a **A** position is attached. However, the features will be restricted as shown in the table below.



The camera operates in **Av** (Aperture Priority) mode even if the mode dial is at **■**, **P**, **Sv**, **Tv** or **TAv** when the aperture is set to a value other than **A**.

Lens used	Exposure mode	Restriction
D FA, FA, F, A, M (lens only or with auto diaphragm accessories such as auto extension tube K)	Av (Aperture Priority) mode	The aperture remains open regardless of the aperture ring position. The shutter speed changes in relation to the open aperture but an exposure error may occur. In the viewfinder, [F--] appears for the aperture indicator.
D FA, FA, F, A, M, S (with diaphragm accessories such as extension tube K)	Av (Aperture Priority) mode	Pictures can be taken with the specified aperture value but an exposure error may occur. In the viewfinder, [F--] appears for the aperture indicator.
Manual diaphragm lens such as reflex lens (lens only)	Av (Aperture Priority) mode	
FA, F Soft 85mm FA Soft 28mm (lens only)	Av (Aperture Priority) mode	Pictures can be taken with the specified aperture value in the manual aperture range. In the viewfinder, [F--] appears for the aperture indicator. When depth of field is checked (Optical Preview), AE Metering is switched on. Exposure check is possible.
All lenses	M (Hyper-manual) mode	Pictures can be taken with the set aperture value and shutter speed. In the viewfinder, [F--] appears for the aperture indicator. When depth of field is checked (Optical Preview), AE Metering is switched on. Exposure check is possible.

Shadows may appear in the image for white backgrounds and other shooting conditions if the CCD becomes dirty or dusty. This indicates that the CCD must be cleaned.

Removing Dust by Shaking the CCD

The Dust Removal function shakes the CCD to remove dust that has collected.

- 1** Select [Dust Removal] in the [**Set-up**] menu and press the four-way controller (**▶**).

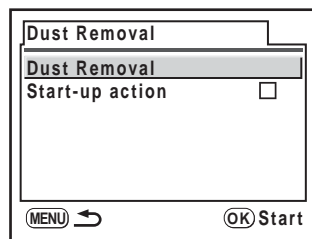

- 2** Press the **OK** button.

The CCD operates and the Dust Removal function activates.

Select [Start-up action] and use the four-way controller (**◀▶**) to select (On) to turn Dust Removal on every time the camera is turned on.

Removing Dust with a Blower

Raise the mirror up and open the shutter to clean with a blower. Please contact PENTAX service center for professional cleaning because the CCD is a precision part. Cleaning services involve a fee.

You can use the Imagesensor Cleaning Kit O-ICK1 (optional) when cleaning the CCD.



- Do not use a spray type blower.
- Do not clean the CCD when the exposure mode is set to **B** (Bulb) mode.
- Always cap the lens mount area to prevent dirt and dust from accumulating on the CCD when no lens is on the camera.
- When the battery level is low, [Not enough battery remaining to clean sensor] is displayed on the LCD monitor.
- If you are not using the AC adapter D-AC50, please use batteries with ample capacity remaining. A warning beep will sound if the battery capacity becomes low during cleaning. Please stop cleaning immediately.
- Do not put the tip of the blower inside the lens mount area. If the power is turned off, this could cause damage to the shutter, CCD sensor or the mirror.



- It is recommended to use the AC adapter D-AC50 (optional) when cleaning the CCD.
- The self-timer lamp blinks and [CIn] appears on the LCD panel while cleaning the CCD.
- This camera features a CCD shifting shake reduction system, and it may generate some operating noise while cleaning the CCD. It is not a malfunction.

1 Turn the camera off and remove the lens.

2 Turn the camera on.

3 Select [Sensor Cleaning] in the [ Set-up] menu.

4 Press the four-way controller (▶).

The Sensor Cleaning screen appears.

-
- 5** Use the four-way controller (▲) to select [Mirror Up].

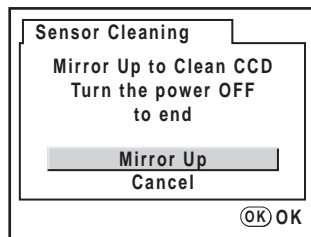

-
- 6** Press the OK button.

The mirror is locked in the up position.

-
- 7** Clean the CCD.

Use a brush-less blower to remove dirt and dust from the CCD. Using a blower with a brush may scratch the CCD. Do not wipe the CCD with a cloth.

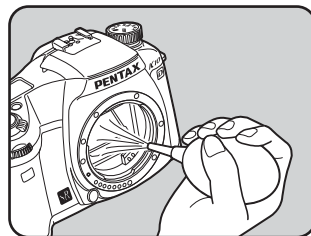

-
- 8** Turn the camera off.

-
- 9** Attach the lens after the mirror returns to its original position.

A number of dedicated accessories are available for this camera. Please contact a service center for details regarding accessories.

Products marked with an asterisk (*) are the same as those supplied with the camera.

Battery Grip D-BG2

The Battery Grip has features such as a shutter release button, front e-dial, rear e-dial, and **AE-L** button to accommodate shooting vertically.

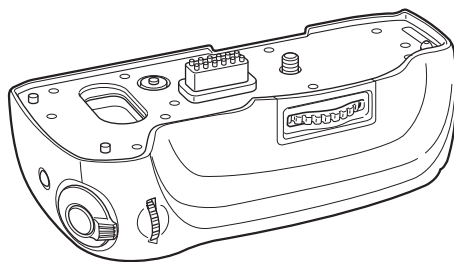

5

Appendix

Power Accessories

AC Adapter D-AC50

Lets you power your camera with the outlet when combined with the AC plug cord.

Battery Charger D-BC50 (*)

Rechargeable Lithium-ion Battery D-LI50 (*)

AC plug cord D-CO2 (*)

Cable Switch CS-205

This is a remote shutter release cord. The cord length is 0.5 m.

Remote Control F

Lets you shoot pictures from within 5 m of the front or back of the camera.

Imagesensor Cleaning Kit O-ICK1

Clean the optical parts such as the CCD and lens of this camera.

Flash Accessories

Auto Flash AF540FGZ

Auto Flash AF360FGZ

The AF540FGZ and AF360FGZ are P-TTL auto flash units with a maximum guide number of 54 and 36 (ISO 100/m), respectively. Their features include slave-sync flash, contrast-control-sync flash, Auto flash, high-speed sync flash, wireless flash, Slow-speed sync and trailing curtain sync flash.

Off-camera Shoe Clip CL-10

This is a setting clip for using the AF540FGZ or AF360FGZ as a wireless slave flash.

Hot Shoe Adapter F₆

Extension Cord F5P

Off-camera Shoe Adapter F

Use the adapters and cords to use the external flash away from the camera.

For Viewfinder

Magnifier Eyecup O-ME53

This viewfinder is for magnifying up to 1.18 times and makes focusing easier.

Magnifier F_B

This viewfinder accessory is for magnifying the central area of the viewfinder.

Ref-convverter A

This is an accessory that changes the viewfinder viewing angle at 90° intervals. The viewfinder magnification can be switched between 1× and 2×.

Diopter correction lens adapter M

This accessory adjusts the diopter. Install it on the viewfinder.

If it is difficult to see the viewfinder image clearly, choose one of the eight correction lens adapter M of -5 to $+3$ m^{-1} (per meter).

ME Viewfinder Cap (*)**Eyecup F_P (*)****Interchangeable Focusing Screen**

LF-80: AF Frame Matte (standard)

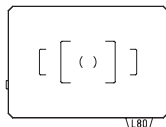

LL-80: AF Divided Matte

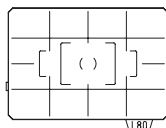

LI-80: AF Scale Matte

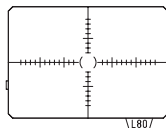
**Camera Case/Strap**

Camera Case O-CC55

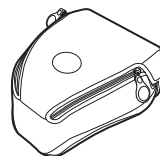

Strap O-ST53 (*)

Others

Hot Shoe Cover F_K (*)

USB Cable I-USB17 (*)

Video Cable I-VC28 (*)

Error Message	Description
Memory card full	The SD Memory Card is full and no more images can be saved. Insert a new SD Memory Card or delete unwanted images. (p.48, p.100) You may be able to save new images by converting to JPEG format or changing the JPEG record pixels or JPEG quality setting. (p.118, p.119)
No image	There are no images for playback on the SD Memory Card.
Camera cannot display this image	You are trying to play back an image in a format not supported by this camera. You may be able to play it back on another brand of camera or your computer.
No card in the camera	The SD Memory Card is not inserted in the camera. (p.48)
Memory card error	The SD Memory Card has a problem, and image capture and playback are impossible. It may be viewable on a PC but not with this camera.
Card not formatted	The SD Memory Card you have inserted is unformatted or has been formatted on a computer or other device and is not compatible with this camera. Use the card after formatting it with this camera. (p.188)
Card locked	A locked SD Memory Card is inserted in the camera. Unlock the SD Memory Card. (p.49)
Card is locked Rotation information cannot be saved	
The card is electronically locked	Data is protected by the SD Memory Card security feature.
This image cannot be enlarged	You are trying to enlarge an image that cannot be enlarged.
This image is protected Rotation information cannot be saved	The selected rotated image is protected. Remove protection from the image. (p.104)
Cannot use this card	The inserted card cannot be used on this camera. Insert a usable card.

Error Message	Description
Battery depleted	The batteries are exhausted. Install new batteries in the camera. (p.43)
Not enough battery remaining to clean sensor	Appears during CCD cleaning if the battery level is insufficient. Replace the battery with a new one or use an AC adaptor D-AC50 (optional). (p.47)
Image folder cannot be created	The maximum folder number (999) and file number (9999) are being used, and no more images can be saved. Insert a new SD Memory Card or format the card. (p.188)
The image is not stored	The image could not be saved because of an SD Memory Card error.
Settings not stored	The DPOF settings or rotated image could not be saved because SD Memory Card is full. Delete unwanted images and perform DPOF settings or rotation again. (p.100)
RAW images cannot be set	DPOF cannot be applied to the RAW images.
RAW images are not supported	RAW images cannot be processed using the digital filter.
No image to be filtered	When digital filter is started from [▶ Playback] menu, this message appears if all saved images are RAW files or images captured with other cameras.
This image cannot be filtered	Appears when digital filter is started from Fn menu for images captured with other cameras.
No DPOF files	No file set with DPOF. Set DPOF and then print. (p.106)
Printer error	There is an error with the printer and the file cannot be printed. Fix all the errors and try printing again.
No paper in the printer	Printer has run out of paper. Put paper in the printer and print.
Low ink level in the printer	Printer is running out of ink and appears once this signal is received from the printer. After two seconds, the printer resumes printing.
No ink in the printer	Printer has run out of ink. Replace ink and print.
Paper stuck in the printer	Paper is jammed in the printer. Remove paper and print.
Data error	A data error has occurred during printing.

We recommend checking the following items before contacting a service center.

Problem	Cause	Remedy
Camera does not turn on	Batteries are not installed	Check if batteries are installed. If not, install batteries.
	Battery power is low	Replace with a charged battery set or use the AC adapter D-AC50 (optional). (p.47)
The shutter does not release	The lens aperture ring setting is other than the A position	Set the lens aperture ring to the A position (p.147) or select [Permitted] in [Using aperture ring] in the [C Custom Setting] menu (p.210).
	Flash is charging	Wait until charging is finished.
	No available space on SD Memory Card	Insert SD Memory Card with available space or delete unwanted images. (p.48, p.100)
	Recording	Wait until recording is finished.
The Autofocus does not work	Subject is difficult to focus on	Autofocus cannot focus well on subjects that have low contrast (the sky, white walls), dark colors, intricate designs, are moving quickly or scenery shot through a window or a net-like pattern. Lock focus on another object located at the same distance as your subject (press shutter release button halfway), then aim at target and press shutter release button fully. Alternatively, use manual focus. (p.136)
	Subject is not in focusing area	Position subject in focus frame in middle of viewfinder. If the subject is outside the focusing area, aim the camera at the subject and lock the focus (press shutter release button halfway), then compose picture and press the shutter release button fully.
	Subject is too close	Move away from the subject and take a picture.
	The focus mode is set to MF	Set the focus mode lever to A.F.S (Single mode). (p.130)
	The focus mode is set to A.F.C (Continuous mode)	Autofocus is not locked (focus lock) when focus mode is set to A.F.C . The camera will continue focusing on the subject while the shutter release button is pressed halfway. If there is a subject that you wish to focus on, slide the focus mode lever to A.F.S and use focus lock.

Problem	Cause	Remedy
AE lock function does not operate	AE lock is not available when set to ■ (Green), B (Bulb) or X (Flash X-sync speed) mode	Use AE lock with any setting other than ■ (Green), B (Bulb) or X (Flash X-sync speed) mode.
Flash does not discharge	Capture mode is set to ■ (Green) mode.	Only ⚡^A (Auto discharge) and ⚡^AⓂ (Auto flash+Redeye reduce) are available for Flash Mode when Capture mode is ■ . Flash will not discharge when the subject is bright in these modes. In Capture modes other than ■ , only the flash mode that discharges every time the flash recharges is available. Try different Capture modes.
USB connection with computer does not work properly*	The Transfer Mode is set to [PictBridge]	Set Transfer Mode to [PC].
	An error occurred while sending USB data	Change the Transfer Mode to [PC-F].
USB connection with printer does not work properly	The Transfer Mode is set to [PC] or [PC-F]	Set Transfer Mode to [PictBridge]. (p.110)
Shake Reduction does not work	Shake Reduction function is off	Turn on the Shake Reduction switch.
	Shake Reduction function is not set properly	If a lens for which focal length information cannot be acquired is used, set the [Focal Length] on the [Shake Reduction] menu. (p.69)
	Shutter speed is too low for Shake Reduction function to be effective when panning or shooting night scenes, etc.	Turn off the Shake Reduction function and use a tripod.
	Subject is too close	Move away from the subject, or turn off the Shake Reduction function and use a tripod.

In rare cases, the camera may not operate correctly due to static electricity. This can be remedied by taking the batteries out and putting them back in again. When the mirror remains in the up position, take the batteries out and put them back in again. Then, turn the power on. The mirror will retract. After the procedure is done, if the camera operates correctly, it does not require any repairs.

* Refer to p.11 of the "PENTAX PHOTO Browser 3/PENTAX PHOTO Laboratory 3 Operating Manual" for details on connecting the camera to a PC.



Type	TTL autofocus, auto-exposure SLR digital-still camera with built-in retractable P-TTL flash
Effective Pixels	10.20 megapixels
Sensor	Total pixels 10.75 megapixels, interline/interlace scan CCD with a primary color filter
Recorded Pixels	10M (RAW/JPEG: 3872×2592 pixels), 6M (3008×2000 pixels), 2M (1824×1216 pixels)
Sensitivity	Auto, Manual (ISO 100 to 1600 (EV steps can be set to 1 EV, 1/2 EV or 1/3 EV))
File Format	RAW (PEF/DNG), JPEG (Exif2.21), DCF compliant, DPOF compatible, Print Image Matching III compatible, RAW+JPEG simultaneous capturing compatible
JPEG Quality	★★★ (Best), ★★ (Better), and ★ (Good)
Storage Medium	SD Memory Card, SDHC Memory Card
Number of Shots	

Recorded Pixels	File Format/ JPEG Quality	Capacity					
		4 GB	2 GB	1 GB	512 MB	256 MB	128 MB
10M 3872×2592	RAW (PEF)	Approx. 237	Approx. 120	Approx. 59	Approx. 29	Approx. 15	Approx. 7
	RAW (DNG)	Approx. 237	Approx. 120	Approx. 59	Approx. 29	Approx. 15	Approx. 7
10M 3872×2592	★★★	Approx. 804	Approx. 409	Approx. 202	Approx. 101	Approx. 50	Approx. 26
	★★	Approx. 1371	Approx. 698	Approx. 345	Approx. 172	Approx. 87	Approx. 44
	★	Approx. 2366	Approx. 1205	Approx. 592	Approx. 296	Approx. 149	Approx. 76
6M 3008×2000	★★★	Approx. 1340	Approx. 682	Approx. 337	Approx. 168	Approx. 85	Approx. 43
	★★	Approx. 2277	Approx. 1159	Approx. 575	Approx. 287	Approx. 145	Approx. 74
	★	Approx. 3893	Approx. 1982	Approx. 990	Approx. 495	Approx. 249	Approx. 128
2M 1824×1216	★★★	Approx. 3657	Approx. 1862	Approx. 915	Approx. 457	Approx. 230	Approx. 118
	★★	Approx. 6034	Approx. 3073	Approx. 1549	Approx. 774	Approx. 390	Approx. 200
	★	Approx. 10057	Approx. 5121	Approx. 2627	Approx. 1313	Approx. 662	Approx. 339

JPEG Quality (Compression): ★★★ (Best) = 1/3, ★★ (Better) = 1/6, ★ (Good) = 1/12

White Balance	Auto, Daylight, Shade, Cloudy, Fluorescent Light (D: Daylight, N: Neutral White, W: White), Tungsten Light, Flash, Manual, Color Temperature (3 types)
LCD Monitor	2.5 inch low-temperature wide viewing field poly-silicon TFT color LCD with approx. 210,000 pixels, brightness adjustment function
Playback Function	Single frame, 4-image display, 9-image display, 16-image display, zoom display (up to 20 times, scrolling possible), rotating, folder display, slideshow, histogram, bright/dark area
Digital Filter	B&W, Sepia, Color, Soft, Slim, Brightness (only for processing after shooting)

Exposure Mode	USER , Green, P Hyper-program, Sv Sensitivity priority, Tv Shutter priority, Av Aperture priority, TAv Shutter & Aperture priority, M Hyper-manual, B Bulb, X Flash X-sync speed
Shutter	Electronically controlled vertical-run focal-plane shutter, Speed range (1) Auto 1/4000 to 30 sec. (stepless), (2) Manual 1/4000 to 30 sec. [1/2 EV step or 1/3 EV step] (3) Bulb, Electromagnetic release, Shutter lock by setting Main switch in OFF position.
Lens Mount	Pentax KAF ₂ bayonet mount (AF coupler, lens information contacts, K-mount with power contacts)
Lens Used	Pentax KAF ₂ mount lenses, KAF mount lenses, KA mount lenses
Autofocus System	TTL phase-matching autofocus system (SAFOX VIII), AF operational brightness range: EV -1 to 18 (at ISO 100 with f/1.4 lens), Focus lock available, Focus Mode: AF.S (Single)/ AF.C (Continuous)/ MF , Adjustable AF point
Viewfinder	Pentaprism Finder, Interchangeable Natural-Bright-Matte II focusing screen, Field of view: 95%, Magnification 0.95× (with 50 mm f/1.4 lens at ∞), Diopter: -2.5m ⁻¹ to +1.5m ⁻¹ (per meter)
Viewfinder Indication	Focus information: ● is lit when in-focus and blinking when unable to focus, ⚡ is lit = Built-in flash ready, ⚡ is blinking = Flash should be used or incompatible lens is being used, Shutter speed, Confirm Sensitivity, Aperture value, e-dial enabled indicator, * = AE lock, Capacity remaining, ☒ = EV compensation, ⚡± = Flash compensation, MF = Manual focus, ISO = ISO warning, Shake Reduction display, EV bar
LCD Panel Display	⚡ is lit = Built-in flash ready, ⚡ is blinking = Flash should be used or incompatible lens is being used, A = Auto discharge, ⊕ = Redeye reduct, SLOW = Slow-speed sync, □ = Single frame shooting, ☐ = Continuous shooting, ⌚ = Self-timer, 📡 = Remote control shooting, ⚡ = Battery exhaustion warning, ☐ = Auto bracket exposure (EV steps can be set to 1/2 EV or 1/3 EV), ⚡± = Flash compensation, ISO warning, Shutter speed, Aperture value, White Balance, Capacity remaining and ☒ = EV compensation, PC (mass storage)/ Pb (PictBridge) appears when the USB cable is connected, EV bar, RAW , RAW+
Preview Function	Optical Preview: Depth of field confirmation (electronically controlled and usable in all exposure modes) Digital Preview: Composition, exposure, focus and white balance confirmation
Continuous Shooting	Approx. 3 fps, JPEG: until SD Memory Card is full RAW: up to 9 frames
Self-timer	Electronically controlled with delay time of 12 sec./2 sec. (with mirror up function). Start by pressing shutter release button. Operation confirmation: Possible to set beep. Can be cancelled after operation
Remote Control	Pentax Remote Control F (optional) Release shutter immediately or three seconds after pressing the remote control shutter button.
Mirror	Quick-return mirror, mirror up function (2 sec. self-timer)
Exposure Bracket	Three or five frames (underexposed, proper exposure and overexposed) are shot continuously with exposure bracketing. (Selectable between 1/2 EV and 1/3 EV for EV steps)
Extended Bracket	Three frames are saved continuously with white balance, saturation, sharpness and contrast bracketing.

Multi-exposure	Select number of shots between 2 and 9 (Auto EV Adjust can be set according to the number of shots)
Exposure Meter/ Metering Range	TTL multi (16)-segment metering, Metering range from EV 0 to EV 21 at ISO 100, with 50 mm f/1.4 lens, Center-weighted and Spot metering mode can be set
EV Compensation	±3 EV (1/2 EV Steps), ±2 EV (1/3 EV Steps), EV Steps can be selected
AE Lock	Button type (timer type: two times the meter operating time set in Custom Setting) Continuous as long as the shutter button is halfway pressed)
Built-in Flash	P-TTL built-in flash with serial control, GN 11 (ISO 100), Angles of coverage: 18 mm lens angle of view, Flash synchronization speed range at 1/180 sec. and slower, Daylight-sync flash, Slow-speed-sync flash, ISO range = P-TTL: 100 to 1600
External Flash Sync	Hot shoe with X -contact, which couples with Pentax dedicated auto flashes, ISO range = P-TTL: 100 to 1600, Automatic flash, Red-eye reduction flash function, High-speed-sync, wireless-sync with PENTAX dedicated flash.
Custom Function	32 functions can be set
Time Function	World Time settings for 71 cities (28 time zones)
Dust Removal	SP coating and CCD operations for dust removal. Can be set to operate when the camera is turned on.
Power	Rechargeable lithium-ion battery D-LI50
Battery Life (23°C)	Number of recordable images: approx. 500 images (without flash) ^{*1} / approx. 480 images (50% flash usage) ^{*2} , playback time: approx. 330 minutes ¹ ^{*1} The number of recordable images (without flash) and playback time are based on PENTAX measuring conditions. Some deviation from the above figures may occur in actual use depending on usage conditions. ^{*2} The number of recordable images (50% flash usage) is based on measuring conditions in accordance with CIPA standards. Some deviation from the above figures may occur in actual use depending on usage conditions.
Battery Exhaustion	Battery exhaustion symbol  is lit. (The shutter is locked and no indication appears in the viewfinder when  starts blinking)
In/Out Port	USB/Video terminal (USB 2.0 (high speed compatible)), DC input terminal, Cable switch terminal
Video Output Format	NTSC/PAL
PictBridge	Compatible printer Print mode PictBridge-compatible printer Print One, Print All, DPOF AUTOPRINT
Dimensions and Weight	141.5 mm (W) x 101 mm (H) x 70 mm (D) (excluding protrusions) 710 g (body only), 790 g (including a battery and an SD Memory Card)
Accessories	Hot shoe cover Fk, Eyecup Fp, ME viewfinder cap, Body mount cover, USB Cable I-USB17, Video cable I-VC28, Software (CD-ROM) S-SW55, Strap O-ST53, Rechargeable lithium-ion battery D-LI50, Battery charger D-BC50, AC plug cord D-CO2, Operating manual (this book) and PENTAX PHOTO Browser 3/PENTAX PHOTO Laboratory 3 operating manual
Languages	English, French, German, Spanish, Portuguese, Italian, Swedish, Dutch, Russian, Korean, Chinese (Traditional / Simplified) and Japanese

AdobeRGB

Color space recommended by Adobe Systems, Inc. for commercial printing. Wider range of color reproduction than sRGB. Covers most of the color range so colors only available when printed are not lost when editing images on a computer. When image is opened by non-compatible software, the colors look lighter.

AE Metering

Brightness of subject is measured to determine exposure. In this camera, select from [Multi-segment Metering], [Center-weighted Metering] and [Spot Metering].

Aperture

The aperture increases or reduces the light beam (thickness) passing through the lens to the CCD.

Auto Bracket

For automatically changing the shooting conditions. An image with no compensation, an underexposed image and an over-exposed image are captured. Features exposure bracket that captures images in different exposures, and extended bracket that captures images with set white balance, saturation, sharpness, and contrast levels.

Bright Portion

Overexposed area in the image loses contrast and appears white.

Camera Shake (Blur)

When the camera moves while the shutter is open, the entire image appears blurred. This occurs more often when shutter speed is low. Prevent camera shake by raising the sensitivity, using the flash, and raising the shutter speed. Alternatively, use a tripod to stabilize the camera. As camera shake is mostly likely to occur when pressing the shutter release button, use the Shake Reduction function, the self-timer, the remote control unit, and the cable switch to prevent camera movement.

CCD (Charge Coupled Devices)

Photography element which converts the light entering through the lens into electric signals that create the image.

Color space

A defined range of colors from the spectrum which are used. In digital cameras, [sRGB] is defined as the standard by Exif. In this camera, [AdobeRGB] is also used because of the richer color expression over sRGB.

Color Temperature

This numerically expresses the color of the light source illuminating the subject. This is indicated in absolute temperature, using Kelvin (K) units. The color of light shifts to a bluish color as the color temperature rises, and to a reddish color as the color temperature falls.

DCF (Design Rule for Camera File System)

A digital camera file system standard established by the Japan Electronics and Information Technology Industries Association (JEITA).

Dark Portion

Underexposed area in the image loses contrast and appears black.

Depth of Field

Area of focus. This depends on the aperture, lens focal length, and distance to the subject. For example, select a smaller aperture to increase the depth of field or use a larger aperture to decrease the depth of field.

DNG RAW file

DNG (Digital Negative) is a general-purpose RAW file format designed by Adobe Systems. When images captured in proprietary RAW formats are converted to DNG format, support and compatibility for the images increases significantly.

DPOF (Digital Print Order Format)

Rules for writing information onto a card with recorded images regarding the specific images and number of copies to be printed. Prints can easily be made by taking images to a DPOF photo printing store.

EV (Exposure Value)

Exposure value is determined by the combination of the aperture value and the shutter speed.

EV Compensation

Process of adjusting the image brightness by changing the shutter speed and aperture value.

Exif (Exchangeable image file format for digital still camera)

A standard digital camera file format established by the Japan Electronics and Information Technology Industries Association (JEITA).

Focus point

Position in the viewfinder that determines focus. In this camera, select from [Auto], [Select] and [Center].

Histogram

A graph that shows the darkest and brightest points in an image. The horizontal axis represents the brightness and the vertical axis represents the number of pixels. This is useful when you wish to refer to the exposure status of an image.

JPEG

An image compression method. In this camera, select from ★★★ (Best), ★★ (Better), or ★ (Good). Images recorded in JPEG format are suited for viewing on your PC or for attaching to e-mail.

Mired

Proportional scale of measurement that consistently shows color change per unit. Determined by multiplying the inverse of the color temperature by 1,000,000.

ND (Neutral Density) Filter

A filter with many saturation levels that adjusts the brightness without affecting the color tone of pictures.

Noise Reduction

Process to reduce noise (image roughness or unevenness) caused by low shutter speed.

NTSC/PAL

These are video output formats. NTSC is mainly used in Japan, North America, and South Korea. PAL is mainly used in Europe and in China.

Quality Level

This refers to the image compression ratio. The lower the compression, the more detailed the image. The image becomes rougher as the compression rate rises.

RAW data

Unedited image data output from the CCD. RAW data is data before being internally processed by the camera. Camera settings at the time of capture, such as White Balance, Contrast, Saturation, Tone, Color Space, Sensitivity and Sharpness can be set for each frame after shooting. In addition, RAW data is 12 bit data that contains 16 times the information of 8 bit JPEG and TIFF data. Rich gradations are possible. Transfer RAW data to your computer and use the provided software to create image data with different settings, such as JPEG or TIFF.

Recorded Pixels

Indicates the size of the image by the number of pixels. The more pixels that compose a picture, the larger the image size.

Sensitivity

The amount of light needed to record an image. With a high sensitivity, images can be shot with a high shutter speed even in dark places, reducing camera shake. However, images with high sensitivity are more susceptible to noise.

Shutter Speed

The length of time that the shutter is open and light strikes the CCD. The amount of light that strikes the CCD can be changed by altering the shutter speed.

sRGB (standard RGB)

International standard of color space established by the IEC (International Electrotechnical Commission). This is defined from color space for PC monitors and is also used as the standard color space for Exif.

Vignetting











The picture edges are blackened when part of the light coming from the subject is blocked by the hood or filter ring, or when the flash is partially blocked by the lens.

White Balance

While shooting, color temperature is adjusted to match the light source so that the subject appears to have correct color.

Symbols

[C Custom Setting]

- Menu 33, 206
-  (Delete) button 21, 100
-  (EV Compensation) button 19, 161
-  (Exposure Bracket) button 19, 163
-  (Flash pop-up) button 19, 71
-  Green mode 146
-  (Playback) button 19, 21, 85
-  [Playback] Menu 31, 204
-  Preview 170, 171
-  (Protect) button 21, 104
-  [Rec. Mode] Menu 31, 204
-  [Set-up] Menu 32, 205

A

- AC Adapter 47
- Adding the Date 106
- AdobeRGB 129
- AE lock 162
- AE Metering 142
- AE-L** button 19
- AF** (Autofocus) 130
- AF** button 19, 137
- AF Point 132
- AF point switching dial ... 19, 132
- AF360FGZ 179
- AF540FGZ 179
- A.F.C** (Continuous mode) 130
- A.F.S** (Single mode) 130
- Aperture 139
- Aperture Priority Mode **Av** 152
- Auto Bracket 163

- Auto Power Off 196
- Autofocus **AF** 130
- Automatic Sensitivity Correction 140
- AV Equipment 94
- Av** (Aperture Priority) mode 152

B

- B&W (Digital Filter) 97
- Battery 43
- Beep 189
- Bright 120
- Bright/Dark area 186
- Brightness (Digital Filter) 97
- Brightness of the LCD Monitor 195
- Built-in flash 71, 172
- B** (Bulb) Mode 159
- Bulb Mode **B** 159

C

- Cable Switch 159
- Capture Information 23, 24
- Card access lamp 17
- Center-weighted 143
- Cloudy (White Balance) 123
- Color (Digital Filter) 97
- Color space 129
- Color Temperature 128
- Continuous mode **A.F.C** 130
- Continuous Shooting 75
- Contrast 121
- Contrast-Control-Sync Flash 185
- Correct exposure 138
- Custom Function 33

[C Custom Setting]

Menu 33, 206

D

Date Adjust 56

Date change 190

Daylight (White Balance) 123

Daylight-Sync Shooting 74

Default Setting 53, 204

Delete 100

Delete All Images 101

🗑️ (Delete) button 21, 100

Deleting a Single Image 100

Depth of Field 139

Digital Filter 95

Digital Preview 170

Diopter Adjust 60

Direct Printing 109

Display Language 194

Display Style 186

DPOF AUTOPRINT 116

DPOF Settings 106

Drive mode 36

Dust Removal 211

E

Error Message 217

EV Compensation 161

📷 (EV Compensation)

button 19, 161

Exposure 138

Exposure Bracket 163

📷 (Exposure Bracket)

button 19, 163

Exposure metering timer 164

Exposure Mode 144

Exposure

Warning 151, 153, 157

Extended Bracket 165

External flash 179

F

Filter 95

Fireworks 159

Fix Focus 134

Flash 71, 172

Flash (White Balance) 123

Flash Compensation 172

⚡ (Flash pop-up)

button 19, 71

Flash X-sync Speed **X** 160

Fluorescent Light

(White Balance) 123

Fn button 19, 21, 36

Fn Menu 36

Focus Indicator 136

Focus Lock 134

Focus Mode 130

Focus mode lever 19

Focusing 130

Folder Name 196

Format 188

Four-way controller

(▲▼◀▶) 19, 21

Front e-dial 18

G

Green button 18

Green mode 146

Guide display 22, 194

H

High-Speed Flash Sync

Mode 181

Histogram 25, 86

Hyper-manual Mode **M** 156Hyper-program Mode **P** 147**I**

Image Tone 120

INFO button 19, 21, 23, 85





Instant Review 197

ISO Sensitivity	140
ISO warning	141
J	
JPEG Quality	50, 119
JPEG Rec. Pixels	50, 118
L	
Language	53
LCD Monitor	22
LCD panel	28
Lens	58, 208
Lens unlock button	18, 59
Lock Exposure	135
M	
M (Hyper-manual) Mode	156
Main switch	18, 21, 52
Manual Exposure Mode M ...	156
MF (Manual focus)	136
Manual focus MF	136
Manual White Balance	125
Matte Field	137
Memory	199
MENU button	19, 21, 29
Menu Operation	29
Meter Operating Time	143
Metering mode lever	19, 142
Mirror Up	84, 213
Mode dial	19, 38
Multi-exposure	166
Multiple Flashes	184
Multi-segment	142
N	
Natural	120
Night Scene (Bulb Mode)	159
Nine-Image Display	89
Noise Reduction	159

O

OK button	19, 21
Optical Preview	170
Optional Accessories	214

P

P (Hyper-program) Mode	147
PAL	195
PC-F	220
PictBridge	109
Pixels	118
Playback	24, 85
 (Playback)	
button	19, 21, 85
[ Playback] Menu	31, 204
Playback Time	46
Power	52
Press fully	65
Press halfway	65
Preview 	170, 171
Preview Method	169
Print All	114
Print One	112
Print Service	106
Printer connection	111
Program Line	145
Program Mode P	147
Protect	104
 (Protect) button	21, 104
P-TTL (Auto)	180
P-TTL (Flash)	182

Q

Quality Level	50, 119
---------------------	---------

R

RAW	122
RAW button	19, 122
RAW+	122
Rear e-dial	19
[ Rec. Mode] Menu	31, 204

Recorded Pixels 50, 118
 Red-eye reduction 74, 183
 Remaining image storage
 capacity 46
 Remote Control 81
 Reset 201, 202
 Rotate 87

S

Saturation 121
 SD Memory Card 48
 Select&Delete 102
 Self-Timer 77
 Sensitivity 140
 Sensitivity Priority Mode

Sv 148

Sensor Cleaning 211

Sepia (Digital Filter) 97

[ Set-up] Menu 32, 205

Shade (White Balance) 123

Shake Reduction 67

Shake Reduction switch ... 19, 67

Sharpness 121

Shutter & Aperture Priority Mode

TAv 154

Shutter Priority Mode **Tv** 150

Shutter release

button 18, 21, 65

Shutter speed 138

Single mode **AfS** 130

Slideshow 92, 187

Slim (Digital Filter) 97

Slow-speed sync 71, 174

Soft (Digital Filter) 97

Spot Metering 143

sRGB 129

Strap 42

Superimpose AF Area 27, 132

Sv (Sensitivity Priority)

Mode 148

T

TAv (Shutter & Aperture Priority)

Mode 154

Trailing Curtain

Sync 71, 175, 183

Transfer Mode 110

Tungsten Light

(White Balance) 123

TV 94

Tv (Shutter Priority) mode ... 150

U

USB cable 109

USER Mode 167

Using aperture ring 210

V

Video cable 94

Video Output Format 195

Viewfinder 26, 60

Vignetting 227

W

White Balance 123

Wireless Mode 181

World Time 191

X

X (Flash X-sync Speed) 160

Z

Zoom Display 88

Zoom Lens 70

All PENTAX cameras purchased through authorized bona fide photographic distribution channels are guaranteed against defects of material or workmanship for a period of twelve months from date of purchase. Service will be rendered, and defective parts will be replaced without cost to you within that period, provided the equipment does not show evidence of impact, sand or liquid damage, mishandling, tampering, battery or chemical corrosion, operation contrary to operating instructions, or modification by an unauthorized repair shop. The manufacturer or its authorized representatives shall not be liable for any repair or alterations except those made with its written consent and shall not be liable for damages from delay or loss of use or from other indirect or consequential damages of any kind, whether caused by defective material or workmanship or otherwise; and it is expressly agreed that the liability of the manufacturer or its representatives under all guarantees or warranties, whether expressed or implied, is strictly limited to the replacement of parts as hereinbefore provided. No refunds will be made on repairs by nonauthorized PENTAX service facilities.

Procedure During 12-month Warranty Period

Any PENTAX which proves defective during the 12-month warranty period should be returned to the dealer from whom you purchased the equipment or to the manufacturer. If there are no representatives of the manufacturer in your country, send the equipment to the manufacturer, with postage prepaid. In this case, it will take a considerable length of time before the equipment can be returned to you owing to the complicated customs procedures required. If the equipment is covered by warranty, repairs will be made and parts replaced free of charge, and the equipment will be returned to you upon completion of servicing. If the equipment is not covered by warranty, regular charges of the manufacturer or of its representatives will apply. Shipping charges are to be borne by the owner. If your PENTAX was purchased outside of the country where you wish to have it serviced during the warranty period, regular handling and servicing fees may be charged by the manufacturer's representatives in that country. Notwithstanding this, your PENTAX returned to the manufacturer will be serviced free of charge according to this procedure and warranty policy. In any case, however, shipping charges and customs clearance fees to be borne by the sender. To prove the date of your purchase when

required, please keep the receipt or bills covering the purchase of your equipment for at least a year. Before sending your equipment for servicing, please make sure that you are sending it to the manufacturer's authorized representatives or their approved repair shops, unless you are sending it directly to the manufacturer. Always obtain a quotation for the service charge, and only after you accept the quoted service charge, instruct the service station to proceed with the servicing.

- **This warranty policy does not affect the customer's statutory rights.**
- **The local warranty policies available from PENTAX distributors in some countries can supersede this warranty policy. Therefore, we recommend that you review the warranty card supplied with your product at the time of purchase, or contact the PENTAX distributor in your country for more information and to receive a copy of the warranty policy.**



The CE Mark is a Directive conformity mark of the European Union.

For customers in USA

STATEMENT OF FCC COMPLIANCE

This device complies with Part 15 of the FCC Rules. Operation is subject to the following two conditions: (1) This device may not cause harmful interference, and (2) this device must accept any interference received, including interference that may cause undesired operation.

Changes or modifications not approved by the party responsible for compliance could void the user's authority to operate the equipment.

This equipment has been tested and found to comply with the limits for a Class B digital device, pursuant to part 15 of the FCC Rules.

These limits are designed to provide reasonable protection against harmful interference in a residential installation. This equipment generates, uses and can radiate frequency energy and, if not installed and used in accordance with the instructions, may cause harmful interference to radio communications. However, there is no guarantee that interference will not occur in a particular installation.

If this equipment does cause harmful interference to radio or television reception, which can be determined by turning the equipment off and on, the user is encouraged to try to correct the interference by one or more of the following measures:

- Reorient or relocate the receiving antenna.
- Increase the separation between the equipment and receiver.
- Connect the equipment into an outlet on a circuit different from that to which the receiver is connected.
- * Consult the dealer or an experienced radio/TV technician for help.

For customers in Canada

This Class B digital apparatus complies with Canadian ICES-003.

Pour les utilisateurs au Canada

Cet appareil numérique de la classe B est conforme à la norme NMB-003 du Canada.

FOR CALIFORNIA, U.S.A. ONLY

Perchlorate Material-special handling may apply.

The lithium battery used in this camera contains perchlorate material, which may require special handling.

See www.dtsc.ca.gov/hazardouswaste/perchlorate

Declaration of Conformity
According to 47CFR, Parts 2 and 15 for
Class B Personal Computers and Peripherals

We: PENTAX Imaging Company
A Division of PENTAX of America, Inc.

Located at: 600 12th Street, Suite 300
Golden, Colorado 80401 U.S.A.
Phone: 303-799-8000 FAX: 303-790-1131

Declare under sole responsibility that the product identified herein complies with 47CFR Parts 2 and 15 of the FCC rules as a Class B digital device. Each product marketed is identical to the representative unit tested and found to be compliant with the standards. Records maintained continue to reflect the equipment being produced can be expected to be within the variation accepted, due to quantity production and testing on the statistical basis as required by 47CFR §2.909. Operation is subject to the following two conditions: (1) This device may not cause harmful interference, and (2) This device must accept any interference received, including interference that may cause undesired operation. The above named party is responsible for ensuring that the equipment complies with the standards of 47CFR §15.101 to §15.109.

Product Name: PENTAX Digital Still Camera

Model Number: ***K10D***

Contact person: Customer Service Manager

Date and Place: October, 2006, Colorado

Information on disposal for users



1. In the European Union

If your product is marked with this symbol, it means that used electrical/electronic products should not be mixed with general household waste. There exists a separate collection system for these products.

Used electric/electronic equipment must be treated separately and in accordance with legislation that requires proper treatment, recovery and recycling of these products. Following the implementation by member states, private households within the EU states may return their used electrical/electronic equipments to designated collection facilities free of charge*. In some countries your local retailer may also take back your old product free of charge if you purchase a similar new one.

*Please contact your local authority for further details.

By disposing of this product correctly you will help ensure that the waste undergoes the necessary treatment, recovery and recycling and thus prevent potential negative effects on the environment and human health which could otherwise arise due to inappropriate waste handling.

2. In other countries outside the EU

If you wish to discard this product, please contact your local authorities and ask for the correct method of disposal.

For Switzerland: Used electrical/electronic equipment can be returned free of charge to the dealer, even when you don't purchase a new product. Further collection facilities are listed on the home page of www.swico.ch or www.sens.ch.

Memo

PENTAX Corporation 2-36-9, Maeno-cho, Itabashi-ku, Tokyo 174-8639, JAPAN
(<http://www.pentax.co.jp/>)

**PENTAX Europe GmbH
(European Headquarters)** Julius-Vosseler-Strasse, 104, 22527 Hamburg,
GERMANY
(HQ - <http://www.pentaxeurope.com>)
(Germany - <http://www.pentax.de>)

PENTAX U.K. Limited PENTAX House, Heron Drive, Langley, Slough, Berks
SL3 8PN, U.K.
(<http://www.pentax.co.uk>)

PENTAX France S.A.S. 112 Quai de Bezons, B.P. 204
95106 Argenteuil Cedex, FRANCE
(<http://www.pentax.fr>)

PENTAX Italia S.r.l. Via Dione Cassio 15, 20138 Milano, ITALY
(<http://www.pentaxitalia.it>)

PENTAX (Schweiz) AG Widenholzstrasse 1, 8304 Wallisellen, Postfach 367 8305
Dietlikon, SWITZERLAND
(<http://www.pentax.ch>)

PENTAX Scandinavia AB P.O. Box 650, 75127 Uppsala, SWEDEN
(<http://www.pentax.se>)

PENTAX Imaging Company
A Division of PENTAX of America, Inc.
(Headquarters)
600 12th Street, Suite 300 Golden, Colorado 80401, U.S.A.
(PENTAX Service Department)
12000 Zuni Street, Suite 100B
Westminster, Colorado 80234,
U.S.A. (<http://www.pentaximaging.com>)

PENTAX Canada Inc. 1770 Argentia Road Mississauga, Ontario L5N 3S7,
CANADA
(<http://www.pentax.ca>)



<http://www.pentax.co.jp/english>

- Specifications and external dimensions are subject to change without notice.