

Manufactured by:
 Polar Electro Oy
 Professorintie 5
 FIN-90440 KEMPELE

 Tel. +358-8-520 2100
 Fax +358-8-520 2300
 www.polar.fi

POLAR
 LISTEN TO YOUR BODY

S625X
 RUNNING COMPUTER

S725X
 CYCLING COMPUTER



ENG

USER MANUAL

POLAR
 LISTEN TO YOUR BODY

Display symbols

- ♥ Indicates an ongoing heart rate measurement and flashes to the beat of your heart.
- ⊘ Indicates there has not been heart rate reception for at least 5 seconds.
- Indicates there is no heart rate reception. Bring the wrist unit up to your chest near the transmitter's Polar logo. The wrist unit starts looking for the heart rate signal again.
- 🏃 Options mode: indicates that you are setting the running functions
 Time of day/Measuring/Recording mode: indicates that running speed is on.
 File mode: indicates running information.
- 🚲 Options mode: indicates that you are setting the bike functions
 Time of day/Measuring/Recording mode: indicates that bike 1 or 2 is on.
 File mode: indicates cycling information.
- 🔔)) In the Time of day display the alarm is on.
 Measuring mode: beeps if you are exercising outside your target heart rate zone.
 Fitness Test mode: sounds an alarm at the end of the fitness test.
- 📊 Indicates the Interval Trainer.
- 📊: Indicates continuous interval (Cont).
- ▲ Recording mode: indicates the heart rate above the target zone.
- ▼ Recording mode: indicates the heart rate below the target zone.
- ▮ The graphic bar consists of five blocks. A flashing block indicates in which level you are in the Options settings or File recalling loops. Continuously running bars indicate that the exercise is recorded.
- 🔋 Indicates low battery.

See the glossary for display text interpretation.

Road Map

Time of Day	File	Options	Tests	Connect	<ul style="list-style-type: none"> OK Scroll Up / Down STOP - exit the displayed mode 	
<ul style="list-style-type: none"> Measuring Mode Recording Mode 	<ul style="list-style-type: none"> Recorded Information 		<ul style="list-style-type: none"> Op. Test Fit. Test Op. Test Reset 	<ul style="list-style-type: none"> Infrared Communication 		
Monitor Set	Watch Set	Exercise Set	Memory Set	Function Set	Speed Set	User Set
<ul style="list-style-type: none"> Sound On/OFF Units 1/2 Help On/OFF 	<ul style="list-style-type: none"> Alarm Time 1/2 Date Remind On/OFF 	<ul style="list-style-type: none"> BasicUse, E0 ExeSet 1, E1 E2 E3 E4 E5 Interval On/OFF 	<ul style="list-style-type: none"> Rec. Rate 5 Sec 15 Sec 60 Sec 	<ul style="list-style-type: none"> OwnCal On/OFF Tests On/OFF HRmax_p On/OFF Altitude On/OFF AutoLap On/OFF 	<ul style="list-style-type: none"> Speed OFF Run On Bike 1/2 Wheel Cadence On/OFF Power On/OFF Foot pod calibration 	<ul style="list-style-type: none"> kg/lbs cm/ft inch Birth day Sex Activity HRmax VO2max

Keep the Road Map and Quick Guide on the back cover open while reading the manual.

Dear Customer

Congratulations on purchasing a Polar running/cycling computer! We are proud to assist you in achieving personal fitness and performance goals.

If you want to get even more out of your running/cycling computer during training, check the accessories on page 126 or www.polar.fi for more detailed product support and www.PolarRunningCoach.com or www.PolarCyclingCoach.com for a personalized exercise program and diary.

Quick Guide



How to Start Measuring Your Heart Rate (BasicUse)

1. Place the transmitter around your chest and wet the electrodes. Place the wrist unit on your wrist.
2. Press and hold the OK button to start the measurement. The stopwatch and the exercise recording start. Your heart rate will appear in about 15 seconds.

How to Stop Measuring Your Heart Rate

1. Press the stop button. The stopwatch and other calculations stop. Heart rate measurement continues but exercise data is not recorded into a file anymore.
2. Press the stop button again. The wrist unit returns to the Time of day display.

The features of this running/cycling computer provide you with the various ways to customize your exercise sessions so they meet your personal needs. For more information about the different functions, see the "All that you can do with your running/cycling computer" section.



This manual contains user information for both Polar S625X™ and Polar S725X™. [The information specific for running features is in a blue text.](#) The information specific for cycling features is marked with a grey background.



Please read this manual carefully to familiarize yourself with the Polar running/cycling computer. Here is where you can find the information you need to use and maintain your equipment. The function Road Map on the front cover is a quick guide to the versatile features of the running/cycling computer. The front cover also contains the different display symbols. There is a Quick Guide on the back cover on how to use the buttons of the wrist unit.



Please refer to the glossary for special terms and text explanations. The alphabetical index will help you quickly find answers to any questions that you might encounter while using your Polar running/cycling computer.

Thank you for choosing Polar!



CONTENTS

-  The information specific for running features is in a blue text.
-  The information specific for cycling features is marked with a grey background.

A. Getting going	5	B. How to enter settings	19
Running/cycling computer parts	5	User information settings	20
Buttons and their functions	6	Exercise settings for Recording mode	23
Easy start	8	Selecting exercise type	23
How to prepare the wrist unit	8	Setting exercise sets	24
 Installing the Polar S1 foot pod	9	Setting timers	26
Assembling the S1 foot pod battery	9	Setting limits	26
Attaching the S1 foot pod on your shoe	10	 Setting pace limit	26
 Installing the Polar Bike Mount	11	Turning limits on/off	27
Installing the Polar Speed Sensor	11	Setting recovery calculation ...	28
How to put the transmitter on	13	Setting interval type	29
How to start measuring your heart rate	13	Setting number of intervals and recoveries	30
How to stop measuring your heart rate	14	Setting interval recovery	31
After exercising	14	Naming exercise sets	32
All that you can do with your running/cycling computer	15	Setting recording rate	33
		Turning functions on/off	35
		OwnCal calorie counter on/off ...	35
		Test on/off	36
		Predicted maximum heart rate on/off	36
		Altitude and thermometer on/off	36
		AutoLap on/off	37

Speed settings	38
 Running settings	38
Calibration by running	39
Calibration manually	40
 Bicycle settings	40
Wheel size	41
Cadence on/off	42
Power on/off	43
Naming bike 1 or 2	44
Monitor settings	45
Activity/button sound on/off	45
Selecting measuring units	45
Help on/off	46
Watch settings	47
Setting alarm	47
Setting time of day	48
Setting date	48
Reminders on/off	49
Setting tips	50
Swap time 1 or time 2	50
Shortcut to watch settings	50
Swap measuring units	50
Swap date, user ID number, user name and logo	50
C. Exercise	51
Measuring mode	51
Recording mode	55
Turning the zone alarm on/off ...	56
Swapping the heart rate/ pace limits	57
Illuminating the display	57
Storing lap and split time	58

Pausing the exercise	58
Swapping the displayed exercise information	59
Starting an exercise set	61
Exercising with Interval Training Set	62
Warm-up phase	63
Interval phase	63
Cool-down phase	66
Interrupting an interval training exercise	67
Exercising with BasicSet	67
Starting the timers	67
Starting the recovery calculation	68
Stopping the exercise	68
Tips during the exercise	68
Swapping the exercise type	68
Swapping the speed setting	69
Resetting the trip distance	69
Returning to the manually set altitude	69
Restarting the interval or recovery calculation	69
Interrupting an interval or recovery calculation	70
Interrupting a phase of an interval training exercise	70
Heart touch function	70
D. How to recall training information	71
Exercise time	73

Recovery information of	
BasicSet exercise	73
Exercise distance	73
 Pace information	73
Speed information	73
 Cadence information	73
Altitude	74
Temperature	74
Ascended meters/feet	74
 Power	74
Pedaling index	74
Left right pedaling balance	74
Limits	74
Exercise time within, above and below the target zones	75
Calorie expenditure	75
Cumulative calorie count	75
Cumulative exercise time count	75
Cumulative running/riding time	75
Total distance	76
Interval Training information	76
Lap information	78
Recorded samples	80
Deleting a file	81
Deleting all files	81
Records file	82
Resetting cumulative counts to zero	83
Returning to your previous maximum value	84

E. Tests	85
Polar Fitness Test	85
OwnIndex	85
Predicted maximum heart rate ...	87
Fitness test settings	88
Carrying out the test	88
Update OwnIndex and HR _{max} -p ...	90
Fitness classes	91
Training Optimizer	93
OwnOptimizer	93
Baseline tests	94
Monitoring OwnOptimizer values	94
Carrying out the test	94
How to interpret the results	96
F. Care and maintenance	100
G. Precautions	105
H. Frequently asked questions	109
I. Technical specifications ...	113
J. Limited Polar International Guarantee	117
K. Disclaimer	118
L. Polar glossary	119
Display texts	120
Index	124
Accessories	126

A. GETTING GOING

Running/cycling computer parts and their functions

The electrode areas of the strap detect your heart rate.

The connector transmits your heart rate signal to the wrist unit.

The wrist unit displays and records your heart rate and running/cycling data during exercise. Enter your personal settings into the wrist unit and analyze the exercise files after you're done.



 **The S625X set contains** Polar S1™ Foot Pod, which transmits the running speed and distance measurements to your wrist unit.

 **The S725X set contains** Polar Bike Mount™, which allows you to attach the wrist unit to the bike's handlebar.

Polar Speed Sensor™, which measures speed and distance when cycling.



S625X Running Computer

- All cycling features of Polar S725X is included.
- Compatible with Polar cycling sensors (speed, distance, cadence and Power output).



S725X Cycling Computer

- All running features of Polar S625X is included.
- Compatible with Polar S1 Foot Pod.

Buttons and their functions

- Signal/ Light** Turns the beep on or off.
Turns the backlight on.
- Stop Return** - Stops measuring the heart rate.
Exits the displayed mode and returns to the previous mode level.
Returns to the Time of day display from any mode by pressing and holding the stop button.
- OK Accept** - Starts measuring the heart rate (start).
Enters the displayed mode shown on the lower level (start). Locks in your selection (ok). Records lap information (lap). The Help text (start, ok or lap) that appears on the display above the button indicates its use.

 **Signal/ Light**

 **Stop**

 **OK**

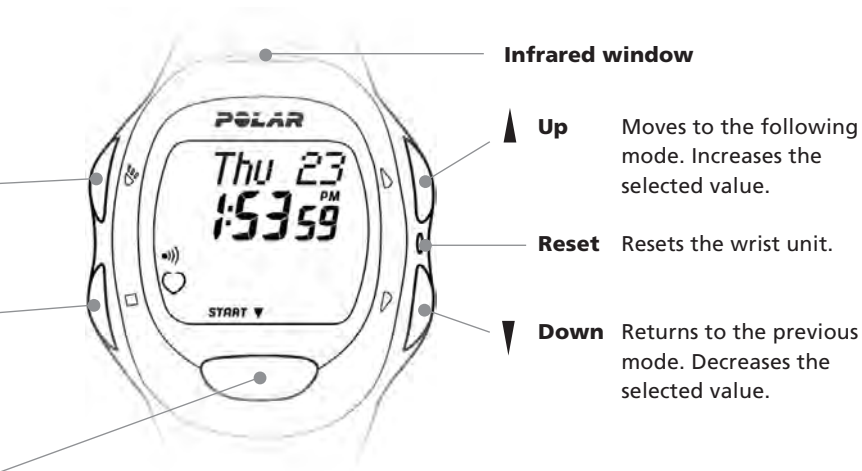

Useful tips

- Briefly pressing a button (approximately 1 second) will do different things than pressing and holding the button for a longer period of time (approximately 2 to 5 seconds). If you press a button for a longer period of time, you can use shortcuts.
- The buttons are slightly stiffer than those of an ordinary watch to prevent them from being pressed accidentally.
- You can always return to the Time of day display from the Options setting or File recalling loops by pressing and holding the stop button.

Easy start

How to prepare the wrist unit

1. Since the display is blank when the wrist unit leaves the factory, you have to activate the wrist unit by pressing the OK button twice, after which the Time of day display appears. This is a one-off procedure; once you have turned on your wrist unit you can not turn it off anymore.
2. You may start measuring your heart rate right away using the default settings. However, the following settings are ones that it would be useful to change as soon as possible: Time of day (see section Setting the watch) and personal user settings (see section User information settings).
3. Your running/cycling computer has various functions that you can use according to your personal training needs. For more information, see section All that you can do with your running/cycling computer. You can either manually enter the settings by pressing the wrist unit buttons or you can define your settings with Polar Precision Performance software, after which the data should be transferred from your PC to the wrist unit.
4. Wear the wrist unit as you would wear an ordinary watch. If you go biking, we recommend attaching the wrist unit to the accessory Polar Bike Mount.

Installing the Polar S1 foot pod

First, make sure that there is a battery in the foot pod. You can check this by pressing and holding the red button on the foot pod. If a green light starts to flash, you can start attaching the foot pod on your shoe. If there is no light, start from the chapter Assembling the S1 foot pod battery.

Assembling the S1 foot pod battery

The estimated average battery life span of the foot pod is 20 hours of use. If you prefer Polar to replace the battery, you can send or take the sensor to a Polar Service Center. There the sensor is tested after the battery is replaced. However, the S1 foot pod was designed so that you can replace the battery yourself. If you do so, follow the instructions below carefully:

1. Detach the foot pod from its holder by unfastening the flap and lifting the foot pod from the rear.

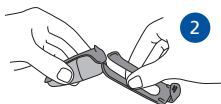

2. Remove the black top cover from the foot pod by lifting the cover from the rear. Use the fork to remove the cover (see picture 2).

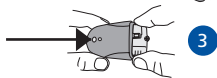

3. Open the battery cover carefully. Pull out the battery case. (See picture 3.) Replace the old battery (AAA) with a new one.

4. Insert the battery case back inside the foot pod. Make sure that the battery case slides into the grooves of the sensor. Be careful not to touch the switch on the foot pod (see the arrow in picture 3).
5. Check that the sealing rings are in the grooves. Close the battery cover and place the black top cover on top of the foot pod. Make sure that it is secured.
6. Test the foot pod by checking that the green light starts to flash after you press and hold the red button on the foot pod. Press and hold the red button again to turn the foot pod off.

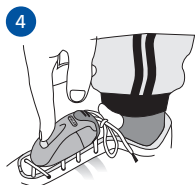
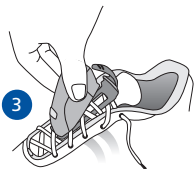
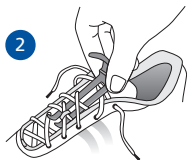
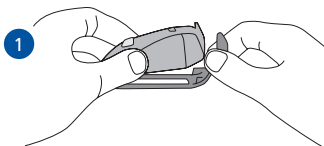

7. Do not throw the replaced battery away with normal waste; take it to a place where batteries are recycled.

Attaching the S1 foot pod on your shoe

1. Detach the holder from the foot pod by unfastening the flap and lifting the foot pod from the rear.
2. Loosen your shoelaces and place the holder under the laces, above the tongue of the shoe. Tighten the laces.
3. Attach the foot pod to the holder by fitting the front part (closer to the red button) of the foot pod to the holder and pressing from the rear. Fasten the flap. Make sure that the foot pod does not move and that it is aligned with your foot.
4. Turn the foot pod on after your heart rate is displayed on the wrist unit. Press and hold the red button on the foot pod and the green light starts to flash.
5. After exercising, turn the foot pod off by pressing and holding the red button. The green light fades.

! When the green light on the foot pod turns red, you need to replace the battery before your next run.

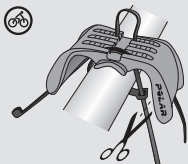

! If you are using Polar S725X/S625X with Polar Power Output Sensor, please see the bike mount and sensor installation instructions in the Power Output Sensor user manual. If you use the Power Sensor, you do not need to mount any other sensors on your bicycle.

Installing the Polar Bike Mount

Use cable ties to secure the bike mount snugly on the rubber pad.

Installing the Polar Speed Sensor

The Polar Speed Sensor measures speed and distance when cycling.

1. Check the front side of the front fork to find a suitable place for the speed sensor. The sensor should be attached less than 50 cm / 1'8" from the mounted wrist unit. The smaller the distance the better. Clean and dry the area underneath the rubber pad before you attach it to the front fork.
2. Place the sensor in the position as in illustration 2. Then adjust the sensor towards the wheel as much as possible.
3. Pass the cable ties through the sensor holes and loosely adjust the ties. Do not tighten fully yet. If the cable ties are too short for your bicycle, put two of them together to make them longer.

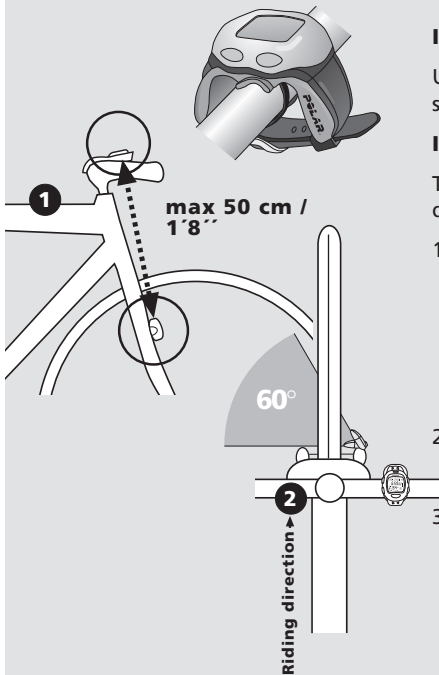

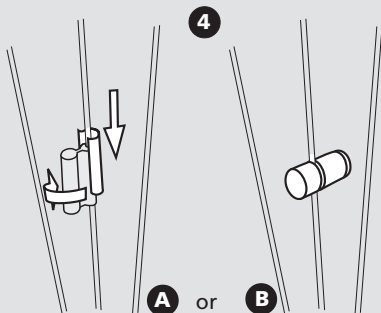

4. There are two spoke magnet options. **You only need to install one of them.** Check which of the magnets fits the spoke of your bike best. One (A) is installed by rotating it around the spoke before putting the metal cover on, another (B) by tightening the screw. The magnet must be facing the speed sensor.
5. Fine-tune the positioning of both the magnet and the sensor so that the magnet passes the sensor closely but does not touch it. The maximum distance between the speed sensor and the spoke magnet should be 5 mm / 0.2". Once positioned correctly, tighten the cable ties securely and cut off any excess cable tie ends.

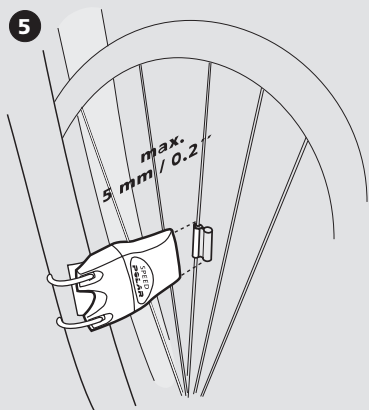

- ! Your safety is important to us. While riding your bike, please keep your eyes on the road to prevent possible accidents and injury. Check that you can turn the handle bar normally and cable wires for brakes or gearing do not catch on the sensor. Check also that the sensor does not disturb pedaling or the use of brakes or gearing.

How to put the transmitter on

1. Moisten the electrode areas of the strap under running water and make sure that they are well moistened.
2. Attach the connector to the strap. Position the connector's letter **L** to the word **LEFT** on the strap and snap the fastener.
3. Adjust the strap length to fit snugly and comfortably. Secure the strap around your chest, just below the chest muscles, and snap the second fastener.
4. Check that the wet electrode areas are firmly against your skin and that the Polar logo of the connector is in a central, upright position.

How to start measuring your heart rate

1. Begin with the display that shows the time of day.
2. Keep the wrist unit within 1 meter/ 3 feet of your transmitter.
3. Check that you are not near other people that have heart rate monitors, high voltage power lines, televisions or other sources of electromagnetic disturbance. In some cases, mobile phones may cause interference when starting the heart rate measurement.



4. Press the OK button to start measuring your heart rate. A heart symbol will start flashing and your heart rate (beats per minute) will appear in a maximum of 15 seconds.
5. Press OK again. The stopwatch starts running and you can start exercising. The exercise data will only be stored in a file if you have turned the stopwatch on.



How to stop measuring your heart rate

1. Press the stop button. The stopwatch and other calculations stop. The heart rate measuring continues, although exercise data is no longer recorded.
2. Press the stop button again. The heart rate measuring stops. The wrist unit shows the Time of day display again.

After exercising

1. To detach the connector from the strap, apply pressure with your thumb and forefinger and turn your hand as indicated in the picture.
2. Carefully wash the strap with a mild soap and water solution. Rinse it with pure water.
3. Dry the transmitter carefully with a soft towel.
4. Store the transmitter in a clean and dry place. Dirt impairs the elasticity and functioning of the transmitter. Sweat and moisture can keep the electrodes wet and the transmitter activated, which shortens battery life.



All that you can do with your running/cycling computer

Here is a short overview of the modes of the wrist unit and the different functions they offer you.

1. TIME OF DAY

In this mode you can use your wrist unit as a watch since it can display the time, date, weekday, alarm and two different time zones. In addition, you can download a personal logo, user number or user name from Polar Precision Performance software and www.polar.fi. You can also download 7 reminders with alarms.

2. MEASURING MODE (SEE SECTION C. EXERCISE)

In this mode your heart rate is displayed, but exercise information is not recorded or stored in the File mode. In Measuring mode you can choose the information that is displayed on the wrist unit during exercise.

3. RECORDING MODE (SEE SECTION C. EXERCISE)

In Recording mode your exercise is recorded and stopwatch and other calculations are started. You can use the BasicUse function when you just want to exercise without setting target limits, timers or other exercise settings. If you use the settings mentioned above, you can program up to five exercise sets for different kind of exercises.

A. BasicUse is the easiest way to start exercising because you do not have to set different target limits or timers. You just start in Measuring mode and choose BasicUse and you are ready to go. You can select among several different heart rate, running or cycling information alternatives for the display of your wrist unit.

B. Freely programmable BasicSet offers you the possibility to set three functions to control your exercise session.

1. Three adjustable target limits (either HR, % of HR_{max} or Pace limit types)
2. Three adjustable alternating timers.
3. Time-based or heart rate-based recovery calculation. By using these functions, you can easily control your normal exercise session. You can program several different kinds of exercise sets. When training, choose the one that suits the training you plan to do best.

C. Freely programmable Interval Trainer automatically guides you through your interval training session. You can program the following exercise phases:

1. warm-up period with target limits and a countdown timer
 2. up to 30 intervals with target limits and an option for a recovery calculation after each interval
 3. a cool-down period, using a countdown timer after intervals
- Use of this Interval Training function leaves you free to concentrate on your exercise during the interval training. Your wrist unit takes care of observing timers and limits, all you have to do is exercise.

4. FILE (SEE SECTION D. HOW TO RECALL TRAINING INFORMATION)

In this mode you can recall your training information. Your wrist unit saves up to 99 files of exercise information when you use the Recording mode (stopwatch on). For more information about the recorded training information, see chapter D. How to Recall Training Information.

5. OPTIONS (SEE SECTION B. HOW TO ENTER SETTINGS)

In the Options mode you set all your personal settings for optimal use of your running/cycling computer. It is highly recommended that you enter all your personal settings in your wrist unit before you start to use your running/cycling computer for the first time. By doing so, you guarantee the optimal functioning of your running/cycling computer. You can also use the Polar Precision Performance software to set and transfer your personal settings from your PC to your wrist unit.

6. TESTS (SEE SECTION E. TESTS)

In this mode you can carry out the Polar Fitness and OwnOptimizer™ Tests.

Polar Fitness Test estimates your maximal aerobic power (VO_{2max}) and shows the result as a Polar OwnIndex value. This test also provides a predicted maximum heart rate value (HR_{max-p}). The Polar Fitness Test is designed to monitor your personal progress. You should do the test regularly to see the changes in your cardiovascular fitness. Your wrist unit will memorize your last OwnIndex value.

Polar OwnOptimizer helps you to optimize training load during training program so that training will develop performance and will not lead to long-term under- or overtraining. OwnOptimizer is a modification of traditional proven orthostatic overtraining test and is based on heart rate and heart rate variability measurements done during an orthostatic test. Polar OwnOptimizer test is a perfect tool for all those who want to practice sports, avoiding at the same time all eventual problems caused by incorrect training methods.

7. CONNECTION (SEE THE SEPARATE TOOLKIT CD-ROM MANUAL)

In Connection mode you can download recorded training information from your wrist unit's memory to your PC for more indepth analysis. You can also transfer your wrist unit settings from your PC. To perform the above-mentioned operations, you need the Polar Precision Performance software.

With the MobileLink™ application you can transfer data from your wrist unit to a compatible Nokia mobile phone and quickly analyse your performance in graphical format on the phone's bright colour screen. Mobile connectivity allows you to share your experience with your friends or coach by SMS, or forward your activity data to the Polar PC Software or Web Service for further analysis and longer-term follow-up.

B. HOW TO ENTER SETTINGS



This section describes how to manually enter settings by pressing the wrist unit buttons. However, the Polar running/cycling computer offers you easier and faster way as well: prepare your settings with Polar Precision Performance software and transfer them to your wrist unit from your PC. See the separate CD-ROM set for infrared communication possibilities.



After preparing your settings you can transfer options lock from the Polar Precision Performance software to ensure that your settings will not change. You must deactivate the options lock from the "user features" of the software.

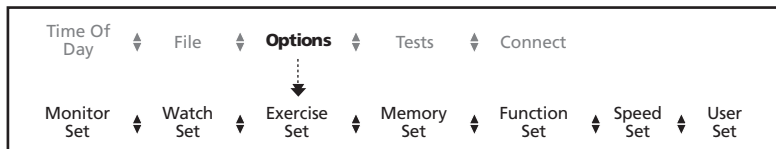

User information settings



- ! In the User Set loop you can move forward only by pressing OK. The digits run faster if you press and hold the up or down button as you adjust the value. Release the button when approaching the desired value.

Measuring units depend on your choice in Options/ Monitor Set/ Unit 1 or Unit 2.

	Units 1	Units 2
Weight	kg	lbs
Height	cm	ft/ inch
Date of birth setting order	day - month - year	month - day - year

- ! As you set your weight and height, adjustable units 1/2 can be changed by pressing and holding the signal/light button.

1. In the Time of day display scroll up or down until OPTIONS is displayed.
2. Press OK to enter the Options mode. EXERCISE SET is displayed.
3. Scroll up or down until USER SET is displayed.
4. Press OK to start the user information settings.



Weight (kg or lbs)

5. Scroll up or down to adjust your weight. Press OK.

Height (cm or ft/ inch)

6. Scroll up or down to adjust your height. Press OK.

Date of birth (Birthday)

7. Scroll up or down to adjust your day of birth. Press OK.
8. Month appears. Scroll up or down to select your month of birth. Press OK.
9. Year appears. Scroll up or down to adjust the year of birth. Press OK.

Units 2: setting order
is month - day - year.

Sex

10. Scroll up or down to select your gender. Press OK.

Activity level (Activity)

11. Scroll up or down to select your activity level for Polar Fitness Test. Press OK.

The activity level is an assessment of your level of physical activity. Select the alternative that best describes the overall amount and intensity of your physical activity in the past half-a-year.

Low You do not participate regularly in programmed recreational sport or heavy physical activity. E.g. you walk only for pleasure or occasionally exercise sufficiently to cause heavy breathing or perspiration.

Middle You participate regularly in recreational sports. E.g. you run 5-10 km/ 3-6 miles per week or spend 1/2-2 hours per week in comparable physical activity or, your work requires modest physical activity.

- High You participate regularly, at least 3 times a week, in heavy physical exercise. E.g. you run 10-20 km/ 6-12 miles per week or spend 2-3 hours per week in comparable physical activity.
- Top You participate regularly in heavy physical exercise at least 5 times a week. E.g. you exercise to improve performance for competitive purposes.

Maximum heart rate value (HR_{max})

12. Your age-predicted maximum heart rate value is displayed as a default setting when you set this value for the first time. **If you know your exact clinically tested current maximum heart rate value**, set the value by scrolling up or down.
13. Press OK.

If you do not know this value, update it in the Fitness Test mode after having carried out the Polar Fitness Test.

Maximal oxygen uptake value (VO_{2max})

14. The wrist unit suggests value 35 for females and value 45 for males as a default setting when you set this value for the first time. **If you know your exact clinically tested current maximal oxygen uptake value**, set the value by scrolling up or down.
15. Press OK. USER SET appears.

If you do not know this value, update it in Fitness Test mode after having carried out the Polar Fitness Test

To continue your settings, press the stop button or to return to the Time of day display, press and hold the stop button.

Exercise settings for Recording mode

When you start setting your exercise preferences your first choice is to select whether you want to set your personal exercise set or to exercise with BasicUse option. If you select to start setting the exercise sets, your second choice is whether you want to select BasicSet or an Interval Training Set.

Selecting exercise type

BasicUse (E0)

BasicUse is a simple mode for exercising. You do not have to do any settings before exercising with this Recording mode. While exercising, you can see the following optional values:

- current heart rate and average heart rate of the exercise
- stopwatch
- time of day
- split- and lap times

Additionally, you can follow calories of your exercise session, percentage of your maximum heart rate and running or cycling information, if you have set all the user information and turned the functions on.

Exercise set (E1-E5)

During exercising with this mode you can see the same optional values as in the BasicUse mode. Additionally, the exercise set will guide you through your exercise according to the settings you have made. You can also name the exercise sets e.g. after an exercise type.

You can set following exercise guiding functions:

- 3 limits (HR, % of HR_{max} or Pace based)
- 3 countdown timers
- interval function
- recovery calculation



Setting exercise sets

Preset exercise sets ready for five exercise sets; when you start exercising, just select one of the sets.

Interval Training Set

If you choose interval on, you can set 3 different exercise phases for each exercise set in following order:

Warm-up phase

- countdown timer 1 On/OFF
- limits 1 On/OFF

Interval phase

- interval calculation type: manual, time-, heart-rate- or distance-based interval
- number of repeated interval phases
- limits 2 On/OFF
- recovery calculation On/OFF

Cool-down phase

- countdown timer 3 On/OFF
- limits 3 On/OFF

summary limits On/OFF

If you set the countdown timers of the phase off, you have to manually stop the phase.

BasicSet

If you choose interval off, you can set the following functions to your exercise:

- timer 1 On/OFF
- timer 2 On/OFF
- timer 3 On/OFF
- limits 1 On/OFF
HR, % of HR_{max} or Pace based limit types
- limits 2 On/OFF
- limits 3 On/OFF
- summary limits On/OFF
- recovery calculation On/OFF

! You should select the timers on sequentially. E.g. you cannot set timer 2 on if timer 1 is off.

! Your choice of HR, % of HR_{max} or Pace limit type in limits 1 determines the way they will be displayed in all other limits. Only one limit type can be selected in an exercise set.

! Summary limits are not shown or alarmed during an exercise. The time spent within/above/below the summary limits can be seen from the exercise file.

1. In the Time of day display scroll up or down until OPTIONS is displayed.
2. Press OK to enter the Options mode. EXERCISE SET is displayed.
3. Press OK to start the exercise settings. BasicUse E0 or exercise set E1 - E5 is displayed.
4. Scroll up or down until the desired exercise type is displayed. Press OK.



If you chose BasicUse (E0): to return to the Time of day display, press and hold the stop button and skip the rest of the exercise settings.

If you chose exercise set (E1-E5) Interval On/OFF is displayed.

5. Scroll up or down to turn the interval function on or off. Press OK. Timer 1 is displayed.

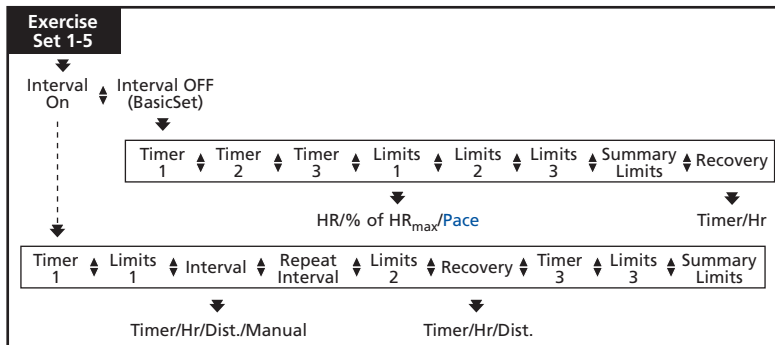

Setting timers

If you start from the Time of day display, repeat steps 1-5.

6. Scroll up or down until desired timer is displayed. Press OK to start setting the timer.
7. Scroll up or down to turn the timer on or off. Press OK.
Timer OFF: skip steps 8-9.
8. Scroll up or down to adjust minutes. Press OK.
9. Scroll up or down to adjust seconds. Press OK.

Setting heart rate limits

If you start from the Time of day display, repeat steps 1-5.

6. Scroll up or down until desired limits are displayed.
7. Press OK to start setting the limits.
8. Only when setting limits 1, scroll up or down to choose HR or % of HR_{max} based limits. Press OK to select.
9. Lim High appears. Scroll up or down to adjust your upper limit. Press OK.
10. Lim Low appears. Scroll up or down to adjust your lower limit. Press OK.

! Only one limit type (HR, % of HR_{max} or Pace) can be selected in an exercise set. The limit type selected in limits 1 determines the limit type in all limits in an exercise set.

Setting pace limit

Pace is the speed at which you run. It is measured in minutes per kilometer or mile. Pace limits can only be used when running.

If you start from the Time of day display, repeat steps 1-5.

6. Scroll up or down until desired limits are displayed.
7. Press OK to start setting the limits.
8. Only when setting limits 1, scroll up or down to choose PACE based limits. Press OK to select.

9. Scroll up or down to adjust minutes. Press OK.
10. Scroll up or down to adjust seconds. Press OK.
11. Scroll up or down to adjust the tolerance value for the pace limit in seconds. Press OK.

! Tolerance value is the time your pace is allowed to differ from the preset pace limit.

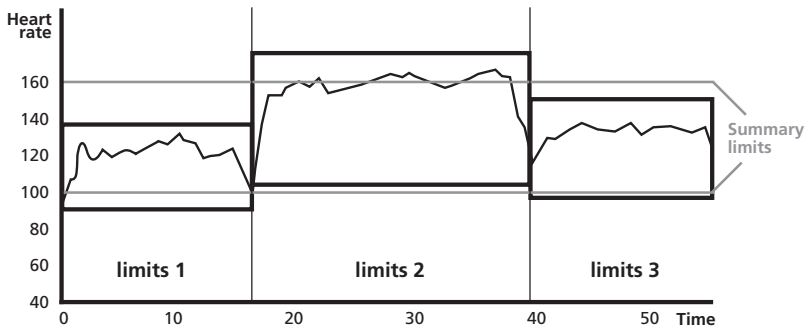

- Time within, above and below limits 1, 2 and 3 is recorded only when those particular limits are activated.
- Time within, above and below summary limits is recorded during the entire exercise, regardless of which limits are in use.

Turning limits on/off

If you start from the Time of day display, repeat steps 1-5 (page 25).

6. Scroll up or down until Limits is displayed.
7. Press and hold the signal/light button to turn limits on or off. Release.

Setting recovery calculation

You can select 2 optional types of recoveries in a BasicSet:

- A. Time-based recovery Ends your recovery as you reach the preset time.
- B. Heart-rate-based recovery Ends your recovery as you reach the preset heart rate.

If you start from the Time of day display, repeat steps 1-5 (page 25).

- 6. Scroll up or down until Recovery TIMER/ Hr is displayed.
- 7. Press OK to start setting recovery calculation on or off.
On/OFF is flashing.
- 8. Scroll up or down to turn the recovery calculation on or off. Press OK.
OFF: skip steps 9-11.
On: TIMER/ Hr is flashing.
- 9. Scroll up or down to select recovery timer or heart rate.
Press OK.

A. RecoTime is displayed.

- 10. Scroll up or down to adjust minutes. Press OK.
- 11. Scroll up or down to adjust seconds. Press OK. Recovery TIMER appears.

Or

B. RecoHr is displayed.

- 10. Scroll up or down to adjust the value. Press OK. Recovery Hr appears.

Setting interval type

You can select four optional types of intervals:

- A. Time-based interval** Ends your interval when you have used the preset time.
- B. Heart-rate-based interval** Ends your interval as you reach the preset heart rate.
 When selecting heart-rate-based interval, recovery calculation must be set on.
- C. Distance-based interval** Ends your interval as you reach the selected distance.
- D. Manual interval** End the interval training session by pressing and holding OK.

If you start from the Time of day display, repeat steps 1-5 (page 25).

6. Scroll up or down until Interval TIMER/ Hr/ DIST/ MANUAL is displayed. Press OK to start setting the interval type. TIMER/ Hr/ DIST/ MANUAL is flashing.
7. Scroll up or down to select the interval type that will be used to end the interval. Press OK. If you chose manual interval skip steps 8-9.

A. Time-based interval

8. Scroll up or down to adjust minutes. Press OK.
9. Scroll up or down to adjust seconds. Press OK. Interval TIMER appears.

Or

B. Heart-rate-based interval

8. Scroll up or down to adjust the heart rate that will end your interval. Press OK. Interval Hr appears.

Or

C. Distance-based interval

8. Scroll up or down to adjust kilometers. Press OK.
9. Scroll up or down to adjust hundreds of meters. Press OK. Interval DIST appears.

Units 2: Adjustable units are miles and feet.

Setting the number of intervals and recoveries (Repeat)

If you start from the Time of day display, repeat steps 1-5 (page 25).

You can set up to 30 intervals and recoveries (if set on) for an interval phase.

6. Scroll up or down until Repeat is displayed.
7. Press OK to start setting the number.
8. Scroll up or down to adjust the number. Press OK.

Or

If you do not know in advance the number of intervals and recoveries, select continuous interval. The intervals will succeed until you manually stop the exercise or until 30 intervals have been made.

8. Scroll down until Cont  appears. Press OK.

Setting interval recovery calculation

You can select 3 optional types of recoveries:

- A.** Time-based recovery Ends your recovery as you reach the preset time.
- B.** Heart-rate-based recovery Ends your recovery as you reach the preset heart rate.
- C.** Distance-based recovery Ends your recovery as you reach the selected distance.

If you start from the Time of day display, repeat steps 1-5 (page 25).

6. Scroll up or down until Recovery TIMER/ Hr/ DIST is displayed.
 7. Press OK to start setting recovery calculation on or off.
On/OFF is flashing.
 8. Scroll up or down to turn the recovery calculation on or off. Press OK.
OFF: skip steps 9-11.
On: TIMER/ Hr/ DIST is flashing.
 9. Scroll up or down to select recovery timer, heart rate or distance.
Press OK.
- A.** RecoTime is displayed.
10. Scroll up or down to adjust minutes. Press OK.
 11. Scroll up or down to adjust seconds. Press OK. Recovery TIMER appears.
- Or**
- B.** RecoHr is displayed.
10. Scroll up or down to adjust the value. Press OK. Recovery Hr appears.
- Or**

C. Rec. Dist is displayed.

10. Scroll up or down to adjust kilometers.

Press OK.

11. Scroll up or down to adjust hundreds

of meters. Press OK. Recovery DIST appears.

Units 2: Adjustable units
are miles and feet.

To continue your settings, press the stop button or to return to the Time of day display, press and hold the stop button.

Naming exercise sets

You can name the exercises with seven letters, numbers or punctual marks.

The available digits are: 0-9, space, A-Z, a-z, - % / () * + : ?.

1. In the Time of day display scroll up or down until OPTIONS is displayed.

2. Press OK to enter the Options mode. EXERCISE SET is displayed.

3. Press OK. E0-E5 is displayed.

4. Scroll up or down until desired exercise set (E1-E5) is displayed.

5. Press and hold signal/light button. Adjustable letter is flashing.

6. Scroll up or down to select the desired mark. Press OK.

7. Repeat previous step until you have chosen all 7 letters.

To continue your settings, press the stop button or to return to the Time of day display, press and hold the stop button.

Setting recording rate

1. In the Time of day display scroll up or down until OPTIONS is displayed.
2. Press OK to enter the Options mode. EXERCISE SET is displayed.
3. Scroll up or down until MEMORY SET is displayed.
4. Press OK to start the memory settings. Rec. Rate is displayed.
5. Scroll up or down to select the desired recording rate. As you change the recording rate you can see the memory there is left in the lower row. Press OK.

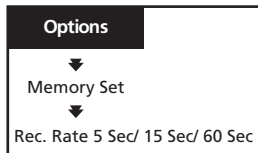

The recording time of the wrist unit depends on the selected recording rate (5 s, 15 s, or 60 s). When the memory is full, you can continue exercising but the exercise is no longer recorded.

The following table shows the maximum exercise times for each recording rate.

Altitude	Speed	Cadence	Power	Rec. Rate 5s	Rec. Rate 15s	Rec. Rate 60s
On	On	On	On	4 h 55 min	14 h 45 min	59 h 2 min
On	On	On	OFF	8 h 51 min	26 h 34 min	99 h 59 min
On	On	OFF	On	5 h 32 min	16 h 36 min	66 h 25 min
On	On	OFF	OFF	11 h 4 min	33 h 13 min	99 h 59 min
On	OFF	OFF	OFF	14 h 45 min	44 h 17 min	99 h 59 min in one file and total 170 h
OFF	On	On	On	5 h 32 min	16 h 36 min	66 h 26 min
OFF	On	On	OFF	11 h 4 min	33 h 13 min	99 h 59 min
OFF	On	OFF	On	6 h 19 min	18 h 58 min	75 h 55 min
OFF	On	OFF	OFF	14 h 45 min	44 h 17 min	99 h 59 min in one file and total 170 h
OFF	OFF	OFF	OFF	44 h 18 min	99 h 59 min	99 h 59 min in one file and total 510 h

The use of exercise sets and lap recording reduces the maximum exercise times.

To continue your settings, press the stop button or to return to the Time of day display, press and hold the stop button.

Turning functions on/off

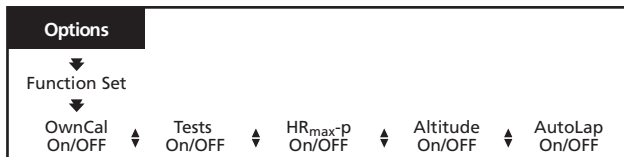

1. In the Time of day display scroll up or down until OPTIONS is displayed.
2. Press OK to enter the Options mode. EXERCISE SET is displayed.
3. Scroll up or down until FUNCTION SET is displayed.
4. Press OK to start the function settings. OwnCal is displayed.



! To set the following functions on you have to set your user information. If kg/lbs are displayed as you start setting the function on, the wrist unit points out that you have not set your all user information.

OwnCal calorie counter on/off

If you start from the Time of day display, repeat steps 1-4.

5. Press OK to start setting the OwnCal function. On/OFF starts to flash.
6. Scroll up or down to set the OwnCal on or off. Press OK.

For getting the most accurate OwnCal results, update the VO_{2max} setting and the HR_{max} setting with clinically measured values (if available). If you do not know your clinically measured values perform Polar Fitness Test and update the OwnIndex and HR_{max-p} settings in Fitness Test mode.

Tests on/off

If you start from the Time of day display, repeat steps 1-4.

5. Scroll up or down until Tests is displayed.
6. Press OK to start setting the tests. On/OFF starts to flash.
7. Scroll up or down to set the tests on or off. Press OK.

Predicted maximum heart rate on/off (HR_{max}-p)

If you start from the Time of day display, repeat steps 1-4.

5. Scroll up or down until HRmax-p is displayed.
6. Press OK to start setting the HR_{max}-p. On/OFF starts to flash.
7. Scroll up or down to set the HR_{max}-p on or off. Press OK.

HR_{max}-p can be turned on only if Polar Fitness Test is on.

Altitude and thermometer on/off

If you start from the Time of day display, repeat steps 1-4

5. Scroll up or down until Altitude is displayed.
6. Press OK to start setting the altitude measurement and thermometer. On/OFF starts to flash.
7. Scroll up or down to set the altitude on or off. Press OK.
If you turned Altitude off, skip the rest of the altitude settings.
8. If you turned Altitude on, "Wait..." appears for a few seconds.
9. Altitude and a flashing number appear. Start adjusting the starting point altitude. Adjustable units of 1/2 can be changed by pressing and holding the signal/light button.
Scroll up or down until the desired altitude is displayed. Press OK.



If dirt is blocking the air pressure channels, send the wrist unit to a Polar Service Center. Do not insert any objects into the openings.

! It is recommended that you calibrate the altitude whenever a reliable reference is available. For most accurate altitude readings, calibrate the altimeter every time before an exercise.

! To use the thermometer the altitude must be turned on. Because your body temperature affects the actual temperature reading, the best way to obtain accurate temperature is to take your wrist unit off for at least 10 minutes.

To continue setting your settings, press the stop button or to return to the Time of day display, press and hold the stop button.

AutoLap on/off

When you use the AutoLap function, the running/cycling computer automatically records lap times continuously after each time you have run or cycled the preset distance. For example if you set the AutoLap distance at 400 meters, the first lap will be recorded at 400 meters, the second lap at 800 meters and so on.

If you start from the time of the day display, repeat steps 1-4.

5. Scroll up or down until AUTOLAP is displayed.
6. Press OK to start setting the AutoLap. On/Off starts to flash.
7. Scroll up or down to set the AutoLap on or off. Press OK.
OFF: skip the rest of AutoLap settings.
8. Set A. Lap Distance is displayed. Scroll up or down to set the AutoLap distance. Press OK to select the lap distance.

! AutoLap can be turned on only if the speed function is activated in speed settings.

Speed settings

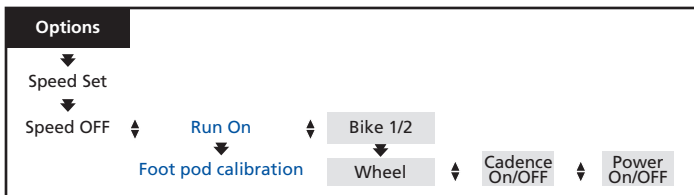

1. In the Time of day display scroll up or down until OPTIONS is displayed.
2. Press OK to enter the Options mode. EXERCISE SET is displayed.
3. Scroll up or down until SPEED SET is displayed.
4. Press OK to start the Speed settings.
5. Choose to start setting Running speed, Bike 1 or 2, or turn the speed features off. Scroll up or down until desired option is displayed. Press OK. If you selected speed features off skip the rest of the speed settings.



Running settings

Calibrating the Polar S1 foot pod

It is recommended that you calibrate the foot pod when; you use it for the first time, there are significant changes in your running style or the position of the foot pod on the shoe is dramatically changed.

Note that if you want calibration settings for walking, it is recommended that you calibrate the foot pod by walking.

You can calibrate the S1 foot pod by running a preset distance; for example, three laps on a 400-meter track, at a steady pace or by manually adjusting the calibration factor.

Calibration by running

If you start from the Time of Day display, repeat steps 1-5.

6. CALIBRATE? SPEED is displayed. Press OK.
7. CALIBRATION RUN is displayed. Press OK.
8. Hundreds of meters start to flash, scroll up or down to adjust the hundreds of meters. Press OK. Meters start to flash, scroll up or down to adjust the meters. Press OK.
9. CALIBRATION START is displayed. Turn the speed sensor on by pressing and holding the red button on the sensor until the blinking green light activates and press OK on the wrist unit to start calibration. Start the run by making the first step with the sensor foot onto the starting line and run the preset distance at a steady pace. While running, the wrist unit shows the uncalibrated distance you have run.
10. Stop exactly on the stop line of the preset distance. Stand still with your arms down and wait until the distance measurement stops accumulating on the wrist unit. Press OK.
11. Press OK to save the calibration. CALIBRATION DONE is displayed.

Minimum recommended calibration distance is 1200 meters (0,75 miles) / 3 laps on a standard track.

You can cancel the calibration by pressing the stop button on the wrist unit. If you ran less than the preset distance, CALIBRATION FAILED is displayed.

Calibration manually

! Adjust the SET factor to the value 1000 before manual calibration.

The calibration factor is calculated as a ratio of the actual distance to the uncalibrated distance. For example if you ran 1200 meters and the wrist unit shows a distance of 1180 meters, the calibration factor should be adjusted to $1200/1180 \times 1000 = 1017$.

If you start from the Time of Day display, repeat steps 1-5.

6. CALIBRATE? SPEED is displayed. Press OK.
7. Scroll up or down until Calibration Manual is displayed.
8. Press OK to start adjusting the calibration factor.
9. SET FACTOR is displayed. Scroll up or down to adjust the factor. Press OK.



Bicycle settings

You can set two bike preferences for the wrist unit. Make the settings ready for both bikes; when you start exercising, just select bike 1 or 2. As you take the bike settings 1 or 2 in use speed and distance measuring functions are always on. Select the bike features off when exercising without a bicycle. Wheel size settings are a prerequisite for cycling information.

Adjusting the wheel size (Wheel)

If you start from the Time of day display, repeat steps 1-5.

6. Start with the display showing Wheel.
7. Press OK to start setting the wheel size.
8. Scroll up or down to adjust the wheel size. Press OK.

You have the following alternatives to find out the wheel size of your bike:

METHOD 1.

Look at the wheel of your bike and find the wheel diameter printed on it. On the chart below, find your wheel diameter in inches or in ERTRO reading and match it to the wheel size in millimeters on the right.

ERTRO	Wheel size diameter (inches)	Wheel size setting (mm)
25-559	26 x 1.0	1884
23-571	650 x 23C	1909
35-559	26 x 1.50	1947
37-622	700 x 35C	1958
47-559	26 x 1.95	2022
20-622	700 x 20C	2051
52-559	26 x 2.0	2054
23-622	700 x 23C	2070
25-622	700 x 25C	2080
28-622	700 x 28	2101
32-622	700 x 32C	2126
42-622	700 x 40C	2189
47-622	700 x 47C	2220

! Wheel sizes on the above chart are advisory as wheel size depends on the wheel type and air pressure.

METHOD 2.

Mark the tread of the front tire with a line and roll the tire perpendicular to the ground. You can also use the valve as a mark. Mark a line on the ground. Move your bike on a flat surface straight ahead for one complete wheel rotation. Check that the tire is perpendicular to the ground. Draw another line on the ground exactly where the mark on the front tire touches the ground.

Measure the distance between the two lines on the ground. _____ mm
Subtract 4 mm to account for your weight on the bike to get your wheel circumference. - 4 mm
This is the value you must set on the meter. _____ mm

! The wheel size is always indicated in millimeters as this is more accurate.
Resetting the monitor enters the default values.

Cadence* on/off

If you start from the Time of day display, repeat steps 1-5.

6. Scroll up or down until Cadence is displayed.
7. Press OK to start setting the Cadence. On/OFF starts to flash.
8. Scroll up or down to set the Cadence on or off. Press OK.

*Optional Polar Cadence Sensor or Polar Power Output Sensor required.

Power* on/off

If you start from the Time of day display, repeat steps 1-5 (page 38).

6. Scroll up or down until Power is displayed.
7. Press OK to start setting the Power Output. On/OFF starts to flash.
8. Scroll up or down to set Power Output on or off. Press OK.
OFF: Skip the rest of the Power Output settings.
9. C. weight is displayed. Scroll up or down to adjust the chain weight. Press OK.
10. C. length is displayed. Scroll up or down to adjust the chain length.
Press OK.
11. S. length is displayed. Scroll up or down to adjust the span length.
Press OK.

If you are using the wireless Polar Speed Sensor, set the Power off.

You can find more information about the Polar Cadence and Polar Power Output Sensor on page 126 of this manual.

Naming bike 1 and bike 2

You can name the bikes with four letters, numbers or marks.

The number in the right corner indicates, which bike settings are in use.

(-- =Speed OFF, b1=Bike 1, b2=Bike 2)

1. In the Time of day display scroll up or down until OPTIONS is displayed.
2. Press OK to enter the Options mode. EXERCISE SET is displayed.
3. Scroll up or down until SPEED SET is displayed. Press OK.
4. Scroll up or down until Bike 1 or 2 is displayed.
5. Press and hold signal/light button. Adjustable letter is flashing.
6. Scroll up or down to select the desired mark. Press OK.
7. Repeat previous step until you have chosen all four letters.

To continue your settings, press the stop button or to return to the Time of day display, press and hold the stop button.

Monitor settings

1. In the Time of day display scroll up or down until OPTIONS is displayed.
2. Press OK to enter the Options mode. EXERCISE SET is displayed.
3. Scroll up or down until MONITOR SET is displayed.
4. Press OK to start the monitor settings. Sound is displayed.

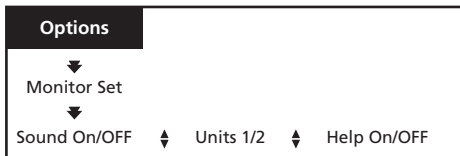

Turning activity/button sound on/off

If you start from the Time of day display, repeat steps 1-4.

5. Press OK to start setting the sound. On/OFF starts to flash.
6. Scroll up or down to set sound On or Off. Press OK.





Activity/button sound consists of the button sound and in the Measuring and Recording modes the following activity sounds: start, stop and lap recording, phase start, interval phase end and recovery calculation end sounds. It does not consist of target zone alarms, watch alarm or fitness test alarm.

Selecting measuring units

If you start from the Time of day display, repeat steps 1-4.

5. Scroll up or down until Units is displayed.
6. Press OK to start setting the units. 1 or 2 starts to flash.
7. Scroll up or down the unit which best suits you. Press OK.

The units settings affect the following features:

	Units 1:	Units 2:
User information	kg, cm	lbs, feet
Date of birth	day-month-year	month-day-year
Speed	km/h	mph
Distance	km, hundreds of meters	miles, feet
 Pace	minutes/km	minutes/mile
Altitude	meters	feet
Meters ascended	meters	feet
Temperature	°C	°F
 Wheel size	mm	mm (Note!)
Power		
Chain weight	g	g
Chain length	mm	mm
Span length	mm	mm

Turning Help on/off

If you start from the Time of day display, repeat steps 1-4.

5. Scroll up or down until Help is displayed.
6. Press OK to start setting the Help function. On/OFF starts to flash.
7. Scroll up or down to set the Help on or off. Press OK.

If you turn Help on, the flashing arrows guide you to use the correct buttons in the Options and File modes. During the exercise, when you are changing the middle row information, you can see the name of the function for few seconds. The names are also shown as you recall information on lap and exercise samples in the File mode.

To continue your settings, press the stop button or to return to the Time of day display, press and hold the stop button.

Watch settings

1. In the Time of day display scroll up or down until OPTIONS is displayed.
2. Press OK to enter the Options mode.
EXERCISE SET is displayed.
3. Scroll up or down until WATCH SET is displayed.
4. Press OK to start the watch settings. ALARM is displayed.



Setting alarm

If you start from the Time of day display, repeat steps 1-4.

5. Press OK to start alarm settings.
 -) On/OFF starts to flash.
6. Scroll up or down to set alarm on or off. Press OK.
24h: skip step 7.
7. 12h: AM/PM starts to flash. Scroll up or down to select AM or PM.
Press OK.
8. The hours start to flash. Scroll up or down to adjust the hours. Press OK.
9. The minutes start to flash. Scroll up or down to adjust the minutes.
Press OK.

OFF: Skip
steps 7-9.

When the alarm comes on, it will sound for one minute or you can turn it off by pressing any of the five buttons.

Setting time of day

If you start from the Time of day display, repeat steps 1-4.

5. Scroll up or down until TIME1/ TIME2 is displayed.
6. Press OK to start setting the time of day.
7. Time is flashing. Scroll up or down to select time 1 or time 2. Press OK.
8. 12h/ 24h starts to flash. Scroll up or down to select 12h or 24h time mode. Press OK. 24h: skip step 9.
9. AM/PM starts to flash. Scroll up or down to select AM or PM. Press OK.
10. The hours start to flash. Scroll up or down to adjust the hours. Press OK.
11. The minutes start to flash. Scroll up or down to adjust the minutes. Press OK.

Setting date

If you start from the Time of day display, repeat steps 1-4.

5. Scroll up or down until DATE is displayed.
6. Press OK to start adjusting the date.
7. Day appears. Scroll up or down to select the desired value. Press OK.
8. Month appears. Scroll up or down to select the desired value. Press OK.
9. Year digits start to flash. Scroll up or down to select the year. Press OK.

12h time mode:
month - day - year

Turning reminders on/off

If you start from the Time of day display, repeat steps 1-4.

5. Scroll up or down until REMIND is displayed.
6. Press OK to start setting the reminders.
7. Scroll up or down until desired reminder is displayed. The number of the reminder is displayed in the corner of the display.
8. Press OK. On/OFF starts to flash.
9. Scroll up or down to set the reminder on or off. Press OK.

You can download 7 reminders, each including time and name, to your wrist unit from Polar Precision Performance software.

The reminder sounds an alarm only when time of day is displayed. When the reminder alarm comes on, it will sound for 15 seconds or you can turn it off by pressing any of the buttons except the signal/light button. Erase the reminder text by pressing any of buttons except the signal/light button.

To continue your settings, press the stop button or to return to the Time of day display, press and hold the stop button.

Setting tips

Swap time 1 or time 2

In the Time of day display press and hold the down button. Time 1 or Time 2 is displayed in the uppermost row for a couple of seconds. Displayed time will now be used in all watch and alarm functions. If you chose time 2, "2" is displayed in the Time of day display.

Shortcut to watch settings

Press and hold the signal/light button for a couple of seconds to enter to watch setting loop. Scroll up or down button until the desired watch function is displayed. Set the function as in the "Watch settings" section.

Swap measuring units

- as you set your user information on weight and height.
- as you set an Interval Training Set on distance-based interval or recovery.
- as you set the altitude reference point.

Press and hold the signal/light button until the units are swapped. Release the button.

Swap date, user ID number, user name and logo

You are able to set a user ID number, user name and logo by Polar Precision Performance software. These settings are shown on the upper row of the Time of day display. You can swap between the user ID, user name, logo and date by pressing and holding the up button.

C. EXERCISE

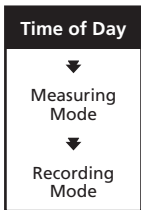

You can use two modes in your exercise: **Measuring or Recording mode.** In the **Measuring mode** you can see your heart rate but your exercise is not recorded. In the **Recording mode** your exercise is recorded and stopwatch and other calculations are started.

Measuring mode

1. Wear the transmitter and the wrist unit as described in “Easy start” section.
2. To make sure that the code search will be successful:
 - Keep the wrist unit within 1 meter/ 3 feet of your transmitter.
 - Check that you are not near other people that have heart rate monitors, high voltage power lines, televisions or other sources of electromagnetic disturbance. In some cases, mobile phones may cause interference when starting the heart rate measurement.
3. Start from the Time of day display by pressing the OK to start measuring your heart rate. A heart symbol will start flashing and your heart rate in beats per minute will appear in max. 15 seconds. The wrist unit returns automatically to the Time of day display within 5 minutes if there is no heart rate reception.

The following displays start to alternate, if you have no speed or altitude settings in use, as you enter the Measuring mode:

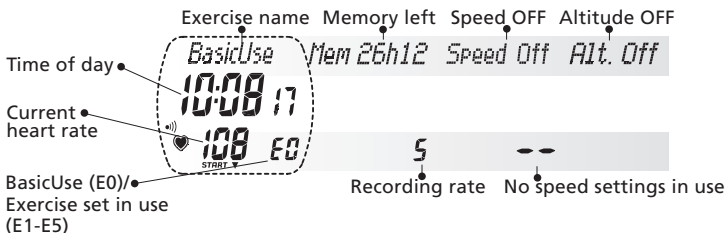

If you are running or cycling, turn the speed settings on by pressing and holding the down button. Repeat until the right speed setting is displayed in the right-hand corner of the display.

-- = speed settings off

ru = running speed

b1 = bike 1

b2 = bike 2

! Make sure that you have the right speed settings turned on before starting the recording.

- ④ The following displays start to alternate, if you have running speed and altitude settings on, as you enter the Measuring mode.

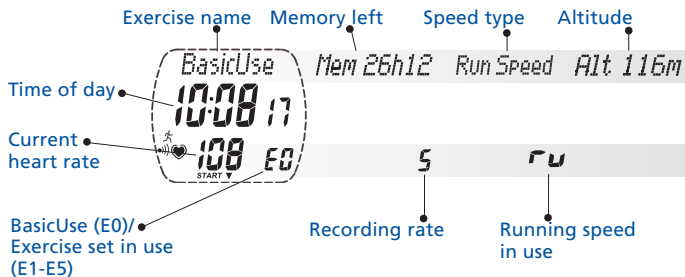

If you are not running, turn the speed settings off by pressing and holding the down button. Repeat until -- appears. This will give you more memory capacity.



If you want to record running information, turn the foot pod on after your heart rate is displayed on the wrist unit. Press OK to start recording your exercise.

Or

If you want to record running information without heart rate measurement: after the heart rate reading 00 appears turn the foot pod on.

-  The following displays start to alternate, if you have bike 1 or 2 and altitude settings on, as you enter the Measuring mode.

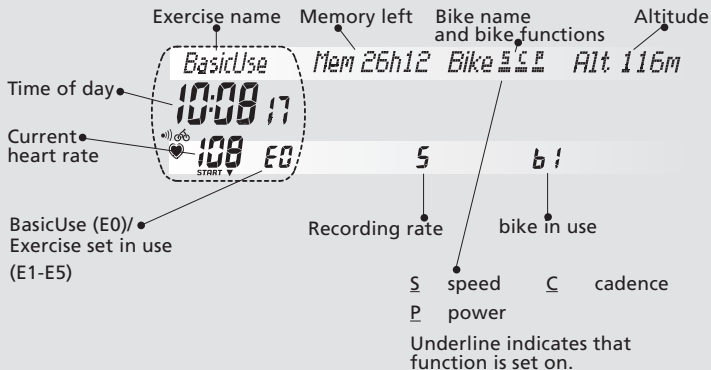

If you are not cycling, turn the cycling settings off by pressing and holding the down button. Repeat until -- appears. This will give you more memory capacity.



If you want to record cycling information, **keep the bike still** until your heart rate appears on the display. Press OK to start recording your exercise.

Or

If you want to record cycling information without heart rate measurement: after the heart rate reading 00 appears press OK and start cycling.

Recording mode

- ! Before starting recording, check that you have enough memory left. This information is displayed in the upper row, in the Measuring mode.

If you are starting from the Time of day display, press and hold OK.

Exercise information will be stored in an exercise file only when the stopwatch is running. The ongoing recording is indicated with a graphic bar that runs continuously on the display.

If your preset exercise requires speed settings, Set Speed is displayed for a few seconds. In order to start the exercise set you need to select running speed, bike 1 or bike 2 by pressing and holding the down button until the desired speed setting is displayed.

The choice is displayed in the lower right corner:

-- = speed off

ru = running speed

b1 = bike 1

b2 = bike 2



If there is -- / 00 reading on the display, there is no heart rate reception. Bring the wrist unit up to your chest near the transmitter's Polar logo. The wrist unit starts looking for the heart rate signal again.



In the beginning of your exercise, when it has lasted less than 60 minutes, the exercise time is displayed in minutes and seconds. When you have exercised more than 60 minutes, the exercise time is displayed in hours and minutes.

-  **If there is no or irregular running speed readings** on the display, check the following:
- Keep distance to other runners with foot pods.
 - If you keep the wrist unit in front of you for longer than 15 seconds the speed and distance measurements stop. You need to reactivate the measurements by moving your hand.

Turning the zone alarm on/off

-   Note that you can not use the alarm when Bicycle functions  are on. Note that trip distance is reset by pressing and holding signal/light button. Therefore Trip should not be displayed in the upper row when turning zone alarm on/off.

Press and hold the signal/light button.

When «») appears on the display the zone alarm is on. You will hear a beeping sound if you are outside the limit.

If you do not want to use the zone alarm the flashing heart rate/**pace** reading indicates if you are outside the limit. This function can be used if you have set limits on for Interval Training Set or BasicSet.

In addition to the alarm you can see:

- ▲ if you are exercising above heart rate/**pace** zone.
- ▼ if you are exercising below heart rate/**pace** zone.

Swapping the heart rate/pace limits

Press and hold the up button. Repeat until the desired limits are displayed. In the Interval Training mode the limits are automatically swapped when the phase changes to the preset limits.

You have three optional Recording modes depending on the selected exercise:

- BasicUse
- Interval Training Set (Int On)
- BasicSet (Int OFF)

The following functions can be used during all three optional Recording modes.

Illuminating the display (Night Mode)

Press the signal/light button in the Measuring or Recording mode. After you have illuminated the display once, the display automatically illuminates:

- at the end of an interval or recovery calculation
- if you start or stop the exercise session
- if you store lap information
- if you bring the wrist unit near the Polar transmitter (Heart touch)

This function is automatically turned off when you return to the Time of the day display. If you want to illuminate the display in the Time of the day mode, press the signal/light button.

Storing lap and split time

Press OK to store lap and split time.

First

Lap time

Average heart
rate of the lap

Number of
the lap



Then

Split time



The wrist unit automatically stores a lap time when you stop recording an exercise. You can store 99 laps if you have not used the interval function. After storing 99 laps FULL appears for a few seconds every time you take a lap on the display. You can continue taking laps but they will not be stored. The wrist unit continues recording all other information of the exercise, except lap and interval information.

Pausing the exercise

Press the stop button.

The exercise recording, stopwatch and other calculations are paused. To continue them, press OK. Or, to return to the Time of day display, press and hold the stop button.



The wrist unit automatically returns to the Time of day display within 30 minutes if you forget to quit the heart rate measuring after having stopped the stopwatch and taken the transmitter off your chest.

Swapping the displayed exercise information

You can swap the display information by pressing the down button in the Measuring or Recording mode. The wrist unit saves the upper and lower row settings for the display options. If the Help function is on, the name of the selected function appears for a few seconds. When you start the exercise next time the stopwatch appears on the middle row and the saved functions appear on the upper and lower rows.

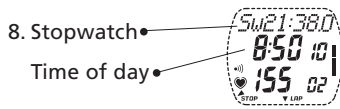
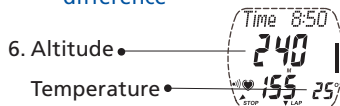
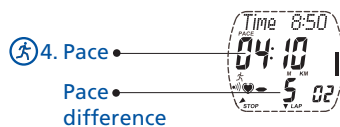
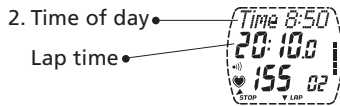
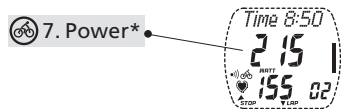
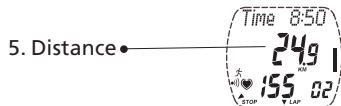
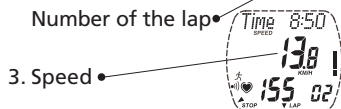
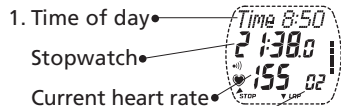

! For most accurate altitude readings, calibrate the altimeter every time before an exercise.

*Optional Polar Cadence Sensor or Polar Power Output Sensor required.

! When you have set your Interval Training Set on, you will have one extra display. You can only change the lower row for this display. See the lower row for this display. See the alternative phase displays from “Exercising with Interval Training Set” section.



 You can configure the middle and upper rows either in the Measuring and Recording mode.

1. Select the middle row information

Press the down button briefly to select the desired display alternative. When you swap the middle row information, the upper and lower rows change also. Continue selecting the upper and lower rows.

2. Select the upper row information

Press the up button briefly to select from the following:
Time of day (Time), stopwatch (Sw), lap time (Lp),
or if you have turned the functions on select from:
calorie expenditure (Cal), trip (Trip), current speed (Spd), average speed (Avg speed), maximum speed (Max speed), **pace (Pc)**, cadence* (Cad), altitude (Alt), ascended meters (Asc), output power* (Pwr), left right pedaling balance* (L - R), pedaling index* (PI).

You cannot select the same displayed function to the upper and middle row i. e. the option on the middle row is no longer available for the upper row.

*Optional Polar Cadence Sensor or Polar Power Output Sensor required.

3. Select the lower row information

Press and hold the down button to select from the following: Current heart rate, average heart rate (avg) or the reading in percentages of your maximum heart rate (% max) if you have set your user information. **If you have pace limits on you can also select the pace difference value to the lower row.**

You can only change the displayed function of the lower row if the stopwatch is on.

 **!** The pace difference value indicates the time you are running slower/faster from your preset target pace. If the value is negative you are running faster than your target pace and vice versa.

Starting an exercise set

1. Start from the Time of day display. Press OK to enter the Measuring mode.
2. If you want to swap the preset exercise set, press and hold the up button until the exercise set (E1-E5) is swapped. Release. Repeat until desired exercise set is displayed.
3. To start exercising and recording the preset exercise type press OK.

Exercising with Interval Training Set (Int On, E1-E5)

In this mode you can also use the functions described in “Recording mode” section.

The Interval Trainer automatically guides you through your exercise. In order to hear the activity sounds when the phase starts and stops make sure the activity sound is on. If you have turned the countdown timer of the phase off, you have to stop the phase manually by pressing and holding OK button. When the stopwatch starts running 📊 indicates that Interval Trainer is on. As the interval training exercise ends the wrist unit automatically starts a BasicUse exercise, which is recorded to the same file as your interval training exercise.

Structure of an interval training exercise:

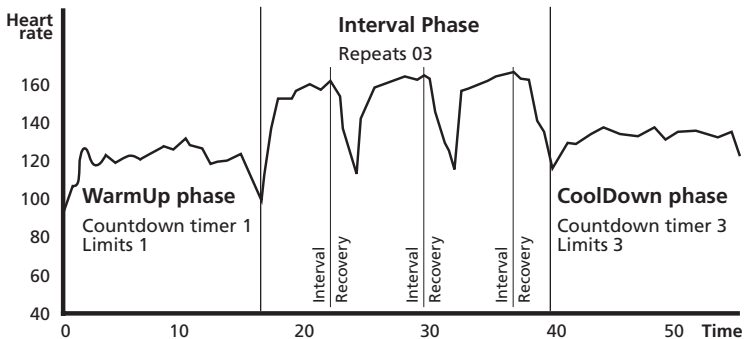

Warm-up phase



1. First

- Heart rate or **pace** limits 1 (if set on).



2. Then

- Countdown timer 1.
- Heart rate information.

Countdown timer starts running if you have set the timer 1 on. If you have set the timer off, press and hold OK and continue from the interval phase.



3. At the end of warm-up phase

- Warm-up phase duration.
- Average heart rate of the warm-up phase.

Interval phase

The wrist unit records up to 30 repeated interval phases. Your interval phase is divided into interval and recovery calculation (if set on) sections, which alternate continuously through your interval phase. As the interval phase changes, the limits are automatically swapped. For example, when the first phase changes to the second phase, the preset limits 1 changes to preset limits 2. You can also swap the limits by pressing and holding the up button. Repeat until the desired limits are displayed.

Interval session



1. *First*

• Preset heart rate or **pace** limits 2 (if set on).

2. *Then*

One of the following is displayed depending on your settings:

- A.** manual, **B.** time-based, **C.** heart rate-based or
- D.** distance-based interval.



A. Manual interval.

- Number of set intervals.
- Current interval number.
- Interval time.
- Heart rate information.

If you selected manual interval your interval will end as you press and hold OK.

Or

B. Time-based interval.



- Countdown timer 2.

If you selected time-based interval your interval will end as you reach the preset time.

Or

C. Heart-rate-based Interval.



- The difference between the preset interval heart rate and current heart rate.

Or

D. Distance-based interval.



- Countdown distance.

Your interval will end as you reach the preset distance.



3. At the end of Interval

- Interval duration.
- Average heart rate of the interval.

When your interval ends the wrist unit automatically continues with following preset function: recovery calculation or cool-down phase.

Recovery calculation

One of the following is displayed depending on your settings:

A. time-based recovery calculation or **B.** heart-rate-based recovery calculation or **C.** distance-based recovery calculation.



- A.** Time-based recovery.
- Recovery countdown timer.
- Current heart rate.

Or



B. Heart-rate-based recovery.

The difference between the preset recovery heart rate and current heart rate.

- Current heart rate.

Or



C. Distance-based recovery.

- Recovery countdown distance.
- Current heart rate.

You will hear two beeps when the recovery calculation is done.



At the end of recovery

A. and B.

- Recovery duration.
- Drop in your heart rate.

Or C.

Recovery distance.



Cool-down phase

1. *First*

- Preset heart rate or **pace** limits 3 (if set on).

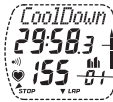

2. *Then*

- Countdown timer 3.
- Heart rate information.

Countdown timer starts running if you have set the timer 3 on. If you have set the timer off, press and hold OK to end a phase.

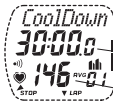

3. *At the end of cool-down phase*

- Cool-down phase duration.
- Average heart rate of the cool-down phase.



After your cool-down phase has ended the wrist unit automatically continues recording exercise with BasicUse mode.

You can continue using the limits of the interval exercise in the BasicUse mode, too. Or, if you want to do another interval training exercise, press and hold the OK button.

Interrupting an interval training exercise

1. Press the stop button to pause the exercise.
2. Press and hold the stop button to return to the Time of day display.

Or

Press the stop button. BasicUse appears. You can continue measuring your heart rate in this mode (Measuring mode). To continue exercising with BasicUse and recording your exercise information press OK. You can continue using and swapping the same limits of the previous exercise. Repeat steps 1 and 2 to return to the Time of day display.

Exercising with BasicSet (Int OFF, E1-E5)

In this mode you can also use the functions in “Recording mode” section.

Starting the timers

If timers are set on, they automatically start running once you start the stopwatch. Timers alternate in the following order: timer 1, 2, 3, 1, 2, 3 etc. At the end of timer 1 you will hear 1 beep, at the end of timer 2 you will hear 2 beeps and at the end of timer 3 you will hear 3 beeps. Timers stop running when you stop the stopwatch.

Starting the recovery calculation

To start the recovery calculation, press and hold the OK button.

See “Exercising with Interval Trainer”/ “Recovery calculation” for the displayed information during the recovery calculation. After the recovery calculation is done the exercise is paused.

You can continue the exercise by pressing the OK button after the recovery calculation. If you do another recovery calculation, the previous recovery information will be deleted.

Stopping the exercise

1. Press the stop button to pause the exercise.
2. Press and hold the stop button until Time of day is displayed.
Your lap and split time are automatically recorded, when you end the exercise.

Tips during the exercise

Swapping the exercise type (E0 or E1-E5)

In the Measuring mode press and hold the up button. Release. Repeat until desired exercise set or BasicUse is displayed.

Swapping the speed settings (--, ru, b1 or b2)

In the Measuring mode press and hold the down button. Release. Repeat until Run speed, Bike 1 or 2 or Speed Off is displayed. You can now exercise with the chosen settings. From running to cycling and vice versa can be swapped in the BasicUse (E0) mode, if the exercise is paused. A new file is created if you change the speed settings.

Resetting the trip distance

Start from the Measuring or Recording mode. Scroll up until Trip is displayed. Press and hold the signal/ light button until the trip reading is zero. Release.

Returning to the manually set altitude

Start from the Measuring mode. Scroll down until altitude is displayed in the middle row. Press and hold the signal/light button until the previous manually set altitude is displayed.

If the manually set altitude reference value deviates over ± 610 m/ ± 2000 ft from the altitude calculated by the wrist unit, Failed appears and the measured altitude appears. Set the reference altitude from the Options mode. As you start adjusting the reference altitude, the wrist unit suggests a measured altitude for you instead of the previously set altitude.

Restarting the interval or recovery calculation

In the Recording mode press the stop button to pause the interval or recovery calculation.

Start resetting by pressing and holding the down button. To restart the same calculation press the OK button.

Interrupting an interval or recovery calculation

Press and hold the OK button during your interval training exercise session to interrupt the calculation. The following section automatically starts. E.g. if you interrupt an interval your recovery calculation (if set on) automatically starts.

Interrupting a phase of an interval training exercise

Press the stop button to pause your phase. Press and hold the OK button. The following phase automatically starts.

Heart touch function

The heart touch function is activated as you bring the wrist unit near the transmitter's Polar logo.

You have three alternatives for the heart touch function. To select heart touch display, use your Polar Precision Performance software:

- Checking the current limits
- Swapping the display options
- Storing lap time

During the heart touch, the backlight is on for a couple of seconds, if you have already used the backlight during the exercise.

D. HOW TO RECALL TRAINING INFORMATION



The wrist unit starts saving exercise information to a file as you start the stopwatch. You can recall the information in the File mode. In the File mode there are up to 99 exercise files and a records file, which keeps track of the cumulative and maximum exercise values.



Your first file is F1, then F2 and so on, until you have recorded maximum 99 exercise files. The bigger the file number the more recent it is.

 There is a two-way communication between the wrist unit and a PC. Polar Precision Performance software offers an easy way to analyze training data, keep training diary, and plan future training. See the CD-ROM for further information.

! If a function was not activated in the settings mode, that information will not be displayed in the recorded file.

Exercise file

1. In the Time of day display scroll up or down until FILE is displayed.
2. Press OK to enter the File mode. The main information of your file is displayed.

Starting date and time alternate on the display.

Exercise name

File number

Used exercise set
(E1-E5)

or BasicUse (E0)



3. Scroll up or down until the desired file is displayed.
 4. Press OK to start recalling an exercise file. Exe. Time is displayed.
- Move forward and backward within file loops with up or down buttons.
 - Press OK to enter a file or to enter a deeper level in the file loop.
 - Press the stop button to move backward to the previous file level.
 - Press and hold the stop button to return to the Time of day display, wherever you are in the File recalling cycle.



Some information alternates on the display automatically.

You can make the alternation faster by pressing the OK button e.g. the target heart rate zone information.

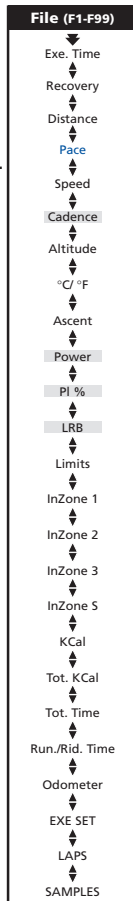



Exercise time (Exe. Time)

The exercise time is the amount of time that you have exercised with the stopwatch running. Average and maximum heart rates of your exercise alternate on the display. To continue recalling the file, scroll up or down button.



Recovery information of BasicSet exercise (Reco)

- Recovery time.
- Recovery duration.
- Drop in your heart rate.

Or



- Recovery heart rate.
- Time it took reach the preset heart rate reading.
- Drop in your heart rate.

Exercise distance (Exe. Dist.)

You can see the exercised distance.



Pace information (Pc. Avg/ Max)

Average and maximum pace of the exercise alternate.

Speed information (Spd. Avg/ Max)

Average and maximum speed of the exercise alternate.



Cadence information* (Cad. Avg/ Max)

Average and maximum cadence of the exercise alternate.

*Optional Polar Cadence Sensor or Polar Power Output Sensor required.

Altitude (Alt. Avg/ Max/ Min)

Average, maximum and minimum altitude of the exercise alternate.

Temperature (°C or °F Avg/ Max/ Min)

Average, maximum and minimum temperature of the exercise alternate.

Ascended meters/feet (Ascent)

You can see the ascended meters/ feet of the exercise.

 **Power*** (Pwr Avg/ Max)

Average and maximum output power of the exercise alternate.

Pedaling index* (PI Avg/Max)

Average and maximum pedaling index of the exercise alternate.

Left right pedaling balance* (LRB Avg)

You can see the average balance between left and right foot pedaling.

Limits 1, 2, 3 and summary (Limits 1/ Limits 2/ Limits 3/ Limits 5)

Settings of the limits alternate on the display. Limits 1 are used for zone 1, limits 2 for zone 2, limits 3 for zone 3 and limits 5 for summary zone.



Summary limits are not shown or alarmed during an exercise.

The time spent within/above/below the summary limits can be seen from the exercise file.

*Optional Polar Cadence Sensor or Polar Power Output Sensor required.

Exercise time within, above and below the target zones

Indicates the exercise time, which you have spent within (InZone), above and below each limits. Time within, above and below limits 1,2 and 3 is recorded only when those particular limits are activated. Time within, above and below summary limits is recorded during the entire exercise, regardless of which limits are in use.

Calorie expenditure (KCal)

You will see how many kilocalories you have expended during the exercise.

Cumulative calorie count (Tot. KCal)

You will have a count for cumulative calories expended during several exercise sessions starting from the previous resetting of the value in records file. This function allows you to follow the calorie count as a gauge of effective exercise e.g. during one week.

Cumulative exercise time count (Tot. Time)

This function counts cumulative exercise time expended during several exercise sessions starting from the previous resetting of the value in records file. It allows you to follow the exercise time count as a gauge of amount of exercise e.g. during one week.

 Your cumulative total time is displayed in hours and minutes until 99 hours 59 minutes is reached. After this your cumulative exercise time is displayed in hours until 9999 hours is reached.

Cumulative running/riding time (Run./Rid. Time)

You will have a count for cumulative running or riding time expended during several exercise sessions starting from the previous resetting of the value in records file.

Total distance (Tot. Dist./Odometer)

Measures cumulative total distance of several exercise sessions starting from the previous resetting of the value in records file. In a running file value is indicated as total distance and in a cycling file as odometer.

Interval Training information (EXE. SET)

Start with the display showing EXE. SET.

1. Press OK to start recalling the interval training information.
2. Scroll up or down to see the information on warm-up, interval and cool-down phases.

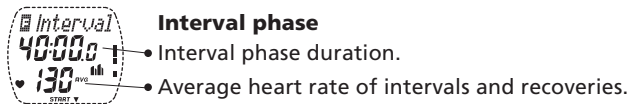
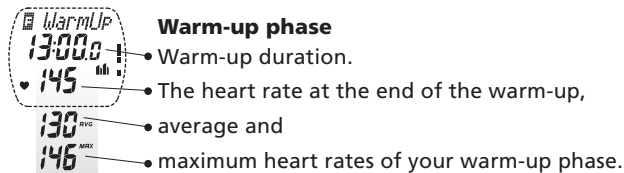
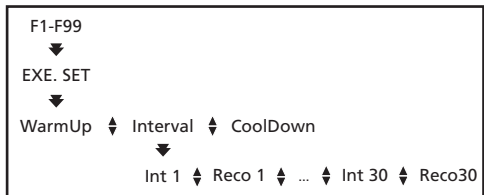

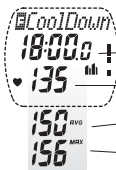

Cool-down phase

- Duration of the cool-down.
- The heart rate at the end of the cool-down,
- average and
- maximum heart rates of the cool-down phase.

3. Press the stop button to return to the previous file level and skip steps 4-6. Or, continue recalling more detailed information of the interval phase.
4. Start with the display showing Interval. Press OK to see details of each interval and recovery.
5. Scroll up or down between intervals (Int) and recoveries (Reco).

Interval information

Interval number.

Split time of the interval

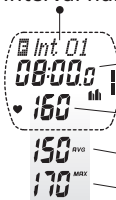

- Interval duration.
- Speed at the end of an interval (if speed was on).
- The heart rate at the end of the interval,
- average and
- maximum heart rates of the selected interval.



Recovery information



Time-based recovery.

Recovery duration.

Drop in your heart rate.

Or



Heart-rate-based recovery.

Time it took reach the preset heart rate reading.

Drop in your heart rate.

Or



Distance-based recovery.

Recovery distance.

Drop in your heart rate.

- To continue recalling, e. g. , lap information press the stop button twice. Scroll up or down until LAPS is displayed.

Lap information (LAPS)

Start with the display showing LAPS and the number of recorded laps.

- Press OK to start recalling the lap information.
- Scroll up or down to see the following information:

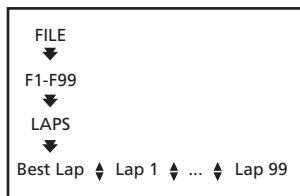



Best Lap

- Shortest lap time.
- The number of the best lap.



The best lap information is displayed if you have stored at least 3 laps. The best lap can not be the last lap.



Laps

- Split time.
- Lap time.
- Lap number.
- The heart rate at the end of the lap,
- average and
- maximum heart rates of the lap.

In the upper row, the split time alternates with the help texts if the Help function is turned on. You can check the following detailed lap information in the middle row by pressing the OK button repeatedly:

- lap time (Lap Time),
- speed at the end of the lap (Speed),
-  • cadence* at the end of the lap (Cadence),
- altitude at the end of the lap (Altitude),
- ascended meters at the end of the lap (Ascent),
-  • power* at the end of the lap (Power),

*Optional Polar Cadence Sensor or Polar Power Output Sensor required.

- left right pedaling balance at the end of the lap* (LRB),
- pedaling index* (PI %),
- run/ridden distance at the end of the lap (Distance),
- temperature at the end of the lap (°C/ °F).

Press the stop button to exit the LAPS display.

Press and hold stop to return to the Time of day display.

Recorded samples

Check the detailed information of the exercise in the sample file.

Start with the display showing SAMPLES and the number of recorded samples.

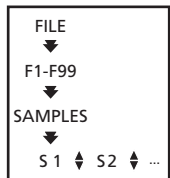

1. Press OK to start recalling the samples.

The sample number, heart rate and time when the sample was recorded are displayed. In the upper row the sample number alternates with the help texts.

2. The following detailed sample information is shown one by one as you press OK repeatedly: stopwatch (Stopwatch), speed (Speed), cadence* (Cadence), altitude (Altitude), power* (Power), left right pedaling balance* (LRB), pedaling index* (PI %).
3. Scroll up or down from one sample to another.
4. Press and hold stop to return to the Time of day display.

*Optional Polar Cadence Sensor or Polar Power Output Sensor required.

Deleting a file

1. In the Time of day display scroll up or down until FILE is displayed.
2. Press OK to enter the File mode.
3. Scroll up or down until desired exercise file is displayed. Press and hold the signal/light button. DELETE FILE and file number are displayed.
4. Press OK. The wrist unit confirms if you want to delete a file (Are you sure).
5. Press OK to delete the selected file.
6. Press stop to exit the file. Wait appears. The wrist unit rearranges your file, which takes few seconds.
7. Repress stop to return to the Time of day display.

Deleting all files

1. In the Time of day display scroll up or down until FILE is displayed.
2. Press and hold the signal/light button. DELETE FILES is displayed.
3. Press OK. The wrist unit confirms if you want to delete all files (Are you sure).
4. Press OK to delete all exercise files.
5. Press stop to return to the Time of day display.

Records file

This file is updated each time your exercise is recorded to file.

1. In the Time of day display scroll up or down until FILE is displayed.
2. Press OK to enter the File mode.
3. Scroll up or down until Records is displayed.
4. Press OK to enter the records file. Tot. KCal is displayed.

You will have a count for cumulative calories expended during several exercise sessions.



5. Scroll up or down to see the following values:
 - cumulative exercise time (Tot. Time)
 - cumulative running/riding time (Run./Rid. Time)
 - cumulative running/riding distance (Tot. Dist./Odometer)
 - maximum speed (Max Spd.)
 - maximum cadence* (Max Cad.)
 - maximum altitude (Max Alt.)
 - maximum power* (Max Pwr.)

You can now return to the Time of day display by pressing and holding the stop button, continue resetting your cumulative counts or return to your previous maximum value.

*Optional Polar Cadence Sensor or Polar Power Output Sensor required.

Resetting your cumulative counts to zero

Once you have reset the cumulative count you cannot retrieve it.

Start with the display showing Tot. KCal, Tot. Time, Run./Rid. Time or Tot. Dist./Odometer in the records file.

1. Press OK to start resetting the desired total count. Reset appears and the value starts to flash.
2. Press and hold the down button. Reset starts to flash. You can still cancel the resetting by releasing the down button before the value is reset. If you are sure that you want to reset the value keep holding the down button until value is reset. Release.
3. Press the stop button to exit the reset display.
Press and hold the stop button to return to the Time of day display.

Returning to your previous maximum value

Start with the display showing Max Spd, Max Cad*, Max Alt or Max Pwr* in the records file.

1. Press and hold the signal/light button to start returning to the previous value. Return OLd appears and the value starts to flash.
2. You can still cancel the reset by pressing the stop button. If you are sure you want to return to the previous value, press OK.
3. Press the stop button to exit the display.
Or, if you want to start resetting your maximum value to zero, press and hold the signal/light button. Reset VALUE starts to flash. Once you have reset the value you cannot retrieve it.
4. You can still cancel the reset by pressing the stop button. If you are sure you want to return to the previous value, press OK.
5. Press and hold the stop button to return to the Time of day display.

*Optional Polar Cadence Sensor or Polar Power Output Sensor required.

E. TESTS

! If you have not set the user information before trying to enter the Tests mode, you will automatically move to the user settings.



Polar Fitness Test

The Polar Fitness Test is an easy, safe and quick way to estimate individual maximal aerobic power and to get predicted maximum heart rate value. The Polar Fitness Test is targeted to healthy adults.



OwnIndex

OwnIndex is a value which is comparable to maximal oxygen uptake (VO_{2max}), a commonly used descriptor of aerobic fitness. Cardiovascular (aerobic) fitness relates to how well your cardiovascular system works to transport and utilize oxygen in your body. The stronger and more efficient your heart is, the better the cardiovascular fitness is. VO_{2max} is a good indicator of performance in endurance sports.

If you want to improve your cardiovascular fitness, it takes a minimum of 6 weeks on an average to see a noticeable change in OwnIndex. Less fit individuals see progress even more rapidly and for more fit individuals more time is needed.

Cardiovascular fitness is best improved by exercise types which employ large muscle groups. Such activities include running, swimming, rowing, skating, cross-country skiing, cycling and walking.

To monitor your fitness progress start with measuring your OwnIndex a couple of times during the first two weeks, to get a baseline value. Thereafter, repeat the test approximately once a month. OwnIndex is based on resting heart rate, heart rate variability at rest, age, gender, height, body weight and self-assessed physical activity.

Predicted maximum heart rate ($HR_{\max-p}$)

The $HR_{\max-p}$ definition is carried out simultaneously with the Polar Fitness Test.

The $HR_{\max-p}$ score predicts your individual maximum heart rate value more accurately than the age-based formula ($220 - \text{age}$). The age-based method provides a rough estimation and is thus not very accurate, especially for people who have been fit for many years or for older people. The most accurate way of determining your individual maximum heart rate is to have it clinically measured (in maximal treadmill or bicycle stress test) by a cardiologist or an exercise physiologist.

Your maximum heart rate changes to some extent in relation to your fitness. Regular exercise tends to decrease HR_{\max} whereas reduced training tends to increase it. There may also be some variation according to the sport you participate in. For example, running $HR_{\max} >$ cycling $HR_{\max} >$ swimming HR_{\max} .

$HR_{\max-p}$ gives the possibility of defining training intensities as percentages of maximum heart rate and of following maximum heart rate changes due to training, without an exhaustive maximal stress test. $HR_{\max-p}$ is based on resting heart rate, heart rate variability at rest, age, gender, height, body weight and maximal oxygen uptake, $VO_{2\max}$ (measured or predicted). The most accurate $HR_{\max-p}$ is obtained by entering your clinically measured $VO_{2\max}$ into the wrist unit.

Fitness test settings

To be able to carry out the Polar Fitness Test you need to do the following settings in the Options mode:

- Set your personal user information and long-term physical activity level.
- Set the Polar Fitness Test on.
- Set the HR_{max}-p on if you want to get a prediction of your maximum heart rate.

Carrying out the test

To get reliable test results, the following basic requirements apply:

- You should be relaxed and calm.
- The test can take place anywhere - home, office, health club - as long as the testing environment is peaceful. No disturbing noises (e.g. television, radio or telephone), no other people talking to you.
- Keep the testing place, time of day and environment the same every time the test is repeated.
- Avoid eating a heavy meal or smoking 2-3 hours prior to testing.
- Avoid heavy physical effort, alcoholic beverages or pharmacological stimulants on the test day and the day before.

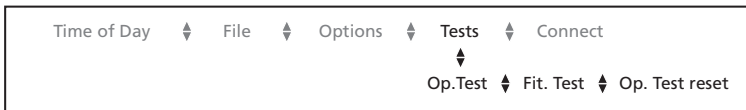

1. In the Time of day display scroll up or down until TESTS is displayed. Press OK: If you cannot find Tests mode check that you have turned the function on in the Options mode.
2. Scroll up or down until FIT. TEST is displayed. Press OK. Your latest OwnIndex and the testing date are displayed.
3. Scroll up or down to see your latest HR_{max}-p and the testing date.
4. **Lie down and relax** yourself for 1-3 minutes before the test.

Start the test

It takes 3-5 minutes to carry out the test.

5. Press OK to start the test. The wrist unit starts searching for your heart rate. TEST On and your heart rate are displayed. The test begins.
6. Lie relaxed. Keep your hands beside your body and avoid body movements. Don't communicate with other people.
7. Your current OwnIndex and the testing date are displayed.
8. If HR_{max}-p is on: Scroll up or down to see the HR_{max}-p result and the testing date.

Turn the Fitness test sound signal on/off

The sound signal will alarm you at the end of the test. If the sound signal is on •)) appears on the display.

- To turn the sound signal on or off either before or during the test, press and hold the signal/light button.

Interrupt the test

- You can stop the test any time during the test by pressing the stop button. Failed TEST is displayed for a few seconds.
The latest OwnIndex and HR_{max}-p are not replaced.

If the wrist unit does not succeed in receiving your heart rate at the beginning or during the test, the test will fail. Check that the transmitter electrodes are wet and the elastic strap is snug enough.

Update OwnIndex and HR_{max}-p

You can update your OwnIndex and HR_{max}-p values to the Options mode/ User information. When you update these values regularly, the reading in percentages of your maximum heart rate and calorie calculation give more accurate individual information.

1. In the Time of day display scroll up or down until TEST is displayed.
2. Press OK to enter the Fitness Test mode.
3. Scroll up or down until Update USER SET is displayed. This display appears if you have not updated your latest test results.
4. Press OK to update the OwnIndex and HR_{max}-p values.
5. To return to the Time of day display, press and hold the stop button.

 Your maximum heart rate value is updated if the HR_{max}-p is on.

Fitness classes

The Polar Fitness Test result, your OwnIndex, is most meaningful when comparing your individual values and changes in them. OwnIndex can also be interpreted according to your gender and age. Locate your OwnIndex on the table to find out your current cardiovascular fitness classification, compared with those who are of the same age and gender.

	Age (years)	1 (very low)	2 (low)	3 (fair)	4 (moderate)	5 (good)	6 (very good)	7 (elite)
MEN	20-24	< 32	32-37	38-43	44-50	51-56	57-62	>62
	25-29	< 31	31-35	36-42	43-48	49-53	54-59	>59
	30-34	< 29	29-34	35-40	41-45	46-51	52-56	>56
	35-39	< 28	28-32	33-38	39-43	44-48	49-54	>54
	40-44	< 26	26-31	32-35	36-41	42-46	47-51	>51
	45-49	< 25	25-29	30-34	35-39	40-43	44-48	>48
	50-54	< 24	24-27	28-32	33-36	37-41	42-46	>46
	55-59	< 22	22-26	27-30	31-34	35-39	40-43	>43
	60-65	< 21	21-24	25-28	29-32	33-36	37-40	>40
WOMEN	20-24	< 27	27-31	32-36	37-41	42-46	47-51	>51
	25-29	< 26	26-30	31-35	36-40	41-44	45-49	>49
	30-34	< 25	25-29	30-33	34-37	38-42	43-46	>46
	35-39	< 24	24-27	28-31	32-35	36-40	41-44	>44
	40-44	< 22	22-25	26-29	30-33	34-37	38-41	>41
	45-49	< 21	21-23	24-27	28-31	32-35	36-38	>38
	50-54	< 19	19-22	23-25	26-29	30-32	33-36	>36
	55-59	< 18	18-20	21-23	24-27	28-30	31-33	>33
	60-65	< 16	16-18	19-21	22-24	25-27	28-30	>30

The classification is based on literature review of 62 studies where VO_{2max} was measured directly in healthy adult subjects in the USA, Canada and 7 European countries. Reference: Shvartz E, Reibold RC: Aerobic fitness norms for males and females aged 6 to 75 years: a review. Aviat Space Environ Med; 61:3-11, 1990.

For various fitness classes we recommend the following:

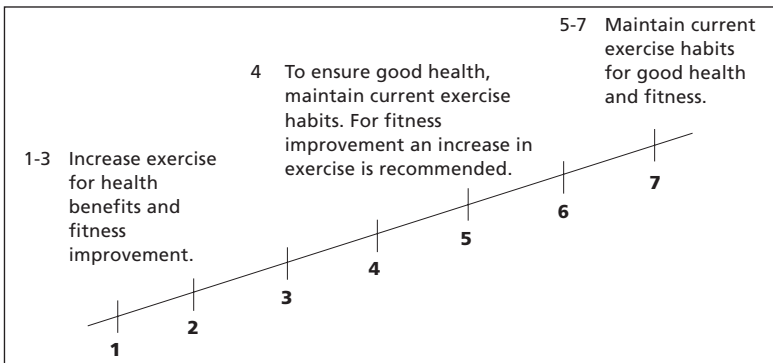

Top athletes typically score OwnIndex values above 70 (men) and 60 (women). As high values as 95 can be reached by Olympic level athletes. OwnIndex is highest in sports that involve large muscle groups such as cross-country skiing and cycling.

Training Optimizer

Successful training requires temporary overloading: longer exercise duration, higher intensity, or higher total volume. In order to avoid severe overtraining, overloading must always be followed by an adequate recovery period. With an inadequate recovery period, you may experience a decrease in performance as a result of high training volumes, instead of improvement. Polar OwnOptimizer is an easy and reliable way to determine whether your training program is optimally developing your performance.

OwnOptimizer

Polar OwnOptimizer is a modification of a traditional orthostatic overtraining test. It is a perfect tool for everyone training regularly, at least three times a week, for fitness improvement or to reach competitive targets. This feature is based on heart rate and heart rate variability measurements taken during an orthostatic test (standing up from relaxed resting). OwnOptimizer helps you to optimize your training load during a training program so that you experience an increase in performance and do not undertrain or overtrain over the long-term.

Polar OwnOptimizer is based on regular long-term measurements of five heart rate parameters. Two of these five values are calculated at rest, one while standing up and two while standing. Each time you perform the test, the wrist unit saves the heart rate values and compares them to the previous values registered.

Baseline tests

When you start using OwnOptimizer for the first time, six baseline tests should be conducted over a period of two weeks to determine your personal baseline value. These baseline measurements should be taken during two typical basic training weeks, not during heavy training weeks. The baseline measurements should include tests taken after training and after recovery days.

Monitoring your OwnOptimizer values

After the baseline recordings, you should continue to perform the test 2-3 times a week. Test yourself weekly in the morning following both a recovery day and a heavy training day (or a series of heavy training days). An optional third test can be performed after a normal training day.

OwnOptimizer may not provide reliable information during detraining or in a very irregular training period. If you take a break from exercise that is 14 days or longer, the baseline tests should be performed again.

Carrying out the test

The test should be always taken in standardized/similar conditions in order to have the most reliable results. It is recommended that you take the test in the morning before breakfast.

To get reliable test results, the following basic requirements apply:

- You should be relaxed and calm.
- Avoid eating, drinking and smoking 2-3 hours prior to the test.
- The test can take place anywhere – at home, in the office, at a health club – as long as the test environment is peaceful. There should be no disturbing noises (for example, television, radio or telephone) or other people talking to you.
- You can be seated in a relaxed position or lying in bed. The position should always be the same when you do the test.

Wear the transmitter and the wrist unit as described in the "Easy start" section.



1. In the Time of day display, scroll up or down until TESTS is shown. If you cannot find the Tests mode, check that you have turned the function on in the Options mode.
2. Press OK to enter the Tests mode.
3. Op. Test is displayed. Press OK.
4. Your latest OwnOptimizer Test information is displayed (date and your latest test value).
5. Sit or lay down, relax and press the OK button to start the test. Lay down is displayed on the wrist unit. Do not move during this first part of the test, which lasts 3 minutes.



6. After 3 minutes, the wrist unit gives a signal and Stand up is displayed. Stand up and remain standing still for 3 minutes.
7. After 3 minutes the wrist unit again gives again a signal and the test is finished.
8. You can see both a numerical and a verbal interpretation of the result on the wrist unit display.

If the test fails, the wrist unit gives a signal and the text "Failed test" is displayed. You can retake the test by starting from the very beginning.

How to interpret the results

The wrist unit calculates five heart rate and heart rate variability based parameters. The OwnOptimizer values are calculated by comparing your latest results to your previous results. The wrist unit will display a written description of your training status. They are defined in detail below. The wrist unit also displays your average heart rate (bpm) while lying down (Rest HR), the highest heart rate while standing up (Peak HR) and the average heart rate while standing (Stand HR).

The display texts for interpretation of your OwnOptimizer values are:

Recovered / Recovered (1)

Your test heart rates are lower than average. This indicates that you have recovered very well. You can continue training, including intensive exercise sessions.

Normal / Normal Training State (2)

Your test heart rates are at a normal level. Go on with your training; include both light and intensive training sessions, and recovery days.

TrEffect / Training Effect (3)

Your test heart rates are higher than average. You may have exercised intensively in the previous days. You have two choices: 1) rest or light train for one or two days, or 2) continue intensive training for one or two days and then recover well.

Other sources of stress, the beginning of a fever or an attack of the flu can result in the same kind of response.

Steady / Steady Training State (4)

Your test heart rates have continuously been at a normal level for a long time now. Effective training requires both heavy training and good recovery, and this should cause variation in your test heart rates. Your OwnOptimizer Test indicates that you have not had very intensive training or good recovery for a while. Perform the test again after a rest or light training day. If the recovery is effective, you will get Recovered as a test result.

Stagnant / Stagnant Training State (5)

Your test heart rates are still at a normal level, and this has continued for a long time. Your test indicates that your training has not been intensive enough to develop optimally. To improve your condition most effectively, you should now include more intense or longer exercise sessions in your training.

Hard Tr / Hard Training Effect (6)

Your test heart rates have been higher than average several times. You may have trained hard on purpose. Your test indicates overloading, and you should recover well now. To control your recovery, perform the test again after one or two resting or easy training days.

OverReach / Overreaching (7)

Your OwnOptimizer Test indicates that you have had a very intensive training period for several days or weeks. Your test heart rates have continuously stayed at a high level. This seriously indicates that you should have a complete recovery period. The longer you have trained intensively, the longer the recovery period required to recover. Perform the test again after at least two days of recovery.

OverTrS / Sympathetic Overtraining (8)

Your OwnOptimizer Test indicates that you have had a very intensive training period for several days or weeks, and your recovery has not been sufficient. This has resulted in a state of overtraining. To get back to a normal training state, you have to rest for a carefully controlled recovery period. Control your recovery with OwnOptimizer Test by performing the test 2 – 3 times per week.

OverTrP / Parasympathetic Overtraining (9)

Your heart rates have stayed at a low level, which is generally interpreted as a sign of a good recovery. However, other parameters indicate parasympathetic overtraining. You may have trained with high volumes for a long time and your recovery times may not have been long enough. You should check if you have other signs of overtraining. For example, overtraining is marked by decreased performance, increased fatigue, mood disturbances, sleeping problems, persistent muscle soreness and/ or a feeling of being burnt out or stale. You may also have been subjected to other stresses.

In general, the development of parasympathetic overtraining requires a long history of heavy training volumes.

To recover from a state of parasympathetic overtraining, you have to recover your body balance completely. Recovering may take several weeks. You should not exercise, and instead rest completely for most of the recovery period. You can possibly have a few days with some light aerobic training in short sessions, and only occasionally include short, high intensity sessions. You can also consider some other sport than your main sport. However, it should be one you are familiar and feel comfortable with. Control your recovery with OwnOptimizer Test by performing the test 2 – 3 times per week. If you feel that you have recovered your body balance and you get Normal Training State or Recovered as a test result, preferably more than once, you can consider continuing your training. When you can start training again, you should start a new testing period with new baseline measurements.

Note

Before you radically change your training program, consider your OwnOptimizer results together with your subjective feelings and the symptoms you have. You should repeat the OwnOptimizer test if you are unsure of the standardized conditions. An individual test result can be affected by several external factors, such as mental stress, latent illness, environmental changes (temperature, altitude) and others.

You should update the baseline calculations at least once a year when you start a new training season.

Analyzing the result with the PC software



If you download the results of the test from your wrist unit to the PC, you can analyze the results with the Polar Precision Performance software. The software offers you various ways to analyze the results and receive more detailed information about your progress. You can also generate graphical comparisons with your previous values.

F. CARE AND MAINTENANCE

Your Polar running/cycling computer is a high-tech instrument of superior design and workmanship and should be treated with care. The suggestions below will help you fulfill the guarantee obligations and enjoy this product for many years to come.

Taking care of your Polar running/cycling computer

- Store your wrist unit and transmitter in a cool and dry place. Do not store it in any kind of non-breathing material, such as a plastic bag or a sports bag if it is wet. Sweat and moisture can keep the transmitters electrodes wet and the transmitter activated, which shortens the battery life.
- Keep your wrist unit and transmitter out of extreme cold (below -10 °C / 14 °F) and heat (above +50 °C / 122 °F).
- Do not expose the wrist unit and transmitter to direct sunlight for extended periods, such as by leaving it in a car.
- If you use insect repellent on your skin, you must ensure that it does not come into contact with the transmitter!
- Detach the connector from the strap when not in use.
- Clean the connector regularly after use with a mild soap and water solution.
- Never use alcohol or any abrasive material such as steel wool or cleaning chemicals on any part of the transmitter.
- Do not dry the connector in any other way than with a towel. Rough handling may damage it.
- Never put the connector in a washing machine or a drier!

- You can wash the strap in a washing machine at +40 °C / 104 °F. We recommend that you use a washing pouch.
- We recommend that you wash the strap after each time you have used it in pool water with a high chlorine content.
- Do not spin-dry the strap!
- Do not put the strap in a dryer!
- Do not iron the strap!
- Keep the air pressure channels (three openings on the wrist unit backcover) clean to make sure that the altitude and temperature measurements work. Do not insert any objects into the openings.
-  Wipe dry the Polar S1 foot pod.
- Avoid hard hits to the S1 foot pod as these may cause damage.
-  Do not immerse the speed sensor in water.
- Avoid hard hits to the speed sensor as these may cause damage.

Batteries

Transmitter

The estimated average battery life span of the transmitter is 2 years (1h/ day, 7 days/ week). If your transmitter stops working, it might be due to the battery running out. We recommend that you have the battery replaced by an authorized Polar Service Center only.

You can, however, change the battery yourself by following the instructions below. To change the battery, you need a coin, a sealing ring and a battery (CR2025).

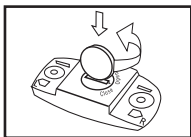

1. Open the connector's battery cover by turning it counterclockwise with the coin from the CLOSE position to the OPEN position. The cover pops out from its niche.
2. Remove the battery cover from the connector, lift the battery from the niche and replace it with a new battery.
3. Remove the sealing ring of the battery cover and replace it with a new ring.
4. Place the negative (-) side of the battery against the connector and the positive (+) side against the cover.
5. Put the battery in the connector's niche and put the cover on so that the arrow points to the OPEN position. Make sure that the cover's sealing ring is placed correctly in its groove.
6. Gently press the cover deep enough so that its exterior surface is on the same level as the connector's surface.
7. Turn the cover clockwise so that the arrow on the cover turns from OPEN to CLOSE. Make sure that the cover is closed properly!

! In order to ensure the maximum life span of the connector's battery cover, open it only when you need to change the battery. We recommend that you change the sealing ring of the battery cover every time you change the battery. You can get the sealing ring/battery kits from well-equipped Polar retailers and authorized Polar Services. In the USA and Canada: Additional sealing rings are available from an authorized Polar Service Center only.

S1 foot pod

The battery of the foot pod needs to be replaced if the green light on the foot pod turns red or there is no light at all when you press and hold the red button on the foot pod. Check the easy start section for replacing the battery.

Speed Sensor

The estimated average battery life of the speed sensor is 2500 hours of use. We highly recommend you send the speed sensor to an authorized Polar Service Center for battery replacement, where the unit is tested after the battery has been replaced. However, if you prefer changing the battery yourself, please follow these instructions carefully: Detach the sensor from your bicycle.

1. Open the sensor by removing the two small screws, counterclockwise, with a small screwdriver.
2. Lift the case off carefully. Hold the sensor cover upwards so that the PCBA (printed circuit board assembled) stays in the case.
3. Remove the PCBA carefully.
4. Press the battery holder gently. Release a hook of the holder from the opposite side of the PCBA and lift the holder upwards. Remove the old battery.
5. Insert a new battery with the plus (+) side facing up and press the battery housing gently so that it is attached to the PCBA at all corners.

6. Put the PCBA back into place.
7. Check that the sealing ring stays in its groove. Replace the cover back.
8. Insert the two screws in their holes and tighten them gradually in turn.
9. Test the sensor by checking that it gives out an orange flash when the spoke magnet passes the speed sensor.
10. Do not throw the replaced battery away with normal waste; take it to a place where problem waste is handled.

Wrist unit

The estimated average battery life of the wrist unit is 2 years in normal use (2h/ day, 7 days a week). Note also that excessive use of the backlight and the alarm signals will use the battery more rapidly. Do not open the Polar wrist unit yourself. To ensure the water resistance properties and the use of qualified components, the wrist unit battery should be replaced only by an authorized Polar Service Center. At the same time a full periodic check of the Polar running/cycling computer will be done.

Batteries should be disposed of properly according to local regulations.

Service

Should your Polar running/cycling computer need service, see Customer Service Card to contact an authorized Polar Service Center.



Water resistance cannot be guaranteed after unauthorized service.

G. PRECAUTIONS

Using the Polar running/cycling computer in a water environment

Your Polar running/cycling computer can be worn when swimming. To maintain the water resistance, do not operate the buttons of the wrist unit under water.

Users measuring their heart rate in water may experience interference for the following reasons:

- Pool water with a high chlorine content and seawater are very conductive. The electrodes of a Polar transmitter may short circuit, which prevents the transmitter unit from detecting ECG signals.
- Jumping into water or strenuous muscle movement during competitive swimming may cause water resistance that shifts the transmitter on the body to a location where it is not possible to pick up an ECG signal.
- ECG signal strength is individual and also varies depending on an individual's tissue composition. The percentage of people who have problems measuring their heart rate is considerably higher in water than in other environments.

 The S1 foot pod can be worn e.g. when raining, but it is not intended for underwater use.

Polar running/cycling computer and interference

Electromagnetic interference

Disturbances may occur near high voltage power lines, traffic lights, overhead lines of electric railways, electric bus lines or trams, televisions, car motors, bike computers, some motor driven exercise equipment or when you walk through electric security gates. In some cases, mobile phones may cause interference when starting the heart rate measurement.

Exercise equipment

Several pieces of exercise equipment with electronic or electrical components such as LED displays, motors and electrical brakes may cause interfering stray signals. To try to tackle these problems, relocate the Polar wrist unit as follows:

1. Remove the transmitter from your chest and use the exercise equipment as you would normally.
2. Move the wrist unit around until you find an area in which it displays no stray reading or flashing of the heart symbol. Interference is often worst right in front of the display panel of the equipment, while the left or right side of the display is relatively free of disturbance.
3. Put the transmitter back on the chest and keep the wrist unit in this interference-free area as far as it is possible.
4. If the Polar running/cycling computer still does not work with the exercise equipment, this piece of equipment may be electrically too noisy for wireless heart rate measurement.

Minimising possible risks in exercising

Exercise may include some risk, especially for those who have been sedentary.

Before starting a regular exercise program you are recommended to answer to the following questions for health status checking. If the answer is yes to any of the questions, we recommend that you consult a doctor before starting an exercise program.

- Have you been physically inactive for the past 5 years?
- Do you have high blood pressure?
- Do you have high blood cholesterol?
- Do you have symptoms of any disease?
- Are you taking any blood pressure or heart medication?
- Do you have a history of breathing problems?
- Are you recovering from a serious illness or medical treatment?
- Do you use a pacemaker or another implanted electronic device?
- Do you smoke?
- Are you pregnant?

Note that in addition to exercise intensity, heart, blood pressure, psyche, asthma, breathing etc. medication as well as some energy drinks, alcohol and nicotine, can affect heart rate.

It is important to be sensitive to your body's reactions during the exercise. If you feel unexpected pain or tiredness regarding your exercise intensity level, it is recommended to stop the exercise or continue at a lighter intensity.

Notice to persons with pacemakers, defibrillator or other implanted electronic device. Persons who have a pacemaker use the Polar running/cycling computer at their own risk. Before starting use, we always recommend an exercise test under doctor's supervision. The test is to ensure the safety and reliability of the simultaneous use of the pacemaker and the running/cycling computer.

If you are allergic to any substance that comes into contact with the skin or if you suspect an allergic reaction due to using the product, check the listed materials in the "Technical specifications" chapter. To avoid any skin reaction risk with the transmitter, wear it over a shirt. However, moisten the shirt well under the electrodes to ensure flawless operation.

! The combined impact of moisture and intense abrasion may cause a black color, which might stain light-colored clothes especially, to come off the transmitter's surface.

⚠ Your safety is important to us. The shape of the foot pod is designed to minimize the possibility of it being caught. Anyhow, take caution when running with the foot pod for example in brushwood.

H. FREQUENTLY ASKED QUESTIONS

What should I do if...

...I don't know where I am in the Options or File cycle?

Press and hold the stop button until time of day is displayed.

...I cannot find the expended calories from my exercise file?

Check that you have set your personal user information and turned the OwnCal function on. Check that your heart rate has reached over 90 bpm or above 60 % of your maximum heart rate during your exercise.

...I cannot turn my HR_{max}-p on?

Check that you have set your personal user information and turned the Fitness Test on before turning the HR_{max}-p on.

...there is no heart rate reading (- -)?

1. Check that the electrodes of the transmitter are moistened and that you are wearing it as instructed.
2. Check that you have kept the transmitter clean.
3. Check that you are not near other people that have heart rate monitors, high voltage power lines, televisions, mobile phones or other sources of electromagnetic disturbance.
4. Have you had a cardiac event which may have altered your ECG waveform? In this case consult your physician.

...heart symbol flashes irregularly?

1. Check that the wrist unit is not further than 1 meter/ 3 feet from the transmitter.
2. Check that the elastic strap has not become loose during exercise.
3. Make sure that the electrodes of the transmitter are moistened.
4. Make sure that there is no other heart rate transmitter within 1 meter/ 3 feet.

5. Cardiac arrhythmia may cause irregular readings. In this case consult your physician.

...other person with heart rate monitor is causing interference?

Your training partner may have exactly the same code as you. In this case proceed as follows: Keep a distance from your training partner and continue your training session normally.

Or

1. Take the transmitter off your chest for 30 seconds. Keep a distance from your training partner.
2. Put the transmitter back and bring the wrist unit up to your chest near the transmitter's Polar logo. The wrist unit starts looking for a heart rate signal again. Continue your training session normally.

...heart rate reading becomes erratic or extremely high?

You may have come within range of strong electromagnetic signals which cause erratic readings. Check your surroundings and move further away from the source of disturbance.

...the display is blank or fading?

If the display is blank, activate the wrist unit by pressing the OK button twice, after which the Time of day display appears. The first sign of a discharged battery is the battery symbol on the display. Also the digits fade when the backlight is used. Have the batteries checked.

...there are no reactions to any buttons?

Reset the Polar running/cycling computer. Resetting clears watch settings which will return to the default settings. User information and measuring units settings will be saved.

1. Press the RESET button with a pen tip. Display becomes full of digits.
If you don't press any button after reset within one minute the wrist unit returns to the Time of day display.

2. Press any of the buttons once. Time of day is displayed.

...the battery of the wrist unit must be replaced?

We recommend having all service done by an authorized Polar Service Center. The guarantee does not cover damage or consequential damage caused by service not authorized by Polar Electro. Polar Service will test your wrist unit for water resistance after battery replacement and make a full periodic check of the complete Polar running/cycling computer.

...there are irregular speed or distance readings?

1. Check that the user settings of the wrist unit are set correctly.
2. You may have come within range of strong electromagnetic-signals, which cause erratic readings.
3. Keep distance to other persons with foot pod or speed sensor.

...inaccurate altitude readings?

The influence of a sudden temperature change (i.e., if you go outdoors in the winter) may cause temporarily inaccurate altitude readings. We recommend that you place the wrist unit on your wrist at least 15 minutes before starting the exercise, so the wrist unit gets adjusted to the surrounding temperature. If the readings are constantly inaccurate, it may be caused by dirt blocking the air pressure channels (three openings on the backover and two on the side of the wrist unit). In this case, send the running/cycling computer to a Polar Service Center.

...the data transfer from wrist unit to PC was unsuccessful?

1. Check the correct position of the wrist unit with the infrared window of the PC or the optional interface.
2. Check that the surroundings are not too bright. This problem often occurs near windows.
3. Check that there is no obstruction between the infrared windows.

...Check Sensor message appears on the display?

1. Check that you have the right speed settings turned on from the wrist unit.
2. Make sure that the foot pod is turned on.
3. If there is no light on the foot pod you may have exceeded 20 running hours and the battery of the foot pod needs to be replaced. Check the Easy start section of this manual for detailed instructions on changing the battery.
4. If you keep the wrist unit in front of you for longer than 15 seconds the speed and distance measurements stop. You need to reactivate the measurements by moving your hand.
5. If you are running on a treadmill and have attached the wrist unit to a crossbar in front of you, try moving the wrist unit sideways.

Suppress the Check Sensor message for the rest of the exercise by pressing and holding the light button when the message is on the display.

...I have replaced the battery of the foot pod, but the sensor still does not work?

Please contact your local Polar distributor. Check www.polar.fi for the contact information of the local Polar distributors.

...the speed reading is 00 or there is no speed reading on the display while cycling?

1. Check the correct position and distance of the speed sensor with the spoke magnet and the wrist unit.
2. Check that you have set bike 1 or 2 on.
3. If the 00 reading appears irregularly, this may be due to temporary electromagnetic interference in your current surroundings.
4. If the 00 reading is constant, you may have exceeded 2500 riding hours and the battery of the speed sensor needs to be replaced.
5. If you are using the wireless Polar Speed Sensor, check that Power is turned off in the Options mode.

I. TECHNICAL SPECIFICATIONS

Polar S625X/S725X is designed to indicate the level of physiological strain and intensity in sports and exercise. It also measures altitude and temperature in running/cycling. No other use is intended or implied. The altitude and temperature functions are not designed to be exclusive measuring equipment in aviation, climbing sports, water sports or their equivalent. Heart rate is displayed as number of heartbeats per minute (bpm).

Wrist unit

Battery type:	CR 2354
Battery life:	Average 2 years (2h/ day, 7 days/ week)
Operating temperature:	-10 °C to +50 °C/ 14 °F to 122 °F
Water resistance:	Water resistant 30 m / 100 feet
Back cover material:	Polycarbonate and glass fibre
Wrist strap material:	Polyurethane

Wrist strap buckle and two openings on the back cover are stainless steel complying with EU Directive 94/27/EU and its amendment 1999/C 205/05 on the release of nickel from products intended to come into direct and prolonged contact with the skin.

Watch accuracy better than $\pm 0,5$ seconds/ day at +25 °C/ 77 °F temperature.

Polar S625X/S725X is a Class 1 Laser Product.

Accuracy of heart rate measurement: $\pm 1\%$ or ± 1 bpm, whichever larger, definition applies to steady state conditions.

Transmitter

Connector

Battery type:	CR 2025
Battery sealing ring:	O-ring 20.0 x 1.0 Material FPM
Battery life:	Average 2 years (1h/ day, 7 days/ week)
Operating temperature:	-10 °C to +50 °C/ 14 °F to 122 °F
Material:	Polyamide
Water resistance:	Water resistant 30 m / 100 feet

Strap

Material:	Polyurethane, polyamide, nylon, polyester and elasthane
-----------	---

Altitude and temperature measurement: The Polar S625X/S725X calculates altitude by using the standard average altitude in certain air pressures according to the ISO 2533. The air pressure is measured and the temperature is compensated every second. The wrist unit displays altitudes between - 448 m - 7590 m or between - 1600 ft - 24900 ft with at least a 1 m / 3 ft resolution. The reference point's adjustable altitude range is ± 610 m/ 2000 ft from the last measured value.



S1 foot pod

Operating temperature:	-10 °C to +50 °C/ 14 °F to 122 °F
Battery:	one AAA sized battery
Battery life:	average 20 hours of use
Weight:	62 g / 2,2 oz (without a battery)
Accuracy:	±3% or better once calibrated, definition applies to steady state conditions.
Water resistance:	Splash proof

Speed sensor

Operating temperature:	-10 °C to +50 °C/ 14 °F to 122 °F
Battery type:	CR 2032
Battery life:	average 2500 hours of use
Accuracy:	±1 %
Water resistance:	Splash proof

Default Settings

Time of day	10:00/ 24h
Alarm	OFF
Date of Birth (adjustable range for year is 1921 – 2020)	0
Sex	male
Weight	0 (kg)
Height	0 (cm)
Activity	Low
HR	190
VO _{2max} male	45
female	35
 Run speed (S625X)	On
Bike 1 (S625X)	OFF
 Run speed (S725X)	OFF
Bike 1 (S725X)	On
Bike 2	OFF
Wheel size for bike 1	2000
Wheel size for bike 2	2100
Cadence	OFF
Power	OFF
Activity sound	On
Units	1
Help	On
OwnCal	OFF
Tests	On
HR _{max-p}	OFF
Altitude _{max-p}	OFF
AutoLap	OFF
Interval function	OFF/ interval timer
Interval heart rate	160
Interval distance	2 km

Number of intervals	3
Timer 1, 2, 3	OFF/ 2 minutes
Heart rate limits	80/ 160
 Pace limits	7 min
Tolerance value	15 sec
Recovery function	OFF/ recovery timer
Recovery heart rate	80
Recovery timer	1 min
Recovery distance	1 km
Heart touch function	Shows limits
Recording rate	5 s

Limit Values

Exercise time	99 h 59 min 59 s
Heart rate limits	30 - 240
 Pace limits	2 min - 60 min
Target zone time	99 h 59 min 59 s
Recovery time	99 min 59 s
Calories	99999 kcal
Cumulative calories	999999 kcal
Cumulative exercise time	9999 h
Running/ Riding time	9999 h
Tot. Dist./Odometer	999 999 km/ miles
Files recorded to memory	99
Laps recorded to memory	99
Interval phases recorded to memory	30
Temperature measurement	- 10 °C to +50 °C 14 °F to 122 °F

J. LIMITED POLAR INTERNATIONAL GUARANTEE

- This limited Polar international guarantee is issued by Polar Electro Inc. for the consumers who have purchased this product in the USA or Canada. This limited Polar international guarantee is issued by Polar Electro Oy for the consumers who have purchased this product in other countries.
- Polar Electro Inc. / Polar Electro Oy guarantees to the original consumer/purchaser of this product that the product will be free from defects in material or workmanship for two years from the date of purchase.
- **Please keep the receipt or stamped Polar Customer Service Card. This is your proof of purchase!**
- The guarantee does not cover the battery, damage due to misuse, abuse, accidents or non-compliance with the precautions; improper maintenance, commercial use, cracked or broken cases or elastic strap.
- Guarantee does not cover any damage/s, losses, costs or expenses, direct, indirect or incidental, consequential or special, arising out of, or related to the product. During the guarantee period the product will be either repaired or replaced at an authorized service center free of charge.
- This guarantee does not affect the consumer's statutory rights under applicable national or state laws in force, or the consumer's rights against the dealer arising from their sales/ purchase contract.

CE 0537 This CE marking shows compliance of this product with Directive 93/42/EEC.



This crossed out wheeled bin marking shows that Polar products are electronic devices and are in the scope of Directive 2002/96/EC of the European Parliament and of the Council on waste electrical and electronic equipment (WEEE). These products should thus be disposed of separately in EU countries. Polar encourages you to minimize possible effects of waste on the environment and human health also outside the European Union by following local waste disposal regulations and, where possible, utilize separate collection of electronic devices.

Polar Electro Oy is a ISO 9001:2000 certified company.

Copyright © 2005-2006 Polar Electro Oy, FIN-90440 KEMPELE, Finland.

All rights reserved. No part of this manual may be used or reproduced in any form or by any means without prior written permission of Polar Electro Oy. The names and logos marked with a TM symbol in this user manual or in the package of this product are trademarks of Polar Electro Oy. The names and logos marked with a ® symbol in this user manual or in the package of this product are registered trademarks of Polar Electro Oy, except that Windows is a registered trademark of Microsoft Corporation.

K. POLAR DISCLAIMER

- The material in this manual is for informational purposes only. The products it describes are subject to change without prior notice, due to the manufacturer's continuous development program.
- Polar Electro Inc. / Polar Electro Oy makes no representations or warranties with respect to this manual or with respect to the products described herein. Polar Electro Inc. / Polar Electro Oy shall not be liable for any damages, losses, costs or expenses, direct, indirect or incidental, consequential or special, arising out of, or related to the use of this material or the products described herein.

This product is protected by one or several of the following patents:
US 6277080, FI 111514, GB 2326240, US 6199021, US 6356848, US 6361502,
US 6537227, US 6229454, EP 836165, FI 100924, FI 68734, DE 3439238,
GB 2149514, HK 812/1989, US 4625733, FI 88223, DE 4215549, FR 92.06120,
GB 2257523, HK 113/1996, SG 9591671-4, US 5491474, FI 88972,
FR 92.09150, GB 2258587, HK 306/1996, SG 9592117-7, US 5486818,
FI 96380, US 5611346, EP 665947, DE 69414362, FI 4150, DE 20008882.3,
US 6477397, FR 0006504, FI 4069, DE 29910633, GB 2339833, US 6272365,
FI 107776, US 6327486, FI 110915.

Other patents and design patents in pending.

L. POLAR GLOSSARY

Activity level:

Your long-term physical activity level you need to assess in order to do the Polar Fitness Test.

Altitude and temperature:

The altitude and temperature are measured by using an atmospheric pressure sensor. Air pressure changes constantly due to various weather conditions and therefore the calculated altitude of a certain spot may differ. Variation of high and low pressure or air conditioning can cause a change in the altitude reading. For example, a thunderstorm can cause a change of up to 80 mbars, which means a change of approximately 700 m/ 2000 ft in the calculated altitude. Therefore, it is recommended that you adjust the exact starting point altitude whenever a reliable reference; for example, a peak pointer or a map, is available. It is also recommended that you check the altitude of your house and other common starting points for training.

AutoLap:

Automatically records lap times continuously after preset distance.

Coded heart rate transmission:

Polar coded transmitter automatically locks in a code to transmit your heart rate to the wrist unit. In a coded transmission the wrist unit accepts heart rate data only from the Polar coded transmitter. Coding significantly reduces crosstalk caused by other users of heart rate monitors. However, it does not necessarily reduce all environmental interference.

Maximal oxygen uptake:

(maximal aerobic power, VO_{2max}) Is the maximal rate at which oxygen can be used by the body during maximal work. VO_{2max} is a good index of aerobic fitness.

Maximum heart rate:

(HR_{max}) Is the highest number of heart beats per minute of a person.

Target zone:

The area between the upper and lower target limits. Target zone selection is based on personal fitness goals.

Display texts

--: Indicates that you have no speed settings on.

ALARM: Indicates the alarm in watch settings.

Alt.: Indicates altitude.

AM or PM: Are used in 12h Time mode. E.g. in 24h Time mode 13:00 means 1:00 PM.

Asc.: Indicates ascended meters/feet.

AVG: Together with a reading indicates average heart rate.

 **b1:** Indicates bike 1 setting.

b2: Indicates bike 2 setting.

BasicUse: Exercising without settings.

BestLap: Indicates the shortest lap time information.

 **Cad*:** Indicates pedaling speed measured in rounds per minute (RPM).

Calibrate: You can return to the previous manually set reference point altitude.

CONNECT: Infrared communication mode.

Cont: Up to 30 intervals succeed one another unless the Interval phase is manually stopped.

CoolDown: Cool-down phase at the end of an interval training exercise.

Dis.: Indicates distance.

E0: BasicUse settings.

E1-E5: Indicates which exercise set you have used for the exercise.

ExeSet: Start setting your BasicSet (Int OFF) or Interval Training Set (Int On).

Exe. Time: Exercise duration.

FILE: Indicates the file mode.

Fit. Test: Indicates fitness test.

FULL: After having stored 99 laps (the use of intervals reduces the amount). FULL appears in the display. You can continue taking lap times or intervals but they won't be recorded into the file.

*Optional Polar Cadence Sensor or Polar Power Output Sensor required.

HR_{max}-p: Predicted maximum heart rate value.

Interval, Int: Options mode: indicates Interval Training Set
Recording mode: Indicates interval exercise session including warm-up, interval and cool-down phases.

InZone/ Above/ Below: indicate the time spent within, above and below the target zone.

KCal: Indicates the energy expenditure of your exercise.

Lp: Indicates lap time.

LAPS: Indicates how many lap times have been stored.

Lim High: The higher limit of the target zone.

Lim Low: The lower limit of the target zone.

Limits 1, 2, 3: Limits for Target Zones 1, 2 and 3.

Limits S: Limits for Summary Zone.

 **LRB, L - R*:** Indicates the left and right pedaling balance.

MAX: Together with a heart rate reading indicates the highest heart rate.

MAX %: Together with a heart rate reading indicates heart rate as a percentage of your maximum heart rate.

Mem full: Appears on the display when the memory is full. You can continue your exercise and taking lap times but they won't be recorded into the file.

Night Mode: Appears when the display is illuminated in the Measuring or Recording mode.

 **Odometer:** Measures cumulative total distance of several cycling exercise sessions.

Op. Test: Indicates OwnOptimizer test.

OPTIONS: Indicates the Options mode.

OwnCal: Calculates energy expenditure during exercise in kilocalories. 1 kilocalorie (kcal) = 1000 calories (cal). You can follow how much energy you loose by exercising in one exercise session or in a day, week or even a year. The OwnCal can be used as a dose measure of exercise

e.g. in nutrition planning. OwnCal calorie calculation starts when your heart rate reaches 90 bpm or is above 60% of your maximum heart rate, whichever is smaller. These limits are set to count only exercise calories. The higher the heart rate, the faster the energy expenditure. OwnCal is individually calibrated by your preset weight, maximal oxygen uptake (VO_{2max}) and maximum heart rate (HR_{max}). The most accurate OwnCal is received by entering your clinically measured (in maximal treadmill or bicycle stress test) VO_{2max} and HR_{max} into the wrist unit. Energy expenditure measurement is most accurate in continuous activities such as cycling and running.

OwnINDEX: Result of Polar Fitness Test and comparable score with maximal oxygen uptake (VO_{2max}) in ml/kg/min.

Pc: Indicates running pace measured minutes/km or minutes/mile.

PI %, Pedaling index*: Helps you to analyze how evenly the power is distributed. The smoother the pedaling motion, the closer the figure is to the ideal 100 %. A pedaling index of 100 % means that power is applied evenly throughout the whole pedal revolution.

Pwr*: Indicates Power Output measurement in cycling.

RecoDist, distance-based

recovery: You set the recovery distance in the Options mode. In the File mode, you will see the drop in your heart rate and the recovery distance.

RecoHr, heart-rate-based

recovery: You set the heart rate, which will end your recovery calculation. In the File mode you will see the drop in your heart rate and the recovery duration.

*Optional Polar Cadence Sensor or Polar Power Output Sensor required.

RecoTime, time-based recovery:

You set the recovery time in the Options mode. In the File mode you will see the drop in your heart rate and the recovery duration.

 **ru:** Indicates running speed settings.

Spd: Indicates velocity.

Split Time: The elapsed time from the beginning of the exercise until storing the split time.









Sw: Indicates stopwatch.



Timer1, 2, 3: Interval Training mode: Countdown timers for the Interval Training set.

 **Tot. Dist.:** Measures cumulative total distance of several running exercise sessions.

WarmUp: Warm-up phase in the beginning of an Interval Training exercise.

Index

- 12h/ 24h time mode 48
- Activity/ button sound on/off 45
- Alarm settings 47
- All that you can do with your
 running/cycling computer 15
- Altitude 36, 53, 54, 59, 74
- Altitude on/off 36
- Altitude reference point 36
- AutoLap on/off 37
- BasicSet exercise 24, 67
-  Bike 1/2 40
- Buttons 6
-  Cadence on/off 42
- Care and maintenance 100
-  Check sensor 112
- Code search 51
- Date settings 48
- Deleting a file 81
- Display configuration 59
- Easy start 8
- Exercise set 23
- File..... 71
- Fitness test 85
- Fitness test on/off 36
-  Foot pod calibration 38
- Foot pod installation 9
- Frequently asked questions 109
- Functions during the exercise 55
- Guarantee 117
- Heart rate limits checking 74
- Heart rate limits on/off 27
- Heart rate limits settings 26
- Heart touch function 70
- Help on/off 46
- How to enter settings 19
- HRmax-p on/off 36
- Illuminate the display 57
- Interrupt an interval
 exercise phase 70
- Interrupt an interval or
 recovery calculation 70
- Interval Training Set 24
- Lap and split time storing 58, 78
- Measuring units settings 45
-  Naming bike 1 or 2 44
- Naming exercise sets 32
-  Odometer 76
- OwnCal calorie expenditure 121
- OwnCal on/off 35
- OwnIndex 85
- OwnOptimizer 93
- OwnOptimizer on/off 36
-  Pace difference value 61
- Pace limits on/off 27
- Pace limit settings 26
- Pause an exercise 58
-  Power on/off 43
- Power output 60, 74
- Precautions 105
- Predicted maximum heart rate 87

Recall training information	71	Start measuring your heart rate	13, 51
Recording rate settings	33	Stop an interval training session	67
Records file	82	Stop measuring your heart rate	14, 68
Recovery during BasicSet	68, 73	Swap the exercise type	68
Recovery during Interval training .	65, 78	Swap the limits	57
Recovery settings	28, 31	Swap the speed settings	69
Reminder on/off	49	Swap the time zones 1/ 2	50
Reset cumulative values	83	Technical specifications	113
Reset maximum values	84	Temperature	36, 59, 74
Reset the trip distance	69	Time of day settings	48
Return to the Time of day display	7	Timer settings	26
Selecting exercise type	23	Transmitter	5, 13
Setting tips	50	Update HRmax-p and	
Speed settings	38	OwnIndex to user information	90
Start an exercise set	61	User information settings	20
 Start cycling measurement	54	 Wheel size	41
 Start running measurement	53	Zone alarm On/OFF	56

Accessories



Polar Cadence Sensor:

A wireless sensor that measures the frequency at which you turn the pedals of your bicycle.



Power Output Sensor:

The Polar Power Output system measures pedaling power when cycling. It also measures left/right balance (LRB describes the share of power output of left and right as a percentage), pedaling index (describes how evenly power output was produced during a cycle round), speed, cadence and distance. If you use the Power Sensor, you do not need to mount any other accessories on your bicycle.



Polar MobileLink Application

The Polar MobileLink application enables infrared communication between the Polar S625X and Polar S725X, and a compatible Nokia mobile phone. You can transfer data from your wrist unit and quickly analyse your performance in graphical format on the phone's bright colour screen. Mobile connectivity allows you to share your experience with your friends or coach by SMS, or forward your activity data to the Polar PC Software or Web Service for further analysis and longer-term follow-up. Check **www.polar.fi/mobilelink** to learn more about the Polar MobileLink application; you will also find a list of compatible phone models and instructions on how to download the application.