

**IMPORTANT MANUAL**

**Do Not Throw Away**

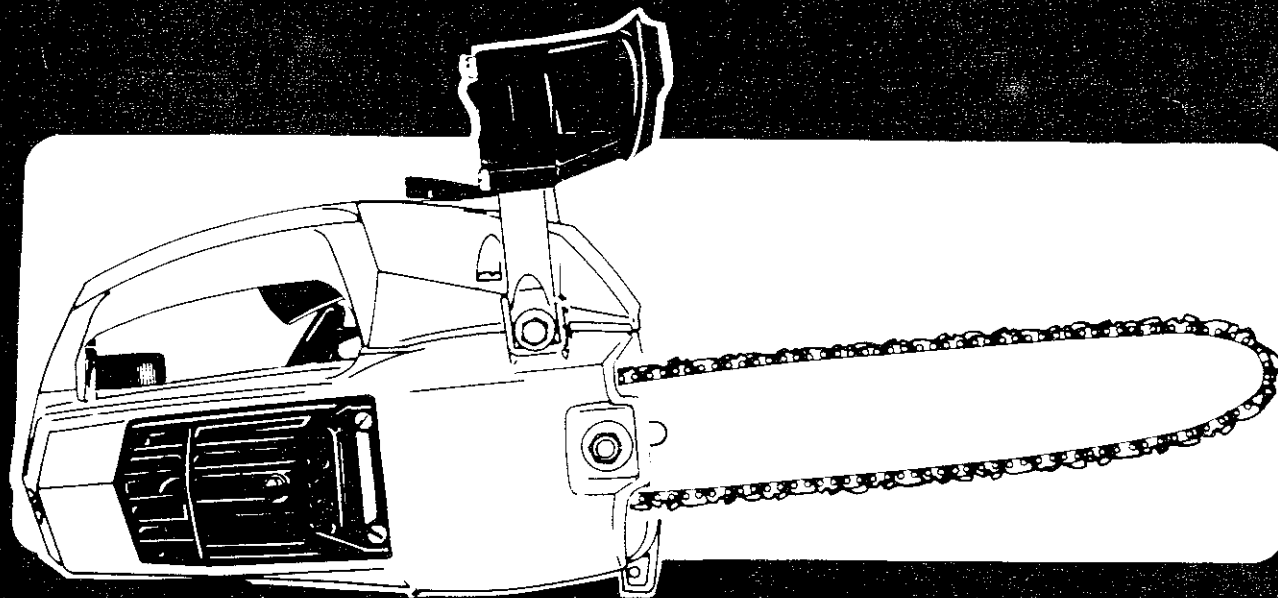

# **Poulan<sup>®</sup>**

## **CHAIN SAW**

### **OPERATOR'S MANUAL**

**Models 1800, 1800 Super,  
2000, 2000 AV, 2300 AV,  
2300 CVA**

**▲WARNING:**

Carefully read and follow Safety Rules, Precautions and Operating Instructions. Failure to do so can result in serious injury.

**POULAN/WEED EATER**

DIVISION WHITE CONSOLIDATED INDUSTRIES, INC.

Shreveport, Louisiana 71139-9329



# TABLE OF CONTENTS

Specifications .....	2	B. Tree Felling Techniques .....	12
<b>SPECIAL SAFETY SECTION</b> .....	3	C. Bucking .....	1
Know Your Chain Saw .....	6	D. Debranching and Pruning .....	15
<b>Preparing Your Saw For Use</b> .....	7	<b>Maintenance</b> .....	16
A. Getting Ready .....	7	A. Guide Bar and Chain .....	16
B. Attaching The Handguard .....	7	B. Spark Arrestor .....	17
C. Attaching the Bar and Chain .....	7	C. Starter Rope .....	18
D. Chain Tension .....	8	D. Carburetor Adjustments .....	19
E. Fueling Your Engine .....	9	E. Air Filter .....	20
F. Bar and Chain Lubricant .....	10	F. Storage .....	20
<b>Using Your Saw</b> .....	11	G. Trouble Shooting Chart .....	21
A. Pre-Operation Checks .....	11	H. Maintenance Chart .....	22
B. Starting Instructions .....	11	<b>Accessories</b> .....	23
<b>Types of Cutting</b> .....	12	<b>Parts and Service</b> .....	Back Cover
A. Basic Cutting Technique .....	12		

**Read  
SPECIAL SAFETY SECTION  
FREQUENTLY**

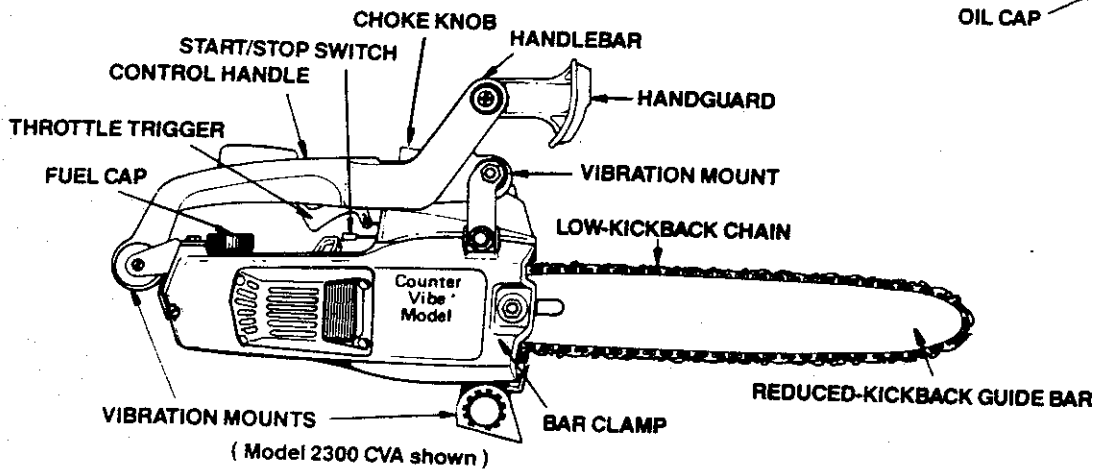
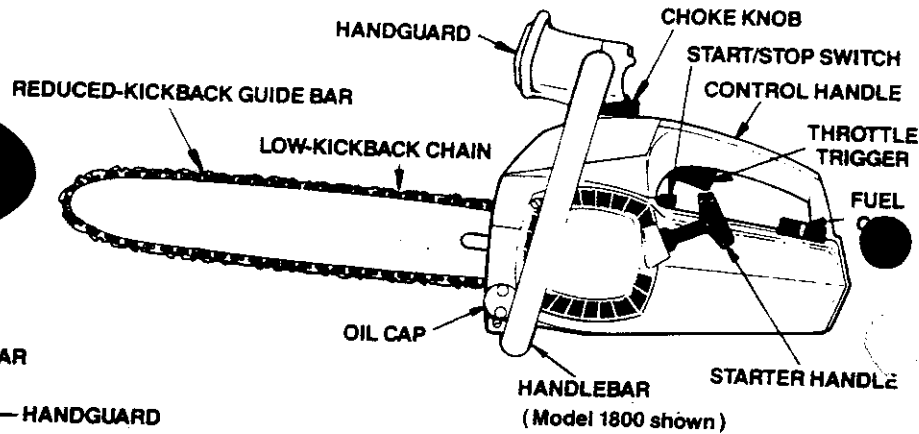

MODEL	1800/10"	1800 Super/12" 1800/12"	1800 Super/14"	18 Super/16"	2000/12"	2000/14" 2000AV/14"	2000/16"	2300/16" AV 2300/16" CVA	2300/18" CVA
ENGINE DISPLACEMENT	1.8 Cu. In.	1.8 Cu. In.	1.8 Cu. In.	1.8 Cu. In.	2.0 Cu. In.	2.0 Cu. In.	2.0 Cu. In.	2.3 Cu. In.	2.3 Cu. In.
GUIDE BAR - Control Tip*	Hard Tipped Part No. 952-044371	Sprocket Nose - Part No. 952-044368	Sprocket Nose - Part No. 952-044368	Sprocket Nose - Part No. 952-044370	Sprocket Nose - Part No. 952-044368	Sprocket Nose - Part No. 952-044368	Sprocket Nose Part No. 952-044370		Sprocket Nose Part No. 952-044418
CHAIN - GUARD LINK	3/8 Pitch 40 Drive Links - Part No. 952-051207	3/8 Pitch Chrome Cutters 45 Drive Links Part No. 952-051208	3/8 Pitch Chrome Cutters 52 Drive Links Part No. 952-051209	3/8 Pitch Chrome Cutters 56 Drive Links Part No. 952-051211	3/8 Pitch Chrome Cutters 45 Drive Links Part No. 952-051208	3/8 Pitch Chrome Cutters 52 Drive Links Part No. 952-051209	3/8 Pitch Chrome Cutters 56 Drive Links Part No. 952-051211		3/8 Pitch Chrome Cutters 82 Drive Links Part No. 952-
SPARK PLUG	Champion C-8								
SPARK PLUG GAP	.025"								
IGNITION	Solid State								
MODULE AIR GAP	008 to 014								
FUEL MIX	Gasoline Oil Mixture (see "Fueling Your Engine")								
OILER	Automatic only								
MUFFLER	Spark Arresting/Temperature Limiting								

# SPECIAL SAFETY SECTION

## GUARD AGAINST KICKBACK

Kickback is a dangerous reaction that can lead to serious injury. Do not rely only on the safety devices provided with your saw. As a chain saw user, you must take special safety precautions to help keep your cutting jobs free from accident or injury.

### ⚠ KICKBACK WARNING

Kickback can occur when the moving chain contacts an object at the upper portion of the tip of the guide bar or when the wood closes in and pinches the saw chain in the cut. Contact at the upper portion of the tip of the guide bar can cause the chain to dig into the object and stop the chain for an instant. The result is a lightning fast, reverse reaction which kicks the guide bar up and back toward the operator. If the saw chain is pinched along the top of the guide bar, the guide bar can be driven rapidly back toward the operator. Either of these reactions can cause loss of saw control which can result in serious injury.

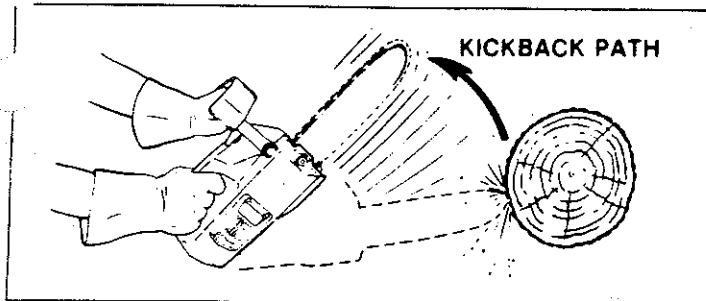

Figure 1

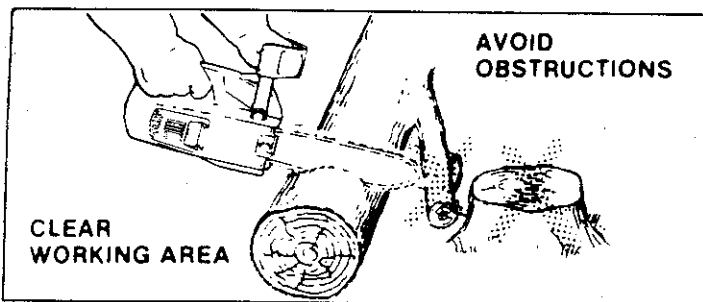

Figure 2

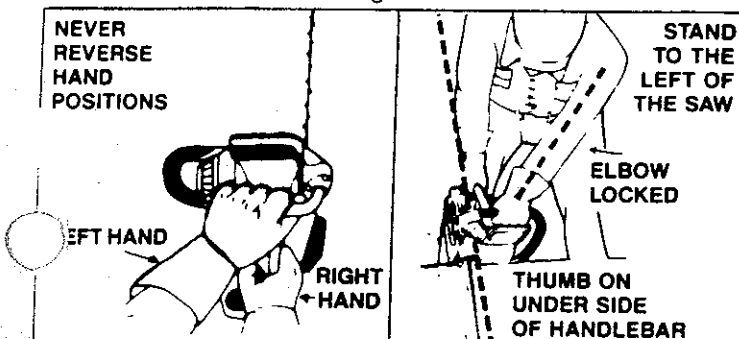

Figure 3

## REDUCE THE CHANCE OF KICKBACK

1. Recognize that kickback can happen. With a basic understanding of kickback, you can reduce the element of surprise which contributes to accidents.
2. Never let the moving chain contact any object at the tip of the guide bar. Figure 1.
3. Keep the working area free from obstructions such as other trees, branches, rocks, fences, stumps, etc. Figure 2. Eliminate or avoid any obstruction that your saw chain could hit while you are cutting through a particular log or branch.
4. Keep your saw chain sharp and properly tensioned. Follow manufacturer's chain sharpening and maintenance instructions. Check tension at regular intervals with the engine stopped, never with the engine running. Make sure the bar clamp nut is securely tightened after tensioning the chain. A loose or dull chain can increase the chance of kickback.
5. Begin and continue cutting at full throttle. If the chain is moving at a slower speed, there is greater chance for kickback to occur.
6. Cut only one log at a time.
7. Use extreme caution when re-entering a previous cut.
8. Do not attempt plunge cuts.
9. Watch for shifting logs or other forces that could close a cut and pinch or fall into the chain.
10. Use the Reduced-Kickback Guide Bar and Low-Kickback Chain specified for your saw.

## MAINTAIN CONTROL

1. Keep a good firm grip on the saw with both hands when the engine is running and don't let go. Figure 3. A firm grip can neutralize kickback and help you maintain control of the saw. Keep the fingers of your left hand encircling and your left thumb under the front handlebar. Keep your right hand completely around the rear handle whether you are right handed or left handed. Keep your left arm straight with the elbow locked.
2. Position your left hand on the front handlebar so it is in a straight line with your right hand on the rear handle when making bucking cuts. Figure 3. Never reverse right and left hand positions for any type of cutting.
3. Stand with your weight evenly balanced on both feet.
4. Stand slightly to the left side of the saw, to keep your body from being in a direct line with the cutting chain. Figure 3.
5. Do not overreach. You could be drawn or thrown off balance and lose control of the saw.
6. Do not cut above shoulder height. It is difficult to maintain control of the saw above shoulder height.

# SPECIAL SAFETY SECTION (continued)

## ⚠ WARNING

Because a chain saw is a high-speed wood-cutting tool, special safety precautions must be observed to reduce the risk of accidents. Careless or improper use can cause serious injury.

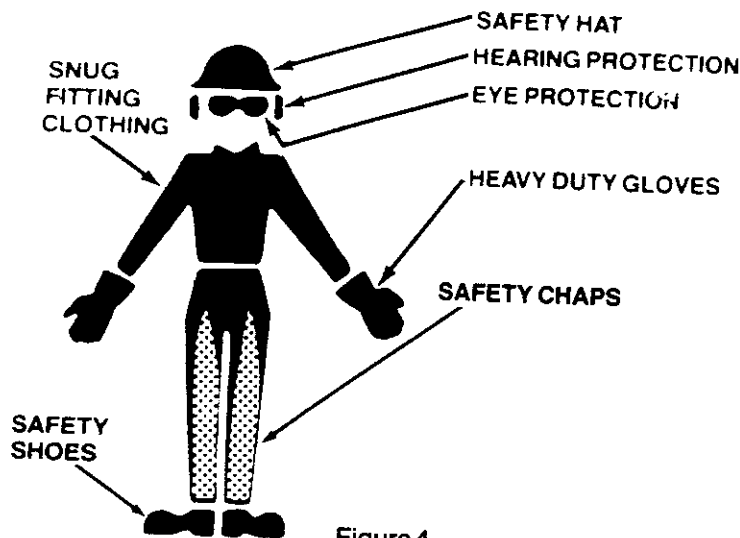

Figure 4

## KNOW YOUR SAW

1. Read your Operator's Manual carefully until you completely understand and follow all safety rules and operating instructions before attempting to operate the unit.
2. Restrict the use of your saw to adult users who understand and follow the safety rules, precautions, and operating instructions in this manual.

## PLAN AHEAD

1. Wear protective gear. Figure 4. Always use steel-toed, safety footwear with non-slip soles; snug-fitting clothing; heavy-duty, non-slip gloves; eye protection such as non-fogging, vented goggles or face screen; an approved safety hard hat; and sound barriers — ear plugs or mufflers to protect your hearing. Regular users should have hearing checked regularly as engine noise can damage hearing.
2. Keep children, bystanders, and animals out of the work area — a minimum of 30 feet (10 meters). Do not allow other people or animals to be near the chain saw when starting or operating the chain saw.
3. Do not handle or operate a chain saw when you are fatigued, ill, or upset; or if you have taken alcohol, drugs or medication. You must be in good physical condition and mentally alert. Chain saw work is strenuous. If you have any condition that might be aggravated by strenuous work, check with your doctor before operating a chain saw.

4. Do not attempt to use your chain saw during bad weather conditions such as strong wind, rain, snow, etc., or at night.
5. Plan your sawing operation carefully in advance. Do not start cutting until you have a clear work area, secure footing, and if you are felling trees, a planned retreat path.

## AVOID REACTIVE FORCES

Pinch-Kickback and Pull-in occur when the chain is suddenly stopped by being pinched, caught, or by contacting a foreign object in the wood. This results in a reversal of the chain force used to cut wood and causes the saw to move in the opposite direction of the chain rotation. Pinch-Kickback drives the saw straight back toward the operator. Pull-in pulls the saw away from the operator. Either reaction can result in loss of control and possibly serious injury.

### To avoid Pinch-Kickback:

1. Be extremely aware of situations or obstructions that can cause material to pinch the top of or otherwise stop the chain.
2. Do not cut more than one log at a time.
3. Do not twist the saw as the bar is withdrawn from an under-cut when bucking.

### To avoid Pull-in:

1. Always begin cutting with the engine at full throttle and the saw housing against the wood.
2. Use wedges made of plastic or wood, (never of metal) to hold the cut open.

## HANDLE FUEL WITH CAUTION

1. Eliminate all sources of sparks or flame in the areas where fuel is mixed, poured, or stored. There should be no smoking, open flames, or work that could cause sparks.
2. Mix and pour fuel in an outdoor area, on bare ground; store fuel in an a cool, dry, well-ventilated place and use an approved, marked container for all fuel purposes.
3. Wipe up all spilled fuel before starting your saw.
4. Move at least 10 feet (3 meters) away from fuel and fueling site before starting the engine.
5. Do not smoke while handling fuel or while operating the saw.
6. Turn the engine off and let your saw cool in a non-combustible area, not on dry leaves, straw, paper, etc.
7. Stop engine before removing fuel cap. Allow the engine to cool before refueling.
8. Store tool and fuel in an area where fuel vapors can reach sparks or open flames from water heaters, electric motors or switches, furnaces, etc.

## OPERATE YOUR SAW SAFELY

1. Do not operate a chain saw that is damaged, improperly adjusted, or not completely and securely assembled.
2. Operate the chain saw only in outdoor areas.
3. Do not operate the saw from a ladder or in a tree.
4. Position all parts of your body to the left of cut and away from the saw chain when the engine is running.
5. **Cut wood only.** Do not cut metal, plastics, masonry, non-wood building materials, etc. Do not use your saw to pry or shove away limbs, roots or other objects.
6. **Make sure the chain will not make contact with any object while starting the engine.** Never try to start the saw when the guide bar is in a cut or kerf.
7. **Use extreme caution when cutting small size brush and saplings.** Slender material can catch the saw chain and be whipped toward you or pull you off balance.
8. **Be alert for springback** when cutting a limb that is under tension so you will not be struck by the limb or saw when the tension in the wood fibers is released.
9. **Do not put pressure on the saw at the end of a cut.** This can cause you to lose control when the cut is completed.
10. **Stop the engine before setting the saw down.**

## MAINTAIN YOUR SAW IN GOOD WORKING ORDER

1. Have all chain saw service performed by a qualified service dealer with the exception of the items listed in the maintenance section of this manual. For example, if improper tools are used to remove or hold the flywheel when servicing the clutch, structural damage to the flywheel can occur and cause the flywheel to burst.
2. Keep fuel and oil caps, screws and fasteners securely tightened.
3. Keep the handles dry, clean, and free of oil or fuel mixture.
4. Make certain the saw chain stops moving when the throttle trigger is released. For correction, refer to page 19 for carburetor idle adjustment instructions.
5. Stop the saw if the chain strikes a foreign object. Inspect the unit and repair or replace parts as necessary.
6. Disconnect the spark plug before performing any maintenance except for carburetor adjustments.
7. Never modify your saw in any way. Use only attachments supplied or specifically recommended by the manufacturer.
8. Always replace the handguard immediately if it becomes damaged, or broken or is otherwise removed.

9. For Models with anti-vibration systems, keep the vibration isolators in good condition. Periodically inspect isolators for tears, rips, or separation of the rubber portion from the metal mountings. Have a qualified service dealer replace the isolators if worn or damaged, if vibration increases, or if mounts develop an out of round or swollen shape from exposure to gasoline and/or oil. It is recommended that all isolators be replaced when a failure to one occurs.

## CARRY AND STORE YOUR SAW SAFELY

1. Hand carry the unit with the engine stopped, the muffler away from your body, and the guide bar and chain to the rear covered preferably with a scabbard.
2. Before transporting in any vehicle or storing in any enclosure, allow your saw to cool completely, cover the bar and chain and properly secure to avoid turnover, fuel spillage or damage.
3. Empty the fuel tank before storing the tool. Use up fuel left in the carburetor by starting the engine and letting the engine run until it stops.
4. Store in a dry area out of the reach of children and away from where fuel vapors can reach sparks or an open flame from hot water heaters, electric motors or switches, furnaces, etc.

### THIS CHAIN SAW IS FOR OCCASIONAL USE ONLY.

**NOTE:** Exposure to vibrations through prolonged use of gasoline powered hand tools could cause blood vessel or nerve damage in the fingers, hands, and wrists of people prone to circulation disorders or abnormal swellings. Prolonged use in cold weather has been linked to blood vessel damage in otherwise healthy people. If symptoms occur such as numbness, pain, loss of strength, change in skin color or texture, or loss of feeling in the fingers, hands, or wrists, discontinue the use of this tool and seek medical attention. An anti-vibration system designed to reduce engine vibration is recommended for those using gasoline powered hand tools on a regular basis and is provided on Models 2000 AV, 2300 AV, and 2300 CVA. An anti vibration system does not guarantee the avoidance of these problems. Users who operate power tools on a continual and regular basis must monitor closely their physical condition and the condition of this tool.

**Notice:** Refer to the Code of Federal Regulations, Section 1910.266(5); 2.5.1 of American National Standard Safety Requirements for Pulpwood Logging, ANSI 03.1-1978; and relevant state safety codes when using a chain saw for logging purposes.

**SAVE THESE INSTRUCTIONS**

# KNOW YOUR CHAIN SAW

## A. INTRODUCTION

- Your saw has been designed with safety in mind and includes the following features as standard equipment:
  - Reduced-Kickback Guide Bar (Control Tip®)
  - Low-Kickback Chain (Guard Link)
  - Spark Arrestor
  - Muffler Shield
  - Handguard
  - Anti-Vibration System (Model 2000 AV, 2300 AV, & 2300 CVA only)

### ⚠ WARNING

The following features are included on your saw to help reduce the hazard of kickback, however, such features will not totally eliminate this dangerous reaction. As a chain saw user, do not rely only on safety devices. You must follow all warnings and safety instructions and maintenance in this manual to help avoid kickback and other forces which can result in serious injury.

## B. KICKBACK SAFETY FEATURES

- **Reduced-Kickback Guide Bar**, designed with a small radius tip which reduces the size of the kickback danger zone on the bar tip. Figure 5. A Reduced Kickback Guide Bar is one which has been demonstrated to significantly reduce the number and seriousness of kickbacks when tested in accordance with the safety requirements for gasoline powered chain saws as set by the American National Standards Institute, Inc., Standard B175.1 - 1985.
- **Low-Kickback Chain**, designed with a contoured depth gauge and guard link which deflect the kickback force and allow wood to gradually ride into the cutter. Figure 5. Low Kickback Saw Chain is chain which has met the kickback performance requirements of ANSI B175.1 (Safety Requirements for Gasoline-Powered Chain Saws) when tested on a representative sample of chain saws below 3.8 cubic inch displacement specified in ANSI B175.1. (American National Standards Institute, Inc., Standard B175.1 - 1985).
- **Handguard**, designed to reduce the chance of your left hand contacting the chain if your hand slips off the front handlebar.
- **Position of front and rear handlebars**, designed with distance between handles and "in line" with each other. The spread and "in line" position of the hands provided by this design work together to give balance and resistance in controlling the pivot of the saw back toward the operator if kickback occurs.

### ⚠ WARNING

Do not operate the chain saw unless the safety devices or their specified replacements are properly installed and maintained according to the instructions in this manual. Do not use any other guide bar and chain combination that is not equivalent to the original equipment or not certified to comply with ANSI B175.1. Failure to follow these instructions can result in serious injury.

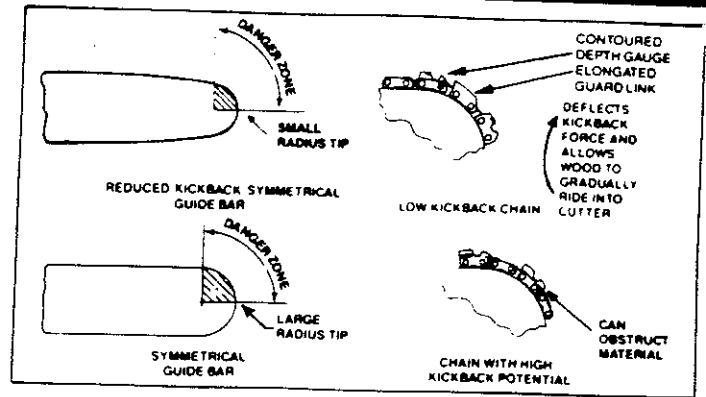

Figure 5

## C. STATE AND LOCAL REQUIREMENTS.

Your saw is equipped with a temperature limiting muffler and spark arresting screen which meets the requirements of California Codes 4442 and 4443. All U.S. forest land and the states of California, Maine, Washington and Oregon require many internal combustion engines to be equipped with a spark arrestor screen by law. Other states are enacting similar laws.

If you operate a chain saw in a state or locale where such regulations exist, you are legally responsible for maintaining the operating condition of these parts. Failure to do so is a violation of a law. Spark arrestor maintenance is on page 17.

## D. CARTON CONTENTS

After you unpack the carton:

1. Check the contents against the list below.
2. Examine the items for damage. Do not use damaged parts.
3. Notify your Poulan® dealer immediately if a part is missing or damaged.

**NOTE:** The filter moving against the wall of the empty tank can cause a rattle-like noise in a powerhead.

### KEY

#### NO. CARTON CONTENTS:

NO.	CARTON CONTENTS:	QTY
1	Power Head	1
2	Guide Bar	1
—	Oil	1
—	Loose Parts Bag	1

#### LOOSE PARTS BAG CONTENTS:

3	Handguard (Models 1800, 1800 Super, 2000, 2000 AV, 2300 AV)	1
4	Cap-Handguard (Models 1800, 1800 Super, 2000, 2000 AV, 2300 AV)	1
5	Screw-Handguard (Models 1800, 1800 Super, 2000, 2000 AV, 2300 AV)	3
6	Chain	1
—	Operator's Manual (not shown)	1

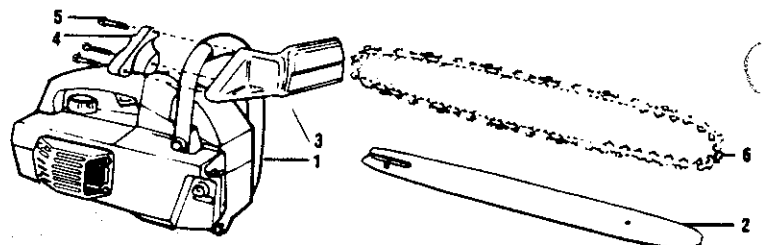

# PREPARING YOUR SAW FOR USE

## A. GETTING READY

1. READ YOUR OPERATOR'S MANUAL CAREFULLY.

Your Operator's Manual has been developed to help you prepare your saw for use and to understand its safe operation. It is important that you read your manual completely to become familiar with the unit *before* you begin assembly or attempt operation. Your Poulan® Dealer is available to show you how to operate your saw. Be sure to ask for his assistance.

2. HAVE THE FOLLOWING AVAILABLE:

- a. Protective gloves.
- b. Approved, marked fuel container.
- c. Regular, leaded or unleaded gasoline.
- d. 2-cycle engine oil (See page 9).
- e. Bar and Chain Oil (See page 10).
- f. Standard screwdriver.
- g. Phillips screwdriver.
- h. 1/2 inch wrench.

## B. ATTACHING THE HANDGUARD — MODELS 1800, 1800 SUPER, 2000, 2000 AV, 2300 AV (Model 2300 CVA is assembled with the Handguard on the saw).

The Handguard is a protective device designed to reduce the chance of your left hand contacting the chain if your hand slips off the front handlebar.

- Lift and carry the chain saw by the handlebar, *not* by the handguard.
- Keep the handguard securely fastened at all times. Check the handguard screws each time the saw is used.

### To install:

1. Align the Handguard and Handguard Cap around the handlebar as shown in Figure 6.
2. Fit the mounting pin on the Handguard into the hole in the handlebar. Figure 6, (inset).
3. Insert the 3 mounting screws into the 3 holes on the Handguard Cap.
4. Turn each screw a little at a time clockwise, with a Phillips screwdriver until the Handguard Cap and Handguard meet and there is no gap between the two parts.

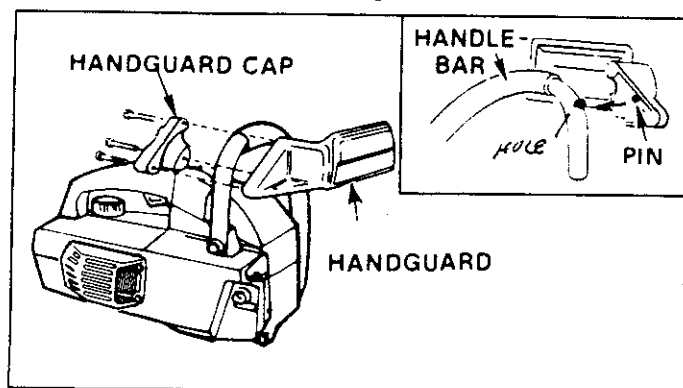

Figure 6

### ⚠ WARNING

Do not use the saw without the handguard in place. Always immediately replace the handguard if it becomes damaged, broken or is otherwise removed.

## C. ATTACHING THE BAR AND CHAIN

### ⚠ WARNING

Do not start engine without guide bar and chain completely assembled. Otherwise, the clutch can come off and serious injury can result.

- Your saw is equipped with a Reduced-Kickback Guide Bar and a Low-Kickback Chain.
- Use only the Reduced-Kickback Guide Bar and Low-Kickback Chain specified for your chain saw model, when replacing these parts. See "Specifications."

**CAUTION:** Wear protective gloves when handling or operating your saw. The chain is sharp and can cut you even when it is not moving!

1. Remove the following parts as shown in Figure 7.  
Use a standard screwdriver and a 1/2 inch Wrench.
  - a.) Bar Clamp Nut.
  - b.) Rear Screw.
  - c.) Bar Clamp.

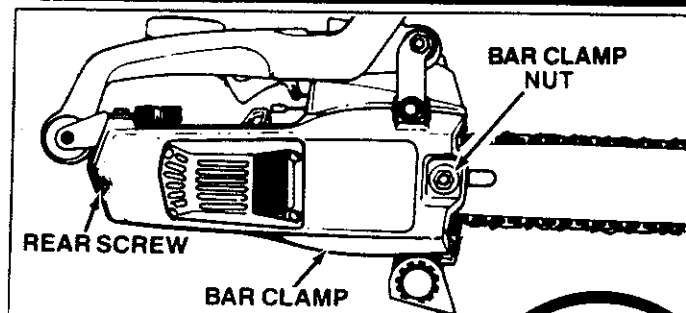

Figure 7

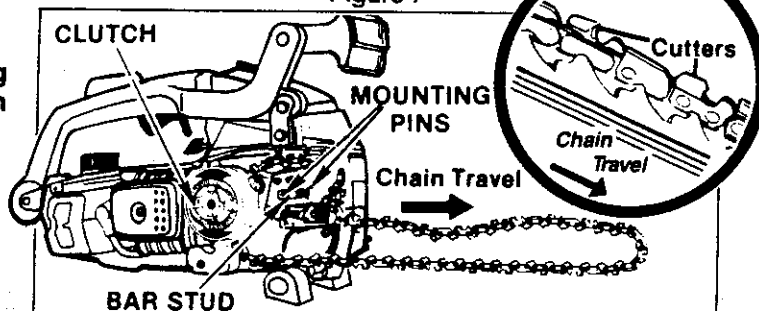

Figure 8

2. Turn the Adjusting Screw counterclockwise to move the Adjusting Screw almost as far as will go to the rear. Figure 11.
3. Hold chain with cutters facing as shown in Figure 8.
4. Place chain over and behind the clutch drum, onto the sprocket. Figure 8.
5. Place the Guide Bar on the saw with the large slot over the Bar Stud and the Mounting Pins (on either side of the Bar Stud). Fit the adjusting pin into the round hole below the large slot. Figure 7 and 9.

**NOTE:** Be sure the Guide Bar is positioned with the adjusting pin hole below the large slot.

6. Start at the top of the guide bar and fit the chain drive links into groove around the guide bar. Figure 9.

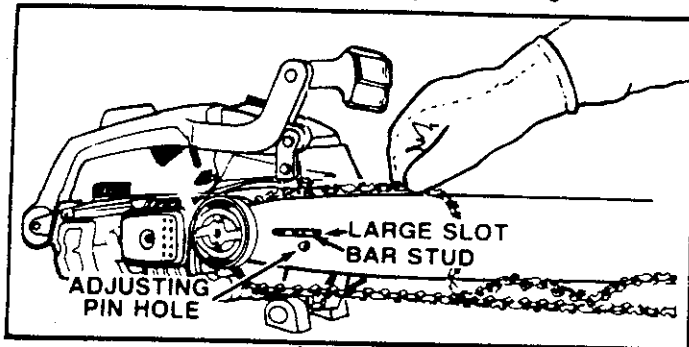

Figure 9

**CAUTION:** Make sure that the tab on the bottom of the fuel tank is aligned in the slot provided in the fan housing. Figure 10.

7. Hold the Guide Bar against the saw frame and install the Bar Clamp.
8. Secure the Bar Clamp with the Bar Clamp Nut, finger tight *only*. Tighten Bar Clamp Nut after chain is tensioned.
9. Replace the Rear Bar Clamp Screw and tighten securely.

10. Follow "Chain Tension" instructions below.

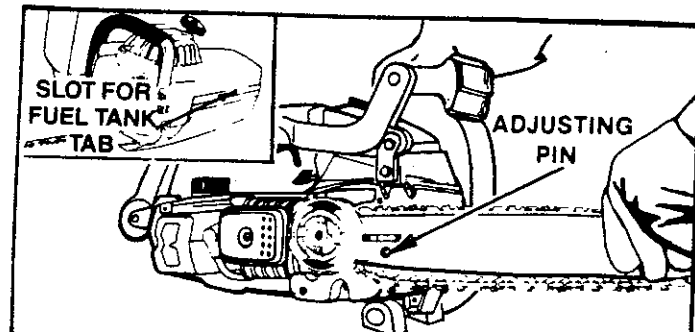

Figure 10

## D. CHAIN TENSION

- Chain tension is very important:

- a loose chain will wear the bar and itself.
- a loose chain can jump off the bar while you are cutting.
- a tight chain can break or damage the saw and/or bar.

- The chain stretches during use, especially when new. Check tension:

- each time the saw is used
- more frequently when the chain is new
- as the chain warms up to normal operating temperature.

- Chain tension is correct when the chain:

- can be lifted about 1/8" from the Guide Bar at a point near the middle of the bar,
- and will move freely around the bar.

- Chain tensioning procedure:

**CAUTION:** Always wear gloves when handling the chain. The chain is sharp and can cut you even when it is not moving.

**NOTE:** The Bar Clamp Nut must be slightly loose for the chain to be properly tensioned.

1. Hold the tip of the Guide Bar up and turn the Adjusting Screw clockwise just until the chain does not sag beneath the Guide Bar. Figure 11.
2. Check the tension by lifting the chain from the Guide Bar at the center of the bar. Figure 12.
3. Continue adjusting the Adjusting Screw until the tension is correct.
4. Hold the tip of the Guide Bar up and tighten the Bar Clamp Nut with a 1/2 inch Wrench.
5. Check the Rear Bar Clamp Screw to be sure it is secure.
6. Recheck chain tension. Figure 12.

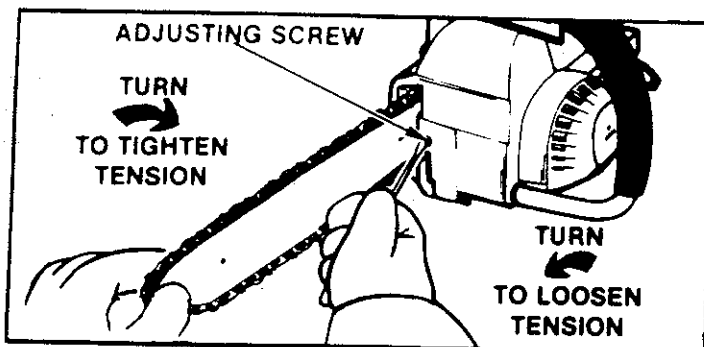

Figure 11

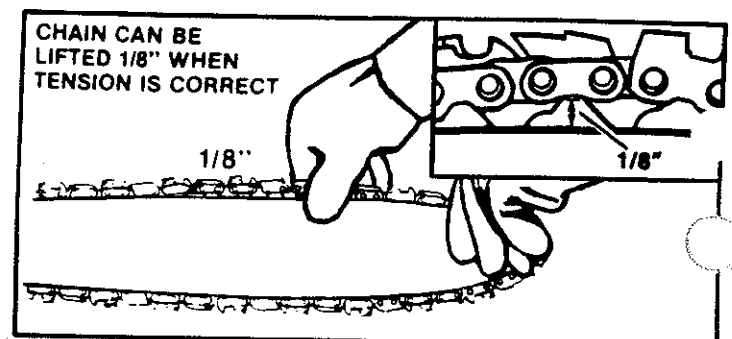

Figure 12



## E. FUELING YOUR ENGINE

### 1. FUEL SAFETY

- a. Use only recommended fuel mixtures.
- b. Mix and pour fuel outdoors and where there are no sparks or flames.
- c. Use a container approved for fuel.
- d. Do not smoke or allow smoking near fuel or the tool or while using the tool.
- e. Wipe up all fuel spills before starting engine.
- f. Move at least 10 feet away from fueling site before starting engine.
- g. Stop engine before removing fuel cap. Allow the engine to cool before refueling.
- h. Empty the fuel tank before storing the tool. Use up fuel left in the carburetor by starting the engine and letting it run until it stops.
- i. Store tool and fuel in an area where fuel vapors cannot reach sparks or open flames from water heaters, electric motors or switches, furnaces, etc.

### 2. FUEL MIXTURE

- Your tool is powered by a 2-cycle engine which requires a fuel mixture of regular unleaded gasoline and a high quality engine oil specially made for 2-cycle, air cooled engines. The internal design of the 2-cycle engine requires lubrication of moving parts. Lubrication is provided when the recommended mixture of gasoline and oil is used.
- Genuine POULAN or WEED EATER® 40:1, 2-cycle engine oil is strongly recommended for the protection of your unit. Extensive engineering tests have proven that Poulan or Weed Eater oil resists breakdown at operating temperatures common to 2-cycle engines, resulting in dependable performance and longer engine life.
- Gasoline must be clean and fresh. After a short period of time, gasoline will chemically break down and form compounds that cause hard starting and damage in 2-cycle engines.
- The correct measure of gasoline to oil is very important. Too much oil in the mixture will foul the spark plug.

**CAUTION:** Too little oil or incorrect oil will cause the engine to overheat and seize.

- Always mix the fuel thoroughly in a container since gasoline and oil do not readily combine. Do not mix gasoline and oil directly in the fuel tank.

### 3. USE THE FOLLOWING ONLY:

POULAN/WEED EATER 40:1, 2-cycle engine oil is strongly recommended. Available in the following convenient container sizes. POULAN/WEED EATER 40:1, 2-cycle engine oil should be mixed as follows:

3.2 oz. Container . . . Mix with 1 gallon gasoline  
8 oz. Container . . . Mix with 2-1/2 gallons gasoline

If none of the above oils are available, use a good quality, 2-cycle, air cooled engine oil mixed at a ratio of 16:1 (8 oz. oil to 1 gallon gasoline).

If POULAN/WEED EATER oil is not available, use other "POULAN" or "WEED EATER" branded 2-cycle engine oils at their recommended mixture as listed on the container.

### 4. DO NOT USE:

- **NMMA Oil — National Marine Manufacturers Association (formerly BIA)**  
Does not have proper additives for 2-cycle, air-cooled engines and can cause engine damage.
- **AUTOMOTIVE OIL —**  
Does not have proper additives for 2-cycle, air-cooled engines and can cause engine damage.

#### CAUTION

Experience indicates that alcohol blended fuels (called gasohol or using ethanol or methanol) can attract moisture which leads to separation and formation of acids during storage. Acidic gas can damage the fuel system of an engine while in storage. To avoid engine problems, do not leave fuel in the unit when storing for 30 days or longer. Start the engine and let it run until the fuel lines and carburetor are empty. Use fresh fuel next season. See the "Storage" section for additional information. Never use engine or carburetor cleaner products in the fuel tank or permanent damage can occur.

### 5. HOW TO MIX FUEL AND FILL TANK

- a. Pour 1/2 of the regular unleaded gasoline to be used into an approved, marked container. Do not mix gasoline and oil directly into the fuel tank.
- b. Add entire measure of engine oil.
- c. Close fuel container tightly. Shake for one minute.
- d. Slowly open fuel container.
- e. Add remainder of gasoline.
- f. Close fuel container tightly and shake again.
- g. Slowly open fuel container.
- h. Slowly remove the fuel cap.
- i. Fill the tank using a spout or funnel.
- j. Reinstall the fuel cap securely.

## F. BAR AND CHAIN LUBRICANT

- The Guide Bar and Cutting Chain require continuous lubrication in order to remain in operating condition. Lubrication is provided by the automatic oiler system when the oil tank is kept filled.

— Lack of oil will quickly ruin the bar and chain.

— Too little oil will cause overheating shown by smoke coming from the chain and/or discoloration of the guide bar rails.

- Genuine Poulan Bar and Chain Oil is recommended to protect your unit against excessive wear due to heat and friction. Poulan lubricant resists high temperature thinning. If Poulan bar and chain oil is not available, use a good grade SAE 30 oil. Never use waste oil for this purpose.

- In freezing weather oil will thicken, making it necessary to thin bar and chain oil with a small amount of Diesel Fuel #1 or Kerosene. Bar and chain oil must be free flowing for the oil system to pump enough oil for adequate lubrication.

### 1. USE THE FOLLOWING:

30° F or above — lubricant — undiluted.

30°-0° F — 95% lubricant to 5% Diesel Fuel #1 or Kerosene.

Below 0° F — 90% lubricant to 10% Diesel Fuel #1 or Kerosene.

### 2. HOW TO FILL THE OIL TANK

- Stop the engine.
- Turn saw on its side with oil cap up.
- Loosen cap slowly and wait for pressure in the tank to be released before removing the cap. Figure 14.
- Fill the oil tank.
- Replace the oil cap securely.

### 3. IMPORTANT POINTS TO REMEMBER

- Fill the oil tank each time you refill the fuel tank to ensure there will be sufficient oil for the chain whenever you start and run the saw.
- The saw will normally use about 1/2 tank of chain oil for each tank of fuel mixture. If less oil is used, check for a plugged oil hole in the guide bar.
- Keep sawdust and debris cleaned from the oil holes in the guide bar to allow an adequate oil flow to the bar and chain.
- Keep spilled and spattered oil wiped from the unit to avoid sawdust and debris build-up. Pay particular attention to oil on the fan housing and starter assembly to avoid overheating the engine.
- It is normal for a small amount of oil to appear under the saw after the engine stops. This is due to oil draining from the bar and chain when not in use.

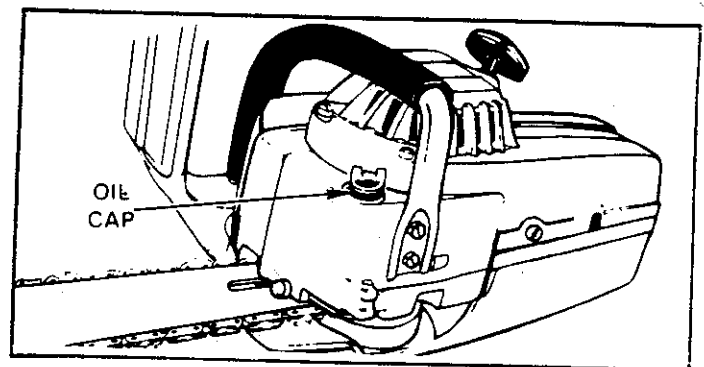

Figure 14

## NOTES

# USING YOUR SAW

## A. PRE-OPERATION CHECKS

Before operating your saw, always:

1. ✓ **Check over safety rules and precautions in this manual.** Make certain you completely understand and can apply each one.
2. ✓ **Check protective gear.** Always use eye, hearing, and head protection devices, safety footwear, protective gloves, and snug-fitting clothing.
3. ✓ **Check the saw for loose bolts, nuts, or fittings.** Tighten, repair or replace parts as necessary. Tools required listed in "Assembly."
4. ✓ **Check the air filter.** Clean the filter before starting the engine. For location, see "Air Filter."
5. ✓ **Check the saw chain.** The chain should be sharp and at the correct tension.
6. ✓ **Check the fuel tank and oil tank.** Both tanks should be filled.
7. ✓ **Check the handles.** Handles should be dry and free of fuel mixture and oil.
8. ✓ **Check weather conditions.** Do not use your saw at night or during bad conditions such as strong wind, rain, snow, etc.
9. ✓ **Check the work area.** Keep children, bystanders, and animals a safe distance away from the work area when starting or operating the saw — a minimum of 30 feet (10 meters).

## B. STARTING INSTRUCTIONS (Refer to "Specifications," page 2, for location of controls.)

### 1. BASIC PROCEDURE

- a. Hold saw firmly with the saw chain free to turn without contacting any object.
- b. Move ignition switch to "Start" position. Figure 15.
- c. Adjust choke according to "Starting Procedure for Varying Conditions" below. Figure 16.
- d. Squeeze trigger with your right hand while pushing saw away from you and pulling the starter rope with your left hand. Figure 17.
- e. Release the trigger after engine starts, allowing the engine to idle.

**⚠ WARNING**  
The chain must not move when the engine runs at idle speed. Refer to "Carburetor Adjustments," for correction.

- f. Stop engine by moving the ignition switch to the "Stop" position. Figure 15.

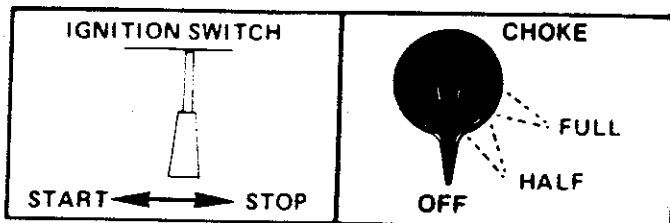

Figure 15

Figure 16

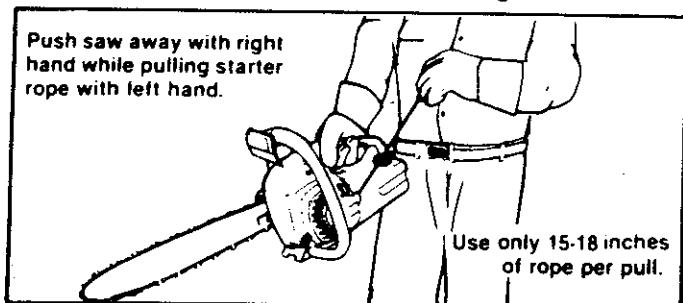

Figure 17

**⚠ WARNING**  
Always wear gloves; safety footwear; snug-fitting clothing; and eye, hearing, and head protection devices when operating a chain saw.

### 2. STARTING PROCEDURE FOR VARYING CONDITIONS

**NOTE:** Be sure to follow "1. Basic Procedure," as described on this page.

#### a. COLD ENGINE

- 1.) Push choke to full choke position. Figure 16.
- 2.) Pull starter rope until engine attempts to run.
- 3.) Push choke until half position is felt. Figure 15.
- 4.) Pull starter rope until engine runs.
- 5.) After 5 second warm up, push choke to the off position.

**⚠ WARNING**  
Avoid bodily contact with the muffler when starting or using a warm engine to avoid serious burns.

#### b. WARM ENGINE

- 1.) Leave choke at the off position. Figure 16.
- 2.) Pull starter rope until engine runs.

#### c. REFUELED WARM ENGINE AFTER RUNNING OUT OF FUEL

- 1.) Push choke to full choke position. Figure 15.
- 2.) Pull starter rope until engine attempts to run.
- 3.) Push choke to the off position. Figure 16.
- 4.) Pull starter rope until engine runs.

### 3. IMPORTANT POINTS TO REMEMBER

- a. **When pulling the starter rope,** do not use the full extent of the rope as this can cause the rope to break. Do not let the starter rope snap back. Hold the handle and let the rope rewind slowly.
- b. **If engine floods,** let the unit set for a few minutes then repeat starting procedure using the half-choke position.
- c. **For cold weather starting,** allow engine to warm up (1-2 min.) at the half-choke position, then move choke to the off position. Do not cut with the choke at the "full" or "half" position.

# TYPES OF CUTTING

## A. BASIC CUTTING TECHNIQUE

### 1. IMPORTANT POINTS

- Cut wood only. Do not cut metal, plastics, masonry, non-wood building materials, etc. Do not use your saw to pry or shove away limbs, roots or other objects.
- Stop the saw if the chain strikes a foreign object. Inspect the saw and repair or replace parts as necessary.
- Keep the chain out of dirt and sand. Even a small amount of dirt will quickly dull a chain and thus increase the possibility of kickback.

#### **⚠ KICKBACK WARNING**

Kickback can occur when the moving chain contacts an object at the upper portion of the tip of the guide bar or when the wood closes in and pinches the saw chain in the cut. Contact at the upper portion of the tip of the guide bar can cause the chain to dig into the object and stop the chain for an instant. The result is a lightning fast, reverse reaction which kicks the guide bar up and back toward the operator. If the saw chain is pinched along the top of the guide bar, the guide bar can be driven rapidly back toward the operator. Either of these reactions can cause loss of saw control which can result in serious injury.

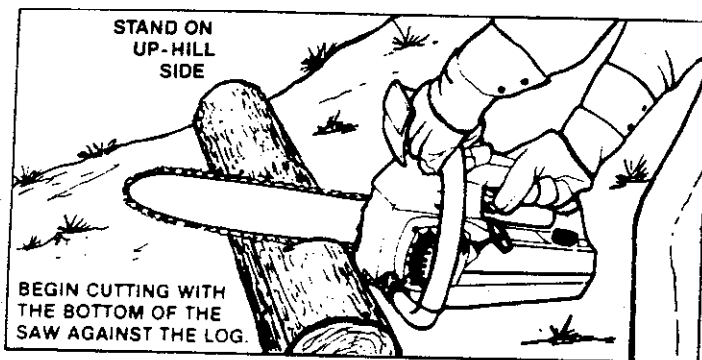

Figure 18

## B. TREE FELLING TECHNIQUES

### 1. PLAN YOUR SAWING OPERATION CAREFULLY IN ADVANCE

- Clear the work area. You need a clear area all around the tree where you can have secure footing.
- Study the natural conditions that can cause the tree to fall in a particular direction.
  - The **WIND** direction and speed.
  - The **LEAN** of the tree.
  - WEIGHTED** with **BRANCHES** on one side.
  - Surrounding **TREES** and **OBSTACLES**.
- Look for decay and rot. If the trunk is rotted, it can snap and fall toward the operator.

### 2. UNDERSTAND REACTIVE FORCES

**Pinch-Kickback** and **Pull-In** occur when the chain is suddenly stopped by being pinched, caught, or by contacting a foreign object in the wood. This results in a reversal of the chain force used to cut wood and causes the saw to move in the opposite direction of chain rotation. Either reaction can result in loss of control and possible serious injury.

#### • Pinch-Kickback —

—occurs when the chain, on top of the bar is suddenly stopped when the top of the bar is used for cutting.  
—rapidly drives the saw straight back toward the operator.

#### • Pull-In —

—can occur when the chain on the bottom of the bar is suddenly stopped.  
—pulls the saw rapidly forward.

### 3. PROCEDURE

Practice cutting a few small logs using the following technique to get the "feel" of using your saw before you begin a major sawing operation.

- Accelerate the engine to full throttle just before entering the cut by squeezing the throttle trigger.
- Begin cutting with the saw frame against the log. Figure 18.
- Keep the engine at full throttle the entire time you are cutting.
- Allow the chain to cut for you; exert only light downward pressure. If you force the cut, damage to the bar, chain, or engine can result.
- Release the throttle trigger as soon as the cut is completed, allowing the engine to idle. If you run the saw at full throttle without a cutting load, unnecessary wear can occur to the chain, bar, and engine.
- Do not put pressure on the saw at the end of the cut to avoid losing control when the cut is complete.
- Stop the engine before setting the saw down after cutting.

## 2. FELLING SMALL TREES — LESS THAN 6" IN DIAMETER

- a. If you know the direction of fall:
  - 1.) Make a single felling cut on the side away from the direction of fall.
  - 2.) Cut all the way through.
  - 3.) Stop the saw, put it down, and get away quickly on your planned retreat path.
- b. If you are not sure which way the tree will fall, use the notch method described for felling large trees.

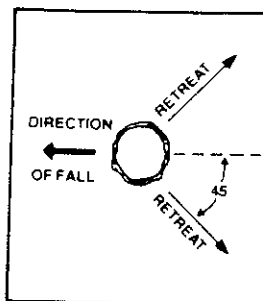

Figure 19

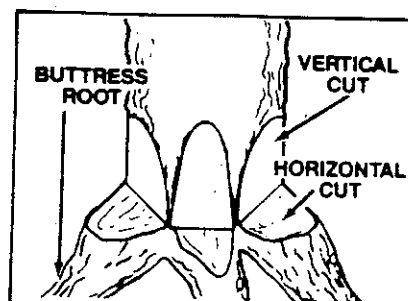

Figure 20

### ⚠ WARNING

#### DO NOT CUT:

- near electrical wires or buildings.
- if you do not know the direction of tree fall.
- at night since you will not be able to see well.
- during bad weather — strong wind, snow, rain, etc.

## 3. FELLING LARGE TREES — 6" DIAMETER OR MORE

The notch method is used to cut large trees. A notch is cut on the side of the tree in the desired direction of fall. After a felling cut is made on the opposite side of the tree, the tree will tend to fall into the notch.

**NOTE:** If the tree has large buttress roots, remove before making the notch. Cut into the buttresses vertically, then horizontally. Figure 20.

- a. Make the notch cut. Figure 21.
  - 1.) Cut the bottom of the notch first, through 1/3 of the diameter of the tree.
  - 2.) Complete the notch by making the slant cut.
  - 3.) Remove the notch of wood.
- b. Make the felling cut on the opposite side of the notch about 2" higher than the bottom of the notch.
- c. Leave enough uncut wood between the felling cut and the notch to form a hinge. Figure 22.

**NOTE:** The hinge helps to keep the tree from twisting and falling in the wrong direction.

- d. Use a wedge if there is any chance that the tree will not fall in the desired direction.

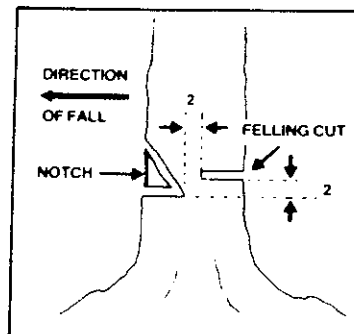

Figure 21

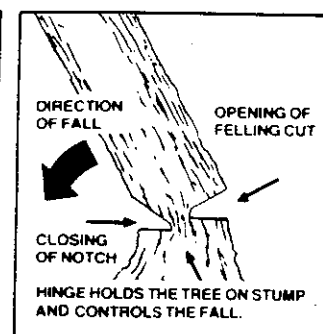

Figure 22

### ⚠ WARNING

Stay on the uphill side of the terrain to avoid the tree rolling or sliding downhill after it has fallen.

**NOTE:** Before the felling cut is complete, drive wedges to open up the cut when necessary to control the direction of fall. Use wood or plastic wedges but *never* steel or iron, to avoid kickback and chain damage.

- e. Be alert for signs that the tree is ready to fall:
  - 1.) cracking sounds.
  - 2.) widening of the felling cut.
  - 3.) movement in the upper branches.
- f. As the tree starts to fall, *stop the saw; put it down, and get away quickly on your planned retreat path.*
- g. Be extremely cautious with partially fallen trees that may be poorly supported. When a tree doesn't fall completely, set the saw aside and pull down the tree with a cable winch, block and tackle or tractor. To avoid injury, do not cut down a partially fallen tree with your saw.

## DON'T PUT YOURSELF IN THESE POSITIONS

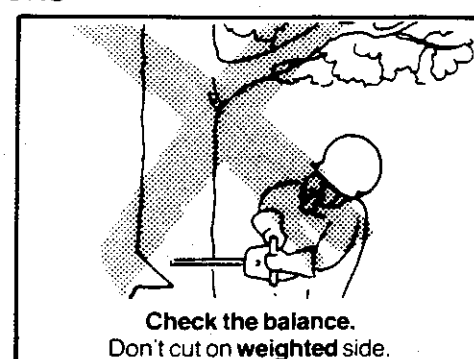
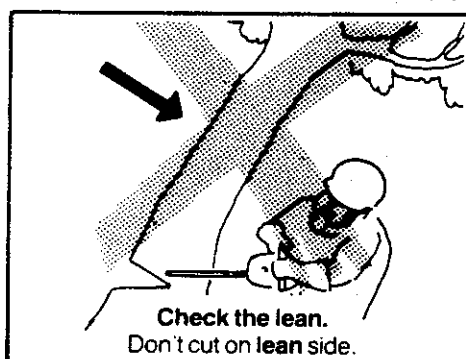
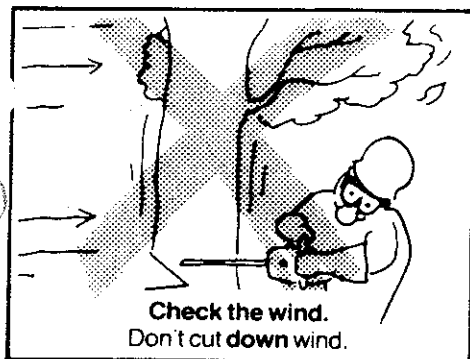

## C. BUCKING

Bucking is the term used for cutting a fallen tree to the desired log size.

### 1. IMPORTANT POINTS

- Cut only one log at a time.
- Cut shattered wood very carefully. Sharp pieces of wood could be flung toward the operator.
- Use a sawhorse to cut small logs. Never allow another person to hold the log while cutting and never hold the log with your leg or foot.
- Do not cut in an area where logs, limbs and roots are tangled such as in a blown down area. Drag the logs into a clear area before cutting by pulling out exposed and cleared logs first.
- Make the first bucking cut 1/3 of the way through the log and finish with a 2/3 cut on the opposite side. As the log is being cut, it will tend to bend. The saw can become pinched or hung in the log if you make the first cut deeper than 1/3 of the diameter of the log.
- Give special attention to logs under strain to prevent the saw from pinching. Make the first cut on the pressure side to relieve the stress on the log. Figure 23.

### 2. TYPES OF CUTTING USED Figure 24

—Overcutting— begin on the top side of the log with the bottom of the saw against the log; exert light pressure downward.

—Undercutting— begin on the under side of the log with the top of the saw against the log; exert light pressure upward. During undercutting, the saw will tend to *push* back at you. Be prepared for this reaction and hold the saw firmly to maintain control.

#### ⚠ WARNING

Never turn the saw upside down to undercut. The saw cannot be controlled in this position.

#### ⚠ WARNING

If saw becomes pinched or hung in a log, don't try to force it out. You can lose control of the saw resulting in serious injury and/or damage to the saw. Stop the saw, drive a wedge of plastic or wood into the cut until the saw can be removed easily. Figure 25. Restart the saw and carefully reenter the cut. To avoid kickback and chain damage, do not use a metal wedge. Do not attempt to restart your saw when it is pinched or hung in a log.

### 3. BUCKING — WITHOUT A SUPPORT

- Overcut with a 1/3 diameter cut.
- Roll log over and finish with an overcut.

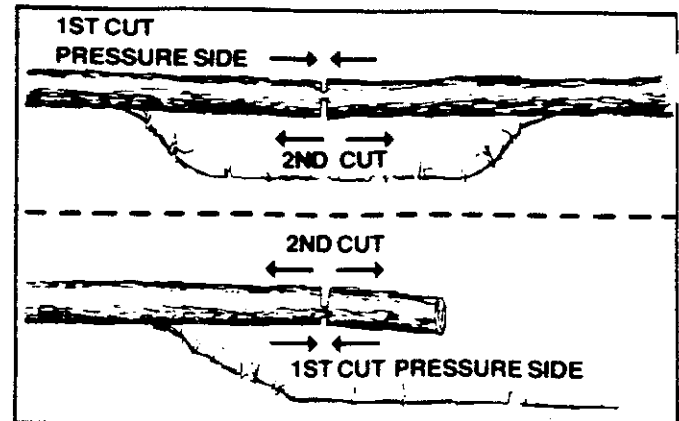

Figure 23

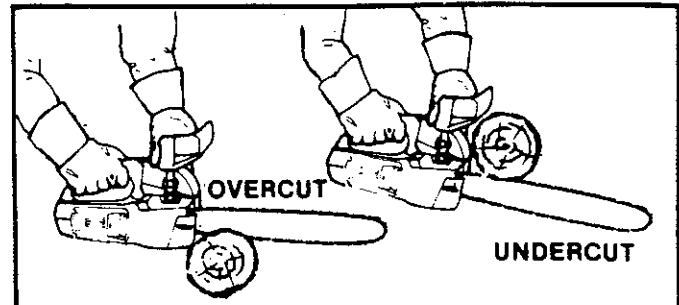

Figure 24

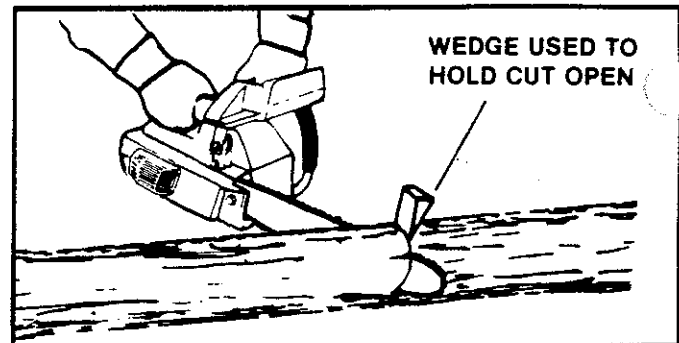

Figure 25

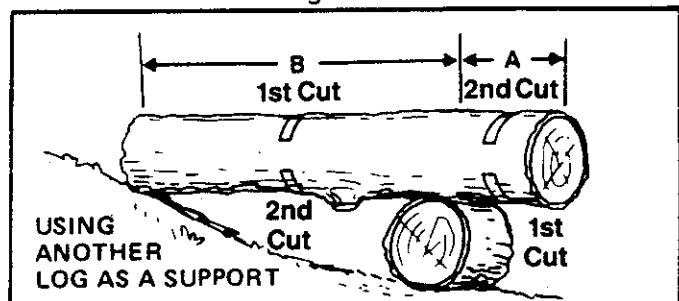

Figure 26

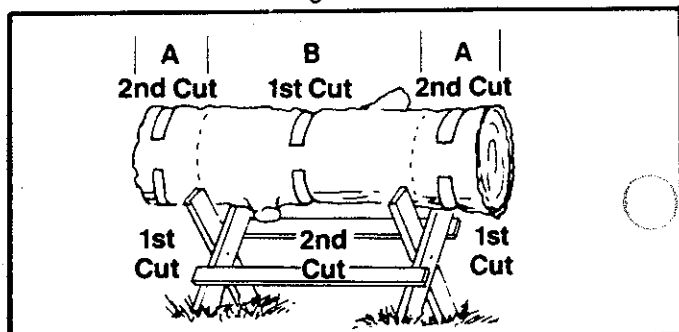

Figure 27

#### 4. BUCKING — USING ANOTHER LOG AS A SUPPORT (Figure 26):

- a. In area A:
  - 1.) Undercut 1/3 of the way through the log.
  - 2.) Finish with an overcut.
- b. In area B:
  - 1.) Overcut, 1/3 of the way through the log.
  - 2.) Finish with an undercut.

#### 5. BUCKING — USING A STAND (Figure 27):

- a. In area A:
  - 1.) Undercut 1/3 of the way through the log.
  - 2.) Finish with an overcut.
- b. In area B:
  - 1.) Over cut 1/3 of the way through the log.
  - 2.) Finish with an undercut.

#### ⚠ WARNING

Do not stand on the log being cut. Any portion can roll causing loss of footing and control.

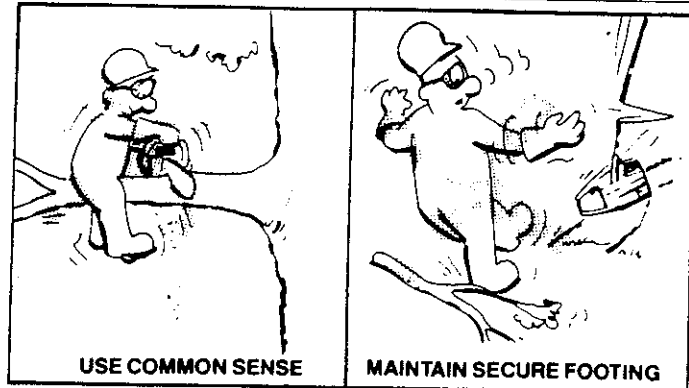

### D. DEBRANCHING AND PRUNING

- **Work slowly, keeping both hands on the saw with a firm grip.** Maintain secure footing and balance.
- **Watch out for springpoles.** Use extreme caution when cutting small size limbs. Slender material may catch the saw chain and be whipped toward you or pull you off balance.
- **Be alert for springback.** Watch out for branches that are bent or under pressure as you are cutting to avoid being struck by the branch or the saw when the tension in the wood fibers is released.
- **Keep a clear work area.** Frequently clear branches out of the way to avoid tripping over them.

#### ⚠ WARNING

Never climb into a tree to debranch or prune. Do not stand on ladders, platforms, a log or in any position which can cause you to lose your balance or control of the saw.

#### 2. PRUNING

- a. **Limit pruning to limbs shoulder height or below.** Do not cut if branches are higher than your shoulder. Get a professional to do the job.
- b. **Refer to Figure 29 for the pruning technique.**
  - 1.) Undercut 1/3 of the way through the limb near the trunk of the tree.
  - 2.) Finish with an overcut farther out from the trunk.
  - 3.) Keep out of the way of the falling limb.
  - 4.) Cut the stump flush near the trunk of the tree.

#### ⚠ WARNING

Be alert for and guard against kickback. Do not allow the moving chain to contact any other branches or objects at the nose of the guide bar when debranching or pruning. Allowing such contact can result in serious injury.

#### 1. DEBRANCHING

- a. **Always debranch a tree after it is cut down.** Only then can debranching be done safely and properly.
- b. **Leave the larger lower limbs to support the tree as you work.**
- c. **Start at the base of the felled tree and work towards the top, cutting branches and limbs.** Remove small limbs with one cut. Figure 28.
- d. **Keep the tree between you and the chain.** Cut from the side of the tree opposite the branch you are cutting.
- e. **Remove larger, supporting branches with the 1/3, 2/3 cutting techniques described in the bucking section.**
  - 1.) Start with an undercut.
  - 2.) Finish with an overcut.
- f. **Always use an overcut to cut small and freely hanging limbs.** Undercutting could cause limbs to fall and pinch the saw.

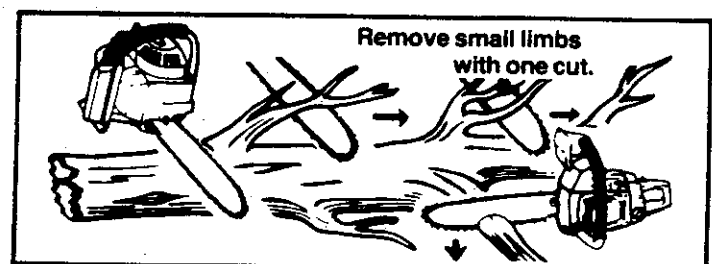

Figure 28

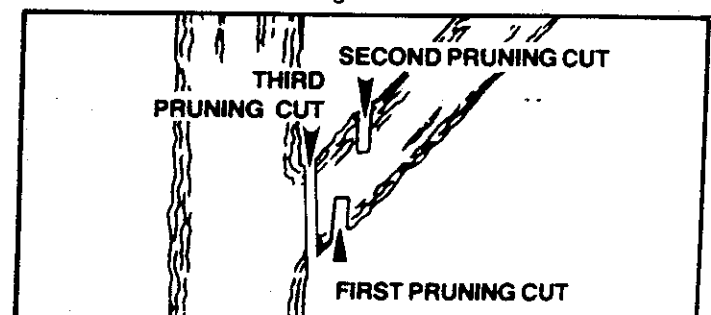

Figure 29

# MAINTENANCE

A good maintenance program of regular inspection and care will increase the service life and help to maintain the safety and performance of your saw.

- Make all adjustments or repairs (except carburetor adjustments) with:
  - spark plug wire disconnected
  - engine cool as opposed to a saw that has just been run.

## A. GUIDE BAR AND CHAIN

Increase the service life of your Guide Bar and Chain by:

- Using the saw properly and as recommended in this manual.
- Maintaining correct Chain Tension, page 8.
- Proper lubrication, page 10.
- Regular maintenance as described in this section.

### 1. CHAIN MAINTENANCE

Sharpen the chain when:

- wood chips are small and powdery. Wood chips made by the saw chain should be about the size of the teeth of the chain.
- saw has to be forced through the cut.
- saw cuts to one side.

**CAUTION:** Always wear gloves when handling the chain. The chain can be sharp enough to cut you even though it is too dull to cut wood.

#### a. SHARPENING INSTRUCTIONS

Items required:

Gloves                      Flat File  
5/32" Dia. file              Depth Gauge Tool  
6" File holder

- 1.) Stop engine.
- 2.) Adjust the chain for proper tension, page 8.
- 3.) Work at the midpoint of the bar, moving the chain forward by hand as each cutter is filed.
- 4.) Sharpen cutters.
  - a.) Position the file holder level on the top plate of the cutter and depth gauge as shown in Figure 30.
  - b.) Align the 30° file holder marks parallel with the bar and to the center of the chain. Figure 31.
  - c.) File from inside toward outside of cutter, straight across on forward stroke in one direction only. Use 2 or 3 strokes per cutting edge. Figure 31.
  - d.) Keep all cutters the same length. Figure 32
  - e.) File enough to remove any damage to cutting edges (side plate and top plate) of cutter. Figure 32.
  - f.) File P100S and P101S chain to meet specifications shown in Figure 33.

- Check the saw for loose bolts, screws, nuts and fittings regularly. Loose fasteners can cause an unsafe condition as well as damage to your saw.

### ⚠ WARNING

Have all chain saw service performed by a qualified service dealer except the items listed in the maintenance section of this manual.

### ⚠ WARNING

Maintain the proper hook angle according to the manufacturer's specification for the chain you are using. Improper hook angle will increase the chance of kickback which can result in serious injury. Figure 33 & 35.

#### 5.) Correct Depth Gauges.

- a.) Place depth gauge tool over each cutter depth gauge. Figure 34.
- b.) File level with the flat file if depth gauge is higher than the depth gauge tool.
- c.) Maintain rounded front corner of depth gauge with a flat file. Figures 34 & 35.

**NOTE:** The very top of the depth gauge should be flat with the front half rounded off with a flat file.

### ⚠ WARNING

Depth gauge tool is required to insure proper depth gauge. Filing the depth gauge too deep will increase the chance of kickback which can result in serious injury.

#### b. CHAIN REPLACEMENT

- 1.) Use only the Low-Kick Chain specified for your saw in "Specifications," for replacement chain.
- 2.) Replace the chain when cutters or links break.
- 3.) See a qualified service dealer to replace and sharpen individual cutters for matching your chain.
- 4.) Always have a worn sprocket replaced by a qualified service dealer when installing a new chain to avoid excessive wear to the chain.

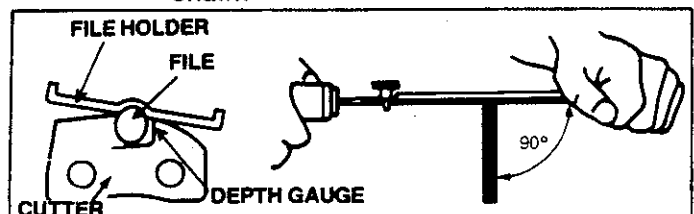

Figure 30

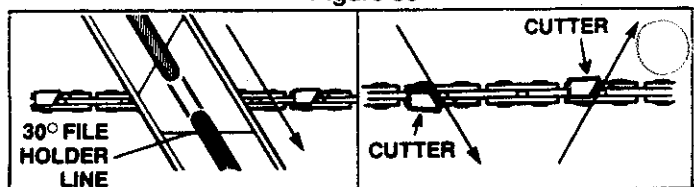

Figure 31



## 2. GUIDE BAR MAINTENANCE

- Conditions which can require guide bar maintenance:
  - saw cuts to one side
  - saw has to be forced through a cut
  - inadequate supply of oil to bar and chain.
- Check the condition of the guide bar each time the chain is sharpened. A worn guide bar will damage the chain and make cutting more difficult.
- Replace the guide bar when:
  - the inside groove of the guide bar rails is worn.
  - the guide bar is bent or cracked.

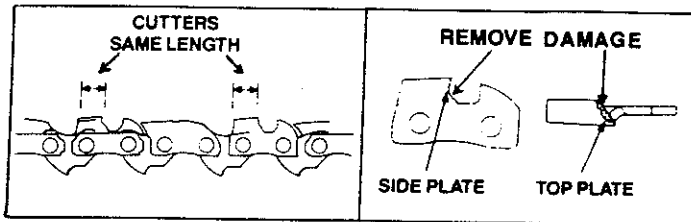

Figure 32

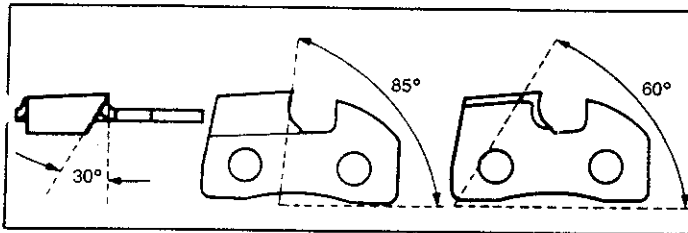

Figure 33

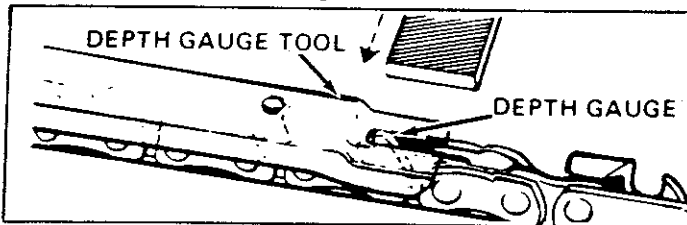

Figure 34

- Use only the Reduced-Kickback Guide Bar specified for your saw in "Specifications" for replacement.
  - a. Remove the guide bar to service.
  - b. Clean oil holes at least once for each five hours of operation.
  - c. Remove sawdust from the guide bar groove periodically with a putty knife or a wire. Figure 36.
  - d. Remove burrs by filing the side edges of the guide bar grooves square with a flat file. Figure 37.
  - e. Restore square edges to an uneven rail top by filing with a flat file. Figure 37.

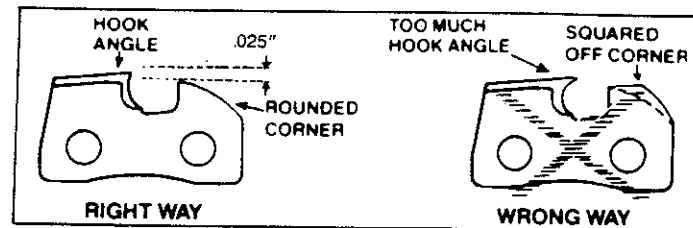

Figure 35

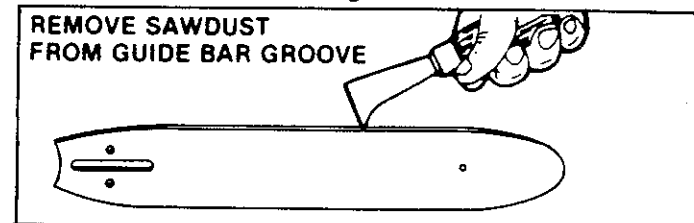

Figure 36

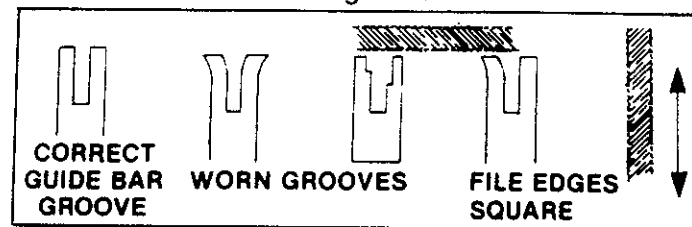

Figure 37

## B. SPARK ARRESTOR

- Carbon deposits build up on the spark arrestor, as the saw is used and must be removed to avoid creating a fire hazard or causing engine damage.
- Replace the spark arrestor if breaks occur.
- Keep the spark arrestor clean at all times.
 

Clean:

  - as required
  - at least once for each 25-30 hours of operation

Items required: wire brush, 3/8" wrench

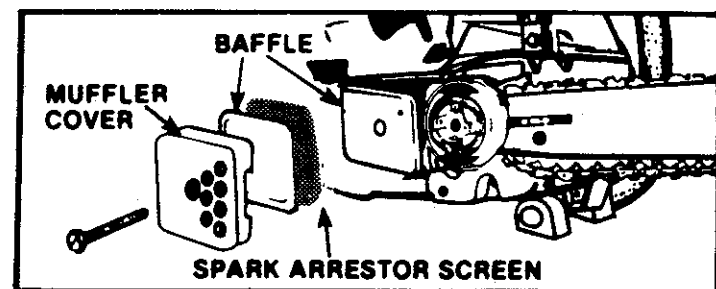

Figure 38

1. Disconnect the spark plug wire.
2. Remove the Muffer Cover. Figure 38.
3. Remove the screen from the baffle.
4. Clean the screen with a wire brush or replace if breaks are found.
5. Reassemble parts.

## C. STARTER ROPE

- A starter rope that breaks next to the pulley can be repaired.
- Replace the starter rope if the rope breaks more than 2-3 inches away from the pulley as the rope will be too short to repair properly.

**NOTE:** A recoil spring lies beneath the pulley and is under tension. If the recoil spring is disturbed, considerable time and effort will be required to reinstall. For this reason, you may want to let a qualified service dealer handle this repair. If you do try to repair the starter rope and the recoil spring pops out, take the saw to your dealer.

### ⚠ WARNING

Always wear eye protection when servicing the starter rope. The recoil spring beneath the pulley is under tension. If the spring pops out, serious injury can result.

1. Drain fuel tank.
  2. Remove the two screws on the side of the fan housing and the screw on the bottom of the fan housing. Figure 39.
  3. Remove the large screw at the rear of the control handle and the small screw directly below it. Figure 40.
  4. Pull the gas line from the fitting going in the saw handle (found on all models except 2300 CVA.)
  5. Separate the fan housing from the unit.
  6. If the starter rope is not broken, release the spring tension by pulling about 10 inches of rope from the pulley and catch the rope in the notch as shown. Figure 41.
- NOTE:** The tension on the starter spring will be released if the rope has broken.
7. Turn the pulley counterclockwise until the spring tension is released.
  8. Remove the pulley screw in the center of the pulley. Figure 42.
  9. Lift the pulley *carefully* while gently twisting it counterclockwise.
  10. Remove Retention screw. Remove the old rope.
  11. Move away from the fuel tank and melt the end of the rope to be installed.
  12. Allow the melted end to drip once; then while the rope is still hot, pull the melted end through a rag to obtain a smooth, pointed end.
  13. Route the rope through the rope hole in the housing.
  14. Guide rope inside pulley, then through the pulley hole. Figure 41.
  15. Wrap rope counterclockwise around pulley ratchet and tuck loose end under rope, leaving about a 1" pigtail. Lay pigtail between the screw post and the retainer rib. Figure 42.
  16. Thread retention screw and washer into the retention post. Figure 42.
  17. Pull rope tightly around the ratchet and wind the rope on the pulley counterclockwise.
  18. Set the pulley into the housing; push it down and engage the spring.
  19. Replace and tighten the pulley screw.
  20. Pull out 10 inches of rope and set the rope in the notch in the pulley. Figure 43.

21. Turn the pulley 2 complete turns clockwise wind up the spring.
  22. Hold the pulley and pull the starter rope to the full extent of length and let the rope re-wind slowly.
  23. Replace the fuel line in the slot in the fan housing (on all models except 2300 CVA). Be certain fuel line is not pinched.
- NOTE:** Make sure that the tab on the bottom of the fuel tank is aligned in the slot provided in the fan housing. Figure 10.
24. Replace fan housing.

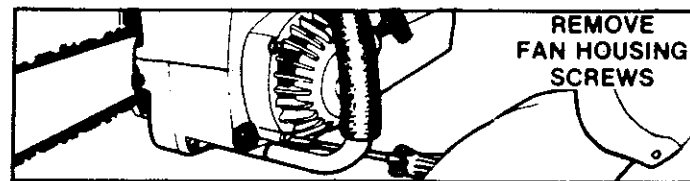

Figure 39

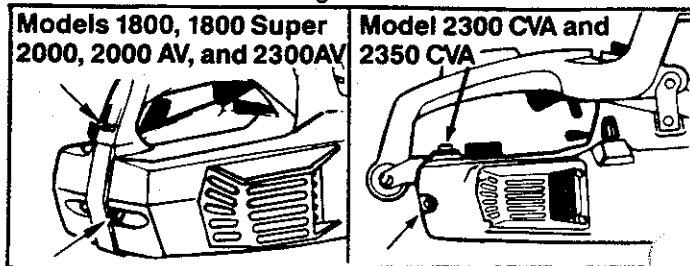

Figure 40

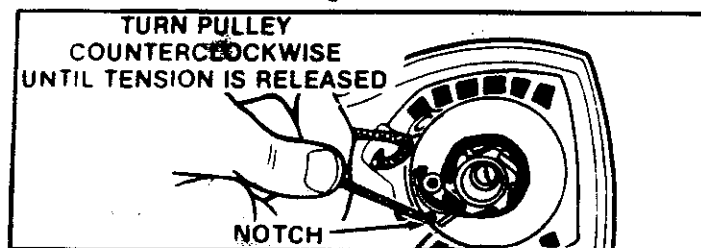

Figure 41

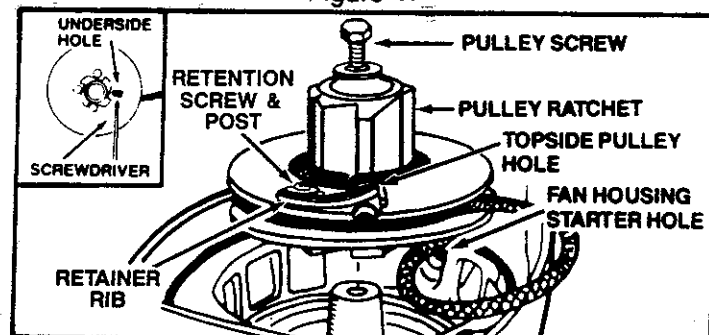

Figure 42

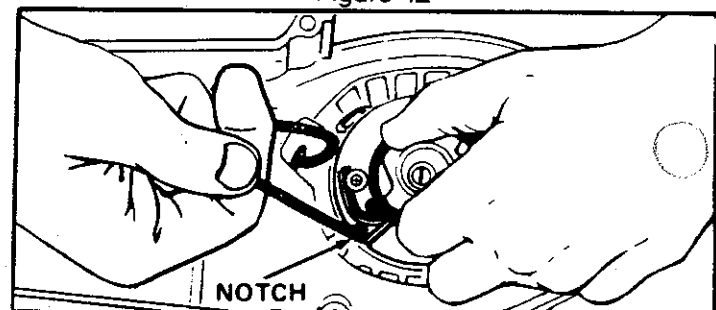

Figure 43

## D. CARBURETOR ADJUSTMENTS

- Poor engine performance can be a result of other causes such as dirty air filter, carbon build-up on muffler outlets, etc. See "Trouble Shooting Chart" before proceeding with carburetor adjustments.
- For best results, Poulan recommends that you have a qualified service dealer make all carburetor adjustments. Your dealer has the training, experience and tools necessary to properly adjust your saw to meet our factory performance specifications. *This service is not covered by warranty.* If it becomes necessary for you to make carburetor adjustments yourself, follow the procedures below very carefully.
- The carburetor has been adjusted at the factory for sea level conditions. Adjustments may become necessary if the saw is used at significantly higher altitudes or if you notice any of the following conditions:

**NOTE:** Be sure to properly prepare the saw as described in "1. Preparation" below, before making any adjustments.

- Chain moves when the engine runs at idle speed. See "2. Idle Speed Adjustment."
- Saw will not idle. See "2. Idle Speed Adjustment" and "3. Low Speed Mixture Adjustment."
- Engine dies or hesitates when it should accelerate. See "4. Acceleration Adjustment."
- Loss of cutting power which is not corrected by air filter cleaning. "See "5. High Speed Mixture Adjustment."

**CAUTION:** Permanent damage will occur to any 2-cycle engine if incorrect carburetor adjustments are made.

- If the unit will not operate properly after making these adjustments, take the saw to a qualified service dealer.

### ⚠ WARNING

The chain will be moving during most of this procedure. Wear your protective gear and observe all safety precautions.

#### 1. PREPARATION

- Stop engine.
- Use a fresh fuel mixture with proper gasoline/oil ratio.
- Place the saw on a solid, flat surface and make sure the chain will not contact any object.
- Remove the two carburetor cover screws and carburetor cover. Figure 45.
- Locate the three (3) carburetor adjusting screw openings to the right of the air filter cover. Figure 44.
- Start the engine and allow engine to idle 3 minutes to warm up. *The engine must be at operating temperature for proper adjustments to be made.*

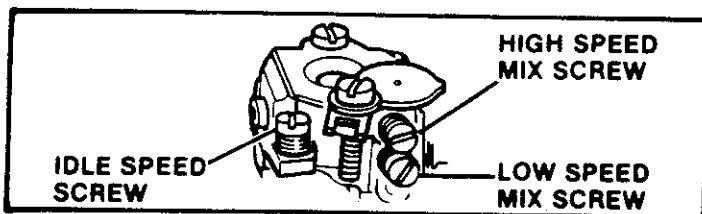

Figure 44

#### 2. IDLE SPEED ADJUSTMENT

- Allow engine to idle.
- Adjust **Idle Speed Screw** until engine continues to run without stalling and without the chain moving.
  - Turn screw clockwise to increase engine speed if engine stalls or dies.
  - Turn screw counterclockwise to slow engine down and/or to keep the chain from turning.
- No further adjustments are necessary if the chain does not move at idle speed and if performance is satisfactory.

### ⚠ WARNING

Recheck idle speed after each adjustment below. The chain must not move at idle speed to avoid serious injury.

#### 3. LOW SPEED MIXTURE ADJUSTMENT

- Allow engine to idle.
- Turn the **Low Speed Mixture Screw** slowly clockwise until the RPM starts to drop. Note the position.
- Turn the **Low Speed Mixture Screw** counterclockwise until the RPM speeds up and starts to drop again. Note the position.
- Set the **Low Speed Mixture Screw** at the midpoint between the two positions.

#### 4. ACCELERATION ADJUSTMENT

If engine dies or hesitates instead of accelerating, turn the **Low Speed Mixture Screw** 1/16 of a turn at a time counterclockwise until you have smooth acceleration.

#### 5. HIGH SPEED MIXTURE ADJUSTMENT

**CAUTION:** Adjustments as small as 1/16 of a turn can affect engine performance. It is important to turn the screw only 1/16 of a turn per adjustment and test the performance of the saw before making further adjustments.

- Make a test cut.
- Adjust the High Speed Mixture Screw 1/16 of a turn as follows:
  - Clockwise if saw smokes or loses power.
  - Counterclockwise if the saw has speed out of the cut but lacks power in the cut.
- Repeat test cut.
- Continue 1/16 of a turn adjustments until the saw runs smoothly in cut.

**CAUTION:** A too lean high speed setting (clockwise adjustment) will cause engine damage to any 2-cycle engine from overheating and lack of lubrication. Never set the high speed mixture screw so far clockwise that you have high speed but lack power while cutting. An effective approach follows.

- Turn screw counterclockwise until engine loses power while cutting.
- Then, turn screw clockwise in 1/16 of a turn increments *only until* the engine has power while cutting.

**NOTE:** If the unit will not operate properly after making these adjustments, take the saw to a qualified service dealer.

## E. AIR FILTER

- A dirty air filter:
    - reduces cutting power
    - increases fuel consumption
  - Clean the Air Filter:
    - frequently, especially under very dusty conditions.
    - always after 10 tanks of fuel mixture or 5 hours of operation whichever is less.
1. Clean off the carburetor cover and the area around it to keep dirt and sawdust from falling into the carburetor chamber when the cover is removed.
  2. Remove the carburetor cover screws and carburetor cover. Figure 45.
  3. Pull out the air filter.
  4. Wash the filter in soap and water.

**CAUTION:** Do not use gasoline or other flammable liquid to clean the filter to avoid creating a fire hazard.

5. Squeeze the filter dry.
6. Add a small amount of oil to coat the filter.  
**NOTE:** Avoid soaking the filter with oil.
7. Squeeze out excess oil.
8. Replace filter by tucking in edges and smoothing it flush with the carburetor housing.  
**NOTE:** Be careful when replacing the carburetor cover as incorrect placement will prevent the choke from working properly.

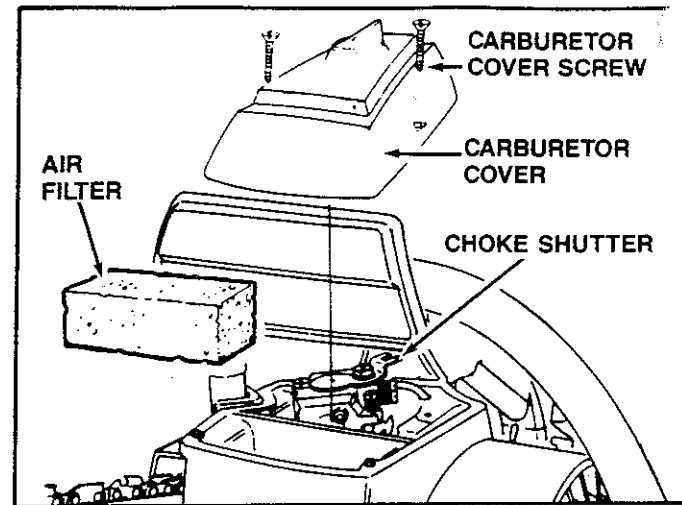

Figure 45

**CAUTION:** Never operate the unit without the air filter in place to avoid damage to the engine.

9. Move the choke knob all the way to the right.
10. Check the choke shutter to be sure it is closed. Figure 45.
11. Reinstall the carburetor cover and tighten the carburetor cover screws.
12. Check the operation of the choke.

**NOTE:** If the choke knob sticks or will not move, remove the cover and repeat steps 9-12 above.

## F. STORAGE

When your saw is to be stored for over 30 days, always:

1. Drain fuel tank in a safe manner. (See "Fueling Your Engine")
2. Start engine and allow to run at idle speed until the engine stops.  
**NOTE:** This will remove most of the fuel from the fuel system.
3. Drain oil tank.

**CAUTION:** Wear protective gloves when handling the chain. The chain is sharp and can cut you even when it is not moving.

4. Remove, clean, and dry the bar and chain.
5. Store the chain in a container filled with oil to prevent rust.
6. Apply a coating of oil to the entire surface of the bar and wrap it in heavy paper, cloth or plastic.
7. Clean the outside surfaces of the engine.
8. Store the saw in a dry place, out of the reach of children, and away from where fuel vapors can reach open flames from hot water heater, furnaces, etc.

## NOTES

## G. TROUBLE SHOOTING CHART

TROUBLE	CAUSE	REMEDY
ENGINE WILL NOT START	<ol style="list-style-type: none"> <li>1. Ignition Switch off.</li> <li>2. Fuel tank empty.</li> <li>3. Spark Plug not firing.</li> <li>4. Fuel not reaching carburetor.</li> <li>5. Engine flooded.</li> <li>6. Compression low.</li> </ol>	<ol style="list-style-type: none"> <li>1. Move switch to "Start."</li> <li>2. Fill tank with correct fuel mixture.</li> <li>3. Install new plug and/or check ignition system.</li> <li>4. Check for dirty fuel filter; clean. Check for kinked or split fuel line; repair or replace.</li> <li>5. See Starting Instructions.</li> <li>6. Contact a qualified service dealer.</li> </ol>
ENGINE WILL NOT IDLE PROPERLY	<ol style="list-style-type: none"> <li>1. Idle speed set too low.</li> <li>2. Idle speed set too high.</li> <li>3. Low speed screw requires adjustment.</li> <li>4. Crankshaft seals worn.</li> <li>5. Compression low.</li> </ol>	<ol style="list-style-type: none"> <li>1. Adjust idle speed screw clockwise to increase speed.</li> <li>2. Adjust idle speed screw counterclockwise to reduce speed.</li> <li>3. See Carburetor Adjustments.</li> <li>4. Contact a qualified service dealer.</li> <li>5. Contact a qualified service dealer.</li> </ol>
ENGINE WILL NOT ACCELERATE, LACKS POWER OR DIES IN THE CUT	<ol style="list-style-type: none"> <li>1. Carburetor requires adjustment.</li> <li>2. Air filter is dirty.</li> <li>3. Spark plug fouled.</li> <li>4. Carbon build-up on exhaust ports.</li> <li>5. Low Compression</li> </ol>	<ol style="list-style-type: none"> <li>1. See Carburetor Adjustments.</li> <li>2. Clean or replace air filter.</li> <li>3. Clean or replace Spark Plug and regap.</li> <li>4. Contact a qualified service dealer.</li> <li>5. Contact a qualified service dealer.</li> </ol>
ENGINE SMOKES EXCESSIVELY	<ol style="list-style-type: none"> <li>1. Fuel mixture incorrect.</li> <li>2. Choke partially on.</li> <li>3. High speed needle requires adjustment.</li> <li>4. Air filter dirty.</li> <li>5. Crankcase leak.</li> </ol>	<ol style="list-style-type: none"> <li>1. See Engine Fuel Mixture.</li> <li>2. Move choke to "OFF" position.</li> <li>3. See Carburetor Adjustments.</li> <li>4. Clean or replace air filter.</li> <li>5. Contact a qualified service dealer.</li> </ol>
ENGINE RUNS HOT	<ol style="list-style-type: none"> <li>1. Fan housing/cylinder fins dirty.</li> <li>2. Fuel Mixture incorrect.</li> <li>3. High Speed Mixture set too low.</li> <li>4. Carbon build-up on spark arrestor screen.</li> <li>5. Spark Plug incorrect.</li> <li>6. Carbon build-up on exhaust ports.</li> </ol>	<ol style="list-style-type: none"> <li>1. Clean area.</li> <li>2. See Engine Fuel Mixture.</li> <li>3. See Carburetor Adjustments.</li> <li>4. See "Spark Arrestor".</li> <li>5. Replace with correct plug.</li> <li>6. Contact a qualified service dealer.</li> </ol>
OIL INADEQUATE FOR BAR AND CHAIN LUBRICATION	<ol style="list-style-type: none"> <li>1. Oil tank empty.</li> <li>2. Oil pump or oil filter clogged.</li> <li>3. Guide bar oil hole blocked.</li> </ol>	<ol style="list-style-type: none"> <li>1. Fill oil tank.</li> <li>2. Contact a qualified service dealer.</li> <li>3. Remove bar and clean.</li> </ol>
CHAIN MOVES AT IDLE SPEED	<ol style="list-style-type: none"> <li>1. Idle speed requires adjustment.</li> <li>2. Clutch requires repair.</li> </ol>	<ol style="list-style-type: none"> <li>1. See Carburetor Adjustments.</li> <li>2. Contact a qualified service dealer.</li> </ol>
CHAIN DOES NOT MOVE WHEN ENGINE IS ACCELERATED	<ol style="list-style-type: none"> <li>1. Chain tension too tight.</li> <li>2. Carburetor requires adjustment.</li> <li>3. Guide bar rails pinched.</li> <li>4. Clutch slipping.</li> </ol>	<ol style="list-style-type: none"> <li>1. See Chain Tension.</li> <li>2. See Carburetor Adjustments.</li> <li>3. Repair or replace.</li> <li>4. Contact a qualified service dealer.</li> </ol>
CHAIN CLATTERS OR CUTS ROUGHLY	<ol style="list-style-type: none"> <li>1. Cutters damaged after striking foreign material.</li> <li>2. Chain tension incorrect or loose.</li> <li>3. Chain wear due to contact with dirt, sand or metal object in wood.</li> <li>4. Sprocket worn.</li> <li>5. Cutters dull, improperly sharpened; depth gauges too high.</li> </ol>	<ol style="list-style-type: none"> <li>1. Contact a qualified service dealer.</li> <li>2. See Chain Tension.</li> <li>3. Resharpen or replace chain.</li> <li>4. Contact a qualified service dealer.</li> <li>5. See Chain Sharpening Instructions.</li> </ol>
CHAIN STOPS WITHIN THE CUT	<ol style="list-style-type: none"> <li>1. Chain cutter tops not filed flat.</li> <li>2. Guide bar burred or bent; rail uneven.</li> <li>3. Clutch slipping.</li> </ol>	<ol style="list-style-type: none"> <li>1. See Chain Sharpening Instructions.</li> <li>2. Repair or replace Guide Bar.</li> <li>3. Contact a qualified service dealer.</li> </ol>
CHAIN CUTS AT AN ANGLE	<ol style="list-style-type: none"> <li>1. Cutters damaged on one side.</li> <li>2. Chain dull on one side.</li> <li>3. Guide bar bent, or worn.</li> </ol>	<ol style="list-style-type: none"> <li>1. Resharpen until all cutters have equal angles and lengths.</li> <li>2. Resharpen until all cutters have equal angles and lengths.</li> <li>3. Replace guide bar.</li> </ol>

## H. MAINTENANCE CHART

		before starting work	after finishing work or daily	after each refueling stop	weekly	monthly
Complete machine	Visual inspection (condition, leaks)	x		x		
	Clean		x			
Throttle trigger, safety throttle lock, stop switch	Check operation	x		x		
Filter in fuel tank	Replace filter assembly — when clogged or dirty					
Fuel tank	Clean					x
Chain oil tank	Clean					x
Chain lubrication	Check	x				
Saw chain	Inspect, also check sharpness	x		x		
	Check chain tension	x		x		
	Sharpen — when dull					
Guide bar	Inspect (wear, damage)	x				
	Clean (whenever chain is removed for maintenance)				x	
	Lubricate sprocket nose	x		x		
	Deburr				x	
	Replace — when worn or damaged					
Chain sprocket	Check — each time bar or chain is removed				x	
Air filter	Clean	x				
	Replace — when worn or damaged					
Exhaust ports	Clean		x			
Cylinder fins	Clean					x
Carburetor	Check idle adjustment — chain must not turn	x				
	Readjust idle — when chain turns at idle					
Spark plug	Replace — when fouled or damaged					
All accessible screws and nuts (not adjusting screws)	Retighten	x				
Vibration mounts	Inspect	x				
	Replace — when worn or damaged					
Spark arrestor screen	Inspect	x				
	Replace — when worn or damaged					

---

---

# POULAN® ACCESSORIES

---

See your Poulan® dealer for accessories and parts.

Electric Sharpener (with all stones) . . . . .	952-800516
Sharpener Stones . . . . .	952-093094
File - Flat - 6" . . . . .	952-055027
File - Round - 5/32" . . . . .	952-055026
File & Holder - 5/32" . . . . .	952-055031
Depth Gauge . . . . .	952-055028
Bar Wrench . . . . .	952-031096
Carry Case . . . . .	952-030116
Safety Helmet . . . . .	952-030013
Sound Suppressor . . . . .	952-006315
Safety Goggles . . . . .	952-062003
Safety Face Shield . . . . .	952-701601
Sprocket - 3/8" Spur . . . . .	952-048078
Spark Plug . . . . .	952-030037

Fuel & Oil Caps . . . . .	952-010436
Air Filter . . . . .	530-023791
2-cycle Engine Oil	
3.2 oz.-40:1 . . . . .	952-030133
8 oz.-40:1 . . . . .	952-030128
Bar & Chain Lubricant	
32 oz. . . . .	952-030129
1 gal. . . . .	952-030130
Chain Brake Kit . . . . .	952-069201
Illustrated Parts List	
Model 1800, 1800 Super, 2000 & 2000 AV	530-066069
Model 2300 AV, 2300 CVA . . . . .	530-064828
Operators Manual . . . . .	530-067580

---

---

## NOTES

## **PARTS AND SERVICE**

Your Poulan® /Weed Eater® product has been expertly engineered and carefully manufactured to rigid quality standards. As with all mechanical products, some adjustments or part replacement may be necessary during the life of your tool.

### **FOR SERVICE OR REPLACEMENT PARTS:**

1. Consult your dealer/place of purchase.
2. Consult the yellow pages of your phone directory for the name of the nearest Poulan/Weed Eater Master Service Dealer (under "saws" for Chain Saws or under "lawnmowers" for Trimmers, Brushcutters and Blowers).
3. For replacement parts, have available the following information.
  - a. Description of the tool.
  - b. Model number.
  - c. Part Number or description of part.

**NOTE:** Poulan/Weed Eater Division provides parts and service through its authorized distributors and dealers; therefore, all requests for parts and service should be directed to your local dealer(s). The philosophy of Poulan/Weed Eater Division is to continually improve all of its products. If the operating characteristics or the appearance of your product differs from those described in this Operator's Manual, please contact your local Poulan/Weed Eater Dealer for updated information and assistance. Always update your tool when improvements are made available, especially those related to safety. Parts and repair service are not available directly from Poulan/Weed Eater Division White Consolidated Industries, Inc.

### **POULAN/WEED EATER**

DIVISION WHITE CONSOLIDATED INDUSTRIES, INC.

Shreveport, Louisiana 71139-9329