

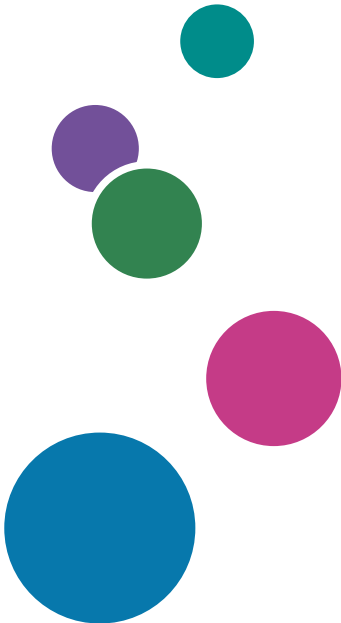

# User Guide

## Selected Version



Getting Started	1
Copy	2
Fax	3
Print	4
Scan	5
Document Server	6
Web Image Monitor	7
Adding Paper and Toner	8
Troubleshooting	9
Specifications for The Machine	10
Legal and Contact Information	11

For information not found in this manuals, see the online manuals available on our web site (<https://www.ricoh.com/>) or via the control panel.





---

# How to Read the Manuals

---

## Symbols Used in the Manuals

---

This manual uses the following symbols:

### **Important**

Indicates points to pay attention to when using the machine, and explanations of likely causes of paper misfeeds, damage to originals, or loss of data. Be sure to read these explanations.



### **Note**

Indicates supplementary explanations of the machine's functions, and instructions on resolving user errors.

### [ ]

Indicates the names of keys on the machine's display or control panels.

# TABLE OF CONTENTS

How to Read the Manuals.....	1
Symbols Used in the Manuals.....	1
<b>1. Getting Started</b>	
Turning On and Off the Power.....	11
Turning On the Main Power.....	11
Turning Off the Main Power.....	12
Energy Saving Mode.....	12
Guide to Names and Functions of Components.....	14
Front and Left View.....	14
Front and Right View.....	16
Rear and Left View  <b>Region A</b> (mainly Europe)  <b>Region B</b> (mainly North America).....	17
Rear and Left View  <b>Region A</b> (mainly Asia).....	18
Names and Functions of the Control Panel.....	20
Touch Panel/Interface.....	20
LED Indicators.....	21
Changing the Display Language.....	23
Confirming the Functions that Are Added in RICOH Always Current Technology.....	24
Confirming the Version of RICOH Always Current Technology Implemented on the Machine.....	24
List of New Functions.....	24
How to Use the Home Screen.....	27
Intuitive Screen Operation Using Fingertips.....	29
How to Use the Copy Screen.....	32
How to Use the Copy Screen (Standard).....	32
How to Use the Copy Screen (No Scrolling Screen).....	34
Changing the Layout or Display of the Keys of the Copy Function.....	35
How to Use the Fax Screen.....	37
Customizing the [Send Settings] Screen.....	37
How to Use the Scanner Screen.....	40
Customizing the [Send Settings] Screen.....	40
Adding a Frequently Used Application or Widget to the Home Screen.....	43
Adding an Icon/Widget to the Home Screen.....	44
Creating a Folder to Organize Icons.....	44
Registering Frequently Used Settings as a Program.....	46



---

Registering Settings as a Program.....	47
Changing the Contents of the Program.....	48
Logging In from the Control Panel.....	51
Logging In by Entering the User Name and Password.....	52
Logging In Using an IC Card.....	53
Logging In Using a Mobile Device.....	54
Authenticating Using the User Code.....	55
Changing the Login Password.....	55
Placing an Original on the Exposure Glass.....	58
Placing an Original in the Auto Document Feeder (ADF).....	60
Placing Originals in the ARDF.....	61
Placing Originals in the One-pass Duplex Scanning ADF.....	63

## 2. Copy

---

Basic Procedure for Copying Documents.....	67
Reserving a Copy Job While Executing Another Copy Job.....	68
Making Enlarged or Reduced Copies.....	70
Specifying a Copy Ratio or Size.....	70
Enlarging or Reducing According to the Paper Size.....	72
Reducing Slightly to Increase the Margins.....	74
Duplex Copying.....	76
Combining and Copying a Multi-page Original onto a Single Sheet of Paper.....	79
Copying Onto Envelopes.....	82
Copying Onto Envelopes in the Bypass Tray.....	82
Copying Onto Envelopes in the Paper Tray.....	83
Copying in Page Order or for Each Page Number.....	85

## 3. Fax

---

Basic Procedure for Transmitting Faxes.....	89
Registering Fax Numbers in the Address Book.....	92
Registering a Fax Number and Send Conditions.....	92
Changing/Deleting the Registered Data Such as Fax Number.....	94
Displaying a Preview before Sending a Fax.....	95
Viewing the Transmission Result of Sent Faxes.....	97
Confirming the Information on the Fax Screen.....	97

---

Checking the Result in Communication Result Report.....	98
Checking the Result in Immediate TX Result Report.....	99
Checking the Result in Communication Failure Report.....	99
Checking the Result in Error Report.....	99
Viewing Memory Storage Report.....	99
Checking by E-mail.....	100
Confirming the Information in Web Image Monitor.....	101

#### 4. Print

---

Installing the Printer Driver by Using Device Software Manager Installer.....	103
Installing Device Software Manager from the CD-ROM.....	103
Installing Device Software Manager from the Downloaded File.....	105
Installing the Printer Driver for Network Connection (Windows).....	109
Installing the PCL 6 Printer Driver from the CD-ROM.....	109
Installing the PostScript 3 Printer Driver from the CD-ROM.....	112
Installing the PCL 6/PostScript 3 Printer Driver from the Downloaded File.....	114
If the Machine Cannot Be Found.....	115
Installing the Printer Driver for Network Connection (OS X/macOS).....	119
Installing the PPD file.....	119
Registering the Machine in [Print & Scan] or [Printers & Scanners].....	120
Specifying the Option Settings.....	123
Basic Procedure for Printing Documents.....	125
Printing a Document in Windows.....	125
Printing a Document in OS X/macOS.....	127
Printing on Both Sides of Paper.....	130
Specifying 2-sided Print (Windows).....	130
Specifying 2-sided Print (OS X/macOS).....	131
Combining and Printing Multiple Pages on a Single Sheet of Paper.....	132
Specifying the Combine 2 Originals Function (Windows).....	132
Specifying the Combine 2 Originals Function (OS X/macOS).....	133
Printing on Envelopes.....	134
Printing Documents Stored in the Printer from the Control Panel.....	138
Printing from a USB Flash Memory Device or SD Card Directly.....	139
Printable File Formats.....	139

---

Printing from a Memory Storage Device or Scan Application.....	140
--	-----

## 5. Scan

---

Scanning Documents and Sending the Scanned Data by E-mail.....	143
Basic Procedure for Sending an E-mail.....	143
Registering the E-mail Destination Specified When Sending an E-mail in the Address Book.....	145
Scanning Documents and Sending the Scanned Data to a Folder.....	148
Printing the Check Sheet.....	148
Confirming the Computer Information (Windows).....	149
Creating a Shared Folder (Windows).....	150
Confirming the Computer Information (OS X/macOS).....	153
Creating a Shared Folder (OS X/macOS).....	153
Registering the Created Shared Folder in the Address Book.....	155
Basic Procedure for Performing Send to Folder.....	157
Scanning an Original with Suitable Quality and Density.....	159
Specifying the File Type or File Name When Scanning a Document.....	162

## 6. Document Server

---

Storing Documents in Document Server.....	165
Printing Documents in Document Server.....	167
Printing a Document with the Settings Specified When Scanned.....	167
Changing the Print Settings to Print a Document.....	168
Specifying a Page to Print.....	170

## 7. Web Image Monitor

---

Using Web Image Monitor.....	173
What You Can Do on the Web Image Monitor.....	174
Web Image Monitor Screen.....	175
Specifying Web Image Monitor Help.....	176

## 8. Adding Paper and Toner

---

Loading Paper into the Paper Tray.....	179
Loading Paper into Tray 1 to 4.....	180
Loading Paper into the Bypass Tray.....	184
Loading Paper into Tray 3 (LCT).....	189
Loading Paper into the Large Capacity Tray (LCT).....	191
Specifying the Paper Size That Is Not Automatically Detected.....	191

---

Recommended Paper Sizes and Types.....	194
Tray 1 .....	194
Tray 2.....	195
Lower Paper Trays (Trays 3, 4).....	196
Bypass Tray.....	198
Tray 3 (LCT).....	200
Large Capacity Tray (LCT).....	201
Notes on Special Paper.....	201
Paper Thickness for Each Paper Weight.....	202
Unusable Paper.....	202
Paper Storage.....	204
Saving Printouts.....	204
Thick Paper Orientation and Recommended Status.....	205
Envelope Orientation and Recommended Status.....	206
Using the Copy Function.....	207
Using the Printer Function.....	207
Loading Orientation-fixed Paper or Two-sided Paper.....	209
Copying onto Letterhead Paper.....	209
Printing onto Letterhead Paper Using the Printer Driver.....	210
Recommended Original Size and Weight.....	212
Sizes Detectable with Auto Paper Select.....	214
Replacing the Toner.....	216
Precautions When Storing Toner.....	217
Precautions When Replacing the Toner.....	218
Disposing Exhausted Toners.....	219
Replacing the Waste Toner Bottle.....	220
Precautions When Replacing the Waste Toner Bottle.....	220
Disposing the Used Waste Toner Bottle.....	222

## 9. Troubleshooting

---

Alert Sounds.....	223
Checking the Indicators, Icons, and Messages on the Control Panel.....	225
When an Icon is Displayed with a Message.....	225
When the [Check Status] Indicator is lit or flashing.....	227

---

When the Machine Cannot Be Operated.....	229
When the Machine Does Not Respond Correctly to an Operation on the Control Panel.....	229
When the Machine Does Not Respond Correctly to an Operation from a Computer.....	233
When a Message Is Displayed and the Machine Cannot Be Operated.....	235
When a Message Appears While Using the Copy Function.....	238
When a Message Is Displayed While Using Document Server.....	240
When a Message Is Displayed While Using the Fax Function.....	242
Messages Displayed During Operation or When Sending/Receiving a Fax Cannot Be Performed.....	242
Messages Displayed When the Machine Cannot Connect to the Network.....	244
Messages Displayed When the Remote Fax Function Is Unavailable.....	252
When a Message Appears While Using the Printer Function.....	256
Messages Displayed without Error Codes.....	256
Messages Displayed with Error Codes.....	269
When a Message Is Displayed While Using the Scanner Function.....	271
Messages Displayed on the Control Panel.....	271
Messages Displayed on the Computer.....	277
When Other Messages Are Displayed.....	283
Messages Displayed When Machine Login Fails.....	285
Messages Displayed When Logging in to the Machine Using an IC Card Fails.....	292
Messages Displayed When the LDAP Server is Unavailable.....	292
Messages Displayed When There Is a Problem with the Certificate.....	294
Messages Displayed When an Application Site Cannot Be Used.....	295

## 10. Specifications for The Machine

---

Model-Specific Information.....	297
List of Specifications.....	298
Specifications for the Main Unit.....	298
Specifications for the Document Server.....	321
Specifications for Facsimile.....	321
Specifications for Printer.....	327
Specifications for Scanner.....	330
Specifications for One-pass Duplex Scanning ADF.....	334
Specifications for Auto Reverse Document Feeder (ARDF).....	335

---





Specifications for Internal Finisher SR3250.....	336
Specifications for Finisher SR3260.....	338
Specifications for Booklet Finisher SR3270.....	340
Specifications for Finisher SR3280.....	343
Specifications for Booklet Finisher SR3290.....	345
Specifications for Internal Finisher SR3300.....	348
Specifications for Internal Multi-Folding Unit.....	349
Specifications for External Tray.....	351
Specifications for Internal Shift Tray.....	352
Specifications for Internal Tray 2.....	353
Specifications for Bridge Unit.....	353
Specifications for Punch Unit (Internal Finisher SR3250).....	354
Specifications for Punch Unit (Finisher SR3260, Booklet Finisher SR3270).....	355
Specifications for Punch Unit (Finisher SR3280, Booklet Finisher SR3290).....	356
Specifications for Lower Paper Tray.....	357
Specifications for Lower Paper Trays.....	357
Specifications for Tray 3 (LCT).....	358
Specifications for Large Capacity Tray (LCT).....	358
Specifications for IEEE 1284 Interface Board.....	359
Specifications for Wireless LAN Board.....	359
Specifications for Device Server Option.....	360
The Setting Values of the Transmission Function.....	361
Send Email.....	361
Send to Folder.....	362
Broadcast Transmission.....	363
Printable Area and Margin.....	364
Machine Options.....	366
Guide to Functions of the Machine's External Options.....	366
Guide to Functions of the Machine's Internal Options.....	372
Functions Requiring Optional Configurations.....	374
Copy Function.....	374
Facsimile Functions.....	376
Printer Function.....	379

---

Scanner Function.....	381
Interface.....	382
Function Compatibility.....	383

## 11. Legal and Contact Information

---

Environmental Regulations.....	385
ENERGY STAR Program.....	385
Energy Saving Functions.....	385
User Information on Electrical and Electronic Equipment  Region <b>A</b> (mainly Europe).....	387
Note for the Battery and/or Accumulator Symbol (For EU countries only)  Region <b>A</b> (mainly Europe) .....	388
Environmental Advice for Users  Region <b>A</b> (mainly Europe).....	389
Notes to users in the state of California (Notes to Users in USA)  Region <b>B</b> (mainly North America).... .....	389
Trademarks.....	390





# 1. Getting Started

## Turning On and Off the Power

To turn the machine on and off, press the main power switch on the right of the machine.

### ★ Important

- When you are using the fax function on the machine, do not turn the power off under normal operation. If the power is turned off, data stored in the fax memory will be lost in about one hour after the machine is turned off. If you have to turn the power off or unplug the power cord for some reason, make sure 100% is shown as available memory on the screen for the fax function.

## Turning On the Main Power

### ★ Important

- Do not press the main power switch soon after you press the main power of the machine. When you turn the power on or off, wait at least 10 seconds after confirming that the main power indicator on the control panel has turned on or off.
1. Make sure the power cord is firmly plugged into the wall outlet.
  2. Open the cover of the main power switch, and push the main power switch.

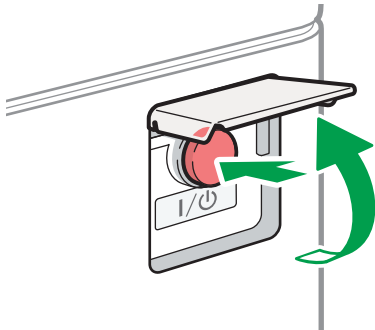

DZB636

The main power indicator on the right side of the control panel turns on.

### ↓ Note

- When the power is turned on, the screen may show that the machine is performing an auto restart. Do not turn off the main power while the machine is processing. It takes about five minutes until the machine restarts.

---

## Turning Off the Main Power

---

### ★ Important

- Do not turn off the power while the machine is in operation. To turn the power off, confirm that the operation is finished.
- Do not hold down the main power switch while turning off the main power. Doing so forcibly turns off the machine's power and may damage the hard disk or memory and cause malfunctions.
- Do not press the main power switch soon after pressing the main power switch on the machine. When you turn the power on or off, wait at least 10 seconds after confirming that the main power indicator on the control panel has turned on or off.

1. Open the cover of the main power switch, and push the main power switch.

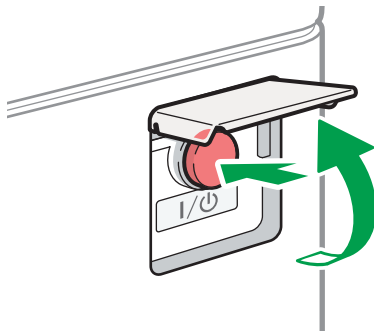

DZB636

The main power indicator on the right side of the control panel turns off. The main power turns off automatically after the machine has shut down properly.

---

## Energy Saving Mode

---

When the machine is not operated for a specified period of time, the machine enters the "Energy Saver Mode" automatically. "Energy Save mode" has two modes, "Fusing Unit Off mode" and "Sleep mode", and the machine enters the Fusing Unit Off mode first. In the factory default, the machine is configured to use both modes.

### Fusing Unit Off Mode

Because the heater of the fusing unit is turned off but the screen of the control panel is still displayed, the power consumption decreases, but you can start operation promptly. If you do not operate the machine for a specified period of time, the machine emits a clicking sound and enters Fusing Unit Off mode.

- You can specify whether to enable the Fusing Unit Off mode and the time to wait before the machine enters Fusing Unit Off mode under [Fusing Unit Off Mode (Energy Saving) On/Off]. See "Timer Settings", User Guide (Full Version).

- See below when [Standard] is specified as the screen type of [Settings]. The names of the setting items may differ from the [Classic] screen type.

See "Date/Time/Timer", User Guide (Full Version).

For details, see "Settings Menu Compatibility List (Classic to Standard Settings)", User Guide (Full Version).

- In this mode, you can scan documents, send faxes, receive faxes into memory, change the machine settings on the control panel, and perform other operations that do not require printing.

## Sleep Mode

In this mode, the display of the control panel turns off and the main power indicator blinks slowly. Power consumption is minimized. When you do not operate the machine for a specified period of time or press [Energy Save] () , the machine enters Sleep mode.

- You can specify the amount of time that the machine waits before entering Sleep mode under [Sleep Mode Timer].

See "Timer Settings", User Guide (Full Version).

- See below when [Standard] is specified as the screen type of [Settings]. The names of the setting items may differ from the [Classic] screen type.

See "Date/Time/Timer", User Guide (Full Version).

For details, see "Settings Menu Compatibility List (Classic to Standard Settings)", User Guide (Full Version).

- The machine recovers from Sleep mode when you perform one of the following:

- Lift the ADF.
- Place an original in the ADF.
- Touch the display of the control panel.
- Approach the machine and are detected by the human detection sensor.

See "Recovering from Sleep Mode When a Person Approaches the Machine", User Guide (Full Version).

### Note

- The energy saving functions are disabled when an error occurs or while an operation is in progress.
- When the machine recovers from Sleep mode using the human detection sensor, the main power indicator turns on. Even if Sleep mode is canceled, the operation screen is not displayed until you touch the touch panel.

# Guide to Names and Functions of Components

## CAUTION

- Do not obstruct the machine's vents. Doing so risks fire caused by overheated internal components.

### Region A and Region B symbols

 **Region A** (mainly Europe and Asia), (mainly Europe), or (mainly Asia)

 **Region B** (mainly North America)

Differences in the functions of Region A and Region B models are indicated by two symbols.

Read the information indicated by the symbol that corresponds to the region of the model you are using.

For details about which symbol corresponds to the model you are using, see page 297 "Model-Specific Information".

## Front and Left View

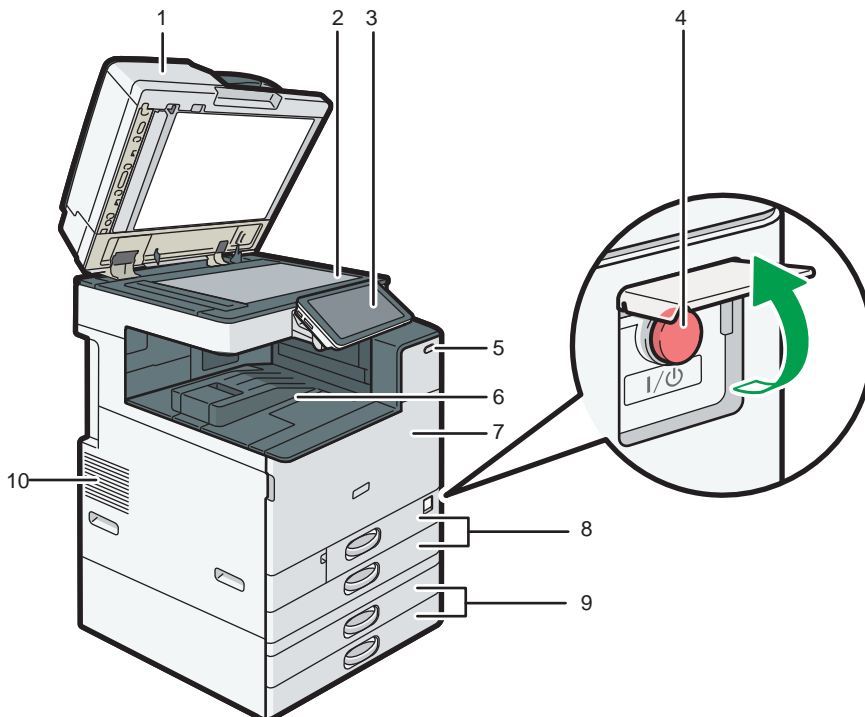

DZB161

### 1. Exposure glass cover/Auto Document Feeder (ADF)

Lower the cover over originals placed on the exposure glass.

If you load a stack of originals in the ADF, the ADF will automatically feed the originals one by one.

## 2. Exposure glass

Place originals facedown here.

page 58 "Placing an Original on the Exposure Glass"

## 3. Control panel

page 20 "Names and Functions of the Control Panel"

## 4. Main power switch

To turn the power on and off, open the cover of the main power switch and press the main power switch.

page 11 "Turning On and Off the Power"

## 5. Human detection sensor

Detects a person approaching the machine.

See "Recovering from Sleep Mode When a Person Approaches the Machine", User Guide (Full Version).

## 6. Internal tray 1

Copied/printed paper and received fax pages are delivered here. And the paper is output under the paper holder attached inside the internal tray.

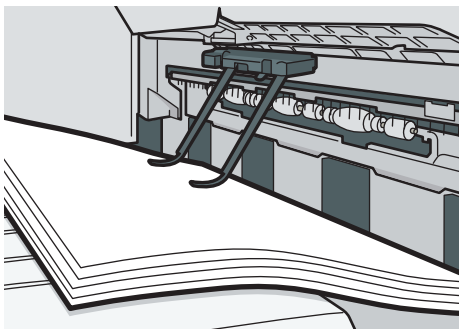

DZW798

## 7. Front cover

Open to access the inside of the machine.

page 216 "Replacing the Toner"

## 8. Paper trays (Trays 1, 2)

Standard paper trays. Load paper here.

page 179 "Loading Paper into the Paper Tray"

## 9. Lower paper trays (Trays 3, 4)

Optional paper trays. Load paper here.

page 179 "Loading Paper into the Paper Tray"

## 10. Vents

Holes for ventilating the inside the machine to prevent the internal components from overheating.

After large-volume printing, the ventilation fan may continue to work to lower the temperature inside the machine.

**Note**

- Note the following when using the paper holder of the internal tray:
  - Once you have drawn out the output sheet on the top of the internal tray, do not push the sheet back under the paper holder. The paper holder does not work on the output sheet properly and may cause a paper jam.

## Front and Right View

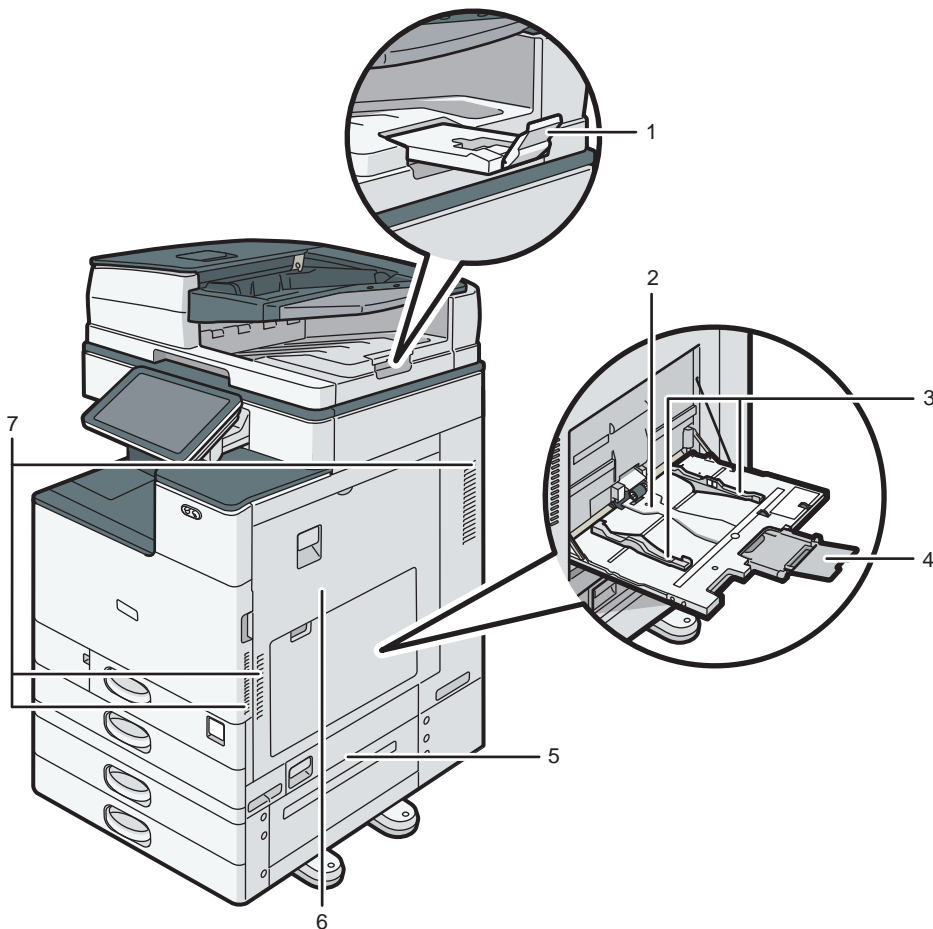

EDM162

### 1. ADF tray extender

Pull this extender out to prevent originals larger than B4 or  $8\frac{1}{2} \times 14$  size from falling.

### 2. Bypass Tray

Use the tray to copy or print on OHP transparencies, adhesive labels, and paper that cannot be loaded in the paper trays.

page 184 "Loading Paper into the Bypass Tray"

**3. Paper guides**

When loading paper in the bypass tray, align the paper guides with the edges of the paper.

**4. Extender**

Pull this extender out when loading paper larger than A4,  $8\frac{1}{2} \times 11$ .

**5. Lower right cover**

Open this cover to remove jammed paper.

**6. Right cover**

Open this cover to remove jammed paper.

**7. Vents**

Holes for ventilating the inside the machine to prevent the internal components from overheat.

After large-volume printing, the ventilation fan may continue to work to lower the temperature inside the machine.

## Rear and Left View Region **A** (mainly Europe) Region **B** (mainly North America)

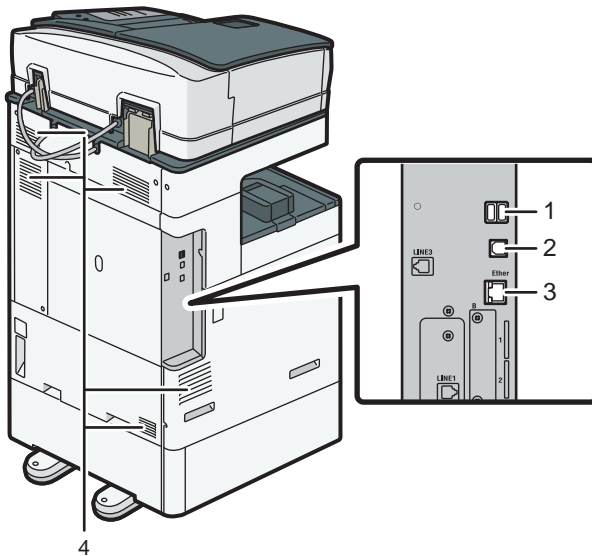

D2C163

**1. USB2.0 Interface Type A**

Use the port to connect the IC card authentication device.

**2. USB2.0 Interface Type B**

Use the port to connect the machine and the computer with the USB cable.

### 3. Ethernet interface

Used the port to connect the machine to the network or to use the remote management service (RICOH @Remote) over the Internet.

### 4. Vents

Holes for ventilating the inside the machine to prevent the internal components from overheat.

After large-volume printing, the ventilation fan may continue to work to lower the temperature inside the machine.

## Rear and Left View Region A (mainly Asia)

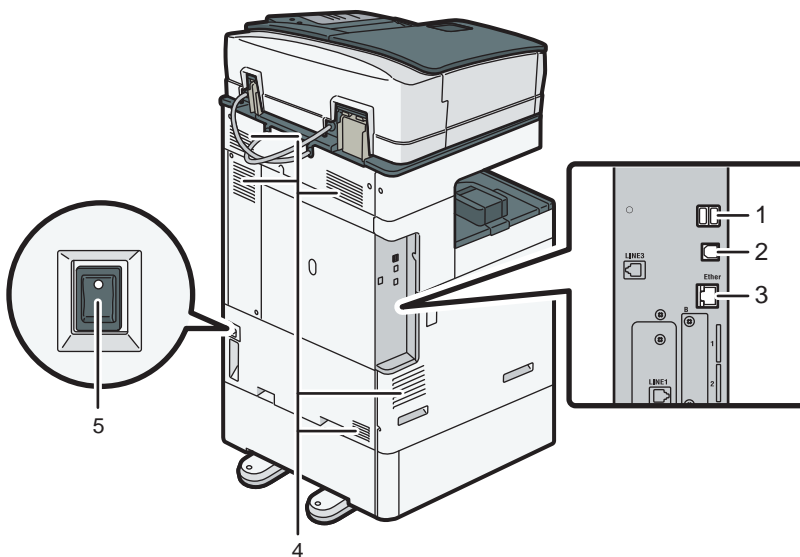

DZC160

### 1. USB2.0 Interface Type A

Use the port to connect the IC card authentication device.

### 2. USB2.0 Interface Type B

Use the port to connect the machine and the computer with the USB cable.

### 3. Ethernet interface

Used the port to connect the machine to the network or to use the remote management service (RICOH @Remote) over the Internet.

### 4. Vents

Holes for ventilating the inside the machine to prevent the internal components from overheat.

After large-volume printing, the ventilation fan may continue to work to lower the temperature inside the machine.



### **5. Anti-humidity heater switch**

Turn the switch "On" to prevent paper from absorbing moisture and maintain print quality. Use this feature when using the machine in a high-humidity or low-temperature environment.

# Names and Functions of the Control Panel

The touch panel (Smart Operation Panel) that displays the operation screen of the machine is referred to as the "Control Panel".

- On both sides of the control panel, interfaces for connecting external devices and slots to insert an SD card/USB flash memory device are provided.
- Even when the screen is turned off, the LED indicators on the frame of the control panel show the status of the machine.

## Touch Panel/Interface

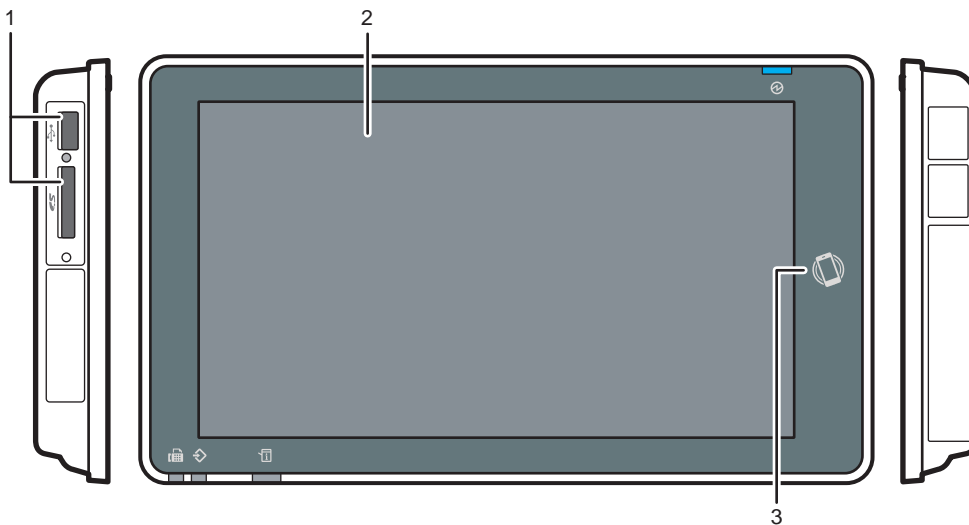

DZB165

### 1. Media slots

Insert an SD card or USB flash memory device. You can store the scanned data or print the file stored on the media.

- Use an SD memory card or SDHC memory card with a maximum capacity of 32 GB. You cannot use an SDXC memory card.
- Use the media formatted in FAT16 or FAT32.
- Certain types of USB flash memory devices cannot be used in the machine.
- A USB extension cable, hub, or card reader cannot be used.
- If the power of the machine is turned off or the media is removed from the machine while the machine is reading the data in the media, check the data in the media.
- Before removing the media from the slot, press the icon displayed on the screen (🗑️/🗑️) to cancel the connection.

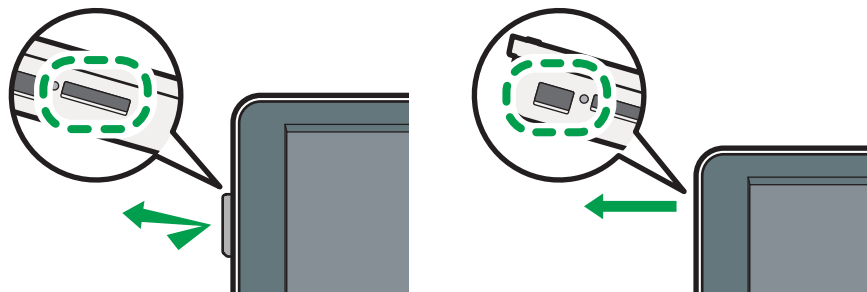

DZW174

## 2. Touch Panel

Displays the Home screen, operation screen of applications, and messages. Operate with the fingertips.

page 27 "How to Use the Home Screen"

page 29 "Intuitive Screen Operation Using Fingertips"

## 3. NFC tag

Used to connect the machine and a smart device with the RICOH Smart Device Connector.

See "Using the Machine Functions from a Mobile Device", User Guide (Full Version).

### ↓ Note

- You can adjust the angle of the control panel to improve visibility.



DZB166

## LED Indicators

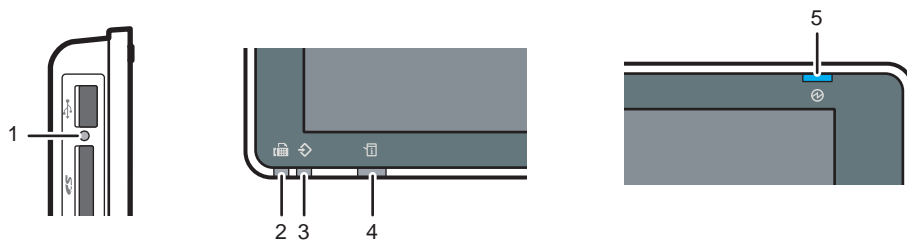

DZB164

**1. Media access indicator**

Flashes when data is being read from or written to an SD card

While the machine is accessing the SD card or USB flash memory device, do not turn the power off or remove the media.

**2. Fax indicator**

Indicates the status of the fax function.

- Flashing: transmitting and receiving data
- Lit: receiving data (Substitute RX File/Memory Lock Reception/Personal Box)

**3. Data In indicator**

Flashes when the machine is receiving data sent from the printer driver or LAN-Fax driver.

**4. Status indicator**

Indicates the status of the system. Stays lit when an error occurs or toner runs out.

page 225 "Checking the Indicators, Icons, and Messages on the Control Panel"

**5. Main power indicator**

The main power indicator lights up when you turn on the main power switch. In Sleep mode, it flickers slowly.

# Changing the Display Language

You can change the language used on the display. English is set as default.

1. On the Home screen, press the change language widget.



2. Select the language you want to display.



3. Press [OK].

# Confirming the Functions that Are Added in RICOH Always Current Technology

You can install the upgrade package for the machine's functions by RICOH Always Current Technology. You can apply the latest functions developed after purchase and security updates.

To install the latest version of RICOH Always Current Technology, access the Application Site from the control panel of the machine.

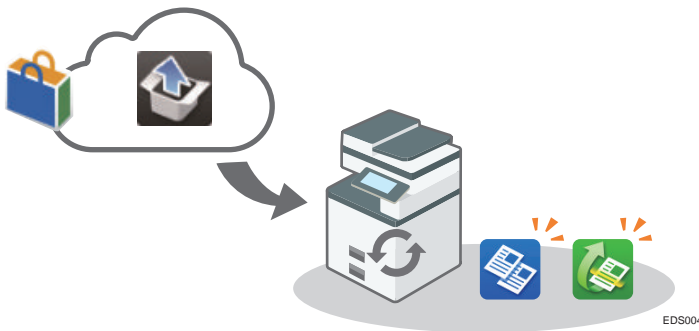

## Note

- For details about installing RICOH Always Current Technology, see the Operating Instructions for Application Site.

## Confirming the Version of RICOH Always Current Technology Implemented on the Machine

1. Press [Maintnc./Inquiry/Mach. Info] on the [Check Status] screen.
2. Press [Inquiry].
3. Check the version of the machine under the machine information.

## List of New Functions

The new functions are added together with each version of RICOH Always Current Technology.

See below for the functions added in RICOH Always Current Technology.

**Version 1.1**

Application	Added Function	Reference
Settings	The following functions are added:	
	<ul style="list-style-type: none"> <li>• You can now switch between different screen types.</li> </ul>	See "How to Use the Settings Screen", User Guide (Full Version).
	<ul style="list-style-type: none"> <li>• You can now change the type of notification sound of the Copier function.                             <ul style="list-style-type: none"> <li>• Copy: Job Done Sound</li> <li>• Copy: Forgot Original Sound</li> </ul> </li> </ul>	See "Sound", User Guide (Full Version).
	<ul style="list-style-type: none"> <li>• You can now specify the sound to notify the user when an original is left unattended on the machine (Scanner: Forgot Original Sound).</li> </ul>	
Address Book	An address book management function is added.	See "Management", User Guide (Full Version).

Application	Added Function	Reference
Copier	The following functions are added:	
	<ul style="list-style-type: none"> <li>• Reserve (Job Preset)</li> </ul>	See "Basic Procedure for Copying Documents", User Guide (Full Version).
	<ul style="list-style-type: none"> <li>• Positive / Negative</li> </ul>	See "Inverting the Brightness of the Original When Copying", User Guide (Full Version).
	<ul style="list-style-type: none"> <li>• Mirror Image</li> </ul>	See "Flipping the Original Horizontally When Copying", User Guide (Full Version).
	<ul style="list-style-type: none"> <li>• Image Repeat</li> </ul>	See "Repeating the Original Image over the Entire Area of Paper When Copying", User Guide (Full Version).
	<ul style="list-style-type: none"> <li>• Slip Sheet</li> </ul>	See "Inserting Slip Sheets Between Pages When Copying", User Guide (Full Version).
Fax	The "Reception File Storage Location" function is added under [Reception Settings] ► [Reception File Settings].	See "Reception Settings (Standard)", User Guide (Full Version).



# How to Use the Home Screen

Press [Home] (🏠) at the bottom center of the screen to display the Home screen on which icons for each function are shown. On the Home screen, you can register frequently used shortcuts and widgets.

- Touch the Home screen to operate it.  
page 29 "Intuitive Screen Operation Using Fingertips"
- You can add or delete icons and widgets, and change their order.  
page 43 "Adding a Frequently Used Application or Widget to the Home Screen"

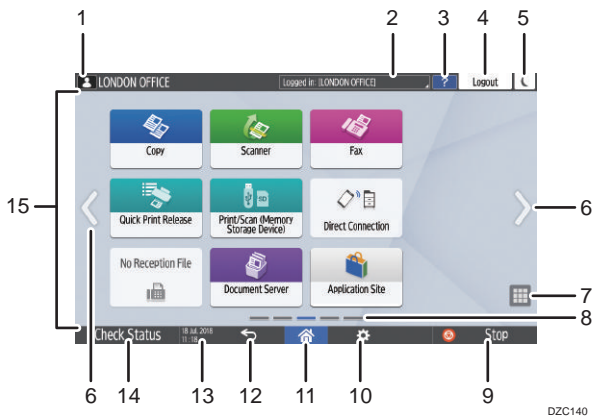

## 1. Login icon

This icon is displayed when users are logged in. When you press the icon, the names of the users who are currently logged in are displayed.

## 2. System message

Displays system and application messages. If there are two or more messages, they will be displayed alternately.

If a message indicating that the toner has run out or an error has occurred is displayed, press the message to display the system message list to check the contents.

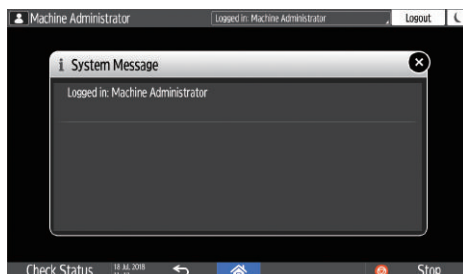

## 3. Help ?

This icon is displayed when Help is available for the displayed screen or errors occurring when the machine is connected to the Internet.

Specify [Cookie] in the control panel browser to [ON] to display Help properly.

See "Browser Settings", User Guide (Full Version).

**4. [Login]/[Logout]**

These keys are displayed when user authentication is enabled. Press the keys to log in to or log out from the machine.

page 51 "Logging In from the Control Panel"

**5. [Energy Save]** 

Press to enter or exit Sleep mode.

page 12 "Energy Saving Mode"

**6. Switch Screens** 

Press to scroll the screens right and left. The Home screen has 5 screens.



DZC180

You can switch between the screens by flicking.

page 29 "Intuitive Screen Operation Using Fingertips"

**7. Application list** 

Press to display applications that are not displayed on the Home screen.

page 43 "Adding a Frequently Used Application or Widget to the Home Screen"

**8. Current display position**

Shows which of the five screens is currently displayed.

**9. [Stop]**

Press to stop scanning or printing.

You can change the setting to stop only a job in progress with [Stop Key to Suspend Print Job].

See "Administrator Tools (System Settings)", User Guide (Full Version).

See below when [Standard] is specified as the screen type of [Settings]. The names of the setting items may differ from the [Classic] screen type.

See "Machine", User Guide (Full Version).

For details, see "Settings Menu Compatibility List (Classic to Standard Settings)", User Guide (Full Version).

**10. [Menu]** 

Displayed if a menu is available in the currently selected application.

On the Home screen, press to restore the icons to their factory default positions.

**11. [Home]** 

Press to display the Home screen.

**12. [Back]** 

Press to return to the previous screen.

**13. Date/Time and Toner remaining**

The current date and time is displayed.

To display the information about Toner remaining, specify [Display Time/Remaining Toner] of [Screen Features Settings] to [Remaining Toner].

The procedure is described using the [Classic] screen type of [Settings] as an example. When you are using the [Standard] screen type, specify the settings in the screen below.

- [System Settings] ► [Display/Input] ► [Display]

The names of the setting items may differ on the setting screen for [Classic] and [Standard] screen types.

For details, see "Settings Menu Compatibility List (Classic to Standard Settings)", User Guide (Full Version).

**14. [Check Status]**

Press to check the following system statuses of the machine. This lights up in red when an error occurs.

- Machine's status  
Indicates the error status and network status.
- Operational status of each function  
Status of functions such as Copy or Scanner
- Current jobs
- Job history
- Machine's maintenance information

See "Checking the Machine Status from the Control Panel", User Guide (Full Version).

**15. Icon display area**

Displays the icons and widgets.

**Note**

- You can change the screen displayed when the power is turned on under [Function Priority].
- See "Displaying Frequently Used Functions on the First Screen", User Guide (Full Version).
- When you press [Menu] ► [Reset Home Screen] with the Embedded Software Architecture application being installed in the machine, the application icons are not deleted.

---

## Intuitive Screen Operation Using Fingertips

---

On the Home screen or application screen, you can perform the following operations by touching the screen with your fingertips.

**Flick (for switching between screens)**

Touch and slide your finger on the screen quickly left or right to switch between the screens.

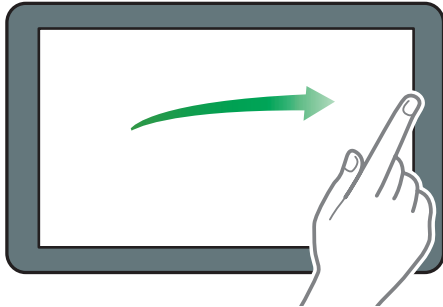

DZB181

### Drag (for moving an icon)

Press and hold an icon, and then slide your finger while pressing on the screen to move the icon.

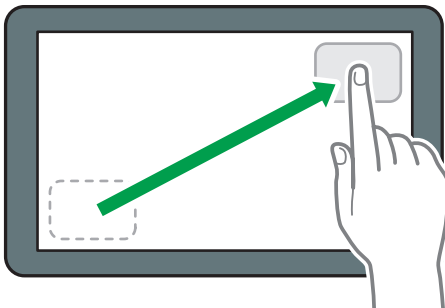

DZB182

### Long tap (for displaying the available menu screen)

Press and hold on a blank area on the screen to display the menu screen.

On the Home screen you can add a folder or change the wallpaper from the menu.

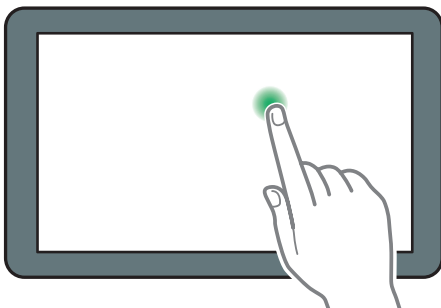

DZB183

In some applications, you can also use the following actions to operate the screen:

### Pinch-in (for zooming out the screen)

Touch the screen with your thumb and forefinger, and pinch them together. This feature is useful when previewing files and images.

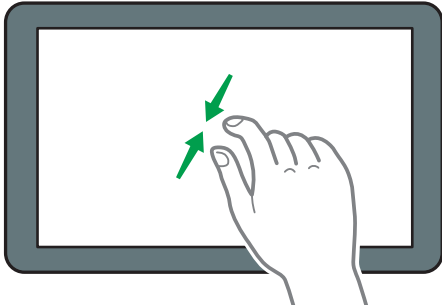

DZB185

**Pinch-out (for zooming in the screen)**

Touch the screen with your thumb and forefinger, and spread them apart. You can also zoom in the screen by tapping the screen twice quickly. When you quickly tap the screen twice again, the screen returns to full display. This feature is useful when previewing files and images.

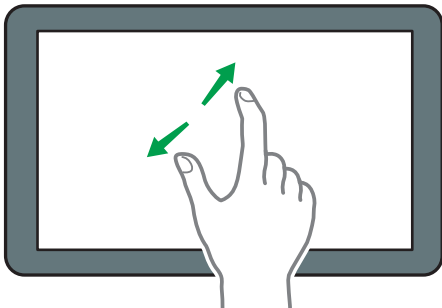

DZB184

# How to Use the Copy Screen

You can select from one of two types for the Copy screen:

## Standard (factory-default)

The basic functions that are used frequently are displayed with big keys. Scroll down the screen to see the keys used to configure the functions for finishing or editing.

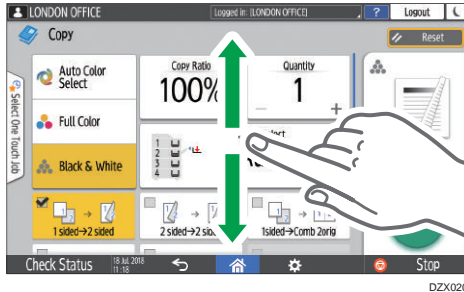

## No Scrolling Screen

You can see all the function keys on a single screen. You do not need to scroll through the screens to select a function.

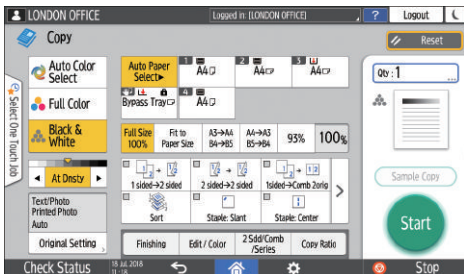

- To switch the screen type, press [Menu]([Settings Icon]) ▶ [Screen Settings] ▶ [Select Screen Layout] on the Copy screen.
- You can use the same functions on either screen.
- When the administrator has configured user authentication and User's Own Customization is enabled, each login user can change the screen type.

## How to Use the Copy Screen (Standard)

You can customize the layout and how the keys are displayed on the Copy screen in Standard. For details, see page 35 "Changing the Layout or Display of the Keys of the Copy Function".

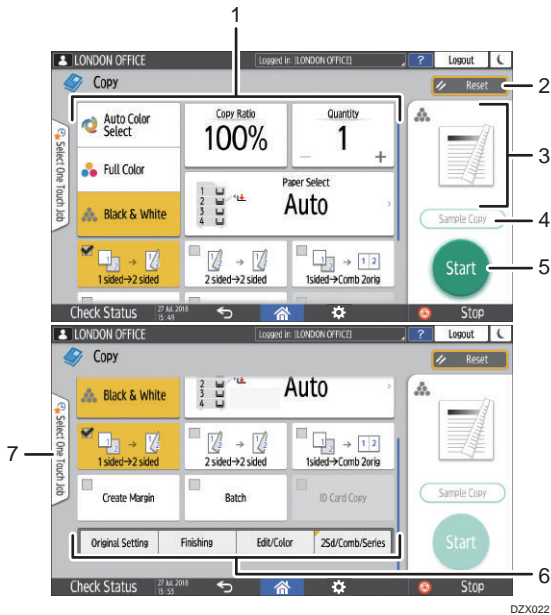

## 1. Copy function keys

Press a key to select the function to assign to the key. Flick up and down on the screen to display the keys out of the visible area. The keys with assigned functions are displayed in yellow or with  in the upper left corner. Depending on the assigned function, the display of the key changes according to the specified setting.

## 2. [Reset]

Reset the settings configured on the Copy screen.

## 3. Preview of the current setting status

Displays an image representing the settings configured on the Copy screen. Press the image to display the list of the settings.

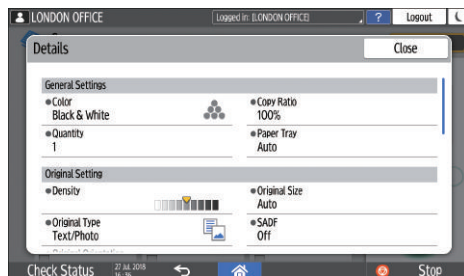

## 4. [Sample Copy]

Press to make a partial copy as a test before proceeding to copy the rest of the original.

See "Making a Partial Copy as a Test and Copying the Rest of the Original", User Guide (Full Version).

## 5. [Start]

Press to perform copying.

## 6. Other keys for Copy function

Press to select the functions whose keys are out of the visible area of the screen. The key of the function that is currently configured is displayed with  in the upper left corner.

## 7. Select One Touch Job

You can see the preset settings in the machine or the job history. When user authentication is configured, display the history of the executed jobs for each login user. When selecting a job history, its settings are displayed on the current Copy screen. You can use the same settings as a previous job by selecting the job history.

## How to Use the Copy Screen (No Scrolling Screen)

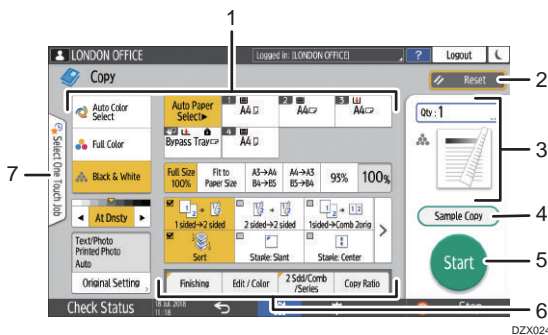

### 1. Copy function keys

Press a key to select the function to assign to the key. The keys with assigned functions are displayed in yellow. To see the display area in the illustration below, press  or flick to the left or right.

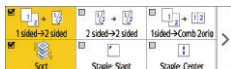

### 2. [Reset]

Reset the settings configured on the Copy screen.

### 3. Preview of the current setting status

Displays an image representing the quantity and the settings configured on the Copy screen. Press [Quantity] to display the number keys. Press the image to display the list of the settings.

### 4. [Sample Copy]

Press to make a partial copy as a test before proceeding to copy the rest of the original.

See "Making a Partial Copy as a Test and Copying the Rest of the Original", User Guide (Full Version).

### 5. [Start]

Press to perform copying.

### 6. Other keys for Copy function

Press to select the functions whose keys are out of the visible area of the screen. The key of the function that is currently configured is displayed with  in the upper left corner.



## 7. Select One Touch Job

You can see the preset settings in the machine or the job history. When user authentication is configured, display the history of the executed jobs for each authenticated user. When selecting a job history, its settings are displayed on the current Copy screen. You can use the same settings as a previous job by selecting the job history.

1

## Changing the Layout or Display of the Keys of the Copy Function

You can customize the layout and how the Copy function keys are displayed on the Copy screen in Standard mode (Arranging keys mode).

When the administrator has configured user authentication and User's Own Customization is enabled, each login user can customize the layout.

### Switching to change the key layout mode

On the Copy screen, press and hold one of the keys until the screen changes, and then press [OK] to display the screen of the arranging keys mode.

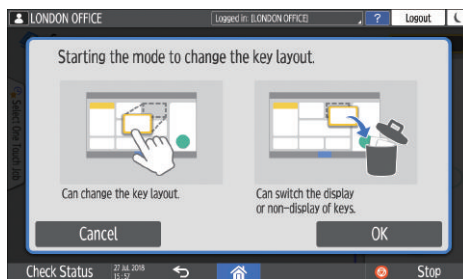

### Changing the key layout

Press and hold the key to move, drag it to the location to display, and then press [OK].

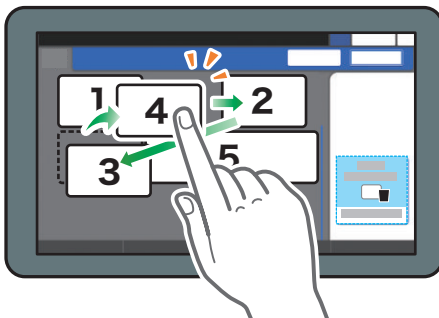

DZX026

### Hiding a key

Press and hold the key to hide, drag it to "Hide the Keys", and then press [OK].

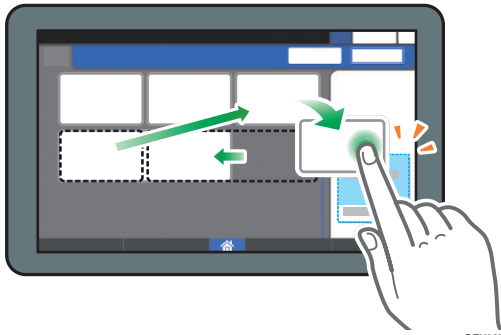

DZX027

### Displaying a hidden key

Press "Hidden Key List" to display the hidden keys. Press and hold the key to display, drag it to the location to display, and then press [OK].

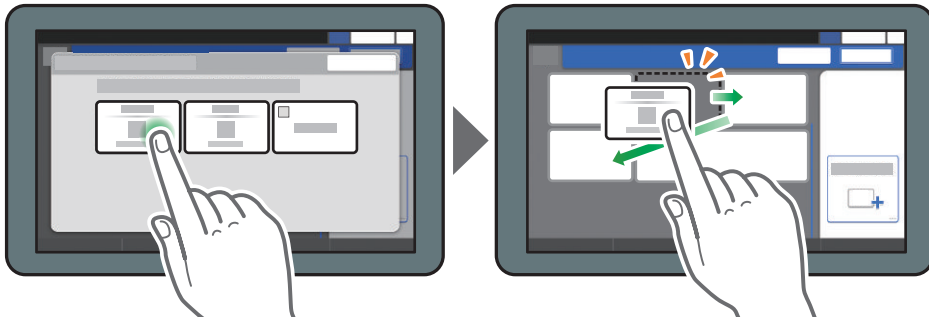

DZX028

### Confirming the initial placement of the keys

Press [Menu]() ► [Screen Settings] ► [Temporarily Restore Initial Key Layout] on the Copy screen. After confirming, press [Back].

### Resetting the key layout to the default

Press [Menu]() ► [Screen Settings] ► [Restore Initial Key Layout] ► [Restore] on the Copy screen.

# How to Use the Fax Screen

There are five kinds of functions and settings on the Fax screen.

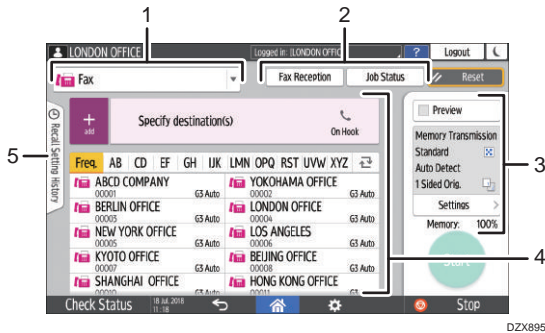

## 1. Destination type selection

Switch the destination type between [Fax] (including IP-Fax) and [Internet Fax]. The items displayed in the address book and destination entry screen for manual entry change also when you switch the destination type.

## 2. Transmission/reception information confirmation

Browse and print the received documents that are stored in the memory or on the hard disk drive of the machine. You can also browse and print the transmission and reception history.

## 3. Transmission settings

You can specify the additional features to use when sending a fax, configure the scan settings appropriately for the original to scan, and display a preview before sending the fax. You can also check the settings that are currently specified and the remaining amount of memory.

## 4. Destination specification

You can select an address registered in the address book through one-touch operation. Press  to specify a destination by using various other methods such as by entering manually or selecting from the history. You can also register a new destination in the address book.

## 5. Job history

Job history of the executed jobs is displayed. When user authentication is set, the job history of each authenticated user is displayed. When you select a job history, the setting will be applied on the current Fax screen. This feature is convenient when you are using the same setting repeatedly.

## Customizing the [Send Settings] Screen

Press and hold a key on the [Send Settings] screen to customize the layout of the keys.

When the administrator has enabled user authentication and User's Own Customization, the screen can be customized for each user.

### Switching to change the key layout mode

Long-press any key and press [OK] on the screen below to switch to the key sorting mode and enable changing of the key layout.

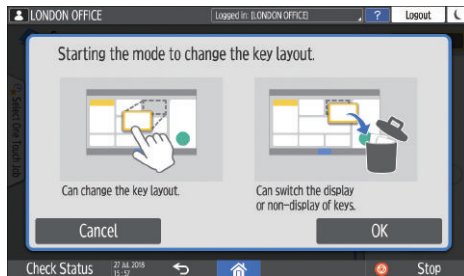

### Changing the key layout

Long-press a key to change the layout, drag it to a new location, and then press [OK].

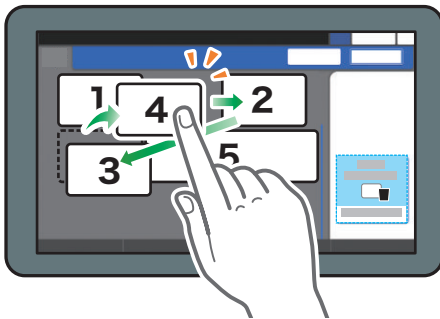

DZX026

### Hiding a key

Long-press a key to hide, drag it to [Hide the Keys] (Trash icon), and then press [OK].

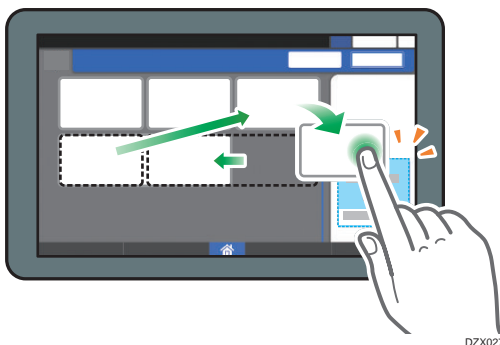

DZX027

### Displaying a hidden key

Press "Hidden Key List" to display the hidden keys. Press and hold the key to display, drag it to the location to display, and then press [OK].

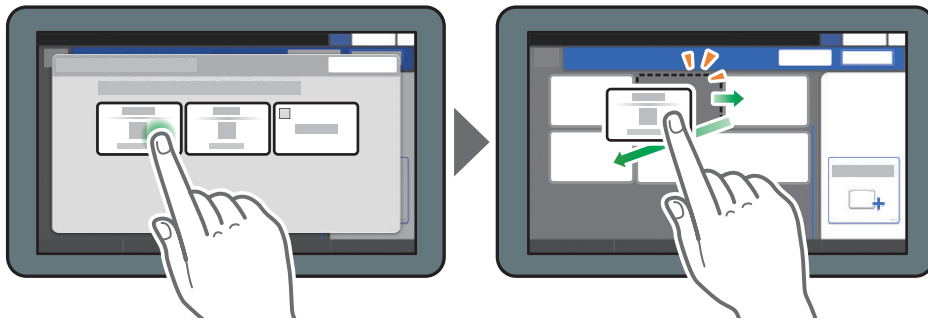

DZX028

### Confirming the initial placement of the keys

Press [Menu] (⚙️) ► [Screen Settings] ► [Temporarily Restore Initial Key Layout] on the Fax screen. After confirming, press [Back].

### Resetting the key layout to the default

Press [Menu] (⚙️) ► [Screen Settings] ► [Restore Initial Key Layout] ► [Restore] on the Fax screen.

# How to Use the Scanner Screen

There are five kinds of functions and settings on the Scanner screen.

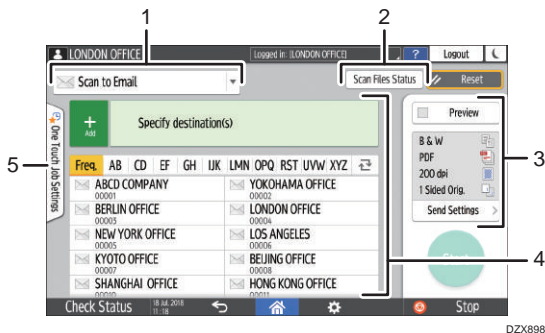

## 1. Destination type selection

You can switch between [Scan to Email] and [Scan to Folder]. The items displayed in the address book and destination entry screen for manual entry also change when you switch the destination type.

## 2. Scan Files Status

You can browse the transmission history of the sent documents and cancel sending of a document waiting in the queue. The transmission file status may not be displayed depending on the security settings.

## 3. Transmission settings

You can specify the scan settings according to the type of document to scan and the purpose of the scanned data, and display a preview before sending the data.

## 4. Destination specification

You can select a destination registered in the address book through one-touch operation. Press  to specify a destination by using various other methods such as by entering manually or selecting from the history. You can also register a new destination in the address book.

## 5. One Touch Job Settings

You can see the preset settings in the machine or the job history. When user authentication is set, the job history of each authenticated user is displayed. When you select a job history, the setting will be applied on the current Scanner screen. This feature is convenient when you are using the same setting repeatedly.

## Customizing the [Send Settings] Screen

Press and hold a key on the [Send Settings] screen to customize the layout of the keys.

When the administrator has enabled user authentication and User's Own Customization, the screen can be customized for each user.

### Switching to change the key layout mode

Long-press any key and press [OK] on the screen below to switch to the key sorting mode and enable changing of the key layout.

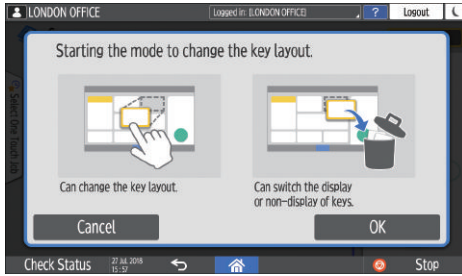

## Changing the key layout

Long-press a key to change the layout, drag it to a new location, and then press [OK].

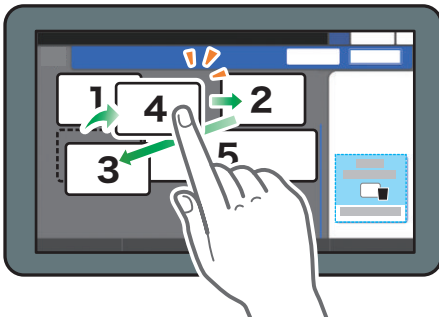

DZX026

## Hiding a key

Long-press a key to hide, drag it to [Hide the Keys] (Trash icon), and then press [OK].

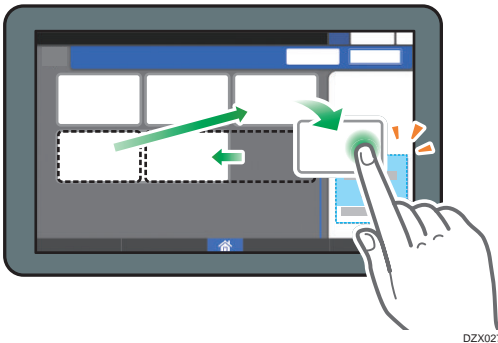

DZX027

## Displaying a hidden key

Press "Hidden Key List" to display the hidden keys. Press and hold the key to display, drag it to the location to display, and then press [OK].

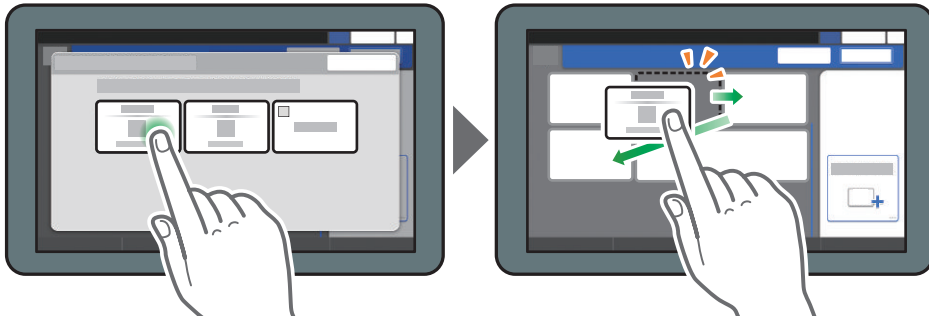

DZX028

### Confirming the initial placement of the keys

Press [Menu] (⚙️) ► [Screen Settings] ► [Temporarily Restore Initial Key Layout] on the Scanner screen. After confirming, press [Back].

### Resetting the key layout to the default

Press [Menu] (⚙️) ► [Screen Settings] ► [Restore Initial Key Layout] ► [Restore] on the Scanner screen.



# Adding a Frequently Used Application or Widget to the Home Screen

You can use a frequently used icon or widget easily by adding it to the Home screen. You can organize the icons on the Home screen as you like by changing their order or using folders.

- Add an icon or widget from the application list screen.
- Each page of the Home screen can display up to 12 icons, widgets or folders, for a total of 60 items. A folder can hold up to 80 icons.
- You can add the following items to the Home screen: shortcuts of bookmarks in the browser on the screen and programs registered in the Copy, Fax or Scanner.



## Note

- You cannot add a shortcut of a program registered by the document server function to the Home screen.
- When you have set user authentication, log in and customize it. Each user can register their own Home screen.
- A shortcut, folder, or widget cannot be created or moved if there is no space on the Home screen. In this case, delete one of the registered items, and then perform the same operation.
- The names of icons and widgets are displayed up to 20 double-byte or 30 single-byte characters. Names composed of 21 or more double-byte characters are displayed with "...", indicating the 20th and later characters.

---

## Adding an Icon/Widget to the Home Screen

---

1. Press the application list icon on the Home screen.

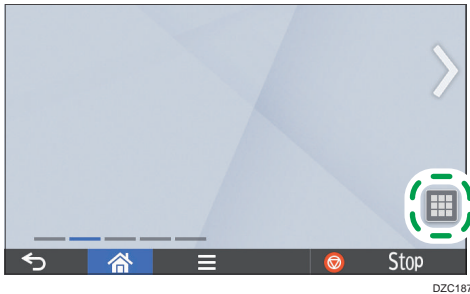

2. Press and hold the icon or widget to be added to the application list screen.



- Select the [WIDGET] tab to add a widget, or select the [PROGRAM] tab to add a program.

3. After the screen changes to the Home screen, move the icon or widget to the desired position and release it.

To add a classic application or program, select the type of application or program from the displayed menu.

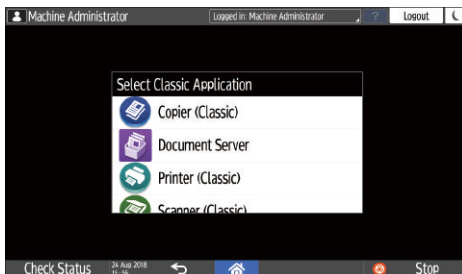

---

## Creating a Folder to Organize Icons

---

1. Press and hold a spot on the Home screen where you want to create a folder.

2. When the "Add to Home Screen" screen is displayed, press [Folder].

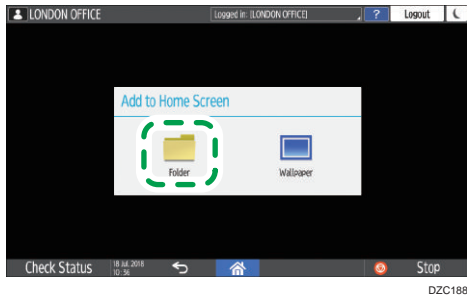

3. Open the created folder, press and hold its title, and then change the folder name.  
You can enter up to 30 characters for a folder name.
4. Drag the icon and release it over the folder.

# Registering Frequently Used Settings as a Program

1

You can register a "program" made of a combination of the functions used in the Copy, Fax, or Scanner, such as the scan setting, output setting, and address.

- You can load the registered program easily from the application screen.

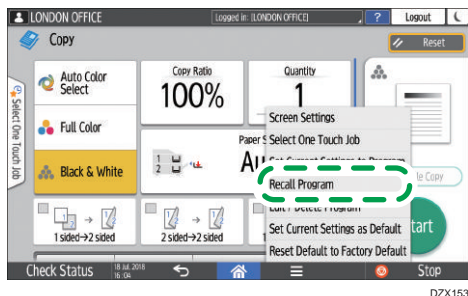

- When you press the icon of a program on the Home screen, the machine applies the settings and performs the function registered in the program automatically.
- You can register the following number of items as programs.
  - Copy: 25 items
  - Fax: 100 items
  - Scanner: 100 items

## Note

- You cannot register the following Touch settings as a program:
  - Copy
    - [Orientation] of [2 Sided/Combine]
  - Fax
    - [Subject], [Sender]
  - Scanner
    - [Sender], [PDF Security Settings], [Start Number]
- You can register a destination on the program of the scanner function only when [Program Setting for Destination] of [Scanner Settings] is set to [Include Destinations].
- "General Settings (Scanner Settings)", User Guide (Full Version)
- See below when [Standard] is specified as the screen type of [Settings]. The names of the setting items may differ from the [Classic] screen type.
- See "Others (Scanner Settings)", User Guide (Full Version).

- For details, see "Settings Menu Compatibility List (Classic to Standard Settings)", User Guide (Full Version).
- When [Program Setting for Destination] of [Scanner Settings] is set to [Exclude Destinations], the destination registered on the recalled program in the scanner function is not displayed.
- A folder destination with a destination protection code cannot be registered on a program of the scanner function.

## Registering Settings as a Program

First, configure the settings to be registered on the Copy, Fax, or Scanner screen, and then register them.

1. On the Home screen, press [Copy], [Fax], or [Scanner].

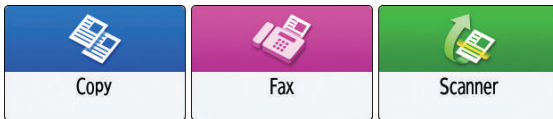

2. Specify scan and output settings to be registered as a program.

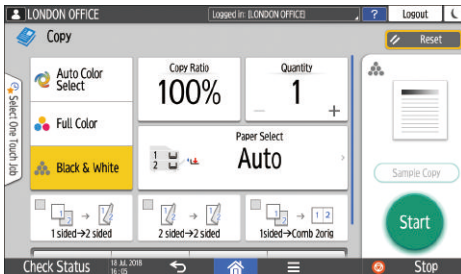

3. Press [Menu] (⚙️).

4. Press [Set Current Settings to Program].

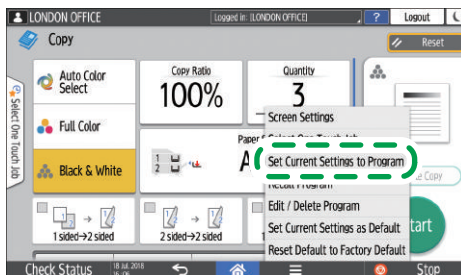

DZX154

5. Press a program number to register the settings.

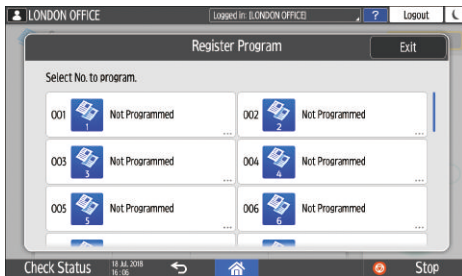

6. Enter a program name and select an icon, and then press [OK].

7. Press [Place].

The selected icon is displayed on the Home screen.

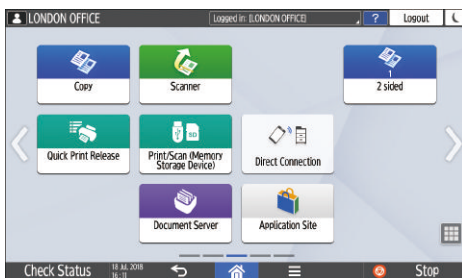

8. Press [Exit].

## Changing the Contents of the Program

You can change a part of the program and overwrite it or change the contents and register them as a new program.

1. On the Home screen, press [Copy], [Fax], or [Scanner].

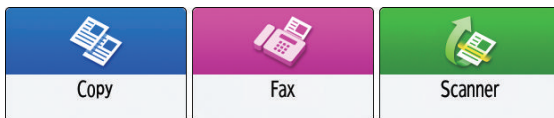

2. Press [Menu] (⚙️), and then press [Recall Program].

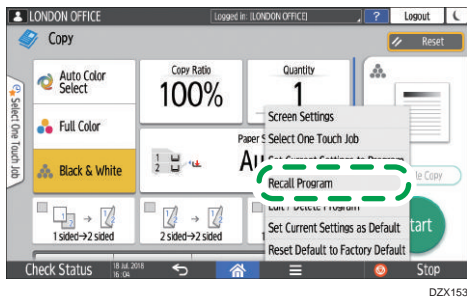

3. Press the program number to be changed.

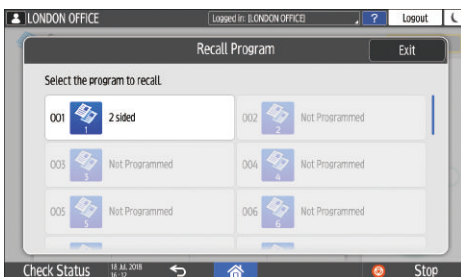

4. Change the scan and output settings.

5. Press [Menu] (⚙️), and then press [Set Current Settings to Program].

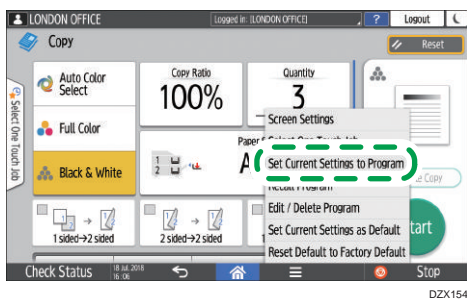

6. Select a program number to register the changed settings.

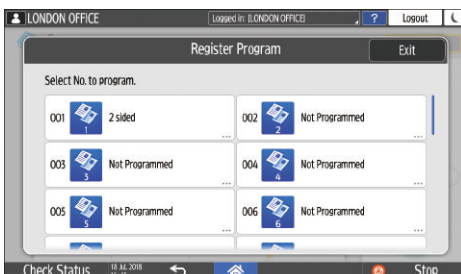

- To overwrite the program, select the number of the loaded program.
- To register the contents as a new program, select a number that is not programmed.

**7. Enter a program name and select an icon.**

**8. Press [OK].**

**Note**

- To change the icon or program name or to delete the program, press [Menu] () and operate from [Edit/Delete Program].



# Logging In from the Control Panel

When the machine is configured by the administrator to restrict use by unauthorized users, you must authenticate your login information before starting the operation.

The authentication methods are described below.

- When Basic Authentication, Windows Authentication, or LDAP Authentication is configured on the machine, enter the user name and password for authentication to log in to the machine before starting operation.

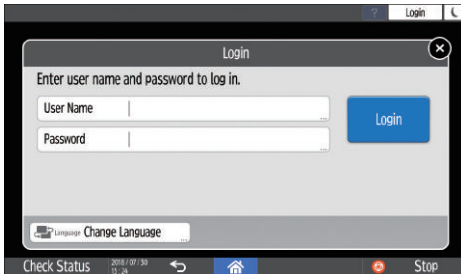

- Depending on the machine settings, you can use an IC card or mobile device for authentication.

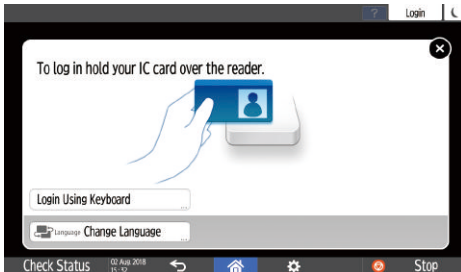

- If user code authentication is specified, you may need to enter the user code to operate the restricted application.

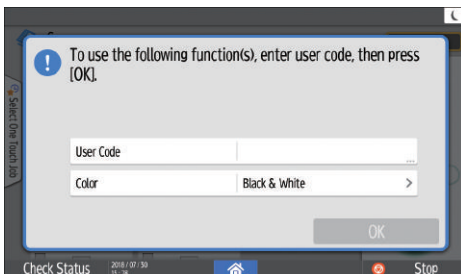

To prevent use of the machine by an unauthorized person, always log out when you have finished using the machine. While a user is logged in, the name of the user is displayed in the system message.

### ↓ Note

- If the machine is not used for a specified period, the user is automatically logged out (Auto Logout). The default setting for Auto Logout is 3 minutes. The period of Auto Logout can be changed by [Auto Logout Timer] of [System Settings] or the Auto Logout setting can be disabled.
- See "Timer Settings", User Guide (Full Version).
- See below when [Standard] is specified as the screen type of [Settings]. The names of the setting items may differ from the [Classic] screen type.
- See "Date/Time/Timer", User Guide (Full Version).
- For details, see "Settings Menu Compatibility List (Classic to Standard Settings)", User Guide (Full Version).
- Ask the administrator for the login user name, login password, and user code.
- See "Verifying Users to Operate the Machine (User Authentication)", User Guide (Full Version).

## Logging In by Entering the User Name and Password

Enter the authentication information using the keyboard displayed on the control panel.

1. Press [Login] at the top right on the screen.

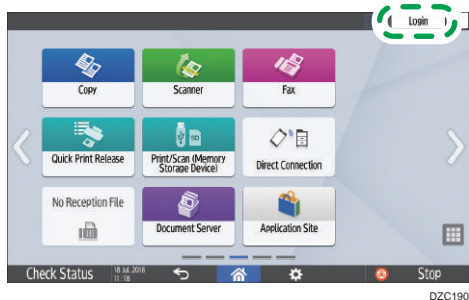

2. Press [User Name].

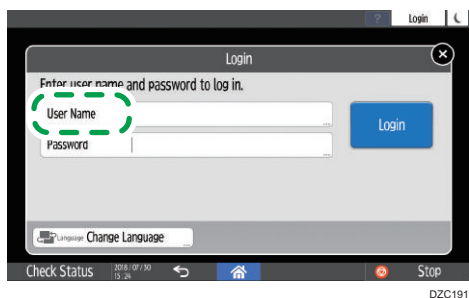

3. Enter the login user name, and then press [Done].
4. Press [Password].

5. Enter the login password, and then press [Done].

6. Press [Login].

### Note

- If an incorrect password is entered a specified number of times, login with the same name is disabled (Lockout Function). The default setting for unsuccessful attempts before a user is locked out is five. If the user is locked out, the administrator must release the lockout.
- To log out from the machine, press [Logout] at the top right on the screen, and then press [Execute].



DZC192

## Logging In Using an IC Card

Hold an IC card over the card reader to the right of the control panel. If the card is not registered on the machine, enter the authentication information and register the card.

1. Hold an IC card over the card reader.

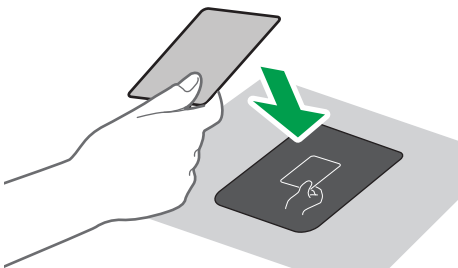

DZB640

- When the card is registered on the machine, login operation finishes.
- When the card is not registered, the registration screen is displayed. Proceed to the next step to register the card.

2. Enter the Login User Name and Login Password, and then press [Register].

3. Hold the IC card over the card reader again.

**Note**

- To log out, hold the IC card over the card reader or press [Logout] at the top right on the screen.
- If another user holds the IC card over the card reader while you are still logged in, you are automatically logged out and the new user logs in.

## Logging In Using a Mobile Device

Log in to the machine using the RICOH Smart Device Connector app on your mobile device. You need a mobile device that supports Bluetooth Low Energy (BLE).

1. **Enable the Bluetooth function on your mobile device.**
2. **Start the RICOH Smart Device Connector application on the mobile device, and then flick left or right to display the login screen.**



3. **Press [NEXT].**

4. Display the login screen on the control panel of the machine, and hold the mobile device over the Bluetooth label.



#### Note

- To log out from the machine, hold the mobile device over the Bluetooth label on the control panel or press [Logout] at the top right on the screen.
- If another user holds a mobile device over the card reader while you are still logged in, you are automatically logged out and the new user logs in.

## Authenticating Using the User Code

When User Code Authentication is specified as the authentication method on the machine, enter the user code before operating an application.

1. Enter the user code, and then press [OK].

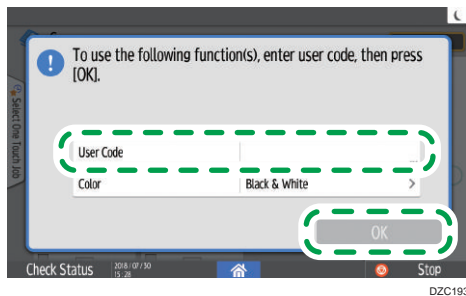

#### Note

- When you finish the operation of the application, press [Energy Save] (⏻) or press and hold [Reset] to release the authentication status.

## Changing the Login Password

When Basic Authentication, Windows Authentication, or LDAP Authentication is configured on the machine, change the password periodically to prevent use of the machine by an unauthorized person.

Passwords can contain the following characters. Make the password difficult to guess.

- Uppercase letters: A to Z (26 characters)
- Lowercase letters: a to z (26 characters)
- Numbers: 0 to 9 (10 characters)
- Symbols: (space) ! " # \$ % & ' ( ) \* + , - . / : ; < = > ? @ [ \ ] ^ \_ ` { | } ~ (33 characters)

1. Log in to the machine.

2. Press [Address Book] on the Home screen.



3. Select the login user from the address book, and then press [Edit].

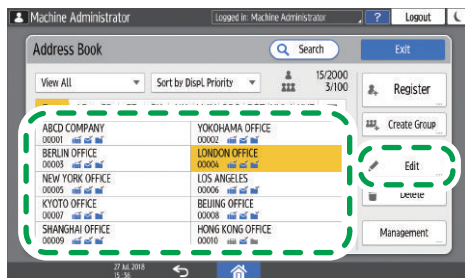

EDN012

The items displayed on the screen vary depending on the version of RICOH Always Current Technology that is implemented on the machine.

4. Press the [User Management / Others] tab ► [User Management].

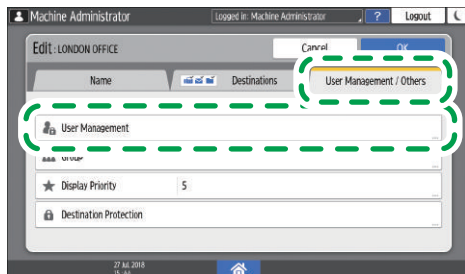

DZX016

5. Enter the new login password, and then press [OK].

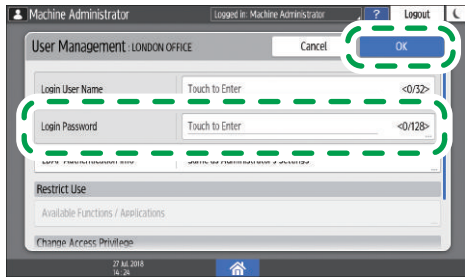

DZX187

You can enter up to 128 characters.

6. Press [Settings].

7. After completing the procedure, press [Home] .

# Placing an Original on the Exposure Glass

Use the exposure glass to scan originals that cannot be placed in the auto document feeder (ADF), such as books and license cards.

## **⚠ CAUTION**

- When lowering the ADF, do not place your hands on the hinges and exposure glass. Your hands or fingers are caught, which can result in injury.

## **★ Important**

- Do not lift the ADF forcefully. The cover of the ADF might open and cause injury. The ADF, or its hinges may also become damaged.

### 1. Lift the ADF.

Lift the ADF by more than 30 degrees to detect the document size automatically when placing an original on the exposure glass.

- ### 2. Place the original face down and aligned to the mark on the upper left corner of the scan area.

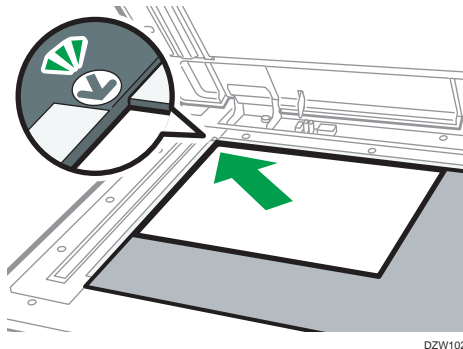

page 212 "Recommended Original Size and Weight"

page 214 "Sizes Detectable with Auto Paper Select"

### 3. Lower the ADF.

## **↓ Note**

- When you place a thick book or three-dimensional original on the exposure glass and lower the ADF, the back side of the ADF rises up to accommodate the original.



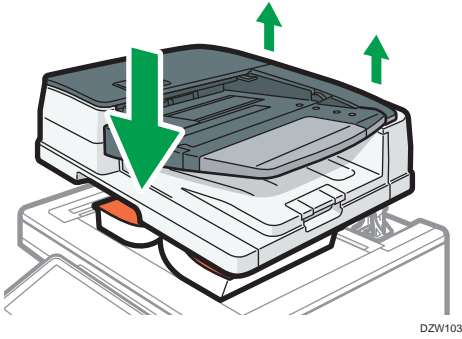

- Do not open or close the ADF with your hands placed in the space between the ADF and exposure glass.

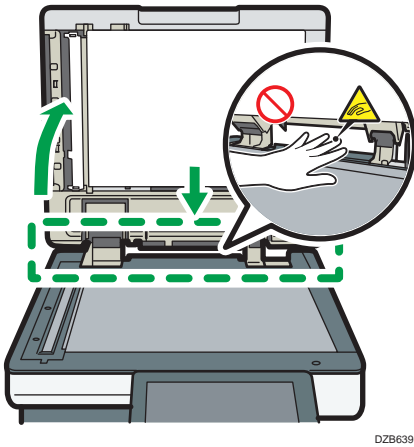

# Placing an Original in the Auto Document Feeder (ADF)

The ADF automatically scans multiple sheets of originals or two-sided originals at one time.

There are two types of ADF as follows:

## Auto Reverse Document Feeder (ARDF)

When scanning a two-sided original, the machine scans the front side of the original first, and then turns it over to scan the back side.

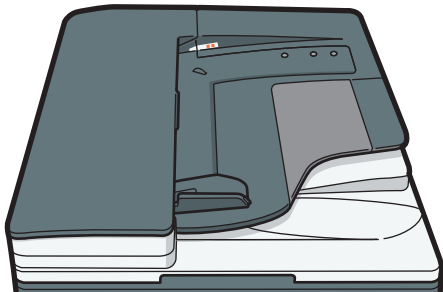

DZW104

## One-pass duplex scanning ADF

When scanning a two-sided original, the machine scans the front and back sides of the two-sided original at one time.

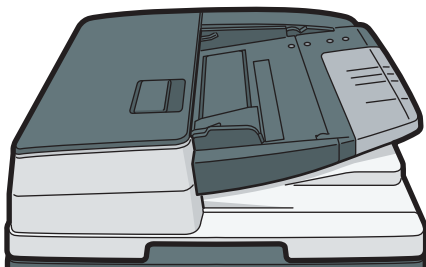

DZW105

- For details about the sizes of originals that you can place in the ADF, see the following:
  - page 212 "Recommended Original Size and Weight"
  - page 214 "Sizes Detectable with Auto Paper Select"
- If the originals described below are placed in the ADF, it may cause misfeeds, white lines, or black lines, or result in damage to the originals. Place these originals on the exposure glass.
  - Stapled or clipped originals

- Perforated or torn originals
  - Curled, folded, or creased originals
  - Pasted originals
  - Originals with adhesive tape, glue or paste stuck to them
  - Originals with any kind of coating, such as thermal paper, art paper, aluminum foil, carbon paper, or conductive paper
  - Originals with perforated lines
  - Originals with indexes, tags, or other projecting parts
  - Sticky originals such as translucent paper
  - Thin or highly flexible originals
  - Thick originals such as postcards
  - Bound originals such as books
  - Transparent originals such as transparencies or translucent paper
- page 58 "Placing an Original on the Exposure Glass"
- When loading an original written by pencil on the ADF, the original may be dirty from by being scraped.
  - Correct an original that tends to curl before setting on the machine.
  - Take care so that multiple originals do not stick to each other and are not fed at once.
  - Do not set an original that is wet with correcting fluid or ink. The scanning glass will be stained and the stain will be scanned with the original.

---

## Placing Originals in the ARDF

---

### ★ Important

- Do not block the sensors with your hand. Be sure to load the originals neatly and do not push them into the ADF forcibly. It may cause paper misfeeds or paper size error.

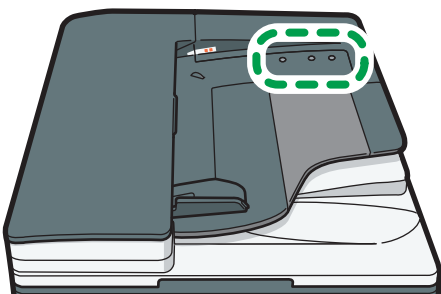

DZW106

**1. Adjust the original guide to the original size.**

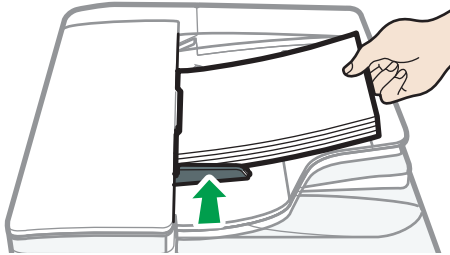

DZW107

**2. Place the aligned originals squarely face up in the ARDF.**

Place the originals with the first page facing up.

Fan sheets before loading so that multiple papers do not stick to each other and are not fed at once.

Do not stack the originals beyond the limit mark.



DZX108

**Note**

- To scan originals larger than B4 or  $8\frac{1}{2} \times 14$  size, raise the ADF's extender on the ADF output tray.

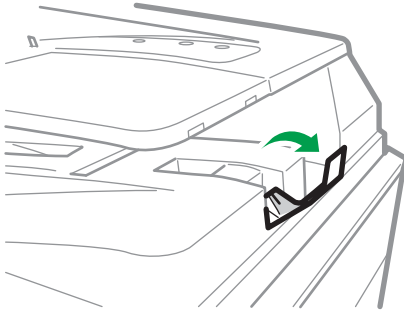

DZW795

- When using the ARDF to scan originals with a paper weight less than  $42 \text{ g/m}^2$  (11 lb. Bond), move the slide tray on the original output tray to the left side. When the slide tray of the Auto Reversible Document Feeder (ARDF) is in the left, the amount of output paper will be low. After scanning a thin original, return the slide tray to the previous position.

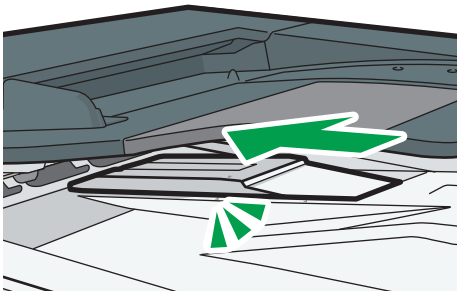

DZW109

## Placing Originals in the One-pass Duplex Scanning ADF

### ★ Important

- Do not block the sensors with your hand. Be sure to load the originals neatly and do not push them into the ADF forcibly. It may cause paper misfeeds or paper size error.

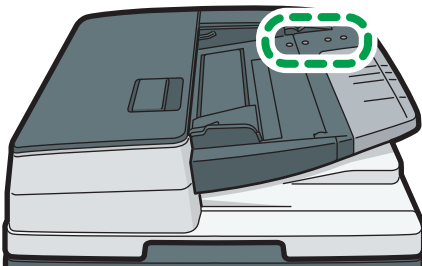

DZW110

**1. Adjust the original guide to the original size.**

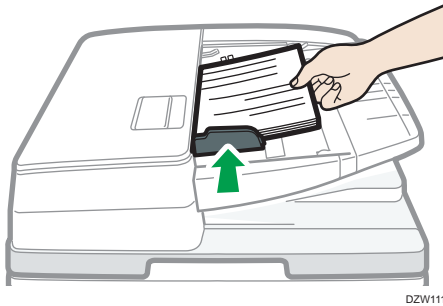

**2. Place the aligned originals squarely face up in the one-pass duplex scanning ADF.**

Place the originals with the first page facing up.

Fan sheets before loading so that multiple papers do not stick to each other and are not fed at once.

Do not stack the originals beyond the limit mark.

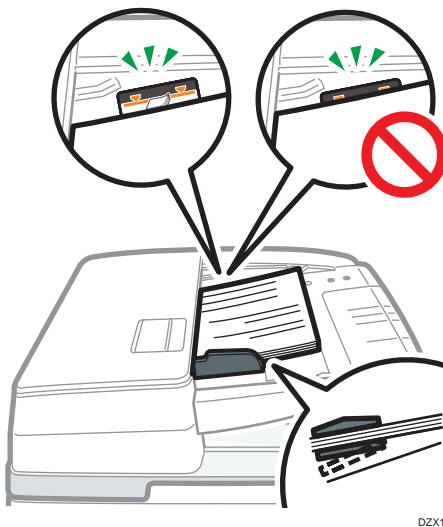

**Note**

- To scan originals larger than B4 or  $8\frac{1}{2} \times 14$  size, pull out the ADF's extender on the original output tray, and then raise the stopper.

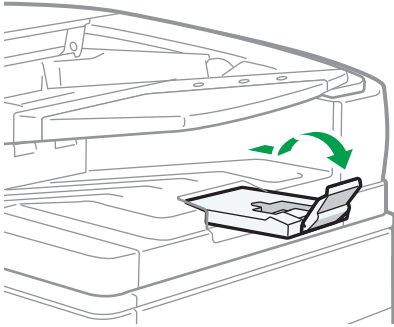

DZW113

- To scan originals that are smaller than A6 size, attach the small size paper unit as follows:
  1. Open the ADF cover.
  2. Engage the two projections of the small size paper unit with the holes on the one-pass duplex scanning ADF.

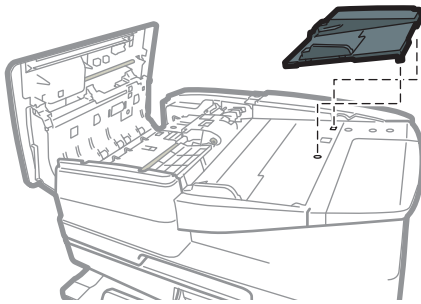

DZW181

3. Close the ADF cover.

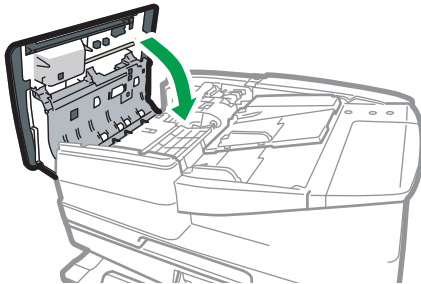

DZW182





## 2. Copy

### Basic Procedure for Copying Documents

Set the original on the exposure glass or auto document feeder (ADF) to make a copy.

#### ★ Important

- If the previous setting is still active, press [Reset] before copying.

1. Press [Copy] on the Home screen.

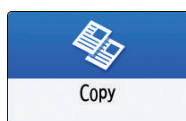

2. Place the original.

See "Placing an Original on the Scanner", User Guide (Full Version).

3. Select the color mode on the Copy screen.

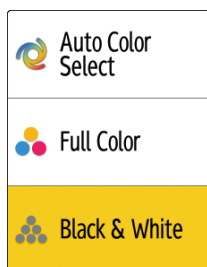

4. Press [+] or [-] in [Quantity] to specify the number of copies.



You can enter this using the keyboard after pressing [Quantity] or a number.

5. Press [Paper Select] and select the paper to use as necessary.



- When you select [Auto Paper Select], the paper suitable for the original is selected automatically. When the orientations of the original and paper in the paper tray do not match, the machine rotates the copied image 90 degrees automatically. However, the copied

image may not be rotated depending on the settings or types of Finishing, staple or punch, for example.

- If the size of the original is not detected properly or when you make a copy on paper of a special size, specify the paper tray in which the paper to use is loaded.

## 6. Press [Start].

- When the [Check the orientation of the original every time after pressing Start] check box is selected in [Select the original's orientation], the screen below is displayed. Select the original orientation as necessary. If you do not need to select this each time, clear the check box.

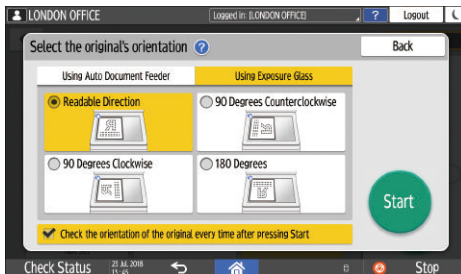

- When you place the original on the ADF, the process of copying the original starts.
- When you place the original on the exposure glass, the copy process starts according to the setting contents. To make a copy of the second page or back side of the original, place the original accordingly on the exposure glass, and then press [Start]. Press [Finish Scn] after scanning all originals if necessary according to the setting contents.

### ↓ Note

- Originals scanned when no paper is loaded or when an error has occurred will be copied automatically when the machine is ready to execute copying.

## Reserving a Copy Job While Executing Another Copy Job

When [Reserve] is displayed on the execution screen of the current copy job, you can scan the original of another copy job to execute after the current job is completed (Job Preset).

You can make reservations for up to eight jobs each in the Copier and Document Server functions.

### ★ Important

- This function is available on machines implemented with RICOH Always Current Technology v1.1 or later.

### 1. Press [Reserve] on the execution screen of a copy job.

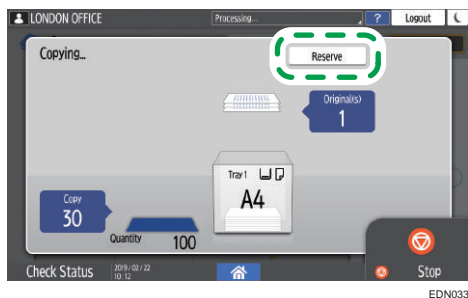

2

### 2. Place a new original to scan on the machine.

See "Placing an Original on the Scanner", User Guide (Full Version).

### 3. Specify 2 sided, Combine, Sort, and other copy settings if necessary.

page 76 "Duplex Copying"

page 79 "Combining and Copying a Multi-page Original onto a Single Sheet of Paper"

page 85 "Copying in Page Order or for Each Page Number"

### 4. Press [Reserve Start].

The machine starts scanning the placed original.

After the current copy job is completed, the reserved copy job starts automatically.

#### ↓ Note

- To display the Job Confirmation screen, press [Job Confirmation]. You can delete the reserved job or view the preview image on the screen.

# Making Enlarged or Reduced Copies

You can enlarge or reduce the original when copying with the following methods:

- Enlarging or reducing at a specified reduction ratio or into a specified size (Zoom/Reduce/Enlarge/Size Magnification)
- Enlarging or reducing according to the paper size (Auto Reduce/Enlarge)
- Reducing slightly (Create Margin)

## Specifying a Copy Ratio or Size

1. Press [Copy] on the Home screen.

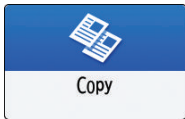

2. Place the original.

See "Placing an Original on the Scanner", User Guide (Full Version).

The base point of reduce/enlarge is different for the exposure glass and Auto Document Feeder (ADF) as shown in the following table:

Setting position	Base point	Enlarge	Reduce
Exposure glass	<p>Enlarged or reduced from the top left.</p> <p>DZB222</p>	<p>DZB224</p>	<p>DZB225</p>
Auto document feeder (ADF)	<p>Enlarged or reduced from the bottom left</p> <p>DZB223</p>	<p>DZB224</p>	<p>DZB225</p>

When you set a 2-sided original in the One-pass duplex scanning ADF, the top right corner of the original will be the base point for the enlargement/reduction of the reverse side. To enlarge or reduce from the same point, set the original on the exposure glass and perform 2-sided copy.

### 3. Press [Copy Ratio] and select a copy ratio or size.



To specify a copy ratio or size other than the displayed setting, press [Others] and perform the following procedure.

#### Specifying a copy ratio (Zoom/Reduce/Enlarge)

Enter a value or select the copy ratio.

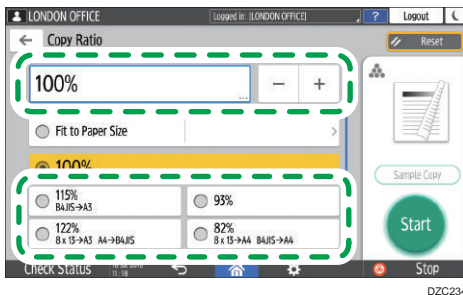

DZC234

#### Specifying a size (Size Magnification)

Press [Specify Copy Size] and enter the length of the original and copied image.

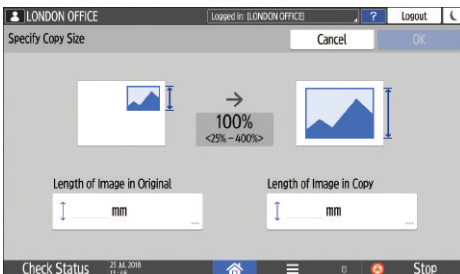

### 4. Press [Start].

#### Note

- You can change the options of the copy ratio that is displayed on the Copy screen when pressing [Copy Ratio]. You can also change the enlargement and reduction ratios that appear when [Copy Ratio] ► [Others] is pressed on the Copy screen.

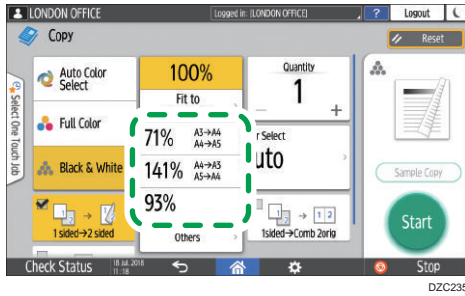

- See "Reproduction Ratio", User Guide (Full Version).
- See below when [Standard] is specified as the screen type of [Settings]. The names of the setting items may differ from the [Classic] screen type.
- See "Reduce / Enlarge", User Guide (Full Version).
- For details, see "Settings Menu Compatibility List (Classic to Standard Settings)", User Guide (Full Version).

## Enlarging or Reducing According to the Paper Size

The original is enlarged or reduced to fit on the specified paper size (Scale to Paper Size)

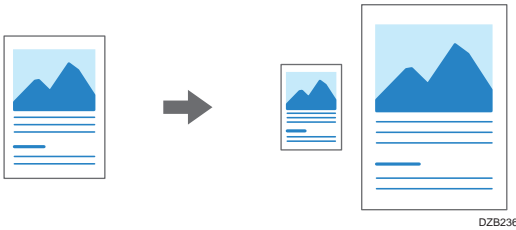

The document sizes that can be detected automatically are shown in the table below. To copy a document whose size is not listed in the table, specify [Original Size] on the Copy screen.

### Region A (mainly Europe and Asia)

Original size	A3	B4 JIS	A4	B5 JIS	A5	B6 JIS	11 × 17	8 <sup>1</sup> / <sub>2</sub> × 11	8 <sup>1</sup> / <sub>2</sub> × 13
Exposure glass	✓	✓	✓	✓	✓*1	-	-	-	-
ADF	✓	✓	✓	✓	✓	✓	✓	✓	✓

\*1 Portrait orientation (📄) only

Region **B** (mainly North America)

Original size	11 × 17	8 <sup>1</sup> / <sub>2</sub> × 14	8 <sup>1</sup> / <sub>2</sub> × 13 <sup>2</sup> / <sub>5</sub>	8 <sup>1</sup> / <sub>2</sub> × 11	5 <sup>1</sup> / <sub>2</sub> × 8 <sup>1</sup> / <sub>2</sub>	10 × 14	7 <sup>1</sup> / <sub>4</sub> × 10 <sup>1</sup> / <sub>2</sub>	A3	A4
Exposure glass	✓	✓	✓	✓	✓	-	-	-	-
ADF	✓	✓	✓	✓	✓	✓	✓	✓	✓

1. Press [Copy] on the Home screen.

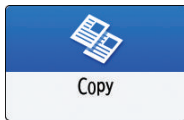

2. Place the original.

See "Placing an Original on the Scanner", User Guide (Full Version).

3. On the Copy screen, press [Copy Ratio] and [Fit to Paper Size].

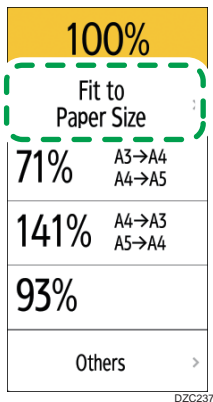

4. Select the tray loaded with the paper to use.

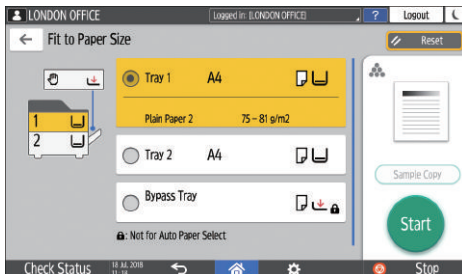

When the orientations of the original and paper in the paper tray do not match, the machine rotates the copied image automatically. To reduce an original of A3 (11 × 17) size to A4 (8½ × 11) size, for example, you can select either A4 (8½ × 11) or A4 (8½ × 11).

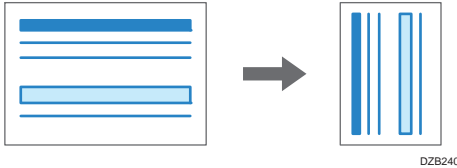

### 5. Press [Start].

## Reducing Slightly to Increase the Margins

The original is reduced to 93% in size and printed in the center of the paper. This setting is useful if you want to copy an original to a paper of the same size without the edges being slightly cropped when copied in full size or to increase the margins.

### 1. Press [Copy] on the Home screen.

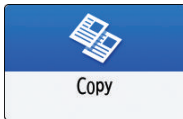

### 2. Place the original.

See "Placing an Original on the Scanner", User Guide (Full Version).

### 3. On the Copy screen, press [Create Margin].



- If the key is not displayed, register [Create Margin], by using [Customize Function: Copy (Standard Mode)] or [Customize Function: Copy (All View Mode)].
- See "General Features (Copier / Document Server Settings)", User Guide (Full Version).
- See below when [Standard] is specified as the screen type of [Settings]. The names of the setting items may differ from the [Classic] screen type.

See "Others (Copier / Document Server Settings)", User Guide (Full Version).

For details, see "Settings Menu Compatibility List (Classic to Standard Settings)", User Guide (Full Version).

### 4. Press [Start].

#### ↓ Note

- You can change the copy ratio of [Create Margin] to a value other than 93%.



- See "Reproduction Ratio", User Guide (Full Version).
- See below when [Standard] is specified as the screen type of [Settings]. The names of the setting items may differ from the [Classic] screen type.
- See "Reduce / Enlarge", User Guide (Full Version).
- For details, see "Settings Menu Compatibility List (Classic to Standard Settings)", User Guide (Full Version).

# Duplex Copying

You can copy two 1-sided pages or one 2-sided page onto the front and back sides of a single sheet of paper.

2

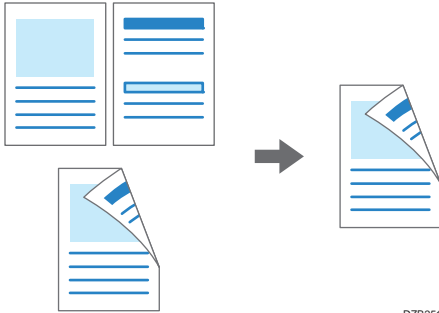

DZB251

The size of the original that can be copied differs from that of the 1-sided copy. page 212 "Recommended Original Size and Weight"

1. Press [Copy] on the Home screen.

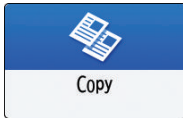

2. Press [1 Sided→2 Sided] or [2 Sided→2 Sided] on the Copy screen.



### Duplex Copying with the Settings Other Than Those Displayed on the Keys

1. Press [2Sd/Comb/Series].
2. Press [2 Sided/Combine].

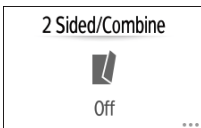

3. Specify the original and print side settings.

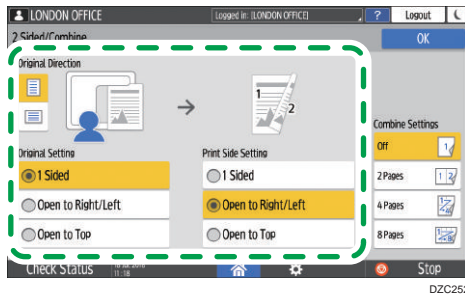

- Original Direction: Specify the orientation to place the originals.
- Original Setting: Specify the condition of the originals to copy (1 sided/2 sided (Page Opening Direction)).
- Print Side Setting: Select the finish from [Open to Right/Left] or [Open to Top].

4. Press [OK].

### 3. Place the original.

See "Placing an Original on the Scanner", User Guide (Full Version).

### 4. Press [Start].

- When placing the originals on the exposure glass, press [Finish Scn] after scanning all of the originals if necessary according to the setting contents and number of originals.

#### ↓ Note

- You can specify the margins when copying a 1-sided original onto both sides of paper.
- See "Edit", User Guide (Full Version).
- See below when [Standard] is specified as the screen type of [Settings]. The names of the setting items may differ from the [Classic] screen type.
- See "Edit / Stamp", User Guide (Full Version).
- For details, see "Settings Menu Compatibility List (Classic to Standard Settings)", User Guide (Full Version).
- You cannot perform Duplex Copy onto the following paper types:
  - Translucent paper
  - Label paper (adhesive labels)
  - Transparency
  - Envelopes
  - Coated paper
- You can change the setting contents of the two-sided copy key on the Copy screen.
- See "General Features (Copier / Document Server Settings)", User Guide (Full Version).









- See below when [Standard] is specified as the screen type of [Settings]. The names of the setting items may differ from the [Classic] screen type.
- See "Others (Copier / Document Server Settings)", User Guide (Full Version).
- For details, see "Settings Menu Compatibility List (Classic to Standard Settings)", User Guide (Full Version).
- Use the [Series] function to copy the front and back sides of a two-sided original onto one side of a sheet page by page.
- See "Copying Facing Pages of a Book Type Original or Two-sided Original", User Guide (Full Version).

# Combining and Copying a Multi-page Original onto a Single Sheet of Paper

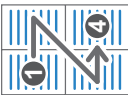
You can copy multiple sheets in an original onto one side or both sides of a sheet of paper to save paper.



The arrangement of copied pages and copy ratio varies depending on the original orientation and combined pages.

Original Orientation	Combine 2 pages	Combine 4 pages	Combine 8 pages
 <p>DZB254</p>	 <p>DZB256</p>	 <p>DZB257</p>	 <p>DZB258</p>
 <p>DZB255</p>	 <p>DZB259</p>	 <p>DZB260</p>	 <p>DZB261</p>

1. Press [Copy] on the Home screen.

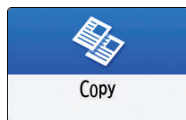

2. On the Copy screen, press [1 sided → Comb 2orig].

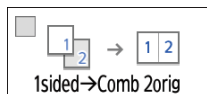

To combine with the settings other than those displayed on the keys

1. Press [2Sd/Comb/Series].
2. Press [2 Sided/Combine].

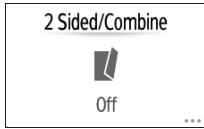

3. Specify about the original, print side, and combining.

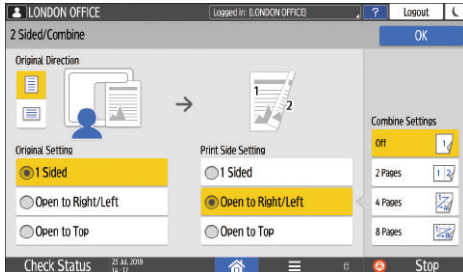

- Original Direction: Specify the orientation to place the originals.
- Original Setting: Specify the condition of the originals to copy (1 sided/2 sided (Page Opening Direction)).
- Print Side Setting: Specify the condition of the copied sheet (1 sided/2 sided (Page Opening Direction)).
- Combine Settings: Specify the number of pages to combine on one side of a sheet.

3. Press [Paper Select] and select the paper to copy onto.



4. Place an original.

See "Placing an Original on the Scanner", User Guide (Full Version).

To position the right-page first and then the left page when copying an original written longitudinally, place the original upside down in the ADF.

Example: Combining 2 Pages

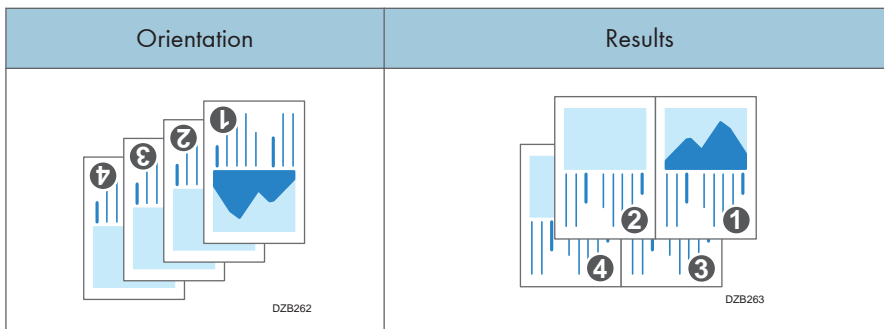

## 5. Press [Start].

When placing the originals on the exposure glass, press [Finish Scn] after scanning all of the originals if necessary according to the number of originals.

### ↓ Note

- The minimum copy ratio in the Combine function is 25%. For example, if you copy an A3 (11 × 17)-size original onto A4 (8<sup>1</sup>/<sub>2</sub> × 11)-size paper with [1 sided → Comb 4orig], the copy ratio becomes less than 25% and parts of the image might not be copied.
  - [Erase Original Shadow in Combine]: Determine whether to erase the boundary margin around each original to maintain the margin
  - [Copy Order in Combine]: The order of combined images
  - [Separation Line in Combine]: The separation line between combined pages  
See "Edit", User Guide (Full Version).
  - See below when [Standard] is specified as the screen type of [Settings]. The names of the setting items may differ from the [Classic] screen type.  
See "2 Sided / Combine", User Guide (Full Version).  
For details, see "Settings Menu Compatibility List (Classic to Standard Settings)", User Guide (Full Version).
- You can change the setting contents of the Combine key on the Copy screen.
- See "General Features (Copier / Document Server Settings)", User Guide (Full Version).
- See below when [Standard] is specified as the screen type of [Settings]. The names of the setting items may differ from the [Classic] screen type.
- See "Others (Copier / Document Server Settings)", User Guide (Full Version).
- For details, see "Settings Menu Compatibility List (Classic to Standard Settings)", User Guide (Full Version).

# Copying Onto Envelopes

To copy onto envelopes that are not usually used, set them in the bypass tray. If you copy onto envelopes frequently, set them in the paper tray.

## Copying Onto Envelopes in the Bypass Tray

### ★ Important

- The Duplex Copy function cannot be used for envelopes. If Duplex Copy is specified, press the [Reset] key to cancel the setting.

1. Press [Copy] on the Home screen.

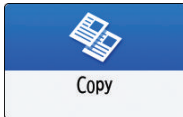

2. Set the envelope in the bypass tray with the copying side face down.

page 206 "Envelope Orientation and Recommended Status"

The "Bypass Tray Paper Settings" screen is displayed.

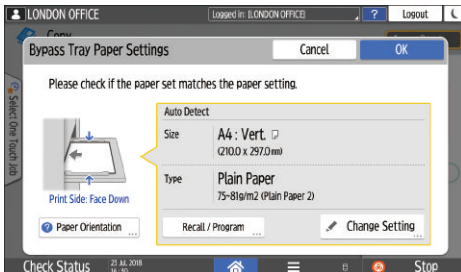

3. Press [Change Setting].

When envelopes are set in the bypass tray, the type and size are not detected automatically. Specify the type and size of the paper manually.

4. Select [Envelope], and then proceed to the next screen.

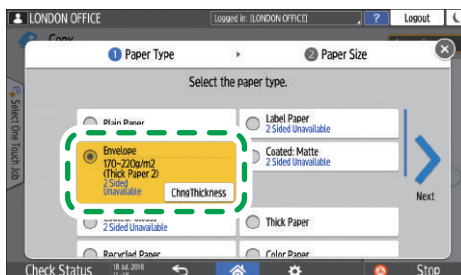

DZC265



To change the envelope weight, press [ChngThickness] to specify the weight.

5. Check that the selected envelope size is correct, and then press [OK].

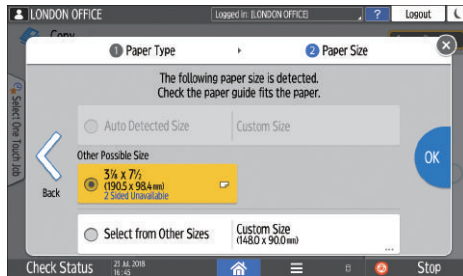

- If the selected envelope size is not the same as the actual size, select the correct envelope size.
- When you select [Custom Size], enter the envelope size. When the envelope is set with the flap opened, be sure to include the width of the flap.

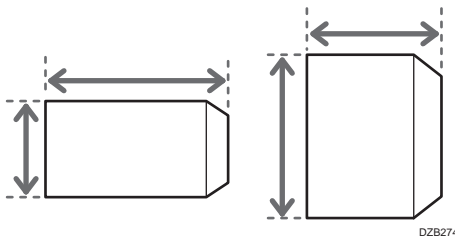

6. Place the original on the exposure glass.

page 206 "Envelope Orientation and Recommended Status"

7. Press [Start].

## Copying Onto Envelopes in the Paper Tray

### ★ Important

- The Duplex Copy function cannot be used for envelopes. If Duplex Copy is specified, press the [Reset] key to cancel the setting.

1. Set the envelopes in the paper tray

page 206 "Envelope Orientation and Recommended Status"

2. Press [Copy] on the Home screen.

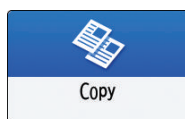

3. Press [Paper Select] on the Copy screen.



4. Select the paper tray in which the envelopes are set.

2

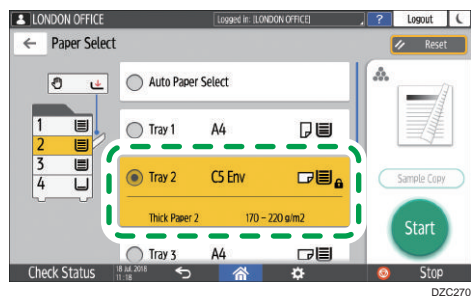

5. Place the original on the exposure glass.  
page 206 "Envelope Orientation and Recommended Status"
6. Press [Start].

# Copying in Page Order or for Each Page Number

When copying two or more copies of multi-page originals, you can specify the page order as described below.

## Sort

Copies in the order of the original.

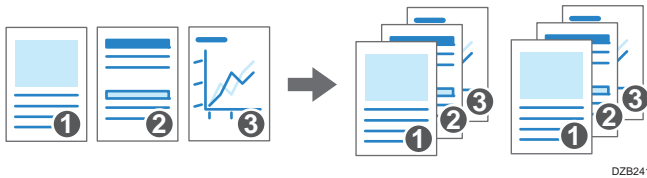

## Stack

Groups together copies of each page in a multi-page original.

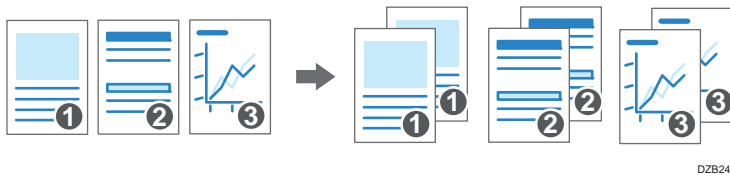

## Rotate Sort

Copies in the order of the original and outputs by rotating each copy set. Each copy set is output lengthwise and breadthwise alternately to identify each set.

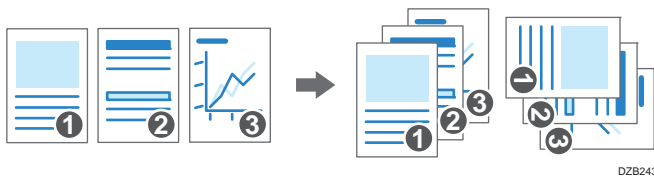

To specify rotate sort, use two paper trays and set the same size and type of paper in the trays in different orientations, vertically () and horizontally (). When the paper cannot be set in vertical () orientation, you cannot specify Rotate Sort.

### ★ Important

- An optional unit such as the shift tray or finisher is required to use this function.
- page 374 "Functions Requiring Optional Configurations"

### 1. Press [Copy] on the Home screen.

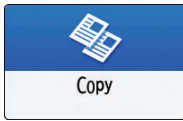

### 2. Place the original.

See "Placing an Original on the Scanner", User Guide (Full Version).

### 3. Press [Sort/Stack] on the Copy screen.



If the key is not displayed, select it from [Finishing].

If the optional equipment that can stack the copied sheets is not attached to the machine, only [Sort] is displayed on the key.

### 4. Select the function to specify.

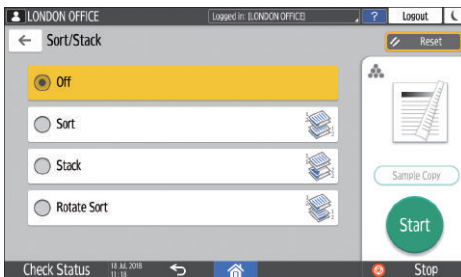

### 5. Press [Start].

- When selecting [Sort] or [Rotate Sort] and placing an original on the exposure glass, a single set of copies is made. After scanning all of the originals, press [Finish Scn] to copy the rest of the sets.

#### Note

- If you specify sort or stack with the finisher or internal shift tray installed, the output sheets will be shifted by each set.
- You can change the action to perform when paper or memory runs out during sorting under [Rotate Sort: Auto Paper Continue] or [Memory Full Auto Scan Restart].
- See "Input / Output", User Guide (Full Version).
- See below when [Standard] is specified as the screen type of [Settings]. The names of the setting items may differ from the [Classic] screen type.
- See "Finishing", User Guide (Full Version).

- For details, see "Settings Menu Compatibility List (Classic to Standard Settings)", User Guide (Full Version).



# 3. Fax

## Basic Procedure for Transmitting Faxes

The machine scans an original to transmit it by fax into the machine's memory before establishing a communication with the destination (Memory Transmission).

You can also transmit a fax while confirming the status of the fax destination.

See "Sending a Fax While Scanning the Original", User Guide (Full Version).

1. Press [Fax] on the Home screen.

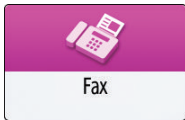

2. Check that [Fax] and [Memory Transmission] are displayed on the fax screen.

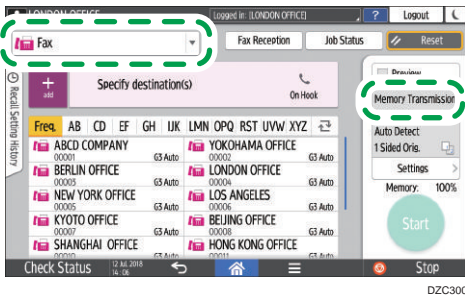

3. Place the original in the ADF or on the exposure glass.

See "Setting an Original to Send by Fax on the Scanner", User Guide (Full Version).

4. Press [Settings], and then specify the scan settings.

See "Sending a Fax at the Image Quality Suitable for the Original", User Guide (Full Version).

5. Specify the destination.

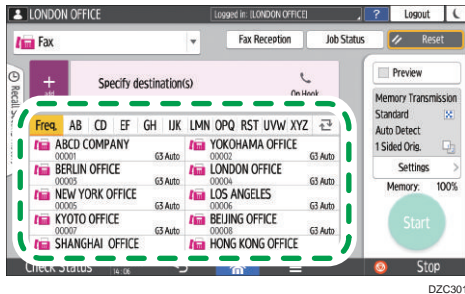

- To enter the fax number manually, select the destination from the destination history, or search for the destination in the address book, press , and specify the destination.

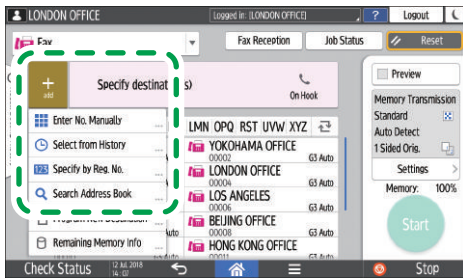

DZC302

You can select only the destination entered using the numeric keypad from the history.

- To specify the destination again, press **3**.

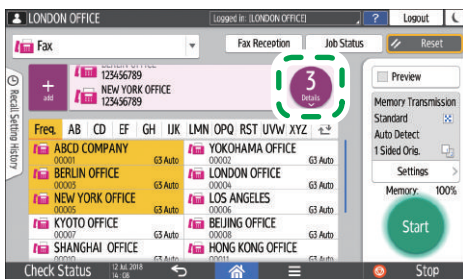

DZC303

## 6. On the [Settings] screen, specify the [Sender] as necessary.

- When a login user is operating the machine, the login user becomes the sender.  
To receive a transmission result by e-mail, select [Email Transmission Results]. The e-mail address that you selected the [Register as both a destination and a sender] check box when registering the address will be used as the e-mail address of the sender.  
See "Registering E-mail Addresses in the Address Book", User Guide (Full Version).
- To print the sender's name on the page received at the destination, select [Stamp Sender Name].

## 7. Press [Start].

To cancel transmission after scanning the original, press [Stop] and operate in [Job Status] ► [Transmission Standby File].

See "Confirming and Handling a Document in the Fax Queue", User Guide (Full Version).

### ↓ Note

- If the telephone line you are connected to requires time to connect to the public line after you dial the external number, enter a [Pause] after entering the number to specify the time to wait before dialing the number. The machine pauses for about two seconds for each single [Pause] entered.
- To use tone-dialing in a pulse-dialing environment, press [Tone]. A tone signal is generated for every number you enter afterward.



- You can perform Immediate transmission only when the total number of destinations specified for all documents exceeds the maximum value.
- The communication that has been initiated first is displayed on the screen when performing three simultaneous communications.

# Registering Fax Numbers in the Address Book

By registering the destinations to which you frequently send faxes together with the send conditions in the address book, you can easily send faxes.

## Registering a Fax Number and Send Conditions

3

1. Press [Address Book] on the Home screen.

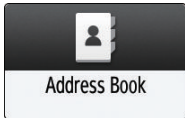

2. Press [Register] on the Address Book screen.

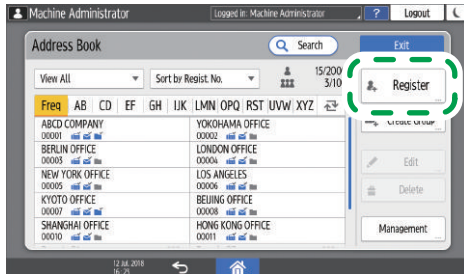

EDN022

The items displayed on the screen vary depending on the version of RICOH Always Current Technology that is implemented on the machine.

3. Enter the information of the destination on the [Name] tab, and then select a title to classify it.

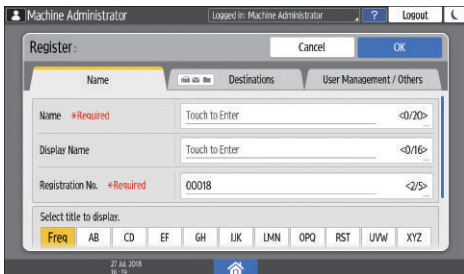

4. Press [Destinations] tab ▶ [Fax].

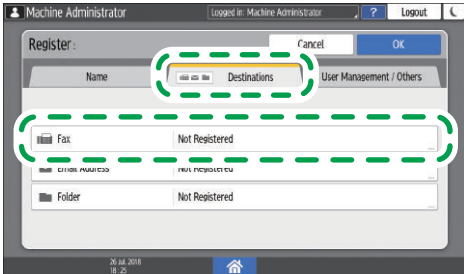

DZC135

5. Specify the Fax Destinations and send conditions.

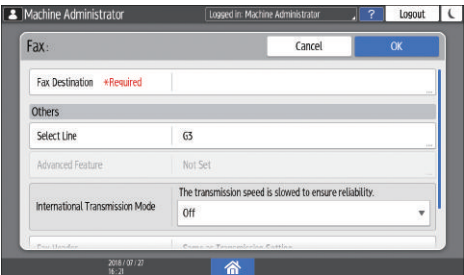

- Select Line: Select the line to use.
- International Transmission Mode: Specify whether to reduce errors occurring when sending abroad.
- Fax Header: Select the name of the sender printed on the reception sheet of the destination. Register the fax header in advance.

See "Printing the Destination Name, Fax Header, and Standard Message on the Fax Received at the Destination", User Guide (Full Version).

- Label Insertion: Specify the name (title + name) and fixed phrase printed on the reception sheet of the destination.

See "Printing the Destination Name, Fax Header, and Standard Message on the Fax Received at the Destination", User Guide (Full Version).

6. Press the [User Management / Others] tab, and specify the required settings.

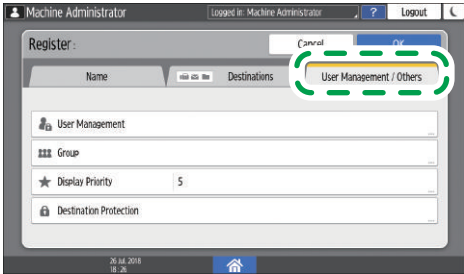

DZC131

- User Management: Enter the authentication information to login and use the machine.
- Registration Destination Group: Select a group to which this destination belongs as necessary. Register the group in advance.

See "Registering Groups in the Address Book", User Guide (Full Version).

- Display Priority: When the destinations are sorted in the order of priority, a destination with higher priority is displayed prior to that with lower priority. The destinations with the same priority are displayed in the order of registration.
- Destination Protection: Select this check box to require entering of the protection code to select the destination.

See "Using the Protection Function to Prevent the Misuse of Addresses", User Guide (Full Version).

7. Press [OK].

8. After completing the procedure, press [Home] (🏠).

## Changing/Deleting the Registered Data Such as Fax Number

If you delete the destination used for the personal box, file transmission will fail. Exclude the destination from the personal box before deleting it.

1. Press [Address Book] on the Home screen.

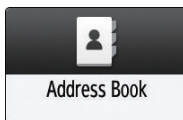

2. Select the destination to change or delete on the Address Book screen.

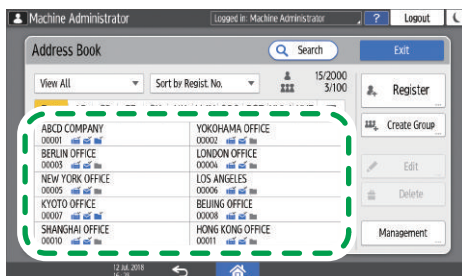

EDN013

The items displayed on the screen vary depending on the version of RICOH Always Current Technology that is implemented on the machine.

You can delete multiple destinations at one time.

3. Press [Edit] or [Delete] to change or delete the destination information.

4. When changing or deleting is complete, press [Home] (🏠).

# Displaying a Preview before Sending a Fax

You can display the preview of the scanned document on the display of the machine to check if it is scanned as specified.

This function cannot be used when sending a fax while using any of the following:

- Immediate Transmission
- On-hook dialing
- Manual dialing

To display the preview in the correct orientation, specify the [Original Orientation] in [Settings] correctly.

## 1. Press [Fax] on the Home screen.

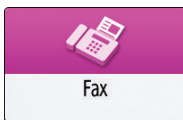

## 2. Place the original in the Auto Document Feeder (ADF) or on the exposure glass.

See "Setting an Original to Send by Fax on the Scanner", User Guide (Full Version).

## 3. On the fax screen, press [Settings] ► [Original Orientation] to specify the orientation of the original, and then press [Preview].

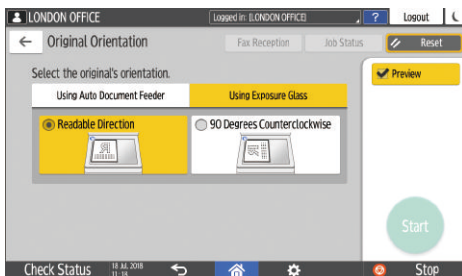

## 4. Configure the scan settings.

See "Sending a Fax at the Image Quality Suitable for the Original", User Guide (Full Version).

## 5. Specify the destination on the fax screen, and then press [Start].

## 6. Check the preview.

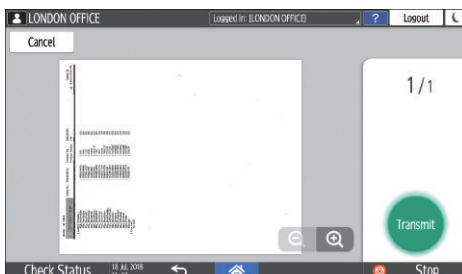

- Flick the image left or right to switch between the pages.
- Pinch in or out on the image to zoom in or out.

**7. Press [Transmit].**

To cancel transmission and perform the procedure from scanning the original again, press [Cancel].

# Viewing the Transmission Result of Sent Faxes

You can check the result of a fax transmission on the fax screen, in various reports, or on the screen of a computer.

The following reports are printed according to the transmission result or the settings:

- Communication Result Report: The result of Memory Transmission is printed.
- Immediate TX Result Report: The result of Immediate Transmission is printed.
- Communication Failure Report: This report is printed when a fax could not be sent to all specified destinations by Memory Transmission.
- Error Report: This report is printed when sending a fax by Immediate Transmission failed.
- Memory Storage Report: This report is printed when the scanned document could not be stored in the memory.

## Note

- The fax transmission results can also be confirmed in Records.
- See "Viewing the History of Sent and Received Faxes", User Guide (Full Version).
- Specify [Notification of Results] when sending a fax to receive the transmission result by e-mail.
- See "Checking by E-mail", User Guide (Full Version).

## Confirming the Information on the Fax Screen

Press [Job Status] ► [Transmission File Status] on the fax screen to view the information.

1. Press [Fax] on the Home screen.

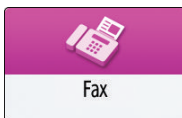

2. Press [Job Status] on the fax screen.

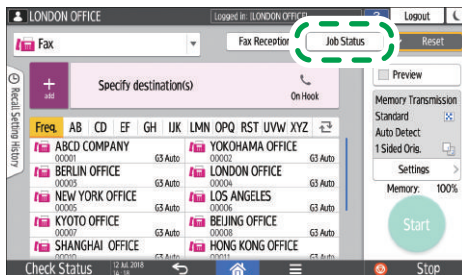

D2C304

### 3. Press [Transmission Result], and select the transmission result to display.

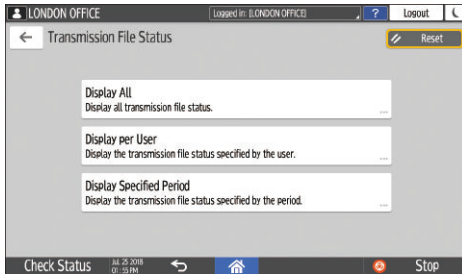

- **Display All**  
Displays the transmission results from among the total number of both transmission and reception results, which cannot exceed 1,000.
- **Display per User**  
Press this to display the result of transmissions performed by a specific user. Select the user to display the results and press [Display].
- **Display Specified Period**  
Press this to display the result of transmissions performed in the specified period. Specify the period by entering the start and end dates or selecting from the calendar displayed on the screen, and press [Display].

### 4. Check the transmission results and press [Exit].

- "--LAN-Fax -->" is shown as the result of transmission to the machine when you send a fax from your computer. For the result of transmission to the destination, refer to the transmission result of the same document number.
- The destination may be displayed as "\*" depending on the security settings.
- In a field for an e-mail that was encrypted and distributed or forwarded, the encryption icon (🔒) is displayed.
- To display the result of the transmission that is completed while displaying the transmission results, close the transmission result screen and open it again.

#### ⓘ Note

- You cannot confirm or change an outgoing document in LAN-Fax, document waiting, or document whose status is "Sending".

## Checking the Result in Communication Result Report

In the factory default setting, the machine is configured not to print the report automatically. Specify Auto Print to print the report every time you send a document by Memory Transmission. When more than one destination is specified, the report is printed after transmitting the fax to all destinations is completed.



To configure auto print, select bit number [0] under switch number [03], and change the current value to "1".

See "Changing the Parameter Setting", User Guide (Full Version).

See below when [Standard] is specified as the screen type of [Settings]. The names of the setting items may differ from the [Classic] screen type.

See "Changing the Parameter Settings (Standard)", User Guide (Full Version).

For details, see "Settings Menu Compatibility List (Classic to Standard Settings)", User Guide (Full Version).

---

## Checking the Result in Immediate TX Result Report

---

In the factory default setting, the machine is configured not to print the report automatically. Specify Auto Print to print it every time you send a document by Immediate Transmission.

To configure Auto Print, select bit number [5] under switch number [03], and change the current value to "1".

See "Changing the Parameter Setting", User Guide (Full Version).

See below when [Standard] is specified as the screen type of [Settings]. The names of the setting items may differ from the [Classic] screen type.

See "Changing the Parameter Settings (Standard)", User Guide (Full Version).

For details, see "Settings Menu Compatibility List (Classic to Standard Settings)", User Guide (Full Version).

---

## Checking the Result in Communication Failure Report

---

This report is printed if the fax could not be sent to all specified destinations by Memory Transmission when Fax is not set to Auto Print (the factory default setting).

---

## Checking the Result in Error Report

---

This report is printed if a fax could not be sent by Immediate Transmission when Immediate Transmission Result Report is not set to Auto Print (the factory default setting).

---

## Viewing Memory Storage Report

---

Memory Storage Report is printed when the document to send by Memory Transmission could not be stored in the memory. If you want to, print the report as a record, and print it even if the document was stored correctly.

To print the Memory Storage Report every time a document is stored in the memory, select bit number [2] under switch number [03], and change the current value to "1".

See "Changing the Parameter Setting", User Guide (Full Version).

See below when [Standard] is specified as the screen type of [Settings]. The names of the setting items may differ from the [Classic] screen type.

See "Changing the Parameter Settings (Standard)", User Guide (Full Version).

For details, see "Settings Menu Compatibility List (Classic to Standard Settings)", User Guide (Full Version).

#### ↓ Note

- It is not printed when you are using Parallel Memory Transmission.

## Checking by E-mail

You can check the fax transmission result on your computer by sending an e-mail to the sender or the e-mail address specified when sending the fax. The image of the original sent by fax, along with the destination, date and time, and transmission result is included in the e-mail.

1. Press [Fax] on the Home screen.

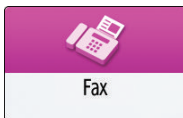

2. Place the original in the Auto Document Feeder (ADF) or on the exposure glass.

See "Setting an Original to Send by Fax on the Scanner", User Guide (Full Version).

3. To send a notification e-mail to the sender, press [Settings] ► [Sender], and then specify the sender.

When a login user is operating the machine, the login user becomes the sender.

The e-mail address that you selected for the [Use as Sender] check box when registering the address will be used as the e-mail address of the sender.

See "Registering E-mail Addresses in the Address Book", User Guide (Full Version).

#### 4. Select the [Notification of Results] check box.

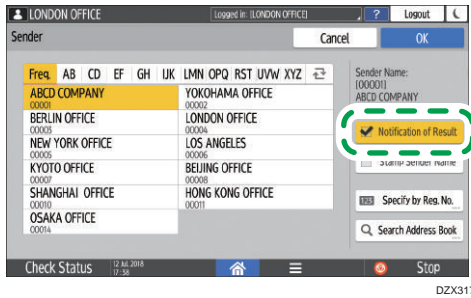

#### 5. To send a notification e-mail to a destination other than the sender, press [Notification of Results] on the [Settings] screen, and then specify the destination of the e-mail.

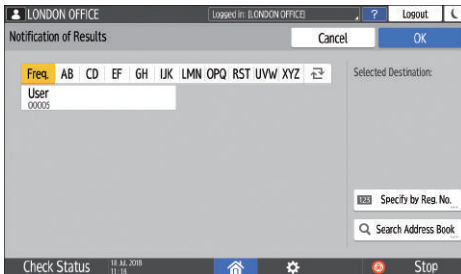

#### 6. Configure the scan settings.

See "Sending a Fax at the Image Quality Suitable for the Original", User Guide (Full Version).

#### 7. After configuring the send settings, specify the destination on the fax screen, and send the fax.

page 89 "Basic Procedure for Transmitting Faxes"

See "Basic Procedure for Sending Internet Faxes" and "Basic Procedure for Sending IP-Faxes", User Guide (Full Version).

## Confirming the Information in Web Image Monitor

In Web Image Monitor, you can view up to 1,000 of the latest total results of the transmission and reception history.

#### 1. Log in to Web Image Monitor as the administrator.

See "Logging in to Web Image Monitor", User Guide (Full Version).

## 2. From the "Status/Information" menu, click [Job].

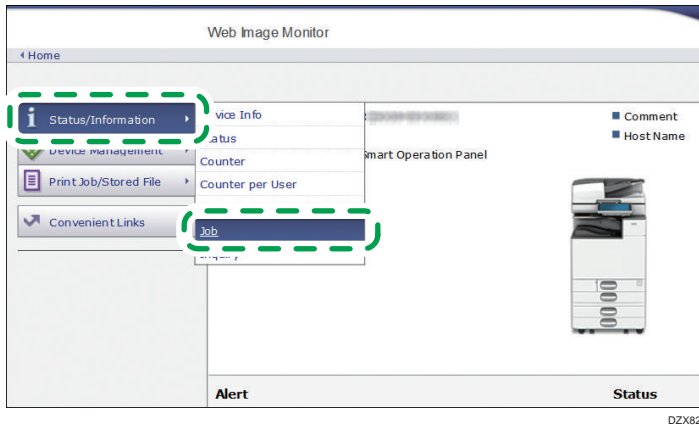

DZX827

## 3. Click [Transmission] under [Fax].

## 4. Confirm the transmission history.

- Click [Details] to view the details.

The screenshot shows the 'Fax Records: Transmission' page. A table lists transmission records with columns for Date, Encryption, Destination, Line, Page(s), Result, User Name, and File No. A green dashed box highlights the 'Details' icon for the first row.

Date	Encryption	Destination	Line	Page(s)	Result	User Name	File No.
Jul 25, 2018 12:30 PM	---	-RmFx10.60.155.129->	G3	1	OK	---	0934
Jul 25, 2018 12:30 PM	---	1111	G3	1	OK	---	0933
Jul 25, 2018 11:07 AM	---	k	Email	1	--	---	0932
Jul 25, 2018 10:53 AM	---	1111	G3	1	OK	---	0931
Jul 25, 2018 10:53 AM	---	-RmFx10.60.155.129->	G3	1	OK	---	0931
Jul 25, 2018 10:21 AM	---	k	Email	1	--	---	0930
Jul 25, 2018 10:17 AM	---	faxtest1@prelude.camel.r	Email	1	--	---	0929
Jul 25, 2018 10:13 AM	---	k	Email	1	Error	---	0920
Jul 9, 2018 3:27 PM	---	faxtest4@prelude.camel.r	Email	1	--	---	0877
Jul 9, 2018 3:09 PM	---	faxtest4@prelude.camel.r	Email	1	--	---	0876

DZX828

- To save the history as a list to a file in the CSV format, click [Download Transmission List].

The screenshot shows the 'Fax Records: Transmission' page. The 'Download Transmission List' button is highlighted with a green dashed box. The table below it is identical to the one in the previous screenshot.

DZX829

## 5. Click [Logout] and then close the Web browser.

# 4. Print

## Installing the Printer Driver by Using Device Software Manager Installer

Device Software Manager is a support utility for driver installation in Windows. Device Software Manager helps you to detect the latest driver via the internet automatically according to the computer you are using and install it with a simple procedure.

### ★ Important

- Device Software Manager supports Windows OS only. To install the printer driver on Mac OS, see the following sections:
- page 119 "Installing the Printer Driver for Network Connection (OS X/macOS)"
- See "Installing the Printer Driver for USB Connection (OS X/macOS)", User Guide (Full Version).
- Follow the instructions of the installer to connect the USB cable.

### Installing Device Software Manager from the CD-ROM

1. Set the CD-ROM in the computer.

If the installer does not start automatically, double-click [Setup.exe] in the root directory of the CD-ROM.

2. Click [Install Online].

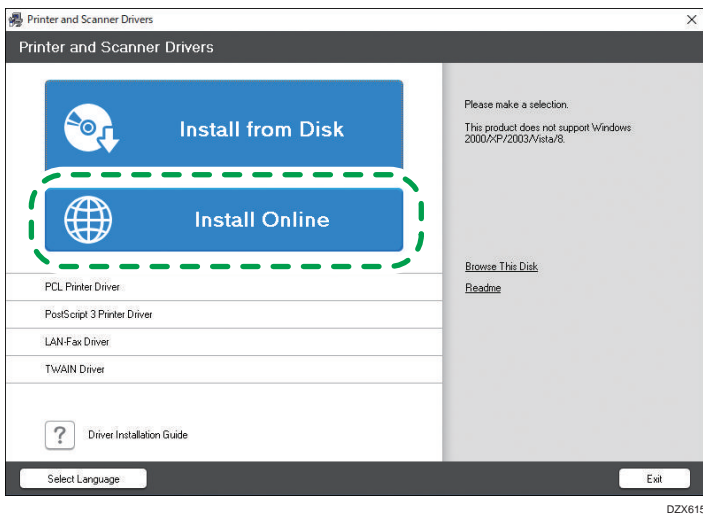

3. Select [I accept the agreement] on the "License Agreement" screen, and then click [Install].

4. On the "Quality Improvement Program" screen, select [I will participate in the Quality Improvement Program] or [I will not participate in the Quality Improvement Program], and then click [Next].
  5. On the "Driver Update Notification Setting" screen, specify whether to display the message about the driver update, and then click [Next].
- The process of installing Device Software Manager starts.
6. Select the connection between the machine and computer, and then click [Next].

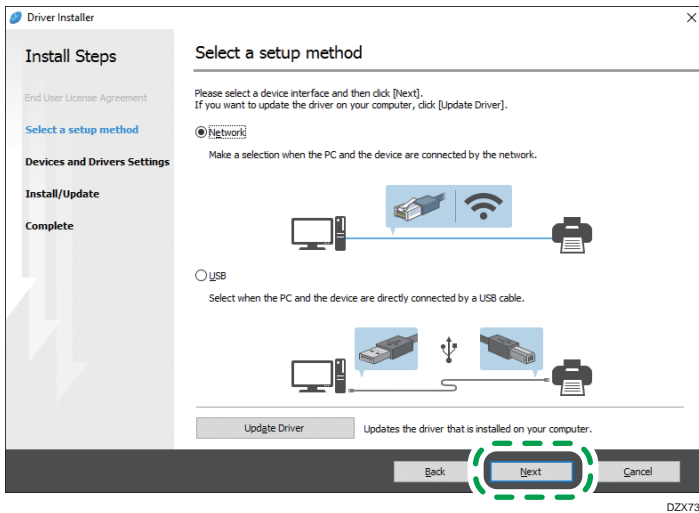

DZX730

- Network: Search for devices connected to the network.
- USB: Following the instructions on the "Connection with device" screen, connect the machine and the computer with the USB cable to search for the machine.

7. Select this machine from among the detected devices, and then click [Next].

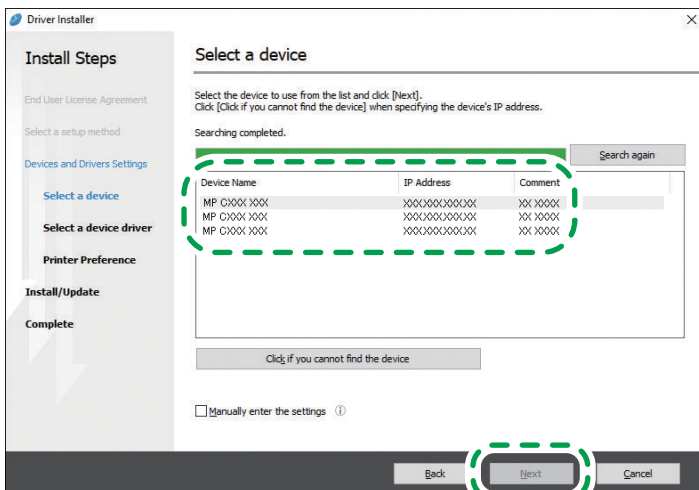

DZC086

The installation of the driver starts.

- If "Could not verify publisher" is displayed at the beginning of installation, continue the installation. There is no problem with the started installer that is downloaded from the manufacturer's website. Continue the installation.
- When you connect the machine and the computer with a USB cable, follow the instructions on the installer screen.

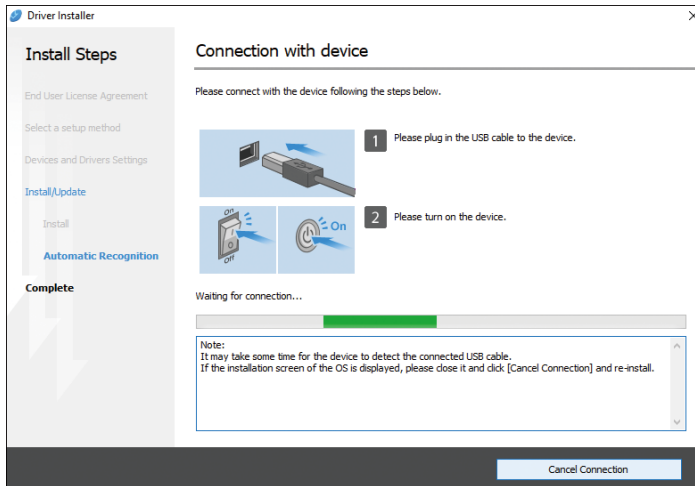

4

If the machine is not detected, click [Cancel Connection]. Even if the connection is canceled, the installation is complete. After the installer screen is closed, the machine is added automatically when it is connected to the computer with the USB cable.

## 8. When the installation is complete, click [Finish].

### ↓ Note

- After completing the installation, Device Software Manager icon is created on the desktop screen.



- You can update the installed printer driver with Device Software Manager.
- See "Updating the Driver (Windows)", User Guide (Full Version).

## Installing Device Software Manager from the Downloaded File

1. Double-click the downloaded file.
2. Select [I accept the agreement] on the "License Agreement" screen, and then click [Install].
3. Click [Next] on the "Welcome to the Device Software Manager Setup Wizard" screen.

4. On the "Quality Improvement Program" screen, select [I will participate in the Quality Improvement Program] or [I will not participate in the Quality Improvement Program], and then click [Next].
5. On the "Driver Update Notification Setting" screen, specify whether to display the message about the driver update, and then click [Next].

The process of installing Device Software Manager starts.

6. After completing the installation, select the [Run Device Software Manager] check box, and then click [Finish].

The installation of Install Online is complete. Next, install the printer driver.

7. On the "End User License Agreement" screen, select [Agree], and then click [Next].
8. Select the connection between the machine and computer, and then click [Next].

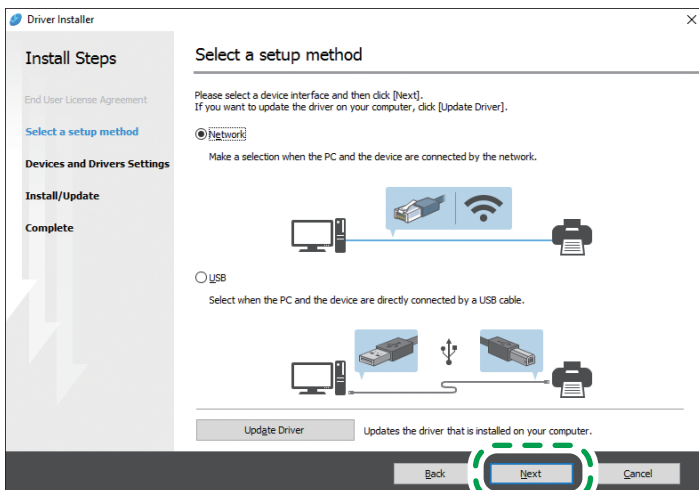

DZX730

- Network: Search for devices connected to the network.
- USB: Following the instructions on the "Connection with device" screen, connect the machine and the computer with the USB cable to search for the machine.



## 9. Select this machine from among the detected devices, and then click [Next].

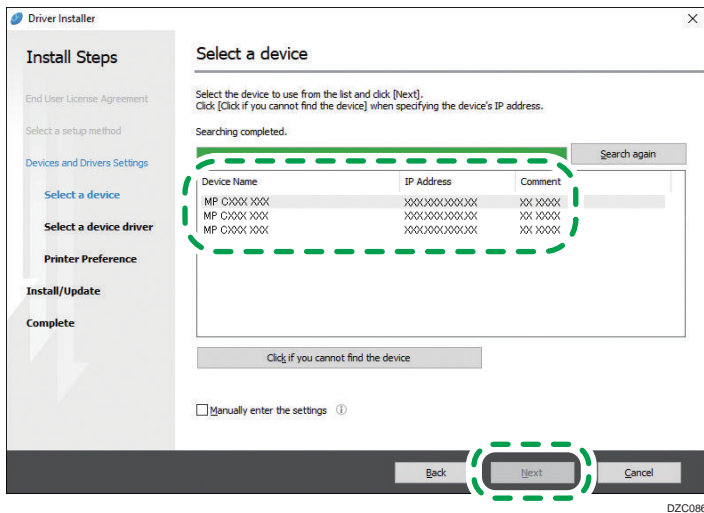

4

The installation of the driver starts.

- If "The publisher could not be verified" is displayed at the beginning of installation, continue the installation. There is no problem with the started installer that is downloaded from the manufacturer's website. Continue the installation.
- When you connect the machine and the computer with a USB cable, follow the instructions on the installer screen.

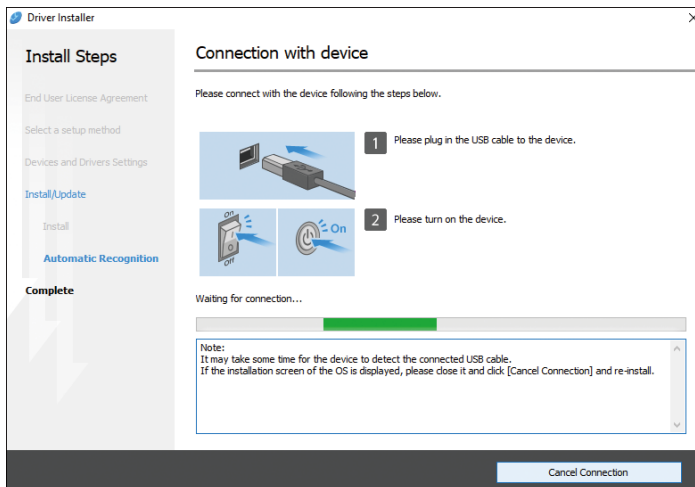

If the machine is not detected, click [Cancel Connection]. Even if the connection is canceled, the installation is complete. After the installer screen is closed, the machine is added automatically when it is connected to the computer with the USB cable.

## 10. When the installation is complete, click [Finish].

**Note**

- Double-click the Device Software Manager icon created on the Finder of the computer to update the printer driver.
- See "Updating the Driver (Windows)", User Guide (Full Version).



# Installing the Printer Driver for Network Connection (Windows)

When the machine and the computer are connected to the same network, the installer searches for the machine to install the printer driver. If the installer cannot find the machine, specify the IP address or machine name to install the printer driver.

## Installing the PCL 6 Printer Driver from the CD-ROM

1. Set the CD-ROM in the computer.

If the installer does not start automatically, double-click [Setup.exe] in the root directory of the CD-ROM.

2. Select a language, and then click [OK].

3. Click [Install from Disk].

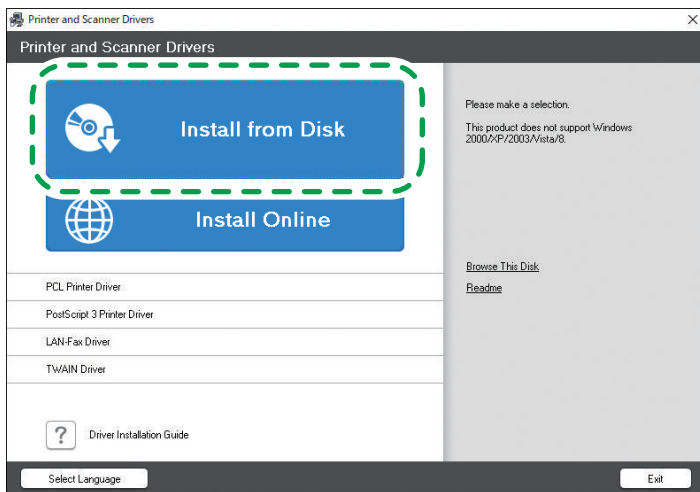

DZC992

4. Click [Network Printer(s)].

5. On the "License Agreement" screen, select [I accept the agreement], and then click [Next].

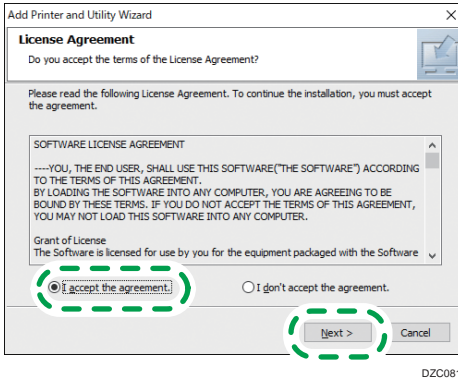

4

6. Confirm the "Confirm Network Connection" screen, and then click [Next].  
The search detects devices connected to the network.
7. Select this machine from among the devices, and then click [Install].

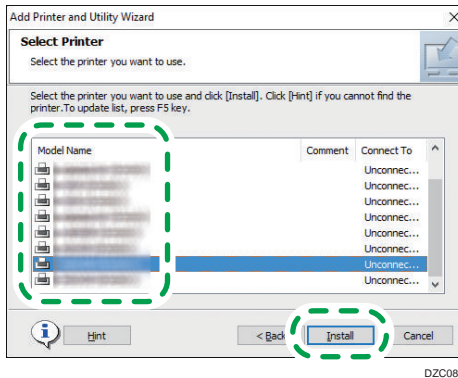

8. If the "Set Port" screen is displayed, select the setting method of the port.  
This screen is displayed when the computer cannot access the machine.

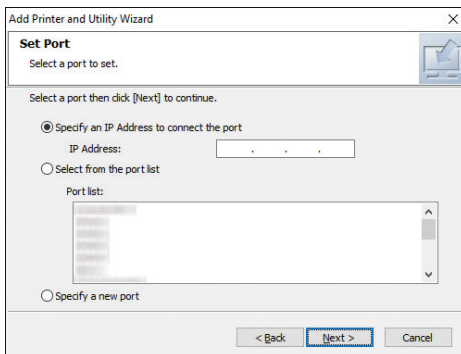

Specify the port to use for the connection between the computer and machine using one of the following methods:

#### To specify the IP address

1. Enter the IP address of the machine, and then click [Next].
2. Proceed to Step 9.

#### To select from the port list

1. Select the port to use for the connection between the computer and machine, and then click [Next].
2. Proceed to Step 9.

#### To create a new port

1. Select [Specify a new port], and then click [Next].
2. On the "Add Printer and Utility Wizard" screen, select [Standard TCP/IP Port] and click [Next].
3. On the "Add Standard TCP/IP Printer Port Wizard" screen, click [Next].
4. On the "Add port" screen, enter the printer name or IP address of the machine, and then click [Next].

The port name is automatically entered. You can change the port name.

5. When the "Additional port information required" screen is displayed, select [RICOH Network Printer C model], and then click [Next].
6. Click [Finish].

### 9. Specify the name of the printer to install, and whether to use it as the default printer.

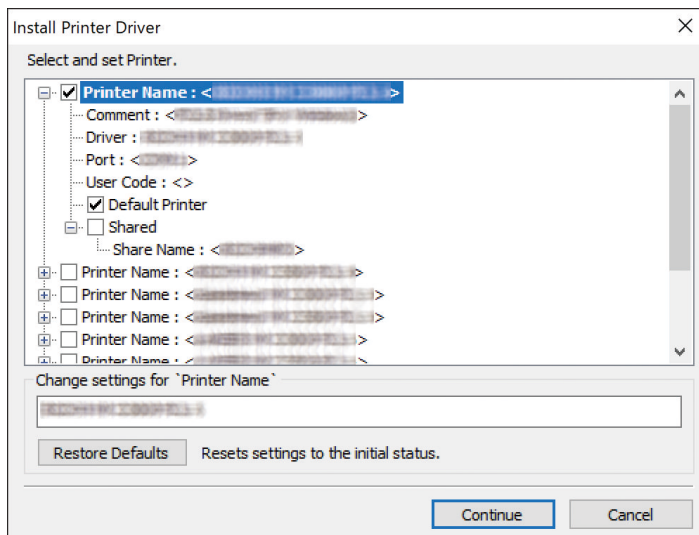

**10. Click [Continue].**

Printer driver installation starts.

**11. Click [Finish].**

When you are prompted to restart your computer, restart it by following the instructions that appear.

---

## Installing the PostScript 3 Printer Driver from the CD-ROM

---

**1. Set the CD-ROM in the computer.**

If the installer does not start automatically, double-click [Setup.exe] in the root directory of the CD-ROM.

**2. Select a language, and then click [OK].**

**3. Click [PostScript 3 Printer Driver].**

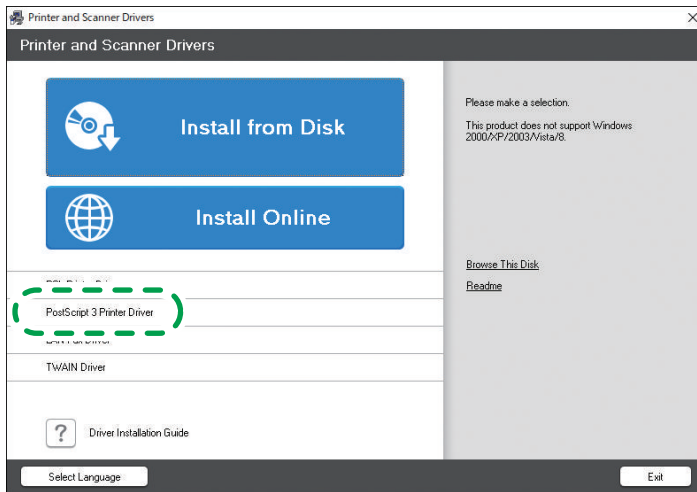

DZC990

4. On the "License Agreement" screen, select [I accept the agreement], and then click [Next].

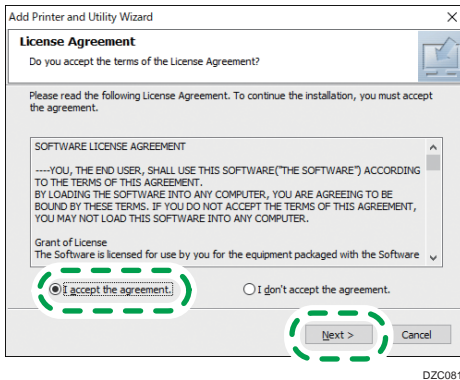

5. Click [Next].

6. Select a method to connect a port.

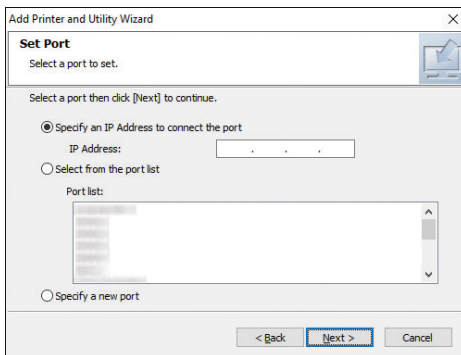

Specify the port to use for the connection between the computer and machine using one of the following methods:

#### To specify the IP address

1. Enter the IP address of the machine, and then click [Next].

#### To select from the port list

1. Select the port to use for the connection between the computer and machine, and then click [Next].

#### To create a new port

1. Select [Specify a new port], and then click [Next].
2. On the "Add Printer and Utility Wizard" screen, select [Standard TCP/IP Port] and click [Next].
3. On the "Add Standard TCP/IP Printer Port Wizard" screen, click [Next].

- On the "Add port" screen, enter the printer name or IP address of the machine, and then click [Next].

The port name is automatically entered. You can change the port name.

- When the "Additional port information required" screen is displayed, select [RICOH Network Printer C model], and then click [Next].
- Click [Finish].

**7. Select the [Printer Name] of the machine to open the menu tree, and then specify the setting items.**

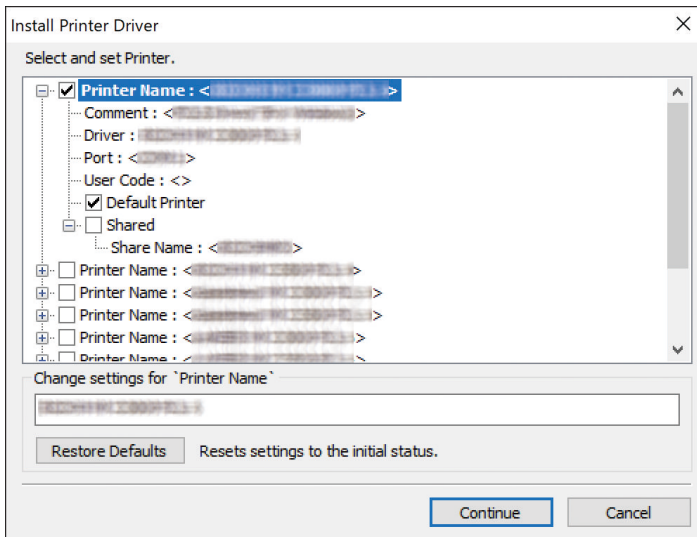

**8. Click [Continue].**

Printer driver installation starts.

**9. Click [Finish].**

When you are prompted to restart your computer, restart it by following the instructions that appear.

## Installing the PCL 6/PostScript 3 Printer Driver from the Downloaded File

- Double-click the downloaded file.
- Confirm where to install, and then click [Extract] or [Install].
  - If the "Security Warning" screen is displayed, click [OK].
  - If the "User Account Control" screen is displayed, click [Yes] or [Allow].
- On the "End User License Agreement" screen, select [Agree], and then click [Next].



#### 4. Select [Network], and then click [Next].

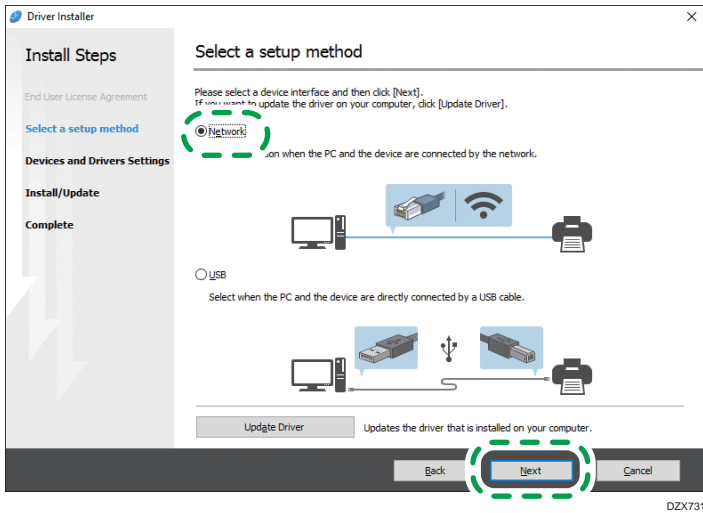

- The search detects devices connected to the network.
- If the error screen is displayed, see page 115 "If the Machine Cannot Be Found".

#### 5. Select this machine from among the detected devices, and then click [Next].

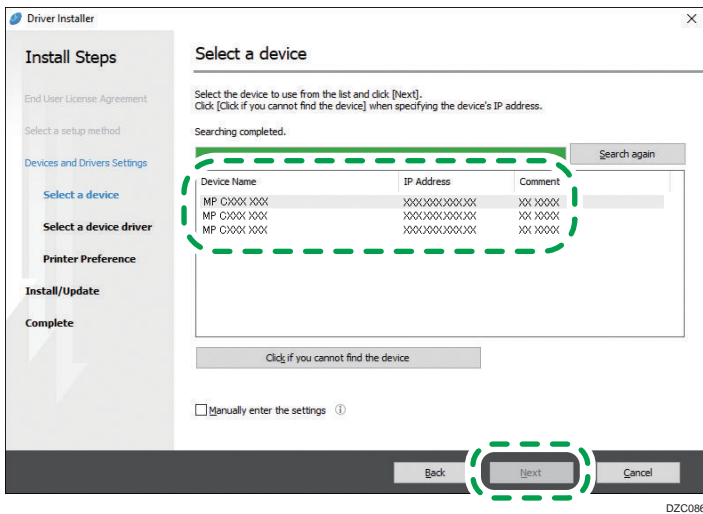

Printer driver installation starts.

#### 6. When the installation is complete, click [Finish].

## If the Machine Cannot Be Found

The "Network Connection Error" screen is displayed.

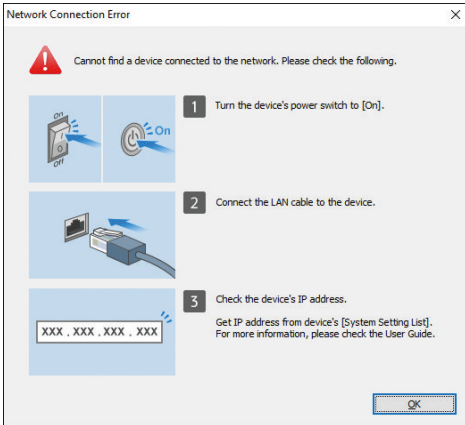

4

Confirm and perform **1** to **3**, and then click [OK]. If the machine still cannot be found, specify the IP address or machine name to install the printer driver.

**1. Click [Click if you cannot find the device].**

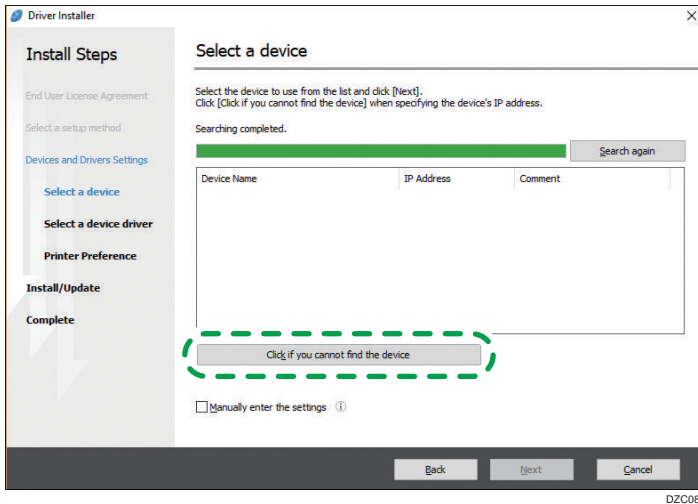

**2. Select [Specify device IP address] or [Specify device name], and then click [Next].**

**When specify the machine IP address**

1. Enter the IP address of the machine and click [Search].

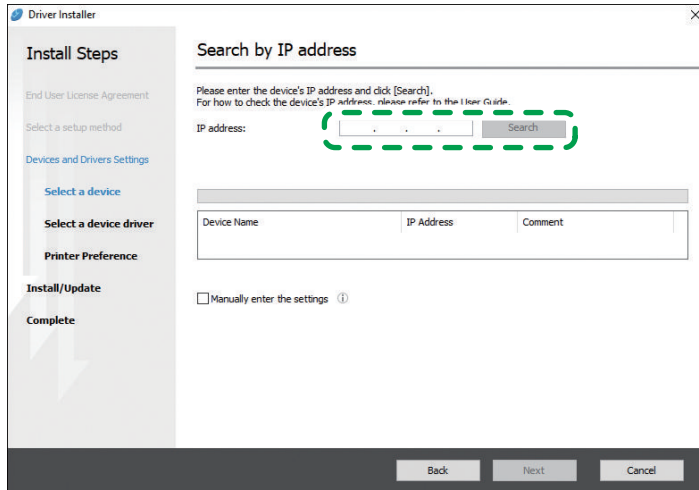

DZC091

2. When the machine is detected, click [Next].

Printer driver installation starts.

### When specify the machine name

1. Select the machine to use, and then click [Next].

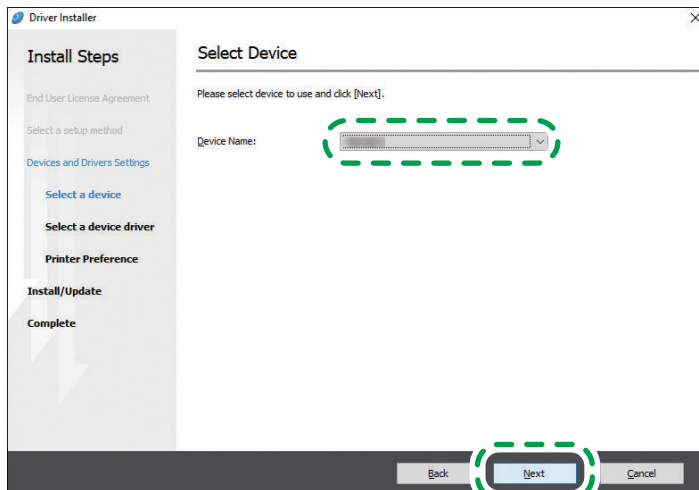

DZC094

2. On the "Printer Preference" screen, select one of the port names from among "Port Name", and then click [Next].

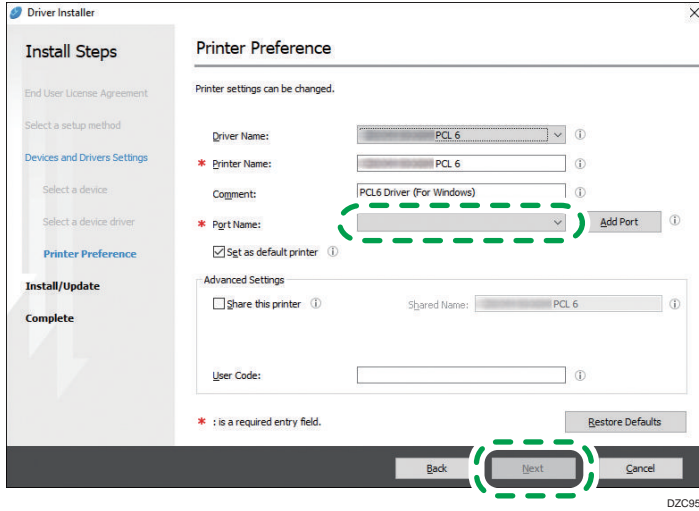

Printer driver installation starts.

For details about the procedure for specifying the IP address after installing the printer driver, see the following section:

See "When You Cannot Print a Document even if the Printer Driver is Installed", User Guide (Full Version).

**3. When the installation is complete, click [Finish].**

# Installing the Printer Driver for Network Connection (OS X/macOS)

Install the PPD file (printer driver) under OS X/macOS, and then register the machine on the computer from the system preferences.

## Installing the PPD file

1. Set the CD-ROM in the computer, and click [macOS] to display the [macOS PPD Installer] folder.

To install the driver from the downloaded file, display the folder that is the location of the downloaded file.

2. Double-click the package file.

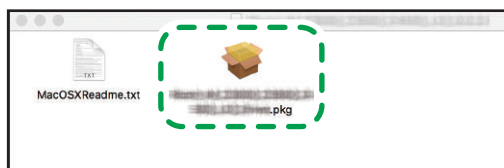

DZX684

- To install from the CD-ROM, double-click the package file in the [macOS] ► [macOS PPD Installer] folder.
  - When the install confirmation screen is displayed, click [Continue].
3. On the "Introduction" screen, click [Continue].
  4. On the "License" screen, click [Continue] and then click [Accept].
    - When prompted to select where to install the driver, specify the install location, and click [Continue].

5. Click [Install].

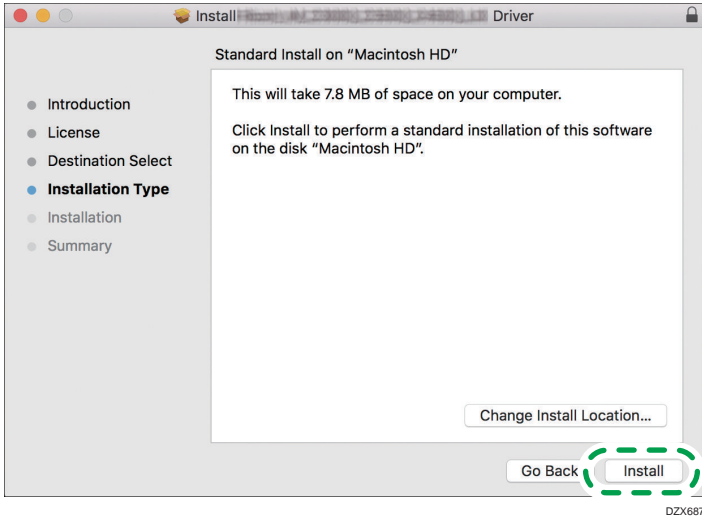

4

6. Enter the computer's user name and password, and then click [Install Software].

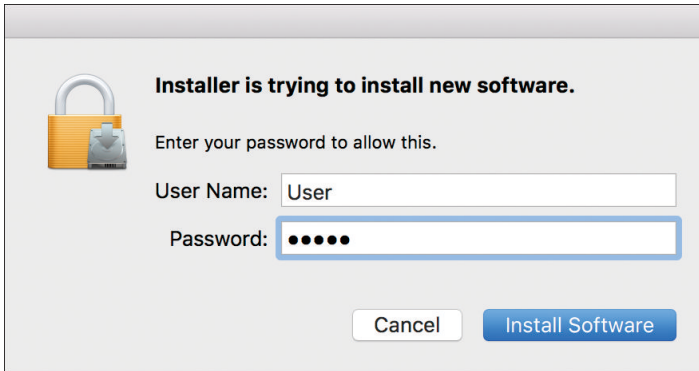

The installation of the PPD file starts.

7. When the installation is complete, click [Close].

---

## Registering the Machine in [Print & Scan] or [Printers & Scanners]

---

Register the PPD file of the machine in the system preferences to enable printing.

1. Select [System Preferences...] from the Apple menu.
2. Click [Print & Scan] or [Printers & Scanners].

### 3. Click [+].

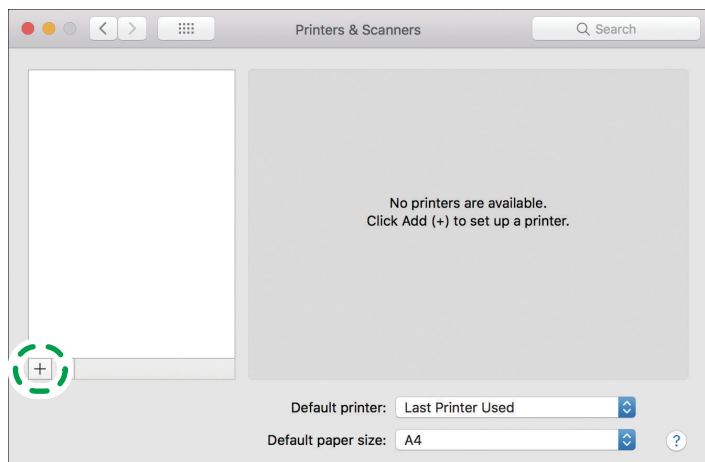

DZX689

### 4. Click [IP], and configure the information of the machine.

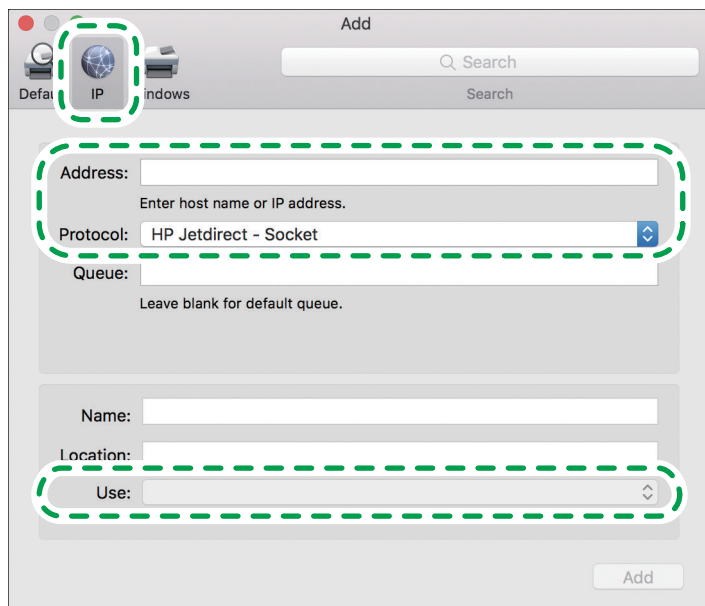

DZX690

- Address: Enter the IP address of the machine.
- Protocol: Select [LPD (Line Printer Daemon)]. If the printer takes time to perform operations when using the [LPD (Line Printer Daemon)] protocol, change the protocol to [HP Jetdirect - Socket].
- Use: Check that the machine name is displayed. If "Generic PostScript Printer" is displayed, the entered IP address may not be correct.

**When "Generic PostScript Printer" is displayed even though the IP address is correct**

Perform the following procedure to select the PPD file of the machine:

1. Select [Select Software...] on "Use".

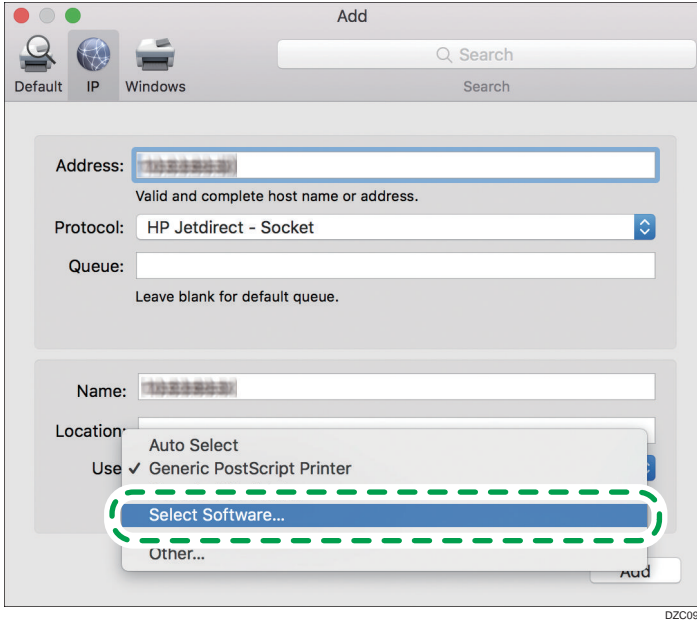

2. Select the machine on the "Printer Software" screen, and then click [OK].

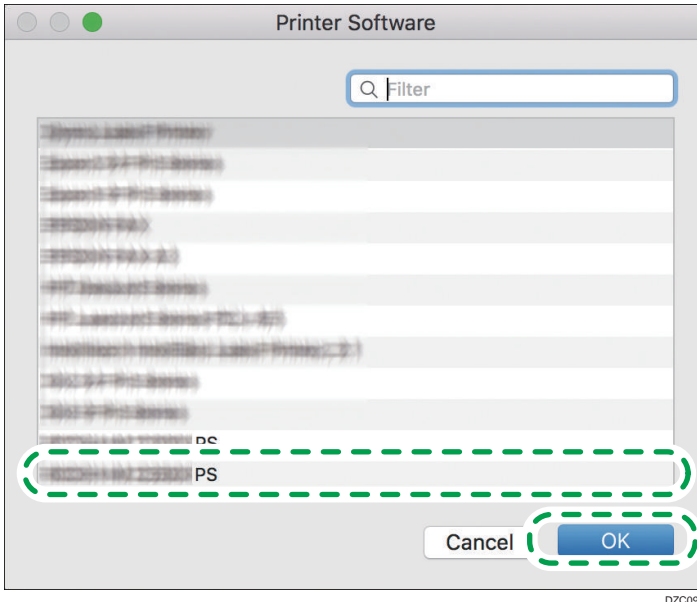



## 5. Click [Add].

The progress screen is displayed.

- If the progress screen does not close after a while, click [Configure...] or [Settings] and configure the option configuration of the printer. For the procedure of the option configuration, see page 123 "Specifying the Option Settings".

## 6. Check that the machine name is added to the [Print & Scan] or [Printers & Scanners] screen.

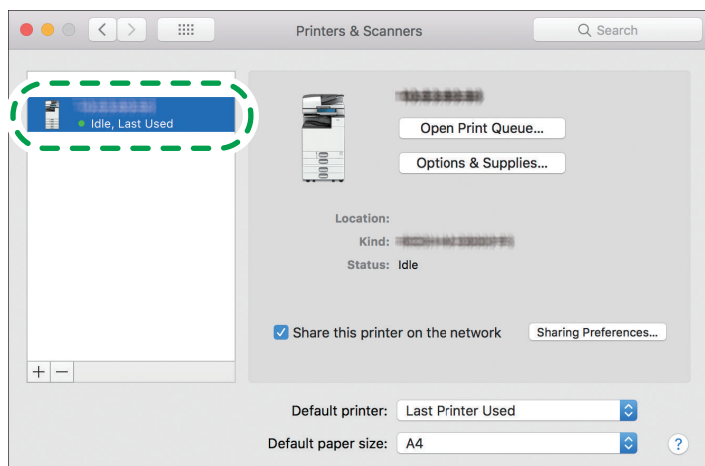

## 7. Close the system preferences screen.

---

## Specifying the Option Settings

---

If the option configuration of the machine is not automatically reflected, select the option installed on the machine in [Print & Scan] or [Printers & Scanners].

1. Select [System Preferences...] from the Apple menu.
2. Click [Print & Scan] or [Printers & Scanners].

3. Select the machine from the list, and then click [Options & Supplies...].

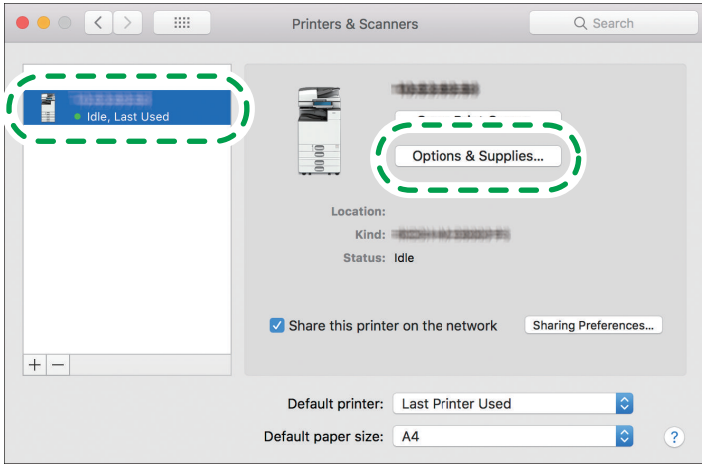

DZX693

4. Click [Driver] or [Options], select the option installed on the machine, and then click [OK].

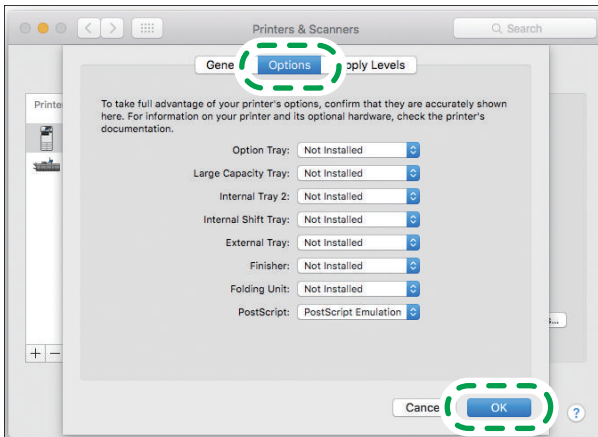

DZX694

- If the usable options are not displayed, the IP address has not been entered correctly or the PPD file has not been registered properly. To enter the IP address or register the PPD file, see page 120 "Registering the Machine in [Print & Scan] or [Printers & Scanners]".

5. Close the system preferences screen.

# Basic Procedure for Printing Documents

Specify the printer driver and configure the Document Size, Paper Type, and other settings to print a document.

## ★ Important

- Duplex printing is selected as the default setting. If you want to print on only one side, select [Off] for the two-sided printing setting.
- If you send a print job via USB 2.0 while the machine is in Sleep mode, an error message may appear after the print job is completed. In this case, check whether the document was printed.

## Printing a Document in Windows

4

1. Open a document to print on the computer, and display the setting screen of the printer driver from the print menu in the application.

The method to display a document varies depending on the applications.

For example in Microsoft Word/Excel, click [Print] on the [File] menu, select the device to use, and then click [Printer Properties].

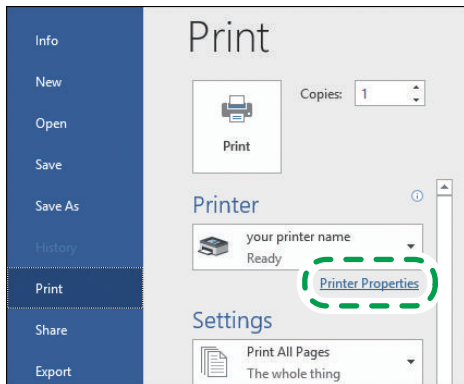

DZC420

2. Specify the Document Size, Paper Type, Paper Tray, and other settings.

You can specify the print settings on the [Frequently Used Settings] tab and [Detailed Settings] tab. Basic settings can be specified on the [Frequently Used Settings] tab, even if you do not use the [Detailed Settings] tab.

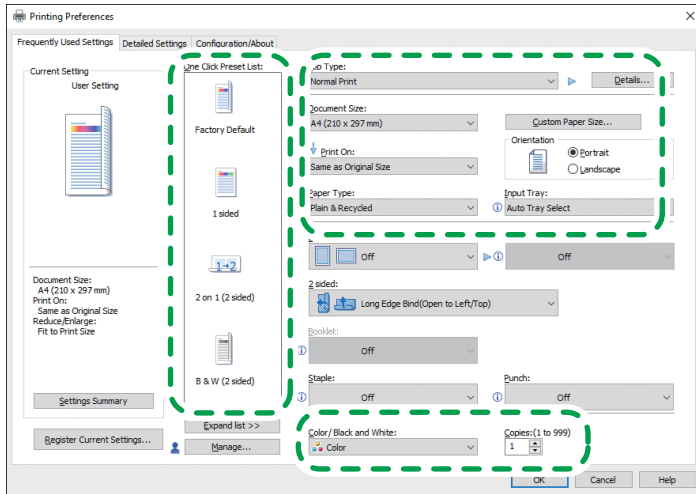

DZC403

- One Click Preset List: Some of the useful functions such as Combine or 2-sided are registered. Click the icon of the function to select. You can register frequently used print settings in One-click settings.

See "Registering Frequently Used Settings", User Guide (Full Version).

- Job Type: Select [Normal Print] to execute printing immediately.

You can make a partial print as a test and proceed to print the rest of the document (Sample Print).

See "Making a Partial Print as a Test and Printing the Rest of the Document", User Guide (Full Version).

You can store documents in the machine (Locked Print, Hold Print, or Stored Print).

See "Storing Documents to Print in the Machine", User Guide (Full Version).

- Document Size: Select the size of the document to print.
- Orientation: Specify the orientation of the document. Select Portrait or Landscape.
- Paper Type: Select the type of paper to use.
- Input Tray: Select the tray loaded with the paper to use. When you select [Auto Tray Select], a suitable paper tray is selected automatically according to the specified [Print On] and [Paper Type].
- Color/ Black and White: Select the print color.

You can print in universal color by using the following settings:

- [Detailed Settings] tab ► [Print Quality:Standard] ► "Barrier-free Color Management" ► [On]
- Copies: Enter the print quantity.

On the [Detailed Settings] tab, you can configure the advanced settings. Change the menu and specify the setting items.

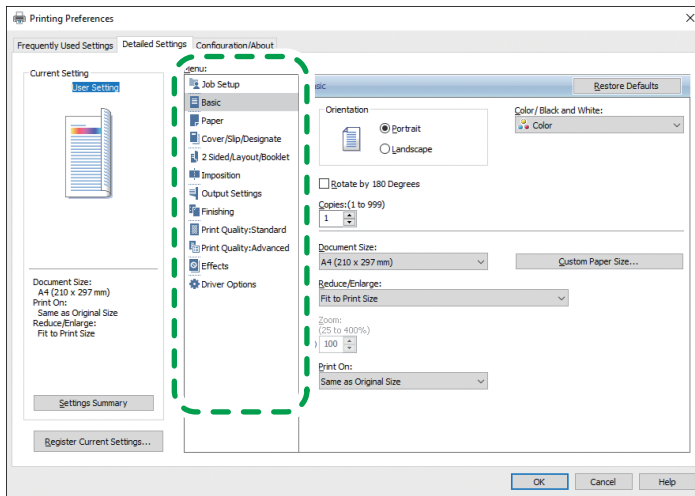

DZC404

The caution icon (ⓘ) indicates that there are disabled items. Click the icon to check the cause.

### 3. After completing the configuration, click [OK] to print.

#### ↓ Note

- On the [Devices and Printers] screen, right-click the printer icon of the machine, and then click [Print Settings] to change the default values of the printer settings.
- When you use the driver distributed from the print server, [Standard settings] specified in the print server are displayed as the default.

## Printing a Document in OS X/macOS

In the following example procedure, OS X 10.13 is used. The procedure may vary for different versions.

1. Open a document to print on the computer, and click [Print] on the [File] menu.
2. Select the printer you use from "Printer:".

### 3. Specify Paper Size, Orientation, and other settings.

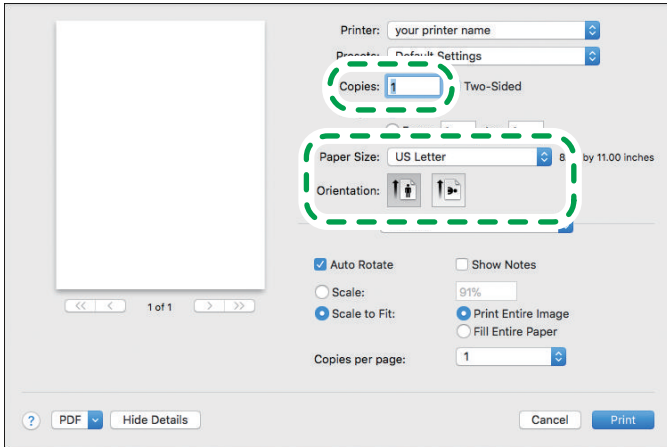

DZC405

- Copies: Enter the print quantity.
- Paper Size: Select the size of the document to print.
- Orientation: Specify the orientation of the document. Select Portrait or Landscape.

### 4. Select a category from the pop-up menu, and then specify the paper tray and paper type.

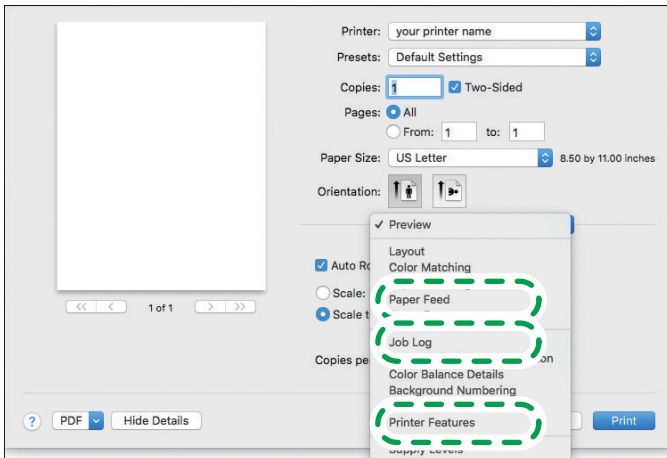

DZC406

#### Paper Feed

- All Pages From: Select the tray loaded with the paper to use. When you select [Auto Select], a suitable paper tray is selected automatically according to the specified paper size and paper type.

When the paper of the specified size is not loaded on the machine, printing is performed following the settings of the machine.

## Job Log

- Job Type: Select [Normal Print] to execute printing immediately.

You can make a partial print as a test and proceed to print the rest of the document (Sample Print).

See "Making a Partial Print as a Test and Printing the Rest of the Document", User Guide (Full Version).

You can store documents in the machine (Locked Print, Hold Print, or Stored Print).

See "Storing Documents to Print in the Machine", User Guide (Full Version).

## Printer Features

Select a category in "Feature Sets", and then specify the setting items.

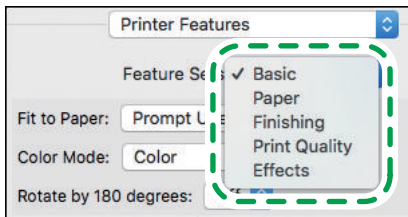

DZC407

- Basic
  - Color Mode: Select the print color.
- Paper
  - Paper Type: Select the type of paper to use.

**5. After completing the configuration, click [Print] to print.**

# Printing on Both Sides of Paper

Specify 2-sided Print in the printer driver.

## Specifying 2-sided Print (Windows)

Specify 2-sided Print on the [Frequently Used Settings] tab.





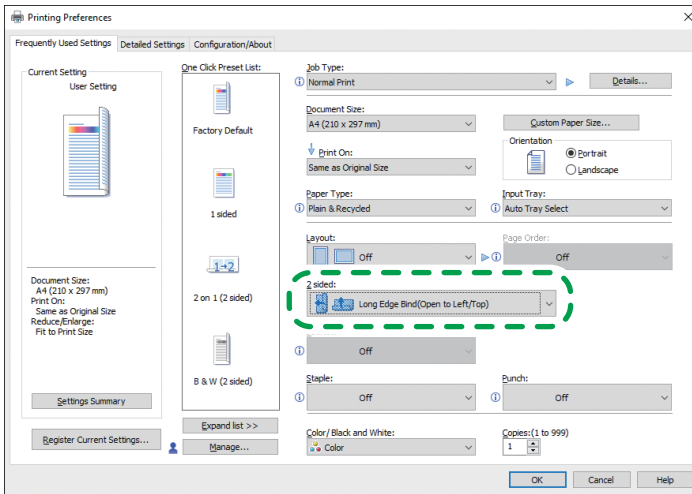

1. Open a document to print on the computer, and display the setting screen of the printer driver from the print menu in the application.
2. Specify Paper Size, Paper Type, Orientation and others.  
page 125 "Basic Procedure for Printing Documents"
3. On the [Frequently Used Settings] tab, click "2 sided" to specify the binding side and opening type of the paper.

4



DZC440

### Orientation of the original and opening type

Orientation	Open to left	Open to top
Portrait 		
Landscape 		

4. After completing the configuration, click [OK] to print.



## Specifying 2-sided Print (OS X/macOS)

Specify 2-sided Print on the [Layout] menu.

1. Open a document to print on the computer, and display the setting screen of the printer driver from the print menu in the application.
2. Specify Paper Size, Orientation, Paper Type, and other settings.  
page 125 "Basic Procedure for Printing Documents"
3. Select the [Two-Sided] check box, and then select [Layout] to specify the binding side and opening type of the paper.

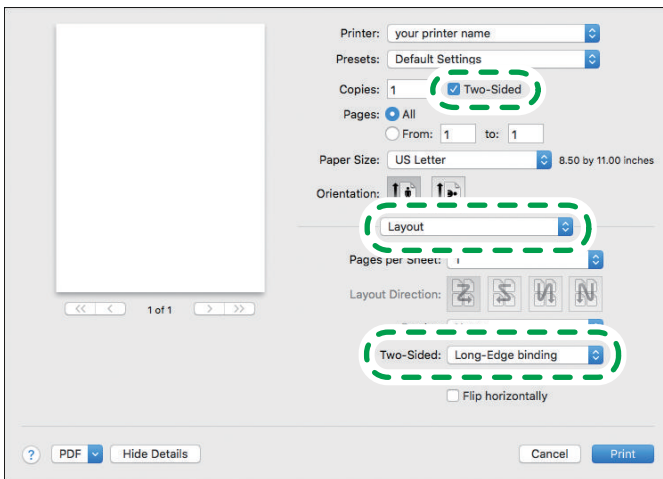

DZC441

### Orientation of the original and opening type

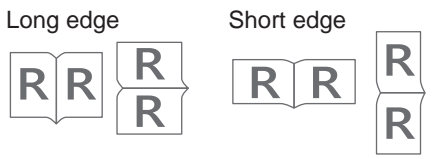

DZC442

4. After completing the configuration, click [Print] to print.

# Combining and Printing Multiple Pages on a Single Sheet of Paper

You can print multiple pages on a single sheet at a reduced size (Combine 2 Originals).

For example, you can reduce an original of A4 size to A5 size and print two pages on an A4 sheet. You can use the 2 Sided Print and Combine 2 Originals functions at the same time to economize on paper.

You can print up to 16 pages on a single sheet and specify the order to arrange the pages on the sheet.

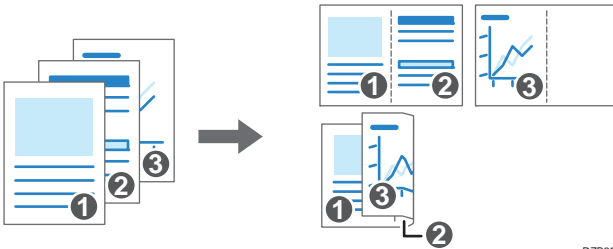

DZB253

## Specifying the Combine 2 Originals Function (Windows)

Specify the Combine 2 Originals function on the [Frequently Used Settings] tab.

1. Open a document to print on the computer, and display the setting screen of the printer driver from the print menu in the application.
2. Specify Paper Size, Paper Type, Orientation and other settings.  
page 125 "Basic Procedure for Printing Documents"
3. Specify the number of pages to combine and the order of the pages.

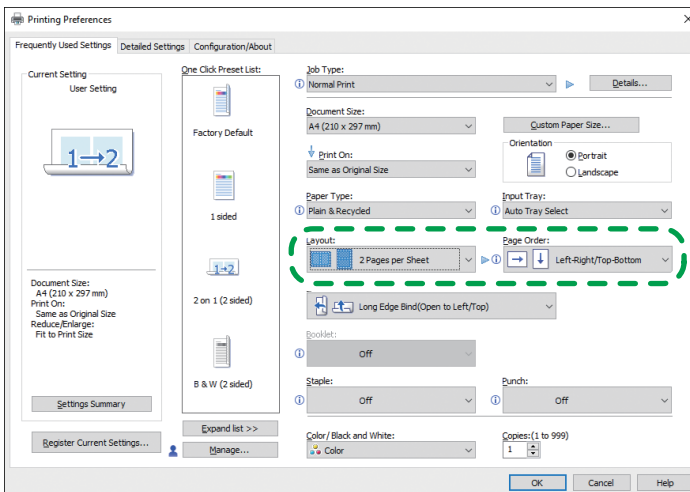

DZC445

- Layout: Select the number of pages to combine.
- Page Order: Select the order of the pages.
- Draw Frame Border: Select the Draw Frame Border check box on the [Detailed Settings] tab ► [2 Sided/Layout/Booklet] to draw a line between pages.

#### 4. After completing the configuration, click [OK] to print.

When printing from an application that supports the same function as the machine, do not set the function in the application. If the setting in the application is enabled, the print result may not be as intended.

## Specifying the Combine 2 Originals Function (OS X/macOS)

4

Specify the Combine 2 Originals function on the [Layout] menu.

1. Open a document to print on the computer, and display the setting screen of the printer driver from the print menu in the application.
2. Specify Paper Size, Orientation, Paper Type, and other settings.  
page 125 "Basic Procedure for Printing Documents"
3. Select [Layout], and then specify the number of pages to combine and the order of the pages.

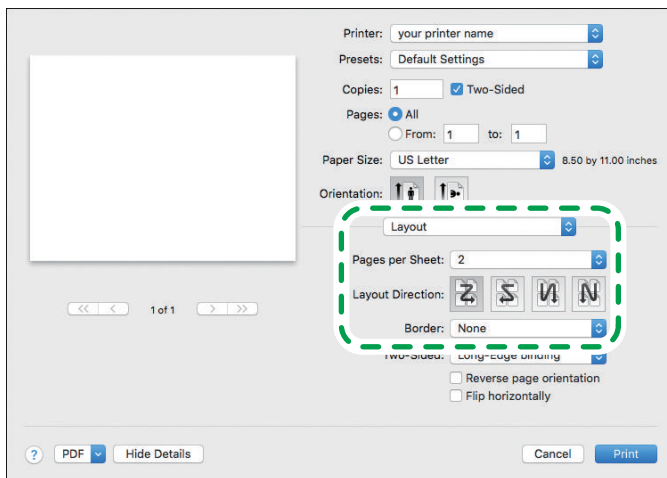

DZC446

- Pages per Sheet: Select the number of pages to combine.
- Layout Direction: Select the order of the pages.
- Border: Select a type of border line to draw between the pages.

#### 4. After completing the configuration, click [Print] to print.

# Printing on Envelopes

Load envelopes in the bypass tray or paper tray.

Load envelopes in the machine and change the Tray Paper Settings in the Control Panel.

The procedure is described using the [Classic] screen type of [Settings] as an example. When you are using the [Standard] screen type, specify the settings in the screen below.

- [Tray/Paper Settings]



The names of the setting items may differ on the setting screen for [Classic] and [Standard] screen types.

For details, see "Settings Menu Compatibility List (Classic to Standard Settings)", User Guide (Full Version).

## 4

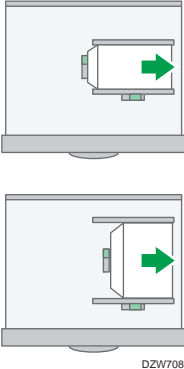
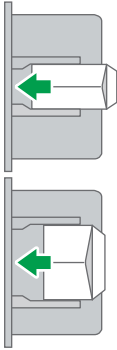
### 1. Load an envelope in the Bypass Tray or the Paper Tray.

Types and orientations of envelopes	Tray 2 to 4	Bypass Tray
Side-opening envelopes 	 <p style="text-align: center;">DZW708</p> <p style="text-align: center;">Flap: open Bottom side of the envelope: right Printing surface: upper side</p>	 <p style="text-align: center;">DZW709</p> <p style="text-align: center;">Flap: open Bottom side of the envelope: left Printing surface: lower side</p>

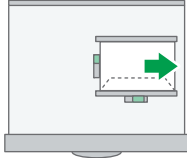
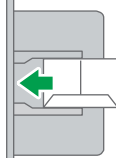
Types and orientations of envelopes	Tray 2 to 4	Bypass Tray
<p>Side-opening envelopes </p> 	 <p>DZB935</p> <p>Flap: close Bottom side of the envelope: back Printing surface: upper side</p>	 <p>DZB936</p> <p>Flap: close Bottom side of the envelope: back Printing surface: lower side</p>

2. On the Home screen, press [Settings].

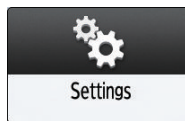

3. Press [Tray Paper Settings] ► [Tray Paper Size] or [Printer Bypass Paper Size], and then select the size of the envelopes.

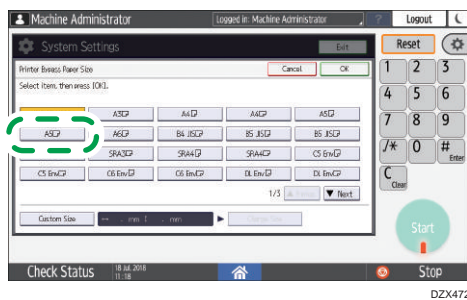

- If the size of the loaded envelope is not included in the list, select [Custom Size] and enter the value.

4. Press [OK].

5. Press "Paper Type" of the tray with loaded the envelopes, and then select [Envelope].

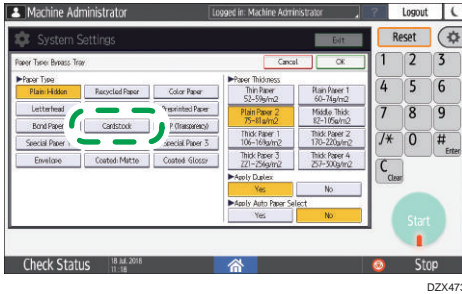

6. After completing the configuration, press [Home] (🏠).

7. Open a document to print in the computer, and display the setting screen of the printer driver from the print menu application.

8. Specify the paper size and paper type.

### Windows

4

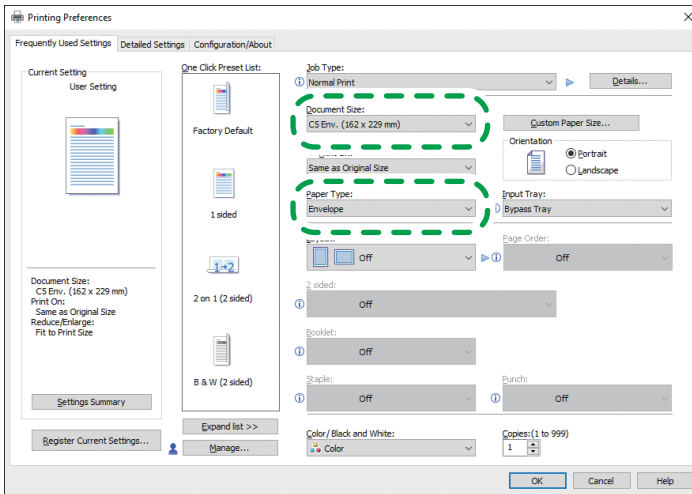

DZC414

- Document Size: Select the envelope size. If the envelope size is not included among the options, enter the value in [Custom Paper Size...].
- Paper Type: [Envelope]

You can specify a custom paper size, which is commonly used as the option of the Document Sizes.

See "Printing on Custom-sized Paper Loaded on the Bypass Tray", User Guide (Full Version).

## OS X/macOS

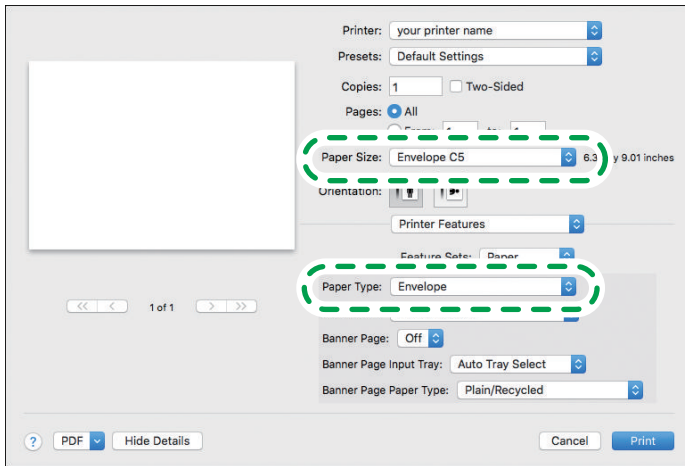

DZC415

- Paper Size: Select the envelope size. If the envelope size is not included among the options, select [Manage Custom Sizes] and enter the value.
- Paper Type: [Envelope]

**9. Execute printing.**

# Printing Documents Stored in the Printer from the Control Panel

To print a document stored from the printer driver in the machine, perform the print operation on Quick Print Release of the control panel. The file administrator also can delete unneeded documents and unlock documents locked by entering an invalid password.

1. On the Home screen, press [Quick Print Release].



2. On the Quick Print Release screen, select the user ID used to store the document.

Enter the password when the Locked Print documents or the Stored Print documents protected by passwords are stored. The screen shows the documents corresponding to the entered password and the documents without passwords.

3. Select a document to print.

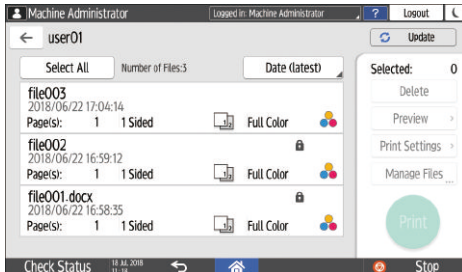

- Preview: The first page of the document is displayed. If you select multiple documents, the preview cannot be displayed.
- Print Settings: Change the print settings for the selected document.  
See "Print Settings Configured on the Control Panel", User Guide (Full Version).
- Manage Files...: Change the print time of a Hold Print job or the password specified on the document. If you select multiple documents, Manage Files... is disabled.

4. Press [Print].



# Printing from a USB Flash Memory Device or SD Card Directly

You can connect a memory storage device to the media slot of the machine and print the files stored on it. Use this to print external data easily.

## CAUTION

- Keep SD cards and USB flash memory devices out of reach of children. If a child accidentally swallows an SD card or USB flash memory device, consult a doctor immediately.

## Note

- USB flash memory device and SD cards are supported for direct printing. However, certain types of USB flash memory device and SD cards cannot be used.
- The machine cannot print a document over 1 GB.
- You can select up to 100 files within 1 GB total.
- If the print job of PDF file is canceled, execute printing from a PDF viewer such as Acrobat Reader while using the printer driver.

4

## Printable File Formats

File format	Details
JPEG files	Exif version 1.0 or later
TIFF files	Uncompressed TIFF files TIFF files compressed using the MH, MR, or MMR method
PDF files	PDF version 1.7 (Acrobat 8.0 compatible) or earlier <sup>* 1</sup>
XPS files	Possible for all XPS files

\* 1 The machine does not support the following functions: Color Space of Crypt Filter or DeviceN (more than eight components), watermark note, optional contents (version 1.6), AcroForm

## Note

- The PDF file of a custom size may not be printed.

## Printing from a Memory Storage Device or Scan Application

1. On the Home screen, press [Print/Scan (Memory Storage Device)]



2. On the Print/Scan (Memory Storage Device) screen, press [Print from Storage Device]

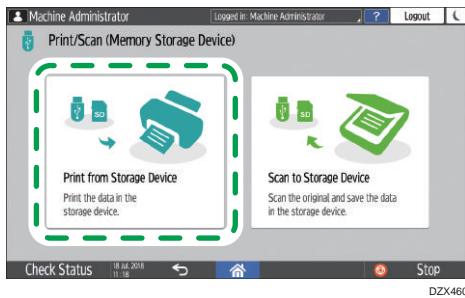

3. Insert a memory storage device in the media slot on the side of the control panel.

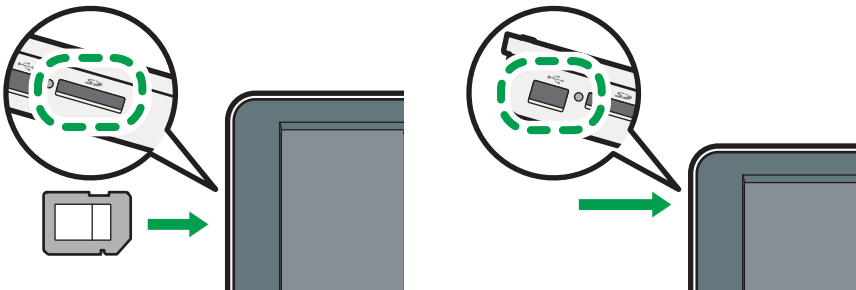

4. Press [USB] or [SD Card].

5. Select the file to print.

Files in the external media are displayed as icons or thumbnail images.

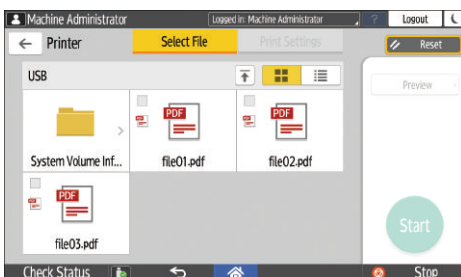

## 6. Press [Print Settings] to specify the settings of 2-Sided Print or Finishing as necessary.

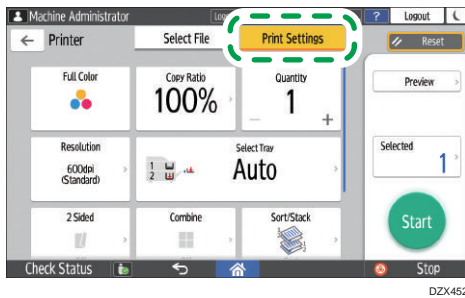

- Full Color: Select whether to print in color. The machine may print a document that appears to be black-and-white in color printing mode. To print a document in full black-and-white, select [Black and White].
- Copy Ratio: Select whether to print in the original size or to reduce or enlarge to match the paper size.
- Quantity: Enter the print quantity.
- Resolution: Select the resolution of the image to print.
- Select Tray: Select the paper tray.
- 2 Sided: Select the opening direction of the printed sheet.
- Combine: Select whether to combine multiple pages into a sheet.
- Sort/Stack: Select whether to print in ordered sets or in a batch page by page.
- Booklet: Select the opening direction of the Magazine binding. You can specify the setting of Magazine binding only when printing a file in the PDF/XPS format.
- Staple: Select the staple position.
- Punch: Select the punch position.
- Fold: Select the type of fold or printing side.

## 7. Press [Start] to start printing.



# 5. Scan

## Scanning Documents and Sending the Scanned Data by E-mail

Scan a document and attach the scanned data to an e-mail and send it from the machine.

- Configure the SMTP server and network settings in advance.  
See "Configuring the Settings to Send E-mails from the Machine", User Guide (Full Version).
- Register an e-mail address in the address book to select the address as the destination easily when sending an e-mail.  
See "Registering E-mail Addresses in the Address Book", User Guide (Full Version).

### Basic Procedure for Sending an E-mail

1. Press [Scanner] on the Home screen.

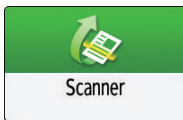

2. Select [Scan to Email] on the scanner screen.

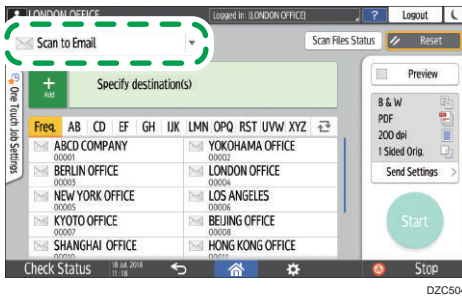

3. Place the original on the scanner.  
See "Placing an Original to Scan", User Guide (Full Version).
4. Press [Send Settings] on the scanner screen.
5. Press [Sender] and specify the sender.
  - When a logged in user is operating the machine, the logged in user becomes the sender.
  - When [On] is specified in [System Settings] ► [File Transfer] tab ► [Auto Specify Sender Name], you can send an e-mail even when the sender is not specified. The administrator's e-mail address that is registered on the machine is used as the sender.

The procedure is described using the [Classic] screen type of [Settings] as an example. When you are using the [Standard] screen type, specify the settings in the screen below.

- [System Settings] ► [Send (Email/Folder)] ► [Email]

The names of the setting items may differ on the setting screen for [Classic] and [Standard] screen types.

For details, see "Settings Menu Compatibility List (Classic to Standard Settings)", User Guide (Full Version).

- Specify the sender to receive an opening confirmation.

**6. Select the [Reception Notice] check box to receive an opening confirmation of the e-mail from the destination.**



**7. Specify the destination on the scanner screen.**

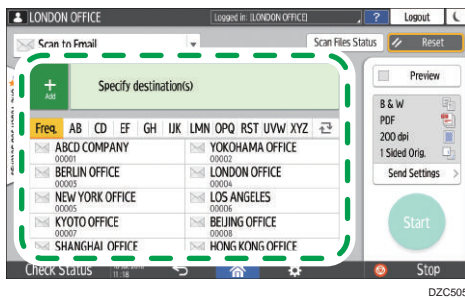

- To enter the e-mail address manually, select the destination from the destination history, or search for the destination in the address book, press **+**, and specify the destination.

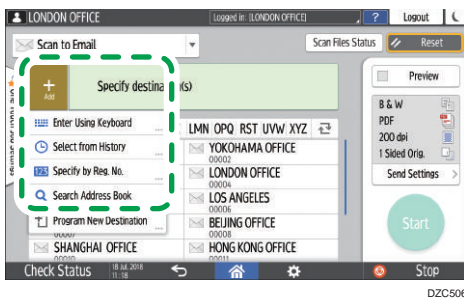

- Press **2** to specify the destination again or select [To], [Cc] or [Bcc].

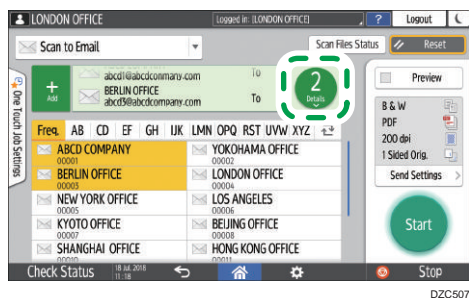

DZC507

8. Specify the scan settings according to the purpose of the scanned data.
  - page 159 "Scanning an Original with Suitable Quality and Density"
  - page 162 "Specifying the File Type or File Name When Scanning a Document"
9. Press [Start].

## Registering the E-mail Destination Specified When Sending an E-mail in the Address Book

5

When specifying an e-mail address by entering it manually or selecting it from the scanner records, you can register the e-mail address in the address book before sending an e-mail.

1. Press [Scanner] on the Home screen.

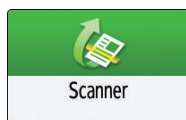

2. Select [Scan to Email] on the scanner screen.

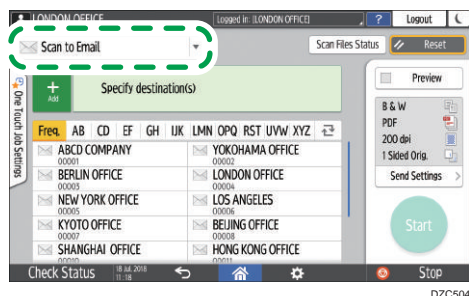

DZC504

3. Place the original on the scanner.
  - See "Placing an Original to Scan", User Guide (Full Version).
4. Press [Send Settings] on the scanner screen and configure the scan settings according to the purpose of the scanned data.
  - page 159 "Scanning an Original with Suitable Quality and Density"

page 162 "Specifying the File Type or File Name When Scanning a Document"

**5. Specify the destination.**

- When entering manually
  1. Press **+** and then select [Enter Using Keyboard].

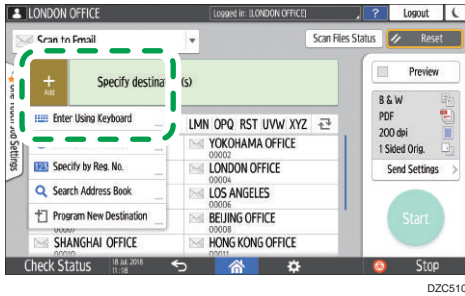

DZC510

2. Enter the e-mail address, and press **1**.

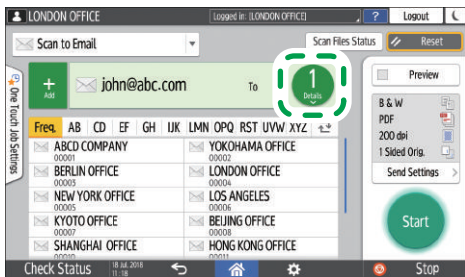

DZC511

3. Specify the e-mail address that was entered manually and press [Reg. to Add. Book].



DZC512

4. Enter the name and other additional information.

- When selecting from the transmission history
  1. Press **+** and then select [Select from History].





2. Press [Program] of the destination to register.

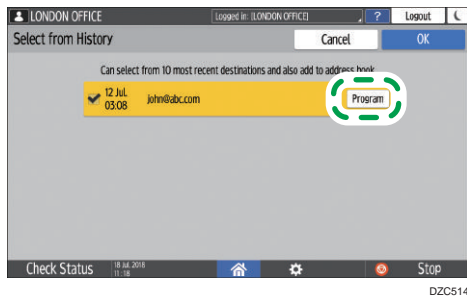

3. Register the name and other additional information.

6. Press [OK] to close the address book screen after registering the information.

7. Press [Start] on the scanner screen.

## Scanning Documents and Sending the Scanned Data to a Folder

To send the data of a scanned original to a shared folder on a computer, create the shared folder on the computer in advance and register the destination folder in the address book.

- You also need to configure the settings for connecting to the network from the machine.  
See "Connecting to a Wired LAN" and "Connecting to a Wireless LAN", User Guide (Full Version).
- You can add a folder destination in the address book easily using Scan to Folder Helper.  
See "Specifying the Destination of Send to Folder Using the Scan to Folder Helper App", User Guide (Full Version).

### Note

- Using the SMB 3.0 protocol, you can save a file in the folder that was configured individually to apply encryption.
- The scanned file can be also saved to an FTP server.
- See "Registering the Destination Folder to Use for Send to Folder", User Guide (Full Version).

## Printing the Check Sheet

Print the check sheet below to make a note of the setting values regarding the destination computer.

Check sheet		
No.	Items to check (example of the setting values)	Setting entry column
[1]	Computer name	
	DHCP server enable/disable setting	
	IP address	
[2]	Domain name/workgroup name	USERDNSDOMAIN:  USERDOMAIN:
	Computer login user name	

Check sheet		
No.	Items to check (example of the setting values)	Setting entry column
[3]	Computer login password	
[4]	Shared folder name on computer	

## Confirming the Computer Information (Windows)

Confirm the name, IP address, and other information of the computer used to create a shared folder, and write down the information on the check list.

1. Click [Start] on the computer and click [Windows System] ► [Command Prompt].
2. Enter "ipconfig/all" and press the [Enter] key.
3. Check the computer name, enable/disable status of the DHCP server and IP address, and write down the information in [1] on the check sheet.

```
C:\Users\WCL2310>ipconfig/all
Windows IP Configuration

Host Name . . . . . : LAPTOP-5955S09U
Node Type . . . . . : Hybrid
IP Routing Enabled. . . . . : No
WINS Proxy Enabled. . . . . : No

Ethernet adapter :

Connection-specific DNS Suffix . . :
Description . . . . . : Realtek PCIe GBE Family Controller
Physical Address. . . . . : 8C 8E 8C 8C 8C 8C
DHCP Enabled. . . . . : No
IP Address . . . . . : 192.168.0.152 (Preferred)
Subnet Mask . . . . . : 255.255.255.0
```

DZCS01

When the screen shown above is displayed, fill in the sheet as follow:

[1]	Computer name	LAPTOP-5955S09U
	DHCP server enable/disable setting	No
	IP address	192.168.0.152

DZCS23

4. Enter "set user" and press the [Enter] key.

Enter a space between "set" and "user".

5. Check the domain name, workgroup name and login user name, and write down the information in [2] on the check sheet.

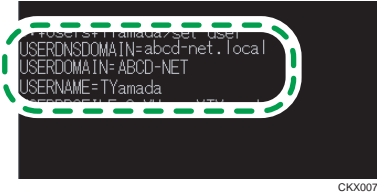

When the screen shown above is displayed, fill in the sheet as follow:

[2]	Domain name/workgroup name	USERDNSDOMAIN [ abcd-net.local ] USERDOMAIN [ ABCD-NET ]
	Computer login user name	TYamada

DZC524

"USERDNSDOMAIN" is not displayed when the login user who executed the command is a local user.

6. Check the login password on the computer, and write down the information in [3] on the check sheet.

The required information on the computer is confirmed. Now create a shared folder on your computer and specify the access permissions of the folder.

## Creating a Shared Folder (Windows)

Create a shared folder on the Windows Desktop and specify the access permissions of the folder.

1. Log on to Windows as a user with administrative privileges.
2. Create a new folder in Windows Explorer and write down the folder name in [4] on the check sheet.
3. Right-click the created folder, and then click [Properties].

4. On the [Sharing] tab, click [Advanced Sharing].

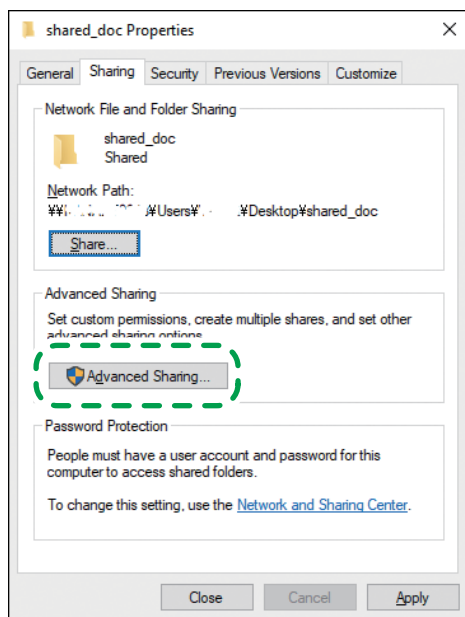

DZC318

5. Select the [Share this folder] check box, and then click [Permissions].

After completing the procedure, remove Everyone (unspecified user), and then add a user allowed access the folder. The user whose information is written down on the check sheet is used in the example shown below.

6. Select [Everyone] under [Group or user names], and then click [Remove].

7. Click [Add] ► [Advanced] ► [Object Types].

8. Select [Users], and then click [OK].

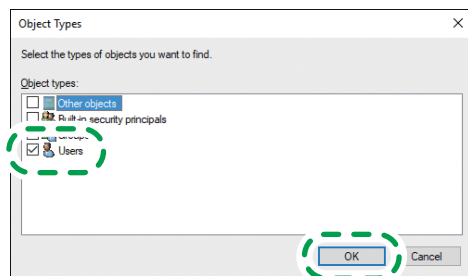

DZC319

9. Click [Locations], select the name of the domain or work group the user belongs to ([2] on the check sheet) and then click [OK].

10. Click [Advanced] ► [Find Now].

- From the Search Results, select the login user name of the computer to be added ([2] on the check sheet) and then click [OK].

When you cannot find a specific user, click [Columns], or right-click the [Search results] field, select [Select Column], and then select [Logon Name] from the [Available columns] list or [Pre-Windows 2000 Logon Name].

- Click [OK].
- Select the added user, and then select the [Allow] check box under [Permissions].

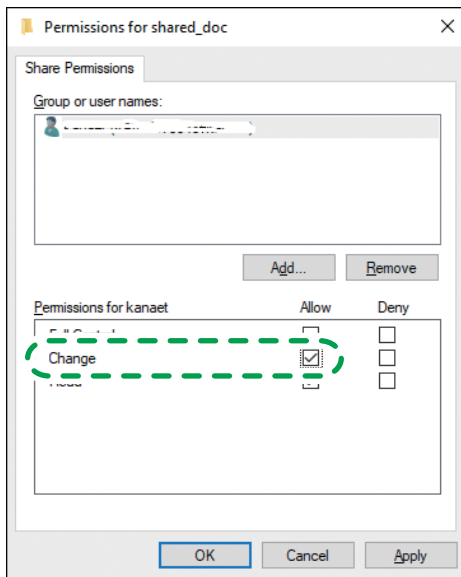

DZC320

- Click [OK] to close all windows.

The access permissions on the folder have been successfully configured. If you want to specify access permissions for the folder to allow other users or groups to access the folder, configure the folder as follows:

- Right-click the created folder and then click [Properties].
- Click [Edit...] on the [Security] tab.
- Click [Add] ► [Advanced].
- Select [Object Types] or [Locations] and click [Search].
- Select the user or group to assign permissions and click [OK].
- Click [OK].
- Select the added user, and then select the [Allow] check box under [Permissions].
- Click [OK] to close all windows.

## Confirming the Computer Information (OS X/macOS)

Confirm the name of the computer used to create the shared folder, login user name and other settings and write down the information on the check list.

1. Log on to OS X/macOS as a user with administrative privileges.
2. Click the Apple menu.
3. Click [System Report].
4. Click [Software] on the left pane and write down the displayed computer name in [1] and the user name in [2] on the check sheet.

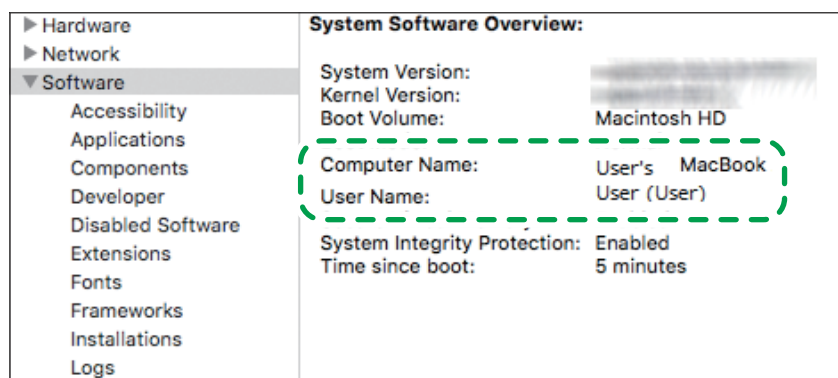

DZC525

When the screen shown above is displayed, fill in the sheet as follow:

[1]	Computer name	User's MacBook
[2]	Computer login user name	User

DZC526

5. Click the Apple menu and select [System Preferences].
6. In [Network], click [Ethernet] or [Wi-Fi] and write down the displayed IP address in [1] on the check sheet.

The required information on the computer is configured. Now create a shared folder.

## Creating a Shared Folder (OS X/macOS)

Create a shared folder and specify the access permissions of the folder.

1. Create a new folder and write down the folder name in [4] on the check sheet.
2. Click the Apple menu and select [System Preferences].

3. Click [Sharing], select the [File Sharing] check box and then click [Options].

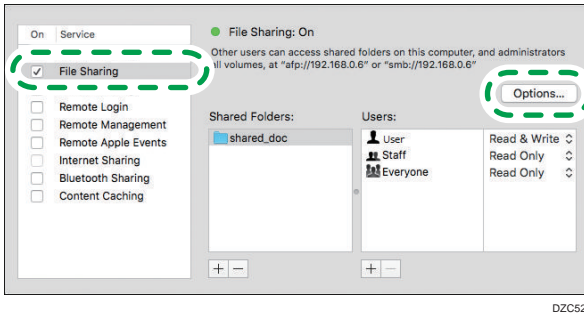

4. Select the check boxes of [Share files and folders using SMB] and the user account to use for file sharing and then click [Done].

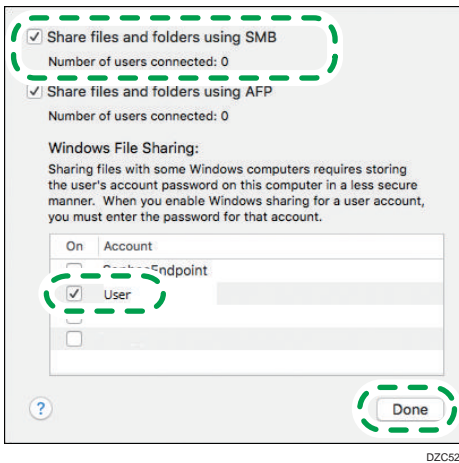

When the [Authentication] screen is displayed, enter the password of the selected account and then click [Done].

5. Click [+] below [Shared Folders] on the [Sharing] screen.

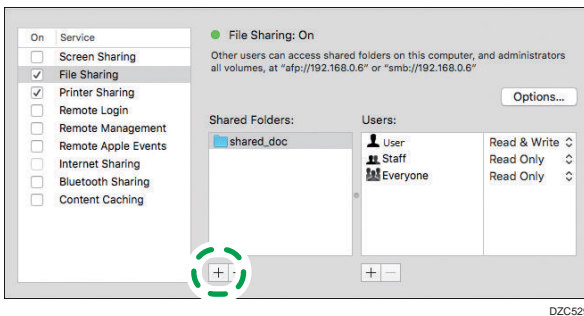

6. Specify the folder created in Step 1 and click [Add].



7. Select the folder added in Step 6 and confirm that the permission of the user to access the folder is set to "Read & Write".

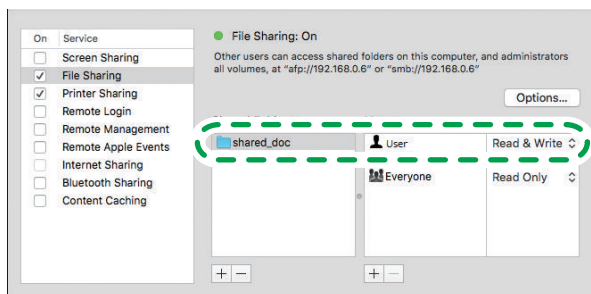

DZC530

## Registering the Created Shared Folder in the Address Book

This section describes the procedure for registering a shared folder created in Windows using the information on the check sheet as an example.

5

1. Press [Address Book] on the Home screen.

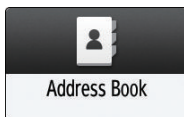

2. Press [Register] on the address book screen.

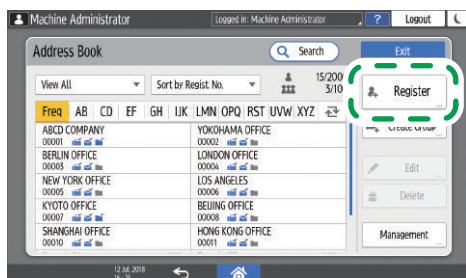

EDN022

The items displayed on the screen vary depending on the version of RICOH Always Current Technology that is implemented on the machine.

3. Enter the information of the destination in the input boxes displayed on the [Name] tab, and select the title to classify the destination.



4. Press the [Destinations] tab, and then press [Folder].

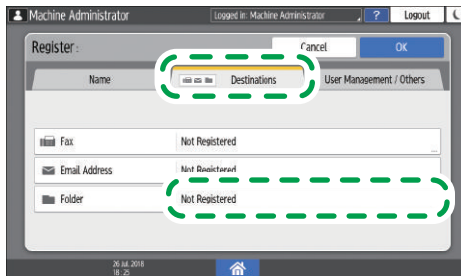

DZC133

5. Select [SMB (Send to Shared Folder on PC)] in [Protocol].

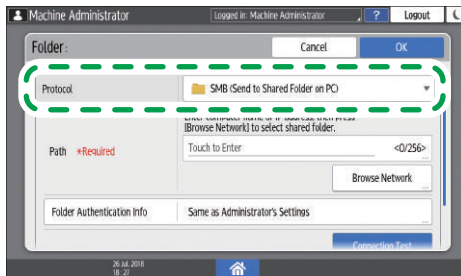

DZC134

6. Specify the network path to the shared folder in "Path".

**Entering the path name manually**

If the computer name is "YamadaPC" ([1] on the check sheet) and the shared folder name is "shared\_doc" ([4]), enter as follows:

\\YamadaPC\shared\_doc

**Selecting a folder from the list**

Enter the IP address or host name of the computer on which to search for a shared folder, press [Browse Network], and then select the destination folder.

7. Under [Folder Authentication Info], select [Specify Other Authentication Information] and then enter the name and password of the login user who will access the shared folder.

**8. Press Connection Test.**

When no connection is established, check the message that appears.

page 271 "When a Message Is Displayed While Using the Scanner Function"

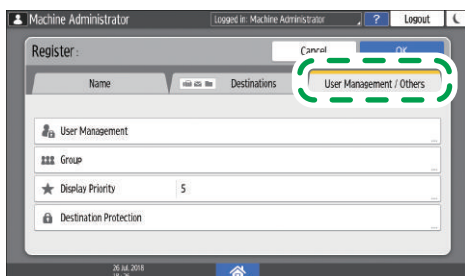
**9. Press [OK].****10. Press the [User Management / Others] tab and specify the settings as required.**

DZC131

**11. Press [OK].****12. Press [Home]  after specifying the settings.**

5

## Basic Procedure for Performing Send to Folder

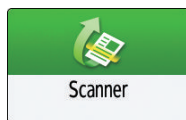
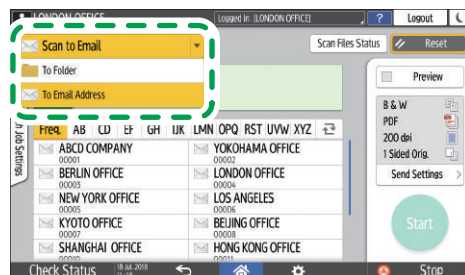
**1. Press [Scanner] on the Home screen.****2. Select [To Folder] on the scanner screen.**

DZC531

**3. Place the original on the scanner.**

See "Placing an Original to Scan", User Guide (Full Version).

**4. Press [Send Settings] and configure the scan settings according to the purpose of the scanned data.**

page 159 "Scanning an Original with Suitable Quality and Density"

page 162 "Specifying the File Type or File Name When Scanning a Document"

5. Press **[+]**, select **[Search Address Book]** or **[Specify by Reg. No.]** and then specify the shared folder that is registered in the address book.

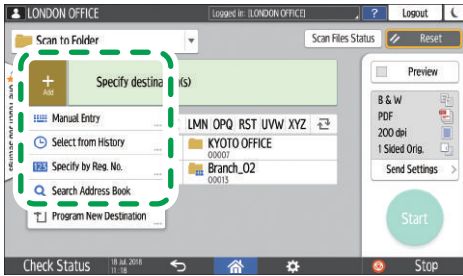

DZC533

- To enter the information manually, press **[+]**, and select **[Manual Entry]**. Select SMB as the protocol and enter the required information.
- To specify the destination again, press **[2]**.

5

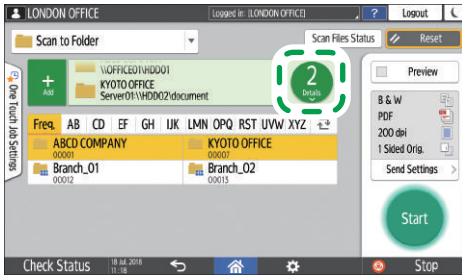

DZC536

6. Press **[Start]**.

# Scanning an Original with Suitable Quality and Density

Specify the quality and density to scan on the [Send Settings] screen.

1. Press [Scanner] on the Home screen.

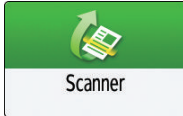

2. Place the original on the scanner.

See "Placing an Original to Scan", User Guide (Full Version).

3. Press [Send Settings] on the scanner screen and specify the original type (quality), density and resolution.

**When specifying the original type**



Original Type	Appropriate for
Black & White: Text	A document mainly composed of text in black and white. The original is scanned in two tones of black and white. <ul style="list-style-type: none"> <li>• Dropout Color The machine scans the original while erasing the specified color (Chromatic Color, Red, Green, Blue). To specify a color to erase more precisely, move  toward [Narrow] in the color range to erase.</li> </ul>
Black & White: Text/ Photo	A document with text and photos in black and white. The original is scanned in two tones of black and white.
Black & White: Text/ Line Art	A document with text and figures in black and white. The original is scanned in two tones of black and white.
Black & White: Photo	A document with figures and photos in black and white. The original is scanned in two tones of black and white.

Original Type	Appropriate for
Gray Scale	A document with figures and photos in black and white. The original is scanned as an image comprising many shades of gray.
Full Color: Text/Photo	A document mainly comprising text in color.
Full Color: Glossy Photo	An original in color such as silver-halide prints or pictures.
Full Color: Shiny Materials	A glossy original in color such as a precious metal or jewelry.
Auto Color Select	The machine determines the type of the original automatically while scanning. It may not be determined correctly depending on the scan settings and original content.

- You can select only [Gray Scale], [Full Color: Text / Photo], [Full Color: Glossy Photo], or [Full Color: Shiny Materials] when [High Compression PDF] is specified in [PDF Type] under [File Type].

page 162 "Specifying the File Type or File Name When Scanning a Document"

### When adjusting the density

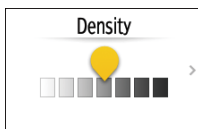

- Move  to the left or right to adjust the density. The colors in the scanned image darken as you move the slider to the right.
- Select the [Auto Density] check box to adjust the density automatically when scanning an original with a non-white background such as newspaper or a document that has show-through.
- You can specify the shading level of [Auto Density] in [Scanner Settings] ► [Scan Settings] tab ► [Background Density of ADS (Full Color)].

See "Scan Settings (Scanner Settings)", User Guide (Full Version).

See below when [Standard] is specified as the screen type of [Settings]. The names of the setting items may differ from the [Classic] screen type.

See "Scan (Scanner Settings)", User Guide (Full Version).

For details, see "Settings Menu Compatibility List (Classic to Standard Settings)", User Guide (Full Version).

### When specifying the resolution



- Select the resolution to use for scanning the original. Image quality improves as the resolution increases, but the size of the scanned data also increases.
  - To ensure the quality of scanned data, [100 dpi] cannot be selected in the following cases:
    - [High Compression PDF] is specified in [PDF Type] under [File Type] page 162 "Specifying the File Type or File Name When Scanning a Document"
    - [OCR] is selected in [PDF Detailed Settings] under [File Type] See "Scanning an Original as a PDF File with Embedded Text Data", User Guide (Full Version).
4. To send the scanned document to an e-mail address, press [Sender] and then specify the sender.
  5. Specify the destination, and press [Start].

# Specifying the File Type or File Name When Scanning a Document

Specify the settings in [Send Settings] on the scanner screen.

1. Press [Scanner] on the Home screen.

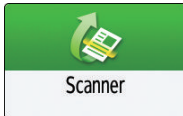

2. Place the original on the scanner.

See "Placing an Original to Scan", User Guide (Full Version).

3. Press [Send Settings] on the scanner screen.

4. Press [File Type], and select the file type to save the scanned document.

Press [Others] to display the detailed settings screen.

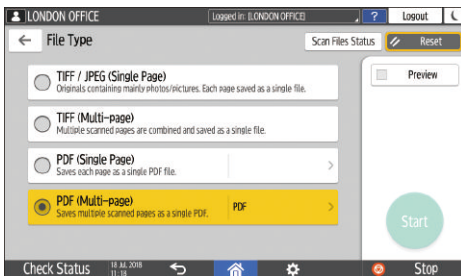

- TIFF/JPEG (Single Page): A separate image file is created for each single page.
  - When you specify Black & White in [Original Type], the scanned document will be sent in TIFF format.
  - When you specify Gray Scale or Full Color in [Original Type], the scanned document will be sent in JPEG format.
- TIFF (Multi-page): Multiple pages are combined into a single image file.
- PDF (Single Page): A PDF file is created for each single page.
- PDF (Multi-page): Multiple pages are combined into a single PDF file.

In addition to the normal PDF format, you can also specify [High Compression PDF] which reduces the file size while maintaining the legibility, or [PDF/A] which conforms to the international standard and is suitable for long-term storage.

5. To specify the file name, press [File Name] and enter the file name.

The file name is generated by combining the following three items:



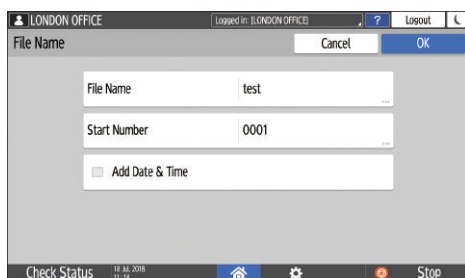

- File Name: Enter the string to use at the beginning of the file name.
- Start Number: Specify the starting number of a serial number that will be appended at the end of each file name when specifying a file format comprising a single page per file.
- Add Date & Time: Select this check box to add the "year, month, day, hour, and minute" the scanning is performed at the end of the file name.

#### 6. Specify the scan settings according to the purpose of the scanned data.

page 159 "Scanning an Original with Suitable Quality and Density"

#### 7. Specify the destination to send the scanned document and then press [Start].

##### ↓ Note

- You can also embed the security and digital signature settings, and text information in the PDF file.
- See "Scanning an Original as a PDF with Security Setting Specified" and "Scanning an Original as a PDF File with Embedded Text Data", User Guide (Full Version).
- There are requirements that must be met when scanning the original to create a file in the High Compression PDF format.
- page 298 "List of Specifications"
- You can change the number of digits in [Scanner Settings] ► [Send Settings] tab ► [No. of Digits for Single Page Files].
- See "Send Settings (Scanner Settings)", User Guide (Full Version).
- See below when [Standard] is specified as the screen type of [Settings]. The names of the setting items may differ from the [Classic] screen type.
- See "Sending Settings", User Guide (Full Version).
- For details, see "Settings Menu Compatibility List (Classic to Standard Settings)", User Guide (Full Version).



# 6. Document Server

## Storing Documents in Document Server

You can store documents scanned by the machine in the document server.

You can also store them using the printer driver.

See "Storing Documents to Print in the Machine", User Guide (Full Version).

### ★ Important

- Documents stored in the document server are deleted after three days (72 hours) in the factory-default configuration. Change the settings in [Auto Delete File in Document Server] to change the period until documents are deleted or to specify not to delete documents automatically.
- See "Changing the Storage Period of Document Server or Specifying an Indefinite Period", User Guide (Full Version).

1. On the Home screen, press [Document Server].



2. On the document server screen, press [To Scanning Screen].

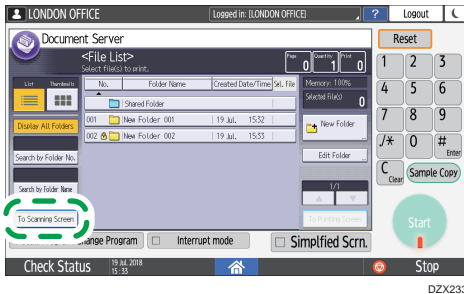

3. Specify the folder to store documents, the document name, and other settings.

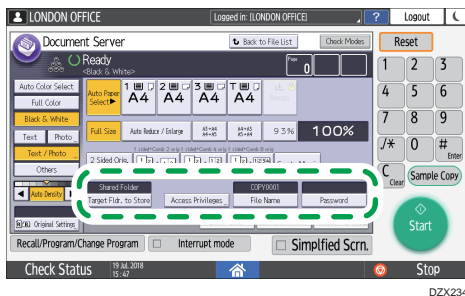

- Target Fldr. to Store: Select the "Shared Folder" created in the factory default configuration or "User Folder" created by a user to store the document.

To select a user folder, create it in advance.

See "Organizing Document Server Using Folders", User Guide (Full Version).

- User Name: Specify the user name displayed as the owner of the document. Select a user from the address book or enter the name.
- File Name: Specify the name of the scanned document. If you do not specify the file name, a name such as "COPY0001" or "COPY0002" is assigned automatically.
- Password: Specify the password required for printing the document.

#### 4. Place the original.

Place the original in the same way as in the Copy.

See "Placing an Original on the Scanner", User Guide (Full Version).

#### 5. Specify the scanning conditions such as color or size.

#### 6. Press [Start].

- When you place the original on the Auto Document Feeder (ADF), the folder list screen is displayed after scanning the original.
- When you place the original on the exposure glass, press [Finish Scanning] after scanning all originals to print to display the folder list screen.

#### Note

- When the machine scans a document of a size that cannot be detected automatically, the document is stored in a different size.
- You can specify whether to allow other users to read or edit the stored document.
- See "Specifying Access Privileges for Documents Stored in Document Server", User Guide (Full Version).
- When you do not want to delete stored documents, specify [Auto Delete File in Document Server] to [Off], and then store the documents. When [Specify Days] or [Specify Hours] are selected after documents have been stored, the documents will not be deleted. Only the documents stored after a setting change are deleted automatically.

# Printing Documents in Document Server

You can print the documents stored in the document server with the same settings, color mode, paper size, and other settings specified when the documents were scanned. You can also change the print settings or specify a page to print.

## Note

- You can print a document in the document server using Web Image Monitor.
- See "Accessing Documents in Document Server from a Web Browser", User Guide (Full Version).

## Printing a Document with the Settings Specified When Scanned

### Important

- When printing two or more documents at a time, the print settings specified for the first document are applied to all the remaining documents.
- Some of the selected documents may not be printed due to the difference in the size or resolution.

1. On the Home screen, press [Document Server].

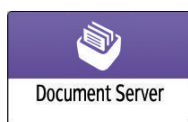

2. On the document server screen, select the desired folder.

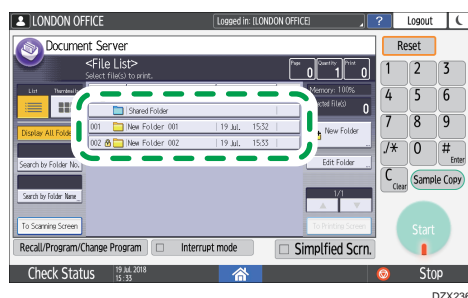

Press [Search by Folder No.] or [Search by Folder Name] to search for a folder.

### 3. Select the document to print.

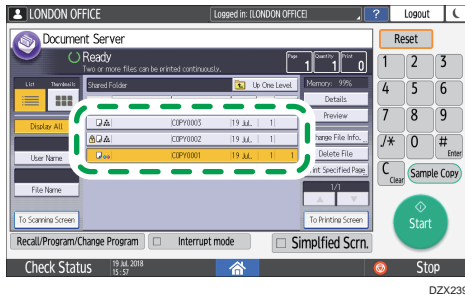

- Press [User Name] or [File Name] to search for a document.
- If the document is password protected, enter the password and press [OK].
- To print two or more copies, enter the quantity using the number keys.
- To print multiple documents at once, select the documents to print in the printing order. You can select up to 30 documents.
- After selecting the documents, you can confirm the selected documents by pressing [Order] to list them in the printing order.

### 4. Press [Start].

#### ↓ Note

- To stop printing, press [Stop] ► [Stop Printing].
- You can change the number of sets during printing. This function can be used only when the Sort function is selected in the printing conditions. To change the quantity while printing is in progress, press [Stop], enter the quantity, and then press [Continue Printing]. The quantity you can enter differs depending on when you press [Stop].

## Changing the Print Settings to Print a Document

### ★ Important

- When you select two or more documents to change the print settings, the first document keeps the changed contents after printing. The second document and later documents do not keep the changed contents and instead keep the settings of when they were stored.

#### 1. On the Home screen, press [Document Server].



**2. On the document server screen, select the desired folder.**

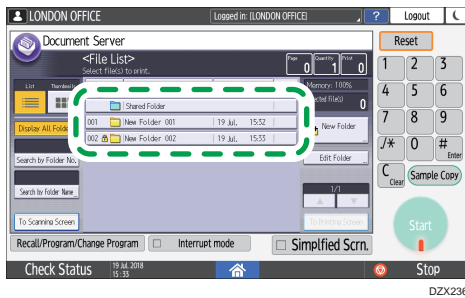

DZX236

**3. Select the document to print.**

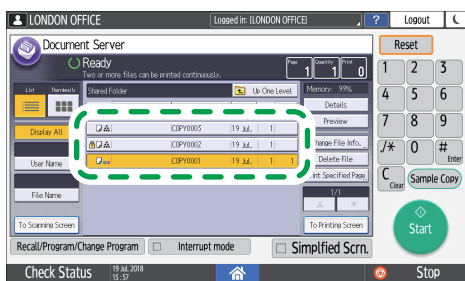

DZX239

6

- If the document is password protected, enter the password and press [OK].
- To print two or more copies, enter the quantity using the number keys.

**4. Press [To Printing Screen].**

**5. Change the print settings.**

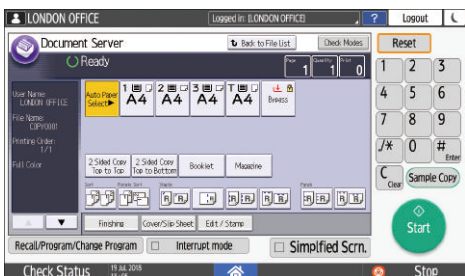

- When specifying Sort/Rotate Sort, you can make a partial print as a test and proceed to print the rest of the quantity by pressing [Sample Copy].
- Press [Back to File List] to return to the screen for selecting documents.

**6. Press [Start].**

## Specifying a Page to Print

1. On the Home screen, press [Document Server].



2. On the document server screen, select the desired folder.

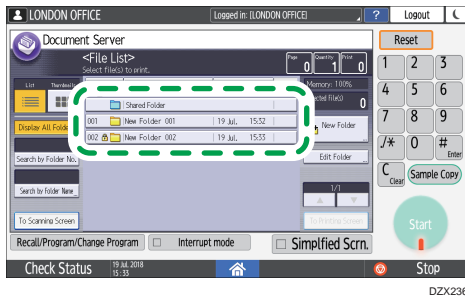

DZX236

3. Select the document to print and press [Print Specified Page].

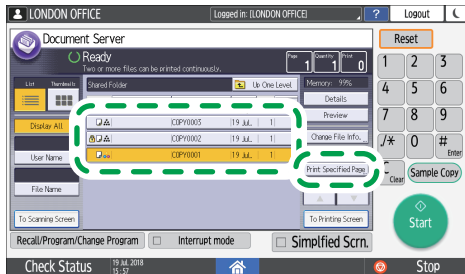

DZX241

- If the document is password protected, enter the password and press [OK].
- To print two or more copies, enter the quantity using the number keys.

4. Specify the page to print.

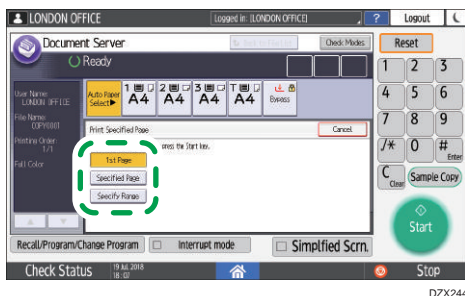

DZX244

- 1st Page: Select this to print the first page only. When you selected two or more documents, the first page of each document is printed.



- Specified Page: Select this to print the specified page.
- Specify Range: Enter the page printing starts in [Start Number] and the page printing ends in [End Number].

**5. Press [Start].**



# 7. Web Image Monitor

## Using Web Image Monitor

Web Image Monitor is a screen to confirm the machine status and settings on the computer.

When the machine and a computer can be connected to a network, you can access to Web Image Monitor by entering the IP address of the machine on the address bar of the Web browser.

### Accessing to Web Image Monitor

1. Enter the IP address of the machine in the address bar of the Web browser.

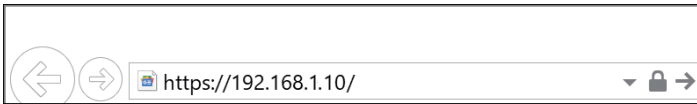

Example: when the IP address of the machine is "192.168.1.10"

- If SSL is specified  
https://192.168.1.10/
- If SSL is not specified  
http://192.168.1.10/

When you do not know whether SSL is specified on the machine, enter the address starting with https. When you fail the connection, enter the address starting with http.

When entering the IPv4 address, do not enter "0" for each segment. If "192.168.001.010" is entered, you cannot access the machine.

2. Confirming the machine status or settings on the top page of Web Image Monitor.

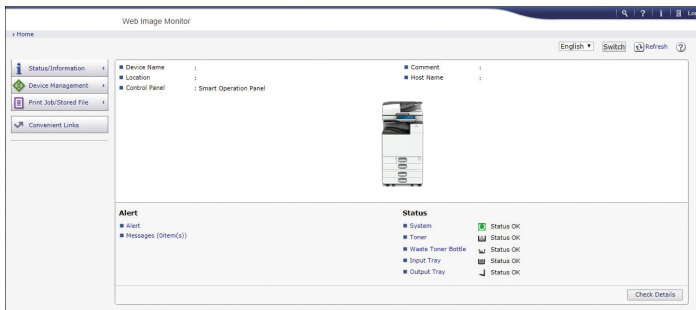

The machine status and remaining amount of consumables are displayed.

To change the settings, click [Login] at the top right on the screen and enter the User Name and Password.

**Recommended Web Browser**

Windows	OS X/macOS
Internet Explorer 11 or later	Safari 3.0 or later
Firefox 52 or later	Firefox 52 or later
Google Chrome version 50 or later	Google Chrome version 50 or later
Microsoft Edge 20 or later	-

- You can use the screen reader software JAWS 7.0 or later on Internet Explorer.

**Note**

- When you use a DNS server or WINS server, you can use Host Name instead of IP address to connect the server.
- When the screen is distorted or the operation is unstable, confirm that "JavaScript" or "Use Cookies" is specified to Active on the computer.
- When using Host Name under Windows Server 2008 or later in the IPv6 environment, resolve Host Name in the external DNS server. You cannot use the host file.
- When specifying the settings from Web Image Monitor, do not log in to the machine from the control panel. The setting value may not be reflected.

**What You Can Do on the Web Image Monitor**

Items displayed on the Web Image Monitor and settings depend whether the machine is logged in.

- When not logged in  
The machine status, settings, and job status are displayed. You can browse the settings of the machine but cannot change them.
- When logged in (as a user)  
Log in as a user registered in the Address Book. The users can operate the jobs that they executed and change a part of settings of the machine.
- When logged in (as an Administrator)  
The administrator can change all settings of the machine.

**What you can do**

Function	Not logged in	User	Administrator
Machine status	✓	✓	✓

Function	Not logged in	User	Administrator
Machine settings	✓ *1	✓ *1	✓
Machine setting change	-	✓ *1	✓
Job list	✓	✓	✓
Job history	✓	✓	✓
Access to Address Book	-	✓	✓
File operation in Document Server	-	✓	✓
Network settings	-	✓ *1	✓
Network settings change	-	✓ *1	✓
Cancel printing	-	-	✓
Security settings	-	-	✓

✓: Available -: Not available

\*1 Depending on the Administrator settings

## Web Image Monitor Screen

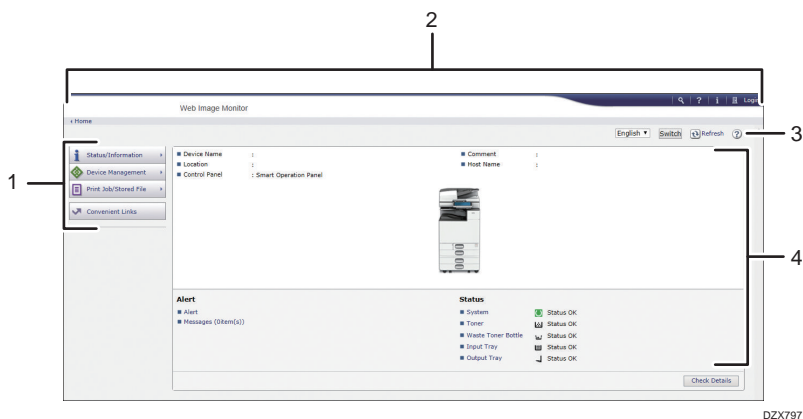

### 1. Menu

Menu items described below are displayed.

- Status/Information: Displays the machine status, option configuration, counter, and job status.
- Device Management: Manages the machine settings and Address Book.
- Print Job/Stored File: Operates the files stored in the printer driver or document server.

- Convenient Links: Displays the link to the Favorite URL.

**2. Header**

An icon to link to the Login screen is placed at the top right on the screen. The Help, Version Information, and Keyword Search buttons are also displayed.

**3. Refresh/Help**

 (Refresh): Update the information in the work area.

 (Help): View or download Help file contents.

**4. Main Area**

The machine status and settings are displayed.

---

## Specifying Web Image Monitor Help



---



Web Image Monitor has Help to describe the function of setting items. When you use Help for the first time, you can select to read online Help or to download Help File.



**View Online Help Now**

You can view the latest Web Image Monitor Help on the Internet.

**Download Help File**

You can download Web Image Monitor Help to the computer and view it. When you store the downloaded Help file in the Web server and assign to the Help button ( ), you can view the Help without connecting to the Internet.

To assign the downloaded Help file to the Help button ( ), specify the path to the Help file following the procedure below.

1. Log in to Web Image Monitor as an Administrator.
2. Click the Help button ( ) at the top right on the screen.

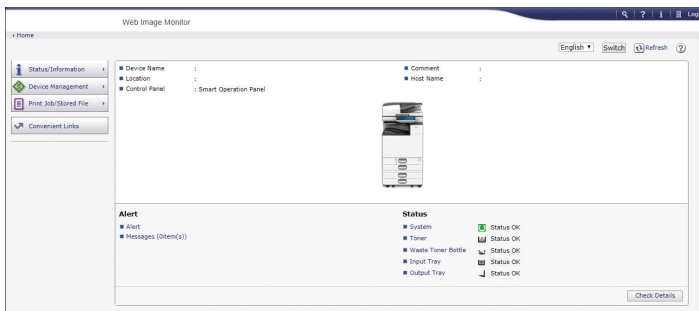

3. Select the operating system and displayed language, and then click [Download].
4. Unzip the downloaded zip file and store it in the Web server.
5. Click [Configuration] on the "Device Management" menu on Web Image Monitor.
6. Click [Webpage] under the "Webpage" category.

**7. Enter the path to the Help file stored in the Web server in "URL" under "Set Help URL Target".**

For example, when URL of the Help File is "http://a.b.c.d/HELP/JA/index.html", enter "http://a.b.c.d/HELP/".

**8. Click [OK].**

**9. After completing the procedure, log out and finish Web Image Monitor.**





# 8. Adding Paper and Toner

## Loading Paper into the Paper Tray

The method of loading paper varies for each tray type.

### CAUTION

- When loading paper, take care not to trap or injure your fingers.

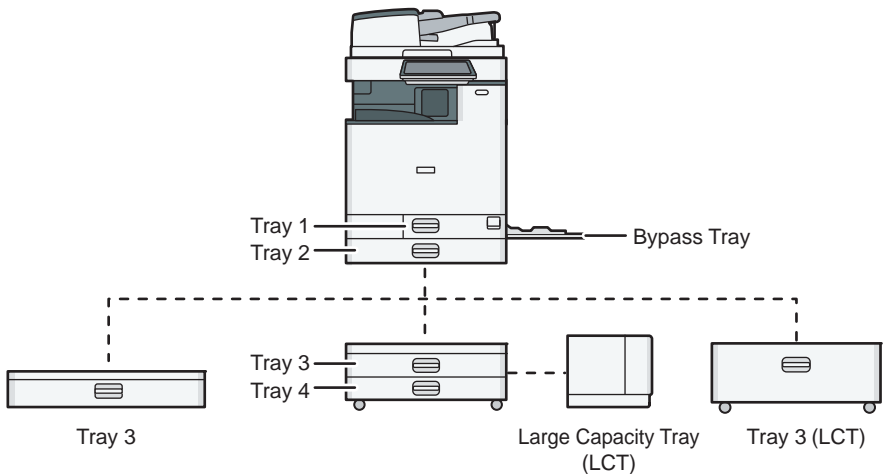

DZX114

- Before loading paper into a tray, check the paper size and type that can be loaded in the tray, and confirm the paper size that is automatically detected.  
page 194 "Recommended Paper Sizes and Types"
- When loading paper of a size that is not automatically detected, specify the paper size in [Tray Paper Settings] of [Settings].  
page 191 "Specifying the Paper Size That Is Not Automatically Detected"
- To load thin paper, thick paper or other special paper, specify the paper type or thickness in [Tray Paper Settings] of [Settings].  
See "Tray Paper Settings", User Guide (Full Version).  
See below when [Standard] is specified as the screen type of [Settings]. The names of the setting items may differ from the [Classic] screen type.  
See "Tray/Paper Settings", User Guide (Full Version).  
For details, see "Settings Menu Compatibility List (Classic to Standard Settings)", User Guide (Full Version).

- When loading paper on a tray which has a few sheets of paper, multiple sheets of paper may be fed at once from the tray. Take out all sheets, fan the sheets, and then load them again.
- You may hear the sound of rubbing paper. This is not a malfunction.

## Loading Paper into Tray 1 to 4

Adjust the side and end fences according to the paper size. When loading paper larger than A3, also change the position of the auxiliary side fence.

### ★ Important

- Do not stack paper over the limit mark. If you load paper over the limit mark, the printed images may become slanted or a paper jam may occur.

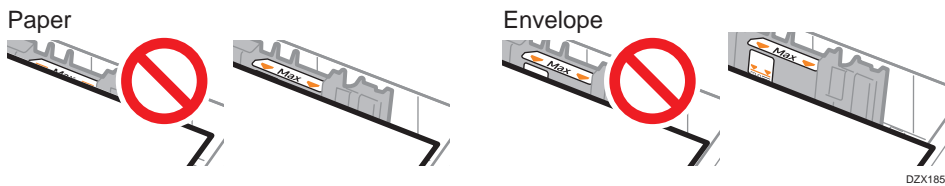

Load paper into every tray in the same way. In the following example procedure, Tray 2 is used.

1. Pull the tray out carefully.

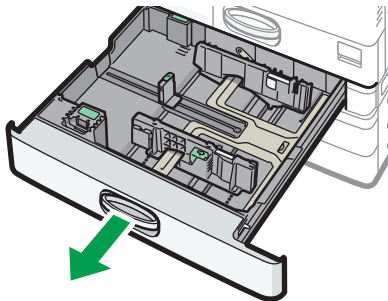

2. While pressing the release lever of the side fence, slide the side fences outward.

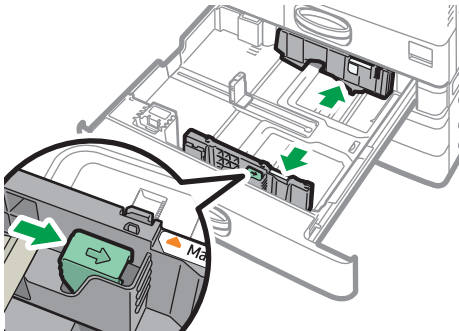

DZW133

3. To load paper larger than A3, pull the tray out completely and then change the positions of the two auxiliary side fences.

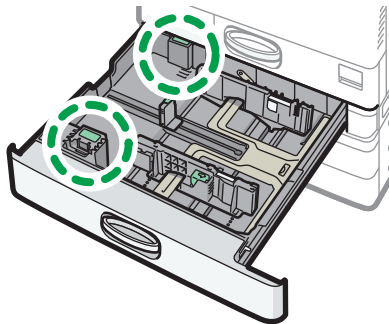

DZW186

1. Press the concave part to distort the auxiliary side fence (1), and then take it out of the tray (2).

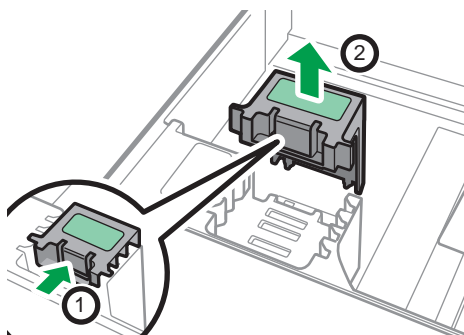

DZW134

2. Put the auxiliary side fence into the groove for the paper size to use.

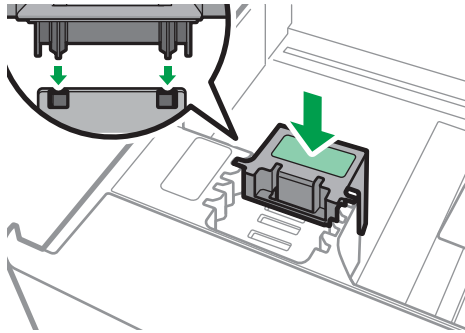

DZW116

\* 1 You do not need to use the auxiliary side fence when loading B4 paper.  
Change the position of the auxiliary side fence in the back in the same way.

**4. While pressing the release lever of the end fence, slide the end fence outward.**

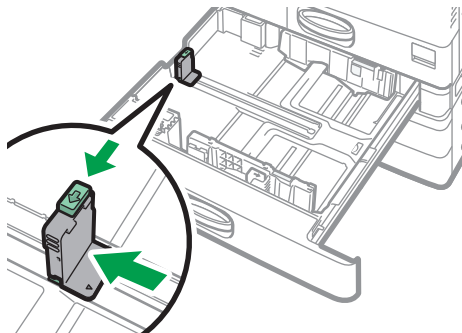

DZW136

If the end fence is fixed with the stopper, rotate the fixing screw of the stopper 90 degrees counterclockwise with a coin or similar object and remove the stopper.

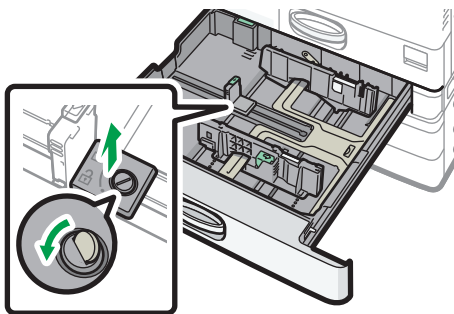

DZW183

**5. Square the paper and load it with the print side facing up.**

Fan sheets before loading so that multiple sheets of paper do not stick to each other and are not fed at once.

Do not stack paper over the limit mark.

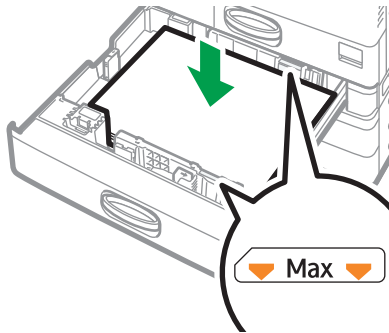

DZW137

**6. While pressing the release lever, adjust the side and end fences to the paper size.**

Do not leave spaces between the paper and fences.

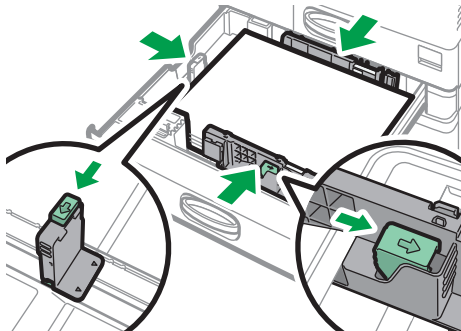

DZW138

To fix the end fence, engage the two projections of the stopper with the holes on the end fence, and then tighten the fixing screw by rotating it 90 degrees clockwise with a coin or similar object.

- If you will not fix the end fence, put the stopper in the position as shown in the illustration, and then rotate the fixing screw 90 degrees clockwise with a coin or similar object.

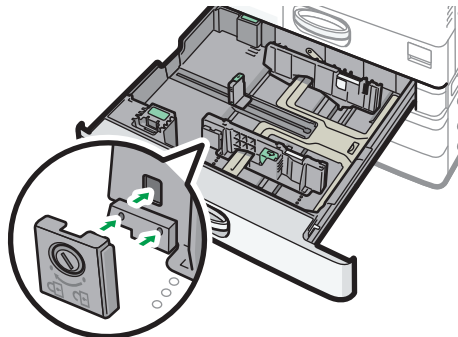

DZW184

**7. Push the tray in the original position carefully.**

To return the completely pulled out tray to the original position, push the tray straight in. If the paper tray is damaged, it may cause a paper jam. Also, if you push the tray forcibly, the side fence of the tray may be moved.

**Note**

- Tray 1 does not have the auto detect function for the paper size. On the control panel, specify the paper size to use.
- page 191 "Specifying the Paper Size That Is Not Automatically Detected"
- You can load envelopes into Tray 2 to 4.
- page 206 "Envelope Orientation and Recommended Status"

## Loading Paper into the Bypass Tray

Use the bypass tray to load paper of a size that cannot be loaded into Tray 1 to 4, such as transparency film and label paper (adhesive labels).

The maximum number of sheets you can load into the bypass tray depends on the paper type.

page 194 "Recommended Paper Sizes and Types"

**Important**

- **Do not stack paper over the limit mark. If you load paper over the limit mark, the print image may be slanted or the paper may be jammed.**

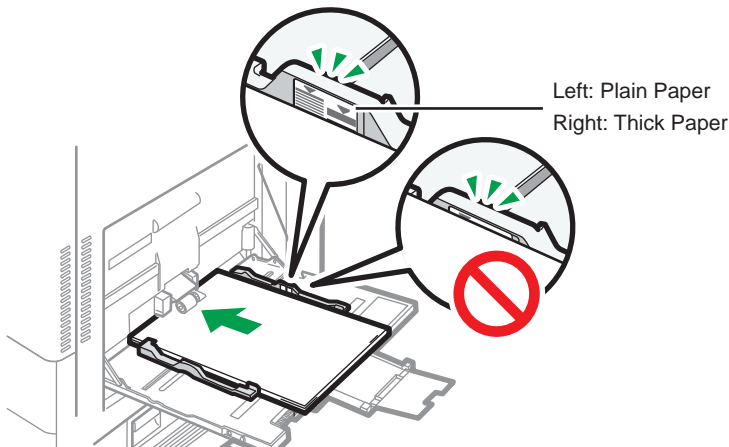

DZX190

### 1. Open the bypass tray.

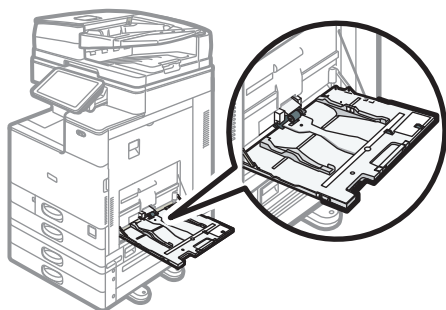

DZW117

When loading paper larger than the bypass tray (longer than A4 paper in landscape orientation), pull out the extender.

### 2. Load the paper with the print side down, and push it in lightly until you hear a beep.

Fan sheets before loading so that multiple sheets of paper do not stick to each other and are not fed at once.

When loading envelopes, postcards, or letterhead paper, confirm the orientation, face and back, or location of flaps.

- page 206 "Envelope Orientation and Recommended Status"
- page 209 "Loading Orientation-fixed Paper or Two-sided Paper"

### 3. Align the paper guides to the paper size.

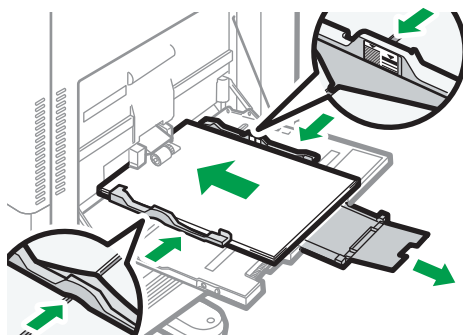

DZW139

#### ↓ Note

- To load paper on the bypass tray, it is better to orient it in the direction of .

#### Loading paper into the banner paper guide tray

##### 1. Turn the knob clockwise until its triangle mark stops at the unlock mark.

Be careful that your hand does not hit the banner paper guide tray when turning the knob.

If you cannot turn the knob, turn it while pushing the banner paper guide tray toward the machine.

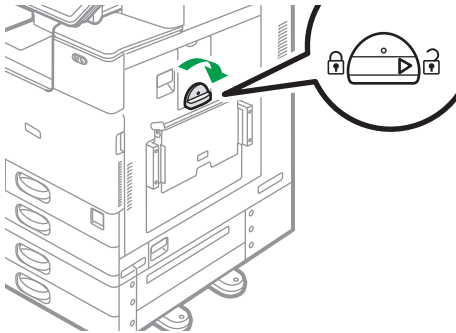

DZC911

2. Hold the handle in one hand while supporting the back of the bypass tray with the other hand, and then open the bypass tray slowly.

Open the bypass tray until it is parallel to the floor.

When loading paper that has a horizontal width of 148–457.2 mm (5.83–18.00 inches), proceed to Step 4.

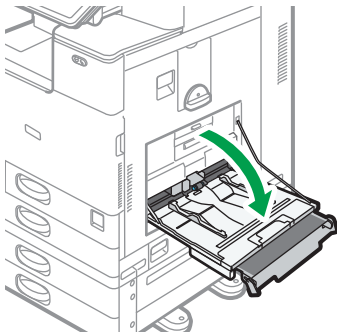

DZC912

3. Raise the banner paper guide tray, and then insert it into the bypass tray until it becomes stable.

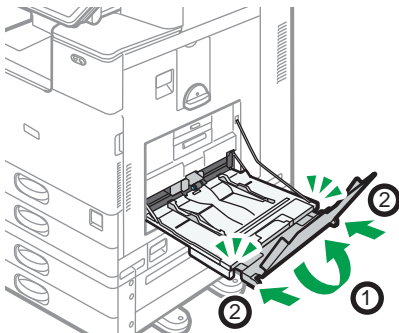

DZC913

4. Load the paper face down until you hear the beep.



### 5. Align the paper guides to the paper size.

If the guides are not flush against the paper, images might be skewed or paper misfeeds might occur.

When loading paper that has a horizontal width of 148–900.0 mm (5.83–35.5 inches), proceed to Step 7.

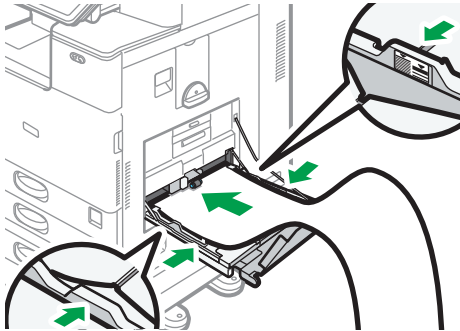

DZC914

### 6. Open the subtray, and then raise the minor banner paper guide tray.

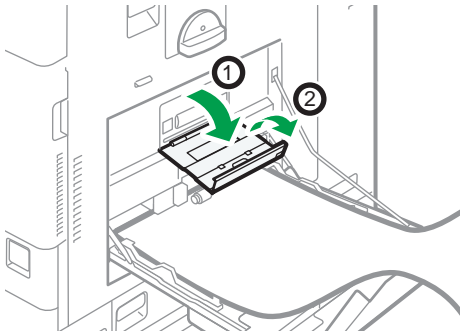

DZC915

### 7. Set the leading edge of the paper according to the paper size.

- When using paper that has a horizontal width of 1,200 mm (47.3 inches), curl the paper so that its leading edge touches the minor banner paper guide tray.

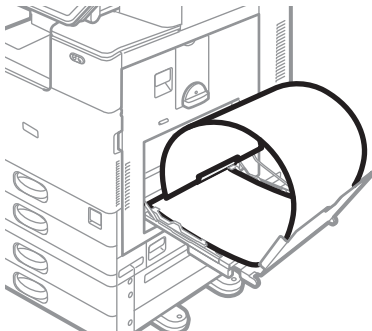

DZC916

- When using paper that has a horizontal width of 900 mm (35.5 inches), curl the paper so that its leading edge touches the side of the machine.

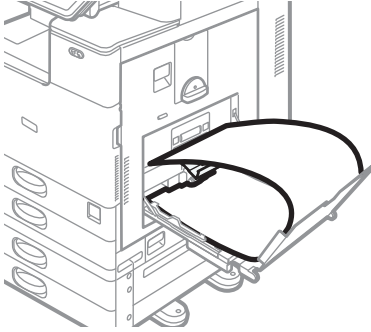

DZC917

- When using paper that has a horizontal width of 457.2–900 mm (18.00–35.5 inches), set the paper so that its leading edge protrudes from the banner paper guide tray.

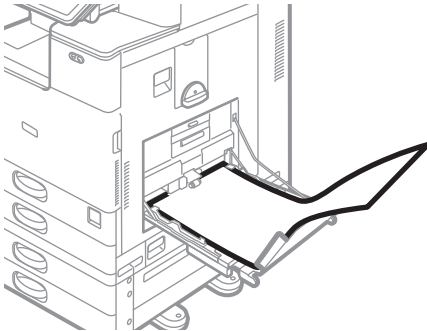

DZC918

- When using paper that has a horizontal width of 148–457.2 mm (5.83–18.00 inches), set the paper as loading paper into the bypass tray.

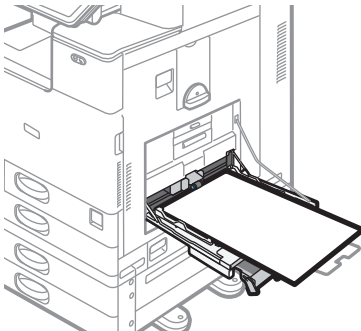

DZC919

**Note**

- You can load up to 10 sheets of paper that has a horizontal width of 457.2–1,260 mm (18.00–49.60 inches) into the banner paper guide tray. When loading multiple sheets

of paper into the banner paper guide tray, be sure to separate them one by one before loading them.

- When [Notification Sound] is set to [No Sound], it does not sound if you load paper into the banner paper guide tray.

### Closing the banner paper guide tray

1. Remove any paper that is loaded.
2. Fold the subtray up.
3. Slide the paper guides outward to the maximum width.
4. Fold up the banner paper guide tray.
5. Hold the handle in one hand while supporting the back of the bypass tray with the other hand, and then close the bypass tray slowly.
6. Turn the knob counter-clockwise until its triangle mark stops at the lock mark.

## Loading Paper into Tray 3 (LCT)

Tray 3 (LCT) can hold A4 portrait paper only. Contact a service representative to set paper of 8 1/2 × 11 size.

- You can load paper in both the left and right sides of the tray.
- The paper in the right side of Tray 3 (LCT) is fed to the machine. When the paper loaded in the right side of Tray 3 (LCT) runs out, paper on the left side is automatically shifted to the right, and the tray continues to feed the paper.
- While printing from Tray 3 (LCT), you can pull out the left side of the tray and load new paper.

### ★ Important

- When the paper loaded in the right side of Tray 3 (LCT) runs out, paper on the left is automatically shifted to the right. Do not pull out Tray 3 (LCT) while you hear the sound of moving paper.

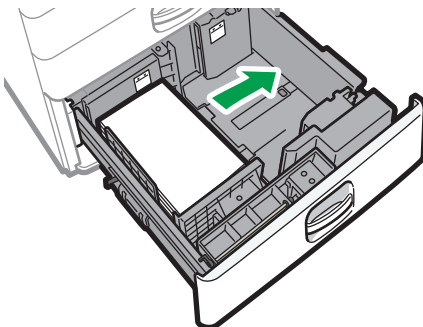

DZW120

**1. Pull Tray 3 (LCT) out carefully.**

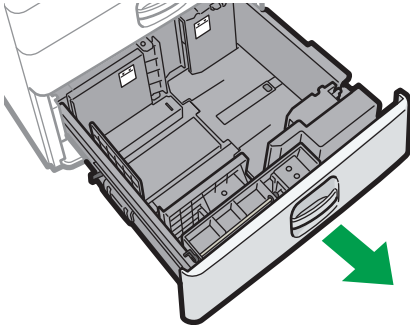

DZW135

**2. Square the paper and load it with the print side facing up.**

Fan sheets before loading so that multiple sheets of paper do not stick to each other and are not fed at once.

For the right stack, align the right edge of the paper with the right edge of the tray. For the left stack, align the left edge of the paper with the left edge of the tray.

Do not stack paper over the limit mark.

**When the whole tray can be pulled out**

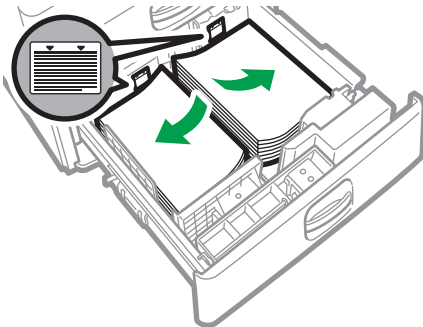

DZW140

**When half of the tray can be pulled out**

Load 30 or more sheets of paper in the left half of the tray.

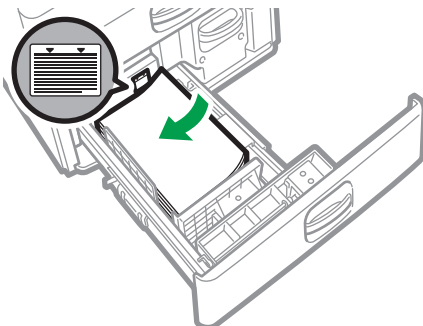

DZW141

- Carefully push Tray 3 (LCT) fully in.

## Loading Paper into the Large Capacity Tray (LCT)

The Large Capacity Tray (LCT) can hold A4 portrait paper only. Contact a service representative to set paper of B5 or 8<sup>1</sup>/<sub>2</sub> × 11 size.

- Open the cover of the Large Capacity Tray (LCT).

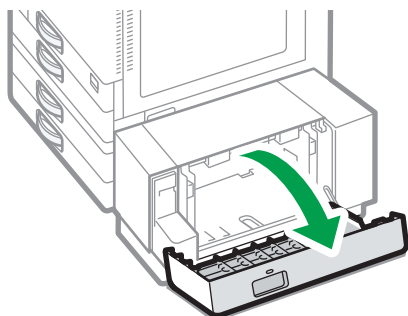

DZW145

- Square the paper and load it with the print side facing down.

Fan sheets before loading so that multiple sheets of paper do not stick to each other and are not fed at once.

Do not stack paper over the limit mark.

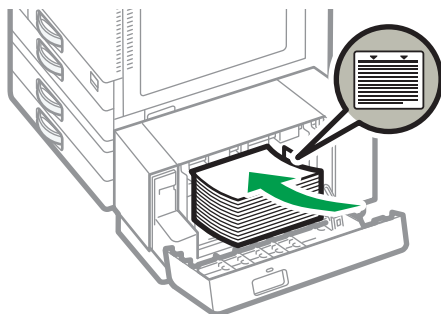

DZW146

- Close the cover of the Large Capacity Tray (LCT).

## Specifying the Paper Size That Is Not Automatically Detected

To load paper into Tray 1, or to load paper of a size that is not automatically detected into Tray 2 to 4, specify the paper size on the control panel.

The procedure is described using the [Classic] screen type of [Settings] as an example. When you are using the [Standard] screen type, specify the settings in the screen below.

- [Tray/Paper Settings]

The names of the setting items may differ on the setting screen for [Classic] and [Standard] screen types. For details, see "Settings Menu Compatibility List (Classic to Standard Settings)", User Guide (Full Version).

**1. On the Home screen, press [Settings].**



**2. Press [Tray Paper Settings].**

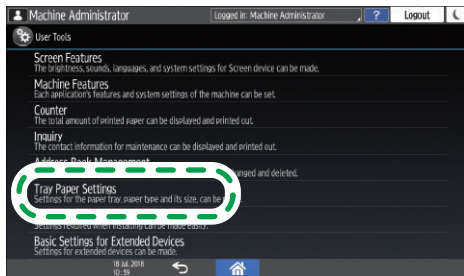

DZX121

**3. Select the paper size specified in "Paper Size Setting" of the tray with loaded the paper. Select from [Tray Paper Size: Tray 1] to [Tray Paper Size: Tray 4] or [Printer Bypass Paper Size].**

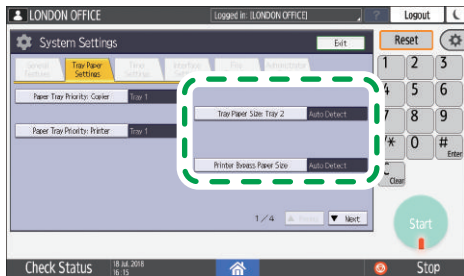

DZX122

**4. Select the size of the loaded paper.**

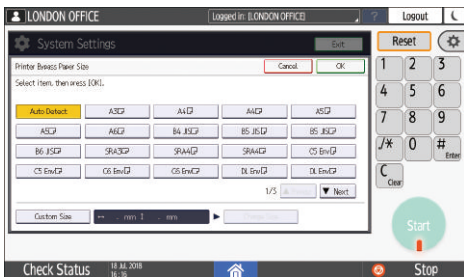

**5. Press [OK].**

6. After completing the configuration, press [Home] ()

 **Note**

- To use paper that can be detected automatically after using paper that cannot be detected automatically, restore the setting of Auto Detect. To restore the setting of Auto Detect, load the paper again, operate steps 1 to 4, select [Auto Detect], and then press [OK].





## Recommended Paper Sizes and Types

The recommended paper sizes and types for each tray are as described below.

### ↓ Note





- When performing multiple sheet feeding, fan sheets thoroughly or load sheets one by one from the bypass tray.
- When you load the following types of paper, you may hear a buzzing sound. This does not affect the performance.
  - Transparency film
  - Translucent paper
  - Postcards
- The printing speed may be lower depending on the paper size or paper type.











### Tray 1

Paper type and weight	Paper size	Paper capacity
60–300 g/m <sup>2</sup> (16 lb. Bond–110 lb. Cover) Plain Paper 1–Thick Paper 4	 Region <b>A</b> A4   Region <b>B</b> 8 <sup>1</sup> / <sub>2</sub> × 11 	550 sheets



## Tray 2

Paper type and weight	Paper size	Paper capacity
60–300 g/m <sup>2</sup> (16 lb. Bond–110 lb. Cover) Plain Paper 1–Thick Paper 4	<p>Paper sizes that can be detected automatically*<sup>1</sup>:</p> <p> <b>Region A</b></p> <p>A3□, A4□□, A5□, B4 JIS□, B5 JIS□□, 8<sup>1</sup>/<sub>2</sub> × 11□, SRA3□</p> <p> <b>Region B</b></p> <p>A4□, A5□, B5 JIS□, 11 × 17□, 8<sup>1</sup>/<sub>2</sub> × 14□, 8<sup>1</sup>/<sub>2</sub> × 11□□, 7<sup>1</sup>/<sub>4</sub> × 10<sup>1</sup>/<sub>2</sub>□, 12 × 18□, 8<sup>1</sup>/<sub>2</sub> × 13<sup>2</sup>/<sub>5</sub>□</p>	550 sheets
60–300 g/m <sup>2</sup> (16 lb. Bond–110 lb. Cover) Plain Paper 1–Thick Paper 4	<p>Select the paper size using the Tray Paper Settings menu*<sup>1</sup>:</p> <p> <b>Region A</b></p> <p>A5□, A6□, B6 JIS□, 11 × 17□, 8<sup>1</sup>/<sub>2</sub> × 14□, 8<sup>1</sup>/<sub>2</sub> × 13□, 8<sup>1</sup>/<sub>2</sub> × 11□, 8<sup>1</sup>/<sub>4</sub> × 14□, 8<sup>1</sup>/<sub>4</sub> × 13□, 8 × 13□, 8 × 10□, 7<sup>1</sup>/<sub>4</sub> × 10<sup>1</sup>/<sub>2</sub>□□, 5<sup>1</sup>/<sub>2</sub> × 8<sup>1</sup>/<sub>2</sub>□, 8K□, 16K□, 12 × 18□, 11 × 15□, 10 × 14□, 8<sup>1</sup>/<sub>2</sub> × 13<sup>2</sup>/<sub>5</sub>□</p> <p> <b>Region B</b></p> <p>A3□, A4□, A5□, A6□, B4 JIS□, B5 JIS□, B6 JIS□, 8<sup>1</sup>/<sub>2</sub> × 13□, 8<sup>1</sup>/<sub>4</sub> × 14□, 8<sup>1</sup>/<sub>4</sub> × 13□, 8 × 13□, 8 × 10□, 7<sup>1</sup>/<sub>4</sub> × 10<sup>1</sup>/<sub>2</sub>□, 5<sup>1</sup>/<sub>2</sub> × 8<sup>1</sup>/<sub>2</sub>□, 8K□, 16K□□, 11 × 15□, 10 × 14□, SRA3□</p>	550 sheets





















Paper type and weight	Paper size	Paper capacity
60–300 g/m <sup>2</sup> (16 lb. Bond–110 lb. Cover) Plain Paper 1–Thick Paper 4	Custom size *2 *3:  <b>Region A</b> Vertical: 90.0–320.0 mm Horizontal: 148.0–457.2 mm  <b>Region B</b> Vertical: 3.55–12.59 inches Horizontal: 5.83–18.00 inches	550 sheets
Envelopes	Select the paper size using the Tray Paper Settings menu: 4 <sup>1</sup> / <sub>8</sub> × 9 <sup>1</sup> / <sub>2</sub>  , 3 <sup>7</sup> / <sub>8</sub> × 7 <sup>1</sup> / <sub>2</sub>   , C5 Env  , C6 Env  , DL Env 	<ul style="list-style-type: none"> <li>: 50 sheets</li> <li>: Double flap: 15 sheets Single flap: 25 sheets</li> </ul>



\*1 Adjust the supporting side fence before loading B4 JIS , A3 , SRA3 , 11 × 17 , or 12 × 18  paper.

\*2 Set the supporting side fence position to SRA3  before loading paper with a vertical length of 297 mm or longer and a horizontal length of over 335 mm.

\*3 When loading paper with a vertical length of more than 304.8 mm (12.0 inches) in Trays 2–4, use paper that has a horizontal width of 450 mm (17.8 inches) or less.



### Lower Paper Trays (Trays 3, 4)





Paper type and weight	Paper size	Paper capacity
60–300 g/m <sup>2</sup> (16 lb. Bond–110 lb. Cover) Plain Paper 1–Thick Paper 4	Paper sizes that can be detected automatically *1:  <b>Region A</b> A3  , A4  , A5  , B4 JIS  , B5 JIS  , 8 <sup>1</sup> / <sub>2</sub> × 11   *2  <b>Region B</b> A4  , A5  , B5 JIS  , 11 × 17   , 8 <sup>1</sup> / <sub>2</sub> × 14  , 8 <sup>1</sup> / <sub>2</sub> × 11   , 7 <sup>1</sup> / <sub>4</sub> × 10 <sup>1</sup> / <sub>2</sub>  , 12 × 18  *2, 8 <sup>1</sup> / <sub>2</sub> × 13 <sup>2</sup> / <sub>5</sub> 	550 sheets







Paper type and weight	Paper size	Paper capacity
<p>60–300 g/m<sup>2</sup> (16 lb. Bond–110 lb. Cover) Plain Paper 1–Thick Paper 4</p>	<p>Select the paper size using the Tray Paper Settings menu<sup>*1</sup>:</p> <p> <b>Region A</b></p> <p>A5☐, A6☐, B6 JIS☐, 11 × 17☐, 8<sup>1</sup>/<sub>2</sub> × 14☐, 8<sup>1</sup>/<sub>2</sub> × 13☐, 8<sup>1</sup>/<sub>2</sub> × 11☐, 8<sup>1</sup>/<sub>4</sub> × 14☐, 8<sup>1</sup>/<sub>4</sub> × 13☐, 8 × 13☐, 8 × 10☐, 7<sup>1</sup>/<sub>4</sub> × 10<sup>1</sup>/<sub>2</sub>☐☐, 5<sup>1</sup>/<sub>2</sub> × 8<sup>1</sup>/<sub>2</sub>☐, 8K☐, 16K☐☐, 12 × 18☐<sup>*2</sup>, 11 × 15☐, 10 × 14☐, 8<sup>1</sup>/<sub>2</sub> × 13<sup>2</sup>/<sub>5</sub>☐</p> <p> <b>Region B</b></p> <p>A3☐, A4☐, A5☐, A6☐, B4 JIS☐, B5 JIS☐, B6 JIS☐, 8<sup>1</sup>/<sub>2</sub> × 13☐, 8<sup>1</sup>/<sub>4</sub> × 14☐, 8<sup>1</sup>/<sub>4</sub> × 13☐, 8 × 13☐, 8 × 10☐, 7<sup>1</sup>/<sub>4</sub> × 10<sup>1</sup>/<sub>2</sub>☐, 5<sup>1</sup>/<sub>2</sub> × 8<sup>1</sup>/<sub>2</sub>☐, 8K☐, 16K☐☐, 11 × 15☐, 10 × 14☐, SRA3☐<sup>*2</sup></p>	550 sheets
<p>60–300 g/m<sup>2</sup> (16 lb. Bond–110 lb. Cover) Plain Paper 1–Thick Paper 4</p>	<p>Custom size<sup>*3 *4</sup>:</p> <p> <b>Region A</b></p> <p>Vertical: 90.0–320.0 mm Horizontal: 148.0–457.2 mm</p> <p> <b>Region B</b></p> <p>Vertical: 3.55–12.59 inches Horizontal: 5.83–18.00 inches</p>	550 sheets
Envelopes	<p>Select the paper size using the Tray Paper Settings menu:</p> <p>4<sup>1</sup>/<sub>8</sub> × 9<sup>1</sup>/<sub>2</sub>☐☐, 3<sup>7</sup>/<sub>8</sub> × 7<sup>1</sup>/<sub>2</sub>☐☐, C5 Env☐☐, C6 Env☐☐, DL Env☐☐</p>	<ul style="list-style-type: none"> <li>• ☐: 50 sheets</li> <li>• ☐:</li> </ul> <p>Double flap: 15 sheets Single flap: 25 sheets</p>

- \*1 Adjust the supporting side fence before loading B4 JIS, A3, SRA3, 11 × 17, or 12 × 18 paper.
- \*2 There are lines to indicate these paper sizes on the labels attached to the lower paper trays, however there is no size description for these paper sizes.
- \*3 When loading paper with a vertical length of more than 304.8 mm (12.0 inches) in Trays 2–4, use paper that has a horizontal width of 450 mm (17.8 inches) or less.
- \*4 Set the supporting side fence position to SRA3 before loading paper with a vertical length of 297 mm or longer and a horizontal length of over 335 mm.

## Bypass Tray

Paper type and weight	Paper size	Paper capacity
52–300 g/m <sup>2</sup> (14 lb. Bond–110 lb. Cover) Thin Paper–Thick Paper 4	<p>Paper sizes that can be detected automatically:</p> <p> <b>Region A</b></p> <p>A3, A4, A5, A6, B4 JIS, B5 JIS, B6 JIS, SRA3</p> <p> <b>Region B</b></p> <p>A5, B5 JIS, 11 × 17, 8 1/2 × 11, 5 1/2 × 8 1/2, 12 × 18, SRA3</p>	<ul style="list-style-type: none"> <li>• 100 sheets (up to 10 mm in height)</li> <li>• Thick Paper 1: 40 sheets</li> <li>• Thick Paper 2–Thick Paper 3: 20 sheets</li> <li>• Thick Paper 4: 16 sheets</li> </ul>

Paper type and weight	Paper size	Paper capacity
52–300 g/m <sup>2</sup> (14 lb. Bond–110 lb. Cover) Thin Paper–Thick Paper 4	<p>*1</p> <p> <b>Region A</b></p> <p>11 × 17□, 8<sup>1</sup>/<sub>2</sub> × 14□, 8<sup>1</sup>/<sub>2</sub> × 13□, 8<sup>1</sup>/<sub>2</sub> × 11□, 8<sup>1</sup>/<sub>4</sub> × 14□, 8<sup>1</sup>/<sub>4</sub> × 13□, 8 × 13□, 8 × 10□,</p> <p>7<sup>1</sup>/<sub>4</sub> × 10<sup>1</sup>/<sub>2</sub>□, 5<sup>1</sup>/<sub>2</sub> × 8<sup>1</sup>/<sub>2</sub>□, 8K□, 16K□, 12 × 18□, 11 × 15□, 10 × 14□, SRA4□, 8<sup>1</sup>/<sub>2</sub> × 13<sup>2</sup>/<sub>5</sub>□</p> <p> <b>Region B</b></p> <p>A3□, A4□, A5□, A6□, B4 JIS□, B5 JIS□, B6 JIS□, 8<sup>1</sup>/<sub>2</sub> × 14□, 8<sup>1</sup>/<sub>2</sub> × 13□, 8<sup>1</sup>/<sub>4</sub> × 14□, 8<sup>1</sup>/<sub>4</sub> × 13□, 8 × 13□, 8 × 10□,</p> <p>7<sup>1</sup>/<sub>4</sub> × 10<sup>1</sup>/<sub>2</sub>□, 8K□, 16K□, 11 × 15□, 10 × 14□, SRA4□, 8<sup>1</sup>/<sub>2</sub> × 13<sup>2</sup>/<sub>5</sub>□</p>	<ul style="list-style-type: none"> <li>• 100 sheets (up to 10 mm in height)</li> <li>• Thick Paper 1: 40 sheets</li> <li>• Thick Paper 2–Thick Paper 3: 20 sheets</li> <li>• Thick Paper 4: 16 sheets</li> </ul>
52–300 g/m <sup>2</sup> (14 lb. Bond–110 lb. Cover) Thin Paper–Thick Paper 4	<p>Custom size *1:</p> <p> <b>Region A</b></p> <p>Vertical: 90.0–320.0 mm Horizontal: 148.0–457.2 mm *2</p> <p> <b>Region B</b></p> <p>Vertical: 3.55–12.59 inches Horizontal: 5.83–18.00 inches *2</p>	<ul style="list-style-type: none"> <li>• 100 sheets (up to 10 mm in height)</li> <li>• Thick Paper 1: 40 sheets</li> <li>• Thick Paper 2–Thick Paper 3: 20 sheets</li> <li>• Thick Paper 4: 16 sheets</li> </ul>
OHP transparencies	A4□, 8 <sup>1</sup> / <sub>2</sub> × 11□	50 sheets
Translucent paper	A3□, A4□, B4 JIS□, B5 JIS□	1 sheet
Label paper (adhesive labels)	B4 JIS□, A4□	30 sheets









Paper type and weight	Paper size	Paper capacity
Envelopes	*1 $4\frac{1}{8} \times 9\frac{1}{2}$  , $3\frac{7}{8} \times 7\frac{1}{2}$   , C5 Env  , C6 Env  , DL Env 	10 sheets

\*1 Specify the paper size.

- Using the Copy function.  
page 67 "Basic Procedure for Copying Documents"
- Using the Printer function.  
page 125 "Basic Procedure for Printing Documents"











\*2 In printer or facsimile mode, the maximum horizontal length of the custom size is 1,260 mm (49.60 inches). If you want to print on paper with a horizontal length of 600–1,260 mm (23.62–49.60 inches), contact your service representative. If you want to load paper with a horizontal length of 600 mm (23.62 inches) or longer in the bypass tray, it must have a vertical width of 305 mm (12.1 inches) or less.

### Tray 3 (LCT)

Paper type and weight	Paper size	Paper capacity
52–300 g/m <sup>2</sup> (14 lb. Bond–110 lb. Cover) Thin Paper–Thick Paper 4	 <b>Region A</b> A4   <b>Region B</b> $8\frac{1}{2} \times 11$ 	1000 sheets × 2
52–300 g/m <sup>2</sup> (14 lb. Bond–110 lb. Cover) Thin Paper–Thick Paper 4	*1  <b>Region A</b> $8\frac{1}{2} \times 11$   <b>Region B</b> A4 	1000 sheets × 2

\*1 To load paper any of the sizes specified above, contact your service representative.

## Large Capacity Tray (LCT)

Paper type and weight	Paper size	Paper capacity
52–300 g/m <sup>2</sup> (14 lb. Bond–110 lb. Cover) Thin Paper–Thick Paper 4	 <b>Region A</b> A4   <b>Region B</b> 8 1/2 × 11 	1500 sheets
52–300 g/m <sup>2</sup> (14 lb. Bond–110 lb. Cover) Thin Paper–Thick Paper 4	*1  <b>Region A</b> B5 JIS  , 8 1/2 × 11   <b>Region B</b> A4  , B5 JIS 	1500 sheets

\*1 To load paper any of the sizes specified above, contact your service representative.

## Notes on Special Paper

Paper Type	Note
Setting thick paper	page 205 "Thick Paper Orientation and Recommended Status"
Setting envelopes	page 206 "Envelope Orientation and Recommended Status"
Setting letterhead paper	page 209 "Loading Orientation-fixed Paper or Two-sided Paper"
Setting label paper (adhesive labels)	We recommend that you use specified label paper. If paper other than the specified one is used, normal operation and quality cannot be guaranteed.
Setting transparencies	When using transparencies, check their print sides carefully. Erroneous loading may cause problems. Remove copied or printed sheets one by one.

Paper Type	Note
Setting translucent paper	<ul style="list-style-type: none"> <li>When loading translucent paper, always use long grain paper.</li> <li>Remove copied or printed sheets one by one.</li> </ul>
Setting coated paper	<ul style="list-style-type: none"> <li>Specify "Paper Type" to [Coated: Matte] and an appropriate item for "Paper Thickness" in paper type setting for each tray under [Tray Paper Settings].</li> <li>To print on high-gloss coated paper, specify "Paper Type" to [Coated: Glossy] in paper type setting for each tray under [Tray Paper Settings].</li> <li>If a paper jam occurs or if the machine makes a strange noise, feed the coated paper from the bypass tray one sheet at a time.</li> </ul>

## Paper Thickness for Each Paper Weight

Paper Thickness	Paper weight
Thin Paper	52–59 g/m <sup>2</sup> (14–15 lb. Bond)
Plain Paper 1	60–74 g/m <sup>2</sup> (16–20 lb. Bond)
Plain Paper 2	75–81 g/m <sup>2</sup> (20 lb. Bond)
Middle Thick	82–105 g/m <sup>2</sup> (20–28 lb. Bond)
Thick Paper 1	106–169 g/m <sup>2</sup> (28 lb. Bond–90 lb. Index)
Thick Paper 2	170–220 g/m <sup>2</sup> (65–80 lb. Cover)
Thick Paper 3	221–256 g/m <sup>2</sup> (80 lb. Cover–140 lb. Index)
Thick Paper 4	257–300 g/m <sup>2</sup> (140 lb. Index–110 lb. Cover)

## Unusable Paper

### CAUTION

- Do not use stapled sheets of paper, aluminum foil, carbon paper, or any kind of conductive paper. Doing so can result in fire.



### Paper causing faults

Do not use any of the following kinds of treated paper. Doing so may cause faults.

- Paper for inkjet printers
- Thermal paper
- Art paper
- Aluminum foil
- Carbon paper
- Conductive paper
- Paper with perforated lines
- Hemmed-edge paper
- Window envelopes
- Tab stock
- Certain types of OHP transparencies for color printing

Do not copy or print onto sides that are already printed.

### Paper causing paper jam

Do not use the following kinds of paper. It may cause a paper jam.

- Bent, folded, or creased paper
- Perforated paper
- Slippery paper
- Torn paper
- Rough paper
- Thin paper with little stiffness
- Paper with a dusty surface

Do not use the copied or printed paper again. It may cause paper jam.

If you use paper curled by humidity or drying, the paper or staple may jam.

Do not load sheets that have already been printed onto by another machine. Doing so may interfere with loading of paper because the powder for preventing offset may attach to the paper roller.

#### Note

- A paper jam may occur depending on the condition of the paper even when using the recommended paper.

---

## Paper Storage

---

When storing paper, the following precautions should always be followed:

- Do not store paper where it will be exposed to direct sunlight.
- Store paper in a dry environment (humidity: 70% or less).
- Store on a flat surface.
- Do not store paper vertically.
- Once opened, store paper in a plastic bag.

---

## Saving Printouts

---



- Prints will fade if exposed to strong light or dampness and humidity for extended periods of time. Preserve the quality of your copies by storing them in a binder in a dark, dry place.
- When folding prints, toner in the folds will come off.
- If the prints are stored in the conditions described below, toner may melt:
  - When a print and a half-dried print are put on top of each other
  - When solvent-type adhesive agents are used for pasting prints
  - When prints are placed on mats made of chlorinated plastic in locations of high temperature for long periods of time
  - When prints are placed in locations of extremely high temperatures, such as near a heater

# Thick Paper Orientation and Recommended Status

When using thick paper of 106–300 g/m<sup>2</sup> (28 lb. Bond–110 lb. Cover), keep in mind the paper orientation or storage environment to prevent misfeeds and loss of image quality.

## Paper Orientation

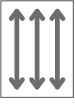
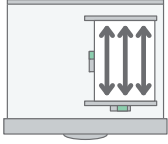
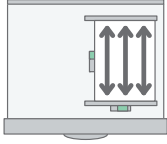
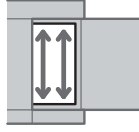
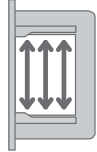
Thick paper has a paper direction according to its grain. Set the paper direction according to the grain, as shown in the following diagram:

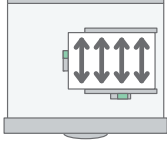
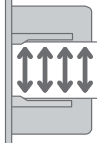
Direction of paper grain	Tray 1 or Tray 3 (LCT)	Tray 2–4	Large Capacity Tray (LCT)	Bypass Tray
				
	Not recommended		Not recommended	

## Paper Storage

- Temperature: 20–25°C (68–77°F)
- Humidity: 30–65%.

Do not use together paper that has been stored in different environments.

## Minimum Number of Sheets

- 20 sheets or more (paper trays of the machine/optional lower paper trays unit used)

After loading paper, position the side fences flush against the paper stack.

### Note

- When printing on thick, smooth paper, be sure to fan the paper thoroughly before loading. If you do not fan thick paper, jams and misfeeds can occur. If paper continues to become jammed or feed in together even after they are fanned, load them one by one from the bypass tray.
- Proper performance and quality may not be achieved under the recommended conditions depending on the paper.
- The printed sheet may curl. If the printed sheet curls, correct it.

# Envelope Orientation and Recommended Status

The way to place an original on the exposure glass and load envelopes varies depending on the shape and orientation of the envelopes.

## ★ Important

- Do not print on the following envelopes:
  - Window envelopes
  - Envelopes with moisture



## Before setting envelopes

- To load envelopes with the flaps opened, use only envelopes that are at least 148 mm (5.9 inches) long including the open flap. Set the envelopes with the flaps fully open. A paper jam may occur depending on the length or shape of the envelope flap.
- Before loading envelopes, press down on them to remove any air from inside and flatten out all four edges. If they are bent or curled, flatten their leading edges (the edge going into the machine) by running a pencil or ruler across them.

## ↓ Note

- For information about recommended envelopes, contact your local dealer.
- The Duplex function cannot be used with envelopes.
- Copied or printed sheets are delivered to the internal tray 1 even if you specified a different tray.
- Set the margins on the top, bottom, left and right to be 15 mm or more so as to print with adequate quality.
- An image may not be printed clearly on a sheet whose thickness is uneven. Print a few sheets and check the result.
- The printing result may not be adequate or the envelope may become wrinkled when the temperature or humidity is high.
- The printing result may not be adequate or output envelopes may become wrinkled depending on the printing environment even when using the recommended envelopes.
- When printing onto paper other than an envelope after printing onto several envelopes, you may have to wait about one minute until printing starts to allow the machine to make adjustments.

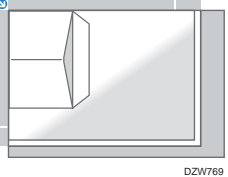
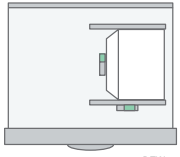
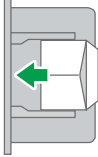
## Using the Copy Function

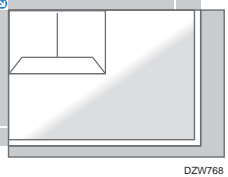
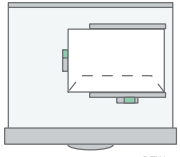
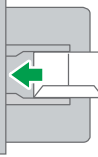

Orientation of Envelopes	Exposure Glass	Tray 2-4	Bypass Tray
Side-opening envelopes 	 <p>DZW769</p> <p>Flaps: open Side to be scanned: face down</p>	 <p>DZW772</p> <p>Flaps: open Side to be printed: face up</p>	 <p>Flaps: open Side to be printed: face down</p>
Side-opening envelopes 	 <p>DZW768</p> <p>Flaps: closed Side to be scanned: face down</p>	 <p>DZW771</p> <p>Flaps: closed Side to be printed: face up</p>	 <p>Flaps: closed Side to be printed: face down</p>

When loading envelopes, specify the envelope size and thickness.

page 82 "Copying Onto Envelopes"

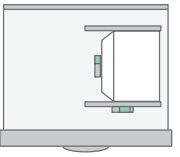
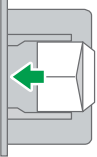
## Using the Printer Function

Orientation of Envelopes	Tray 2-4	Bypass Tray
Side-opening envelopes 	 <p>DZW772</p> <p>Flaps: open Side to be printed: face up</p>	 <p>Flaps: open Side to be printed: face down</p>

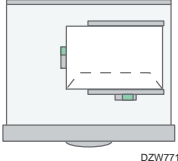
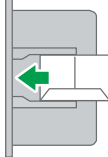
Orientation of Envelopes	Tray 2-4	Bypass Tray
<p data-bbox="203 348 363 413">Side-opening envelopes  *1</p> 	 <small data-bbox="666 505 705 515">DZW771</small> <p data-bbox="477 544 754 623">Flaps: closed Side to be printed: face up</p>	 <p data-bbox="864 535 1171 613">Flaps: closed Side to be printed: face down</p>

\*1 Select the check box of [Rotate by 180 Degrees] on [Detailed Settings] tab ► [Basic] menu, and then print.

# Loading Orientation-fixed Paper or Two-sided Paper

To print onto letterhead paper or business letter paper on which logos or patterns are printed, confirm how to set the paper or the settings of this machine so that the original is printed onto the orientation-fixed (top to bottom) or two-sided paper correctly.

## Copying onto Letterhead Paper

Specify the settings of this machine as described below, and then place an original and load the paper.

- [Copier / Document Server Settings] ► [Input / Output] tab ► [Letterhead Setting] ► [On]

The procedure is described using the [Classic] screen type of [Settings] as an example. When you are using the [Standard] screen type, specify the settings in the screen below.

- [Copier / Document Server Settings] ► [Paper/Paper Input] ► [Letterhead Setting]







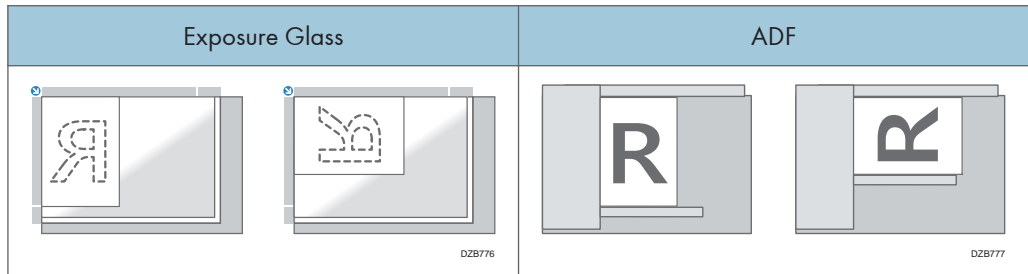

The names of the setting items may differ on the setting screen for [Classic] and [Standard] screen types.

For details, see "Settings Menu Compatibility List (Classic to Standard Settings)", User Guide (Full Version).

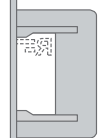
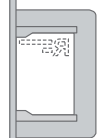
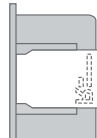
### Original Orientation

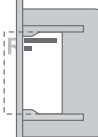

**Paper Orientation**

Copy Side	Tray 1 Tray 3 (LCT)	Tray 2-4	Large Capacity Tray (LCT)	Bypass Tray
One-sided originals	 DZB778	 DZB778   DZB779	 DZB782	 DZB784   DZB785
Two-sided originals *1	 DZB780	 DZB780   DZB781	 DZB783	 DZB786   DZB787

\*1 When printing the first page onto the letterhead side

**Printing onto Letterhead Paper Using the Printer Driver**

Specify the settings of this machine as described below.

- [Printer Settings] ► [System] tab ► [Letterhead Setting] ► [Auto Detect]

The procedure is described using the [Classic] screen type of [Settings] as an example. When you are using the [Standard] screen type, specify the settings in the screen below.





- [Tray/Paper Settings] ► [Printer] ► [Letterhead Setting]

The names of the setting items may differ on the setting screen for [Classic] and [Standard] screen types.

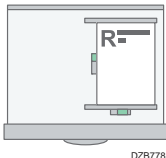
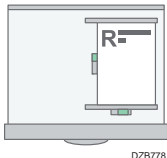
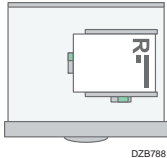
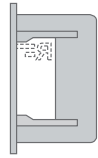
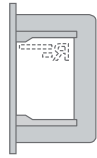

For details, see "Settings Menu Compatibility List (Classic to Standard Settings)", User Guide (Full Version).

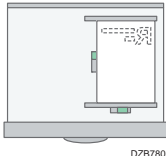
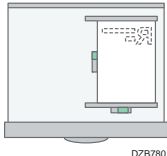
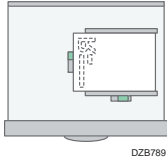
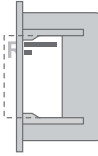
### Paper Orientation

Copy Side	Tray 1 Tray 3 (LCT)	Tray 2-4	Large Capacity Tray (LCT)	Bypass Tray
One-sided originals	 DZB778	 DZB778   DZB788	 DZB782	 DZB784   DZB790
Two-sided originals	 DZB780	 DZB780   DZB789	 DZB783	 DZB786   DZB791

**Note**

- When you specify [Letterhead Setting] to [On (Always)], you can print onto letterhead paper without specifying the paper type in the printer driver's settings to [Letterhead].

# Recommended Original Size and Weight

## Region A (mainly Europe and Asia)

Original location		Original size	Original weight
Exposure glass		Up to A3	-
ADF	One-sided originals	A3–B6 JIS (Japanese Industrial Standard), A6 <sup>*1</sup> , 11 × 17–5 <sup>1</sup> / <sub>2</sub> × 8 <sup>1</sup> / <sub>2</sub> <sup>*2</sup>	40–128 g/m <sup>2</sup> (11–34 lb. Bond) <sup>*3</sup>
	Two-sided originals	A3–A5, A6 <sup>*1</sup> , 11 × 17–5 <sup>1</sup> / <sub>2</sub> × 8 <sup>1</sup> / <sub>2</sub> <sup>*2</sup>	52–128 g/m <sup>2</sup> (14–34 lb. Bond) <sup>*3</sup>
	Mixed Sizes mode	A3, B4 JIS, A4, B5 JIS, 11 × 17, 8 <sup>1</sup> / <sub>2</sub> × 13, 8 <sup>1</sup> / <sub>2</sub> × 11	52–81 g/m <sup>2</sup> (14–20 lb. Bond)

\*1 When a small size paper unit is used on the one-pass duplex scanning ADF

\*2 5<sup>1</sup>/<sub>2</sub> × 8<sup>1</sup>/<sub>2</sub> can be used only in the scanner function.

\*3 When a small size paper unit is used on the one-pass duplex scanning ADF: 64–128 g/m<sup>2</sup> (17–34 lb. Bond)

8

## Region B (mainly North America)

Original location		Original size	Original weight
Exposure glass		Up to 11 × 17	-
ADF	One-sided originals	11 × 17–5 <sup>1</sup> / <sub>2</sub> × 8 <sup>1</sup> / <sub>2</sub> A3–A5 <sup>*1</sup> , A6 <sup>*2</sup>	40–128 g/m <sup>2</sup> (11–34 lb. Bond) <sup>*3</sup>
	Two-sided originals	11 × 17–5 <sup>1</sup> / <sub>2</sub> × 8 <sup>1</sup> / <sub>2</sub> A3–A5 <sup>*1</sup> , A6 <sup>*2</sup>	52–128 g/m <sup>2</sup> (14–34 lb. Bond) <sup>*3</sup>
	Mixed Sizes mode	11 × 17, 8 <sup>1</sup> / <sub>2</sub> × 14, 8 <sup>1</sup> / <sub>2</sub> × 11, 10 × 14, 7 <sup>1</sup> / <sub>4</sub> × 10 <sup>1</sup> / <sub>2</sub> , A3, A4	52–81 g/m <sup>2</sup> (14–20 lb. Bond)

\*1 A5 can be used only in the scanner function.

\*2 When a small size paper unit is used on the one-pass duplex scanning ADF

\*3 When a small size paper unit is used on the one-pass duplex scanning ADF: 64–128 g/m<sup>2</sup> (17–34 lb. Bond)





**Note**

- An original whose size is within the range of the maximum original scan area can be placed.
- page 298 "Specifications for the Main Unit"
- On all sides of the original, there is a missing image area. Even if you place originals on the exposure glass or in the ADF correctly, the missing image area on all four sides of the original might not be copied.
- page 298 "Specifications for the Main Unit"
- You can place originals of two different sizes only in Mixed Sizes mode.

## Sizes Detectable with Auto Paper Select

### Region **A** (mainly Europe and Asia)







Original location	A3 	B4 JIS 	A4  	B5 JIS  	A5 	A5 	B6 JIS  
Exposure glass	✓	✓	✓	✓	✓	-	-
ADF	✓	✓	✓	✓	✓	✓	✓*1







Original location	11 × 17 	8 <sup>1</sup> / <sub>2</sub> × 11  	8 <sup>1</sup> / <sub>2</sub> × 13 
Exposure glass	-	-	✓
ADF	✓	✓	✓

✓: Detectable size, -: Undetectable size

\*1 You cannot use the two-sided scanning mode.

### Region **B** (mainly North America)

Original location	11 × 17 	8 <sup>1</sup> / <sub>2</sub> × 14 	8 <sup>1</sup> / <sub>2</sub> × 11 	8 <sup>1</sup> / <sub>2</sub> × 11  	5 <sup>1</sup> / <sub>2</sub> × 8 <sup>1</sup> / <sub>2</sub> 	5 <sup>1</sup> / <sub>2</sub> × 8 <sup>1</sup> / <sub>2</sub> 
Exposure glass	✓	✓*1	✓	✓	✓	-
ADF	✓	✓*1	✓	✓	✓	✓

Original location	10 × 14 	7 <sup>1</sup> / <sub>4</sub> × 10 <sup>1</sup> / <sub>2</sub>  	A3 	A4  
Exposure glass	-	-	-	-
ADF	✓	✓	✓	✓

✓: Detectable size, -: Undetectable size

\*1 You can switch the detectable size from 8<sup>1</sup>/<sub>2</sub> × 14 to 8<sup>1</sup>/<sub>2</sub> × 13<sup>2</sup>/<sub>5</sub> by using [Auto Detect: Switch Size Detec Legal/Oficio] in the Tray Paper Settings menu.

#### Note

- If the original type is one of the following, the machine may not be able to detect the paper size automatically. Select the paper size manually.

- Dark originals with a lot of text and drawings
- Originals that partially contain a solid image
- Originals that have solid images at their edges
- Originals with indexes, tags, or other projecting parts
- Transparent originals such as transparencies or translucent paper
- Originals with glossy surfaces
- Bound originals with a thickness of more than 10 mm (0.4 inches), such as books
- When the ADF scans an original of a size that cannot be detected automatically, the size of the scanned image will be different from the original.
- When loading an original of a size that is not automatically detected, specify the original size or select the paper tray that is the same size as the original. The output image may not be full size or it may be different from the intended one if the print settings are not specified properly.

# Replacing the Toner

Toner is almost depleted when the "Check you have a print cartridge replacement(s)." message is displayed. Prepare a replacement print cartridge.

See "Contact Information", User Guide (Full Version).

See the video displayed on the control panel of the machine for the procedure to replace the toner.

**★ Important**

- Replace the toner after the message prompting replacement is displayed on the control panel.
- The machine may become damaged if you use toner of a different type.
- Do not turn off the power of the machine when replacing the toner. If you turn off the power when replenishing the toner, the specified settings are canceled, and printing will not resume afterwards.
- Store the toner in a dry environment away from direct sunlight and generally under the temperature below 35°C.
- Keep the toner horizontal when storing it.
- After removing the toner cartridge from the machine, do not shake it while its opening is facing downward. The remaining toner may spill out.
- Do not pull out and put back the toner cartridge repeatedly. The remaining toner may leak.
- Follow the procedure displayed on the screen to replenish the toner.

1. Press [Watch Video].

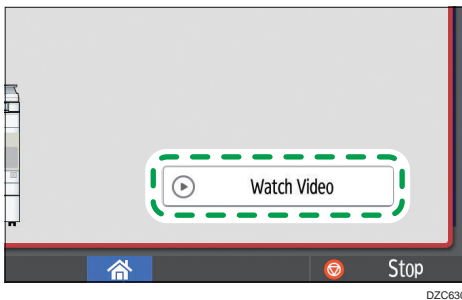

To display this screen again, press [Confirm] in the system message widget, or press [Check Status] and then press [Check] under "Mach. Status" on the [Mach./Applic. Stat] tab.

## 2. Press the play key.



## 3. Replace the toner by following the procedure shown in the video.

### ↓ Note

- You can transmit data in the fax or scanner function even after the toner runs out. However, you cannot transmit a fax when the number of times of reception and transmission performed in the fax function after the toner has run out and the number of times of communication not recorded in the Records exceeds a total of 200. Replace the toner earlier.
- While the message prompting you to replace the toner is displayed, Memory Storage Report for Memory Transmission will not be printed.

## Precautions When Storing Toner

### ⚠ WARNING

- Do not store toner (new or used) or toner containers while toner is inside in a place with an open flame. The toner can ignite and result in burns or fire.

### ⚠ CAUTION

- Do not leave the following items in a place where children can reach them:
  - Toner (new or used)
  - Toner containers while toner is inside
  - Toner-attached parts

---

## Precautions When Replacing the Toner

---

### **WARNING**

- Do not dispose of the following items into a fire. Toner will ignite on contact with naked flame and burns can result.
  - Toner (new or used)
  - Toner containers while toner is inside
  - Toner-attached parts
- Do not absorb spilled toner (including used toner) using a vacuum cleaner. Absorbed toner may cause ignition or explosion due to electric contact sparks inside the vacuum cleaner. However, you can use a toner-compatible industrial vacuum cleaner. When toner is spilled, remove the spilled toner using a wet cloth so that the toner is not scattered.
- The following explains the warning messages on the plastic bag used in this product's packaging:
  - Do not leave the polythene materials (bags, etc.) supplied with this machine close to babies and small children. Suffocation can result if polythene materials are brought into contact with the mouth or nose.

### **CAUTION**

- When the following occurs while toner is handled, receive emergency measures first, and then consult a doctor if necessary.
  - When inhaling toner, gargle with a large amount of water and move into a fresh air environment.
  - When swallowing toner, dilute gastric contents with a large amount of water.
  - When getting toner into your eyes, flush them with a large amount of water.
- When removing jammed paper, replenishing or replacing toner (new or used), make sure not to inhale toner.
- When removing jammed paper, replenishing or replacing toner (new or used), be careful not to have toner dirt your skin or clothes.



## CAUTION

- If toner (new or used) comes into contact with your skin or clothes and smears them, take the following actions:
  - If toner comes into contact with your skin, wash the affected area thoroughly with soap and water.
  - If toner comes into contact with your clothes, wash the stained area with cold water. Heating the stained area by applying hot water will set the toner into the fabric and removing the stain may become impossible.
- When replacing a container with toner (including used toner) or consumables with toner, be careful that the toner does not splatter. After removing used consumables and shutting the lid of the container if the lid is available, put them in a bag.
- Do not open toner containers forcibly while toner is inside, crush or squeeze them. Toner spillage can cause accidental ingestion or dirtying of clothes, hands, or floor.

## Disposing Exhausted Toners

You cannot reuse exhausted toners.

When disposing a depleted print cartridge, place the cartridge in a box or plastic bag while paying attention not to spill any toner powder.

 **Region A** (mainly Europe and Asia)

If you want to discard your used toner container, please contact your local sales office. If you discard it by yourself, treat it as general plastic waste material.

 **Region B** (mainly North America)

Please see our local company website for information on the recycling of supply products, or you can recycle items according to the requirements of your local municipalities or private recyclers.

# Replacing the Waste Toner Bottle

The waste toner bottle needs to be replaced soon when the "Waste Toner Bottle is almost full." message is displayed. Prepare a replacement waste toner bottle.

See "Contact Information", User Guide (Full Version).

See the video displayed on the control panel of the machine for the procedure to replace the waste toner bottle.

### 1. Press [Watch Video].

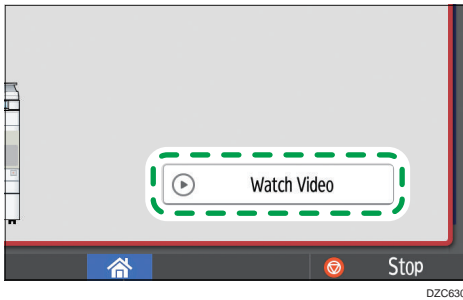

To display this screen again, press [Confirm] in the system message widget or press [Check Status] and then press [Check] under "Mach. Status" on the [Mach./Applic. Stat] tab.

### 2. Press the play key.



### 3. Replace the waste toner bottle by following the procedure shown in the video.

## Precautions When Replacing the Waste Toner Bottle

### WARNING

- Do not store toner (new or used) or toner containers while toner is inside in a place with an open flame. The toner can ignite and result in burns or fire.

**⚠ WARNING**

- Do not dispose of the following items into a fire. Toner will ignite on contact with naked flame and burns can result.
  - Toner (new or used)
  - Toner containers while toner is inside
  - Toner-attached parts

- Do not absorb spilled toner (including used toner) using a vacuum cleaner. Absorbed toner may cause ignition or explosion due to electric contact sparks inside the vacuum cleaner. However, you can use a toner-compatible industrial vacuum cleaner. When toner is spilled, remove the spilled toner using a wet cloth so that the toner is not scattered.

- The following explains the warning messages on the plastic bag used in this product's packaging:
  - Do not leave the polythene materials (bags, etc.) supplied with this machine close to babies and small children. Suffocation can result if polythene materials are brought into contact with the mouth or nose.

**⚠ CAUTION**

- Do not leave the following items in a place where children can reach them:
  - Toner (new or used)
  - Toner containers while toner is inside
  - Toner-attached parts

- When the following occurs while toner is handled, receive emergency measures first, and then consult a doctor if necessary.
  - When inhaling toner, gargle with a large amount of water and move into a fresh air environment.
  - When swallowing toner, dilute gastric contents with a large amount of water.
  - When getting toner into your eyes, flush them with a large amount of water.

- When removing jammed paper, replenishing or replacing toner (new or used), make sure not to inhale toner.

- When removing jammed paper, replenishing or replacing toner (new or used), be careful not to have toner dirt your skin or clothes.

## CAUTION

- If toner (new or used) comes into contact with your skin or clothes and smears them, take the following actions:
  - If toner comes into contact with your skin, wash the affected area thoroughly with soap and water.
  - If toner comes into contact with your clothes, wash the stained area with cold water. Heating the stained area by applying hot water will set the toner into the fabric and removing the stain may become impossible.
- When replacing a container with toner (including used toner) or consumables with toner, be careful that the toner does not splatter. After removing used consumables and shutting the lid of the container if the lid is available, put them in a bag.
- Do not open toner containers forcibly while toner is inside, crush or squeeze them. Toner spillage can cause accidental ingestion or dirtying of clothes, hands, or floor.

### Important

- You cannot reuse the waste toner bottle.
- To prevent the toner being spilled on the floor, table, or other object from the removed waste toner bottle, cover these objects with sheets of newspaper.

---

## Disposing the Used Waste Toner Bottle

---

When disposing the used waste toner bottle, place the bottle in a box or plastic bag while paying attention not to spill any toner powder.

 **Region A** (mainly Europe and Asia)

If you want to discard your used waste toner bottle, please contact your local sales office. If you discard it by yourself, treat it as general plastic waste material.

 **Region B** (mainly North America)

Please see our local company website for information on the recycling of supply products, or you can recycle items according to the requirements of your local municipalities or private recyclers.

# 9. Troubleshooting

## Alert Sounds

The machine notifies you with an alert sound when a paper jam occurs, the original is left on the machine, or another problem occurs. Listen to the alert sound for one of the patterns described below, and perform the required procedure accordingly.

The settings procedure is described using the [Classic] screen type of [Settings] as an example. When you are using the [Standard] screen type, confirm the name of the setting items in the list below.

For details, see "Settings Menu Compatibility List (Classic to Standard Settings)", User Guide (Full Version).

Sound pattern *1	Condition	Solution
A short beep	[Notification Sound] (operation tone) [Login]/[Logout]	-
A short beep, followed by long beep	[Operation Invalid]	<ul style="list-style-type: none"><li>• If you entered an incorrect password, enter the correct password.</li><li>• If you hear this sound when touching an icon or key, you do not have permission to use the function or setting. Log in to the machine as a user with permission, or consult your user administrator.</li></ul>
A long beep	[Operation Completed] [Fax Printing Finished] [Fax Transmission Finished] [Fax Reception Finished]	Check the operation result.
Two long beeps	[Warm-up]	The machine is ready for use after the machine is turned on or recovers from the sleep mode.

Sound pattern *1	Condition	Solution
Five long beeps	[Auto Reset]	The machine has been reset to the default state after the specified period of time has passed with the machine unoperated. If you were performing and paused an operation, perform the operation from the beginning again.
Five long beeps (repeating four times)	[Sound of Less Urgent Level]	Check that an original is not left on the exposure glass and that paper is loaded in the paper tray.
Five short beeps (repeating five times)	[Sound of Urgent Level]	Check the message displayed on the screen, and resolve the problem by removing the jammed paper or original, or replacing the toner.
12 short beeps	[Blank Page Detected]	Check that the original is placed in the ADF with the side to scan facing up.

\*1 The factory default sound pattern is used as an example in the table above.

**Note**

- You cannot pause an alert sound that has started. The machine continues to emit the sound until the preset sound pattern is completed.
- You can specify the volume and type of alert sound in [Settings] ▶ [Screen Features Settings] ▶ [Sound]. The type of sound can be specified for each condition described in the table above. You can also specify the volume of the sound emitted when using On-hook or Immediate Transmission to send a fax in [Settings] ▶ [Machine Features Settings] ▶ [Fax Settings] ▶ [General Features] tab ▶ [Adjust Sound Volume]. Press [Home] (🏠) after specifying the settings.
- See "Setting the Sound Volume and Type", User Guide (Full Version).

# Checking the Indicators, Icons, and Messages on the Control Panel

The machine notifies you of the machine condition or status of an application with the [Check Status] indicator or a message displayed on the control panel. Check the status and resolve the problem accordingly.

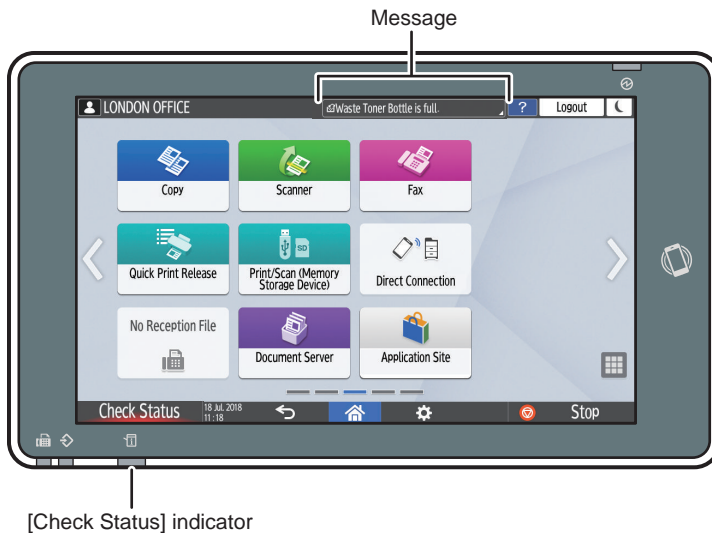

DZC702









- Message
  - Displays a message indicating the status of the machine or application. Press the message to display it in full text. You can also view more than one message as a list.
- [Check Status] indicator
  - If there is a problem such as a paper jam, the [Check Status] indicator lights up or flashes along with a message displayed on the screen. Press [Check Status] to check the status of the machine or application, and resolve the problem accordingly.

## When an Icon is Displayed with a Message



When you need to resolve a problem such as a paper jam, an icon is displayed at the beginning of a message. See the table below for the meaning of each icon.

The settings procedure is described using the [Classic] screen type of [Settings] as an example. When you are using the [Standard] screen type, confirm the name of the setting items in the list below.

For details, see "Settings Menu Compatibility List (Classic to Standard Settings)", User Guide (Full Version).

Icon	Condition	Solution and reference
	Maintenance or repair is required.	Prepare for maintenance or consider repairing the machine.
	Paper is jammed.	See the animated illustration displayed on the control panel, and remove the jammed paper.  See "When Paper or an Original is Jammed", User Guide (Full Version).
	An original has jammed.	See the animated illustration displayed on the control panel, and remove the jammed original.  See "When Paper or an Original is Jammed", User Guide (Full Version).
	Paper has run out.	Load paper into the paper tray.  page 179 "Loading Paper into the Paper Tray"
	Toner is almost depleted, or has run out.	Prepare a replacement toner. Replace the toner when it runs out.  page 216 "Replacing the Toner"  <b>Note</b> <ul style="list-style-type: none"><li>If  appears when there is a lot of toner remaining, pull out the print cartridge by following the toner replacement procedure that is displayed on the screen, and then set it back again.</li></ul>
	The waste toner bottle is full, or almost full.	Prepare a replacement waste toner bottle. Replace the bottle when it becomes full.  page 220 "Replacing the Waste Toner Bottle"
	Staples are nearly depleted, or have run out.	Prepare a cartridge for replacement, and load it when the staples run out.  See "Replenishing the Staples", User Guide (Full Version).



Icon	Condition	Solution and reference
	The hole punch receptacle is full.	Empty the receptacle. See "When the Hole Punch Receptacle is Full", User Guide (Full Version).
	A cover is open.	Check that all covers of the machine and options are closed.

**Note**

- For the names and the contact information of consumables, check [Settings] ► [Inquiry]. Press [Home] (🏠) after completing the operation to close [Settings].
- See "Contact Information", User Guide (Full Version).

## When the [Check Status] Indicator is lit or flashing

The [Check Status] indicator notifies the user when the machine requires immediate attention.

### Flashing in red

The machine is unavailable for use. Press [Check Status] and resolve the problem as soon as possible.

### Flashing in yellow

Maintenance on the machine needs to be performed soon. Perform the required procedure accordingly.

You can display the status confirmation screen with [Check Status]. On the screen, check the detailed status of the machine or application.

1. Press [Check Status].

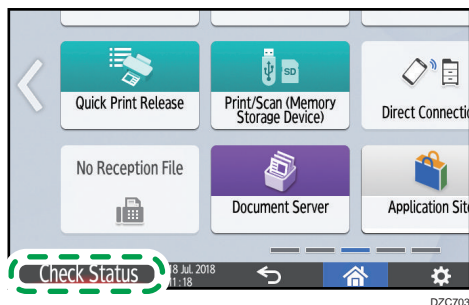

2. Press [Check] to check the details, and perform the required procedure.

page 225 "When an Icon is Displayed with a Message"

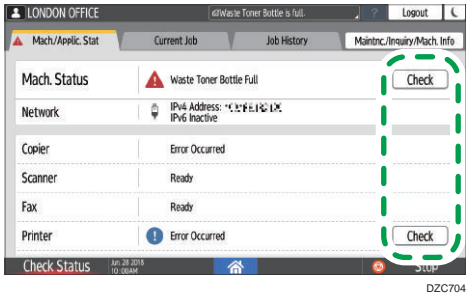

: The machine cannot be used.

: Some of the functions cannot be used, or the toner is almost depleted.

 **Note**

- Depending on the machine condition, such as a paper jam or open cover, the status confirmation screen may be displayed automatically without pressing [Check Status].

# When the Machine Cannot Be Operated

## Note

- If a message is displayed on the screen, check the message.
- page 235 "When a Message Is Displayed and the Machine Cannot Be Operated"
- When confirming or changing the settings in [Settings], press [Home] (🏠) after completing the operation to close [Settings].

## When the Machine Does Not Respond Correctly to an Operation on the Control Panel

The settings procedure is described using the [Classic] screen type of [Settings] as an example. When you are using the [Standard] screen type, confirm the name of the setting items in the list below.

For details, see "Settings Menu Compatibility List (Classic to Standard Settings)", User Guide (Full Version).

Condition	Cause	Solution and reference
The screen of the control panel is not lit.	The machine is in the sleep mode.	Touch the screen.
Nothing is displayed when you touch the screen.	The power of the machine is turned off.	Check that the main power indicator is not lit, and then turn on the main power of the machine. page 11 "Turning On and Off the Power"

Condition	Cause	Solution and reference
<p>The power of the machine does not come on.</p>	<p>The power cable is unplugged from the wall outlet.</p>	<p>Connect the ground wire, and plug the power cable into the wall outlet. See "Installation Requirements After Moving the Machine", User Guide (Full Version).</p>
	<p>The machine is connected to an extension cord.</p>	<p>You cannot use an extension cord. After checking that the screen is not lit when you touch it and the main power indicator is unlit, remove the extension cord and plug the power cable directly into the wall outlet.</p>
	<p>There may be a problem with the wall outlet.</p>	<p>After checking that the screen is not lit when you touch it and the main power indicator is unlit, plug the power cord into a confirmed operating wall outlet.</p>
<p>Only the copy icon is displayed when the machine is turned on.</p>	<p>The functions other than the copy function are starting up.</p>	<p>The time required for a function to start up varies depending on the function. Wait a while.</p>
<p>Only some of the menu items are displayed when you press [Settings] after turning on the power of the machine.</p>	<p>The functions other than the copy function are starting up.</p>	<p>The time required for a function to start up varies depending on the function. More items on the menu in [Settings] are displayed as the functions start up. Wait a while.</p>
<p>The login screen is displayed.</p>	<p>Basic Authentication, Windows Authentication, or LDAP Authentication is specified.</p>	<p>Enter the login user name and password, and then press [Login]. For the login user name and password, consult the user administrator. page 51 "Logging In from the Control Panel"</p>
<p>The User Code entry screen is displayed.</p>	<p>User Code authentication is specified.</p>	<p>Enter the User Code, and press [OK]. Consult the user administrator for the user code.</p>

Condition	Cause	Solution and reference
A function is not executed, or you cannot perform an operation.	Another function that cannot be used with the specified function at the same time is being executed.	<p>Wait for the function in progress to end, and then perform the next operation. For details about functions that cannot be used at the same time, see page 383 "Function Compatibility".</p> <p>When a backup of the address book is being created using Web Image Monitor or another method, the next function is executed after the backup is completed.</p>
The key is unresponsive, or another key is activated.	A malfunction is temporarily occurring on the machine.	<p>Turn off the power of the machine, wait for 10 seconds or more after confirming that the main power indicator is turned off, and then turn on the power again.</p> <p>page 11 "Turning On and Off the Power"</p>
You cannot interrupt copying even after pressing [Stop] while the copy function is operating.		
You cannot interrupt copying or scanning even after pressing [Stop], and the login screen is displayed.	Basic Authentication, Windows Authentication, or LDAP Authentication is specified, and the user who started the copying or scanning operation has logged out.	Log in to the machine as the user who started the copying or scanning operation or as the machine administrator, and press [Stop].

Condition	Cause	Solution and reference
<p>Help is not displayed when you press [Help] ( ? ).</p>	<p>The application that is currently in use does not support the help function, or ? is grayed out because "Paper Misfeed" or another message is being displayed.</p>	<p>The help function cannot be used when ? is grayed out. Close the application or message, and then try again.</p>
	<p>? is grayed out because the user does not have permission to use the browser function.</p>	<p>The help function cannot be used if the user does not have permission to use the browser function. If ? is always grayed out, consult the user administrator to check whether you have permission to use the browser function. The user administrator can change the access permissions in the address book.</p> <p>See "Confirming the Available Functions", User Guide (Full Version).</p>
<p>The screen changes to Web Browser when you press [Help] ( ? ), but the help content is not displayed.</p>	<p>The machine is not connected to the network correctly.</p>	<p>Check if you can display a web page in [Web Browser]. If a web page cannot be displayed, check that the machine is connected to the network correctly.</p> <p>See "Selecting the Network Connection Method", User Guide (Full Version).</p>
	<p>The browser is configured not to save cookies.</p>	<p>Check that the [Web Browser] ► [Menu] ( ? ) ► [Settings] ► [Privacy &amp; security] ► [Accept cookies] check box is selected.</p>
<p>The screen remains turned on and the machine does not enter the sleep mode when you press [Energy Saving] ( ? ).</p>	<p>The machine is in a condition that does not allow the machine to enter the sleep mode.</p>	<p>Check the conditions in which the machine does not enter the sleep mode.</p> <p>page 11 "Turning On and Off the Power"</p>
<p>The machine does not shut down when more than five minutes have passed after you press the main power switch.</p>	<p>The shutdown operation could not be performed normally.</p>	<p>Press the main power switch again.</p>

Condition	Cause	Solution and reference
The power of the machine is turned off automatically.	[Main Power Off] is specified in the weekly timer.	Check [Weekly Timer Easy Settings] and [Weekly Timer Detailed Settings] on the [Settings] ► [Machine Features Settings] ► [System Settings] ► [Timer Settings] tab.

## When the Machine Does Not Respond Correctly to an Operation from a Computer

The settings procedure is described using the [Classic] screen type of [Settings] as an example. When you are using the [Standard] screen type, confirm the name of the setting items in the list below.

For details, see "Settings Menu Compatibility List (Classic to Standard Settings)", User Guide (Full Version).

Condition	Cause	Solution and reference
When using the address book from Device Manager NX, an incorrect password error is displayed even when you enter the correct login user name and password.	A certificate is not installed on the computer when SSL/TLS is enabled on the machine.	Install the certificate on the computer. Consult your network administrator for the certificate.
	An item other than [Simple Encryption] is specified in [Extended Security].	Specify [Simple Encryption] in "Driver Encryption Key:Encryption Strength" in [Settings] ► [Machine Features Settings] ► [System Settings] ► [Administrator Tools] tab ► [Extended Security].

Condition	Cause	Solution and reference
<p>You cannot access the machine using Web Image Monitor.</p>	<p>There is a problem with the connection between the machine and the computer.</p>	<p>Check the cable connecting the machine and the computer, and disconnect and then connect the cable again. Also, check the connection to the hub or router, and turn off and on the power of the device if possible. Next, turn off the power of the machine, wait for 10 seconds or more after confirming that the main power indicator is turned off, and then turn on the power.</p> <p>page 11 "Turning On and Off the Power"</p>
	<p>A proxy server is not specified.</p>	<p>In the proxy setting of the Web browser, specify the IP address of the machine as an exception. You can check the IP address in [Check Status] ► "Network".</p>
<p>"There is a problem with this website's security certificate." is displayed and you cannot connect to the machine when accessing the machine using Web Image Monitor.</p>	<p>[Permit SSL / TLS Communication] is set to [Ciphertext Only].</p>	<ul style="list-style-type: none"> <li>• Click [Continue to this website (not recommended)].</li> <li>• To specify not to display the message, log in to the machine in the administrator mode, and specify [Ciphertext / Clear Text] in [SSL/TLS] ► "Permit SSL / TLS Communication" under [Device Management] ► [Settings] ► "Security".</li> </ul>
	<p>"https" is entered at the beginning of the URL.</p>	<p>Do not enter "s" after "http".</p>



## When a Message Is Displayed and the Machine Cannot Be Operated

Message	Condition	Solution and reference
"Call Service" SCxxx-xx Contact Serial No. of Machine	The machine needs to be repaired.	Consider repairing the machine.
"Functional Problems" SCxxx-xx Contact Serial No. of Machine	A malfunction that requires maintenance or repair has occurred.	<p>Prepare for maintenance or consider repairing the machine.</p> <ul style="list-style-type: none"> <li>If a message prompts you to turn the power of the machine off and then on, the problem may be resolved by turning off the power, waiting for 10 seconds or more after confirming that the main power indicator is turned off, and then turning on the power. page 11 "Turning On and Off the Power"</li> <li>When "Press [Cancel] to cancel mode" is displayed, you can continue using the machine except for the function in which the malfunction is occurring after pressing [Cancel].</li> </ul>
"Please wait."	The machine is recovering from the sleep mode.	<p>Wait a while. Turn off the power of the machine if the message persists after five minutes, wait for 10 seconds or more after confirming that the main power indicator is turned off, and then turn on the power. page 11 "Turning On and Off the Power"</p>

Message	Condition	Solution and reference
"Please wait."	The machine is preparing to perform a function or executing the image stabilization process.	Wait a while and do not turn off the power of the machine.
	The ambient temperature is outside the temperature range specified for the machine operation.	<p>Check the room temperature and whether it satisfies the operational requirements of the machine. If the machine has just been moved to the current location, leave it be for some time and allow it to adapt to the environment before use.</p> <p>See "Installation Requirements After Moving the Machine", User Guide (Full Version).</p> <p>If the message persists after five minutes even when the room temperature is within the specifications, wait for 10 seconds or more after confirming that the main power indicator is turned off, and then turn on the power.</p> <p>page 11 "Turning On and Off the Power"</p>
"Please wait."	A consumable or supply such as the toner has been replenished.	<p>Wait a while and do not turn off the power of the machine. Turn off the power of the machine if the message persists after five minutes, wait for 10 seconds or more after confirming that the main power indicator is turned off, and then turn on the power.</p> <p>page 11 "Turning On and Off the Power"</p>
"Shutting down... Please wait. Main power will be turned off automatically. Maximum waiting time: 5 minute(s)"	The power of the machine was turned off while the machine was starting up or in the standby mode.	Wait until the power is turned off.

**Note**

- If the message persists even after you have performed the operations as instructed in the following message, a malfunction may temporarily occur on the machine. Turn off the power of the machine, wait for 10 seconds or more after confirming that the main power indicator is turned off, and then turn on the power.

- page 11 "Turning On and Off the Power"
  - "Cover Open"
  - "Add Toner" / "Add Staples"
  - "Replace Waste Toner Bottle" / "Hole Punch Receptacle Full"
  - "Original left on exposure glass."
  - "No paper."

## When a Message Appears While Using the Copy Function

Message	Condition	Solution and reference
"Cannot Detect Original Size"	An original is not placed correctly on the machine.	Place the original correctly. When you place an original on the exposure glass, the machine detects the original size by opening and closing the exposure glass cover or ADF. Open the cover or ADF by more than 30 degrees when placing an original.
	An original with a difficult-to-detect size even in the regular size, such as a transparency or paper with sticky notes, is placed on the machine.	When scanning an original with a difficult-to-detect size, specify the paper tray in [Paper Select]. Also, when making an enlarged or reduced copy, select an item other than [Fit to Paper Size] page 214 "Sizes Detectable with Auto Paper Select"
	An original of a custom size is placed on the machine.	When scanning an original of a custom size, specify the original size in [Original Settings] ► [Original Size] ► [Custom Size].
"Cannot XXX paper of this size." "XXX is not available with this paper size." ("2 Sided Copy" or the name of specified finishing appears in place of XXX)	A paper size that is not supported in 2-Sided copying or the specified finishing type is specified.	Check the paper size supported in 2-Sided copying and the specified finishing type and load the supported paper. page 298 "List of Specifications"
"Exceeded the maximum number of multi-sheet fold."	The number of sheets that can be folded at a time is exceeded.	Check the number of sheets that can be folded at a time, and reduce the number of sheets in the original placed on the machine. page 298 "List of Specifications"

Message	Condition	Solution and reference
"Exceeded the maximum number of sheets that can be used. Copying will be stopped."	When the copy volume use limitation is enabled, copying was canceled because the copy volume of the user exceeded the upper limit allotted for the user.	For details about the copy volume use limitation, consult the user administrator. The user administrator can change the limit on the copy volume use.  See "Specifying Maximum Print Volume Use of Each User", User Guide (Full Version).
"Set next original(s), then press [Start]."	Duplex copying is specified.	When not copying onto both sides of paper, clear the [1 sided→2 sided] and [2 sided→2 sided] check boxes.
"Stapling capacity exceeded."	The number of sheets that can be stapled together is exceeded.	Check the number of sheets that can be stapled together at a time, and reduce the number of sheets in the original placed on the machine.  page 298 "List of Specifications"

# When a Message Is Displayed While Using Document Server

For details about the messages that are displayed when printing a document, see the descriptions of the messages that are displayed in the copy function.

page 238 "When a Message Appears While Using the Copy Function"

Message	Condition	Solution and reference
"Cannot delete the folder because it contains locked files. Please contact the file administrator."	The folder contains a locked document.	Request the file administrator to unlock the document. The file administrator can unlock documents.  See "Specifying Access Privileges for Documents Stored in Document Server", User Guide (Full Version).
"Cannot detect original size."	An original is not placed on the machine.	Place the original correctly. When you place an original on the exposure glass, the machine detects the original size by opening and closing the exposure glass cover or ADF. Open the cover or ADF by more than 30 degrees when placing an original.
	An original with a difficult-to-detect size even in the regular size, such as a transparency or paper with sticky notes, is placed on the machine.	When scanning an original of a difficult-to-detect size, specify the paper tray. Also, when making an enlarged or reduced copy, select an item other than [Auto Reduce/Enlarge]. page 214 "Size Detectable with Auto Paper Select"
	An original with a custom size is placed on the machine.	When scanning an original with a custom size, specify the original size in [Original Settings] ► [Original Size] ► [Custom Size].
"Cannot display preview of this page."	The format of the image data is corrupted.	Press [Confirm] to display the preview screen without a thumbnail. If the image data comprises multiple pages, press [Switch Display Page] to display a different page.

Message	Condition	Solution and reference
"Magazine or Booklet mode is not available due to mixed image mode."	A document scanned in the copy function and a document stored in the printer function are selected together, and [Booklet] or [Magazine] is specified.	You cannot specify [Booklet] or [Magazine] to the document comprising data stored in the different functions.
"The selected folder is locked. Please contact the file administrator."	The wrong password was entered 10 times while performing operation on a password-protected folder, and the folder is locked.	Request the file administrator to unlock the folder. The file administrator can unlock folders. See "Managing Folders as a File Administrator", User Guide (Full Version).

# When a Message Is Displayed While Using the Fax Function

## Note

- When confirming or changing the settings in [Settings], press [Home] (🏠) after closing [Settings].

## Messages Displayed During Operation or When Sending/Receiving a Fax Cannot Be Performed

The settings procedure is described using the [Classic] screen type of [Settings] as an example. When you are using the [Standard] screen type, confirm the name of the setting items in the list below.

For details, see "Settings Menu Compatibility List (Classic to Standard Settings)", User Guide (Full Version).

Message	Condition	Solution and reference
"Cannot detect original size."	An original is not placed correctly on the machine.	Place the original correctly. When you place an original on the exposure glass, the machine detects the original size by opening and closing the exposure glass cover or ADF. Open the cover or ADF by more than 30 degrees when placing an original.
	An original with a difficult-to-detect size, even in the regular size, such as a transparency or paper with sticky notes or a custom size original, is placed on the machine.	Specify [Scan Size] in [Send Settings].
"Cannot receive emails currently."	The machine is receiving a On-demand Email Notification (a query e-mail from the administrator), and manual reception cannot be performed.	Wait a while, and press [Manual Reception: Email].



Message	Condition	Solution and reference
"Destination does not support IP-Fax. Transmission was cancelled."	A fax was sent by Immediate Transmission to a destination that does not support IP-Fax.	Send the fax using the G3 line. To switch to the G3 line automatically when sending a fax, select [On] in [Settings] ► [Machine Features Settings] ► [Fax Settings] ► [Send Settings] tab ► [IP-Fax TX Route Auto Switch (IP/G3)].
"Error occurred, and transmission was cancelled."	An original had jammed while sending a fax.	Press [Confirm], remove the jammed original, and then send the fax again.
	An error occurred temporarily in the machine, or there was interference on the line such as excessive noise or cross-talk.	Press [Confirm] and send the fax again.
"Functional problem occurred. Stopped processing."	The power of the machine was lost while receiving an Internet Fax.	Even if you turn on the power immediately, you may not be able to resume reception until the timeout duration has passed depending on the settings of the e-mail server. Wait a while. To receive the fax manually, wait until the duration has passed and then operate the machine to perform reception. For the timeout duration, consult the administrator.
"Memory is full. Cannot scan more. Transmitting only scanned pages."	The memory is full.	Press [Confirm] to return to the stand-by state and start sending the pages that are already scanned and stored. Check the transmission result report for unsent pages, and send those pages later.
"Some invalid destination(s) contained. Do you want to select only valid destination(s)?"	A folder destination is included in the group.	When sending a fax to a destination other than a folder destination, press [Select].

**Note**

- When the JPEG/PDF file that is attached to an e-mail is sent to the machine, check the message and resolve the problem accordingly.

- page 238 "When a Message Appears While Using the Copy Function"

## Messages Displayed When the Machine Cannot Connect to the Network

For details about your network environment, consult the network administrator.

The settings procedure is described using the [Classic] screen type of [Settings] as an example. When you are using the [Standard] screen type, confirm the name of the setting items in the list below.

For details, see "Settings Menu Compatibility List (Classic to Standard Settings)", User Guide (Full Version).

Message	Condition	Solution and reference
"Network communication has failed. Cannot access the SIP server. Please check the address setting of the SIP server or the SIP server settings."	The SIP server could not be accessed.	Specify the correct "SIP Server IP Address" in [Settings] ► [Machine Features Settings] ► [Fax Settings] ► [Initial Settings] tab ► [SIP Settings].  See "Sending Documents by IP-Fax", User Guide (Full Version).
"Network communication has failed. Cannot connect to the destination normally because there is no IP-FAX function compatibility between the destination and this machine."	The destination device is unable to connect with the IP-Fax function of the machine.	Sending a fax using the IP-Fax function is not possible. Send the fax using the G3 line if possible.
"Network communication has failed. Cannot register this machine to SIP server. Please check the address setting of the SIP server or other settings of the SIP server."	The SIP server rejected the registration of the user name.	Specify the correct "SIP Server IP Address" and "SIP User Name" in [Settings] ► [Machine Features Settings] ► [Fax Settings] ► [Initial Settings] tab ► [SIP Settings].  See "Sending Documents by IP-Fax", User Guide (Full Version).

Message	Condition	Solution and reference
"Network communication has failed. Failed to connect to POP/IMAP server. Please check machine settings and the status of server and network."	The POP3 (IMAP4) server could not be found.	Check the settings in [Reception Protocol], [POP3 / IMAP4 Settings] and [Email Communication Port] on the [Settings] ► [Machine Features Settings] ► [System Settings] ► [File Transfer] tab.
	The DNS server could not be found.	Check the [DNS Configuration] setting on the [Settings] ► [Machine Features Settings] ► [System Settings] ► [Interface Settings] tab.
	The machine is not connected to the network.	Check that the machine is connected to the network correctly.
"Network communication has failed. Failed to connect to the destination. Please check if the destination is correct and destination machine status."	The SMTP server could not be found.	Check [SMTP Server] on the [Settings] ► [Machine Features Settings] ► [System Settings] ► [File Transfer] tab.
	The DNS server could not be found.	Check [DNS Configuration] on the [Settings] ► [Machine Features Settings] ► [System Settings] ► [Interface Settings] tab.
	The machine is not connected to the network.	Check that the machine is connected to the network correctly.
	Communication with the destination specified for Folder Transfer could not be established properly.	<ul style="list-style-type: none"> <li>• Check that the computer specified as the transfer destination is operating normally and connected to the network.</li> <li>• Check the transfer settings. See "Transferring a Received Fax Document to E-mail Address or Folder", User Guide (Full Version).</li> </ul>
	The destination could not be found when the fax was sent without using the SMTP server.	<p>Check that the destination is specified correctly.</p> <p>See "Sending Internet Faxes without Using SMTP Server", User Guide (Full Version).</p>

Message	Condition	Solution and reference
"Network communication has failed. Failed to connect to the destination folder. Please check if the destination is correct and destination machine settings."	The shared folder specified as the destination of Folder Transfer cannot be found.	Specify the destination from the address book, press [Edit], and check that the setting in the [Destinations] tab ► [Folder] matches the folder name or path of the shared folder on the destination computer.  If the shared folder on the destination computer has been deleted, create the folder.  See "Transferring a Received Fax Document to E-mail Address or Folder", User Guide (Full Version).
"Network communication has failed. Failed to send. Please check a destination machine status and both authentication setting of destination machine and this machine."	A malfunction is occurring on the SMTP server or the computer specified as the destination when sending an e-mail without using the SMTP server.	Check that the SMTP server and the computer specified as the transfer destination are functioning normally.
"Network communication has failed. Failed to send. Please check destination machine status and remaining memory."	No free space is available on an SMTP server, the computer specified as the destination for Folder Transfer, or the computer specified as the destination when sending an e-mail without using the SMTP server.	Check that free space is available on the SMTP server and the destination computer.
"Network communication has failed. Failed to send. Please check if the destination is correct."	The specified destination does not exist.	Check the destination e-mail address, and specify again if necessary.
	The destination could not be found when the fax was sent without using the SMTP server.	Check that the destination is specified correctly.  See "Sending Internet Faxes without Using SMTP Server", User Guide (Full Version).

Message	Condition	Solution and reference
"Network communication has failed. Failed to send. Please check status and settings of the destination machine."	A malfunction is occurring on an SMTP server, the computer specified as the destination for Folder Transfer, or the computer specified as the destination when sending an e-mail without using the SMTP server.	Check that the SMTP server and the destination computer are functioning normally.
"Network communication has failed. Failed to send. Please check the access privilege setting of the destination."	A malfunction is occurring on an SMTP server, the computer specified as the destination for Folder Transfer, or the computer specified as the destination when sending an e-mail without using the SMTP server.	Check that the SMTP server and the destination computers are functioning normally.
	The shared folder specified as the transfer destination cannot be found in Folder Transfer.	Creating a shared folder on the destination computer. To check the folder name, select the destination in the address book, press [Edit], and see "Path Name" in [Destination] tab [Folder].  See "Transferring a Received Fax Document to E-mail Address or Folder", User Guide (Full Version).
	The user name and/or password registered in the address book are invalid when performing Folder Transfer.	Select the forwarding destination in the address book, press [Edit], and specify [Destinations] tab ► [Folder] ► [Folder Authentication Info] again.  See "Registering the Destination Folder to Use for Send to Folder", User Guide (Full Version).

Message	Condition	Solution and reference
<p>"Network communication has failed. Failed to send. Please check the administrator email address setting."</p>	<p>The administrator e-mail address is not registered when the machine is configured to send Records by e-mail.</p>	<ul style="list-style-type: none"> <li>Specify [Settings] ► [Machine Features Settings] ► [System Settings] ► [File Transfer] tab ► [Administrator's Email Address].</li> <li>When configuring the machine to not send Records by e-mail, change the current value of bit number [4] under switch number [21] in [Parameter Setting].</li> </ul> <p>See "Viewing the History of Sent and Received Faxes", User Guide (Full Version).</p>
<p>"Network communication has failed. Failed to send. Please check user name and password."</p>	<p>The user name and/or password registered in the address book are invalid when performing Folder Transfer.</p>	<p>Select the forwarding destination in the address book, press [Edit], and specify [Destinations] tab ► [Folder] ► [Folder Authentication Info] again.</p> <p>See "Registering the Destination Folder to Use for Send to Folder", User Guide (Full Version).</p>
<p>"Network communication has failed. Failed to send. The registration of fax email address or administrator email address is required."</p>	<p>Both the e-mail address to use for sending and receiving e-mails and the administrator e-mail address are not registered when sending an e-mail.</p>	<p>Specify [Fax Email Account] or [Administrator's Email Address] on the [Settings] ► [Machine Features Settings] ► [System Settings] ► [File Transfer] tab.</p> <p>See "Sending Documents by Internet Fax", User Guide (Full Version).</p>
<p>"Network communication has failed. Failed to send. The specified address is invalid."</p>	<p>A domain name was not specified when sending an e-mail without using the SMTP server.</p>	<ul style="list-style-type: none"> <li>Specify a host name or IP address as the destination, and send the e-mail again.</li> <li>When you specified the destination from the address book, select [Destination] in the address book, press [Edit], and then check the settings in "Send via SMTP Server" and "SMTP Authentication Info" in [Destinations] tab ► [Email Address].</li> </ul> <p>See "Sending Internet Faxes without Using SMTP Server", User Guide (Full Version).</p>

Message	Condition	Solution and reference
"Network communication has failed. Fax email account is not registered. Please check settings."	[Fax Email Account] is not specified.	Specify the settings in "User Name" and "Password" in [Settings] ► [Machine Features Settings] ► [System Settings] ► [File Transfer] tab ► [Fax Email Account].
"Network communication has failed. Fax email address is not registered. Please check settings."	[Fax Email Account] is not specified.	Register Email Address in [Settings] ► [Machine Features Settings] ► [System Settings] ► [File Transfer] tab ► [Fax Email Account].
"Network communication has failed. No response from the destination. Please check the cable connection and if the network equipment is turned on."	The destination device did not respond.	<ul style="list-style-type: none"> <li>• Check that the computer specified as the destination is operating normally and connected to the network.</li> <li>• Check that the machine is connected to the network correctly.</li> </ul>
"Network communication has failed. POP/IMAP server authentication error has occurred. Please check email account and password."	A login attempt to the POP3 (IMAP4) server failed.	Specify the setting in [Settings] ► [Machine Features Settings] ► [System Settings] ► [File Transfer] tab ► [POP3 / IMAP4 Settings].
"Network communication has failed. POP/IMAP server is not registered. Please check settings."	The POP3 (IMAP4) server address is not registered.	Specify the setting in [Settings] ► [Machine Features Settings] ► [System Settings] ► [File Transfer] tab ► [POP3 / IMAP4 Settings].
"Network communication has failed. S/MIME certificate error has occurred. Please check the certificate of both destination and this machine."	A user certificate (destination certificate) is not registered or has expired.	Install the correct user certificate. See "Encrypting Network Communication", User Guide (Full Version).
	A device certificate (destination certificate) is not registered or has expired.	Install the correct device certificate. See "Encrypting Network Communication", User Guide (Full Version).

Message	Condition	Solution and reference
"Network communication has failed. SIP digest authentication failed. Please check the SIP digest authentication user name and password."	The authentication password on the SIP server and the password registered on the machine do not match.	Check that the password registered on the SIP server and "Password" in SIP Digest Authentication under [Settings] ► [Machine Features Settings] ► [Fax Settings] ► [Initial Settings] tab ► [SIP Settings] match.  See "Sending Documents by IP-Fax", User Guide (Full Version).
"Network communication has failed. The certificate of destination is not currently valid. Please re-issue it."	The user certificate (destination certificate) has expired.	Install a new user certificate.  See "Encrypting Network Communication", User Guide (Full Version).
"Network communication has failed. The certificate of this machine is not currently valid. Please re-issue it."	A device certificate (destination certificate) is not registered or has expired.	Install a new device certificate.  See "Encrypting Network Communication", User Guide (Full Version).
"Network communication has failed. The certificate of this machine or destination machine is not currently valid. Please re-issue it."	The user certificate (destination certificate) and device certificate have expired.	Install a new user certificate and device certificate.  See "Encrypting Network Communication", User Guide (HTML version).
"Network communication has failed. The destination does not support IP-FAX."	An IP-Fax was sent to a destination that does not support IP-Fax.	Sending a fax using the IP-Fax function is not possible. Send the fax using the G3 line if possible.
"Network communication has failed. The IP address is invalid. Please check the network settings."	An invalid IP address is registered.	Specify the correct [Effective Protocol] and [Machine IPv4 Address], or [Machine IPv6 Address] on the [Settings] ► [Machine Features Settings] ► [System Settings] ► [Interface Settings] tab.  See "Connecting to a Wired LAN", User Guide (Full Version).



Message	Condition	Solution and reference
"Network communication has failed. The IP address may be invalid. Please check the network settings."	The settings in [SIP Server IP Address] and [Effective Protocol] do not match.	Check that SIP Server IP Address in [Settings] ► [Machine Features Settings] ► [Fax Settings] ► [Initial Settings] tab ► [SIP Settings] and [Effective Protocol] on the [Settings] ► [Machine Features Settings] ► [System Settings] ► [Interface Settings] tab are correct.
	An invalid IP address is registered.	Specify the correct [Machine IPv4 Address], or [Machine IPv6 Address] on the [Settings] ► [Machine Features Settings] ► [System Settings] ► [Interface Settings] tab.  See "Connecting to a Wired LAN", User Guide (Full Version).
"Network communication has failed. The line has been disconnected. Please check the destination and caller ID notification setting."	The destination terminated the communication.	<ul style="list-style-type: none"> <li>• Check that the destination is specified correctly.</li> <li>• If the destination refuses to receive a fax with no sender information, enable notifying of the information and send the fax again.</li> </ul>
"Network communication has failed. The mail address for authentication does not match with administrator's one. Please check the settings."	When a signature is specified, the SMTP authentication e-mail address or POP before SMTP authentication e-mail address does not match the administrator e-mail address.	Check that the authentication e-mail address matches the address specified in [Settings] ► [Machine Features Settings] ► [System Settings] ► [File Transfer] tab ► [Administrator's Email Address].  See "Machine Status Notification by E-mail", User Guide (Full Version).

**Note**

- Change the current value to [1] under switch number [21] and bit number [6] in [Settings] ► [Machine Features Settings] ► [Fax Settings] ► [Initial Settings] tab ► [Parameter Setting] to disable displaying the "Network communication has failed." message. Change the setting when you are not using the IP-Fax or Internet Fax function.
- See "Changing the Parameter Settings", User Guide (Full Version).

## Messages Displayed When the Remote Fax Function Is Unavailable

For details about your network environment, consult the network administrator.

### When a message is displayed on the main-machine

The settings procedure is described using the [Classic] screen type of [Settings] as an example. When you are using the [Standard] screen type, confirm the name of the setting items in the list below.

For details, see "Settings Menu Compatibility List (Classic to Standard Settings)", User Guide (Full Version).

Message	Condition	Solution and reference
"Check whether there are any network problems." [16-00]	The machine is not connected to the network.	<ul style="list-style-type: none"> <li>• Check that the machine is connected to the network correctly.</li> <li>• Press [Confirm] to use the G3 fax.</li> </ul>
"Connection with the remote machine has failed. There is a problem with the remote machine structure. Contact the administrator."	Another main-machine is registered in [Remote Machine].	Register the sub-machine in [Settings] ► [Machine Features Settings] ► [System Settings] ► [Administrator Tools] tab ► [Program/Change/Delete Remote Machine].
	Another main-machine is registered in [Remote Machine] on the sub-machine.	Register the machine in [Settings] ► [Machine Features Settings] ► [System Settings] ► [Administrator Tools] tab ► [Program/Change/Delete Remote Machine] on the sub-machine.

Message	Condition	Solution and reference
"Transfer error has occurred. Check the status of the remote machine."	A network error occurred while transferring the data.	<ul style="list-style-type: none"> <li>• Check that the machine is connected to the network correctly.</li> <li>• Check that the sub-machine is connected to the network and functioning normally.</li> <li>• Check that the IP address or host name of the main-machine is specified correctly in [Settings] ► [Machine Features Settings] ► [System Settings] ► [Administrator Tools] tab ► [Program/Change/Delete Remote Machine] on the sub-machine.</li> </ul>

### When a message is displayed on the sub-machine

The settings procedure is described using the [Classic] screen type of [Settings] as an example. When you are using the [Standard] screen type, confirm the name of the setting items in the list below.

For details, see "Settings Menu Compatibility List (Classic to Standard Settings)", User Guide (Full Version).

Message	Condition	Solution and reference
"Authentication with remote machine failed. Check remote machine's authentication settings."	Authentication failed when user authentication is enabled on the main-machine, or the user does not have permission to use the fax function.	Specify the same user authentication setting as the main-machine, and register a user who has the permission to use the fax function. See "Verifying Users to Operate the Machine (User Authentication)", User Guide (Full Version).
"Check whether there are any network problems." [16-00]	The machine is not connected to the network.	Check that the machine is connected to the network correctly.

Message	Condition	Solution and reference
"Connection with the remote machine has failed. Check the remote machine status."	The main-machine is turned off, or not functioning normally.	Turn on the power of the main-machine. If the power is turned on, check that the device is functioning normally.
	A network error occurred.	Check that the machine and the main-machine are connected to the network correctly.
	A timeout error occurred while connecting to the main-machine.	Check that the IP address or host name of the main-machine is specified correctly in [Settings] ► [Machine Features Settings] ► [System Settings] ► [Administrator Tools] tab ► [Program/Change/Delete Remote Machine] on the sub-machine.
"Connection with the remote machine has failed. There is a problem with the remote machine structure. Contact the administrator."	Another sub-machine is registered in [Remote Machine].	Register the main-machine in [Settings] ► [Machine Features Settings] ► [System Settings] ► [Administrator Tools] tab ► [Program/Change/Delete Remote Machine].
	The machine is not registered in [Remote Machine] on the main-machine.	Register the machine in [Settings] ► [Machine Features Settings] ► [System Settings] ► [Administrator Tools] tab ► [Program/Change/Delete Remote Machine] on the main-machine.
"Remote fax is not available because [User Code Authentication] is active."	User Code authentication is specified.	User Code authentication is not supported on both the main-machine and sub-machine. Consider another method of user authentication.

Message	Condition	Solution and reference
"Remote machine registration is incorrect. Contact the administrator."	The main-machine could not be found.	Check that the IP address or host name of the main-machine is specified correctly in [Settings] ► [Machine Features Settings] ► [System Settings] ► [Administrator Tools] tab ► [Program/Change/Delete Remote Machine].
"Transfer error has occurred. Check the status of the remote machine."	A network error occurred while transferring the data.	<ul style="list-style-type: none"> <li>• Check that the machine is connected to the network correctly.</li> <li>• Check that the main-machine is connected to the network and functioning normally.</li> <li>• Check that the IP address or host name of the main-machine is specified correctly in [Settings] ► [Machine Features Settings] ► [System Settings] ► [Administrator Tools] tab ► [Program/Change/Delete Remote Machine].</li> </ul>
"Transfer error has occurred. Check the status of the remote machine." "The HDD of the remote machine is full."	There is no free space available on the hard disk of the main-machine.	Delete files that are no longer needed on the main-machine.

# When a Message Appears While Using the Printer Function

## Note

- When confirming or changing the settings in [Settings], press [Home] () after closing [Settings].

## Messages Displayed without Error Codes

The settings procedure is described using the [Classic] screen type of [Settings] as an example. When you are using the [Standard] screen type, confirm the name of the setting items in the list below.

For details, see "Settings Menu Compatibility List (Classic to Standard Settings)", User Guide (Full Version).

Message	Cause	Solution and reference
"Address Book is currently in use by another function. Authentication has failed."	The address book is in use by another function, and authentication query is not possible.	Try again later.
"A function which cannot be used with Fold mode was set. The job has been cancelled."	A setting that cannot be specified with folding was specified, and printing was canceled.	Check the setting, and cancel the function that cannot be specified with the fold function.
"A job via the network that was not printed exists because an error occurred. It was stored as a job not printed."	When the error job storing function is enabled, an error occurred in the print job sent via the network and the canceled job was stored.	<ul style="list-style-type: none"> <li>Check that the machine is connected to the network correctly. For details about your network environment, consult the network administrator.</li> <li>The stored document can be printed. page 138 "Printing Documents Stored in the Printer from the Control Panel"</li> </ul>

Message	Cause	Solution and reference
"All the remaining print volume has been allocated to another central managed client(s). The job has been cancelled."	The job was canceled because the usage count information could not be obtained from the Central Management machine.	All job slots are occupied by other devices. Check the status of the client machine.
"An error occurred while printing a job with Background Numbering. The job has been cancelled."	A size that is impossible to print was specified.	Specify a size smaller than 316.0 mm (12.5 inches) wide and 432 mm (17.1 inches) long in "Print On:" in the printer driver. When [Same as Original Size] is specified in "Print On:", reduce the size specified in "Print On:" or adjust the size in the application.
"An error occurred while processing an Unauthorized Copy Prevention job. The job was cancelled."	The settings in the printer driver are incorrect.	<p>Check the following in the printer driver:</p> <ul style="list-style-type: none"> <li>Is a value smaller than 600 dpi specified in [Resolution]?</li> </ul> <p>See "Applying Different Print Settings Depending on the Document Type", User Guide (Full Version).</p> <ul style="list-style-type: none"> <li>Is only space(s) entered as the text to use for the background pattern in the unauthorized copy prevention function?</li> <li>Is Document Server specified as the print method?</li> </ul> <p>See "Storing Documents to Print in the Machine", User Guide (Full Version).</p>
	Unauthorized copy prevention is given priority in the [Administrator Tools] tab.	<p>Consult the device administrator for the settings of the machine. The machine administrator can change the setting in [Unauthorized Copy Prevention Printing: Printer].</p> <p>See "Administrator Tools", User Guide (Full Version).</p>

Message	Cause	Solution and reference
"Auto-registration of user information has failed."	The maximum number of items that can be registered has been exceeded and the authentication information for LDAP authentication or Windows authentication cannot be registered automatically.	Delete a user that is no longer necessary from the address book.
"Booklet/Half Fold is not available with the settings. The job has been cancelled."	A setting in which Booklet or Half-fold cannot be performed was specified, and printing was canceled.	Check the setting for the availability of the Booklet or Half-fold function. page 298 "List of Specifications"
"Cannot access the Memory Storage Device."	An SD card or USB flash memory device is unavailable for use.	<ul style="list-style-type: none"> <li>• Check that the external media is formatted in FAT16 or FAT32, and write protection is not enabled on the media.</li> <li>• Check that the external media is not corrupted or damaged.</li> </ul>
"Cannot store data of this size."	The paper size is too large.	Reduce the paper size of the document to send. The document to send cannot be stored at a custom size.
"Classification Code is incorrect."	A classification code is not specified.	Consult the machine administrator for the classification code, and enter the code in "Classification Code" on the [Detailed Settings] tab ► [Job Setup] menu in the printer driver.
	The document was printed in a printer driver that does not support the classification code.	Request the machine administrator to change the setting of the classification code. Machine administrator: Change the [Classification Code] to [Optional] in Web Image Monitor if necessary. See "Managing the Number of Printed Sheets Using the Classification Code", User Guide (Full Version).



Message	Cause	Solution and reference
"Collate has been cancelled."	The sort function was canceled.	Turn off the power of the machine, wait for 10 seconds or more after confirming that the main power indicator is turned off, and then turn on the power. page 11 "Turning On and Off the Power"
"Command Error"	A problem occurred in the data because of the communication status or another reason.	Check that the machine can communicate with the computer properly.
	A printer driver that does not support the machine was used.	Use the printer driver for the machine. Obtain and install the latest version of the driver.
"Communication error with central management server has occurred. The job has been cancelled."	The job was canceled because a Central Management communication error occurred.	Check the status of the Central Management machine.
"Compressed Data Error."	Compressed data is corrupted.	<ul style="list-style-type: none"> <li>• Check that the tool used for creating the compressed data is functioning properly.</li> <li>• Check that the machine can communicate with the computer properly.</li> </ul>
"Connection with the machine has failed. Check the machine structure."	The machine is malfunctioning, and [Printer] cannot be used.	<ul style="list-style-type: none"> <li>• Check whether a message is displayed on the control panel.</li> <li>• Turn off the power of the machine, wait for 10 seconds or more after confirming that the main power indicator is turned off, and then turn on the power. page 11 "Turning On and Off the Power"</li> </ul>

Message	Cause	Solution and reference
"Data storage error."	Printing a document as Test Print, Locked Print, Hold Print, Store Print, or storing the document in Document Server failed. The hard disk is malfunctioning.	If the message persists even after you have turned the power off and then on, consider repairing the machine.
"Document Server is not available to use. Cannot store."	Use of the Document Server function is restricted.	Consult the user administrator.
"Duplex has been cancelled."	The paper source tray is not specified for duplex printing.	Specify to use the paper tray for duplex printing in [Settings] ► [Tray Paper Settings] ► [Paper Type].
"Error has occurred."	An error such as a syntactic error has occurred.	Check that the PDF file to print does not have an error.
"Error occurred in the Folding Unit. The job has been cancelled."	A malfunction occurred in the fold unit.	Consider repairing the machine.
"Error occurred while processing a Compulsory Security Stamp print job. The job was cancelled."	The job was canceled because an error occurred while applying Compulsory Security Stamp.	When feeding paper from the bypass tray, specify the correct paper size and do not enable [Auto Detect].
"Exceeded max. capacity of Document Server. Cannot store."	The hard disk is almost full.	<ul style="list-style-type: none"> <li>Reduce the size of the document to send.</li> <li>Erase documents that are no longer needed.</li> </ul> See "Deleting Documents Stored in the Machine" and "Erasing Documents from Document Server", User Guide (Full Version).

Message	Cause	Solution and reference
"Exceeded max. number of files. (Auto)"	The maximum number of Store Print jobs or the maximum number of jobs that can be managed for Hold Print (Auto) documents has been exceeded while storing a document printed by Normal Print as a Hold Print job by the error job storing function.	Erase a Hold Print (Auto) document that is no longer needed. See "Deleting Documents Stored in the Machine", User Guide (Full Version).
"Exceeded max. number of files of Document Server. Cannot store."	The number of documents stored in the machine exceeds the maximum number.	Erase documents that are no longer needed. See "Erasing Documents from Document Server", User Guide (Full Version).
"Exceeded max. number of pages. (Auto)"	An "exceeded max. number of pages" error occurred while storing a document printed by Normal Print as a Hold Print job by the error job storing function.	<ul style="list-style-type: none"> <li>• Reduce the number of pages to print.</li> <li>• Erase documents that are no longer needed.</li> </ul> See "Deleting Documents Stored in the Machine" and "Erasing Documents from Document Server", User Guide (Full Version).
"Exceeded max. number of pages of Document Server. Cannot store."	The number of pages stored in the machine exceeds the maximum number.	<ul style="list-style-type: none"> <li>• Reduce the number of pages in the document to send.</li> <li>• Erase documents that are no longer needed.</li> </ul> See "Erasing Documents from Document Server", User Guide (Full Version).

Message	Cause	Solution and reference
"Exceeded max. pages. Collate is incomplete."	The maximum number of sheets that can be sorted has been exceeded.	Reduce the number of pages to print.
"Exceeded the maximum number of multi-sheet fold (Half Fold)."	The number of sheets that can be folded in half was exceeded, and printing was canceled.	Check the number of sheets that can be folded in half on the finisher in use. page 298 "List of Specifications"
"Exceeded the maximum unit count for Print Volume Use. The job has been cancelled."	When the print volume is limited, printing was canceled because the print volume of a user exceeded the upper limit allotted for the user.	For details about the print volume use limitation, consult the user administrator. The user administrator can clear the counter or change the limit on the print volume. See "Checking the Counter of the Machine for Each Color Category" and "Specifying Maximum Print Volume Use of Each User", User Guide (Full Version).
"File system is full."	The file system is full, and the PDF file cannot be printed.	Erase documents that are no longer needed. See "Deleting Documents Stored in the Machine" and "Erasing Documents from Document Server", User Guide (Full Version).
"Fold is not available with the settings. The job has been cancelled."	A setting in which folding cannot be performed was specified, and printing was canceled.	Check the tray, paper size, paper type settings and the specified position for post-processing.

Message	Cause	Solution and reference
"Hardware Problem: HDD"	An error is occurring on the hard disk of the machine.	Turn off the power of the machine, wait for 10 seconds or more after confirming that the main power indicator is turned off, and then turn on the power. page 11 "Turning On and Off the Power"
"Hardware Problem: USB"	An error has occurred on the USB interface.	If the message persists even after you have turned the power off and then on, consider repairing the machine.
"Hardware Problem: Ethernet"	An error has occurred in the Ethernet interface.	
"Hardware Problem: Wireless Card"	An error has occurred in the Wireless LAN board.	Turn off the power of the machine, check that the Wireless LAN board is correctly installed in the machine, and then turn on the power. page 11 "Turning On and Off the Power"  If the message persists even after you have turned the power off and then on, consider repairing the machine.
"HDD is full."	The area reserved for forms or fonts in PostScript 3 is full.	Delete a registered form or font that is no longer necessary.
"HDD is full. (Auto)"	An overflow error occurred in the hard disk while storing a document printed by Normal Print as a Hold Print job by the error job storing function.	<ul style="list-style-type: none"> <li>Reduce the size of the document to print.</li> <li>Erase documents that are no longer needed.</li> </ul> See "Deleting Documents Stored in the Machine" and "Erasing Documents from Document Server", User Guide (Full Version).
"I/O buffer overflow."	An overflow has occurred in the receive buffer.	<ul style="list-style-type: none"> <li>Reduce the transmission data.</li> <li>Increase the value in [I/O Buffer] on the [Settings]               <ul style="list-style-type: none"> <li>▶ [Machine Features Settings] ▶ [Printer Settings]</li> <li>▶ [Host Interface] tab.</li> </ul> </li> </ul>

Message	Cause	Solution and reference
"Information for user authentication is already registered for another user."	In LDAP authentication, the same name is registered under different IDs on different servers, and duplicate names (account names) occurred such as when switching the domain (server).	Consult the user administrator. User administrator: Delete the corresponding user from the address book, and register the user again after resolving the duplicate names on different servers.
"Insufficient Memory"	The amount of available memory is insufficient.	Decrease [Resolution] in the printer driver. See "Applying Different Print Settings Depending on the Document Type", User Guide (Full Version).
"Load following paper in XXX. To force print, select another tray and press [Continue]." (XXX indicates the tray name)	The paper tray specified in the printer driver has no paper loaded.	<ul style="list-style-type: none"> <li>To proceed with printing after changing the paper setting, select a tray and press [Continue]. However, when Staple, Punch, Fold, Cover Sheet, Slip Sheet, Chaptering, or Designate is specified, or when Duplex printing is specified on a paper tray that does not support the function, printing cannot be performed. When Sort is specified, only one copy of the document is printed.</li> <li>To proceed with printing on the specified paper, load the paper in the tray. page 179 "Loading Paper into the Paper Tray"</li> </ul>
"Memory Overflow"	The insufficient memory error has occurred while printing from the printer driver (PCL 6).	In the printer driver, change "Vector/Raster" to [Raster] in the [Detailed Settings] tab ► [Print Quality:Advanced] menu.
"Memory Retrieval Error"	The data in the memory could not be retrieved.	Turn off the power of the machine, wait for 10 seconds or more after confirming that the main power indicator is turned off, and then turn on the power. page 11 "Turning On and Off the Power"

Message	Cause	Solution and reference
"No response from the server. Authentication has failed."	In LDAP or Windows authentication, a timeout error occurred while submitting an authentication query to the server.	Consult the administrator of the authentication server.
"Output tray has been changed."	The destination to deliver the output paper was changed because of the paper size limitation of the output destination.	Specify the correct destination to deliver the output paper.
"Paper size and type are mismatched. Select another tray from the following and press [Continue]. To cancel job, press [Job Reset]. Paper size and type can also be changed in User Tools."	The paper tray loaded with paper of the size or type specified in the printer driver is not available.	<ul style="list-style-type: none"> <li>To proceed with printing after changing the paper setting, select a tray and press [Continue]. When Staple, Punch, Fold, Cover Sheet, Slip Sheet, Chaptering, or Designate is specified, or when Duplex printing is specified on a paper tray that does not support the function, printing cannot be performed. When Sort is specified, only one copy of the document is printed.</li> <li>To proceed with printing on the specified paper, load the paper and then check that the paper size and type are correctly specified in [Settings] ▶ [Tray Paper Settings]. page 179 "Loading Paper into the Paper Tray"</li> </ul>
"Parallel I/F board has a problem."	An error has occurred in the parallel interface.	<p>Turn off the power of the machine, wait for 10 seconds or more after confirming that the main power indicator is turned off, and then turn on the power.</p> <p>page 11 "Turning On and Off the Power"</p> <p>If the message persists even after you have turned the power off and then on, consider repairing the machine.</p>
"Printer font error."	There is a problem in the font file of the machine.	Consider repairing the machine.

Message	Cause	Solution and reference
"Print overrun."	A page image is discarded while printing the page.	Decrease [Resolution] in the printer driver. See "Applying Different Print Settings Depending on the Document Type", User Guide (Full Version).
"Punch has been cancelled."	The Punch function was canceled because the staple position is specified incorrectly.	Check the orientation of the paper and print data, and the specified punch position. See "Punching Holes on Printed Pages", User Guide (Full Version).
"Receiving data failed."	Transmission of data was canceled.	Send the data again.
"Sending data failed."	Transmission of data from the printer driver was canceled.	Check that the computer is operating normally.
"Staple error occurred. The job has been cancelled."	The number of sheets that can be stapled was exceeded, and printing was canceled.	Check the number of sheets that can be stapled on the finisher in use. page 298 "List of Specifications"



Message	Cause	Solution and reference
"Staple has been cancelled."	The Staple function was canceled because too many printed sheets were specified to be stapled.	<p>Check the specification of the finisher in use, and specify the setting accordingly.</p> <ul style="list-style-type: none"> <li>Number of sheets that can be stapled together page 298 "List of Specifications"</li> <li>Staple position that can be specified on different paper orientation and print data orientation See "Stapling Printed Pages", User Guide (Full Version).</li> </ul>
	Incorrect finisher is specified in the printer driver.	<p>Check the option configuration specified in the printer driver.</p> <p>See "The Option Configuration of the Machine Is Not Reflected in the Printer Driver", User Guide (Full Version).</p>
	A malfunction occurred temporarily on the machine.	<p>Turn off the power of the machine, wait for 10 seconds or more after confirming that the main power indicator is turned off, and then turn on the power.</p> <p>page 11 "Turning On and Off the Power"</p>
"The job was cancelled because the specified settings are not applicable for Booklet."	A condition in which binding cannot be performed was specified, and printing was canceled.	Check the binding condition.
"The print job has been cancelled because capture file(s) could not be stored: Exceeded max. memory."	The amount of available space on the hard disk became low while saving the capture data.	<ul style="list-style-type: none"> <li>Reduce the size of the document to send.</li> <li>Erase documents that are no longer needed.</li> </ul> <p>See "Deleting Documents Stored in the Machine" and "Erasing Documents from Document Server", User Guide (Full Version).</p>
"The print job has been cancelled because capture file(s) could not be stored: Exceeded max. number of files."	The number of documents stored in the machine exceeded the maximum number while saving the capture data.	<p>Erase documents that are no longer needed.</p> <p>See "Erasing Documents from Document Server", User Guide (Full Version).</p>

Message	Cause	Solution and reference
"The print job has been cancelled because capture file(s) could not be stored: Exceeded max. number of pages per file."	The number of pages stored in the machine exceeded the maximum number while saving the capture data.	<ul style="list-style-type: none"> <li>Reduce the number of pages in the document to send.</li> <li>Erase documents that are no longer needed.</li> </ul> See "Erasing Documents from Document Server", User Guide (Full Version).
"The selected paper size is not supported. This job has been cancelled."	A paper size that cannot be fed on the machine was specified and printing was canceled by the auto job cancel function that was activated.	Print the document on paper of a size that can be fed on the machine.
"The selected paper type is not supported. This job has been cancelled."	A paper type that cannot be fed on the machine was specified and printing was canceled by the auto job cancel function that was activated.	Print the document on paper of a type that can be fed on the machine.
"You do not have a privilege to use this function. This job has been cancelled."	Authentication information is not registered correctly in the printer driver.	Specify the authentication information in the printer driver. For the authentication information, consult the user administrator. See "Specifying Login Information in the Printer Driver", User Guide (Full Version).
	The user registered in the printer driver does not have permission to use the printer function.	Consult the user administrator. The user administrator can change the access permissions in the address book. See "Confirming the Available Functions", User Guide (Full Version).

Message	Cause	Solution and reference
"Z-fold error."	A setting in which Z-fold cannot be performed was specified, and the Z-fold function was canceled.	Check the tray, paper orientation and print data orientation settings, and the specified position for post-processing.

## Messages Displayed with Error Codes

Check the system configuration list or print settings list. The details of the error may also be printed in the list.

See "List / Test Print", User Guide (Full Version).

See below when [Standard] is specified as the screen type of [Settings]. The names of the setting items may differ from the [Classic] screen type.

See "List/Test Print", User Guide (Full Version).

For details, see "Settings Menu Compatibility List (Classic to Standard Settings)", User Guide (Full Version).

Message	Cause	Solution and reference
"84: Error"	The amount of available work area is insufficient for processing images.	Reduce the transmission data.
"86: Error"	The parameter in the control code is incorrect.	Specify the correct parameter.
"91: Error" (displayed in the error history)	The auto job cancel function was activated because an unable-to-analyze-command or illegal command error occurred, and printing was canceled.	Check that the data is correct.
"92: Error" (displayed in the error history)	Printing is canceled from the control panel.	To perform printing, operate the control panel again.

Message	Cause	Solution and reference
"98: Error"	Accessing the hard disk failed.	Turn off the power of the machine, wait for 10 seconds or more after confirming that the main power indicator is turned off, and then turn on the power. page 11 "Turning On and Off the Power"
"99: Error"	When printing a file from an SD card or USB flash memory device, the file to print is in an unsupported format or corrupt.	Check the data to print.

# When a Message Is Displayed While Using the Scanner Function

## Note

- When confirming or changing the settings in [Settings], press [Home] (🏠) after closing [Settings].

## Messages Displayed on the Control Panel

The settings procedure is described using the [Classic] screen type of [Settings] as an example. When you are using the [Standard] screen type, confirm the name of the setting items in the list below.

For details, see "Settings Menu Compatibility List (Classic to Standard Settings)", User Guide (Full Version).

Message	Cause	Solution and reference
"All the pages are detected as blank. No file was created."	The original was placed with the wrong side facing down when [Delete Blank Page] or [Delete Blank Page] in OCR is specified.	<ul style="list-style-type: none"> <li>When scanning on the exposure glass, place the original with the side to scan facing down.</li> <li>When scanning on the ADF, place the original with the side to scan facing up.</li> </ul>
	All pages in the scanned original were determined to be blank when [Delete Blank Page] is specified.	
	All pages in the scanned original were determined to be blank when [Delete Blank Page] in OCR is specified.	<p>Change [Settings] ▶ [Machine Features Settings] ▶ [Scanner Settings] ▶ [Send Settings] tab ▶ [OCR Scanned PDF: Blank Page Sensitivity] to [Level 1]. The machine detects a blank page only when the original is completely white.</p> <p>Decrease the value in [Settings] ▶ [Machine Features Settings] ▶ [Scanner Settings] ▶ [Scan Settings] tab ▶ [Blank Page Detection Level].</p>

Message	Cause	Solution and reference
"Authentication with the destination has failed. Check settings. To check the current status, press [Scan Files Status]."	The user name/ password of SMTP authentication specified when sending the e-mail are incorrect.	Select the destination in the address book, press [Edit], and check the setting in [Destination] tab ► [Email Address].
	The user ID/password specified on the destination folder in Send to Folder are incorrect.	<ul style="list-style-type: none"> <li>• Select the forwarding destination in the address book, press [Edit], and check the information registered in [Destinations] tab ► [Folder] ► [Folder Authentication Info].</li> <li>• Adding "@domain-name" behind the user name may resolve the problem.</li> <li>• When a login password is not specified on your computer, specify a login password on the computer and register it to the machine.</li> </ul>
"Cannot access the Memory Storage Device."	An SD card or USB flash memory device is unavailable for use.	<ul style="list-style-type: none"> <li>• Check that the external media is formatted in FAT16 or FAT32, and write encryption or protection is not enabled on the media.</li> <li>• Check that the external media is not corrupted or damaged.</li> </ul>
"Cannot detect original size. Select scan size."	An original is not placed correctly on the machine.	Place the original correctly. When you place an original on the exposure glass, the machine detects the original size by opening and closing the exposure glass cover or ADF. Open the cover or ADF by more than 30 degrees when placing an original.
	An original with a difficult-to-detect size even in the regular size is placed on the machine.	When scanning an original with a difficult-to-detect size, specify [Send Settings] ► [Scan Size]. page 214 "Sizes Detectable with Auto Paper Select"
	An original with a custom size is placed on the machine.	When scanning an original with a custom size, specify the original size in [Send Settings] ► [Scan Size] ► [Custom Size].

Message	Cause	Solution and reference
"Cannot find the specified path. Please check the settings."	The machine or the computer is not connected to the network correctly.	Check that the machine or the computer is connected to the network correctly. For details about your network environment, consult the network administrator.
	The computer name or folder name specified in the path name is incorrect.	Register the computer name and folder name again.
	The firewall function is enabled on the computer.	In the firewall function on the computer, register the machine IP address and the port to use for sending files as exceptions. You can check the IP address in [Check Status] ► "Network". For details about the ports, see the following: page 298 "List of Specifications"
"Check original's orientation."	The original is placed in the wrong orientation.	Depending on the combination of the specified settings, the orientation to set the original differs. Be sure to place the original in the correct orientation. See "Placing an Original to Scan", User Guide (Full Version).

Message	Cause	Solution and reference
"Connection with PC has failed. Check the settings."	The machine or the computer is not connected to the network correctly.	Check that the machine or the computer is connected to the network correctly. For details about your network environment, consult the network administrator.
	The computer name or folder name specified in the path name is incorrect.	Register the computer name and folder name again.
	The firewall function is enabled on the computer.	In the firewall function on the computer, register the machine IP address and the port to use for sending files as exceptions.  You can check the IP address in [Check Status] ► "Network". For details about the ports, see the following:  page 298 "List of Specifications"
"Exceeded max. data capacity. Check the resolution or ratio, then press [Start] again."	The data scanned by specifying [Reduce/Enlarge] ► [Specify Size] exceeds the limit.	<ul style="list-style-type: none"> <li>Decrease [Send Settings] ► [Resolution].</li> <li>Specify a smaller paper size in [Send Settings] ► [Reduce/Enlarge] ► [Specify Size].</li> </ul>
"Exceeded max. data capacity. Check the scanning resolution, then XXX."  (procedure described in place of XXX)	A large size original was scanned at a high resolution, and the resulting data size exceeds the limit.	<ul style="list-style-type: none"> <li>Decrease [Send Settings] ► [Resolution].</li> <li>Specify a smaller size in [Send Settings] ► [Scan Size].</li> </ul>
"Exceeded max. email size. Sending email has been cancelled. Check [Max. Email Size] in Scanner Features."	The file size per page has exceeded the maximum e-mail size specified in [Max. Email Size].	<ul style="list-style-type: none"> <li>Specify a lower value in [Send Settings] ► [Resolution], or select a smaller paper size in [Send Settings] ► [Reduce/Enlarge] ► [Specify Size].</li> <li>You can change the [Max. Email Size] setting on the [Settings] ► [Machine Features Settings] ► [Scanner Settings] ► [Send Settings] tab. To divide an e-mail that exceeds the maximum size, specify [Yes (per Page)] or [Yes (per Max. Size)] in [Divide &amp; Send Email].</li> </ul>



Message	Cause	Solution and reference
"Exceeded max. number of alphanumeric characters."	The number of entered characters has exceeded the maximum.	Check the maximum number of characters. page 361 "The Setting Values of the Transmission Function"
"Insufficient memory in the memory storage device."	There is no free space available on the SD card or USB flash memory device, or the file could not be saved due to insufficient space on the media.	Change the external media. When scanning an original in the divide-document or single-page mode, the saved data may not contain all pages in the original. Change the external media and press [Retry] to resume saving the remaining data.
"Not all of the image will be scanned. Check the ratio and then press [Start] again."	The scaling factor specified in [Reduce/Enlarge] is too large.	Specify a smaller value in [Send Settings] ► [Reduce/Enlarge].
	The paper size specified in [Reduce/Enlarge] ► [Specify Size] requires a reduction value smaller than 25%.	Specify a paper size for which a reduction ratio greater than 25% is specified in [Send Settings] ► [Reduce/Enlarge] ► [Specify Size].
"Programmed. Cannot program the destination(s) that is not programmed in the address book."	A folder specified by Manual Entry is included among the programmed destinations.	Register the destination in the address book of the machine, and then register it to a program.
"Programmed. Cannot program the folder destination(s) with protection code(s)."	A destination specified with a protection code is included among the programmed destinations.	<ul style="list-style-type: none"> <li>You cannot program a destination specified with a protection code. Specify this destination individually.</li> <li>To program this destination, cancel the protection code and then register the destination to a program.</li> </ul> <p>See "Using the Protection Function to Prevent the Misuse of Addresses", User Guide (Full Version).</p>

Message	Cause	Solution and reference
"SMTP authentication email address and administrator email address mismatch."	The SMTP authentication e-mail address is not registered in the administrator e-mail address.	Register the SMTP authentication e-mail address in [Settings] ► [Machine Features Settings] ► [System Settings] ► [File Transfer] tab ► [Administrator's Email Address].
"Some invalid destination(s) contained. Do you want to select only valid destination(s)?"	The group contains an e-mail address.	When sending data to a destination other than an e-mail address, press [Select].
"The program is recalled. Cannot recall the folder destination(s) with protection code(s)."	A folder destination specified with a protection code is included among the programmed destinations.	<ul style="list-style-type: none"> <li>You cannot recall a destination specified with a protection code in a program. Specify this destination individually.</li> <li>To program this destination, cancel the protection code and then register the destination to a program.</li> </ul> <p>See "Using the Protection Function to Prevent the Misuse of Addresses", User Guide (Full Version).</p>
"The size of the scanned data is too small. Check the resolution and the ratio and then press [Start] again."	The data scanned by specifying [Reduce/Enlarge] ► [Specify Size] is too small.	<ul style="list-style-type: none"> <li>Increase [Send Settings] ► [Resolution].</li> <li>Specify a larger paper size in [Send Settings] ► [Reduce/Enlarge] ► [Specify Size].</li> </ul>
"Transmission has failed. Insufficient memory in the destination hard disk. To check the current status, press [Scan Files Status]."	The amount of available hard disk space on the destination computer, SMTP server, or FTP server is insufficient.	Check that the amount of free space is sufficient.
"Transmission has failed. To check the current status, press [Scan Files Status]."	A network error occurred while transferring the data due to a busy network or another reason.	If the same message is displayed after scanning the original again, consult the administrator.

## Messages Displayed on the Computer

Message	Cause	Solution and reference
"Any of Login User Name, Login Password or Driver Encryption Key is incorrect."	The login user name or password entered in [General User Authentication] is incorrect.	Enter the correct login user name and password in [General User Authentication] that is displayed after clicking [Scan]. For the login user name and password, consult the user administrator.
	The driver encryption key is not registered correctly in the TWAIN driver.	Register the driver encryption key on the [Details] ► [Authenticate] tab in the TWAIN driver. For the driver encryption key, consult the network administrator.
"Authentication password and/or authentication algorithm may be incorrect. Please check."	The SNMPv3 authentication information registered in Network Connection Tool does not match the information of the machine.	Consult the network administrator for the SNMPv3 authentication information, and change the information registered in Network Connection Tool. See "Installing the TWAIN Driver", User Guide (Full Version).
"Authentication succeeded. However, the access privileges for scanner function has been denied."	The logged-in user does not have access privileges to use the scanner function.	Consult the user administrator. The user administrator can change the access permissions in the address book. See "Confirming the Available Functions", User Guide (Full Version).
"Cannot add any more scanning mode."	The maximum number of scanning modes that can be registered exceeds the maximum number (100).	Delete scanning modes that are no longer necessary.
"Cannot connect to the scanner. Check the network Access Mask settings in User Tools."	An access mask is specified.	Consult your administrator.

Message	Cause	Solution and reference
"Cannot detect the paper size of the original. Specify the scanning size."	The original is not placed correctly on the machine.	When you place an original on the exposure glass, the machine detects the original size by opening and closing the exposure glass cover or ADF. Open the cover or ADF by more than 30 degrees when placing an original.
	An original with a difficult-to-detect size even in the regular size is placed on the machine.	When scanning an original with a difficult-to-detect size, specify [Send Settings] ► [Scan Size]. page 214 "Sizes Detectable with Auto Paper Select"
	An original with a custom size is placed on the machine.	When scanning an original with a custom size, specify the original size in [Send Settings] ► [Scan Size] ► [Custom Size].
"Cannot specify any more scanning area."	The maximum number of scanning areas that can be registered exceeds the maximum number (100).	Delete scanning areas that are no longer necessary.
"Communication error has occurred on the network."	A communication error has occurred on the network.	Check that the settings for the communication protocol (TCP/IP) are configured correctly on the computer.
"Entered User Code is not registered or you do not have access privileges to use the scanner function, please contact your administrator."	The correct user code is not registered in the TWAIN drive when User Code authentication is specified on the machine.	Register the User Code on the [Details] ► [Authenticate] tab in the TWAIN driver. For the User Code, consult the user administrator.
	The User Code registered in the TWAIN driver is not assigned with the privileges to use the scanner function.	Consult the user administrator. The user administrator can change the access permissions in the address book. See "Confirming the Available Functions", User Guide (Full Version).

Message	Cause	Solution and reference
"Error has occurred in the scanner."	The scan condition specified in the application exceeds the range that can be specified on the machine.	Specify the scan condition within the range that can be specified on the machine. page 298 "List of Specifications"
	A malfunction is occurring in the driver.	<ul style="list-style-type: none"> <li>Restart the application, and perform scanning again.</li> <li>Install the TWAIN driver again.</li> </ul>
	A malfunction is temporarily occurring on the machine.	Turn off the power of the machine, wait for 10 seconds or more after confirming that the main power indicator is turned off, and then turn on the power. page 11 "Turning On and Off the Power"
"Error has occurred in the scanner driver."	An error is occurring in the driver or operating system.	Restart the computer.
	There is a problem with the network environment.	Check that the computer is connected to the network correctly and in an environment where the TCP/IP protocol can be used.
"Fatal error has occurred in the scanner."	An unrecoverable error is occurring on the machine.	Consider repairing the machine.
"Insufficient memory. Close all other applications, then restart scanning."	Other applications are running on the computer, and the amount of free memory is insufficient.	<ul style="list-style-type: none"> <li>Close applications on the computer.</li> <li>If the same message is displayed when no other applications are running after starting the computer, uninstall the TWAIN driver, restart the computer, and then install the TWAIN driver again.</li> </ul>

Message	Cause	Solution and reference
"Insufficient memory. Reduce the scanning area."	The memory allocated for the scanner function is insufficient.	<ul style="list-style-type: none"> <li>Reduce the scan size or resolution. You may be able to resolve the error also by reducing the brightness value when Duotone (black and white) or a high resolution is specified.</li> <li>Specify [No Compression] on the [Initial Settings] ► [Compression] tab in the TWAIN driver.</li> </ul>
"Invalid Winsock version. Please use version 1.1 or higher."	Winsock is corrupted.	Restore Winsock on the computer.
"Scanner is not available. Check the scanner connection status."	The power of the machine is not turned on, or the machine is not connected to the network correctly.	Check that the machine is turned on, and connected to the network correctly.
	The firewall function is enabled on the computer.	Configure the firewall function of the computer to allow communication of the application used, or disable the firewall function.
	The IP address of the machine could not be resolved from the host name.	Check that the host name of the machine is configured in Network Connection Tool that is installed with the TWAIN driver. See "Installing the TWAIN Driver", User Guide (Full Version).
	The IPv6 address could not be obtained when only IPv6 is enabled on the machine.	Log in to Web Image Monitor in the administrator mode, and select [Active] in [IPv4] ► "LLMNR" under [Device Management] ► [Configuration] ► "Network".
"Scanner is not available on the specified device."	The TWAIN scanner function is disabled on the machine.	The TWAIN scanner function cannot be used.
"Scanner is not ready. Check the scanner and the options."	The exposure glass cover or ADF is open.	Close the exposure glass cover or ADF.

Message	Cause	Solution and reference
"Scanning has been aborted because memory in Mainframe became full."	The amount of available space on the hard disk of the machine is insufficient when scanning is performed with the [Read-ahead] check box selected in the TWAIN driver.	<ul style="list-style-type: none"> <li>• Clear the [Read-ahead] check box in the TWAIN driver.</li> <li>• Erase documents that are no longer needed from the machine.</li> </ul>
"The device's authentication service cannot be performed."	Authentication cannot be performed because the authentication service is starting up or busy.	<ul style="list-style-type: none"> <li>• When User Code or Basic authentication is specified, wait a while until processing the machine address is completed.</li> <li>• When Windows or LDAP authentication is specified, wait a while until the server becomes ready for processing. If authentication is not possible even after waiting for a while, consult your administrator.</li> </ul>
"There is no response from the scanner. There may be a number of reasons for this, e.g. the data between the computer and scanner has been lost because of an increase in network traffic, the firewall in the virus protection software may be activated, there might be problems with the hardware etc. If you can not fix this problem, please call service."	The network is busy.	Wait a while.
	The firewall function is enabled on the computer.	Configure the firewall function of the computer to allow communication of the application used, or disable the firewall function.
	The machine or the computer is not connected to the network correctly.	Check that the machine or the computer is connected to the network correctly.

Message	Cause	Solution and reference
"User Authentication in SNMPv3 connection has failed."	The authentication information is registered incorrectly in Network Connection Tool when SNMPv3 encrypted communication is enabled on the machine.	Register the SNMPv3 authentication information in Network Connection Tool that is installed on the computer with the TWAIN driver. For the SNMPv3 authentication information, consult your network administrator.  See "Installing the TWAIN Driver", User Guide (Full Version).



# When Other Messages Are Displayed

## Note

- When confirming or changing the settings in [Settings], press [Home] (🏠) after closing [Settings].

The settings procedure is described using the [Classic] screen type of [Settings] as an example. When you are using the [Standard] screen type, confirm the name of the setting items in the list below.

For details, see "Settings Menu Compatibility List (Classic to Standard Settings)", User Guide (Full Version).

Message	Cause	Solution and reference
"Administrator Authentication for User Management must be set to on before this selection can be made."	The User Management privilege is disabled in the administrator authentication management.	When specifying Basic, Windows, or LDAP authentication, configure the User Management privilege in [Settings] ► [Machine Features Settings] ► [Administrator Tools] tab ► [Administrator Authentication Management].  See "Registering Administrators Before Using the Machine", User Guide (Full Version).
"Destination list / machine settings are updated. Selected destinations or function settings have been cleared. Please re-select the settings."	A destination is being registered and devices are being configured using Web Image Monitor.	Wait until the message disappears and do not turn off the power of the machine. You may not be able to perform operations for a while depending on the number of destinations being registered.
"Failed to read the PDF file."	The user attempted to display a PDF file that is not supported by the Web browser of the machine.	The Web browser of the machine supports the PDF versions and encryption levels shown below. Other PDF files cannot be displayed. <ul style="list-style-type: none"> <li>PDF version: 1.3-1.7</li> <li>PDF encryption level: 128-bit AES, 256-bit AES</li> </ul>
"Firmware update will start. Press [OK]. It will start automatically after 30 seconds."	A firmware update is available, and the machine is about to perform an update.	It is recommended to apply the update, but you can stop the updating process by pressing [Stop] within 30 seconds after the message is displayed.  Do not turn off the power of the machine while the updating process is in progress.

Message	Cause	Solution and reference
"Internal cooling fan is active."	The fan installed in the vent for cooling the interior of the machine became active after a large number of pages has been printed.	You may hear a rotating noise while the fan is active, but you can continue using the machine as usual.
"Output Tray is full. Remove paper."	The output tray is full.	Remove the paper from the output tray. When the finisher tray is specified as the output destination, press [Stop] to pause printing and then remove the output paper to prevent paper from falling off the tray.
"Problems with the wireless board. Please call service."	The Wireless LAN board can be accessed, but an error has been detected.	Turn off the power of the machine, check that the Wireless LAN board is correctly installed in the machine, and then turn on the power. page 11 "Turning On and Off the Power" If the message persists even after you have turned the power off and then on, consider repairing the machine.
"Updating the destination list... Please wait. Specified destination(s) or sender's name has been cleared."	A destination is being registered using Web Image Monitor.	Wait until the message disappears and do not turn off the power of the machine. You may not be able to perform operations for a while depending on the number of destinations being registered.
"Updating the destination list has failed." "Try again?"	A network error occurred.	Check the connection between the machine and the computer.
	Anti-virus software or a firewall function is running on the computer.	Add the destination list program to the exception list in the anti-virus software on the computer, or register the machine IP address to the exception list in the firewall function. You can check the IP address in [Check Status] ► "Network".

Message	Cause	Solution and reference
"You do not have the privileges to use this function."	The logged-in user does not have the privileges to use the specified function.	Consult the user administrator. The user administrator can change the access permissions in the address book. See "Preventing Information Leaks", User Guide (Full Version).
	Changing the setting is not allowed under the administrative privileges granted to the logged-in user.	Check the administrative privilege required for changing the specified setting. See "Registering Administrators Before Using the Machine", User Guide (Full Version).

## Messages Displayed When Machine Login Fails

Check the error code displayed with the "Authentication has failed." message, and taken the necessary action.

### Note

- The letter at the beginning of the error code indicates the type of authentication specified on the machine.
  - B: Basic authentication
  - W: Windows authentication
  - L: LDAP authentication

The settings procedure is described using the [Classic] screen type of [Settings] as an example. When you are using the [Standard] screen type, confirm the name of the setting items in the list below.

For details, see "Settings Menu Compatibility List (Classic to Standard Settings)", User Guide (Full Version).

Message	Cause	Solution and reference
"Authentication has failed." B/W/L0103-000	An operation in the TWAIN supporting application was performed from the computer while a user was logged in to the machine or performing the login procedure.	Check whether another user is logged in to the machine, and then perform the operation.

Message	Cause	Solution and reference
"Authentication has failed." B/W/L0104-000	An incorrect password was entered.	Enter the correct password.
	The Driver Encryption Key is not registered correctly in the TWAIN driver.	Consult the network administrator whether the Driver Encryption Key is required, and configure the driver accordingly.  See "Specifying Login Information in the Printer Driver" and "Specifying Login Information in the LAN-Fax Driver", User Guide (Full Version).  The network administrator can check the setting of "Driver Encryption Key" in [Settings] ► [Machine Features Settings] ► [System Settings] ► [Administrator Tools] tab ► [Extended Security].
"Authentication has failed." B/W/L0206-002	An incorrect login user name or password was entered.	Enter the correct login user name and password.
	A user has attempted to log in to the functions that can be accessed only by the administrator such as [Settings] when [Application Authentication Management] is specified.	The user needs to log in from the application login screen.
"Authentication has failed." B/W/L0206-003	":" or another character that cannot be used in a login user name was entered.	<ul style="list-style-type: none"> <li>• Enter the correct login user name.</li> <li>• Change the user name if it contains a space, ":" or other unusable characters.</li> </ul>
"Authentication has failed." B/W/L0207-001	Web Image Monitor or another method was used to edit or create a backup of the address book.	Wait a while.

Message	Cause	Solution and reference
"Authentication has failed." B/W/L0208-000 B/W/L0208-002	The account is locked because the number of failed login attempts has exceeded the limit.	Request the user administrator to unlock the account.
"Authentication has failed." L0307-001	Web Image Monitor or another method was used to edit or create a backup of the address book.	Try again later.
"Authentication has failed." W0400-102	Kerberos authentication has failed because the server was not responsive.	Check whether the server is operating normally.
"Authentication has failed." W0400-200	Available resources are insufficient due to too many authentication requests.	Try again later.
"Authentication has failed." W0400-202	sAMAccountName was used as the login user name when a user in the child domain logged in under a parent-child domain environment, and ldap_bind failed.	Use UserPrincipalName as the login user name.
	The SSL settings specified on the authentication server and the device do not match.	Check whether the SSL settings specified on the authentication server and the device match.
"Authentication has failed." L0400-210	The login name attribute is not specified, or an attribute on which the information cannot be obtained is specified.	Check whether [Login Name Attribute] is specified correctly.  See "Verifying Users to Operate the Machine (User Authentication)", User Guide (Full Version).

Message	Cause	Solution and reference
"Authentication has failed." W/L0406-003	":" or other characters that cannot be used in a login user name was entered.	<ul style="list-style-type: none"> <li>• Enter the correct login user name.</li> <li>• Change the user name if it contains a space, ":" or other unusable characters.</li> </ul>
"Authentication has failed." W0406-101	Too many requests for authentication occurred at one time.	Try again later. If the problem persists, check whether the machine is under an authentication attack. The attack status can be checked by the screen message, in the system log, or in the e-mail notification sent to the administrator.
"Authentication has failed." W0406-107	A user group cannot be obtained.	Check whether the group name registered on the machine is correct and whether the DC settings are configured correctly. *1
	Kerberos Authentication has failed.	Check whether the realm name registered on the clock at the KDC (key distribution center) and the clock of the device are synchronized. *3
	No connection is established to the authentication server.	Enter the server IP address in [Settings] ► [Machine Features Settings] ► [System Settings] ► [Interface Settings] tab ► [Ping Command] to check whether a connection can be established to the server.
	The domain name is incorrect or cannot be resolved.	Check whether the domain name registered on the machine is correct and whether the name can be resolved. *2
	The login user name or password is incorrect.	Check the login user name and/or password of the user registered on the server.
"Authentication has failed." L0406-200	Too many requests for authentication occurred at one time.	Try again later. If the problem persists, check whether the machine is under an authentication attack. The attack status can be checked by the screen message, in the system log, or in the e-mail notification sent to the administrator.

Message	Cause	Solution and reference
"Authentication has failed." L0406-201	[Off] is specified in the authentication settings of the LDAP server.	Set "Authentication" to a setting other than [Off] in [Settings] ► [Machine Features Settings] ► [System Settings] ► [Administrator Tools] tab ► [Program / Change / Delete LDAP Server].
"Authentication has failed." L0406-202 L0406-203	The LDAP authentication settings or LDAP server settings are incorrect.	Check whether the LDAP authentication settings or LDAP server settings are correctly configured.* <sup>4</sup>  Check whether the SSL settings are supported on the LDAP server.
	The login user name or password is incorrect.	Enter the correct login user name and password. Change the login user name if it exceeds 128 bytes in length or contains a space, ":" or other unusable character.
	The simplified authentication mode is incorrectly used.	Check whether the server name, login user name, password, and information entered into the search filter are correct. Note that authentication cannot be performed if obtaining DN of the login user name under the representative account fails in the simple authentication mode.
"Authentication has failed." L0406-204	Kerberos Authentication has failed.	Check whether the realm name registered on the clock at the KDC (key distribution center) and the clock of the device are synchronized.* <sup>3</sup>
"Authentication has failed." W/L0409-000	There was no response returned from the authentication server, and an authentication timeout error occurred.	Check the status of the network and the server to use for authentication.
"Authentication has failed." W/L0511-000 W0517-000	The user registered on the machine has the same name as another user distinguished by the unique attribute of the authentication server.	<ul style="list-style-type: none"> <li>• Delete the older user that is redundant, or change the login name.</li> <li>• If the message is displayed after switching the authentication server, delete the user on the old server.</li> </ul>

Message	Cause	Solution and reference
"Authentication has failed." W/L0606-004	A user name that cannot be specified in the login user name was specified.	Do not use "other", "admin", "supervisor", or "HIDE*" in user account names.
"Authentication has failed." W/L0607-001	Web Image Monitor or another method was used to edit or create a backup of the address book.	Wait a while.
"Authentication has failed." W/L0612-005	The number of users registered in the address book has reached the upper limit, and auto-registration failed.	Ask the user administrator to delete users that are no longer needed from the address book.
"Authentication has failed." W/L0707-001	Web Image Monitor or another method was used to edit or create a backup of the address book.	Wait a while.
"Authentication has failed." B/W/L09XX-019	Auto-registration of a user on the server machine has failed when authentication was performed on the client machine using Central Management.	<ul style="list-style-type: none"> <li>• Check the network communication between the client and server machines.</li> <li>• Registration cannot be performed while the address book of the server machine is being edited.</li> </ul>

\* 1 When obtaining user groups, check the following:

- The user account that can obtain user groups is sAMAccountName (user). Do not use UserPrincipalName (user@domain.xxx.co.jp) as the user name.
- Check whether the name in "Group" is correctly specified including the case-sensitivity in [Settings] ► [Machine Features Settings] ► [System Settings] ► [Administrator Tools] tab ► [User Authentication Management] ► [Windows Auth.].
- Select the user in the address book, press [Edit], and then check that [User Management / Others] tab ► [User Management] ► [Available Functions / Applications] check box is cleared.
- Check whether "Global Scope" is specified as the scope of the group in a property for the user group created in DC, and the group type specified in "Security". Also check whether an account is



registered to the user group that has been created. If more than one DC exists, check whether a trust relationship between DCs is established.

\*2 To resolve the domain name, see the following:

- Check whether [Domain Name] and [DNS Configuration] or [WINS Configuration] is specified correctly in [Settings] ► [Machine Features Settings] ► [System Settings] ► [Interface Settings] tab.
- Enter the IP address in [Domain Name] to check the connection. If authentication can be performed using the IP address, check [DNS Configuration] or [WINS Configuration] again.
- If authentication by IP address is not possible, check whether LM/NTLM is set to be denied in the domain controller security policy or domain security policy. Also check that the port is not closed in the firewall between the device and the domain controller or in the firewall settings of the domain controller. When the Windows firewall is enabled, create a new rule that allows communication on port 137 and port 139 in "Advanced" of the Windows firewall. Open the TCP/IP properties from the network connection properties, select the "Enable NetBIOS Over TCP/IP" check box on the [Advanced] ► [WINS] tab, and open port 137.

\*3 For Kerberos authentication, check the following:

- Check that "Realm Name", "KDC Server Name", "Domain Name" are specified correctly in [Settings] ► [Machine Features Settings] ► [System Settings] ► [Administrator Tools] tab ► [Program / Change / Delete Realm]. Enter "Realm Name" in upper case.
- Configure the setting so that the difference in time between the clocks on KDC and device is less than five minutes. The clock on the machine can be adjusted in [Settings] ► [Machine Features Settings] ► [System Settings] ► [Timer Settings] tab ► [Set Time].
- Kerberos authentication fails if auto-obtaining of KDC in Windows authentication fails. When auto-obtaining cannot be activated, switch to manual.

\*4 For LDAP settings, check the following:

- Check whether the LDAP server is correctly specified in [Settings] ► [Machine Features Settings] ► [System Settings] ► [Administrator Tools] tab ► [User Authentication Management] ► [LDAP Auth.] and Login Name Attribute is registered correctly.
- Check that the representative account is registered in "Authentication" ► "Kerberos Authentication" under [Settings] ► [Machine Features Settings] ► [System Settings] ► [Administrator Tools] tab ► [Program / Change / Delete LDAP Server], and then execute [Connection Test].  
See "Programming the LDAP Server", User Guide (Full Version).
- If the connection test fails, check whether [Domain Name] and [DNS Configuration] or [WINS Configuration] is specified correctly on the [Settings] ► [Machine Features Settings] ► [System Settings] ► [Interface Settings] tab.

## Messages Displayed When Logging in to the Machine Using an IC Card Fails

Message	Cause	Solution and reference
"Authentication has failed." *0150-401	The card is locked because the number of times an incorrect PIN code was entered exceeds the limit.	Unlock the card.
"Authentication has failed." *0151-401	An incorrect PIN code was entered.	Enter the correct PIN.
"Authentication has failed." *0153-402	The card authentication device has been removed or is not connected properly.	Connect the card authentication device again. Connect the card authentication device to the USB2.0 Interface Type A on the back left side of the machine.
"Authentication has failed." *0154-402	Reading of an IC card has failed.	Set the IC card on the authentication device correctly and for a longer duration.
"Authentication has failed." *0156-401	An incorrect user name or password was entered.	Enter the correct user name and password.
"The card authentication device is not connected."	The card authentication device has been removed or is not connected properly.	Connect the card authentication device again. Connect the card authentication device to the USB2.0 Interface Type A on the back left side of the machine.
	A malfunction is temporarily occurring on the machine.	Turn off the power of the machine, wait for 10 seconds or more after confirming that the main power indicator is turned off, and then turn on the power.  page 11 "Turning On and Off the Power"

## Messages Displayed When the LDAP Server is Unavailable

The settings procedure is described using the [Classic] screen type of [Settings] as an example. When you are using the [Standard] screen type, confirm the name of the setting items in the list below.

For details, see "Settings Menu Compatibility List (Classic to Standard Settings)", User Guide (Full Version).

Message	Cause	Solution and reference
"Connection with LDAP server has failed. Check the server status."	The network is busy.	Try again.
	The setting information is incorrect.	Check the setting information of the [Settings] ► [Machine Features Settings] ► [System Settings] ► [Administrator Tools] tab ► [Program / Change / Delete LDAP Server]. See "Programming the LDAP Server", User Guide (Full Version).
"Exceeded time limit for LDAP server search. Check the server status."	The network is busy.	Try again.
	The setting information is incorrect.	Check the setting information of the [Settings] ► [Machine Features Settings] ► [System Settings] ► [Administrator Tools] tab ► [Program / Change / Delete LDAP Server]. See "Programming the LDAP Server", User Guide (Full Version).
"LDAP server authentication has failed. Check the settings."	The user name or password is incorrect.	Select the user in the address book, press [Edit], and specify the correct user name and password in [User Management / Others] tab ► [User Management] ► [LDAP Authentication Info]. See "Registering a User in the Address Book and Specifying the Login Information", User Guide (Full Version).

## Messages Displayed When There Is a Problem with the Certificate

Message	Cause	Solution and reference
"The destination cannot be selected because the device certificate used for the S/MIME signature is not currently valid."	The device certificate used for the S/MIME signature is not currently valid.	Install a new device certificate used for the S/MIME signature. See "Encrypting Network Communication", User Guide (Full Version).
"Signature cannot be set because there is a problem with the Digital Signature's device certificate. Check the device certificate."		
"Signature cannot be set because the Digital Signature's device certificate is not currently valid."	The device certificate used for the digital signature in PDF or PDF/A is not currently valid.	Use a valid device certificate for the digital signature in PDF or PDF/A. See "Scanning an Original as a PDF with Security Setting Specified", User Guide (Full Version).
"The destination cannot be selected because there is a problem with the device certificate used for the S/MIME signature. Check the device certificate."	The device certificate used for the digital signature in PDF or PDF/A is missing or invalid.	

Message	Cause	Solution and reference
"The destination cannot be selected because its encryption certificate is not currently valid."	The user certificate (destination certificate) has expired.	Install a new user certificate. See "Encrypting Network Communication", User Guide (Full Version).
"The group destination cannot be selected because it contains a destination with a encryption certificate that is not currently valid."		
"Transmission cannot be performed because the encryption certificate is not currently valid."		

## Messages Displayed When an Application Site Cannot Be Used

Message	Cause	Solution and reference
"A server error has occurred."	An unexpected error has occurred on the server.	<ul style="list-style-type: none"> <li>• See the server maintenance information in [Information].</li> <li>• Check whether the network settings ([DNS Configuration], [Proxy Settings]) are correctly configured.</li> </ul> See "Installing an Application from Application Site", User Guide (Full Version).
"Cannot connect to server which installs applications. Check maintenance information on Information screen or network settings."	Cannot connect to the installation server.	
"Could not update the firmware."		
"Failed to download the application"		
"Failed to install the application because an error has occurred."		

Message	Cause	Solution and reference
"Could not restore the firmware because the required data does not exist."	The firmware from Application Site has not been updated.	The firmware cannot be recovered.
"JavaTM Platform has not been started. Install the application after JavaTM Platform has been started from Web Image Monitor."	JavaVM is not running.	Log in to Web Image Monitor in the administrator mode, and enable "JavaTM Platform" in [Device Management] ► [Configuration] ► [Extended Feature Settings].
"The specified page cannot be found."	An error has occurred in Application Site.	See the server maintenance information in [Information].
"There is insufficient space to store internally, delete any unnecessary applications."	The remaining free space on the hard disk is insufficient.	Delete applications that are not necessary.

# 10. Specifications for The Machine

## Model-Specific Information

This section explains how you can identify the region your machine belongs to.

There is a label on the rear of the machine, located in the position shown below. The label contains details that identify the region your machine belongs to. Read the label.

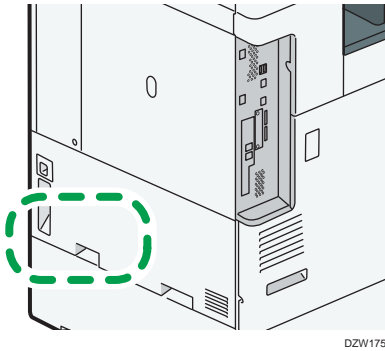

The following information is region-specific. Read the information under the symbol that corresponds to the region of your machine.

### **Region A** (mainly Europe and Asia)

If the label contains the following, your machine is a region A model:



- CODE XXXX -27, -29, -65
- 220–240 V

### **Region B** (mainly North America)

If the label contains the following, your machine is a region B model:

- CODE XXXX -17, -18
- 120–127 V

### **Note**

- Dimensions in this manual are given in two units of measure: metric and inch. If your machine is a Region A model, refer to the metric units. If your machine is a Region B model, refer to the inch units.
- If your machine is a region A model and "CODE XXXX -27, -65" is printed on the label, see " **Region A** (mainly Europe)" also.
- If your machine is a region A model and "CODE XXXX -29" is printed on the label, see " **Region A** (mainly Asia)" also.

## List of Specifications

### Note

- We have licenses from the authors to use their software including open sources. Refer to the files in the Licenses folder included in the supplied CD-ROM for statements requested from the authors.

### Specifications for the Main Unit



Item	Specifications
Configuration	Desktop
Memory	2 GB
Hard disk size	320 GB
Color	Full Color
Copy process	Laser beam scanning and electro-photographic printing
Exposure glass	Stationary original exposure type
Scan method	CMOS integrated type Md method
Warm-up time (23°C (73.4°F), rated voltage)	21 seconds









Item	Specifications
First copy time	<p> <b>Region A</b> (mainly Europe)</p> <ul style="list-style-type: none"> <li>• IM C2000/C2500 series Full color: 7.4 seconds / B&amp;W: 5.1 seconds</li> <li>• IM C3000/C3500 series Full color: 6.9 seconds / B&amp;W: 4.5 seconds</li> <li>• IM C4500 series Full color: 5.4 seconds / B&amp;W: 3.6 seconds</li> <li>• IM C5500/C6000 series Full color: 4.2 seconds / B&amp;W: 2.9 seconds</li> </ul> <p> <b>Region A</b> (mainly Asia)</p> <ul style="list-style-type: none"> <li>• IM C2000/C2500 Full color: 7.4 seconds / B&amp;W: 5.1 seconds</li> <li>• IM C3000/C3500 Full color: 6.9 seconds / B&amp;W: 4.5 seconds</li> <li>• IM C4500 Full color: 5.4 seconds / B&amp;W: 3.6 seconds</li> <li>• IM C6000 Full color: 4.2 seconds / B&amp;W: 2.9 seconds</li> </ul> <p> <b>Region B</b> (mainly North America)</p> <ul style="list-style-type: none"> <li>• IM C2000/C2500 series Full color: 7.4 seconds / B&amp;W: 5.1 seconds</li> <li>• IM C3000/C3500 series Full color: 6.9 seconds / B&amp;W: 4.5 seconds</li> <li>• IM C4500 series Full color: 5.4 seconds / B&amp;W: 3.6 seconds</li> <li>• IM C6000 series Full color: 4.2 seconds / B&amp;W: 2.9 seconds</li> </ul> <p>(A4<sup>D</sup>, Tray 1, exposure glass)</p>

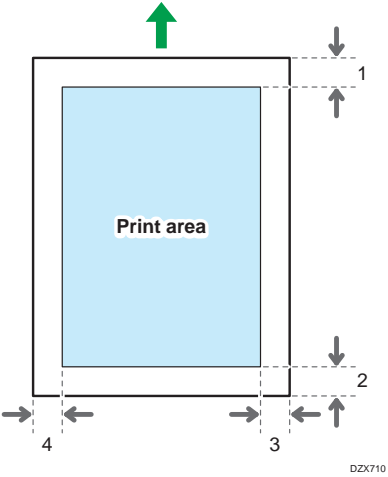

Item	Specifications
Copy/print speed (per minute)	<p> <b>Region A</b> (mainly Europe)</p> <ul style="list-style-type: none"> <li>• IM C2000 series: 20 sheets/minute</li> <li>• IM C2500 series: 25 sheets/minute</li> <li>• IM C3000 series: 30 sheets/minute</li> <li>• IM C3500 series: 35 sheets/minute</li> <li>• IM C4500 series: 45 sheets/minute</li> <li>• IM C5500 series: 55 sheets/minute</li> <li>• IM C6000: 60 sheets/minute</li> </ul> <p> <b>Region A</b> (mainly Asia)</p> <ul style="list-style-type: none"> <li>• IM C2000: 20 sheets/minute</li> <li>• IM C2500: 25 sheets/minute</li> <li>• IM C3000: 30 sheets/minute</li> <li>• IM C3500: 35 sheets/minute</li> <li>• IM C4500: 45 sheets/minute</li> <li>• IM C6000: 60 sheets/minute</li> </ul> <p> <b>Region B</b> (mainly North America)</p> <ul style="list-style-type: none"> <li>• IM C2000 series: 20 sheets/minute</li> <li>• IM C2500 series: 25 sheets/minute</li> <li>• IM C3000 series: 30 sheets/minute</li> <li>• IM C3500 series: 35 sheets/minute</li> <li>• IM C4500 series: 45 sheets/minute</li> <li>• IM C6000 series: 60 sheets/minute</li> </ul> <p>(A4□, 8<sup>1</sup>/<sub>2</sub> × 11□)</p>
Maximum original size	<p> <b>Region A</b> (mainly Europe and Asia)</p> <p>A3</p> <p> <b>Region B</b> (mainly North America)</p> <p>11×17</p>



Item	Specifications
Original scanning area	<ul style="list-style-type: none"> <li>• Exposure Glass           <div data-bbox="459 368 702 564" style="text-align: center;"> <p style="text-align: center; font-size: small;">DZW788</p> </div> <ol style="list-style-type: none"> <li>1. Vertical: Up to 297 mm (11.7 inches)</li> <li>2. Horizontal: Up to 432 mm (17.1 inches)</li> </ol> </li> <li>• ADF           <div data-bbox="459 740 702 936" style="text-align: center;"> <p style="text-align: center; font-size: small;">DZW789</p> </div> <ol style="list-style-type: none"> <li>1. Vertical: 128 to 297 mm (5.1 to 11.7 inches)</li> <li>2. Horizontal               <ul style="list-style-type: none"> <li>• Copy function: 128 to 1,260 mm (5.1 to 49.7 inches)</li> <li>• Scanner function: 128 to 432 mm (5.1 to 17.1 inches)</li> <li>• Facsimile function: 128 to 1,200 mm (5.1 to 47.3 inches) *</li> </ul> </li> </ol> <p>* Specify "Parameter Setting" under [Fax Settings] to use the long length original.</p> <p>See "List of Parameter Settings", User Guide (Full Version).</p> <p>See below when [Standard] is specified as the screen type of [Settings]. The names of the setting items may differ from the [Classic] screen type.</p> <p>See "List of Parameter Settings (Standard)", User Guide (Full Version).</p> <p>For details, see "Settings Menu Compatibility List (Classic to Standard Settings)", User Guide (Full Version).</p> </li> </ul>
Originals	Sheet, book, three-dimensional object

Item	Specifications
Copy size	<ul style="list-style-type: none"> <li>• Tray 1–2, Bypass Tray: page 194 "Recommended Paper Sizes and Types"</li> <li>• Duplex: A3, A4, A5, A6, B4 JIS, B5 JIS, B6 JIS, 11 × 17, 8 1/2 × 14, 8 1/2 × 13, 8 1/2 × 11, 8 1/4 × 14, 8 1/4 × 13, 8 × 13, 8 × 10, 7 1/4 × 10 1/2, 5 1/2 × 8 1/2, 8K, 16K, 12 × 18, 11 × 15, 10 × 14, SRA3, SRA4, 8 1/2 × 13 2/5</li> <li>• Duplex (Custom Size): Vertical: 90.0–320.0 mm (3.55-12.59 inches), Horizontal: 148.0–457.2 mm (5.83–18.00 inches)</li> </ul>
Paper weight	<ul style="list-style-type: none"> <li>• Trays 1–2, Bypass Tray: page 194 "Recommended Paper Sizes and Types"</li> <li>• Duplex: <ul style="list-style-type: none"> <li>•  <b>Region A</b> (mainly Europe) <ul style="list-style-type: none"> <li>• IM C2000/C2500 series 52–169 g/m<sup>2</sup> (14 lb. Bond–90 lb. Index) *1</li> <li>• IM C3000/C3500/C4500/C5500/C6000 series 52–256 g/m<sup>2</sup> (14 lb. Bond–140 lb. Index) *2</li> </ul> </li> <li>•  <b>Region A</b> (mainly Asia) <ul style="list-style-type: none"> <li>• IM C2000/C2500 52–169 g/m<sup>2</sup> (14 lb. Bond–90 lb. Index) *1</li> <li>• IM C3000/C3500/C4500/C6000 52–256 g/m<sup>2</sup> (14 lb. Bond–140 lb. Index) *2</li> </ul> </li> <li>•  <b>Region B</b> (mainly North America) <ul style="list-style-type: none"> <li>• IM C2000/C2500 series 52–169 g/m<sup>2</sup> (14 lb. Bond–90 lb. Index) *1</li> <li>• IM C3000/C3500/C4500/C6000 series 52–256 g/m<sup>2</sup> (14 lb. Bond–140 lb. Index) *2</li> </ul> </li> </ul> </li> </ul>





Item	Specifications
Missing image area (Copy)	 <p style="text-align: right; margin-right: 100px;">DZX710</p> <ol style="list-style-type: none"> <li>1. Leading edge: 4.2 ± 1.5 mm (0.17 ± 0.06 inches)</li> <li>2. Trailing edge: 0.5–6.0 mm (0.02–0.24 inches)</li> <li>3. Left edge: 0.5–4.0 mm (0.02–0.16 inches)</li> <li>4. Right edge: 0.5–4.0 mm (0.02–0.16 inches)</li> </ol>
Preset reproduction ratio	<p> <b>Region A</b> (mainly Europe and Asia)</p> <p>Preset reproduction ratios (%):</p> <ul style="list-style-type: none"> <li>• Enlargement: 400, 200, 141, 122, 115</li> <li>• Full size: 100</li> <li>• Reduction: 93, 82, 75, 71, 65, 50, 25</li> </ul> <p> <b>Region B</b> (mainly North America)</p> <p>Preset reproduction ratios (%):</p> <ul style="list-style-type: none"> <li>• Enlargement: 400, 200, 155, 129, 121</li> <li>• Full size: 100</li> <li>• Reduction: 93, 85, 78, 73, 65, 50, 25</li> </ul>
Reproduction ratio (zoom)	From 25–400% in increments of 1%
Resolution (scanning originals)	600 × 600 dpi
Resolution (copying)	600 × 600 dpi
Tone	256 tones

Item	Specifications
Paper capacity (80 g/m <sup>2</sup> , 20 lb. Bond)	page 194 "Recommended Paper Sizes and Types"
Continuous copy run	1–999 sheets
Duplex	Standard
Power requirements	<p> <b>Region A</b> (mainly Europe and Asia) 220–240 V, 8 A, 50/60 Hz</p> <p> <b>Region B</b> (mainly North America) 120–127 V, 12 A, 60 Hz</p>
Power consumption (Main unit only)  <b>Region A</b> (mainly Europe)	<ul style="list-style-type: none"> <li>• IM C2000/C2500 series Ready: 46.2 W During printing: B&amp;W: 416 W / Color: 465 W (IM C2000 series) During printing: B&amp;W: 452 W / Color: 497 W (IM C2500 series) Maximum: 1850 W or less</li> <li>• IM C3000/C3500 series Ready: 47.6 W During printing: B&amp;W: 503 W / Color: 560 W (IM C3000 series) During printing: B&amp;W: 533 W / Color: 599 W (IM C3500 series) Maximum: 1850 W or less</li> <li>• IM C4500/C5500/C6000 series Ready: 59.0 W During printing: B&amp;W: 645 W / Color: 730 W (IM C4500 series) During printing: B&amp;W: 822 W / Color: 935 W (IM C5500 series) During printing: B&amp;W: 838 W / Color: 957 W (IM C6000 series) Maximum: 1850 W or less</li> </ul> <p>The power level when the main switch is turned off and the power cord is plugged into an outlet: 1 W or less</p>

Item	Specifications
Power consumption (Complete system)  Region A (mainly Europe)	Maximum: 1850 W or less <ul style="list-style-type: none"> <li>• The complete system of the IM C3000/C3500 series consists of the main unit, ARDF, lower paper trays, internal tray 2, large capacity tray (LCT), bridge unit, Booklet Finisher SR3270, fax unit, two extra G3 interface unit, NFC card reader, and wireless LAN board.</li> <li>• The complete system of the IM C4500/C5500/C6000 series consists of the main unit, one-pass duplex scanning ADF, lower paper trays, internal tray 2, large capacity tray (LCT), bridge unit, Booklet Finisher SR3290, fax unit, two extra G3 interface unit, NFC card reader, wireless LAN board, and file format converter.</li> <li>• The complete system of the IM C2000/C2500 series consists of the main unit, ARDF, lower paper trays, internal tray 2, bridge unit, Booklet Finisher SR3270, fax unit, extra G3 interface unit, NFC card reader, and wireless LAN board.</li> </ul>
Power consumption (Main unit only)  Region A (mainly Asia)	<ul style="list-style-type: none"> <li>• IM C2000/C2500              Ready: 46.2 W              During printing: B&amp;W: 416 W / Color: 465 W (IM C2000)              During printing: B&amp;W: 452 W / Color: 497 W (IM C2500)              Maximum: 1850 W or less</li> <li>• IM C3000/C3500              Ready: 47.6 W              During printing: B&amp;W: 503 W / Color: 560 W (IM C3000)              During printing: B&amp;W: 533 W / Color: 599 W (IM C3500)              Maximum: 1850 W or less</li> <li>• IM C4500/6000              Ready: 59.0 W              During printing: B&amp;W: 645 W / Color: 730 W (IM C4500)              During printing: B&amp;W: 838 W / Color: 957 W (IM C6000)              Maximum: 1850 W or less</li> </ul> <p>The power level when the main switch is turned off and the power cord is plugged into an outlet: 1 W or less</p>

Item	Specifications
Power consumption (Complete system)  <b>Region A</b> (mainly Asia)	Maximum: 1850 W or less <ul style="list-style-type: none"> <li>• The complete system of the IM C3000/C3500 consists of the main unit, ARDF, lower paper trays, internal tray 2, large capacity tray (LCT), bridge unit, Booklet Finisher SR3270, fax unit, two extra G3 interface unit, NFC card reader, and wireless LAN board.</li> <li>• The complete system of the IM C4500/C6000 consists of the main unit, one-pass duplex scanning ADF, lower paper trays, internal tray 2, large capacity tray (LCT), bridge unit, Booklet Finisher SR3290, fax unit, two extra G3 interface unit, NFC card reader, wireless LAN board, and file format converter.</li> <li>• The complete system of the IM C2000/C2500 consists of the main unit, ARDF, lower paper trays, internal tray 2, bridge unit, Booklet Finisher SR3270, fax unit, extra G3 interface unit, NFC card reader, and wireless LAN board.</li> </ul>
Power consumption (Main unit only)  <b>Region B</b> (mainly North America)	<ul style="list-style-type: none"> <li>• IM C2000/C2500 series               <ul style="list-style-type: none"> <li>Ready: 45.2 W</li> <li>During printing: B&amp;W: 423 W / Color: 462 W (IM C2000 series)</li> <li>During printing: B&amp;W: 455 W / Color: 459 W (IM C2500 series)</li> <li>Maximum: 1584 W or less</li> </ul> </li> <li>• IM C3000/C3500 series               <ul style="list-style-type: none"> <li>Ready: 47.7 W</li> <li>During printing: B&amp;W: 508 W / Color: 561 W (IM C3000 series)</li> <li>During printing: B&amp;W: 534 W / Color: 600 W (IM C3500 series)</li> <li>Maximum: 1584 W or less</li> </ul> </li> <li>• IM C4500/C6000 series               <ul style="list-style-type: none"> <li>Ready: 54.3 W</li> <li>During printing: B&amp;W: 620 W / Color: 705 W (IM C4500 series)</li> <li>During printing: B&amp;W: 823 W / Color: 938 W (IM C6000 series)</li> <li>Maximum: 1584 W or less</li> </ul> </li> </ul> <p>The power level when the main switch is turned off and the power cord is plugged into an outlet: 1 W or less</p>







Item	Specifications
Power consumption (Complete system)  <b>Region B</b> (mainly North America)	Maximum: 1584 W or less <ul style="list-style-type: none"> <li>• The complete system of the IM C3000/C3500 series consists of the main unit, ARDF, lower paper trays, internal tray 2, large capacity tray (LCT), bridge unit, Booklet Finisher SR3270, fax unit, two extra G3 interface unit, NFC card reader, and wireless LAN board.</li> <li>• The complete system of the IM C4500/C6000 series consists of the main unit, one-pass duplex scanning ADF, lower paper trays, internal tray 2, large capacity tray (LCT), bridge unit, Booklet Finisher SR3290, fax unit, two extra G3 interface unit, NFC card reader, wireless LAN board, and file format converter.</li> <li>• The complete system of the IM C2000/C2500 series consists of the main unit, ARDF, lower paper trays, internal tray 2, bridge unit, Booklet Finisher SR3270, fax unit, extra G3 interface unit, NFC card reader, and wireless LAN board.</li> </ul>
Dimensions	 <b>Region A</b> (mainly Europe) <ul style="list-style-type: none"> <li>• IM C2000/C2500/C3000/C3500/C4500/C5500 (W × D × H up to ADF): 587 × 685 × 913 mm (23.2 × 27.0 × 36.0 inches)</li> <li>• IM C2000A/C2500A/C3000A/C3500A/C4500A/C5500A/C6000 (W × D × H up to ADF): 587 × 685 × 963 mm (23.2 × 27.0 × 38.0 inches)</li> </ul>  <b>Region A</b> (mainly Asia) <ul style="list-style-type: none"> <li>• IM C2000/C2500/3000/3500 (W × D × H up to exposure glass): 587 × 685 × 788 mm (23.2 × 27.0 × 31.1 inches)</li> <li>• IM C4500/C6000 (W × D × H up to ADF): 587 × 685 × 963 mm (23.2 × 27.0 × 38.0 inches)</li> </ul>  <b>Region B</b> (mainly North America) <ul style="list-style-type: none"> <li>• IM C2000/C2500 series (W × D × H up to ADF): 587 × 685 × 913 mm (23.2 × 27.0 × 36.0 inches)</li> <li>• IM C3000/C3500/C4500/C6000 series (W × D × H up to ADF): 587 × 685 × 963 mm (23.2 × 27.0 × 38.0 inches)</li> </ul>
Space for main unit (W × D)	1,149 × 1,236 mm (45.3 × 48.7 inches) (including the bypass tray and output trays)

Item	Specifications
Noise emission (Sound power level: Main unit only)  <b>Region A</b> (mainly Europe)	<ul style="list-style-type: none"> <li>• IM C2000/C2000A              Stand-by: 30.5 dB (A)              Copying: B&amp;W: 57.1 dB (A) / Color: 57.9 dB (A)</li> <li>• IM C2500/C2500A              Stand-by: 30.5 dB (A)              Copying: B&amp;W: 57.4 dB (A) / Color: 58.1 dB (A)</li> <li>• IM C3000/C3000A              Stand-by: 31.4 dB (A)              Copying: B&amp;W: 58.4 dB (A) / Color: 58.6 dB (A)</li> <li>• IM C3500/C3500A              Stand-by: 31.4 dB (A)              Copying: B&amp;W: 58.7 dB (A) / Color: 59.9 dB (A)</li> <li>• IM C4500/C4500A              Stand-by: 31.4 dB (A)              Copying: B&amp;W: 60.8 dB (A) / Color: 61.5 dB (A)</li> <li>• IM C5500/C5500A              Stand-by: 31.4 dB (A)              Copying: B&amp;W: 62.7 dB (A) / Color: 63.7 dB (A)</li> <li>• IM C6000              Stand-by: 31.4 dB (A)              Copying: B&amp;W: 62.9 dB (A) / Color: 64.0 dB (A)</li> </ul>

Item	Specifications
Noise emission (Sound power level: Complete system)  <b>Region A</b> (mainly Europe)	<ul style="list-style-type: none"> <li data-bbox="422 309 683 437">             • IM C2000/C2000A              Stand-by: 31.3 dB (A)              Copying: 65.0 dB (A)           </li> <li data-bbox="422 452 683 580">             • IM C2500/C2500A              Stand-by: 31.3 dB (A)              Copying: 66.0 dB (A)           </li> <li data-bbox="422 595 683 723">             • IM C3000/C3000A              Stand-by: 33.6 dB (A)              Copying: 67.1 dB (A)           </li> <li data-bbox="422 738 683 866">             • IM C3500/C3500A              Stand-by: 33.6 dB (A)              Copying: 67.6 dB (A)           </li> <li data-bbox="422 882 683 1009">             • IM C4500/C4500A              Stand-by: 33.7 dB (A)              Copying: 69.1 dB (A)           </li> <li data-bbox="422 1025 683 1152">             • IM C5500/C5500A              Stand-by: 33.7 dB (A)              Copying: 70.1 dB (A)           </li> <li data-bbox="422 1168 683 1275">             • IM C6000              Stand-by: 33.7 dB (A)              Copying: 70.4 dB (A)           </li> </ul>

Item	Specifications
Noise emission (Sound pressure level: Main unit only)  (mainly Europe)	<ul style="list-style-type: none"> <li>• IM C2000/C2000A              Stand-by: 20.4 dB (A)              Copying: B&amp;W: 43.4 dB (A) / Color: 44.1 dB (A)</li> <li>• IM C2500/C2500A              Stand-by: 20.4 dB (A)              Copying: B&amp;W: 44.2 dB (A) / Color: 44.7 dB (A)</li> <li>• IM C3000/C3000A              Stand-by: 20.3 dB (A)              Copying: B&amp;W: 45.4 dB (A) / Color: 45.7 dB (A)</li> <li>• IM C3500/C3500A              Stand-by: 20.3 dB (A)              Copying: B&amp;W: 45.8 dB (A) / Color: 46.4 dB (A)</li> <li>• IM C4500/C4500A              Stand-by: 20.1 dB (A)              Copying: B&amp;W: 47.2 dB (A) / Color: 47.9 dB (A)</li> <li>• IM C5500/C5500A              Stand-by: 20.1 dB (A)              Copying: B&amp;W: 49.5 dB (A) / Color: 50.7 dB (A)</li> <li>• IM C6000              Stand-by: 20.1 dB (A)              Copying: B&amp;W: 50.0 dB (A) / Color: 50.8 dB (A)</li> </ul>



Item	Specifications
Noise emission (Sound pressure level: Complete system)  Region A (mainly Europe)	<ul style="list-style-type: none"> <li data-bbox="422 309 683 439">             • IM C2000/C2000A              Stand-by: 20.9 dB (A)              Copying: 52.8 dB (A)           </li> <li data-bbox="422 452 683 582">             • IM C2500/C2500A              Stand-by: 20.9 dB (A)              Copying: 53.7 dB (A)           </li> <li data-bbox="422 595 683 725">             • IM C3000/C3000A              Stand-by: 20.1 dB (A)              Copying: 52.7 dB (A)           </li> <li data-bbox="422 738 683 868">             • IM C3500/C3500A              Stand-by: 20.1 dB (A)              Copying: 53.2 dB (A)           </li> <li data-bbox="422 882 683 1011">             • IM C4500/C4500A              Stand-by: 19.5 dB (A)              Copying: 55.0 dB (A)           </li> <li data-bbox="422 1025 683 1154">             • IM C5500/C5500A              Stand-by: 19.5 dB (A)              Copying: 55.7 dB (A)           </li> <li data-bbox="422 1168 683 1297">             • IM C6000              Stand-by: 19.5 dB (A)              Copying: 56.3 dB (A)           </li> </ul>

Item	Specifications
<p>Noise emission (Sound pressure level)</p> <p> <b>Region A</b> (mainly Europe)</p>	<p> <b>Note</b></p> <ul style="list-style-type: none"> <li>• Sound power levels and sound pressure levels are actual values measured in accordance with ISO 7779.</li> <li>• Sound pressure levels are measured from the position of the bystander.</li> <li>• The complete system of the IM C3000/C3500 series consists of the main unit, one-pass duplex scanning ADF, lower paper trays, internal tray 2, large capacity tray (LCT), bridge unit, and Booklet Finisher SR3270.</li> <li>• The complete system of the IM C4500/C5500/C6000 series consists of the main unit, one-pass duplex scanning ADF, lower paper trays, internal tray 2, large capacity tray (LCT), bridge unit, and Booklet Finisher SR3290.</li> <li>• The complete system of the IM C2000/C2500 series consists of the main unit, one-pass duplex scanning ADF, lower paper trays, internal tray 2, and Internal Finisher SR3250.</li> </ul>
<p>Noise emission (Sound power level: Main unit only)</p> <p> <b>Region A</b> (mainly Asia)</p>	<ul style="list-style-type: none"> <li>• IM C2000 Stand-by: 30.5 dB (A) Copying: B&amp;W: 57.1 dB (A) / Color: 57.9 dB (A)</li> <li>• IM C2500 Stand-by: 30.5 dB (A) Copying: B&amp;W: 57.4 dB (A) / Color: 58.1 dB (A)</li> <li>• IM C3000 Stand-by: 31.4 dB (A) Copying: B&amp;W: 58.4 dB (A) / Color: 58.6 dB (A)</li> <li>• IM C3500 Stand-by: 31.4 dB (A) Copying: B&amp;W: 58.7 dB (A) / Color: 59.9 dB (A)</li> <li>• IM C4500 Stand-by: 31.4 dB (A) Copying: B&amp;W: 60.8 dB (A) / Color: 61.5 dB (A)</li> <li>• IM C6000 Stand-by: 31.4 dB (A) Copying: B&amp;W: 62.9 dB (A) / Color: 64.0 dB (A)</li> </ul>

Item	Specifications
Noise emission (Sound power level: Complete system)  <b>Region A</b> (mainly Asia)	<ul style="list-style-type: none"> <li data-bbox="422 315 683 433">           • IM C2000            Stand-by: 31.3 dB (A)            Copying: 65.0 dB (A)         </li> <li data-bbox="422 452 683 570">           • IM C2500            Stand-by: 31.3 dB (A)            Copying: 66.0 dB (A)         </li> <li data-bbox="422 589 683 707">           • IM C3000            Stand-by: 33.6 dB (A)            Copying: 67.1 dB (A)         </li> <li data-bbox="422 727 683 844">           • IM C3500            Stand-by: 33.6 dB (A)            Copying: 67.6 dB (A)         </li> <li data-bbox="422 864 683 981">           • IM C4500            Stand-by: 33.7 dB (A)            Copying: 69.1 dB (A)         </li> <li data-bbox="422 1001 683 1119">           • IM C6000            Stand-by: 33.7 dB (A)            Copying: 70.4 dB (A)         </li> </ul>

Item	Specifications
Noise emission (Sound pressure level: Main unit only)  (mainly Asia)	<ul style="list-style-type: none"> <li>• IM C2000              Stand-by: 20.4 dB (A)              Copying: B&amp;W: 43.4 dB (A) / Color: 44.1 dB (A)</li> <li>• IM C2500              Stand-by: 20.4 dB (A)              Copying: B&amp;W: 44.2 dB (A) / Color: 44.7 dB (A)</li> <li>• IM C3000              Stand-by: 20.3 dB (A)              Copying: B&amp;W: 45.4 dB (A) / Color: 45.7 dB (A)</li> <li>• IM C3500              Stand-by: 20.3 dB (A)              Copying: B&amp;W: 45.8 dB (A) / Color: 46.4 dB (A)</li> <li>• IM C4500              Stand-by: 20.1 dB (A)              Copying: B&amp;W: 47.2 dB (A) / Color: 47.9 dB (A)</li> <li>• IM C6000              Stand-by: 20.1 dB (A)              Copying: B&amp;W: 50.0 dB (A) / Color: 50.8 dB (A)</li> </ul>









Item	Specifications
Noise emission (Sound pressure level: Complete system)  Region A (mainly Asia)	<ul style="list-style-type: none"> <li>• IM C2000 Stand-by: 20.9 dB (A) Copying: 52.8 dB (A)</li> <li>• IM C2500 Stand-by: 20.9 dB (A) Copying: 53.7 dB (A)</li> <li>• IM C3000 Stand-by: 20.1 dB (A) Copying: 52.7 dB (A)</li> <li>• IM C3500 Stand-by: 20.1 dB (A) Copying: 53.2 dB (A)</li> <li>• IM C4500 Stand-by: 19.5 dB (A) Copying: 55.0 dB (A)</li> <li>• IM C6000 Stand-by: 19.5 dB (A) Copying: 56.3 dB (A)</li> </ul>
Noise emission (Sound pressure level)  Region A (mainly Asia)	<p> <b>Note</b></p> <ul style="list-style-type: none"> <li>• Sound power levels and sound pressure levels are actual values measured in accordance with ISO 7779.</li> <li>• Sound pressure levels are measured from the position of the bystander.</li> <li>• The complete system of the IM C3000/C3500 consists of the main unit, one-pass duplex scanning ADF, lower paper trays, internal tray 2, large capacity tray (LCT), bridge unit, and Booklet Finisher SR3270.</li> <li>• The complete system of the IM C4500/C6000 consists of the main unit, one-pass duplex scanning ADF, lower paper trays, internal tray 2, large capacity tray (LCT), bridge unit, and Booklet Finisher SR3290.</li> <li>• The complete system of the IM C2000/C2500 consists of the main unit, one-pass duplex scanning ADF, lower paper trays, internal tray 2, and Internal Finisher SR3250.</li> </ul>

Item	Specifications
Noise emission (Sound power level: Main unit only)  <b>Region B</b> (mainly North America)	<ul style="list-style-type: none"> <li>• IM C2000/C2000G              Stand-by: 30.5 dB (A)              Copying: B&amp;W: 57.1 dB (A) / Color: 57.9 dB (A)</li> <li>• IM C2500/C2500G              Stand-by: 30.5 dB (A)              Copying: B&amp;W: 57.4 dB (A) / Color: 58.1 dB (A)</li> <li>• IM C3000/C3000G              Stand-by: 31.4 dB (A)              Copying: B&amp;W: 58.4 dB (A) / Color: 58.6 dB (A)</li> <li>• IM C3500/C3500G              Stand-by: 31.4 dB (A)              Copying: B&amp;W: 58.7 dB (A) / Color: 59.9 dB (A)</li> <li>• IM C4500/C4500G              Stand-by: 31.4 dB (A)              Copying: B&amp;W: 60.8 dB (A) / Color: 61.5 dB (A)</li> <li>• IM C6000/C6000G              Stand-by: 31.4 dB (A)              Copying: B&amp;W: 62.9 dB (A) / Color: 64.0 dB (A)</li> </ul>

Item	Specifications
Noise emission (Sound power level: Complete system)  <b>Region B</b> (mainly North America)	<ul style="list-style-type: none"> <li data-bbox="422 309 680 439">             • IM C2000/C2000G              Stand-by: 31.3 dB (A)              Copying: 65.2 dB (A)           </li> <li data-bbox="422 452 680 582">             • IM C2500/C2500G              Stand-by: 31.3 dB (A)              Copying: 66.1 dB (A)           </li> <li data-bbox="422 595 680 725">             • IM C3000/C3000G              Stand-by: 33.6 dB (A)              Copying: 67.1 dB (A)           </li> <li data-bbox="422 738 680 868">             • IM C3500/C3500G              Stand-by: 33.6 dB (A)              Copying: 67.6 dB (A)           </li> <li data-bbox="422 882 680 1011">             • IM C4500/C4500G              Stand-by: 33.7 dB (A)              Copying: 69.1 dB (A)           </li> <li data-bbox="422 1025 680 1154">             • IM C6000/C6000G              Stand-by: 33.7 dB (A)              Copying: 70.4 dB (A)           </li> </ul>

Item	Specifications
Noise emission (Sound pressure level: Main unit only)  (mainly North America)	<ul style="list-style-type: none"> <li>• IM C2000/C2000G              Stand-by: 20.4 dB (A)              Copying: B&amp;W: 43.4 dB (A) / Color: 44.1 dB (A)</li> <li>• IM C2500/C2500G              Stand-by: 20.4 dB (A)              Copying: B&amp;W: 44.2 dB (A) / Color: 44.7 dB (A)</li> <li>• IM C3000/C3000G              Stand-by: 20.3 dB (A)              Copying: B&amp;W: 45.4 dB (A) / Color: 45.7 dB (A)</li> <li>• IM C3500/C3500G              Stand-by: 20.3 dB (A)              Copying: B&amp;W: 45.8 dB (A) / Color: 46.4 dB (A)</li> <li>• IM C4500/C4500G              Stand-by: 20.1 dB (A)              Copying: B&amp;W: 47.2 dB (A) / Color: 47.9 dB (A)</li> <li>• IM C6000/C6000G              Stand-by: 20.1 dB (A)              Copying: B&amp;W: 50.0 dB (A) / Color: 50.8 dB (A)</li> </ul>

Item	Specifications
Noise emission (Sound pressure level: Complete system)  Region B (mainly North America)	<ul style="list-style-type: none"> <li>• IM C2000/C2000G Stand-by: 20.8 dB (A) Copying: 53.1 dB (A)</li> <li>• IM C2500/C2500G Stand-by: 20.8 dB (A) Copying: 53.9 dB (A)</li> <li>• IM C3000/C3000G Stand-by: 20.1 dB (A) Copying: 52.7 dB (A)</li> <li>• IM C3500/C3500G Stand-by: 20.1 dB (A) Copying: 53.2 dB (A)</li> <li>• IM C4500/C4500G Stand-by: 19.5 dB (A) Copying: 55.0 dB (A)</li> <li>• IM C6000/C6000G Stand-by: 19.5 dB (A) Copying: 56.3 dB (A)</li> </ul>
Noise emission (Sound pressure level)  Region B (mainly North America)	<p> <b>Note</b></p> <ul style="list-style-type: none"> <li>• Sound power levels and sound pressure levels are actual values measured in accordance with ISO 7779.</li> <li>• Sound pressure levels are measured from the position of the bystander.</li> <li>• The complete system of the IM C3000/C3500 series consists of the main unit, one-pass duplex scanning ADF, lower paper trays, internal tray 2, large capacity tray (LCT), bridge unit, and Booklet Finisher SR3270.</li> <li>• The complete system of the IM C4500/C6000 series consists of the main unit, one-pass duplex scanning ADF, lower paper trays, internal tray 2, large capacity tray (LCT), bridge unit, and Booklet Finisher SR3290.</li> <li>• The complete system of the IM C2000/C2500 series consists of the main unit, ARDF, lower paper trays, internal tray 2, and Internal Finisher SR3250.</li> </ul>

Item	Specifications
Weight	<p> <b>Region A</b> (mainly Europe)</p> <ul style="list-style-type: none"> <li>• IM C2000/C2500: Approx. 91 kg (200.7 lb.)</li> <li>• IM C2000A/C2500A: Approx. 97 kg (213.9 lb.)</li> <li>• IM C3000/C3500: Approx. 94 kg (207.3 lb.)</li> <li>• IM C3000A/C3500A: Approx. 100 kg (220.5 lb.)</li> <li>• IM C4500/C5500: Approx. 96 kg (211.7 lb.)</li> <li>• IM C4500A/C5500A/C6000: Approx. 102 kg (224.9 lb.)</li> </ul> <p> <b>Region A</b> (mainly Asia)</p> <ul style="list-style-type: none"> <li>• IM C2000/C2500: Approx. 83 kg (183.0 lb.)</li> <li>• IM C3000/C3500: Approx. 86 kg (189.6 lb.)</li> <li>• IM C4500/C6000: Approx. 102 kg (224.9 lb.)</li> </ul> <p> <b>Region B</b> (mainly North America)</p> <ul style="list-style-type: none"> <li>• IM C2000/C2500 series: Approx. 91 kg (200.7 lb.)</li> <li>• IM C3000/C3500 series: Approx. 100 kg (220.5 lb.)</li> <li>• IM C4500/C6000 series: Approx. 102 kg (224.9 lb.)</li> </ul>

\*1 Paper type used for two-sided/book print: Plain 1, Plain 2, Recycled paper, Special paper 1, Special paper 2, Special paper 3, Middle thick, Thick paper 1, Thick paper 2, Thick paper 3, Thin paper, Color paper, Letterhead

\*2 Paper type used for two-sided/book print: Plain 1, Plain 2, Recycled paper, Special paper 1, Special paper 2, Middle thick, Thick paper 1, Thin paper, Color paper, Letterhead

## Specifications for the Document Server

Item	Specifications
HDD (Document Server)	<p>Approx. 73 GB</p> <p>Maximum: 9,000 pages (Total number of pages that can be stored with all functions combined.)</p> <p>Copy/B&amp;W/A4 original: Approx. 9,000 pages</p> <p>Copy/Full Color/A4 original: Approx. 2,000 pages</p> <p>Printer/Full Color/A4/600 dpi, 2 bits: Approx. 9,000 pages</p> <p>Scanner/Full Color/A4/200 dpi, 8 bits/JPEG: Approx. 9,000 pages</p> <p>(Under the printer and scanner modes, the number of the pages that can be stored depends on the print image and original.)</p>
Maximum number of stored documents	3,000 documents
Number of pages supported by memory sorting	<p>Maximum: 2,000 pages</p> <p>Copy/B&amp;W/A4 original: Approx. 2,000 pages</p> <p>Printer/B&amp;W/A4/600 dpi, 4 bits: Approx. 2,000 pages</p> <p>(Under the printer mode, the number of pages that can be sorted depends on the print image.)</p>

### ↓ Note

- After the documents have been stored up to the maximum, no more document can be stored. Delete unneeded documents.

10

## Specifications for Facsimile

This function may not be used depending on the telephone line or area status.

### ↓ Note

- To connect the machine to the network, use a LAN cable supporting 1000BASE-T, 100BASE-TX, and 10BASE-T. The length of the usable cable is up to 100 m.

### Fax Transmissions and Reception

Item	Specifications
Standard	G3

Item	Specifications
Resolution	<ul style="list-style-type: none"> <li>Standard: 8 × 3.85 lines/mm, 200 × 100 dpi (Standard character), 8 × 7.7 lines/mm, 200 × 200 dpi (Detail character)</li> <li>Optional: 8 × 15.4 lines/mm, 16 × 15.4 lines/mm, 400 × 400 dpi (Super Fine character)<sup>*1</sup></li> </ul>
Transmission time	3 seconds at 28,800 bps, Standard resolution (JBIG transmission: 2 seconds)
Data compression method	MH, MR, MMR, JBIG <sup>*2</sup>
Maximum original size	Standard: A3☐ or 11 × 17☐ Custom (w × h): 297 × 1,200 mm (11.7 × 47.3 inches)
Maximum scanning size	297 × 1,200 mm (11.7 × 47.3 inches)
Print process	Laser beam scanning and electro-photographic printing
Transmission speed	33,600 / 31,200 / 28,800 / 26,400 / 24,000 / 21,600 / 19,200 / 16,800 / 14,400 / 12,000 / 9,600 / 7,200 / 4,800 / 2,400 bps (auto shift down system)

\*1 For Super Fine transmission, an expansion memory (optional) is required.

\*2 JBIG transmission cannot be performed if the JBIG reception and ECM functions are not available on the destination fax. The ECM function is valid for communication over the G3 line.

### Internet Fax Transmissions and Reception

Item	Specifications
Network	<ul style="list-style-type: none"> <li>Standard: Ethernet (10BASE-T/100BASE-TX/1000BASE-T)</li> <li>Option: IEEE802.11a/b/g/n wireless LAN interface</li> </ul>
Transmit function	E-mail
Scan line density	<ul style="list-style-type: none"> <li>Standard: 200 × 100 dpi (Standard character), 200 × 200 dpi (Detail character)</li> <li>Optional: 200 × 400 dpi, 400 × 400 dpi (Super Fine character)<sup>*1*2</sup></li> </ul>
Original size: Scanning width	297 mm (A3☐) <sup>*1</sup> , 257 mm (B4 JIS☐) <sup>*1</sup> , 210 mm (A4☐)



Item	Specifications
Communication Protocols	<ul style="list-style-type: none"> <li>• Transmission: SMTP, TCP/IP</li> <li>• Reception: POP3, SMTP, IMAP4, TCP/IP</li> </ul>
E-mail format	Single/Multi-part, MIME Conversion Attached file forms: TIFF-F (MH, MR <sup>*1</sup> , MMR <sup>*1</sup> compression)
Internet communication	Send and receive e-mail with a computer that has an e-mail address
Encryption method (for forwarding)	S/MIME
Internet Fax send functions:	Automatic conversion of sent documents to e-mail format and e-mail transmission. Memory transmission only.
Internet Fax receive functions	Automatic detection and printing of appended TIFF-F (MH) files and ASCII text. Memory reception only.

\*1 Full mode

\*2 For superfine-character transmission, an expansion memory (optional) is required.

### IP-Fax Transmissions and Reception

Item	Specifications
Network	<ul style="list-style-type: none"> <li>• Standard: Ethernet (10BASE-T/100BASE-TX/1000BASE-T)</li> <li>• Option: IEEE802.11a/b/g/n wireless LAN interface</li> </ul>
Scan line density	<ul style="list-style-type: none"> <li>• Standard: 8 × 3.85 lines/mm, 200 × 100 dpi (Standard character), 8 × 7.7 lines/mm, 200 × 200 dpi (Detail character)</li> <li>• Optional: 8 × 15.4 lines/mm, 16 × 15.4 lines/mm, 400 × 400 dpi (Super Fine character)<sup>*1</sup></li> </ul>
Maximum original size	Standard: A3☐ or 11 × 17☐ Custom (w × h): 297 × 1,200 mm (11.7 × 47.3 inches)
Maximum scanning size	297 × 1,200 mm (11.7 × 47.3 inches)

Item	Specifications
Transmission protocol	Recommendation: T.38, TCP, UDP/IP communication, SIP (RFC 3261 compliant), H.323 v2
Compatible machines	IP-Fax compatible machines
IP-Fax transmission function	Specify an IP address and send faxes to an IP-Fax compatible fax through a network. Also capable of sending faxes to a G3 fax connected to a telephone line via a VoIP gateway.
IP-Fax reception function	Receive faxes sent from an IP-Fax compatible fax through a network. Also capable of receiving faxes from a G3 fax connected to a telephone line via a VoIP gateway.

\* 1 For detail-character and superfine-character transmission, an expansion memory (optional) is required.

### Validated Peripherals

Item	Specifications
Gateway (T.38 compliant)	<ul style="list-style-type: none"> <li>InnovaPhone VoIP-Gateway IP305 Software version: v7 hotfix (09-70300.17)</li> <li>Cisco VoIP-Gateway (Operation confirmed with H.323) Software version: IOS 12.3 (5) Platform: Cisco2600XM, 3725, 847-4V, 26xx, 36xx, 37xx, 7200, AS5300, ICS 7750</li> <li>Siemens VoIP-Gateway RG8300 (Operation confirmed with SIP) Software version: Version 5</li> </ul>
Gatekeeper	<ul style="list-style-type: none"> <li>InnovaPhone VoIP-Gateway IP305 Software version: v7 hotfix (09-70300.17)</li> <li>Cisco Gatekeeper Software version: IOS 12.1 (2) T Platform: Cisco2600XM, 3620, 3640, 3660, 3725, 3745, 7200, 7400</li> </ul>

Item	Specifications
SIP server	<ul style="list-style-type: none"> <li>• Cisco SIP proxy server Software version: Version 2.0</li> <li>• Cisco VoIP-Gateway Software version: IOS12.3 (17) a Platform: Cisco3725 (256Mbyte RAM), Cisco2621XM (128Mbyte RAM)</li> <li>• Cisco unified CallManager Software version: Ver6.2</li> <li>• InnovaPhone VoIP-Gateway IP305 Software version: v7 hotfix (09-70300.17)</li> <li>• Siemens HiPath8000 (Operation confirmed with SIP) Software version: Voice redundant v4</li> </ul>

**Note**

- You can assign multiple addresses of the machine in the IPv6 environment, but only one address can receive IP-fax.
- The SIP connection is specified to connect to either IPv4 or IPv6 depending on the environment of the machine. To change the setting, contact your local dealer.

**E-mail Transmission and Folder Transmission (Fax (Classic) only)**

Item	Specifications
Network	<ul style="list-style-type: none"> <li>• Standard: Ethernet (10BASE-T/100BASE-TX/1000BASE-T)</li> <li>• Option: IEEE802.11a/b/g/n wireless LAN interface</li> </ul>
Scan line density	<ul style="list-style-type: none"> <li>• Standard: 200 × 100 dpi (Standard character)<sup>*1</sup>, 200 × 200 dpi (Detail character)</li> <li>• Optional: 200 × 400 dpi, 400 × 400 dpi (Super Fine character)<sup>*2</sup></li> </ul>
Maximum original size	Standard: A3 or 11 × 17 Custom (w × h): 297 × 1,200 mm (11.7 × 47.3 inches)
Maximum scanning size (w × h)	297 × 1,200 mm (11.7 × 47.3 inches)

Item	Specifications
E-mail transmission protocols	SMTP, TCP/IP
Protocols for sending files to folders	SMB, FTP, TCP/IP
E-mail format	Single/Multi-part, MIME Conversion
File formats	TIFF (MH, MR, MMR compression), PDF, PDF/A When you select PDF or PDF/A for the file format, you can attach a digital signature.
Authentication methods	SMTP-AUTH, POP before SMTP, A-POP
Encryption method	S/MIME
E-mail sending functions	Automatically converts documents to e-mail format and sends them as e-mail.
Sending to folder functions	Sends scanned files over the network to shared folders or FTP server folders.

\*1 When you send documents in TIFF format.

\*2 For detail-character and superfine-character transmission, an expansion memory (optional) is required.

### E-mail Reception

Item	Specifications
Network	<ul style="list-style-type: none"> <li>• Standard: Ethernet (10BASE-T/100BASE-TX/1000BASE-T)</li> <li>• Option: IEEE802.11a/b/g/n wireless LAN interface</li> </ul>
E-mail reception protocols (Mail to Print)	POP3, SMTP, IMAP4, TCP/IP
E-mail format	Single/Multi-part, MIME Conversion
File formats (Mail to Print)	JPEG (JFIF), PDF
Authentication methods	SMTP-AUTH, POP before SMTP, A-POP
Encryption method	S/MIME

---

Item	Specifications
E-mail receiving functions	Automatically detects and outputs JPEG and PDF documents attached to received e-mail.



---

## Specifications for Printer

---

**Note**

- To connect the machine to the network, use a LAN cable supporting 1000BASE-T, 100BASE-TX, and 10BASE-T. The length of the usable cable is up to 100 m.

Item	Specifications
Printing speed	<p> <b>Region A</b> (mainly Europe)</p> <ul style="list-style-type: none"> <li>• IM C2000/C2000A: 20 sheets/minute</li> <li>• IM C2500/C2500A: 25 sheets/minute</li> <li>• IM C3000/C3000A: 30 sheets/minute</li> <li>• IM C3500/C3500A: 35 sheets/minute</li> <li>• IM C4500/C4500A: 45 sheets/minute</li> <li>• IM C5500/C5500A: 55 sheets/minute</li> <li>• IM C6000: 60 sheets/minute</li> </ul> <p> <b>Region A</b> (mainly Asia)</p> <ul style="list-style-type: none"> <li>• IM C2000: 20 sheets/minute</li> <li>• IM C2500: 25 sheets/minute</li> <li>• IM C3000: 30 sheets/minute</li> <li>• IM C3500: 35 sheets/minute</li> <li>• IM C4500: 45 sheets/minute</li> <li>• IM C6000: 60 sheets/minute</li> </ul> <p> <b>Region B</b> (mainly North America)</p> <ul style="list-style-type: none"> <li>• IM C2000/C2000G: 20 sheets/minute</li> <li>• IM C2500/C2500G: 25 sheets/minute</li> <li>• IM C3000/C3000G: 30 sheets/minute</li> <li>• IM C3500/C3500G: 35 sheets/minute</li> <li>• IM C4500/C4500G: 45 sheets/minute</li> <li>• IM C6000/C6000G: 60 sheets/minute</li> </ul> <p>(A4□, 8 1/2 × 11□, plain paper)</p>
Resolution	200 dpi, 300 dpi, 400 dpi, 600 dpi, 1,200 dpi
Printer language	<ul style="list-style-type: none"> <li>• Standard: PCL 5c/6, PostScript 3 Emulation, PDF Emulation, MediaPrint (JPEG, TIFF)</li> <li>• Option: Genuine Adobe PostScript 3, PictBridge, IPDS, XPS</li> </ul>

Item	Specifications
Interface	<ul style="list-style-type: none"> <li>• Standard: <ul style="list-style-type: none"> <li>Ethernet (10BASE-T/100BASE-TX/1000BASE-T)</li> <li>USB2.0 (Type B) port</li> <li>USB2.0 (Type A) port (on the control panel)</li> <li>SD card slot (on the control panel)</li> </ul> </li> <li>• Option: <ul style="list-style-type: none"> <li>IEEE 1284 parallel interface</li> <li>IEEE 802.11a/b/g/n wireless LAN interface</li> <li>File format converter</li> <li>Device Server option</li> </ul> </li> </ul>
Network protocol	TCP/IP (IPv4, IPv6)
USB interface	<ul style="list-style-type: none"> <li>• Transmission spec: <ul style="list-style-type: none"> <li>USB 2.0 Standard</li> </ul> </li> <li>• Connectable device: <ul style="list-style-type: none"> <li>Devices corresponding to USB 2.0 Standard</li> </ul> </li> </ul>
Operating system	<ul style="list-style-type: none"> <li>• Windows 7/8.1/10</li> <li>• Windows Server 2008/2008 R2/2012/2012 R2/2016</li> <li>• OS X 10.11 or later</li> </ul>
Fonts	<ul style="list-style-type: none"> <li>• PostScript 3/PDF Emulation, PCL 5c/6: 93 fonts</li> <li>• Genuine Adobe PostScript 3/PDF: 136 fonts</li> <li>• IPDS: 108 fonts</li> </ul>
Store function	<p>Total number of documents that can be stored: Up to 100 documents</p> <p>Number of pages for each document that can be stored: Up to 2,000 pages</p> <p>Total number of pages of all documents that can be stored: Up to 9,000 pages</p>
Sort function	<p>Number of pages that can be sorted: Up to 2,000 pages</p> <p>Number of copies that can be sorted: Up to 999 copies</p>





**Note**

- When the resolution is 1200 dpi, the printing speed may be slower for the IM C3500/C3000/C2500/C2000 series.

**Specifications for Scanner****Note**

- To connect the machine to the network, use a LAN cable supporting 1000BASE-T, 100BASE-TX, and 10BASE-T. The length of the usable cable is up to 100 m.

**Scanning**

Item	Specifications
Type	Full-color scanner
Scan method	Flatbed scanning
Image sensor type	CCD Image Sensor
Scan type	Sheet, book, three-dimensional object
Original sizes that can be scanned	<ul style="list-style-type: none"> <li>Length: 10–297 mm (0.4–11 inches)</li> <li>Width: 10–432 mm (0.4–17 inches)</li> </ul>
Scan sizes automatically detectable from the exposure glass	<p> <b>Region A</b> (mainly Europe and Asia) A3, A4, A5, B4 JIS, B5 JIS</p> <p> <b>Region B</b> (mainly North America) 11 × 17, 8½ × 14, 8½ × 13⅔, 8½ × 11, 5½ × 8½</p>
Scan sizes automatically detectable from the ADF	<p> <b>Region A</b> (mainly Europe and Asia) A3, A4, A5, B4 JIS, B5 JIS, B6 JIS, 11 × 17, 8½ × 11</p> <p> <b>Region B</b> (mainly North America) A3, A4, 11 × 17, 8½ × 14, 8½ × 13⅔, 8½ × 11, 7¼ × 10½, 5½ × 8½, 10 × 14</p>



Item	Specifications
Scan speed (the machine equipped with the ARDF)	<p>80 pages/minute (black and white, full color)</p> <p>When using the E-mail, Scan to Folder, WSD (Push Type), or Scan to Removable device (Original size: A4<math>\square</math>/8<sup>1</sup>/<sub>2</sub> × 11, Resolution: 200 dpi/300 dpi)</p> <ul style="list-style-type: none"> <li>• Black and white Original Type: B &amp; W two-value, Compression (MMR): Compressed, ITU-T No1 Chart</li> <li>• Full color Original type: Text / Photo, Compression (Gray Scale / Full Color): Default, Original Chart</li> </ul> <p>Scanning speed differs depending on the operating environment of the machine and computer, scan settings, and the content of originals.</p>
Scan speed (the machine equipped with the one-pass duplex scanning ADF):	<ul style="list-style-type: none"> <li>• When scanning one-sided originals (black and white, full color) 110 pages/minute</li> <li>• When scanning two-sided originals (black and white, full color) 180 pages/minute</li> </ul> <p>When using the E-mail, Scan to Folder, WSD (Push Type), or Scan to Removable device (Original size: A4<math>\square</math>/8<sup>1</sup>/<sub>2</sub> × 11, Resolution: 300 dpi)</p> <ul style="list-style-type: none"> <li>• Black and white Original Type: B &amp; W two-value, Compression (MMR): Compressed, ITU-T No1 Chart</li> <li>• Full Color Original type: Text/Photo, Compression (Gray Scale/Full Color): Default, Original Chart</li> </ul> <p>Scanning speed differs depending on the operating environment of the machine and computer, scan settings, and the content of originals.</p>
Tone	<ul style="list-style-type: none"> <li>• Black &amp; White: 2 tones</li> <li>• Full Color/Gray Scale: 256 tones</li> </ul>
Basic scanning resolution:	200 dpi
Image compression type for black and white (two-value)	TIFF (MH, MR, MMR, JBIG2)

Item	Specifications
Image compression type for gray scale/full color	JPEG
Interface	<ul style="list-style-type: none"> <li>Standard: <ul style="list-style-type: none"> <li>Ethernet (10BASE-T/100BASE-TX/1000BASE-T)</li> <li>USB 2.0 (Type A) port (on the control panel)</li> <li>SD card slot (on the control panel)</li> </ul> </li> <li>Option: <ul style="list-style-type: none"> <li>IEEE 802.11a/b/g/n wireless LAN interface</li> </ul> </li> </ul>
Network protocol	TCP/IP
WSD	Supported
DSM	Supported* <sup>1</sup>

\*<sup>1</sup> The function can be used only in Scanner (Classic).

### E-mail transmission

Item	Specifications
Scanning resolution	100 dpi, 200 dpi, 300 dpi, 400 dpi, 600 dpi
Protocol* <sup>1</sup>	POP, SMTP* <sup>2</sup> , IMAP4
Output format	TIFF, JPEG, PDF, High Compression PDF, PDF/A, Searchable PDF* <sup>3</sup>

\*<sup>1</sup> Supporting Web mail transmission

\*<sup>2</sup> Supporting SMTP over SSL

\*<sup>3</sup> The number of characters that can be scanned optically is about 40,000 characters per page.

#### Note

- When you select [PDF], [High Compression PDF], or [PDF/A] for the file format, you can attach a digital signature. You can also specify the security settings for [PDF] or [High Compression PDF].
- See "Scanning an Original as a PDF with Security Setting Specified", User Guide (Full Version).
- To specify High Compression PDF for the PDF type, the following settings are required:
  - Selecting Gray Scale or Full Color for [Original Type] under [Send Settings]
  - Selecting other than [Reduce / Enlarge] under [Send Settings]
  - Selecting [200 dpi], [300 dpi], [400 dpi], or [600 dpi] for [Resolution] under [Send Settings]

- Selecting other than [Preview]
- Specifying [PDF File Type: PDF/A Fixed] under [System Settings] to [Off]

### Scan to Folder

Item	Specifications
Scanning resolution	100 dpi, 200 dpi, 300 dpi, 400 dpi, 600 dpi
Protocol	SMB, FTP <ul style="list-style-type: none"> <li>• You can use SMB protocol (139/TCP, 137/UDP) or CIFS protocol (445/TCP) for sending folders with SMB.</li> <li>• The Scan to Folder function with SMB protocol (139/TCP, 137/UDP) is enabled under NetBIOS over TCP/IP environment only.</li> <li>• You cannot use the Scan to Folder function with SMB under NetBEUI.</li> </ul>
Output format	TIFF, JPEG, PDF, High Compression PDF, PDF/A, Searchable PDF* <sup>1</sup>

\*<sup>1</sup> The number of characters that can be scanned optically is about 40,000 characters per page.

#### Note

- When you select [PDF], [High Compression PDF], or [PDF/A] for the file format, you can attach a digital signature. You can also specify the security settings for [PDF] or [High Compression PDF].
- See "Scanning an Original as a PDF with Security Setting Specified", User Guide (Full Version).
- To specify High Compression PDF for the PDF type, the following settings are required:
  - Selecting Gray Scale or Full Color for [Original Type] under [Transmission Settings]
  - Selecting other than [Reduce / Enlarge] under [Transmission Settings]
  - Selecting [200 dpi], [300 dpi], [400 dpi], or [600 dpi] for [Resolution] under [Transmission Settings]
  - Selecting other than [Preview]
  - Specifying [PDF File Type: PDF/A Fixed] under [System Settings] to [Off]

### Network TWAIN Scanner

Item	Specifications
Scanning resolution	100–1,200 dpi* <sup>1</sup>
Protocol	TCP/IP

Item	Specifications
Operating system	<ul style="list-style-type: none"> <li>Windows 7/8.1/10</li> <li>Windows Server 2008/2008 R2/2012/2012 R2/2016</li> </ul> (TWAIN scanner runs in 32-bit compatible mode on a 64-bit operating system, so TWAIN scanner is not compatible with 64-bit applications. Use 32-bit applications. IC card Authentication System is not compatible with 64-bit operating system.)



\*1 The maximum resolution depends on the scan size.



### WIA scanner

Item	Specifications
Scanning resolution (Main scanning × Sub-scanning)	100–1,200 dpi*1
Protocol	TCP/IP
Operating system	<ul style="list-style-type: none"> <li>Windows 7/8.1/10</li> <li>Windows Server 2008/2008 R2/2012/2012 R2/2016</li> </ul> (WIA scanner can function under both 32- and 64-bit operating systems.)

\*1 The maximum resolution depends on the scan size.



## Specifications for One-pass Duplex Scanning ADF



Item	Specifications
Mode	Batch mode, SADF mode, Mixed Sizes mode, Custom Size originals mode, Original Orientation mode
Original size	<p> <b>Region A</b> (mainly Europe and Asia)</p> <p>A3□–A5, A6 *1, B4 JIS□–B6 JIS, 11 × 17□–8<sup>1</sup>/<sub>2</sub> × 11</p> <ul style="list-style-type: none"> <li>You cannot scan two sides of B6 JIS originals.</li> </ul> <p> <b>Region B</b> (mainly North America)</p> <p>11 × 17□–5<sup>1</sup>/<sub>2</sub> × 8<sup>1</sup>/<sub>2</sub>, A3□–A4, A6 *1</p>

Item	Specifications
Original weight	One-sided: 40-128 g/m <sup>2</sup> (11-34 lb. Bond) Two-sided: 52-128 g/m <sup>2</sup> (14-34 lb. Bond) <ul style="list-style-type: none"> <li>Small size paper unit: One-sided/Two-sided: 64-128 g/m<sup>2</sup> (17-34 lb. Bond)</li> </ul>
Number of originals to be set	220 sheets (80 g/m <sup>2</sup> , 20 lb. Bond) <ul style="list-style-type: none"> <li>Small size paper unit: 44 sheets (81.4g/m<sup>2</sup>)</li> </ul>
Power requirements	Power is supplied from the main unit.
Maximum power consumption  Region A (mainly Asia)	60 W or less
Dimensions (W × D × H)  Region A (mainly Asia)	587 × 520 × 175 mm (23.2 × 20.5 × 6.9 inches)
Weight  Region A (mainly Asia)	Approx. 15 kg (33.1 lb.)

\*1 Small size paper unit is used. (Readable original size: Vertical 76–105 mm (3–4.2 inches), Horizontal 148–218 mm (5.9–8.6 inches))

## Specifications for Auto Reverse Document Feeder (ARDF)

Item	Specifications
Mode	Batch mode, SADF mode, Mixed Sizes mode, Custom Size originals mode, Original Orientation mode
Original Size	 Region A (mainly Europe and Asia) A3☐–A5, B4 JIS☐–B6 JIS, 11 × 17☐–8 <sup>1</sup> / <sub>2</sub> × 11 <ul style="list-style-type: none"> <li>You cannot scan two sides of B6 JIS originals.</li> </ul>  Region B (mainly North America) 11 × 17☐–5 <sup>1</sup> / <sub>2</sub> × 8 <sup>1</sup> / <sub>2</sub> , A3☐–B6 JIS <ul style="list-style-type: none"> <li>You cannot scan two sides of B6 JIS originals.</li> </ul>
Original weight	1 Sided: 40-128 g/m <sup>2</sup> (11-34 lb. Bond) Two Sided: 52-128 g/m <sup>2</sup> (14-34 lb. Bond)

Item	Specifications
Number of originals to be set	100 sheets (80 g/m <sup>2</sup> , 20 lb. Bond)
Power requirements	Power is supplied from the main unit.
Maximum power consumption  Region <b>A</b> (mainly Asia)	42 W or less
Dimensions (W × D × H)  Region <b>A</b> (mainly Asia)	565 × 500 × 125 mm (22.3 × 19.7 × 5.0 inches)
Weight  Region <b>A</b> (mainly Asia)	Approx. 9 kg (19.9 lb.)

### Specifications for Internal Finisher SR3250

Item	Specifications
Paper size	A3, A4, A5, A6, B4 JIS, B5 JIS, B6 JIS, 11 × 17, 8 <sup>1</sup> / <sub>2</sub> × 14, 8 <sup>1</sup> / <sub>2</sub> × 13, 8 <sup>1</sup> / <sub>2</sub> × 11, 8 <sup>1</sup> / <sub>4</sub> × 14, 8 <sup>1</sup> / <sub>4</sub> × 13, 8 × 13, 8 × 10, 7 <sup>1</sup> / <sub>4</sub> × 10 <sup>1</sup> / <sub>2</sub> , 5 <sup>1</sup> / <sub>2</sub> × 8 <sup>1</sup> / <sub>2</sub> , 4 <sup>1</sup> / <sub>8</sub> × 9 <sup>1</sup> / <sub>2</sub> , 3 <sup>7</sup> / <sub>8</sub> × 7 <sup>1</sup> / <sub>2</sub> , C5 Env, C6 Env, DL Env, 8K, 16K, 12 × 18, 11 × 15, 10 × 14, SRA3, SRA4, 8 <sup>1</sup> / <sub>2</sub> × 13 <sup>2</sup> / <sub>5</sub> , custom size
Paper weight	52–300 g/m <sup>2</sup> (14 lb. Bond–110 lb. Cover)
Paper sizes that can be shifted	A3, A4, A5, B4 JIS, B5 JIS, 11 × 17, 8 <sup>1</sup> / <sub>2</sub> × 14, 8 <sup>1</sup> / <sub>2</sub> × 13, 8 <sup>1</sup> / <sub>2</sub> × 11, 8 <sup>1</sup> / <sub>4</sub> × 14, 8 <sup>1</sup> / <sub>4</sub> × 13, 8 × 13, 8 × 10, 7 <sup>1</sup> / <sub>4</sub> × 10 <sup>1</sup> / <sub>2</sub> , 8K, 16K, 11 × 15, 10 × 14, SRA4, 8 <sup>1</sup> / <sub>2</sub> × 13 <sup>2</sup> / <sub>5</sub> , custom size
Paper weight that can be shifted	64–105 g/m <sup>2</sup> (17–28 lb. Bond)
Stack capacity (80 g/m <sup>2</sup> , 20 lb. Bond)	<ul style="list-style-type: none"> <li>• 500 sheets: A4, 8<sup>1</sup>/<sub>2</sub> × 11 or smaller</li> <li>• 250 sheets: B4 JIS, 8<sup>1</sup>/<sub>2</sub> × 14 or larger</li> </ul>
Staple paper size	A3, A4, B4 JIS, B5 JIS, 11 × 17, 8 <sup>1</sup> / <sub>2</sub> × 14, 8 <sup>1</sup> / <sub>2</sub> × 13, 8 <sup>1</sup> / <sub>2</sub> × 11, 8 <sup>1</sup> / <sub>4</sub> × 14, 8 <sup>1</sup> / <sub>4</sub> × 13, 7 <sup>1</sup> / <sub>4</sub> × 10 <sup>1</sup> / <sub>2</sub> , 8K, 16K, 8 <sup>1</sup> / <sub>2</sub> × 13 <sup>2</sup> / <sub>5</sub>

Item	Specifications
Staple paper weight	64-105 g/m <sup>2</sup> (16-28 lb. Bond)
Staple capacity (80 g/m <sup>2</sup> , 20 lb. Bond)	<p>Without Mixed Size:</p> <ul style="list-style-type: none"> <li>• 30 sheets: A3, B4 JIS, 11 × 17, 8<sup>1</sup>/<sub>2</sub> × 14, 8<sup>1</sup>/<sub>2</sub> × 13, 8<sup>1</sup>/<sub>4</sub> × 14, 8<sup>1</sup>/<sub>4</sub> × 13, 8K, 8<sup>1</sup>/<sub>2</sub> × 13<sup>2</sup>/<sub>5</sub></li> <li>• 50 sheets: A4, B5 JIS, 8<sup>1</sup>/<sub>2</sub> × 11, 7<sup>1</sup>/<sub>4</sub> × 10<sup>1</sup>/<sub>2</sub>, 16K</li> </ul> <p>With Mixed Size:</p> <ul style="list-style-type: none"> <li>• 30 sheets: A3/A4, B4 JIS/B5, 11 × 17/8<sup>1</sup>/<sub>2</sub> × 11</li> </ul>
Stack capacity after stapling (80 g/m <sup>2</sup> , 20 lb. Bond)	<ul style="list-style-type: none"> <li>• A4, B5 JIS, 8<sup>1</sup>/<sub>2</sub> × 11 <ul style="list-style-type: none"> <li>• 2-9 sheets: 55-46 sets</li> <li>• 10-50 sheets: 45-10 sets</li> </ul> </li> <li>• A4, B5 JIS, 8<sup>1</sup>/<sub>2</sub> × 11: <ul style="list-style-type: none"> <li>• 2-9 sheets: 55-27 sets</li> <li>• 10-50 sheets: 25-8 sets</li> </ul> </li> <li>• A3, B4 JIS, 11 × 17, 8<sup>1</sup>/<sub>2</sub> × 14: <ul style="list-style-type: none"> <li>• 2-9 sheets: 55-27 sets</li> <li>• 10-30 sheets: 25-8 sets</li> </ul> </li> </ul>
Staple position	Top 1, Bottom 1, Left 2, Top 2
Power requirements	Power is supplied from the main unit.
Maximum power consumption	<ul style="list-style-type: none"> <li>• 47 W or less (without punch unit)</li> <li>• 60 W or less (with punch unit)</li> </ul>
Dimensions (W × D × H)	546 × 523 × 170 mm (21.5 × 20.6 × 6.7 inches)
Weight	<ul style="list-style-type: none"> <li>• Approx. 13 kg (28.7 lb.) (without punch unit)</li> <li>• Approx. 18 kg (39.7 lb.) (with punch unit)</li> </ul>

## Specifications for Finisher SR3260

Item	Specifications
Paper size for the finisher upper tray	A3, B4 JIS, A4, B5 JIS, A5, B6 JIS, A6, 12 × 18, 11 × 17, 11 × 15, 10 × 14, 8 <sup>1</sup> / <sub>2</sub> × 14, 8 <sup>1</sup> / <sub>2</sub> × 13, 8 <sup>1</sup> / <sub>2</sub> × 11, 8 <sup>1</sup> / <sub>4</sub> × 14, 8 <sup>1</sup> / <sub>4</sub> × 13, 8 × 13, 8 × 10, 7 <sup>1</sup> / <sub>4</sub> × 10 <sup>1</sup> / <sub>2</sub> , 5 <sup>1</sup> / <sub>2</sub> × 8 <sup>1</sup> / <sub>2</sub> , 8K, 16K, SRA3, SRA4, 8 <sup>1</sup> / <sub>2</sub> × 13 <sup>2</sup> / <sub>5</sub> , custom size
Paper weight for the finisher upper tray	52-169 g/m <sup>2</sup> (14 lb. Bond-90 lb. Index)
Stack capacity for the finisher upper tray (80 g/m <sup>2</sup> , 20 lb. Bond)	<ul style="list-style-type: none"> <li>• 250 sheets : A4, 8<sup>1</sup>/<sub>2</sub> × 11 or smaller</li> <li>• 50 sheets: B4 JIS, 8<sup>1</sup>/<sub>2</sub> × 14 or larger</li> </ul>
Paper size for the finisher shift tray	A3, B4 JIS, A4, B5 JIS, A5, B6 JIS, A6, 12 × 18, 11 × 17, 11 × 15, 10 × 14, 8 <sup>1</sup> / <sub>2</sub> × 14, 8 <sup>1</sup> / <sub>2</sub> × 13, 8 <sup>1</sup> / <sub>2</sub> × 11, 8 <sup>1</sup> / <sub>4</sub> × 14, 8 <sup>1</sup> / <sub>4</sub> × 13, 8 × 13, 8 × 10, 7 <sup>1</sup> / <sub>4</sub> × 10 <sup>1</sup> / <sub>2</sub> , 5 <sup>1</sup> / <sub>2</sub> × 8 <sup>1</sup> / <sub>2</sub> , 8K, 16K, SRA3, SRA4, 8 <sup>1</sup> / <sub>2</sub> × 13 <sup>2</sup> / <sub>5</sub> , custom size
Paper weight for the finisher shift tray (without staple)	52-300 g/m <sup>2</sup> (14 lb. Bond-110 lb. Cover)
Paper sizes that can be shifted when delivered to the finisher shift tray	A3, B4 JIS, A4, B5 JIS, A5, 12 × 18, 11 × 17, 11 × 15, 10 × 14, 8 <sup>1</sup> / <sub>2</sub> × 14, 8 <sup>1</sup> / <sub>2</sub> × 13, 8 <sup>1</sup> / <sub>2</sub> × 11, 8 <sup>1</sup> / <sub>4</sub> × 14, 8 <sup>1</sup> / <sub>4</sub> × 13, 8 × 13, 8 × 10, 7 <sup>1</sup> / <sub>4</sub> × 10 <sup>1</sup> / <sub>2</sub> , 5 <sup>1</sup> / <sub>2</sub> × 8 <sup>1</sup> / <sub>2</sub> , 8K, 16K, SRA4, 8 <sup>1</sup> / <sub>2</sub> × 13 <sup>2</sup> / <sub>5</sub> , custom size
Paper weight that can be shifted when delivered to the finisher shift tray	52-300 g/m <sup>2</sup> (14 lb. Bond-110 lb. Cover)
Stack capacity for the finisher shift tray (80 g/m <sup>2</sup> , 20 lb. Bond)	<ul style="list-style-type: none"> <li>• 1,000 sheets: A4, 8<sup>1</sup>/<sub>2</sub> × 11 or smaller:</li> <li>• 500 sheets: B4 JIS, 8<sup>1</sup>/<sub>2</sub> × 14 or larger:</li> </ul>
Staple paper size	A3, B4 JIS, A4, B5 JIS, 12 × 18, 11 × 17, 11 × 15, 10 × 14, 8 <sup>1</sup> / <sub>2</sub> × 14, 8 <sup>1</sup> / <sub>2</sub> × 13, 8 <sup>1</sup> / <sub>2</sub> × 11, 8 <sup>1</sup> / <sub>4</sub> × 14, 8 <sup>1</sup> / <sub>4</sub> × 13, 8 × 13, 8 × 10, 7 <sup>1</sup> / <sub>4</sub> × 10 <sup>1</sup> / <sub>2</sub> , 8K, 16K, SRA4, 8 <sup>1</sup> / <sub>2</sub> × 13 <sup>2</sup> / <sub>5</sub> , custom size



Item	Specifications
Staple paper weight	<ul style="list-style-type: none"> <li>• Staple: 52-105 g/m<sup>2</sup> (14-28 lb. Bond)*<sup>1</sup></li> <li>• Staple-free staple: 64-80 g/m<sup>2</sup> (17-20 lb. Bond)</li> </ul>
Staple capacity (80 g/m <sup>2</sup> , 20 lb. Bond)	<p>Without Mixed Size:</p> <ul style="list-style-type: none"> <li>• 30 sheets: A3□, B4 JIS□, 11 × 17□, 8<sup>1</sup>/<sub>2</sub> × 14□, 8 × 13□, 8<sup>1</sup>/<sub>2</sub> × 13□, 8<sup>1</sup>/<sub>4</sub> × 14□, 8<sup>1</sup>/<sub>4</sub> × 13□, 11 × 15□, 10 × 14□, 8K□, 12 × 18□, SRA4□, 8<sup>1</sup>/<sub>2</sub> × 13<sup>2</sup>/<sub>5</sub>□</li> <li>• 50 sheets: A4, B5 JIS, 8<sup>1</sup>/<sub>2</sub> × 11, 8 × 10□, 7<sup>1</sup>/<sub>4</sub> × 10<sup>1</sup>/<sub>2</sub>, 16K</li> </ul> <p>With Mixed Size:</p> <ul style="list-style-type: none"> <li>• 22 sheets: A3□/A4□, B4 JIS□/B5 JIS□, 11 × 17□/8<sup>1</sup>/<sub>2</sub> × 11□</li> </ul>
Stack capacity after stapling (80 g/m <sup>2</sup> , 20 lb. Bond)	<p>Staple:</p> <ul style="list-style-type: none"> <li>• 2–9 sheets: 100 sets (A4□, B5 JIS□, 8<sup>1</sup>/<sub>2</sub> × 11□)</li> <li>• 10–50 sheets: 100–20 sets (A4□, B5 JIS□, 8<sup>1</sup>/<sub>2</sub> × 11□)</li> <li>• 10–50 sheets: 50–10 sets (A4□, B5 JIS□, 8<sup>1</sup>/<sub>2</sub> × 11□)</li> <li>• 2–9 sheets: 50 sets (A3□, A4□, B4 JIS□, B5 JIS□, 11 × 17□, 8<sup>1</sup>/<sub>2</sub> × 14□, 8<sup>1</sup>/<sub>2</sub> × 11□)</li> <li>• 10–30 sheets: 50–10 sets (A3□, B4 JIS□, 11 × 17□, 8<sup>1</sup>/<sub>2</sub> × 14□)</li> </ul> <p>Staple-free staple:</p> <ul style="list-style-type: none"> <li>• 2–5 sheets: 100 sets (A4□, B5 JIS□, 8<sup>1</sup>/<sub>2</sub> × 11□)</li> <li>• 2–5 sheets: 50 sets (A3□, A4□, B4 JIS□, B5 JIS□, 11 × 17□, 8<sup>1</sup>/<sub>2</sub> × 14□, 8<sup>1</sup>/<sub>2</sub> × 11□)</li> </ul>
Staple position	3 positions (Top, Bottom, 2 Staples)
Power requirements	Power is supplied from the main unit.
Maximum power consumption	36 W or less
Dimensions (W × D × H)	<ul style="list-style-type: none"> <li>• 575 × 665 × 960 mm (22.6 × 26.2 × 37.8 inches) (Tray is folded.)</li> <li>• 658 × 665 × 960 mm (25.9 × 26.2 × 37.8 inches) (Tray is extended.)</li> </ul> <p>(the height to reach the top board)</p>
Weight	Approx. 34 kg (75.0 lb.)

\*1 You can use two sheets of paper weighing up to 216 g/m<sup>2</sup> (80 lb. Cover) per set as cover sheets.

## Specifications for Booklet Finisher SR3270

Item	Specifications
Paper size for the finisher upper tray	A3, B4 JIS, A4, B5 JIS, A5, B6 JIS, A6, 12 × 18, 11 × 17, 11 × 15, 10 × 14, 8 <sup>1</sup> / <sub>2</sub> × 14, 8 <sup>1</sup> / <sub>2</sub> × 13, 8 <sup>1</sup> / <sub>2</sub> × 11, 8 <sup>1</sup> / <sub>4</sub> × 14, 8 <sup>1</sup> / <sub>4</sub> × 13, 8 × 13, 8 × 10, 7 <sup>1</sup> / <sub>4</sub> × 10 <sup>1</sup> / <sub>2</sub> , 5 <sup>1</sup> / <sub>2</sub> × 8 <sup>1</sup> / <sub>2</sub> , 8K, 16K, SRA3, SRA4, 8 <sup>1</sup> / <sub>2</sub> × 13 <sup>2</sup> / <sub>5</sub> , custom size
Paper weight for the finisher upper tray	52-169 g/m <sup>2</sup> (14 lb. Bond-90 lb. Index)
Stack capacity for the finisher upper tray (80 g/m <sup>2</sup> , 20 lb. Bond)	<ul style="list-style-type: none"> <li>• 250 sheets : A4, 8<sup>1</sup>/<sub>2</sub> × 11 or smaller</li> <li>• 50 sheets: B4 JIS, 8<sup>1</sup>/<sub>2</sub> × 14 or larger</li> </ul>
Paper size for the finisher shift tray	A3, B4 JIS, A4, B5 JIS, A5, B6 JIS, A6, 12 × 18, 11 × 17, 11 × 15, 10 × 14, 8 <sup>1</sup> / <sub>2</sub> × 14, 8 <sup>1</sup> / <sub>2</sub> × 13, 8 <sup>1</sup> / <sub>2</sub> × 11, 8 <sup>1</sup> / <sub>4</sub> × 14, 8 <sup>1</sup> / <sub>4</sub> × 13, 8 × 13, 8 × 10, 7 <sup>1</sup> / <sub>4</sub> × 10 <sup>1</sup> / <sub>2</sub> , 5 <sup>1</sup> / <sub>2</sub> × 8 <sup>1</sup> / <sub>2</sub> , 8K, 16K, SRA3, SRA4, 8 <sup>1</sup> / <sub>2</sub> × 13 <sup>2</sup> / <sub>5</sub> , custom size
Paper weight for the finisher shift tray	52-300 g/m <sup>2</sup> (14 lb. Bond-110 lb. Cover)
Paper sizes that can be shifted when delivered to the finisher shift tray	A3, B4 JIS, A4, B5 JIS, A5, 12 × 18, 11 × 17, 11 × 15, 10 × 14, 8 <sup>1</sup> / <sub>2</sub> × 14, 8 <sup>1</sup> / <sub>2</sub> × 13, 8 <sup>1</sup> / <sub>2</sub> × 11, 8 <sup>1</sup> / <sub>4</sub> × 14, 8 <sup>1</sup> / <sub>4</sub> × 13, 8 × 13, 8 × 10, 7 <sup>1</sup> / <sub>4</sub> × 10 <sup>1</sup> / <sub>2</sub> , 5 <sup>1</sup> / <sub>2</sub> × 8 <sup>1</sup> / <sub>2</sub> , 8K, 16K, SRA4, 8 <sup>1</sup> / <sub>2</sub> × 13 <sup>2</sup> / <sub>5</sub> , custom size
Paper weight that can be shifted when delivered to the finisher shift tray	52-300 g/m <sup>2</sup> (14 lb. Bond-110 lb. Cover)
Stack capacity for the finisher shift tray (80 g/m <sup>2</sup> , 20 lb. Bond)	<ul style="list-style-type: none"> <li>• 1,000 sheets: A4, 8<sup>1</sup>/<sub>2</sub> × 11 or smaller:</li> <li>• 500 sheets: B4 JIS, 8<sup>1</sup>/<sub>2</sub> × 14 or larger:</li> </ul>

Item	Specifications
Staple paper size	A3, B4 JIS, A4, B5 JIS, 12 × 18, 11 × 17, 11 × 15, 10 × 14, 8½ × 14, 8½ × 13, 8½ × 11, 8¼ × 14, 8¼ × 13, 8 × 13, 8 × 10, 7¼ × 10½, 8K, 16K, SRA4, 8½ × 13²/₅, custom size
Staple paper weight	52-105 g/m² (14-28 lb. Bond) You can use two sheets of paper weighing up to 216 g/m² (80 lb. Cover) per set as cover sheets.
Staple capacity (80 g/m², 20 lb. Bond)	Without Mixed Size: <ul style="list-style-type: none"> <li>• 30 sheets: A3, B4 JIS, 11 × 17, 8½ × 14, 8 × 13, 8½ × 13, 8¼ × 14, 8¼ × 13, 11 × 15, 10 × 14, 8K, 12 × 18, SRA4, 8½ × 13²/₅</li> <li>• 50 sheets: A4, B5 JIS, 8½ × 11, 8 × 10, 7¼ × 10½, 16K</li> </ul> With Mixed Size: <ul style="list-style-type: none"> <li>• 22 sheets: A3/A4, B4 JIS/B5 JIS, 11 × 17/8½ × 11</li> </ul>
Stack capacity after stapling (80 g/m², 20 lb. Bond)	Without Mixed Size: <ul style="list-style-type: none"> <li>• 2–9 sheets: 100 sets (A4, B5 JIS, 8½ × 11)</li> <li>• 10–50 sheets: 100–20 sets (A4, B5 JIS, 8½ × 11)</li> <li>• 10–50 sheets: 50–10 sets (A4, B5 JIS, 8½ × 11)</li> <li>• 2–9 sheets: 50 sets (A3, A4, B4 JIS, B5 JIS, 11 × 17, 8½ × 14, 8½ × 11)</li> <li>• 10–30 sheets: 50–10 sets (A3, B4 JIS, 11 × 17, 8½ × 14)</li> </ul> With Mixed Size: <ul style="list-style-type: none"> <li>• 2–22 sheets: 22 sets (A3/A4, B4 JIS/B5 JIS, 11 × 17/8½ × 11)</li> </ul>
Staple position	3 positions (Top, Bottom, 2 Staples)
Saddle stitch paper size	A3, A4, B4 JIS, B5 JIS, 11 × 17, 8½ × 14, 8½ × 11, 12 × 18, 8½ × 13²/₅
Saddle stitch paper weight	52-105 g/m² (14-28 lb. Bond)
Saddle stitch capacity (80 g/m², 20 lb. Bond)	1 set (15 sheets)

Item	Specifications
Stack capacity after saddle stitching (80 g/m <sup>2</sup> , 20 lb. Bond)	<ul style="list-style-type: none"> <li>• 2-5 sheets: approx. 20 sets</li> <li>• 6-10 sheets: approx. 10 sets</li> <li>• 11-15 sheets: approx. 7 sets</li> </ul> (Stack capacity depends on the paper type and use conditions.)
Saddle stitch position	Center 2 positions
Types of folds	Half Fold
Half fold paper size	A3□, A4□, B4 JIS□, B5 JIS□, 11 × 17□, 8 <sup>1</sup> / <sub>2</sub> × 14□, 8 <sup>1</sup> / <sub>2</sub> × 11□, 12 × 18□, 8 <sup>1</sup> / <sub>2</sub> × 13 <sup>2</sup> / <sub>5</sub> □
Half fold paper weight	52-105 g/m <sup>2</sup> (14-28 lb. Bond)
Half fold paper type	Plain 1, Plain 2, Recycled Paper, Middle Thick, Thin Paper, Color Paper
Power requirements	Power is supplied from the main unit.
Maximum power consumption	36 W or less
Dimensions (W × D × H)	<ul style="list-style-type: none"> <li>• 575 × 620 × 960 mm (22.6 × 24.5 × 37.8 inches) (Tray is folded.)</li> <li>• 658 × 620 × 960 mm (25.9 × 24.5 × 37.8 inches) (Tray is extended.)</li> </ul> (the height to reach the top board)
Weight	Approx. 44 kg (97.1 lb.)

 **Note**

- The Half Fold function can fold one sheet at a time.

## Specifications for Finisher SR3280

Item	Specifications
Paper size for the finisher upper tray	A3☐, B4 JIS☐, A4, B5 JIS, A5, B6 JIS☐, A6☐, 12 × 18☐, 11 × 17☐, 11 × 15☐, 10 × 14☐, 8 <sup>1</sup> / <sub>2</sub> × 14☐, 8 <sup>1</sup> / <sub>2</sub> × 13☐, 8 <sup>1</sup> / <sub>2</sub> × 11, 8 <sup>1</sup> / <sub>4</sub> × 14☐, 8 <sup>1</sup> / <sub>4</sub> × 13☐, 8 × 13☐, 8 × 10☐, 7 <sup>1</sup> / <sub>4</sub> × 10 <sup>1</sup> / <sub>2</sub> , 5 <sup>1</sup> / <sub>2</sub> × 8 <sup>1</sup> / <sub>2</sub> ☐, 8K☐, 16K, SRA3☐, SRA4, 8 <sup>1</sup> / <sub>2</sub> × 13 <sup>2</sup> / <sub>5</sub> ☐, custom size
Paper weight for the finisher upper tray	52-220 g/m <sup>2</sup> (14 lb. Bond-80 lb. Cover)
Stack capacity for the finisher upper tray (80 g/m <sup>2</sup> , 20 lb. Bond)	<ul style="list-style-type: none"> <li>• 250 sheets : A4, 8<sup>1</sup>/<sub>2</sub> × 11 or smaller</li> <li>• 50 sheets: B4 JIS, 8<sup>1</sup>/<sub>2</sub> × 14 or larger</li> </ul>
Paper size for the finisher shift tray:	A3☐, B4 JIS☐, A4, B5 JIS, A5, B6 JIS☐, A6☐, 12 × 18☐, 11 × 17☐, 11 × 15☐, 10 × 14☐, 8 <sup>1</sup> / <sub>2</sub> × 14☐, 8 <sup>1</sup> / <sub>2</sub> × 13☐, 8 <sup>1</sup> / <sub>2</sub> × 11, 8 <sup>1</sup> / <sub>4</sub> × 14☐, 8 <sup>1</sup> / <sub>4</sub> × 13☐, 8 × 13☐, 8 × 10☐, 7 <sup>1</sup> / <sub>4</sub> × 10 <sup>1</sup> / <sub>2</sub> , 5 <sup>1</sup> / <sub>2</sub> × 8 <sup>1</sup> / <sub>2</sub> ☐, 8K☐, 16K, SRA3☐, SRA4, 8 <sup>1</sup> / <sub>2</sub> × 13 <sup>2</sup> / <sub>5</sub> ☐, custom size
Paper weight for the finisher shift tray (without staple)	52-300 g/m <sup>2</sup> (14 lb. Bond-110 lb. Cover)
Paper sizes that can be shifted when delivered to the finisher shift tray	A3☐, B4 JIS☐, A4, B5 JIS, A5, B6 JIS☐, 12 × 18☐, 11 × 17☐, 11 × 15☐, 10 × 14☐, 8 <sup>1</sup> / <sub>2</sub> × 14☐, 8 <sup>1</sup> / <sub>2</sub> × 13☐, 8 <sup>1</sup> / <sub>2</sub> × 11, 8 <sup>1</sup> / <sub>4</sub> × 14☐, 8 <sup>1</sup> / <sub>4</sub> × 13☐, 8 × 13☐, 8 × 10☐, 7 <sup>1</sup> / <sub>4</sub> × 10 <sup>1</sup> / <sub>2</sub> , 5 <sup>1</sup> / <sub>2</sub> × 8 <sup>1</sup> / <sub>2</sub> ☐, 8K☐, 16K, SRA4☐, 8 <sup>1</sup> / <sub>2</sub> × 13 <sup>2</sup> / <sub>5</sub> ☐, custom size
Paper weight that can be shifted when delivered to the finisher shift tray	52-300 g/m <sup>2</sup> (14 lb. Bond-110 lb. Cover)
Stack capacity for the finisher shift tray (80 g/m <sup>2</sup> , 20 lb. Bond)	<ul style="list-style-type: none"> <li>• 3,000 sheets: A4☐, 8<sup>1</sup>/<sub>2</sub> × 11☐</li> <li>• 1,500 sheets: A3☐, B4 JIS☐, A4☐, B5 JIS, 12 × 18☐, 11 × 17☐, 8<sup>1</sup>/<sub>2</sub> × 14☐, 8<sup>1</sup>/<sub>2</sub> × 11☐</li> <li>• 500 sheets: A5☐</li> <li>• 100 sheets: A5☐, A6☐, B6 JIS☐, 5<sup>1</sup>/<sub>2</sub> × 8<sup>1</sup>/<sub>2</sub>☐</li> </ul>

Item	Specifications
Staple paper size	A3, B4 JIS, A4, B5 JIS, 11 × 17, 11 × 15, 10 × 14, 8 <sup>1</sup> / <sub>2</sub> × 14, 8 <sup>1</sup> / <sub>2</sub> × 13, 8 <sup>1</sup> / <sub>2</sub> × 11, 8 <sup>1</sup> / <sub>4</sub> × 14, 8 <sup>1</sup> / <sub>4</sub> × 13, 8 × 13, 8 × 10, 7 <sup>1</sup> / <sub>4</sub> × 10 <sup>1</sup> / <sub>2</sub> , 8K, 16K, SRA4, 8 <sup>1</sup> / <sub>2</sub> × 13 <sup>2</sup> / <sub>5</sub> , custom size
Staple paper weight	52-105 g/m <sup>2</sup> (14-28 lb. Bond) You can use two sheets of paper weighing up to 256 g/m <sup>2</sup> (80 lb. Cover) per set as cover sheets.
Staple capacity (80 g/m <sup>2</sup> , 20 lb. Bond)	Without Mixed Size: <ul style="list-style-type: none"> <li>• 50 sheets: A3, B4 JIS, A4, B5 JIS, 11 × 17, 11 × 15, 10 × 14, 8<sup>1</sup>/<sub>2</sub> × 14, 8<sup>1</sup>/<sub>2</sub> × 13, 8<sup>1</sup>/<sub>2</sub> × 11, 8<sup>1</sup>/<sub>4</sub> × 14, 8<sup>1</sup>/<sub>4</sub> × 13, 8 × 13, 8 × 10, 7<sup>1</sup>/<sub>4</sub> × 10<sup>1</sup>/<sub>2</sub>, 8K, 16K, SRA4, 8<sup>1</sup>/<sub>2</sub> × 13<sup>2</sup>/<sub>5</sub></li> </ul> With Mixed Size: <ul style="list-style-type: none"> <li>• 50 sheets: A3/A4, B4 JIS/B5 JIS, 11 × 17/8<sup>1</sup>/<sub>2</sub> × 11</li> </ul>
Stack capacity after stapling (80 g/m <sup>2</sup> , 20 lb. Bond)	Without Mixed Size: <ul style="list-style-type: none"> <li>• 2–19 sheets: 150 sets (A4, 8<sup>1</sup>/<sub>2</sub> × 11)</li> <li>• 20–50 sheets: 150–46 sets (A4, 8<sup>1</sup>/<sub>2</sub> × 11)</li> <li>• 2–14 sheets: 100 sets (A4, B5 JIS, 8<sup>1</sup>/<sub>2</sub> × 11)</li> <li>• 15–50 sheets: 100–23 sets (A4, B5 JIS, 8<sup>1</sup>/<sub>2</sub> × 11)</li> <li>• 2–14 sheets: 100 sets (other size paper)</li> <li>• 15–50 sheets: 100–23 sets (other size paper)</li> </ul> With Mixed Size: <ul style="list-style-type: none"> <li>• 2–50 sheets: 23 sets (A3/A4, B4 JIS/B5 JIS, 11 × 17/8<sup>1</sup>/<sub>2</sub> × 11)</li> </ul>
Staple position	4 positions (Top, Top Slant, Bottom, 2 Staples)
Power requirements	Power is supplied from the main unit.
Maximum power consumption	64 W or less

Item	Specifications
Dimensions (W × D × H)	<ul style="list-style-type: none"> <li>657 × 613 × 960 mm (25.9 × 24.2 × 37.8 inches) (Tray is folded.)</li> <li>757 × 613 × 960 mm (29.9 × 24.2 × 37.8 inches) (Tray is extended.)</li> </ul> (the height to reach the top board)
Weight	<ul style="list-style-type: none"> <li>Approx. 36 kg (79.4 lb.) (without punch unit)</li> <li>Approx. 39 kg (86.0 lb.) (with punch unit)</li> </ul>

### Specifications for Booklet Finisher SR3290

Item	Specifications
Paper size for the finisher upper tray	A3, B4 JIS, A4, B5 JIS, A5, B6 JIS, A6, 12 × 18, 11 × 17, 11 × 15, 10 × 14, 8 1/2 × 14, 8 1/2 × 13, 8 1/2 × 11, 8 1/4 × 14, 8 1/4 × 13, 8 × 13, 8 × 10, 7 1/4 × 10 1/2, 5 1/2 × 8 1/2, 8K, 16K, SRA3, SRA4, 8 1/2 × 13 2/5, custom size
Paper weight for the finisher upper tray	52-220 g/m <sup>2</sup> (14 lb. Bond-80 lb. Cover)
Stack capacity for the finisher upper tray (80 g/m <sup>2</sup> , 20 lb. Bond)	<ul style="list-style-type: none"> <li>250 sheets : A4, 8 1/2 × 11 or smaller</li> <li>50 sheets: B4 JIS, 8 1/2 × 14 or larger</li> </ul>
Paper size for the finisher shift tray	A3, B4 JIS, A4, B5 JIS, A5, B6 JIS, A6, 12 × 18, 11 × 17, 11 × 15, 10 × 14, 8 1/2 × 14, 8 1/2 × 13, 8 1/2 × 11, 8 1/4 × 14, 8 1/4 × 13, 8 × 13, 8 × 10, 7 1/4 × 10 1/2, 5 1/2 × 8 1/2, 8K, 16K, SRA3, SRA4, 8 1/2 × 13 2/5, custom size
Paper weight for the finisher shift tray	52-300 g/m <sup>2</sup> (14 lb. Bond-110 lb. Cover)
Paper sizes that can be shifted when delivered to the finisher shift tray	A3, B4 JIS, A4, B5 JIS, A5, B6 JIS, 12 × 18, 11 × 17, 11 × 15, 10 × 14, 8 1/2 × 14, 8 1/2 × 13, 8 1/2 × 11, 8 1/4 × 14, 8 1/4 × 13, 8 × 13, 8 × 10, 7 1/4 × 10 1/2, 5 1/2 × 8 1/2, 8K, 16K, SRA4, 8 1/2 × 13 2/5, custom size

Item	Specifications
Paper weight that can be shifted when delivered to the finisher shift tray	52-300 g/m <sup>2</sup> (14 lb. Bond-110 lb. Cover)
Stack capacity for the finisher shift tray (80 g/m <sup>2</sup> , 20 lb. Bond)	<ul style="list-style-type: none"> <li>• 2,000 sheets: A4☐, 8<sup>1</sup>/<sub>2</sub> × 11☐</li> <li>• 1,000 sheets: A3☐, B4 JIS☐, A4☐, B5 JIS, 12 × 18☐, 11 × 17☐, 8<sup>1</sup>/<sub>2</sub> × 14☐, 8<sup>1</sup>/<sub>2</sub> × 11☐</li> <li>• 500 sheets: A5☐</li> <li>• 100 sheets: A5☐, A6☐, B6 JIS☐, 5<sup>1</sup>/<sub>2</sub> × 8<sup>1</sup>/<sub>2</sub>☐</li> </ul>
Staple paper size	A3☐, B4 JIS☐, A4, B5 JIS, 11 × 17☐, 11 × 15☐, 10 × 14☐, 8 <sup>1</sup> / <sub>2</sub> × 14☐, 8 <sup>1</sup> / <sub>2</sub> × 13☐, 8 <sup>1</sup> / <sub>2</sub> × 11, 8 <sup>1</sup> / <sub>4</sub> × 14☐, 8 <sup>1</sup> / <sub>4</sub> × 13☐, 8 × 13☐, 8 × 10☐, 7 <sup>1</sup> / <sub>4</sub> × 10 <sup>1</sup> / <sub>2</sub> , 8K☐, 16K, SRA4☐, 8 <sup>1</sup> / <sub>2</sub> × 13 <sup>2</sup> / <sub>5</sub> ☐, custom size
Staple paper weight	52-105 g/m <sup>2</sup> (14-28 lb. Bond) You can use two sheets of paper weighing up to 256 g/m <sup>2</sup> (80 lb. Cover) per set as cover sheets.
Staple capacity (80 g/m <sup>2</sup> , 20 lb. Bond)	<p>Without Mixed Size:</p> <ul style="list-style-type: none"> <li>• 50 sheets: A3☐, B4 JIS☐, A4, B5 JIS, 11 × 17☐, 11 × 15☐, 10 × 14☐, 8<sup>1</sup>/<sub>2</sub> × 14☐, 8<sup>1</sup>/<sub>2</sub> × 13☐, 8<sup>1</sup>/<sub>2</sub> × 11, 8<sup>1</sup>/<sub>4</sub> × 14☐, 8<sup>1</sup>/<sub>4</sub> × 13☐, 8 × 13☐, 8 × 10☐, 7<sup>1</sup>/<sub>4</sub> × 10<sup>1</sup>/<sub>2</sub>, 8K☐, 16K, SRA4☐, 8<sup>1</sup>/<sub>2</sub> × 13<sup>2</sup>/<sub>5</sub>☐</li> </ul> <p>With Mixed Size:</p> <ul style="list-style-type: none"> <li>• 50 sheets: A3☐/A4☐, B4 JIS☐/B5 JIS☐, 11 × 17☐/8<sup>1</sup>/<sub>2</sub> × 11☐</li> </ul>
Stack capacity after stapling (80 g/m <sup>2</sup> , 20 lb. Bond)	<p>Without Mixed Size:</p> <ul style="list-style-type: none"> <li>• 2–12 sheets: 150 sets (A4☐, 8<sup>1</sup>/<sub>2</sub> × 11☐)</li> <li>• 13–50 sheets: 150–30 sets (A4☐, 8<sup>1</sup>/<sub>2</sub> × 11☐)</li> <li>• 2–9 sheets: 100 sets (A4☐, B5 JIS, 8<sup>1</sup>/<sub>2</sub> × 11☐)</li> <li>• 10–50 sheets: 100–15 sets (A4☐, B5 JIS, 8<sup>1</sup>/<sub>2</sub> × 11☐)</li> <li>• 2–9 sheets: 100 sets (other size paper)</li> <li>• 10–50 sheets: 100–23 sets (other size paper)</li> </ul> <p>With Mixed Size:</p> <ul style="list-style-type: none"> <li>• 2–50 sheets: 23 sets (A3☐/A4☐, B4 JIS☐/B5 JIS☐, 11 × 17☐/8<sup>1</sup>/<sub>2</sub> × 11☐)</li> </ul>



Item	Specifications
Staple position	4 positions (Top, Top Slant, Bottom, 2 Staples)
Saddle stitch paper size	A3, A4, B4 JIS, B5 JIS, 11 × 17, 8 <sup>1</sup> / <sub>2</sub> × 14, 8 <sup>1</sup> / <sub>2</sub> × 11, 8 <sup>1</sup> / <sub>4</sub> × 14, 8 <sup>1</sup> / <sub>4</sub> × 13, 12 × 18, 11 × 15, 10 × 14, SRA4, 8 <sup>1</sup> / <sub>2</sub> × 13 <sup>2</sup> / <sub>5</sub> , custom size
Saddle stitch paper weight	64-105 g/m <sup>2</sup> (17-28 lb. Bond) You can use two sheets of paper weighing up to 216 g/ m <sup>2</sup> (80 lb. Cover) per set as cover sheets.
Saddle stitch capacity (80 g/m <sup>2</sup> , 20 lb. Bond)	1 set (20 sheets)
Stack capacity after saddle stitching (80 g/m <sup>2</sup> , 20 lb. Bond)	<ul style="list-style-type: none"> <li>• 2-5 sheets: approx. 30 sets</li> <li>• 6-10 sheets: approx. 15 sets</li> <li>• 11-15 sheets: approx. 10 sets</li> <li>• 16-20 sheets: approx. 5 sets</li> </ul> (Stack capacity depends on the paper type and use conditions.)
Saddle stitch position	Center 2 positions
Types of folds	Half Fold
Half fold paper size	A3, A4, B4 JIS, B5 JIS, 11 × 17, 8 <sup>1</sup> / <sub>2</sub> × 14, 8 <sup>1</sup> / <sub>2</sub> × 11, 8 <sup>1</sup> / <sub>4</sub> × 14, 8 <sup>1</sup> / <sub>4</sub> × 13, 12 × 18, 11 × 15, 10 × 14, SRA4, 8 <sup>1</sup> / <sub>2</sub> × 13 <sup>2</sup> / <sub>5</sub>
Half fold paper weight:	<ul style="list-style-type: none"> <li>• 1 sheet: 64-216 g/m<sup>2</sup> (17 lb. Bond-80 lb. Cover)</li> <li>• 2-5 sheets: 64-90 g/m<sup>2</sup> (17-24 lb. Bond)</li> </ul>
Half fold paper type	Plain 1, Plain 2, Recycled Paper, Middle Thick, Thick Paper 1, Thick Paper 2, Color Paper
Power requirements	Power is supplied from the main unit.
Maximum power consumption	64 W or less

Item	Specifications
Dimensions (W × D × H)	<ul style="list-style-type: none"> <li>657 × 613 × 960 mm (25.9 × 24.2 × 37.8 inches) (Tray is folded.)</li> <li>757 × 613 × 960 mm (29.9 × 24.2 × 37.8 inches) (Tray is extended.)</li> </ul> (the height to reach the top board)
Weight	<ul style="list-style-type: none"> <li>Approx. 56 kg (123.5 lb.) (without punch unit)</li> <li>Approx. 59 kg (130.1 lb.) (with punch unit)</li> </ul>

**Note**

- The Multi-sheet Fold function can fold a maximum of five sheets at a time.

### Specifications for Internal Finisher SR3300

Item	Specifications
Paper size	A3, A4, B4 JIS, B5 JIS, 11 × 17, 8 1/2 × 14, 8 1/2 × 13, 8 1/2 × 11, 8 1/4 × 14, 8 1/4 × 13, 7 1/4 × 10 1/2, 8K, 16K, 8 1/2 × 13 2/5, Custom Size
Paper weight	52-300 g/m <sup>2</sup> (14 lb. Bond-110 lb. Cover)
Paper sizes that can be shifted	A3, A4, B4 JIS, B5 JIS, 11 × 17, 8 1/2 × 14, 8 1/2 × 13, 8 1/2 × 11, 8 1/4 × 14, 8 1/4 × 13, 7 1/4 × 10 1/2, 8K, 16K, 8 1/2 × 13 2/5, Custom Size
Paper weight that can be shifted	64-80 g/m <sup>2</sup> (17-20 lb. Bond)
Stack capacity (80 g/m <sup>2</sup> , 20 lb. Bond)	<ul style="list-style-type: none"> <li>250 sheets or more: A4, B5 JIS, 8 1/2 × 11</li> <li>125 sheets: A3-A4, B4 JIS, 8 1/2 × 14, 11 × 17</li> </ul>
Staple paper size	A3, A4, B4 JIS, B5 JIS, 11 × 17, 8 1/2 × 14, 8 1/2 × 13, 8 1/2 × 11, 8 1/4 × 14, 8 1/4 × 13, 7 1/4 × 10 1/2, 8K, 16K, 8 1/2 × 13 2/5
Staple paper weight	64-80 g/m <sup>2</sup> (17-20 lb. Bond)
Staple capacity (80 g/m <sup>2</sup> , 20 lb. Bond)	5 sheets

Item	Specifications
Stack capacity after stapling	<ul style="list-style-type: none"> <li>• 30 sets or more: A4□, 8<sup>1</sup>/<sub>2</sub> × 11□</li> <li>• 20 sets or more: B5 JIS</li> <li>• 15 sets or more: A3□-A4□, B4 JIS□, 11 × 17□, 8<sup>1</sup>/<sub>2</sub> × 11□</li> </ul>
Staple position	Slant
Power requirements	Power is supplied from the main unit.
Maximum power consumption	30 W or less
Dimensions (W × D × H)	435 × 515 × 150 mm (17.2 × 20.3 × 6.0 inches)
Weight	Approx. 10 kg (22.1 lb.)

### Specifications for Internal Multi-Folding Unit

Item	Specifications
Types of folds	Half Fold, Letter Fold-out, Letter Fold-in, Z-fold
Half fold paper size	<ul style="list-style-type: none"> <li>• Z-fold A3□, A4□, B4 JIS□, 11 × 17□, 8<sup>1</sup>/<sub>2</sub> × 14□, 8<sup>1</sup>/<sub>2</sub> × 11□, 8K□, 8<sup>1</sup>/<sub>2</sub> × 13<sup>2</sup>/<sub>5</sub>□</li> <li>• Half Fold A3□, A4□, B4 JIS□, 11 × 17□, 8<sup>1</sup>/<sub>2</sub> × 14□, 8<sup>1</sup>/<sub>2</sub> × 11□, 8K□, 12 × 18□, SRA3□, 8<sup>1</sup>/<sub>2</sub> × 13<sup>2</sup>/<sub>5</sub>□ When only the Internal Multi-Folding unit is mounted, you cannot use the paper whose size is 12 × 18□ or SRA3□.</li> <li>• Letter Fold-out, Letter Fold-in A3□, A4□, 11 × 17□, 8<sup>1</sup>/<sub>2</sub> × 14□, 8<sup>1</sup>/<sub>2</sub> × 11□, 8<sup>1</sup>/<sub>2</sub> × 13<sup>2</sup>/<sub>5</sub>□</li> </ul>
Half fold paper weight:	64-105 g/m <sup>2</sup> (17-28 lb. Bond)

Item	Specifications
Paper weight that can be output	When only the Internal Multi-Folding unit is attached <ul style="list-style-type: none"> <li>• 52–220 g/m<sup>2</sup> (14 lb. Bond–80 lb. Cover)</li> </ul> When the Finisher is attached <ul style="list-style-type: none"> <li>• 52–300 g/m<sup>2</sup> (14 lb. Bond–110 lb. Cover)</li> </ul>
Folded paper output tray <sup>*1</sup>	Finisher SR3280, Booklet Finisher SR3290 <ul style="list-style-type: none"> <li>• Z-fold, half fold: Finisher shift tray, finisher upper tray, fold tray</li> <li>• Letter fold-out, letter fold-in: Fold tray</li> </ul> Finisher SR3260, Booklet Finisher SR3270 <ul style="list-style-type: none"> <li>• Z-fold, half fold: Finisher upper tray, fold tray</li> <li>• Letter fold-out, letter fold-in: Fold tray</li> </ul>
Power requirements	Power is supplied from the main unit.
Maximum power consumption	40 W or less
Dimensions (W × D × H)	<ul style="list-style-type: none"> <li>• 612 × 555 × 184 mm (24.1 × 21.9 × 7.3 inches): when the tray is pulled out</li> <li>• 714 × 555 × 242 mm (28.2 × 21.9 × 9.6 inches): when the tray is folded</li> <li>• 420 × 555 × 152 mm (16.6 × 21.9 × 6.0 inches): when the finisher is mounted</li> </ul>
Weight	Approx. 15 kg (33.1 lb.) or less

\*1 Specify the output tray using the Machine Features Settings.

See "General Features (System Settings)", User Guide (Full Version).

See below when [Standard] is specified as the screen type of [Settings]. The names of the setting items may differ from the [Classic] screen type.

See "Output Tray", User Guide (Full Version).

For details, see "Settings Menu Compatibility List (Classic to Standard Settings)", User Guide (Full Version).

**Note**

- The sheets are output to the folding tray of the attached finisher only in the following cases:
  - When Z-fold sheets (A3, 11 × 17) and non-fold sheets (A4 $\square$ , 8<sup>1</sup>/<sub>2</sub> × 11 $\square$ ) are output at once

- When envelopes are output
- When banner paper is output
- When only the Internal Multi-Folding unit is mounted, you cannot use the paper whose width is wider than 297 mm.
- When you output envelopes or banner paper to the fold tray with the Finisher SR3280 or Booklet Finisher SR3290 attached, an exclusive tray must be attached.

## Specifications for External Tray

Item	Specifications
Paper size	A3☐, A4, A5, A6☐, B4 JIS☐, B5 JIS, B6 JIS☐, 11 × 17☐, 8 <sup>1</sup> / <sub>2</sub> × 14☐, 8 <sup>1</sup> / <sub>2</sub> × 13☐, 8 <sup>1</sup> / <sub>2</sub> × 11, 8 <sup>1</sup> / <sub>4</sub> × 14☐, 8 <sup>1</sup> / <sub>4</sub> × 13☐, 8 × 13☐, 8 × 10☐, 7 <sup>1</sup> / <sub>4</sub> × 10 <sup>1</sup> / <sub>2</sub> , 5 <sup>1</sup> / <sub>2</sub> × 8 <sup>1</sup> / <sub>2</sub> ☐, 8K☐, 16K, 12 × 18☐, 11 × 15☐, 10 × 14☐, SRA3☐, SRA4, 8 <sup>1</sup> / <sub>2</sub> × 13 <sup>2</sup> / <sub>5</sub> ☐, custom size
Paper weight	52–300 g/m <sup>2</sup> (14 lb. Bond–110 lb. Cover)
Paper capacity (80 g/m <sup>2</sup> , 20 lb. Bond)	Internal tray 1: <ul style="list-style-type: none"> <li>• 250 sheets: A4, 8<sup>1</sup>/<sub>2</sub> × 11 or smaller</li> <li>• 125 sheets: B4 JIS, 8<sup>1</sup>/<sub>2</sub> × 14 or larger</li> </ul> External tray: 125 sheets
Power requirements	Power is supplied from the main unit.
Maximum power consumption	12 W or less
Dimensions (W × D × H)	800 × 549 × 156 mm (31.5 × 21.7 × 6.2 inches)
Weight	Approx. 4 kg (8.9 lb.)

## Specifications for Internal Shift Tray

Item	Specifications
Paper size	A3, A4, A5, A6, B4 JIS, B5 JIS, B6 JIS, 11 × 17, 8½ × 14, 8½ × 13, 8½ × 11, 8¼ × 14, 8¼ × 13, 8 × 13, 8 × 10, 7¼ × 10½, 5½ × 8½, 4⅛ × 9½, 3⅞ × 7½, C5 Env, C6 Env, DL Env, 8K, 16K, 12 × 18, 11 × 15, 10 × 14, SRA3, SRA4, 8½ × 13⅖, custom size
Paper weight	52-300 g/m <sup>2</sup> (14 lb. Bond-110 lb. Cover)
Paper sizes that can be shifted	A3, A4, A5, B4 JIS, B5 JIS, 11 × 17, 8½ × 14, 8½ × 13, 8½ × 11, 8¼ × 14, 8¼ × 13, 8 × 13, 8 × 10, 7¼ × 10½, 5½ × 8½, 8K, 16K, 11 × 15, 10 × 14, SRA4, 8½ × 13⅖, custom size
Paper weight that can be shifted	60-300 g/m <sup>2</sup> (16 lb. Bond-110 lb. Cover)
Stack capacity (80 g/m <sup>2</sup> , 20 lb. Bond)	<ul style="list-style-type: none"> <li>• 250 sheets: A4, 8½ × 11 or smaller</li> <li>• 125 sheets: B4 JIS, 8½ × 14 or larger</li> </ul>
Power requirements	Power is supplied from the main unit.
Maximum power consumption	5 W or less
Dimensions (W × D × H)	420 × 489 × 107 mm (16.6 × 19.3 × 4.3 inches)
Weight	Approx. 2 kg (4.5 lb.)

## Specifications for Internal Tray 2

Item	Specifications
Number of bins:	1
Paper size	A3, A4, A5, A6, B4 JIS, B5 JIS, B6 JIS, 11 × 17, 8 <sup>1</sup> / <sub>2</sub> × 14, 8 <sup>1</sup> / <sub>2</sub> × 13, 8 <sup>1</sup> / <sub>2</sub> × 11, 8 <sup>1</sup> / <sub>4</sub> × 14, 8 <sup>1</sup> / <sub>4</sub> × 13, 8 × 13, 8 × 10, 7 <sup>1</sup> / <sub>4</sub> × 10 <sup>1</sup> / <sub>2</sub> , 5 <sup>1</sup> / <sub>2</sub> × 8 <sup>1</sup> / <sub>2</sub> , 8K, 16K, 12 × 18, 11 × 15, 10 × 14, SRA3, SRA4, 8 <sup>1</sup> / <sub>2</sub> × 13 <sup>2</sup> / <sub>5</sub> , custom size
Paper weight	52-300 g/m <sup>2</sup> (14 lb. Bond-110 lb. Cover)
Stack capacity (80 g/m <sup>2</sup> , 20 lb. Bond)	125 sheets
Power requirements	Power is supplied from the main unit.
Maximum power consumption	1 W or less
Dimensions (W × D × H)	444 × 450 × 150 mm (17.5 × 17.8 × 6.0 inches)
Weight	Approx. 2 kg (4.5 lb.)

## Specifications for Bridge Unit

Item	Specifications
Stack capacity	<ul style="list-style-type: none"> <li>• 250 sheets: A4, 8<sup>1</sup>/<sub>2</sub> × 11 or smaller</li> <li>• 125 sheets: B4 JIS, 8<sup>1</sup>/<sub>2</sub> × 14 or larger</li> </ul>
Power requirements	Power is supplied from the main unit.
Maximum power consumption	1.2 W or less
Dimensions (W × D × H)	412 × 466 × 143 mm (16.3 × 18.4 × 5.7 inches)
Weight	Approx. 4 kg (8.9 lb.)

## Specifications for Punch Unit (Internal Finisher SR3250)

Punch unit type	Paper size	Paper weight
2 & 4 holes type: 2 holes	☐: A3, A4, B4 JIS, B5 JIS, 11 × 17, 8 <sup>1</sup> / <sub>2</sub> × 14, 8 <sup>1</sup> / <sub>2</sub> × 13, 8 <sup>1</sup> / <sub>2</sub> × 11, 7 <sup>1</sup> / <sub>4</sub> × 10 <sup>1</sup> / <sub>2</sub> , 8K, 16K, 8 <sup>1</sup> / <sub>2</sub> × 13 <sup>2</sup> / <sub>5</sub>	60–169 g/m <sup>2</sup> (16 lb. Bond –90 lb. Index)
2 & 4 holes type: 2 holes	☐: A4, B5 JIS, 8 <sup>1</sup> / <sub>2</sub> × 11, 16K	
2 & 4 holes type: 4 holes	☐: A3, 11 × 17	
2 & 4 holes type: 4 holes	☐: A4, 8 <sup>1</sup> / <sub>2</sub> × 11	
4 holes type: 4 holes	☐: A3, A4, B4 JIS, B5 JIS, 11 × 17, 8 <sup>1</sup> / <sub>2</sub> × 14, 8 <sup>1</sup> / <sub>2</sub> × 13, 8 <sup>1</sup> / <sub>2</sub> × 11, 7 <sup>1</sup> / <sub>4</sub> × 10 <sup>1</sup> / <sub>2</sub> , 8 <sup>1</sup> / <sub>2</sub> × 13 <sup>2</sup> / <sub>5</sub>	
4 holes type: 4 holes	☐: A4, B5 JIS, 8 <sup>1</sup> / <sub>2</sub> × 11	
2 & 3 holes type: 2 holes	☐: A3, 11 × 17, 8 <sup>1</sup> / <sub>2</sub> × 14, 8 <sup>1</sup> / <sub>2</sub> × 13, 8 <sup>1</sup> / <sub>2</sub> × 11, 7 <sup>1</sup> / <sub>4</sub> × 10 <sup>1</sup> / <sub>2</sub> , 8 <sup>1</sup> / <sub>2</sub> × 13 <sup>2</sup> / <sub>5</sub>	
2 & 3 holes type: 2 holes	☐: A4, 8 <sup>1</sup> / <sub>2</sub> × 11	
2 & 3 holes type: 3 holes	☐: A3, 11 × 17	
2 & 3 holes type: 3 holes	☐: A4, 8 <sup>1</sup> / <sub>2</sub> × 11	



## Specifications for Punch Unit (Finisher SR3260, Booklet Finisher SR3270)

Punch unit type	Paper size	Paper weight
2 & 4 holes type: 2 holes	☐: A3, B4 JIS, A4, B5 JIS, A5, 11 × 17, 8 <sup>1</sup> / <sub>2</sub> × 14, 8 <sup>1</sup> / <sub>2</sub> × 11, 5 <sup>1</sup> / <sub>2</sub> × 8 <sup>1</sup> / <sub>2</sub> , 7 <sup>1</sup> / <sub>4</sub> × 10 <sup>1</sup> / <sub>2</sub> , 8 × 13, 8 <sup>1</sup> / <sub>2</sub> × 13, 8 <sup>1</sup> / <sub>4</sub> × 13, 8K, 16K, 8 <sup>1</sup> / <sub>4</sub> × 14, 8 × 10, 11 × 15, 10 × 14, 8 <sup>1</sup> / <sub>2</sub> × 13 <sup>2</sup> / <sub>5</sub>	52–256 g/m <sup>2</sup> (14 lb. Bond–140 lb. Index)
2 & 4 holes type: 2 holes	☐: A4, B5 JIS, A5, 8 <sup>1</sup> / <sub>2</sub> × 11, 7 <sup>1</sup> / <sub>4</sub> × 10 <sup>1</sup> / <sub>2</sub> , 16K	
2 & 4 holes type: 4 holes	☐: A3, B4 JIS, 11 × 17, 11 × 15, 8K	
2 & 4 holes type: 4 holes	☐: A4, B5 JIS, 8 <sup>1</sup> / <sub>2</sub> × 11, 7 <sup>1</sup> / <sub>4</sub> × 10 <sup>1</sup> / <sub>2</sub> , 16K	
4 holes type: 4 holes	☐: A3, B4 JIS, A4, B5 JIS, A5, 11 × 17, 8 <sup>1</sup> / <sub>2</sub> × 14, 8 <sup>1</sup> / <sub>2</sub> × 11, 5 <sup>1</sup> / <sub>2</sub> × 8 <sup>1</sup> / <sub>2</sub> , 7 <sup>1</sup> / <sub>4</sub> × 10 <sup>1</sup> / <sub>2</sub> , 8 × 13, 8 <sup>1</sup> / <sub>2</sub> × 13, 8 <sup>1</sup> / <sub>4</sub> × 13, 8K, 16K, 8 <sup>1</sup> / <sub>4</sub> × 14, 8 × 10, 11 × 15, 10 × 14, 8 <sup>1</sup> / <sub>2</sub> × 13 <sup>2</sup> / <sub>5</sub>	
4 holes type: 4 holes	☐: A4, B5 JIS, A5, 8 <sup>1</sup> / <sub>2</sub> × 11, 7 <sup>1</sup> / <sub>4</sub> × 10 <sup>1</sup> / <sub>2</sub> , 16K	
2 & 3 holes type: 2 holes	☐: A3, B4 JIS, B5 JIS, A5, 11 × 17, 8 <sup>1</sup> / <sub>2</sub> × 14, 8 <sup>1</sup> / <sub>2</sub> × 11, 5 <sup>1</sup> / <sub>2</sub> × 8 <sup>1</sup> / <sub>2</sub> , 7 <sup>1</sup> / <sub>4</sub> × 10 <sup>1</sup> / <sub>2</sub> , 8 × 13, 8 <sup>1</sup> / <sub>2</sub> × 13, 8 <sup>1</sup> / <sub>4</sub> × 13, 8K, 16K, 8 <sup>1</sup> / <sub>4</sub> × 14, 8 × 10, 11 × 15, 10 × 14, 8 <sup>1</sup> / <sub>2</sub> × 13 <sup>2</sup> / <sub>5</sub>	
2 & 3 holes type: 2 holes	☐: A4, B5 JIS, 8 <sup>1</sup> / <sub>2</sub> × 11, 7 <sup>1</sup> / <sub>4</sub> × 10 <sup>1</sup> / <sub>2</sub> , 16K	
2 & 3 holes type: 3 holes	☐: A3, B4 JIS, 11 × 17, 11 × 15, 10 × 14, 8K	
2 & 3 holes type: 3 holes	☐: A4, B5 JIS, 8 <sup>1</sup> / <sub>2</sub> × 11, 7 <sup>1</sup> / <sub>4</sub> × 10 <sup>1</sup> / <sub>2</sub> , 16K	

## Specifications for Punch Unit (Finisher SR3280, Booklet Finisher SR3290)

Punch unit type	Paper size	Paper weight
2 & 4 holes type: 2 holes	☐: A3, B4 JIS, A4, B5 JIS, A5, $11 \times 17$ , $8\frac{1}{2} \times 14$ , $8\frac{1}{2} \times 11$ , $5\frac{1}{2} \times 8\frac{1}{2}$ , $7\frac{1}{4} \times 10\frac{1}{2}$ , $8 \times 13$ , $8\frac{1}{2} \times 13$ , $8\frac{1}{4} \times 13$ , 8K, 16K, $8\frac{1}{4} \times 14$ , $8 \times 10$ , $11 \times 15$ , $10 \times 14$ , $8\frac{1}{2} \times 13\frac{2}{5}$ , custom size	52–256 g/m <sup>2</sup> (14 lb. Bond–140 lb. Index)
2 & 4 holes type: 2 holes	☐: A4, B5 JIS, A5, $8\frac{1}{2} \times 11$ , $7\frac{1}{4} \times 10\frac{1}{2}$ , 16K, custom size	
2 & 4 holes type: 4 holes	☐: A3, B4 JIS, $11 \times 17$ , $11 \times 15$ , 8K, custom size	
2 & 4 holes type: 4 holes	☐: A4, B5 JIS, $8\frac{1}{2} \times 11$ , $7\frac{1}{4} \times 10\frac{1}{2}$ , 16K, custom size	
4 holes type: 4 holes	☐: A3, B4 JIS, A4, B5 JIS, A5, $11 \times 17$ , $8\frac{1}{2} \times 14$ , $8\frac{1}{2} \times 11$ , $5\frac{1}{2} \times 8\frac{1}{2}$ , $7\frac{1}{4} \times 10\frac{1}{2}$ , $8 \times 13$ , $8\frac{1}{2} \times 13$ , $8\frac{1}{4} \times 13$ , 8K, 16K, $8\frac{1}{4} \times 14$ , $8 \times 10$ , $11 \times 15$ , $10 \times 14$ , $8\frac{1}{2} \times 13\frac{2}{5}$ , custom size	
4 holes type: 4 holes	☐: A4, B5 JIS, A5, $8\frac{1}{2} \times 11$ , $7\frac{1}{4} \times 10\frac{1}{2}$ , 16K, custom size	
2 & 3 holes type: 2 holes	☐: A3, B4 JIS, B5 JIS, A5, $11 \times 17$ , $8\frac{1}{2} \times 14$ , $8\frac{1}{2} \times 11$ , $5\frac{1}{2} \times 8\frac{1}{2}$ , $7\frac{1}{4} \times 10\frac{1}{2}$ , $8 \times 13$ , $8\frac{1}{2} \times 13$ , $8\frac{1}{4} \times 13$ , 8K, 16K, $8\frac{1}{4} \times 14$ , $8 \times 10$ , $11 \times 15$ , $10 \times 14$ , $8\frac{1}{2} \times 13\frac{2}{5}$ , custom size	
2 & 3 holes type: 2 holes	☐: A4, B5 JIS, $8\frac{1}{2} \times 11$ , $7\frac{1}{4} \times 10\frac{1}{2}$ , 16K, custom size	
2 & 3 holes type: 3 holes	☐: A3, B4 JIS, $11 \times 17$ , $11 \times 15$ , $10 \times 14$ , 8K, custom size	
2 & 3 holes type: 3 holes	☐: A4, B5 JIS, $8\frac{1}{2} \times 11$ , $7\frac{1}{4} \times 10\frac{1}{2}$ , 16K, custom size	

## Specifications for Lower Paper Tray

Item	Specifications
Page size	page 194 "Recommended Paper Sizes and Types"
Paper capacity	page 194 "Recommended Paper Sizes and Types"
Paper weight	page 194 "Recommended Paper Sizes and Types"
Power requirements	Power is supplied from the main unit.
Maximum power consumption	19 W or less
Dimensions (W × D × H)	587 × 685 × 120 mm (23.2 × 27.0 × 4.8 inches)
Weight	Approx. 12 kg (26.5 lb.)

## Specifications for Lower Paper Trays

Item	Specifications
Page size	page 194 "Recommended Paper Sizes and Types"
Paper capacity (80 g/m <sup>2</sup> , 20 lb. Bond)	page 194 "Recommended Paper Sizes and Types"
Paper weight	page 194 "Recommended Paper Sizes and Types"
Power requirements	Power is supplied from the main unit.
Maximum power consumption	21 W or less
Dimensions (W × D × H)	587 × 685 × 247 mm (23.2 × 27.0 × 9.8 inches)
Weight	Approx. 23 kg (50.8 lb.)

### Specifications for Tray 3 (LCT)

Item	Specifications
Page size	page 194 "Recommended Paper Sizes and Types"
Paper capacity (80 g/m <sup>2</sup> , 20 lb. Bond)	page 194 "Recommended Paper Sizes and Types"
Paper weight	page 194 "Recommended Paper Sizes and Types"
Power requirements	Power is supplied from the main unit.
Maximum power consumption	15 W or less
Dimensions (W × D × H)	<ul style="list-style-type: none"> <li>• Except stabilizers 587 × 685 × 247 mm (23.2 × 27.0 × 9.8 inches)</li> <li>• With stabilizers 670 × 755 × 247 mm (26.4 × 29.8 × 9.8 inches)</li> </ul>
Weight	Approx. 22 kg (48.5 lb.)

### Specifications for Large Capacity Tray (LCT)

Item	Specifications
Page size	page 194 "Recommended Paper Sizes and Types"
Paper capacity (80 g/m <sup>2</sup> , 20 lb. Bond)	page 194 "Recommended Paper Sizes and Types"
Paper weight	page 194 "Recommended Paper Sizes and Types"
Power requirements	Power is supplied from the main unit.
Maximum power consumption	13 W or less
Dimensions (W × D × H)	340 × 544.5 × 290 mm (13.4 × 21.4 × 11.5 inches)
Weight	Approx. 11 kg (24.3 lb.)

## Specifications for IEEE 1284 Interface Board

Item	Specifications
Transmission spec	IEEE 1284
Required cable	Standard IEEE 1284 compliant Micro Centronics 36 pin cable

## Specifications for Wireless LAN Board

### ★ Important

- Note that the available channels (frequency ranges) and locations to use the wireless LAN are subject to the regulations of the country or region where the printer is used. Be sure to use the wireless LAN according to the applicable regulations.

Item	Specifications
Transmission spec	Based on IEEE 802.11a/b/g/n (wireless LAN)
Protocol	TCP/IP
Transmission rate	2.4 GHz band: 1–130 Mbps
Frequency range (Center Frequency)	2412–2472 MHz (1–13 channels)
Ad-hoc mode Channel Frequency range (Center Frequency)	2412–2462 MHz (1–11 channels)
Transmission mode	<ul style="list-style-type: none"> <li>• Ad-hoc mode</li> <li>• Infrastructure mode</li> <li>• Direct Connection Mode</li> <li>• Direct Connection: Group Owner Mode</li> </ul>

### ↓ Note

- Web Image Monitor is supported.
- The transmission rates of 130 Mbps in the 2.4 GHz band is the theoretical values of the wireless LAN specification. The actual transmission rate may be lower, depending on the operating environment.

- The maximum transmission rate in the ad-hoc mode is 11 Mbps for IEEE802.11b. The Ad-hoc communication is not supported in an IEEE802.11g/n environment.
- Channels other than 1–11 cannot be used because of the specifications and the configuration of the access point.
- The channel in use might differ depending on the country.

---

## Specifications for Device Server Option

---

Item	Specifications
Interface	<ul style="list-style-type: none"> <li>• Gigabit Ethernet (10BASE-T/100BASE-TX/1000BASE-T)</li> </ul>
Operating systems	<ul style="list-style-type: none"> <li>• Windows 7/8.1/10, Windows Server 2008/2008 R2/2012/2012 R2/2016</li> <li>• OS X 10.11 or later</li> </ul>
Protocol	<ul style="list-style-type: none"> <li>• Port 9100, IPP, LPR IPP does not support SPL.</li> <li>• The device server option allows simultaneous connection of up to eight sessions of printing protocols.</li> </ul>

# The Setting Values of the Transmission Function

## ↓ Note

- Depending on the type or settings of a document or original, you may not be able to specify or enter the maximum number of destinations or characters.

## Send Email

Item	Value	Remarks
Maximum number of characters entered in a subject	128 alphanumeric characters	-
Maximum number of characters entered in the an e-mail message	<ul style="list-style-type: none"> <li>When selecting an item from the destination list in the address book: 380 alphanumeric characters (76 alphanumeric characters × 5 lines)</li> <li>When entering manually: 76 alphanumeric characters</li> </ul>	You cannot select an item from the destination list in the address book and enter the value manually at the same time.
Maximum number of characters entered in an e-mail address	128 alphanumeric characters	An e-mail; address that has been searched from the LDAP server and exceeds 128 alphanumeric characters cannot be specified correctly as the destination.
Number of destinations that can be specified at one time	500	Up to 100 items can be specified when entering an item manually (including the items specified by LDAP search) For the rest, select up to 400 items from the registered destinations.
Size of a document that can be sent	Up to 700 MB per document	-
Number of pages that can be sent	Up to 2,000 pages per document	-

## Send to Folder

Item	Value	Remarks
Maximum number of characters in a path name specified for the SMB protocol	256 characters	-
Maximum number of characters in a user name specified for the SMB protocol	64 characters	-
Maximum number of characters in a password specified for the SMB protocol	64 characters	-
Maximum number of characters in a server name specified for the FTP protocol	64 characters	-
Maximum number of characters in a path name specified for the FTP protocol	256 characters	-
Maximum number of characters in a user name specified for the FTP protocol	64 alphanumeric characters	-
Maximum number of characters in a password specified for the FTP protocol	64 alphanumeric characters	-
Number of destinations that can be specified at one time	50	Up to 50 items can be entered also when entering the items manually.
Size of a document that can be sent	2,000 MB per document	-



## Broadcast Transmission

Item	Value	Remarks
Total number of destinations that can be specified for Send Email and Send to Folder	550	-
Number of destinations that can be specified when sending a document by Send Email	500	Up to 100 items can be specified when entering an item manually (including the items specified by LDAP search)
Number of destinations that can be specified when sending a document by Send to Folder	50	-

## Printable Area and Margin

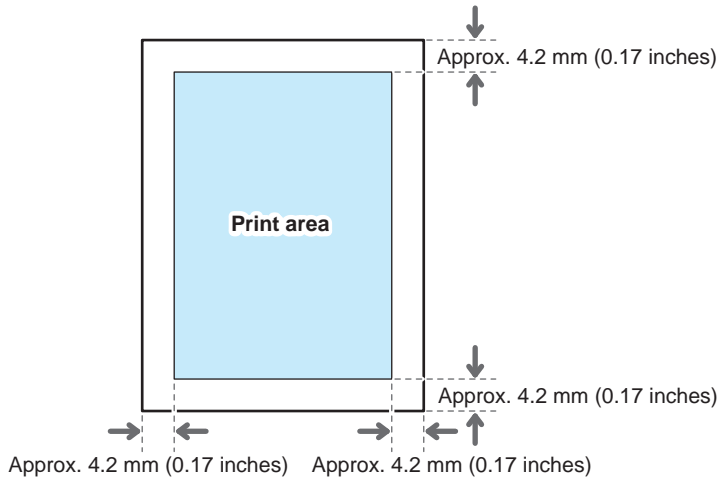

### Note

- The machine does not support edge-to-edge printing. To minimize the margins, specify the maximum printable area with the settings on the printer driver.
- See "Maximizing the Printable Area When Printing", User Guide (Full Version).
- The maximum width of the printable area perpendicular to the feeding direction is 305 mm (12.1 inches). When an optional Image Area Extension Unit is mounted, the maximum width of the printable area can be extended to 316 mm (12.5 inches). Printing starts from the upper left corner of the paper in relation to the feed direction. Accordingly, the right and bottom edges of an image will be cropped if the width of the image exceeds the maximum width of a printable area.

10

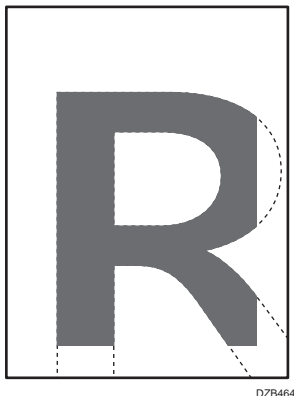

- The printable area may vary due to the paper size or settings of the printer driver.

- The outside of the printable area can be printed due to the settings of the printer driver or printing condition; however, the print result may be different from the intended one or the paper may not be fed correctly.

# Machine Options

## Guide to Functions of the Machine's External Options

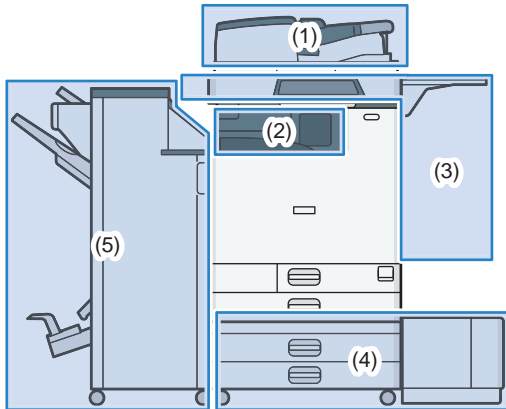

DZB770

### (1) Options Mounted to the Scanner Unit

**Region A** (mainly Europe)

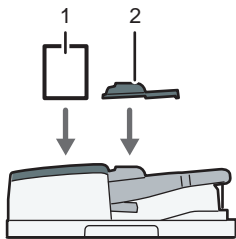

DZC771

10

No.	Option	Description
1	ADF double-feed detection kit	Detects a double feeding of the original when it is placed in the ADF.
2	Small size paper unit	Used to scan an original smaller than B6 JIS size with the one-pass duplex scanning ADF.

**Region B** (mainly North America)

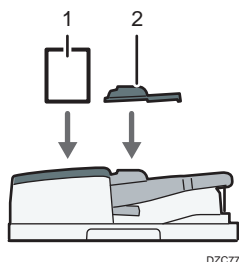

DZC771

No.	Option	Description
1	ADF double-feed detection kit	Detects a double feeding of the original when it is placed in the ADF.
2	Small size paper unit	Used to scan an original smaller than B6 JIS <sup>□</sup> size with the one-pass duplex scanning ADF.

 **Region A** (mainly Asia)

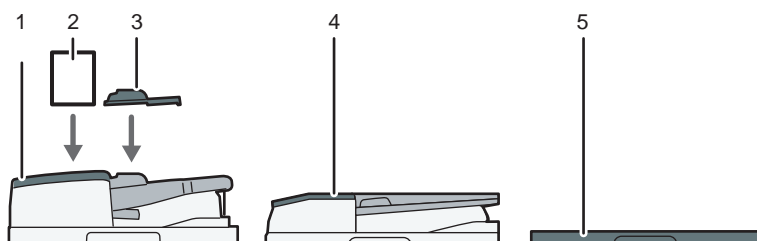

DZC772

No.	Option	Description
1	One-pass duplex scanning ADF *1	Feeds the loaded originals to the exposure glass one by one.
2	ADF double-feed detection kit	Detects a double feeding of the original when it is placed in the ADF.
3	Small size paper unit	Used to scan an original smaller than B6 JIS <sup>□</sup> size with the one-pass duplex scanning ADF.
4	ARDF*2	Feeds the loaded originals to the exposure glass one by one.
5	Exposure Glass Cover *2	Lowers the cover over originals placed on the exposure glass.

\*1 IM C4500/C6000 is attached as standard.

\*2 This cannot be mounted to IM C4500/C6000.

**(2) Options Mounted to the Machine's Paper Output Section**

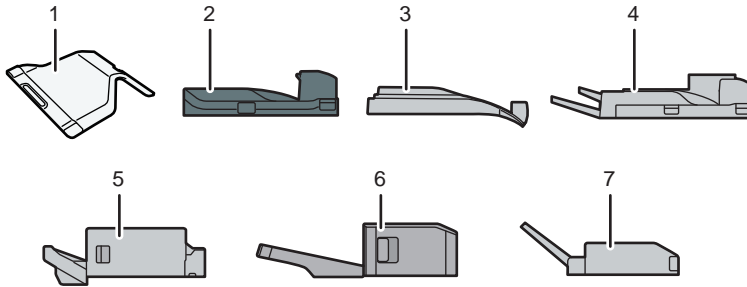

DZB772

No.	Option	Description
1	Internal Tray 2	Specify the output tray for the function, such as Copy or Fax, added to the Internal Tray 1. When you use this tray together with the optional external tray, you can specify up to three output trays. Copied/printed paper or fax messages are delivered here face down.
2	Bridge Unit	Relays the main unit and finisher.
3	Internal Shift Tray	Sorts and stacks multiple sheets of paper for each set or each job. page 85 "Copying in Page Order or for Each Page Number" See "Sorting Printed Sheets by Individual Copies", User Guide (Full Version).
4	External Tray	Specify the output tray for the function, such as Copy or Fax, added to the Internal Tray 1. When you use this tray together with the optional Internal Tray 2, you can specify up to three output trays. Copied/printed paper or fax messages are delivered here face down.
5	Internal Finisher SR3250 *1	Sorts, stacks, and staples multiple sheets of paper. Copies can be punched if the optional punch unit is installed on the finisher.
6	Internal Finisher SR3300 *2	Shifts, sorts, stacks, and staples multiple sheets of paper with a stapleless stapler.
7	Internal Multi-Folding unit *3	Folds the printed paper in half fold, letter fold-in, letter fold-out, or Z-fold. See "Folding Printed Sheets", User Guide (Full Version).

- \*1 This cannot be mounted to IM C6000 series.
- \*2 This cannot be mounted to IM C4500/C5500/C6000 series.
- \*3 This cannot be mounted to IM C2000/C2500 series.

### (3) Options Mounted on the Machine's Side Panel

#### Region A (mainly Europe and Asia)

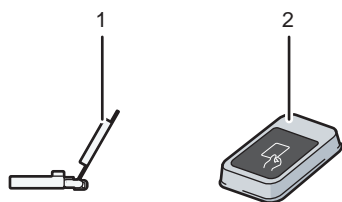

DZC775

No.	Option	Description
1	Banner Paper Guide Tray	Banner paper is loaded here. page 179 "Loading Paper into the Paper Tray"
2	Card reader	Pass an IC card over the card reader to log in to the machine. page 51 "Logging In from the Control Panel"

#### Region B (mainly North America)

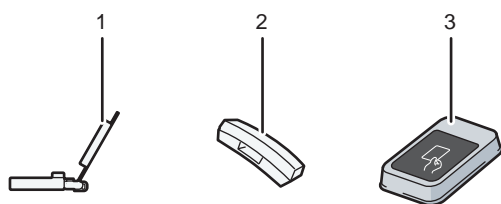

DZC773

No.	Option	Description
1	Banner Paper Guide Tray	Banner paper is loaded here. page 179 "Loading Paper into the Paper Tray"
2	Handset	Used as a receiver when a fax unit is installed and enables you to use the machine as a telephone. Allows you to use the On Hook Dial and Manual Dial functions. See "Confirming a Dial Tone or Voice of a Person at the Destination Before Sending or Receiving a Fax", User Guide (Full Version).

No.	Option	Description
3	Card reader	Pass an IC card over the card reader to log in to the machine. page 51 "Logging In from the Control Panel"

**(4) Options Mounted on the Machine's Bottom**

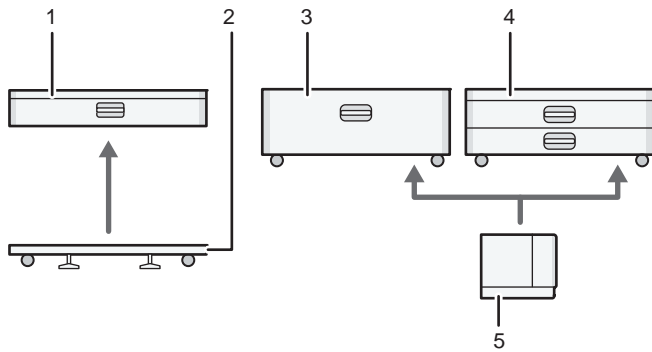

DZC774

No.	Option	Description
1	Lower Paper Tray	Paper is loaded here. You can load up to 590 sheets of paper.
2	Caster Table for Lower Paper Tray	To use the lower paper tray, attach the caster table. Allows you to move the machine easily.
3	Tray 3 (LCT) *1	Consists of two paper trays, right and left, for A4 size paper. You can load up to 2,150 sheets of paper.
4	Lower Paper Trays	Consists of two paper trays. You can load up to 1,180 sheets of paper.
5	Large Capacity Tray (LCT) *1	Paper tray for A4 size paper. You can load up to 1,600 sheets of paper.

\*1 The Tray 3 (LCT) and Large Capacity Tray (LCT) cannot be mounted to IM C2500/C2000 series.

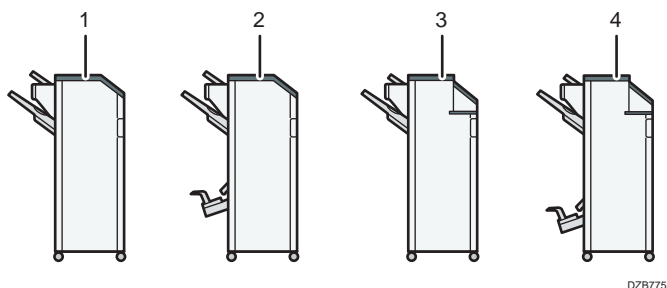

**(5) Finisher**

DZB775

No.	Option	Description
1	Finisher SR3260*1	<p>Sorts, stacks, and staples multiple sheets of paper.</p> <p>Copies can be punched if the optional punch unit is installed on the finisher.</p> <p>Consists of the following paper trays:</p> <ul style="list-style-type: none"> <li>• Finisher Upper Tray</li> <li>• Finisher Shift Tray</li> </ul>
2	Booklet Finisher SR3270	<p>Sorts, stacks, and staples multiple sheets of paper. The saddle stitch function can staple multiple sheets of paper in the center and fold them into booklets.</p> <p>See "Folding Printed Sheets", User Guide (Full Version).</p> <p>Consists of the following paper trays:</p> <ul style="list-style-type: none"> <li>• Finisher Upper Tray</li> <li>• Finisher Shift Tray</li> <li>• Finisher Booklet Tray</li> </ul> <p>Copies can be punched if the optional punch unit is installed on the finisher.</p>
3	Finisher SR3280*2	<p>Sorts, stacks, and staples multiple sheets of paper. Copies can be punched if the optional punch unit is installed on the finisher.</p> <p>Consists of the following paper trays:</p> <ul style="list-style-type: none"> <li>• Finisher Upper Tray</li> <li>• Finisher Shift Tray</li> </ul>

No.	Option	Description
4	Booklet Finisher SR3290 <sup>*2</sup>	<p>Sorts, stacks, and staples multiple sheets of paper. The saddle stitch function can staple multiple sheets of paper in the center and fold them into booklets, and copies can be punched</p> <p>See "Folding Printed Sheets", User Guide (Full Version).</p> <p>Consists of the following paper trays:</p> <ul style="list-style-type: none"> <li>• Finisher Upper Tray</li> <li>• Finisher Shift Tray</li> <li>• Finisher Booklet Tray</li> </ul>

\*1 The Finisher SR3260 cannot be mounted to IM C2500/C2000 series.

\*2 The Finisher SR3280 and Booklet Finisher SR3290 cannot be mounted to IM C3500/C3000/C2500/C2000 series.



#### Note

- You cannot install multiple finishers simultaneously.
- To mount the Finisher SR3260, Booklet Finisher SR3270, Finisher SR3280, or Booklet Finisher SR3290, one of the lower paper trays, or tray 3 (LCT) and the bridge unit or Internal Multi-Folding unit must be mounted.

## Guide to Functions of the Machine's Internal Options

- Fax unit  
Allows you to use the facsimile function.
- Extra G3 interface unit  
This lets you add a G3 fax line. A maximum of two G3 interface units can be installed.
- Expansion Memory  
Provides 60 MB of additional memory for the facsimile function. (Standard 4 MB)  
This allows you to send and receive fax documents at high resolution (Super Fine), and also to receive fax documents at high resolution (Fine). This enables you to increase the number of sheets of originals that can be stored in memory.
- PostScript 3 unit  
Allows you to output using Genuine Adobe PostScript 3.
- PCL card  
Allows you to output using PCL 6 (PCL XL/PCL 5c).
- OCR unit

Recognizes the scanned originals optically, and creates a PDF with the text data embedded.

- IPDS unit <sup>\*1</sup>  
Allows you to print using Intelligent Printer Data Stream (IPDS).
- XPS card  
Allows you to directly output XPS files.
- PictBridge card  
Allows you to directly print photos taken with a PictBridge-compatible digital camera.
- Device server option  
Allows you to add an Ethernet port to the printer. Allows you to print using the printer function via a network other than that connected to the machine.
- IEEE 1284 interface board  
Allows you to connect to an IEEE 1284 cable.
- Wireless LAN board  
Allows you to communicate over wireless LAN.
- File format converter  
Allows you to download documents that are stored in the Document Server to the computer.
- Enhanced Security HDD (  Region **A** (mainly Europe)/  Region **B** (mainly North America))  
Allows you to enhance the security of the hard disk by using an encryption function that is compliant with FIPS 140-2.
- Fax connection unit  
Allows you to send and receive faxes via a different machine that has the fax unit installed.
- VM card  
Allows you to install applications compatible with the "Embedded Software Architecture" platform.  
To expand the function of this machine, various applications written in Java language can be added.
- Extra memory module  
Adds 4 GB of additional memory.

\*1 IM C4500/C5500/C6000 series only

#### Note

- Only one of the following can be installed: IEEE 1284 interface board, wireless LAN board, file format converter, or device server option.
- Only one of the following options can be installed on the machine at any one time: HDD and Enhanced Security HDD.
- The Ethernet interface and wireless LAN board cannot be used simultaneously.





## Functions Requiring Optional Configurations

When options are installed, the functions and interface of this machine can be expanded.

- The options that can be installed differ depending on the models.

page 366 "Machine Options"

### Copy Function



Function/Reference	Option
 Region A Batch See "Copying a Separately Scanned Original as a Single Document", User Guide (Full Version).	 Region A ADF
 Region A SADF See "Copying a Separately Scanned Original as a Single Document", User Guide (Full Version).	
 Region A Mixed Sizes mode See "Coping Mixed-size Originals", User Guide (Full Version).	
Shift Collate page 85 "Copying in Page Order or for Each Page Number"	One of the following options is required: <ul style="list-style-type: none"> <li>• Internal shift tray</li> <li>• Finisher SR3260</li> <li>• Booklet Finisher SR3270</li> <li>• Finisher SR3280</li> <li>• Booklet Finisher SR3290</li> <li>• Internal Finisher SR3250</li> <li>• Internal Finisher SR3300</li> </ul>
Stack page 85 "Copying in Page Order or for Each Page Number"	



Function/Reference	Option
<p>Staple</p> <p>See "Stapling Copied Pages", User Guide (Full Version).</p>	<p>One of the following options is required:</p> <ul style="list-style-type: none"> <li>• Finisher SR3260</li> <li>• Booklet Finisher SR3270</li> <li>• Finisher SR3280</li> <li>• Booklet Finisher SR3290</li> <li>• Internal Finisher SR3250</li> <li>• Internal Finisher SR3300</li> </ul>
<p>Staple (Center)</p> <p>See "Stapling Copied Pages", User Guide (Full Version).</p>	<p>One of the following options is required:</p> <ul style="list-style-type: none"> <li>• Booklet Finisher SR3270</li> <li>• Booklet Finisher SR3290</li> </ul>
<p>Half Fold</p> <p>See "Folding Copied Sheets", User Guide (Full Version).</p>	
<p>Punch</p> <p>See "Punching Holes on the Copied Pages", User Guide (Full Version).</p>	<p>One of the following combinations of options is required:</p> <ul style="list-style-type: none"> <li>• Finisher SR3260 and punch unit</li> <li>• Booklet Finisher SR3270 and punch unit</li> <li>• Finisher SR3280</li> <li>• Booklet Finisher SR3290</li> <li>• Internal Finisher SR3250 and punch unit</li> </ul>

Function/Reference	Option
Z-fold See "Folding Copied Sheets", User Guide (Full Version).	Internal Multi-Folding unit
Half Fold See "Folding Copied Sheets", User Guide (Full Version).	
Letter Fold-out See "Folding Copied Sheets", User Guide (Full Version).	
Letter Fold-in See "Folding Copied Sheets", User Guide (Full Version).	

## Facsimile Functions

Fax functions require the optional fax unit.

Functions	Option
 Manual Dial See "Confirming a Dial Tone or Voice of a Person at the Destination Before Sending or Receiving a Fax", User Guide (Full Version).	 Handset
 Manual Reception See "Answering a Phone Call on the Machine", User Guide (Full Version).	

Functions	Option
<p> <b>Region A</b></p> <p>Two-sided Original See "Setting an Original to Send by Fax on the Scanner", User Guide (Full Version).</p>	<p> <b>Region A</b></p> <p>ADF</p>
<p> <b>Region A</b></p> <p>Stamp <sup>*2</sup> See "Pressing a OK Stamp on Pages Scanned for Fax", User Guide (Full Version).</p>	
<p> <b>Region A</b></p> <p>Blank Page Detection See "Setting an Original to Send by Fax on the Scanner", User Guide (Full Version).</p>	
<p> <b>Region A</b></p> <p>Mixed Sizes mode See "Setting an Original to Send by Fax on the Scanner", User Guide (Full Version).</p>	
<p>Transmission of Super Fine resolution See "Sending a Fax at the Image Quality Suitable for the Original", User Guide (Full Version).</p>	<p>Expansion Memory</p>
<p>Reception of Fine or Super Fine resolution</p>	
<p>Transmission using the extra G3 line</p> <p>Routing received documents utilizing extra G3 lines See "Transferring Received Fax Documents to Another Fax Destination", User Guide (Full Version).</p>	<p>Extra G3 interface unit</p>

Functions	Option
<p>Specify Tray for Lines</p> <p>See "Specifying the Output Tray to Deliver the Received Page", User Guide (Full Version).</p>	<p>One of the following options is required:</p> <ul style="list-style-type: none"> <li>• Internal tray 2</li> <li>• Internal shift tray</li> <li>• External tray</li> <li>• Finisher SR3260</li> <li>• Booklet Finisher SR3270</li> <li>• Finisher SR3280</li> <li>• Booklet Finisher SR3290</li> <li>• Internal Finisher SR3250</li> <li>• Internal Finisher SR3300</li> </ul>
<p>Tray Shift</p> <p>See "Specifying the Output Tray to Deliver the Received Page", User Guide (Full Version).</p>	<p>One of the following options is required:</p> <ul style="list-style-type: none"> <li>• Internal shift tray</li> <li>• Finisher SR3260</li> <li>• Booklet Finisher SR3270</li> <li>• Finisher SR3280</li> <li>• Booklet Finisher SR3290</li> <li>• Internal Finisher SR3250</li> <li>• Internal Finisher SR3300</li> </ul>
<p>Remote Fax <sup>*1</sup></p> <p>See "Overview of the Remote Fax Function", User Guide (Full Version).</p>	<p>Fax connection unit</p>

\*1 A sub-machine on which fax function is not included can send and receive faxes using the fax function of the main-machine connected via network. This function is available when fax connection units are installed in the main- and sub-machines.

 **Region A** (mainly Asia)

\*2 The remote fax function can be used by the ARDF.









## Printer Function

Functions	Option
<p>Shift Collate</p> <p>See "Sorting Printed Sheets by Individual Copies", User Guide (Full Version).</p>	<p>One of the following options is required:</p> <ul style="list-style-type: none"> <li>• Internal shift tray</li> <li>• Finisher SR3260</li> <li>• Booklet Finisher SR3270</li> <li>• Finisher SR3280</li> <li>• Booklet Finisher SR3290</li> <li>• Internal Finisher SR3250</li> <li>• Internal Finisher SR3300</li> </ul>
<p>Punch</p> <p>See "Punching Holes on Printed Pages", User Guide (Full Version).</p>	<p>One of the following combinations of options is required:</p> <ul style="list-style-type: none"> <li>• Finisher SR3260 and punch unit</li> <li>• Booklet Finisher SR3270 and punch unit</li> <li>• Finisher SR3280</li> <li>• Booklet Finisher SR3290</li> <li>• Internal Finisher SR3250 and punch unit</li> </ul>
<p>Staple</p> <p>See "Stapling Printed Pages", User Guide (Full Version).</p>	<p>One of the following options is required:</p> <ul style="list-style-type: none"> <li>• Finisher SR3260</li> <li>• Booklet Finisher SR3270</li> <li>• Finisher SR3280</li> <li>• Booklet Finisher SR3290</li> <li>• Internal Finisher SR3250</li> <li>• Internal Finisher SR3300</li> </ul>
<p>Staple (Center)</p> <p>See "Stapling Printed Pages", User Guide (Full Version).</p>	<p>One of the following options is required:</p> <ul style="list-style-type: none"> <li>• Booklet Finisher SR3270</li> <li>• Booklet Finisher SR3290</li> </ul>
<p>Half Fold</p> <p>See "Folding Printed Sheets", User Guide (Full Version).</p>	

Functions	Option
Half Fold Letter Fold-out Letter Fold-in Z-fold See "Folding Printed Sheets", User Guide (Full Version).	Internal Multi-Folding unit
PictBridge See "Printing Photos from a Digital Camera Directly without Using a Computer (PictBridge)", User Guide (Full Version).	PictBridge card
Genuine Adobe PostScript 3 <sup>*1</sup>	PostScript 3 unit
XPS	XPS card

\*1 If an optional Genuine Adobe PostScript 3 is installed, the built-in standard PostScript 3 cannot be used.

## Scanner Function

Functions	Option
<p> <b>Region A</b></p> <p>Documents scanned automatically See "Placing an Original to Scan", User Guide (Full Version).</p>	<p> <b>Region A</b></p> <p>ADF</p>
<p> <b>Region A</b></p> <p>SADF See "Combining the Data of Multiple Scans into a Single File", User Guide (Full Version).</p>	
<p> <b>Region A</b></p> <p>Mixed Sizes mode See "Placing an Original to Scan", User Guide (Full Version).</p>	
<p> <b>Region A</b></p> <p>Stamp<sup>*1</sup> See "Pressing an OK Stamp on Pages of the Scanned Original", User Guide (Full Version).</p>	
<p> <b>Region A</b></p> <p>Blank Page Detection See "Scan Settings", User Guide (Full Version). See below when [Standard] is specified as the screen type of [Settings]. The names of the setting items may differ from the [Classic] screen type. See "Scan (Scanner Settings)", User Guide (Full Version). For details, see "Settings Menu Compatibility List (Classic to Standard Settings)", User Guide (Full Version).</p>	<p> <b>Region A</b></p> <p>ADF</p>
<p>Creating PDF files with OCR text information See "Scanning an Original as a PDF File with Embedded Text Data", User Guide (Full Version).</p>	OCR unit

 **Region A** (mainly Asia)

\*1 The stamp function can be used in the One-pass duplex scanning ADF.

\*2 The stamp function can be used by the ARDF.

---

**Interface**

---

Functions	Option
Wireless LAN communication See "Connecting to a Wireless LAN", User Guide (Full Version).	Wireless LAN board
Parallel Interface Connection See "Connecting an IEEE Cable", User Guide (Full Version).	IEEE 1284 interface board
Extra Ethernet Interface (for Printer) See "Connecting a LAN Cable", User Guide (Full Version).	Device server option

# Function Compatibility

## Function Compatibility

The chart shows Function Compatibility when [Interleave Priority] is set to [Switch Every Specified No.].

○ : Simultaneous operations are possible.

● : Operation is enabled when the relevant function key is pressed and remote switching (of the scanner/external extension) is done.

▲ : Operation is performed automatically once the preceding operation ends.

✕ : Simultaneous operations are not possible. The operation must be started once the preceding operation ends.

Mode after you select		Copy			Fax				Printer			Scanner		TWAIN		Document Server		Web Document Server		
		Operations for Copying	Stapling	Start	Transmission	Reception	Print	Scanning	Scanning	Operations for Document Server	Operations for Document Server	Printing from Document Server	Printing							
Mode before you select	Operations for Copying	○	○	○	○	○	○	○	○	○	○	○	○	○	○	○	○	○	○	○
	Stapling	○	○	○	○	○	○	○	○	○	○	○	○	○	○	○	○	○	○	○
Copy	Start	○	○	○	○	○	○	○	○	○	○	○	○	○	○	○	○	○	○	○
	Transmission Operator/Manual Reception Operation	○	○	○	○	○	○	○	○	○	○	○	○	○	○	○	○	○	○	○
	Scanning as Original for Memory Transmission	○	○	○	○	○	○	○	○	○	○	○	○	○	○	○	○	○	○	○
	Memory Transmission	○	○	○	○	○	○	○	○	○	○	○	○	○	○	○	○	○	○	○
Fax	Immediate Transmission	○	○	○	○	○	○	○	○	○	○	○	○	○	○	○	○	○	○	○
	Memory Reception	○	○	○	○	○	○	○	○	○	○	○	○	○	○	○	○	○	○	○
	Printing Received Data	○	○	○	○	○	○	○	○	○	○	○	○	○	○	○	○	○	○	○
	Data Reception	○	○	○	○	○	○	○	○	○	○	○	○	○	○	○	○	○	○	○
Printer	Print	○	○	○	○	○	○	○	○	○	○	○	○	○	○	○	○	○	○	○
	Stapling	○	○	○	○	○	○	○	○	○	○	○	○	○	○	○	○	○	○	○
	Operations for Scanning	○	○	○	○	○	○	○	○	○	○	○	○	○	○	○	○	○	○	○
Scanner	Scanning	○	○	○	○	○	○	○	○	○	○	○	○	○	○	○	○	○	○	○
	Scanning	○	○	○	○	○	○	○	○	○	○	○	○	○	○	○	○	○	○	○
TWAIN	Operations for Document Server	○	○	○	○	○	○	○	○	○	○	○	○	○	○	○	○	○	○	○
	Scanning a Document to Store in Document Server	○	○	○	○	○	○	○	○	○	○	○	○	○	○	○	○	○	○	○
Document Server	Printing from Document Server	○	○	○	○	○	○	○	○	○	○	○	○	○	○	○	○	○	○	○
	Printing	○	○	○	○	○	○	○	○	○	○	○	○	○	○	○	○	○	○	○
Web Document Server	Printing	○	○	○	○	○	○	○	○	○	○	○	○	○	○	○	○	○	○	○
	Printing	○	○	○	○	○	○	○	○	○	○	○	○	○	○	○	○	○	○	○

<sup>1</sup> You can scan a document after the preceding job documents are all scanned.  
<sup>2</sup> When you print an image that is A3 size and 4800 x 1200 dpi or bigger, printing may not start until the current print job is complete. (type A and B models only)  
<sup>3</sup> During stapling, printing automatically starts after the current job.  
<sup>4</sup> Simultaneous operations can be performed when a different line is used.  
<sup>5</sup> During parallel reception, any subsequent job is suspended until the reception is completed.  
<sup>6</sup> If an attempt is made to manually print a received document while automatically printing a different received document, the document printed manually will be printed first.  
<sup>7</sup> Simultaneous operation becomes possible after you press [New Job].

### Note

- The scanning speed may become slower when scanning an original with another function while executing printing.

# 10. Specifications for The Machine

## Copy Function Compatibility

Blank: These modes can be used together.

- : These modes cannot be used together. The second mode selected will be the mode you are working in.
- x : These modes cannot be used together. The first mode selected will be the mode you are working in.

Function selected first	Function selected second																																								
	Mixed Sizes	Regular Size Originals	Custom Size Originals	Original Orientation	Auto Image Density	Image Density (Manual)	Full Color	Black & White	Auto Color Select	Auto Paper Select	Paper Select	Bypass Tray	Auto Reduce / Enlarge	Reduce / Enlarge	Create Margin	2 Sided Original	Book Type Original	Poster	Z-Sided	Combine	Booklet	Magazine	ID Card Copy	Circle Copies	Margin Adjustment	Centering	Erase Center/Border	Erase Color	Background Numbering (Stamp) <sup>1</sup>	Unauthorized Copy Prevention	Sort	Rotate Sort	Staple	Punch	Z-Fold	Multifold	Half Fold				
Mixed Sizes	x																																								
Regular Size Originals		x																																							
Custom Size Originals			x																																						
Original Orientation				x																																					
Auto Image Density					x																																				
Image Density (Manual)						x																																			
Full Color							x																																		
Black & White								x																																	
Auto Color Select									x																																
Auto Paper Select										x																															
Paper Select											x																														
Bypass Tray												x																													
Auto Reduce / Enlarge													x																												
Reduce / Enlarge														x																											
Create Margin															x																										
2 Sided Original																x																									
Book Type Original																	x																								
Poster																		x																							
Z-Sided																			x																						
Combine																				x																					
Booklet																					x																				
Magazine																						x																			
ID Card Copy																							x																		
Circle Copies																								x																	
Margin Adjustment																									x																
Centering																										x															
Erase Center/Border																											x														
Erase Color																												x													
Background Numbering (Stamp) <sup>1</sup>																																									
Unauthorized Copy Prevention																																									
Sort																																									
Rotate Sort																																									
Staple																																									
Punch																																									
Z-Fold																																									
Multifold																																									
Half Fold																																									

<sup>1</sup> Stamps include Preset Stamp, User Stamp, Date Stamp, Page Numbering, and Stamp Text.  
<sup>2</sup> [90 Degrees Counterclockwise] or [90 Degrees Clockwise], and [Open Book 2 Sided] cannot be selected simultaneously. The function selected first has priority.  
<sup>3</sup> When [Auto Paper Select] or [Fit to Paper Size] is not selected, [90 Degrees Counterclockwise] or [90 Degrees Clockwise] and stapling one position cannot be selected simultaneously. The function selected first has priority.  
<sup>4</sup> [Magazine] and [Staple: Center] can be selected simultaneously.  
<sup>5</sup> [Staple: Top] and [Punch: Left], [Staple: Center] and [Punch: Left], or [Punch: Top] and [Punch: Left] cannot be selected simultaneously.  
<sup>6</sup> [Staple: Top] and [Right Fold], [Staple: Center] and [Right Fold], or [Bottom Fold], or [Staple: Left] and [Bottom Fold] cannot be selected simultaneously.

# 11. Legal and Contact Information

## Environmental Regulations

### ENERGY STAR Program

#### ENERGY STAR® Program Requirements for Imaging Equipment



This company is a participant in the ENERGY STAR® Program.  
This machine is compliant with the regulations specified by the ENERGY STAR® Program.

The ENERGY STAR® Program Requirements for Imaging Equipment encourage energy conservation by promoting energy efficient computers and other office equipment.

The program backs the development and dissemination of products that feature energy saving functions.

It is an open program in which manufacturers participate voluntarily.

Targeted products are computers, monitors, printers, facsimiles, copiers, scanners, and multi-function devices. Energy Star standards and logos are internationally uniform.

### Energy Saving Functions

If this machine remains idle for a specified period of time or when [Energy Save] (⏻) is pressed, it enters Sleep mode to further reduce its electrical consumption. This is called "Sleep Mode".

- The default delay time the machine waits before entering Sleep mode is one minute.
- The machine can print jobs from computers and receive faxes while in Sleep mode.
- The time it takes to recover from the energy saving functions and low power consumption in Sleep Mode may differ depending on the machine.

 **Region A** (mainly Europe)

Model Name	Power Consumption	Time to Recover from Sleep Mode	Duplex Function <sup>*1</sup>
IM C2000 series	0.55 W	6.1 seconds	Standard
IM C2500 series	0.55 W	6.1 seconds	Standard
IM C3000 series	0.55 W	6.0 seconds	Standard
IM C3500 series	0.55 W	6.0 seconds	Standard
IM C4500 series	0.62 W	7.0 seconds	Standard
IM C5500 series	0.62 W	8.1 seconds	Standard
IM C6000 series	0.62 W	8.1 seconds	Standard

 **Region A** (mainly Asia)

Model Name	Power Consumption	Time to Recover from Sleep Mode	Duplex Function <sup>*1</sup>
IM C2000	0.55 W	6.1 seconds	Standard
IM C2500	0.55 W	6.1 seconds	Standard
IM C3000	0.55 W	6.0 seconds	Standard
IM C3500	0.55 W	6.0 seconds	Standard
IM C4500	0.62 W	7.0 seconds	Standard
IM C6000	0.62 W	8.1 seconds	Standard

 **Region B** (mainly North America)

Model Name	Power Consumption	Time to Recover from Sleep Mode	Duplex Function <sup>*1</sup>
IM C2000 series	0.54 W	6.6 seconds	Standard
IM C2500 series	0.54 W	6.6 seconds	Standard
IM C3000 series	0.53 W	6.3 seconds	Standard
IM C3500 series	0.53 W	6.3 seconds	Standard
IM C4500 series	0.59 W	6.6 seconds	Standard



Model Name	Power Consumption	Time to Recover from Sleep Mode	Duplex Function <sup>*1</sup>
IM C6000 series	0.59 W	7.9 seconds	Standard

\*1 Achieves ENERGY STAR energy savings; product fully qualifies when packaged with (or used with) a duplex tray and the duplex function is enabled as an option.

#### ↓ Note

- You can change the amount of time that the machine waits before entering Sleep mode under [Sleep Mode Timer].
- See "Timer Settings", User Guide (Full Version)
- See below when [Standard] is specified as the screen type of [Settings]. The names of the setting items may differ from the [Classic] screen type.
- See "Date/Time/Timer", User Guide (Full Version).
- For details, see "Settings Menu Compatibility List (Classic to Standard Settings)", User Guide (Full Version).
- It may take longer than the specified time to enter Sleep mode according to the type of Embedded Software Architecture application installed in the machine.

## User Information on Electrical and Electronic Equipment Region A (mainly Europe)

### Users in the countries where this symbol shown in this section has been specified in national law on collection and treatment of E-waste

Our Products contain high quality components and are designed to facilitate recycling.

Our products or product packaging are marked with the symbol below.



The symbol indicates that the product must not be treated as municipal waste. It must be disposed of separately via the appropriate return and collection systems available. By following these instructions you ensure that this product is treated correctly and help to reduce potential impacts on the environment and human health, which could otherwise result in inappropriate handling. Recycling of products helps to conserve natural resources and protect the environment.

For more detailed information on collection and recycling systems for this product, please contact the shop where you purchased it, your local dealer or sales/service representatives.

### All Other Users

---

If you wish to discard this product, please contact your local authorities, the shop where you bought this product, your local dealer or sales/service representatives.

### For Turkey only

---

AEEE Yönetmeliğine Uygundur.

Bu sistem sarf malzemeleri ve yedek parçaları da dahil olmak üzere AEEE Yönetmeliğine Uygundur.

#### Üretici:

Ricoh Company, Ltd.

3-6, Nakamagome 1-chome,

Ohta-ku, Tokyo 143-8555 Japan

+81-3-3777-8111 (English only/Sadece İngilizce)

---

### Note for the Battery and/or Accumulator Symbol (For EU countries only)

 Region **A** (mainly Europe)

---



In accordance with the Battery Directive 2006/66/EC Article 20 Information for end-users Annex II, the above symbol is printed on batteries and accumulators.

This symbol means that in the European Union, used batteries and accumulators should be disposed of separately from your household waste.

In the EU, there are separate collection systems for not only used electrical and electronic products but also batteries and accumulators.

Please dispose of them correctly at your local community waste collection/recycling centre.

Contact your sales or service representative to change the battery.

---

## Environmental Advice for Users Region **A** (mainly Europe)

---

### Users in the EU, Switzerland and Norway

---

#### Consumables yield

Please refer to either the User's Manual for this information or the packaging of the consumable.

#### Recycled paper

The machine can use recycled paper which is produced in accordance with European standard EN 12281:2002 or DIN 19309. For products using EP printing technology, the machine can print on 64 g/m<sup>2</sup> paper, which contains less raw materials and represents a significant resource reduction.

#### Duplex printing (if applicable)

Duplex printing enables both sides of a sheet of paper to be used. This saves paper and reduces the size of printed documents so that fewer sheets are used. We recommend that this feature is enabled whenever you print.

#### Toner and ink cartridge return program

Toner and ink cartridge for recycling will be accepted free of charge from users in accordance with local regulations.

For details about the return program, please refer to the Web page below or consult your service person.

<https://www.ricoh-return.com/>

#### Energy efficiency

The amount of electricity a machine consumes depends as much on its specifications as it does on the way you use it. The machine is designed to allow you to reduce electricity costs by switching to Ready mode after it prints the last page. If required, it can immediately print again from this mode. If no additional prints are required and a specified period of time passes, the device switches to an energy saving mode.

In these modes, the machine consumes less power (watts). If the machine is to print again, it needs a little longer to return from an energy saving mode than from Ready mode.

For maximum energy savings, we recommend that the default setting for power management is used.

---

## Notes to users in the state of California (Notes to Users in USA) Region **B** (mainly North America)

---

Perchlorate Material - special handling may apply. See: [www.dtsc.ca.gov/hazardouswaste/perchlorate](http://www.dtsc.ca.gov/hazardouswaste/perchlorate)

## Trademarks

Adobe, Acrobat, PostScript, and PostScript 3 are either registered trademarks or trademarks of Adobe Systems Incorporated in the United States and/or other countries.

The Bluetooth® word mark and logos are registered trademarks owned by Bluetooth SIG, Inc. and any use of such marks by Ricoh Company, Ltd. is under license.

Firefox is registered trademarks of the Mozilla Foundation.

Google and Chrome are trademarks of Google Inc.

Java is a registered trademark of Oracle and/or its affiliates.

Kerberos is a trademark of the Massachusetts Institute of Technology (MIT).

macOS, OS X, and Safari are trademarks of Apple Inc., registered in the U.S. and other countries.

Microsoft, Windows, Windows Server, and Internet Explorer are either registered trademarks or trademarks of Microsoft Corp. in the United States and/or other countries.

PictBridge is a trademark.

The SD and SD logo are trademarks of SD-3C, LLC.



This product includes RSA BSAFE® Cryptographic software of EMC Corporation. RSA and BSAFE are registered trademarks or trademarks of EMC Corporation in the United States and other countries.

The proper names of Internet Explorer 11 is as follows:

- Internet Explorer® 11

The proper names of the Windows operating systems are as follows:

- The product names of Windows 7 are as follows:
  - Microsoft® Windows® 7 Home Premium
  - Microsoft® Windows® 7 Professional
  - Microsoft® Windows® 7 Ultimate
  - Microsoft® Windows® 7 Enterprise
- The product names of Windows 8.1 are as follows:
  - Microsoft® Windows® 8.1
  - Microsoft® Windows® 8.1 Pro
  - Microsoft® Windows® 8.1 Enterprise

- The product names of Windows 10 are as follows:
  - Microsoft® Windows® 10 Home Premium
  - Microsoft® Windows® 10 Pro
  - Microsoft® Windows® 10 Enterprise
  - Microsoft® Windows® 10 Education
- The product names of Windows Server 2008 are as follows:
  - Microsoft® Windows Server® 2008 Standard
  - Microsoft® Windows Server® 2008 Enterprise
- The product names of Windows Server 2008 R2 are as follows:
  - Microsoft® Windows Server® 2008 R2 Standard
  - Microsoft® Windows Server® 2008 R2 Enterprise
- The product names of Windows Server 2012 are as follows:
  - Microsoft® Windows Server® 2012 Foundation
  - Microsoft® Windows Server® 2012 Essentials
  - Microsoft® Windows Server® 2012 Standard
- The product names of Windows Server 2012 R2 are as follows:
  - Microsoft® Windows Server® 2012 R2 Foundation
  - Microsoft® Windows Server® 2012 R2 Essentials
  - Microsoft® Windows Server® 2012 R2 Standard
- The product names of Windows Server 2016 are as follows:
  - Microsoft® Windows Server® 2016 Essentials
  - Microsoft® Windows Server® 2016 Standard

Wi-Fi® and Wi-Fi Direct® are registered trademarks of Wi-Fi Alliance.

Other product names used herein are for identification purposes only and might be trademarks of their respective companies. We disclaim any and all rights to those marks.

Microsoft product screen shots reprinted with permission from Microsoft Corporation.

---

MEMO



