



RICOH Ri 100/
RICOH Ri 100 Pink/RICOH Ri 100 Green

User's Guide

Names of Components

1

Printing on Fabric

2

If Errors Occur

3

If Print Results Are Not Satisfactory

4

Machine Maintenance

5

Replacing Consumables

6

CONTENTS

- Notice

P.3

1 Names of Components

- Whole View
- Optional Trays
- Control Panel

P.4
P.5
P.6

2 Printing on Fabric

- Creation Flow P.7
- Removing Dust and Flattening Fibers P.9
- Loading a Fabric in the A4 Standard Tray P.10
- Loading Socks in the Sleeve & Socks Tray P.15
- Loading a Sleeve in the Sleeve & Socks Tray P.18
- Printing P.21
- Removing the Fabric P.25
- Fixing Ink P.27
- Handling Printed Goods P.28

3 If Errors Occur

- Error Messages and Troubleshooting

P.30

4 If Print Results Are Not Satisfactory

- Troubleshooting for Each Error

P.33

5 Machine Maintenance

- Nozzle Check P.40
- Head-cleaning P.42
- No-fuss Head Cleaning P.43
- Head-flushing P.44
- Head Position P.45
- Registration P.49
- Regular Maintenance/Cleaning the Internal Compartments P.52

6 Replacing Consumables

- Replacing an Ink Cartridge P.53



Notice

Read this manual carefully before you use the product and keep it handy for future reference.

For safe and correct use, be sure to read Safety Information before using the machine.

Whole View

Machine Body

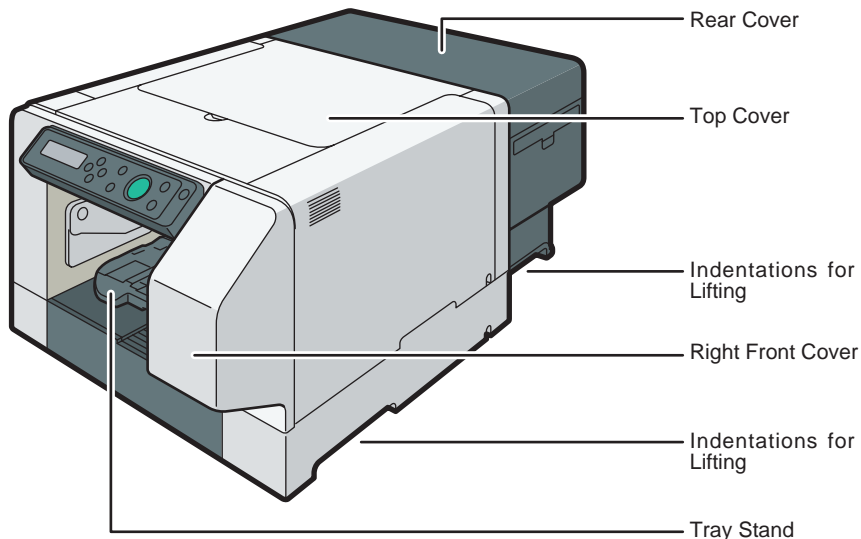

DYX009

Tray (A4 Standard Tray)

You can print within an A4 size (210 × 297 mm) (8.3 × 11.7 inches) area on a garment using this tray.

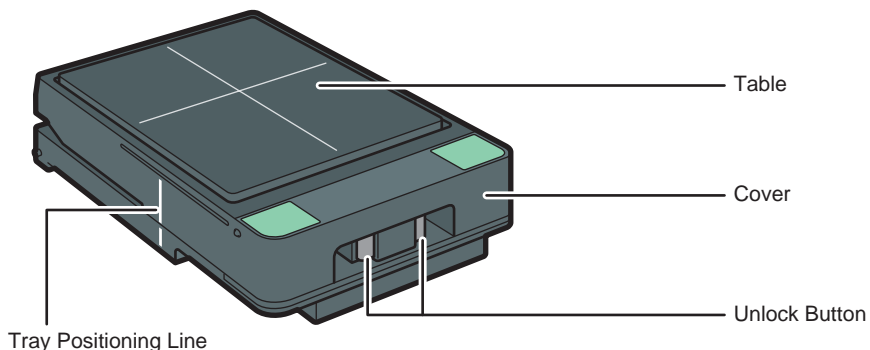

DYX092

Optional Trays

Tray (A5 Tray)

You can print within an A5 size (148 × 210 mm) (5.9 × 8.3 inches) area on a garment using this tray.

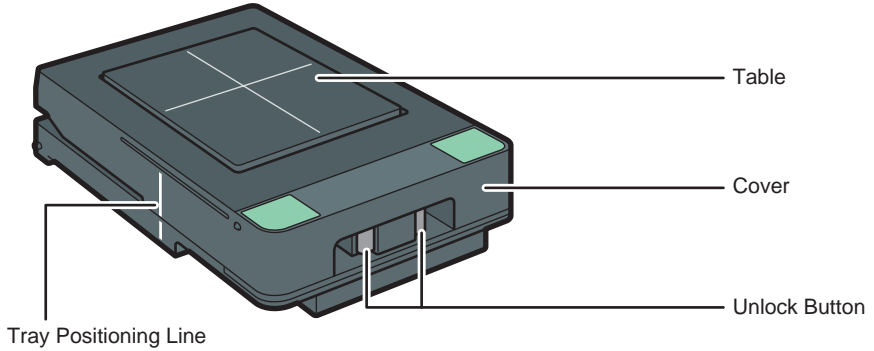

DYX093

1

Sleeve & Socks Tray

You can print sleeve or socks using this tray.

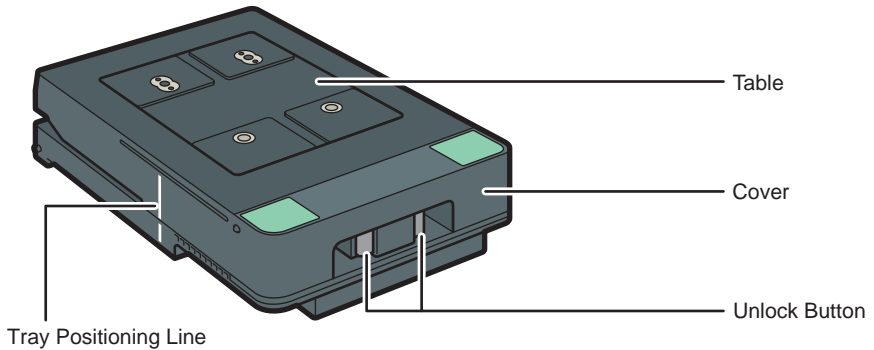

DYX085

Control Panel

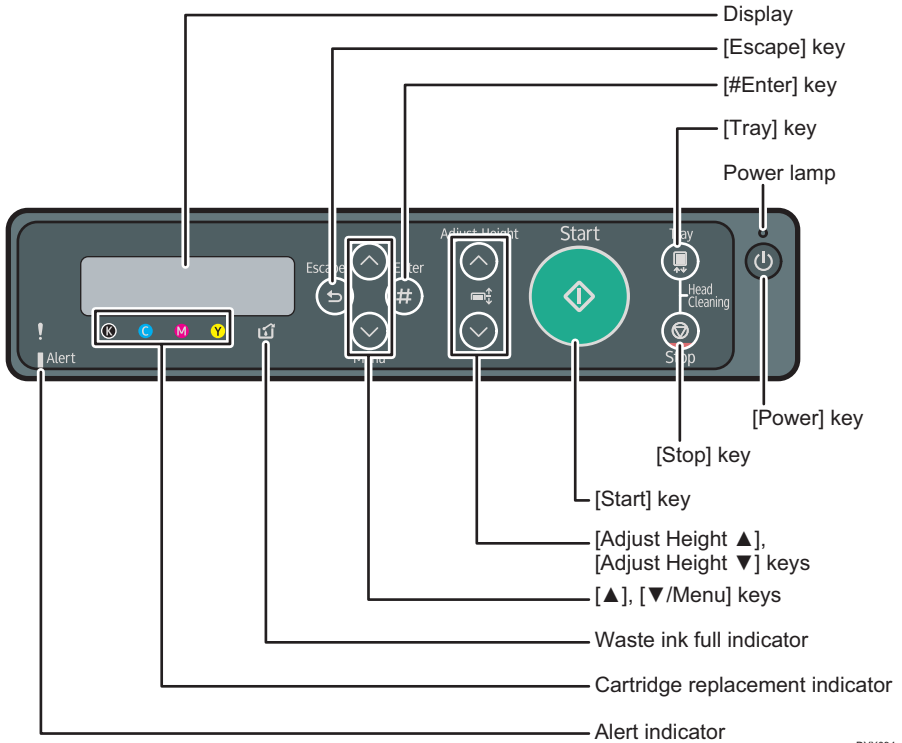

DYX094

[Start] key's display

After receiving the print job:
Lit in blue



While printing:
Flashing in blue



After printing (in standby mode):
Off



Creation Flow

This section explains the operation flow when printing is performed on fabric using the "Easy Designer" mode of the dedicated "Design Software" application. Use the Design Software to do the operations in Steps 3 to 7.

★ Important

- To use Sleeve & Socks Tray, you need to install the latest firmware (ver. 1.20 or later) on the machine.
- Use the latest version of the Design Software. See the latest help for the operating procedures.

1 Removing dust and flattening fibers of the fabric.

See page 9 "Removing Dust and Flattening Fibers".

2 Load the fabric in the tray.

See page 10 "Loading a Fabric in the A4 Standard Tray", page 15 "Loading Socks in the Sleeve & Socks Tray", and page 18 "Loading a Sleeve in the Sleeve & Socks Tray".

3 Select the type and thickness of the fabric.

4 Select the tray size and direction.

5 Select the image to print.

6 Set the layout.

7 Print.

See page 21 "Printing".

8 Remove the fabric from the tray.

See page 25 "Removing the Fabric".

9 Fixing ink to the fabric.

See page 27 "Fixing Ink".

↓ Note

- For the installation method of the Design Software and detailed operation methods, see "Printing on T-shirts", Operating Instructions.
- For details about the functions of the Design Software, see the Design Software Help.
- The print direction varies depending on the application you use. Select the direction of image and fabric referring to the figures below.

Design Software

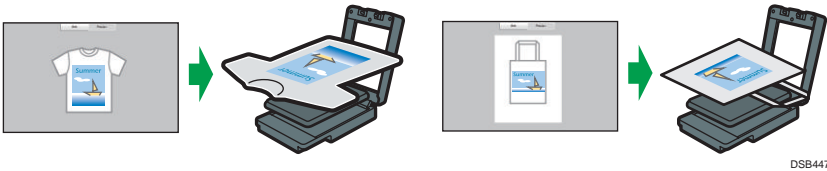

Printer Driver (Windows)

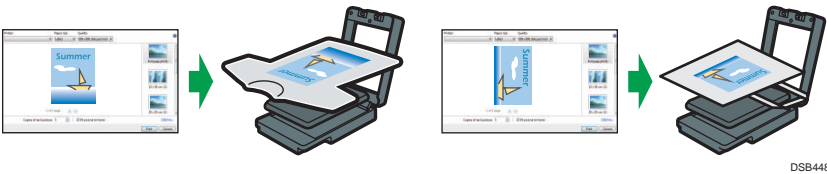

Removing Dust and Flattening Fibers

This process is to print on fabrics clearly. The optional finisher is used.

★ Important

- As the A4 standard tray, A5 tray, and Sleeve & Socks Tray becomes hot when continuously used on the optional finisher, give an interval of five minutes or longer to set them after they are pulled out.
- Do not print on wet fabric. Doing so may result in a blurry image.
- Do not use the spray. If you wet the T-shirt with the spray, the color of the tray may stain the back of the T-shirt.
- In high temperature environments, fabric might absorb moisture and stretch after smoothed. Print immediately after loading the fabric.
- Remove dust and lint from fabric before printing because dust and lint whose color is the same with the fabric color are hard to find, we recommend using a lint roller to remove dust and lint from fabric before smoothing it.

1 Remove dust and lint from the print surface of the fabric.

Remove them with a brush for clothes or a roller.

2 Use the finisher to flatten fibers and remove wrinkles.

↓ Note

- When using the finisher, you can carry out heat press processing for the fabric being loaded in the A4 standard tray, A5 tray, or Sleeve & Socks Tray.

Loading a Fabric in the A4 Standard Tray

This section explains how to load a fabric into the A4 standard tray. The same operation applies when the A5 tray is used.

⚠ CAUTION

- When attaching or removing fabrics in tray, take care not to trap or injure your fingers.

★ Important

- When printing on thin fabrics, the ink may adhere to the table. Place paper or something similar on the table before loading the fabric.

1 Press the [Power] key, and then turn on the machine.

- Detach the tray after turning on the machine. If you detach the tray before turning on the machine, turn it off first, and then turn it on again.

2 Make sure that the tray stand is out of the machine, and then detach the tray.

- If it is not out of the machine, press the [Tray] key to eject the tray.
- Lift up the tray lightly and pull the tray to detach it.

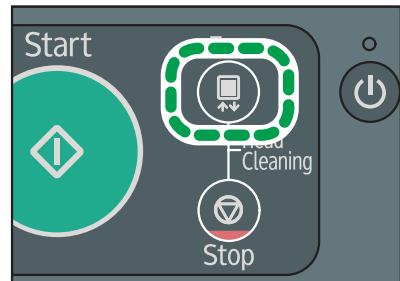

DSB002

-
- 3** Press the unlock button to open the cover.

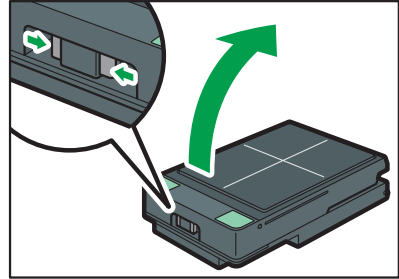

DSA348

-
- 4** Put marks on the fabric when loading it in the tray.

The image will be printed in the direction from the front side to the back side of the tray. Turn the protective cover inside out and put it on the fabric in the direction as shown in the figure. Then, use a pen with erasable ink to make the marks through the holes in the protective cover.

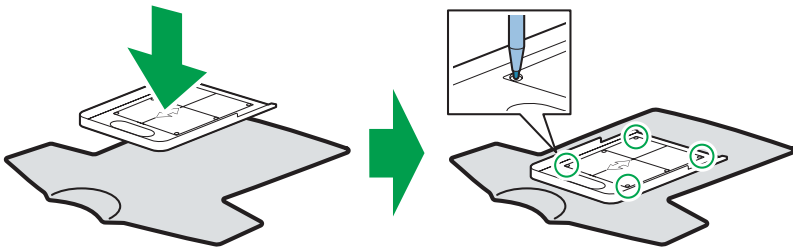

DSA197

2

5 Load the fabric on the table.

- When loading the fabric, align the corners of the table with the marks on the fabric.
- When loading a T-shirt or sweatshirt

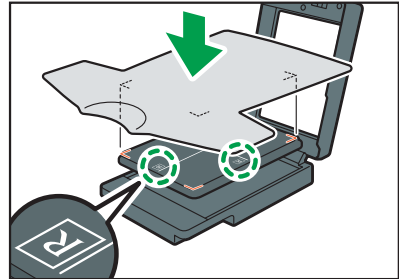

DSA219

- When loading a canvas tote bag or natural cotton tote bag

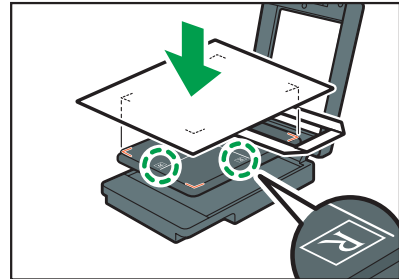

DSA220

- When loading a medium size canvas tote bag or natural cotton tote bag in the A4 standard tray, the tray might not have enough space for the tote bag. If it is difficult to load the tote bag in the A4 standard tray, use the A5 tray for the tote bag.
- When you print on a natural cotton tote bag or a T-shirt other than a Heavyweight T-shirt, the ink may bleed through the fabric and stain other parts. You can prevent this staining by inserting a piece of paper against the inner side.

6 Tuck the edges of the fabric under the table.

- Smooth out the fabric so that no wrinkles or slack remain on the print surface.
- Tuck the fabric so that no wrinkles or folds remain in the area at the edges of the table.

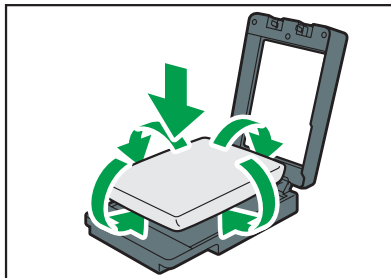

DSA370

7 Make sure that no wrinkles or slack remain on the print surface, and then close the cover. As you close the cover, smooth away any wrinkles with your hand.

- Make sure that the fabric fits on the tray.
- When using the optional finisher, smooth wrinkles and flatten fibers after loading the fabric in the tray.

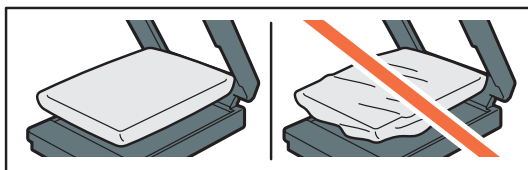
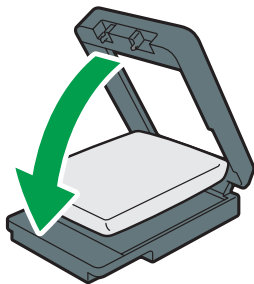

DSA014

- After closing the cover, make sure that the fabric is loaded so its surface is parallel to the cover.

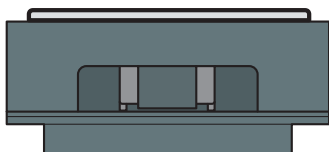

DSA217

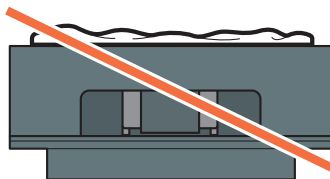

DSA218

8 After closing the cover, if there are still wrinkles or slack on the printing surface at the center of the table, push both ends of the tray lightly and push the fabric under the table.

- After closing the cover, check that the fabric is not caught between the cover and the tray.

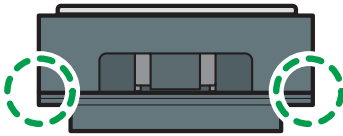

DSA048

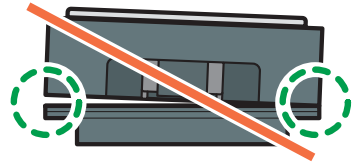

DSA049

Loading Socks in the Sleeve & Socks Tray

When you want to print on socks, use the sleeve & socks tray.

★ Important

- To use Sleeve & Socks Tray, you need to install the latest firmware (ver. 1.20 or later) on the machine.
- If you perform printing with the edges of the fabric still outside of the table, the fabric or this machine might be damaged. After fixing the fabric, make sure that it fits within the width of the tray.
- Do not forcibly lift or twist the table. Doing so may cause a failure.

1 Press the [Power] key, and then turn on the machine.

- Detach the tray after turning on the machine. If you detach the tray before turning on the machine, turn it off first, and then turn it on again.

2 Make sure that the tray stand is out of the machine, and then detach the tray.

- If it is not out of the machine, press the [Tray] key to eject the tray.
- Lift up the tray lightly and pull the tray to detach it.

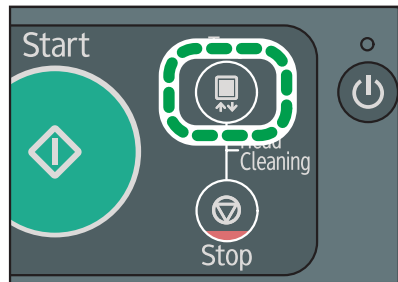

DSB002

3 Press the unlock button to open the cover.

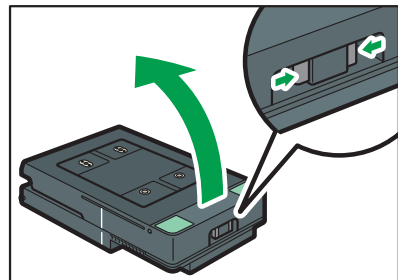

DYX063

-
- 4** Load the socks on the table.

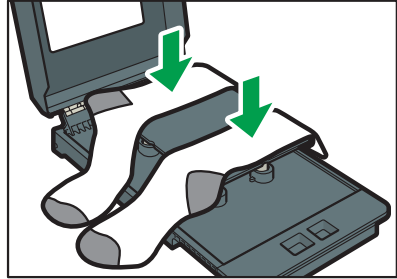

DYX064

- 5** Tuck the edges of the fabric under the table.

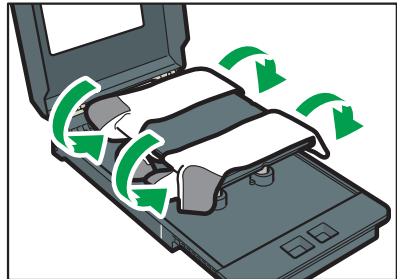

DYX065

- 6** Make sure that no wrinkles or slack remain on the print surface, and then close the cover.

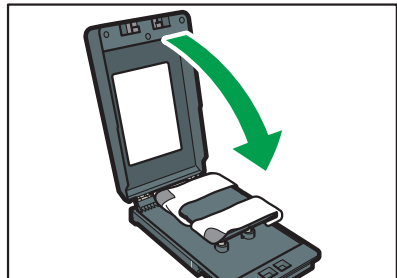

DYX066

7 Load the tray in the tray stand and start printing.

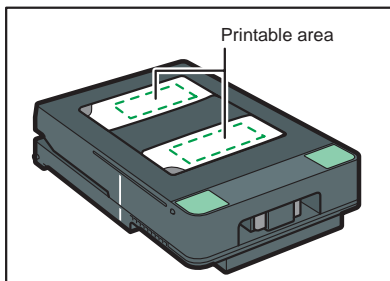

DYX086

↓ Note

- Load the fabric so that its surface is as flat as possible and it is parallel to the table.

■ Printable area of socks

You can print socks in the positions shown.

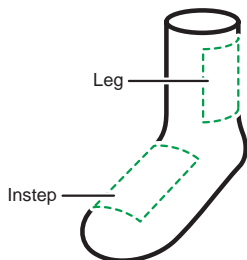

Example: Instep

When printing on the instep, widen and load the fabric so that the printable area of the instep is in the middle.

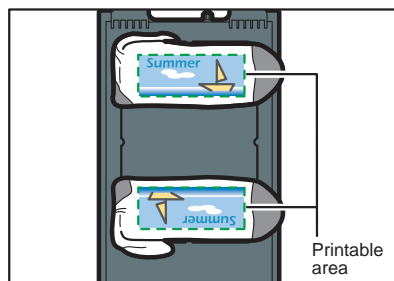

DYX087

DYX088

Loading a Sleeve in the Sleeve & Socks Tray

When you want to print on the sleeves of a garment, use the sleeve & socks tray.

★ Important

- To use Sleeve & Socks Tray, you need to install the latest firmware (ver. 1.20 or later) on the machine.
- If you perform printing with the edges of the fabric still outside of the table, the fabric or this machine might be damaged. After fixing the fabric, make sure that it fits within the width of the tray.
- Do not forcibly lift or twist the table. Doing so may cause a failure.

1 Press the [Power] key, and then turn on the machine.

- Detach the tray after turning on the machine. If you detach the tray before turning on the machine, turn it off first, and then turn it on again.

2 Make sure that the tray stand is out of the machine, and then detach the tray.

- If it is not out of the machine, press the [Tray] key to eject the tray.
- Lift up the tray lightly and pull the tray to detach it.

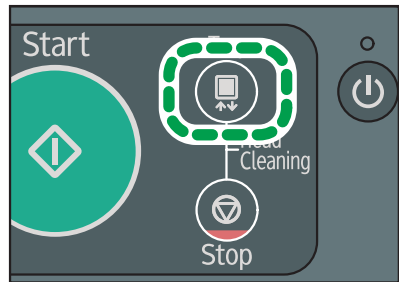

DSB02

3 Press the unlock button to open the cover.

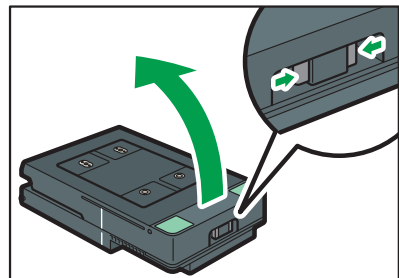

DYX063

-
- 4** Slip the sleeve onto the table.

If you cannot slip it on, load it onto the table.

Align the perforation with the indentation on the table.

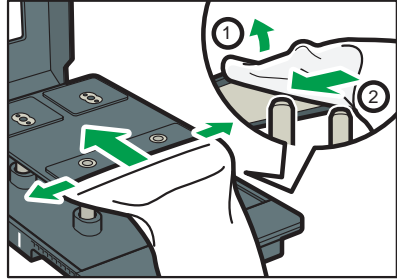

DYX067

-
- 5** Tuck the edges of the fabric under the table.

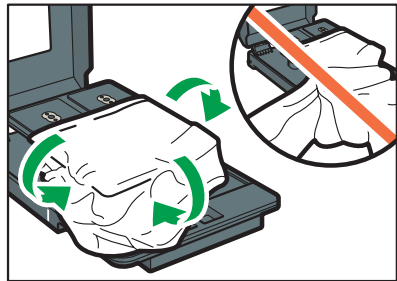

DYX068

-
- 6** Make sure that no wrinkles or slack remain on the print surface, and then close the cover.

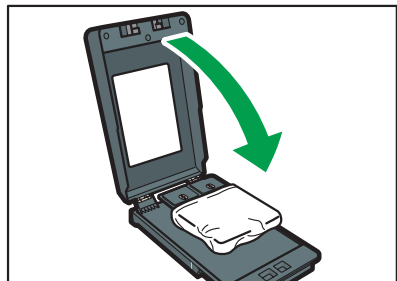

DYX069

7 Load the tray in the tray stand and start printing.

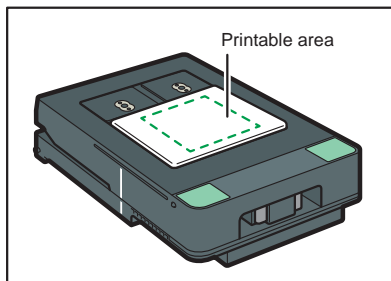

DYX089

■ Printable area of sleeves

You can print sleeves in the positions shown.

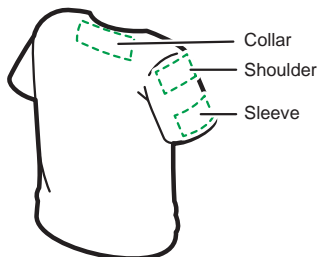

↓ Note

- You can print without margins on the sleeves. Cover the table with paper so the table does not get dirty, and then position the sleeve of the garment.

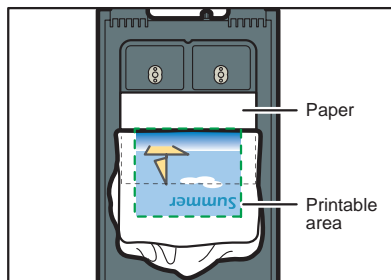

DYX090

DYX091

Printing

★ Important

- Do not touch the tray or put your hand in the machine while printing is performed.
- Do not open the top cover while printing is performed. Printing is forcibly interrupted and cannot be resumed.
- When a garment misfeed error appears, see "Adjusting the Height of the Tray" in "The Tray Does Not Operate Correctly" in "Troubleshooting", Operating Instructions.
- Do not print if no fabric is loaded on the tray. It may cause the ink to stick to the tray. After printing without loading a fabric in the tray, do the following:

■ Solutions if Printing Was Performed Without a Fabric Loaded in the Tray

1 Wipe the tray with a dry cloth.

Do not use tissue paper because it makes the tray dirty.
Use polythene gloves to avoid touching the ink directly.
Do not use chemicals such as thinner or ethanol.

2 Dry the remaining ink using the optional finisher or an iron.

Stains might remain on the tray, which can still be used however.

When using the optional finisher, use it in dry mode.

When ironing, lay down a sheet of paper on the surface of the tray, and apply the iron to the paper.

After drying the ink, rub the surface of the tray with a cloth to check whether or not the ink is dry. If ink does not stick to the cloth, the ink has dried completely.

Printing

1 Load the tray in the tray stand.

Put the back side of the tray in the tray stand and push it in gently until it stops with a click.

You can check whether the tray is loaded correctly by looking at the line on the left side of the tray.

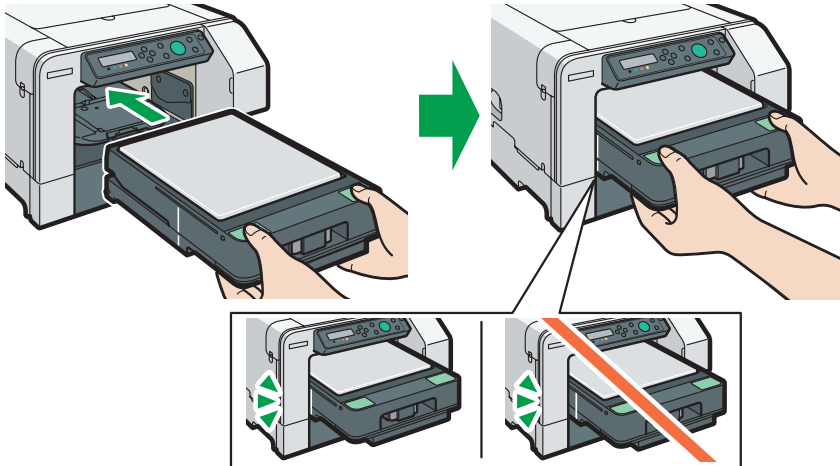

DSA063

2 Click [Start Printing] on the Design Software.

- Print data are transferred to the machine.
- When the machine receives the data correctly, the [Start] key lights up in blue.

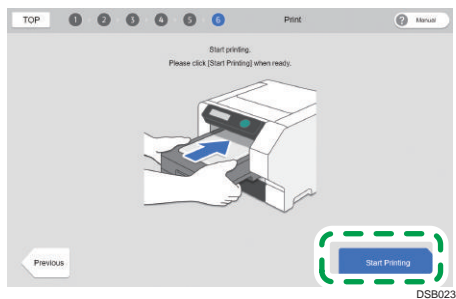

3 Make sure that the [Start] key is lit up in blue, and then press it.

- After the tray is loaded into the machine and the height of the table is automatically adjusted, printing starts.

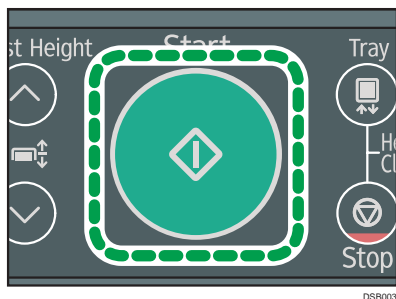

2

4 After the tray returns to the front side of the machine, detach the tray.

- If the [Start] key is still lit, the printing has not been completed. Press the [Start] key again without detaching or removing the tray from the machine. The printing will resume.
- When using the A4 standard tray or A5 tray, insert the protection cover horizontally as illustrated in the figure, and then remove it with the A4 standard tray or A5 tray. This prevents you from touching the print surface. Make sure the protection cover is correctly positioned horizontally.

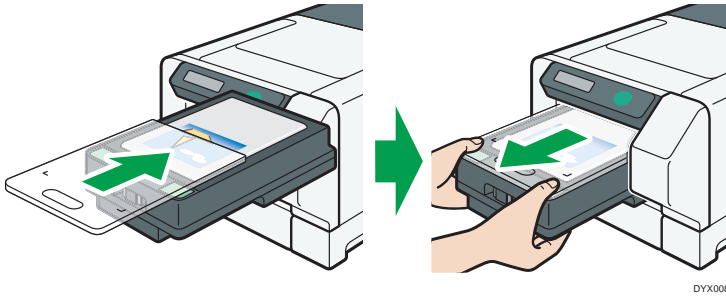

DYX008

5 Exit the Design Software.

- By clicking [Print One More], you can configure the layout settings again for the image loaded.
- Clicking [Back to TOP] discards the loaded image and returns you to the top screen of the Design Software.

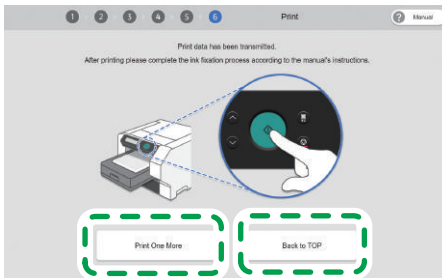

DSB024

Removing the Fabric

★ Important

- When removing the fabric, be sure to prevent the print surface from touching the other parts.
- If you touch the print surface before the ink fixes, the ink might blot on the fabric.

When using the A4 standard tray or A5 tray

1 Press the unlock button to open the cover.

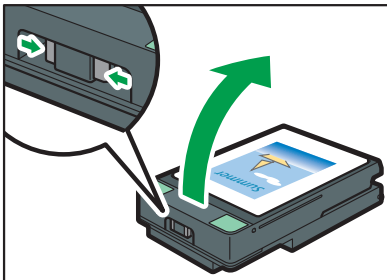

DSA357

2

2 Pull out the tucked edges of the fabric.

Be careful not to touch the printed side.

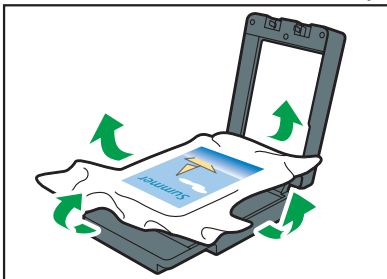

DSA342

-
- 3** Hold the fabric by the shoulders and remove it from the tray.

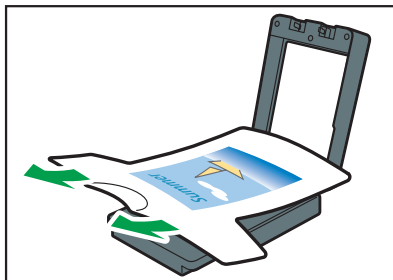

DSA344

Fixing Ink

Use the optional finisher to fix ink to the fabric.

★ Important

- As the A4 standard tray, A5 tray, and Sleeve & Socks Tray becomes hot when continuously used on the optional finisher, give an interval of five minutes or longer to set them after they are pulled out.

↓ Note

- For reference, in the case of a commercially available heat press, ink was fixed at 330°F (approx. 165°C) in 90 seconds.
- When using the finisher, you can carry out heat press processing for the fabric loaded in the A4 standard tray, A5 tray, or Sleeve & Socks Tray.

Handling Printed Goods

Precautions when washing printed goods

■Note the following handling precautions for T-shirts and sweat-shirts:

- Turn garments inside out before washing them.
- When washing T-shirts and other garments by hand, dissolve some neutral detergent in lukewarm water of about 30°C (approx. 86°F) and wash them without rubbing the printed areas. After that, spin them dry for about 1 minute in a washing machine, smooth wrinkles, and then hang them to dry.



DSA541

- Do not rub the printed surfaces. Doing so may cause discoloration due to friction.



DSA542

- When washing T-shirts and other garments in a washing machine, turn them inside out so the printed side is inside and put them in a laundry net. After washing them, shake out as much water as possible, smooth out wrinkles, and hang them in the shade to dry.

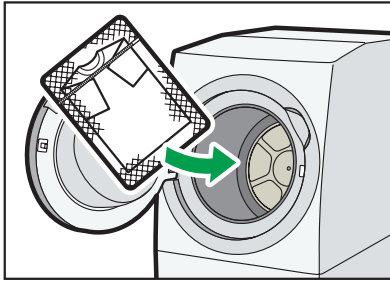

DSA543

- Do not use a dryer or bleach.
- Avoid ironing the printed surfaces.
- Do not dry-clean garments.

2

■ **Note the following handling precautions for tote bags:**

- Do not machine wash tote bags. Doing so may cause the tote bag to lose its shape or cause its colors to fade.
- When washing tote bags by hand, dissolve some neutral detergent in lukewarm water of about 30°F (approx. 86°F) and wash them without rubbing their printed areas. After washing a tote bag, shake it out to remove as much water as possible. Then, flatten it to remove wrinkles and dry it in the shade.





Error Messages and Troubleshooting

CAUTION

- Keep ink and ink containers out of reach of children.
 - If ink gets into contact with eyes, wash eyes immediately with running water. Consult a doctor if necessary.
 - When replacing ink, avoid getting ink on your skin. If ink comes into contact with your skin, wash the affected area thoroughly with soap and water.
-
- Be sure to locate the machine as close as possible to a wall outlet. This will allow easy disconnection of the power cord in the event of an emergency.
-
- Do not open the cover while the machine is operating. Doing so might cause your hand or fingers to get trapped in the machine, and an injury might occur.

Error Messages and Troubleshooting

Error Messages	Troubleshooting
Adjust height, press Start to / restart or Tray to reset garment	Wrinkles, slack or a float remain on the fabric or the edges of the fabric are out of the tray. Detach the tray, and then load the fabric again. If the message reappears, adjust the height of the tray manually.
Adjust height, press Start to / restart or Tray to reset garment	Fabric that is 4 mm (about 0.2 inches) or thicker is loaded on the A4 standard tray or A5 tray. Load fabric that is up to 4 mm (about 0.2 inches) thick on the A4 standard tray or A5 tray.
Auto Head Maint. Required.	Regular maintenance is needed. Clean the print head nozzles. Usually it is displayed once every one or two weeks. Even if the frequency of use is low, it is always displayed once every four weeks.
Cannot use High Temp. / Power Off On Cannot use Low Temp. / Power Off On	The temperature is abnormally high or low. Check the installation area and relocate the machine. Alternatively, wait until the machine acclimates to the room temperature.

Error Messages	Troubleshooting
Clean Maint Unit Required.	Regular maintenance is needed. Clean the Maintenance Unit. Usually it is displayed once every one or two weeks. Even if the frequency of use is low, it is always displayed once every four weeks.
Exchange Fan Filter	The number of prints that have been performed with the filter installed in the machine exceeds the maximum number (2,000). Replace the filter, and then reset the count for the number of prints using the [Maintenance] menu.
Hardware Problem Ethernet Board	An error in the Ethernet port (Ethernet board) network function has occurred. Disconnect all cables, turn the machine off, and then turn it on again. If the message reappears, contact your sales or service representative.
Ink Collector is not set / Set the Ink Collector Unit	The ink collector unit is not installed or is installed incorrectly. Alternatively, an ink collector unit not meant for this machine may be installed. Install the ink collector unit for this machine correctly. The ink collector unit meant for this machine is labeled "J089" under its handle.
Ink Collector Unit is full / Replace Ink Collector Unit	The ink collector unit is full. Replace the ink collector unit.
Low Ink	The ink will soon run out. Make sure you have a new ink cartridge for the color indicated by  or  .
Maintenance in process...	The machine is cleaning or flushing its print head. Wait a moment. You might hear a clicking sound while the maintenance is in process. This is not a malfunction.
Maintenance failed	Head cleaning, head flushing, or other maintenance operations have failed. Run the maintenance again after clearing the error. You can clear a maintenance error when the machine receives another print job or the [#Enter] key is pressed.
Open Front Cover / Replace Ink Crtg	The ink has run out. Install a new ink cartridge for the color indicated by  or  . See page 53 "Replacing an Ink Cartridge".
Open Front Cover / Reset Cartridge	The ink cartridges are not installed or are installed incorrectly. Alternatively, an ink cartridge not meant for this machine may be installed. Install the ink cartridge for this machine correctly.

Error Messages	Troubleshooting
Press Tray key	The tray is not loaded correctly. Detach the tray, and then load it again.
Prepare new Ink Collector Unit	The ink collector unit is almost full. Make sure you have a new ink collector on hand.
Prepare new Ink& Ink Collect. Unit	The ink will soon run out and the ink collector unit is almost full. Prepare new ink cartridges and an ink collector unit.
Replace Ink: ### / Press Start key for Force Print ###: Cyan, Magenta, Yellow, Black	The ink (cyan, magenta, yellow, black) will soon run out. If you continue printing, press the [Start] key. Because the specified print setting (garment type, print quality, thickness) uses a large volume of ink, it may run out while you are printing. Prepare the ink cartridge soon.
Right Front Cover is open / Close Right Front Cover	The right front cover is open. Close the right front cover.
SCXXX-XX Power Off On / Call Service if error reoccurs	An error has occurred. Turn the machine off and then on. If the message reappears, contact your sales or service representative.
SC523-00 Power Off On / Call Service if error reoccurs	An error has occurred that the height position sensor cannot detect correctly. Turn the machine off and then on. If the message appears again, clean the height position sensor. If this problem persists, contact your sales or service representative.
Set Tray	The tray is not loaded. Load the tray on the tray stand.
Size Mismatch Tray to print or Stop to reset	The tray of the specified size is not set. Change the print size. To continue printing without size mismatch, press the [Tray] key.
Top Cover open close it to / restart machine / Power Off On	The top cover is open. Close the top cover.
Waiting...	Wait a moment. You might hear a clicking sound while the print heads are being filled. This is not a malfunction.

How to troubleshoot the other error messages

For details, see "Error & Status Messages on the Display" in "Troubleshooting", Operating Instructions.

Troubleshooting for Each Error

When black or white streaks appear or when color shading or color shifting appears

The print head nozzles might become clogged. Print and check a nozzle check test pattern, and then perform a head cleaning or a head flushing.

If nozzle problems occur, print head nozzles become clogged and ink cannot be ejected properly.

-
- 1 Execute a nozzle check to determine the number of the clogged print head.**

See page 40 "Nozzle Check".

-
- 2 Perform a head cleaning for the clogged print head.**

See page 42 "Head-cleaning".

-
- 3 Execute a nozzle check to determine whether the problem has been eliminated.**

-
- 4 If the problem persists, do not use the machine for 5–10 minutes.**

By doing this, minute bubbles in the print head nozzle may disappear as the air in them dissolves into the ink, resulting in unclogging.

-
- 5 Execute a nozzle check to determine whether the problem has been eliminated.**
-

If the print head is still clogged

Repeat Steps 1–5. After this procedure is performed multiple times and you wait for a while, normal printing may become possible.

If the print head is still clogged even after the procedure above is performed

Repeat Steps 1–5. However, perform a head flushing in Step 2 instead of performing a head cleaning.

See page 44 "Head-flushing".

Clean the maintenance unit and print head.

For details, see "Cleaning the Maintenance Unit" or "Cleaning the Print Head Nozzles", Maintenance Guide.

When the error still occurs even after you perform the treatments described above, consult your dealer or service representative.

When printed lines are vertically misaligned or printed colors are blurred

The print head might not be properly positioned. Print a test pattern to adjust print head positions, and then set the optimal adjustment values.

1 Adjust the print head positions.

See page 45 "Head Position".

2 Execute a nozzle check to determine whether the problem has been eliminated.

See page 40 "Nozzle Check".

3 If the problem persists, perform a head cleaning.

See page 42 "Head-cleaning".

When the error still occurs even after you perform the treatments described above, consult your dealer or service representative.

The characters printed in yellow on a black fabric are faint

To reproduce the detail of the image, try the following:

- Change the application you are using to print
- Edit the data
- Change the saving format you are using

When the error still occurs even after you perform the treatments described above, consult your dealer or service representative.

Fabric color changes

If the fabric's color changes, lower the temperature and adjust it for the fabric. If this does not resolve the problem, attach the spacer to the inside of the tray.

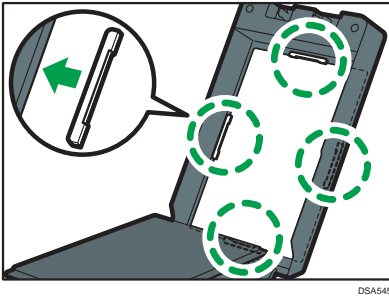

↓ Note

- As the spacer is needed to operate the finisher, keep it in a safe place.
- Before attaching the spacers, make sure that the tray is sufficiently cool. Before removing the spacers, make sure that the tray and spacers are sufficiently cool.
- If the fabric's color does not change or the fabric does not become dirty, remove the spacers and use just the tray.

Fabric becomes dirty

The heater and fabric are in contact.

If the fabric becomes dirty, attach the spacer to the inside of the tray.

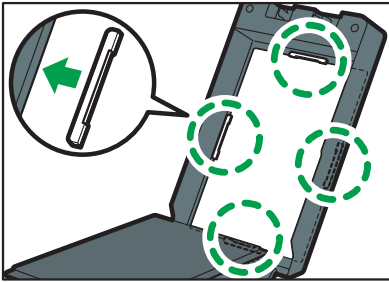

↓ Note

- As the spacer is needed to operate the finisher, keep it in a safe place.
- Before attaching the spacers, make sure that the tray is sufficiently cool. Before removing the spacers, make sure that the tray and spacers are sufficiently cool.
- If the fabric's color does not change or the fabric does not become dirty, remove the spacers and use just the tray.

When the other troubles occur

- **They may be solved by updating the printer driver.**

Check the version of the printer driver. If it is not the latest version, update it.

For details, see "Printing Does Not Start" in "Troubleshooting", Operating Instructions.

- **They may be solved by changing the printer driver settings.**

For details, see "Other Problems" in "Print Results Are Not Satisfactory" in "Troubleshooting", Operating Instructions.

Nozzle Check

When black or white streaks appear or when color shading or color shifting appears

The print head nozzles might become clogged. Print and check a nozzle check test pattern, and then perform a head cleaning or a head flushing.

If nozzle problems occur, print head nozzles become clogged and ink cannot be ejected properly.

-
- 1** Load the fabric in the tray.

 - 2** Press the [▼/Menu] key.

 - 3** Press the [▲] or [▼/Menu] key to display [Maintenance], and then press the [#Enter] key.

 - 4** Press the [▲] or [▼/Menu] key to display [Nozzle Check], and then press the [#Enter] key.

 - 5** Press the [#Enter] key.

 - 6** Press the [Start] key.
A test pattern is printed.
Wait while "Maintenance in process..." is displayed.

 - 7** Press the [Escape] key until the top screen appears.

8 Check the printed test pattern.

- Using the test pattern, check print head clogging and the number of clogged heads.
- The number appearing above each color in the test pattern is the number of the print head.
- The number appearing above each color in the test pattern is the number of the print head.
- The print head for cyan and black is [Head 1]. The print head for yellow and magenta is [Head 2].
- If the nozzles clog, clean the print heads.

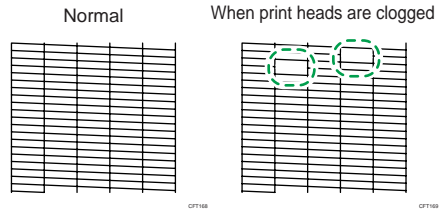
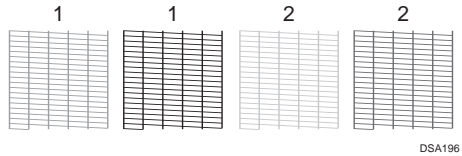

↓ Note

- This function can also be used with paper. When loading the paper on the tray, fix it to all sides of the tray with tape so that the paper does not lift up.

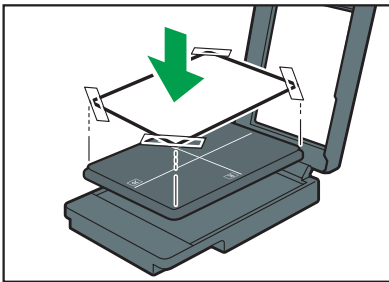

You also need to adjust the height of the tray. For details, see "Adjusting the Height of the Tray", Operating Instructions.

Head-cleaning

Follow the procedure below to perform a normal print head cleaning. Perform a head cleaning when a particular color cannot be printed or print images are blurred. Head cleaning consumes ink.

When the ink cartridge is empty, replace it instead of performing a print head cleaning. After an ink cartridge is replaced, a print head cleaning will be automatically performed.

★ Important

- Do not turn the machine off during print head cleaning. If the machine is turned off during print head cleaning, start again from the beginning.

1 Press the [▼/Menu] key.

2 Press the [▲] or [▼/Menu] key to display [Maintenance], and then press the [#Enter] key.

3 Press the [▲] or [▼/Menu] key to display [Head-cleaning], and then press the [#Enter] key.

4 Press the [▲] or [▼/Menu] key to select a color, and then press the [#Enter] key.

- To clean all the print heads, select [All Heads].
 - To clean the print head for cyan and black, select [Head 1].
 - To clean the print head for yellow and magenta, select [Head 2].
-

5 Press the [#Enter] key.

Head cleaning starts.

Wait while "Maintenance in process..." is displayed.

6 Press the [Escape] key until the top screen appears.

No-fuss Head Cleaning

You can perform a one-touch head cleaning for all colors.

★ Important

- Do not turn the machine off during print head cleaning. If the machine is turned off during print head cleaning, start again from the beginning.

1 Press the [Tray] and [Stop] keys at the same time.

2 Press the [#Enter] key.

Head cleaning starts.

Wait while "Maintenance in process..." is displayed.

3 Confirm that the top screen re-appears.

Head-flushing

Follow the procedure below to perform a thorough print head cleaning. Because head flushing consumes more ink than head cleaning, do it only if the print head cannot be cleaned properly by head cleaning.

When the ink cartridge is empty, replace it instead of performing a print head cleaning. After an ink cartridge is replaced, a print head cleaning will be automatically performed.

★ Important

- Do not turn the machine off during print head cleaning. If the machine is turned off during print head cleaning, start again from the beginning.

1 Press the [▼/Menu] key.

2 Press the [▲] or [▼/Menu] key to display [Maintenance], and then press the [#Enter] key.

3 Press the [▲] or [▼/Menu] key to display [Head-flushing], and then press the [#Enter] key.

4 Press the [▲] or [▼/Menu] key to select a color, and then press the [#Enter] key.

- To clean all the print heads, select [All Heads].
 - To clean the print head for cyan and black, select [Head 1].
 - To clean the print head for yellow and magenta, select [Head 2].
-

5 Press the [#Enter] key.

Head flushing starts.

Wait while "Maintenance in process..." is displayed.

6 Press the [Escape] key until the top screen appears.

Head Position

Adjusts the print head. Perform this operation if printed lines are vertically misaligned or printed colors are blurred.

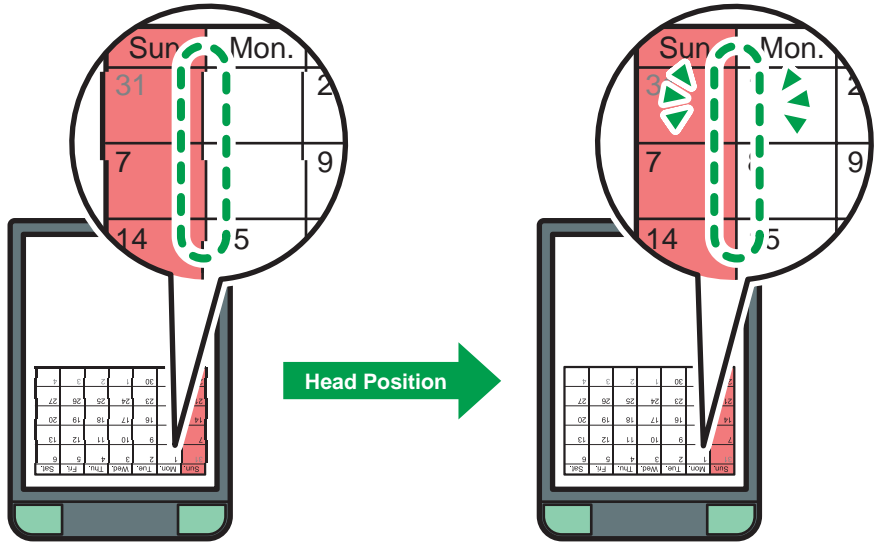

DYX110

To check adjustment values, print test patterns applying "Thick", "Standard", "T-shirt Fine", "T-shirt Speed", or "T-shirt Vivid" settings.

Check adjustment values for each line (A, B, C), and adjust the print head positions. If the adjustment value is set to "0", adjustment is not necessary. Adjust all lines so their adjustment values indicate "0".

1 Load the fabric in the tray.

2 Press the [▼/Menu] key.

3 Press the [▲] or [▼/Menu] key to display [Maintenance], and then press the [#Enter] key.

4 Press the [▲] or [▼/Menu] key to display [Head Position], and then press the [#Enter] key.

5 Press the [▲] or [▼/Menu] key to display [Pr.Test Pattern], and then press the [#Enter] key.

6 Press the [▲] or [▼/Menu] key to select the target's resolutions, and then press the [#Enter] key.

7 Press the [Start] key.

A test pattern to adjust print head positions is printed.

8 To determine the adjustment value, select the square that is faintest (closest to white). Alternatively, select the square whose internal lines overlap to form a single color.

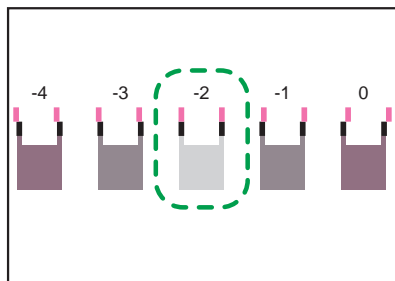

DYX104

Combined two-color lines form squares, and depending on line overlapping, (white) spaces between the lines are painted and look darker. Sometimes the colors of the lines are identical.

For this illustration, the adjustment value is "-2".

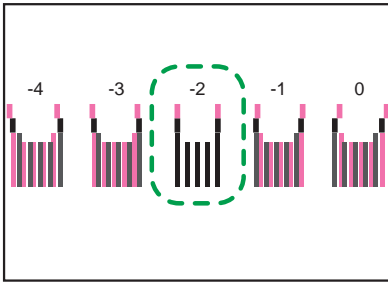

DYX105

- If you cannot determine the adjustment value, select the square that is between the straightest lines.

Each vertical line is made of an upper part and lower part. If the print head is not properly positioned, the vertical line will be displayed as two disconnected lines, so that the line looks misaligned. This illustration indicates an adjustment value of "-3".

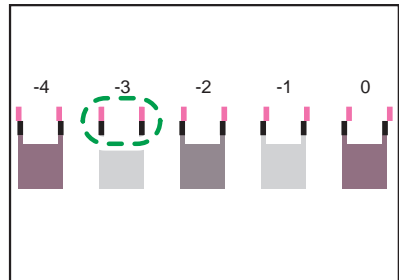

DYX106

- If you still cannot determine the adjustment value, check the deviations of the lines to the left, right, and both sides of the pale squares, and then select the square whose lines deviate symmetrically. This illustration indicates an adjustment value of "-1".

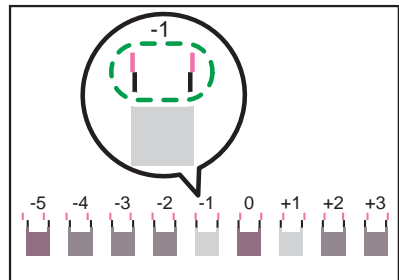

DYX107

9 Press the [**▲**] or [**▼/Menu**] key to display [Adjustment], and then press the [**#Enter**] key.

10 Press the [**▲**] or [**▼/Menu**] key to select a resolution from Step 6, and then press the [**#Enter**] key.

11 Select the items that you need to adjust, and then press the [**# Enter**] key.

12 Enter the optimal adjustment values from Step 8, and then press the [**#Enter**] key.

13 Press the [**Escape**] key until the top screen appears.

↓ Note

- This function can also be used with paper. When loading the paper on the tray, fix it to all sides of the tray with tape so that the paper does not lift up.

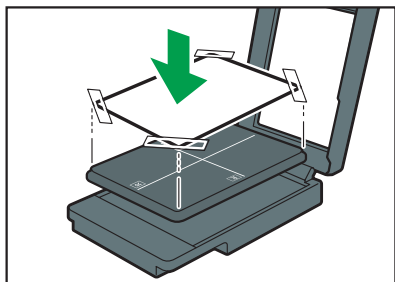

You also need to adjust the height of the tray. For details, see "Adjusting the Height of the Tray", Operating Instructions.

Registration

Follow the procedure below to adjust where to start printing on fabric after checking the test pattern printed.

Look at the left, right, upper, and lower margins, and adjust them if you want to shift the printing position. Doing this is usually not necessary.

1 Load the fabric in the tray. Align the fabric with the corners of the table.

2 Press the [▼/Menu] key.

3 Press the [▲] or [▼/Menu] key to display [Maintenance], and then press the [#Enter] key.

4 Press the [▲] or [▼/Menu] key to display [Registration], and then press the [#Enter] key.

5 Press the [▲] or [▼/Menu] key to display [Pr.Test Pattern], and then press the [#Enter] key.

6 Press the [Start] key.

A test pattern to adjust the print start position is printed. Check the optimal adjustment values on the printed test pattern if necessary.

7 Check the length of "a" and "b", or "x" and "y" in the figure.

Keep the fabric or paper loaded on the tray.

- **When adjusting the print position in the horizontal direction**
Check the length of "a" and "b" in the figure. To shift the printed cross mark by one gradation on the scale in the "+" direction, the adjustment value in [Read Direction] should be "+1.0".

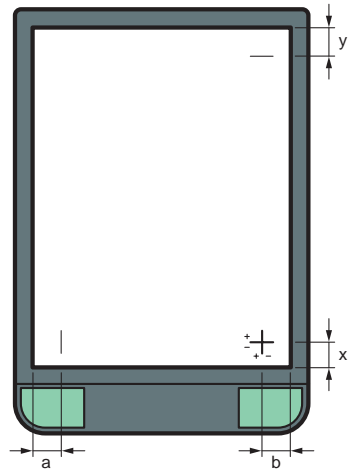

- **When adjusting the print position in the vertical direction**

Check the length of "x" and "y" in the figure. To shift the printed cross mark by one gradation on the scale in the "+" direction, the adjustment value in [Feed Direction] should be "+1.0".

8 Press the [▲] or [▼/Menu] key to display [Adjustment], and then press the [#Enter] key.

9 Press the [▲] or [▼/Menu] key to enter the adjustment values (-4.0–+4.0) in the [Read Direction] from Step 8, and then press the [#Enter] key.

10 Press the [▲] or [▼/Menu] key to enter the adjustment values (-4.0–+4.0) in the [Feed Direction] from Step 9, and then press the [#Enter] key.

11 Press the [Escape] key until the top screen appears.

Note

- This function can also be used with paper. When loading the paper on the tray, fix it to all sides of the tray with tape so that the paper does not lift up.

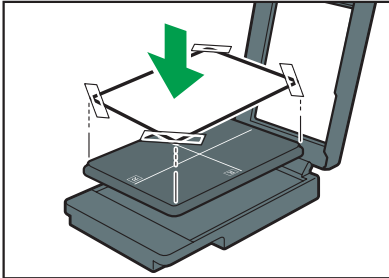

DYX111

You also need to adjust the height of the tray. For details, see "Adjusting the Height of the Tray", Operating Instructions.

Regular maintenance

If the message prompt to perform regular maintenance appears, clean both the Maintenance Unit and print head. Even if the message does not appear, performing regular maintenance may resolve image quality problems.

For details, see "Cleaning the Maintenance Unit" or "Cleaning the Print Head Nozzles", Maintenance Guide.

Cleaning the interior

Clean the interior if you do not use the machine for three months or longer.

For details, see "Clean Internals" in "Using the [Maintenance] Menu" in "Machine Setup Menus", Operating Instructions.

Replacing an Ink Cartridge

Preparing an Ink cartridge

★ Important

- If the ink cartridge has been empty for a long time, you will not be able to perform the maintenance for the print head. This may cause a printer malfunction.
- Do not push the right front cover to insert the ink cartridge when replacing it.

Make sure you always have a new ink cartridge. Install it soon after the message about replacement appears.







Preparing a new ink cartridge

When  appears on the display, the ink will run out soon. Get ready to install a new ink cartridge.



Time to replace ink cartridges

When  or  appears on the display, the ink has run out. Replace the ink cartridge for the color indicated by  or .

If the message "Open Front Cover / Replace Ink Crtg" appears on the display and the alert indicator lights up in red, this machine will stop operating.

Procedure to replace an Ink cartridge

CAUTION

- Keep ink and ink containers out of reach of children.
- If ink gets into contact with eyes, wash eyes immediately with running water. Consult a doctor if necessary.
- When replacing ink, avoid getting ink on your clothing. If ink comes into contact with your clothing, wash the stained area with cold water. Hot water will set the ink into the fabric and make removing the stain impossible.
- When replacing ink, avoid getting ink on your skin. If ink comes into contact with your skin, wash the affected area thoroughly with soap and water.
- When removing the ink cartridge, avoid putting your hand near the place where the ink cartridge is installed. If ink comes in contact with your hands, wash them thoroughly with soap and water.

- 1** Take the ink cartridge out of the box, and then open the right front cover.

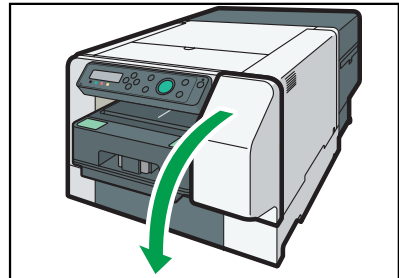

DYX030

- 2** Take out the empty cartridges.

While taking out the cartridges, be sure to hold the machine firmly so that it does not move.

3 Check the cartridges' orientation, and then push each cartridge in fully.

Install in the following order from the left: black, cyan, magenta, and yellow.

4 Close the right front cover.

- Make sure that the ink cartridge has been fully pushed in before closing the right front cover.
 - The machine starts feeding ink into its print heads. Leave the machine idle until the message "Ready" appears.
-

Note

- If an error occurs in the printer, resolve it, and then replace the ink cartridge.
- You might hear a clicking sound while the print heads are being filled. This is not a malfunction.

RICOH Ri 100/
RICOH Ri 100 Pink/RICOH Ri 100 Green

User's Guide

1 Names of Components

2 Printing on Fabric

3 If Errors Occur

4 If Print Results Are Not Satisfactory

5 Machine Maintenance

6 Replacing Consumables