

RYOBI®

700r

2-Cycle Gas Trimmer

OPERATOR'S MANUAL



FOR QUESTIONS, CALL 1-800-345-8746 in U.S. or
1-800-265-6778 in CANADA

www.ryobi.com

IMPORTANT MANUAL

DO NOT THROW AWAY

INTRODUCTION

THANK YOU

Thank you for buying this quality product. This modern outdoor power tool will provide many hours of useful service. You will find it to be a great labor-saving device. This operator's manual provides you with easy-to-understand operating instructions. Read the whole manual and follow all the instructions to keep your new outdoor power tool in top operating condition. The other manual that came with your power tool, the parts manual, contains all the information that you need to order parts.

PRODUCT REFERENCES, ILLUSTRATIONS AND SPECIFICATIONS

All information, illustrations and specifications in this manual are based on the latest product information available at the time of printing. We reserve the right to make changes at any time without notice.

Copyright© 1998 Ryobi Outdoor Products, Inc. All Rights Reserved.

Bump Head™ is a trademark of Ryobi Outdoor Products.

SERVICE INFORMATION

Service on this unit both within and after the warranty period should be performed only by an authorized and approved service dealer.

Dial:

1-800-345-8746 in the United States or

1-800-265-6778 in Canada

to obtain the listing of the authorized service dealer nearest you.

DO NOT RETURN THE UNIT TO THE RETAILER.

NOTE: PROOF OF PURCHASE WILL BE REQUIRED FOR WARRANTY SERVICE.

Make sure this manual is carefully read and understood before starting or operating this equipment.

THIS PRODUCT IS COVERED BY ONE OR MORE OF THE US PATENTS LISTED BELOW:
5,076,149; 4,901,682; 4,779,405; 4,651,422;
4,505,040; 4,463,498; 4,369,742; 4,342,236;
4,223,441; 2,125,688; D-249,012; D-239,329;

OTHER PATENTS PENDING.

TABLE OF CONTENTS

I.	California Emission Regulations	3
II.	Rules for Safe Operation	4-8
	A. Important Safty Information	4-6
	B. Safety and International Symbols . . .	6-7
	C. Know Your Unit	8
III.	Assembly Instructions	9-10
	A. Installing and Adjusting D-Handle . . .	9
	B. Installing Cutting Attachment Shield .	10
IV.	Oil and Fuel Information	11
V.	Starting/Stopping Instructions	12
VI.	Operating Instructions	13-14
	A. Holding the Trimmer	13
	B. Adjusting Trimming Line Length . . .	13
	C. Tips for Best Trimming Results	14
	D. Decorative Trimming	14
VII.	Maintenance and Repair Instructions .	14-20
	A. Maintenance Schedule	14
	B. Winding the Inner Reel with New Line	15
	C. Installing a Prewound Reel	17
	D. Air Filter Maintenance	17-18
	E. Removing the Air Filter/Muffler Cover	17
	F. Cleaning the Air Filter	18
	G. Reinstalling the Air Filter/Muffler Cover	18
	H. Carburetor Adjustment	19
	I. Replacing the Spark Plug	20
	J. Accessories and replacement parts .	20
VIII.	Cleaning and Storage	21
IX.	Transporting	21
X.	Troubleshooting Chart	22
XI.	Specifications	23
XII.	Warranty	26-27

CONTENTS OF CARTON

This unit should consist of the following:

- Model 700r Trimmer
- D-Handle and Hardware
- Cutting Attachment Shield and Hardware
- Bottle of 2-Cycle Oil
- Operator's Manual
- Parts Manual
- Product Registration Card
- These items may be in the hardware bag or assembled on your unit.

CALIFORNIA EMISSION REGULATIONS

This unit meets the 1995 to 1998 California emissions regulations for small off-road engines. These units are identified by the label on the engine of your product. A typical identification label is shown. To ensure that your unit continues to meet these regulations, refer to the following information and instructions in this operator's manual.

RYOBI®

IMPORTANT ENGINE INFORMATION

ENGINE DISPLACEMENT: *31cc*
ENGINE FAMILY: *SN4031UB24RA; EM*
THIS ENGINE CONFORMS TO U.S. EPA PH1
AND 1995-1998 CALIFORNIA EMISSION
REGULATIONS FOR ULGE ENGINES.
REFER TO OPERATOR'S MANUAL FOR
MAINTENANCE SPECIFICATIONS
AND ADJUSTMENTS.

California Proposition 65 Warning:



WARNING



THE ENGINE EXHAUST FROM THIS
PRODUCT CONTAINS CHEMICALS
KNOWN TO THE STATE OF
CALIFORNIA TO CAUSE CANCER,
BIRTH DEFECTS OR OTHER
REPRODUCTIVE HARM.

SPARK ARRESTOR

NOTE: For users on U.S. Forest Land and in the states of California, Maine, Oregon and Washington. All U.S. Forest Land and the states of California (Public Resources Codes 4442 and 4443), Oregon and Washington require, by law that certain internal combustion engines operated on forest brush and/or grass-covered areas be equipped with a spark arrestor, maintained in effective working order, or the engine be constructed, equipped and maintained for the prevention of fire. Check with your state or local authorities for regulations pertaining to these requirements. Failure to follow these requirements could subject you to liability or a fine. **This unit is not factory equipped with a spark arrestor.** If these items are required in your area, ask your LOCAL SERVICE dealer to install the **Optional Accessory Part #180030 Spark Arrestor Kit.**

WARNING!

Read the Operator's Manual(s) and follow all warnings and safety instructions. Failure to do so can result in serious injury to the operator and/or bystanders.

FOR QUESTIONS, CALL 1-800-345-8746 IN U.S. OR 1-800-265-6778 in CANADA

RULES FOR SAFE OPERATION

The purpose of safety symbols is to attract your attention to possible dangers. The safety symbols, and their explanations, deserve your careful attention and understanding. The safety warnings do not by themselves eliminate any danger. The instructions or warnings they give are not substitutes for proper accident prevention measures.

SYMBOL	MEANING
	SAFETY ALERT SYMBOL: Indicates danger, warning, or caution. Attention is required in order to avoid serious personal injury. May be used in conjunction with other symbols or pictographs.
	NOTE: Advises you of information or instructions vital to the operation or maintenance of the equipment.



DANGER: Failure to obey a safety warning will result in serious injury to yourself or to others. Always follow the safety precautions to reduce the risk of fire, electric shock, and personal injury.



WARNING: Failure to obey a safety warning can result in injury to yourself and others. Always follow the safety precautions to reduce the risk of fire, electric shock, and personal injury.



CAUTION: Failure to obey a safety warning may result in property damage or personal injury to yourself or to others. Always follow the safety precautions to reduce the risk of fire, electric shock, and personal injury.

• IMPORTANT SAFETY INFORMATION •

READ ALL INSTRUCTIONS BEFORE OPERATING

- Read the instructions carefully. Be familiar with the controls and proper use of the unit.
- Do not operate this unit when tired, ill, or under the influence of alcohol, drugs, or medication.
- Children and teens under the age of 15 must not use the unit, except for teens guided by an adult.
- Inspect the unit before use. Replace damaged parts. Check for fuel leaks. Make sure all fasteners are in place and secure. Replace cutting attachment parts that are cracked, chipped, or damaged in any way. Make sure the cutting attachment is properly installed and securely fastened. Be sure the cutting attachment shield is properly attached, and positioned as recommended. Failure to do so can result in personal injury to the operator and bystanders, as well as damage to the unit.
- Use only 0.080 in. (2.03 mm) diameter genuine Ryobi replacement line. Never use metal-reinforced line, wire, or rope, etc.. These can break off and become a dangerous projectile.

- Be aware of the risk of injury to the head, hands and feet.
- Clear the area to be cut before each use. Remove all objects such as rocks, broken glass, nails, wire, or string which can be thrown or become entangled in the cutting attachment. Clear the area of children, bystanders, and pets. At a minimum, keep all children, bystanders and pets outside a 50 ft. (15m.) radius; there still may be a risk to bystanders from thrown objects. Bystanders should be encouraged to wear eye protection. If you are approached, stop the engine and cutting attachment immediately.
- Squeeze the throttle control and check that it returns automatically to the neutral position. Make all adjustments or repairs before using unit.
- This unit was not designed to be used as a brushcutter. Do not attach or operate this unit with any type of brushcutting blade or brushcutting attachment.

SAFETY WARNINGS FOR GAS TRIMMERS

WARNING: Gasoline is highly flammable, and its vapors can explode if ignited. Take the following precautions:

RULES FOR SAFE OPERATION

- Store fuel only in containers specifically designed and approved for the storage of such materials.
- Always stop the engine and allow it to cool before filling the fuel tank. Never remove the cap of the fuel tank, or add fuel, when the engine is hot. Never operate the unit without the fuel cap securely in place. Loosen the fuel tank cap slowly to relieve any pressure in the tank.
- Mix and add fuel in a clean, well-ventilated area outdoors where there are no sparks or flames. Slowly remove the fuel cap only after stopping engine. Do not smoke while fueling or mixing fuel. Wipe up any spilled fuel from the unit immediately.
- Avoid creating a source of ignition for spilled fuel. Do not start the engine until fuel vapors dissipate.
- Move the unit at least 30 ft. (9.1 m) from the fueling source and site before starting the engine. Do not smoke, keep sparks and open flames from the area while adding fuel or operating the unit.
- Avoid accidental starting. Be in the starting position whenever pulling the starter rope. The operator and unit must be in a stable position while starting. See **Starting/Stopping** Instructions.
- Use the right tool. Only use this tool for the purpose intended.
- Do not overreach. Always keep proper footing and balance.
- Always hold the unit with both hands when operating. Keep a firm grip on both the front and rear handle or grips.
- Keep hands, face, and feet at a distance from all moving parts. Do not touch or try to stop the cutting attachment when it is rotating.
- Do not touch the engine or muffler. These parts get extremely hot from operation. When turned off they remain hot for a short time.
- Do not operate the engine faster than the speed needed to cut, trim or edge. Do not run the engine at high speed when not cutting.

WHILE OPERATING

- Never start or run the unit inside a closed room or building. Breathing exhaust fumes can kill. Operate this unit only in a well ventilated area outdoors.
- Wear safety glasses or goggles that are marked as meeting ANSI Z87.1-1989 standards, and ear/hearing protection when operating this unit. Wear a face or dust mask if the operation is dusty. Long sleeve shirts are recommended.
- Wear heavy, long pants, boots and gloves. Do not wear loose clothing, jewelry, short pants, sandals or go barefoot. Secure hair above shoulder level.
- The cutting attachment shield must always be in place while operating the unit. Do not operate unit without both trimming lines extended, and the proper line installed. Do not extend the trimming line beyond the length of the shield.
- This unit does not have a clutch. The cutting attachment rotates when the engine is idling.
- Adjust the D-handle to your size to provide the best grip.
- Be sure the cutting attachment is not in contact with anything before starting the unit.
- Use the unit only in daylight or good artificial light.
- Always stop the engine when cutting is delayed or when walking from one cutting location to another.
- If you strike or become entangled with a foreign object, stop the engine immediately and check for damage. Do not operate before repairing damage. Do not operate the unit with loose or damaged parts.
- Stop and switch the engine to off for maintenance, repair, or for changing the cutting attachment or other attachments.
- Use only genuine Ryobi replacement parts when servicing this unit. These parts are available from your authorized service dealer. Do not use parts, accessories or attachments not authorized by Ryobi for this unit. Doing so could lead to serious injury to the user, or damage to the unit, and void your warranty.
- Keep unit clean of vegetation and other materials. They may become lodged between the cutting attachment and shield.
- To reduce fire hazard, replace faulty muffler and spark arrestor, keep the engine and muffler free from grass, leaves, excessive grease or carbon build up.

RULES FOR SAFE OPERATION

OTHER SAFETY WARNINGS







- Never store the unit, with fuel in the tank, inside a building where fumes may reach an open flame or spark.
- Allow the engine to cool before storing or transporting. Be sure to secure the unit while transporting.
- Store the unit in a locked up and dry or high and dry place to prevent unauthorized use or damage, out of the reach of children.

- Never douse or squirt the unit with water or any other liquid. Keep handles dry, clean and free from debris. Clean after each use, see **Cleaning and Storage** instructions.
- Keep these instructions. Refer to them often and use them to instruct other users. If you loan someone this unit, also loan them these instructions.

SAVE THESE INSTRUCTIONS

SAFETY AND INTERNATIONAL SYMBOLS

This operator's manual describes safety and international symbols and pictographs that may appear on this product. Read the operator's manual for complete safety, assembly, operating and maintenance and repair information.

SYMBOL	MEANING
	<ul style="list-style-type: none"> • SAFETY ALERT SYMBOL Indicates danger, warning, or caution. May be used in conjunction with other symbols or pictographs.
	<ul style="list-style-type: none"> • WARNING - READ OPERATOR'S MANUAL Read the Operator's Manual(s) and follow all warnings and safety instructions. Failure to do so can result in serious injury to the operator and/or bystanders.
	<ul style="list-style-type: none"> • FOR SERVICE INFORMATION, CALL: USA: 1-800-345-8746 CANADA: 1-800-265-6778
	<ul style="list-style-type: none"> • WEAR EYE AND HEARING PROTECTION WARNING: Thrown objects and loud noise can cause severe eye injury and hearing loss. Wear eye protection meeting ANSI Z87.1-1989 standards and ear protection when operating this unit.
	<ul style="list-style-type: none"> • KEEP BYSTANDERS AWAY WARNING: Keep all bystanders, especially children and pets, at least 50 feet (15 m.) from the trimming area.
	<ul style="list-style-type: none"> • PRIMER BULB Push primer bulb, fully and slowly, 5 to 7 times.
	<ul style="list-style-type: none"> • UNLEADED FUEL Always use clean, fresh unleaded fuel.

RULES FOR SAFE OPERATION

SYMBOL	MEANING
	<ul style="list-style-type: none"> • THROWN OBJECTS AND ROTATING CUTTER CAN CAUSE SEVERE INJURY WARNING: Do not operate without the cutting attachment shield in place. Keep away from the rotating cutting attachment.
	<ul style="list-style-type: none"> • ON/OFF STOP CONTROL ON / START / RUN
	<ul style="list-style-type: none"> • ON/OFF STOP CONTROL OFF OR STOP
	<ul style="list-style-type: none"> • HOT SURFACE WARNING Do not touch a hot muffler or cylinder. You may get burned. These parts get extremely hot from operation. When turned off they remain hot for a short time.
	<ul style="list-style-type: none"> • SHARP BLADE WARNING: There is a sharp blade on the cutting attachment shield. To prevent serious injury, do not touch blade.
	<ul style="list-style-type: none"> • DO NOT USE BLADES WARNING: To prevent serious injury, do not attach or operate the unit with any type of blade.
	<ul style="list-style-type: none"> • INDICATES OIL Refer to operator's manual for the proper type of oil.
	<ul style="list-style-type: none"> • CHOKE CONTROL A • FULL CHOKE position. B • PARTIAL CHOKE position. C • RUN position.



WARNING: The operation of any power tool can cause foreign objects to be thrown into your eyes. This can lead to severe eye damage. Before commencing power tool operation, always wear safety glasses or goggles that are marked as meeting ANSI Z87.1-1989 standards, and a full face shield when needed.

RULES FOR SAFE OPERATION

KNOW YOUR UNIT

APPLICATION

Use this unit for;

- Cutting grass and light weeds.
- Decorative trimming around trees, fences, etc.

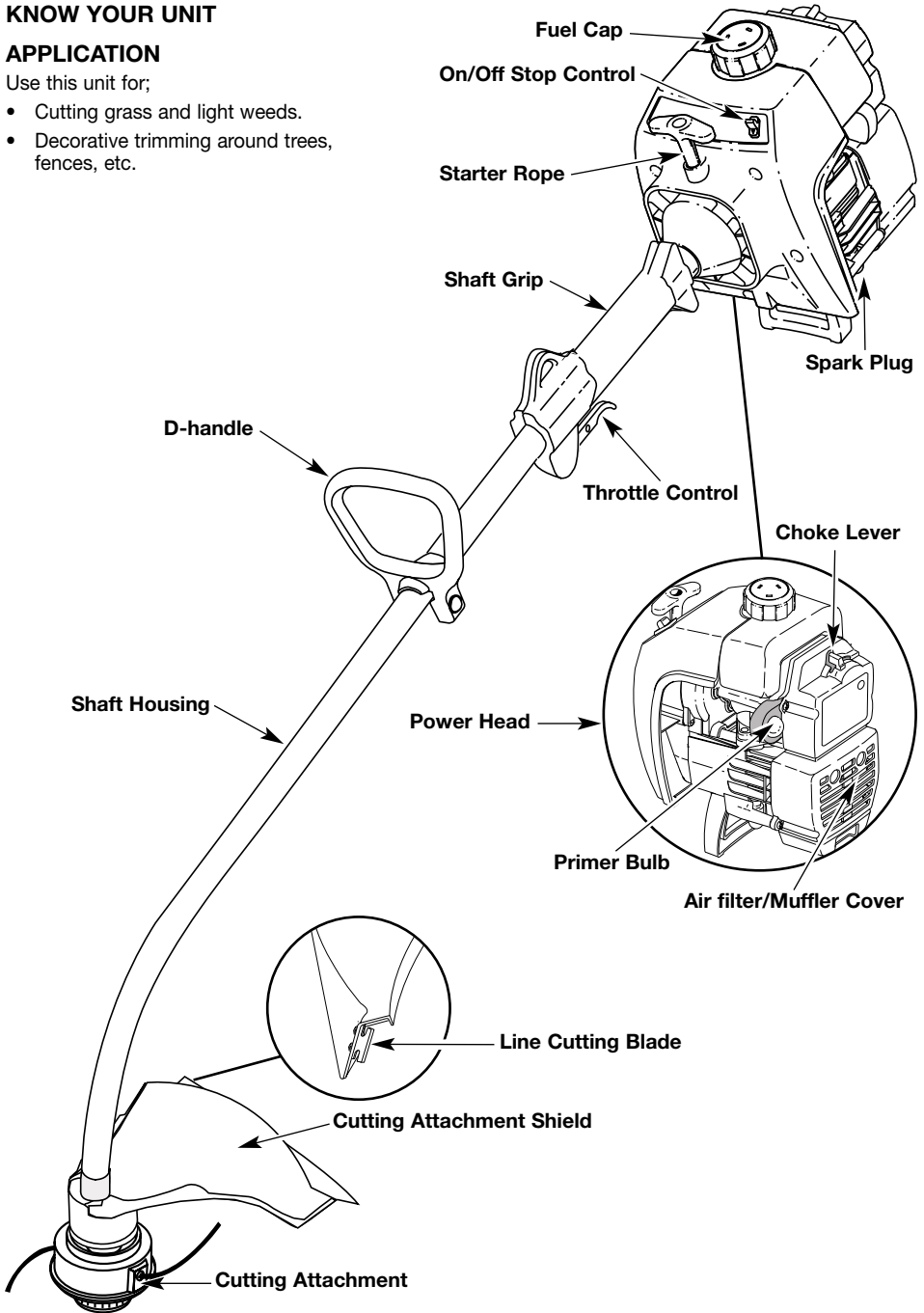

ASSEMBLY INSTRUCTIONS

INSTALLING AND ADJUSTING THE D-HANDLE

1. Push the D-handle down onto the shaft housing so that the handle slants to the powerhead (Fig. 1). The squared bolt hole in the handle is to the right.

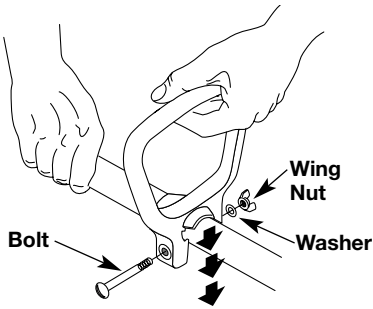

Fig. 1

2. Insert the shoulder bolt into the squared hole in the handle. Place the washer on the bolt, and screw the wing nut onto the bolt.
3. Rotate the D-handle to place the grip above the top of the shaft housing.
4. While holding the unit in the operating position (Fig. 2), position the D-handle to the location that provides you the best grip.



Fig. 2

5. Tighten the wing nut (Fig. 3).

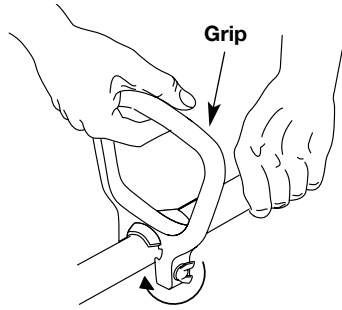

Fig. 3

ASSEMBLY INSTRUCTIONS

INSTALLING THE CUTTING ATTACHMENT SHIELD

Use the following instructions if the cutting attachment shield on your unit is not installed.



WARNING: Never operate the trimmer without the cutting attachment shield in place to prevent serious personal injury.

1. Place the cutting attachment shield onto the shaft housing above the clamp assembly, so that the shield is in front of the cutting attachment (Fig. 4).

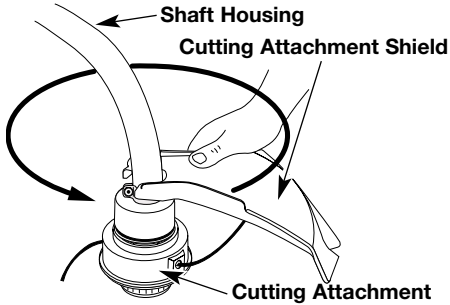

Fig. 4

2. Push the cutting attachment shield down to the top of the cutting attachment assembly. Rotate the cutting attachment shield so that it points to the engine, and the holes in the cutting attachment shield line up with the holes in the top of the cutting attachment assembly (Fig. 5).
3. Install the four (4) screws with a small Phillips screwdriver (Fig. 5).

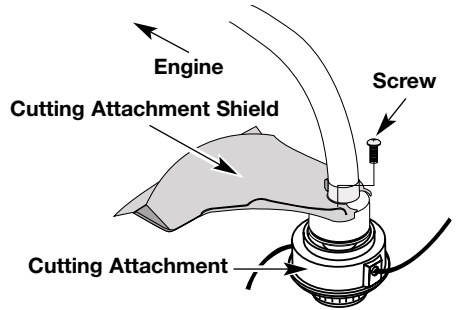



Fig. 5

OIL AND FUEL INFORMATION

OIL AND FUEL MIXING INSTRUCTIONS

 Old and/or improperly mixed fuel are the main reasons for the unit not running properly. Be sure to use fresh, clean unleaded fuel. Follow the instructions carefully for the proper fuel/oil mixture.

Definition of Blended Fuels

Today's fuels are often a blend of gasoline and oxygenates such as ethanol, methanol or MTBE (ether). Alcohol-blended fuel absorbs water. As little as 1% water in the fuel can make fuel and oil separate. It forms acids when stored. When using alcohol-blended fuel, use fresh fuel (less than 60 days old).

Using Blended Fuels

If you choose to use a blended fuel, or its use is unavoidable, follow recommended precautions.

- Always use fresh fuel mix per your operator's manual.
- Use the fuel additive STA-BIL® or an equivalent.
- Always agitate the fuel mix before fueling the unit.
- Drain the tank and run the engine dry before storing the unit.

Using Fuel Additives

The use of fuel additive, such as STA-BIL® Gas Stabilizer or an equivalent, will inhibit corrosion and minimize the formation of gum deposits. Using a fuel additive can keep fuel from forming harmful deposits in the carburetor for up to six (6) months. Add 0.8 oz. (23 ml.) of fuel additive per gallon of fuel according to the instructions on the container. NEVER add fuel additives directly to the unit's fuel tank.





CAUTION: For proper engine operation and maximum reliability, pay strict attention to the oil and fuel mixing instructions on the 2-cycle oil container. Using improperly mixed fuel can severely damage the engine.



Thoroughly mix the proper ratio of 2-cycle engine oil with unleaded gasoline in a separate fuel can. Use a 32:1 fuel/oil ratio. Do not mix them directly in the engine fuel tank. See the table below for specific gas and oil mixing ratios.

NOTE: One gallon (3.8 liters) of unleaded gasoline mixed with one 4 oz. (120 ml.) bottle of RYOBI 2 CYCLE OIL makes a 32:1 fuel/oil ratio.

	+	
UNLEADED GAS		RYOBI 2 CYCLE OIL
1 US. GALLON	+	4.0 FL. OZ.
(3.8 LITERS)		(120 ml)
1 LITER + 30 ml		
=		
MIXING RATIO - 32:1		



WARNING: Gasoline is extremely flammable. Ignited Vapors may explode. Always stop the engine and allow it to cool before filling the fuel tank. Do not smoke while filling the tank. Keep sparks and open flames at a distance from the area.



WARNING: Remove fuel cap slowly to avoid injury from fuel spray. Never operate the unit without the fuel cap securely in place.



WARNING: Add fuel in a clean, well ventilated area outdoors. Wipe up any spilled fuel immediately. Avoid creating a source of ignition for spilled fuel. Do not start the engine until fuel vapors dissipate.

NOTE: Dispose of the old fuel/oil mix in accordance to Federal, State, and Local regulations.

STARTING/STOPPING INSTRUCTIONS

STARTING INSTRUCTIONS



WARNING: Avoid accidental starting. Be in the starting position when pulling the starter rope (Fig. 8). The operator and unit must be in a stable position while starting to avoid serious personal injury.

1. Mix gas with oil. Fill fuel tank with fuel/oil mixture. See **Oil and Fuel Mixing Instructions** Pg. 11.
2. Put the On/Off Stop Control in the **ON** position (Fig. 6).

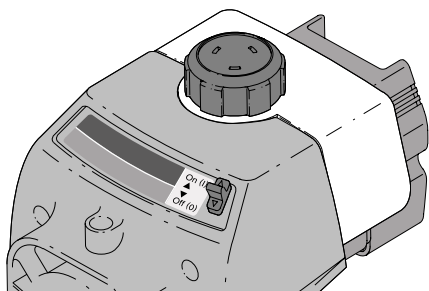

Fig. 6

3. Fully press and release primer bulb 5 to 7 times. Fuel should be visible in the bulb (Fig. 7).

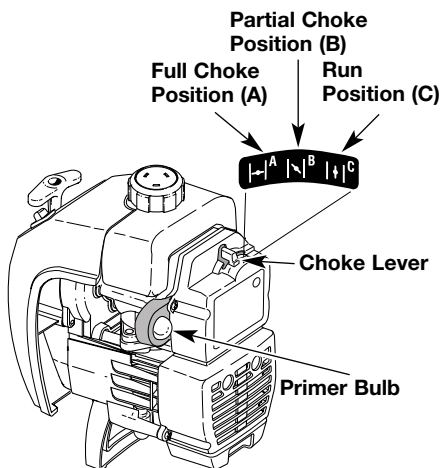

Fig. 7

4. Place the choke lever in the **FULL** choke position (**A**) (Fig. 7).

5. With the unit on the ground, squeeze the throttle control and pull starter rope briskly (Fig. 8). Continue pulling until the engine sounds as though it wants to run (normally 2 to 5 pulls).

NOTE: Squeeze the throttle control until the engine has started and warmed up.

6. Place the choke lever in the **PARTIAL** choke position (**B**) (Fig. 7).
7. Pull starter rope briskly 1 to 3 times to start the engine (Fig. 8).

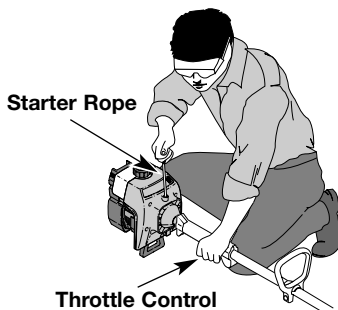

Fig. 8

8. If the engine does not start, repeat steps 4 through 7.

NOTE: If the engine floods while trying to start, place the choke lever in the **RUN** position (**C**). Squeeze the throttle control. Pull the starter rope briskly. The engine should start within three (3) to eight (8) pulls.

9. Squeeze the throttle control to warm up engine for 5 to 10 seconds. Place the choke lever in the **RUN** position (**C**) (Fig. 7).

NOTE: Choking is unnecessary when starting a warm engine. Put the On/Off Stop Control in the **ON** position (Fig. 9), and start in with the choke in the **PARTIAL** position (**B**) (Fig. 7).



WARNING: Operate this unit only in a well ventilated area outdoors. Carbon monoxide exhaust fumes can be lethal in a confined area.

STOPPING INSTRUCTIONS

1. Release your hand from the throttle control (Fig. 8). Allow the engine to cool down by idling.
2. Put the On/Off Stop Control in the **OFF** position (Fig. 6).

OPERATING INSTRUCTIONS

HOLDING THE TRIMMER



WARNING: Always wear eye, hearing, foot and body protection to reduce the risk of injury when operating this unit.

Before operating the unit, stand in the operating position (Figs. 9). Check for the following:

- The operator is wearing eye protection and proper clothing.
- The right arm is slightly bent, and the hand is holding the shaft grip.
- The left arm is straight, and the hand is holding the handle.
- The unit is below waist level.
- The cutting attachment is parallel to the ground and easily contacts the vegetation to be cut without the operator having to bend over.



Fig. 9

ADJUSTING TRIMMING LINE LENGTH

The Bump Head™ cutting attachment allows you to release trimming line without stopping the engine. To release more line, lightly tap the cutting attachment on the ground (Fig. 10) while operating the trimmer at high speed.

NOTE: Always keep the trimming line fully extended. Line release becomes more difficult as cutting line becomes shorter.

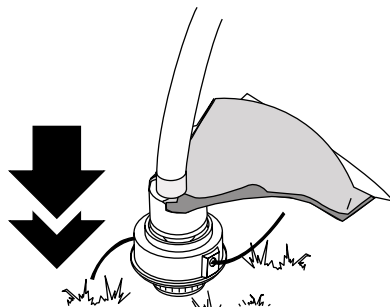

Fig. 10

Each time the head is bumped, about 1 in. (25.4 mm.) of trimming line is released. A blade in the cutting attachment shield will cut the line to the proper length if excess line is released.

For best results, tap the Bump Head™ on bare ground or hard soil. If line release is attempted in tall grass, the engine may stall. Always keep the trimming line fully extended. Line release becomes more difficult as the cutting line becomes shorter.

NOTE: Do not rest the Bump Head™ on the ground.



CAUTION: Do not remove or alter the line cutting blade assembly. Excessive line length will make the clutch overheat. This may lead to serious personal injury or damage to the unit.

Some line breakage will occur from:

- Entanglement with foreign matter
- Normal line fatigue
- Attempting to cut thick, stalky weeds
- Forcing the line into objects such as walls or fence posts

OPERATING INSTRUCTIONS

TIPS FOR BEST TRIMMING RESULTS

- The correct angle for the cutting attachment is parallel to the ground.
- Do not force the cutting attachment. Allow the tip of the line to do the cutting (especially along walls). Cutting with more than the tip will reduce cutting efficiency and may overload the engine.
- Cut grass over 8 in. (200 mm.) by working from top to bottom in small increments to avoid premature line wear or engine drag.
- Cut from right to left whenever possible. Cutting to the left improves the unit's cutting efficiency. Clippings are thrown away from the operator.
- Slowly move the trimmer into and out of the cutting area at the desired height. Move either in a forward-backward or side-to-side motion. Cutting shorter lengths produces the best results.
- Trim only when grass and weeds are dry.
- The life of your cutting line is dependent upon;
 - Following the previous trimming techniques
 - What vegetation is being cut
 - Where it's being cut

For example, the line will wear faster when trimming against a foundation wall as opposed to trimming around a tree.

DECORATIVE TRIMMING

Decorative trimming is accomplished by removing all vegetation around trees, posts, fences, etc.

Rotate the whole unit so that the cutting attachment is at a 30° angle to the ground (Fig. 11).

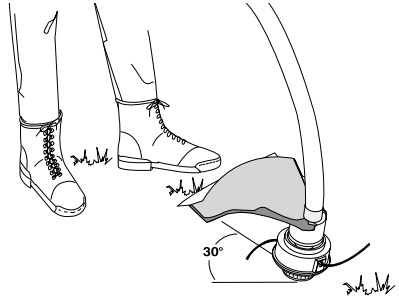

Fig. 11

MAINTENANCE AND REPAIR INSTRUCTIONS

NOTE: Some maintenance procedures may require special tools or skills. If you are unsure about these procedures take your unit to an authorized service dealer.



WARNING: Never do maintenance or repairs with unit running. Always do maintenance and repairs on a cool unit. Disconnect spark plug wire to ensure the unit will not start.

MAINTENANCE SCHEDULE

These required maintenance procedures should be performed at the frequency stated in the table. They should also be included as part of any seasonal tune-up.

FREQUENCY	MAINTENANCE REQUIRED	REFER TO:
Before Starting Engine	Fill fuel tank with correct oil and fuel mixture.	Page 11
Every 10 Hours	Clean and re-oil air filter.	Page 18
Every 50 Hours	Check spark plug condition and gap.	Page 20

MAINTENANCE AND REPAIR INSTRUCTIONS

LINE INSTALLATION

Always use genuine Ryobi 0.080 in. (2.03 mm.) replacement line. Larger line may make the engine overheat or fail.

WARNING: Do not use metal reinforced line.

There are two methods to replace the trimming line.

- Wind the inner reel with new line
- Install a prewound inner reel

NOTE: Replacement line Part # 610375, or a prewound reel, Part # 153577 can be purchased from you local authorized dealer.

Winding the Existing Inner Reel

1. Hold the outer spool with one hand and unscrew the Bump Knob™ counterclockwise (Fig. 12). Inspect the bolt inside the Bump Knob™ to make sure it moves freely. Replace the Bump Knob™ if damaged.

NOTE: A Bump Knob™, Part # 153066 can be purchased from you local authorized dealer.

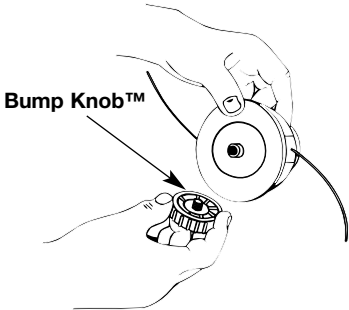

Fig. 12

2. Remove the inner reel from the outer spool (Fig. 13).
3. Remove spring from the inner reel (Fig. 13).

NOTE: An inner reel spring, Part # 610317 can be purchased from you local authorized dealer.

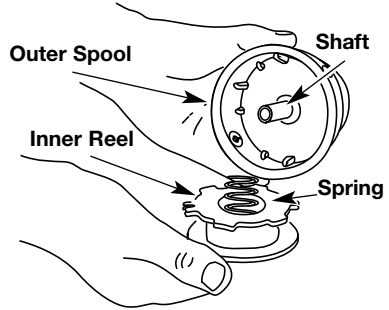

Fig. 13

4. Use a clean cloth to clean the the inner reel, spring, shaft, and inner surface of the outer spool (Fig. 14).

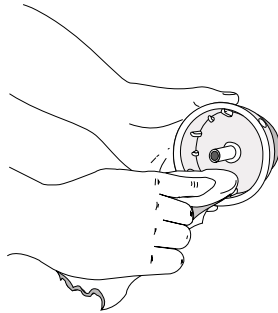

Fig. 14

5. Check the indexing teeth on the inner reel and outer spool for wear (Fig. 15). If necessary, remove burrs or replace the reel and spool.

NOTE: A cutting attachment head assembly, Part # 180879 can be purchased from you local authorized dealer.

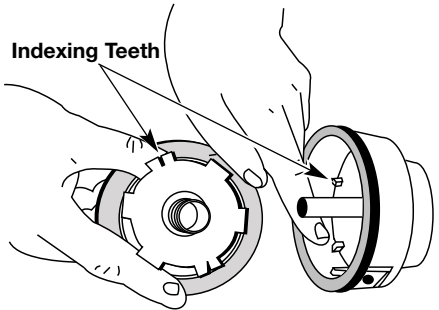

Fig. 15

MAINTENANCE AND REPAIR INSTRUCTIONS

6. Take approximately 25 feet (7.6 m) of new 0.080 in. (2.03 mm.) trimming line, loop it into two equal lengths. Insert each end of the line through one of the two holes in the inner reel (Fig. 16). Pull the line through the inner reel so that the loop is as small as possible.

NOTE: Always use the correct line length when installing trimming line on the unit. The line may not release properly if the line is too long.

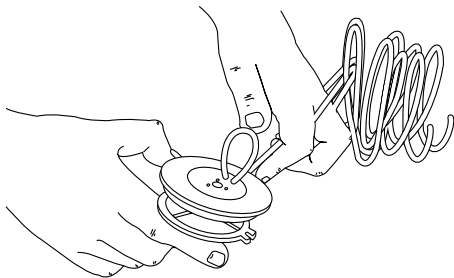

Fig. 16

7. Wind the lines in tight even layers, onto the reel (Fig. 17). Wind the line in the direction indicated on the inner reel. Place your index finger between the two lines to stop the lines from overlapping. Do not overlap the ends of the line.

NOTE: Failure to wind the line in the direction indicated will cause the cutting attachment to operate incorrectly.

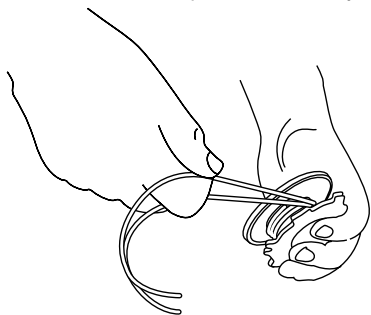

Fig. 17

8. Insert the ends of the line into the two holding slots (Fig. 18).

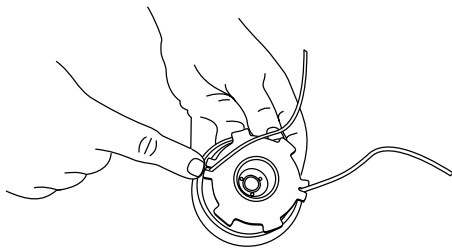

Fig. 18

9. Place the spring in the inner reel. Insert the ends of the line through the eyelets in the outer spool and place inner reel inside the outer spool (Fig. 19). Push the inner reel and outer spool together. While holding the inner reel and outer spool together, grasp the ends and pull firmly to release the line from the holding slots in the spool.

NOTE: The spring must be assembled on the inner reel before reassembling the cutting attachment.

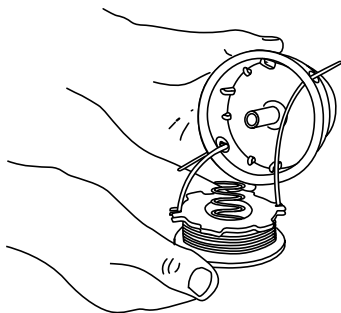

Fig. 19

10. Hold the inner reel in place and install the Bump Knob™ by turning clockwise. Tighten securely.

MAINTENANCE AND REPAIR INSTRUCTIONS

Installing a Prewound Reel

1. Hold the outer spool with one hand and unscrew the Bump Knob™ counterclockwise (Fig. 12, Pg 15). Inspect the bolt inside the Bump Knob™ to make sure it moves freely. Replace the Bump Knob™ if damaged.
2. Remove the old inner reel from the outer spool (Fig. 13), Pg. 15.
3. Remove the spring from the old inner reel (Fig. 13), Pg. 15.
4. Place the spring in the new inner reel. Insert the ends of the line through the eyelets in the outer spool.
5. Place the new inner reel inside the outer spool. Push the inner reel and outer spool together. While holding the inner reel and outer spool, grasp the ends and pull firmly to release the line from the holding slots in the spool.

NOTE: The spring must be assembled on the inner reel before reassembling the cutting attachment.

6. Hold the inner reel in place and install the Bump Knob™ by turning clockwise. Tighten securely.

AIR FILTER MAINTENANCE

Removing the Air Filter/Muffler Cover



WARNING: To avoid serious personal injury, always turn your trimmer off and allow it to cool before you clean or do any maintenance on it.

1. Place the choke lever in the **PARTIAL** choke position (**B**).

NOTE: The choke lever must be in the **PARTIAL** choke position (**B**) (Fig. 20) to remove the air filter/muffler cover.

2. Remove the four (4) screws securing the air filter/muffler cover (Fig. 20). Use a flat blade or #20 Torx bit screwdriver.

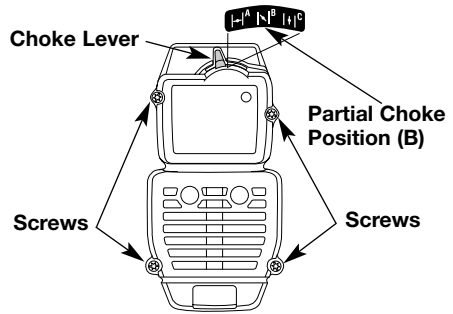

Fig. 20

3. Pull the cover from the engine. Do not force.

MAINTENANCE AND REPAIR INSTRUCTIONS

Cleaning the Air Filter



WARNING: To avoid serious personal injury, always turn your trimmer off and allow it to cool before you clean or do any maintenance on it.

Clean and re-oil the air filter every 10 hours of operation. It is an important item to maintain. Not maintaining the air filter will **VOID** the warranty.

1. Remove air filter/muffler cover. See **Removing the Air filter/Muffler Cover**, Pg. 17.
2. Remove the air filter from behind the air filter/muffler cover (Fig. 21).

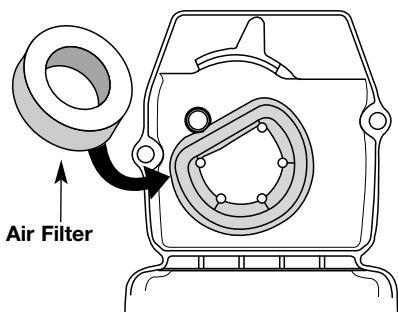

Fig. 21

3. Wash the filter in detergent and water (Fig. 22). Rinse the filter thoroughly. Squeeze out excess water. Allow it to dry completely.

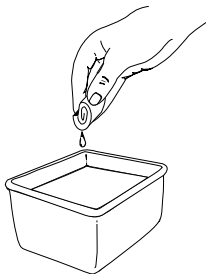

Fig. 22

4. Apply enough clean SAE 30 oil to lightly coat the filter (Fig. 23).

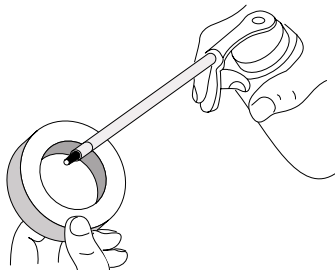

Fig. 23

5. Squeeze the filter to spread and remove excess oil (Fig. 24).

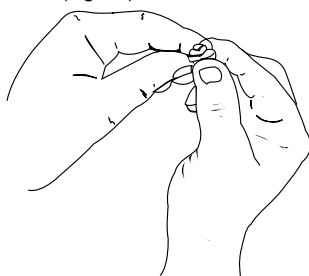

Fig. 24

6. Replace the air filter in the air filter/muffler cover (Fig. 21).

NOTE: Operating the unit without the air filter and air filter/muffler cover assembly, will **VOID** the warranty.

Reinstalling the Air filter/Muffler Cover

1. Place the air filter/muffler cover over the back of the carburetor and muffler.

NOTE: The choke lever must be in the **PARTIAL** choke position (**B**) (Fig. 20, Pg. 17) to install the air filter/muffler cover.

2. Insert the four (4) screws into the holes in the air filter/muffler cover and tighten. Do not over tighten.

MAINTENANCE AND REPAIR INSTRUCTIONS

CARBURETOR ADJUSTMENT

The idle speed of the engine is adjustable through the air filter/muffler cover (Fig. 25).

NOTE: Careless adjustments can seriously damage your unit. An authorized service dealer should make carburetor adjustments.

Check Fuel Mixture

Old and/or improperly mixed fuel is usually the reason for the unit not running properly. Drain and refill the tank with fresh, properly mixed fuel prior to making any adjustments. Refer to Oil and Fuel Information Pg. 11.

Clean Air Filter

The condition of the air filter is important to the operation of the unit. A dirty air filter will restrict air flow and change the air/fuel mixture. This is often mistaken for an out of adjustment carburetor. Check the condition of the air filter before adjusting the idle speed screw. Refer to **Air Filter Maintenance** Pg. 18.

Adjust Idle Speed Screw



WARNING: The cutting attachment may be spinning during idle speed adjustments. Wear protective clothing and observe all safety instructions to prevent serious personal injury.

If after checking the fuel mixture and cleaning the air filter the engine still will not idle, adjust the idle speed screw as follows.

1. Start the engine and let it run at a high idle for a minute to warm up.
2. Release the throttle trigger and let the engine idle. If the engine stops, insert a small phillips or flat blade screwdriver into the hole in the air filter/muffler cover (Fig. 25). Turn the idle speed screw in, clockwise, 1/8 of a turn at a time (as needed) until the engine idles smoothly.

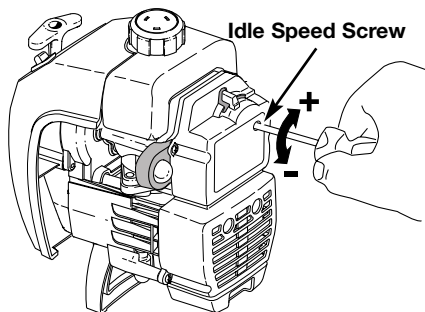

Fig. 25

3. Turn the idle speed screw counterclockwise 1/8 of a turn at a time (as needed), to reduce idle speed.

Checking the fuel mixture, cleaning the air filter, and adjusting the idle speed screw should solve most engine problems.

If not and:

- The engine will not idle,
 - The engine hesitates or stalls on acceleration,
 - There is a loss of engine power,
- have the carburetor adjusted by an authorized service dealer.

MAINTENANCE AND REPAIR INSTRUCTIONS

REPLACING THE SPARK PLUG

Use a Champion RDJ7Y spark plug (or equivalent). The correct air gap is **0.020 in. (0.5 mm.)**. Remove the plug after every 50 hours of operation and check its condition.

1. Stop the engine and allow it to cool. Grasp the plug wire firmly and pull it from the spark plug.
2. Clean dirt from around the spark plug. Remove the spark plug from the cylinder head by turning a 5/8 in. socket counterclockwise.
3. Replace cracked, fouled or dirty spark plug. Set the air gap at **0.020 in. (0.5 mm.)** using a feeler gauge (Fig. 26).



CAUTION: Do not sand blast, scrape, or clean electrodes. Grit in the engine could damage the cylinder.

4. Install a correctly gapped spark plug in the cylinder head. Tighten by turning the 5/8 in. socket clockwise until snug.

If using a torque wrench torque to;

110-120 in. •lb. (12.3-13.5 N•m).

Do not over tighten.

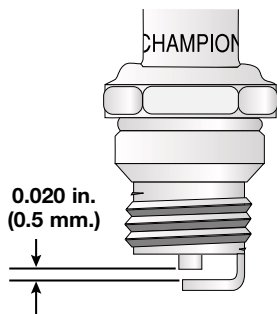

Fig. 26

ACCESSORIES/REPLACEMENT PARTS

2-Cycle Oil	147543
Spark Plug	610311
Replacement Line	610375
Replacement Line Cartridge	153577
Inner Reel Spring	610317
Bump Head Knob Assembly	153066
Head Assembly	180897
Fuel Cap	180000
Shoulder Strap	682075

CLEANING AND STORAGE

CLEANING



WARNING: To avoid serious personal injury, always turn your trimmer off and allow it to cool before you clean or do any maintenance on it.

Use a small brush to clean off the outside of the unit. Do not use strong detergents. Household cleaners that contain aromatic oils such as pine and lemon, and solvents such as kerosene, can damage plastic housing or handle. Wipe off any moisture with a soft cloth.

STORAGE

- Never store the unit with fuel in the tank where fumes may reach an open flame or spark.
- Allow the engine to cool before storing.
- Store the unit locked up to prevent unauthorized use or damage.
- Store the unit in a dry, well ventilated area.
- Store the unit out of the reach of children.

LONG TERM STORAGE

If the unit will be stored for an extended time, use the following storage procedure.

1. Drain all fuel from the fuel tank and drain into a container with the same 2-cycle fuel mixture. Do not use fuel that has been stored for more than 60 days. Dispose of the old fuel/oil mix in accordance to Federal, State, and Local regulations.
2. Start the engine and allow it to run until it stalls. This ensures that all fuel has been drained from the carburetor.
3. Allow the engine to cool. Remove the spark plug and put 1 oz. (30 ml.) of any high quality motor oil or 2-cycle oil into the cylinder. Pull the starter rope slowly to distribute the oil. Reinstall the spark plug.

NOTE: Remove the spark plug and drain all of the oil from the cylinder before attempting to start the trimmer after storage.

4. Thoroughly clean the unit and inspect for any loose or damaged parts. Repair or replace damaged parts and tighten loose screws, nuts or bolts. The unit is ready for storage.

TRANSPORTING

- Allow the engine to cool before transporting.
- Secure the unit while transporting.
- Tighten fuel cap before transporting.

TROUBLESHOOTING

PROBLEM	CAUSE	ACTION
Engine will not start	Ignition switch is OFF Empty fuel tank Primer bulb wasn't pressed enough Engine flooded Old or Improperly Mixed Fuel Fouled spark plug	Turn switch to ON Fill fuel tank Press primer bulb fully and slowly 5-7 times Use starting procedure with choke lever in the RUN position Pg. 12 Drain fuel tank / Add fresh fuel mixture Replace or clean the spark plug
Engine will not idle	Air Filter is Plugged Old or Improperly Mixed Fuel	Replace or clean the air filter Drain fuel tank / Add fresh fuel mixture
Low idle speed	Improper carburetor adjustment	Adjust per instruction Pg. 19
Engine will not accelerate	Old or Improperly Mixed Fuel Improper carburetor adjustment	Drain fuel tank / Add fresh fuel mixture Take to an authorized service dealer for carburetor adjustment
Engine lacks power or stalls when cutting	Cutting head bound with grass Dirty air filter Old or Improperly Mixed Fuel Improper carburetor adjustment	Stop the engine and clean the cutting attachment Clean or replace the air filter Drain fuel tank / Add fresh fuel mixture Take to an authorized service dealer for carburetor adjustment
Cutting head will not advance line	Cutting head bound with grass Cutting head out of line Inner reel bound up Cutting head dirty Line welded Line twisted when refilled Not enough line is exposed	Stop the engine and clean cutting attachment Refill with new line Replace the inner reel Clean inner reel and outer spool Disassemble, remove the welded section and rewind the line Disassemble and rewind the line Push the Bump Knob and pull out line until 4 in. (102 mm.) of line is outside of the cutting attachment

SPECIFICATIONS

ENGINE

Engine Type	Air-Cooled, 2-Cycle
Stroke	1.25 in. (31.75 mm.)
Displacement	1.9 cu in. (31 cc.)
Operating RPM	7,200 - 8,300 rpm
Idle Speed RPM	3,400 - 4,400 rpm
Ignition Type	Electronic
Ignition Switch	Slide Switch
Spark Plug Gap	0.020 in. (0.5 mm.)
Lubrication	Fuel/Oil Mixture
Fuel/Oil Ratio	32:1
Carburetor	Diaphragm, All-Position
Starter	Auto Rewind
Muffler	Baffled with Guard
Throttle	Manual Spring Return
Fuel Tank Capacity	18 oz. (530 ml.)
Fuel Tank	HD Polyethylene

DRIVE SHAFT & STRING HEAD

Drive Shaft Housing	Steel Tube
Throttle Control	Finger-Tip Trigger
Unit Weight (No fuel, with string cutting head, string guard and loop handle)	TBD
Cutting Mechanism	Bump Head
Shoulder Strap	Optional
Line Spool Diameter	3 in. (76.2 mm.)
Trimming Line Diameter	0.080 in. (2.03 mm.)
Cutting Path Diameter	15 in. (38.1 cm.)

NOTES

CALIFORNIA EMISSION CONTROL WARRANTY STATEMENT YOUR WARRANTY RIGHTS AND OBLIGATIONS

The California Air Resources Board and Ryobi Outdoor Products (ROP), are pleased to explain the emission control system warranty on your 1995 and later small off-road engine. In California, new small off-road engines must be designed, built and equipped to meet the State's stringent anti-smog standards. ROP must warrant the emission control system on your small off-road engine for the periods of time listed below provided there has been no abuse, neglect or improper maintenance of your small off-road engine.

Your emission control system may include parts such as the carburetor or fuel injection system, the ignition system, and catalytic converter. Also included may be hoses, belts, connectors and other emission-related assemblies.

Where a warrantable condition exists, ROP will repair your small off-road engine at no cost to you including diagnosis, parts and labor.

The 1995 and later small off-road engines are warranted for two years. If any emission-related part on your engine is defective, the part will be repaired or replaced by ROP.

OWNER'S WARRANTY RESPONSIBILITIES:

- As the small off-road engine owner, you are responsible for the performance of the required maintenance listed in your operator's manual. ROP recommends that you retain all receipts covering maintenance on your small off-road engine, but ROP cannot deny warranty solely for the lack of receipts or for your failure to ensure the performance of all scheduled maintenance.
- As the small off-road engine owner, you should however be aware that ROP may deny you warranty coverage if your small off-road engine or a part has failed due to abuse, neglect, improper maintenance or unapproved modifications.
- You are responsible for presenting your small off-road engine to a Ryobi Authorized Service Center as soon as a problem exists. The warranty repairs should be completed in a reasonable amount of time, not to exceed 30 days.

If you have any questions regarding your warranty rights and responsibilities, you should call 1-800-345-8746.

MANUFACTURER'S WARRANTY COVERAGE:

- The warranty period begins on the date the engine or equipment is delivered to the retail purchaser.
- The manufacturer warrants to the initial owner and each subsequent purchaser, that the engine is free from defects in material and workmanship which cause the failure of a warranted part for a period of two years.
- Repair or replacement of warranted part will be performed at no charge to the owner at an Authorized Ryobi Service Center. For the nearest location, please contact Ryobi at: 1-800-345-8746.
- Any warranted part which is not scheduled for replacement, as required maintenance which is scheduled only for regular inspection to the effect of "Repair or replace as necessary" is warranted for the warranty period. Any warranted part which is scheduled for replacement as required maintenance will be warranted for the period of time up to the first scheduled replacement point for that part.
- The owner will not be charged for diagnostic labor which leads to the determination that a warranted part is defective, if the diagnostic work is performed at an Authorized Ryobi Service Center.
- The manufacturer is liable for damages to other engine components caused by the failure of a warranted part still under warranty.
- Failures caused by abuse, neglect or improper maintenance are not covered under warranty.
- The use of add-on or modified parts can be grounds for disallowing a warranty claim. The manufacturer is not liable to cover failures or warranted parts caused by the use of add-on or modified parts.
- In order to file a claim, go to your nearest Authorized Ryobi Service Center. Warranty services or repairs will be provided at all Authorized Ryobi Service Centers.
- Any manufacturer approved replacement part may be used in the performance of any warranty maintenance or repair of emission related parts and will be provided without charge to the owner. Any replacement part that is equivalent in performance or durability may be used in non-warranty maintenance or repair and will not reduce the warranty obligations of the manufacturer.
- The following components are included in the emission related warranty of the engine, air filter, carburetor, primer, fuel lines, fuel pick up/fuel filter, ignition module, spark plug and muffler.

LIMITED TWO-YEAR WARRANTY

RYOBI OUTDOOR PRODUCTS warrants each new RYOBI Product for two (2) years according to the following terms.

This warranty extends to the original retail purchaser only and commences on the date of original retail purchase.

Any part of the RYOBI Product manufactured or supplied by RYOBI and found in the reasonable judgement of RYOBI to be defective in material or workmanship will be repaired or replaced by an authorized RYOBI service dealer without charge for parts and labor.

The RYOBI Product including any defective part must be returned to an authorized service dealer within the warranty period. The expense of delivering the RYOBI Product to the dealer for warranty work and the expense of returning it back to the owner after repair or replacement will be paid for by the owner. RYOBI's responsibility in respect to claims is limited to making the required repairs or replacements and no claim of breach of warranty shall be cause for cancellation or rescission of the contract of sale of any RYOBI Product. Proof of purchase will be required by the dealer to substantiate any warranty claim. All warranty work must be performed by an authorized RYOBI service dealer.

This warranty is limited to ninety (90) days from the date of original retail purchase for any RYOBI Product that is used for rental or commercial purposes, or any other income-producing purpose.

This warranty does not cover any RYOBI Product that has been subject to misuse, neglect, negligence, or accident, or that has been operated in any way contrary to the operating instructions as specified in the RYOBI Operator's Manual. This warranty does not apply to any damage to the RYOBI Product that is the result of improper maintenance or to any RYOBI Product that has been altered or modified so as to adversely affect the product's operation, performance or durability or that has been altered or modified so as to change its intended use. The warranty does not extend to repairs made necessary by normal wear or by the use of parts or accessories which are either incompatible with the RYOBI Product or adversely affect its operation, performance or durability.

In addition, this warranty does not cover:

- A. Tune-ups - Spark Plugs, Carburetor Adjustments, Filters
- B. Wear items - Bump Knobs, Outer Spools, Cutting Line, Inner Reels, Starter Pulley, Starter Ropes, Drive Belts

RYOBI reserves the right to change or improve the design of any RYOBI Product without assuming any obligation to modify any product previously manufactured.

ALL IMPLIED WARRANTIES ARE LIMITED IN DURATION TO THE TWO (2) YEAR WARRANTY PERIOD OR NINETY (90) DAYS FOR PRODUCTS USED FOR ANY COMMERCIAL PURPOSE. ACCORDINGLY, ANY SUCH IMPLIED WARRANTIES INCLUDING MERCHANTABILITY, FITNESS FOR A PARTICULAR PURPOSE, OR OTHERWISE, ARE DISCLAIMED IN THEIR ENTIRETY AFTER THE EXPIRATION OF THE APPROPRIATE TWO-YEAR OR NINETY DAY WARRANTY PERIOD. RYOBI'S OBLIGATION UNDER THIS WARRANTY, IS STRICTLY AND EXCLUSIVELY LIMITED TO THE REPAIR OR REPLACEMENT OF DEFECTIVE PARTS, AND ROP DOES NOT ASSUME OR AUTHORIZE ANYONE TO ASSUME FOR THEM ANY OTHER OBLIGATION. SOME STATES DO NOT ALLOW LIMITATIONS ON HOW LONG AN IMPLIED WARRANTY LASTS, SO THE ABOVE LIMITATION MAY NOT APPLY TO YOU.

RYOBI ASSUMES NO RESPONSIBILITY FOR INCIDENTAL, CONSEQUENTIAL OR OTHER DAMAGES INCLUDING, BUT NOT LIMITED TO EXPENSE OF RETURNING THE RYOBI PRODUCT TO AN AUTHORIZED SERVICE DEALER AND EXPENSE OF DELIVERING IT BACK TO THE OWNER, MECHANIC'S TRAVEL TIME, TELEPHONE OR TELEGRAM CHARGES, RENTAL OF A LIKE PRODUCT DURING THE TIME WARRANTY SERVICE IS BEING PERFORMED, TRAVEL, LOSS OR DAMAGE TO PERSONAL PROPERTY, LOSS OF REVENUE, LOSS OF USE OF THE PRODUCT, LOSS OF TIME, OR INCONVENIENCE. SOME STATES DO NOT ALLOW THE EXCLUSION OR LIMITATION OF INCIDENTAL OR CONSEQUENTIAL DAMAGES, SO THE ABOVE LIMITATION OR EXCLUSION MAY NOT APPLY TO YOU.

This warranty gives you specific legal rights, and you may also have other rights which vary from state to state.

This warranty applies to all RYOBI Products manufactured by RYOBI and sold in the United States and Canada.

To locate your nearest service dealer dial 1-800-345-8746 in the United States or 1-800-265-6778 in Canada.

RYOBI®

RYOBI OUTDOOR PRODUCTS

550 N. 54th Street
Chandler, AZ 85226 U.S.A.

RYOBI CANADA INC.

275 Industrial Rd
Cambridge, Ontario N1R 6K2 CANADA

**SAVE THESE INSTRUCTIONS FOR FUTURE REFERENCE.
FOR QUESTIONS CALL 1-800-345-8746 IN U.S.**

OR 1-800-265-6778 IN CANADA

OPERATOR'S MANUAL PART NO. 182087

REV. A (7704)

PRINTED IN U.S.A.

9/98