

SAMSUNG

GT-N8000
user manual



Using this manual

Congratulations on your purchase of the Samsung mobile device. This powerful, “go anywhere” device, puts the best of the web and mobile computing at your fingertips in a lightweight, highly versatile platform that fits your active lifestyle. Built on the Google Android operating system, the Samsung mobile device gives you access to thousands of useful and entertaining applications to enrich your mobile web experience.

With integrated wireless access and a responsive touch screen, you can read books and newspapers on the go; stay up-to-date on the latest news, sports, and weather; manage your multimedia and business files; and browse the web for maps, business locations, and more.

Read me first

- Please read all safety precautions and this manual carefully before using your device to ensure safe and proper use.
- The descriptions in this manual are based on the default settings of your device.
- Images and screenshots used in this user manual may differ in appearance from the actual product.
- Content in this user manual may differ from the product, or from software provided by service providers or carriers, and is subject to change without prior notice. Refer to www.samsung.com for the latest version of the user manual.

- Available features and additional services may vary by device, software, or service provider.
- Formatting and delivery of this user manual is based on Google Android operating systems and may vary depending on the user's operating system.
- Applications and their functions may vary by country, region, or hardware specifications. Samsung is not liable for performance issues caused by third-party applications.
- Samsung is not liable for performance issues or incompatibilities caused by edited registry settings or modified operating system software. Attempting to customise the operating system may cause your device or applications to work improperly.
- You may upgrade your mobile device's software by accessing www.samsung.com.
- Software, sound sources, wallpapers, images, and other contents provided in this device are licenced for limited use between Samsung and their respective owners. Extracting and using these materials for commercial or other purposes is an infringement of copyright laws. Samsung is not liable for such copyright infringement by the user.
- Please keep this manual for future reference.

Instructional icons

Before you start, familiarise yourself with the icons you will see in this manual:



Warning—situations that could cause injury to yourself or others



Caution—situations that could cause damage to your device or other equipment



Note—notes, usage tips, or additional information

- ▶ **Refer to**—pages with related information; for example: ▶ p.12 (represents “see page 12”)
- **Followed by**—the order of options or menus you must select to perform a step; for example: Open the application list and select **Settings** → **About device** (represents **Settings**, followed by **About device**)

Copyright

Copyright © 2012 Samsung Electronics

This user manual is protected under international copyright laws.

No part of this user manual may be reproduced, distributed, translated, or transmitted in any form or by any means, electronic or mechanical, including photocopying, recording, or storing in any information storage and retrieval system, without the prior written permission of Samsung Electronics.

Trademarks

- SAMSUNG and the SAMSUNG logo are registered trademarks of Samsung Electronics.
- The Android logo, Google™, Google Maps™, Google Mail™, YouTube™, Google Play™ Store, and Google Talk™ are trademarks of Google, Inc.
- Bluetooth® is a registered trademark of the Bluetooth SIG, Inc. worldwide.
- Windows Media Player® is a registered trademark of Microsoft Corporation.
- Wi-Fi®, Wi-Fi Protected Setup™, Wi-Fi Direct™, Wi-Fi CERTIFIED™, and the Wi-Fi logo are registered trademarks of the Wi-Fi Alliance.
- DivX®, DivX Certified® and associated logos are trademarks of Rovi Corporation or its subsidiaries and are used under licence.
- All other trademarks and copyrights are the property of their respective owners.



ABOUT DIVX VIDEO

DivX[®] is a digital video format created by DivX, LLC, a subsidiary of Rovi Corporation. This is an official DivX Certified[®] device that plays DivX video. Visit www.divx.com for more information and software tools to convert your files into DivX videos.

ABOUT DIVX VIDEO-ON-DEMAND

This DivX Certified[®] device must be registered in order to play purchased DivX Video-on-Demand (VOD) movies. To obtain your registration code, locate the DivX VOD section in your device setup menu. Go to vod.divx.com for more information on how to complete your registration.

DivX Certified[®] to play DivX[®] video up to HD 720p, including premium content.

May play DivX[®] video up to HD 1080p.

Contents

Assembling	11
Unpack	11
Install the SIM or USIM card	11
Charge the battery	12
Insert a memory card (optional)	14
Getting started	17
Turn your device on and off	17
Get to know your device	18
Use the S Pen and the touch screen	22
Get to know the Home screen	24
Access applications	28
Customise your device	29
Enter text	34
Using special features	37
Learn basic S Pen actions.....	37
Learn advanced S Pen actions.....	37
Replacing the tip of S Pen	39
Learn motions	39
Use Handwriting mode.....	41
Use S Note.....	45
Use the quick note pad	53
Use S Planner	54
Web	57
Internet	57
Game Hub	61

Play Books	62
Play Store	62
YouTube	63
Video Hub	64
Maps	64
Latitude	66
Places	66
Navigation	67
Samsung Apps	68
S Suggest	68
Communication	69
Calling	69
Messaging	79
Google Mail	81
Email	83
Talk	86
ChatON	87
Messenger	87
Google+	87
Entertainment	88
Music Player	88
Music Hub	90
Camera	91
Video Player	99
Gallery	103
Video Maker	106

Personal information 109

- Contacts 109

Connectivity 113

- PC connections 113
- Wi-Fi 115
- Wi-Fi Direct 118
- AllShare Cast 119
- AllShare Play 120
- Bluetooth 123
- Mobile network sharing 125
- GPS 127
- TV connections 128
- VPN connections 130

Tools 132

- Alarm 132
- Calculator 133
- Downloads 133
- Dropbox 134
- Search 135
- My Files 135
- Polaris Office 137
- PS Touch 139
- World Clock 139

Settings 140

- Access the Settings menu 140
- Wi-Fi 140

Bluetooth	140
Data usage	140
More settings	141
Sound	143
Display	143
Wallpaper	144
Motion	144
Power saving	145
Storage	145
Battery	146
Applications manager	146
Accounts and sync	146
Location services	146
Security	146
Language and input	148
Back up and reset	151
Pen	151
Accessory	151
Date and time	152
Accessibility	152
Developer options	153
About device	154
Troubleshooting	155
Index	160

Assembling

Unpack

Check your product box for the following items:

- Mobile device
- Quick start guide

 Use only Samsung-approved software. Pirated or illegal software may cause damage or malfunctions that are not covered by your manufacturer's warranty.

- 
- The items supplied with your device and available accessories may vary depending on your region or service provider.
 - You can purchase additional accessories from your local Samsung dealer.
 - The supplied accessories perform best for your device.
 - Accessories other than the supplied ones may not be compatible with your device.

Install the SIM or USIM card

When you subscribe to a cellular service, you will receive a Subscriber Identity Module (SIM) card, with subscription details, such as your personal identification number (PIN) and optional services. To use UMTS or HSDPA services, you can purchase a Universal Subscriber Identity Module (USIM) card.

To install the SIM or USIM card,

- 1 Open the cover of the SIM card slot.
- 2 Insert the SIM or USIM card with the gold-coloured contacts facing down.

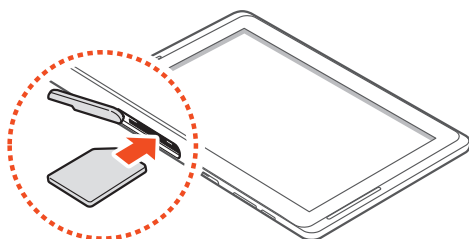

- ⚠ Do not insert a memory card into the SIM card slot. If the memory card becomes lodged in the SIM card slot, you must take your device to a Samsung Service Centre to have the memory card removed.
 - The SIM card slot of your device is only suited for standard SIM cards. Inserting a microSIM card or a microSIM card with an unauthorised holder may cause damage to the SIM card slot of your device.
- 3 Close the cover of the SIM card slot.

Charge the battery

Your device has a built-in battery. Before using the device for the first time or when the battery has been unused for an extended period, you must charge the battery.

- ⚠ Use only Samsung-approved chargers. Unauthorised chargers can cause batteries to explode or damage your device.



- Charge the battery only with a charger. You cannot charge the battery with the USB cable.
- When your battery is low, the device will emit a warning tone and display a low battery message. The battery icon  will also be empty. If the battery level becomes too low, the device will automatically power off. Recharge your battery to continue using your device.
- If the battery is completely discharged, you cannot turn on the device, even with the USB power adapter connected. Allow a depleted battery to charge for a few minutes before you try to turn on the device.

I Connect the USB cable to the USB power adapter, and then plug the end of the USB cable into the multifunction jack.



The shape of the USB power adapter may differ depending on your region.

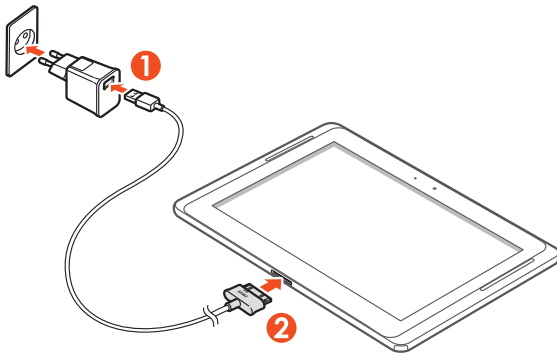

Connecting the USB cable improperly may cause serious damage to the device or USB power adapter. Any damage caused by misuse is not covered by the warranty.

2 Plug the USB power adapter into a power outlet.



- You can use the device while it is charging, but it may take longer to fully charge the battery.
- While the device is charging, the touch screen may not function due to an unstable power supply. If this happens, unplug the USB power adapter from the power outlet or unplug the USB cable from the device.
- While charging, the device may heat up. This is normal and should not affect your device's lifespan or performance.
- If your device is not charging properly, bring your device and the charger to a Samsung Service Centre.

3 When the battery is fully charged, first unplug the USB power adapter and USB cable from the device, and then from the power outlet.



To save energy, unplug the USB power adapter when not in use. The USB power adapter does not have a power switch, so you must unplug the USB power adapter from the electrical socket when not in use to avoid wasting power. The device should remain close to the electrical socket while charging.

Insert a memory card (optional)

Your device accepts memory cards with maximum capacities of 64 GB. Depending on the memory card manufacturer and type, some memory cards may not be compatible with your device.

 Samsung uses approved industry standards for memory cards, but some brands may not be fully compatible with your device. Using an incompatible memory card may damage your device or the memory card and can corrupt data stored on the card.

-  • Your device supports only the FAT file structure for memory cards. If you insert a card formatted with a different file structure, your device will ask you to reformat the memory card.
- Frequent writing and erasing of data will shorten the lifespan of memory cards.
- When you insert a memory card in your device, the file directory of the memory card will appear in the extSdCard folder under the internal memory.

1 Open the cover of the memory card slot.

2 Insert a memory card with the gold-coloured contacts facing down.

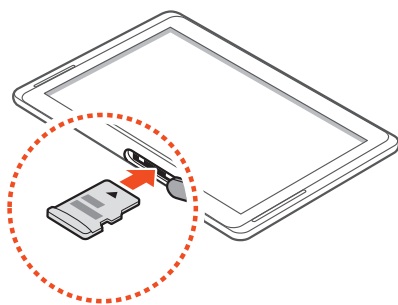

3 Push the memory card in the memory card slot until it locks in place.

4 Close the memory card cover.

› Remove the memory card

Before removing a memory card, first unmount it for safe removal.

- 1 Open the application list and select **Settings** → **Storage** → **Unmount SD card** → **OK**.
 - 2 Open the memory card cover.
 - 3 Push the memory card gently until it disengages from the device.
 - 4 Remove the memory card.
 - 5 Close the memory card cover.
-  Do not remove a memory card while the device is transferring or accessing information, as this could result in loss of data or damage to the memory card or device.

› Format the memory card

Formatting your memory card on a PC may cause incompatibilities with your device. Format the memory card only on the device.

Open the application list and select **Settings** → **Storage** → **Format SD card** → **Format SD card** → **Erase everything**.

-  Before formatting the memory card, remember to make backup copies of all important data stored on your device. The manufacturer's warranty does not cover loss of data resulting from user actions.

Getting started

Turn your device on and off

To turn on your device, press and hold the Power key. If you turn on your device for the first time, follow the on-screen instructions to set up your device.

To turn off your device, press and hold the Power key and select **Power off** → **OK**.



- Follow all posted warnings and directions from authorised personnel in areas where the use of wireless devices is restricted, such as aeroplanes and hospitals.
- To use your device's non-network services only, switch to Flight mode.

› Switch to Flight mode

In Flight mode, you can disable all wireless connections and use non-network services in areas where wireless devices are prohibited, such as aeroplanes and hospitals.

To activate or deactivate Flight mode, go to **Settings** → **More settings**, and then check the check box next to **Flight mode**.

Get to know your device

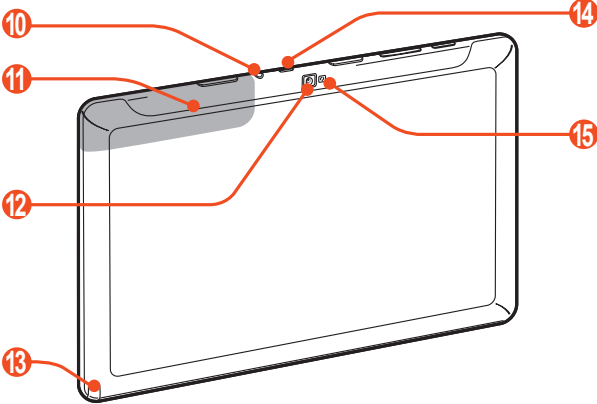
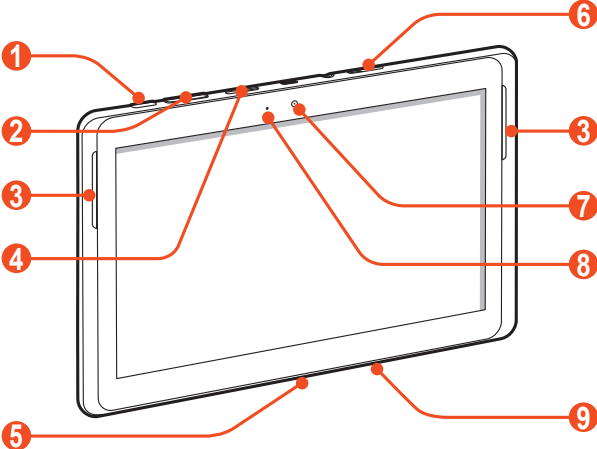

> Device layout



Number	Function
1	Power/Reset/Lock key
2	Volume key
3	Speaker
4	Memory card slot
5	Multifunction jack
6	SIM card slot
7	Front camera lens
8	Ambient light sensor
9	Mouthpiece
10	Headset jack ¹
11	Internal antenna
12	Rear camera lens
13	S Pen slot
14	IrLED
15	Flashbulb











1. Connecting a headset to your device improperly can damage the headset jack or the headset.

› Keys





















Key	Function
 Power/ Reset ² / Lock	Turn on the device (press and hold); Access the device options (press and hold); Lock the touch screen; Reset the device (press and hold for 8-10 seconds.)
 Volume	Adjust the device's volume.

› Indicator icons

 Icons shown on the bottom of the screen may vary depending on your region or service provider.

Icon	Definition
	No signal
	Signal strength
	GPRS network connected
	EDGE network connected
	UMTS network connected
	Open Wi-Fi APs available
	Wi-Fi AP connected
	Bluetooth activated
	GPS activated
	Call in progress

2. If your device has fatal errors or hang-ups, or freezes, you may need to reset the device to regain functionality.

Icon	Definition
	Call on hold
	Missed call
	Uploading data
	Downloading data
	Call diverting activated
	Connected to PC
	USB tethering activated
	Wi-Fi tethering activated
	New text or multimedia message
	New email message
	New Google Mail
	New voice mail message
	Alarm activated
	Event notification
	Roaming (outside of normal service area)
	Smart stay activated
	Flight mode activated
	Music playback in progress
	Error occurred or caution required
	Battery power level ³
10:00 AM	Current time

3. If you use a charger that is not approved by Samsung, this indicator will not appear.

Use the S Pen and the touch screen

Your device's touch screen lets you easily select items or perform functions. Learn basic actions for using the touch screen.



- Do not press the touch screen with your fingertips, or use sharp tools on the touch screen. Doing so may damage the touch screen or cause it to malfunction.
- Do not allow the touch screen to come into contact with other electrical devices. Electrostatic discharges can cause the touch screen to malfunction.
- Do not allow the touch screen to come into contact with water. The touch screen may malfunction in humid conditions or when exposed to water.
- Leaving the touch screen idle for extended periods may result in afterimages (screen burn-in) or ghosting. Turn off the touch screen when you do not use the device.
- Do not bend the S Pen.
- Do not use the S Pen near by a source of magnetic interference. It may cause the S Pen to malfunction or freeze.



- For optimal use of the touch screen, remove the screen protection film before using your device.
- You can purchase a replacement S Pen from your local Samsung dealer.
- If your S Pen is not working properly, replace the tip of the S pen or take it to a Samsung Service Centre.
- For best results, keep the S Pen mostly perpendicular to the touch screen and avoid using it at sharp angles.

Control your touch screen with the following actions:

- **Tap:** Touch once with your finger or the supplied S Pen to select or launch a menu, option, or application.
- **Tap and hold:** Tap an item and hold it for more than 2 seconds to open a list of options.
- **Drag:** Tap and drag your finger up, down, left, or right to move to items on lists.
- **Drag and drop:** Tap and hold your finger on an item, and then drag your finger to move the item.
- **Double-tap:** Tap twice quickly with your finger to zoom in or out while viewing photos or web pages.

› Rotate the touch screen

Your device has a built-in motion sensor that detects its orientation. If you rotate the device, the interface will automatically rotate according to the orientation.

To set the interface to keep the orientation, select the right side of the system bar, and then select **Screen rotation** on the notifications panel.

› Lock or unlock the touch screen

When you do not use the device for a specified period, your device turns off the touch screen and automatically locks the touch screen to prevent any unwanted device operations. To manually lock the touch screen, press the Power key.

To unlock, turn on the screen by pressing the Power key, tap anywhere on the screen, and then flick your finger in any direction.



You can activate the screen lock feature to prevent others from using or accessing your personal data and information saved in your device. ► p. 31

Get to know the Home screen

When the device is in Idle mode, you will see the Home screen. From the Home screen, you can view indicator icons, widgets, shortcuts to applications, and other items. Scroll left or right to a panel of the Home screen.

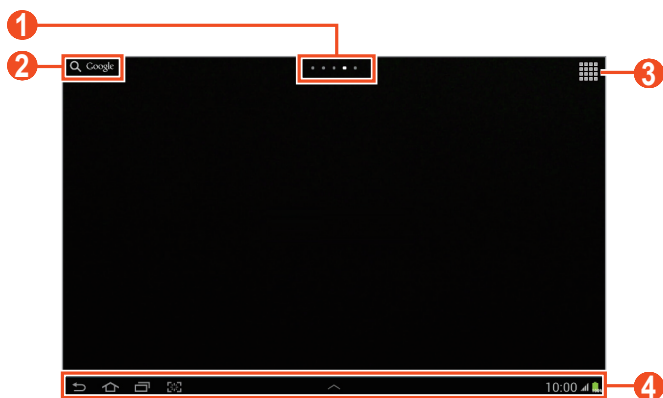

The above screen may differ depending on your region or service provider.

Number	Function
1	Select a dot at the top of the screen to move directly to the corresponding screen.
2	Search for applications and files in your device and specific data on the web with the Google Search widget.
3	Access the application list.
4	System bar (See the following section.)

System bar

From the system bar, you can quickly navigate screens, access applications, view system information, and more.

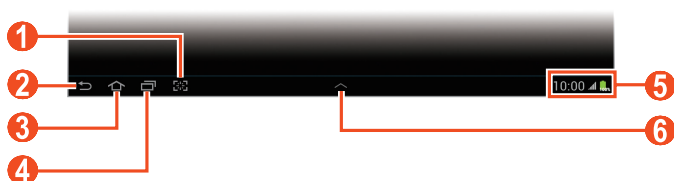

Number	Function
1	Capture the current screen; Capture the current screen and open the drawing pad (tap and hold).
2	Return to the previous screen.
3	Return to the Home screen; Access the task manager (tap and hold).
4	Open the list of recent application; Access the application list (tap and hold).
5	Display indicator icons and your device's current status; Open the notifications panel.
6	Open the mini apps panel.

> Add an application shortcut on the Home screen

- 1 Open the application list and tap and hold an application icon.
- 2 Move the icon to the location you want or move it to another panel of the Home screen.

› Add a widgets on the Home screen

Widgets are small applications that provide convenient functions and information on your Home screen.



- Some widgets connect to web services. Using a web-based widget may result in additional charges.
- The widgets available may vary depending on your region or service provider.

- 1 Open the application list and select **Widgets** to open the widget panel.
- 2 Scroll left or right on the widget panel.
- 3 Tap and hold a widget to add it to the Home Screen.

› Move an item on the Home screen

- 1 Tap and hold an item to move until the Home screen grid appears.
- 2 Drag the item to the location you want.



› Remove an item on the Home screen

- 1 Tap and hold an item to remove.
The rubbish bin appears at the top of the Home screen.
- 2 Drag the item to the rubbish bin.
- 3 When the item turns red, release the item.

› Add or remove a panel from the Home screen

You can add or remove Home screen panels to organise widgets.

- 1 On the Home screen, place two fingers on the screen and pinch them together to switch to Edit mode.

- 2 Add, remove, or reorganise panels:
 - To add a new panel, select .
 - To remove a panel, tap and hold the panel's thumbnail image, and then drag it to the rubbish bin.
 - To set a panel for the default Home screen, select .
 - To change the order of panels, tap and hold the panel's thumbnail image, and then drag it to a new location.
- 3 Select  to return to the previous screen.

► Use the notifications panel



From the Home screen or while using an application, select the right side of the system bar, and then select an option on the notifications panel.

You can view the device's current status and use the following options:

- **Wi-Fi:** Activate or deactivate the Wi-Fi feature.
- **GPS:** Activate or deactivate the GPS feature.
- **Sound:** Activate or deactivate Silent mode. You can vibrate or mute your device in Silent mode.
- **Screen rotation:** Activate or deactivate the auto rotation.
- **Power saving:** Activate or deactivate Power saving mode.
- **Notification:** Set the device to alert you for various events.
- **Mobile data:** Activate or deactivate the data connection.
- **Bluetooth:** Activate or deactivate the Bluetooth feature.
- **Driving mode:** Activate or deactivate Driving mode.
- **Sync:** Activate or deactivate auto-syncing of applications.

 Available options may vary depending on your region or service provider.

Access applications

- 1 From the Home screen, select  to access the application list.
- 2 Scroll left or right to another screen.
You can also select one of dots at the bottom of the screen to move directly to the corresponding screen.
- 3 Select an application.
To view the widgets panel, select **Widgets**.
- 4 Select  to return to the previous screen; Select  to return to the Home screen.

› Access recent applications

- 1 Select  to view the applications you have accessed recently.
- 2 Select an application.

› Use the task manager

Your device is a multitasking device. It can run more than one application at the same time. However, multitasking may cause hang-ups, freezing, memory problems, or additional power consumption. To avoid these problems, end unnecessary programs using the task manager.

- 1 Select  → **Task manager** → **Active applications**.
- 2 To close an application, select **End**.
To close all active applications, select **End all**.

Customise your device

Get more from your device by customising it to match your preferences.

› Change the language of the display

- 1 Open the application list and select **Settings** → **Language and input** → **Language**.
- 2 Select a language you want.

› Set the current time and date

- 1 Open the application list and select **Settings** → **Date and time**.
- 2 Select your time zone, set the time and date, and change other options.

› Turn the touch tone on or off



Open the application list and select **Settings** → **Sound** → **Touch sounds**.

› Adjust the device's volume

- 1 Press the Volume key up or down.
- 2 Select  and drag the sliders to adjust the volume level for each sounds.

› Switch to Silent mode

To mute or unmute your device, do one of the following:

- Open the notifications panel at the right side of the system bar and select **Sound**.
- Press and hold the Power key and select .
- Open the application list and select **Phone** → **Keypad** and tap and hold .

› Select a wallpaper for the Home screen

- 1 Tap and hold anywhere on the Home Screen.
- 2 Select **Set wallpaper for** → **Home screen**.
 - **Gallery**: Photos you took or images downloaded from the Internet.
 - **Live wallpapers**: Animated images included with the device.
 - **Wallpapers**: Wallpaper images included with the device.
- 3 Select an item.
- 4 Select **Set wallpaper**.
If you selected an item from **Gallery**, move or resize the blue frame by dragging it, and then select **Done**.

 Samsung is not responsible for any use of default images or wallpapers provided on your device.

› Adjust the brightness of the display

- 1 Open the application list and select **Settings** → **Display** → **Brightness**.
- 2 Clear the check box next to **Automatic brightness**.
- 3 Drag the slider to adjust the brightness.
- 4 Select **OK**.

 The brightness level of the display will affect how quickly the device consumes battery power.

› Set a screen lock

You can lock your device by activating the screen lock feature.



- Once you set a screen lock, your device will require an unlock code each time you turn it on or unlock the touch screen.
- If you forget your PIN or password, bring your device to a Samsung Service Centre to reset it.
- Samsung is not responsible for any loss of security codes or private information or other damages caused by illegal software.

Set a face detection unlock

- 1 Open the application list and select **Settings** → **Security** → **Screen lock** → **Face unlock**.
- 2 Read the warning message, and then select **Next**.
- 3 Select **Set it up** → **Continue**.
- 4 Adjust the device to fit your face inside the figure.
- 5 When your face is captured correctly, select **Continue**.
- 6 Complete the setup of the secondary unlock PIN or pattern.

Set an unlock signature

- 1 Open the application list and select **Settings** → **Security** → **Screen lock** → **Signature**.
- 2 Select **Set it up**.
- 3 Draw a signature and select **Continue**.
Repeat this step 3 times to set the signature unlock.
- 4 Complete the setup of the secondary unlock PIN or pattern.

Set an unlock pattern

- 1 Open the application list and select **Settings** → **Security** → **Screen lock** → **Pattern**.
 - 2 See the on-screen instructions and example patterns and select **Next**.
 - 3 Draw a pattern by dragging your finger to connect at least 4 dots and select **Continue**.
 - 4 Draw the pattern again to confirm and select **Confirm**.
 - 5 Complete the setup of the backup PIN.
-  If you forget your unlock pattern, you can deactivate the screen lock feature with a backup PIN.

Set an unlock PIN

- 1 Open the application list and select **Settings** → **Security** → **Screen lock** → **PIN**.
- 2 Enter a new PIN (numeric) and select **Continue**.
- 3 Enter the PIN again and select **OK**.

Set an unlock password

- 1 Open the application list and select **Settings** → **Security** → **Screen lock** → **Password**.
- 2 Enter a new password (alphanumeric) and select **Continue**.
- 3 Enter the password again and select **OK**.

› Lock your SIM or USIM card

You can lock your device by activating the PIN supplied with your SIM or USIM card.

1 Open the application list and select **Settings** → **Security** → **Set up SIM card lock** → **Lock SIM card**.

2 Enter your PIN and select **OK**.

Once the PIN lock is enabled, you must enter the PIN each time you turn on the device.



- If you enter an incorrect PIN too many times, your SIM or USIM card will be blocked. You must enter a PIN unlock key (PUK) to unblock the SIM or USIM card.
- If you block your SIM or USIM card by entering an incorrect PUK, bring the card to your service provider to unblock it.

› Activate the Find my mobile feature

When someone inserts a new SIM or USIM card into your device, the Find my mobile feature will automatically send the contact number to specified recipients to help you locate and recover your device.

To use this feature, you need a Samsung account for controlling the device from the web remotely.

1 Open the application list and select **Settings** → **Security** → **SIM Change Alert**.

2 Select **Sign in**.

To create an account, select **Create new account**.

Read the terms and conditions, check the check box next to **I accept all the terms above** and select **Agree**.

3 Enter your email address and password for your Samsung account and select **Sign in**.

- 4 Drag the slide bar to the right next to **Save**.
- 5 Select **Alert message**.
- 6 Enter the text message that will be sent to the recipients and select **OK**.
- 7 Add recipients:
 - Select **Create** and enter phone numbers manually, including the country code and the + symbol.
 - Select phone numbers from your contact list by selecting **Contacts**.
- 8 Select **Save**.

Enter text

You can enter text by selecting characters on the virtual keypad, inputting handwriting on the screen, or speaking words into the microphone.

 You cannot enter text in some languages. To enter text, you should change the writing language to one of the supported languages.

> Change the keyboard type

You can change the keyboard type. Select  on the system bar and select a keyboard type.

You can also enter text with your voice. Select  and a voice input option, according to the language you want to use.

› Enter text using the Samsung keypad

Enter text by selecting alphanumeric keys and you can use the following keys:

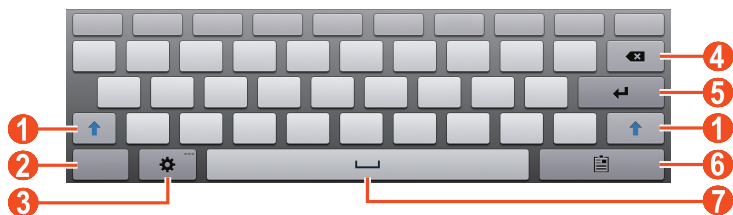



Number	Function
1	Change case.
2	Switch between Number/Symbol mode and ABC mode.
3	Access the keypad settings. Tap and hold  to switch to Handwriting mode, enter text by voice.
4	Clear your input.
5	Start a new line.
6	Attach an item.
7	Insert a space.



When Predictive text (XT9) mode is activated, you can use continuous input, which allows you to enter text by sweeping on the keypad. ► p. 149

› Copy and paste text

While you are entering text, you can use the copy and paste feature to use text in other applications.

- 1 Tap and hold a word.
- 2 Drag  or  to select the text you want.
- 3 Select **Copy** to copy, or **Cut** to cut the text onto the clipboard.
- 4 In another application, tap and hold the text input field.
- 5 Select  → **Paste** to insert the text from the clipboard into the text input field.

Using special features

Your device can be used as a powerful notepad, thanks to multiple features that help you input text, capture drawings, and use motion controls or voice commands.

Learn basic S Pen actions

Your device is supplied with a specialised S Pen. With the S Pen, you can perform the following actions:

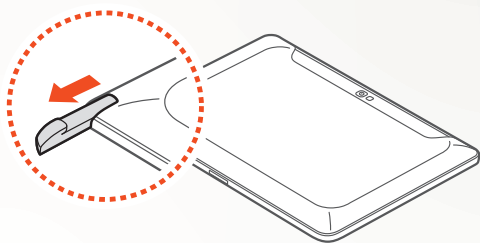

- Tap: Tap an item or area on the screen to select an item, open a menu, or launch an application.
- Tap and hold: Tap and hold the S Pen on an item for more than two seconds.
- Double-tap: Quickly tap an item or area on the screen twice.
- Flick: Tap an area on the screen, and then slowly drag the S Pen up, down, left, or right to move through lists or screens.
- Draw: Draw a line or shape on the drawing pad.
- Write: Write text on the handwriting panel.

Learn advanced S Pen actions

With the S Pen, you can also perform the following advanced actions.



Back

While pressing the S Pen button, drag the S Pen to the left to return to the previous screen.

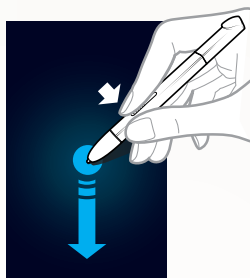

Menu

While pressing the S Pen button, drag the S Pen down to open a list of options available on the current screen.



Screen capture

While pressing the S Pen button, tap and hold the screen to capture a screenshot.

After capturing a screenshot, you can draw on it, write on it, or crop it. The edited image will be saved in **My Files** → **sdcard** → **Pictures** → **Screenshots**.



Quick note

While pressing the S Pen button, double-tap the screen to launch the Quick note function.

Replacing the tip of S Pen

If the tip is worn down or seems the S Pen is not working properly, replace the tip as new one.

 If the S Pen is not working properly after replacing the tip, make sure the tip is fully inserted until it reach the end.

- 1 Grab the tip with the tip extractor tool, and then pull it out.
- 2 Insert a new tip into the S Pen where you just removed until it reach the end.

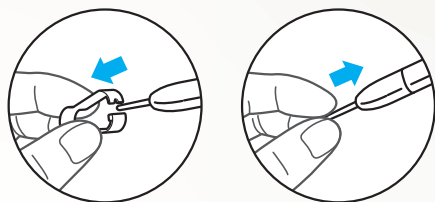

Learn motions

Built-in motion recognition provides you with enhanced controls. You can perform actions by moving your device or performing gestures with your hands.

To use some of these functions, you must first activate the motion recognition feature. Open the application list, select **Settings** → **Motion**, and then drag the slider to the right of the top right of the screen.

› Tilt

While holding the device with two hands, tap and hold two points on the screen, and then tilt the device back and forth to zoom in or out.

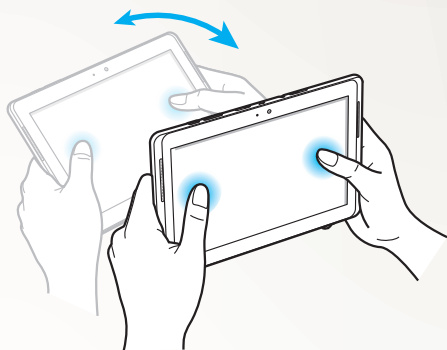

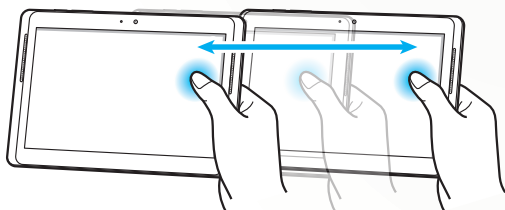

› Pan

Tap and hold an item on the screen, and then pan the device to the left or right to move the item to another page on the home screen or application list. When an image is zoomed in, slide the device in any direction to scroll through the image.



Use Handwriting mode

From the Samsung keypad, you can switch to Handwriting mode to enter text more easily. To switch to Handwriting mode, tap and hold , and then select  without lifting from screen.



Write your text on the handwriting panel.

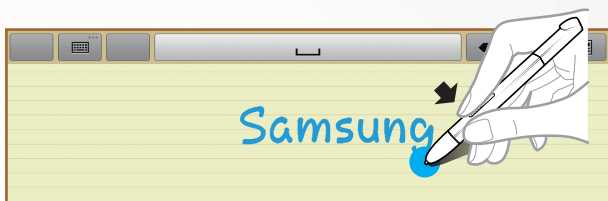

To switch to the Samsung keypad, select .

› Handwriting Tutorial

- When you have written one character, write the next one. Write each letter to the right of the previous character. If you draw a stroke on top of a previous character, it may be recognised as a new character.
 - E.g. Not recognised

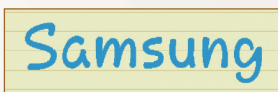

- Write characters upright (do not slant).
 - E.g. Recognised

A rectangular box containing a piece of lined paper. The word "Samsung" is written in blue cursive handwriting, oriented vertically (upright).

- E.g. Not recognised

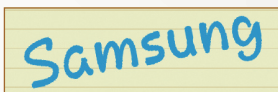
A rectangular box containing a piece of lined paper. The word "Samsung" is written in blue cursive handwriting, slanted to the right.

- Do not write characters on top of one another.
 - E.g. Recognised

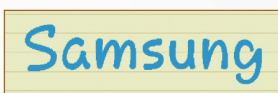
A rectangular box containing a piece of lined paper. The word "Samsung" is written in blue cursive handwriting, oriented vertically (upright), with each letter clearly separated from the others.

- E.g. Not recognised

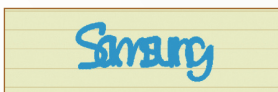
A rectangular box containing a piece of lined paper. The word "Samsung" is written in blue cursive handwriting, oriented vertically (upright), but the letters are overlapping and difficult to distinguish.

- Most of the languages can recognise not only individual characters but characters written together that make up words. (This is referred to as supporting words and phrases.) The languages that do and do not support words and phrase should be listed in this guide. (All languages which support Handwriting SIP should support words and phrases.)

- Languages that support words and phrases: English UK, English US, Čeština, Български, Dansk, Deutsch, Ελληνικά, Español, Eesti, Suomi, Français, Hrvatski, Magyar, íslenska, Italiano, Қазақ, 한국어, Lietuvių, Latviešu, Norsk, Nederlands, Polski, Português, Română, Русский, Slovenčina, Slovenščina, Srpski, Svenska, Türkçe, Українська
- Supporting recognition of individual characters

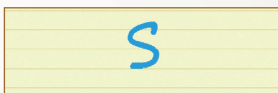

- Supporting recognition of words and phrases

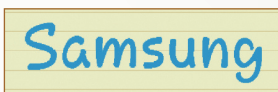

- In some languages, cursive writing can be recognised. (Cursive writing recognition)
 - For languages in which cursive writing is recognised, connected character writing should also be recognised.
 - For languages in which cursive writing is not recognised, characters should be written separately.
 - Languages that do and do not support cursive writing should be listed in this guide.
 - Languages that support cursive writing: English UK, English US, Deutsch, Español, Français, Italiano, Nederlands, Português
 - Languages that do not support cursive writing: Čeština, Български, Ελληνικά, Eesti, Hrvatski, Magyar, íslenska, Қазақ, 한국어, Lietuvių, Latviešu, Polski, Română, Русский, Slovenčina, Slovenščina, Srpski, Türkçe, Українська, Dansk, Suomi, Norsk, Svenska

- E.g. A language that supports cursive writing: English

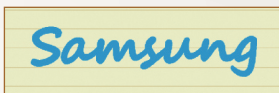

Samsung

- E.g. A language that does not support cursive writing:
한국어



삼성전자 → 삼성전자

- When writing more than one line, make sure you leave enough space.
 - E.g. Recognised

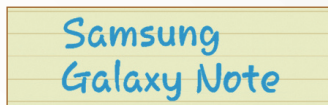

Samsung
Galaxy Note

- E.g. Not recognised

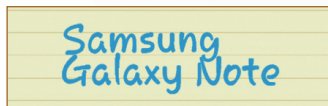

Samsung
Galaxy Note

Use S Note

With S Note, you can create notes by inserting various multimedia contents into notes and add a note shortcut to the home screen.

S Note provides various templates to help you create notes easily.

- **Note/Idea note:** You can create a simple note from an empty page.
- **Meeting note:** You can create a record of meetings, conferences, or lectures.
- **Magazine:** You can create a multimedia note by inserting multimedia files.
- **Diary:** You can create a photo diary.
- **Recipe:** You can create your own recipes.
- **Travel:** You can create travel essays.
- **Memo:** You can create memos.

› Create a note

- 1 Open the application list and select **S Note**.
- 2 Select **+** → a template.
- 3 Enter text or draw a sketch.

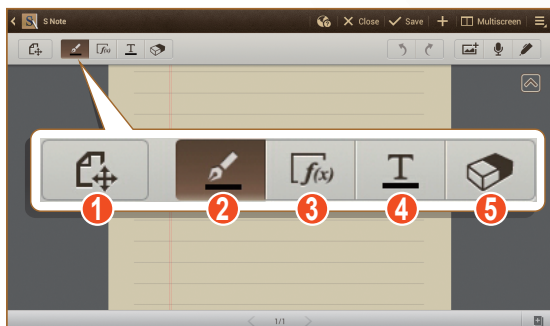

Number	Function
1	Switch between View and Edit modes.
2	Draw a sketch; Change the pen settings (double-tap). ► p. 47
3	Use productivity tools. ► p. 48
4	Enter text with the keyboard; Change the text settings (double-tap). ► p. 47
5	Erase your text or sketch; Change the eraser thickness or clear your input (double-tap).

4 Add a photo or sound clip.

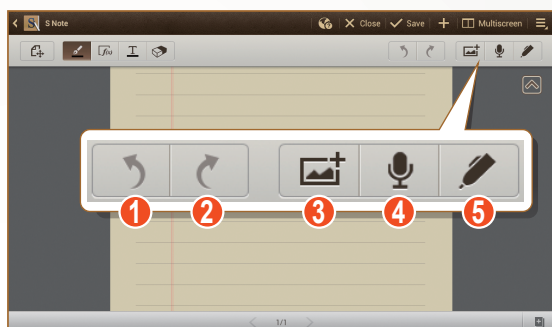

Number	Function
1	Undo your last action.
2	Redo your last action.
3	Add a multimedia file, such as text or a photo.
4	Add a sound clip by recording voices or other sounds.
5	Restrict handwriting input only with the S Pen.

- To add a page, select .
- To zoom in, place two fingers on the screen and spread them apart. To zoom out, move your fingers closer together. When zoomed in, drag with two fingers to scroll through the screen.

5 When you are finished, select **Save**.

› Change the pen or text attributes

While creating a note, you can change following attributes:

- To change the pen type, line thickness, or pen colour, double-tap .

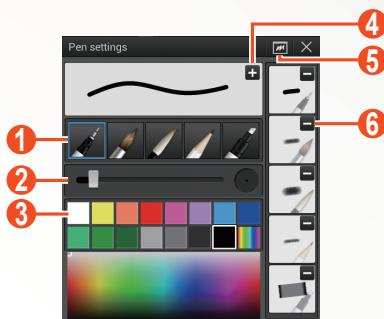



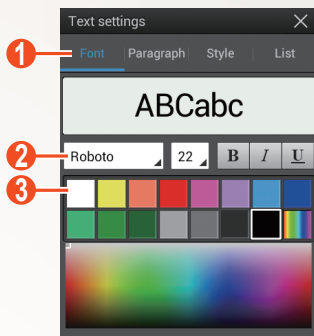

Number	Function
1	Change the pen type.
2	Change the line thickness.
3	Change the pen colour.
4	Save the current settings as a pen profile.
5	Open a small window to predraw the pen setting.
6	Delete the preset pen profile.

- To change the text attributes, double-tap .



Number	Function
1	Select an option.
2	View or change the current attributes.
3	Change the text colour.

› Use productivity tools

- 1 Open the application list and select **S Note**.
 - 2 Select  → a template.
 - 3 Double-tap  and select a tool.
 - **Formula match:** Convert a handwritten formula to a well-organised formula.
 - **Shape match:** Convert shapes you have drawn.
 - **Handwriting-to-Text:** Convert a handwritten note.
-  • When you tap and hold , the tool panel will appear and you can switch between tools easily.
- Select  to search for information about the handwritten keyword on a preset webpage.

› Tutorial for handwritten formulas and figures

- Write a formula on a single line. If you write a long formula or a formula on more than one line, the device will convert the formula incorrectly.

$$y = t + e^t - \int_0^t y(\tau) \cosh(t - \tau) d\tau$$

↓

$$y = t + e^t - \int_0^t y(\tau) \cosh(t - T_{dT})$$

$$\begin{array}{l} 2x + 3y = 1 \\ 5x + y = 0 \end{array} \quad \Rightarrow \quad \begin{array}{l} ?x+3 \\ bx+y \end{array} \frac{y = 1}{-0}$$

- Unclosed parenthesis or missing figure in the square root will temporarily result in incorrect formula conversion. The formula will be complete when you finish writing the formula.

$$\sum_{x=0}^{100} (x - \frac{3}{2}) \quad \Rightarrow \quad \sum_{x=0}^{100} cx - \frac{3}{2} \quad (X)$$

$$\sum_{x=0}^{100} (x - \frac{3}{2}) \quad \Rightarrow \quad \sum_{x=0}^{100} \left(x - \frac{3}{2} \right) \quad (O)$$

$$\sqrt{\quad} \quad \Rightarrow \quad r \quad (X) \quad \sqrt{x} \quad \Rightarrow \quad \sqrt{x} \quad (O)$$

- When you draw an arrow, draw the body of the arrow first.



- When you draw the head of an arrow, draw it in one stroke.

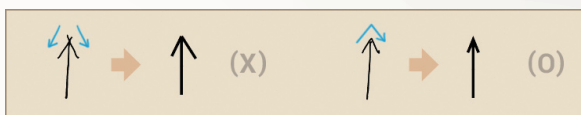









› View notes





- 1 Open the application list and select **S Note**.
- 2 Select  to search for a note (if necessary).
- 3 Select a note.

While viewing the note, use the following options:

- To zoom in, place two fingers on the screen and spread them apart. To zoom out, move your fingers closer together.
- To move to other pages of the note, select the arrow at the bottom of the screen, scroll left or right, and then select a page.
- To display different applications on the same screen at the same time, select **Multiscreen** → an option. While using this feature, you can switch the position of the applications by tapping and holding the application titles.

- To hide or show the menu bar, select  or .
- To switch to Edit mode, select  or tap the screen.
- To send the note to others, select  → **Share via**.
- To export the note, select  → **Export**. Your note will be exported as an image file or a PDF file to **My Files** → **sdcard** → **S Note Export**.
- To manage the note with multiple pages, select  → **Edit pages**.
- To save the note as an event, select  → **Create event**. This feature may be unavailable depending on the selected template.
- To add a shortcut of the note to the home screen, select  → **Set as shortcut**.
- To print the note using a Wi-Fi or USB connection, select  → **Print**. Your device is compatible only with some Samsung printers.
- To save the note for other name, select  → **Save as**.

› Edit notes

- 1 Open the application list and select **S Note**.
- 2 Select a note.
To add or change the note cover, tap and hold a note and select **Edit cover**.
- 3 Select  or tap the screen to switch to the Edit mode.
- 4 Edit the note with the icons on the screen.
 - To change the background image of the note, select  → **Change background**.
 - To delete the note, select  → **Delete**.
 - To add a tag, select  → **Add tag**.
- 5 Select **Save**.



› Synchronise notes

You can synchronise your notes with the web server.

- 1 Open the application list and select **S Note**.
- 2 Select  → **Sync** → an option.
- 3 Select notes to sync → **Sync**.
To synchronise all notes, select → **Sync all**.
- 4 Enter your email address and password, and then select **Login**.
- 5 Select **Sync now**.

› Manage notes with folders

Create a folder

- 1 Open the application list and select **S Note**.
- 2 Select  → **Create folder**.
- 3 Enter a name and select **OK**.
- 4 Select the new folder.
 - To create a note, select  → a template.
 - To create sub-folders, select  → **Create folder**.

Copy or move notes

- 1 Open the application list and select **S Note**.
- 2 Select a folder (if necessary).
- 3 Select  → **Copy** or **Move**.
- 4 Select notes → **Copy** or **Move**.
- 5 Move to a new location.
- 6 Select **Copy here** or **Move here**.

Use the quick note pad

From any screen, you can create a quick note of text and sketches.

- 1 While pressing the S Pen button, double-tap the screen to open the quick note pad.
- 2 Enter text or draw a sketch.

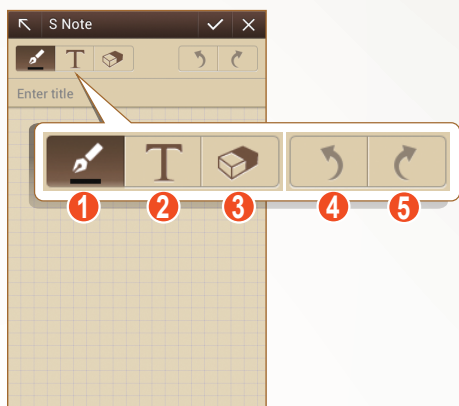

Number	Function
1	Draw a sketch; Change the pen settings, such as the pen type, line thickness, or pen colour (double-tap).
2	Enter text with the keyboard.
3	Erase your text or sketch; Change the eraser thickness or clear your input (double-tap).
4	Undo your last action.
5	Redo your last action.

- 3 When you are finished, select .

Use S Planner

Your device provides you with a powerful planner to help you organise your schedules and tasks more conveniently and effectively. You can create and view events, add items, and change view modes.

To launch S Planner, open the application list and select **S Planner**.

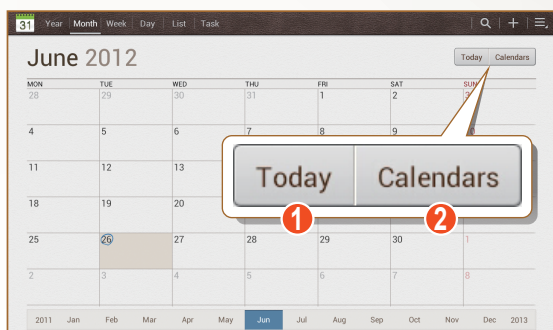

Number	Function
1	Select today's date.
2	Set which calendars to display.

› Create an event or task



The tasks and notes you create cannot be synchronised with Google Calendar™.

To create an event,

- 1 Open the application list and select **S Planner** → .
- 2 If alert messages about the calendar sync appear, select **Done**.

- 3 Select **Add event**, and then enter details.
 - To search for and add a location view, select .
 - To add a note, select **Notes** → **Add link to S Note**.
 - To add a image, select **Images** → **Take picture** or **Images**.
- 4 When you are finished, select **Save**.

To create a task,





- 1 Open the application list and select **S Planner** → .
- 2 Select **Add task**, and then enter details.
 - To add a note, select **Notes** → **Add link to S Note**.
 - To add a image, select **Images** → **Take picture** or **Images**.
- 3 When you are finished, select **Save**.

➤ Change the view mode

To switch the calendar's view mode, select a view mode tab. You can also tap the screen with two fingers, and then pinch or spread them to change the view mode.

- 1 Open the application list and select **S Planner**.
- 2 Select a view mode at the top of the screen.
 - **Year**: Monthly blocks for the current year.
 - **Month**: Daily blocks for the current month.
 - **Week**: Hourly blocks for the days in one full week.
 - **Day**: Hourly blocks for one full day.
 - **List**: A list of all the events.
 - **Task**: A list of all task.

› View an event or task

- 1 Open the application list and select **S Planner**.
- 2 Select  to search for an event or task (if necessary).
- 3 To limit the range of your search, select **All** → an option.
- 4 Select a date on the calendar.
 - To select today's date, select **Today**.
 - To move to a specific day by entering a date manually, select  → **Go to**, enter the date by selecting  or , and then select **Set**.
- 5 Select an event or task to view its details.

› Stop an event alarm

If you set an alarm for a calendar event, the event alarm icon appears at the specified time.

- 1 Select the event notification from the notifications panel.
- 2 Select an event or task to view more details.

To snooze or dismiss the event alarm, check the box next to the event or task name and select **Snooze** or **Dismiss**.

Web

Internet

Learn to access and bookmark your favourite web pages.



- You may incur additional charges for accessing the web and downloading media files. For details, contact your service provider.
- The web browser menu may be labelled differently depending on your region or service provider.
- Available icons may vary depending on your region or service provider.

> Browse web pages

1 Open the application list and select **Internet** to launch your homepage.

To access a specific web page, select the URL input field, and then enter the web address of the web page.

2 Navigate web pages with the following keys:













The above screen may differ depending on your region or service provider.

Number	Function
1	Close the current tab.
2	Move backward or forward to web pages in history.
3	Reload the current web page; While the device is loading web pages, this icon changes to  .
4	Open a new tab.
5	Open another applications; Not all applications support this feature.
6	Access a list of web browser options.
7	Open a list of saved bookmarks and recent internet history.
8	Search for information.
9	Bookmark the current web page.

While browsing a web page, use the following options:

- To zoom in or out, tap the screen with two fingers and spread them apart (move your fingers closer together to zoom out).
-  If you activate tilting motions, you can zoom in or out by tapping and holding two points with your fingers, and then tilting the device back and forth.
- To display different applications on the same screen at the same time, select **Multiscreen** → an option. While using this feature, you can switch the position of the applications by tapping and holding the application titles.

- To open a new tab, select  → **New tab**.
- To open a new tab without saving cookies, select  → **New incognito tab**.
- To add the bookmark shortcut to the Home screen, select  → **Add shortcut to home**.
- To send the web address of the web page to others, select  → **Share page**.
- To search for text on the web page, select  → **Find on page**.
- To switch to the desktop view, select  → **Desktop view**.
- To save the current web page and read it offline later, select  → **Save for offline reading**. You can view the saved pages by selecting  → **Saved pages**.
- To view the items downloaded from the web, select  → **Downloads**.
- To print the web page using a Wi-Fi or USB connection, select  → **Print**. Your device is compatible only with some Samsung printers.
- To customise browser settings, select  → **Settings**.

▶ Search for information by voice



This feature may be unavailable depending on your region or service provider.

- 1 Open the application list and select **Internet**.
- 2 Select the URL input field.
- 3 Select  and say a keyword into your device's microphone.

The device searches for information and web pages related with the keyword.

› Open multiple pages



You can open multiple pages and switch back and forth between them.

- 1 Open the application list and select **Internet**.
- 2 Select  to open a new tab.
- 3 Access another web page on the new tab.
- 4 To switch back and forth between currently open tabs, select the title of a tab.

› Bookmark your favourite web pages

If you know the web address of a web page, you can manually add a bookmark.

Add a bookmark



- 1 Open the application list and select **Internet**.
- 2 Enter a web address or a navigate to a web page.
- 3 Select  →  to bookmark the current web page.
You can also select  to bookmark the current web page.
- 4 Enter a name for the bookmark.
- 5 Enter the web address for your favourite web page, and then select a bookmark location to add (if necessary).
- 6 Select **OK**.

To use bookmark options, select  and tap and hold a bookmark:

- To open the web page in the current tab, select **Open**.
- To open the web page in a new tab, select **Open in new tab**.

- To edit the bookmark, select **Edit bookmark**.
- To add the bookmark shortcut to the Home screen, select **Add shortcut to home**.
- To send the web address of the web page to others, select **Share link**.
- To copy the web address of the web page, select **Copy link URL**.
- To delete the bookmark, select **Delete bookmark**.
- To use the web page as your homepage of the browser, select **Set as homepage**.

Create a bookmark folder

- 1 Open the application list and select **Internet**.
- 2 Select  →  → .
- 3 Enter a name for the bookmark folder.
- 4 Select **Done**.

› Access recent history

- 1 Open the application list and select **Internet**.
- 2 Select  → **History**.
- 3 Select a web page to access.

Game Hub

Learn to access games.

- 1 Open the application list and select **Game Hub**.
- 2 Select a game service.
- 3 Search for and access games.



The games available may vary depending on your region or service provider.

Play Books

Browse and download book files with Google Play Books. You can read book files on your device. In the application list, select **Play Books**.



This feature may be unavailable depending on your region or service provider.

Play Store

Based on the Android platform, your device's functionality can be extended by installing additional applications. Play Store provides you an easy and quick way to shop for games and mobile applications.



- This feature may be unavailable depending on your region or service provider.
- Your device will save user files from downloaded applications to the internal memory.

› Download and install an application

- 1 Open the application list and select **Play Store**.
You can also select  → **Play Store** at the top right of the application list.
- 2 If you are launching this application for the first time, select **Accept**.
- 3 Search for an application and download it to the device. When the download is complete, the device will install the application automatically.

› Uninstall an application

- 1 Open the application list and select **Play Store**.
- 2 Select .
- 3 Select the item you want to delete.
- 4 Select **Uninstall** → **OK**.

YouTube

Learn to view and upload videos via YouTube.



This feature may be unavailable depending on your region or service provider.

› Watch videos

- 1 Open the application list and select **YouTube**.
- 2 Select a video.
- 3 Tap a video screen and select  to display a full screen.
- 4 Control playback with the virtual keys.

› Upload videos

- 1 Open the application list and select **YouTube**.
- 2 Select  → **Sign in**, and then select your Google account if it is linked to YouTube. You can also select **Add account** and set up an account to sign in YouTube.
- 3 Select **UPLOAD**, and then select a video.
- 4 Enter details for the upload and select **Upload**.

Video Hub

Learn to access videos.

- 1 Open the application list and select **Video Hub**.
- 2 Select a category.
- 3 Search for and access videos.







Maps



Learn to use Google Maps™ to find your location, search the map for streets, cities, or countries, and get directions.





- This feature may be unavailable depending on your region or service provider.
- You must activate location services to find your location and search the map. ► p. 127

› Search for a specific location

- 1 Open the application list and select **Maps**.
The map will display your current location.
- 2 Select .
- 3 Enter a keyword for the location.
To search for a location by voice, select .
- 4 Select the location you want to view details.
 - To view the all of the search result, select **Search Results**.
 - To view your current location, select .
 - To search for a place around you, select .
 - To get directions to a specific destination, select .
 - To add layers to the map, select .

- To access a list of other options, select .
- To zoom in or out, place two fingers on the screen and slowly spread them apart or pinch them together. You can also double-tap the screen. To return to the original size, double-tap the screen.
- To add a star to the location, select the balloon of the location name → .

› Get directions to a specific destination

- 1 Open the application list and select **Maps**.
- 2 Select .
- 3 Enter the addresses of the starting location and the ending location.
To enter an address from your contact list or starred places, or point the location on the map, select  → an option.
- 4 Select a travel method (car, bus, or walk) and select **Go**.
The route is indicated on the map. Depending on the selected travel method, you may see multiple routes.
- 5 When you are finished, select  → **Clear Map**.

Latitude

Learn to share your location with your friends and view friends' locations via Google Latitude™.



This feature may be unavailable depending on your region or service provider.

- 1 Open the application list and select **Latitude**.
The device automatically joins Latitude.
- 2 Select  → an option.
- 3 Select a friend you want to add, or enter an email address and select **Add friends**.
- 4 Select **Yes**.
When your friend accepts your invitation, you can share locations.
- 5 Select a friend from the list.
Your friends' locations are marked with their photos on the map.



Places

Learn to search for a place around you.



This feature may be unavailable depending on your region or service provider.

- 1 Open the application list and select **Places**.
- 2 Select a category.
Your device searches for places around your current location that are related to the category.
- 3 Select a place name to view its details.

- 4 While viewing information, use the following options:
 - To view the place on the map, select .
 - To view the route to the place, select .
 - To view the phone number of the place, select .

Navigation

Learn to use the GPS navigation system to find and show your destination with voice guidance.



- Navigation maps, your current location, and other navigational data may differ from actual location information. You should always pay attention to road conditions, traffic, and any other factors that may affect your driving and follow all safety warnings and regulations while driving.
- This feature may be unavailable depending on your region or service provider.

- 1 Open the application list and select **Navigation**.
- 2 If you are launching this application for the first time, select **Accept**.
- 3 Enter your destination by using one of the following methods:
 - Speak your destination such as “Navigate to destination.”
 - Enter your destination with the virtual keypad.
 - Select your destination from addresses of your contacts.
 - Select your destination from the list of your starred places.
- 4 Follow the on-screen instructions to use the navigation service.

Samsung Apps

Samsung Apps allows you to simply and easily download an abundance of applications directly to your device. Featuring a wealth of games, news, reference, social networking, navigation, health related applications and more, Samsung Apps gives you instant access to a huge choice of mobile experience.

Your device gets smarter with fully optimised applications from Samsung Apps. Explore amazing applications and make your mobile life even better.



- This feature may be unavailable depending on your region or service provider.
- For details, please visit www.samsungapps.com.

- 1 Open the application list and select **Samsung Apps**.
- 2 If you are launching this application for the first time, read the terms and conditions and select **Accept**.
- 3 Search for and download applications as desired.

S Suggest

Find and download the latest applications suggested by Samsung. Open the application list and select **S Suggest**.

Communication

Calling

Learn to use calling functions, such as making and answering calls, using options available during a call or customising and using call-related features.

› Make or answer a call

You can use the buttons or the touch screen when you make, accept, end or reject calls.



Static electricity discharged from your body or clothing may interfere with the proximity sensor during a call.

Make a call

- 1 Open the application list and select **Phone** → **Keypad**, and enter an area code and a phone number.
- 2 Select  to make a voice call.
For a video call, select **Video call**.
- 3 To end the call, select **End**.



- Use the phonebook to save numbers you dial frequently. ► p. 109
- To quickly access the call log to redial the numbers you dialled recently, select **Phone** → **Logs**.

Answer a call

1 When a call comes in, drag  in any direction until it reaches the border of the circle.

 When the device is ringing, press the Volume key to mute the ringtone.

2 To end the call, select **End call**.

Reject a call

When a call comes in, drag  in any direction until it reaches the border of the circle.



To send a message when you reject incoming calls, select **Reject call with message**.

 First set a text message to be sent to callers. Open the application list and select **Phone** → **Keypad** →  → **Call settings** → **Call settings** → **Set reject messages**.

Make an IP call



1 Open the application list and select **Phone** → **Keypad**, and enter an area code and a phone number.

2 Select .

-  • You can set accounts for IP calls. Open the application list and select **Phone** → **Keypad** →  → **Call settings** → **Internet call settings** → **Accounts**.
- You can set an account as your default IP call account. Open the application list and select **Phone** → **Keypad** →  → **Call settings** → **Internet call settings** → **Accounts** → an account → **Set as primary account**.

Insert a pause

Learn to insert a pause between numbers when entering a PIN or account number on an automatic answering system.

- 1 Open the application list and select **Phone** → **Keypad**, and then enter an area code and a phone number.
- 2 Select  → **Add 2-sec pause** or **Add wait**.
- 3 Enter additional numbers.
- 4 Select  to dial the number.
 - For a 2-second pause, the additional numbers will be sent to the system automatically after 2 seconds.
 - For a waiting pause, select **Yes** when the pop-up window appears.

Call an international number

- 1 Open the application list and select **Phone** → **Keypad**, and tap and hold **0** to insert the + character.
- 2 Enter the complete number you want to dial (country code, area code and phone number), and then select  to dial the number.

› Use a headset

By plugging a headset into the device, you can answer and control calls hands-free:

- To answer a call, press the headset button.
- To reject a call, press and hold the headset button.
- To place a call on hold or retrieve a held call during a call, press and hold the headset button.
- To end a call, press the headset button.



› Use options during a voice call

You can use the following options while a voice call is in progress:

- To adjust the voice volume, press the Volume key up or down.
- To place a call on hold, select **Hold**. To retrieve a held call, select **Unhold**.
- To dial a second call, select **Add call**, and then dial a new number.
- To answer a second call, drag  in any direction until it reaches the border of the circle when a call waiting tone sounds. The device asks whether to end or hold the first call. You must subscribe to the call waiting service to use this feature.
- To open the dialling screen, select **Keypad**.
- To turn off the microphone so that the other party cannot hear you, select **Mute**.
- To listen and talk to the other party via a Bluetooth headset, select **Headset**.
- To open the phonebook, select  → **Contacts**.
- To switch between two calls, select **Swap**.
- To make a multiparty call (conference call), make or answer a second call and select **Merge** when connected to the second party. Repeat to add more parties. You must subscribe to the multiparty call service to use this feature.

› Use options during a video call

You can use the following options while a video call is in progress:

- To switch between the front and rear camera lens, select **Switch camera**.
- To open the dialling screen, select **Keypad**.
- To turn off the microphone so that the other party cannot hear you, select **Mute**.
- To listen and talk to the other party via a Bluetooth headset, select **Headset**.
- To hide your image from the other party, select  → **Hide me**.
- To select an alternative image or video to be shown to the other party, select  → **Images** or **Videos**.
- To use the other party's image, tap and hold the other party's image. You can capture an image of the screen or record the video call by selecting **Capture** or **Record**.





It is illegal in many areas to record a call without permission. Always ask the other party for permission before recording a call.

› View and dial missed calls

Your device will display calls you have missed on the display. To dial the number of a missed call, open the notifications panel and select the missed call.

› Set auto rejection

Use auto rejection to reject calls from certain numbers automatically. To activate auto rejection and create auto reject lists,

- 1 Open the application list and select **Phone** → **Keypad** →  → **Call settings** → **Call settings** → **Call rejection**.
- 2 Select **Auto reject mode**, and then select an option.
 - **All numbers:** Reject all calls.
 - **Auto reject numbers:** Reject calls for the certain number.
- 3 Turn on the auto rejection mode by dragging the slide bar to the right next to **Auto reject mode**.
- 4 Select **Auto reject list**.
- 5 Select .
- 6 Enter a number to reject and select **Save**.
You can set the criteria for the number.
- 7 To add more numbers, repeat steps 4-6.

› Set call forwarding

Call diverting is a network feature to send incoming calls to another number that you specify. You can set this feature separately for several conditions when you are not able to answer calls, such as when you are already on the phone or when you are outside of the service area.

- 1 Open the application list and select **Phone** → **Keypad** →  → **Call settings** → **Call settings** → **Call forwarding** → a call type.

- 2 Select a condition.
- 3 Enter a number to which calls will be forwarded and select **Enable**.
Your setting will be sent to the network.

› Use Fixed Dialling Number (FDN) mode

In FDN mode, your device will restrict outgoing calls, except for the numbers stored in the FDN list. To activate FDN mode,

- 1 Open the application list and select **Phone** → **Keypad** →  → **Call settings** → **Call settings** → **Additional settings** → **Fixed Dialling Numbers** → **Enable FDN**.
- 2 Enter the PIN2 supplied with your SIM or USIM card and select **OK**.
- 3 Select **FDN list** and add contacts to be used in FDN mode.

› Set call barring

Call barring is a network feature that restricts certain types of calling or prevents others from making calls with your device.

- 1 Open the application list and select **Phone** → **Keypad** →  → **Call settings** → **Call settings** → **Additional settings** → **Call barring** → a call type.
- 2 Select a condition.
- 3 Enter a call barring password and select **OK**.
Your setting will be sent to the network.

› Set call waiting

Call waiting is a network feature to alert you of an incoming call while you are on a previous call. This feature is available only for voice calls.

Open the application list and select **Phone** → **Keypad** →  → **Call settings** → **Call settings** → **Additional settings** → **Call waiting**. Your setting will be sent to the network.

› View call logs

You can view logs of your calls and messages filtered by their types.

- 1 Open the application list and select **Phone** → **Logs**.
- 2 Select  → **View by** → an option.
- 3 Select a log to view its details.

 From the detail view, you can dial or send a message to the number. You can also use some helpful functions by tapping and holding a log on the list.

› Customise call settings

- 1 Open the application list and select **Phone** → **Keypad** →  → **Call settings** → an option.
- 2 Change the following options:

Option	Function
Call rejection	Set to reject all calls or from specified phone numbers automatically. You can add phone numbers to the auto reject list.
Set reject messages	Add or edit the message that will be sent when you reject a call.

Option	Function
Call alert	<ul style="list-style-type: none"> • Call vibrations: Set the device to vibrate when the other party answers or ends a call. • Call status tones: Set the device to alert you to the call status during a call. • Alerts on call: Set the device to alert you to events during a call.
The power key ends calls	Set to end a call when you press the Power key.
Accessory settings for call	<ul style="list-style-type: none"> • Automatic answering: Set whether or not the device answers calls automatically after a specified period (available only when a headset is connected). • Automatic answering timer: Select the length of time that the device waits before answering calls. • Outgoing call condition: Set to allow outgoing calls with a Bluetooth headset, even when your device is locked. • Outgoing call type: Select the type of outgoing calls to make you use a Bluetooth headset.
Use extra vol. for calls	Set to show the volume key during a call.
Increase volume in pocket	Set the device to raise the ringtone volume when the device is in an enclosed, such as a bag or pocket.

Option	Function
Call forwarding	Set to send incoming calls to a specified number.
Additional settings	<ul style="list-style-type: none"> • Caller ID: Display your caller ID to other parties for outgoing calls. • Call barring: Set to restrict calls by call type. • Call waiting: Set the device to alert you to incoming calls during a call. • Auto redial: Set to automatically redial a call that was not connected or that was cut off. • Fixed Dialling Numbers: Activate FDN mode to prevent calls to phone numbers that are not in the FDN list on the SIM or USIM card. • Auto area code: Set to insert a prefix (area or country code) automatically before a phone number.
Video call image	Select an alternative image to be shown to the other party.
Own video in received call	Set to show your live image to the other party.
Use call fail options	Set to attempt a voice call when a video call fails to connect.
Voicemail service	Select a voicemail service provider.
Voicemail settings	Enter the voicemail server number. You can obtain this number from your service provider.





Option	Function
Vibrate	Set the device to vibrate when voicemails are received.
Accounts	Set to accept IP calls and set up your accounts for IP call services.
Use Internet calling	Set the device to use IP call services. IP call services are provided only via Wi-Fi.

Messaging







Learn to create and send text (SMS) or multimedia (MMS) messages, and view or manage messages you have sent or received.

 You may incur additional charges for sending or receiving messages while outside your home service area. For details, contact your service provider.

› Send a text message

- 1 Open the application list and select **Messaging** → .
- 2 Add recipients of your message.
 - Enter phone numbers manually, separating them with a semicolon or a comma.
 - Select phone numbers from the lists by selecting .
- 3 Select **Enter message** and enter your message text. To insert emoticons, select  → **Insert smiley**.
- 4 Select  to send the message.

› Send a multimedia message

- 1 Open the application list and select **Messaging** → .
 - 2 Add recipients of your message.
 - Enter phone numbers or email addresses manually, separating them with a semicolon or a comma.
 - Select phone numbers or email addresses from the lists by selecting .
-  When you enter an email address, the device will convert the message as a multimedia message.
- 3 Select **Enter message** and enter your message text.
To insert emoticons, select  → **Insert smiley**.
 - 4 Select  and add an item.
You can select a file from the file list or create a new photo or video.
 - 5 Select  to send the message.

› View a text or multimedia message

- 1 Open the application list and select **Messaging**.
Your messages are grouped into message threads by contact, like a messenger.
- 2 Select a contact.
- 3 For a multimedia message, select a message to view the details.

› Listen to voice mail messages

If you have set missed calls to be diverted to the voice mail server, callers can leave voice messages when you do not answer incoming calls. To access your voice mail inbox and listen to your messages,

- 1 Open the application list and select **Phone** → **Keypad**, and then tap and hold **1** .
- 2 Follow the instructions from the voice mail server.



You must save the voice mail server number before accessing the server. Contact your service provider for the number.

Google Mail



You can retrieve new email messages from Google Mail™ to your Inbox. When you access this application, the Inbox screen appears. The total number of unread messages displays in the title bar and unread messages display in bold.



- This feature may be unavailable depending on your region or service provider.
- This Google Mail menu may be labelled differently depending on your region or service provider.

› Send an email message

- 1 Open the application list and select **Google Mail** → .
- 2 Select the recipient field and enter an email address.
- 3 Select the subject field and enter a subject.

- 4 Select the text field and enter your email text.
 - To attach a photo, select .
 - To remove an attached photo, select  to the right of an attachment's name.
- 5 Select **SEND** to send the message.



















If you are offline or outside your service area, the message will be held in the message thread until you are online and inside your service area.

› View an email message

- 1 Open the application list and select **Google Mail**.
- 2 Select  to update the message list.
- 3 Select an email message.

From the message view, use the following options:

- To create a new message, select .
- To search for an email message, select .
- To archive the message, select .
- To delete the message, select .
- To add a label to the message, select .
- To move to the next or previous message, scroll left or right.
- To reply to the message, select .
- To reply to the message including all recipients, select .
- To forward the message to other people, select .
- To add a star to the message, select .
- To view an attachment, select **VIEW**. To save it to your device, select **SAVE**.
- To make the message as unread, select  → **Mark unread**.
- To mark the message as important, select  → **Mark as important**.

- To hide the message, select  → **Mute**. To move the message to the inbox folder, select **All Mail** and drag the message to **Inbox**.
- To register the message to the spam list, select  → **Report spam**.
- To reload the messages, select  → **Refresh**.
- To add a label to a message, select  → **Manage labels**.
- To customise the email settings, select  → **Settings**.



Available options may vary depending on the account.

Email





Learn to send or view email messages via your personal or company email account.

› Set up an email account

- 1 Open the application list and select **Email**.
- 2 Enter your email address and password.
- 3 Select **Next** (for general email accounts) or **Manual setup** (for other company email accounts).
- 4 Follow the on-screen instructions.
- 5 To add more email accounts, select  → **Settings** → **Add account** and repeat steps 2-4.

When you are finished setting up the email account, the email messages are downloaded to your device. If you have created more than two accounts, you can switch between email accounts. Select an account name at the top left of the screen and select the one you want to retrieve messages from.

› Send an email message



- 1 Open the application list and select **Email** → .
 - 2 Add recipients of your message.
 - Enter email addresses manually, separating them with a semicolon or a comma.
 - Select email addresses from the lists by selecting .
 - 3 Select the subject field and enter a subject.
 - 4 Select the text input field and enter your email text.
 - 5 Select  → files to attach.
 - 6 Select  to send the message.
-  If you are offline or outside your service area, the message will be held in the outbox until you are online and in your service area.















› View an email message

When you open an email account, you can view previously retrieved emails offline or connect to the email server to view new messages. After retrieving email messages, you can view them offline.

- 1 Open the application list and select **Email**.
- 2 Select  to update the message list.
- 3 Select an email message.

From the message view, use the following options:

- To search for an email message, select .
- To create a new message, select .
- To reply to the message, select .

- To reply to the message including all recipients, select .
- To forward the message to other people, select .
- To delete the message, select .
- To display different applications on the same screen at the same time, select **Multiscreen** → an option. While using this feature, you can switch the position of the applications by tapping and holding the application titles.
- To add a star to the message, select .
- To make the message as unread, select  → **Mark as unread**.
- To move the message to another folder, select  → **Move**.
- To save the message, select  → **Save email**. The message will be saved in **My Files** → **sdcard** → **Saved Email**.
- To view the messages by category, select  → **Sort by**.
- To change the view mode, select  → **View mode**.
- To print the message using a Wi-Fi or USB connection, select  → **Print**. Your device is compatible only with some Samsung printers.
- To save the email addresses of the recipients to the phonebook as a group of contacts, select  → **Save as group**.
- To customise the email settings, select  → **Settings**.
- To delete all messages, select  → **Delete all**.
- To save an attachment to your device, select the attachment tab → .



The options available may vary depending on the email account or device's orientation.

Talk

Learn to chat with friends and family via Google Talk™.



This feature may be unavailable depending on your region or service provider.





› Set your status

- 1 Open the application list and select **Talk**.
- 2 Add your Google account (if necessary).
- 3 Customise your status, image, and message to display.

› Add friends to your friend list

- 1 Open the application list and select **Talk** → .
- 2 Enter an email address of the friend and select **DONE**.
When your friend accepts the invitation, the friend is added to your friend list.

› Start a chat

- 1 Open the application list and select **Talk**.
- 2 Select a friend from the friends list. The chat screen opens.
- 3 Enter and send your message.
 - To add more friends to a chat, select  → **Add to chat**.
 - To switch between active chats, select a friend from the friends list.
 - To use video chat, select .
 - To use voice chat, select .
 - To end the chat, select  → **End chat**.

ChatON

Learn to use ChatON to send and receive instant messages from any device that has a mobile phone number.

1 Open the application list and select **ChatON**.

 If you are launching this application for the first time, follow the on-screen instructions to complete the account setup.

2 Enter and send your message.

Messenger

Learn to send and receive instant messages to friends and family with the Google+ messenger instant messaging service.

1 Open the application list and select **Messenger**.

 If you are launching this application for the first time, follow the on-screen instructions to complete the account setup.

2 Enter and send your message.

Google+

Learn to access the Google's social network service. You can create groups to share interests and thoughts or send and receive instant messages, and upload your photos.

1 Open the application list and select **Google+**.

 If you are launching this application for the first time, follow the on-screen instructions to complete the account setup.

2 Select a social network feature.

Entertainment

Music Player

Learn to listen to your favourite music while on the go with the music player. The music player supports the following file formats: mp3, aac, ogg, wma, flac, m4a.



- You can also play music files in the following formats if you open them from My files or the web browser: mid, xmf, rtttl, imy, rtx, ota, amr, wav, mxmf.
- Some file formats are not supported depending on the software of the device.
- If the file size exceeds the available memory, an error can occur when you open files.
- Playback quality may vary by content type.
- Some files may not play properly depending on how they are encoded.

› Add music files to your device

Start by transferring files to your device or memory card:

- Download from the wireless web. ► p. 57
- Download from a PC with Samsung Kies. ► p. 113
- Receive via Bluetooth. ► p. 125
- Synchronise with Windows Media Player 11. ► p. 114
- Copy to your memory card.

› Play music

After transferring music files to your device or memory card,

- 1 Open the application list and select **Music Player**.
- 2 Select a music category → a music file.

- 3 Tap the music player field.
- 4 Control playback with the virtual keys.



During playback, select  to access the following options:

- To add music files to a playlist, select **Add to playlist**.
- To listen to music via a Bluetooth headset, select **Via Bluetooth**. You cannot use this option when you connect a headset to your device.
- To send the music file to others or share it, select **Share via**.
- To set the music file as various tones, select **Set as**.
- To search for devices that have media sharing activated **Scan for nearby devices**.
- To change the music player settings, select **Settings**.



- You can control the music player with a headset. In Idle mode, press and hold the headset button to launch the music player. Press the headset button to start or pause playback.
- You can experience virtual 5.1 surround sound when listening to multichannel content, such as DVD movies.

› Create a playlist

- 1 Open the application list and select **Music Player**.
- 2 Select  → **New playlist**.
- 3 Enter a title for your new playlist and select **OK**.
- 4 To add music files to the playlist, select  next to the music files.
To delete music files from the playlist, select  next to the music files.
- 5 Select **Done**.

› Customise music player settings

- 1 Open the application list and select **Music Player**.
- 2 Select  → **Settings**.
- 3 Adjust the following settings to customise your music player:

Option	Function
SoundAlive	Select a sound effect.
Play speed	Change the playback speed.
Lyrics	Set to display lyrics during playback.
Music auto off	Set the music player to turn off automatically after a specific period of time.
Music menu	Select music categories to display on the music library screen.

Music Hub

You can access the online music store, and search for and buy your favourite songs. You can also add a music file to your wish list and play downloaded music files.

 This feature may be unavailable depending on your region or service provider.

- 1 Open the application list and select **Music Hub**.
- 2 If you are launching this application for the first time, check the check box next to **Skip this message for 90 days**, and then select **Confirm**.
- 3 Search for songs, and preview or buy your favourite songs.

Camera

Learn how to capture and view photos and videos.





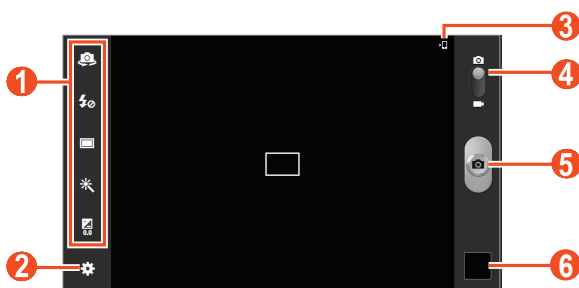

- The camera automatically turns off when you do not use it for a specified period.
- The memory capacity may differ depending on the shooting scene or shooting conditions.

› Capture a photo

- 1 Open the application list and select **Camera**.
- 2 Aim the lens at the subject and make any necessary adjustments.



Number	Function
1	<p>Use camera shortcuts.</p> <ul style="list-style-type: none">• : Switch between the front and rear camera lenses.• : Change the flash setting.• : Change the shooting mode.• : Apply a special effect.• : Adjust the exposure value. <p>You can add or remove shortcuts to frequently used options. ► p. 99</p>
2	<p>Change the camera settings.</p>





Number	Function
	View the storage location.
	Switch to the camcorder.
	Capture a photo.
	View photos you have taken.













To zoom in, place two fingers on the screen and slowly spread them apart. To zoom out, pinch them together. You can also zoom in or out with the Volume key.

- 3 Tap where you want to focus on the preview screen. The focus frame moves to the place you tapped and changes to green when the subject is in focus.
- 4 Select  to take a photo. The photo is saved automatically.

After taking photos, select the image viewer to view the captured photos.

- To view more photos, scroll left or right. You can also tap the screen and scroll through the thumbnails of photos at the bottom of the screen.
- To zoom in or out, place two fingers on the screen and slowly spread them apart or pinch them together. To return to the original size, double-tap the screen.
- To view the photo on a DLNA certified device, select . This option appears only if one or more DLNA certified devices are on the same Wi-Fi network.
- To send the photo to others, select  → an option.
- To delete the photo, select  → **OK**.
- To start a slide show, select  → **Start slideshow**. Tap the screen to stop the slide show.

- To register the faces in the photo as face tags, select  → **Face tag.** ► p. 105
- To add the photo to the clipboard, select  → **Copy to clipboard.**
- To rotate the photo anti-clockwise, select  → **Rotate left.**
- To rotate the photo clockwise, select  → **Rotate right.**
- To crop a section from the photo, select  → **Crop.**
- To edit the photo with the image editor, select  → **Edit.**
- To set the photo as your wallpaper or a contact image, select  → **Set picture as.**
- To send the photo to a person whose face is tagged in the photo, select  → **Buddy photo share.**
- To print the photo via Wi-Fi or USB, select  → **Print.** Your device is compatible only with some Samsung printers.
- To change the name of a file, select  → **Rename.**
- To view photo details, select  → **Details.**

► Change the shooting mode

You can take photos with various shooting modes. To change the shooting mode, select  → **Shooting mode** → an option.

Option	Function
Smile shot	Set the device to recognise people's faces and help you take photos of them when they smile.
Panorama	Take panoramic photos.
Cartoon	Take photos with cartoon effects.
Share shot	Take a photo and send it to others via Wi-Fi Direct.
Buddy photo share	Send the photo to a person whose face is tagged in the image.

› Customise camera settings

Before taking a photo, select  to access the following options:

Option	Function
Edit shortcuts	Edit shortcuts to frequently-used options.
Self portrait	Switch between the front and rear camera lenses.
Flash	Change the flash setting; You can manually turn the flash on or off, or set the camera to automatically use the flash when needed.
Shooting mode	Change the shooting mode.
Scene mode	Change the scene mode.
Exposure value	Adjust the exposure value to change the brightness.
Focus mode	Take close-up photos or set the camera to focus on the subject automatically.
Timer	Select the length of the delay before the camera takes a photo.
Effects	Apply a special effect, such as sepia or black and white tones.
Resolution	Change the resolution option.
White balance	Adjust the colour balance according to lighting conditions.

Option	Function
ISO	Adjust the sensitivity of the imaging sensor.
Metering	Select a type of exposure metre.
Outdoor visibility	Activate Outdoor visibility to select an appropriate lighting condition.
Guidelines	Display guidelines on the preview screen.
Image quality	Select a quality level for your photos.
GPS tag	<p>Set the camera to include location information for your photos.</p> <ul style="list-style-type: none"> • To improve GPS signals, avoid shooting in locations where the signal may be obstructed, such as between buildings or in low-lying areas, or in poor weather conditions. • Your location may appear on your photos when you upload them to the web. To avoid this, deactivate the GPS tag setting.
Save as flipped	Set the camera to flip the image automatically when you take a photo with the front camera.
Storage	Select a memory location for saving captured photos.
Reset	Reset camera settings.

Record a video

- 1 Open the application list and select **Camera**.
- 2 Drag the slider to switch to the camcorder.
- 3 Aim the lens at the subject and make any necessary adjustments.

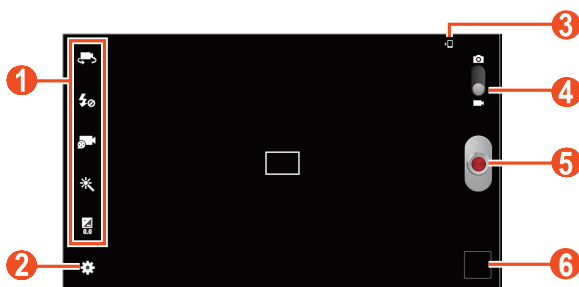



Number	Function
1	<p>Use camcorder shortcuts.</p> <ul style="list-style-type: none">• : Switch to the front camera lens and record a video of yourself.• : Change the flash setting.• : Change the recording mode (for attaching to a message or for saving normally).• : Apply a special effect.• : Adjust the exposure value. <p>You can add or remove shortcuts to frequently used options. ► p. 99</p>
2	Change the camcorder settings.
3	View the storage location.
4	Switch to the camera.







Number	Function
5	Record a video.
6	View videos you have recorded.



To zoom in, place two fingers on the screen and slowly spread them apart. To zoom out, pinch them together. You can also zoom in or out with the Volume key.

- 4 Tap where you want to focus on the preview screen. The focus frame moves to the place you tap and changes to green when the subject is in focus.
- 5 Select  to start recording.
- 6 Select  to stop recording.
The video is saved automatically.

After recording videos, select the image viewer to view the recorded videos.

- To view more videos, scroll left or right. You can also tap the screen and scroll through the thumbnails of videos at the bottom of the screen.
- To play the video, select .
- To send the video to others, select  → an option.
- To delete the video, select  → **OK**.
- To start a slide show, select  → **Start slideshow**. Tap the screen to stop the slide show.
- To change the name of a file, select  → **Rename**.
- To view video details, select  → **Details**.

› Customise camcorder settings

Before recording a video, select  to access the following options:

Option	Function
Edit shortcuts	Edit shortcuts to frequently used options.
Self recording	Switch between the front and rear camera lenses.
Flash	Change the flash setting; You can manually turn the flash on or off.
Recording mode	Change the recording mode.
Exposure value	Adjust the exposure value to change the brightness.
Timer	Select the length of the delay before the camera starts recording a video.
Effects	Apply a special effect, such as sepia or black and white tones.
Resolution	Change the resolution option.
White balance	Adjust the colour balance according to lighting conditions.
Outdoor visibility	Activate Outdoor visibility to select an appropriate lighting condition.
Guidelines	Display guidelines on the preview screen.
Video quality	Select a quality level for your videos.

Option	Function
Save as flipped	Set the camcorder to flip the image automatically when you record a video with the front camera.
Storage	Select a memory location for saving recorded videos.
Reset	Reset camcorder settings.

› Edit the shortcut icons

You can add or remove shortcuts to frequently-used options.

- 1 From the preview screen, select  → **Edit shortcuts**.
- 2 Tap and hold an icon from the option list and drag it to the shortcut area.
To remove shortcuts, tap and hold an icon and drag it to the option list.
- 3 Tap the screen to return to the preview screen.

Video Player

Learn to use the video player.



- Some file formats are not supported depending on the device's software.
- If a file size exceeds the memory available, an error may occur when you try to open the file.
- Playback quality may vary by content type.
- Some files may not play properly depending on how they are encoded.

▶ Play a video



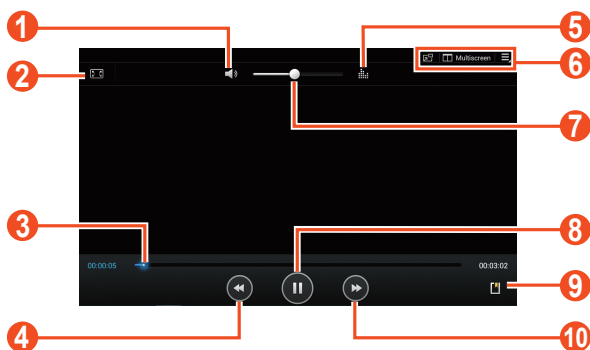





- 1 Open the application list and select **Video Player**.
- 2 Select a video.
- 3 Control playback with the following keys.







Number	Function
1	Mute the video.
2	Change the ratio of the video screen.
3	Scan forwards or backwards in the file by dragging or tapping the bar.
4	Restart playback; Skip to the previous file (double-tap); Scan backwards in the file (tap and hold).
5	Select a sound effect.
6	Open different applications that enable Multiscreen feature; Switch to the floating screen mode; Access video player options.

Number	Function
7	Adjust the volume.
8	Pause playback; Select  to resume playback.
9	Insert a bookmark.
10	Skip to the next file; Scan forwards in the file (tap and hold).

While playing a video, use the following options:

- To display different applications on the same screen at the same time, select **Multiscreen** → an option. While using this feature, you can switch the position of the applications by tapping and holding the application titles.
- To switch to the floating screen mode, select . You can move the screen by tapping and holding it. To return to the full screen mode, tap the screen.
- To send the video to others or share it, select  → **Share via**.
- To divide the video into segments, select  → **Chapter preview**. You can search for a segment and skip directly to that point.
- To trim a segment of the video, select  → **Trim**.
- To listen to audio via a Bluetooth headset, select  → **Via Bluetooth**.
- To export the current video to Video maker, select  → **Video maker**.
- To view your bookmarks, select  → **Bookmarks**. This option appears only if you have bookmarked during playback by selecting .

- To change the video player settings, select  → **Settings**.
- To view video details, select  → **Details**.
- To set the video player to turn off automatically after a specific period of time, select  → **Video auto off**.
- To search for devices that have media sharing activated, select  → **Scan for nearby devices**.

› Customise video player settings

1 During playback, select  → **Settings**.

2 Change the following options:

Option	Function
Play speed	Change the playback speed.
Subtitles	Customise the settings for a subtitle file.
Auto play next	Set the video player to play the next file automatically.
Colour tone	Select a colour tone.
Outdoor visibility	Set to improve the contrast of the display in bright sunlight.

Gallery

Learn to view photos and play videos saved in your device's memory.



- Avoid locking the device's screen while playing a DivX Video-On-Demand. Each time you lock the screen while playing a DivX Video-On-Demand, one of your available rental counts will be decremented.
- Some file formats are not supported depending on the software of the device.
- If the file size exceeds the available memory, an error can occur when you open files.
- Playback quality may vary by content type.
- Some files may not play properly depending on how they are encoded.

› View a photo

1 Open the application list and select **Gallery**.

2 Select a folder → an image.

While viewing a photo, use the following options:

- To view more photos, scroll left or right.
- To zoom in or out, place two fingers on the screen and slowly spread them apart or pinch them together. You can also double-tap the screen. To return to the original size, double-tap the screen.



If you activated tilting motions, you can zoom in or out by tapping and holding two points with your fingers, and then tilting the device back and forth.

- To view the photo on a DLNA certified device, select . This option appears only if one or more DLNA certified devices are on the same Wi-Fi network.
- To send the photo to others, select  → an option.
- To delete the photo, select  → **OK**.
- To start a slide show, select  → **Start slideshow**. Tap the screen to stop the slide show.
- To display different applications on the same screen at the same time, select **Multiscreen** → an option. While using this feature, you can switch the position of the applications by tapping and holding the application titles.
- To register the faces in the photo as face tags, select  → **Face tag**.
- To add the photo to the clipboard, select  → **Copy to clipboard**.
- To rotate the photo anti-clockwise, select  → **Rotate left**.
- To rotate the photo clockwise, select  → **Rotate right**.
- To crop a section from the image, select  → **Crop**.
- To edit the photo with the image editor, select  → **Edit**.
- To set the photo as your wallpaper or a contact image, select  → **Set picture as**.
- To send the photo to a person whose face is tagged in the photo, select  → **Buddy photo share**.
- To print the photo via Wi-Fi or USB, select  → **Print**. Your device is compatible only with some Samsung printers.
- To change the name of a file, select  → **Rename**.
- To search for devices that have media sharing activated, select  → **Scan for nearby devices**.
- To view photo details, select  → **Details**.

› Tag a face in an image

Learn to tag faces in your images to make calls, send messages, and upload messages to social networks with the face tag shortcuts.





Face recognition may fail depending on face angle, face size, skin colour, facial expression, light conditions, or accessories the subject is wearing.

- 1 Open the application list and select **Gallery**.
- 2 Select an image.
- 3 Select  → **Face tag** → **On**.
Recognised faces appear in the frame.
- 4 Select a recognised face → **Add name**.
- 5 Select the person's name from the contact list.
The contact is linked to the face in the image.

When the face tag appears with a name, select the face tag and use the available options.

› Play a video

- 1 Open the application list and select **Gallery**.
- 2 Select a folder → a video (indicated by the  icon).
- 3 Select  to begin playback.
- 4 Control playback with the keys. ▶ p. 99

During playback, select  to access the following options:

- To send the video to others or share it, select **Share via**.
- To divide the video into segments, select **Chapter preview**. You can search for a segment and skip directly to that point.
- To trim a segment of the video, select **Trim**.
- To listen to audio via a Bluetooth headset, select **Via Bluetooth**.
- To export the current video to Video maker, select **Video maker**.
- To view your bookmarks, select **Bookmarks**. This option appears only if you have bookmarked during playback by selecting .
- To change the video settings, select **Settings**.
- To view video details, select **Details**.
- To search for devices that have media sharing activated, select **Scan for nearby devices**.

Video Maker

You can edit videos and apply various effects.

› Create a video

- 1 Open the application list and select **Video Maker**.
- 2 Select  (if necessary).
- 3 Select a frame theme.
- 4 Select a category.
- 5 Tap and hold a file, and then drag it to the bottom panel of the screen.
 - To delete images or videos, tap and hold an item, and then drag it to the rubbish bin.

- To rearrange images or videos, tap and hold an item, and then drag it to a new location.
- To trim a segment of an image or video, tap an item, and then drag the brackets to the left or right.
- To add a caption to an image or video, drag the thumbnail to place the black dotted line at the desired point, and then select **T** on the preview screen.

6 Select  → a transition effect option.

7 When you are finished, select  → **Export**.

8 Select a resolution option.

9 Enter a name for the video and select **OK**.

▶ Trim a segment of a video

1 Launch the video editor and open a video file.

2 Select the thumbnail.

3 Move the start bracket to the point where trimming should begin.

4 Move the end bracket to the point where the trimming should end.

5 Save the edited video.

▶ Split a video

1 Launch the video editor and open a video file.

2 Select the thumbnail.

3 Drag the thumbnail at the bottom of the screen to place the black dotted line.

4 Select .





5 Save the edited video.

› Apply an effect to a video

- 1 Launch the video editor and open a video file.
- 2 Select the thumbnail.
- 3 Select **Effect** → an effect option.
- 4 Save the edited video.

› Insert a drawing in a video

- 1 Launch the video editor and open a video file.
- 2 Select the thumbnail.
- 3 Drag the thumbnail at the bottom of the screen to place the black dotted line.
- 4 Select  on the preview screen, and then draw on the screen with the following tools:

Icon	Function
	Undo your last action.
	Redo your last action.
	Change the pen settings.
	Change the eraser thickness.

- 5 When you are finished, select **Done**.
- 6 Save the edited video.

Personal information

Contacts

Learn to create and manage a list of your personal or business contacts. You can save names, mobile phone numbers, home phone numbers, email addresses, birthdays and more for your contacts.

› Create a contact

- 1 Open the application list and select **Contacts**.
- 2 Select **Contacts** → .
- 3 Select a memory location.
- 4 Enter contact information.
- 5 Select **Save** to add the contact to memory.







You can also create a contact from the dialling screen.

- 1 Open the application list and select **Phone** → **Keypad**.
- 2 Enter a phone number and select  → an option.
- 3 Enter contact information.
- 4 Select **Save** to add the contact to memory.

› Find a contact

- 1 Open the application list and select **Contacts**.
- 2 Select **Contacts**.
- 3 Scroll up or down the contact list.
You can also find a contact by entering a few letters in the text input field at the top of the contact list.
- 4 Select a contact's name.

Once you find a contact, you can use the following options:

- To edit the contact information, select .
- To delete the contact, select  → **OK**.
- To call the contact, select  or .
- To send a message, select .
- To send an email message, select .
- To set the contact as your favourites, select .

► Import or export contacts

You can import or export files (in vcf format) to or from your device's USB storage or a memory card.

Import contact files

- 1 Open the application list and select **Contacts**.
- 2 Select **Contacts**.
- 3 Select  → **Import/Export** → **Import from SD card** or **Import from USB storage**.
- 4 Select an option for importing a single contact file, multiple contact files, or all contact files, and select **OK**.
- 5 Select contact files to import and select **OK**.

Export contact files

- 1 Open the application list and select **Contacts**.
- 2 Select **Contacts**.
- 3 Select  → **Import/Export** → **Export to SD card** or **Export to USB storage**.
- 4 Select **OK** to confirm.

› Copy or move contacts

Copy contacts from the SIM or USIM card to your device

- 1 Open the application list and select **Contacts**.
- 2 Select **Contacts**.
- 3 Select  → **Import/Export** → **Import from SIM card**.
- 4 Select contacts and select **Done**.

Copy contacts from your device to the SIM or USIM card

- 1 Open the application list and select **Contacts**.
- 2 Select **Contacts**.
- 3 Select  → **Import/Export** → **Export to SIM card**.
- 4 Select contacts and select **Done** → **OK**.

› Create your namecard

- 1 Open the application list and select **Contacts**.
- 2 Select **Contacts**.
- 3 Select **Set up my profile** at the top of the contact list.
- 4 Enter your personal details and select **Save**.

 You can send your namecard to others by selecting  → **Share namecard via**.

› Create a group of contacts

- 1 Open the application list and select **Contacts**.
- 2 Select **Groups** → **+**.
- 3 Enter a name and customise the settings for the group.
- 4 Select **Add member**.
- 5 Select members from the contact list and select **Done**.
- 6 When you are finished, select **Save**.

› Set a speed dial number

- 1 Open the application list and select **Contacts**.
- 2 Select **Contacts**.
- 3 Select  → **Speed dial setting**.
- 4 Select a location number → a contact.



You can call a speed dial number by tapping and holding the location number on the dialling screen.

Connectivity

PC connections

Learn to connect your device to a PC with a USB cable in various USB connection modes. By connecting the device to a PC, you can synchronise files with Windows Media Player, transfer data to and from your device directly, and use the Samsung Kies program.



Do not disconnect the USB cable from a PC while the device is transferring or accessing data. Doing so may result in data loss or damage to the device.



For best results, connect the USB cable directly to a USB port on a PC. Data transfers may fail when using a USB hub.

› Connect with Samsung Kies

Ensure that Samsung Kies is installed on your PC. You can download the program from the Samsung website.



Samsung Kies will work on both Windows and Macintosh computers.

- 1 Connect your device to a PC with a USB cable. Samsung Kies will launch automatically. If Samsung Kies does not launch automatically, double-click the Samsung Kies icon on your PC.
- 2 Copy files from the PC to the device. Refer to the Samsung Kies help for more information.

› Synchronise with Windows Media Player

Ensure that Windows Media Player is installed on your PC.

- 1 Connect your device to a PC with a USB cable.
- 2 Open Windows Media Player and synchronise music files.

› Connect as a media device

You can connect your device to a PC and access media files stored on your device.

- 1 Connect your device to a PC with a USB cable.
- 2 Select the right side of the system bar, and then select **Connected as a media device** → **Media device (MTP)**.
- 3 Transfer files between your device and the PC.

› Connect as a camera device

You can connect your device to a PC as a camera and access files in your device.

 Use this USB connection mode when your PC does not support the media transfer protocol (MTP) or does not have the USB driver for your device installed.

- 1 Connect your device to a PC with a USB cable.
- 2 Select the right side of the system bar, and then select **Connected as a media device** → **Camera (PTP)**.
- 3 Transfer files between your device and the PC.

Wi-Fi

Learn to use your device's wireless networking capabilities to activate and connect to any wireless local area network (WLAN) compatible with the IEEE 802.11 a/b/g/n standards. You can connect to the internet or other network devices anywhere an access point or wireless hotspot is available.



Your device uses a non-harmonised frequency and is intended for use in all European countries. The WLAN can be operated in the EU without restriction indoors, but cannot be operated outdoors.

▶ Activate the Wi-Fi feature

Open the application list, select **Settings**, and then drag the **Wi-Fi** switch to the right.



The Wi-Fi feature running in the background will consume battery power. To preserve battery power, activate the feature only when needed.

▶ Find and connect to a Wi-Fi network

- 1 Open the application list and select **Settings** → **Wi-Fi**. The device will automatically search for available Wi-Fi networks.
- 2 Select a network under **Wi-Fi networks**.
- 3 Enter a password for the network (if necessary).
- 4 Select **Connect**.

› Add a Wi-Fi network manually

- 1 Open the application list and select **Settings** → **Wi-Fi** → **Add Wi-Fi network**.
- 2 Enter an SSID for the network and select a security type.
- 3 Set the security settings depending on the selected security type.
- 4 Select **Save**.

› Connect to a Wi-Fi network using a Wi-Fi Protected Setup (WPS)

Using WPS, you can connect to a secured network.

Connect with a WPS button

- 1 Open the application list and select **Settings** → **Wi-Fi**.
- 2 Select a network indicated as WPS available under **Wi-Fi networks**, and then check the check box next to **Show advanced options**.
- 3 Select the drop-down menu under **WPS**, and then select **Push button** → **Connect**.
- 4 Press a WPS button on the access point within 2 minutes.

Connect with a WPS PIN

- 1 Open the application list and select **Settings** → **Wi-Fi**.
- 2 Select a network indicated as WPS available under **Wi-Fi networks**, and then check the check box next to **Show advanced options**.
- 3 Select the drop-down menu under **WPS**, and then select **PIN from access point** or **PIN from this device** → **Connect**.
- 4 On the access point, enter the PIN and press the start button.

› Set the static IP settings

- 1 Open the application list and select **Settings** → **Wi-Fi**.
- 2 Select a network under **Wi-Fi networks**, and then check the check box next to **Show advanced options**.
- 3 Select the drop-down menu under **IP settings**.
- 4 Select **Static**.
- 5 Change the IP settings for the network such as IP address, Gateway, Network prefix length, DNS.
- 6 Select **Connect**.

› Customise Wi-Fi settings

- 1 Open the application list select **Setting** → **Wi-Fi** →  → **Advanced**.
- 2 Change the following options:

Option	Function
Network notification	Set the device to notify you when an open Wi-Fi network is available.
Keep Wi-Fi on during sleep	Set whether or not to keep the Wi-Fi feature active in Sleep mode.
Check for Internet service	Set to check if you can access Internet services while using the current network.
MAC address	View the MAC address for the device.
IP address	View the IP address for the current network.

Wi-Fi Direct

Learn to use the Wi-Fi Direct feature to connect two devices via Wi-Fi without requiring an access point.

› Connect your device to another device

- 1 Open the application list and select **Settings** → **More settings** → **Wi-Fi Direct**.
- 2 Drag the **Wi-Fi Direct** switch to the right.
- 3 Select **Scan** → a device.
When the owner of the other device accepts the connection, the devices are connected.

› Send data via Wi-Fi

- 1 Select a file or item from an appropriate application.
- 2 Select an option for sending data via Wi-Fi.
 The method for selecting an option may vary by data type.
- 3 Search for and select another device.

› Receive data via Wi-Fi

When you receive data, it is saved to your device automatically. Received data is saved to the ShareViaWifi folder.

AllShare Cast

Learn to connect your device to a large screen by using an AllShare Cast dongle, and then share your contents.



- This feature may be unavailable depending on your region or service provider.
- Some files may be buffered while playing depending on the network connection.
- If you specify a Wi-Fi frequency band (5 GHz or 2.4 GHz), AllShare Cast dongles may not be found or connected.
- If you play videos or games with a TV, select an appropriate TV mode to get the best experience with AllShare Cast.

1 Open the application list and select **Settings** → **More settings** → **AllShare Cast**.

2 Drag the **AllShare Cast** switch to the right.

3 Select a device.

When the devices are connected, you can see your device's display on the other's display.

4 Open or play a file.

5 Control the display with the keys on your device.

AllShare Play

You can play and send any file between registered devices, or registered web storage via AllShare Play.

To use the AllShare Play service, you must sign in to your Samsung account, and register two or more devices as file servers. The registration methods may vary depending on the device type. To get more details about using AllShare Play, select  → **FAQ**.

 This feature may be unavailable depending on your region or service provider.

› Send a file

- 1 Open the application list and select **AllShare Play**.
- 2 Select a registered device or storage that contains media files.
- 3 Select a media category and select the check box on a file.
- 4 Select .
- 5 Select a registered device or storage to save the file.

› Share a file

- 1 Open the application list and select **AllShare Play**.
- 2 Select a registered device or storage that contains media files.
- 3 Select a media category and select the check box on a file.
- 4 Select , and then choose a share option.

› Play a file on a nearby device



- Supported file formats may differ depending on connected devices as a media player.
- Some files may be buffered while playing depending on the network connection.

- 1 Open the application list and select **AllShare Play**.
- 2 Select a registered device or storage that contains media files.
- 3 Select a media category and select the check box on a file.
- 4 Select
- 5 Select a device to use as a media player.
- 6 Control playback with the keys on your device.

› Use the Group Cast feature

You can share screens with multiple other devices that are connected to the same Wi-Fi AP.

- 1 Open the application list and select **AllShare Play**.
- 2 Select a media category and select the check box on a file.
- 3 Select → **Group Cast**.
- 4 Enter a PIN and select **Done**.
- 5 Select **OK** to start **Group Cast**.
- 6 On another device, join Group Cast with the PIN.

› Manage contents on a registered device or storage

- 1 Open the application list and select **AllShare Play**.
- 2 Select a registered device or storage.
- 3 View and manage your files.

› Customise AllShare Play settings

- 1 Open the application list and select **AllShare Play**.
- 2 Select  → **Settings**.
- 3 Change the following options:

Option	Function
Registered Storage	View registered storages that have been added to AllShare Play.
Registered Devices	View or edit devices that have been added to AllShare Play.
Setting up web services	Sign in to social network sites to upload files.
Auto Upload photos from mobile	Set to upload photos to the registered storage automatically when you sign in.
Video quality settings	Set to optimise the video quality for your device when playing videos saved on a computer.
Lock AllShare Play	Set to lock AllShare Play with the password for your Samsung account.
Language	Select a display language.
About	View AllShare Play information.

Bluetooth

Bluetooth is a short-range wireless communications technology capable of exchanging information over a distance of about 10 m without requiring a physical connection.

You do not need to line up the devices to beam information with Bluetooth. If the devices are within range of one another, you can exchange information between them even if they are located in different rooms.



- Samsung is not responsible for the loss, interception, or misuse of data sent or received via the Bluetooth wireless feature.
- Always ensure that you share and receive data with devices that are trusted and properly secured. If there are obstacles between the devices, the operating distance may be reduced.
- Some devices, especially those that are not tested or approved by Bluetooth SIG, may be incompatible with your device.
- Do not use the Bluetooth feature for illegal purposes (for example, pirating copies of files or illegally tapping communications for commercial purposes). Samsung is not responsible for the repercussions of illegal use of the Bluetooth feature.

› Turn on the Bluetooth wireless feature

Open the application list, select **Settings**, and then drag the **Bluetooth** switch to the right.

› Find and pair with another devices



- 1 Open the application list and select **Settings** → **Bluetooth** → **Scan**.
- 2 Select a device.
- 3 Select **OK** to match the Bluetooth PIN between two devices. Alternately, enter a Bluetooth PIN and select **OK**. When the owner of the other device enters the same PIN or accepts the connection, pairing is complete. If the pairing is successful, the device will automatically search for available services.

 Some devices, especially headsets or hands-free car kits, may have a fixed Bluetooth PIN, such as 0000. If the other device has a PIN, you must enter it.

› Send data via Bluetooth

- 1 Select a file or item from an appropriate application.
 - 2 Select an option for sending data via Bluetooth.
-  The method for selecting an option may vary by data type.
- 3 Search for and pair with a Bluetooth-enabled device.

› Receive data via Bluetooth

- 1 Open the application list and select **Settings** → **Bluetooth**, and then check the check box next to your device name.
 To select the length of time that your device will be visible, select  → **Visible time-out**.
- 2 When prompted, enter the PIN for the Bluetooth wireless feature and select **OK** (if necessary).
- 3 Select **Accept** to confirm the connection between two devices.

Received data is saved to the Bluetooth folder. If you receive a contact, it is saved to the phonebook automatically.

Mobile network sharing

Learn to set your device as a wireless modem or wireless access point for PCs or other devices, and share your device's mobile network connection.

› Share your device's mobile network via Wi-Fi

- 1 Open the application list and select **Settings** → **More settings** → **Tethering and portable hotspot** → **Portable Wi-Fi hotspot**.
- 2 Drag the slide bar to the right next to **Portable Wi-Fi hotspot**.
- 3 Select **Configure** to configure network settings to use your device as an access point.

Option	Function
Network SSID	View and edit the device name that will be shown to external devices.
Hide my device	Set to prevent other devices from locating your device.
Security	Select the security type.
Password	View or edit the network key to prevent unauthorised access to the network.
Show password	Set to show your password as you enter them.
Show advanced options	Select a broadcast channel.

- 4 When you are finished, select **Save**.
- 5 From another device, locate your device's name in the available connection list and connect to the network. Your device shares the mobile network connection with the other device.



You can restrict mobile network sharing to specified devices. Select **Allowed devices**, create a device list, and then select your device's name to change the sharing mode to **Only allowed devices**.

› Share your device's mobile network via USB

- 1 Connect your device to a PC with a USB cable.
- 2 Open the application list and select **Settings** → **More settings** → **Tethering and portable hotspot**.
- 3 Select **USB tethering**.
To stop sharing the network connection, clear the check box next to **USB tethering**.



The sharing method for the network connection may differ depending on the PC's operating system.

GPS

Your device is equipped with a global positioning system (GPS) receiver. Learn to activate location services.

To receive better GPS signals, avoid using your device in the following conditions:

- Between buildings, in tunnels or underground passages, or inside buildings
- In poor weather
- Around high voltage or electromagnetic fields
- In a vehicle with sun protection film



Do not touch or cover the antenna area with your hands or other objects while using the GPS functions.



This feature may be unavailable depending on your region or service provider.

› Activate location services

You must activate location services to receive location information and search the map.

- 1 Open the application list and select **Settings** → **Location services**.
- 2 Change the following options:

Option	Function
Use wireless networks	Set to use Wi-Fi and/or mobile networks for finding your location.
Use GPS satellites	Set to use the GPS satellite for finding your location.
Location and Google search	Set the device to use your current location for Google search and other Google services.

TV connections

You can control a TV remotely with your device to browse your favourite shows and get programming suggestions based on your choices. You can also control other devices connected to the TV.

› Set your device as a remote control for a TV

You must first connect your device to a Wi-Fi AP and ensure that the device's infrared port is facing the TV.

- 1 Open the application list and select **Smart Remote**.
- 2 If you are launching this application for the first time, select **Agree**.

- 3 Rotate the device anti-clockwise to landscape orientation.
- 4 Select an option next to **Set Up Smart Remote Now:**
- 5 Select **Choose Brand** → the brand of your TV.
- 6 Select **Test Power On/Off** → **Yes** to check the connection between your device and TV.
- 7 Select **Done**.
To add other devices, select **Add New Device**.
- 8 Control your TV or other devices with the icons on your device.

› Customise remote control settings

- 1 Open the application list and select **Smart Remote**.
- 2 Select .
- 3 Change the following options:

Option	Function
Television	Change command codes if you have problems with a particular control.
Add New Device	Set up connections to peripheral devices connected to the TV.
Reset Peel	Reset the connection settings.
Send Feedback	Report your opinion for application development.

VPN connections

You can create virtual private networks (VPN) and connect to your private network securely through a public network, such as the internet.



- Your device should already be configured with internet access. If you have trouble accessing the internet, you need to edit connections. If you are not sure about the connection information to enter, ask your service provider.
- To use this feature, you must activate the screen lock feature.

› Set up VPN connections

1 Open the application list and select **Settings** → **More settings** → **VPN** → **Add VPN network**.

2 Change the following options:

Option	Function
Name	Enter a name for the VPN server.
Type	Select a VPN type.
Server address	Enter the IP address of the VPN server.
L2TP secret	Enter an L2TP secret password.
IPSec identifier	Enter a user name.
IPSec pre-shared key	Enter a pre-shared security key.

Option	Function
IPSec user certificate	Select a user certificate that the VPN server will use to identify you. You can import certificates from the VPN server or download them from the Internet.
IPSec CA certificate	Select a certificate authority (CA) certificate that the VPN server will use to identify you. You can import certificates from the VPN server or download them from the Internet.
IPSec server certificate	Select a server certificate that the VPN server will use to identify you. You can import certificates from the VPN server or download them from the Internet.
PPP encryption (MPPE)	Set to encrypt data before sending it to the VPN server.
Show advanced options	Set to change the advanced network settings.



The options available may vary depending on the VPN type.

3 When you are finished, select **Save**.

› Connect to a private network

- 1 Open the application list and select **Settings** → **More settings** → **VPN**.
- 2 Select a private network.
- 3 Enter the user name and password and select **Connect**.

Tools

Alarm



Learn to set and control alarms for important events.

› Set a new alarm



- 1 Open the application list and select **Alarm** → .
- 2 Set alarm details.
Check the check box next to **Smart alarm** to activate simulated nature sound prior to the main alarm.
- 3 When you are finished, select **Done**.

› Stop an alarm

When the alarm sounds,

- To stop the alarm, drag  in any direction until it reaches the border of the circle.
- To repeat the alarm after a specified length of time, drag  in any direction until it reaches the border of the circle.

› Delete an alarm

- 1 Open the application list and select **Alarm** → .
- 2 Check the check box next to an alarm, then select **Delete**.
 • You can delete alarms by tapping and holding an alarm and selecting **Delete**.
 - To deactivate an alarm, select the clock icon next to the alarm.



Calculator

Learn to perform mathematical calculations directly on your device like a typical hand-held or desktop calculator.

- 1 Open the application list and select **Calculator**.
- 2 Use the keys that correspond to the calculator display to perform a basic or scientific calculator.

Downloads

Learn to manage logs of files you have downloaded from the web.

- 1 Open the application list and select **Downloads**.
- 2 Select a download category.
- 3 To open a downloaded file, select the log.
 - To delete a log, check the check box, and then select .
 - To share a downloaded file to others, check the check box, and then select .

Dropbox

Learn to use the Dropbox cloud storage service to save and share your files with others. When you save files to your Dropbox folder, your device automatically synchronise with the web server and any other PCs that have Dropbox installed.



If you are a new user, create an account.

› Activate Dropbox

- 1 Open the application list and select **Dropbox** → **Start**.
- 2 Enter an email address and password, and then select **Log in**.
- 3 Select **Next** → **Turn on**.

› Upload files to your Dropbox folder



- 1 Open the application list and select **Dropbox**.
- 2 Select  → **Photos or videos** or **Other files**.
- 3 Select files.
- 4 Select **Dropbox** → a folder.
- 5 Select **Upload**.
The files in the folder will be added to the web server and your PC at home.

› View a file

- 1 Open the application list and select **Dropbox** → .
- 2 Select a file.

Search

You can search for applications and data in your device and specific data on the web.

- 1 Open the application list and select **Search**.
- 2 Enter a keyword and select .
To search for data by voice, select  and say a keyword into your device's microphone.
- 3 Select a search result.

My Files

Learn to quickly and easily access all of your images, videos, music, sound clips, and other types of files stored on your device.

› Supported file formats



Your device supports the following file formats:

Type	Format
Image	BMP, GIF, JPG, PNG
Video	MP4, 3GP, AVI, WMV, ASF, MKV, FLV, WEBM
Music	MP3, AAC, OGG, FLAC, MP4, 3GP, M4A, WMA, WAV, IMY, MID, XMF, OTA



- Some file formats are not supported depending on the software of the device.
- If the file size exceeds the available memory, an error can occur when you open files.
- Playback quality may vary by content type.
- Some files may not play properly depending on how they are encoded.



› Open a file

- 1 Open the application list and select **My Files**.
- 2 Select a folder.
 - To move up one level in the file directory, select .
 - To return to the top level of the file directory, select .
- 3 Select a file to open.

› Create a folder

- 1 Open the application list and select **My Files**.
- 2 Select .
- 3 Enter a name and select **Done**.

› Copy or move files

- 1 Open the application list and select **My Files**.
- 2 Check the check box next to folders or files to copy or cut.
- 3 Select  or .
- 4 Locate a folder and select .

› Send files

- 1 Open the application list and select **My Files**.
- 2 Check the check box next to files to send.
- 3 Select  → an option.

› Delete files

- 1 Open the application list and select **My Files**.
- 2 Check the check box next to folders or files to delete.
- 3 Select  → **Yes**.

Polaris Office

Learn to create or view Microsoft Word, Excel, PowerPoint, and Adobe PDF files on your device.





› Create a new document

1 Open the application list and select **Polaris Office**.

 If you are launching this application for the first time, register as an online user or skip the registration.

2 Select  → a document type.

3 Enter contents in the document.

- To undo your last action, select .
- To redo your last action, select .
- To insert an object such as image, hyperlink, and table, select .
- To change the text or object preference, select .

4 When you are finished, select .

5 Enter a name for the document and select the location to save the document.

6 Select **Save**.





› Open a document

1 Open the application list and select **Polaris Office**.

2 Select **Browser** → a document file.

3 View the document as desired.

- To edit the document (word, presentation, or excel file), tap the screen.

- To display different applications on the same screen at the same time, select **Multiscreen** → an option. While using this feature, you can switch the position of the applications by tapping and holding the application titles.
- To save the document for other name, select  → **Save as**.
- To search or replace text on the document, select  → **Find&Replace**.
- To zoom in or out, place two fingers on the screen and slowly spread them apart or pinch them together. You can also select  → **Zoom**.
- To print the file using a Wi-Fi or USB connection, select  → **Print**. Your device is compatible only with some Samsung printers.



Available options may vary depending on a document type.

› Manage documents online

- 1 Open the application list and select **Polaris Office**.
- 2 Select **Clouds** → an account.
- 3 Enter your email address and password to access your account, and then select **OK**.
- 4 View and manage your documents on the server.

PS Touch

Experience core Photoshop features, such as layers, selection tools, adjustments, filters and more to create professional looking images from your device.

With PS Touch, you can easily combine multiple images, edit specific elements and apply filter effects, and you can access your content using Adobe Creative Cloud service.

Open the application list and select **PS Touch**.



To use Adobe Creative Cloud service, you need an Adobe ID.

World Clock

Learn to view the time in another region.

1 Open the application list and select **World Clock**.

2 Select .

3 Enter a city name and select a city from the list.
You can select a city in the world map view.

4 Select .

5 To add more world clocks, repeat steps 2-4.



To apply the summer time to the clocks, tap and hold a clock and select **DST settings**.

Settings

Access the Settings menu

- 1 Open the application list and select **Settings**.
- 2 Select a setting category, and then select an option.

Wi-Fi

Activate the Wi-Fi feature to connect to a Wi-Fi network and access the Internet or other network devices.

Bluetooth

Activate the Bluetooth feature to exchange information over short distances.

Data usage

Keep track of your data usage amount, and customise the settings for the limitation.

- **Mobile data:** Set to use data connections on any mobile network.
- **Set mobile data limit:** Set a limit for the mobile data usage.
- **Data usage cycle:** Change the settings for the limit cycle.

To use more options, select .

- **Data roaming:** Set to use data connections when you are roaming.
- **Restrict background data:** Set to disable synchronisation in the background while using a mobile network.
- **Show Wi-Fi usage:** Set to show your data usage via Wi-Fi.

More settings

Change the settings to control connections with other devices or networks.

› Flight mode

Activate Flight mode to disable all wireless functions on your device. You can use only non-network features.

› Mobile networks

- **Use packet data:** Set to use data connections on any mobile network.
- **Data roaming:** Set to use data connections when you are roaming.
- **Access Point Names:** Select an access point name (APN) for mobile networks. You can add or edit APNs. To reset your APN settings to the factory defaults, select  → **Reset to default**.
- **Network mode:** Select a network type.
- **Network operators:**
 - **Search networks:** Search for and select a network.
 - **Select automatically:** Set the device to select the first available network.

› Tethering and portable hotspot

- **Portable Wi-Fi hotspot:** Set to use your device as a wireless access point for other devices.
- **USB tethering:** Set to use your device as a wireless modem by making a USB connection with a PC.
- **Help:** View information about using the tethering features.

› Wi-Fi Direct

Activate the Wi-Fi Direct feature to connect two devices via Wi-Fi without requiring an AP.

› AllShare Cast

Activate the AllShare Cast feature and share your display with others.

› VPN

Set up and manage virtual private networks (VPNs).

› Kies via Wi-Fi

Connect your device to Samsung Kies via Wi-Fi.

› Nearby devices

- **File sharing:** Activate media sharing to allow other DLNA certified devices to access media files on your device.
- **Shared contents:** Set to share your contents with other devices.
- **Device name:** Enter a media server name for your device.
- **Access control:** Set which devices can access and control your media servers.
- **Allowed device list:** View the list of devices that can access your device.
- **Not-allowed devices list:** View the list of devices that are blocked from accessing your device.
- **Download to:** Select a memory location for saving downloaded media files.
- **Upload from other devices:** Set to accept uploads from other device.

Sound

Change the settings for various sounds on your device.

- **Silent mode:** Activate Silent mode to mute all sounds, except for media sounds and alarm ringtones.
- **Volume:** Adjust the volume for various sounds on your device.
- **Vibration intensity:** Adjust the vibration intensity.
- **Device ringtone:** Select a ringtone to alert you to incoming calls.
- **Device vibration:** Set the device to vibration with custom vibration pattern when you receive a incoming call.
- **Default notifications:** Select a ringtone to alert you to events, such as new messages and missed calls.
- **Sound and vibration:** Set the device to vibrate and play a ringtone for incoming calls.
- **Keytones:** Set the device to sound when you enter numbers on the dialling screen.
- **Touch sounds:** Set the device to sound when you select an application or option.
- **Screen lock sound:** Set the device to sound when you lock or unlock the touch screen.
- **Haptic feedback:** Set the device to vibrate when you select the touch keys or when the device reacts to certain situations.

Display

Change the settings to control the display and backlight on your device.

- **Brightness:** Adjust the brightness of the display.

- **Screen timeout:** Select the length of time that the device waits before turning off the display backlight.
- **Smart stay:** Set to prevent the display backlight from turning off while you are looking at the display.
- **Auto-rotate screen:** Set the interface to rotate automatically when you rotate the device.
- **Font style:** Change the font type for the display text.
- **Font size:** Change the font size for creating or showing items in applications.
- **Screen mode:** Select a display mode.
- **Quick launch:** Change the quick launch application on the system bar. The shortcut icon changes to indicate the selected application.

Wallpaper

Change the wallpaper settings.

- **Home screen:** Select a background image for the Home screen.
- **Lock screen:** Select a background image for the locked screen.
- **Home and lock screens:** Select a background image for the Home screen and the locked screen.

Motion



Change the settings that control the motion recognition feature on your device.

- **Tilt to zoom:** Set to use a tilting motion to zoom in or out when viewing images or browsing webpages.

- **Pan to move icon:** Set to move an item to another page when you tap and hold the item, and then slide the device to the left or right.
- **Pan to browse images:** Set to scroll through an image by sliding the device in any direction when the image is zoomed in.
- **Sensitivity settings:** Adjust the reaction speed for each motion.
- **Learn about motions:** View the tutorial for controlling motions.

Power saving

Activate Power saving mode. To change the following settings for Power saving mode, deactivate Power saving mode.

- **CPU power saving:** Set the device to limit some system resource usage.
- **Screen power saving:** Set the device to decrease the brightness of the display.
- **Turn off haptic feedback:** Set to prevent the device from vibrating when you select  or , or press and hold the Power key.
- **Learn about power saving:** View information for saving battery power.

Storage

View memory information for your device and memory card. You can also format the memory card.

 Formatting a memory card will permanently delete all data from the memory location.

 The actual available capacity of the internal memory is less than the specified capacity because the operating system and default applications occupy part of the memory.

Battery

View the amount of battery power consumed by your device.

Applications manager

View and manage the applications on your device.

Accounts and sync

Change the settings for the auto sync feature or manage accounts for synchronisation.

Location services

Change the settings for location services.

- **Use wireless networks:** Set to use Wi-Fi and/or mobile networks for finding your location.
- **Use GPS satellites:** Set to use the GPS satellite for finding your location.
- **Location and Google search:** Set the device to use your current location for Google search and other Google services.

Security

Change the settings for securing your device and the SIM or USIM card.

- **Screen lock:** Activate the screen lock feature.
- **Lock screen options:**



The settings are applied only when you set the swipe lock option.

- **Shortcuts:** Set to show and edit application shortcuts on the locked screen.
- **Information ticker:** Set to show news or stock information on the locked screen.
- **Clock:** Set to show the clock on the locked screen.
- **Dual Clock:** Set to show the dual clock on the locked screen.
- **Weather:** Set to show the weather information and change the settings for the weather display.
- **Ripple effect:** Set to show the ripple effect on the locked screen.
- **Help text:** Set to show the help text on the locked screen.
- **Owner information:** Enter your information that is shown on the locked screen.
- **Encrypt device:** Set a password to encrypt data saved on the device. You must enter the password each time you turn on the device.



Charge the battery before enabling this setting because it may take more than an hour to encrypt your data.

- **Encrypt external SD card:**
 - **Encrypt external SD card:** Set to encrypt files when you save them to a memory card.
 - **Full encryption:** Set to encrypt all files on your memory card.
 - **Exclude multimedia files:** Set to encrypt all files except multimedia files on your memory card.



You may not access the encrypted memory card after the factory data reset. First, decode the memory card before the factory data reset.

- **Remote controls:** Set to allow remote control of your device via the Internet when your device is lost or stolen.

- **SIM Change Alert:** Activate the Find my mobile feature.
- **SamsungDive web page:** Access the SamsungDive website to register your Samsung account.
- **Set up SIM card lock:**
 - **Lock SIM card:** Set to lock the SIM or USIM card. To use your device with the SIM or USIM card, you must enter the PIN.
 - **Change SIM PIN:** Change the PIN supplied with the SIM or USIM card.
- **Make passwords visible:** Set to show your passwords as you enter them.
- **Device administrators:** View the administrators you have approved for your device. You can allow device administrators to apply new policies to your device.
- **Unknown sources:** Set the device to install applications downloaded from any source. If you do not select this option, you can install only applications downloaded from Play Store.
- **Trusted credentials:** Set to use certificates and credentials to ensure the secure use of applications.
- **Install from device storage:** Install encrypted certificates that are stored in the USB storage.
- **Clear credentials:** Delete credentials from the device and reset the password.

Language and input

Change the settings for languages and text input.

› Language

Select a display language.

› Default

Select a text input method.

› Google voice typing

Activate the Google voice input feature to enter text by voice. To change the voice input settings, select .

- **Select input languages:** Select input languages for Google voice recognition.
- **Block offensive words:** Set to prevent the device from recognising offensive words in voice inputs.

› Samsung keyboard

To change the Samsung keypad settings, select .

- **Input language:** Select input languages to use with the keypad.
- **Predictive text:** Activate XT9 mode to predict words based on your input and show word suggestions.
- **Continuous input:** Set to enter text by sweeping on the keypad.
- **Handwriting:** Change the settings for Handwriting mode, such as recognition time, pen thickness, or pen colour.
- **Voice input:** Activate the voice input feature to enter text by voice.
- **Auto capitalisation:** Set to capitalise the first letter of a sentence automatically.
- **Auto-punctuate:** Set the device to insert a full stop when you double-tap the space bar.
- **Character preview:** Set the device to show a preview image of each letter you tap.
- **Key-tap vibration:** Set the device to vibrate when you tap a key.

- **Key-tap sound:** Set the device to sound when you tap a key.
- **Tutorial:** View the tutorial for using the Samsung keypad.
- **Reset settings:** Reset the Samsung keypad settings to the factory defaults.

› Voice search

The following options are available for Google voice recognition:

- **Language:** Select a language for Google voice recognition.
- **SafeSearch:** Select a level for filtering out explicit text and images from voice search results.
- **Block offensive words:** Set to hide offensive words from voice search results.

› Text-to-speech output

- **Preferred TTS engine:** Select a speech synthesis engine. To change the settings for speech synthesis engines, select .
- **Speech rate:** Select a speed for the TTS feature.
- **Listen to an example:** Listen to the spoken text for an example.
- **Driving mode:** Activate Driving mode to provide audible notifications for incoming calls, messages, or event details.

› Pointer speed

Adjust the pointer speed for the mouse or trackpad connected to your device.

Back up and reset

Change the settings for managing settings and data.

- **Back up my data:** Set to back up your settings and application data to the Google server.
- **Backup account:** Set up or edit your Google backup account.
- **Automatic restore:** Set to restore your settings and application data when you must reinstall an application.
- **Factory data reset:** Reset your settings to the factory defaults and delete all your data.

Pen

- **Hovering pen icon:** Select to display the pen icon on the screen when the S pen is near the screen.
- **Pen attach/detach sound:** Set the device to sound when the S Pen is inserted into or pulled out from the slot.
- **Battery saving:** Set the screen not to respond to the S Pen when the S Pen is in the slot.
- **Options after detaching pen:** Set the device to launch the preset application automatically when the S Pen is pulled out from the slot.

Accessory

- **Dock sound:** Set the device to play a sound when your device is connected to or removed from a desktop dock.
- **Audio output:** Set to use the dock speaker when your device is connected to a desktop dock.

Date and time

Change the settings to control how time and date appears on your device.



If the battery remains fully discharged or removed from the device, the time and date will be reset.

- **Automatic date and time:** Set to receive time information from the network and update the time and date automatically.
- **Set date:** Set the current date manually.
- **Set time:** Set the current time manually.
- **Automatic time zone:** Set to receive time zone information from the network when you move across time zones.
- **Select time zone:** Select a time zone.
- **Use 24-hour format:** Set to show the time in 24-hour format or 12-hour format.
- **Select date format:** Select a date format.

Accessibility

Accessibility services are special features for those with physical challenges. Change the settings to improve accessibility to the device's interface and features.

- **Auto-rotate screen:** Set the interface to rotate automatically when you rotate the device.
- **Speak passwords:** Set the device to read aloud passwords you enter on websites with TalkBack.
- **The power key ends calls:** Set to end a call when you press the Power key.

- **Accessibility shortcut:** Add a shortcut to accessibility settings that appears when you press and hold the Power key.
- **Screen timeout:** Select the length of time that the device waits before turning off the display backlight.
- **TalkBack:** Activate TalkBack, which provides voice feedback.
- **Install web scripts:** Set applications to install web scripts to make their web content more accessible.
- **Negative colours:** Reverse the display colours to improve visibility.
- **Font size:** Change the font size for creating or showing items in applications.
- **Mono audio:** Enable mono sound when you listen to audio with one earbud.
- **Turn off all sounds:** Mute all device sounds.
- **Tap and hold delay:** Set the recognition time for tapping and holding the screen.

Developer options

Change the settings for application development.

- **USB debugging:** Activate USB debugging mode to connect your device to a PC with a USB cable.
- **Development device ID:** View your device's development ID.
- **Allow mock locations:** Allow mock locations and service information to be sent to a Location Manager service for testing.
- **Desktop backup password:** Set a password to secure your backup data.

- **Strict mode:** Set the device to flash the screen when applications perform long operations.
- **Show pointer location:** Set to show the coordinates and traces of the pointer when you touch the screen.
- **Show touches:** Set to show the pointer when you touch the screen.
- **Show screen updates:** Set to flash areas of the screen when they are updated.
- **Show CPU usage:** Set to list all active processes.
- **Force GPU rendering:** Set to use 2D hardware acceleration to improve graphic performance.
- **Window animation scale:** Select a speed for opening and closing pop-up windows.
- **Transition animation scale:** Select a speed for switching between screens.
- **Do not keep activities:** Set to end a running application when you launch a new application.
- **Limit background processes:** Set to limit the number of processes that can run in the background.
- **Show all ANRs:** Set the device to alert you to unresponsive applications that are running in the background.

About device

View information about your device, such as model number and version.



You can download and install firmware update with the firmware over-the-air (FOTA) service. To check for firmware updates, select **Software update** → **Update**.

Troubleshooting

When you turn on your device or while you are using the device, it prompts you to enter one of the following codes:

Code	Try this to solve the problem:
Password	When the device lock feature is enabled, you must enter the password you set for the device.
PIN	When using the device for the first time or when the PIN requirement is enabled, you must enter the PIN supplied with the SIM or USIM card. You can disable this feature by using the Lock SIM card menu.
PUK	Your SIM or USIM card is blocked, usually as a result of entering your PIN incorrectly several times. You must enter the PUK supplied by your service provider.
PIN2	When you access a menu requiring the PIN2, you must enter the PIN2 supplied with the SIM or USIM card. For details, contact your service provider.

Your device displays network or service error messages

- When you are in areas with weak signals or poor reception, you may lose reception. Move to another area and try again.
- You cannot access some options without a subscription. Contact your service provider for more details.

The touch screen responds slowly or improperly

If your device has a touch screen and the touch screen is not responding properly, try the following:

- Remove any protective covers from the touch screen. Protective covers may prevent the device from recognising your inputs and are not recommended for touch screen devices.
- Ensure that your hands are clean and dry when tapping the touch screen.
- Restart your device to clear any temporary software bugs.
- Ensure that your device software is upgraded to the latest version.
- If the touch screen is scratched or damaged, take it to your local Samsung Service Centre.

Your device freezes or has fatal errors

If your device freezes or hangs, you may need to close programs or reset the device to regain functionality. If your device is frozen and unresponsive, press and hold the Power key for 8-10 seconds. The device will reboot automatically.

If this does not solve the problem, perform a factory data reset. Open the application list and select **Settings** → **Back up and reset** → **Factory data reset** → **Reset device** → **Erase everything**.

Calls are being dropped

When you are in areas with weak signals or poor reception, you may lose your connection to the network. Move to another area and try again.

Outgoing calls are not connected

- Ensure that you have pressed the Dial key.
- Ensure that you have accessed the right cellular network.

Incoming calls are not connected

- Ensure that your device is turned on.
- Ensure that you have accessed the right cellular network.

Others cannot hear you speaking on a call

- Ensure that you are not covering the built-in microphone.
- Ensure that the microphone is close to your mouth.
- If using a headset, ensure that it is properly connected.

Audio quality is poor

- Ensure that you are not blocking the device's internal antenna.
- When you are in areas with weak signals or poor reception, you may lose reception. Move to another area and try again.

When dialling from contacts, the call is not connected

- Ensure that the correct number is stored in the contact list.
- Re-enter and save the number, if necessary.

The device beeps and the battery icon is empty

Your battery is low. Recharge the battery to continue using the device.

The battery does not charge properly or the device turns off

If the battery will no longer charge completely, you need to replace it with a new battery. Take your device to your local Samsung Service Centre.

Your device is hot to the touch

When you use applications that require more power or use applications on your device for an extended period of time, your device may feel hot to the touch. This is normal and should not affect your device's lifespan or performance.

Error messages appear when launching the camera

Your Samsung mobile device must have sufficient available memory and battery power to operate the camera application. If you receive error messages when launching the camera, try the following:

- Charge the battery.
- Free some memory by transferring files to a PC or deleting files from your device.
- Restart the device. If you are still having trouble with the camera application after trying these tips, contact a Samsung Service Centre.

Error messages appear when opening music files

Some music files may not play on your Samsung mobile device for a variety of reasons. If you receive error messages when opening music files on your device, try the following:

- Free some memory by transferring files to a PC or deleting files from your device.
- Ensure that the music file is not Digital Rights Management (DRM)-protected. If the file is DRM-protected, ensure that you have the appropriate license or key to play the file.
- Ensure that your device supports the file type.

Another Bluetooth device is not located

- Ensure that the Bluetooth wireless feature is activated on your device.
- Ensure that the Bluetooth wireless feature is activated on the device you wish to connect to, if necessary.
- Ensure that your device and the other Bluetooth device are within the maximum Bluetooth range (10 m).

If the tips above do not solve the problem, contact a Samsung Service Centre.

A connection is not established when you connect the device to a PC

- Ensure that the USB cable you are using is compatible with your device.
- Ensure that you have the proper drivers installed and updated on your PC.
- If you are a Windows XP user, ensure that you have Windows XP Service Pack 3 or higher installed on your PC.
- Ensure that you have Samsung Kies 2.0 or Windows Media Player 10 or higher installed on your PC.

Index

- access codes 155
- alarms
 - creating 132
 - deactivating 132
 - stopping 132
- AllShare Cast 119
- AllShare Play 120
- auto rejection 74
- battery
 - charging 12
- Bluetooth
 - activating 124
 - receiving data 125
 - sending data 124
- brightness, display 30
- call forwarding 74
- call log 76
- calls
 - answering 70
 - forwarding 74
 - international numbers 71
 - multiparty 72
 - rejecting 70
 - using headset 71
 - using options during voice 72
 - viewing missed 73
 - waiting 76
- call waiting 76
- camera
 - capturing photos 91
 - customising camcorder 98
 - customising camera 93, 94
 - recording videos 96
- connectivity
 - AllShare Play 120
 - Bluetooth 123
 - GPS connections 127
 - mobile network sharing 125
 - PC connections 113
 - VPN connections 130
 - Wi-Fi 115
- contacts
 - copying 111
 - creating 109
 - importing or exporting 110
- device
 - customising 29
 - indicator icons 20
 - keys 20
 - layout 18
 - notifications panel 27
 - settings 140
 - turning on or off 17
- download manager 133
- email
 - sending 84
 - setting accounts 83
 - viewing 84

- file manager
 - copying or cutting files 136
 - deleting files 136
 - opening files 136
 - supported file formats 135
- find my mobile 33
- fixed dialling number mode 75
- Google Latitude 66
- Google Mail 81
- Google Maps 64
- Google Talk 86
- map
 - getting directions 65
 - searching for locations 64
 - searching for nearby places 66
 - sharing locations with friends 66
 - using navigation 67
- memory card
 - formatting 16
 - inserting 14
 - removing 16
- menu screen
 - accessing 28
- messages
 - accessing voice mail 81
 - sending email 84
 - sending multimedia 80
 - sending text 79
 - setting email accounts 83
- multimedia messages
 - sending 80
 - viewing 80
- music hub 90
- music player
 - creating playlists 89
 - playing music 88
- navigation 67
- PC connections
 - mass storage 114
 - Samsung Kies 113
 - Windows Media Player 114
- phonebook
 - creating contacts 109
 - finding contacts 109
- photos
 - capturing 91
 - viewing 103
- PIN lock 33
- Play Books 62
- Polaris Office 137
- Samsung Apps 68
- Samsung Kies 113
- silent mode 29
- SIM/USIM card
 - installing 11
 - locking 33
- S Note 45
- S Pen 37
- S Planner 54
- S Suggest 68

- text input 34
- text messages
 - sending 79
 - viewing 80
- time and date, set 29
- touch screen
 - locking 23
 - using 22
- unpack 11
- video calls
 - answering 70
 - making 69
 - using options 73
- video editor 106
- video maker 106
- video player 105
- videos
 - playing 99, 105
 - recording 96
- voice calls
 - answering 70
 - making 69
 - using options 72
- voice mail 81
- VPN connections
 - connecting to 131
 - creating 130
- web browser
 - adding bookmarks 60
 - browsing web pages 57
- Wi-Fi
 - activating 115
 - finding and connecting to networks 115
 - using WPS 116
- world clock 139
- YouTube
 - uploading videos 63
 - watching videos 63

Some of the contents in this manual may differ from your device depending on the software of the device or your service provider.

To install Kies (PC Sync) Kies

1. Download the latest version of Kies from the Samsung website (www.samsung.com/kies) and install it on your PC.
2. Using a USB cable, connect your device to your PC. Samsung Kies will launch automatically. Refer to the Kies help for more information.