



Contact SAMSUNG WORLDWIDE

If you have any questions or comments relating to Samsung products, please contact the SAMSUNG customer care center.

Comuníquese con SAMSUNG WORLDWIDE

Si desea formular alguna pregunta o comentario en relación con los productos de Samsung, comuníquese con el centro de atención al cliente de SAMSUNG.

Country	Customer Care Center ☎	Web Site	Address
CANADA	1-800-SAMSUNG(726-7864)	www.samsung.com	Samsung Electronics Canada Inc., Customer Service 55 Standish Court Mississauga, Ontario L5R 4B2 Canada
			Samsung Electronique Canada Inc., Service à la Clientèle 55 Standish Court Mississauga, Ontario L5R 4B2 Canada
U.S.A	1-800-SAMSUNG(726-7864)	www.samsung.com	Samsung Electronics America, Inc. 85 Challenger Road Ridgefield Park, NJ 07660-2112

SERIES | 3
350

LCD TV user manual

imagine the possibilities

Thank you for purchasing this Samsung product. To receive more complete service, please register your product at

www.samsung.com/register

Model _____ Serial No. _____



BN68-02620A-06



Figures and illustrations in this User Manual are provided for reference only and may differ from actual product appearance. Product design and specifications may be changed without notice.

Important Warranty Information Regarding Television Format Viewing

See the warranty card for more information on warranty terms.

Wide screen format LCD Displays (16:9, the aspect ratio of the screen width to height) are primarily designed to view wide screen format full-motion video. The images displayed on them should primarily be in the wide screen 16:9 ratio format, or expanded to fill the screen if your model offers this feature and the images are constantly moving. Displaying stationary graphics and images on screen, such as the dark sidebars on nonexpanded standard format television video and programming, should be limited to no more than 5% of the total television viewing per week. Additionally, viewing other stationary images and text such as stock market reports, video game displays, station logos, web sites or computer graphics and patterns, should be limited as described above for all televisions. Displaying stationary images that exceed the above guidelines can cause uneven aging of LCD Displays that leave subtle, but permanent burned-in ghost images in the LCD picture. To avoid this, vary the programming and images, and primarily display full screen moving images, not stationary patterns or dark bars. On LCD models that offer picture sizing features, use these controls to view different formats as a full screen picture. Be careful in the selection and duration of television formats used for viewing. Uneven LCD aging as a result of format selection and use, as well as burned-in images, are not covered by your Samsung limited warranty.

SAMSUNG ELECTRONICS NORTH AMERICAN LIMITED WARRANTY STATEMENT

Subject to the requirements, conditions, exclusions and limitations of the original Limited Warranty supplied with Samsung Electronics (SAMSUNG) products, and the requirements, conditions, exclusions and limitations contained herein, SAMSUNG will additionally provide Warranty Repair Service in the United States on SAMSUNG products purchased in Canada, and in Canada on SAMSUNG products purchased in the United States, for the warranty period originally specified, and to the Original Purchaser only.

The above described warranty repairs must be performed by a SAMSUNG Authorized Service Center. Along with this Statement, the Original Limited Warranty Statement and a dated Bill of Sale as Proof of Purchase must be presented to the Service Center. Transportation to and from the Service Center is the responsibility of the purchaser. Conditions covered are limited only to manufacturing defects in material or workmanship, and only those encountered in normal use of the product.

Excluded, but not limited to, are any originally specified provisions for, in-home or on-site services, minimum or maximum repair times, exchanges or replacements, accessories, options, upgrades, or consumables.

For the location of a SAMSUNG Authorized Service Center, please call toll-free:

- In the United States : 1-800-SAMSUNG (1-800-726-7864)
- In Canada : 1-800-SAMSUNG

Still image warning

Avoid displaying still images (such as jpeg picture files) or still image elements (such as TV channel logos, panorama or 4:3 image format, stock or news bars at screen bottom etc.) on the screen. Constant displaying of still pictures can cause ghosting of LCD screen, which will affect image quality. To reduce risk of this effect, please follow below recommendations:

- Avoid displaying the same TV channel for long periods.
- Always try to display any image on full screen, use TV set picture format menu for best possible match.
- Reduce brightness and contrast values to minimum required to achieve desired picture quality, exceeded values may speed up the burnout process.
- Frequently use all TV features designed to reduce image retention and screen burnout, refer to proper user manual section for details.

Securing the Installation Space

Keep the required distances between the product and other objects (e.g. walls) to ensure proper ventilation. Failing to do so may result in fire or a problem with the product due to an increase in the internal temperature of the product.

When using a stand or wall-mount, use parts provided by Samsung Electronics only.

- If you use parts provided by another manufacturer, it may result in a problem with the product or an injury due to the product falling.

The appearance may differ depending on the product.

Be careful when you contact the TV because some parts can be somewhat hot.

Installation with a stand.

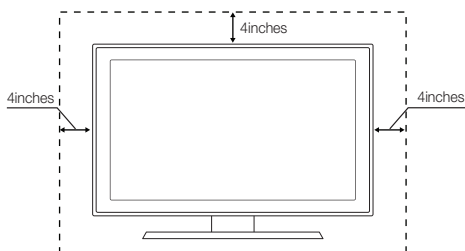

Installation with a wall-mount.

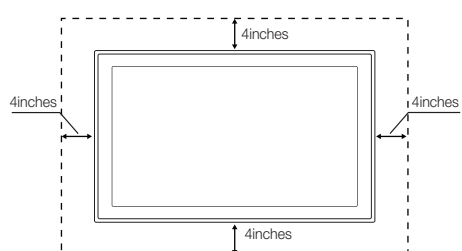

© 2010 Samsung Electronics Co., Ltd. All rights reserved.

Contents

Getting Started

- List of Features 4
- Accessories 4
- Installing the LCD TV Stand 4
- Viewing the Control Panel 5
- Viewing the Remote Control..... 6
- Connecting to an Antenna 7
- Plug & Play (Initial Setup)..... 7

Connections

- Connecting to an AV Device..... 8
- Connecting to an Audio Device..... 9
- Connecting to a PC 9
- Changing the Input source..... 10

Basic Features

- How to Navigate Menus..... 11
- Channel Menu 11
 - Seeing Channels 11
 - Using Favorite Channels 12
 - Memorizing channels 12
 - Editing channels 12
 - Other Features 12
- Picture Menu 13
 - Changing the Preset Picture Mode 13
 - Adjusting picture settings 13
 - Setting up the TV with your PC 14
 - Changing the Picture Options 14
- Sound Menu 16
 - Changing the Preset Sound Mode 16
 - Adjusting sound settings 16
 - Sound Settings 16
- Setup Menu 17
 - Setting the Time 17
 - Using the Sleep Timer 17
 - Setting the On/Off Timer 17
 - Locking Programs 18
 - Other Features 19
- Support Menu..... 20

Advanced Features

- Media Play 21
 - Connecting a USB Device 21

Other Information

- Installing the Wall Mount 25
- Securing the TV to the Wall (LN32C350 Only) 26
- Securing the TV to the Wall 27
- Anti-theft Kensington Lock..... 27
- Troubleshooting 28
 - Storage and Maintenance 30
- Specifications 31
 - License 31
- Dimensions 32
- Index 33

Check the Symbol!



This function can be used by pressing the TOOLS button on the remote control.



Note :
Important information



Step by step guide :
Informs you how to access the menu.

Getting Started

List of Features

- Excellent Digital Interface & Networking: With a built-in HD digital tuner, nonsubscription HD broadcasts can be viewed without a cable box / STB (Set-Top-Box) satellite receiver.
- **Media Play:** Allows you to play music files, and pictures saved on a USB device. (P. 21)
- **Self Diagnosis:** You can check picture and sound operation. (P. 20)

Accessories

- ✎ Please make sure the following items are included with your LCD TV. If any items are missing, contact your dealer.
- ✎ The items' colors and shapes may vary depending on the models.

- Remote Control (BN59-01006A) & Batteries (AAA x 2)
- Cleaning Cloth (BN63-01798B)
- Owner's Instructions
- Warranty Card / Safety Guide / Quick Setup Guide

Installing the LCD TV Stand

Components

When installing the stand, use the provided components and parts.

A

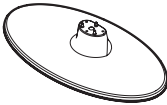

1 EA

B



• Stand

• Screws

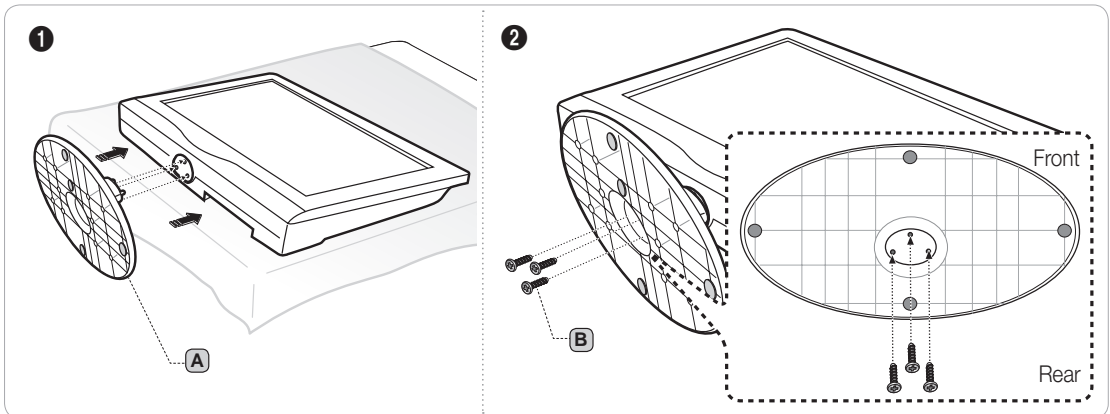



- ✎ Make sure to distinguish between the front and back of the Stand and Guide Stand when assembling them.
- ✎ Make sure that at least two persons lift and move the LCD TV.
- ✎ Lay the product down, with the screen facing up and fasten the screws.

Viewing the Control Panel

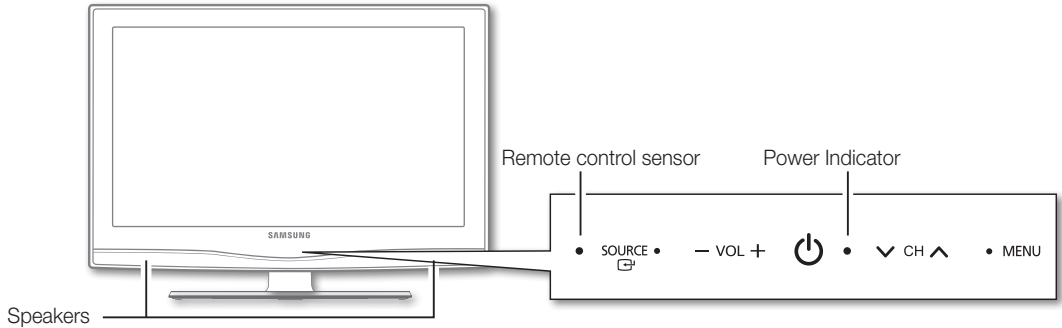
 The product color and shape may vary depending on the model.



 (Power)	Turns the TV on or off.
Remote control sensor	Aim the remote control towards this spot on the TV.
SOURCE 	Toggles between all the available input sources. In the on-screen menu, use this button as you would use the ENTER  button on the remote control.
MENU	Displays an on-screen menu, the OSD (on screen display), of your TV's features.
-VOL+	Adjusts the volume. In the OSD, use the -VOL+ buttons as you would use the ◀ and ▶ buttons on the remote control.
▼ CH ▲	Changes the channels. In the OSD, use the ▼ CH ▲ buttons as you would use the ▼ and ▲ buttons on the remote control.
Power Indicator	Blinks and turns off when the power is on and lights up in standby mode.

Standby mode

Do not leave your TV in standby mode for long periods of time (when you are away on a holiday, for example). A small amount of electric power is still consumed even when the power button is turned off. It is best to unplug the power cord.

Getting Started

Viewing the Remote Control

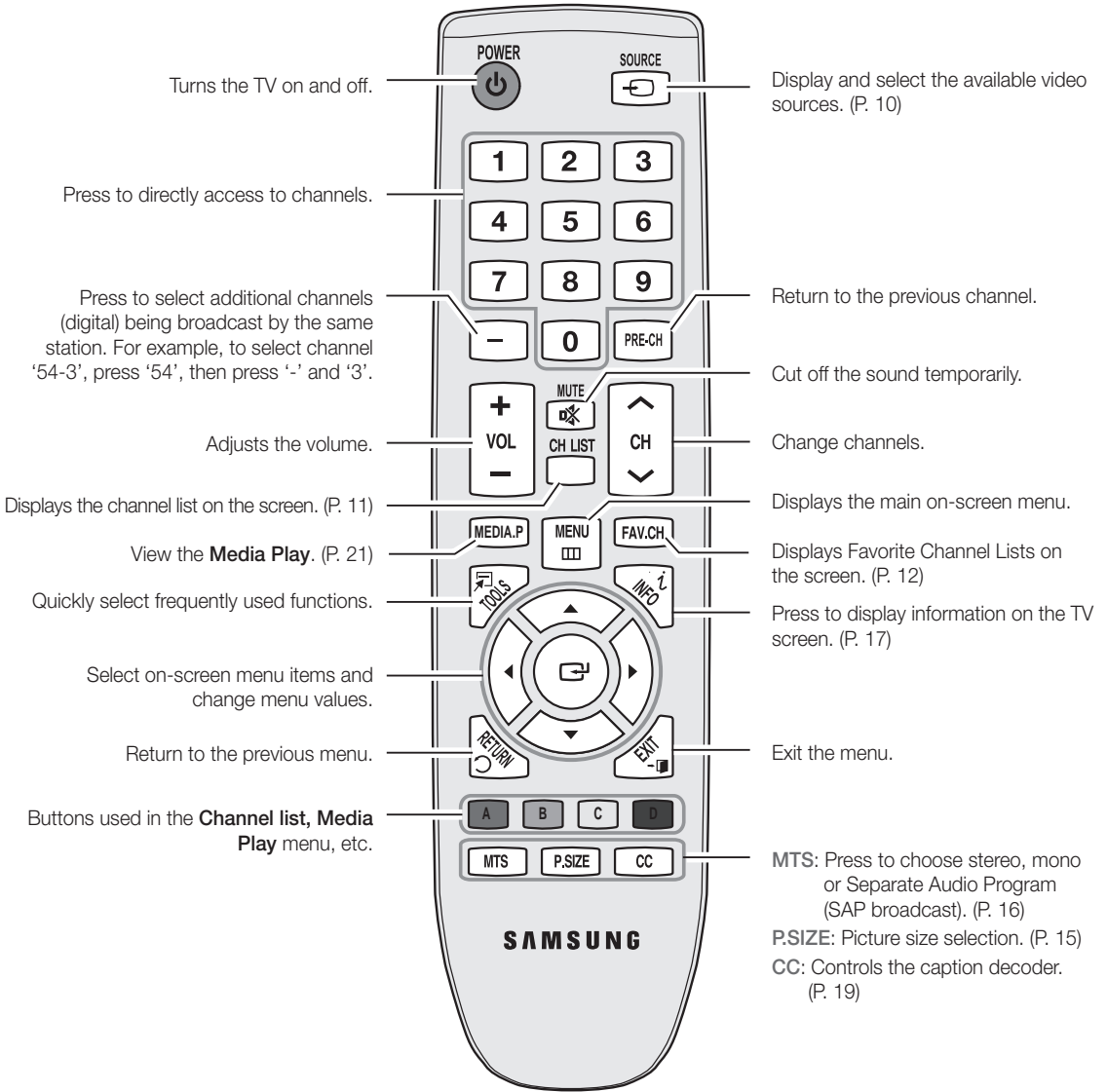

Installing batteries (Battery size: AAA)

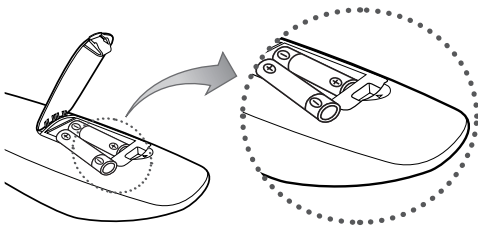

NOTE

- Use the remote control within 23 feet from the TV.
- Bright light may affect the performance of the remote control. Avoid use when nearby fluorescent lights or neon signs.
- The color and shape may vary depending on the model.

Connecting to an Antenna

When the TV is initially powered on, basic settings proceed automatically.



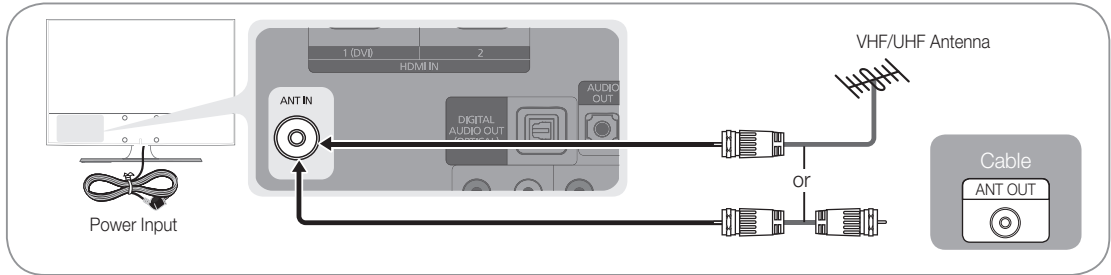

 Connecting the power cord and antenna.



Plug & Play (Initial Setup)

When the TV is initially powered on, a sequence of on-screen prompts will assist in configuring basic settings. Press the **POWER** button. **Plug & Play** is available only when the **Input** source is set to TV.

 To return to the previous step, press the red button.

1	Selecting a language	Press the ▲ or ▼ button, then press the ENTER button. Select the desired OSD (On Screen Display) language.	
2	Selecting Store Demo or Home Use	Press the ◀ or ▶ button, then press the ENTER button. <ul style="list-style-type: none"> Select the Home Use mode. Store Demo Mode is for retail environments. To return to the unit's settings from Store Demo to Home Use (standard): Press the volume button on the TV. When you see the volume in the OSD, press and hold MENU for 5 sec. 	
3	Selecting an antenna	Press the ▲ or ▼ button, then press the ENTER button. Select Air , Cable or Auto . <p> In Cable mode, you can select the correct signal source among STD, HRC, and IRC by pressing the ▲, ▼, ◀ or ▶ button, then press the ENTER button.</p>	
4	Selecting a channel	The channel search will start automatically. For more information, refer to Channel → Auto Program . (P. 12) <p> Press the ENTER button at any time to interrupt the memorization process.</p>	
5	Setting the Clock Mode	Set the Clock Mode automatically or manually. <p> If you select the Auto, set the daylight saving time. Select the time zone where you live.</p>	
6	Viewing the HD Connection Guide .	The connection method for the best HD screen quality is displayed.	
7	Enjoy your TV.	Press the ENTER button.	

If You Want to Reset This Feature...

 **MENU** → **Setup** → **Plug & Play** → **ENTER**

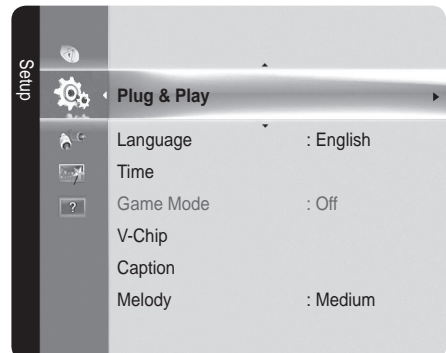

Connections

Connecting to an AV Device

Using an HDMI / DVI Cable: HD connection (up to 1080p)

We recommend using the HDMI connection for the best quality HD picture.

Available devices: DVD, Blu-ray player, HD cable box, HD satellite receiver (STB).

HDMI IN 1(DVI), 2 / PC/DVI AUDIO IN

- When using an HDMI/DVI cable connection, you must use the **HDMI IN 1 (DVI)** jack for video. A DVD, Blu-ray player, HD cable box, HD STB satellite receiver, cable box, or STB satellite receiver may require a DVI-HDMI (DVI to HDMI) cable or DVI-HDMI (DVI to HDMI) adapter. The **PC/DVI AUDIO IN** jack is required for audio.
- The picture may not display normally (if at all) or the audio may not work if an external device that uses an older version of HDMI mode is connected to the TV. If such a problem occurs, ask the manufacturer of the external device about the HDMI version and, if out of date, request an upgrade.
- Be sure to purchase a certified HDMI cable. Otherwise, the picture may not display or a connection error may occur.

Using a Component Cable: (up to 1080p), Using an Audio/Video Cable: (480i only)

Available devices: DVD, Blu-ray player, cable box, STB satellite receiver, VCR

When connecting to **AV IN**, the color of the **AV IN [Y/VIDEO]** jack (Green) does not match the color of the video cable (Yellow).

For better picture quality, the Component connection is recommended over the A/V connection.

Yellow Red White Red Blue Green

Connecting to an Audio Device

Using an Optical (Digital) or Audio (Analog) Cable Connection

Available devices: Digital Audio System, Amplifier, Home Theater

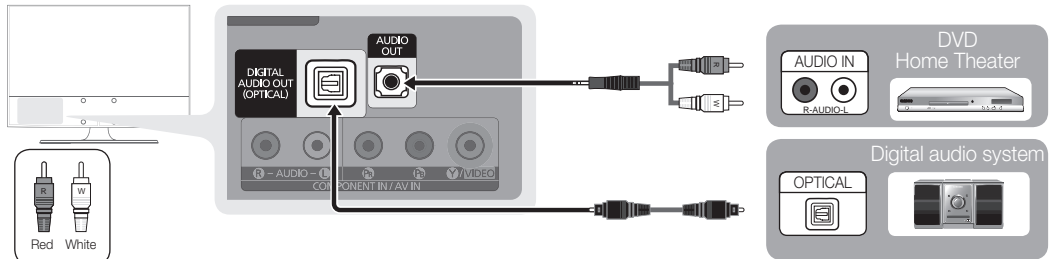

DIGITAL AUDIO OUT (OPTICAL)

- When a Digital Audio System is connected to the **DIGITAL AUDIO OUT (OPTICAL)** jack, decrease the volume of both the TV and the system.
- 5.1 CH (channel) audio is available when the TV is connected to an external device supporting 5.1 CH.
- When the receiver (home theater) is set to on, you can hear sound output from the TV's optical jack. When the TV is receiving a DTV signal, the TV will send 5.1 CH sound to the home theater receiver. When the source is a digital component such as a DVD / Blu-ray player / cable box / STB (Set-Top-Box) satellite receiver and is connected to the TV via HDMI, only 2 CH audio will be heard from the home theater receiver. If you want to hear 5.1 CH audio, connect the digital audio out jack from your DVD / Blu-ray player / cable box / STB satellite receiver directly to an amplifier or home theater.

AUDIO OUT: Connects to the audio input jacks on your amplifier/home theater.

- When connecting, use the appropriate connector (sold separately).
- When an audio amplifier is connected to the **AUDIO OUT** jacks: Decrease the volume of the TV and adjust the volume level with the amplifier's volume control.

Connecting to a PC

Using an HDMI/DVI Cable / a D-sub Cable

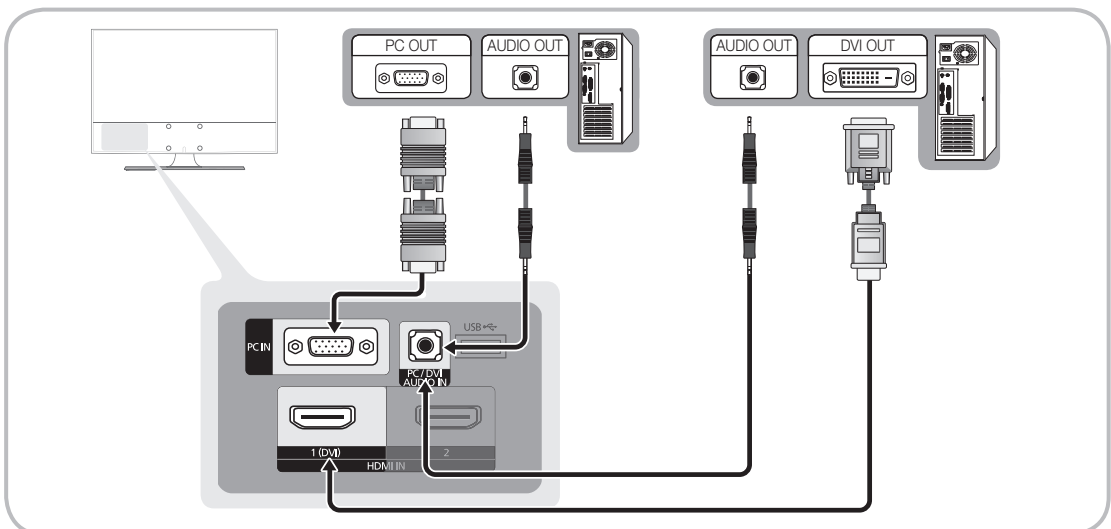

Basic Features

Display Modes (D-Sub and HDMI/DVI Input)

Optimal resolution is 1360x768@60Hz.

Mode	Resolution	Horizontal Frequency (KHz)	Vertical Frequency (Hz)	Pixel Clock Frequency (MHz)	Sync Polarity (H / V)
IBM	640 x 350	31.469	70.086	25.175	+ / -
	720 x 400	31.469	70.087	28.322	- / +
MAC	640 x 480	35.000	66.667	30.240	- / -
	832 x 624	49.726	74.551	57.284	- / -
VESA DMT	640 x 480	31.469	59.940	25.175	- / -
		37.861	72.809	31.500	- / -
		37.500	75.000	31.500	- / -
	800 x 600	37.879	60.317	40.000	+ / +
		48.077	72.188	50.000	+ / +
		46.875	75.000	49.500	+ / +
	1024 x 768	48.363	60.004	65.000	- / -
		56.476	70.069	75.000	- / -
		60.023	75.029	78.750	+ / +
	1280 x 720	45.000	60.000	74.250	+ / +
1360 x 768	47.712	60.015	85.500	+ / +	
VESA CVT	720 x 576	35.910	59.950	32.750	- / +
	1280 x 720	56.456	74.777	95.750	- / +
VESA GTF	1280 x 720	52.500	70.000	89.040	- / +

NOTE

- For HDMI/DVI cable connection, you must use the **HDMI IN 1(DVI)** jack.
- The interlace mode is not supported.
- The set might operate abnormally if a non-standard video format is selected.
- Separate and Composite modes are supported. SOG(Sync On Green) is not supported.

Input Cables (Sold Separately)

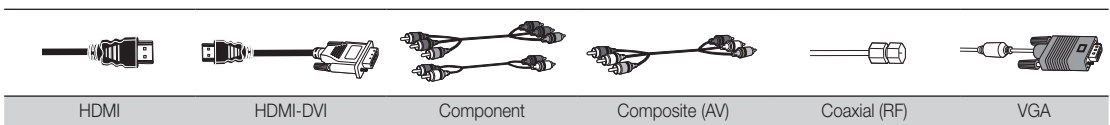

Changing the Input source

Source List

MENU → Input → Source List → ENTER

Use to select TV or an external input sources such as a DVD / Blu-ray player / cable box / STB satellite receiver.

■ TV / AV / Component / PC / HDMI1/DVI / HDMI2

- You can only choose external devices that are connected to the TV. In the Source List, connected inputs will be highlighted.

PC always stay activated.



Edit Name

MENU → Input → Edit Name → ENTER

- VCR / DVD / Cable STB / Satellite STB / PVR STB / AV Receiver / Game / Camcorder / PC / DVI PC / DVI / TV / IPTV / Blu-ray / HD DVD / DMA: Name the device connected to the input jacks to make your input source selection easier.

When connecting an HDMI/DVI cable to the HDMI IN 1(DVI) port, you should set to **DVI PC** or **DVI** mode under **Edit Name**.

Basic Features

How to Navigate Menus

Before using the TV, follow the steps below to learn how to navigate the menu and select and adjust different functions.

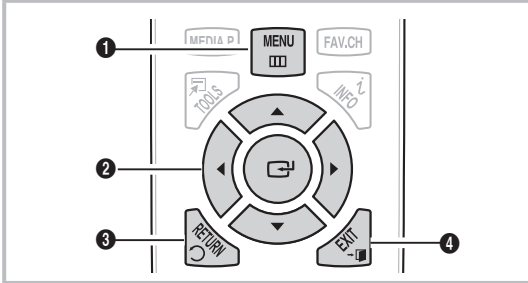

- 1 MENU button: Displays the main on-screen menu.
- 2 ENTER / Direction button: Move the cursor and select an item. Confirm the setting.
- 3 RETURN button: Returns to the previous menu.
- 4 EXIT button: Exits the on-screen menu.

How to Operate the OSD (On Screen Display)

The access step may differ depending on the selected menu.

1	MENU	The main menu options appear on the screen: Picture, Sound, Channel, Setup, Input, Application, Support.
2	▲ / ▼	Select an icon with the ▲ or ▼ button.
3	ENTER	Press ENTER to access the sub-menu.
4	▲ / ▼	Select the desired submenu with the ▲ or ▼ button.
5	◀ / ▶	Adjust the value of an item with the ◀ or ▶ button. The adjustment in the OSD may differ depending on the selected menu.
6	ENTER	Press ENTER to confirm the selection.
7	EXIT	Press EXIT.

Channel Menu

Seeing Channels

Channel List

MENU → Channel → Channel List → ENTER

Add, delete or set Favorite channels and use the program guide for digital broadcasts. Select a channel in the **All Channels, Added Channels, Favorite** or **Programmed** screen by pressing the ▲ / ▼ buttons, and pressing the ENTER button. Then you can watch the selected channel.

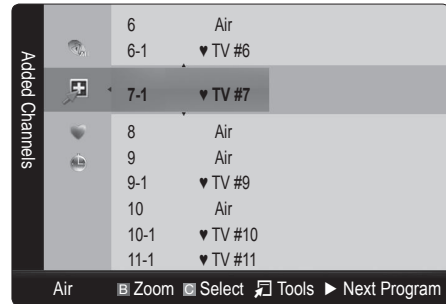

- All Channels: Shows all currently available channels.
- Added Channels: Shows all added channels.
- Favorite: Shows all favorite channels.
- Programmed: Shows all currently reserved programs.

Using the color buttons with the **Channel List**



- Green (Zoom): Enlarges or shrinks a channel number.
- Yellow (Select): Selects multiple channel lists. You can perform the add/delete or add to Favorite/delete from Favorite function for multiple channels at the same time. Select desired channels and press the Yellow button to set all the selected channels at the same time. The ✓ mark appears to the left of the selected channels.
- Tools: Displays the **Channel List** option menu. (The Options menus may differ depending on the situation.)

Channel Status Display Icons

Icons	Operations
✓	A channel selected.
♥	A channel set as a Favorite.
⌚	A reserved Program.
📺	A program currently being broadcast.

Basic Features

Using Favorite Channels

 MENU  → Channel → Channel List → ENTER 

♥ Add to Favorite / Delete from Favorite

Set channels you watch frequently as Favorites.

1. Select a channel and press the **TOOLS** button.
2. Add or delete a channel using the **Add to Favorite** or **Delete from Favorite** menu respectively.



Memorizing channels

 MENU  → Channel → ENTER 

Antenna (Air / Cable)

Before your television can begin memorizing the available channels, you must specify the type of signal source that is connected to the TV (i.e. an Air or a Cable system).

Auto Program

- **Air:** Air antenna signal.
- **Cable:** Cable antenna signal.
- **Auto:** Air and Cable antenna.



NOTE

- When selecting the Cable TV system: Selects the cable system. **STD**, **HRC** and **IRC** identify various types of cable TV systems. Contact your local cable company to identify the type of cable system that exists in your particular area. At this point, the signal source has been selected.
- After all the available channels are stored, it starts to remove scrambled channels. The **Auto program** menu then reappears.

How to Stop Auto Programming

1. Press the **ENTER**  button.
2. A message will ask **Stop Auto Program?** Select **Yes** by pressing the **◀** or **▶** button.
3. Press the **ENTER**  button.

Editing channels

 MENU  → Channel → Channel List → ENTER 

Channel Name Edit

1. Select a channel and press the **TOOLS** button.
 2. Edit the channel name using the **Channel Name Edit** menu.
- **Channel Name Edit** (analog channels only): Assign your own channel name.



Other Features

 MENU  → Channel → ENTER 

Clear Scrambled Channel



This function is used to filter out scrambled channels after Auto Program is completed. This process may take up to 20-30 minutes.

How to Stop Searching Scrambled Channels

1. Press the **ENTER**  button to select **Stop**.
2. Press the **◀** button to select **Yes**.
3. Press the **ENTER**  button.

 This function is only available in **Cable** mode.

Channel List

 MENU  → Channel → Channel List → ENTER 

Channel List Option Menu

Set each channel using the Channel List menu options (**Add/Delete**, **Timer Viewing**, **Select All/ Deselect All**). Option menu items may differ depending on the channel status.

1. Select a channel and press the **TOOLS** button.
 2. Select a function and change its settings.
- **Add / Delete:** Delete or add a channel to display the channels you want.

NOTE

- All deleted channels will be shown on the **All Channels** menu.
- A gray-colored channel indicates the channel has been deleted.
- The **Add** menu only appears for deleted channels.
- Delete a channel from the **Added Channels** or **Favorite** menu in the same manner.

- **Timer Viewing:** You can set a desired channel to be displayed automatically at the set time; even when you are watching another channel. Set the current time first to use this function.(P. 17)

1. Press the ◀ / ▶ / ▲ / ▼ buttons to select the desired channel in **Channel List**.
2. Press the **TOOLS** button, then select **Timer Viewing**.
3. Scroll up or down to adjust the settings in the box, or use the numeric buttons on your remote for entering the date and time.

 If you selected **Once, Every Week** or **Every Day** in **Repeat**, you can enter the date you want.

4. Select **OK**, then press the **ENTER** button when done.

NOTE

- Only memorized channels can be reserved.
- Reserved programs will be displayed in the **Programmed** menu.
- When a digital channel is selected, press the ▶ button to view the digital program.

- **Select All:** Select all the channels in the channel list.

- **Deselect All:** Deselect all the selected channels.

 You can only select **Deselect All** when one or more channels are selected.

Programmed

(in **Channel List**)



You can view, modify or delete a show you have reserved to watch.

1. Press the **ENTER** button to select **Channel List**.
 2. Press the ◀ and ▼ button move to the **Programmed** menu.
- **Change Info:** Change a show you have reserved to watch.
 - **Cancel Schedules:** Cancel a show you have reserved to watch.
 - **Information:** Display a show you have reserved to watch. (You can also change the reservation Information.)
 - **Select All / Deselect All:** You can select or deselect all channels in the channel list.

Fine Tune

(analog channels only)

If the reception is clear, you do not have to fine tune the channel, as this is done automatically during the search and store operation. If the signal is weak or distorted, fine tune the channel manually.

- Select **Fine Tune** in the **Channel** menu.
-  Fine tuned channels that have been saved are marked with an asterisk "*" on the right-hand side of the channel number in the channel banner.
-  To reset the fine-tuning, select **Reset**.

Picture Menu

Changing the Preset Picture Mode

 **MENU** → **Picture** → **Mode** → **ENTER**

Mode

Select your preferred picture type.

- **Dynamic:** Suitable for a bright room.
- **Standard:** Suitable for a normal environment.
- **Movie:** Suitable for watching movies in a dark room.

Adjusting picture settings

 **MENU** → **Picture** → **Backlight** → **ENTER**

Backlight / Contrast / Brightness / Sharpness / Color / Tint (G/R)

Your television has several setting options for picture quality control.

NOTE



- When you make changes to **Backlight, Contrast, Brightness, Sharpness, Color** or **Tint (G/R)** the OSD will be adjusted accordingly.
- In PC mode, you can only make changes to **Backlight, Contrast** and **Brightness**.
- Settings can be adjusted and stored for each external device connected to the TV.
- Lowering picture brightness reduces power consumption.

Basic Features

Setting up the TV with your PC

Set the input source to PC.

Auto Adjustment TOOLS

 MENU  → Picture → Auto Adjustment → ENTER 

Adjust frequency values/positions and fine tune the settings automatically.

 Not available when connecting through HDMI/DVI cable.

Screen

- **Coarse / Fine:** Removes or reduces picture noise. If the noise is not removed by Fine-tuning alone, then adjust the frequency as best as possible (**Coarse**) and Fine-tune again. After the noise has been reduced, readjust the picture so that it is aligned to the center of screen.
- **Position:** Adjust the PC's screen positioning if it does not fit the TV screen. Press the ▲ or ▼ button to adjust the Vertical-Position. Press the ◀ or ▶ button to adjust the Horizontal-Position.
- **Image Reset:** Resets the image to default settings.



Using Your TV as a Computer (PC) Display

Setting Up Your PC Software (Based on Windows XP)
Depending on the version of Windows and the video card, the actual screens on your PC will probably look different, but the same basic set-up information will apply in most cases. (If not, contact your computer manufacturer or Samsung Dealer.)

1. Click on "Control Panel" on the Windows start menu.
2. Click on "Appearance and Themes" in the "Control Panel" window and a display dialog-box will appear.
3. Click on "Display" and a display dialog box will appear.
4. Navigate to the "Settings" tab on the display dialog-box.
 - The correct size setting (resolution) [Optimum: 1360X768 pixels]
 - If a vertical-frequency option exists on your display settings dialog box, the correct value is '60' or '60 Hz'. Otherwise, just click 'OK' and exit the dialog box.

Changing the Picture Options

Advanced Settings

 MENU  → Picture → Advanced Settings → ENTER 

(available in **Standard / Movie** mode)

Compared to previous models, new Samsung TVs have a more precise picture.

 In PC mode, you can only make changes to **Gamma** and **White Balance**.

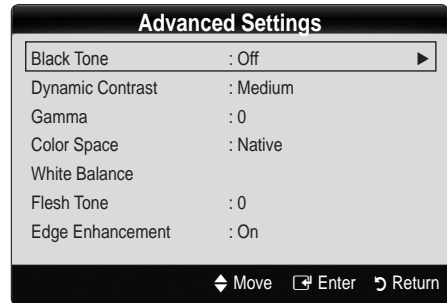

- **Black Tone (Off / Dark / Darker / Darkest):** Select the black level to adjust the screen depth.
- **Dynamic Contrast (Off / Low / Medium / High):** Adjust the screen contrast.
- **Gamma:** Adjust the primary color intensity.
- **Color Space (Auto / Native):** Adjust the range of colors available to create the image.
- **White Balance:** Adjust the color temperature for a more natural picture.
 - R-Offset / G-Offset / B-Offset:** Adjust each color's (red, green, blue) darkness.
 - R-Gain / G-Gain / B-Gain :** Adjust each color's (red, green, blue) brightness.
 - Reset:** Resets the **White Balance** to its default settings.
- **Flesh Tone:** Emphasize pink "flesh tone".
- **Edge Enhancement (Off / On):** Emphasize object boundaries.

Picture Options

 MENU  → Picture → Picture Options → ENTER 

 In PC mode, you can only make changes to the **Color Tone** and **Size**.

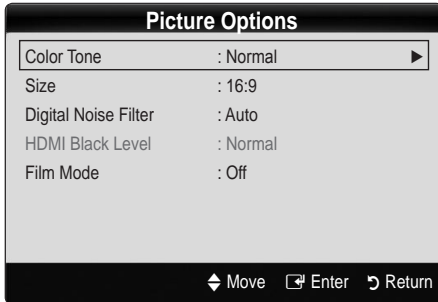

■ Color Tone (Cool / Normal / Warm1 / Warm2)

 **Warm1** or **Warm2** will be deactivated when the picture mode is **Dynamic**.

 Settings can be adjusted and stored for each external device connected to an input on the TV.

■ Size: Your cable box/satellite receiver may have its own set of screen sizes as well. However, we highly recommend you use 16:9 mode most of the time.

16:9: Sets the picture to 16:9 wide mode.

Zoom1: Use for moderate magnification.

Zoom2: Use for a stronger magnification.

Wide Fit: Enlarges the aspect ratio of the picture to fit the entire screen.



4:3: Sets the picture to basic (4:3) mode.

 Do not watch in 4:3 format for a long time. Traces of borders displayed on the left, right and center of the screen may cause image retention (screen burn) which are not covered by the warranty.

Screen Fit: Displays the full image without any cut-off when HDMI (720p / 1080i / 1080p) or Component (1080i / 1080p) signals are input.



NOTE

• After selecting **Zoom1**, **Zoom2** or **Wide Fit**:

1. Press the **▶** button to select **Position**.
2. Press the ENTER  button.
3. Press the **▲** or **▼** button to move the picture up or down.
4. Press the ENTER  button.
5. Press the **▶** button to select **Reset**.
6. Press the ENTER  button to reset the picture to its default position.



• After selecting **Screen Fit** in HDMI (1080i/1080p) or Component (1080i/1080p) mode, you may need to center the picture:

1. Press the **◀** or **▶** button to select **Position**.
2. Press the ENTER  button.
3. Press the **▲**, **▼**, **◀** or **▶** button to move the picture.
4. Press the ENTER  button.
5. Press the **◀** or **▶** button to select **Reset**.
6. Press the ENTER  button.

• HD (High Definition): 16:9 - 1080i/1080p (1920x1080), 720p (1280x720)

• Settings can be adjusted and stored for each external device you have connected to an input on the TV.

Input Source	Picture Size
ATV, AV, Component (480i, 480p)	16:9, Zoom1, Zoom2, 4:3
DTV(1080i), Component (1080i, 1080p), HDMI (720p, 1080i, 1080p)	16:9, 4:3, Wide Fit, Screen Fit
PC	16:9, 4:3

■ **Digital Noise Filter (Off / Low / Medium / High / Auto):** If the broadcast signal received by your TV is weak, you can activate the **Digital Noise Filter** feature to reduce any static and ghosting that may appear on the screen.

 When the signal is weak, try other options until the best picture is displayed.

■ **HDMI Black Level (Normal / Low):** Selects the black level on the screen to adjust the screen depth.

 Available only in HDMI mode (RGB signals).

■ **Film Mode (Off / Auto):** Sets the TV to automatically sense and process film signals from all sources and adjusts the picture for optimum quality.

 Available in TV, AV, COMPONENT (480i / 1080i) and HDMI (480i / 1080i).

Picture Reset

(Reset Picture Mode / Cancel)



Reset all picture settings to the default values.

■ **Reset Picture Mode:** Returns all picture values in the currently selected mode to the default settings.

Basic Features

Sound Menu



Changing the Preset Sound Mode

 MENU  → Sound → Mode → ENTER 

Mode

- **Standard:** Selects the normal sound mode.
- **Music:** Emphasizes music over voices.
- **Movie:** Provides the best sound for movies.
- **Clear Voice:** Emphasizes voices over other sounds.
- **Custom:** Recalls your customized sound settings.

Adjusting sound settings

 MENU  → Sound → Equalizer → ENTER 

Equalizer

Adjusts the sound mode.

- **Mode:** Selects the sound mode among the predefined settings.
- **Balance L/R:** Adjusts the balance between the right and left speaker.
- **100Hz / 300Hz / 1KHz / 3KHz / 10KHz (Bandwidth Adjustment):** Adjusts the level of specific bandwidth frequencies.
- **Reset:** Resets the equalizer to its default settings.

Sound Settings

SRS TruSurround HD (Off / On)

SRS TruSurround HD is a patented SRS technology that solves the problem of playing 5.1 multichannel content over two speakers. TruSurround delivers a compelling, virtual surround sound experience through any two-speaker playback system, including internal television speakers. It is fully compatible with all multichannel formats.

Preferred Language

(digital channels only)

Digital-TV broadcasts are capable of simultaneous transmission of many audio tracks (for example, simultaneous translations of the program into foreign languages).

 You can only select a language among the ones being broadcasted.

Multi-Track Sound (MTS)

(analog channels only)

- **Mono:** Choose for channels that are broadcasting in mono or if you are having difficulty receiving a stereo signal.
 - **Stereo:** Choose for channels that are broadcasting in stereo.
 - **SAP:** Choose to listen to the Separate Audio Program, which is usually a foreign-language translation.
-  Depending on the particular program being broadcast, you can listen to **Mono**, **Stereo** or **SAP**.







Auto Volume (On/Off)

Because each broadcasting station has its own signal conditions, the volume may fluctuate each time channel is changed. This feature lets you automatically adjust the volume of the desired channel by lowering the sound output when the modulation signal is high or by raising the sound output when the modulation signal is low.

Speaker Select (External Speaker / TV Speaker)

A sound echo may occur due to a difference in decoding speed between the main speaker and the audio receiver. In this case, set the TV to **External Speaker**.

-  When **Speaker Select** is set to **External Speaker**, the volume and MUTE buttons will not operate and the sound settings will be limited.
-  When **Speaker Select** is set to **External Speaker**, you should use these settings.
 - **TV speaker: Off, External speaker: On**
-  When **Speaker Select** is set to **TV Speaker**, you should use these settings.
 - **TV speaker: On, External speaker: On**
-  If there is no video signal, both speakers will be mute.

Sound Reset (Reset All / Reset Sound Mode / Cancel)

- **Reset All:** Resets all sound settings to the factory defaults.
- **Reset Sound Mode:** Returns all sound values in the currently selected mode to the default settings.

Setup Menu

Setting the Time

MENU → Setup → Time → ENTER

Time

- The current time will appear every time you press the INFO button.
- **Clock:** Setting the clock is for using various timer features of the TV.
 - If you disconnect the power cord, you have to set the clock again.
- Clock Mode:** Set up the current time manually or automatically.
 - **Auto:** Set the current time automatically using the time from a digital channel.
 - The antenna must be connected in order to set the time automatically.
 - **Manual:** Set the current time manually.
 - Depending on the broadcast station and signal, the auto time set up may not be correct. In this case, set the time manually.
- Clock Set:** Set the **Month, Day, Year, Hour, Minute** and **am/pm**.
 - Available only when **Clock Mode** is set to **Manual**.
 - You can set the month, day, year, hour and minute directly by pressing the number buttons on the remote control.
- DST (Off / On / Auto):** Switches the DST(Daylight Saving Time) function on or off.
 - This function is only available when the **Clock Mode** is set to **Auto**.
- Time Zone:** Select your time zone.
 - This function is only available when the **Clock Mode** is set to **Auto**.

Using the Sleep Timer

MENU → Setup → Time → Sleep Timer → ENTER

- **Sleep Timer** : Automatically shuts off the TV after a preset period of time. (30, 60, 90, 120, 150 and 180 minutes).
 - To cancel the **Sleep Timer**, select **Off**.

Setting the On/Off Timer

MENU → Setup → Time → Timer 1 → ENTER

- **Timer 1 / Timer 2 / Timer 3:** Three different on / off timer settings can be made. You must set the clock first.

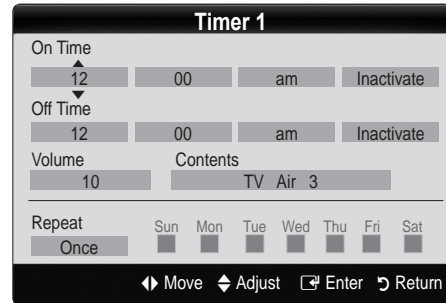

On Time / Off Time: Set the hour, minute, am/pm and activate / inactivate. (To activate the timer with the setting you have chosen, set to **Activate**.)

Volume: Set the desired volume level.

Contents: When the On Time is activated, you can turn on a specific channel or play back contents such as photo or audio files.

- **TV/USB:** Select **TV** or **USB**. (Make sure that an USB device is connected to your TV.)
- **Antenna:** Select **Air** or **Cable**.
- **Channel:** Select the desired channel.
- **Music:** Select the folder containing MP3 files on the USB device.
- **Photo:** Select the folder containing JPEG files on the USB device.



Repeat: Select **Once**, **Everyday**, **Mon~Fri**, **Mon~Sat**, **Sat~Sun** or **Manual** to set at your convenience. If you select **Manual**, you can set up the day you want to activate the timer.

The ✓ mark indicates the day is selected.

- Auto Power Off** (available only when the TV is turned on by the Timer): The TV will be automatically turned off after 3 hours of being left idle to prevent overheating.

Basic Features

Locking Programs

 MENU  → Setup → V-Chip → ENTER 

V-Chip

The V-Chip feature automatically locks out programs that are deemed inappropriate for children. The user must enter a PIN (personal ID number) before any of the V-Chip restrictions are set up or changed.

NOTE

- **V-Chip** function is not available in **HDMI, Component** or **PC** mode.
- The default PIN number of a new TV set is "0-0-0-0"
- **Allow all**: Press to unlock all TV ratings.
- **Block all**: Press to lock all TV ratings.

- **Change PIN**: The Change PIN screen will appear. Choose any 4 digits for your PIN and enter them. As soon as the 4 digits are entered, the **Confirm New PIN** screen appears. Re-enter the same 4 digits. When the Confirm screen disappears, your PIN has been memorized.

 If you forget the PIN, press the remote-control buttons in the following sequence, which resets the pin to "0-0-0-0": **POWER** (off) → **MUTE** → 8 → 2 → 4 → **POWER** (on).

- **V-Chip Lock (Off / On)**: You can block rated TV Programs.

- **TV Parental Guidelines**: You can block TV programs depending on their rating. This function allows you to control what your children are watching.

TV-Y: Young children / **TV-Y7**: Children 7 and over / **TV-G**: General audience / **TV-PG**: Parental guidance / **TV-14**: Viewers 14 and over / **TV-MA**: Mature audience
ALL: Lock all TV ratings. / **FV**: Fantasy violence / **V**: Violence / **S**: Sexual situation / **L**: Adult Language / **D**: Sexually Suggestive Dialog

 The V-Chip will automatically block certain categories dealing with more sensitive material. For example, if you block **TV-Y** category, then **TV-Y7** will automatically be blocked. Similarly, if you block the **TV-G** category, then all the categories in the young adult group will be blocked (**TV-G, TV-PG, TV-14** and **TV-MA**). The sub-ratings (**D, L, S, V**) work together similarly. So, if you block **L** sub-rating in **TV-PG**, then the **L** sub-ratings in **TV-14** and **TV-MA** will automatically be blocked.

- **MPAA Rating**: You can block movies depending on their MPAA rating. The Motion Picture Association of America(MPAA) has implemented a rating system that provides parents or guardians with advance information on which films are appropriate for children.

G: General audience (no restrictions). / **PG**: Parental guidance suggested. / **PG-13**: Parents strongly cautioned. / **R**: Restricted. Children under 17 should be accompanied by an adult. / **NC-17**: No children under age 17. / **X**: Adults only. / **NR**: Not rated.

 The **V-Chip** will automatically block any category that is 'More restrictive'. For example, if you block the **PG-13** category, then **R, NC-17** and **X** will automatically be blocked also.

- **Canadian English**

C: Programming intended for children under age 8. / **C8+**: Programming generally considered acceptable for children 8 years and over to watch on their own. / **G**: General programming, suitable for all audiences. / **PG**: Parental Guidance. / **14+**: Programming contains themes or content which may not be suitable for viewers under the age of 14. / **18+**: Adult programming.

 The **V-Chip** will automatically block any category that is 'More restrictive'. For example, if you block **G** category, then **PG, 14+** and **18+** will automatically be blocked also.

- **Canadian French**

G: General / **8 ans+**: Programming generally considered acceptable for children 8 years and over to watch on their own. / **13 ans+**: Programming may not be suitable for children under the age of 13. / **16 ans+**: Programming is not suitable for children under the age of 16. / **18 ans+**: Programming restricted to adults.

 The **V-Chip** will automatically block any category that is 'More restrictive'. For example, if you block **8 ans+** category, then **13 ans+, 16 ans+** and **18 ans+** will automatically be blocked also.

- **Downloadable U.S. Rating**: Parental restriction information can be used while watching DTV channels.

NOTE

- If information is not downloaded from the broadcasting station, the **Downloadable U.S. Rating** menu is deactivated.
- Parental restriction information is automatically downloaded while watching DTV channels. It may take several seconds.
- The **Downloadable U.S. Rating** menu is available for use after information is downloaded from the broadcasting station. However, depending on the information from the broadcasting station, it may not be available for use.
- Parental restriction levels differ depending on the broadcasting station. The default menu name and **Downloadable U.S. Rating** changes depending on the downloaded information.



- Even if you set the On-screen display to your desired language, the **Downloadable U.S. Rating** menu will appear in English only.
- The rating will automatically block certain categories that are more restrictive.
- The rating titles (For example: Humor Level..etc) and TV ratings (For example: DH, MH, H..etc) may differ depending on the broadcasting station.

How to watch a restricted channel

If the TV is tuned to a restricted channel, the V-Chip will block it. The screen will go blank and the following message will appear: **This channel is blocked by V-Chip. Please enter the PIN to unblock.**



 If you forget the PIN, press the remote-control buttons in the following sequence, which resets the pin to 0-0-0-0 : **POWER** (off) → **MUTE** → 8 → 2 → 4 → **POWER** (on)

Other Features

 **MENU**  → **Setup** → **ENTER** 

Language

Set the menu language.

1. Select **Language** and press the **ENTER**  button.
2. Choose desired language and press the **ENTER**  button.
 -  Choose between **English**, **Español** and **Français**.

Caption

(On-Screen Text Messages)

- **Caption (Off / On):** You can switch the caption function on or off. If captions are not available, they will not be displayed on the screen.

 The Caption feature does not work in Component, HDMI or PC modes.



- **Caption Mode:** You can select the desired caption mode.

 The availability of captions depends on the program being broadcasted.

Default / CC1~CC4 / Text1~Text4: (analog channels only) The Analog Caption function operates in either analog TV channel mode or when a signal is supplied from an external device to the TV. (Depending on the broadcasting signal, the Analog Caption function may or may not work with digital channels.)

Default / Service1~Service6 / CC1~CC4 / Text1~Text4: (digital channels only) The Digital Captions function works with digital channels.

 **Service1~6** may not be available in digital caption mode depending on the broadcast.

- **Digital Caption Options:** (digital channels only)

Size: Options include Default, Small, Standard and Large. The default is Standard.

Font Style: Options include Default and Styles 0 to 7. The default is Style 0.

Foreground Color: Options include Default, White, Black, Red, Green, Blue, Yellow, Magenta and Cyan. You can change the color of the letter. The default is White.

Background Color: Options include Default, White, Black, Red, Green, Blue, Yellow, Magenta and Cyan. You can change the background color of the caption. The default is Black.

Foreground Opacity: This adjusts the opacity of text. Options include Default, Transparent, Translucent, Solid and Flashing.

Background Opacity: This adjusts the opacity of the caption background. Options include Default, Transparent, Translucent, Solid and Flashing.

Return to Default: This option sets each Size, Font Style, Foreground Color, Background Color, Foreground Opacity and Background Opacity to its default.

NOTE

- **Digital Caption Options** are available only when **Default** and **Service1 ~ Service6** can be selected in Caption Mode.
- The availability of captions depends on the program being broadcasted.
- The **Default** setting follow the standards set by the broadcaster.
- The Foreground and Background cannot be set to have the same color.
- You cannot set both the **Foreground Opacity** and the **Background Opacity** to Transparent.

Game Mode (Off / On)

When connecting to a game console such as PlayStation™ or Xbox™, you can enjoy a more realistic gaming experience by selecting the game menu.

NOTE

- Restrictions on game mode (Caution)
 - To disconnect the game console and connect another external device, set **Game Mode** to **Off** in the setup menu.
 - If you display the TV menu in **Game Mode**, the screen shakes slightly.
- **Game Mode** is not available when the input source is set to TV or PC.
- After connecting the game console, set **Game Mode** to **On**. Unfortunately, you may notice reduced picture quality.
- If **Game Mode** is **On**:
 - **Picture** mode is set to **Standard** and **Sound** mode is set to **Movie**.
 - **Equalizer** is not available.

Basic Features

Melody (Off / Low / Medium / High)

Set up so that a melody sound comes on when the TV is powered On or Off.

- ✎ Only available when the **Input** source is set to TV. To turn the melody off, set **Melody** to **Off**.
- ✎ The **Melody** does not play.
 - When no sound is output from the TV because the **MUTE** button has been pressed.
 - When no sound is output from the TV because the volume has been reduced to minimum with the **VOL -** button.
 - When the TV is turned off by **Sleep Timer** function.

Energy Saving (Off / Low / Medium / High / Auto)

Adjust the brightness of the TV in order to reduce power consumption. When watching TV at night, set the **Energy Saving** to High to reduce eye fatigue as well as power consumption.

Support Menu

 MENU  → Support → ENTER 

Self Diagnosis

- **Picture Test:** Use to check for picture problems. If the problem continues to occur, check the Color pattern.
 - Yes:** If the test pattern does not appear or there is noise in the test pattern, select Yes. There may be a problem with the TV. Contact Samsung's Call Center for assistance (1-800-SAMSUNG).
 - No:** If the test pattern is properly displayed, select No. There may be a problem with your external equipment. Please check your connections. If the problem persists, refer to the external device's user manual.

- **Sound Test:** Use the built-in melody sound to check for sound problems.

- ✎ If you hear no sound from the TV's speakers, before performing the sound test, make sure **Speaker Select** is set to **TV speaker** in the **Sound** menu.
- ✎ The melody will be heard during the test even if **Speaker Select** is set to **External Speaker** or the sound is muted by pressing the **MUTE** button.

Yes: If you can hear sound only from one speaker or not at all during the sound test, select Yes. There may be a problem with the TV. Contact Samsung's Call Center for assistance (1-800-SAMSUNG).

No: If you can hear sound from the speakers, select No. There may be a problem with your external equipment. Please check your connections. If the problem persists, refer to the external device's user manual.

- **Signal Strength:** (Digital channels only) An HD channel's reception quality is either perfect or the channels are unavailable. Adjust your antenna to increase signal strength.

Software Upgrade

Upgrades will be possible by connecting a USB drive to the USB port. Download the latest firmware from samsung.com and save to the USB drive.

Current Version - the software already installed in the TV.

- ✎ Software is represented as 'Year/Month/Day_Version'.

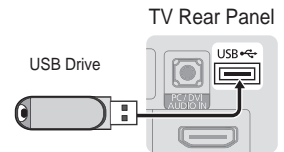

HD Connection Guide

Refer to this information when connecting external devices to the TV.

Contact Samsung



View this information when your TV does not work properly or when you want to upgrade the software. You can find information regarding our call centers and how to download products and software.

Media Play

Enjoy photos and/or music files saved on a USB Mass Storage Class (MSC) device.



MEDIA.P

MENU  → Application → Media Play (USB) → ENTER 





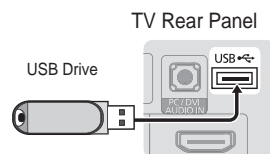

Connecting a USB Device

1. Turn on your TV.
2. Connect a USB device containing photo and/or music files to the **USB** jack on the rear of the TV.
3. When the **Application** selection screen is displayed, press the **▶** button to select **Media Play (USB)**, then press the **ENTER**  button.



Using the Media Play Menu

Viewing a Photo (or Slide Show)

1. Press the **MENU** button. Press the **▲** or **▼** button to select **Application**, then press the **ENTER**  button.
2. Press the **▲** or **▼** button to select **Media Play (USB)**, then press the **ENTER**  button.
3. Press the **▲** or **▼** button to select the corresponding USB Memory Device, then press the **ENTER**  button.
 -  The Media Play menu differs depending on the USB Memory Device connected to TV.
 -  Some devices may not be supported due to compatibility problems.
4. Press the **◀** or **▶** button to select an icon (**Photo**, **Music**, **Setup**), then press the **ENTER**  button.

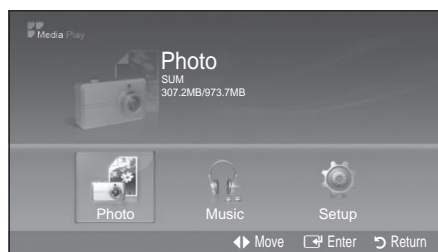

 It might not work properly with unlicensed multimedia files.

 **Need-to-Know List before using Media Play (USB)**

- Only alphanumeric characters must be used as a folder name or file name (photo, music).
- The file system only supports FAT16/32 (The NTFS file system is not supported) Certain types of USB Digital camera and audio devices may not be compatible with this TV.
- Media Play only supports USB Mass Storage Class (MSC) devices. MSC is a Mass Storage Class Bulk-Only Transport device. Examples of MSC are Thumb drives and Flash Card Readers. Devices should be connected directly to the TV's USB port. USB (HDD) is not supported.
- Before connecting your device to the TV, please back up your files to prevent them from damage or loss of data. SAMSUNG is not responsible for any data file damage or data loss.
- Please connect directly to the **USB** port of your TV. If you are using a separate cable connection, there may be a USB Compatibility problem.
- Only MP3 and JPEG file formats are supported.
- The **Media Play (USB)** mp3 format only supports music files with a high sampling frequency (32 kHz, 44.1 kHz, or 48 kHz).
- We recommend the sequential jpeg format.
- Do not disconnect the USB device while it is loading.

Advanced Features

- MSC supports MP3 and JPEG files, and the PTP device supports JPEG files only.
- MTP (Media Transfer Protocol) is not supported.
- The playing duration of an mp3 file may be displayed as “00:00:00” if its playing time information is not found at the start of the file.
- The higher the resolution of the image, the longer it takes to display on the screen.
- The Photo or Music List displays up to 300 folders or files.
- Loading may take some time depending on the size of the file.
- MP3 files with DRM that have been downloaded from a non-free site cannot be played.
- Digital Rights Management (DRM) is a technology that supports the creation, distribution and management of the content in an integrated and comprehensive way, including the protection of the rights and interests of the content providers, the prevention of the illegal copying of contents, as well as managing billings and settlements.
- If a USB extension cable is used, the USB device may not be recognized or the files on the device may not be read.
- If a USB device connected to the TV is not recognized, the list of files on the device is corrupted or a file in the list is not played, connect the USB device to the PC, format the device and check the connection.
- If a file deleted from the PC is still found when Media Play is run, use the “Empty the Recycle Bin” function on the PC to permanently delete the file.

Photo

Viewing a Photo (or Slide Show)

1. Press the **INFO** button to display the option **View, Start Slide Show, Delete, Delete All, Deselect All**.

2. Press the **▲** or **▼** button to select **Start Slide Show** then press the **ENTER** button.

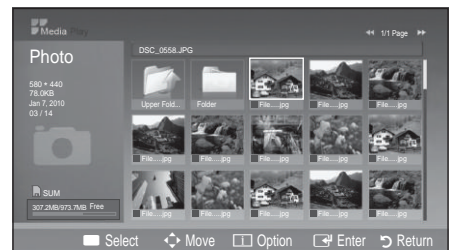

- ✎ During the slide show, files are displayed in order from the currently shown file.
- ✎ MP3 files can be automatically played during the Slide Show if the Default **Background Music** is set to **On**. To enable this function, MP3 files and other photo files must be located in the same folder on the USB Memory Device.



- ✎ Press the **INFO** button during the slide show to set the following options **Slide Show Speed, Background Music, Background Music Setting, List**. Press the **▲** or **▼** button to select the option, then press the **ENTER** button.
 - After setting the option press the **ENTER** button to make a change.
- ✎ Press the **INFO** button during the photo view to set the following options **Start Slide Show, Zoom, Rotate, List**. Press the **▲** or **▼** button to select the option, then press the **ENTER** button.
 - After setting the option press the **ENTER** button to make a change.

Music

Using the MP3 List

	Folder icon
	Music list icon
	Move to the previous folder stage icon

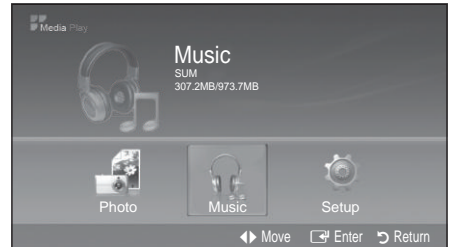

 The selected file is displayed on the top with its playing time.

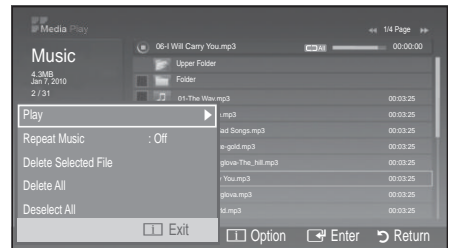

- To select all files or a file, press the **INFO** button to display the **Music** menus.
Press the **ENTER** button to select **Play**, **Repeat Music**, **Delete Selected File**, **Delete**, **Delete All** or **Deselect All**.
- Press the **▲** or **▼** button to move to an icon, then press the **ENTER** button.
Pressing the **ENTER** button over a musical note icon immediately plays the music file.
Pressing the **ENTER** button over a folder icon shows the music files included in the folder.





■ **Play:** Select to play MP3 files.

-  This menu only shows files with the MP3 file extension. Files with other file extensions are not displayed, even if they are saved on the same USB device.
-  To adjust the music volume, press the **—VOL+** button on the remote control. To mute the sound, press the **MUTE** button on the remote control.

■ **Repeat Music (On / Off):** Select to repeatedly play MP3 files in the current folder.

Playing Music

- Only displays files with the MP3 file extension. Other file extensions are not displayed, even if they are saved on the same USB device.
- If the sound is strange when playing MP3 files, adjust the **Equalizer** and **SRS TruSurround HD** in the **Sound** menu. (An over-modulated MP3 file may cause a sound problem.)
- Music function information icons

	Repeat Mode is On.
	Repeat Mode is Off.
	When pressing the ENTER button on the remote control while music is playing.

Advanced Features

Setup

Using the Setup Menu

- **Slide Show Speed:** Select to control the slide show speed. You can select **Fast**, **Normal** or **Slow**.
- **Background Music:** Select to determine whether to play an MP3 file during a slide show. You can select Music **On** or Music **Off**.
- **Background Music Setting:** While a slide show is in progress, use the **Background Music Setting** to select a music file to listen to. Select an MP3 file as the background music.
- **Repeat Music:** Select to determine whether to repeat playing the music when all MP3 files in the current folder have been played.
- **Screen Saver:** Select to set the waiting time before the screen saver appears. The screensaver will appear when no button is pressed for **2 hours**, **4 hours**, **8 hours**, **10 hours** or **Off**.
- **Safe Remove:** You can remove the device safely from the TV.

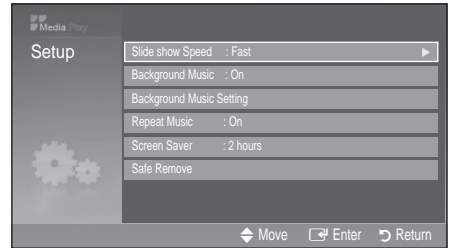

Playing the selected photos / music files

- Press the Yellow button.
- Repeat the above operation to select desired photos / music files.
 - 📁 Selected photos or files are marked with the symbol ✓. To cancel a selection, press the Yellow button again.
- Press the ENTER  button to play the selected photos or files.

Installing the Wall Mount

Installing the Wall Mount Kit

The wall mount kit (sold separately) allows you to mount the TV on the wall.

For detailed information on installing the wall mount, see the instructions provided with the wall mount items. Contact a technician for assistance when installing the wall mount bracket. Samsung Electronics is not responsible for any damage to the product or injury to yourself or others if you elect to install the TV on your own.

Wall Mount Kit Specifications (VESA)

 The wall mount kit is not supplied, but sold separately.

Install your wall mount on a solid wall perpendicular to the floor. When attaching to other building materials, please contact your nearest dealer. If installed on a ceiling or slanted wall, it may fall and result in severe personal injury.

NOTE

- Standard dimensions for wall mount kits are shown in the table below.
- When purchasing our wall mount kit, a detailed installation manual and all parts necessary for assembly are provided.
- Do not use screws that do not comply with the VESA standard screw specifications.
- Do not use screws that are longer than the standard dimension or do not comply with the VESA standard screw specifications. Screws that are too long may cause damage to the inside of the TV set.
- For wall mounts that do not comply with the VESA standard screw specifications, the length of the screws may differ depending on the wall mount specifications.
- Do not fasten the screws too strongly; this may damage the product or cause the product to fall, leading to personal injury. Samsung is not liable for these kinds of accidents.
- Samsung is not liable for product damage or personal injury when a non-VESA or non-specified wall mount is used or the consumer fails to follow the product installation instructions.
- Do not mount the TV at more than a 15 degree tilt.
- Always use two people to mount the TV to a wall.

Product Family	inches	VESA Spec. (A * B)	Standard Screw	Quantity
LCD-TV	19~22	75 X 75 100 X 100	M4	4
	23~29	200 X 100		
	30~40	200 X 200	M6	
	46~55	400 X 400	M8	
	57~65	600 X 400		
	70~80	800 X 400		
	80~	1400 X 800		

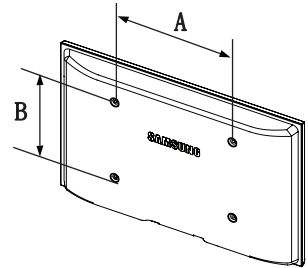

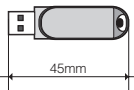

If the length of the USB device is equal to or longer than 45 mm when used with 26" or 32" models installed with a wall mount, the USB device may touch the wall. Therefore, using a short type USB device is recommended.



Do not install your Wall Mount Kit while your TV is turned on. It may result in personal injury due to electric shock.

Other Information

Securing the TV to the Wall (LN32C350 Only)



Caution: Pulling, pushing, or climbing on the TV may cause the TV to fall. In particular, ensure your children do not hang over or destabilize the TV. Doing so may cause the TV to tip over, causing serious injuries or death. Follow all safety precautions provided in the Safety Flyer included with your TV. For added stability and safety, you can purchase and install the anti-fall device as described below.

The TV-Holder Kit (Sold Separately)

The parts below are included in the TV Holder kit. In addition, you need to provide a wood screw, screw and molly, or other screw appropriate for the wall or cabinet you intend to secure the TV-Holder string to. We recommend a size M4xL20 wood screw.



TV-Holder (BN96-15753A)



(M6 X L16)





Screw ① (3/2 inches only)

Installing the TV-Holder

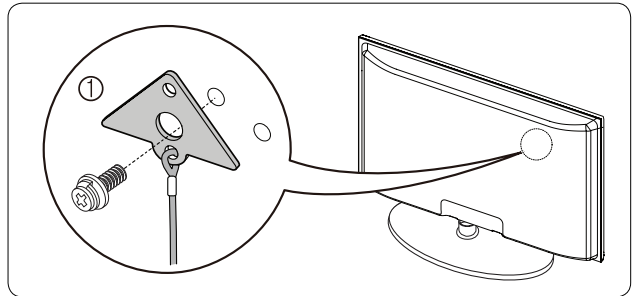
1. Remove the screw attached to the back of your TV, and then connect the TV-Holder to the TV with the screw included in the TV Holder Kit that is designated for your TV.

 Make sure to use only the appropriate supplied screw. If you use a different screw, you can damage your TV.



2. Firmly fasten the screw you provided (size M4xL20 or similar) to the wall or cabinet where the TV is to be installed.
 -  If you fasten the screw to the wall, we recommend you drive the screw into a stud. If that is not possible, use a molly to anchor the screw.
3. Tie the TV-Holder cord to the screw fastened to the wall or cabinet so that the TV is fixed. See the illustrations below.
 -  Install the TV close to the wall so that it does not fall.
 -  When attaching the TV Holder cord to the wall, tie the cord level with the ground or slanted downwards for safety purposes.
 -  Check the cord occasionally to make sure it is secure.
 -  Before moving the TV, separate the connected cord first.

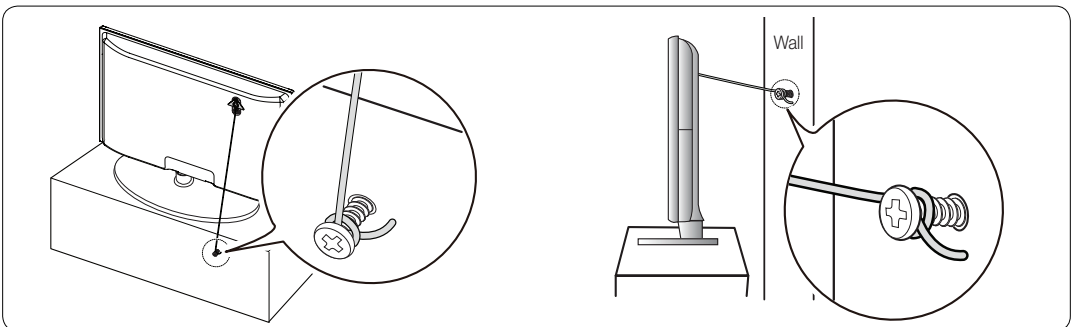

4. Verify all connections are properly secured. Periodically check the connections for any sign of fatigue or failure. If you have any doubt about the security of your connections, contact a professional installer.

To purchase the TV-Holder Kit, contact Samsung Customer Care

- In the United States: 1-800-Samsung (1-800-726-7864)
- In Canada: 1-800-Samsung (1-800-726-7864)

Securing the TV to the Wall



Caution: Pulling, pushing, or climbing onto the TV may cause the TV to fall. In particular, ensure that your children do not hang over or destabilize the TV; doing so may cause the TV to tip over, resulting in serious injuries or death. Follow all safety precautions provided on the included Safety Flyer. For added stability, install the anti-fall device for safety purposes, as follows.

To prevent the TV from falling

- ✎ Since the necessary clamps, screws, and string are not supplied, please purchase these additionally.
- 1. Drive the screws into the clamps and firmly fasten them onto the wall. Make sure the screws are firmly fixed into the wall.
 - ✎ Screw Specifications
 - For a 17 ~ 29 Inches LCD TV: M4
 - For a 32 ~ 40 Inches LCD TV: M6
- 2. Remove the screws from the back center of the TV, put the screws into the clamps, and then fasten the screws onto the TV again.
- 3. Connect the clamps fixed onto the TV and the clamps fixed onto the wall with a strong cable and then tie the string tightly.

NOTE

- Verify all connections are properly secured. Periodically check connections for any sign of fatigue for failure. If you have any doubt about the security of your connections, contact a professional installer.
- Install the TV near to the wall so that it does not fall backwards.
- It is safe to connect the string so that the clamps fixed on the wall are equal to or lower than the clamps fixed on the TV.
- Untie the string before moving the TV.

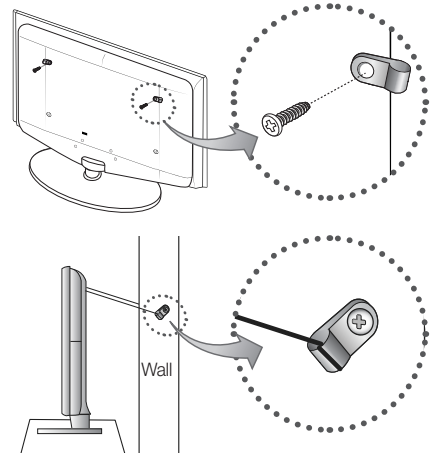

Anti-theft Kensington Lock

The Kensington Lock is not supplied by Samsung. It is a device used to physically fix the system when using it in a public place. The appearance and locking method may differ from the illustration depending on the manufacturer. Refer to the manual provided with the Kensington Lock for additional information on proper use.

✎ Please find a “” icon on the rear of the TV. A kensington slot is beside the “” icon.

To lock the product, follow these steps:

1. Wrap the Kensington lock cable around a large, stationary object such as desk or chair.
2. Slide the end of the cable with the lock attached through the looped end of the Kensington lock cable.
3. Insert the locking device into the Kensington slot on the product (❶).
4. Lock the lock.

✎ These are general instructions. For exact instructions, see the User manual supplied with the locking device.

✎ The locking device has to be purchased separately.

✎ The location of the Kensington slot may be different depending on the TV model.

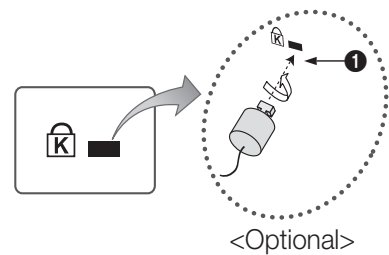

Other Information

Troubleshooting

If the TV seems to have a problem, first try this list of possible problems and solutions. If none of these troubleshooting tips apply, visit samsung.com, then click on Support, or call Samsung customer service at 1-800-SAMSUNG.

Issues	Solutions and Explanations
Poor picture	<p>First of all, please perform the Picture Test and confirm that your TV is properly displaying the test image.</p> <ul style="list-style-type: none"> go to MENU - Support - Self Diagnosis - Picture Test (P. 20) <p>If the test image is properly displayed, the poor picture may be caused by the source or signal.</p>
The TV image does not look as good as it did in the store.	<ul style="list-style-type: none"> If you have an analog cable/satellite box, upgrade to a digital set top box. Use HDMI or Component cables to deliver HD (high definition) picture quality. Cable/Satellite subscribers: Try HD stations from the channel line up. Air/Cable Antenna connection: Try HD stations after performing Auto program. <ul style="list-style-type: none"> Many HD channels are upscaled from SD(Standard Definition) contents. Adjust the Cable/Sat box video output resolution to 1080i or 720p.
The picture is distorted: macroblock error, small block, dots, pixelization.	<ul style="list-style-type: none"> Compression of video contents may cause picture distortion, especially in fast moving pictures such as sports and action movies. Low signal level can cause picture distortion. This is not a TV problem. Mobile phones used close to the TV (up to 3.3ft) may cause noise in picture on analog and digital TV.
Color is wrong or missing.	<ul style="list-style-type: none"> If you're using Component connection, make sure the component cables are connected to the correct jacks. Incorrect or loose connections may cause color problems or a blank screen.
There is poor color or brightness.	<ul style="list-style-type: none"> Adjust the Picture options in the TV menu. (go to Picture mode / Color / Brightness / Sharpness) (P. 13) Adjust Energy Saving option in the TV menu (go to MENU - Setup - Energy Saving) (P. 20) Try resetting the picture to view the default picture setting. (go to MENU - Picture - Picture Reset) (P. 15)
There is a dotted line on the edge of the screen.	<ul style="list-style-type: none"> If the picture size is set to Screen Fit, change it to 16:9. Change cable/satellite box resolution.
The picture is black and white.	<ul style="list-style-type: none"> If you are using an AV composite input, connect the video cable (yellow) to the Green jack of component input 1 on the TV.
When changing channels, the picture freezes or is distorted or delayed.	<ul style="list-style-type: none"> If connected to a cable box, please try to reset it. (reconnect the AC cord and wait until the cable box reboots. It may take up to 20 minutes) Set output resolution of the cable box to 1080i or 720p.
Sound Problem	<p>First of all, please perform the Sound Test to confirm that your TV audio is properly operating.</p> <ul style="list-style-type: none"> go to MENU - Support - Self Diagnosis - Sound Test (P. 20) <p>If the audio is OK, the sound problem may be caused by the source or signal.</p>
There is no sound or the sound is too low at maximum volume.	<ul style="list-style-type: none"> Please check the volume of device (Cable/Sat Box, DVD, Blu-ray etc) connected to your TV.
The picture is good but there is no sound.	<ul style="list-style-type: none"> Set the Speaker Select option to TV speaker in the Sound menu. (P. 16) If you are using an external device, check the device's audio output option (ex. you may need to change your cable box's audio option to HDMI when you have a HDMI connected to your TV). If you are using a DVI to HDMI cable, a separate audio cable is required. Reboot the connected device by reconnecting the device's power cable.
The speakers are making an inappropriate noise.	<ul style="list-style-type: none"> Check the cable connections. Make sure a video cable is not connected to an audio input. For Antenna or Cable connections, check the signal information. Low signal level may cause sound distortion. Perform the Sound Test as explained above.

Issues	Solutions and Explanations
No Picture, No Video	
The TV will not turn on.	<ul style="list-style-type: none"> • Make sure the AC power cord is securely plugged into to the wall outlet and the TV. • Make sure the wall outlet is working. • Try pressing the POWER button on the TV to make sure the problem is not the remote. If the TV turns on, refer to 'Remote control does not work' below.
The TV turns off automatically.	<ul style="list-style-type: none"> • Ensure the Sleep Timer is set to Off in the Setup menu. (P. 17) • If your PC is connected to the TV, check your PC power settings. • Make sure the AC power cord is plugged in securely to the wall outlet and the TV. • When watching TV from an antenna or cable connection, the TV will turn off after 10 - 15 minutes if there is no signal.
There is no picture/video.	<ul style="list-style-type: none"> • Check cable connections. (remove and reconnect all cables connected to the TV and external devices). • Set your external device's (Cable/Sat Box, DVD, Blu-ray etc) video outputs to match the connections to the TV input. For example, if an external device's output is HDMI, it should be connected to an HDMI input on the TV. • Make sure your connected devices are powered on. • Be sure to select the TV's correct source by pressing the SOURCE button on the remote control. • Reboot the connected device by reconnecting the device's power cable.
RF(Cable/Antenna) Connection	
The TV is not receiving all channels.	<ul style="list-style-type: none"> • Make sure the coaxial cable is connected securely. • Please try Auto Program to add available channels to the channel list. go to MENU - Channel - Auto Program then select Auto and make sure the correct Cable TV signal type is set in the menu. There are 3 options. (STD, HRC and IRC) (P. 12) • Verify the Antenna is positioned correctly.
No Caption on digital channels.	<ul style="list-style-type: none"> • Check Caption Setup menu. Try changing Caption Mode Service 1 to CC1. (P. 19) • Some channels may not have caption data.
The picture is distorted: macroblock error, small block, dots, pixelization.	<ul style="list-style-type: none"> • Compression of video contents may cause picture distortion. especially on fast moving pictures such as sports and action movies. • A low signal can cause picture distortion. This is not a TV problem.
PC Connection	
A " Mode Not Supported " message appears.	<ul style="list-style-type: none"> • Set your PC's output resolution so it matches the resolutions supported by the TV.
"PC" is always shown on the source list, even if a PC is not connected.	<ul style="list-style-type: none"> • This is normal; "PC" is always shown on the source list, regardless of whether a PC is connected.
The video is OK but there is no audio.	<ul style="list-style-type: none"> • If you are using a HDMI connection, check the audio output setting on your PC.
Others	
Purple/green rolling horizontal bars and buzzing noise from the TV speakers with Component cable connection.	<ul style="list-style-type: none"> • Remove the left and right audio connections from the set-top-box. If the buzzing stops, this indicates that the set-top-box has a grounding issue. Replace the Component video cables with an HDMI connection.
The picture will not display in full screen.	<ul style="list-style-type: none"> • HD channels will have black bars on either side of the screen when displaying upscaled SD (4:3) contents. • Black bars on the Top & Bottom will be shown on movies that have aspect ratios different from your TV. • Adjust picture size option on your external device or TV to full screen.
The remote control does not work.	<ul style="list-style-type: none"> • Replace the remote control batteries with correct polarity (+/-). • Clean the transmission window located on the top of the remote. • Try pointing the remote directly at the TV from 5-6 feet away.

Other Information

Issues	Solutions and Explanations
Others	
The cable/set top box remote control does not turn the TV on or off, or adjust the volume.	<ul style="list-style-type: none"> Program the Cable/Sat remote control to operate the TV. Refer to the Cable/Sat user manual for SAMSUNG TV code.
A " Mode Not Supported " message appears.	<ul style="list-style-type: none"> Check the supported resolution of the TV and adjust the external device's output resolution accordingly. Refer to resolution settings in this manual.
Caption on TV menu is greyed out.	<ul style="list-style-type: none"> Caption can not be selected in the TV menu when connected via HDMI or Component. Caption must be activated on the external device.
There is a plastic smell from the TV.	<ul style="list-style-type: none"> This smell is normal and will dissipate over time.
TV Signal Strength is unavailable in the Self Diagnosis Test menu.	<ul style="list-style-type: none"> This function is only available with digital channels from an Antenna / RF/Coax connection. (P. 20)
TV is tilted to the right or left side.	<ul style="list-style-type: none"> Remove the stand base from the TV and reassemble it.
The Channel menu is greyed out (unavailable).	<ul style="list-style-type: none"> The Channel menu is only available when the TV source is selected.
Your settings are lost after 30 minutes or every time the TV is turned off.	<ul style="list-style-type: none"> If TV is in the Store Demo mode, it will reset audio and picture settings every 30 minutes. Please change from Store Demo mode to Home Use mode in the Plug & Play procedure. Press the SOURCE button to select TV mode, go to MENU → Setup → Plug & Play → ENTER .
You have intermittent loss of audio or video.	<ul style="list-style-type: none"> Check the cable connections and reconnect them. Loss of audio or video can be caused by using overly rigid or thick cables. Make sure the cables are flexible enough for long term use. mounting the TV to the wall, we recommend using cables with 90 degree connectors.
You see small particles when you look closely at the edge of the frame of the TV.	<ul style="list-style-type: none"> This is part of the product's design and is not a defect.
POP (TV's internal banner ad) appears on the screen.	<ul style="list-style-type: none"> Select Home Use under Plug & Play mode. For details, refer to Plug & Play (Initial Setup). (P. 7)

 This TFT LCD panel uses a panel consisting of sub pixels which require sophisticated technology to produce. However, there may be a few bright or dark pixels on the screen. These pixels will have no impact on the performance of the product.

Storage and Maintenance

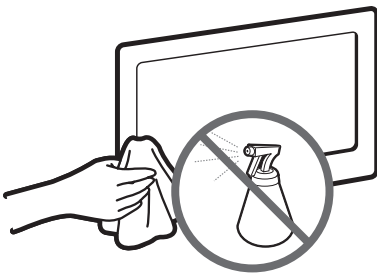

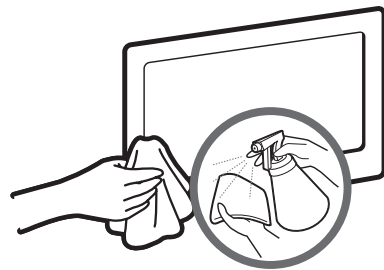

Do not spray water or a cleaning agent directly onto the product. Any liquid that goes into the product may cause a failure, fire, or electric shock.



Clean the product with a soft cloth dipped in a small amount of water.

Specifications

Display Resolution	1360 x768	
Environmental Considerations		
Operating Temperature	50°F to 104°F (10°C to 40°C)	
Operating Humidity	10% to 80%, non-condensing	
Storage Temperature	-4°F to 113°F (-20°C to 45°C)	
Storage Humidity	5% to 95%, non-condensing	
Model Name	LN26C350	LN32C350
Screen Size (Diagonal)	26 inches (26.0 inches measured diagonally)	32 inches (31.5 inches measured diagonally)
Sound Output	5 W X 2	5 W X 2
Dimensions (WxDxH)		
Body	26.5 X 2.6 X 18 inches (673.3 X 65.6 X 456.0 (mm))	31.3 X 2.6 X 20.7 inches (795.3 X 65.6 X 525.8 (mm))
With stand	26.5 X 8.7 X 20.2 inches (673.3 X 222.2 X 513.4 (mm))	31.3 X 9.7 X 23 inches (795.3 X 247.2 X 585.3 (mm))
Weight		
Without Stand	12.7 lbs (5.7 kg)	15.7 lbs (7.1 kg)
With Stand	13.4 lbs (6.1 kg)	16.8 lbs (7.6 kg)

-  Design and specifications are subject to change without prior notice.
-  This device is a Class B digital apparatus.
-  For information about power supply, and more about power consumption, refer to the label attached to the product.

License



TruSurround HD, SRS and  symbol are trademarks of SRS Labs, Inc. TruSurround HD technology is incorporated under license from SRS Labs, Inc.



Manufactured under license from Dolby Laboratories. Dolby and the double-D symbol are trademarks of Dolby Laboratories.

Open source license notice

In the case of using open source software, Open Source Licenses are available on the product menu.

Other Information

Dimensions

■ Front view / side view

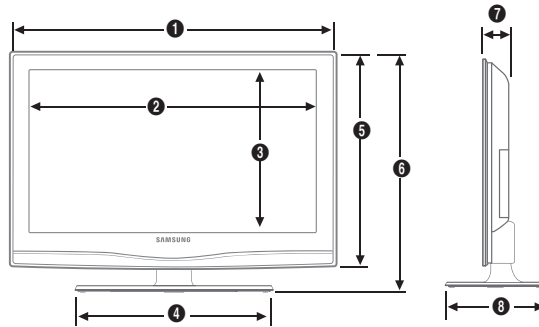

(Unit: inches)

Model name	1	2	3	4	5	6	7	8
LN26C350	26.5	22.7	12.8	17.2	18	20.2	2.6	8.7
LN32C350	31.3	27.5	15.5	18.3	20.7	23	2.6	9.7

■ Jack panel detail (5.2"H x 6.6"W) / rear view

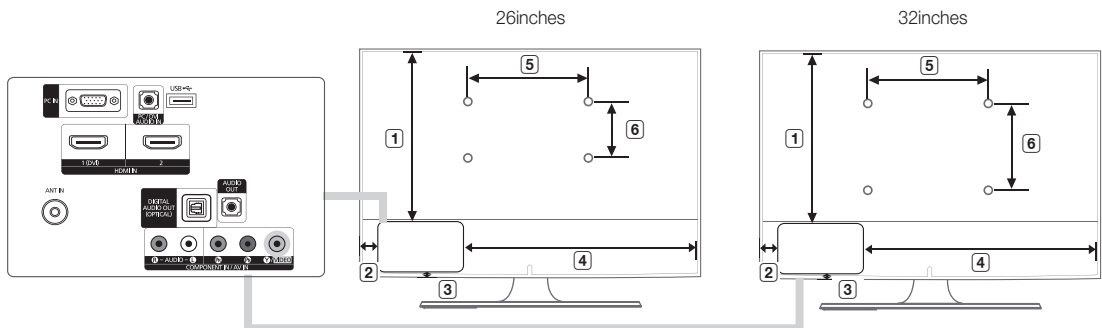

(Unit: inches)

Model name	1	2	3	4	5	6
LN26C350	13.8	17.1	0.3	3.4	7.9	3.9
LN32C350	16.6	19.5	0.3	5.8	7.9	7.9

NOTE: All drawings are not necessarily to scale. Some dimensions are subject to change without prior notice. Refer to the dimensions prior to performing installation of your TV. Not responsible for typographical or printed errors.

© 2010 Samsung Electronics America, Inc

Index

A

Antenna	7
AUDIO OUT	9
Auto Adjustment	14
Auto Program	12

B

Balance	16
---------	----

C

Cables	10
Caption	19
Clear Scrambled Channel	12
Clear Voice	16
Component	8
Composite	10

D

DIGITAL AUDIO OUT	9
DST (Daylight Saving Time)	17
D-sub	9, 10
Dynamic Contrast	14

E

Energy Saving	20
Equalizer	16
External Speaker	16

F

FAV.CH button	6, 12
Favorite Channel	12

G

Game Mode	19
-----------	----

H

HD	15
HDMI	8
Home theater	9

L

Language	19
License	31

M

Media Play	21
Melody	20
MP3 Play	22
MTS	16

O

Optimal resolution	10
--------------------	----

P

Photo view	22
Picture Reset	15
PIN number	18
Position	14
Power Indicator	5

R

Remote Control	6
RGB	14

S

Screen Fit	15
Sleep Timer	17
Slide Show	22
Software Upgrade	20
Source List	10
Speaker Select	16
SRS TruSurround HD	16
Standby mode	5

T

Timer	17
-------	----

V

Volume	5, 6, 17
--------	----------

W

Wall Mount	25
White Balance	14
Wide Fit	15